



## FCC/IC - TEST REPORT

Report Number	: <b>68.950.18.0410.01</b>	Date of Issue: <b>September 25, 2018</b>
Model / HVIN	: <b>HCE001</b>	
Product Type	: Hive View Outdoor	
Applicant	: Centrica Hive Limited	
Address	: Millstream, Maidenhead Road, Windsor, Berkshire SL4 5GD	
	United Kingdom Of Great Britain And Northern Ireland	
Manufacturer	: Centrica Hive Limited	
Address	: Millstream, Maidenhead Road, Windsor, Berkshire SL4 5GD	
	United Kingdom Of Great Britain And Northern Ireland	
Test Result	: <input checked="" type="radio"/> <b>Positive</b> <input type="radio"/> <b>Negative</b>	
Total pages including Appendices	: <b>32</b>	

*TÜV SÜD Certification and Testing (China) Co., Ltd. – Shenzhen Branch is a subcontractor to TÜV SÜD Product Service GmbH according to the principles outlined in ISO 17025.*

*TÜV SÜD Certification and Testing (China) Co., Ltd. – Shenzhen Branch reports apply only to the specific samples tested under stated test conditions. Construction of the actual test samples has been documented. It is the manufacturer's responsibility to assure that additional production units of this model are manufactured with identical electrical and mechanical components. The manufacturer/importer is responsible to the Competent Authorities in Europe for any modifications made to the production units which result in non-compliance to the relevant regulations. TÜV SÜD Certification and Testing (China) Co., Ltd. – Shenzhen Branch shall have no liability for any deductions, inferences or generalizations drawn by the client or others from TÜV SÜD Certification and Testing (China) Co., Ltd. – Shenzhen Branch issued reports.*

*This report is the confidential property of the client. As a mutual protection to our clients, the public and ourselves, extracts from the test report shall not be reproduced except in full without our written approval*



# 1 Table of Contents

1	Table of Contents.....	2
2	Details about the Test Laboratory .....	3
3	Description of the Equipment Under Test.....	4
4	Summary of Test Standards.....	5
5	Summary of Test Results .....	6
6	General Remarks.....	7
7	Test Setups.....	8
8	Systems test configuration .....	9
9	Technical Requirement .....	10
9.1	Conducted Emission .....	10
9.1	Conducted peak output power .....	13
9.2	Power spectral density.....	14
9.3	6 dB Bandwidth and 99% Occupied Bandwidth.....	15
9.4	Spurious RF conducted emissions .....	19
9.5	Band edge .....	25
9.6	Spurious radiated emissions for transmitter .....	27
10	Test Equipment List.....	31
11	System Measurement Uncertainty.....	32



## 2 Details about the Test Laboratory

### Details about the Test Laboratory

#### Test Site 1

Company name: TÜV SÜD Certification and Testing (China) Co., Ltd. Shenzhen Branch  
Building 12 & 13, Zhiheng Wisdomland Business Park, Nantou Checkpoint  
Road 2, Nanshan District  
Shenzhen 518052  
P.R. China

Telephone: 86 755 8828 6998  
Fax: 86 755 828 5299

FCC Registration No.: 514049

IC Registration No.: 10320A

### 3 Description of the Equipment Under Test

Product:	Hive View Outdoor
Model no.:	HCE001
Hardware Version Identification No. (HVIN):	HCE001
FCC ID:	WJHHCE001
IC:	21719-HCE001
Options and accessories:	Adapter and USB Cable
Rating:	5Vdc, 2.5A supplied by an external adapter
Adapter information:	Adapter Model: HPA001 Adapter Input: 100-240Vac, 50/60Hz; 0.3A Adapter Output: 5.0Vdc, 2.5A
RF Transmission Frequency:	2402MHz-2480MHz
No. of Operated Channel:	40
Modulation:	GFSK
Antenna Type:	Integrated antenna
Antenna Gain:	2.0dBi
Description of the EUT:	The Equipment Under Test (EUT) is a wireless camera which support WiFi at 2.4GHz and 5GHz, Bluetooth function operated at 2.4GHz.

## 4 Summary of Test Standards

Test Standards	
FCC Part 15 Subpart C 10-1-2017 Edition	PART 15 - RADIO FREQUENCY DEVICES Subpart C - Intentional Radiators
RSS-Gen Issue 5 April 2018	General Requirements for Compliance of Radio Apparatus
RSS-247 Issue 2 February 2017	Digital Transmission Systems (DTSS), Frequency Hopping Systems (FHSS) and License-Exempt Local Area Network (LE-LAN) Devices

All the test methods were according to KDB 558074 D01 15.247 Meas Guidance v05 Measurement Guidance and ANSI C63.10 (2013).

## 5 Summary of Test Results

Technical Requirements						
FCC Part 15 Subpart C/ RSS-247 Issue 2/RSS-Gen Issue 5						
Test Condition	Pages	Test Site	Test Result			
			Pass	Fail	N/A	
§15.207 & RSS-GEN 8.8	Conducted emission AC power port	10	Site 1	<input checked="" type="checkbox"/>	<input type="checkbox"/>	<input type="checkbox"/>
§15.247 (b) (1) & RSS-247 5.4(d)	Conducted peak output power	13	Site 1	<input checked="" type="checkbox"/>	<input type="checkbox"/>	<input type="checkbox"/>
§15.247(a)(1) & RSS-247 5.1(b)	20dB bandwidth	---	---	<input type="checkbox"/>	<input type="checkbox"/>	<input checked="" type="checkbox"/>
§15.247(a)(1) & RSS-247 5.1(b)	Carrier frequency separation	---	---	<input type="checkbox"/>	<input type="checkbox"/>	<input checked="" type="checkbox"/>
§15.247(a)(1)(iii) & RSS-247 5.1(d)	Number of hopping frequencies	---	---	<input type="checkbox"/>	<input type="checkbox"/>	<input checked="" type="checkbox"/>
§15.247(a)(1)(iii) & RSS-247 5.1(d)	Dwell Time	---	---	<input type="checkbox"/>	<input type="checkbox"/>	<input checked="" type="checkbox"/>
§15.247(e) & RSS-247 5.2(b)	Power spectral density	14	Site 1	<input checked="" type="checkbox"/>	<input type="checkbox"/>	<input type="checkbox"/>
§15.247(a)(2) & RSS-247 5.2(a) & RSS-GEN 6.7	6dB bandwidth and 99% Occupied Bandwidth	15	Site 1	<input checked="" type="checkbox"/>	<input type="checkbox"/>	<input type="checkbox"/>
§15.247(d) & RSS-247 5.5	Spurious RF conducted emissions	19	Site 1	<input checked="" type="checkbox"/>	<input type="checkbox"/>	<input type="checkbox"/>
§15.247(d) & RSS-247 5.5	Band edge	25	Site 1	<input checked="" type="checkbox"/>	<input type="checkbox"/>	<input type="checkbox"/>
§15.247(d) & §15.209 & RSS-247 5.5 & RSS-Gen 6.13	Spurious radiated emissions for transmitter	27	Site 1	<input checked="" type="checkbox"/>	<input type="checkbox"/>	<input type="checkbox"/>
§15.203 & RSS-Gen 6.8	Antenna requirement	See note 1		<input checked="" type="checkbox"/>	<input type="checkbox"/>	<input type="checkbox"/>

Note 1: N/A=Not Applicable.

Note 2: The EUT uses an Integrated antenna, which gain is 2.0dBi. In accordance to §15.203 & RSS-Gen 6.8, it is considered sufficiently to comply with the provisions of this section.

## 6 General Remarks

### Remarks

This submittal(s) (test report) is intended for FCC ID: WJHHCE001, IC: 21719-HCE001, complies with Section 15.207, 15.209, 15.247 of the FCC Part 15, Subpart C rules and RSS-247, RSS-GEN.

### SUMMARY:

All tests according to the regulations cited on page 5 were

n - Performed

o - **Not** Performed

The Equipment under Test

n - **Fulfills** the general approval requirements.

o - **Does not** fulfill the general approval requirements.

Sample Received Date: August 20, 2018

Testing Start Date: September 10, 2018

Testing End Date: September 13, 2018

- TÜV SÜD Certification and Testing (China) Co., Ltd. Shenzhen Branch -

Reviewed by:

Prepared by:

Tested by:



John Zhi  
Project Manager



Alan Xiong  
Project Engineer



Tree Zhan  
Test Engineer

## 7 Test Setups

### 7.1 AC Power Line Conducted Emission test setups

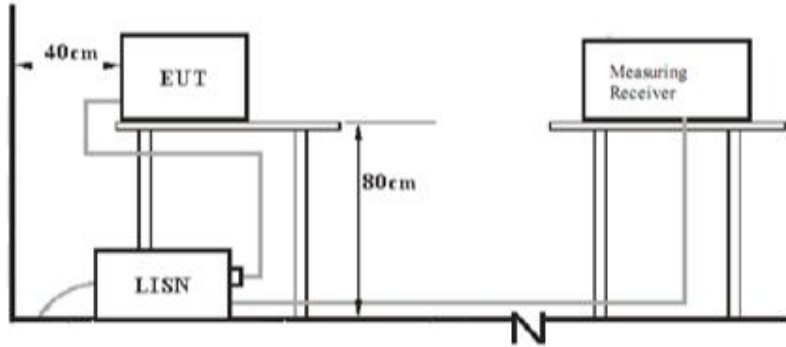

### 7.2 Radiated test setups Below 1GHz

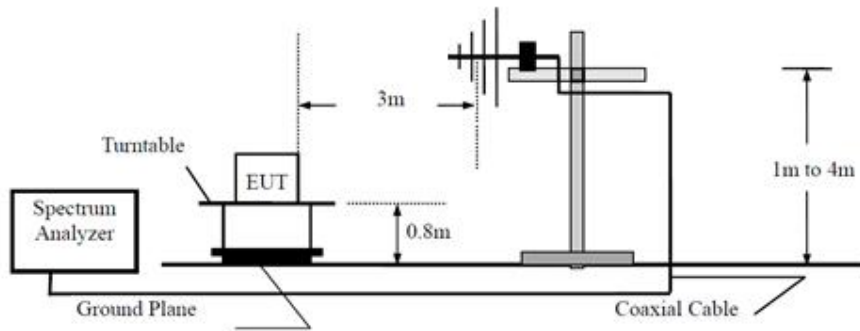

### Above 1GHz

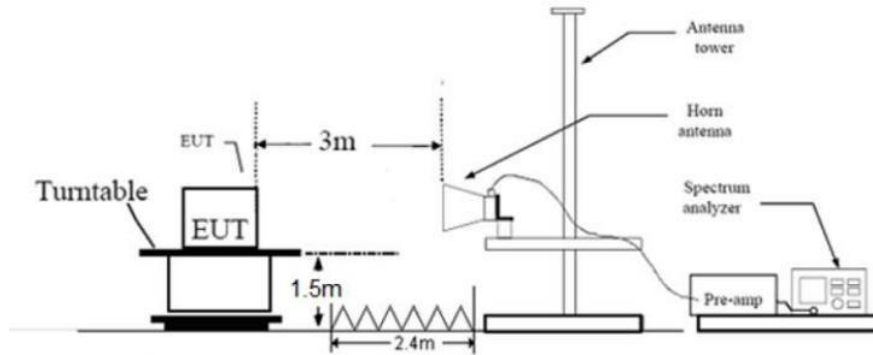

### 7.3 Conducted RF test setups

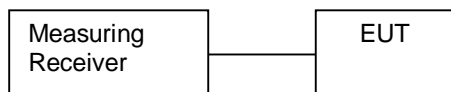



## 8 Systems test configuration

Auxiliary Equipment Used during Test:

DESCRIPTION	MANUFACTURER	MODEL NO.	S/N
PC	Lenovo	X240	---

The system was configured to non-hopping mode.

Non-hopping mode: The system was configured to operate at a signal channel transmitting. The test software allows the configuration and operation at the worst-case duty and the highest transmit power.

## 9 Technical Requirement

### 9.1 Conducted Emission

#### Test Method

1. The EUT was placed on a table, which is 0.8m above ground plane
2. The power line of the EUT is connected to the AC mains through an Artificial Mains Network (A.M.N.).
3. Maximum procedure was performed to ensure EUT compliance
4. A EMI test receiver is used to test the emissions from both sides of AC line

#### Limit

According to §15.207 & RSS-GEN 8.8, conducted emissions limit as below:

Frequency MHz	QP Limit dB $\mu$ V	AV Limit dB $\mu$ V
0.150-0.500	66-56*	56-46*
0.500-5	56	46
5-30	60	50

n

\*Decreasing linearly with logarithm of the frequency

## Conducted Emission

Product Type : Hive View Outdoor  
 M/N : HCE001  
 Operating Condition : normal working Mode with BLE traffic  
 Test Specification : Line  
 Comment : AC 120V/60Hz

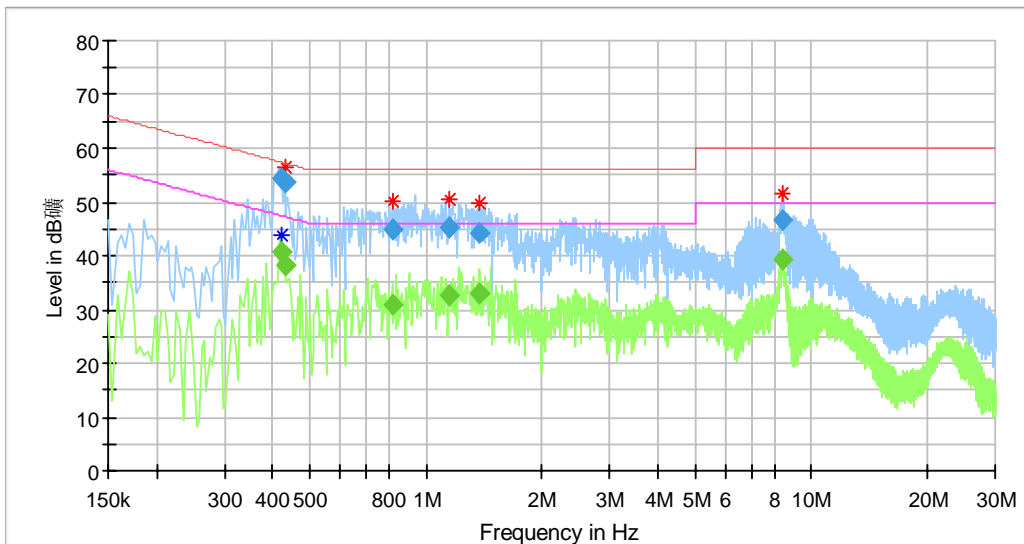

Frequency (MHz)	QuasiPeak (dBµV)	Average (dBµV)	Limit (dBµV)	Margin (dB)	Line	Filter	Corr. (dB)
0.421500	---	40.57	47.42	6.85	L1	OFF	10.3
0.421500	54.24	---	57.42	3.18	L1	OFF	10.3
0.433500	---	38.31	47.19	8.88	L1	OFF	10.3
0.433500	53.68	---	57.19	3.51	L1	OFF	10.3
0.822500	---	30.79	46.00	15.21	L1	OFF	10.3
0.822500	45.07	---	56.00	10.93	L1	OFF	10.3
1.149500	---	32.54	46.00	13.46	L1	OFF	10.3
1.149500	45.16	---	56.00	10.84	L1	OFF	10.3
1.377500	---	32.92	46.00	13.08	L1	OFF	10.3
1.377500	44.13	---	56.00	11.87	L1	OFF	10.3
8.457500	---	39.18	50.00	10.82	L1	OFF	10.6
8.457500	46.68	---	60.00	13.32	L1	OFF	10.6

\*Correct factor=cable loss + LISN factor

## Conducted Emission

Product Type : Hive View Outdoor  
 M/N : HCE001  
 Operating Condition : normal working Mode with BLE traffic  
 Test Specification : Neutral  
 Comment : AC 120V/60Hz

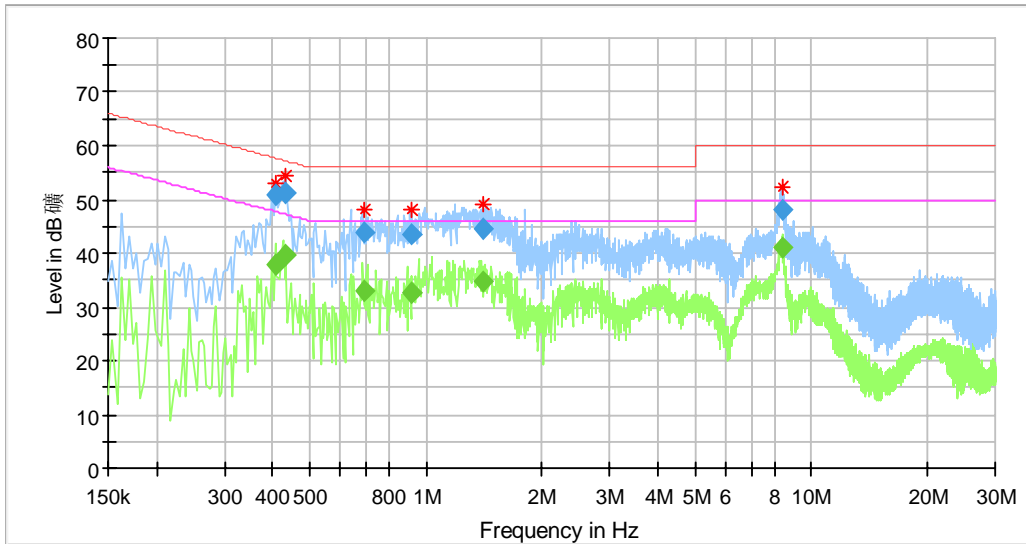

Frequency (MHz)	QuasiPeak (dBμV)	Average (dBμV)	Limit (dBμV)	Margin (dB)	Line	Filter	Corr. (dB)
0.409500	---	37.89	47.66	9.77	N	OFF	10.3
0.409500	50.94	---	57.66	6.72	N	OFF	10.3
0.429500	---	39.62	47.26	7.64	N	OFF	10.3
0.429500	51.38	---	57.26	5.88	N	OFF	10.3
0.689500	---	32.87	46.00	13.13	N	OFF	10.3
0.689500	43.69	---	56.00	12.31	N	OFF	10.3
0.917500	---	32.67	46.00	13.33	N	OFF	10.3
0.917500	43.57	---	56.00	12.43	N	OFF	10.3
1.401500	---	34.60	46.00	11.40	N	OFF	10.3
1.401500	44.57	---	56.00	11.43	N	OFF	10.3
8.453500	---	40.90	50.00	9.10	N	OFF	10.7
8.453500	48.00	---	60.00	12.00	N	OFF	10.7

\*Correct factor=cable loss + LISN factor



## 9.1 Conducted peak output power

### Test Method

1. Use the following spectrum analyzer settings:  
 RBW > the 6 dB bandwidth of the emission being measured, VBW ≥ 3RBW, Span ≥ 3RBW  
 Sweep = auto, Detector function = peak, Trace = max hold.
2. Add a correction factor to the display.
3. Allow the trace to stabilize. Use the marker-to-peak function to set the marker to the peak of the emission. The indicated level is the peak output power.

### Limits

According to §15.247 (b) (1) & RSS-247 5.4(d), conducted peak output power limit as below:

Frequency Range MHz	Limit W	Limit dBm
2400-2483.5	≤1	≤30

Test result as below table

Frequency MHz	Conducted Peak Output Power dBm	Result
Bottom channel 2402MHz	5.49	Pass
Middle channel 2440MHz	6.19	Pass
Top channel 2480MHz	4.86	Pass



## 9.2 Power spectral density

### Test Method

This procedure shall be used if maximum peak conducted output power was used to demonstrate compliance:

1. Set analyzer center frequency to DTS channel center frequency. RBW=3kHz, VBW≥3RBW, Span=1.5 times DTS bandwidth, Detector=Peak, Sweep=auto, Trace= max hold.
2. Allow trace to fully stabilize, use the peak marker function to determine the maximum amplitude level within the RBW.
3. Repeat above procedures until other frequencies measured were completed.

### Limit

**Limit [dBm]**

-----  
≤8

### Test result

Frequency MHz	Power spectral density dBm	Result
Top channel 2402MHz	-3.98	Pass
Middle channel 2440MHz	-3.29	Pass
Bottom channel 2480MHz	-4.33	Pass

### 9.3 6 dB Bandwidth and 99% Occupied Bandwidth

#### Test Method for 6 dB Bandwidth

1. Use the following spectrum analyzer settings:  
RBW=100K, VBW≥3RBW, Sweep = auto, Detector function = peak, Trace = max hold
2. Use the automatic bandwidth measurement capability of an instrument, may be employed using the X dB bandwidth mode with X set to 6 dB, care shall be taken so that the bandwidth measurement is not influenced by any intermediate power nulls in the fundamental emission that might be ≥ 6 dB.
3. Allow the trace to stabilize, record the X dB Bandwidth value.

#### Test Method for 99 % Bandwidth

1. Use the following spectrum analyzer settings:  
RBW=1% to 5% of the actual occupied, VBW≥3RBW, Sweep = auto, Detector function = peak, Trace = max hold
2. Use the automatic bandwidth measurement capability of an instrument, care shall be taken so that the bandwidth measurement is not influenced by any intermediate power nulls in the fundamental emission that might be ≥ 6 dB.
3. Allow the trace to stabilize, record the X dB Bandwidth value.

#### Limit

Limit [kHz]

—————  
≥500

#### Test result

Frequency MHz	6dB bandwidth kHz	99% bandwidth kHz	Result
Bottom channel 2402MHz	728	1059	Pass
Middle channel 2440MHz	732	1067	Pass
Top channel 2480MHz	732	1063	Pass

**6 dB Bandwidth**

Low channel 2402MHz

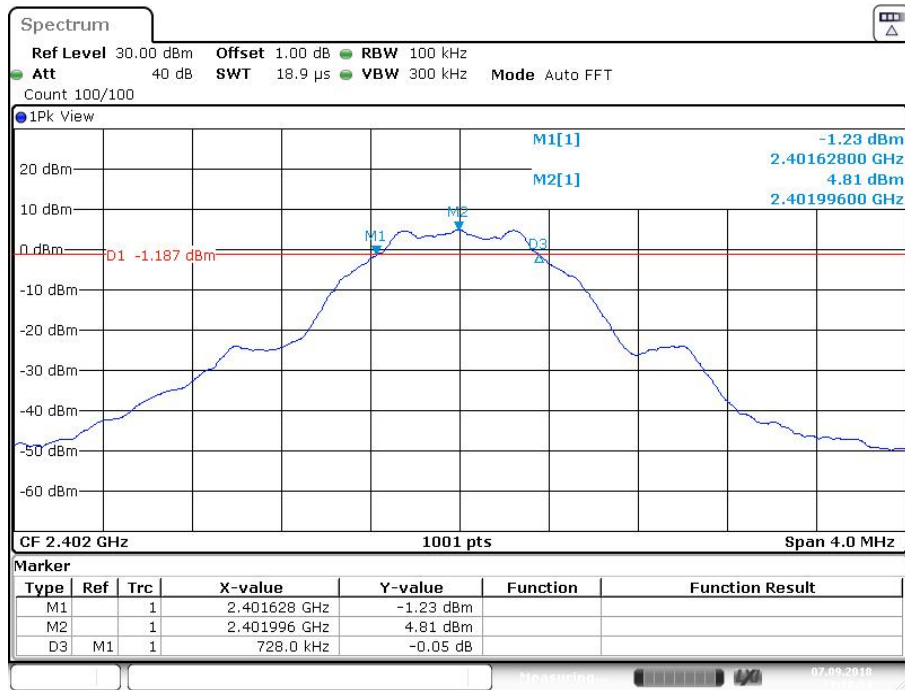

Date: 7.SEP.2018 21:10:55

Middle channel 2440MHz

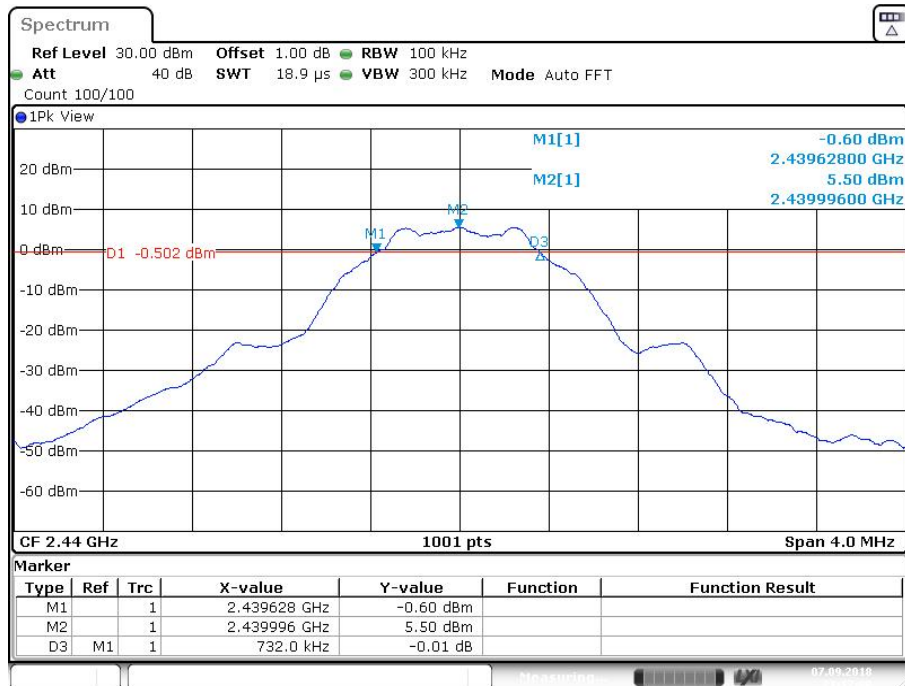

Date: 7.SEP.2018 21:17:00



**6 dB Bandwidth and 99% Bandwidth**

High channel 2480MHz

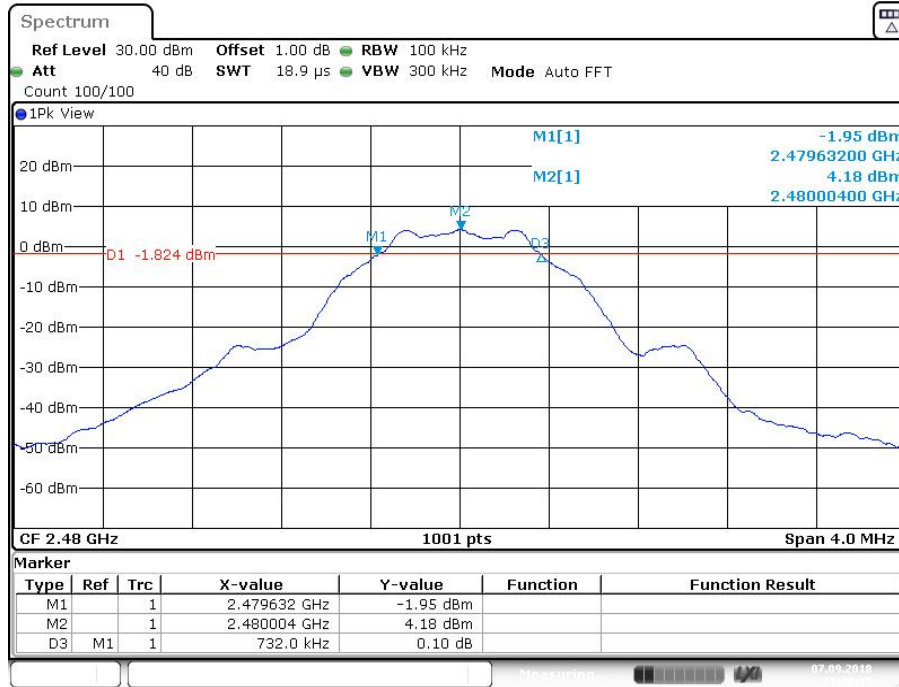

Low channel 2402MHz

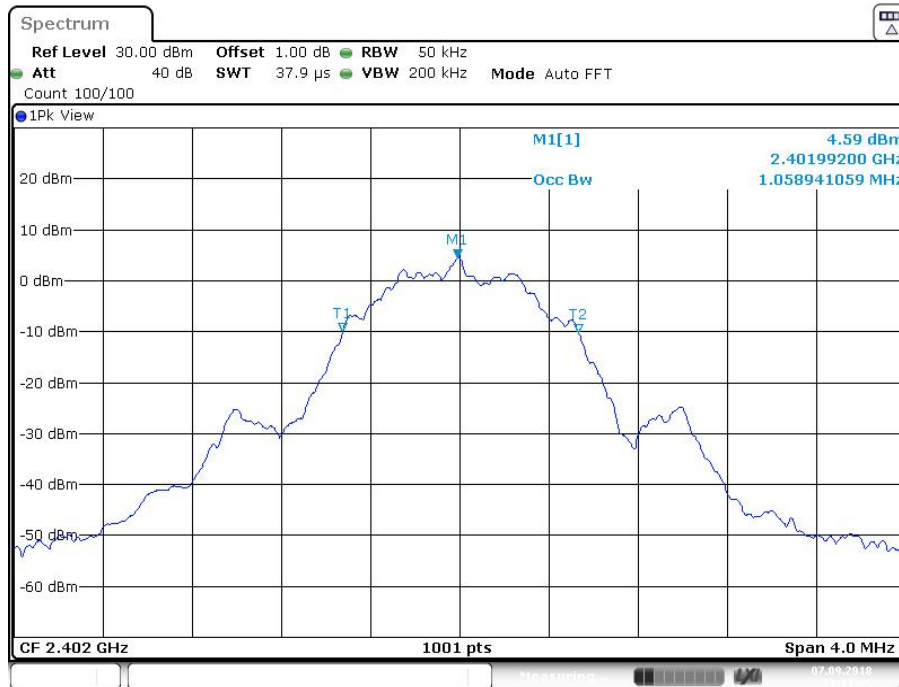

### 99% Bandwidth

#### Middle channel 2440MHz

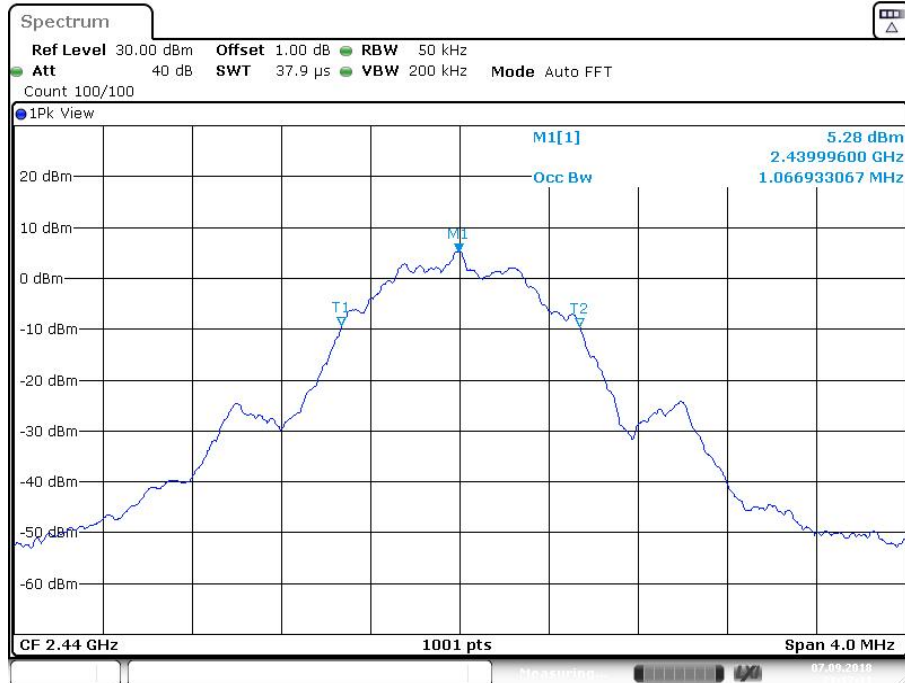

Date: 7 SEP 2018 21:17:11

#### High channel 2480MHz

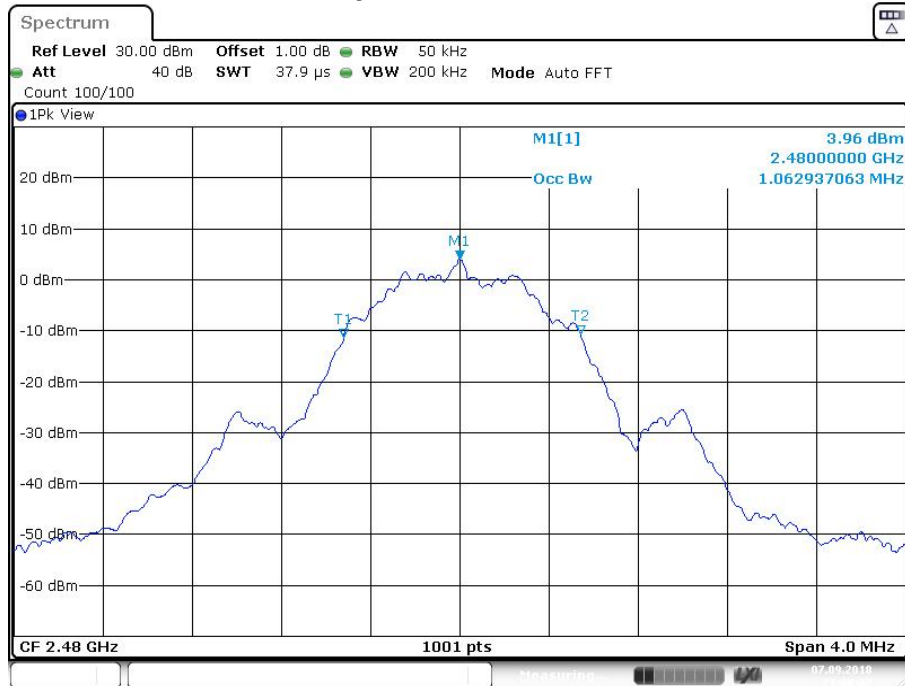

Date: 7 SEP 2018 21:28:27



## 9.4 Spurious RF conducted emissions

### Test Method

1. Establish a reference level by using the following procedure:
  - a. Set RBW=100 kHz. VBW≥3RBW. Detector =peak, Sweep time = auto couple, Trace mode = max hold.
  - b. Allow trace to fully stabilize, use the peak marker function to determine the maximum PSD level.
2. Use the maximum PSD level to establish the reference level.
  - a. Set the center frequency and span to encompass frequency range to be measured.
  - b. Use the peak marker function to determine the maximum amplitude level. Ensure that the amplitude of all unwanted emissions outside of the authorized frequency band (excluding restricted frequency bands) are attenuated by at least the minimum requirements, report the three highest emissions relative to the limit.
3. Repeat above procedures until other frequencies measured were completed.

### Limit

Frequency Range MHz	Limit (dBc)
30-25000	-20

### Spurious RF conducted emissions

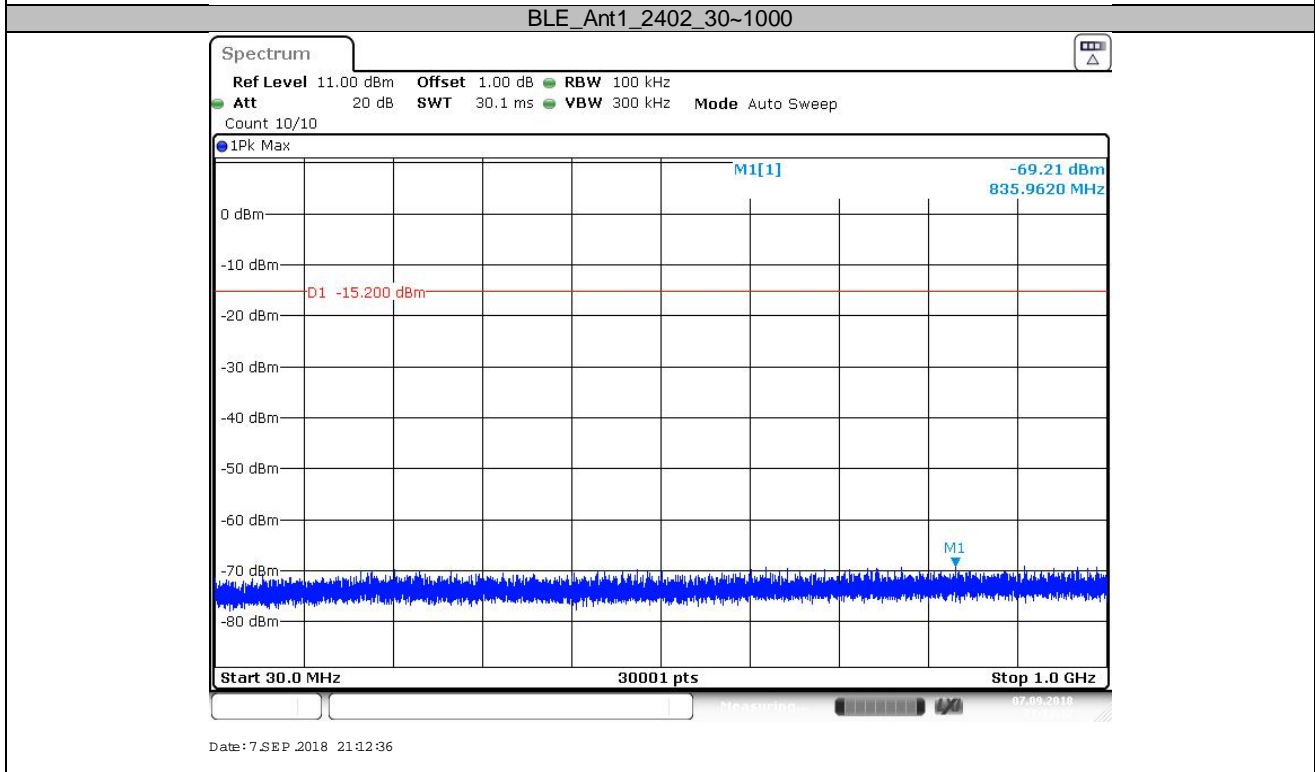
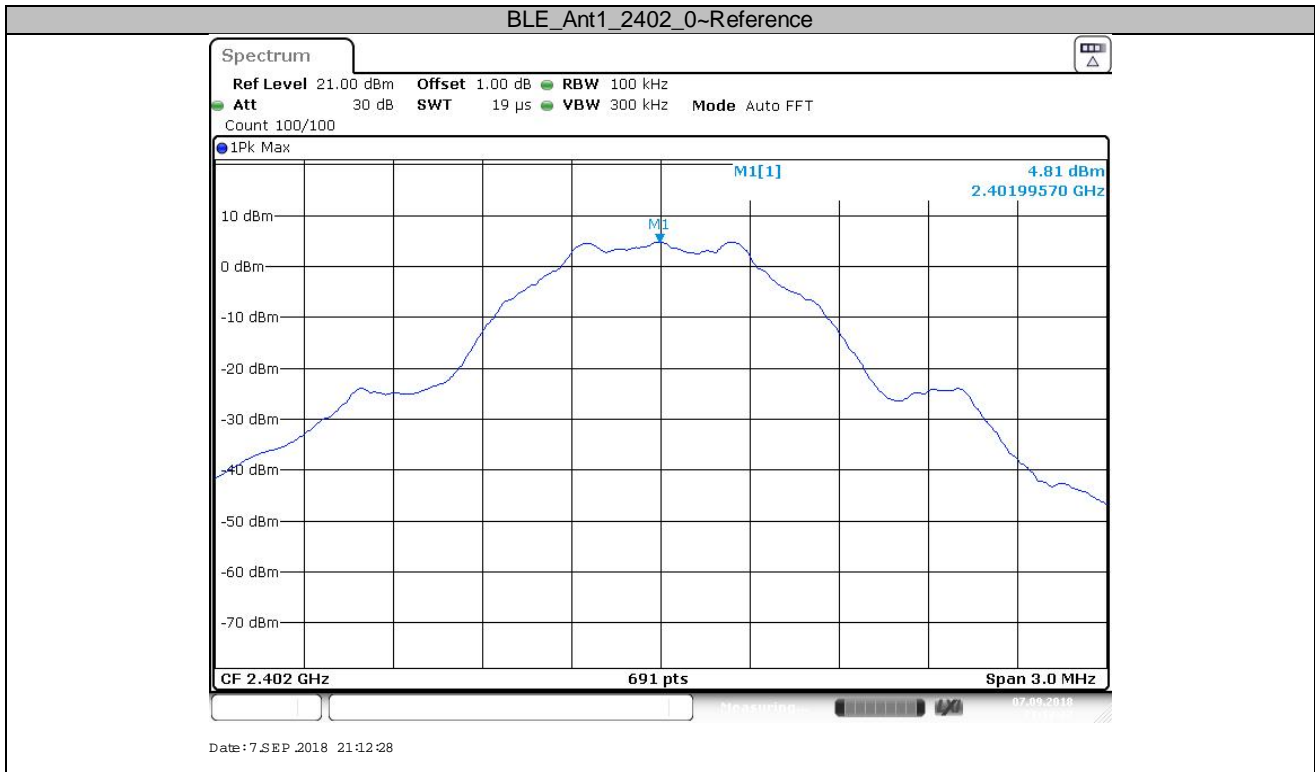

BLE\_Ant1\_2402\_1000~26500

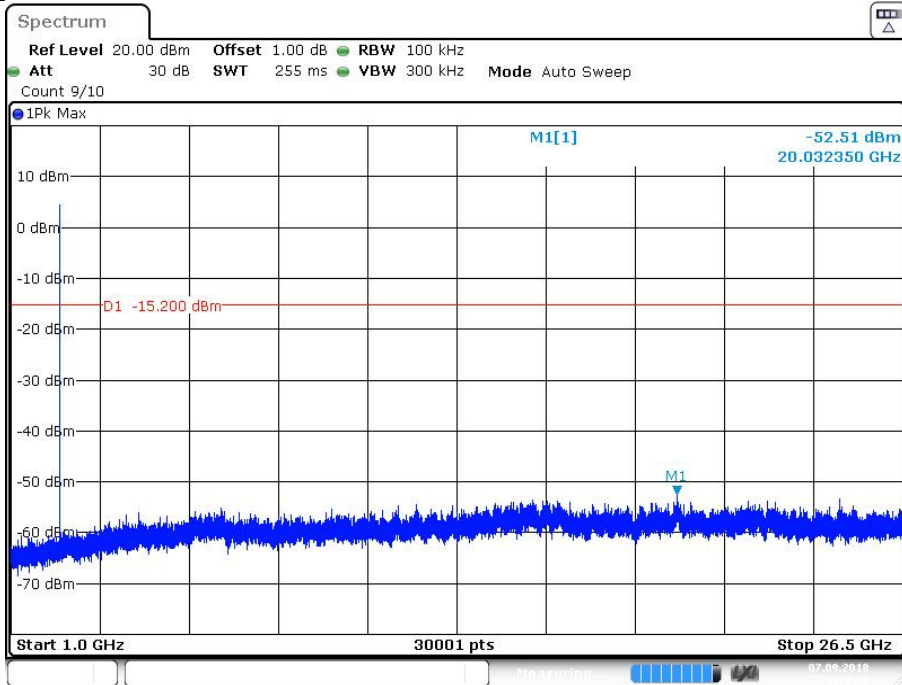

BLE\_Ant1\_2440\_0~Reference

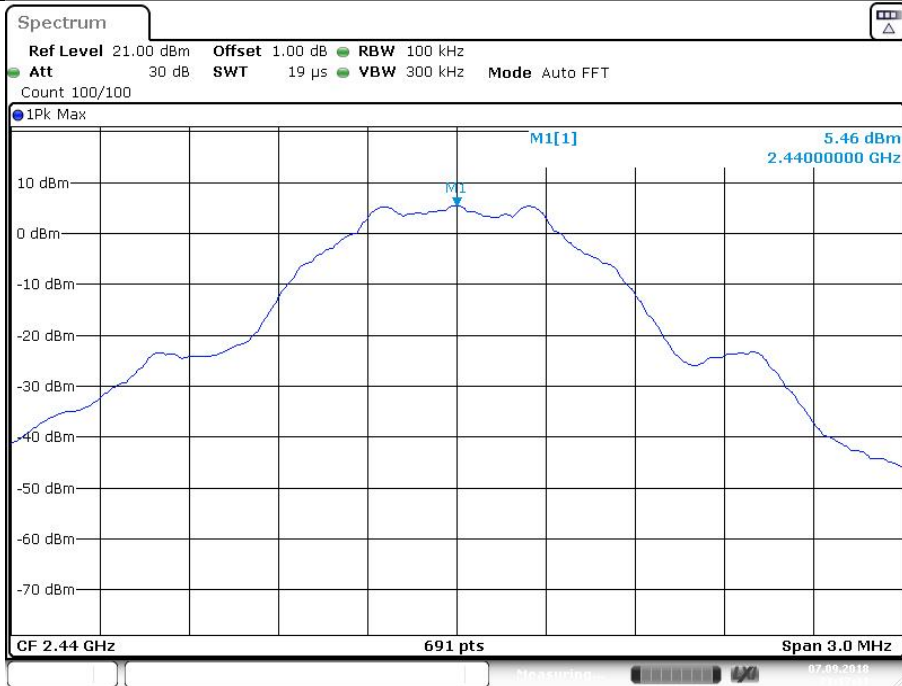

BLE\_Ant1\_2440\_30~1000

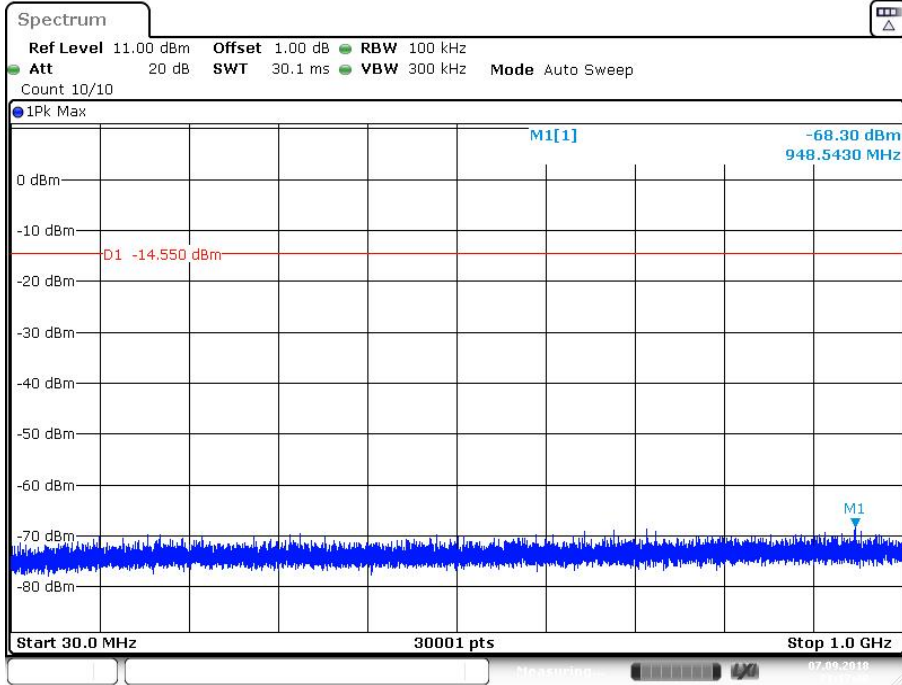

Date: 7.SEP.2018 21:17:39

BLE\_Ant1\_2440\_1000-26500

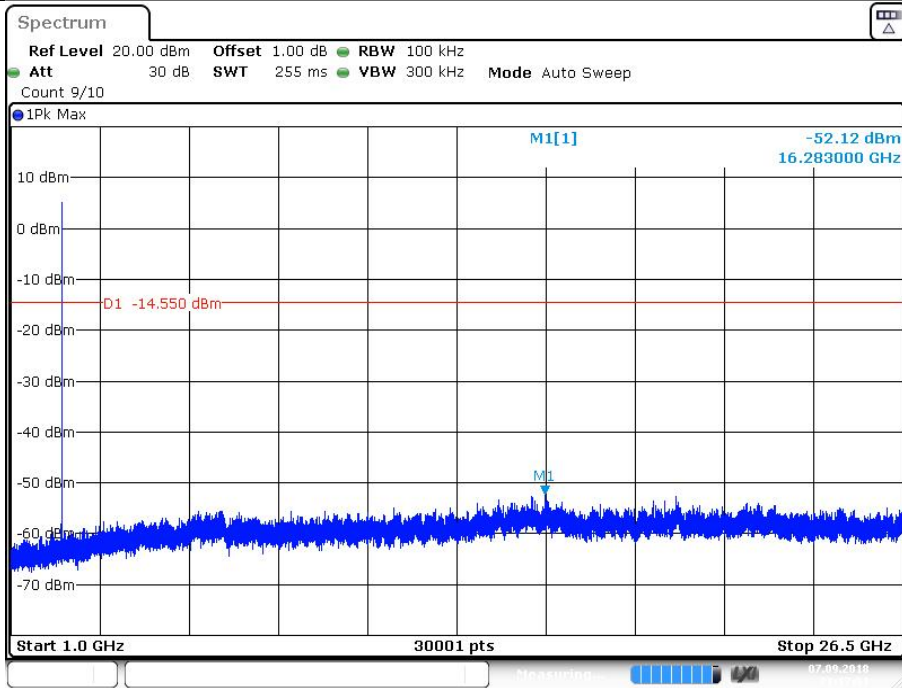

Date: 7.SEP.2018 21:17:51

BLE\_Ant1\_2480\_0-Reference

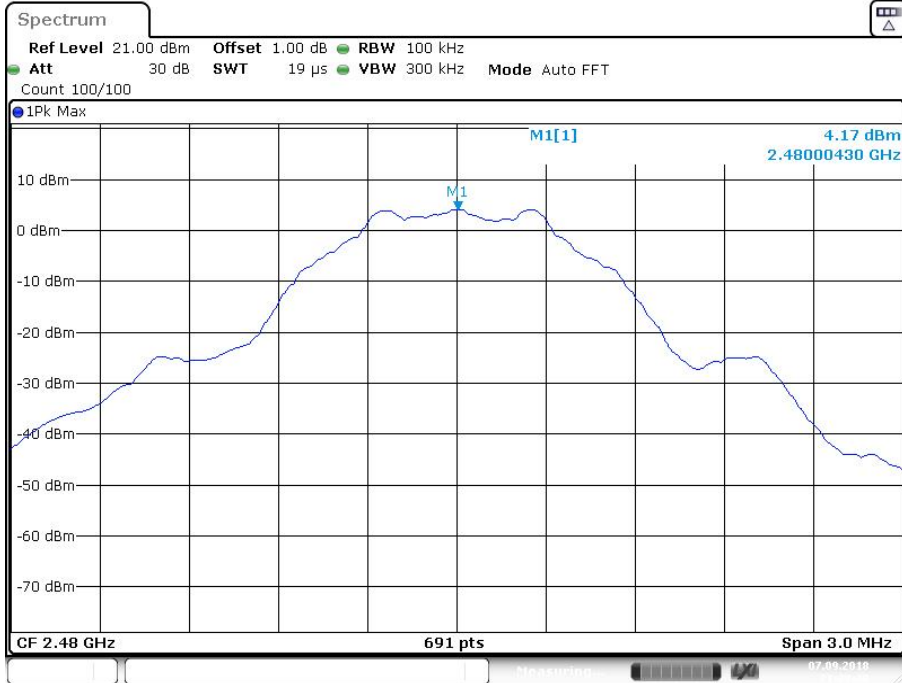

BLE\_Ant1\_2480\_30~1000

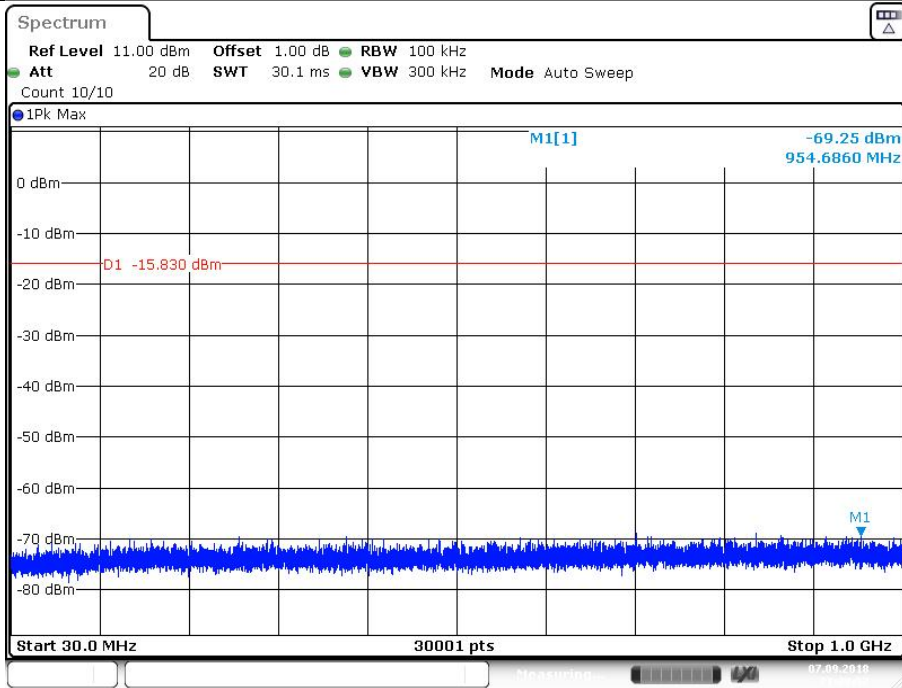

BLE\_Ant1\_2480\_1000~26500

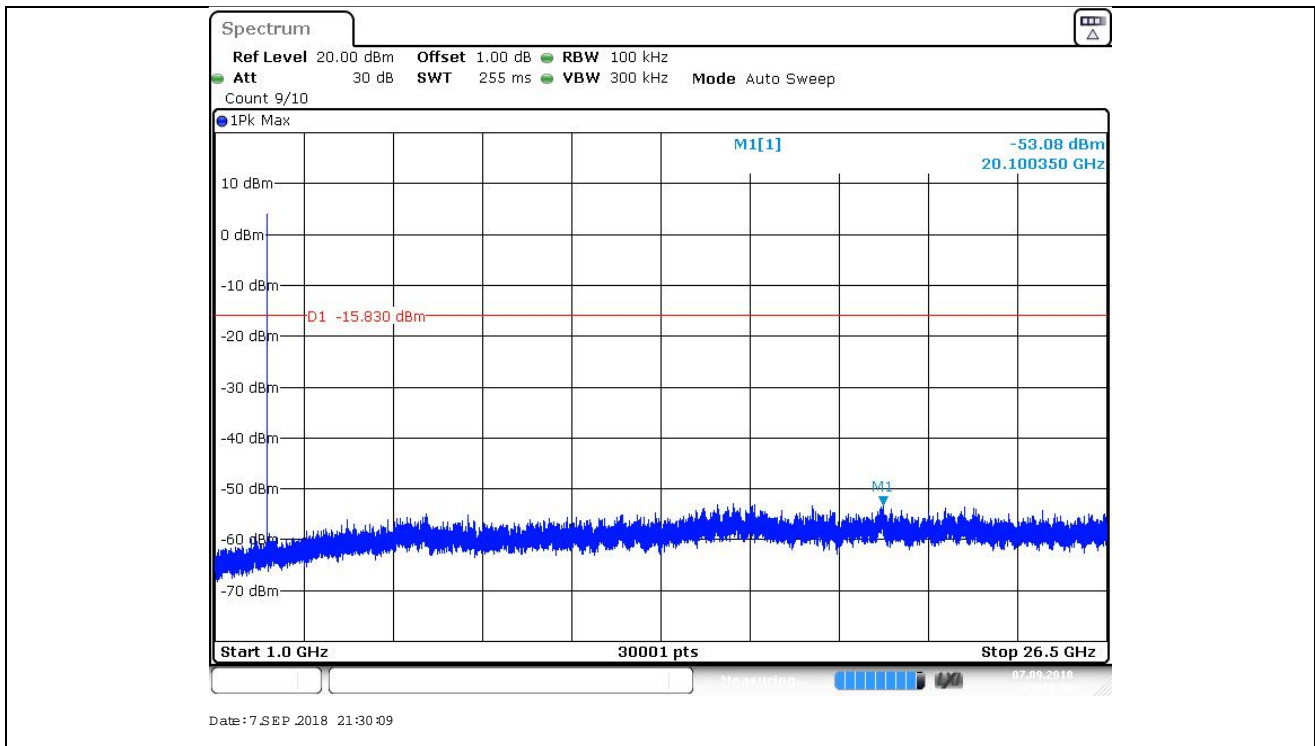



## 9.5 Band edge

### Test Method

- 1 Use the following spectrum analyzer settings:  
Span = wide enough to capture the peak level of the in-band emission and all spurious  
RBW = 100 kHz, VBW  $\geq$  RBW, Sweep = auto, Detector function = peak, Trace = max hold.
- 2 Allow the trace to stabilize, use the peak and delta measurement to record the result.
- 3 The level displayed must comply with the limit specified in this Section.

### Limit

Frequency Range MHz	Limit (dBc)
30-25000	-20

## Band edge testing

### 2402MHz

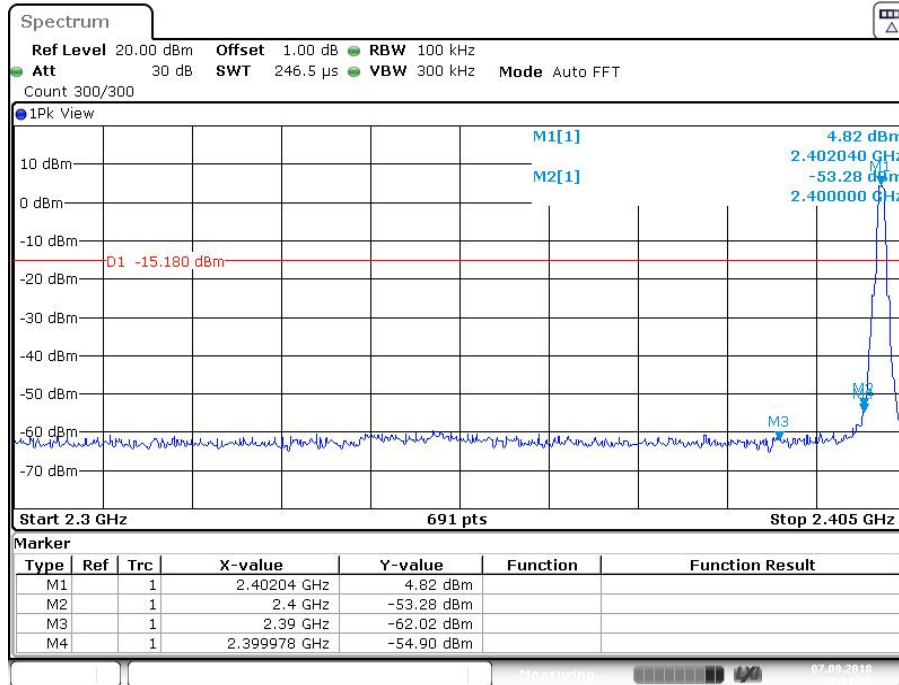

Date: 7.SEP.2018 21:11:29

### 2480MHz

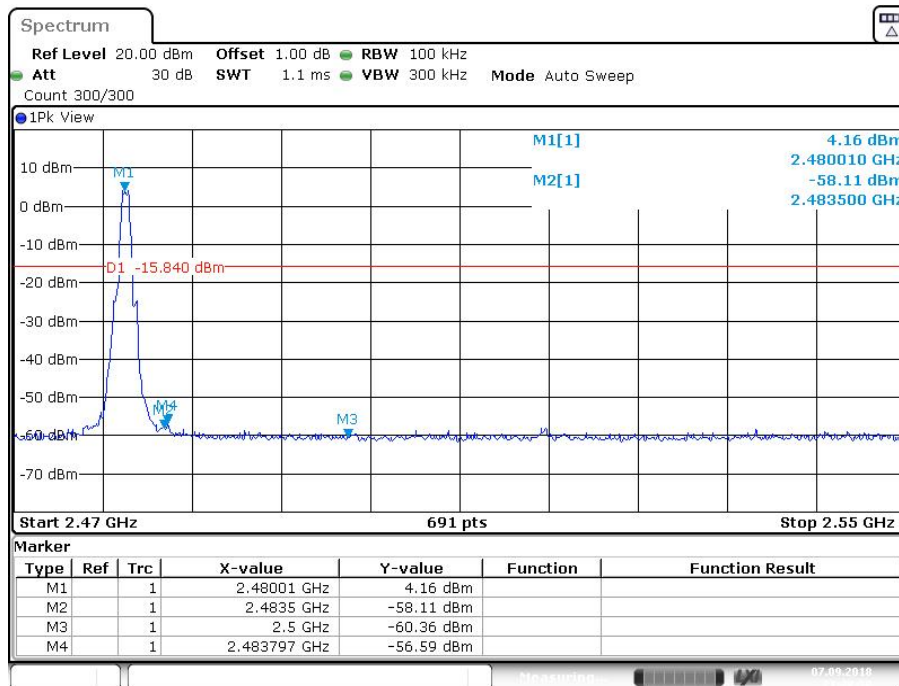

Date: 7.SEP.2018 21:28:50

## 9.6 Spurious radiated emissions for transmitter

### Test Method

- 1: The EUT was placed on a turn table which is 1.5m above ground plane for above 1GHz and 0.8m above ground for below 1GHz at 3meter chamber room for test. The table was rotated 360 degrees to determine the position of the highest radiation.
- 2: The EUT was set 3 meters away from the interference – receiving antenna, which was mounted on the top of a variable – height antenna tower.
- 3: The height of antenna is varied from one meter to four meters above the ground to determine the maximum value of the field strength. Both horizontal and vertical polarizations of the antenna are set to make the measurement.
- 4: For each suspected emission, the EUT was arranged to its worst case and then the antenna was tuned to heights from 1 meter to 4 meters and the rotatable table was turned from 0 degrees to 360 degrees to find the maximum reading.
- 5: Use the following spectrum analyzer settings According to C63.10:  
For Above 1GHz  
Span = wide enough to capture the peak level of the in-band emission and all spurious  
RBW = 1MHz, VBW $\geq$ RBW for peak measurement and VBW = 10Hz for average measurement, Sweep = auto, Detector function = peak, Trace = max hold.  
For Below 1GHz  
Use the following spectrum analyzer settings:  
Span = wide enough to capture the peak level of the in-band emission and all spurious  
RBW = 100 KHz, VBW $\geq$ RBW for peak measurement, Sweep = auto, Detector function = peak, Trace = max hold.

### Note:

- 1: The resolution bandwidth and video bandwidth of test receiver/spectrum analyzer is 120 KHz for Quasi-peak detection (QP) at frequency below 1GHz.
- 2: The resolution bandwidth of test receiver/spectrum analyzer is 1MHz and the video bandwidth is 3MHz for peak detection (PK) at frequency above 1GHz.
- 3: The resolution bandwidth of test receiver/spectrum analyzer is 1MHz and the video bandwidth is 3MHz for RMS Average ((duty cycle < 98%) for Average detection (AV) at frequency above 1GHz, then the measurement results was added to a correction factor (20log(1/duty cycle)).
- 4: The resolution bandwidth of test receiver/spectrum analyzer is 1MHz and the video bandwidth is 10Hz (duty cycle > 98%) for Average detection (AV) at frequency above 1GHz.

## Spurious radiated emissions for transmitter

### Limit

The radio emission outside the operating frequency band shall be at least 20 dB below that in the 100 kHz bandwidth within the band that contains the highest level of the desired power. Radiated emissions which fall in the restricted bands, as defined in section 15.205, must comply with the radiated emission limits specified in section 15.209.

Frequency MHz	Field Strength uV/m	Field Strength dBμV/m	Detector
30-88	100	40	QP
88-216	150	43.5	QP
216-960	200	46	QP
960-1000	500	54	QP
Above 1000	500	54	AV
Above 1000	5000	74	PK

## Spurious radiated emissions for transmitter

According to C63.10, if the peak (or quasi-peak) measured value complies with the average limit, it is unnecessary to perform an average measurement, so AV emission value did not show in below table if the peak value complies with average limit.

### Transmitting spurious emission test result as below:

#### Low channel 2402MHz Test Result

Frequency Band	Frequency	Emission Level	Polarization	Limit	Detector	Margin	Correct factor	Result
	MHz	dBuV/m		dBuV/m		dBuV/m	(dB)	
30-1000MHz	168.01	38.50	H	43.50	QP	5.00	-30.0	Pass
	464.29	37.01	H	46.00	QP	8.99	-22.4	Pass
	535.80	36.53	H	46.00	QP	9.47	-20.9	Pass
	837.04	39.14	H	46.00	QP	6.86	-16.3	Pass
	Other Frequency	---	H	---	---	---	---	Pass
	161.76	34.14	V	43.50	QP	9.36	-30.2	Pass
	272.02	36.00	V	46.00	QP	10.00	-26.3	Pass
	464.29	35.83	V	46.00	QP	10.17	-22.4	Pass
	837.04	36.98	V	46.00	QP	9.02	-16.3	Pass
Other Frequency	---	V	---	---	---	---	Pass	
1000-25000MHz	3300.00	38.28	H	74	PK	35.72	-1.7	Pass
	Other Frequency	---	H	74	---	---	---	Pass
	3300.00	41.02	V	74	PK	32.98	-1.7	Pass
	Other Frequency	---	V	74	---	---	---	Pass

#### Middle channel 2440MHz Test Result

Frequency Band	Frequency	Emission Level	Polarization	Limit	Detector	Margin	Correct factor	Result
	MHz	dBuV/m		dBuV/m		dBuV/m	(dB)	
1000-25000MHz	*7626.56	41.59	H	74	PK	32.41	9.8	Pass
	Other Frequency	---	H	74	---	---	---	Pass
	9854.06	43.18	V	74	PK	30.82	9.5	Pass
	Other Frequency	---	V	74	---	---	---	Pass

#### High channel 2480MHz Test Result

Frequency Band	Frequency	Emission Level	Polarization	Limit	Detector	Margin	Correct factor	Result
	MHz	dBuV/m		dBuV/m		dBuV/m	(dB)	
1000-25000MHz	3300.00	38.24	H	74	PK	35.76	-1.7	Pass
	Other Frequency	--	H	--	--	--	--	Pass
	9456.56	40.74	V	74	PK	33.26	9.7	Pass
	Other Frequency	--	V	--	--	--	--	Pass

Remark:

- (1) “\*” means the emission(s) appear within the restrict bands shall follow the requirement of section 15.205.
- (2) Data of measurement within this frequency range shown “--” in the table above means the reading of emissions are the noise floor or attenuated more than 20dB below the permissible limits or the field strength is too small to be measured.
- (3) Above 1GHz: Corrector factor = Antenna Factor + Cable Loss- Amplifier Gain  
Below 1GHz: Corrector factor = Antenna Factor + Cable Loss

## 10 Test Equipment List

### Conducted Emission Test

Description	Manufacturer	Model no.	Serial no.	cal. due date
EMI Test Receiver	Rohde & Schwarz	ESR 3	101782	2019-7-6
LISN	Rohde & Schwarz	ENV4200	100249	2019-7-6
LISN	Rohde & Schwarz	ENV432	101318	2019-7-6
LISN	Rohde & Schwarz	ENV216	100326	2019-7-6
ISN	Rohde & Schwarz	ENY81	100177	2019-7-6
ISN	Rohde & Schwarz	ENY81-CA6	101664	2019-7-6
High Voltage Probe	Rohde & Schwarz	TK9420(VT9420)	9420-584	2019-6-30
RF Current Probe	Rohde & Schwarz	EZ-17	100816	2019-6-30
Attenuator	Shanghai Huaxiang	TS2-26-3	080928189	2019-7-6
Test software	Rohde & Schwarz	EMC32	Version9.15.00	N/A

### Radiated Emission Test

DESCRIPTION	MANUFACTURER	MODEL NO.	SERIAL NO.	CAL. DUE DATE
EMI Test Receiver	Rohde & Schwarz	ESR 26	101269	2019-7-6
Trilog Super Broadband Test Antenna	Schwarzbeck	VULB 9163	707	2019-6-28
Horn Antenna	Rohde & Schwarz	HF907	102294	2019-6-28
Pre-amplifier	Rohde & Schwarz	SCU 18	102230	2019-7-6
Signal Generator	Rohde & Schwarz	SMY01	839369/005	2019-7-6
Attenuator	Agilent	8491A	MY39264334	2019-7-6
3m Semi-anechoic chamber	TDK	9X6X6	----	2020-7-7
Test software	Rohde & Schwarz	EMC32	Version 9.15.00	N/A

### TS8997 Test System

DESCRIPTION	MANUFACTURER	MODEL NO.	SERIAL NO.	CAL. DUE DATE
Signal Generator	Rohde & Schwarz	SMB100A	108272	2019-7-6
Vector Signal Generator	Rohde & Schwarz	SMBV100A	262825	2019-7-6
Communication Synthetical Test Instrument	Rohde & Schwarz	CMW 270	101251	2019-5-31
Signal Analyzer	Rohde & Schwarz	FSV40	101030	2019-7-6
Vector Signal Generator	Rohde & Schwarz	SMU 200A	105324	2019-7-6
RF Switch Module	Rohde & Schwarz	OSP120/OSP-B157	101226/100851	2019-7-6
Power Splitter	Weinschel	1580	SC319	2019-7-5
10dB Attenuator	Weinschel	4M-10	43152	2019-7-6
10dB Attenuator	R&S	DNF	DNF-001	2019-7-6
10dB Attenuator	R&S	DNF	DNF-002	2019-7-6
10dB Attenuator	R&S	DNF	DNF-003	2019-7-6
10dB Attenuator	R&S	DNF	DNF-004	2019-7-6
Test software	Rohde & Schwarz	EMC32	Version 10.38.00	N/A
Test software	Tonscend	System for BT/WIFI	Version 2.6	N/A

## 11 System Measurement Uncertainty

For a 95% confidence level, the measurement expanded uncertainties for defined systems, in accordance with the recommendations of ISO 17025 were:

System Measurement Uncertainty	
Test Items	Extended Uncertainty
Uncertainty for Conducted Emission 150kHz-30MHz	3.21dB
Uncertainty for Radiated Spurious Emission 25MHz-3000MHz	Horizontal: 4.91dB; Vertical: 4.89dB;
Uncertainty for Radiated Spurious Emission 3000MHz-18000MHz	Horizontal: 4.80dB; Vertical: 4.79dB;
Uncertainty for Conducted RF test with TS 8997	Power level test involved: 1.16dB Frequency test involved: $0.6 \times 10^{-7}$