



TEST REPORT

Test Report No. : UL-RPT-RP-11867511-1816-FCC

Applicant : Kathrein Sachsen GmbH
Model No. : 52010302-000
FCC ID : WJ9-ARU3560
Technology : 3G (US Bands) + RFID 915 MHz Intermodulations
Test Standard(s) : FCC Parts 15.207, 15.209(a)

For details of applied tests refer to test result summary

1. This test report shall not be reproduced in full or partial, without the written approval of UL International Germany GmbH.
2. The results in this report apply only to the sample tested.
3. The test results in this report are traceable to the national or international standards.
4. Test Report Version 1.0
5. Result of the tested sample: **PASS**

Prepared by: Abdoufataou Salifou
Title: Laboratory Engineer
Date: 13 March 2019

Approved by: Ajit Phadtare
Title: Lead Test Engineer
Date: 13 March 2019



Deutsche
Akkreditierungsstelle
D-PL-19381-02-00

This laboratory is accredited by DAkkS.
The tests reported herein have been performed in
accordance with its' terms of accreditation.

UL INTERNATIONAL GERMANY GMBH

Hedelfinger Str. 61
70327 Stuttgart, Germany
STU.CTECHLab@ul.com

This page has been left intentionally blank.

Table of Contents

1. Customer Information.....	4
1.1.Applicant Information	4
1.2.Manufacturer Information	4
2. Summary of Testing.....	5
2.1. General Information	5
Applied Standards	5
Location	5
Date information	5
2.2. Summary of Test Results	6
2.3. Methods and Procedures	6
2.4. Deviations from the Test Specification	6
3. Equipment Under Test (EUT)	7
3.1. Identification of Equipment Under Test (EUT)	7
3.2. Description of EUT	7
3.3. Modifications Incorporated in the EUT	7
3.4. Additional Information Related to Testing	8
3.5. Antenna Information	9
3.6. Support Equipment	10
A. Support Equipment (In-house)	10
B. Support Equipment (Manufacturer supplied)	10
4. Operation and Monitoring of the EUT during Testing	11
4.1. Operating Modes	11
4.2. Configuration and Peripherals	11
4.3. Used Power settings	11
5. Measurements, Examinations and Derived Results	12
5.1. General Comments	12
5.2. Test Results	13
5.2.1. Transmitter AC Conducted Spurious Emissions	13
5.2.2. Transmitter Radiated Emissions	16
6. Measurement Uncertainty	24
7. Used equipment	25
8. Report Revision History	26

1. Customer Information

1.1.Applicant Information

Company Name:	Kathrein Sachsen GmbH
Company Address:	Lindenstrasse 3, 09241 Muehlau
Contact Person:	Daniel Schkalda
Contact E-Mail:	d.schkalda@kathrein-sachsen.de
Contact Phone No.:	+49 3722 6073 79

1.2.Manufacturer Information

Company Name:	Kathrein Sachsen GmbH
Company Address:	Lindenstrasse 3, 09241 Muehlau
Contact Person:	Daniel Schkalda
Contact E-Mail:	d.schkalda@kathrein-sachsen.de
Contact Phone No.:	+49 3722 6073 79

2. Summary of Testing

2.1. General Information

Applied Standards

Specification Reference:	47CFR15.207 and 47CFR15.209
Specification Title:	Code of Federal Regulations Volume 47 (Telecommunications): Part 15 Subpart C (Intentional Radiators) - Sections 15.207 and 15.209
Test Firm Registration:	399704

Location

Location of Testing:	UL International Germany GmbH Hedelfinger Str. 61 70327 Stuttgart Germany
-----------------------------	--

Date information

Order Date:	17 July 2018
EUT arrived:	27 August 2018
Test Dates:	22 January to 23 January 2019
EUT returned:	-/-

2.2. Summary of Test Results

Clause	Measurement	Complied	Did not comply	Not performed	Not applicable
Part 15.207	Transmitter AC Conducted Emissions	<input checked="" type="checkbox"/>	<input type="checkbox"/>	<input type="checkbox"/>	<input type="checkbox"/>
Part 15.209(a)	Transmitter Radiated Emissions	<input checked="" type="checkbox"/>	<input type="checkbox"/>	<input type="checkbox"/>	<input type="checkbox"/>

Note:**2.3. Methods and Procedures**

Reference:	ANSI C63.10-2013
Title:	American National Standard of Procedures for Compliance Testing of Unlicensed Wireless Devices
Reference:	KDB 174176 D01 Line Conducted FAQ v01r01 June 3, 2015
Title:	AC Power-Line Conducted Emissions Frequently Asked Questions

2.4. Deviations from the Test Specification

For the measurements contained within this test report, there were no deviations from, additions to, or exclusions from the test specification identified above.

3. Equipment Under Test (EUT)

3.1. Identification of Equipment Under Test (EUT)

Brand Name:	KATHREIN
Model Name or Number:	52010302-000
Test Sample Serial Number:	GOK4587504
Hardware Version Number:	52010302-000
Firmware Version Number:	3.03.03
FCC ID:	WJ9-ARU3560

3.2. Description of EUT

The equipment under test was a UHF RFID Tag Reader with an integrated RFID and 2G/3G module.

3.3. Modifications Incorporated in the EUT

No modifications were applied to the EUT during testing.

3.4. Additional Information Related to Testing

Tested Technology:	RFID 902-928 MHz (FHSS)		
Power Supply Requirement:	Nominal	90 - 264(V AC)	
Type of Unit:	Transceiver		
Channel Spacing:	500 kHz		
Modulation:	PR-ASK		
Data Rate (kbps):	40	80	160
Transmit Frequency Range:	902 MHz to 928 MHz		
Transmit Channels Tested:	Channel ID	Channel Number	Channel Frequency (MHz)
	Bottom	1	902.25
	Middle	26	915.25
	Top	52	927.75
Tested Technology:	3 G (US Bands)		
Transmit Frequency Range:	826 MHz to 1908 MHz		
	Channel ID	Channel Number	Channel Frequency (MHz)
	Bottom	4132	826.4
	Middle	4233	846.4
	Second last	9262	1852.4
	Top	9538	1907.6

3.5. Antenna Information

Internal RFID Antenna:

Antenna Name:	ARU 3570 Antenna Reader Unit
Antenna Type:	Wide Range Antenna, 902MHz - 928MHz
Antenna Gain	4 dBi/ 7dBiC
Antenna Beamwidth:	h/v: 65°
Antenna Polarisation:	Circular

Internal WWAN Antenna:

Antenna Name:	ARU 3570 Antenna Reader Unit
Antenna Type:	Patch Antenna
Antenna Gain:	-0.4dBi @ 850 MHz +1.9 dBi @ 1900 MHz
Antenna Beamwidth:	133.2°
Antenna Polarisation:	Linear

3.6. Support Equipment

The following support equipment was used to exercise the EUT during testing:

A. Support Equipment (In-house)

Item	Description	Brand Name	Model Name or Number	Serial Number
1	Laptop	Lenovo	L560	MP-16X73B 16/11

B. Support Equipment (Manufacturer supplied)

Item	Description	Brand Name	Model Name or Number	Serial Number
1	RRU/ARU AC/DC Adapter 24V/90 W	MEANWELL	GST90A24	EB79F85440

4. Operation and Monitoring of the EUT during Testing

4.1. Operating Modes

The EUT was tested in the following operating mode(s):

Transmitting Mode (Fixed Frequency Mode) for the both technologies.

4.2. Configuration and Peripherals

The EUT was tested in the following configuration(s):

- The EUT was powered by 120 V AC 60Hz power supply.
- The test mode settings were activated using a customer supplied software application ReaderStart V3, rev.3.01.03.2531 installed Lab test laptop. The application was used to enable continuous transmission and to select the test channels as required for RFID and for 3G the GSMTTest app was used.
- EUT in RFID mode supports three data rates (40 kbps / 80 kbps/160 kbps) out of which worst case (40 kbps) data rate producing maximum peak power has been tested.
- EUT was tested with maximum output power for both technologies. The supplied antenna given in section 3.5 have been tested with used power settings section 4.3.
- RFID and 3G co-location, with the EUT configured to simultaneously transmit two signals at maximum output power (Bottom Channel 3G 826.4 MHz + Bottom Channel RFID 902.25 MHz) .
- RFID and 3G co-location, with the EUT configured to simultaneously transmit two signals at maximum output power (Bottom Channel 3G 826.4 MHz + Middle Channel RFID 915.25 MHz).
- RFID and 3G co-location, with the EUT configured to simultaneously transmit two signals at maximum output power (Bottom Channel 3G 826.4 MHz + Top Channel RFID 927.75 MHz)
- RFID and 3G co-location, with the EUT configured to simultaneously transmit two signals at maximum output power (Channel 9262 3G 1852.4 MHz + Top Channel RFID 927.75 MHz)
- RFID and 3G co-location, with the EUT configured to simultaneously transmit two signals at maximum output power (Top Channel 3G 1907.6 MHz + Top Channel RFID 927.75 MHz)
- It is to be noted that only internal antennas supports the co-location/ intermodulation mode.
- EUT's unused ports (Port 2 | Port 3 | Port 4) were terminated using 50 Ohm termination during testing.
- EMC32 v10.1 from Rohde and Schwarz was used for the measurement.

4.3. Used Power settings

The EUT was configured with the settings below based on the different antenna type. The antenna gain on the GUI was set to 0 dBi and Cable attenuation was set to 0 dB.

The port power settings selected in GUI is given as in the table below.

Technologies Type	Power Settings
RFID	30
3G	60

5. Measurements, Examinations and Derived Results

5.1. General Comments

Measurement uncertainties are evaluated in accordance with current best practice. Our reported expanded uncertainties are based on standard uncertainties, which are multiplied by an appropriate coverage factor to provide a statistical confidence level of approximately 95%. Please refer to Section 6 *Measurement Uncertainty* for details.

In accordance with DAkkS requirements all the measurement equipment is on a calibration schedule. All equipment was within the calibration period on the date of testing.

5.2. Test Results

5.2.1. Transmitter AC Conducted Spurious Emissions

Test Summary:

Test Engineer:	M. Fawad Khan	Test Date:	23 January 2019
Test Sample Serial Number:	GOK4587504		
Test Site Identification	SR 7/8		

FCC Reference:	Part 15.207
Test Method Used:	ANSI C63.10 Section 6.2 / FCC KDB 174176 and notes below

Environmental Conditions:

Temperature (°C):	22
Relative Humidity (%):	26

Settings of the Instrument

Detector	Quasi Peak /Average Peak
-----------------	--------------------------

Note:

1. The EUT was connected to 120 VAC 60 Hz single phase supply via a LISN.
2. The EUT was tested in Transmitting Mode (Fixed Frequency Mode) for the both technologies.

Test setup:

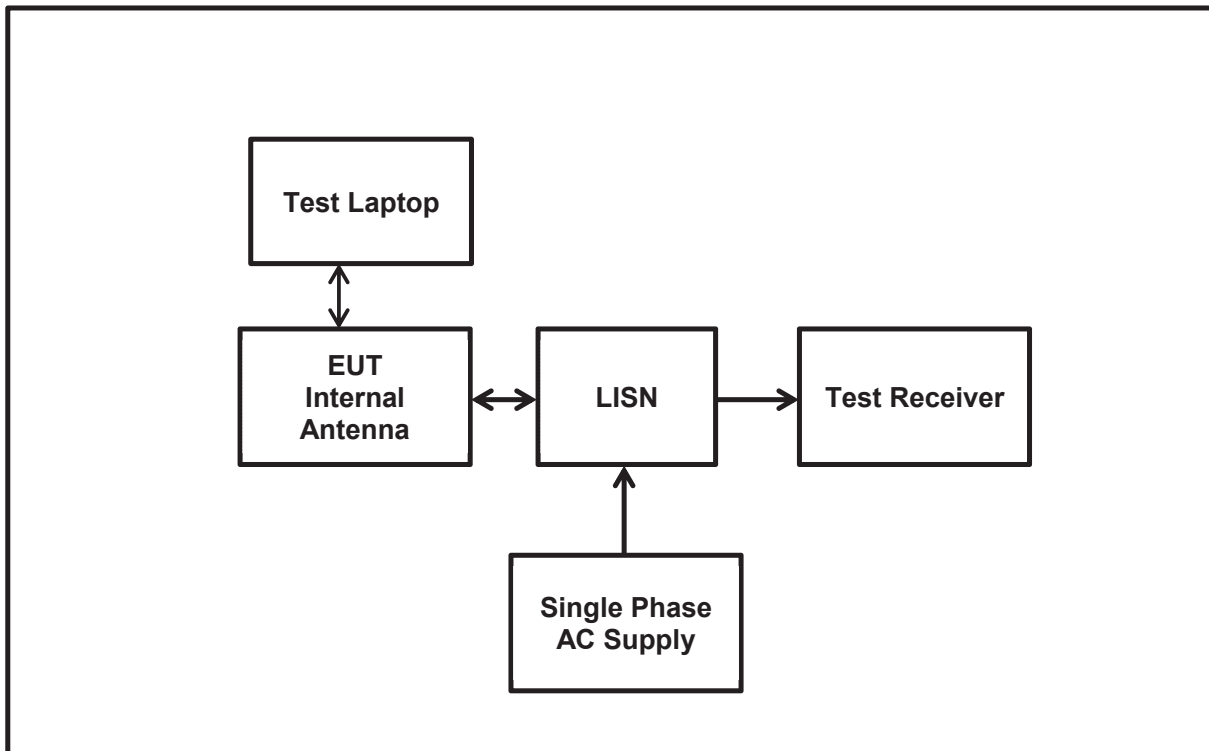

Transmitter AC Conducted Spurious Emissions (continued)**Results: Live / Quasi Peak / 120 VAC 60 Hz**

Frequency (MHz)	Line	Level (dB μ V)	Limit (dB μ V)	Margin (dB)	Result
0.152	Live	41.7	65.9	24.2	Complied
0.16002	Live	40.6	65.5	24.9	Complied
0.16904	Live	39.5	65	25.5	Complied
0.1986	Live	35.8	63.7	27.9	Complied
0.23768	Live	31.9	62.2	30.3	Complied
0.24569	Live	32.3	61.9	29.6	Complied

Results: Live / Average / 120 VAC 60 Hz

Frequency (MHz)	Line	Level (dB μ V)	Limit (dB μ V)	Margin (dB)	Result
0.152	Live	19.5	55.9	36.4	Complied
0.16002	Live	16.6	55.5	38.9	Complied
0.16904	Live	21.5	55	33.5	Complied
0.1986	Live	15.7	53.7	38	Complied
0.23768	Live	15.2	52.2	37	Complied
0.24569	Live	23.4	51.9	28.5	Complied

Results: Neutral / Quasi Peak / 120 VAC 60 Hz

Frequency (MHz)	Line	Level (dB μ V)	Limit (dB μ V)	Margin (dB)	Result
0.15351	Neutral	41.6	65.8	24.2	Complied
0.16202	Neutral	40.4	65.4	25	Complied
0.18257	Neutral	41	64.4	23.4	Complied
0.20661	Neutral	35	63.3	28.3	Complied
0.22816	Neutral	33	62.5	29.5	Complied
0.92204	Neutral	32.7	56	23.3	Complied

Results: Neutral / Average / 120 VAC 60 Hz

Frequency (MHz)	Line	Level (dB μ V)	Limit (dB μ V)	Margin (dB)	Result
0.15351	Neutral	17.6	55.8	38.2	Complied
0.16202	Neutral	16.6	55.4	38.8	Complied
0.18257	Neutral	32.7	54.4	21.7	Complied
0.20661	Neutral	22.6	53.3	30.7	Complied
0.22816	Neutral	15.5	52.5	37	Complied
0.92204	Neutral	24	46	22	Complied

Result: Pass

Transmitter AC Conducted Spurious Emissions (continued)

Plot: Live and Neutral Line

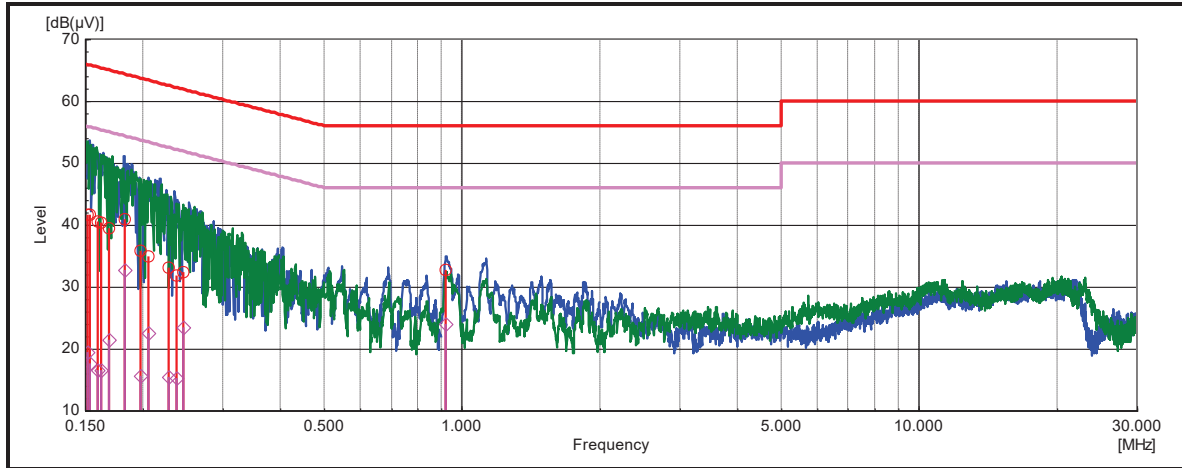

Note: These plots are pre-scans and for indication purposes only. For final measurements, see accompanying tables.

5.2.2. Transmitter Radiated Emissions

Test Summary:

Test Engineer:	Abdoufataou Salifou	Test Date:	22 to 23 January 2019
Test Sample Serial Number:	GOK4587504		
Test Site Identification	SR 1/2		

FCC Reference:	Part 15.209(a)
Test Method Used:	ANSI C63.10 Sections 6.7 and 7.8.8
Frequency Range	30 MHz to 1 GHz

Environmental Conditions:

Temperature (°C):	20 & 21
Relative Humidity (%):	21 & 22

Notes:

1. The final measured value, for the given emission, in the table below incorporates the calibrated antenna factor and cable loss.
2. 20 dBc Limit* from worst case Antenna has been selected from the RFID carrier peak due to the fact that the spurious are coming from the RFID technology.

Test setup:

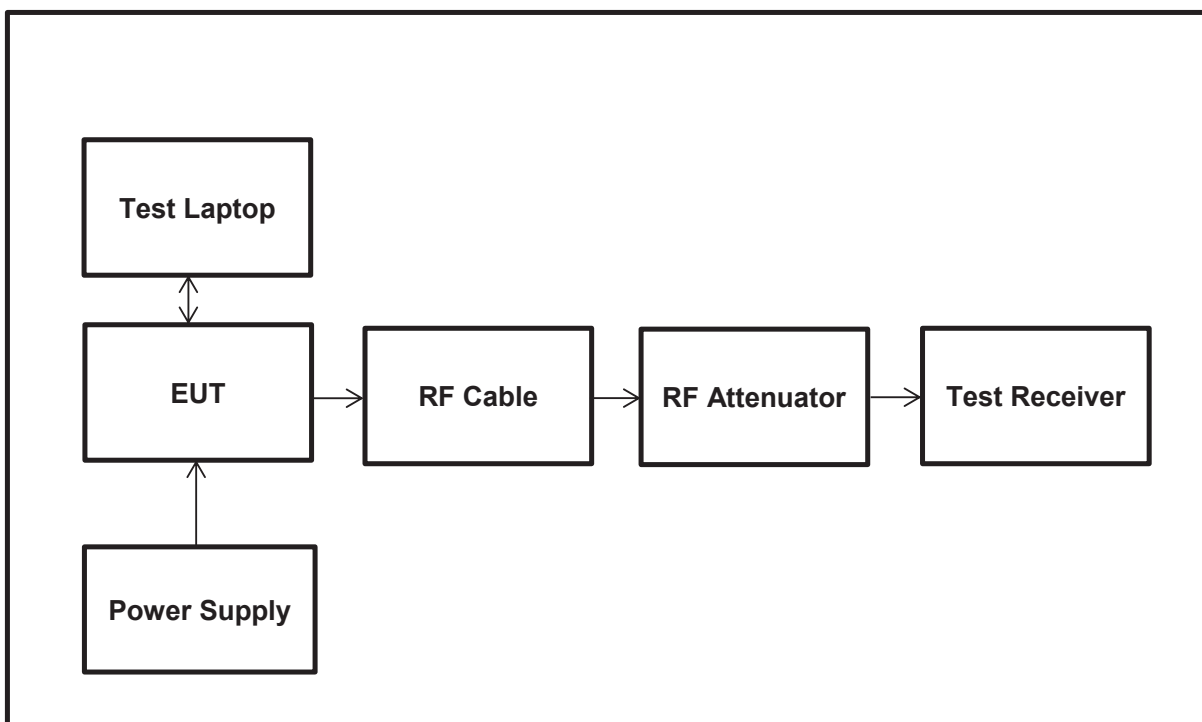

Transmitter Radiated Emissions (continued)**Results: Peak / Bottom Channel 3G + Bottom Channel RFID**

Frequency (MHz)	Antenna Polarization	Level (dB μ V/m)	20 dBc RFID Peak Limit (dB μ V/m)	Margin (dB)	Result
No critical spurious					

Results: Peak / Bottom Channel 3G + Middle Channel RFID

Frequency (MHz)	Antenna Polarization	Level (dB μ V/m)	20 dBc RFID Peak Limit (dB μ V/m)	Margin (dB)	Result
899.958	Vertical	50.6	92.4	41.8	Complied

Results: Peak / Bottom Channel 3G + Top Channel RFID

Frequency (MHz)	Antenna Polarization	Level (dB μ V/m)	20 dBc RFID Peak Limit (dB μ V/m)	Margin (dB)	Result
899.958	Vertical	52.4	91.1	38.7	Complied

Results: Peak / Channel 9262 3G + Top Channel RFID

Frequency (MHz)	Antenna Polarization	Level (dB μ V/m)	20 dBc RFID Peak Limit (dB μ V/m)	Margin (dB)	Result
899.630	Horizontal	52.1	90.4	38.3	Complied

Results: Peak / Top Channel 3G + Top Channel RFID

Frequency (MHz)	Antenna Polarization	Level (dB μ V/m)	20 dBc RFID Peak Limit (dB μ V/m)	Margin (dB)	Result
899.958	Vertical	53.0	91.5	38.5	Complied

Transmitter Radiated Emissions (Continued)

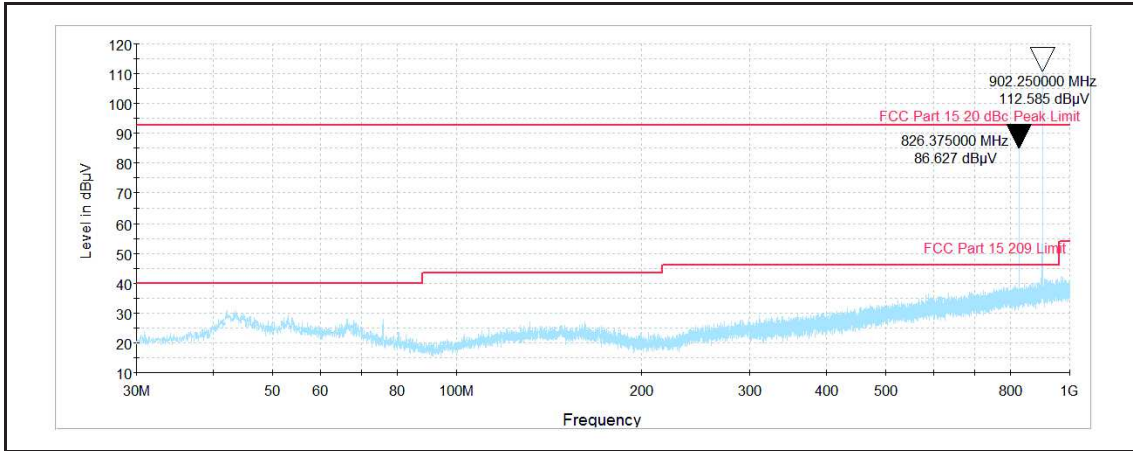

Bottom channel 3G and Bottom channel RFID

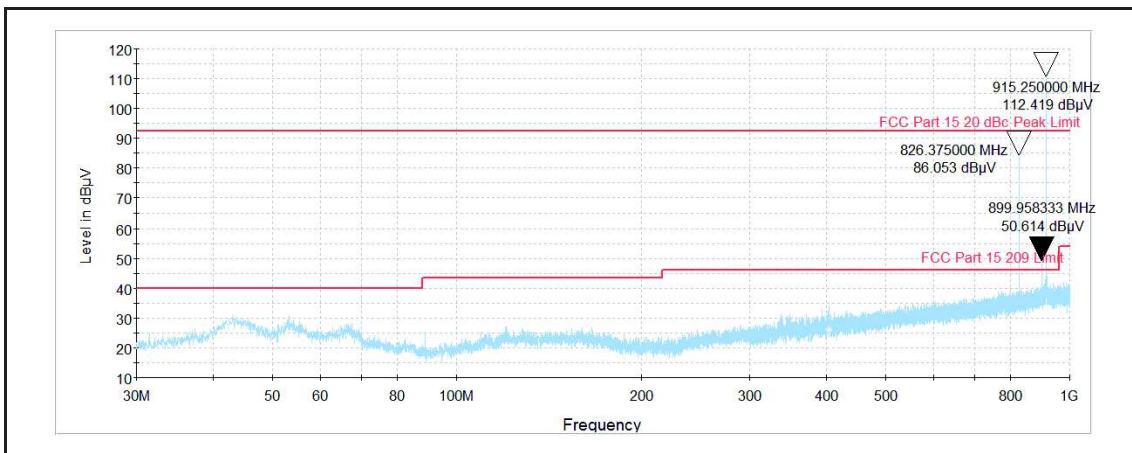

Bottom channel 3G and Middle channel RFID

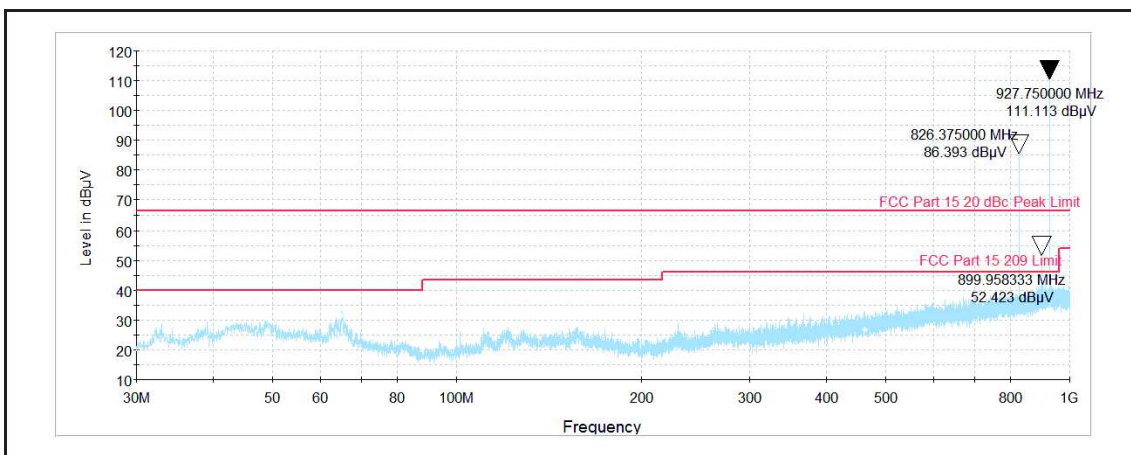

Bottom channel 3G and Top channel RFID

Transmitter Radiated Emissions (Continued)

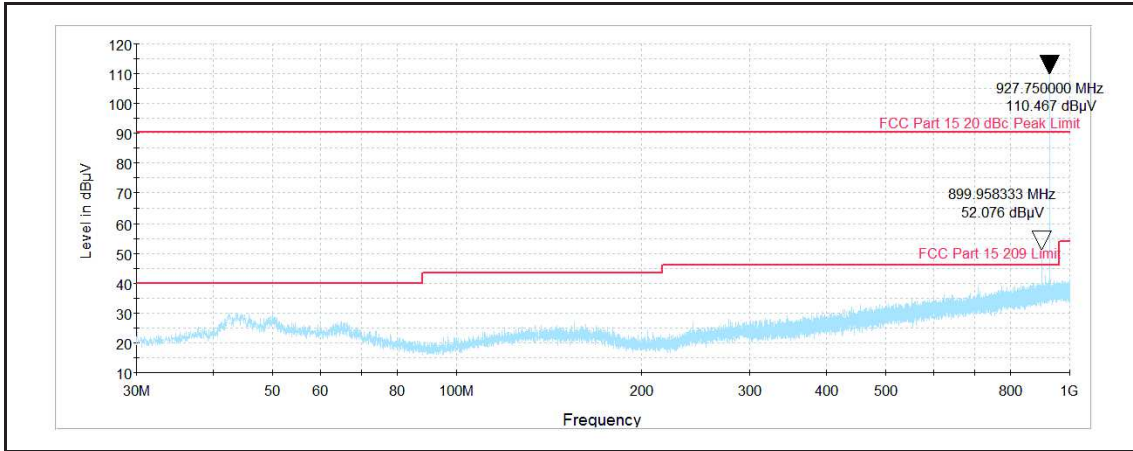

Channel 9262 3G and Top channel RFID

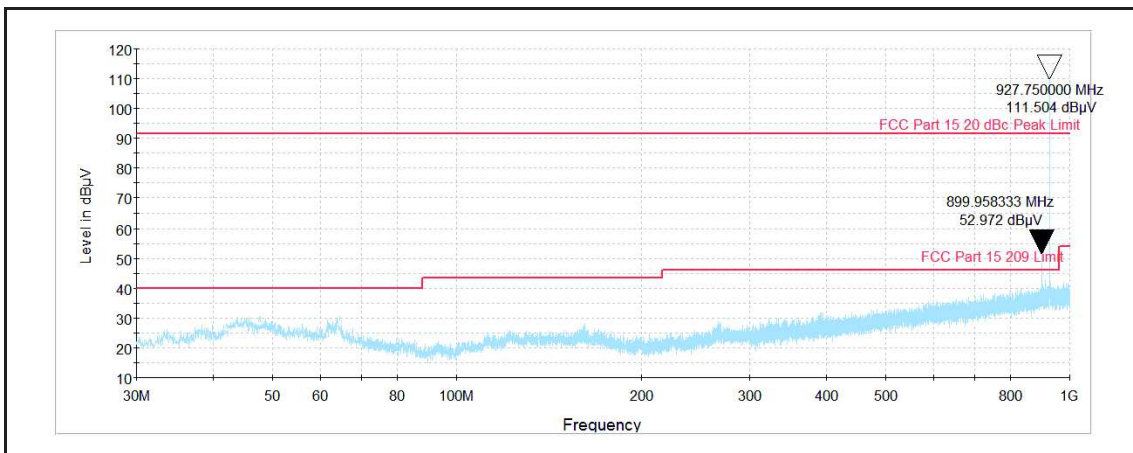

Top channel 3G and Top channel RFID

Test Summary:

Test Engineer:	Abdoufataou Salifou	Test Date:	23 January 2019
Test Sample Serial Number:	GOK4587504		
Test Site Identification	SR 1/2		

FCC Reference:	Part 15.209(a)
Test Method Used:	ANSI C63.10 Sections 6.7 and 7.8.8
Frequency Range	1 GHz to 10 GHz

Environmental Conditions:

Temperature (°C):	21
Relative Humidity (%):	22

Notes:

1. The final measured value, for the given emission, in the table below incorporates the calibrated antenna factor and cable loss.
2. All spurious found were below the FCC Part 15.209 Average Limit.

Test setup:

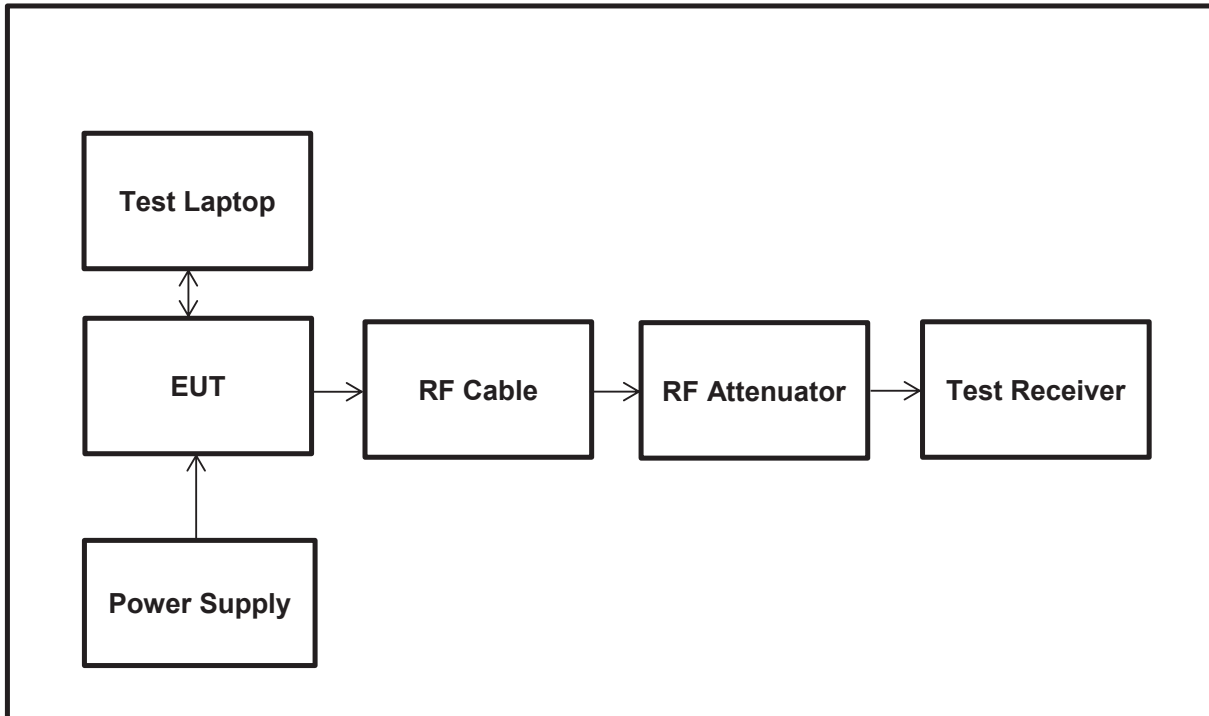

Transmitter Radiated Emissions (continued)**Results: Peak / Bottom Channel 3G + Bottom Channel RFID**

Frequency (MHz)	Antenna Polarization	Level (dB μ V/m)	Average Limit (dB μ V/m)	Margin (dB)	Result
8961.000	Horizontal	50.9	54.0	3.1	Complied
13878.750	Horizontal	51.2	54.0	2.8	Complied

Results: Peak / Bottom Channel 3G + Middle Channel RFID

Frequency (MHz)	Antenna Polarization	Level (dB μ V/m)	Average Limit (dB μ V/m)	Margin (dB)	Result
9012.333	Vertical	50.5	54.0	3.5	Complied
12419.083	Vertical	50.8	54.0	3.2	Complied

Results: Peak / Bottom Channel 3G + Top Channel RFID

Frequency (MHz)	Antenna Polarization	Level (dB μ V/m)	Average Limit (dB μ V/m)	Margin (dB)	Result
8956.333	Vertical	49.7	54.0	4.3	Complied
12480.958	Vertical	50.8	54.0	3.2	Complied

Results: Peak / Channel 9262 3G + Top Channel RFID

Frequency (MHz)	Antenna Polarization	Level (dB μ V/m)	Average Limit (dB μ V/m)	Margin (dB)	Result
8989.667	Horizontal	50.8	54.0	3.2	Complied
13857.708	Horizontal	51.0	54.0	3.0	Complied

Results: Peak / Top Channel 3G + Top Channel RFID

Frequency (MHz)	Antenna Polarization	Level (dB μ V/m)	Average Limit (dB μ V/m)	Margin (dB)	Result
12474.542	Vertical	50.8	54.0	3.2	Complied

Transmitter Radiated Emissions (Continued)

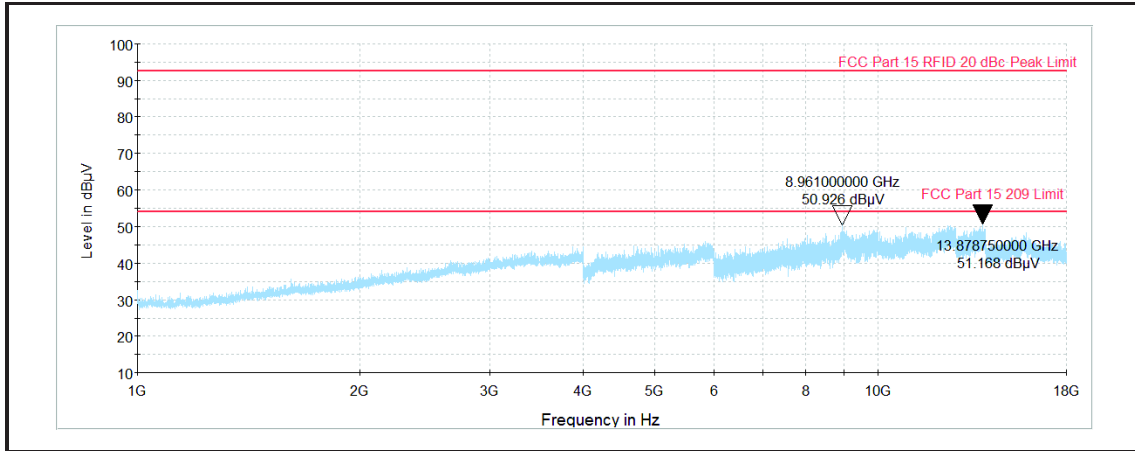

Bottom channel 3G and Bottom channel RFID

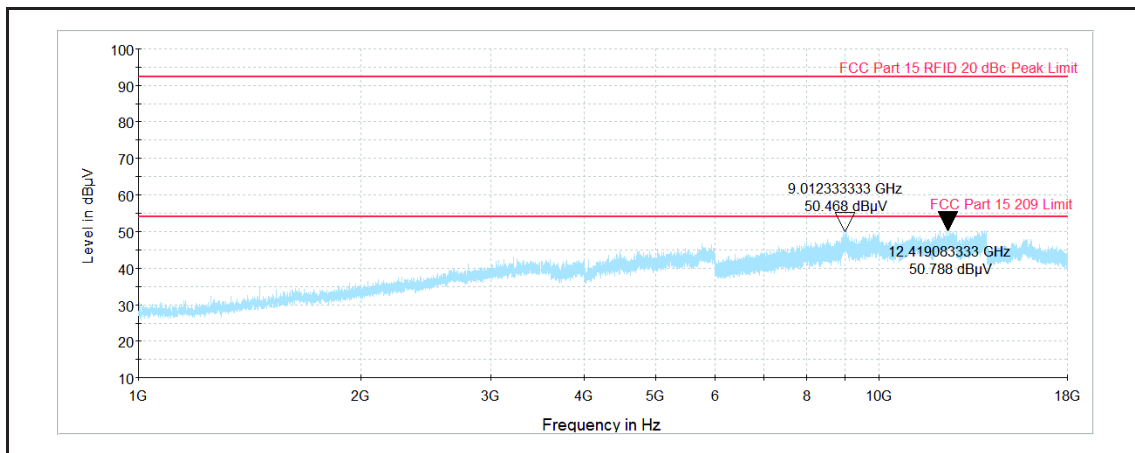

Bottom channel 3G and Middle channel RFID

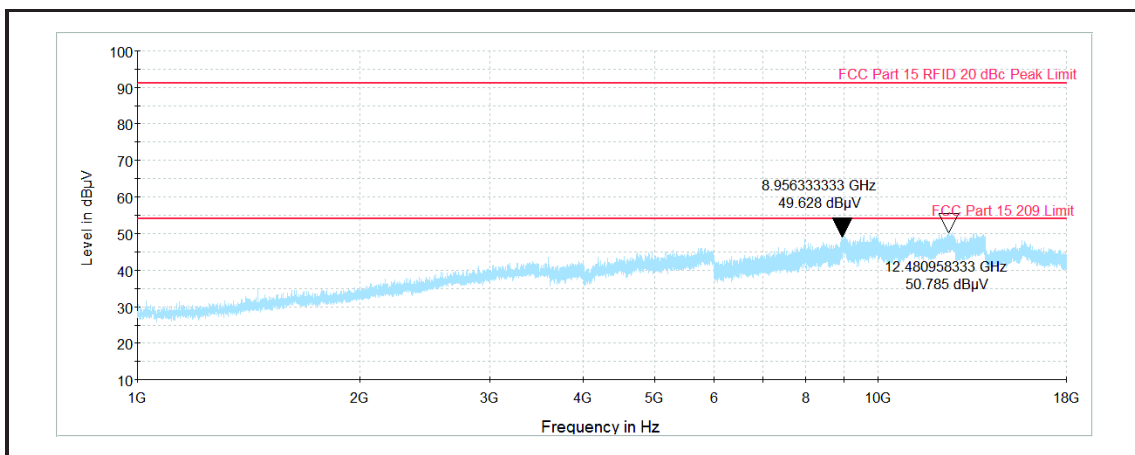

Bottom channel 3G and Top channel RFID

Transmitter Radiated Emissions (Continued)

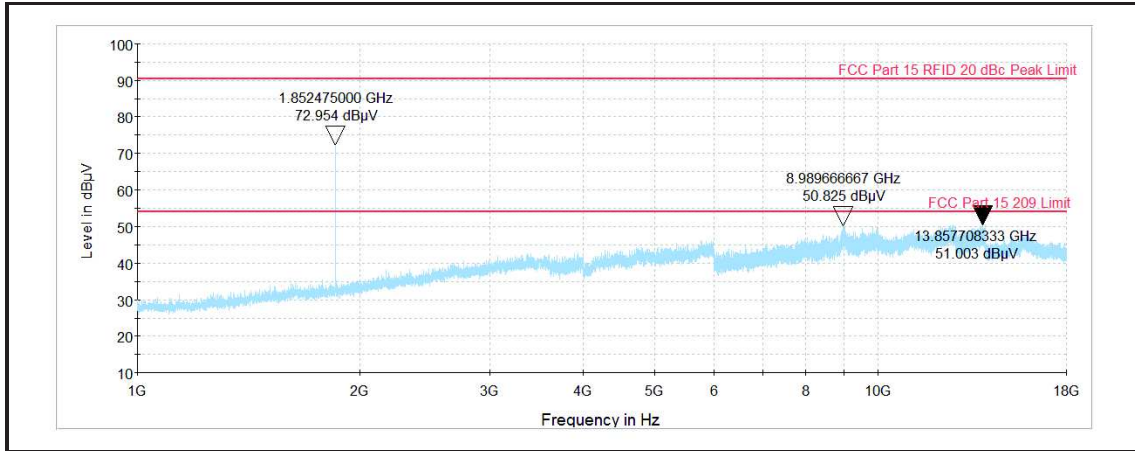

Channel 9262 3G and Top channel RFID

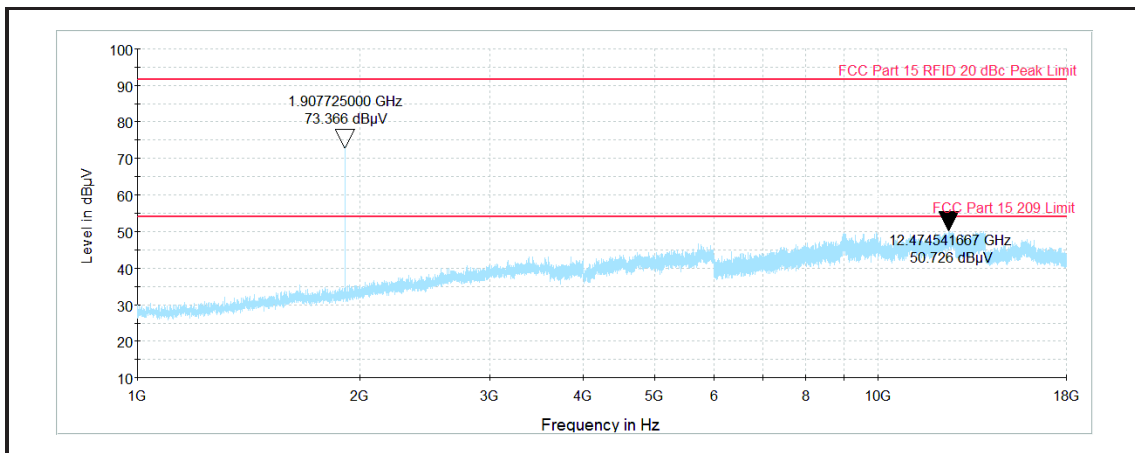

Top channel 3G and Top channel RFID

6. Measurement Uncertainty

The expression of uncertainty of a measurement result allows realistic comparison of results with reference values and limits given in specifications and standards.

The uncertainty of the result may need to be taken into account when interpreting the measurement results.

The reported expanded uncertainties below are based on a standard uncertainty multiplied by an appropriate coverage factor such that a confidence level of approximately 95% is maintained. For the purposes of this document “approximately” is interpreted as meaning “effectively” or “for most practical purposes”.

Measurement Type	Confidence Level (%)	Calculated Uncertainty
AC Conducted Spurious Emissions	95%	±2.49 dB
Radiated Spurious Emissions	95%	±3.10 dB

The methods used to calculate the above uncertainties are in line with those recommended within the various measurement specifications. Where measurement specifications do not include guidelines for the evaluation of measurement uncertainty the published guidance of the appropriate accreditation body is followed.

7. Used equipment

Test site: SR 1/2

ID	Manufacturer	Type	Model	Serial No.	Calibration Date	Cal. Cycle
377	BONN Elektronik	Amplifier, Low Noise Pre	BLMA 0118-1A	025294B	7/12/2018	12
383	Rohde & Schwarz	Antenna, Rod	HFH2-Z1	890151/11	7/14/2017	24
460	Deisl	Turntable	DT 4250 S		n/a	n/a
465	Schwarzbeck	Antenna, Trilog Broadband	VULB 9168	9168-240	8/8/2016	36
474	Agilent	Analyzer, ENA Network	E5071C	MY46100912	7/13/2018	24
496	Rohde & Schwarz	Antenna, log. - periodical	HL050	100297	7/20/2016	24
497	Schwarzbeck	Antenna, Biconical	VHBB 9124	423	7/7/2016	36
587	Maturo	antenna mast, tilting	TAM 4.0-E	011/7180311	n/a	n/a
588	Maturo	Controller	NCD	029/7180311	n/a	n/a
591	Rohde & Schwarz	Receiver	ESU 40	100244/040	7/12/2018	12
608	Rohde & Schwarz	Switch Matrix	OSP 120	101227	4/8/2014	60
614	Wainwright Instruments	Highpass Filter 3GHz	WHKX10-	1	Lab verification	n/a
615	Wainwright Instruments	Highpass Filter 1GHz	WHKX12-	3	Lab verification	n/a
628	Maturo	Antenna mast	CAM 4.0-P	224/19590716	n/a	n/a
629	Maturo	Kippeinrichtung	KE 2.5-R-M	MAT002	n/a	n/a

Test site: SR 7/8

ID	Manufacturer	Type	Model	Serial No.	Calibration Date	Cal. Cycle
22	Rohde & Schwarz	Artificial Mains	50 Ohm// 50uH	831767/014	7/11/2018	12
215	Rohde & Schwarz	Artificial Mains Network	9 kHz - 30 MHz; 3 phase	879675/002	7/11/2018	12
349	Rohde & Schwarz	Receiver, EMI Test	20 Hz - 7 GHz	836697/009	7/10/2018	12
616	Rohde & Schwarz	ISN	8 wire ISN for CAT6	101656	7/12/2018	12

8. Report Revision History

Version Number	Revision Details		
	Page No(s)	Clause	Details
1.0	26	-	Initial Version

--- END OF REPORT ---