



TEST REPORT

Test Report No. : UL-RPT-RP11867511-316A V4.0

Customer : Kathrein Sachsen GmbH
Model No. / PMN : ARU3560
HVIN : 52010301
FCC ID : WJ9-ARU3560
ISED Certification No. : IC: 5530C-ARU3560
Technologies : RFID (902 MHz to 928 MHz) &
WLAN (2400 MHz to 2483.5 MHz)
Test Standard(s) : FCC Parts 15.209(a) & 15.247(d)
ISED Canada RSS-247 5.5 &
RSS-Gen 6.13
Test Laboratory : UL VS LTD, Basingstoke, Hampshire, RG24 8AH, United Kingdom

1. This test report shall not be reproduced in full or partial, without the written approval of UL VS LTD.
2. The results in this report apply only to the sample(s) tested.
3. The sample tested is in compliance with the above standard(s).
4. The test results in this report are traceable to the national or international standards.
5. Version 4.0 supersedes all previous versions.

Date of Issue: 27 March 2019

Checked by: 
Ben Mercer
Senior Test Engineer, Radio Laboratory

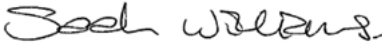
Company Signatory: 
Sarah Williams
Senior Test Engineer, Radio Laboratory
UL VS LTD

This page has been left intentionally blank.

Table of Contents

1. Customer Information.....	4
2. Summary of Testing.....	5
2.1. General information	5
2.2. Summary Of Test Results	5
2.3. Methods and Procedures	5
2.4. Deviations from the Test Specification	5
3. Equipment Under Test (EUT)	6
3.1. Identification of Equipment Under Test (EUT)	6
3.2. Description of EUT	6
3.3. Modifications Incorporated in the EUT	6
3.4. Additional Information Related to Testing	6
3.5. Description of Available Antennas	7
3.6. Support Equipment	7
3.7. Description of Test Setup	8
4. Operation and Monitoring of the EUT during Testing	10
4.1. Operating Modes	10
4.2. Configuration and Peripherals	10
5. Measurements, Examinations and Derived Results.....	11
5.1. General Comments	11
5.2. Test Results	12
5.2.1. Transmitter Out of Band Radiated Emissions - RFID & 2.4 GHz WLAN bottom channel	12
5.2.2. Transmitter Out of Band Radiated Emissions - RFID & 2.4 GHz WLAN top channel	15
6. Measurement Uncertainty	18
7. Report Revision History	19

1. Customer Information

Company Name:	Kathrein Saschen GmbH
Address:	Gewerbegebiet Muehlau, Lindenstrasse 3, Muehlau, 09241 Germany

2. Summary of Testing

2.1. General information

Specification Reference:	47CFR15.247
Specification Title:	Code of Federal Regulations Volume 47 (Telecommunications): Part 15 Subpart C (Intentional Radiators) - Section 15.247
Specification Reference:	47CFR15.209
Specification Title:	Code of Federal Regulations Volume 47 (Telecommunications): Part 15 Subpart C (Intentional Radiators) - Section 15.209
Specification Reference:	RSS-Gen Issue 5 April 2018
Specification Title:	General Requirements for Compliance of Radio Apparatus
Specification Reference:	RSS-247 Issue 2 February 2017
Specification Title:	Digital Transmission Systems (DTSs), Frequency Hopping Systems (FHSs) and Licence-Exempt Local Area Network (LE-LAN) Devices
Site Registration:	FCC: 621311; ISED Canada: 3245B-3 & 3245B-4
Test Dates:	09 January 2018 to 19 January 2018

2.2. Summary Of Test Results

FCC Reference (47CFR)	ISED Canada Reference	Measurement	Result
15.209(a)/15.247(d)	RSS-Gen 6.13 / RSS-247 5.5	Transmitter Out of Band Radiated Emissions	Complied

2.3. Methods and Procedures

Reference:	ANSI C63.10-2013
Title:	American National Standard of Procedures for Compliance Testing of Unlicensed Wireless Devices
Reference:	KDB 558074 D01 DTS Measurement Guidance v05r01 February 11, 2019
Title:	Guidance for Compliance Measurements on Digital Transmission System, Frequency Hopping Spread Spectrum System, and Hybrid System Devices Operating Under Section 15.247 of the FCC Rules

2.4. Deviations from the Test Specification

For the measurements contained within this test report, there were no deviations from, additions to, or exclusions from the test specification identified above.

3. Equipment Under Test (EUT)

3.1. Identification of Equipment Under Test (EUT)

Brand Name:	Kathrein RFID
Model Number / PMN:	ARU3560
Test Sample Serial Number:	G0K4485947
Hardware Version:	52010301
Software Version:	3.01.00
FCC ID:	WJ9-ARU3560
ISED Certification Number:	IC: 5530C-ARU3560

3.2. Description of EUT

The EUT was a UHF RFID Reader System incorporating *Bluetooth* and 2.4 GHz & 5 GHz WLAN technologies.

3.3. Modifications Incorporated in the EUT

No modifications were applied to the EUT during testing.

3.4. Additional Information Related to Testing

Technology Tested:	RFID
Type of Unit:	Transceiver
Channel Spacing:	500 kHz
Transmit Frequency Range:	902 MHz to 928 MHz
Transmit Frequency Tested	902.75 MHz

Technology Tested:	WLAN (IEEE 802.11g) / Digital Transmission System	
Channel Spacing:	20 MHz	
Modulation:	BPSK	
Data Rate:	802.11g HT20 (SISO)	
Transmit Frequency Range:	2412 MHz to 2472 MHz	
Transmit Channels Tested:	Channel Number	Channel Frequency (MHz)
	1	2412
	11	2462

3.5. Description of Available Antennas

The EUT utilizes integrated patch antennas for the RFID and WLAN band with the following maximum gains. The EUT also supports 3 external antennas which were not supplied.

Antenna Port	Antenna Gain (dBi)
RFID Antenna	6.0
2.4 GHz WLAN Antenna	3.2

3.6. Support Equipment

The following support equipment was used to exercise the EUT during testing:

Description:	Laptop PC
Brand Name:	Lenovo
Model Name or Number:	E555
Serial Number:	N0599

Description:	Ethernet Cable. Length 5 metres
Brand Name:	Not marked or stated
Model Name or Number:	Not marked or stated
Serial Number:	Not marked or stated

Description:	R-AC TNC-TNCR Antenna cable x2. Length 3 metres
Brand Name:	Not marked or stated
Model Name or Number:	Not marked or stated
Serial Number:	Not marked or stated

Description:	Power Supply. 120 VAC Input / 24 VDC output
Brand Name:	Meanwell
Model Name or Number:	GST90A24-P1M
Serial Number:	EB79F8S440

Description:	Ethernet 5 port Switch
Brand Name:	Netgear
Model Name or Number:	GS605
Serial Number:	1YG194390218E

3.7. Description of Test Setup

Test Setup for Transmitter Radiated Emissions

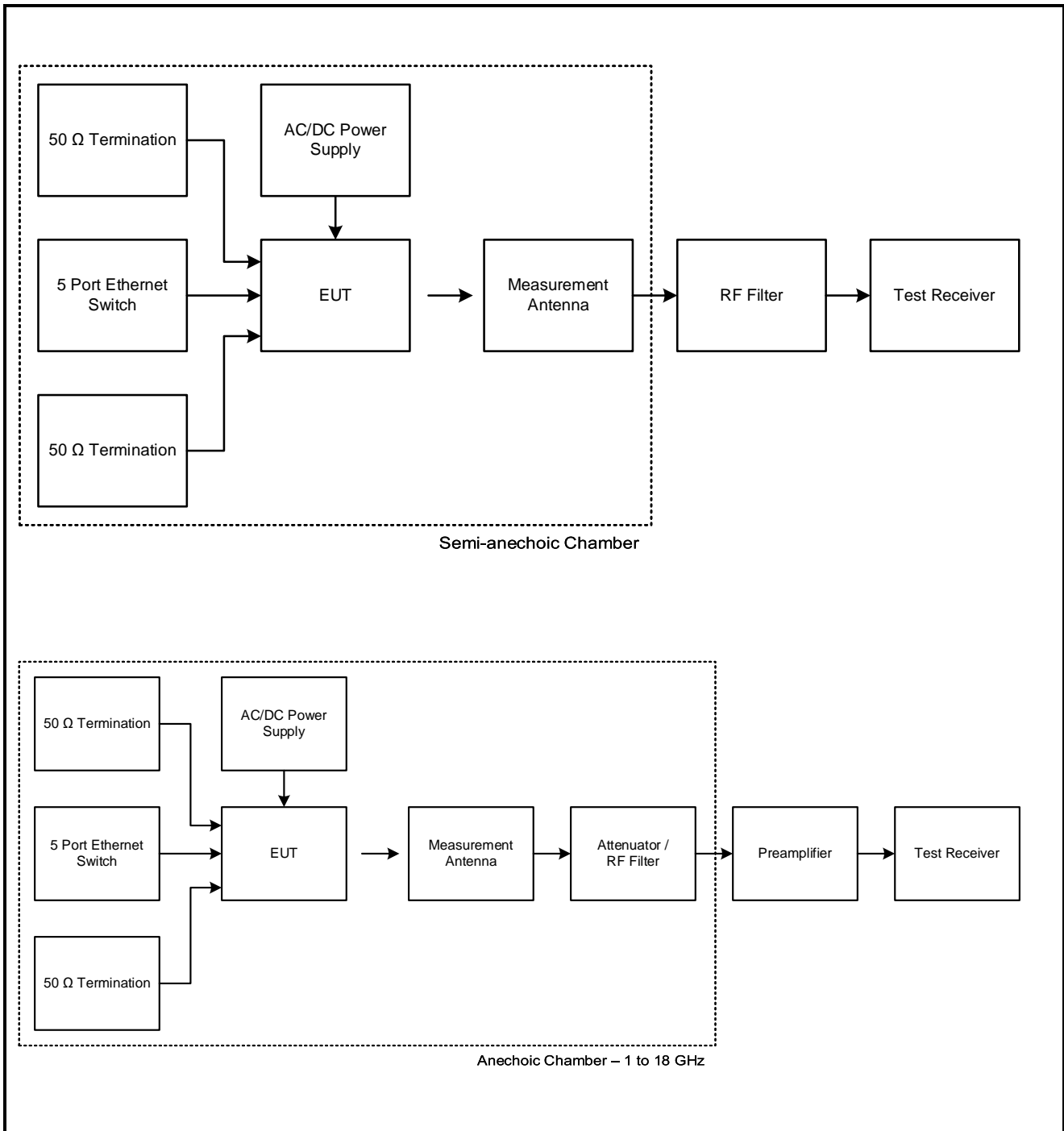

Test Setup for Transmitter Radiated Emissions (continued)

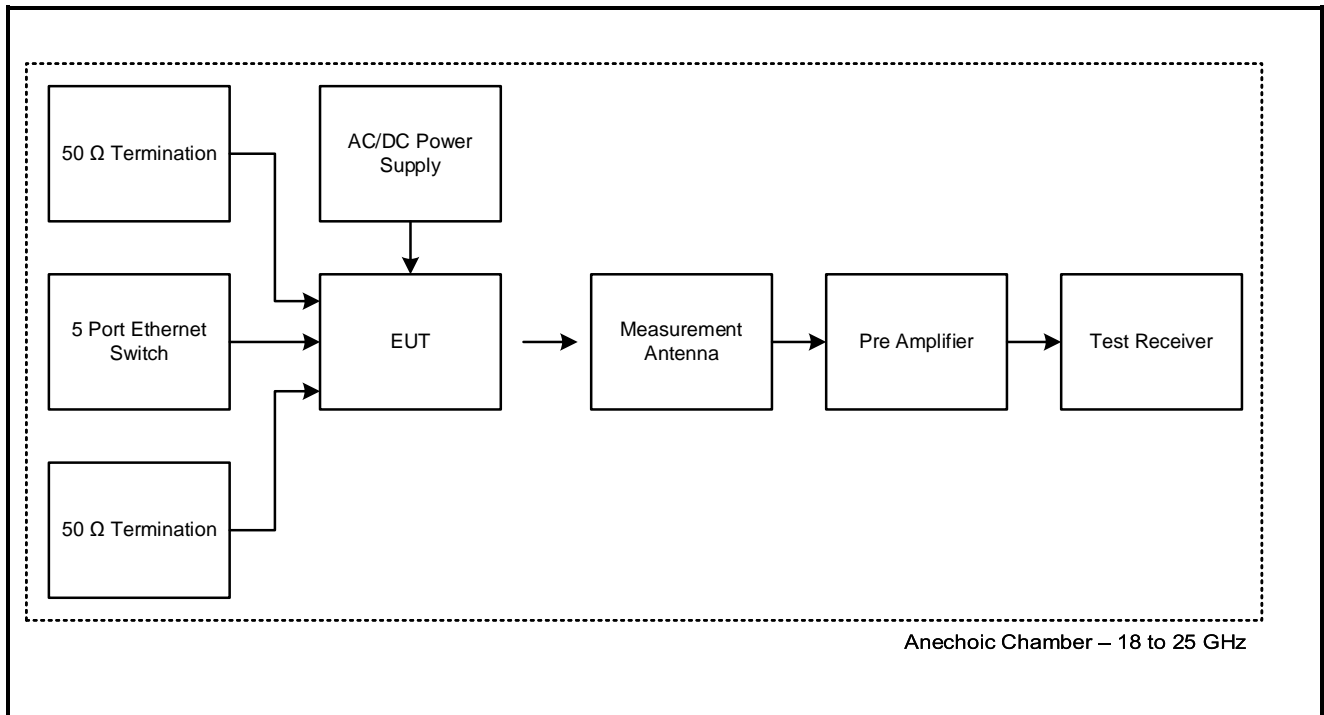

4. Operation and Monitoring of the EUT during Testing

4.1. Operating Modes

The EUT was tested in the following operating mode(s):

- Transmitting at maximum power on 902.75 MHz RFID and bottom and top channels of 2.4 GHz bands.
- 2.4 GHz WLAN was selected as the worst case as it has higher power than *Bluetooth*.
- The customer declared the worst case 2.4 GHz WLAN mode as 802.11g 6 Mbps 20 MHz channel.

4.2. Configuration and Peripherals

The EUT was tested in the following configuration(s):

- Controlled using a bespoke application supplied by the customer and installed on a laptop PC. The application was used to enable a continuous transmission of both RFID and 2.4 GHz modes and to select the test channels as required. The customer supplied a document containing the setup instructions ‘____RJ ARU Instructions READY’. The laptop PC was connected to the EUT via an Ethernet connection.
- RFID and 2.4 GHz WLAN co-location, with the EUT configured to simultaneously transmit two signals at maximum output power (RFID 902.75 MHz and 2.4 GHz WLAN on bottom channel).
- RFID and 2.4 GHz WLAN co-location, with the EUT configured to simultaneously transmit two signals at maximum output power (RFID 902.75 MHz and 2.4 GHz WLAN on top channel).
- The EUT was powered via an AC/DC switch mode power supply.
- Two of the external antenna ports were terminated into 50 ohm using the customer supplied antenna cables.

5. Measurements, Examinations and Derived Results

5.1. General Comments

Measurement uncertainties are evaluated in accordance with current best practice. Our reported expanded uncertainties are based on standard uncertainties, which are multiplied by an appropriate coverage factor to provide a statistical confidence level of approximately 95%. Please refer to Section 6. Measurement Uncertainty for details.

In accordance with UKAS requirements all the measurement equipment is on a calibration schedule. All equipment was within the calibration period on the date of testing.

5.2. Test Results

5.2.1. Transmitter Out of Band Radiated Emissions - RFID & 2.4 GHz WLAN bottom channel

Test Summary:

Test Engineer:	John Ferdinand	Test Dates:	09 January 2018 & 19 January 2018
Test Sample Serial Number:	G0K4485947		

FCC Reference:	Parts 15.209(a) / 15.247(d)
ISED Canada Reference:	RSS-Gen 6.13 / RSS-247 5.5
Test Method Used:	KDB 558074 & ANSI C63.10 Sections 6.3, 6.5 and 6.6
Frequency Range:	30 MHz to 25 GHz
Configuration:	RFID and 2.4 GHz WLAN bottom channel

Environmental Conditions:

Temperature (°C):	21 to 23
Relative Humidity (%):	33 to 35

Note(s):

- All intermodulation products were below the noise floor level or greater than 20 dB from the specification limit.
- The RFID uplink is not shown in the 30 MHz to 1 GHz plots as a notch filter is used to prevent overload of test receiver.
- The 2.4 GHz uplink is shown on the 1 GHz to 3 GHz plot.
- Pre-scans were made against the FCC Part 15 general limits for radiated emissions.
- The emission at 4824 MHz is the 2nd harmonic of the 2.4 GHz signal and was therefore not measured.
- Final measurements were made using appropriate RF attenuators and filters where required.
- The test receiver resolution bandwidth was set to 120 kHz and video bandwidth 500 kHz, for measurements below 1 GHz. For measurements above 1 GHz resolution bandwidth was set 1 MHz and video bandwidth 3 MHz, with the sweep time set to auto. Markers were placed on the highest measured level.
- Measurements below 1 GHz were performed in a semi-anechoic chamber (Asset Number K0017) at a distance of 3 metres. The EUT was placed at a height of 80 cm above the reference ground plane in the centre of the chamber turntable. Maximum emission levels were determined by height searching the measurement antenna over the range 1 metre to 4 metres.
- Pre-scans over range 1 GHz – 18 GHz were performed in a fully anechoic chamber (Asset Number K0017) at a distance of 3 metres. The EUT was placed at a height of 1.5 m above the reference ground plane in the centre of the chamber turntable. Maximum emission levels were determined by height searching the measurement antenna over the range 1 metre to 4 metres.
- Pre-scans over range 18 GHz – 25 GHz were performed in a fully anechoic chamber (Asset Number K0002) at a distance of 3 metres. The EUT was placed at a height of 1.5 m above the reference ground plane in the centre of the chamber turntable
- Plots have incorrect job numbers.

Transmitter Out of Band Radiated Emissions - RFID & 2.4 GHz WLAN bottom channel (continued)

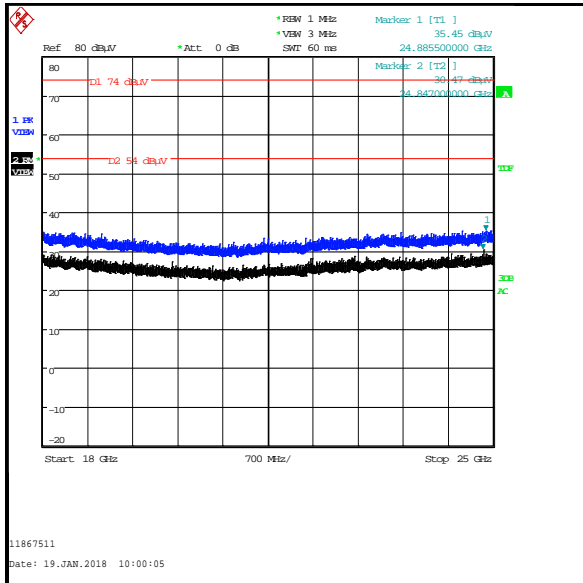

Test Equipment Used:

Asset No.	Instrument	Manufacturer	Type No.	Serial No.	Date Calibration Due	Cal. Interval (Months)
M2003	Thermohygrometer	Testo	608-H1	45046641	22 Feb 2018	12
K0017	3m RSE Chamber	Rainford	N/A	N/A	14 Apr 2018	12
M1995	Test Receiver	Rohde & Schwarz	ESU40	100428	13 Apr 2018	12
A2893	Preamplifier	Schwarzbeck	BBV 9721	9721-021	11 Apr 2018	12
A2889	Antenna	Schwarzbeck	BBHA 9120B	BBHA 9120B653	11 Aug 2018	12
A2888	Antenna	Schwarzbeck	VULB 9163	9163-941	25 Apr 2018	12
A2890	Antenna	Schwarzbeck	HWRD 750	014	11 Apr 2018	12
A2892	Antenna	Schwarzbeck	BBHA 9170	9170-727	11 Apr 2018	12
A2914	High Pass Filter	AtlanTecRF	AFH-03000	2155	06 Mar 2018	12
A2947	High Pass Filter	AtlanTecRF	AFH-07000	160190001	06 Mar 2018	12
M1874	Test Receiver	Rohde & Schwarz	ESU26	100553	28 Nov 2018	12
K0002	3m RSE Chamber	Rainford EMC	N/A	N/A	16 Feb 2018	12
A1551	Notch Filter	Wainright Instruments	WRCT902.6-0.3/40-8EE	2	Calibrated before use	-
M1656	Thermohygrometer	JM Handelspunkt	30.5015.13	Not stated	22 Feb 2018	12

5.2.2. Transmitter Out of Band Radiated Emissions - RFID & 2.4 GHz WLAN top channel**Test Summary:**

Test Engineer:	John Ferdinand	Test Dates:	09 January 2018 & 19 January 2018
Test Sample Serial Number:	G0K4485947		

FCC Reference:	Parts 15.209(a) / 15.247(d)
ISED Canada Reference:	RSS-Gen 6.13 / RSS-247 5.5
Test Method Used:	KDB 558074 & ANSI C63.10 Sections 6.3, 6.5 and 6.6
Frequency Range:	30 MHz to 40 GHz
Configuration:	RFID and 2.4 GHz WLAN top channel

Environmental Conditions:

Temperature (°C):	21 to 23
Relative Humidity (%):	33 to 35

Note(s):

- All intermodulation products were below the noise floor level or greater than 20 dB from the specification limit.
- The RFID uplink is not shown in the 30 MHz to 1 GHz plots as a notch filter is used to prevent overload of test receiver.
- The 2.4 GHz uplink is shown on the 1 GHz to 3 GHz plot.
- Pre-scans were made against the FCC Part 15 general limits for radiated emissions.
- The emission at 4924 MHz is the 2nd harmonic of the 2.4 GHz signal and was therefore not measured.
- Final measurements were made using appropriate RF attenuators and filters where required.
- The test receiver resolution bandwidth was set to 120 kHz and video bandwidth 500 kHz, for measurements below 1 GHz. For measurements above 1 GHz resolution bandwidth was set 1 MHz and video bandwidth 3 MHz, with the sweep time set to auto. Markers were placed on the highest measured level.
- Measurements below 1 GHz were performed in a semi-anechoic chamber (Asset Number K0017) at a distance of 3 metres. The EUT was placed at a height of 80 cm above the reference ground plane in the centre of the chamber turntable. Maximum emission levels were determined by height searching the measurement antenna over the range 1 metre to 4 metres.
- Pre-scans over range 1 GHz – 18 GHz were performed in a fully anechoic chamber (Asset Number K0017) at a distance of 3 metres. The EUT was placed at a height of 1.5 m above the reference ground plane in the centre of the chamber turntable. Maximum emission levels were determined by height searching the measurement antenna over the range 1 metre to 4 metres.
- Pre-scans over range 18 GHz – 25 GHz were performed in a fully anechoic chamber (Asset Number K0002) at a distance of 3 metres. The EUT was placed at a height of 1.5 m above the reference ground plane in the centre of the chamber turntable
- Plots have incorrect job numbers.

Transmitter Out of Band Radiated Emissions - RFID & 2.4 GHz WLAN top channel (continued)

Results:

Frequency (MHz)	Antenna Polarity	Level (dBμV/m)	Limit (dBμV/m)	Margin (dB)	Result
See note 1					

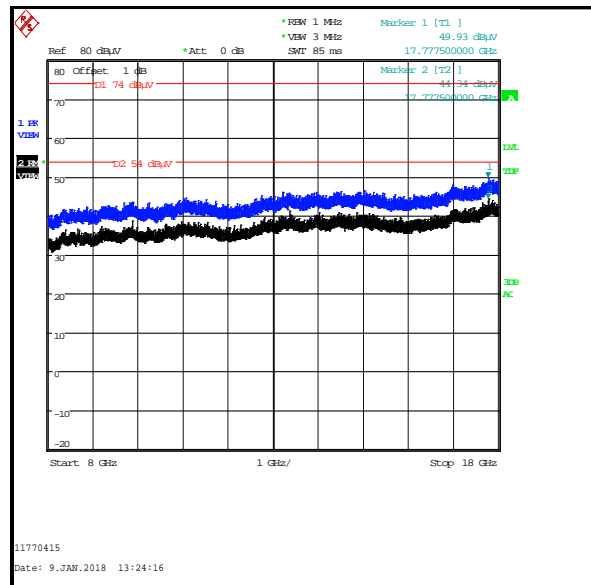
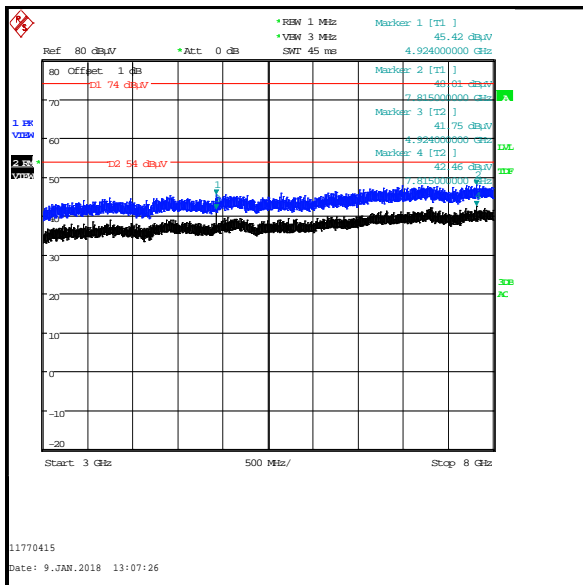
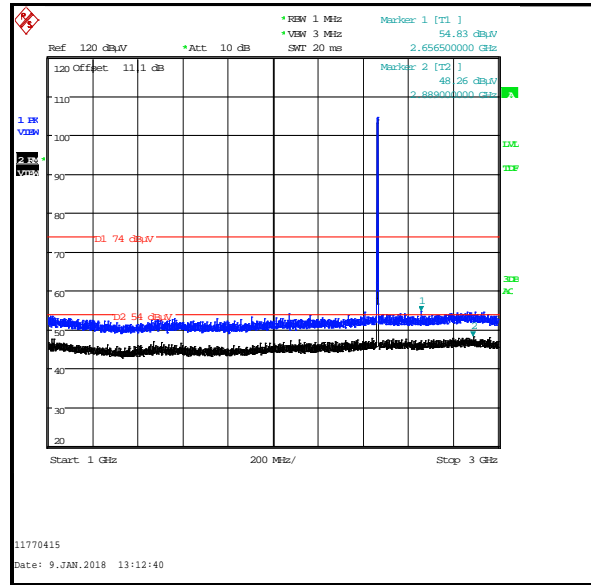
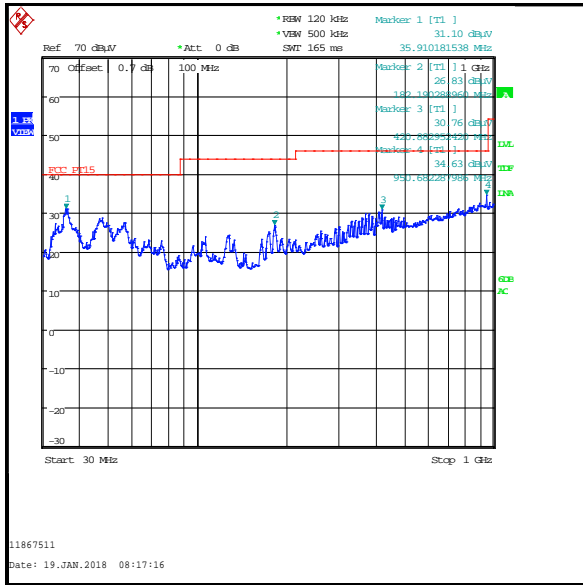

**Transmitter Out of Band Radiated Emissions - RFID & 2.4 GHz WLAN top channel
(continued)**

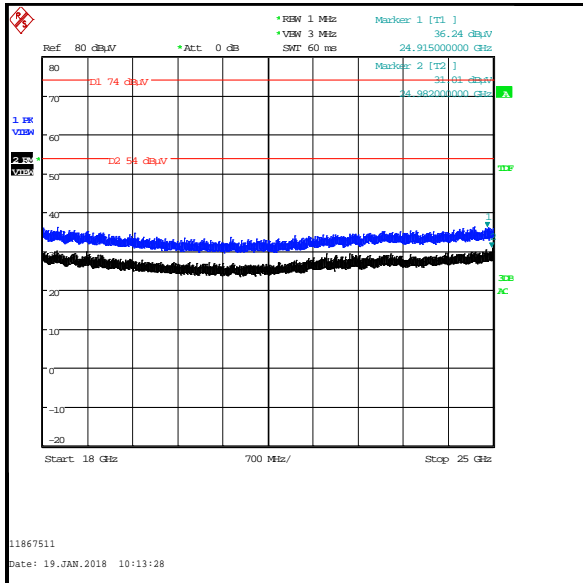

Test Equipment Used:

Asset No.	Instrument	Manufacturer	Type No.	Serial No.	Date Calibration Due	Cal. Interval (Months)
M2003	Thermohyrometer	Testo	608-H1	45046641	22 Feb 2018	12
K0017	3m RSE Chamber	Rainford	N/A	N/A	14 Apr 2018	12
M1995	Test Receiver	Rohde & Schwarz	ESU40	100428	13 Apr 2018	12
A2893	Preamplifier	Schwarzbeck	BBV 9721	9721-021	11 Apr 2018	12
A2889	Antenna	Schwarzbeck	BBHA 9120B	BBHA 9120B653	11 Aug 2018	12
A2888	Antenna	Schwarzbeck	VULB 9163	9163-941	25 Apr 2018	12
A2890	Antenna	Schwarzbeck	HWRD 750	014	11 Apr 2018	12
A2892	Antenna	Schwarzbeck	BBHA 9170	9170-727	11 Apr 2018	12
A2914	High Pass Filter	AtlanTecRF	AFH-03000	2155	06 Mar 2018	12
A2947	High Pass Filter	AtlanTecRF	AFH-07000	160190001	06 Mar 2018	12
M1874	Test Receiver	Rohde & Schwarz	ESU26	100553	28 Nov 2018	12
K0002	3m RSE Chamber	Rainford EMC	N/A	N/A	16 Feb 2018	12
A1551	Notch Filter	Wainright Instruments	WRCT902.6-0.3/40-8EE	2	Calibrated before use	-
M1656	Thermohyrometer	JM Handelpunkt	30.5015.13	Not stated	22 Feb 2018	12

6. Measurement Uncertainty

No measurement or test can ever be perfect and the imperfections give rise to error of measurement in the results. Consequently the result of a measurement is only an approximation to the value of the measurand (the specific quantity subject to measurement) and is only complete when accompanied by a statement of the uncertainty of the approximation.

The expression of uncertainty of a measurement result allows realistic comparison of results with reference values and limits given in specifications and standards.

The uncertainty of the result may need to be taken into account when interpreting the measurement results.

The reported expanded uncertainties below are based on a standard uncertainty multiplied by an appropriate coverage factor such that a confidence level of approximately 95% is maintained. For the purposes of this document “approximately” is interpreted as meaning “effectively” or “for most practical purposes”.

Measurement Type	Range	Confidence Level (%)	Calculated Uncertainty
Radiated Spurious Emissions	30 MHz to 1 GHz	95%	±3.0 dB
Radiated Spurious Emissions	1 GHz to 25 GHz	95%	±2.94 dB

The methods used to calculate the above uncertainties are in line with those recommended within the various measurement specifications. Where measurement specifications do not include guidelines for the evaluation of measurement uncertainty the published guidance of the appropriate accreditation body is followed.

7. Report Revision History

Version Number	Revision Details		
	Page No(s)	Clause	Details
1.0	-	-	Initial Version
2.0	6	3.4	RFID channel spacing corrected.
3.0	-	-	FCC site registration corrected. KDB 558074 and RSS-Gen references updated to the latest versions – no impact on test results.
4.0	7	3.5	Antenna gains corrected.

--- END OF REPORT ---