

编号: Z-PKQG-TWS130-V2

材质: 80g书纸

尺寸: 展开尺寸: 440x166mm 折叠尺寸: 110x83mm



Ace 130 True Wireless Earbuds Model NO.: BTHS-TWS130

Quick Start Guide Schnellanleitung Guide de démarrage rapide Guida Rapida all'uso Guia de iniciación rápida

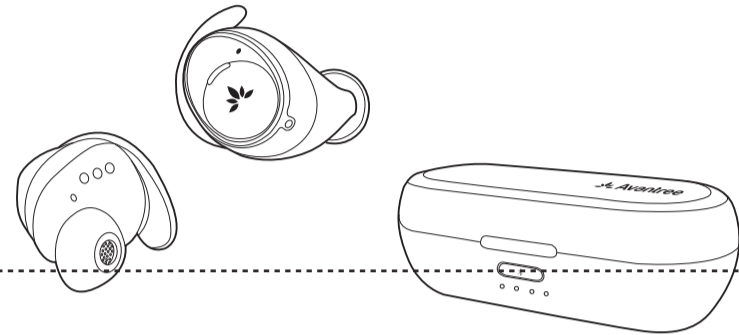

Avantree Center



Download the Avantree Center app to change your Ace 130 multifunction button operations and set your EQ modes.

Box Contents / Box Inhalt / Box Contents / Contenido della confezione / Contenido de la caja

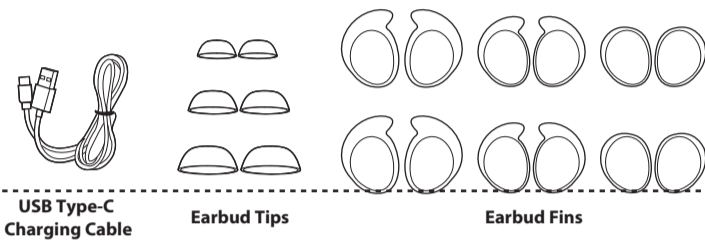
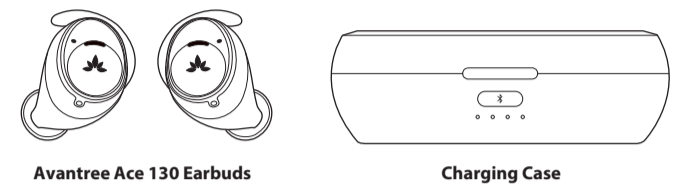

EN: Please contact Avantree Customer Support if you are missing any items listed above... ES: Póngase en contacto con el servicio de atención al cliente de Avantree si le falta alguno de los elementos enumerados anteriormente... IT: Si prega di contattare l'Assistenza clienti Avantree se mancano gli elementi sopra elencati

Product Overview / Produktübersicht / Présentation du produit / Panoramica del Prodotto / Descripción del product

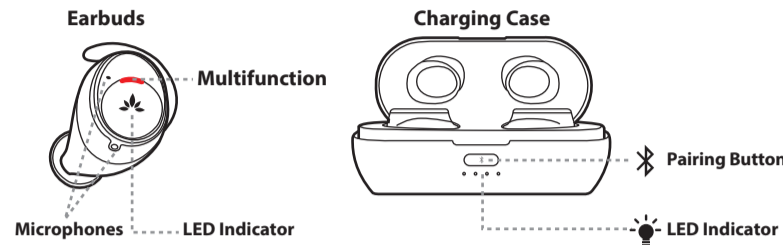

Controls / Kontrollen / Les contrôles / Controllo / Controlar

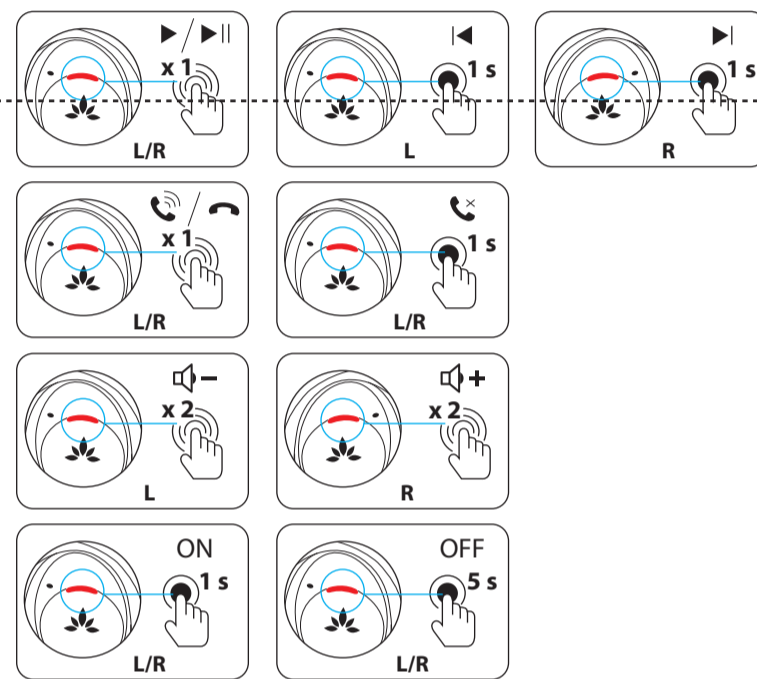

Wearing / Tragen / Portant / Indossare / Desgaste

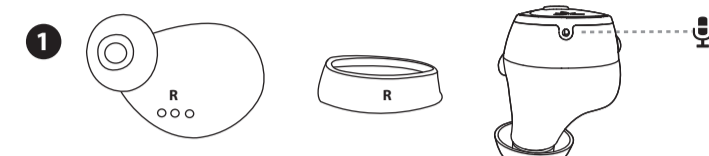

EN: When replacing the earbud fin, make sure you align the holes so the microphone is not covered... DE: Achten Sie beim Ersetzen der Ohrhörerflanke darauf, dass Sie die Löcher so ausrichten, dass das Mikrophon nicht abgedeckt ist... IT: Quando si sostituisce l'alletta dell'auricolare, assicurarsi di allinearla in modo che il microfono non sia coperto

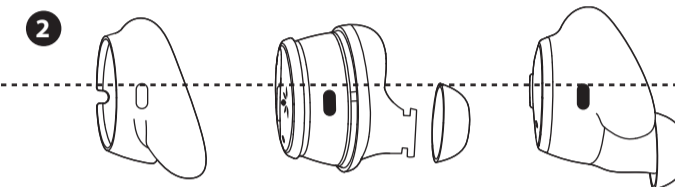

EN: Three sizes of earbud tips to choose from, the M size is already on the earbuds... DE: Drei Größen von Ohrhörerstippen zur Auswahl, die Größe M befindet sich bereits auf den Ohrhörern... IT: Tre dimensioni di punta per auricolari tra cui scegliere, la taglia M è già sugli auricolari

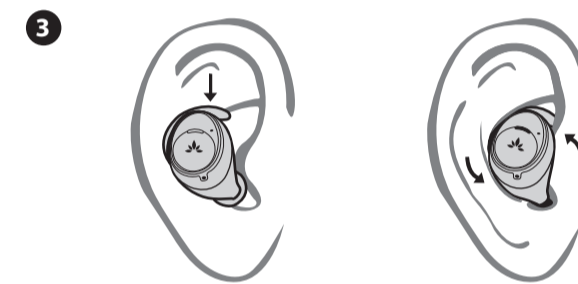

Charging / Aufladen / Mise en charge / Ricarica / Cargando

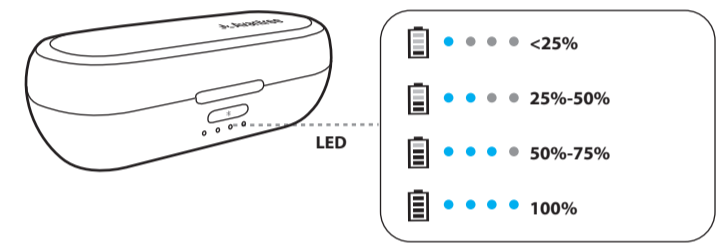
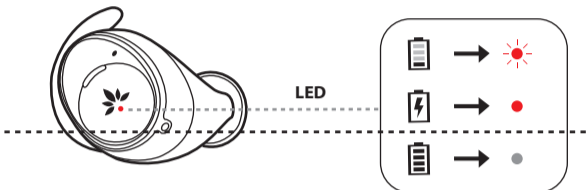
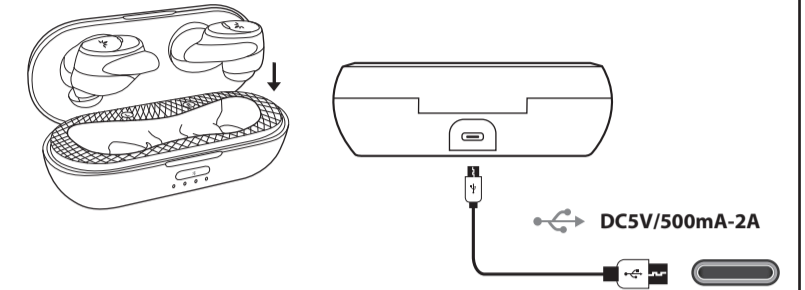

EN: It takes about 1 hour to fully charge the earbuds and 1.5 hours for the case... DE: Das vollständige Aufladen der Ohrhörer dauert ca. 1 Stunde und 1.5 Stunden für das Gehäuse... IT: Ci vuole 1 ora circa per ricaricare gli auricolari completamente e un'ora e mezza per la custodia

1st Time Pairing/ Paarung zum ersten Mal / Emparejamiento, primera vez/ Appairage - Première fois/ La prima volta appaiamento

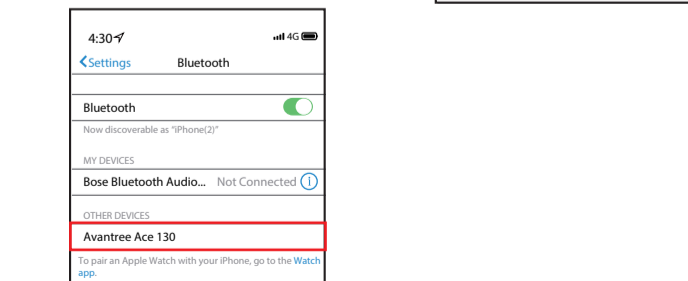
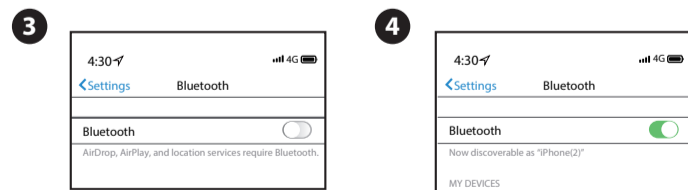
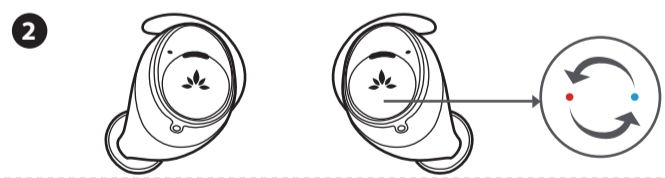
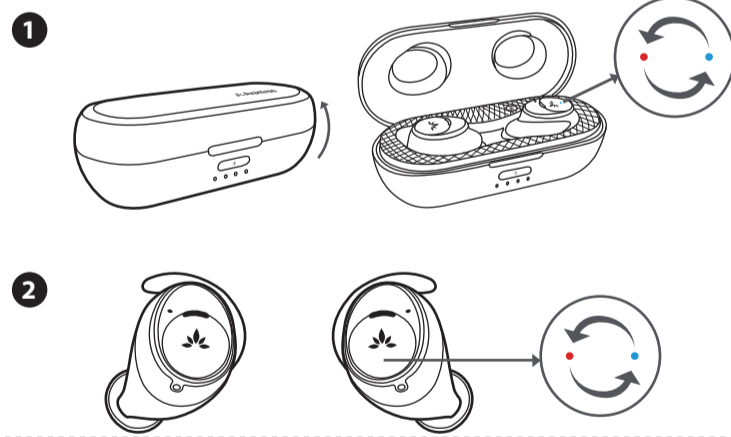

Reconnecting / Wiederverbindung / Reconnectando/ Reconexión / Riconnessione

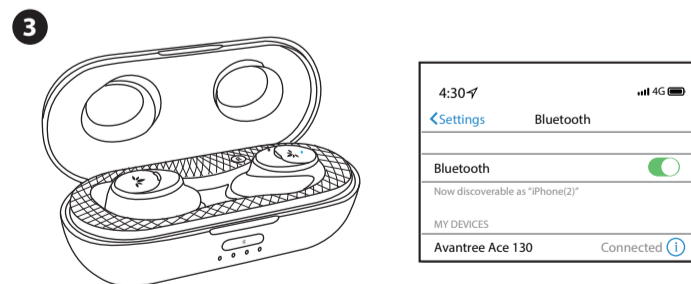
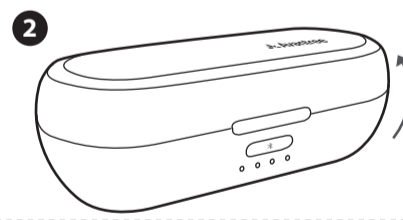
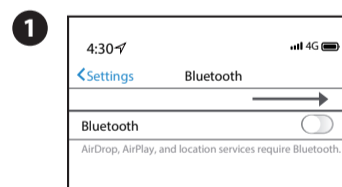

EN: Note: The Ace 130 earbuds will always try to reconnect to the last connected device when you open the case... DE: Hinweis: Die Ace 130-Ohrhörer versuchen immer, die Verbindung zum zuletzt angeschlossenen Gerät wiederherzustellen... IT: Nota: gli auricolari Ace 130 cercheranno sempre di ricollegarsi all'ultimo dispositivo connesso quando aprì la custodia

Pairing to Another Device/ Paarung mit einem anderen Gerät/ Emparejamiento con otro dispositivo/ Appaiamento a un altro dispositivo

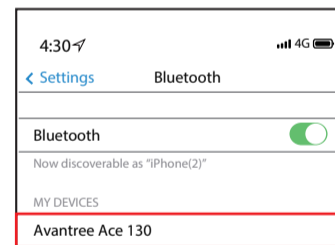
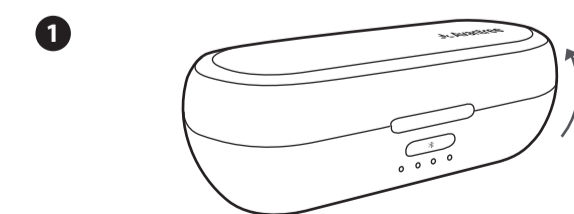

EN: To reconnect manually go to your device's Bluetooth settings and select the Avantree Ace 130... DE: Um die Verbindung manuell wiederherzustellen, rufen Sie die Bluetooth-Einstellungen Ihres Geräts auf und wählen Sie Avantree Ace 130 aus... IT: Per riconnetterli manualmente, vai alle impostazioni Bluetooth del tuo dispositivo e seleziona Avantree Ace 130

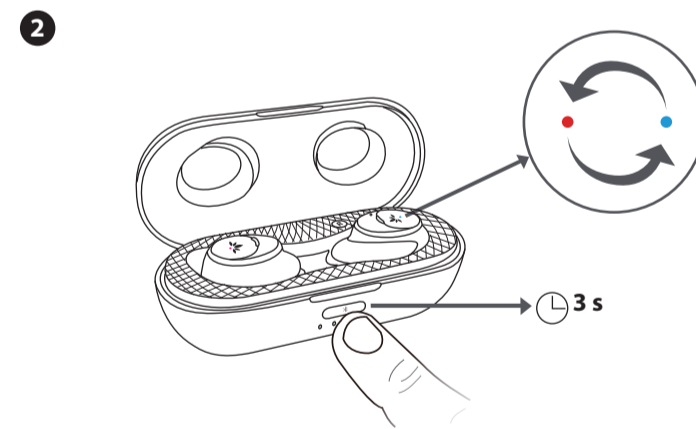

EN: Open the charging case and keep earbuds inside. Press & hold the multifunction button for 3 seconds to enter Ace 130 into Pairing Mode... DE: Öffnen Sie den Ladekoffer und lassen Sie die Ohrhörer im Inneren. Halten Sie die Multifunktions Taste 3 Sekunden lang gedrückt, um Ace 130 in den Pairing-Modus zu versetzen... IT: Aprire la custodia di ricarica e tenere le cuffie all'interno. Apprezze sul pulsante multifunzione e mantenzelo premuto per 3 secondi per attivare la modalità di accoppiamento di Ace 130

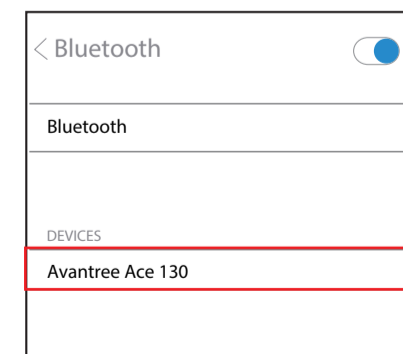

Questions?/Fragen?/ Preguntas?/ Des questions?/ Domande?

- 1. Only hearing out of one earbud / one side sound
2. Lip-Sync / Audio Lag when watching TV

EN: For FAQs or troubleshooting tips go to the URL below... DE: FAQs oder Tipps zur Fehlerbehebung finden Sie unter der folgenden URL... IT: Per domande frequenti o suggerimenti per la risoluzione dei problemi, vai all'URL di seguito

www.support.avantree.com



Avantree www.avantree.com

Email support: support@avantree.com (Response Time: 1 working day) Live chat: www.avantree.com



Z-PKQG-TWS130-V2

FCC Requirement

Any changes or modifications not expressly approved by the party responsible for compliance could void the user's authority to operate the equipment.

This device complies with Part 15 of the FCC Rules. Operation is subject to the following two conditions:

- (1) this device may not cause harmful interference, and
- (2) this device must accept any interference received, including interference that may cause undesired operation.

Note: This equipment has been tested and found to comply with the limits for a Class B digital device, pursuant to Part 15 of the FCC Rules. These limits are designed to provide reasonable protection against harmful interference in a residential installation. This equipment generates, uses, and can radiate radio frequency energy, and if not installed and used in accordance with the instructions, may cause harmful interference to radio communications. However, there is no guarantee that interference will not occur in a particular installation. If this equipment does cause harmful interference to radio or television reception, which can be determined by turning the equipment off and on, the user is encouraged to try to correct the interference by one or more of the following measures:

- Reorient or relocate the receiving antenna.
- Increase the separation between the equipment and receiver.
- Connect the equipment into an outlet on a circuit different from that to which the receiver is connected.
- Consult the dealer or an experienced radio/TV technician for help.