

1. Antenna Description:

Antenna Plate	FPC Antenna
Antenna peak gain	0 dBi
Frequency range	2.402MHz~2.480MHz
Brand	N/A
Manufacturer	Shenzhen Changsheng Electronics Co., Ltd
Antenna Model	N/A

2. Picture of antenna

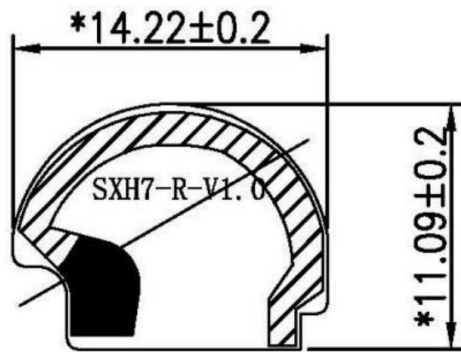

3. Antenna Radiation Pattern  
Radiation pattern @2.400GHz

frequency 频率(MHz)	gain 增益(dBi)	efficiency 效率(dB)	efficiency 效率(%)
2400	-1.64	-5.38	28.94
2440	-0.71	-5.12	30.79
2480	0	-4.74	33.58

Theta=90 freq=2400MHz

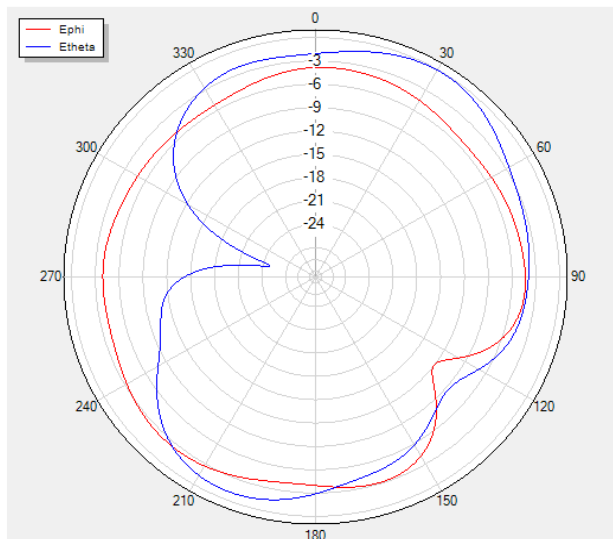

## Phi=90 freq=2400MHz

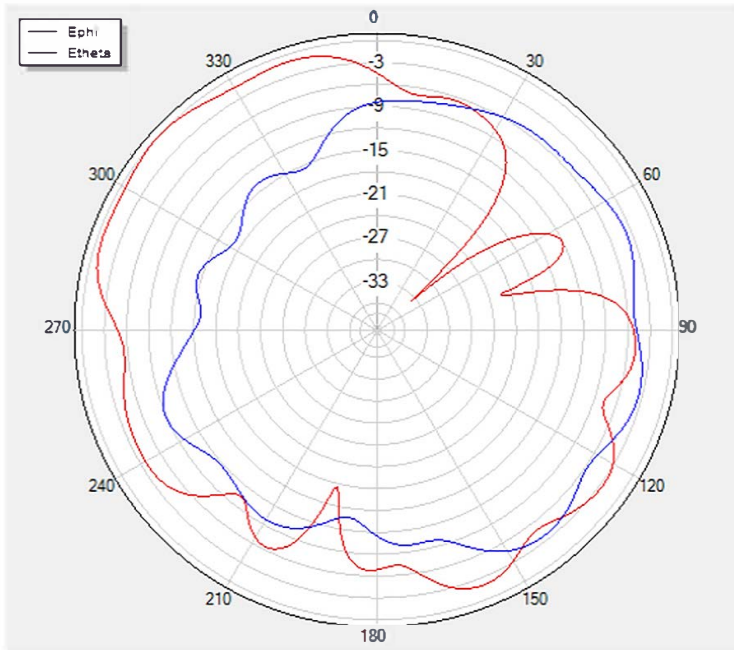

## Phi=0 freq=2400MHz

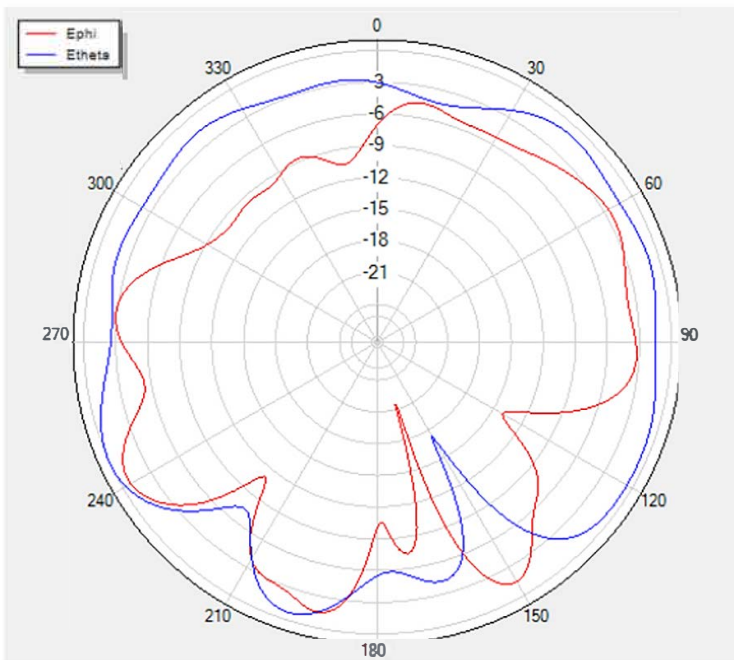

Radiation pattern @2.440GHz

## Theta=90 freq=2440MHz

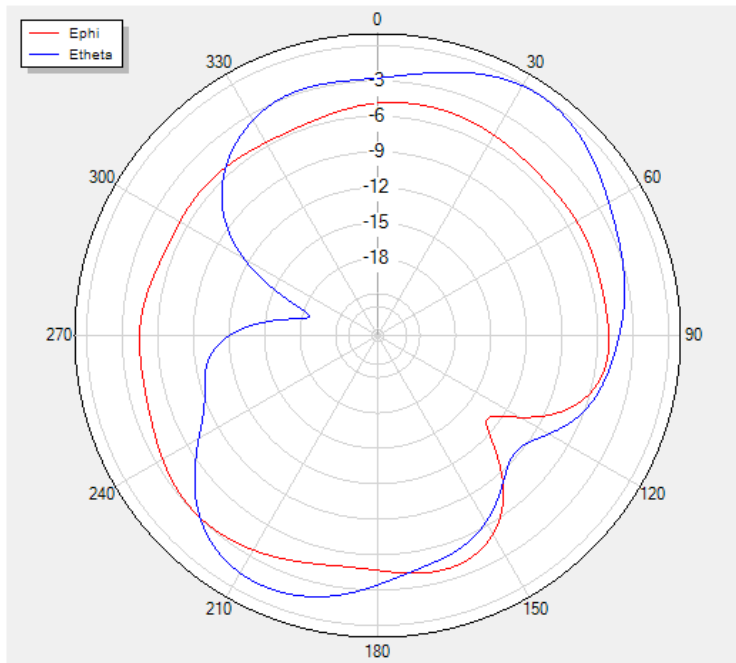

## Phi=90 freq=2440MHz

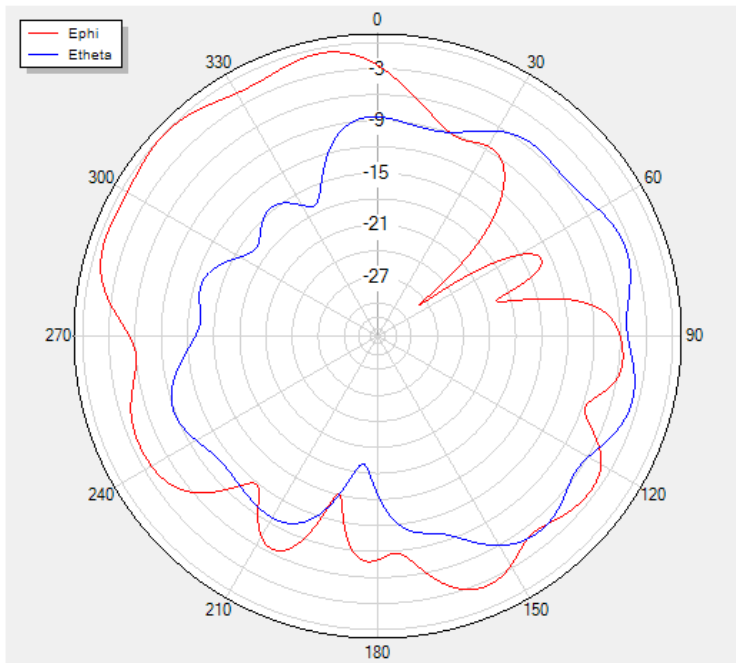

# Phi=0 freq=2440MHz

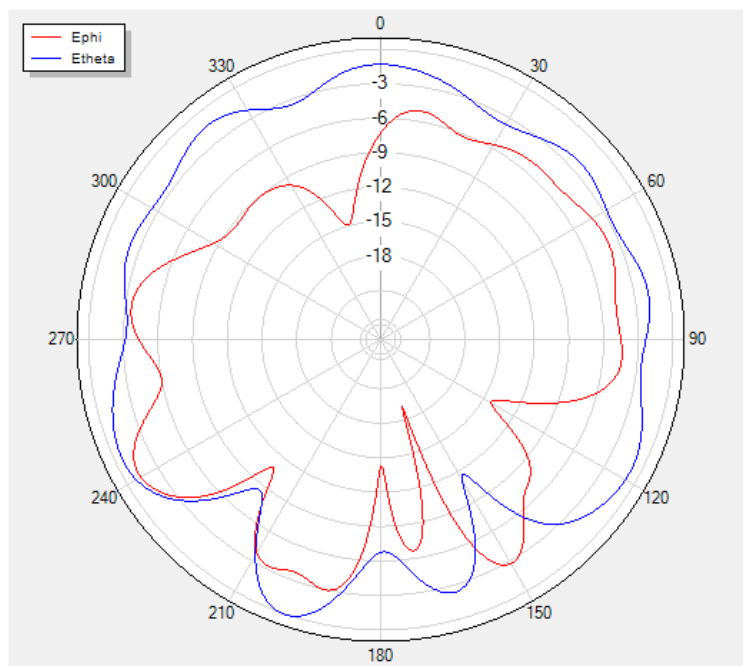

2400MHz

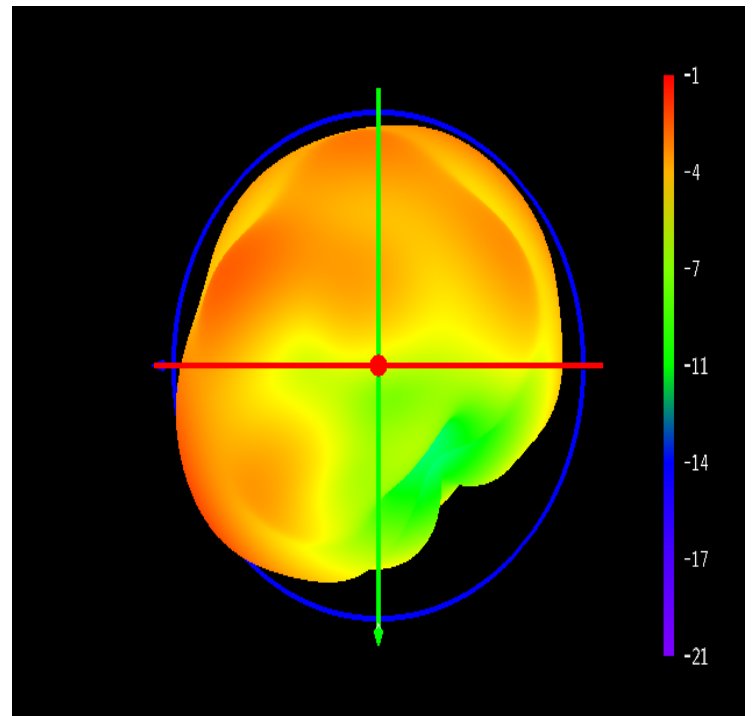
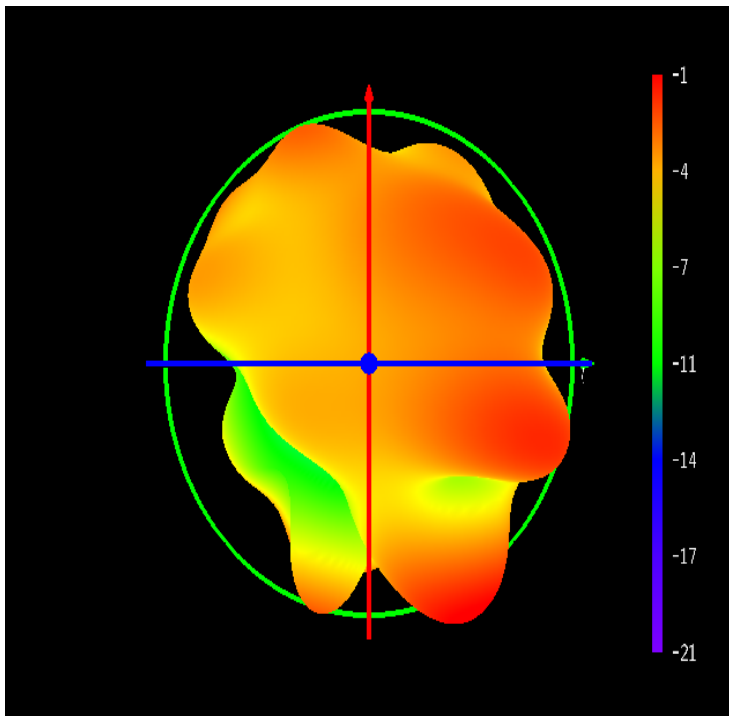
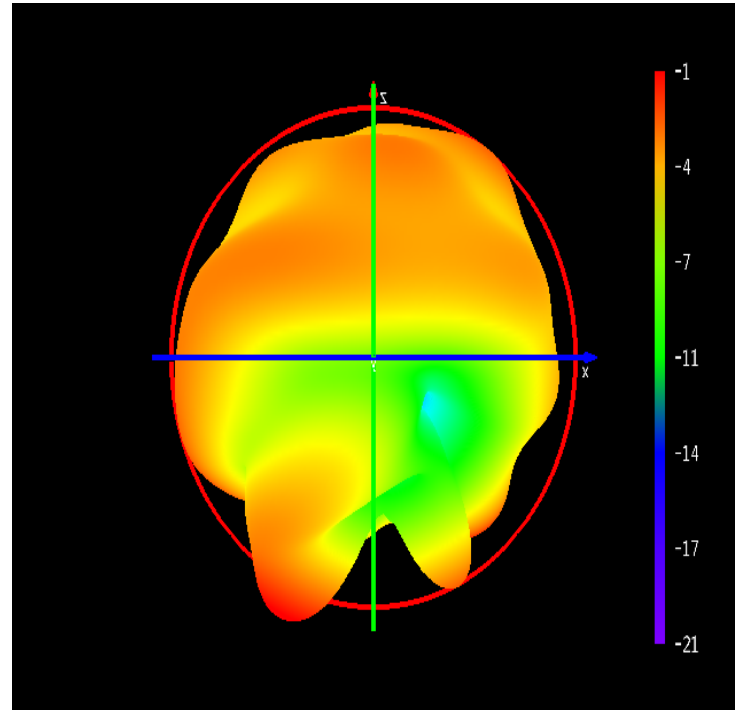
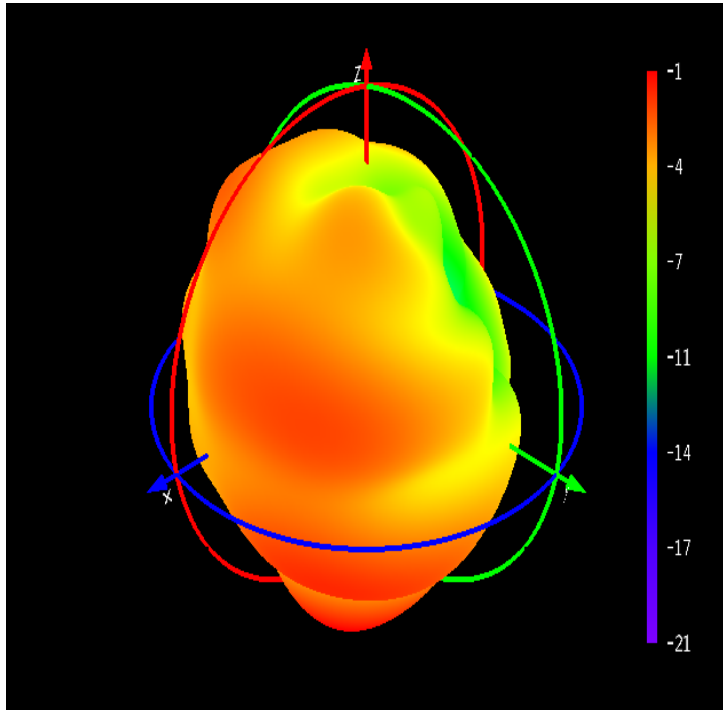

# 2440MHz

