

FCC Test Report

Report No.: RF191209C13

FCC ID: WIYUPT1000-BV

Test Model: UPT1000B

Received Date: Dec. 09, 2019

Test Date: Feb. 17 ~ Feb. 19, 2020

Issued Date: Feb. 26, 2020

Applicant: CASTLES TECHNOLOGY CO., LTD.

Address: 6F, NO. 207-5, SEC. 3, BEIXIN RD., XINDIAN DISTRICT, NEW TAIPEI CITY 23143, TAIWAN (R. O. C.)

Issued By: Bureau Veritas Consumer Products Services (H.K.) Ltd., Taoyuan Branch
Lin Kou Laboratories

Lab Address: No. 47-2, 14th Ling, Chia Pau Vil., Lin Kou Dist., New Taipei City, Taiwan

Test Location: No. 19, Hwa Ya 2nd Rd., Wen Hwa Vil., Kwei Shan Dist., Taoyuan City
33383, TAIWAN

**FCC Registration /
Designation Number:** 788550 / TW0003



This report is for your exclusive use. Any copying or replication of this report to or for any other person or entity, or use of our name or trademark, is permitted only with our prior written permission. This report sets forth our findings solely with respect to the test samples identified herein. The results set forth in this report are not indicative or representative of the quality or characteristics of the lot from which a test sample was taken or any similar or identical product unless specifically and expressly noted. Our report includes all of the tests requested by you and the results thereof based upon the information that you provided to us. You have 60 days from date of issuance of this report to notify us of any material error or omission caused by our negligence, provided, however, that such notice shall be in writing and shall specifically address the issue you wish to raise. A failure to raise such issue within the prescribed time shall constitute your unqualified acceptance of the completeness of this report, the tests conducted and the correctness of the report contents. Unless specific mention, the uncertainty of measurement has been explicitly taken into account to declare the compliance or non-compliance to the specification. The report must not be used by the client to claim product certification, approval, or endorsement by TAF or any government agencies.

Table of Contents

Release Control Record	4
1 Certificate of Conformity	5
2 Summary of Test Results	6
2.1 Measurement Uncertainty.....	6
2.2 Modification Record.....	6
3 General Information	7
3.1 General Description of EUT.....	7
3.2 Description of Test Modes.....	8
3.2.1 Test Mode Applicability and Tested Channel Detail.....	9
3.3 Description of Support Units.....	10
3.3.1 Configuration of System under Test.....	10
3.4 General Description of Applied Standards and References.....	11
4 Test Types and Results	12
4.1 Radiated Emission and Bandedge Measurement.....	12
4.1.1 Limits of Radiated Emission and Bandedge Measurement.....	12
4.1.2 Test Instruments.....	13
4.1.3 Test Procedures.....	14
4.1.4 Deviation from Test Standard.....	14
4.1.5 Test Setup.....	15
4.1.6 EUT Operating Conditions.....	16
4.1.7 Test Results.....	17
4.2 Conducted Emission Measurement.....	25
4.2.1 Limits of Conducted Emission Measurement.....	25
4.2.2 Test Instruments.....	25
4.2.3 Test Procedures.....	26
4.2.4 Deviation from Test Standard.....	26
4.2.5 Test Setup.....	26
4.2.6 EUT Operating Conditions.....	26
4.2.7 Test Results.....	27
4.3 Number of Hopping Frequency Used.....	29
4.3.1 Limits of Hopping Frequency Used Measurement.....	29
4.3.2 Test Setup.....	29
4.3.3 Test Instruments.....	29
4.3.4 Test Procedure.....	29
4.3.5 Deviation from Test Standard.....	29
4.3.6 Test Results.....	30
4.4 Dwell Time on Each Channel.....	31
4.4.1 Limits of Dwell Time on Each Channel Measurement.....	31
4.4.2 Test Setup.....	31
4.4.3 Test Instruments.....	31
4.4.4 Test Procedures.....	31
4.4.5 Deviation from Test Standard.....	31
4.4.6 Test Results.....	32
4.5 Channel Bandwidth.....	34
4.5.1 Limits of Channel Bandwidth Measurement.....	34
4.5.2 Test Setup.....	34
4.5.3 Test Instruments.....	34
4.5.4 Test Procedure.....	34
4.5.5 Deviation from Test Standard.....	34
4.5.6 EUT Operating Condition.....	34
4.5.7 Test Results.....	35
4.6 Hopping Channel Separation.....	36
4.6.1 Limits of Hopping Channel Separation Measurement.....	36

4.6.2	Test Setup	36
4.6.3	Test Instruments	36
4.6.4	Test Procedure	36
4.6.5	Deviation from Test Standard	36
4.6.6	Test Results	37
4.7	Maximum Output Power	38
4.7.1	Limits of Maximum Output Power Measurement	38
4.7.2	Test Setup	38
4.7.3	Test Instruments	38
4.7.4	Test Procedure	38
4.7.5	Deviation from Test Standard	38
4.7.6	EUT Operating Condition	38
4.7.7	Test Results	39
4.8	Conducted Out of Band Emission Measurement	40
4.8.1	Limits Of Conducted Out Of Band Emission Measurement	40
4.8.2	Test Instruments	40
4.8.3	Test Procedure	40
4.8.4	Deviation from Test Standard	40
4.8.5	EUT Operating Condition	40
4.8.6	Test Results	40
5	Pictures of Test Arrangements	43
	Appendix – Information of the Testing Laboratories	44

Release Control Record

Issue No.	Description	Date Issued
RF191209C13	Original release	Feb. 26, 2020

1 Certificate of Conformity

Product: POS Terminal

Brand: CASTLES TECHNOLOGY

Test Model: UPT1000B

Sample Status: Identical Prototype

Applicant: CASTLES TECHNOLOGY CO., LTD.

Test Date: Feb. 17 ~ Feb. 19, 2020

Standards: 47 CFR FCC Part 15, Subpart C (Section 15.247)
ANSI C63.10:2013

The above equipment has been tested by **Bureau Veritas Consumer Products Services (H.K.) Ltd., Taoyuan Branch**, and found compliance with the requirement of the above standards. The test record, data evaluation & Equipment Under Test (EUT) configurations represented herein are true and accurate accounts of the measurements of the sample's RF characteristics under the conditions specified in this report.

Prepared by : *Polly Chien* , **Date:** Feb. 26, 2020
Polly Chien / Specialist

Approved by : *Bruce Chen* , **Date:** Feb. 26, 2020
Bruce Chen / Senior Project Engineer

2 Summary of Test Results

47 CFR FCC Part 15, Subpart C (Section 15.247)			
FCC Clause	Test Item	Result	Remarks
15.207	AC Power Conducted Emission	Pass	Meet the requirement of limit. Minimum passing margin is -7.55dB at 0.16977MHz.
15.247(a)(1)(iii)	Number of Hopping Frequency Used	Pass	Meet the requirement of limit.
15.247(a)(1)(iii)	Dwell Time on Each Channel	Pass	Meet the requirement of limit.
15.247(a)(1)	1. Hopping Channel Separation 2. Spectrum Bandwidth of a Frequency Hopping Sequence Spread Spectrum System	Pass	Meet the requirement of limit.
15.247(a)(1)	Maximum Peak Output Power	Pass	Meet the requirement of limit.
15.205 & 209 & 15.247(d)	Radiated Emissions & Band Edge Measurement	Pass	Meet the requirement of limit. Minimum passing margin is -2.9dB at 2390.00MHz.
15.247(d)	Antenna Port Emission	Pass	Meet the requirement of limit.
15.203	Antenna Requirement	Pass	Antenna connectors are SMA at antenna side not standard connector..

Note:

1. If The Frequency Hopping System operating in 2400-2483.5MHz band and the output power less than 125mW. The hopping channel carrier frequencies separated by a minimum of 25kHz or two-thirds of the 20dB bandwidth of hopping channel whichever is greater.
2. Determining compliance based on the results of the compliance measurement, not taking into account measurement instrumentation uncertainty.

2.1 Measurement Uncertainty

Where relevant, the following measurement uncertainty levels have been estimated for tests performed on the EUT as specified in CISPR 16-4-2:

Measurement	Frequency	Expanded Uncertainty (k=2) (±)
Conducted Emissions at mains ports	150kHz ~ 30MHz	2.79 dB
Radiated Emissions up to 1 GHz	9kHz ~ 30MHz	3.04 dB
	30MHz ~ 200MHz	3.86 dB
	200MHz ~ 1000MHz	3.87 dB
Radiated Emissions above 1 GHz	1GHz ~ 18GHz	2.29 dB
	18GHz ~ 40GHz	2.29 dB

2.2 Modification Record

There were no modifications required for compliance.

3 General Information

3.1 General Description of EUT

Product	POS Terminal
Brand	CASTLES TECHNOLOGY
Test Model	UPT1000B
Sample Status	Identical Prototype
Power Supply Rating	9Vdc~48Vdc, 1.5A~0.5A
Modulation Type	GFSK, $\pi/4$ -DQPSK, 8DPSK
Modulation Technology	FHSS
Transfer Rate	1/2/3Mbps
Operating Frequency	2402~2480MHz
Number of Channel	79
Output Power	9.528mW
Antenna Type	Dipole antenna with -0.1 dBi gain
Antenna Connector	SMA
Accessory Device	Antenna
Cable Supplied	NA

Note:

1. The LTE module (Brand: Telit, Model: LE910-NA1) was installed in the EUT.

3.2 Description of Test Modes

79 channels are provided to this EUT:

Channel	Freq. (MHz)	Channel	Freq. (MHz)	Channel	Freq. (MHz)	Channel	Freq. (MHz)
0	2402	20	2422	40	2442	60	2462
1	2403	21	2423	41	2443	61	2463
2	2404	22	2424	42	2444	62	2464
3	2405	23	2425	43	2445	63	2465
4	2406	24	2426	44	2446	64	2466
5	2407	25	2427	45	2447	65	2467
6	2408	26	2428	46	2448	66	2468
7	2409	27	2429	47	2449	67	2469
8	2410	28	2430	48	2450	68	2470
9	2411	29	2431	49	2451	69	2471
10	2412	30	2432	50	2452	70	2472
11	2413	31	2433	51	2453	71	2473
12	2414	32	2434	52	2454	72	2474
13	2415	33	2435	53	2455	73	2475
14	2416	34	2436	54	2456	74	2476
15	2417	35	2437	55	2457	75	2477
16	2418	36	2438	56	2458	76	2478
17	2419	37	2439	57	2459	77	2479
18	2420	38	2440	58	2460	78	2480
19	2421	39	2441	59	2461		

3.2.1 Test Mode Applicability and Tested Channel Detail

EUT Configure Mode	Applicable to				Description
	RE \geq 1G	RE<1G	PLC	APCM	
-	√	√	√	√	-

Where RE \geq 1G: Radiated Emission above 1GHz & Bandedge Measurement
 RE<1G: Radiated Emission below 1GHz
 PLC: Power Line Conducted Emission
 APCM: Antenna Port Conducted Measurement

Note:

1. The EUT had been pre-tested on the positioned of each 3 axis. The worst case was found when positioned on **Z-plane**.
2. Radiated emission test (below 1GHz) and power line conducted emission test items chosen the worst maximum power.

Radiated Emission Test (Above 1GHz):

- Pre-Scan has been conducted to determine the worst-case mode from all possible combinations between available modulations, data rates and antenna ports (if EUT with antenna diversity architecture).
- Following channel(s) was (were) selected for the final test as listed below.

EUT Configure Mode	Available Channel	Tested Channel	Modulation Technology	Modulation Type	Pakcet Type
-	0 to 78	0, 39, 78	FHSS	GFSK	DH5
-	0 to 78	0, 39, 78	FHSS	8DPSK	3DH5

Radiated Emission Test (Below 1GHz):

- Pre-Scan has been conducted to determine the worst-case mode from all possible combinations between available modulations, data rates and antenna ports (if EUT with antenna diversity architecture).
- Following channel(s) was (were) selected for the final test as listed below.

EUT Configure Mode	Available Channel	Tested Channel	Modulation Technology	Modulation Type	Pakcet Type
-	0 to 78	78	FHSS	GFSK	DH5

Power Line Conducted Emission Test:

- Pre-Scan has been conducted to determine the worst-case mode from all possible combinations between available modulations, data rates and antenna ports (if EUT with antenna diversity architecture).
- Following channel(s) was (were) selected for the final test as listed below.

EUT Configure Mode	Available Channel	Tested Channel	Modulation Technology	Modulation Type	Pakcet Type
-	0 to 78	78	FHSS	GFSK	DH5

Antenna Port Conducted Measurement:

- This item includes all test value of each mode, but only includes spectrum plot of worst value of each mode.
- Pre-Scan has been conducted to determine the worst-case mode from all possible combinations between available modulations, data rates and antenna ports (if EUT with antenna diversity architecture).
- Following channel(s) was (were) selected for the final test as listed below.

EUT Configure Mode	Available Channel	Tested Channel	Modulation Technology	Modulation Type	Pakcet Type
-	0 to 78	0, 39, 78	FHSS	GFSK	DH5
-	0 to 78	0, 39, 78	FHSS	8DPSK	3DH5

Test Condition:

Applicable to	Environmental Conditions	Input Power (System)	Tested by
RE \geq 1G	23 deg. C, 66% RH	9Vdc	Titan Hsu
RE<1G	23 deg. C, 66% RH	9Vdc	Titan Hsu
PLC	23 deg. C, 66% RH	9Vdc	Titan Hsu
APCM	25 deg. C, 60% RH	9Vdc	Ivan Tseng

3.3 Description of Support Units

The EUT has been tested as an independent unit together with other necessary accessories or support units. The following support units or accessories were used to form a representative test configuration during the tests.

ID	Product	Brand	Model No.	Serial No.	FCC ID	Remarks
A.	DC power supply	SHUOKANG	33010D	807748	NA	-
B.	Antenna	Aristotle	RFA-LTE-T1000F-41-2M-A1	NA	NA	Accessory of EUT
C.	Antenna	Aristotle	RFA-25-T100-41-3M-A2	NA	NA	Accessory of EUT

Note: All power cords of the above support units are non-shielded (1.8m).

ID	Cable Descriptions	Qty.	Length (m)	Shielding (Yes/No)	Cores (Qty.)	Remarks
1.	ANT cable	1	2.05	Y	0	Accessory of EUT
2.	ANT cable	1	3	Y	0	Accessory of EUT
3.	USB Type B cable	1	0.7	Y	0	Provided by client.
4.	RS232 cable	1	0.71	N	0	Provided by client.
5.	Power cable	1	0.7	N	0	Provided by client.
6.	Power cable	1	2	N	0	-

3.3.1 Configuration of System under Test

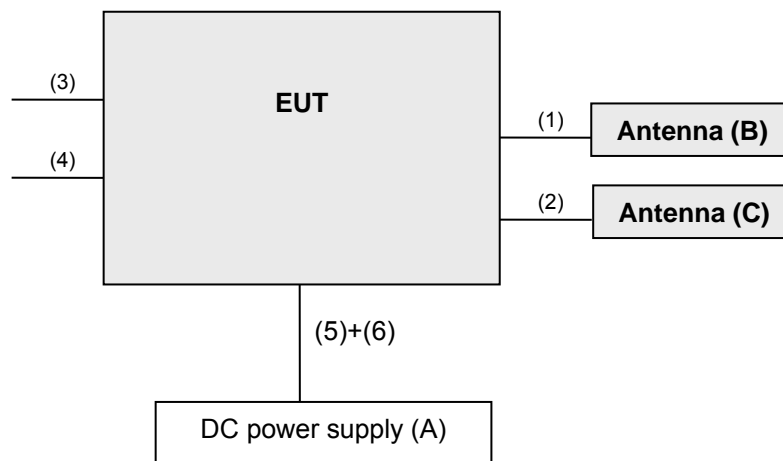

3.4 General Description of Applied Standards and References

The EUT is a RF Product. According to the specifications of the manufacturer, it must comply with the requirements of the following standards and references:

Test standard:

FCC Part 15, Subpart C (15.247)

ANSI C63.10:2013

All test items have been performed and recorded as per the above standards.

References Test Guidance:

KDB 558074 D01 15.247 Meas Guidance v05r02

All test items have been performed as a reference to the above KDB test guidance.

4 Test Types and Results

4.1 Radiated Emission and Bandedge Measurement

4.1.1 Limits of Radiated Emission and Bandedge Measurement

Radiated emissions which fall in the restricted bands must comply with the radiated emission limits specified as below table. Other emissions shall be at least 20dB below the highest level of the desired power:

Frequencies (MHz)	Field Strength (microvolts/meter)	Measurement Distance (meters)
0.009 ~ 0.490	2400/F(kHz)	300
0.490 ~ 1.705	24000/F(kHz)	30
1.705 ~ 30.0	30	30
30 ~ 88	100	3
88 ~ 216	150	3
216 ~ 960	200	3
Above 960	500	3

Note:

1. The lower limit shall apply at the transition frequencies.
2. Emission level (dBuV/m) = 20 log Emission level (uV/m).
3. For frequencies above 1000MHz, the field strength limits are based on average detector, however, the peak field strength of any emission shall not exceed the maximum permitted average limits, specified above by more than 20dB under any condition of modulation.

4.1.2 Test Instruments

Description & Manufacturer	Model No.	Serial No.	Cal. Date	Cal. Due
Test Receiver ROHDE & SCHWARZ	ESIB7	100187	May 30, 2019	May 29, 2020
Spectrum Analyzer ROHDE & SCHWARZ	FSP40	100269	Jun. 10, 2019	Jun. 09, 2020
Spectrum Analyzer ROHDE & SCHWARZ	FSV40	100980	May. 07, 2019	May. 06, 2020
BILOG Antenna SCHWARZBECK	VULB9168	9168-171	Nov. 11, 2019	Nov. 10, 2020
HORN Antenna SCHWARZBECK	9120D	209	Nov. 24, 2019	Nov. 23, 2020
HORN Antenna SCHWARZBECK	BBHA 9170	BBHA9170241	Nov. 24, 2019	Nov. 23, 2020
Loop Antenna TESEQ	HLA 6121	45745	Jul. 01, 2019	Jun. 30, 2020
Preamplifier Agilent (Below 1GHz)	8447D	2944A10738	Aug. 20, 2019	Aug. 19, 2020
Preamplifier Agilent (Above 1GHz)	8449B	3008A02465	Mar. 27, 2019	Mar. 26, 2020
RF Coaxial Cable WOKEN With 5dB PAD	8D-FB	Cable-CH3-01	Aug. 20, 2019	Aug. 19, 2020
RF signal cable HUBER+SUHNER	SUCOFLEX 104	Cable-CH3-03 (223653/4)	Aug. 20, 2019	Aug. 19, 2020
RF signal cable HUBER+SUHNER& EMCI	SUCOFLEX 104&EMC104-SM-SM- 8000	Cable-CH3-03 (309224+170907)	Aug. 20, 2019	Aug. 19, 2020
Software BV ADT	ADT_Radiated_ V7.6.15.9.5	NA	NA	NA
Antenna Tower inn-co GmbH	MA 4000	013303	NA	NA
Antenna Tower Controller BV ADT	AT100	AT93021702	NA	NA
Turn Table BV ADT	TT100	TT93021702	NA	NA
Turn Table Controller BV ADT	SC100	SC93021702	NA	NA
Boresight Antenna Fixture	FBA-01	FBA-SIP01	NA	NA
USB Wideband Power Sensor KEYSIGHT	U2021XA	MY55050005/MY55190 004/MY55190007/MY55 210005	Jul. 15, 2019	Jul. 14, 2020

Note: 1. The calibration interval of the above test instruments is 12 months and the calibrations are traceable to NML/ROC and NIST/USA.
2. The test was performed in HwaYa Chamber 3.

4.1.3 Test Procedures

For Radiated emission below 30MHz

- a. The EUT was placed on the top of a rotating table 0.8 meters above the ground at a 3 meter chamber room. The table was rotated 360 degrees to determine the position of the highest radiation.
- b. The EUT was set 3 meters away from the interference-receiving antenna, which was mounted on the top of a variable-height antenna tower.
- c. Parallel, perpendicular, and ground-parallel orientations of the antenna are set to make the measurement.
- d. For each suspected emission, the EUT was arranged to its worst case and the rotatable table was turned from 0 degrees to 360 degrees to find the maximum reading.
- e. The test-receiver system was set to Quasi-Peak Detect Function and Specified Bandwidth with Maximum Hold Mode.

Note:

1. The resolution bandwidth and video bandwidth of test receiver/spectrum analyzer is 9kHz at frequency below 30MHz.

For Radiated emission above 30MHz

- a. The EUT was placed on the top of a rotating table 0.8 meters (for 30MHz ~ 1GHz) / 1.5 meters (for above 1GHz) above the ground at 3 meter chamber room for test. The table was rotated 360 degrees to determine the position of the highest radiation.
- b. The EUT was set 3 meters away from the interference-receiving antenna, which was mounted on the top of a variable-height antenna tower.
- c. The height of antenna is varied from one meter to four meters above the ground to determine the maximum value of the field strength. Both horizontal and vertical polarizations of the antenna are set to make the measurement.
- d. For each suspected emission, the EUT was arranged to its worst case and then the antenna was tuned to heights from 1 meter to 4 meters and the rotatable table was turned from 0 degrees to 360 degrees to find the maximum reading.
- e. The test-receiver system was set to quasi-peak detect function and specified bandwidth with maximum hold mode when the test frequency is below 1 GHz.
- f. The test-receiver system was set to peak and average detect function and specified bandwidth with maximum hold mode when the test frequency is above 1 GHz. If the peak reading value also meets average limit, measurement with the average detector is unnecessary.

Note:

1. The resolution bandwidth and video bandwidth of test receiver/spectrum analyzer is 120kHz for Quasi-peak detection (QP) at frequency below 1GHz.
2. The resolution bandwidth of test receiver/spectrum analyzer is 1 MHz and the video bandwidth is 3 MHz for Peak detection (PK) at frequency above 1GHz.
3. The resolution bandwidth of test receiver/spectrum analyzer is 1MHz and the video bandwidth is $\geq 1/T$ (Duty cycle < 98%) or 10Hz (Duty cycle $\geq 98\%$) for Average detection (AV) at frequency above 1GHz. (GFSK: RBW = 1MHz, VBW = 3kHz; 8DPSK: RBW = 1MHz, VBW = 3kHz)
4. All modes of operation were investigated and the worst-case emissions are reported.

4.1.4 Deviation from Test Standard

No deviation.

4.1.5 Test Setup

For Radiated emission below 30MHz

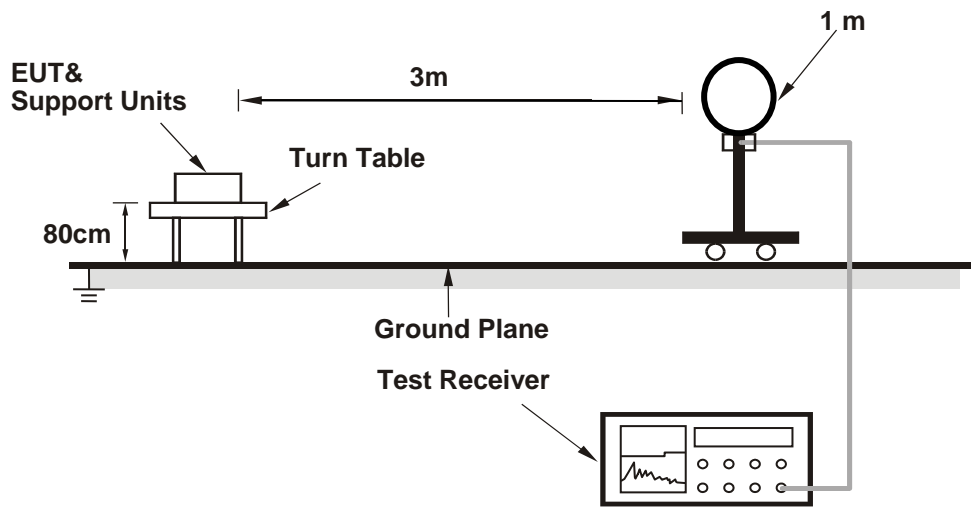

For Radiated emission 30MHz to 1GHz

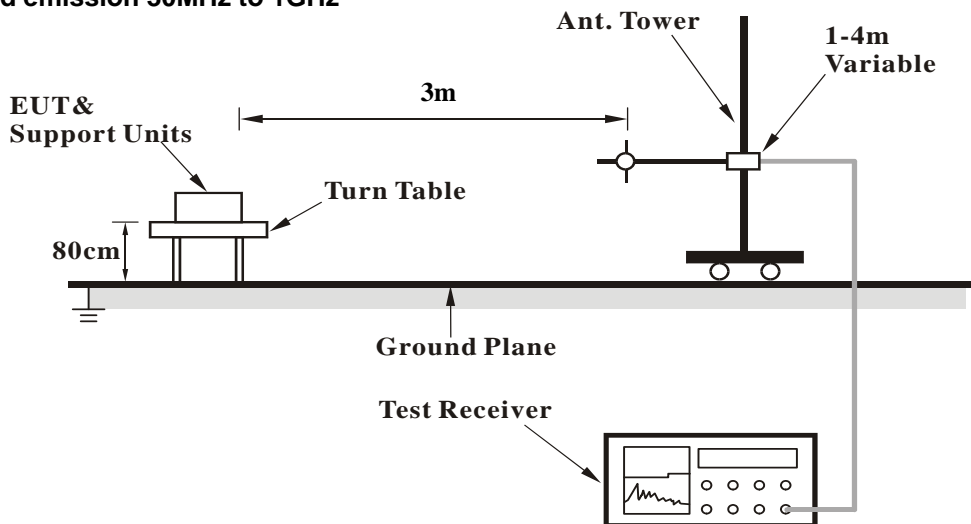

For Radiated emission above 1GHz

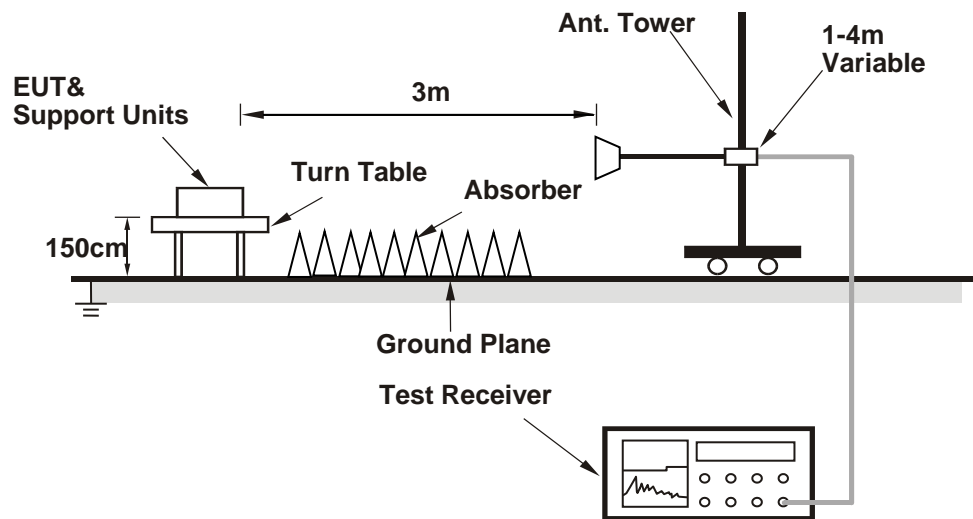

For the actual test configuration, please refer to the attached file (Test Setup Photo).

4.1.6 EUT Operating Conditions

- a. Set the EUT under transmission condition continuously at specific channel frequency.

4.1.7 Test Results

Above 1GHz data:

GFSK

CHANNEL	TX Channel 0	DETECTOR FUNCTION	Peak (PK) Average (AV)
FREQUENCY RANGE	1GHz ~ 25GHz		

ANTENNA POLARITY & TEST DISTANCE: HORIZONTAL AT 3 M

NO.	FREQ. (MHz)	EMISSION LEVEL (dBuV/m)	LIMIT (dBuV/m)	MARGIN (dB)	ANTENNA HEIGHT (m)	TABLE ANGLE (Degree)	RAW VALUE (dBuV)	CORRECTION FACTOR (dB/m)
1	2390.00	58.8 PK	74.0	-15.2	1.47 H	224	26.5	32.3
2	2390.00	47.1 AV	54.0	-6.9	1.47 H	224	14.8	32.3
3	*2402.00	91.1 PK			1.49 H	225	58.8	32.3
4	*2402.00	90.1 AV			1.49 H	225	57.8	32.3
5	4804.00	47.2 PK	74.0	-26.8	1.55 H	290	44.0	3.2
6	4804.00	36.4 AV	54.0	-17.6	1.55 H	290	33.2	3.2

ANTENNA POLARITY & TEST DISTANCE: VERTICAL AT 3 M

NO.	FREQ. (MHz)	EMISSION LEVEL (dBuV/m)	LIMIT (dBuV/m)	MARGIN (dB)	ANTENNA HEIGHT (m)	TABLE ANGLE (Degree)	RAW VALUE (dBuV)	CORRECTION FACTOR (dB/m)
1	2390.00	59.3 PK	74.0	-14.7	1.41 V	178	27.0	32.3
2	2390.00	51.1 AV	54.0	-2.9	1.41 V	178	18.8	32.3
3	*2402.00	98.6 PK			1.39 V	170	66.3	32.3
4	*2402.00	97.6 AV			1.39 V	170	65.3	32.3
5	4804.00	47.9 PK	74.0	-26.1	1.43 V	336	44.7	3.2
6	4804.00	39.7 AV	54.0	-14.3	1.43 V	336	36.5	3.2

Remarks:

1. Emission Level(dBuV/m) = Raw Value(dBuV) + Correction Factor(dB/m).
2. Correction Factor(dB/m) = Antenna Factor(dB/m) + Cable Factor(dB) – Pre-Amplifier Factor(dB).
3. Margin value = Emission Level – Limit value.
4. The other emission levels were very low against the limit.
5. " * ": Fundamental frequency.

CHANNEL	TX Channel 39	DETECTOR FUNCTION	Peak (PK) Average (AV)
FREQUENCY RANGE	1GHz ~ 25GHz		

ANTENNA POLARITY & TEST DISTANCE: HORIZONTAL AT 3 M

NO.	FREQ. (MHz)	EMISSION LEVEL (dBuV/m)	LIMIT (dBuV/m)	MARGIN (dB)	ANTENNA HEIGHT (m)	TABLE ANGLE (Degree)	RAW VALUE (dBuV)	CORRECTION FACTOR (dB/m)
1	*2441.00	93.2 PK			1.61 H	221	60.9	32.3
2	*2441.00	92.5 AV			1.61 H	221	60.2	32.3
3	4882.00	47.2 PK	74.0	-26.8	1.61 H	225	43.7	3.5
4	4882.00	35.8 AV	54.0	-18.2	1.61 H	225	32.3	3.5

ANTENNA POLARITY & TEST DISTANCE: VERTICAL AT 3 M

NO.	FREQ. (MHz)	EMISSION LEVEL (dBuV/m)	LIMIT (dBuV/m)	MARGIN (dB)	ANTENNA HEIGHT (m)	TABLE ANGLE (Degree)	RAW VALUE (dBuV)	CORRECTION FACTOR (dB/m)
1	*2441.00	99.4 PK			1.45 V	177	67.1	32.3
2	*2441.00	98.5 AV			1.45 V	177	66.2	32.3
3	4882.00	47.6 PK	74.0	-26.4	1.44 V	321	44.1	3.5
4	4882.00	37.4 AV	54.0	-16.6	1.44 V	321	33.9	3.5

Remarks:

1. Emission Level(dBuV/m) = Raw Value(dBuV) + Correction Factor(dB/m).
2. Correction Factor(dB/m) = Antenna Factor(dB/m) + Cable Factor(dB) – Pre-Amplifier Factor(dB).
3. Margin value = Emission Level – Limit value.
4. The other emission levels were very low against the limit.
5. " * ": Fundamental frequency.

CHANNEL	TX Channel 78	DETECTOR FUNCTION	Peak (PK) Average (AV)
FREQUENCY RANGE	1GHz ~ 25GHz		

ANTENNA POLARITY & TEST DISTANCE: HORIZONTAL AT 3 M

NO.	FREQ. (MHz)	EMISSION LEVEL (dBuV/m)	LIMIT (dBuV/m)	MARGIN (dB)	ANTENNA HEIGHT (m)	TABLE ANGLE (Degree)	RAW VALUE (dBuV)	CORRECTION FACTOR (dB/m)
1	*2480.00	93.0 PK			1.54 H	222	60.6	32.4
2	*2480.00	92.4 AV			1.54 H	222	60.0	32.4
3	2483.50	59.4 PK	74.0	-14.6	1.56 H	225	27.0	32.4
4	2483.50	47.8 AV	54.0	-6.2	1.56 H	225	15.4	32.4
5	4960.00	49.0 PK	74.0	-25.0	1.46 H	339	44.9	4.1
6	4960.00	39.8 AV	54.0	-14.2	1.46 H	339	35.7	4.1

ANTENNA POLARITY & TEST DISTANCE: VERTICAL AT 3 M

NO.	FREQ. (MHz)	EMISSION LEVEL (dBuV/m)	LIMIT (dBuV/m)	MARGIN (dB)	ANTENNA HEIGHT (m)	TABLE ANGLE (Degree)	RAW VALUE (dBuV)	CORRECTION FACTOR (dB/m)
1	*2480.00	98.3 PK			1.36 V	206	65.9	32.4
2	*2480.00	97.3 AV			1.36 V	206	64.9	32.4
3	2483.50	59.2 PK	74.0	-14.8	1.43 V	187	26.8	32.4
4	2483.50	49.8 AV	54.0	-4.2	1.43 V	187	17.4	32.4
5	4960.00	48.4 PK	74.0	-25.6	1.44 V	323	44.3	4.1
6	4960.00	38.1 AV	54.0	-15.9	1.44 V	323	34.0	4.1

Remarks:

1. Emission Level(dBuV/m) = Raw Value(dBuV) + Correction Factor(dB/m).
2. Correction Factor(dB/m) = Antenna Factor(dB/m) + Cable Factor(dB) – Pre-Amplifier Factor(dB).
3. Margin value = Emission Level – Limit value.
4. The other emission levels were very low against the limit.
5. " * ": Fundamental frequency.

8DPSK

CHANNEL	TX Channel 0	DETECTOR FUNCTION	Peak (PK) Average (AV)
FREQUENCY RANGE	1GHz ~ 25GHz		

ANTENNA POLARITY & TEST DISTANCE: HORIZONTAL AT 3 M								
NO.	FREQ. (MHz)	EMISSION LEVEL (dBuV/m)	LIMIT (dBuV/m)	MARGIN (dB)	ANTENNA HEIGHT (m)	TABLE ANGLE (Degree)	RAW VALUE (dBuV)	CORRECTION FACTOR (dB/m)
1	2390.00	59.5 PK	74.0	-14.5	1.51 H	230	27.2	32.3
2	2390.00	46.7 AV	54.0	-7.3	1.51 H	230	14.4	32.3
3	*2402.00	88.5 PK			1.49 H	227	56.2	32.3
4	*2402.00	84.2 AV			1.49 H	227	51.9	32.3
5	4804.00	46.2 PK	74.0	-27.8	1.50 H	280	43.0	3.2
6	4804.00	33.8 AV	54.0	-20.2	1.50 H	280	30.6	3.2

ANTENNA POLARITY & TEST DISTANCE: VERTICAL AT 3 M								
NO.	FREQ. (MHz)	EMISSION LEVEL (dBuV/m)	LIMIT (dBuV/m)	MARGIN (dB)	ANTENNA HEIGHT (m)	TABLE ANGLE (Degree)	RAW VALUE (dBuV)	CORRECTION FACTOR (dB/m)
1	2390.00	22.6 PK	74.0	-51.4	1.44 V	204	26.2	-3.6
2	2390.00	12.0 AV	54.0	-42.0	1.44 V	204	15.6	-3.6
3	*2402.00	95.1 PK			1.68 V	195	62.8	32.3
4	*2402.00	90.9 AV			1.68 V	195	58.6	32.3
5	4804.00	45.6 PK	74.0	-28.4	1.49 V	269	42.4	3.2
6	4804.00	33.6 AV	54.0	-20.4	1.49 V	269	30.4	3.2

Remarks:

1. Emission Level(dBuV/m) = Raw Value(dBuV) + Correction Factor(dB/m).
2. Correction Factor(dB/m) = Antenna Factor(dB/m) + Cable Factor(dB) – Pre-Amplifier Factor(dB).
3. Margin value = Emission Level – Limit value.
4. The other emission levels were very low against the limit.
5. " * ": Fundamental frequency.

CHANNEL	TX Channel 39	DETECTOR FUNCTION	Peak (PK) Average (AV)
FREQUENCY RANGE	1GHz ~ 25GHz		

ANTENNA POLARITY & TEST DISTANCE: HORIZONTAL AT 3 M

NO.	FREQ. (MHz)	EMISSION LEVEL (dBuV/m)	LIMIT (dBuV/m)	MARGIN (dB)	ANTENNA HEIGHT (m)	TABLE ANGLE (Degree)	RAW VALUE (dBuV)	CORRECTION FACTOR (dB/m)
1	*2441.00	90.2 PK			1.45 H	225	57.9	32.3
2	*2441.00	85.9 AV			1.45 H	225	53.6	32.3
3	4882.00	47.3 PK	74.0	-26.7	1.48 H	281	43.8	3.5
4	4882.00	34.2 AV	54.0	-19.8	1.48 H	281	30.7	3.5

ANTENNA POLARITY & TEST DISTANCE: VERTICAL AT 3 M

NO.	FREQ. (MHz)	EMISSION LEVEL (dBuV/m)	LIMIT (dBuV/m)	MARGIN (dB)	ANTENNA HEIGHT (m)	TABLE ANGLE (Degree)	RAW VALUE (dBuV)	CORRECTION FACTOR (dB/m)
1	*2441.00	96.5 PK			1.41 V	208	64.2	32.3
2	*2441.00	92.3 AV			1.41 V	208	60.0	32.3
3	4882.00	47.0 PK	74.0	-27.0	1.66 V	214	43.5	3.5
4	4882.00	34.3 AV	54.0	-19.7	1.66 V	214	30.8	3.5

Remarks:

1. Emission Level(dBuV/m) = Raw Value(dBuV) + Correction Factor(dB/m).
2. Correction Factor(dB/m) = Antenna Factor(dB/m) + Cable Factor(dB) – Pre-Amplifier Factor(dB).
3. Margin value = Emission Level – Limit value.
4. The other emission levels were very low against the limit.
5. " * " : Fundamental frequency.

CHANNEL	TX Channel 78	DETECTOR FUNCTION	Peak (PK) Average (AV)
FREQUENCY RANGE	1GHz ~ 25GHz		

ANTENNA POLARITY & TEST DISTANCE: HORIZONTAL AT 3 M

NO.	FREQ. (MHz)	EMISSION LEVEL (dBuV/m)	LIMIT (dBuV/m)	MARGIN (dB)	ANTENNA HEIGHT (m)	TABLE ANGLE (Degree)	RAW VALUE (dBuV)	CORRECTION FACTOR (dB/m)
1	*2480.00	90.0 PK			1.54 H	223	57.6	32.4
2	*2480.00	85.9 AV			1.54 H	223	53.5	32.4
3	2483.50	60.4 PK	74.0	-13.6	1.56 H	225	28.0	32.4
4	2483.50	47.1 AV	54.0	-6.9	1.56 H	225	14.7	32.4
5	4960.00	47.5 PK	74.0	-26.5	1.42 H	338	43.4	4.1
6	4960.00	35.0 AV	54.0	-19.0	1.42 H	338	30.9	4.1

ANTENNA POLARITY & TEST DISTANCE: VERTICAL AT 3 M

NO.	FREQ. (MHz)	EMISSION LEVEL (dBuV/m)	LIMIT (dBuV/m)	MARGIN (dB)	ANTENNA HEIGHT (m)	TABLE ANGLE (Degree)	RAW VALUE (dBuV)	CORRECTION FACTOR (dB/m)
1	*2480.00	96.1 PK			1.07 V	186	63.7	32.4
2	*2480.00	92.0 AV			1.07 V	186	59.6	32.4
3	2483.50	58.8 PK	74.0	-15.2	1.07 V	212	26.4	32.4
4	2483.50	47.7 AV	54.0	-6.3	1.07 V	212	15.3	32.4
5	4960.00	47.3 PK	74.0	-26.7	1.54 V	225	43.2	4.1
6	4960.00	35.0 AV	54.0	-19.0	1.54 V	225	30.9	4.1

Remarks:

1. Emission Level(dBuV/m) = Raw Value(dBuV) + Correction Factor(dB/m).
2. Correction Factor(dB/m) = Antenna Factor(dB/m) + Cable Factor(dB) – Pre-Amplifier Factor(dB).
3. Margin value = Emission Level – Limit value.
4. The other emission levels were very low against the limit.
5. " * ": Fundamental frequency.

Below 1GHz worst-case data:

GFSK

CHANNEL	TX Channel 78	DETECTOR FUNCTION	Quasi-Peak (QP)
FREQUENCY RANGE	9kHz ~ 1GHz		

ANTENNA POLARITY & TEST DISTANCE: HORIZONTAL AT 3 M								
NO.	FREQ. (MHz)	EMISSION LEVEL (dBuV/m)	LIMIT (dBuV/m)	MARGIN (dB)	ANTENNA HEIGHT (m)	TABLE ANGLE (Degree)	RAW VALUE (dBuV)	CORRECTION FACTOR (dB/m)
1	39.84	36.6 QP	40.0	-3.4	1.99 H	222	46.1	-9.5
2	92.20	40.0 QP	43.5	-3.5	2.00 H	72	54.2	-14.2
3	110.37	38.4 QP	43.5	-5.1	1.50 H	174	50.3	-11.9
4	184.64	37.8 QP	43.5	-5.7	1.00 H	90	48.3	-10.5
5	368.80	38.9 QP	46.0	-7.1	1.00 H	120	44.3	-5.4
6	513.59	40.9 QP	46.0	-5.1	1.50 H	20	41.9	-1.0

Remarks:

1. Emission Level(dBuV/m) = Raw Value(dBuV) + Correction Factor(dB/m).
2. Correction Factor(dB/m) = Antenna Factor(dB/m) + Cable Factor(dB) – Pre-Amplifier Factor(dB).
3. The other emission levels were very low against the limit of frequency range 30MHz ~ 1000MHz.
4. Margin value = Emission Level – Limit value.
5. The emission levels were very low against the limit of frequency range 9kHz ~ 30MHz: the amplitude of spurious emissions attenuated more than 20 dB below the permissible value to be report.

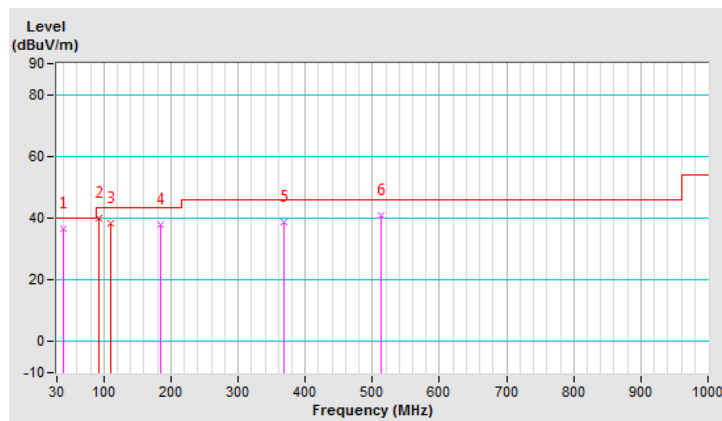

CHANNEL	TX Channel 78	DETECTOR FUNCTION	Quasi-Peak (QP)
FREQUENCY RANGE	9kHz ~ 1GHz		

ANTENNA POLARITY & TEST DISTANCE: VERTICAL AT 3 M								
NO.	FREQ. (MHz)	EMISSION LEVEL (dBuV/m)	LIMIT (dBuV/m)	MARGIN (dB)	ANTENNA HEIGHT (m)	TABLE ANGLE (Degree)	RAW VALUE (dBuV)	CORRECTION FACTOR (dB/m)
1	39.92	33.3 QP	40.0	-6.7	2.00 V	43	42.7	-9.4
2	76.76	35.1 QP	40.0	-4.9	2.00 V	141	47.5	-12.4
3	92.50	37.4 QP	43.5	-6.1	2.00 V	312	51.6	-14.2
4	183.23	39.7 QP	43.5	-3.8	1.49 V	230	49.9	-10.2
5	513.59	35.8 QP	46.0	-10.2	1.49 V	114	36.8	-1.0
6	555.77	33.7 QP	46.0	-12.3	1.00 V	260	34.1	-0.4

Remarks:

1. Emission Level(dBuV/m) = Raw Value(dBuV) + Correction Factor(dB/m).
2. Correction Factor(dB/m) = Antenna Factor(dB/m) + Cable Factor(dB) – Pre-Amplifier Factor(dB).
3. The other emission levels were very low against the limit of frequency range 30MHz ~ 1000MHz.
4. Margin value = Emission Level – Limit value.
5. The emission levels were very low against the limit of frequency range 9kHz ~ 30MHz: the amplitude of spurious emissions attenuated more than 20 dB below the permissible value to be report.

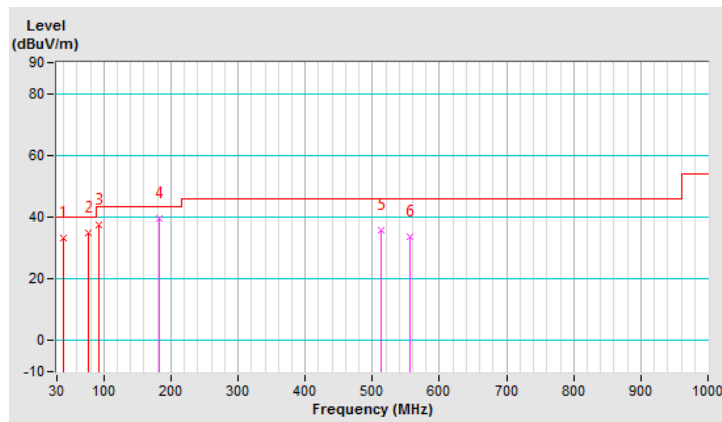

4.2 Conducted Emission Measurement

4.2.1 Limits of Conducted Emission Measurement

Frequency (MHz)	Conducted Limit (dBuV)	
	Quasi-peak	Average
0.15 - 0.5	66 - 56	56 - 46
0.50 - 5.0	56	46
5.0 - 30.0	60	50

Note: 1. The lower limit shall apply at the transition frequencies.

2. The limit decreases in line with the logarithm of the frequency in the range of 0.15 to 0.50MHz.

4.2.2 Test Instruments

Tested date: Feb. 19, 2020

Description & Manufacturer	Model No.	Serial No.	Cal. Date	Cal. Due
Test Receiver ROHDE & SCHWARZ	ESR3	102412	Feb. 17, 2020	Feb. 16, 2021
RF signal cable (with 10dB PAD) Woken	5D-FB	Cable-cond2-01	Sep. 05, 2019	Sep. 04, 2020
LISN ROHDE & SCHWARZ (EUT)	ESH2-Z5	100100	Jan. 20, 2020	Jan. 19, 2021
LISN ROHDE & SCHWARZ (Peripheral)	ESH3-Z5	100312	Aug. 13, 2019	Aug. 12, 2020
Software ADT	BV ADT_Cond_ V7.3.7.4	NA	NA	NA

Note: 1. The calibration interval of the above test instruments is 12 months and the calibrations are traceable to NML/ROC and NIST/USA.

2. The test was performed in HwaYa Shielded Room 2.

3. The VCCI Site Registration No. is C-12047.

4.2.3 Test Procedures

- The EUT was placed 0.4 meters from the conducting wall of the shielded room with EUT being connected to the power mains through a line impedance stabilization network (LISN). Other support units were connected to the power mains through another LISN. The two LISNs provide 50 ohm/ 50uH of coupling impedance for the measuring instrument.
- Both lines of the power mains connected to the EUT were checked for maximum conducted interference.
- The frequency range from 150kHz to 30MHz was searched. Emission levels under (Limit - 20dB) was not recorded.

Note: The resolution bandwidth and video bandwidth of test receiver is 9kHz for quasi-peak detection (QP) and average detection (AV) at frequency 0.15MHz-30MHz.

4.2.4 Deviation from Test Standard

No deviation.

4.2.5 Test Setup

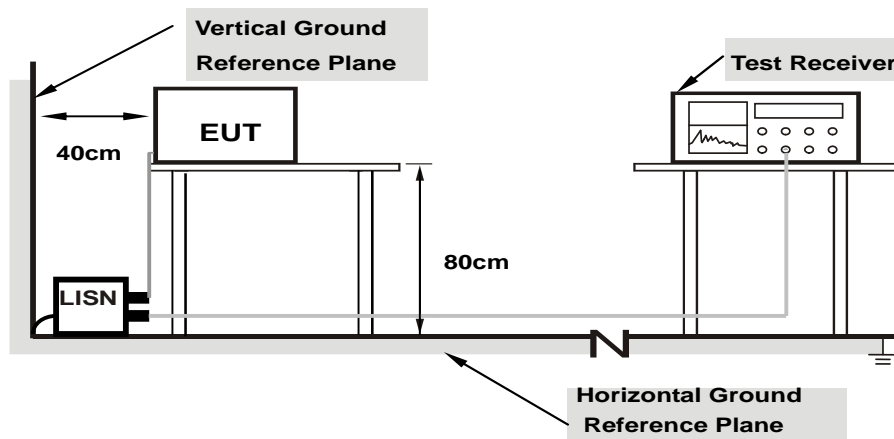

Note: 1.Support units were connected to second LISN.

For the actual test configuration, please refer to the attached file (Test Setup Photo).

4.2.6 EUT Operating Conditions

Same as 4.1.6.

4.2.7 Test Results

Worst-case data:

GFSK

Phase	Line (L)	Detector Function	Quasi-Peak (QP) / Average (AV)
-------	----------	-------------------	--------------------------------

No	Freq. [MHz]	Corr. Factor (dB)	Reading Value [dB (uV)]		Emission Level [dB (uV)]		Limit [dB (uV)]		Margin (dB)	
			Q.P.	AV.	Q.P.	AV.	Q.P.	AV.	Q.P.	AV.
			1	0.16977	10.16	47.26	16.65	57.42	26.81	64.97
2	0.19000	10.17	43.39	13.33	53.56	23.50	64.04	54.04	-10.48	-30.54
3	0.23800	10.18	35.99	7.31	46.17	17.49	62.17	52.17	-16.00	-34.68
4	0.49400	10.21	18.92	2.72	29.13	12.93	56.10	46.10	-26.97	-33.17
5	1.20600	10.27	11.98	4.27	22.25	14.54	56.00	46.00	-33.75	-31.46
6	6.34200	10.43	4.43	1.33	14.86	11.76	60.00	50.00	-45.14	-38.24

Remarks:

1. Q.P. and AV. are abbreviations of quasi-peak and average individually.
2. The emission levels of other frequencies were very low against the limit.
3. Margin value = Emission level - Limit value
4. Correction factor = Insertion loss + Cable loss
5. Emission Level = Correction Factor + Reading Value.

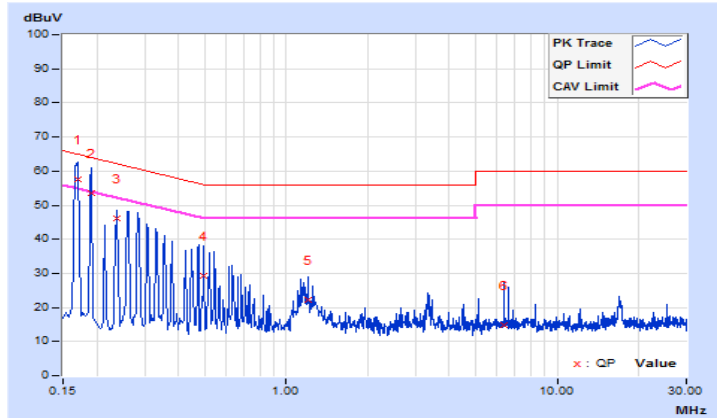

Phase	Neutral (N)	Detector Function	Quasi-Peak (QP) / Average (AV)
-------	-------------	-------------------	--------------------------------

No	Freq. [MHz]	Corr. Factor (dB)	Reading Value [dB (uV)]		Emission Level [dB (uV)]		Limit [dB (uV)]		Margin (dB)	
			Q.P.	AV.	Q.P.	AV.	Q.P.	AV.	Q.P.	AV.
			1	0.17000	10.12	46.79	16.02	56.91	26.14	64.96
2	0.19000	10.13	42.95	12.74	53.08	22.87	64.04	54.04	-10.96	-31.17
3	0.21000	10.13	39.63	10.04	49.76	20.17	63.21	53.21	-13.45	-33.04
4	0.25800	10.14	32.95	5.49	43.09	15.63	61.50	51.50	-18.41	-35.87
5	1.10600	10.24	9.55	2.65	19.79	12.89	56.00	46.00	-36.21	-33.11
6	3.37400	10.36	7.29	1.82	17.65	12.18	56.00	46.00	-38.35	-33.82

Remarks:

1. Q.P. and AV. are abbreviations of quasi-peak and average individually.
2. The emission levels of other frequencies were very low against the limit.
3. Margin value = Emission level - Limit value
4. Correction factor = Insertion loss + Cable loss
5. Emission Level = Correction Factor + Reading Value.

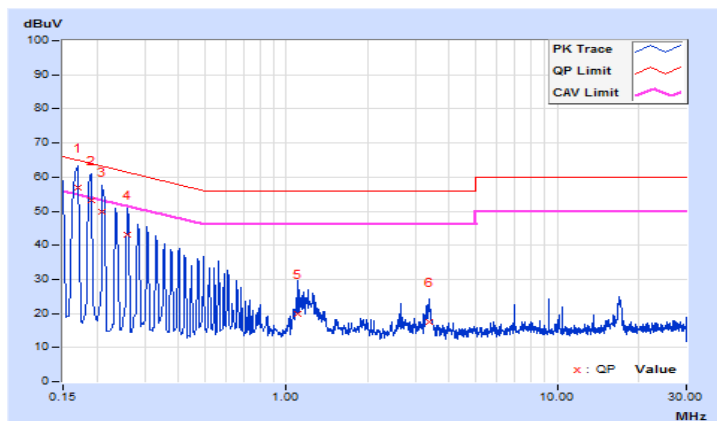

4.3 Number of Hopping Frequency Used

4.3.1 Limits of Hopping Frequency Used Measurement

At least 15 channels frequencies, and should be equally spaced.

4.3.2 Test Setup

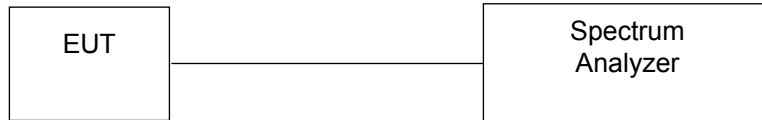

4.3.3 Test Instruments

Refer to section 4.1.2 to get information of above instrument.

4.3.4 Test Procedure

- a. Check the calibration of the measuring instrument (SA) using either an internal calibrator or a known signal from an external generator.
- b. Turn on the EUT and connect its antenna terminal to measurement via a low loss cable. Then set it to any one measured frequency within its operating range and make sure the instrument is operated in its linear range.
- c. Set the SA on MaxHold Mode, and then keep the EUT in hopping mode. Record all the signals from each channel until each one has been recorded.
- d. Set the SA on View mode and then plot the result on SA screen.
- e. Repeat above procedures until all frequencies measured were complete.

4.3.5 Deviation from Test Standard

No deviation.

4.3.6 Test Results

There are 79 hopping frequencies in the hopping mode. Please refer to the test result. On the plots, it shows that the hopping frequencies are equally spaced.

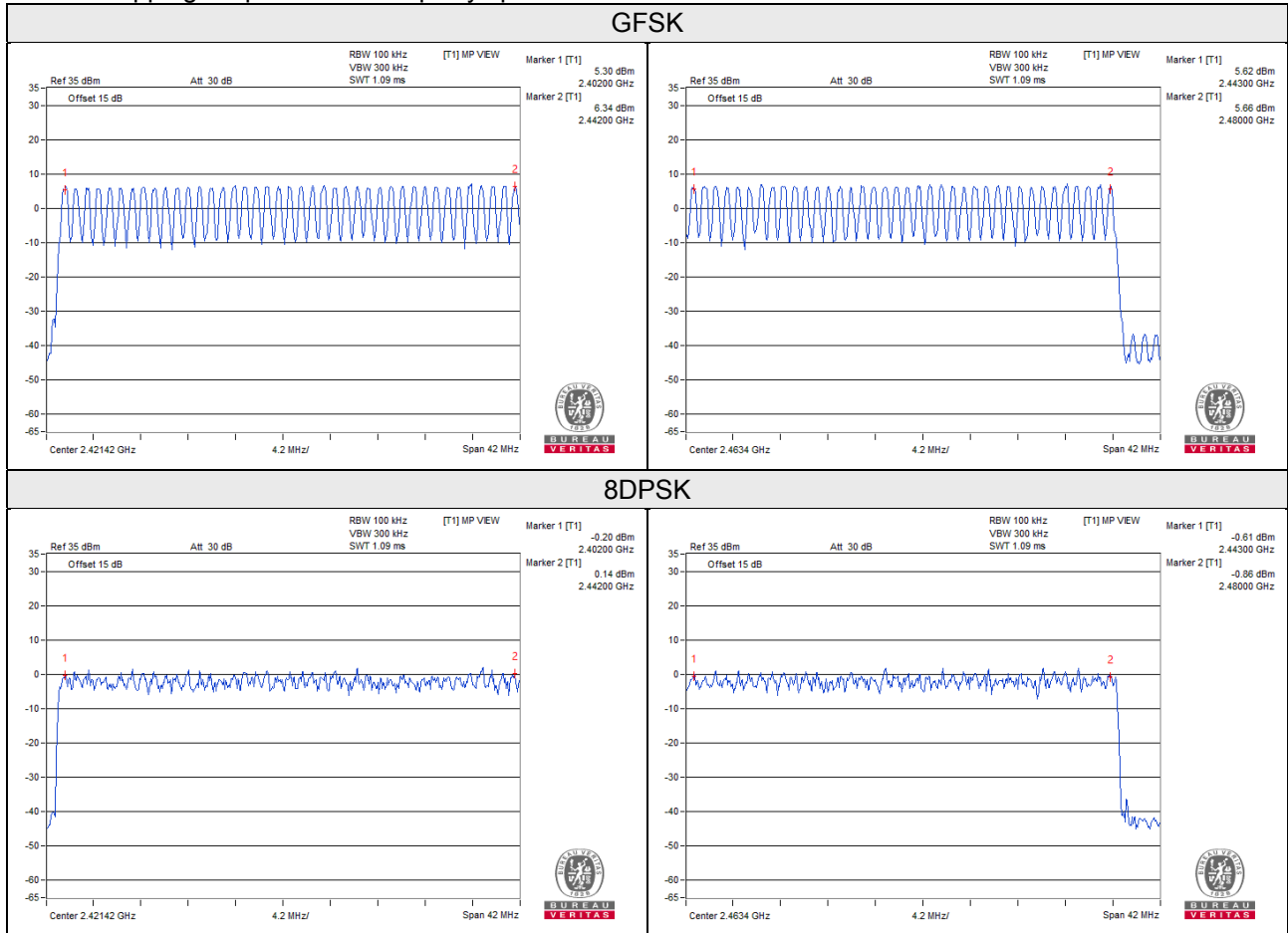

4.4 Dwell Time on Each Channel

4.4.1 Limits of Dwell Time on Each Channel Measurement

The average time of occupancy on any channel shall not be greater than 0.4 seconds within a period of 0.4 seconds multiplied by the number of hopping channels employed.

4.4.2 Test Setup



4.4.3 Test Instruments

Refer to section 4.1.2 to get information of above instrument.

4.4.4 Test Procedures

- a. Check the calibration of the measuring instrument (SA) using either an internal calibrator or a known signal from an external generator.
- b. Turn on the EUT and connect its antenna terminal to measurement via a low loss cable. Then set it to any one measured frequency within its operating range and make sure the instrument is operated in its linear range.
- c. Adjust the center frequency of SA on any frequency be measured and set SA to zero span mode. And then, set RBW and VBW of spectrum analyzer to proper value.
- d. Measure the time duration of one transmission on the measured frequency. And then plot the result with time difference of this time duration.
- e. Repeat above procedures until all different time-slot modes have been completed.

4.4.5 Deviation from Test Standard

No deviation.

4.4.6 Test Results

GFSK

Mode	Number of transmission in a 31.6 (79Hopping*0.4)	Length of transmission time (msec)	Result (msec)	Limit (msec)
DH1	51 (times / 5 sec) * 6.32 = 322.32 times	0.432	139.24	400
DH3	26 (times / 5 sec) * 6.32 = 164.32 times	1.720	282.63	400
DH5	17 (times / 5 sec) * 6.32 = 107.44 times	2.950	316.95	400

Note: Test plots of the transmitting time slot are shown as below.



8DPSK

Mode	Number of transmission in a 31.6 (79Hopping*0.4)	Length of transmission time (msec)	Result (msec)	Limit (msec)
3DH1	50 (times / 5 sec) * 6.32 = 316.00 times	0.456	144.10	400
3DH3	25 (times / 5 sec) * 6.32 = 158.00 times	1.750	276.50	400
3DH5	16 (times / 5 sec) * 6.32 = 101.12 times	2.930	296.28	400

Note: Test plots of the transmitting time slot are shown as below.



4.5 Channel Bandwidth

4.5.1 Limits of Channel Bandwidth Measurement

For frequency hopping system operating in the 2400-2483.5MHz, If the 20dB bandwidth of hopping channel is greater than 25kHz, two-thirds 20dB bandwidth of hopping channel shall be a minimum limit for the hopping channel separation.

4.5.2 Test Setup



4.5.3 Test Instruments

Refer to section 4.1.2 to get information of above instrument.

4.5.4 Test Procedure

- Check the calibration of the measuring instrument using either an internal calibrator or a known signal from an external generator.
- Turn on the EUT and connect it to measurement instrument. Then set it to any one convenient frequency within its operating range. Set a reference level on the measuring instrument equal to the highest peak value.
- Measure the frequency difference of two frequencies that were attenuated 20dB from the reference level. Record the frequency difference as the emission bandwidth.
- Repeat above procedures until all frequencies measured were complete.

4.5.5 Deviation from Test Standard

No deviation.

4.5.6 EUT Operating Condition

The software provided by client enabled the EUT to transmit and receive data at lowest, middle and highest channel frequencies individually.

4.5.7 Test Results

Channel	Frequency (MHz)	20dB Bandwidth (MHz)	
		GFSK	8DPSK
0	2402	1.02	1.35
39	2441	1.00	1.35
78	2480	1.05	1.34

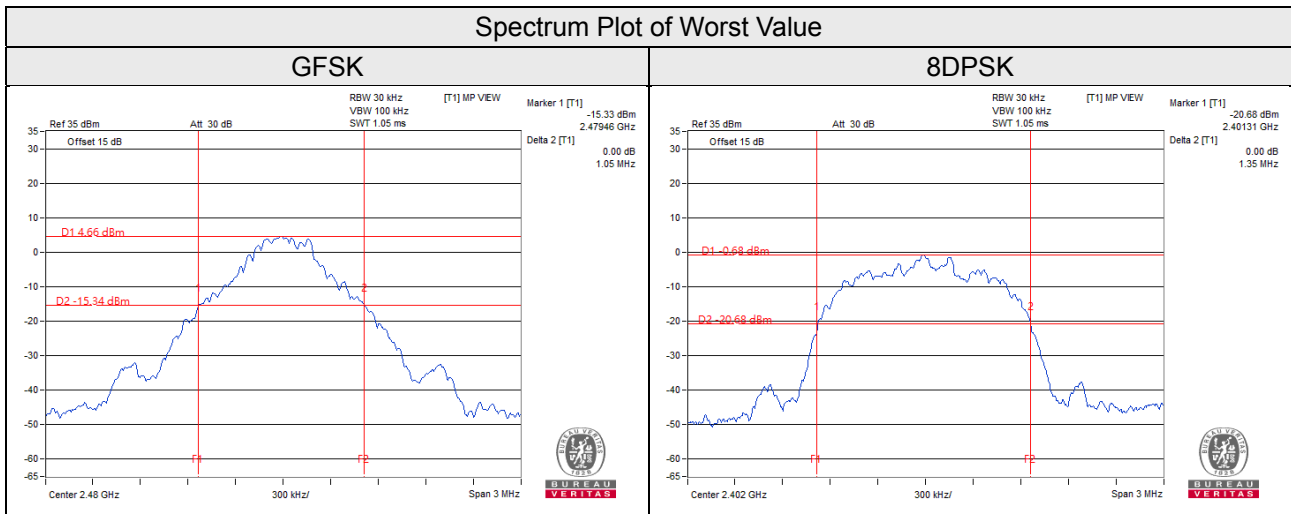

4.6 Hopping Channel Separation

4.6.1 Limits of Hopping Channel Separation Measurement

At least 25kHz or two-third of 20dB hopping channel bandwidth (whichever is greater).

4.6.2 Test Setup

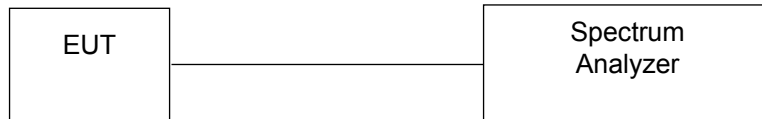

4.6.3 Test Instruments

Refer to section 4.1.2 to get information of above instrument.

4.6.4 Test Procedure

Measurement Procedure REF

- Check the calibration of the measuring instrument using either an internal calibrator or a known signal from an external generator.
- Turn on the EUT and connect it to measurement instrument. Then set it to any one convenient frequency within its operating range.
- By using the MaxHold function record the separation of two adjacent channels.
- Measure the frequency difference of these two adjacent channels by SA MARK function. And then plot the result on SA screen.
- Repeat above procedures until all frequencies measured were complete.

4.6.5 Deviation from Test Standard

No deviation.

4.6.6 Test Results

Channel	Frequency (MHz)	Adjacent Channel Separation (MHz)		20dB Bandwidth (MHz)		Minimum Limit (MHz)		Pass / Fail
		GFSK	8DPSK	GFSK	8DPSK	GFSK	8DPSK	
0	2402	1.00	1.00	1.02	1.35	0.68	0.90	Pass
39	2441	1.00	1.00	1.00	1.35	0.66	0.90	Pass
78	2480	1.00	1.00	1.05	1.34	0.70	0.89	Pass

Note: The minimum limit is two-third 20dB bandwidth.

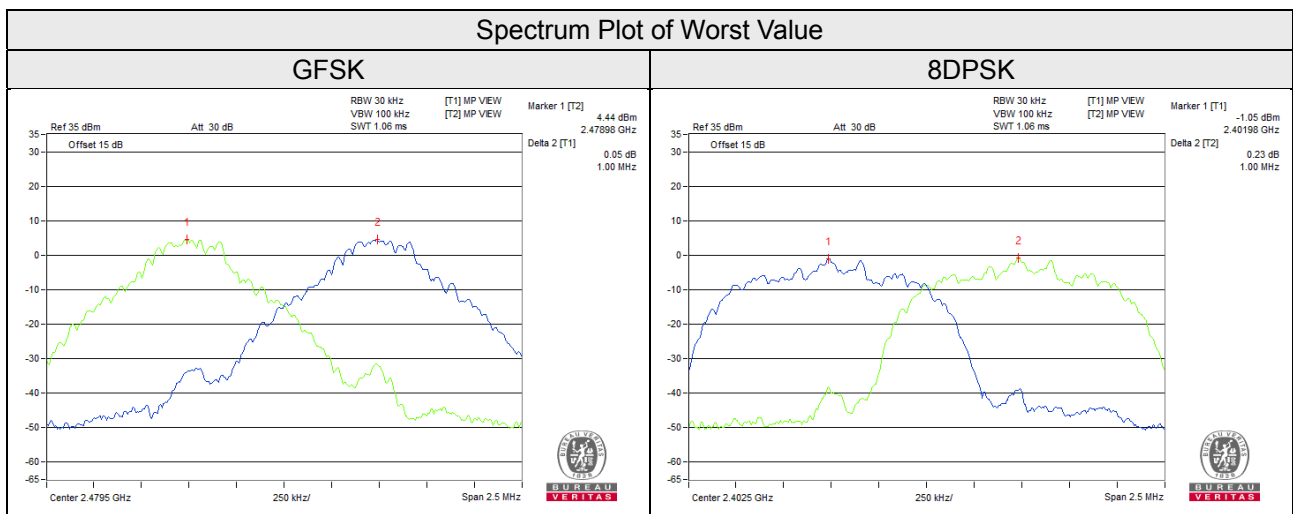

4.7 Maximum Output Power

4.7.1 Limits of Maximum Output Power Measurement

Refer to Regulation 15.247 (a) (1), the Maximum Output Power Measurement is 125mW.

4.7.2 Test Setup

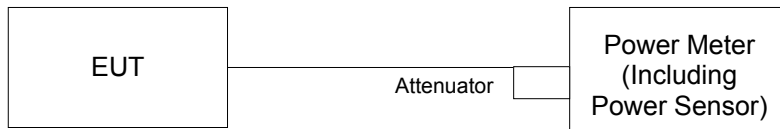

4.7.3 Test Instruments

Refer to section 4.1.2 to get information of above instrument.

4.7.4 Test Procedure

For Peak Power

A peak power sensor was used on the output port of the EUT. A power meter was used to read the response of the peak power sensor. Record the power level.

For Average Power

Average power sensor was used to perform output power measurement, trigger and gating function of wide band power meter is enabled to measure max output power of TX on burst. Duty factor is not added to measured value.

4.7.5 Deviation from Test Standard

No deviation.

4.7.6 EUT Operating Condition

The software provided by client enabled the EUT to transmit and receive data at lowest, middle and highest channel frequencies individually.

4.7.7 Test Results

For Peak Power

Channel	Frequency (MHz)	Output Power (mW)		Output Power (dBm)		Power Limit (mW)	Pass / Fail
		GFSK	8DPSK	GFSK	8DPSK		
0	2402	7.603	3.443	8.81	5.37	125.00	Pass
39	2441	8.730	3.954	9.41	5.97	125.00	Pass
78	2480	9.528	4.236	9.79	6.27	125.00	Pass

For Average Power

Channel	Frequency (MHz)	Average Power (mW)		Average Power (dBm)	
		GFSK	8DPSK	GFSK	8DPSK
0	2402	7.261	3.304	8.61	5.19
39	2441	8.395	3.776	9.24	5.77
78	2480	9.183	4.036	9.63	6.06

4.8 Conducted Out of Band Emission Measurement

4.8.1 Limits Of Conducted Out Of Band Emission Measurement

Below -20dB of the highest emission level of operating band (in 100kHz RBW).

4.8.2 Test Instruments

Refer to section 4.1.2 to get information of above instrument.

4.8.3 Test Procedure

The transmitter output was connected to the spectrum analyzer via a low lose cable. Set both RBW and VBW of spectrum analyzer to 100 kHz and 300 kHz with suitable frequency span including 100 MHz bandwidth from band edge. The band edges was measured and recorded.

4.8.4 Deviation from Test Standard

No deviation.

4.8.5 EUT Operating Condition

The software provided by client enabled the EUT to transmit and receive data at lowest, middle and highest channel frequencies individually.

4.8.6 Test Results

The spectrum plots are attached on the following images. D1 line indicates the highest level, D2 line indicates the 20dB offset below D1. It shows compliance with the requirement.

GFSK

Hopping disabled_Low Channel

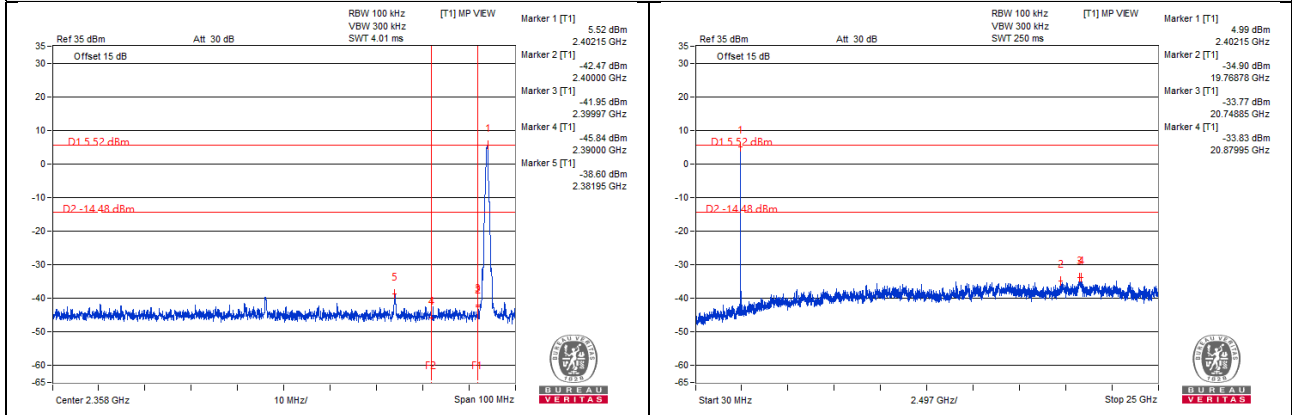

Hopping disabled_High Channel

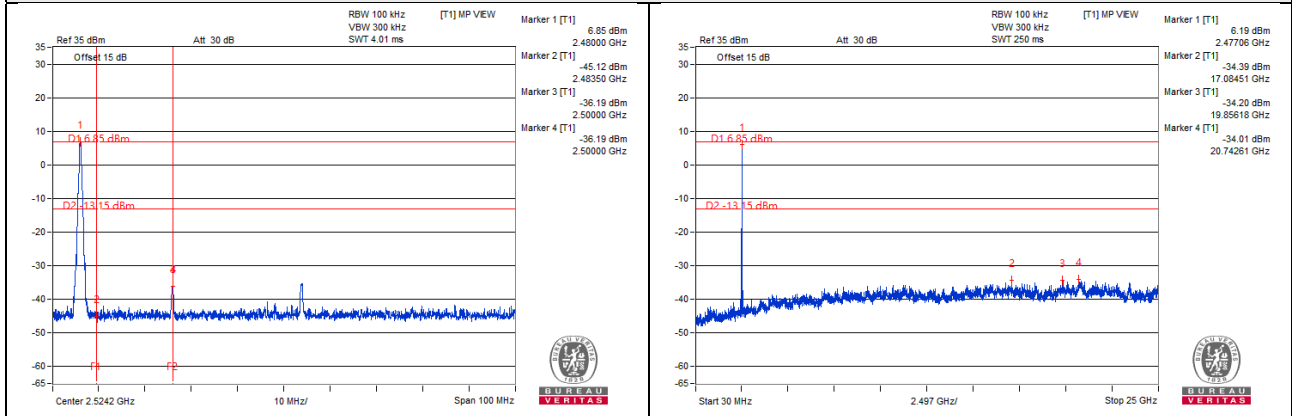

Hopping enabled_Low Channel

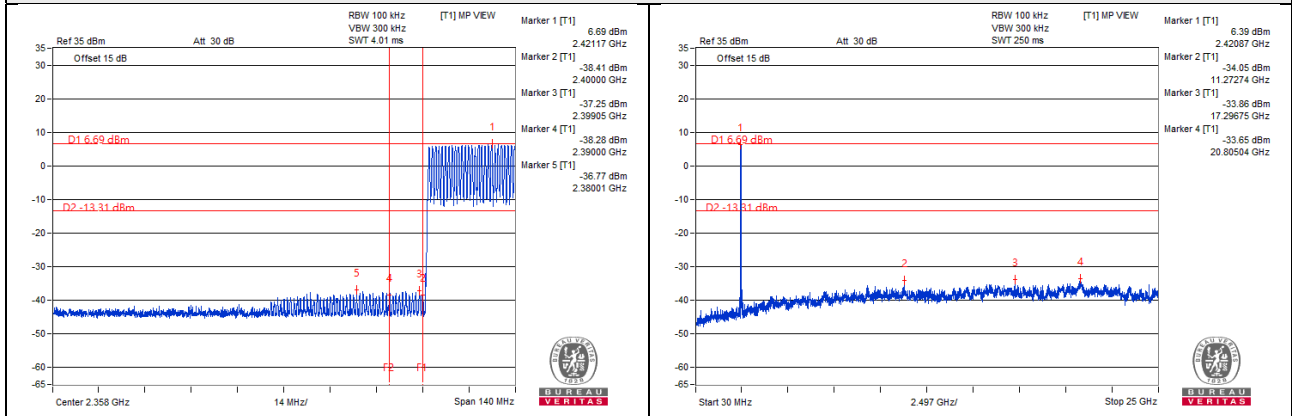

Hopping enabled_High Channel

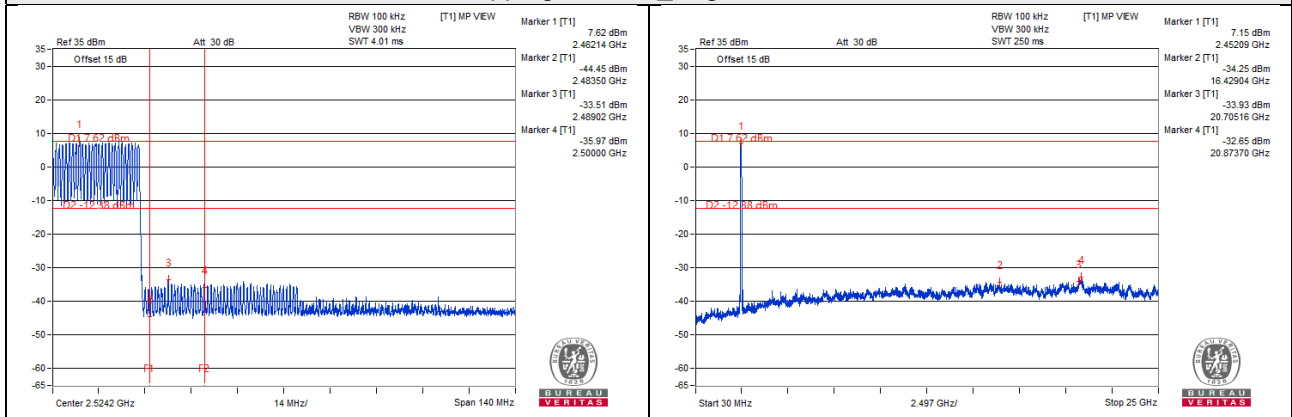

8DPSK

Hopping disabled_Low Channel

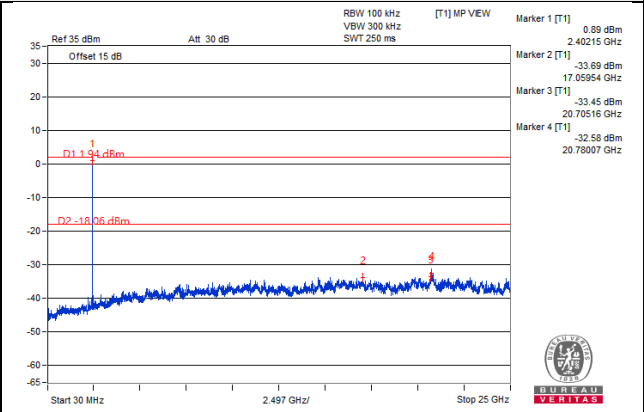
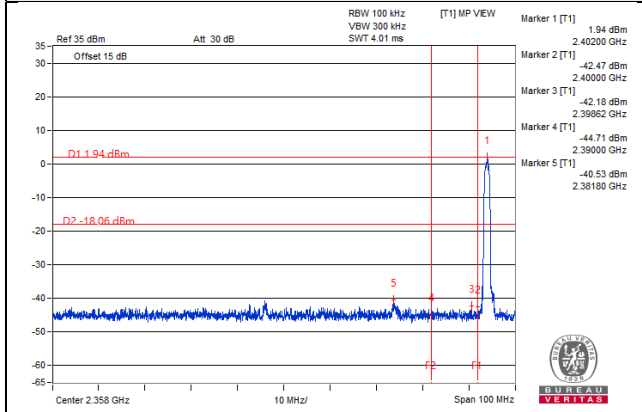

Hopping disabled_High Channel

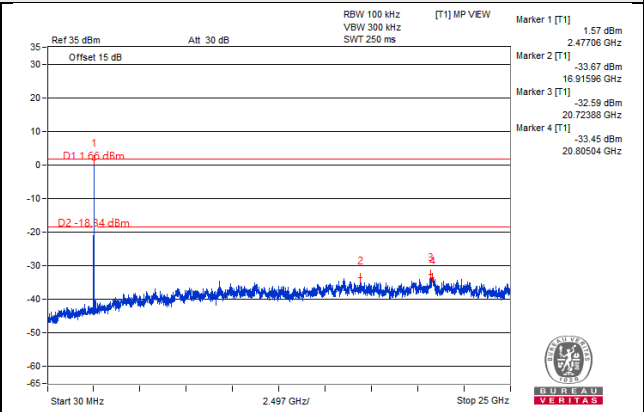
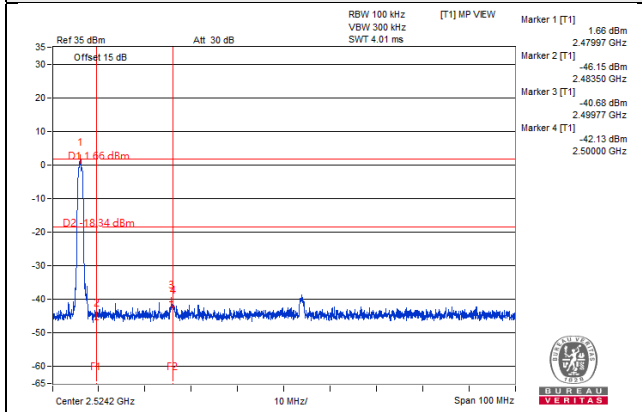

Hopping enabled_Low Channel

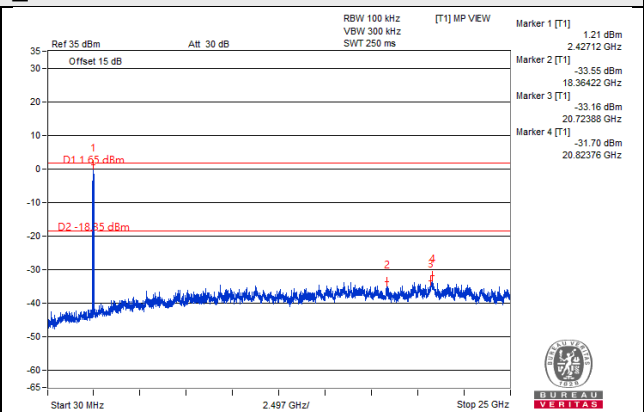
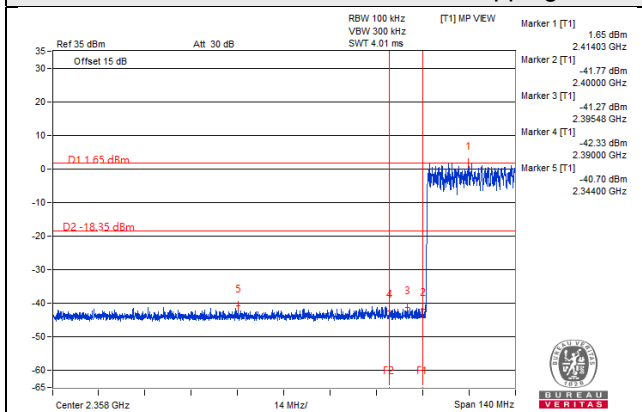

Hopping enabled_High Channel

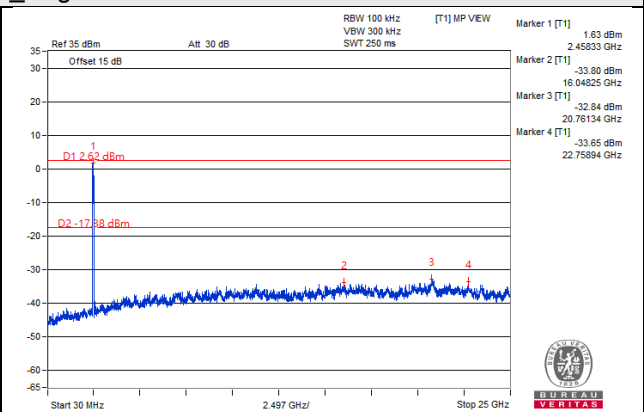
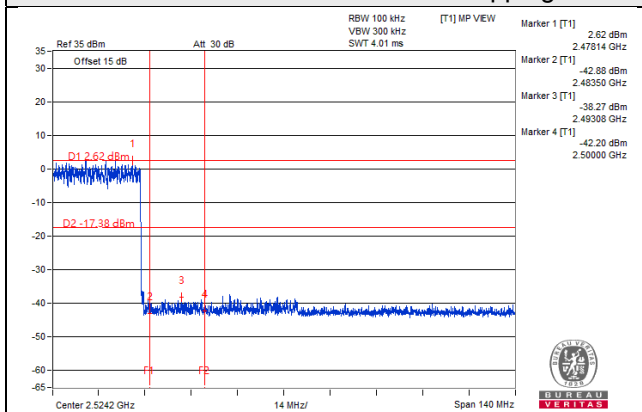

5 Pictures of Test Arrangements

Please refer to the attached file (Test Setup Photo).

Appendix – Information of the Testing Laboratories

We, Bureau Veritas Consumer Products Services (H.K.) Ltd., Taoyuan Branch, were founded in 1988 to provide our best service in EMC, Radio, Telecom and Safety consultation. Our laboratories are FCC recognized accredited test firms and accredited and approved according to ISO/IEC 17025.

If you have any comments, please feel free to contact us at the following:

Lin Kou EMC/RF Lab

Tel: 886-2-26052180

Fax: 886-2-26051924

Hsin Chu EMC/RF/Telecom Lab

Tel: 886-3-6668565

Fax: 886-3-6668323

Hwa Ya EMC/RF/Safety Lab

Tel: 886-3-3183232

Fax: 886-3-3270892

Email: service.adt@tw.bureauveritas.com

Web Site: www.bureauveritas-adt.com

The address and road map of all our labs can be found in our web site also.

--- END ---