

## Partial FCC Test Report (Part 27)

**Report No.:** RF191209C13-4

**FCC ID:** WIYT910

**Test Model:** LE910-NA1

**Received Date:** Dec. 09, 2019

**Test Date:** Feb. 20 ~ Feb. 21, 2020

**Issued Date:** Feb. 26, 2020

**Applicant:** CASTLES TECHNOLOGY CO., LTD.

**Address:** 6F, NO. 207-5, SEC. 3, BEIXIN RD., XINDIAN DISTRICT, NEW TAIPEI CITY  
23143, TAIWAN (R. O. C.)

**Issued By:** Bureau Veritas Consumer Products Services (H.K.) Ltd., Taoyuan Branch  
Lin Kou Laboratories

**Lab Address:** No. 47-2, 14th Ling, Chia Pau Vil., Lin Kou Dist., New Taipei City, Taiwan

**Test Location:** No. 19, Hwa Ya 2nd Rd., Wen Hwa Vil., Kwei Shan Dist., Taoyuan City  
33383, TAIWAN

**FCC Registration /** 788550 / TW0003

**Designation Number:**



This report is for your exclusive use. Any copying or replication of this report to or for any other person or entity, or use of our name or trademark, is permitted only with our prior written permission. This report sets forth our findings solely with respect to the test samples identified herein. The results set forth in this report are not indicative or representative of the quality or characteristics of the lot from which a test sample was taken or any similar or identical product unless specifically and expressly noted. Our report includes all of the tests requested by you and the results thereof based upon the information that you provided to us. You have 60 days from date of issuance of this report to notify us of any material error or omission caused by our negligence, provided, however, that such notice shall be in writing and shall specifically address the issue you wish to raise. A failure to raise such issue within the prescribed time shall constitute your unqualified acceptance of the completeness of this report, the tests conducted and the correctness of the report contents. Unless specifically mentioned, the uncertainty of measurement has been explicitly taken into account to declare the compliance or non-compliance to the specification. The report must not be used by the client to claim product certification, approval, or endorsement by TAF or any government agency.

## Table of Contents

<b>Release Control Record</b> .....	<b>3</b>
<b>1 Certificate of Conformity</b> .....	<b>4</b>
<b>2 Summary of Test Results</b> .....	<b>5</b>
2.1 Measurement Uncertainty.....	5
2.2 Test Site and Instruments.....	6
<b>3 General Information</b> .....	<b>7</b>
3.1 General Description of EUT.....	7
3.2 Configuration of System under Test.....	9
3.2.1 Description of Support Units.....	9
3.3 Test Mode Applicability and Tested Channel Detail.....	10
3.4 EUT Operating Conditions.....	12
3.5 General Description of Applied Standards.....	12
<b>4 Test Types and Results</b> .....	<b>13</b>
4.1 Output Power Measurement.....	13
4.1.1 Limits of Output Power Measurement.....	13
4.1.2 Test Procedures.....	13
4.1.3 Test Setup.....	14
4.1.4 Test Results.....	15
4.2 Radiated Emission Measurement.....	27
4.2.1 Limits of Radiated Emission Measurement.....	27
4.2.2 Test Procedure.....	27
4.2.3 Deviation from Test Standard.....	27
4.2.4 Test Setup.....	28
4.2.5 Test Results.....	29
<b>5 Pictures of Test Arrangements</b> .....	<b>60</b>
<b>Appendix – Information of the Testing Laboratories</b> .....	<b>61</b>



### Release Control Record

Issue No.	Description	Date Issued
RF191209C13-4	Original release	Feb. 26, 2020

## 1 Certificate of Conformity

**Product:** LTE module

**Brand:** Telit

**Test Model:** LE910-NA1

**Sample Status:** Identical Prototype

**Applicant:** CASTLES TECHNOLOGY CO., LTD.

**Test Date:** Feb. 20 ~ Feb. 21, 2020

**Standards:** FCC Part 27, Subpart C, L, H, F

The above equipment has been tested by **Bureau Veritas Consumer Products Services (H.K.) Ltd., Taoyuan Branch**, and found compliance with the requirement of the above standards. The test record, data evaluation & Equipment Under Test (EUT) configurations represented herein are true and accurate accounts of the measurements of the sample's RF characteristics under the conditions specified in this report.

**Prepared by :** , **Date:** Feb. 26, 2020  
Polly Chien / Specialist

**Approved by :** , **Date:** Feb. 26, 2020  
Bruce Chen / Senior Project Engineer

## 2 Summary of Test Results

Applied Standard: FCC Part 27 & Part 2					
FCC Clause			Test Item	Result	Remarks
LTE B4	LTE B12	LTE B13			
2.1046 27.50 (d)(4)	2.1046 27.50 (c)(10)	2.1046 27.50 (b)(10)	Equivalent Isotropically Radiated Power / Effective Radiated Power	Pass	Meet the requirement of limit.
27.50 (d)(5)	----	----	Peak To Average Ratio	N/A	Refer to Note 1
2.1055 27.54	2.1055 27.54	2.1055 27.54	Frequency Stability Stay with the authorized bands of operation	N/A	Refer to Note 1
2.1049	2.1049	2.1049	Emission Bandwidth	N/A	Refer to Note 1
2.1051 27.53(h)	2.1051 27.53(g)	2.1051 27.53(c)	Band Edge Measurements	N/A	Refer to Note 1
2.1051 27.53(h)	2.1051 27.53(g)	2.1051 27.53(c)	Conducted Spurious Emissions	N/A	Refer to Note 1
2.1053 27.53(h)	2.1053 27.53(g)	2.1053 27.53(c)&(f)	Radiated Spurious Emissions	Pass	Meet the requirement of limit. Minimum passing margin is -18.8dB at 1564.00MHz.

### Note:

1. This report is a partial report. Therefore, only test item of Effective Radiated Power / Effective Isotropically Radiated Power and Radiated Spurious Emissions tests were performed for this report. Other testing data please refer to A Test Lab Techno Corp. report no.: 1506FR22-01 for module (Brand: Telit, Model: LE910-NA1).
2. Determining compliance based on the results of the compliance measurement, not taking into account measurement instrumentation uncertainty.

### 2.1 Measurement Uncertainty

Where relevant, the following measurement uncertainty levels have been estimated for tests performed on the EUT as specified in CISPR 16-4-2:

Measurement	Frequency	Expanded Uncertainty (k=2) ( $\pm$ )
Radiated Emissions up to 1 GHz	9kHz ~ 30MHz	3.04 dB
	30MHz ~ 200MHz	3.86 dB
	200MHz ~ 1000MHz	3.87 dB
Radiated Emissions above 1 GHz	1GHz ~ 18GHz	2.29 dB
	18GHz ~ 40GHz	2.29 dB

## 2.2 Test Site and Instruments

Description & Manufacturer	Model No.	Serial No.	Cal. Date	Cal. Due
Test Receiver ROHDE & SCHWARZ	ESIB7	100187	May 30, 2019	May 29, 2020
Spectrum Analyzer ROHDE & SCHWARZ	FSP40	100269	Jun. 10, 2019	Jun. 09, 2020
MXG Vector signal generator Agilent	N5182B	MY53050430	Nov. 25, 2019	Nov. 24, 2020
Radio Communication Analyzer Anritsu	MT8820C	6201010284	Nov. 25, 2019	Nov. 24, 2020
BILOG Antenna SCHWARZBECK	VULB9168	9168-161	Nov. 08, 2019	Nov. 07, 2020
BILOG Antenna SCHWARZBECK	VULB9168	9168-171	Nov. 11, 2019	Nov. 10, 2020
HORN Antenna SCHWARZBECK	9120D	209	Nov. 24, 2019	Nov. 23, 2020
HORN Antenna SCHWARZBECK	BBHA 9170	BBHA9170241	Nov. 24, 2019	Nov. 23, 2020
HORN Antenna SCHWARZBECK	BBHA 9120 D	9120D-563	Nov. 24, 2019	Nov. 23, 2020
Loop Antenna TESEQ	HLA 6121	45745	Jul. 01, 2019	Jun. 30, 2020
Preamplifier Agilent (Below 1GHz)	8447D	2944A10738	Aug. 20, 2019	Aug. 19, 2020
Preamplifier Agilent (Above 1GHz)	8449B	3008A02465	Mar. 27, 2019	Mar. 26, 2020
RF Coaxial Cable WOKEN With 5dB PAD	8D-FB	Cable-CH3-01	Aug. 20, 2019	Aug. 19, 2020
RF signal cable HUBER+SUHNER	SUCOFLEX 104	Cable-CH3-03 (223653/4)	Aug. 20, 2019	Aug. 19, 2020
RF signal cable HUBER+SUHNER& EMCI	SUCOFLEX 104&EMC104-SM-SM- 8000	Cable-CH3-03 (309224+170907)	Aug. 20, 2019	Aug. 19, 2020
Software BV ADT	ADT_Radiated_ V7.6.15.9.5	NA	NA	NA
Antenna Tower inn-co GmbH	MA 4000	013303	NA	NA
Antenna Tower Controller BV ADT	AT100	AT93021702	NA	NA
Turn Table BV ADT	TT100	TT93021702	NA	NA
Turn Table Controller BV ADT	SC100	SC93021702	NA	NA
Boresight Antenna Fixture	FBA-01	FBA-SIP01	NA	NA

Note: 1. The calibration interval of the above test instruments is 12 months and the calibrations are traceable to NML/ROC and NIST/USA.  
2. The test was performed in HwaYa Chamber 3.

### 3 General Information

#### 3.1 General Description of EUT

Product	LTE module		
Brand	Telit		
Test Model	LE910-NA1		
Status of EUT	Identical Prototype		
Power Supply Rating	9Vdc~48Vdc, 1.5A~0.5A		
Modulation Type	LTE: QPSK, 16QAM		
Operating Frequency	LTE Band 4	Channel Bandwidth 1.4MHz	1710.7MHz ~ 1754.3MHz
		Channel Bandwidth 3MHz	1711.5MHz ~ 1753.5MHz
		Channel Bandwidth 5MHz	1712.5MHz ~ 1752.5MHz
		Channel Bandwidth 10MHz	1715.0MHz ~ 1750.0MHz
		Channel Bandwidth 15MHz	1717.5MHz ~ 1747.5MHz
		Channel Bandwidth 20MHz	1720.0MHz ~ 1745.0MHz
	LTE Band 12	Channel Bandwidth 1.4MHz	699.7MHz ~ 715.3MHz
		Channel Bandwidth 3MHz	700.5MHz ~ 714.5MHz
		Channel Bandwidth 5MHz	701.5MHz ~ 713.5MHz
		Channel Bandwidth 10MHz	704.0MHz ~ 711.0MHz
	LTE Band 13	Channel Bandwidth 5MHz	779.5MHz ~ 784.5MHz
		Channel Bandwidth 10MHz	782.0MHz
Max. EIRP Power			QPSK
	LTE Band 4	Channel Bandwidth 1.4MHz	204.174mW (23.1dBm)
		Channel Bandwidth 3MHz	208.930mW (23.2dBm)
		Channel Bandwidth 5MHz	208.930mW (23.2dBm)
		Channel Bandwidth 10MHz	208.930mW (23.2dBm)
		Channel Bandwidth 15MHz	229.087mW (23.6dBm)
		Channel Bandwidth 20MHz	186.209mW (22.7dBm)
Max. ERP Power			QPSK
	LTE Band 12	Channel Bandwidth 1.4MHz	138.038mW (21.4dBm)
		Channel Bandwidth 3MHz	144.544mW (21.6dBm)
		Channel Bandwidth 5MHz	144.544mW (21.6dBm)
		Channel Bandwidth 10MHz	147.911mW (21.7dBm)
	LTE Band 13	Channel Bandwidth 5MHz	134.896mW (21.3dBm)
		Channel Bandwidth 10MHz	128.825mW (21.1dBm)
Antenna Type	Refer to Note		
Antenna Connector	Refer to Note		
Accessory Device	Refer to note		
Cable Supplied	NA		

Note:

1. This report is a partial report. Therefore, only test item of Effective Radiated Power / Effective Isotropically Radiated Power and Radiated Spurious Emissions tests were performed for this report. Other testing data please refer to A Test Lab Techno Corp. report no.: 1506FR21-01 & 1506FR22-01 for module (Brand: Telit, Model: LE910-NA1).

2. The EUT uses following antennas.

Antenna Type	Antenna Connector	Frequency	Antenna Gain (dBi)
Dipole	SMA	698-791MHz	0
		1710-2170MHz	1.95

3. The EUT was installed in a specific End-product.

Product	Brand	Model
POS Terminal	CASTLES TECHNOLOGY	UPT1000B



### 3.2 Configuration of System under Test

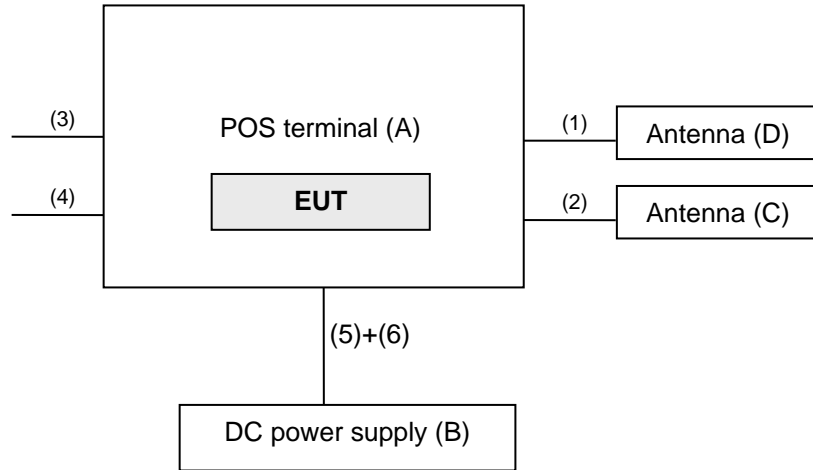

Remote site



#### 3.2.1 Description of Support Units

The EUT has been tested as an independent unit together with other necessary accessories or support units. The following support units or accessories were used to form a representative test configuration during the tests.

ID	Product	Brand	Model No.	Serial No.	FCC ID	Remarks
A.	POS Terminal	CASTLES TECHNOLOGY	UPT1000B	NA	WIYUPT1000-BV	Provided by client.
B.	DC power supply	SHUOKANG	33010D	807748	NA	-
C.	Antenna	Aristotle	RFA-LTE-T1000F-41-2M-A1	NA	NA	Provided by client.
D.	Antenna	Aristotle	RFA-25-T100-41-3M-A2	NA	NA	Provided by client.
E.	Radio Communication Analyzer	Anritsu	MT8820C	6201010284	NA	-

Note:

1. All power cords of the above support units are non-shielded (1.8m).
2. Item E acted as a communication partner to transfer data.

ID	Cable Descriptions	Qty.	Length (m)	Shielding (Yes/No)	Cores (Qty.)	Remarks
1.	ANT cable	1	2.05	Y	0	Accessory of EUT
2.	ANT cable	1	3	Y	0	Accessory of EUT
3.	USB Type B cable	1	0.7	Y	0	Provided by client.
4.	RS232 cable	1	0.71	N	0	Provided by client.
5.	Power cable	1	0.7	N	0	Provided by client.
6.	Power cable	1	2	N	0	-

### 3.3 Test Mode Applicability and Tested Channel Detail

Pre-Scan has been conducted to determine the worst-case mode from all possible combinations between available modulations, data rates, XYZ axis and antenna ports. The worst case was found when positioned on Z-plane. Following channel(s) was (were) selected for the final test as listed below.

#### LTE Band 4

EUT Configure Mode	Test Item	Available Channel	Tested Channel	Channel Bandwidth	Modulation	Mode
-	EIRP	19957 to 20393	19957(1710.7MHz), 20175(1732.5MHz), 20393(1754.3MHz)	1.4MHz	QPSK	1 RB / 0 RB Offset
		19965 to 20385	19965(1711.5MHz), 20175(1732.5MHz), 20385(1753.5MHz)	3MHz	QPSK	1 RB / 0 RB Offset
		19975 to 20375	19975(1712.5MHz), 20175(1732.5MHz), 20375(1752.5MHz)	5MHz	QPSK	1 RB / 0 RB Offset
		20000 to 20350	20000(1715.0MHz), 20175(1732.5MHz), 20350(1750.0MHz)	10MHz	QPSK	1 RB / 0 RB Offset
		20025 to 20325	20025(1717.5MHz), 20175(1732.5MHz), 20325(1747.5MHz)	15MHz	QPSK	1 RB / 0 RB Offset
		20050 to 20300	20050(1720.0MHz), 20175(1732.5MHz), 20300(1745.0MHz)	20MHz	QPSK	1 RB / 0 RB Offset
-	Radiated Emission Below 1GHz	19957 to 20393	20393(1754.3MHz)	1.4MHz	QPSK	1 RB / 0 RB Offset
		19975 to 20375	20375(1752.5MHz)	5MHz	QPSK	1 RB / 0 RB Offset
		20050 to 20300	20175(1732.5MHz)	20MHz	QPSK	1 RB / 0 RB Offset
-	Radiated Emission Above 1GHz	19957 to 20393	19957(1710.7MHz), 20175(1732.5MHz), 20393(1754.3MHz)	1.4MHz	QPSK	1 RB / 0 RB Offset
		19975 to 20375	19975(1712.5MHz), 20175(1732.5MHz), 20375(1752.5MHz)	5MHz	QPSK	1 RB / 0 RB Offset
		20050 to 20300	20050(1720.0MHz), 20175(1732.5MHz), 20300(1745.0MHz)	20MHz	QPSK	1 RB / 99 RB Offset

### LTE Band 12

EUT Configure Mode	Test item	Available channel	Tested channel	Channel Bandwidth	Modulation	Mode
-	ERP	23017 to 23171	23017(699.7MHz), 23095(707.5MHz), 23173(715.3MHz)	1.4MHz	QPSK	1 RB / 0 RB Offset
		23025 to 23165	23025(700.5MHz), 23095(707.5MHz), 23165(714.5MHz)	3MHz	QPSK	1 RB / 0 RB Offset
		23035 to 23155	23035(701.5MHz), 23095(707.5MHz), 23155(713.5MHz)	5MHz	QPSK	1 RB / 0 RB Offset
		23060 to 23130	23060(704.0MHz), 23095(707.5 MHz), 23130(711.0 MHz)	10MHz	QPSK	1 RB / 0 RB Offset
-	Radiated Emission Below 1GHz	23017 to 23173	23017(699.7MHz)	1.4MHz	QPSK	1 RB / 0 RB Offset
		23035 to 23155	23095(707.5 MHz)	5MHz	QPSK	1 RB / 0 RB Offset
		23060 to 23130	23060(704.0MHz)	10MHz	QPSK	1 RB / 0 RB Offset
-	Radiated Emission Above 1GHz	23017 to 23171	23017(699.7MHz), 23095(707.5MHz), 23173(715.3MHz)	1.4MHz	QPSK	1 RB / 0 RB Offset
		23035 to 23155	23035(701.5MHz), 23095(707.5MHz), 23155(713.5MHz)	5MHz	QPSK	1 RB / 0 RB Offset
		23060 to 23130	23060(704.0MHz), 23095(707.5 MHz), 23130(711.0 MHz)	10MHz	QPSK	1 RB / 0 RB Offset

### LTE Band 13

EUT Configure Mode	Test item	Available channel	Tested channel	Channel Bandwidth	Modulation	Mode
-	ERP	23205 to 23255	23205(779.5MHz), 23230(782.0MHz), 23255(784.5MHz)	5MHz	QPSK	1 RB / 0 RB Offset
		23230	23230(782.0MHz)	10MHz	QPSK	1 RB / 0 RB Offset
-	Radiated Emission Below 1GHz	23205 to 23255	23230(782.0MHz)	5MHz	QPSK	1 RB / 0 RB Offset
		23230	23230(782.0MHz)	10MHz	QPSK	1 RB / 0 RB Offset
-	Radiated Emission Above 1GHz	23205 to 23255	23205(779.5MHz), 23230(782.0MHz), 23255(784.5MHz)	5MHz	QPSK	1 RB / 0 RB Offset
		23230	23230(782.0MHz)	10MHz	QPSK	1 RB / 0 RB Offset

**Note:**

- For radiated emission below 1GHz, low, mid and high channels were pre-tested in chamber. The worst cases were chosen for final test as above table.
- This device was tested under all bandwidths, RB configurations and modulations. The worst case was found in QPSK modulation.
- For radiated emission, according to 3GPP 36.521 Section 6.6.3.1.4, choose the lowest, 5 MHz & highest channel bandwidth for final test.

**Test Condition:**

Test Item	Environmental Conditions	Input Power (System)	Tested By
EIRP/ ERP	23deg. C, 66%RH	9Vdc	Titan Hsu
Radiated Emission	23deg. C, 66%RH	9Vdc	Titan Hsu, Adair Peng

### **3.4 EUT Operating Conditions**

The EUT makes a call to the communication simulator. The communication simulator station system controlled a EUT to export maximum output power under transmission mode and specific channel frequency

### **3.5 General Description of Applied Standards**

The EUT is a RF Product. According to the specifications of the manufacturer, it must comply with the requirements of the following standards:

**FCC 47 CFR Part 2**

**FCC 47 CFR Part 27**

**KDB 971168 D01 Power Meas License Digital Systems v03r01**

**ANSI/TIA/EIA-603-E 2016**

**ANSI 63.26-2015**

Note: All test items have been performed and recorded as per the above standards.

## 4 Test Types and Results

### 4.1 Output Power Measurement

#### 4.1.1 Limits of Output Power Measurement

Mobile / Portable station are limited to 1 watts e.i.r.p for LTE Band 4 and 3 watts e.r.p for LTE Band 12, Band 13.

#### 4.1.2 Test Procedures

##### EIRP / ERP Measurement:

- a. All measurements were done at low, middle and high operational frequency range. RBW and VBW is 20MHz for LTE mode.
- b. Substitution method is used for E.I.R.P measurement. In the semi-anechoic chamber, EUT placed on the 0.8m(below or equal 1GHz) and/or 1.5m(above 1GHz) height of Turn Table, rotated the table around 360 degrees to search the maximum radiation power and receiver antenna shall be rotated vertical and horizontal polarization and moved height from 1m to 4m to find the maximum polar radiated power. The "Read Value" is the spectrum reading the maximum power value.
- c. The substitution horn antenna is substituted for EUT at the same position and signals generator export the CW signal to the substitution antenna via a TX cable. Rotated the Turn Table and moved receiving antenna to find the maximum radiation power. Adjust output power level of S.G to get a Value of spectrum reading equal to "Read Value" of step b. Record the power level of S.G
- d.  $EIRP = \text{Output power level of S.G} - \text{TX cable loss} + \text{Antenna gain of substitution horn}$ . E.R.P power can be calculated form E.I.R.P power by subtracting the gain of dipole,  $E.R.P \text{ power} = E.I.R.P \text{ power} - 2.15\text{dBi}$ .

Where:

$$ERP/EIRP = P_{Meas} + G_T - L_C$$

$P_{Meas}$  : Measure transmitter output power.

$G_T$  : Gain of the transmitting antenna.

$L_C$  : signal attenuation in the connecting cable between the transmitter and antenna.

### 4.1.3 Test Setup

EIRP / ERP Measurement:

For radiated emission 30MHz to 1GHz

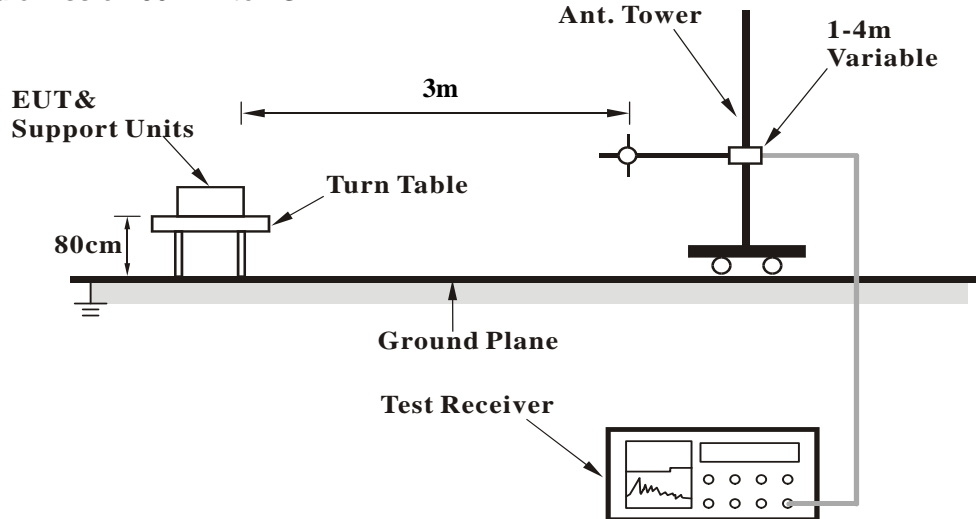

For radiated emission above 1GHz

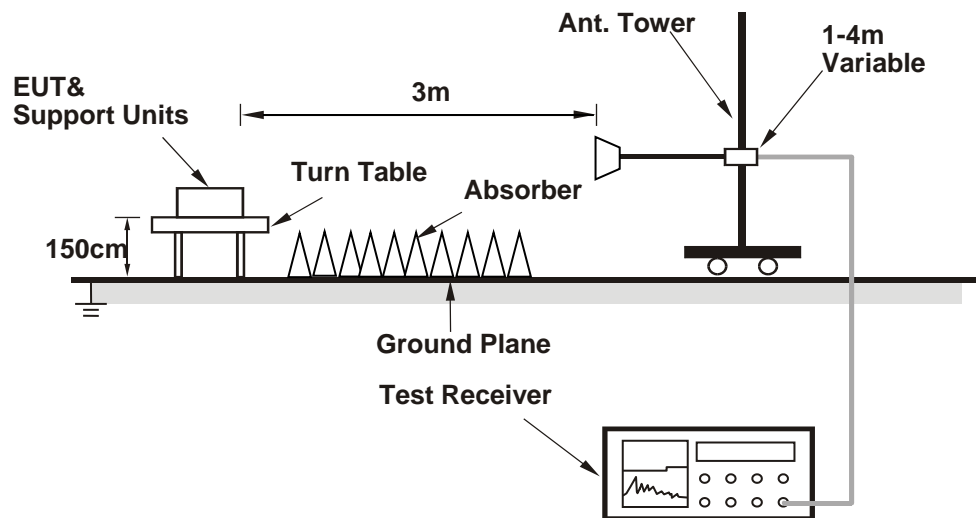

For the actual test configuration, please refer to the attached file (Test Setup Photo).

#### 4.1.4 Test Results

##### EIRP / ERP Power

**Modulation Type: QPSK**

LTE Band 4, Channel Bandwidth: 1.4MHz

Mode		TX channel 19957					
Antenna Polarity & Test Distance: Horizontal at 3 M							
No.	Freq. (MHz)	Reading (dBm)	S.G Power Value (dBm)	Correction Factor (dB)	EIRP (dBm)	Limit (dBm)	Margin (dB)
1	1710.70	-19.4	18.1	1.0	19.1	30.0	-10.9
Antenna Polarity & Test Distance: Vertical at 3 M							
No.	Freq. (MHz)	Reading (dBm)	S.G Power Value (dBm)	Correction Factor (dB)	EIRP (dBm)	Limit (dBm)	Margin (dB)
1	1710.70	-16.5	22.1	1.0	<b>23.1</b>	30.0	-6.9

Mode		TX channel 20175					
Antenna Polarity & Test Distance: Horizontal at 3 M							
No.	Freq. (MHz)	Reading (dBm)	S.G Power Value (dBm)	Correction Factor (dB)	EIRP (dBm)	Limit (dBm)	Margin (dB)
1	1732.50	-19.3	18.4	1.0	19.4	30.0	-10.6
Antenna Polarity & Test Distance: Vertical at 3 M							
No.	Freq. (MHz)	Reading (dBm)	S.G Power Value (dBm)	Correction Factor (dB)	EIRP (dBm)	Limit (dBm)	Margin (dB)
1	1732.50	-16.8	21.7	1.0	22.7	30.0	-7.3

Mode		TX channel 20393					
Antenna Polarity & Test Distance: Horizontal at 3 M							
No.	Freq. (MHz)	Reading (dBm)	S.G Power Value (dBm)	Correction Factor (dB)	EIRP (dBm)	Limit (dBm)	Margin (dB)
1	1754.30	-19.3	18.4	1.1	19.5	30.0	-10.5
Antenna Polarity & Test Distance: Vertical at 3 M							
No.	Freq. (MHz)	Reading (dBm)	S.G Power Value (dBm)	Correction Factor (dB)	EIRP (dBm)	Limit (dBm)	Margin (dB)
1	1754.30	-16.6	21.7	1.1	22.8	30.0	-7.2

Note: EIRP (dBm) = S.G Power Value (dBm) + Correction Factor (dB).

LTE Band 4, Channel Bandwidth: 3MHz

Mode		TX channel 19965					
Antenna Polarity & Test Distance: Horizontal at 3 M							
No.	Freq. (MHz)	Reading (dBm)	S.G Power Value (dBm)	Correction Factor (dB)	EIRP (dBm)	Limit (dBm)	Margin (dB)
1	1711.50	-19.4	18.2	1.0	19.2	30.0	-10.8
Antenna Polarity & Test Distance: Vertical at 3 M							
No.	Freq. (MHz)	Reading (dBm)	S.G Power Value (dBm)	Correction Factor (dB)	EIRP (dBm)	Limit (dBm)	Margin (dB)
1	1711.50	-17.0	21.6	1.0	22.6	30.0	-7.4

Mode		TX channel 20175					
Antenna Polarity & Test Distance: Horizontal at 3 M							
No.	Freq. (MHz)	Reading (dBm)	S.G Power Value (dBm)	Correction Factor (dB)	EIRP (dBm)	Limit (dBm)	Margin (dB)
1	1732.50	-19.1	18.6	1.0	19.6	30.0	-10.4
Antenna Polarity & Test Distance: Vertical at 3 M							
No.	Freq. (MHz)	Reading (dBm)	S.G Power Value (dBm)	Correction Factor (dB)	EIRP (dBm)	Limit (dBm)	Margin (dB)
1	1732.50	-16.3	22.2	1.0	<b>23.2</b>	30.0	-6.8

Mode		TX channel 20385					
Antenna Polarity & Test Distance: Horizontal at 3 M							
No.	Freq. (MHz)	Reading (dBm)	S.G Power Value (dBm)	Correction Factor (dB)	EIRP (dBm)	Limit (dBm)	Margin (dB)
1	1753.50	-19.5	18.2	1.1	19.3	30.0	-10.7
Antenna Polarity & Test Distance: Vertical at 3 M							
No.	Freq. (MHz)	Reading (dBm)	S.G Power Value (dBm)	Correction Factor (dB)	EIRP (dBm)	Limit (dBm)	Margin (dB)
1	1753.50	-16.3	22.0	1.1	23.1	30.0	-6.9

Note: EIRP (dBm) = S.G Power Value (dBm) + Correction Factor (dB).



LTE Band 4, Channel Bandwidth: 5MHz

Mode		TX channel 19975					
Antenna Polarity & Test Distance: Horizontal at 3 M							
No.	Freq. (MHz)	Reading (dBm)	S.G Power Value (dBm)	Correction Factor (dB)	EIRP (dBm)	Limit (dBm)	Margin (dB)
1	1712.50	-19.4	18.2	1.0	19.2	30.0	-10.8
Antenna Polarity & Test Distance: Vertical at 3 M							
No.	Freq. (MHz)	Reading (dBm)	S.G Power Value (dBm)	Correction Factor (dB)	EIRP (dBm)	Limit (dBm)	Margin (dB)
1	1712.50	-16.7	21.9	1.0	22.9	30.0	-7.1

Mode		TX channel 20175					
Antenna Polarity & Test Distance: Horizontal at 3 M							
No.	Freq. (MHz)	Reading (dBm)	S.G Power Value (dBm)	Correction Factor (dB)	EIRP (dBm)	Limit (dBm)	Margin (dB)
1	1732.50	-19.4	18.3	1.0	19.3	30.0	-10.7
Antenna Polarity & Test Distance: Vertical at 3 M							
No.	Freq. (MHz)	Reading (dBm)	S.G Power Value (dBm)	Correction Factor (dB)	EIRP (dBm)	Limit (dBm)	Margin (dB)
1	1732.50	-16.3	22.2	1.0	<b>23.2</b>	30.0	-6.8

Mode		TX channel 20375					
Antenna Polarity & Test Distance: Horizontal at 3 M							
No.	Freq. (MHz)	Reading (dBm)	S.G Power Value (dBm)	Correction Factor (dB)	EIRP (dBm)	Limit (dBm)	Margin (dB)
1	1752.50	-19.3	18.4	1.1	19.5	30.0	-10.5
Antenna Polarity & Test Distance: Vertical at 3 M							
No.	Freq. (MHz)	Reading (dBm)	S.G Power Value (dBm)	Correction Factor (dB)	EIRP (dBm)	Limit (dBm)	Margin (dB)
1	1752.50	-16.4	21.9	1.1	23.0	30.0	-7.0

Note: EIRP (dBm) = S.G Power Value (dBm) + Correction Factor (dB).

LTE Band 4, Channel Bandwidth: 10MHz

Mode		TX channel 20000					
Antenna Polarity & Test Distance: Horizontal at 3 M							
No.	Freq. (MHz)	Reading (dBm)	S.G Power Value (dBm)	Correction Factor (dB)	EIRP (dBm)	Limit (dBm)	Margin (dB)
1	1715.00	-19.3	18.3	1.0	19.3	30.0	-10.7
Antenna Polarity & Test Distance: Vertical at 3 M							
No.	Freq. (MHz)	Reading (dBm)	S.G Power Value (dBm)	Correction Factor (dB)	EIRP (dBm)	Limit (dBm)	Margin (dB)
1	1715.00	-16.3	22.2	1.0	<b>23.2</b>	30.0	-6.8

Mode		TX channel 20175					
Antenna Polarity & Test Distance: Horizontal at 3 M							
No.	Freq. (MHz)	Reading (dBm)	S.G Power Value (dBm)	Correction Factor (dB)	EIRP (dBm)	Limit (dBm)	Margin (dB)
1	1732.50	-19.1	18.6	1.0	19.6	30.0	-10.4
Antenna Polarity & Test Distance: Vertical at 3 M							
No.	Freq. (MHz)	Reading (dBm)	S.G Power Value (dBm)	Correction Factor (dB)	EIRP (dBm)	Limit (dBm)	Margin (dB)
1	1732.50	-16.6	21.9	1.0	22.9	30.0	-7.1

Mode		TX channel 20350					
Antenna Polarity & Test Distance: Horizontal at 3 M							
No.	Freq. (MHz)	Reading (dBm)	S.G Power Value (dBm)	Correction Factor (dB)	EIRP (dBm)	Limit (dBm)	Margin (dB)
1	1750.00	-19.5	18.1	1.1	19.2	30.0	-10.8
Antenna Polarity & Test Distance: Vertical at 3 M							
No.	Freq. (MHz)	Reading (dBm)	S.G Power Value (dBm)	Correction Factor (dB)	EIRP (dBm)	Limit (dBm)	Margin (dB)
1	1750.00	-16.6	21.9	1.0	22.9	30.0	-7.1

Note: EIRP (dBm) = S.G Power Value (dBm) + Correction Factor (dB).

LTE Band 4, Channel Bandwidth: 15MHz

Mode		TX channel 20025					
Antenna Polarity & Test Distance: Horizontal at 3 M							
No.	Freq. (MHz)	Reading (dBm)	S.G Power Value (dBm)	Correction Factor (dB)	EIRP (dBm)	Limit (dBm)	Margin (dB)
1	1717.50	-19.5	18.1	1.0	19.1	30.0	-10.9
Antenna Polarity & Test Distance: Vertical at 3 M							
No.	Freq. (MHz)	Reading (dBm)	S.G Power Value (dBm)	Correction Factor (dB)	EIRP (dBm)	Limit (dBm)	Margin (dB)
1	1717.50	-16.5	22.0	1.0	23.0	30.0	-7.0

Mode		TX channel 20175					
Antenna Polarity & Test Distance: Horizontal at 3 M							
No.	Freq. (MHz)	Reading (dBm)	S.G Power Value (dBm)	Correction Factor (dB)	EIRP (dBm)	Limit (dBm)	Margin (dB)
1	1732.50	-19.1	18.6	1.0	19.6	30.0	-10.4
Antenna Polarity & Test Distance: Vertical at 3 M							
No.	Freq. (MHz)	Reading (dBm)	S.G Power Value (dBm)	Correction Factor (dB)	EIRP (dBm)	Limit (dBm)	Margin (dB)
1	1732.50	-15.9	22.6	1.0	<b>23.6</b>	30.0	-6.4

Mode		TX channel 20325					
Antenna Polarity & Test Distance: Horizontal at 3 M							
No.	Freq. (MHz)	Reading (dBm)	S.G Power Value (dBm)	Correction Factor (dB)	EIRP (dBm)	Limit (dBm)	Margin (dB)
1	1747.50	-19.2	18.4	1.1	19.5	30.0	-10.5
Antenna Polarity & Test Distance: Vertical at 3 M							
No.	Freq. (MHz)	Reading (dBm)	S.G Power Value (dBm)	Correction Factor (dB)	EIRP (dBm)	Limit (dBm)	Margin (dB)
1	1747.50	-16.0	22.3	1.1	23.4	30.0	-6.6

Note: EIRP (dBm) = S.G Power Value (dBm) + Correction Factor (dB).

LTE Band 4, Channel Bandwidth: 20MHz

Mode		TX channel 20050					
Antenna Polarity & Test Distance: Horizontal at 3 M							
No.	Freq. (MHz)	Reading (dBm)	S.G Power Value (dBm)	Correction Factor (dB)	EIRP (dBm)	Limit (dBm)	Margin (dB)
1	1720.00	-19.1	18.5	1.0	19.5	30.0	-10.5
Antenna Polarity & Test Distance: Vertical at 3 M							
No.	Freq. (MHz)	Reading (dBm)	S.G Power Value (dBm)	Correction Factor (dB)	EIRP (dBm)	Limit (dBm)	Margin (dB)
1	1720.00	-16.8	21.7	1.0	<b>22.7</b>	30.0	-7.3

Mode		TX channel 20175					
Antenna Polarity & Test Distance: Horizontal at 3 M							
No.	Freq. (MHz)	Reading (dBm)	S.G Power Value (dBm)	Correction Factor (dB)	EIRP (dBm)	Limit (dBm)	Margin (dB)
1	1732.50	-19.1	18.6	1.0	19.6	30.0	-10.4
Antenna Polarity & Test Distance: Vertical at 3 M							
No.	Freq. (MHz)	Reading (dBm)	S.G Power Value (dBm)	Correction Factor (dB)	EIRP (dBm)	Limit (dBm)	Margin (dB)
1	1732.50	-16.9	21.6	1.0	22.6	30.0	-7.4

Mode		TX channel 20300					
Antenna Polarity & Test Distance: Horizontal at 3 M							
No.	Freq. (MHz)	Reading (dBm)	S.G Power Value (dBm)	Correction Factor (dB)	EIRP (dBm)	Limit (dBm)	Margin (dB)
1	1745.00	-19.2	18.5	1.0	19.5	30.0	-10.5
Antenna Polarity & Test Distance: Vertical at 3 M							
No.	Freq. (MHz)	Reading (dBm)	S.G Power Value (dBm)	Correction Factor (dB)	EIRP (dBm)	Limit (dBm)	Margin (dB)
1	1745.00	-16.7	21.7	1.0	<b>22.7</b>	30.0	-7.3

Note: EIRP (dBm) = S.G Power Value (dBm) + Correction Factor (dB).

LTE Band 12, Channel Bandwidth: 1.4MHz

MODE		TX channel 23017					
Antenna Polarity & Test Distance: Horizontal at 3 M							
No.	Freq. (MHz)	Reading (dBm)	S.G Power Value (dBm)	Correction Factor (dB)	ERP (dBm)	Limit (dBm)	Margin (dB)
1	699.70	-8.2	21.1	-0.5	20.6	34.8	-14.2
Antenna Polarity & Test Distance: Vertical at 3 M							
No.	Freq. (MHz)	Reading (dBm)	S.G Power Value (dBm)	Correction Factor (dB)	ERP (dBm)	Limit (dBm)	Margin (dB)
1	699.70	-12.4	20.0	-0.5	19.5	34.8	-15.3

MODE		TX channel 23095					
Antenna Polarity & Test Distance: Horizontal at 3 M							
No.	Freq. (MHz)	Reading (dBm)	S.G Power Value (dBm)	Correction Factor (dB)	ERP (dBm)	Limit (dBm)	Margin (dB)
1	707.50	-8.0	21.4	-0.5	20.9	34.8	-13.9
Antenna Polarity & Test Distance: Vertical at 3 M							
No.	Freq. (MHz)	Reading (dBm)	S.G Power Value (dBm)	Correction Factor (dB)	ERP (dBm)	Limit (dBm)	Margin (dB)
1	707.50	-12.8	19.6	-0.5	19.1	34.8	-15.7

MODE		TX channel 23173					
Antenna Polarity & Test Distance: Horizontal at 3 M							
No.	Freq. (MHz)	Reading (dBm)	S.G Power Value (dBm)	Correction Factor (dB)	ERP (dBm)	Limit (dBm)	Margin (dB)
1	715.30	-7.8	21.9	-0.5	<b>21.4</b>	34.8	-13.4
Antenna Polarity & Test Distance: Vertical at 3 M							
No.	Freq. (MHz)	Reading (dBm)	S.G Power Value (dBm)	Correction Factor (dB)	ERP (dBm)	Limit (dBm)	Margin (dB)
1	715.30	-10.7	21.7	-0.5	21.2	34.8	-13.6

Note: ERP (dBm) = S.G Power Value (dBm) + Correction Factor (dB).

LTE Band 12, Channel Bandwidth: 3MHz

MODE		TX channel 23025					
Antenna Polarity & Test Distance: Horizontal at 3 M							
No.	Freq. (MHz)	Reading (dBm)	S.G Power Value (dBm)	Correction Factor (dB)	ERP (dBm)	Limit (dBm)	Margin (dB)
1	700.50	-8.1	21.3	-0.5	20.8	34.8	-14.0
Antenna Polarity & Test Distance: Vertical at 3 M							
No.	Freq. (MHz)	Reading (dBm)	S.G Power Value (dBm)	Correction Factor (dB)	ERP (dBm)	Limit (dBm)	Margin (dB)
1	700.50	-12.2	20.1	-0.5	19.6	34.8	-15.2

MODE		TX channel 23095					
Antenna Polarity & Test Distance: Horizontal at 3 M							
No.	Freq. (MHz)	Reading (dBm)	S.G Power Value (dBm)	Correction Factor (dB)	ERP (dBm)	Limit (dBm)	Margin (dB)
1	707.50	-7.4	22.0	-0.5	21.5	34.8	-13.3
Antenna Polarity & Test Distance: Vertical at 3 M							
No.	Freq. (MHz)	Reading (dBm)	S.G Power Value (dBm)	Correction Factor (dB)	ERP (dBm)	Limit (dBm)	Margin (dB)
1	707.50	-12.4	20.0	-0.5	19.5	34.8	-15.3

MODE		TX channel 23165					
Antenna Polarity & Test Distance: Horizontal at 3 M							
No.	Freq. (MHz)	Reading (dBm)	S.G Power Value (dBm)	Correction Factor (dB)	ERP (dBm)	Limit (dBm)	Margin (dB)
1	714.50	-7.6	22.1	-0.5	<b>21.6</b>	34.8	-13.2
Antenna Polarity & Test Distance: Vertical at 3 M							
No.	Freq. (MHz)	Reading (dBm)	S.G Power Value (dBm)	Correction Factor (dB)	ERP (dBm)	Limit (dBm)	Margin (dB)
1	714.50	-10.7	21.8	-0.5	21.3	34.8	-13.5

Note: ERP (dBm) = S.G Power Value (dBm) + Correction Factor (dB).

LTE Band 12, Channel Bandwidth: 5MHz

MODE		TX channel 23035					
Antenna Polarity & Test Distance: Horizontal at 3 M							
No.	Freq. (MHz)	Reading (dBm)	S.G Power Value (dBm)	Correction Factor (dB)	ERP (dBm)	Limit (dBm)	Margin (dB)
1	701.50	-7.8	21.6	-0.5	21.1	34.8	-13.7
Antenna Polarity & Test Distance: Vertical at 3 M							
No.	Freq. (MHz)	Reading (dBm)	S.G Power Value (dBm)	Correction Factor (dB)	ERP (dBm)	Limit (dBm)	Margin (dB)
1	701.50	-12.2	20.2	-0.5	19.7	34.8	-15.1

MODE		TX channel 23095					
Antenna Polarity & Test Distance: Horizontal at 3 M							
No.	Freq. (MHz)	Reading (dBm)	S.G Power Value (dBm)	Correction Factor (dB)	ERP (dBm)	Limit (dBm)	Margin (dB)
1	707.50	-7.7	21.7	-0.5	21.2	34.8	-13.6
Antenna Polarity & Test Distance: Vertical at 3 M							
No.	Freq. (MHz)	Reading (dBm)	S.G Power Value (dBm)	Correction Factor (dB)	ERP (dBm)	Limit (dBm)	Margin (dB)
1	707.50	-12.4	20.0	-0.5	19.5	34.8	-15.3

MODE		TX channel 23155					
Antenna Polarity & Test Distance: Horizontal at 3 M							
No.	Freq. (MHz)	Reading (dBm)	S.G Power Value (dBm)	Correction Factor (dB)	ERP (dBm)	Limit (dBm)	Margin (dB)
1	713.50	-7.6	22.1	-0.5	<b>21.6</b>	34.8	-13.2
Antenna Polarity & Test Distance: Vertical at 3 M							
No.	Freq. (MHz)	Reading (dBm)	S.G Power Value (dBm)	Correction Factor (dB)	ERP (dBm)	Limit (dBm)	Margin (dB)
1	713.50	-10.7	21.8	-0.5	21.3	34.8	-13.5

Note: ERP (dBm) = S.G Power Value (dBm) + Correction Factor (dB).

LTE Band 12, Channel Bandwidth: 10MHz

MODE		TX channel 23060					
Antenna Polarity & Test Distance: Horizontal at 3 M							
No.	Freq. (MHz)	Reading (dBm)	S.G Power Value (dBm)	Correction Factor (dB)	ERP (dBm)	Limit (dBm)	Margin (dB)
1	704.00	-7.9	21.5	-0.5	21.0	34.8	-13.8
Antenna Polarity & Test Distance: Vertical at 3 M							
No.	Freq. (MHz)	Reading (dBm)	S.G Power Value (dBm)	Correction Factor (dB)	ERP (dBm)	Limit (dBm)	Margin (dB)
1	704.00	-12.2	20.3	-0.5	19.8	34.8	-15.0

MODE		TX channel 23095					
Antenna Polarity & Test Distance: Horizontal at 3 M							
No.	Freq. (MHz)	Reading (dBm)	S.G Power Value (dBm)	Correction Factor (dB)	ERP (dBm)	Limit (dBm)	Margin (dB)
1	707.50	-7.7	21.7	-0.5	21.2	34.8	-13.6
Antenna Polarity & Test Distance: Vertical at 3 M							
No.	Freq. (MHz)	Reading (dBm)	S.G Power Value (dBm)	Correction Factor (dB)	ERP (dBm)	Limit (dBm)	Margin (dB)
1	707.50	-12.4	20.0	-0.5	19.5	34.8	-15.3

MODE		TX channel 23130					
Antenna Polarity & Test Distance: Horizontal at 3 M							
No.	Freq. (MHz)	Reading (dBm)	S.G Power Value (dBm)	Correction Factor (dB)	ERP (dBm)	Limit (dBm)	Margin (dB)
1	711.00	-7.3	22.2	-0.5	<b>21.7</b>	34.8	-13.1
Antenna Polarity & Test Distance: Vertical at 3 M							
No.	Freq. (MHz)	Reading (dBm)	S.G Power Value (dBm)	Correction Factor (dB)	ERP (dBm)	Limit (dBm)	Margin (dB)
1	711.00	-10.4	22.0	-0.5	21.5	34.8	-13.3

Note: ERP (dBm) = S.G Power Value (dBm) + Correction Factor (dB).



LTE Band 13, Channel Bandwidth: 5MHz

MODE		TX channel 23205					
Antenna Polarity & Test Distance: Horizontal at 3 M							
No.	Freq. (MHz)	Reading (dBm)	S.G Power Value (dBm)	Correction Factor (dB)	ERP (dBm)	Limit (dBm)	Margin (dB)
1	779.50	-9.8	21.3	-0.5	20.8	34.8	-14.0
Antenna Polarity & Test Distance: Vertical at 3 M							
No.	Freq. (MHz)	Reading (dBm)	S.G Power Value (dBm)	Correction Factor (dB)	ERP (dBm)	Limit (dBm)	Margin (dB)
1	779.50	-11.8	21.8	-0.5	<b>21.3</b>	34.8	-13.5

MODE		TX channel 23230					
Antenna Polarity & Test Distance: Horizontal at 3 M							
No.	Freq. (MHz)	Reading (dBm)	S.G Power Value (dBm)	Correction Factor (dB)	ERP (dBm)	Limit (dBm)	Margin (dB)
1	782.00	-9.8	21.5	-0.5	21.0	34.8	-13.8
Antenna Polarity & Test Distance: Vertical at 3 M							
No.	Freq. (MHz)	Reading (dBm)	S.G Power Value (dBm)	Correction Factor (dB)	ERP (dBm)	Limit (dBm)	Margin (dB)
1	782.00	-12.0	21.6	-0.5	21.1	34.8	-13.7

MODE		TX channel 23255					
Antenna Polarity & Test Distance: Horizontal at 3 M							
No.	Freq. (MHz)	Reading (dBm)	S.G Power Value (dBm)	Correction Factor (dB)	ERP (dBm)	Limit (dBm)	Margin (dB)
1	784.50	-10.0	21.3	-0.4	20.9	34.8	-13.9
Antenna Polarity & Test Distance: Vertical at 3 M							
No.	Freq. (MHz)	Reading (dBm)	S.G Power Value (dBm)	Correction Factor (dB)	ERP (dBm)	Limit (dBm)	Margin (dB)
1	784.50	-12.0	21.5	-0.4	21.1	34.8	-13.7

Note: ERP (dBm) = S.G Power Value (dBm) + Correction Factor (dB).

LTE Band 13, Channel Bandwidth: 10MHz

MODE		TX channel 23230					
Antenna Polarity & Test Distance: Horizontal at 3 M							
No.	Freq. (MHz)	Reading (dBm)	S.G Power Value (dBm)	Correction Factor (dB)	ERP (dBm)	Limit (dBm)	Margin (dB)
1	782.00	-9.8	21.5	-0.5	21.0	34.8	-13.8
Antenna Polarity & Test Distance: Vertical at 3 M							
No.	Freq. (MHz)	Reading (dBm)	S.G Power Value (dBm)	Correction Factor (dB)	ERP (dBm)	Limit (dBm)	Margin (dB)
1	782.00	-12.0	21.6	-0.5	<b>21.1</b>	34.8	-13.7

Note: ERP (dBm) = S.G Power Value (dBm) + Correction Factor (dB).

## 4.2 Radiated Emission Measurement

### 4.2.1 Limits of Radiated Emission Measurement

For LTE Band 4

According to FCC 27.53(h) for operations in the 1695-1710 MHz, 1710-1755 MHz, 1755-1780 MHz, 1915-1920 MHz, 1995-2000 MHz, 2000-2020 MHz, 2110-2155 MHz, 2155-2180 MHz, and 2180-2200 MHz, the power of any emission outside a licensee's frequency block shall be attenuated below the transmitter power (P) in watts by at least  $43 + 10 \log (P)$  dB.

For LTE Band 12

According to FCC 27.53(g) for operations in the 600 MHz band and the 698-746 MHz band, the power of any emission outside a licensee's frequency band(s) of operation shall be attenuated below the transmitter power (P) within the licensed band(s) of operation, measured in watts, by at least  $43 + 10 \log (P)$  dB. Compliance with this provision is based on the use of measurement instrumentation employing a resolution bandwidth of 100 kilohertz or greater.

For LTE Band 13

According to FCC 27.53(c)(2) for on any frequency outside the 776-788 MHz band, the power of any emission shall be attenuated outside the band below the transmitter power (P) by at least  $43 + 10 \log (P)$  dB.

For operations in the 775-788 MHz, emissions in the band 1559-1610 MHz shall be limited to -70 dBW/MHz. The limit of emissions is equal to -40 dBm

### 4.2.2 Test Procedure

- a. The power was measured with R&S Spectrum Analyzer. All measurements were done at 3 channels (low, middle and high channel of operational frequency range.)
- b. Substitution method is used for E.I.R.P measurement. In the semi-anechoic chamber, EUT placed on the 0.8m height of Turn Table, rotated the table around 360 degrees to search the maximum radiation power and receiver antenna shall be rotated vertical and horizontal polarization and moved height from 1m to 4m to find the maximum polar radiated power. The "Read Value" is the spectrum reading the maximum power value.
- c. The substitution antenna is substituted for EUT at the same position and signals generator export the CW signal to the substitution antenna via a TX cable. Rotated the Turn Table and moved receiving antenna to find the maximum radiation power. Adjust output power level of S.G to get a Value of spectrum reading equal to "Read Value" of step b. Record the power level of S.G
- d.  $EIRP = \text{Output power level of S.G} - \text{TX cable loss} + \text{Antenna gain of substitution antenna}$ .

**Note:** The resolution bandwidth and video bandwidth of test receiver/spectrum analyzer is 1MHz/3MHz.

### 4.2.3 Deviation from Test Standard

No deviation.

#### 4.2.4 Test Setup

For radiated emission 30MHz to 1GHz

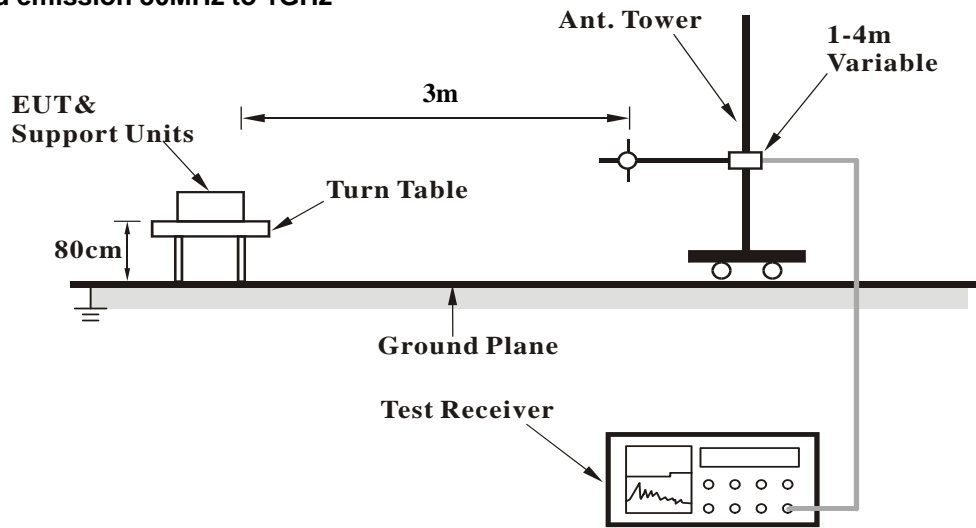

For radiated emission above 1GHz

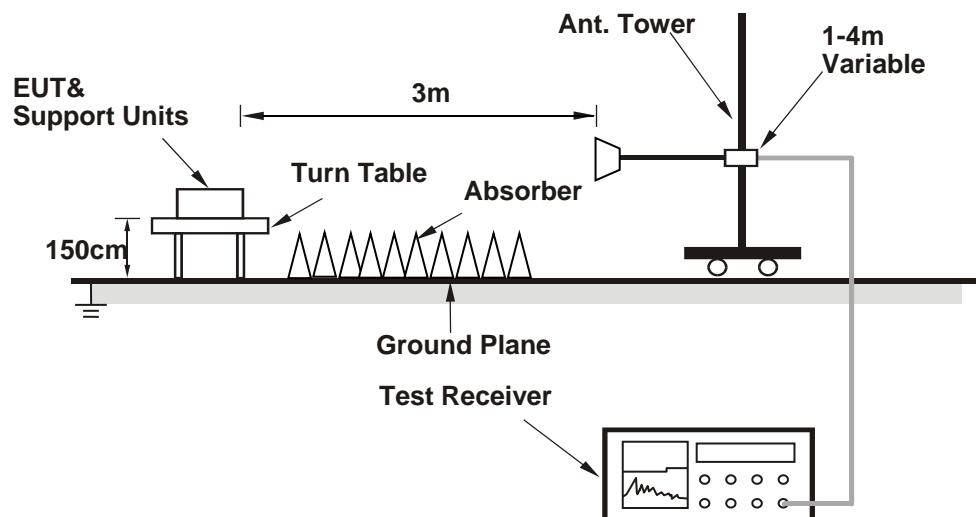

For the actual test configuration, please refer to the attached file (Test Setup Photo).

#### 4.2.5 Test Results

Below 1GHz

LTE Band 4, Channel Bandwidth: 1.4MHz

Mode	TX channel 20393 (1754.3MHz)	Frequency Range	Below 1000 MHz
Environmental Conditions	22deg. C, 66%RH	Input Power	9Vdc
Tested By	Han Wu		

Antenna Polarity & Test Distance: Horizontal at 3 M							
No.	Freq. (MHz)	Reading (dBm)	S.G Power Value (dBm)	Correction Factor (dB)	EIRP (dBm)	Limit (dBm)	Margin (dB)
1	41.25	-62.5	-48.6	-10.7	-59.3	-13.0	-46.3
2	74.99	-52.2	-55.0	-3.3	-58.3	-13.0	-45.3
3	114.35	-51.0	-59.6	0.3	-59.3	-13.0	-46.3
4	145.28	-51.1	-55.8	-0.2	-56.0	-13.0	-43.0
5	197.29	-48.5	-61.9	5.2	-56.7	-13.0	-43.7
6	297.10	-52.9	-60.4	5.1	-55.3	-13.0	-42.3

Remarks:

1. EIRP (dBm) = S.G Value (dBm) + Correction Factor (dB).
2. Correction Factor (dB) = Substitution Antenna Gain (dB) - Cable Loss (dB).

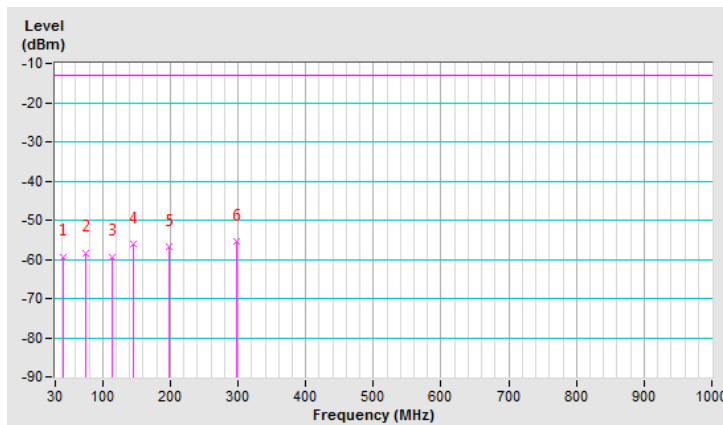

Mode	TX channel 20393 (1754.3MHz)	Frequency Range	Below 1000 MHz
Environmental Conditions	22deg. C, 66%RH	Input Power	9Vdc
Tested By	Han Wu		

Antenna Polarity & Test Distance: Vertical at 3 M							
No.	Freq. (MHz)	Reading (dBm)	S.G Power Value (dBm)	Correction Factor (dB)	EIRP (dBm)	Limit (dBm)	Margin (dB)
1	63.74	-46.9	-47.3	-6.6	-53.9	-13.0	-40.9
2	97.48	-48.7	-56.8	1.0	-55.8	-13.0	-42.8
3	143.87	-52.6	-55.0	-0.3	-55.3	-13.0	-42.3
4	297.10	-49.6	-53.8	5.1	-48.7	-13.0	-35.7
5	353.33	-52.8	-58.5	5.2	-53.3	-13.0	-40.3
6	513.59	-60.9	-64.8	4.8	-60.0	-13.0	-47.0

Remarks:

1. EIRP (dBm) = S.G Value (dBm) + Correction Factor (dB).
2. Correction Factor (dB) = Substitution Antenna Gain (dB) - Cable Loss (dB).

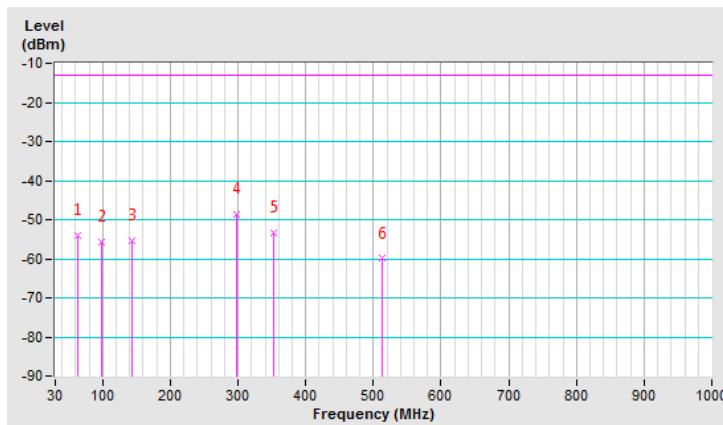

LTE Band 4, Channel Bandwidth: 5MHz

Mode	TX channel 20375 (1752.5MHz)	Frequency Range	Below 1000 MHz
Environmental Conditions	22deg. C, 66%RH	Input Power	9Vdc
Tested By	Han Wu		

Antenna Polarity & Test Distance: Horizontal at 3 M

No.	Freq. (MHz)	Reading (dBm)	S.G Power Value (dBm)	Correction Factor (dB)	EIRP (dBm)	Limit (dBm)	Margin (dB)
1	30.00	-54.4	-39.2	-12.2	-51.4	-13.0	-38.4
2	76.39	-53.9	-57.1	-2.8	-59.9	-13.0	-46.9
3	112.94	-49.7	-58.2	0.3	-57.9	-13.0	-44.9
4	197.29	-47.7	-61.1	5.2	-55.9	-13.0	-42.9
5	297.10	-52.5	-60.0	5.1	-54.9	-13.0	-41.9
6	454.55	-56.7	-61.5	5.0	-56.5	-13.0	-43.5

Remarks:

1. EIRP (dBm) = S.G Value (dBm) + Correction Factor (dB).
2. Correction Factor (dB) = Substitution Antenna Gain (dB) - Cable Loss (dB).

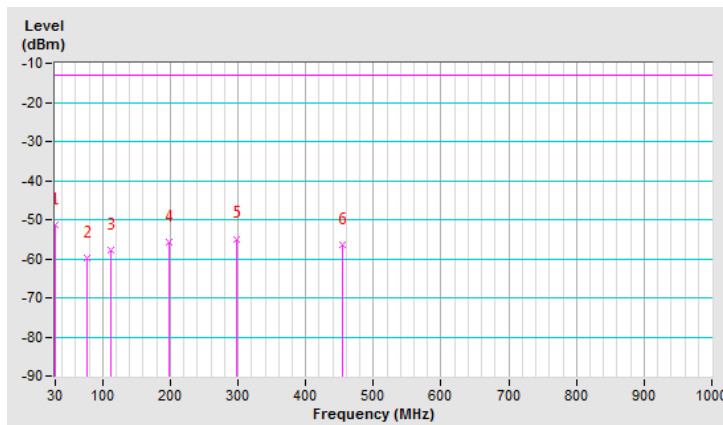

Mode	TX channel 20375 (1752.5MHz)	Frequency Range	Below 1000 MHz
Environmental Conditions	22deg. C, 66%RH	Input Power	9Vdc
Tested By	Han Wu		

Antenna Polarity & Test Distance: Vertical at 3 M							
No.	Freq. (MHz)	Reading (dBm)	S.G Power Value (dBm)	Correction Factor (dB)	EIRP (dBm)	Limit (dBm)	Margin (dB)
1	63.74	-46.9	-47.3	-6.6	-53.9	-13.0	-40.9
2	101.70	-48.9	-57.2	0.8	-56.4	-13.0	-43.4
3	143.87	-51.9	-54.3	-0.3	-54.6	-13.0	-41.6
4	193.07	-57.4	-64.7	4.6	-60.1	-13.0	-47.1
5	297.10	-50.5	-54.7	5.1	-49.6	-13.0	-36.6
6	351.93	-53.3	-59.0	5.2	-53.8	-13.0	-40.8

Remarks:

1. EIRP (dBm) = S.G Value (dBm) + Correction Factor (dB).
2. Correction Factor (dB) = Substitution Antenna Gain (dB) - Cable Loss (dB).

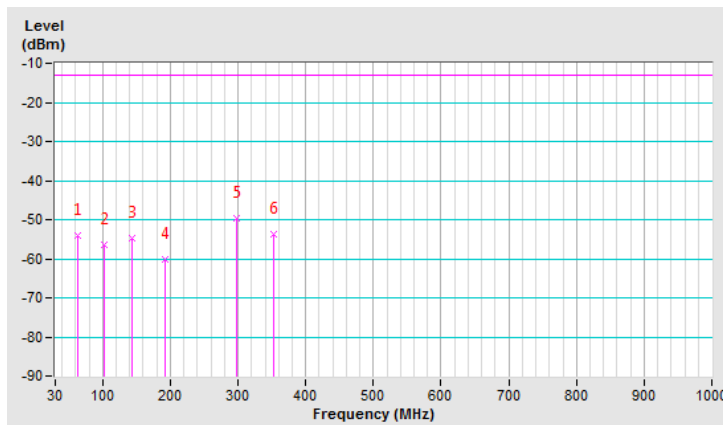



LTE Band 4, Channel Bandwidth: 20MHz

Mode	TX channel 20175 (1732.5MHz)	Frequency Range	Below 1000 MHz
Environmental Conditions	22deg. C, 66%RH	Input Power	9Vdc
Tested By	Han Wu		

Antenna Polarity & Test Distance: Horizontal at 3 M							
No.	Freq. (MHz)	Reading (dBm)	S.G Power Value (dBm)	Correction Factor (dB)	EIRP (dBm)	Limit (dBm)	Margin (dB)
1	48.28	-59.9	-49.3	-9.5	-58.8	-13.0	-45.8
2	111.54	-48.9	-57.6	0.4	-57.2	-13.0	-44.2
3	180.42	-48.7	-59.9	3.0	-56.9	-13.0	-43.9
4	297.10	-52.5	-60.0	5.1	-54.9	-13.0	-41.9
5	351.93	-55.7	-63.8	5.2	-58.6	-13.0	-45.6
6	454.55	-59.3	-64.1	5.0	-59.1	-13.0	-46.1

Remarks:

1. EIRP (dBm) = S.G Value (dBm) + Correction Factor (dB).
2. Correction Factor (dB) = Substitution Antenna Gain (dB) - Cable Loss (dB).

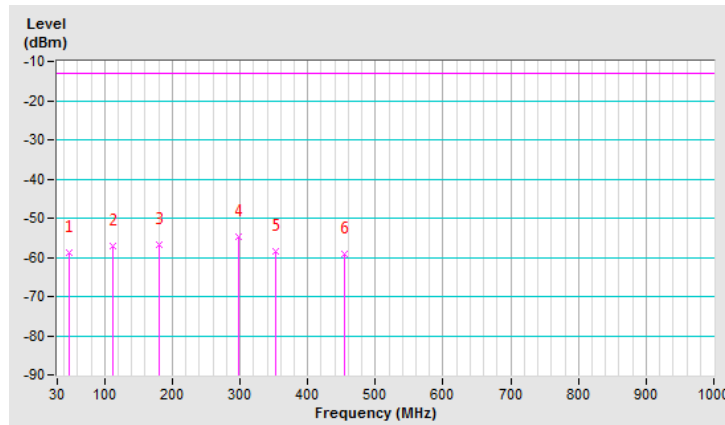

Mode	TX channel 20175 (1732.5MHz)	Frequency Range	Below 1000 MHz
Environmental Conditions	22deg. C, 66%RH	Input Power	9Vdc
Tested By	Han Wu		

Antenna Polarity & Test Distance: Vertical at 3 M							
No.	Freq. (MHz)	Reading (dBm)	S.G Power Value (dBm)	Correction Factor (dB)	EIRP (dBm)	Limit (dBm)	Margin (dB)
1	98.88	-49.4	-57.5	0.9	-56.6	-13.0	-43.6
2	143.87	-54.0	-56.4	-0.3	-56.7	-13.0	-43.7
3	205.72	-58.5	-65.3	5.4	-59.9	-13.0	-46.9
4	297.10	-51.7	-55.9	5.1	-50.8	-13.0	-37.8
5	351.93	-55.0	-60.7	5.2	-55.5	-13.0	-42.5
6	513.59	-60.3	-64.2	4.8	-59.4	-13.0	-46.4

Remarks:

1. EIRP (dBm) = S.G Value (dBm) + Correction Factor (dB).
2. Correction Factor (dB) = Substitution Antenna Gain (dB) - Cable Loss (dB).

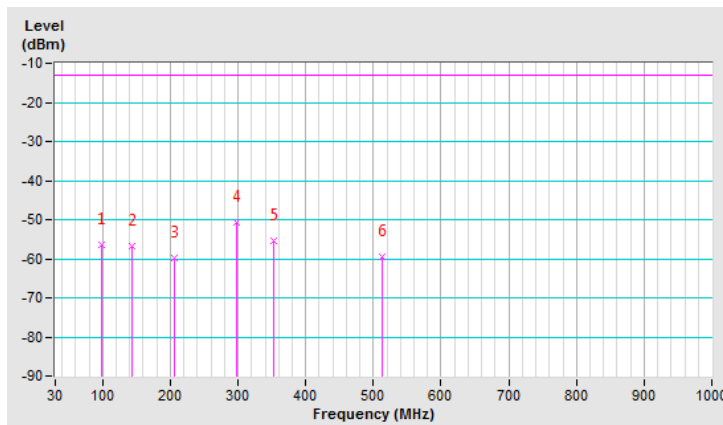

LTE Band 12, Channel Bandwidth: 1.4MHz

Mode	TX channel 23017 (699.7MHz)	Frequency Range	Below 1000 MHz
Environmental Conditions	22deg. C, 66%RH	Input Power	9Vdc
Tested By	Han Wu		

Antenna Polarity & Test Distance: Horizontal at 3 M							
No.	Freq. (MHz)	Reading (dBm)	S.G Power Value (dBm)	Correction Factor (dB)	ERP (dBm)	Limit (dBm)	Margin (dB)
1	30.00	-55.6	-42.5	-12.2	-54.7	-13.0	-41.7
2	74.99	-54.1	-59.1	-3.3	-62.4	-13.0	-49.4
3	107.32	-50.8	-62.0	0.5	-61.5	-13.0	-48.5
4	146.68	-53.2	-59.9	-0.2	-60.1	-13.0	-47.1
5	197.29	-48.8	-64.3	5.2	-59.1	-13.0	-46.1
6	297.10	-52.2	-61.9	5.1	-56.8	-13.0	-43.8

Remarks:

- ERP (dBm) = S.G Value (dBm) + Correction Factor (dB).
- Correction Factor (dB) = Substitution Antenna Gain (dB) - Cable Loss (dB).

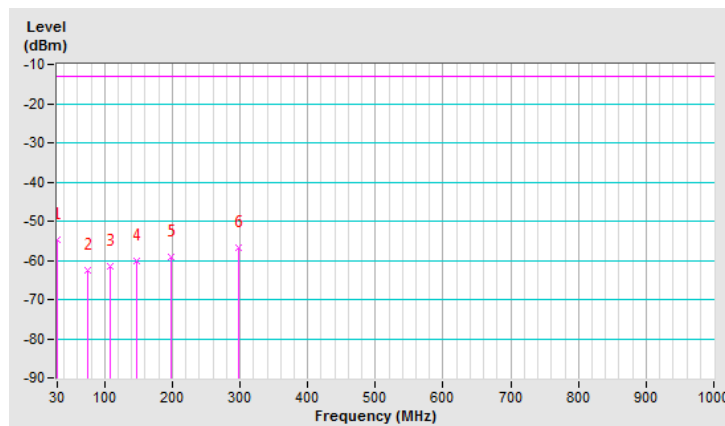

Mode	TX channel 23017 (699.7MHz)	Frequency Range	Below 1000 MHz
Environmental Conditions	22deg. C, 66%RH	Input Power	9Vdc
Tested By	Han Wu		

Antenna Polarity & Test Distance: Vertical at 3 M							
No.	Freq. (MHz)	Reading (dBm)	S.G Power Value (dBm)	Correction Factor (dB)	ERP (dBm)	Limit (dBm)	Margin (dB)
1	62.33	-45.9	-48.3	-7.0	-55.3	-13.0	-42.3
2	82.01	-49.2	-55.3	-1.1	-56.4	-13.0	-43.4
3	143.87	-51.5	-56.1	-0.3	-56.4	-13.0	-43.4
4	297.10	-49.2	-55.6	5.1	-50.5	-13.0	-37.5
5	351.93	-52.6	-60.5	5.2	-55.3	-13.0	-42.3
6	513.59	-60.0	-66.0	4.8	-61.2	-13.0	-48.2

Remarks:

- ERP (dBm) = S.G Value (dBm) + Correction Factor (dB).
- Correction Factor (dB) = Substitution Antenna Gain (dB) - Cable Loss (dB).

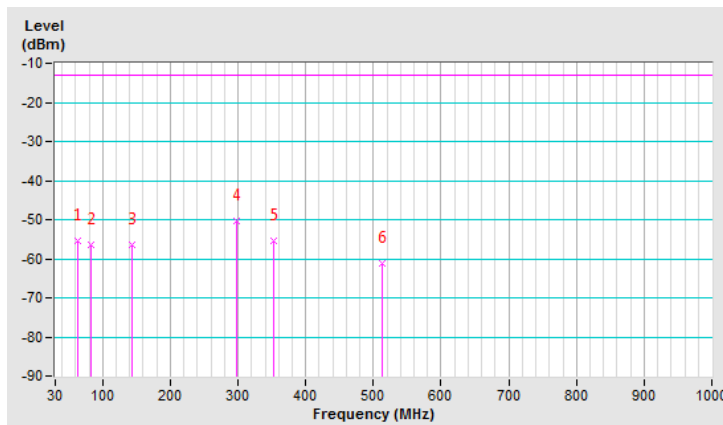

LTE Band 12, Channel Bandwidth: 5MHz

Mode	TX channel 23095 (707.5 MHz)	Frequency Range	Below 1000 MHz
Environmental Conditions	22deg. C, 66%RH	Input Power	9Vdc
Tested By	Han Wu		

Antenna Polarity & Test Distance: Horizontal at 3 M							
No.	Freq. (MHz)	Reading (dBm)	S.G Power Value (dBm)	Correction Factor (dB)	ERP (dBm)	Limit (dBm)	Margin (dB)
1	30.00	-57.1	-44.1	-12.2	-56.3	-13.0	-43.3
2	79.20	-54.5	-60.6	-2.0	-62.6	-13.0	-49.6
3	114.35	-49.3	-60.1	0.3	-59.8	-13.0	-46.8
4	150.90	-51.0	-57.6	-0.1	-57.7	-13.0	-44.7
5	197.29	-48.4	-63.9	5.2	-58.7	-13.0	-45.7
6	297.10	-53.8	-63.4	5.1	-58.3	-13.0	-45.3

Remarks:

- ERP (dBm) = S.G Value (dBm) + Correction Factor (dB).
- Correction Factor (dB) = Substitution Antenna Gain (dB) - Cable Loss (dB).

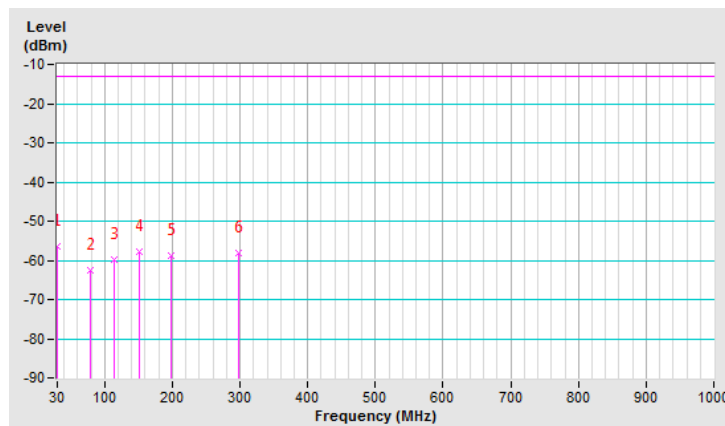

Mode	TX channel 23095 (707.5 MHz)	Frequency Range	Below 1000 MHz
Environmental Conditions	22deg. C, 66%RH	Input Power	9Vdc
Tested By	Han Wu		

Antenna Polarity & Test Distance: Vertical at 3 M							
No.	Freq. (MHz)	Reading (dBm)	S.G Power Value (dBm)	Correction Factor (dB)	ERP (dBm)	Limit (dBm)	Margin (dB)
1	63.74	-46.6	-49.2	-6.6	-55.8	-13.0	-42.8
2	80.61	-48.2	-53.8	-1.5	-55.3	-13.0	-42.3
3	143.87	-52.4	-57.0	-0.3	-57.3	-13.0	-44.3
4	231.03	-59.4	-70.2	5.4	-64.8	-13.0	-51.8
5	297.10	-49.0	-55.4	5.1	-50.3	-13.0	-37.3
6	347.71	-53.2	-61.1	5.2	-55.9	-13.0	-42.9

Remarks:

- ERP (dBm) = S.G Value (dBm) + Correction Factor (dB).
- Correction Factor (dB) = Substitution Antenna Gain (dB) - Cable Loss (dB).

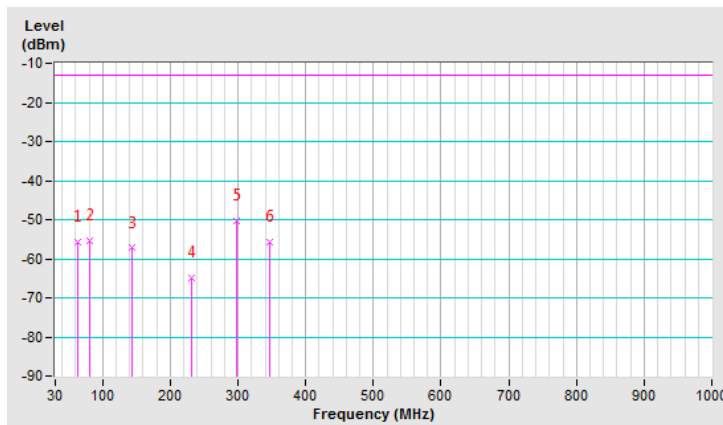

LTE Band 12, Channel Bandwidth: 10MHz

Mode	TX channel 23060 (704.0MHz)	Frequency Range	Below 1000 MHz
Environmental Conditions	22deg. C, 66%RH	Input Power	9Vdc
Tested By	Han Wu		

Antenna Polarity & Test Distance: Horizontal at 3 M							
No.	Freq. (MHz)	Reading (dBm)	S.G Power Value (dBm)	Correction Factor (dB)	ERP (dBm)	Limit (dBm)	Margin (dB)
1	77.80	-52.7	-58.4	-2.3	-60.7	-13.0	-47.7
2	118.57	-48.6	-58.8	0.1	-58.7	-13.0	-45.7
3	156.52	-50.0	-57.5	0.2	-57.3	-13.0	-44.3
4	268.99	-56.0	-67.6	5.3	-62.3	-13.0	-49.3
5	297.10	-54.2	-63.9	5.1	-58.8	-13.0	-45.8
6	478.45	-57.5	-64.7	5.0	-59.7	-13.0	-46.7

Remarks:

- ERP (dBm) = S.G Value (dBm) + Correction Factor (dB).
- Correction Factor (dB) = Substitution Antenna Gain (dB) - Cable Loss (dB).

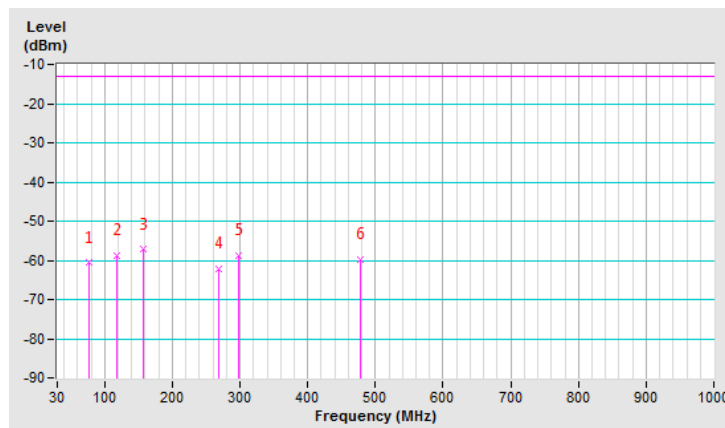

Mode	TX channel 23060 (704.0MHz)	Frequency Range	Below 1000 MHz
Environmental Conditions	22deg. C, 66%RH	Input Power	9Vdc
Tested By	Han Wu		

Antenna Polarity & Test Distance: Vertical at 3 M							
No.	Freq. (MHz)	Reading (dBm)	S.G Power Value (dBm)	Correction Factor (dB)	ERP (dBm)	Limit (dBm)	Margin (dB)
1	63.74	-49.2	-51.8	-6.6	-58.4	-13.0	-45.4
2	101.70	-48.6	-59.1	0.8	-58.3	-13.0	-45.3
3	142.46	-53.0	-57.6	-0.3	-57.9	-13.0	-44.9
4	297.10	-52.5	-58.9	5.1	-53.8	-13.0	-40.8
5	365.99	-57.5	-65.4	5.2	-60.2	-13.0	-47.2
6	491.10	-60.5	-67.1	4.9	-62.2	-13.0	-49.2

Remarks:

- ERP (dBm) = S.G Value (dBm) + Correction Factor (dB).
- Correction Factor (dB) = Substitution Antenna Gain (dB) - Cable Loss (dB).

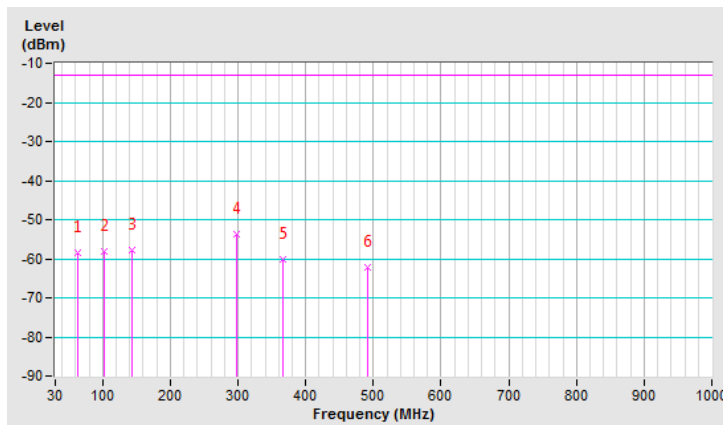



LTE Band 13, Channel Bandwidth: 5MHz

Mode	TX channel 23230 (782.0MHz)	Frequency Range	Below 1000 MHz
Environmental Conditions	22deg. C, 66%RH	Input Power	9Vdc
Tested By	Han Wu		

Antenna Polarity & Test Distance: Horizontal at 3 M							
No.	Freq. (MHz)	Reading (dBm)	S.G Power Value (dBm)	Correction Factor (dB)	ERP (dBm)	Limit (dBm)	Margin (dB)
1	39.84	-60.5	-49.9	-10.9	-60.8	-13.0	-47.8
2	76.39	-49.6	-54.9	-2.8	-57.7	-13.0	-44.7
3	149.49	-49.9	-56.4	-0.2	-56.6	-13.0	-43.6
4	197.29	-48.8	-64.3	5.2	-59.1	-13.0	-46.1
5	297.10	-51.8	-61.4	5.1	-56.3	-13.0	-43.3
6	351.93	-55.2	-65.4	5.2	-60.2	-13.0	-47.2

Remarks:

- ERP (dBm) = S.G Value (dBm) + Correction Factor (dB).
- Correction Factor (dB) = Substitution Antenna Gain (dB) - Cable Loss (dB).

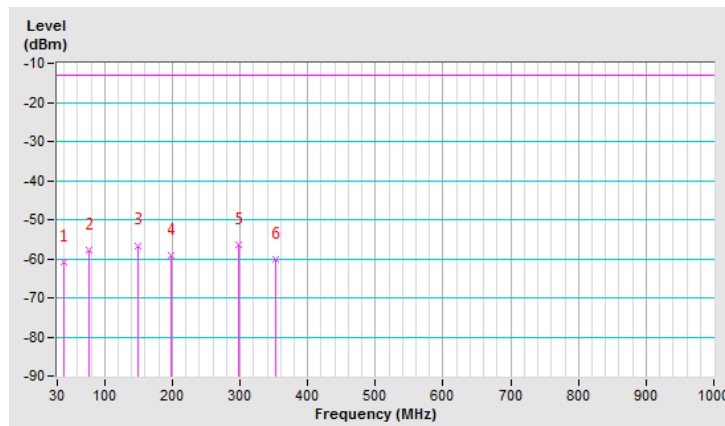

Mode	TX channel 23230 (782.0MHz)	Frequency Range	Below 1000 MHz
Environmental Conditions	22deg. C, 66%RH	Input Power	9Vdc
Tested By	Han Wu		

Antenna Polarity & Test Distance: Vertical at 3 M							
No.	Freq. (MHz)	Reading (dBm)	S.G Power Value (dBm)	Correction Factor (dB)	ERP (dBm)	Limit (dBm)	Margin (dB)
1	62.33	-46.6	-49.0	-7.0	-56.0	-13.0	-43.0
2	80.61	-50.2	-55.7	-1.5	-57.2	-13.0	-44.2
3	98.88	-47.4	-57.7	0.9	-56.8	-13.0	-43.8
4	145.28	-54.0	-58.7	-0.2	-58.9	-13.0	-45.9
5	191.67	-55.1	-64.3	4.4	-59.9	-13.0	-46.9
6	297.10	-52.2	-58.6	5.1	-53.5	-13.0	-40.5

Remarks:

- ERP (dBm) = S.G Value (dBm) + Correction Factor (dB).
- Correction Factor (dB) = Substitution Antenna Gain (dB) - Cable Loss (dB).

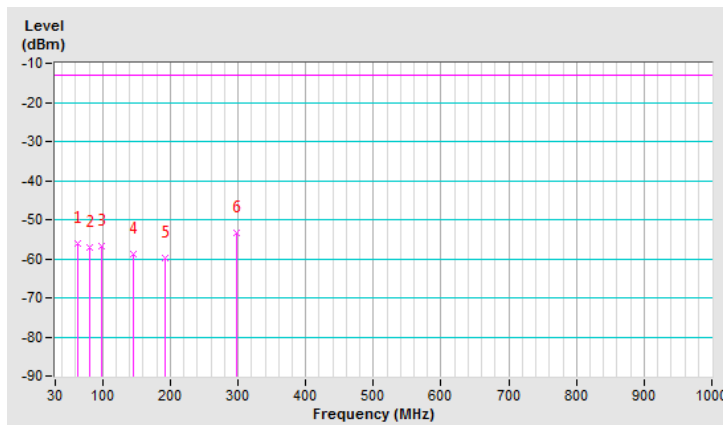

LTE Band 13, Channel Bandwidth: 10MHz

Mode	TX channel 23230 (782.0MHz)	Frequency Range	Below 1000 MHz
Environmental Conditions	22deg. C, 66%RH	Input Power	9Vdc
Tested By	Han Wu		

Antenna Polarity & Test Distance: Horizontal at 3 M							
No.	Freq. (MHz)	Reading (dBm)	S.G Power Value (dBm)	Correction Factor (dB)	ERP (dBm)	Limit (dBm)	Margin (dB)
1	79.20	-54.2	-60.2	-2.0	-62.2	-13.0	-49.2
2	114.35	-46.6	-57.4	0.3	-57.1	-13.0	-44.1
3	169.17	-50.2	-60.7	1.5	-59.2	-13.0	-46.2
4	385.67	-59.2	-67.8	5.2	-62.6	-13.0	-49.6
5	513.59	-57.9	-64.5	4.8	-59.7	-13.0	-46.7
6	604.97	-58.4	-63.4	4.5	-58.9	-13.0	-45.9

Remarks:

- ERP (dBm) = S.G Value (dBm) + Correction Factor (dB).
- Correction Factor (dB) = Substitution Antenna Gain (dB) - Cable Loss (dB).

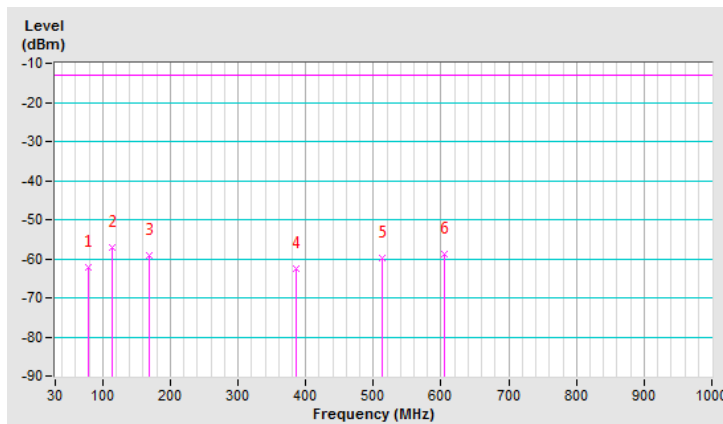

Mode	TX channel 23230 (782.0MHz)	Frequency Range	Below 1000 MHz
Environmental Conditions	22deg. C, 66%RH	Input Power	9Vdc
Tested By	Han Wu		

Antenna Polarity & Test Distance: Vertical at 3 M							
No.	Freq. (MHz)	Reading (dBm)	S.G Power Value (dBm)	Correction Factor (dB)	ERP (dBm)	Limit (dBm)	Margin (dB)
1	62.33	-46.2	-48.6	-7.0	-55.6	-13.0	-42.6
2	100.29	-48.0	-58.4	0.9	-57.5	-13.0	-44.5
3	145.28	-52.9	-57.6	-0.2	-57.8	-13.0	-44.8
4	257.74	-61.5	-67.5	5.3	-62.2	-13.0	-49.2
5	330.84	-55.6	-63.1	5.2	-57.9	-13.0	-44.9
6	429.25	-61.3	-68.5	5.2	-63.3	-13.0	-50.3

Remarks:

- ERP (dBm) = S.G Value (dBm) + Correction Factor (dB).
- Correction Factor (dB) = Substitution Antenna Gain (dB) - Cable Loss (dB).

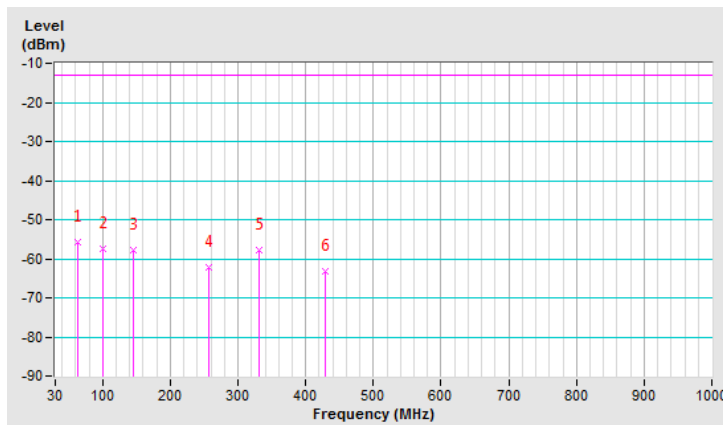

Above 1GHz

LTE Band 4, Channel Bandwidth: 1.4MHz

Mode	TX channel 19957 (1710.7MHz)	Frequency Range	1GHz ~ 18GHz
Environmental Conditions	23deg. C, 66%RH	Input Power	9Vdc
Tested By	Adair Peng		

Antenna Polarity & Test Distance: Horizontal at 3 M

No.	Freq. (MHz)	Reading (dBm)	S.G Power Value (dBm)	Correction Factor (dB)	EIRP (dBm)	Limit (dBm)	Margin (dB)
1	3421.40	-60.5	-56.4	7.1	-49.3	-13.0	-36.3

Antenna Polarity & Test Distance: Vertical at 3 M

No.	Freq. (MHz)	Reading (dBm)	S.G Power Value (dBm)	Correction Factor (dB)	EIRP (dBm)	Limit (dBm)	Margin (dB)
1	3421.40	-59.7	-55.6	7.1	-48.5	-13.0	-35.5

Remarks:

1. EIRP (dBm) = S.G Value (dBm) + Correction Factor (dB).
2. Correction Factor (dB) = Substitution Antenna Gain (dB) + Cable Loss (dB).

Mode	TX channel 20175 (1732.5MHz)	Frequency Range	1GHz ~ 18GHz
Environmental Conditions	23deg. C, 66%RH	Input Power	9Vdc
Tested By	Adair Peng		

Antenna Polarity & Test Distance: Horizontal at 3 M

No.	Freq. (MHz)	Reading (dBm)	S.G Power Value (dBm)	Correction Factor (dB)	EIRP (dBm)	Limit (dBm)	Margin (dB)
1	3465.00	-60.7	-56.2	7.1	-49.1	-13.0	-36.1

Antenna Polarity & Test Distance: Vertical at 3 M

No.	Freq. (MHz)	Reading (dBm)	S.G Power Value (dBm)	Correction Factor (dB)	EIRP (dBm)	Limit (dBm)	Margin (dB)
1	3465.00	-59.3	-54.8	7.1	-47.7	-13.0	-34.7

Remarks:

1. EIRP (dBm) = S.G Value (dBm) + Correction Factor (dB).
2. Correction Factor (dB) = Substitution Antenna Gain (dB) + Cable Loss (dB).

Mode	TX channel 20393 (1754.3MHz)	Frequency Range	1GHz ~ 18GHz
Environmental Conditions	23deg. C, 66%RH	Input Power	9Vdc
Tested By	Adair Peng		

Antenna Polarity & Test Distance: Horizontal at 3 M							
No.	Freq. (MHz)	Reading (dBm)	S.G Power Value (dBm)	Correction Factor (dB)	EIRP (dBm)	Limit (dBm)	Margin (dB)
1	3508.60	-60.2	-55.5	7.2	-48.3	-13.0	-35.3
Antenna Polarity & Test Distance: Vertical at 3 M							
No.	Freq. (MHz)	Reading (dBm)	S.G Power Value (dBm)	Correction Factor (dB)	EIRP (dBm)	Limit (dBm)	Margin (dB)
1	3508.60	-59.1	-54.4	7.2	-47.2	-13.0	-34.2

Remarks:

1. EIRP (dBm) = S.G Value (dBm) + Correction Factor (dB).
2. Correction Factor (dB) = Substitution Antenna Gain (dB) + Cable Loss (dB).

LTE Band 4, Channel Bandwidth: 5MHz

Mode	TX channel 19975 (1712.5MHz)	Frequency Range	1GHz ~ 18GHz
Environmental Conditions	23deg. C, 66%RH	Input Power	9Vdc
Tested By	Adair Peng		

Antenna Polarity & Test Distance: Horizontal at 3 M

No.	Freq. (MHz)	Reading (dBm)	S.G Power Value (dBm)	Correction Factor (dB)	EIRP (dBm)	Limit (dBm)	Margin (dB)
1	3425.00	-60.1	-55.9	7.1	-48.8	-13.0	-35.8

Antenna Polarity & Test Distance: Vertical at 3 M

No.	Freq. (MHz)	Reading (dBm)	S.G Power Value (dBm)	Correction Factor (dB)	EIRP (dBm)	Limit (dBm)	Margin (dB)
1	3425.00	-59.7	-55.5	7.1	-48.4	-13.0	-35.4

Remarks:

1. EIRP (dBm) = S.G Value (dBm) + Correction Factor (dB).
2. Correction Factor (dB) = Substitution Antenna Gain (dB) + Cable Loss (dB).

Mode	TX channel 20175 (1732.5MHz)	Frequency Range	1GHz ~ 18GHz
Environmental Conditions	23deg. C, 66%RH	Input Power	9Vdc
Tested By	Adair Peng		

Antenna Polarity & Test Distance: Horizontal at 3 M

No.	Freq. (MHz)	Reading (dBm)	S.G Power Value (dBm)	Correction Factor (dB)	EIRP (dBm)	Limit (dBm)	Margin (dB)
1	3465.00	-59.8	-55.3	7.1	-48.2	-13.0	-35.2

Antenna Polarity & Test Distance: Vertical at 3 M

No.	Freq. (MHz)	Reading (dBm)	S.G Power Value (dBm)	Correction Factor (dB)	EIRP (dBm)	Limit (dBm)	Margin (dB)
1	3465.00	-58.3	-53.8	7.1	-46.7	-13.0	-33.7

Remarks:

1. EIRP (dBm) = S.G Value (dBm) + Correction Factor (dB).
2. Correction Factor (dB) = Substitution Antenna Gain (dB) + Cable Loss (dB).

Mode	TX channel 20375 (1752.5MHz)	Frequency Range	1GHz ~ 18GHz
Environmental Conditions	23deg. C, 66%RH	Input Power	9Vdc
Tested By	Adair Peng		

Antenna Polarity & Test Distance: Horizontal at 3 M							
No.	Freq. (MHz)	Reading (dBm)	S.G Power Value (dBm)	Correction Factor (dB)	EIRP (dBm)	Limit (dBm)	Margin (dB)
1	3505.00	-59.5	-54.8	7.2	-47.6	-13.0	-34.6
Antenna Polarity & Test Distance: Vertical at 3 M							
No.	Freq. (MHz)	Reading (dBm)	S.G Power Value (dBm)	Correction Factor (dB)	EIRP (dBm)	Limit (dBm)	Margin (dB)
1	3505.00	-57.1	-52.4	7.2	-45.2	-13.0	-32.2

Remarks:

1. EIRP (dBm) = S.G Value (dBm) + Correction Factor (dB).
2. Correction Factor (dB) = Substitution Antenna Gain (dB) + Cable Loss (dB).



LTE Band 4, Channel Bandwidth: 20MHz

Mode	TX channel 20050 (1720.0MHz)	Frequency Range	1GHz ~ 18GHz
Environmental Conditions	23deg. C, 66%RH	Input Power	9Vdc
Tested By	Adair Peng		

Antenna Polarity & Test Distance: Horizontal at 3 M

No.	Freq. (MHz)	Reading (dBm)	S.G Power Value (dBm)	Correction Factor (dB)	EIRP (dBm)	Limit (dBm)	Margin (dB)
1	3440.00	-58.7	-54.4	7.1	-47.3	-13.0	-34.3

Antenna Polarity & Test Distance: Vertical at 3 M

No.	Freq. (MHz)	Reading (dBm)	S.G Power Value (dBm)	Correction Factor (dB)	EIRP (dBm)	Limit (dBm)	Margin (dB)
1	3440.00	-56.8	-52.5	7.1	-45.4	-13.0	-32.4

Remarks:

1. EIRP (dBm) = S.G Value (dBm) + Correction Factor (dB).
2. Correction Factor (dB) = Substitution Antenna Gain (dB) + Cable Loss (dB).

Mode	TX channel 20175 (1732.5MHz)	Frequency Range	1GHz ~ 18GHz
Environmental Conditions	23deg. C, 66%RH	Input Power	9Vdc
Tested By	Adair Peng		

Antenna Polarity & Test Distance: Horizontal at 3 M

No.	Freq. (MHz)	Reading (dBm)	S.G Power Value (dBm)	Correction Factor (dB)	EIRP (dBm)	Limit (dBm)	Margin (dB)
1	3465.00	-59.5	-55.0	7.1	-47.9	-13.0	-34.9

Antenna Polarity & Test Distance: Vertical at 3 M

No.	Freq. (MHz)	Reading (dBm)	S.G Power Value (dBm)	Correction Factor (dB)	EIRP (dBm)	Limit (dBm)	Margin (dB)
1	3465.00	-56.9	-52.4	7.1	-45.3	-13.0	-32.3

Remarks:

1. EIRP (dBm) = S.G Value (dBm) + Correction Factor (dB).
2. Correction Factor (dB) = Substitution Antenna Gain (dB) + Cable Loss (dB).

Mode	TX channel 20300 (1745.0MHz)	Frequency Range	1GHz ~ 18GHz
Environmental Conditions	23deg. C, 66%RH	Input Power	9Vdc
Tested By	Adair Peng		

Antenna Polarity & Test Distance: Horizontal at 3 M							
No.	Freq. (MHz)	Reading (dBm)	S.G Power Value (dBm)	Correction Factor (dB)	EIRP (dBm)	Limit (dBm)	Margin (dB)
1	3490.00	-58.6	-54.0	7.2	-46.8	-13.0	-33.8
Antenna Polarity & Test Distance: Vertical at 3 M							
No.	Freq. (MHz)	Reading (dBm)	S.G Power Value (dBm)	Correction Factor (dB)	EIRP (dBm)	Limit (dBm)	Margin (dB)
1	3490.00	-57.2	-52.6	7.2	-45.4	-13.0	-32.4

Remarks:

1. EIRP (dBm) = S.G Value (dBm) + Correction Factor (dB).
2. Correction Factor (dB) = Substitution Antenna Gain (dB) + Cable Loss (dB).

LTE Band 12, Channel Bandwidth: 1.4MHz

Mode	TX channel 23017 (699.7MHz)	Frequency Range	1GHz ~ 10GHz
Environmental Conditions	23deg. C, 66%RH	Input Power	9Vdc
Tested By	Adair Peng		

Antenna Polarity & Test Distance: Horizontal at 3 M

No.	Freq. (MHz)	Reading (dBm)	S.G Power Value (dBm)	Correction Factor (dB)	ERP (dBm)	Limit (dBm)	Margin (dB)
1	1399.40	-61.2	-63.2	4.7	-58.5	-13.0	-45.5

Antenna Polarity & Test Distance: Vertical at 3 M

No.	Freq. (MHz)	Reading (dBm)	S.G Power Value (dBm)	Correction Factor (dB)	ERP (dBm)	Limit (dBm)	Margin (dB)
1	1399.40	-60.0	-61.9	4.7	-57.2	-13.0	-44.2

Remarks:

1. ERP (dBm) = S.G Value (dBm) + Correction Factor (dB).
2. Correction Factor (dB) = Substitution Antenna Gain (dB) + Cable Loss (dB).

Mode	TX channel 23095 (707.5MHz)	Frequency Range	1GHz ~ 10GHz
Environmental Conditions	23deg. C, 66%RH	Input Power	9Vdc
Tested By	Adair Peng		

Antenna Polarity & Test Distance: Horizontal at 3 M

No.	Freq. (MHz)	Reading (dBm)	S.G Power Value (dBm)	Correction Factor (dB)	ERP (dBm)	Limit (dBm)	Margin (dB)
1	1415.00	-60.8	-62.7	4.7	-58.0	-13.0	-45.0

Antenna Polarity & Test Distance: Vertical at 3 M

No.	Freq. (MHz)	Reading (dBm)	S.G Power Value (dBm)	Correction Factor (dB)	ERP (dBm)	Limit (dBm)	Margin (dB)
1	1415.00	-60.2	-62.2	4.7	-57.5	-13.0	-44.5

Remarks:

1. ERP (dBm) = S.G Value (dBm) + Correction Factor (dB).
2. Correction Factor (dB) = Substitution Antenna Gain (dB) + Cable Loss (dB).

Mode	TX channel 23173 (715.3MHz)	Frequency Range	1GHz ~ 10GHz
Environmental Conditions	23deg. C, 66%RH	Input Power	9Vdc
Tested By	Adair Peng		

Antenna Polarity & Test Distance: Horizontal at 3 M							
No.	Freq. (MHz)	Reading (dBm)	S.G Power Value (dBm)	Correction Factor (dB)	ERP (dBm)	Limit (dBm)	Margin (dB)
1	1430.60	-61.0	-63.0	4.8	-58.2	-13.0	-45.2
Antenna Polarity & Test Distance: Vertical at 3 M							
No.	Freq. (MHz)	Reading (dBm)	S.G Power Value (dBm)	Correction Factor (dB)	ERP (dBm)	Limit (dBm)	Margin (dB)
1	1430.60	-60.2	-62.3	4.8	-57.5	-13.0	-44.5

Remarks:

1.  $ERP (dBm) = S.G \text{ Value (dBm)} + \text{Correction Factor (dB)}$ .
2.  $\text{Correction Factor (dB)} = \text{Substitution Antenna Gain (dB)} + \text{Cable Loss (dB)}$ .

LTE Band 12, Channel Bandwidth: 5MHz

Mode	TX channel 23035 (701.5MHz)	Frequency Range	1GHz ~ 10GHz
Environmental Conditions	23deg. C, 66%RH	Input Power	9Vdc
Tested By	Adair Peng		

Antenna Polarity & Test Distance: Horizontal at 3 M

No.	Freq. (MHz)	Reading (dBm)	S.G Power Value (dBm)	Correction Factor (dB)	ERP (dBm)	Limit (dBm)	Margin (dB)
1	1403.00	-61.1	-63.1	4.7	-58.4	-13.0	-45.4

Antenna Polarity & Test Distance: Vertical at 3 M

No.	Freq. (MHz)	Reading (dBm)	S.G Power Value (dBm)	Correction Factor (dB)	ERP (dBm)	Limit (dBm)	Margin (dB)
1	1403.00	-60.1	-62.1	4.7	-57.4	-13.0	-44.4

Remarks:

1. ERP (dBm) = S.G Value (dBm) + Correction Factor (dB).
2. Correction Factor (dB) = Substitution Antenna Gain (dB) + Cable Loss (dB).

Mode	TX channel 23095 (707.5MHz)	Frequency Range	1GHz ~ 10GHz
Environmental Conditions	23deg. C, 66%RH	Input Power	9Vdc
Tested By	Adair Peng		

Antenna Polarity & Test Distance: Horizontal at 3 M

No.	Freq. (MHz)	Reading (dBm)	S.G Power Value (dBm)	Correction Factor (dB)	ERP (dBm)	Limit (dBm)	Margin (dB)
1	1415.00	-60.8	-62.7	4.7	-58.0	-13.0	-45.0

Antenna Polarity & Test Distance: Vertical at 3 M

No.	Freq. (MHz)	Reading (dBm)	S.G Power Value (dBm)	Correction Factor (dB)	ERP (dBm)	Limit (dBm)	Margin (dB)
1	1415.00	-59.8	-61.7	4.7	-57.0	-13.0	-44.0

Remarks:

1. ERP (dBm) = S.G Value (dBm) + Correction Factor (dB).
2. Correction Factor (dB) = Substitution Antenna Gain (dB) + Cable Loss (dB).

Mode	TX channel 23155 (713.5MHz)	Frequency Range	1GHz ~ 10GHz
Environmental Conditions	23deg. C, 66%RH	Input Power	9Vdc
Tested By	Adair Peng		

Antenna Polarity & Test Distance: Horizontal at 3 M							
No.	Freq. (MHz)	Reading (dBm)	S.G Power Value (dBm)	Correction Factor (dB)	ERP (dBm)	Limit (dBm)	Margin (dB)
1	1427.00	-61.1	-63.2	4.8	-58.4	-13.0	-45.4
Antenna Polarity & Test Distance: Vertical at 3 M							
No.	Freq. (MHz)	Reading (dBm)	S.G Power Value (dBm)	Correction Factor (dB)	ERP (dBm)	Limit (dBm)	Margin (dB)
1	1427.00	-59.9	-61.9	4.8	-57.1	-13.0	-44.1

Remarks:

1. ERP (dBm) = S.G Value (dBm) + Correction Factor (dB).
2. Correction Factor (dB) = Substitution Antenna Gain (dB) + Cable Loss (dB).

LTE Band 12, Channel Bandwidth: 10MHz

Mode	TX channel 23060 (704MHz)	Frequency Range	1GHz ~ 10GHz
Environmental Conditions	23deg. C, 66%RH	Input Power	9Vdc
Tested By	Adair Peng		

Antenna Polarity & Test Distance: Horizontal at 3 M

No.	Freq. (MHz)	Reading (dBm)	S.G Power Value (dBm)	Correction Factor (dB)	ERP (dBm)	Limit (dBm)	Margin (dB)
1	1408.00	-61.5	-63.5	4.7	-58.8	-13.0	-45.8

Antenna Polarity & Test Distance: Vertical at 3 M

No.	Freq. (MHz)	Reading (dBm)	S.G Power Value (dBm)	Correction Factor (dB)	ERP (dBm)	Limit (dBm)	Margin (dB)
1	1408.00	-59.6	-61.6	4.7	-56.9	-13.0	-43.9

Remarks:

1. ERP (dBm) = S.G Value (dBm) + Correction Factor (dB).
2. Correction Factor (dB) = Substitution Antenna Gain (dB) + Cable Loss (dB).

Mode	TX channel 23095 (707.5MHz)	Frequency Range	1GHz ~ 10GHz
Environmental Conditions	23deg. C, 66%RH	Input Power	9Vdc
Tested By	Adair Peng		

Antenna Polarity & Test Distance: Horizontal at 3 M

No.	Freq. (MHz)	Reading (dBm)	S.G Power Value (dBm)	Correction Factor (dB)	ERP (dBm)	Limit (dBm)	Margin (dB)
1	1415.00	-61.0	-62.9	4.7	-58.2	-13.0	-45.2

Antenna Polarity & Test Distance: Vertical at 3 M

No.	Freq. (MHz)	Reading (dBm)	S.G Power Value (dBm)	Correction Factor (dB)	ERP (dBm)	Limit (dBm)	Margin (dB)
1	1415.00	-59.8	-61.7	4.7	-57.0	-13.0	-44.0

Remarks:

1. ERP (dBm) = S.G Value (dBm) + Correction Factor (dB).
2. Correction Factor (dB) = Substitution Antenna Gain (dB) + Cable Loss (dB).

Mode	TX channel 23130 (711MHz)	Frequency Range	1GHz ~ 10GHz
Environmental Conditions	23deg. C, 66%RH	Input Power	9Vdc
Tested By	Adair Peng		

Antenna Polarity & Test Distance: Horizontal at 3 M							
No.	Freq. (MHz)	Reading (dBm)	S.G Power Value (dBm)	Correction Factor (dB)	ERP (dBm)	Limit (dBm)	Margin (dB)
1	1422.00	-60.5	-62.6	4.8	-57.8	-13.0	-44.8
Antenna Polarity & Test Distance: Vertical at 3 M							
No.	Freq. (MHz)	Reading (dBm)	S.G Power Value (dBm)	Correction Factor (dB)	ERP (dBm)	Limit (dBm)	Margin (dB)
1	1422.00	-59.9	-61.9	4.8	-57.1	-13.0	-44.1

Remarks:

1. ERP (dBm) = S.G Value (dBm) + Correction Factor (dB).
2. Correction Factor (dB) = Substitution Antenna Gain (dB) + Cable Loss (dB).



LTE Band 13, Channel Bandwidth: 5MHz

Mode	TX channel 23205 (779.5MHz)	Frequency Range	1GHz ~ 10GHz
Environmental Conditions	23deg. C, 66%RH	Input Power	9Vdc
Tested By	Adair Peng		

Antenna Polarity & Test Distance: Horizontal at 3 M

No.	Freq. (MHz)	Reading (dBm)	S.G Power Value (dBm)	Correction Factor (dB)	ERP (dBm)	Limit (dBm)	Margin (dB)
1	1559.00	-61.2	-64.5	5.3	-59.2	-40.0	-19.2

Antenna Polarity & Test Distance: Vertical at 3 M

No.	Freq. (MHz)	Reading (dBm)	S.G Power Value (dBm)	Correction Factor (dB)	ERP (dBm)	Limit (dBm)	Margin (dB)
1	1559.00	-61.1	-64.4	5.3	-59.1	-40.0	-19.1

Remarks:

1. ERP (dBm) = S.G Value (dBm) + Correction Factor (dB).
2. Correction Factor (dB) = Substitution Antenna Gain (dB) + Cable Loss (dB).

Mode	TX channel 23230 (782.0MHz)	Frequency Range	1GHz ~ 10GHz
Environmental Conditions	23deg. C, 66%RH	Input Power	9Vdc
Tested By	Adair Peng		

Antenna Polarity & Test Distance: Horizontal at 3 M

No.	Freq. (MHz)	Reading (dBm)	S.G Power Value (dBm)	Correction Factor (dB)	ERP (dBm)	Limit (dBm)	Margin (dB)
1	1564.00	-60.9	-64.2	5.3	-58.9	-40.0	-18.9

Antenna Polarity & Test Distance: Vertical at 3 M

No.	Freq. (MHz)	Reading (dBm)	S.G Power Value (dBm)	Correction Factor (dB)	ERP (dBm)	Limit (dBm)	Margin (dB)
<b>1</b>	<b>1564.00</b>	<b>-60.8</b>	<b>-64.1</b>	<b>5.3</b>	<b>-58.8</b>	<b>-40.0</b>	<b>-18.8</b>

Remarks:

1. ERP (dBm) = S.G Value (dBm) + Correction Factor (dB).
2. Correction Factor (dB) = Substitution Antenna Gain (dB) + Cable Loss (dB).

Mode	TX channel 23255 (784.5MHz)	Frequency Range	1GHz ~ 10GHz
Environmental Conditions	23deg. C, 66%RH	Input Power	9Vdc
Tested By	Adair Peng		

Antenna Polarity & Test Distance: Horizontal at 3 M							
No.	Freq. (MHz)	Reading (dBm)	S.G Power Value (dBm)	Correction Factor (dB)	ERP (dBm)	Limit (dBm)	Margin (dB)
1	1569.00	-61.2	-64.7	5.3	-59.4	-40.0	-19.4
Antenna Polarity & Test Distance: Vertical at 3 M							
No.	Freq. (MHz)	Reading (dBm)	S.G Power Value (dBm)	Correction Factor (dB)	ERP (dBm)	Limit (dBm)	Margin (dB)
1	1569.00	-60.8	-64.2	5.3	-58.9	-40.0	-18.9

Remarks:

1. ERP (dBm) = S.G Value (dBm) + Correction Factor (dB).
2. Correction Factor (dB) = Substitution Antenna Gain (dB) + Cable Loss (dB).

LTE Band 13, Channel Bandwidth: 10MHz

Mode	TX channel 23230 (782.0MHz)	Frequency Range	1GHz ~ 10GHz
Environmental Conditions	23deg. C, 66%RH	Input Power	9Vdc
Tested By	Adair Peng		

Antenna Polarity & Test Distance: Horizontal at 3 M

No.	Freq. (MHz)	Reading (dBm)	S.G Power Value (dBm)	Correction Factor (dB)	ERP (dBm)	Limit (dBm)	Margin (dB)
1	1564.00	-61.1	-64.4	5.3	-59.1	-40.0	-19.1

Antenna Polarity & Test Distance: Vertical at 3 M

No.	Freq. (MHz)	Reading (dBm)	S.G Power Value (dBm)	Correction Factor (dB)	ERP (dBm)	Limit (dBm)	Margin (dB)
1	1564.00	-61.0	-64.3	5.3	-59.0	-40.0	-19.0

Remarks:

1. ERP (dBm) = S.G Value (dBm) + Correction Factor (dB).
2. Correction Factor (dB) = Substitution Antenna Gain (dB) + Cable Loss (dB).

## 5 Pictures of Test Arrangements

Please refer to the attached file (Test Setup Photo).

## Appendix – Information of the Testing Laboratories

We, Bureau Veritas Consumer Products Services (H.K.) Ltd., Taoyuan Branch, were founded in 1988 to provide our best service in EMC, Radio, Telecom and Safety consultation. Our laboratories are FCC recognized accredited test firms and accredited and approved according to ISO/IEC 17025.

If you have any comments, please feel free to contact us at the following:

### Lin Kou EMC/RF Lab

Tel: 886-2-26052180

Fax: 886-2-26051924

### Hsin Chu EMC/RF/Telecom Lab

Tel: 886-3-6668565

Fax: 886-3-6668323

### Hwa Ya EMC/RF/Safety Lab

Tel: 886-3-3183232

Fax: 886-3-3270892

**Email:** [service.adt@tw.bureauveritas.com](mailto:service.adt@tw.bureauveritas.com)

**Web Site:** [www.bureauveritas-adt.com](http://www.bureauveritas-adt.com)

The address and road map of all our labs can be found in our web site also.

--- END ---