

Partial FCC Test Report (Part 22)

Report No.: RF191209C13-2

FCC ID: WIYT910

Test Model: LE910-NA1

Received Date: Dec. 09, 2019

Test Date: Feb. 20 ~ Feb. 21, 2020

Issued Date: Feb. 26, 2020

Applicant: CASTLES TECHNOLOGY CO., LTD.

Address: 6F, NO. 207-5, SEC. 3, BEIXIN RD., XINDIAN DISTRICT, NEW TAIPEI CITY
23143, TAIWAN (R. O. C.)

Issued By: Bureau Veritas Consumer Products Services (H.K.) Ltd., Taoyuan Branch
Lin Kou Laboratories

Lab Address: No. 47-2, 14th Ling, Chia Pau Vil., Lin Kou Dist., New Taipei City, Taiwan

Test Location: No. 19, Hwa Ya 2nd Rd., Wen Hwa Vil., Kwei Shan Dist., Taoyuan City
33383, TAIWAN

FCC Registration / 788550 / TW0003

Designation Number:



This report is for your exclusive use. Any copying or replication of this report to or for any other person or entity, or use of our name or trademark, is permitted only with our prior written permission. This report sets forth our findings solely with respect to the test samples identified herein. The results set forth in this report are not indicative or representative of the quality or characteristics of the lot from which a test sample was taken or any similar or identical product unless specifically and expressly noted. Our report includes all of the tests requested by you and the results thereof based upon the information that you provided to us. You have 60 days from date of issuance of this report to notify us of any material error or omission caused by our negligence, provided, however, that such notice shall be in writing and shall specifically address the issue you wish to raise. A failure to raise such issue within the prescribed time shall constitute your unqualified acceptance of the completeness of this report, the tests conducted and the correctness of the report contents. Unless specific mention, the uncertainty of measurement has been explicitly taken into account to declare the compliance or non-compliance to the specification. The report must not be used by the client to claim product certification, approval, or endorsement by TAF or any government agencies

Table of Contents

Release Control Record	3
1 Certificate of Conformity	4
2 Summary of Test Results	5
2.1 Measurement Uncertainty.....	5
2.2 Test Site and Instruments.....	6
3 General Information	7
3.1 General Description of EUT.....	7
3.2 Configuration of System under Test.....	8
3.2.1 Description of Support Units.....	8
3.3 Test Mode Applicability and Tested Channel Detail.....	9
3.4 EUT Operating Conditions.....	10
3.5 General Description of Applied Standards.....	10
4 Test Types and Results	11
4.1 Output Power Measurement.....	11
4.1.1 Limits of Output Power Measurement.....	11
4.1.2 Test Procedures.....	11
4.1.3 Test Setup.....	12
4.1.4 Test Results.....	13
4.2 Radiated Emission Measurement.....	18
4.2.1 Limits of Radiated Emission Measurement.....	18
4.2.2 Test Procedure.....	18
4.2.3 Deviation from Test Standard.....	18
4.2.4 Test Setup.....	19
4.2.5 Test Results.....	20
5 Pictures of Test Arrangements	36
Appendix – Information of the Testing Laboratories	37

Release Control Record

Issue No.	Description	Date Issued
RF191209C13-2	Original release	Feb. 26, 2020

1 Certificate of Conformity

Product: LTE module

Brand: Telit

Test Model: LE910-NA1

Sample Status: Identical Prototype

Applicant: CASTLES TECHNOLOGY CO., LTD.

Test Date: Feb. 20 ~ Feb. 21, 2020

Standards: FCC Part 22, Subpart H

The above equipment has been tested by **Bureau Veritas Consumer Products Services (H.K.) Ltd., Taoyuan Branch**, and found compliance with the requirement of the above standards. The test record, data evaluation & Equipment Under Test (EUT) configurations represented herein are true and accurate accounts of the measurements of the sample's RF characteristics under the conditions specified in this report.

Prepared by :  , **Date:** Feb. 26, 2020
Polly Chien / Specialist

Approved by :  , **Date:** Feb. 26, 2020
Bruce Chen / Senior Project Engineer

2 Summary of Test Results

Applied Standard: FCC Part 22 & Part 2			
FCC Clause	Test Item	Result	Remarks
2.1046 22.913 (a)	Effective radiated power	Pass	Meet the requirement of limit.
2.1047	Modulation Characteristics	N/A	Refer to Note 1
22.913 (d)	Peak To Average Ratio	N/A	Refer to Note 1
2.1055 22.355	Frequency Stability	N/A	Refer to Note 1
2.1049	Occupied Bandwidth	N/A	Refer to Note 1
22.917	Band Edge Measurements	N/A	Refer to Note 1
2.1051 22.917	Conducted Spurious Emissions	N/A	Refer to Note 1
2.1053 22.917	Radiated Spurious Emissions	Pass	Meet the requirement of limit. Minimum passing margin is -37.1dB at 297.10MHz.

Note:

1. This report is a partial report. Therefore, only test item of Effective Radiated Power and Radiated Spurious Emissions tests were performed for this report. Other testing data please refer to A Test Lab Techno Corp. report no.: 1506FR21-01 & 1506FR22-01 for module (Brand: Telit, Model: LE910-NA1).
2. Determining compliance based on the results of the compliance measurement, not taking into account measurement instrumentation uncertainty.

2.1 Measurement Uncertainty

Where relevant, the following measurement uncertainty levels have been estimated for tests performed on the EUT as specified in CISPR 16-4-2:

Measurement	Frequency	Expanded Uncertainty (k=2) (\pm)
Radiated Emissions up to 1 GHz	9kHz ~ 30MHz	3.04 dB
	30MHz ~ 200MHz	3.86 dB
	200MHz ~ 1000MHz	3.87 dB
Radiated Emissions above 1 GHz	1GHz ~ 18GHz	2.29 dB
	18GHz ~ 40GHz	2.29 dB

2.2 Test Site and Instruments

Description & Manufacturer	Model No.	Serial No.	Cal. Date	Cal. Due
Test Receiver ROHDE & SCHWARZ	ESIB7	100187	May 30, 2019	May 29, 2020
Spectrum Analyzer ROHDE & SCHWARZ	FSP40	100269	Jun. 10, 2019	Jun. 09, 2020
MXG Vector signal generator Agilent	N5182B	MY53050430	Nov. 25, 2019	Nov. 24, 2020
Radio Communication Analyzer Anritsu	MT8820C	6201010284	Nov. 25, 2019	Nov. 24, 2020
BILOG Antenna SCHWARZBECK	VULB9168	9168-161	Nov. 08, 2019	Nov. 07, 2020
BILOG Antenna SCHWARZBECK	VULB9168	9168-171	Nov. 11, 2019	Nov. 10, 2020
HORN Antenna SCHWARZBECK	9120D	209	Nov. 24, 2019	Nov. 23, 2020
Loop Antenna TESEQ	HLA 6121	45745	Jul. 01, 2019	Jun. 30, 2020
Preamplifier Agilent (Below 1GHz)	8447D	2944A10738	Aug. 20, 2019	Aug. 19, 2020
Preamplifier Agilent (Above 1GHz)	8449B	3008A02465	Mar. 27, 2019	Mar. 26, 2020
RF Coaxial Cable WOKEN With 5dB PAD	8D-FB	Cable-CH3-01	Aug. 20, 2019	Aug. 19, 2020
RF signal cable HUBER+SUHNER	SUCOFLEX 104	Cable-CH3-03 (223653/4)	Aug. 20, 2019	Aug. 19, 2020
RF signal cable HUBER+SUHNER& EMCI	SUCOFLEX 104&EMC104-SM-SM- 8000	Cable-CH3-03 (309224+170907)	Aug. 20, 2019	Aug. 19, 2020
Software BV ADT	ADT_Radiated_ V7.6.15.9.5	NA	NA	NA
Antenna Tower inn-co GmbH	MA 4000	013303	NA	NA
Antenna Tower Controller BV ADT	AT100	AT93021702	NA	NA
Turn Table BV ADT	TT100	TT93021702	NA	NA
Turn Table Controller BV ADT	SC100	SC93021702	NA	NA
Boresight Antenna Fixture	FBA-01	FBA-SIP01	NA	NA

Note: 1. The calibration interval of the above test instruments is 12 months and the calibrations are traceable to NML/ROC and NIST/USA.
2. The test was performed in HwaYa Chamber 3.

3 General Information

3.1 General Description of EUT

Product	LTE module	
Brand	Telit	
Test Model	LE910-NA1	
Sample Status	Identical Prototype	
Power Supply Rating	9Vdc~48Vdc, 1.5A~0.5A	
Modulation Type	WCDMA: QPSK HSDPA: BPSK HSUPA: QPSK LTE: QPSK, 16QAM	
Operating Frequency	WCDMA	826.4 ~ 846.6 MHz
	LTE 5 (Channel Bandwidth: 1.4 MHz)	824.7 ~ 848.3 MHz
	LTE 5 (Channel Bandwidth: 3 MHz)	825.5 ~ 847.5 MHz
	LTE 5 (Channel Bandwidth: 5 MHz)	826.5 ~ 846.5 MHz
	LTE 5 (Channel Bandwidth: 10 MHz)	829 ~ 844 MHz
Max. ERP Power	WCDMA Band 5	213.796mW (23.3dBm)
		QPSK
	LTE Band 5 (Channel Bandwidth 1.4MHz)	186.209mW (22.7dBm)
	LTE Band 5 (Channel Bandwidth 3MHz)	181.970mW (22.6dBm)
	LTE Band 5 (Channel Bandwidth 5MHz)	181.970mW (22.6dBm)
	LTE Band 5 (Channel Bandwidth 10MHz)	186.209mW (22.7dBm)
Antenna Type	Refer to Note	
Antenna Connector	Refer to Note	
Accessory Device	Refer to note	
Cable Supplied	NA	

Note:

- This report is a partial report. Therefore, only test item of Effective Radiated Power and Radiated Spurious Emissions tests were performed for this report. Other testing data please refer to A Test Lab Techno Corp. report no.: 1506FR21-01 & 1506FR22-01 for module (Brand: Telit, Model: LE910-NA1).
- The EUT uses following antennas.

Antenna Type	Antenna Connector	Frequency	Antenna Gain (dBi)
Dipole	SMA	824-960MHz	1.61

- The EUT was installed in a specific End-product.

Product	Brand	Model
POS Terminal	CASTLES TECHNOLOGY	UPT1000B

3.2 Configuration of System under Test

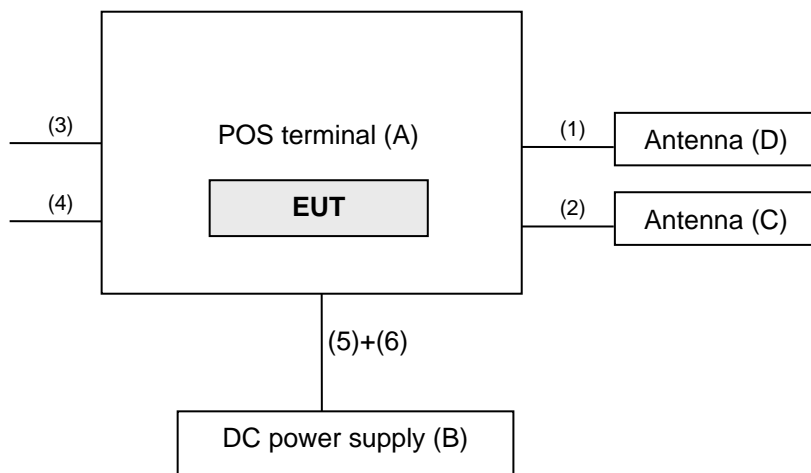

Remote site



3.2.1 Description of Support Units

The EUT has been tested as an independent unit together with other necessary accessories or support units. The following support units or accessories were used to form a representative test configuration during the tests.

ID	Product	Brand	Model No.	Serial No.	FCC ID	Remarks
A.	POS Terminal	CASTLES TECHNOLOGY	UPT1000B	NA	WIYUPT1000-BV	Provided by client.
B.	DC power supply	SHUOKANG	33010D	807748	NA	-
C.	Antenna	Aristotle	RFA-LTE-T1000F-41-2M-A1	NA	NA	Provided by client.
D.	Antenna	Aristotle	RFA-25-T100-41-3M-A2	NA	NA	Provided by client.
E.	Radio Communication Analyzer	Anritsu	MT8820C	6201010284	NA	-

Note:

1. All power cords of the above support units are non-shielded (1.8m).
2. Item E acted as a communication partner to transfer data.

ID	Cable Descriptions	Qty.	Length (m)	Shielding (Yes/No)	Cores (Qty.)	Remarks
1.	ANT cable	1	2.05	Y	0	Accessory of EUT
2.	ANT cable	1	3	Y	0	Accessory of EUT
3.	USB Type B cable	1	0.7	Y	0	Provided by client.
4.	RS232 cable	1	0.71	N	0	Provided by client.
5.	Power cable	1	0.7	N	0	Provided by client.
6.	Power cable	1	2	N	0	-

3.3 Test Mode Applicability and Tested Channel Detail

Pre-Scan has been conducted to determine the worst-case mode from all possible combinations between available modulations, data rates, XYZ axis and antenna ports. The worst case was found when positioned on Z-plane. Following channel(s) was (were) selected for the final test as listed below.

WCDMA Band 5

EUT Configure Mode	Test Item	Available Channel	Tested Channel	Mode
-	ERP	4132 to 4233	4132 (826.4MHz), 4182 (836.4MHz), 4233 (846.6MHz)	WCDMA
-	Radiated Emission Below 1GHz	4132 to 4233	4233 (846.6MHz)	WCDMA
-	Radiated Emission Above 1GHz	4132 to 4233	4132 (826.4MHz), 4182 (836.4MHz), 4233 (846.6MHz)	WCDMA

LTE Band 5

EUT Configure Mode	Test item	Available channel	Tested channel	Channel Bandwidth	Modulation	Mode
-	ERP	20407 to 20643	20407(824.7MHz), 20525(836.5MHz), 20643(848.3MHz)	1.4MHz	QPSK	1 RB / 0 RB Offset
		20415 to 20635	20415(825.5MHz), 20525(836.5MHz), 20635(847.5MHz)	3MHz	QPSK	1 RB / 0 RB Offset
		20425 to 20625	20425(826.5MHz), 20525(836.5MHz), 20625(846.5MHz)	5MHz	QPSK	1 RB / 0 RB Offset
		20450 to 20600	20450(829.0MHz), 20525(836.5MHz), 20600(844.0MHz)	10MHz	QPSK	1 RB / 0 RB Offset
-	Radiated Emission Below 1GHz	20407 to 20643	20643(848.3MHz)	1.4MHz	QPSK	1 RB / 0 RB Offset
		20425 to 20625	20625(846.5MHz)	5MHz	QPSK	1 RB / 0 RB Offset
		20450 to 20600	20600(844.0MHz)	10MHz	QPSK	1 RB / 0 RB Offset
-	Radiated Emission Above 1GHz	20407 to 20643	20407(824.7MHz), 20525(836.5MHz), 20643(848.3MHz)	1.4MHz	QPSK	1 RB / 0 RB Offset
		20425 to 20625	20425(826.5MHz), 20525(836.5MHz), 20625(846.5MHz)	5MHz	QPSK	1 RB / 0 RB Offset
		20450 to 20600	20450(829.0MHz), 20525(836.5MHz), 20600(844.0MHz)	10MHz	QPSK	1 RB / 0 RB Offset

Note:

1. For radiated emission below 1GHz, low, mid and high channels were pre-tested in chamber. High channel for WCDMA mode was the worst case for all final tests. High channel for LTE mode was the worst case for all final tests
2. This device was tested under all bandwidths, RB configurations and modulations. The worst case was found in QPSK modulation.
3. For radiated emission, according to 3GPP 36.521 Section 6.6.3.1.4, choose the lowest, 5 MHz & highest channel bandwidth for final test.

Test Condition:

Test Item	Environmental Conditions	Input Power (System)	Tested By
ERP	23deg. C, 66%RH	9Vdc	Titan Hsu
Radiated Emission	23deg. C, 66%RH	9Vdc	Titan Hsu, Adair Peng

3.4 EUT Operating Conditions

The EUT makes a call to the communication simulator. The communication simulator station system controlled a EUT to export maximum output power under transmission mode and specific channel frequency

3.5 General Description of Applied Standards

The EUT is a RF Product. According to the specifications of the manufacturer, it must comply with the requirements of the following standards:

FCC 47 CFR Part 2

FCC 47 CFR Part 22

KDB 971168 D01 Power Meas License Digital Systems v03r01

ANSI/TIA/EIA-603-E 2016

ANSI 63.26-2015

All test items have been performed and recorded as per the above standards.

4 Test Types and Results

4.1 Output Power Measurement

4.1.1 Limits of Output Power Measurement

Mobile / Portable station are limited to 7 watts e.r.p.

4.1.2 Test Procedures

EIRP / ERP Measurement:

- a. All measurements were done at low, middle and high operational frequency range. RBW and VBW is 5MHz for WCDMA mode, 10MHz for LTE mode.
- b. Substitution method is used for E.I.R.P measurement. In the semi-anechoic chamber, EUT placed on the 0.8m(below or equal 1GHz) and/or 1.5m(above 1GHz) height of Turn Table, rotated the table around 360 degrees to search the maximum radiation power and receiver antenna shall be rotated vertical and horizontal polarization and moved height from 1m to 4m to find the maximum polar radiated power. The "Read Value" is the spectrum reading the maximum power value.
- c. The substitution horn antenna is substituted for EUT at the same position and signals generator export the CW signal to the substitution antenna via a TX cable. Rotated the Turn Table and moved receiving antenna to find the maximum radiation power. Adjust output power level of S.G to get a Value of spectrum reading equal to "Read Value" of step b. Record the power level of S.G
- d. EIRP = Output power level of S.G – TX cable loss + Antenna gain of substitution horn. E.R.P power can be calculated form E.I.R.P power by subtracting the gain of dipole, E.R.P power = E.I.R.P power - 2.15dBi.

Where:

$$\text{ERP/EIRP} = P_{\text{Meas}} + G_{\text{T}} - L_{\text{C}}$$

P_{Meas} : Measure transmitter output power.

G_{T} : Gain of the transmitting antenna.

L_{C} : signal attenuation in the connecting cable between the transmitter and antenna.

4.1.3 Test Setup

EIRP / ERP Measurement:

For radiated emission 30MHz to 1GHz

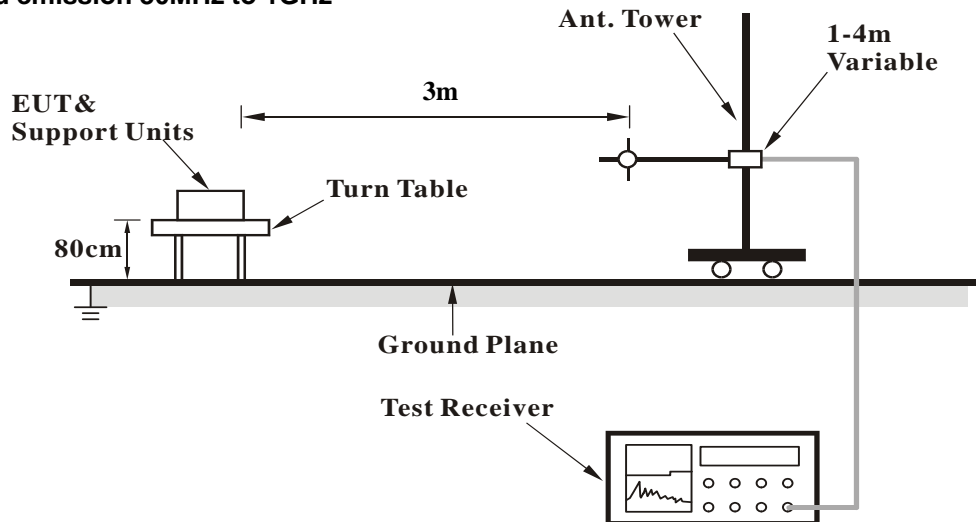

For radiated emission above 1GHz

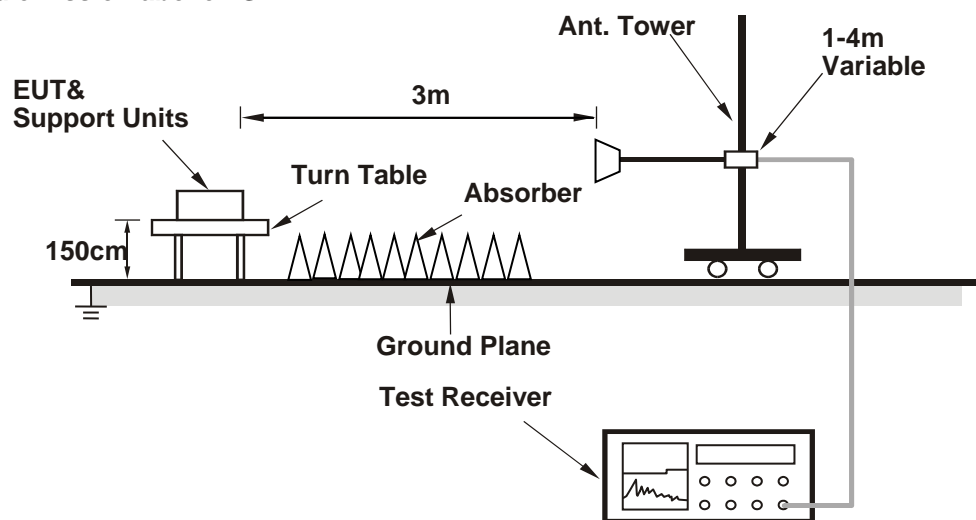

For the actual test configuration, please refer to the attached file (Test Setup Photo).

4.1.4 Test Results

ERP Power

WCDMA Band 5

MODE		TX channel 4132					
Antenna Polarity & Test Distance: Horizontal at 3 M							
No.	Freq. (MHz)	Reading (dBm)	S.G Power Value (dBm)	Correction Factor (dB)	ERP (dBm)	Limit (dBm)	Margin (dB)
1	826.40	-12.1	20.1	0.0	20.1	38.5	-18.4
Antenna Polarity & Test Distance: Vertical at 3 M							
No.	Freq. (MHz)	Reading (dBm)	S.G Power Value (dBm)	Correction Factor (dB)	ERP (dBm)	Limit (dBm)	Margin (dB)
1	826.40	-10.2	23.2	0.0	23.2	38.5	-15.3

MODE		TX channel 4182					
Antenna Polarity & Test Distance: Horizontal at 3 M							
No.	Freq. (MHz)	Reading (dBm)	S.G Power Value (dBm)	Correction Factor (dB)	ERP (dBm)	Limit (dBm)	Margin (dB)
1	836.40	-12.6	19.8	0.2	20.0	38.5	-18.5
Antenna Polarity & Test Distance: Vertical at 3 M							
No.	Freq. (MHz)	Reading (dBm)	S.G Power Value (dBm)	Correction Factor (dB)	ERP (dBm)	Limit (dBm)	Margin (dB)
1	836.40	-10.1	23.1	0.2	23.3	38.5	-15.2

MODE		TX channel 4233					
Antenna Polarity & Test Distance: Horizontal at 3 M							
No.	Freq. (MHz)	Reading (dBm)	S.G Power Value (dBm)	Correction Factor (dB)	ERP (dBm)	Limit (dBm)	Margin (dB)
1	846.60	-11.9	19.8	0.4	20.2	38.5	-18.3
Antenna Polarity & Test Distance: Vertical at 3 M							
No.	Freq. (MHz)	Reading (dBm)	S.G Power Value (dBm)	Correction Factor (dB)	ERP (dBm)	Limit (dBm)	Margin (dB)
1	846.60	-9.8	22.9	0.4	23.3	38.5	-15.2

Note: ERP (dBm) = S.G Power Value (dBm) + Correction Factor (dB).

Modulation Type: QPSK

LTE Band 5, Channel Bandwidth: 1.4MHz

MODE		TX channel 20407					
Antenna Polarity & Test Distance: Horizontal at 3 M							
No.	Freq. (MHz)	Reading (dBm)	S.G Power Value (dBm)	Correction Factor (dB)	ERP (dBm)	Limit (dBm)	Margin (dB)
1	824.70	-13.9	18.5	0.0	18.5	38.5	-20.0
Antenna Polarity & Test Distance: Vertical at 3 M							
No.	Freq. (MHz)	Reading (dBm)	S.G Power Value (dBm)	Correction Factor (dB)	ERP (dBm)	Limit (dBm)	Margin (dB)
1	824.70	-10.7	22.7	0.0	22.7	38.5	-15.8

MODE		TX channel 20525					
Antenna Polarity & Test Distance: Horizontal at 3 M							
No.	Freq. (MHz)	Reading (dBm)	S.G Power Value (dBm)	Correction Factor (dB)	ERP (dBm)	Limit (dBm)	Margin (dB)
1	836.50	-14.0	18.3	0.2	18.5	38.5	-20.0
Antenna Polarity & Test Distance: Vertical at 3 M							
No.	Freq. (MHz)	Reading (dBm)	S.G Power Value (dBm)	Correction Factor (dB)	ERP (dBm)	Limit (dBm)	Margin (dB)
1	836.50	-11.4	21.8	0.2	22.0	38.5	-16.5

MODE		TX channel 20643					
Antenna Polarity & Test Distance: Horizontal at 3 M							
No.	Freq. (MHz)	Reading (dBm)	S.G Power Value (dBm)	Correction Factor (dB)	ERP (dBm)	Limit (dBm)	Margin (dB)
1	848.30	-13.8	17.8	0.5	18.3	38.5	-20.2
Antenna Polarity & Test Distance: Vertical at 3 M							
No.	Freq. (MHz)	Reading (dBm)	S.G Power Value (dBm)	Correction Factor (dB)	ERP (dBm)	Limit (dBm)	Margin (dB)
1	848.30	-10.9	21.7	0.5	22.2	38.5	-16.3

Note: ERP (dBm) = S.G Power Value (dBm) + Correction Factor (dB).

LTE Band 5, Channel Bandwidth: 3MHz

MODE		TX channel 20415					
Antenna Polarity & Test Distance: Horizontal at 3 M							
No.	Freq. (MHz)	Reading (dBm)	S.G Power Value (dBm)	Correction Factor (dB)	ERP (dBm)	Limit (dBm)	Margin (dB)
1	825.50	-13.9	18.4	0.0	18.4	38.5	-20.1
Antenna Polarity & Test Distance: Vertical at 3 M							
No.	Freq. (MHz)	Reading (dBm)	S.G Power Value (dBm)	Correction Factor (dB)	ERP (dBm)	Limit (dBm)	Margin (dB)
1	825.50	-10.8	22.6	0.0	22.6	38.5	-15.9

MODE		TX channel 20525					
Antenna Polarity & Test Distance: Horizontal at 3 M							
No.	Freq. (MHz)	Reading (dBm)	S.G Power Value (dBm)	Correction Factor (dB)	ERP (dBm)	Limit (dBm)	Margin (dB)
1	836.50	-14.1	18.2	0.2	18.4	38.5	-20.1
Antenna Polarity & Test Distance: Vertical at 3 M							
No.	Freq. (MHz)	Reading (dBm)	S.G Power Value (dBm)	Correction Factor (dB)	ERP (dBm)	Limit (dBm)	Margin (dB)
1	836.50	-11.2	22.0	0.2	22.2	38.5	-16.3

MODE		TX channel 20635					
Antenna Polarity & Test Distance: Horizontal at 3 M							
No.	Freq. (MHz)	Reading (dBm)	S.G Power Value (dBm)	Correction Factor (dB)	ERP (dBm)	Limit (dBm)	Margin (dB)
1	847.50	-13.8	18.0	0.4	18.4	38.5	-20.1
Antenna Polarity & Test Distance: Vertical at 3 M							
No.	Freq. (MHz)	Reading (dBm)	S.G Power Value (dBm)	Correction Factor (dB)	ERP (dBm)	Limit (dBm)	Margin (dB)
1	847.50	-10.8	21.9	0.4	22.3	38.5	-16.2

Note: ERP (dBm) = S.G Power Value (dBm) + Correction Factor (dB).

LTE Band 5, Channel Bandwidth: 5MHz

MODE		TX channel 20425					
Antenna Polarity & Test Distance: Horizontal at 3 M							
No.	Freq. (MHz)	Reading (dBm)	S.G Power Value (dBm)	Correction Factor (dB)	ERP (dBm)	Limit (dBm)	Margin (dB)
1	826.50	-13.9	18.4	0.0	18.4	38.5	-20.1
Antenna Polarity & Test Distance: Vertical at 3 M							
No.	Freq. (MHz)	Reading (dBm)	S.G Power Value (dBm)	Correction Factor (dB)	ERP (dBm)	Limit (dBm)	Margin (dB)
1	826.50	-10.8	22.6	0.0	22.6	38.5	-15.9

MODE		TX channel 20525					
Antenna Polarity & Test Distance: Horizontal at 3 M							
No.	Freq. (MHz)	Reading (dBm)	S.G Power Value (dBm)	Correction Factor (dB)	ERP (dBm)	Limit (dBm)	Margin (dB)
1	836.50	-14.1	18.2	0.2	18.4	38.5	-20.1
Antenna Polarity & Test Distance: Vertical at 3 M							
No.	Freq. (MHz)	Reading (dBm)	S.G Power Value (dBm)	Correction Factor (dB)	ERP (dBm)	Limit (dBm)	Margin (dB)
1	836.50	-11.2	22.0	0.2	22.2	38.5	-16.3

MODE		TX channel 20625					
Antenna Polarity & Test Distance: Horizontal at 3 M							
No.	Freq. (MHz)	Reading (dBm)	S.G Power Value (dBm)	Correction Factor (dB)	ERP (dBm)	Limit (dBm)	Margin (dB)
1	846.50	-13.8	18.0	0.4	18.4	38.5	-20.1
Antenna Polarity & Test Distance: Vertical at 3 M							
No.	Freq. (MHz)	Reading (dBm)	S.G Power Value (dBm)	Correction Factor (dB)	ERP (dBm)	Limit (dBm)	Margin (dB)
1	846.50	-10.7	22.0	0.4	22.4	38.5	-16.1

Note: ERP (dBm) = S.G Power Value (dBm) + Correction Factor (dB).

LTE Band 5, Channel Bandwidth: 10MHz

MODE		TX channel 20450					
Antenna Polarity & Test Distance: Horizontal at 3 M							
No.	Freq. (MHz)	Reading (dBm)	S.G Power Value (dBm)	Correction Factor (dB)	ERP (dBm)	Limit (dBm)	Margin (dB)
1	829.00	-14.1	18.3	0.1	18.4	38.5	-20.1
Antenna Polarity & Test Distance: Vertical at 3 M							
No.	Freq. (MHz)	Reading (dBm)	S.G Power Value (dBm)	Correction Factor (dB)	ERP (dBm)	Limit (dBm)	Margin (dB)
1	829.00	-10.7	22.6	0.1	22.7	38.5	-15.8

MODE		TX channel 20525					
Antenna Polarity & Test Distance: Horizontal at 3 M							
No.	Freq. (MHz)	Reading (dBm)	S.G Power Value (dBm)	Correction Factor (dB)	ERP (dBm)	Limit (dBm)	Margin (dB)
1	836.50	-14.1	18.2	0.2	18.4	38.5	-20.1
Antenna Polarity & Test Distance: Vertical at 3 M							
No.	Freq. (MHz)	Reading (dBm)	S.G Power Value (dBm)	Correction Factor (dB)	ERP (dBm)	Limit (dBm)	Margin (dB)
1	836.50	-11.0	22.2	0.2	22.4	38.5	-16.1

MODE		TX channel 20600					
Antenna Polarity & Test Distance: Horizontal at 3 M							
No.	Freq. (MHz)	Reading (dBm)	S.G Power Value (dBm)	Correction Factor (dB)	ERP (dBm)	Limit (dBm)	Margin (dB)
1	844.00	-14.0	18.1	0.4	18.5	38.5	-20.0
Antenna Polarity & Test Distance: Vertical at 3 M							
No.	Freq. (MHz)	Reading (dBm)	S.G Power Value (dBm)	Correction Factor (dB)	ERP (dBm)	Limit (dBm)	Margin (dB)
1	844.00	-10.9	22.1	0.4	22.5	38.5	-16.0

Note: ERP (dBm) = S.G Power Value (dBm) + Correction Factor (dB).

4.2 Radiated Emission Measurement

4.2.1 Limits of Radiated Emission Measurement

The power of any emission outside of the authorized operating frequency ranges must be attenuated below the transmitting power (P) by a factor of at least $43 + 10 \log(P)$ dB. The emission limit equal to -13dBm .

4.2.2 Test Procedure

- a. Substitution method is used for E.I.R.P measurement. In the semi-anechoic chamber, EUT placed on the 0.8m height of Turn Table, rotated the table around 360 degrees to search the maximum radiation power and receiver antenna shall be rotated vertical and horizontal polarization and moved height from 1m to 4m to find the maximum polar radiated power. The "Read Value" is the spectrum reading the maximum power value.
- b. The substitution horn antenna is substituted for EUT at the same position and signals generator export the CW signal to the substitution antenna via a TX cable. Rotated the Turn Table and moved receiving antenna to find the maximum radiation power. Adjust output power level of S.G to get a Value of spectrum reading equal to "Read Value" of step a. Record the power level of S.G
- c. $\text{EIRP} = \text{Output power level of S.G} - \text{TX cable loss} + \text{Antenna gain of substitution horn}$.
- d. E.R.P power can be calculated form E.I.R.P power by subtracting the gain of dipole, $\text{E.R.P power} = \text{E.I.R.P power} - 2.15\text{dBi}$.

NOTE: The resolution bandwidth and video bandwidth of test receiver/spectrum analyzer is 1MHz/3MHz.

4.2.3 Deviation from Test Standard

No deviation.

4.2.4 Test Setup

For radiated emission 30MHz to 1GHz

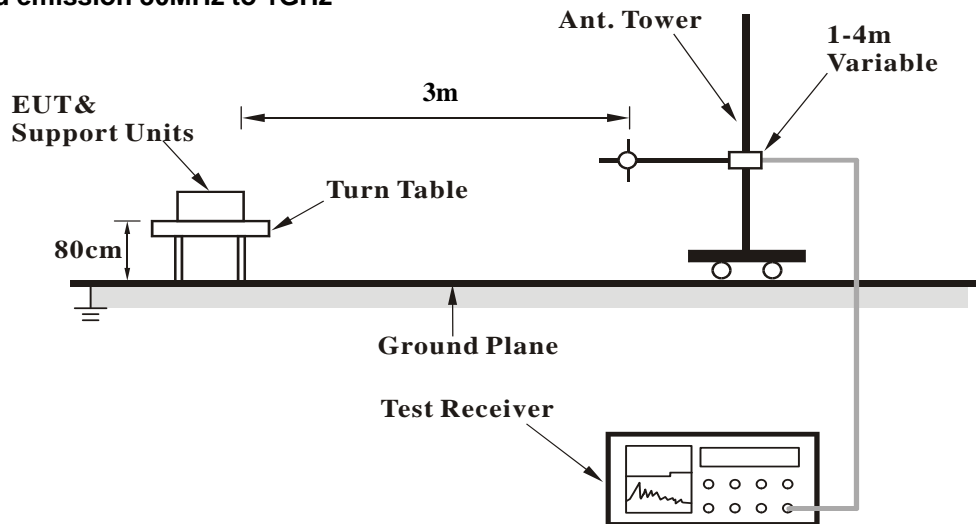

For radiated emission above 1GHz

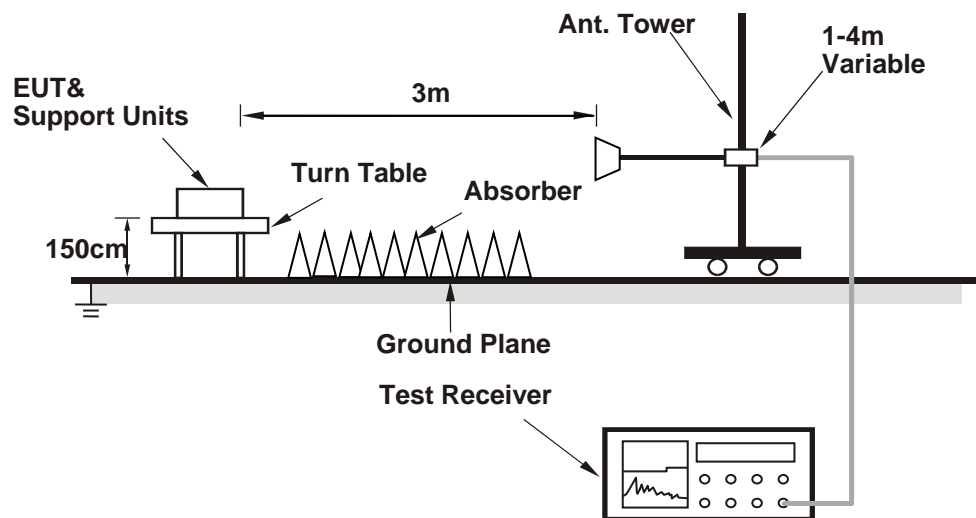

For the actual test configuration, please refer to the attached file (Test Setup Photo).

4.2.5 Test Results

Below 1GHz
WCDMA Band 5

Mode	TX channel 4233 (846.6MHz)	Frequency Range	Below 1000 MHz
Environmental Conditions	23deg. C, 66%RH	Input Power	9Vdc
Tested By	Titan Hsu		

Antenna Polarity & Test Distance: Horizontal at 3 M							
No.	Freq. (MHz)	Reading (dBm)	S.G Power Value (dBm)	Correction Factor (dB)	ERP (dBm)	Limit (dBm)	Margin (dB)
1	30.00	-59.1	-46.0	-12.2	-58.2	-13.0	-45.2
2	80.61	-50.7	-57.2	-1.5	-58.7	-13.0	-45.7
3	153.71	-48.8	-56.0	0.1	-55.9	-13.0	-42.9
4	297.10	-53.0	-62.6	5.1	-57.5	-13.0	-44.5
5	454.55	-55.0	-62.0	5.0	-57.0	-13.0	-44.0
6	595.13	-60.1	-65.1	4.5	-60.6	-13.0	-47.6

Remarks:

- ERP (dBm) = S.G Value (dBm) + Correction Factor (dB).
- Correction Factor (dB) = Substitution Antenna Gain (dB) + Cable Loss (dB).

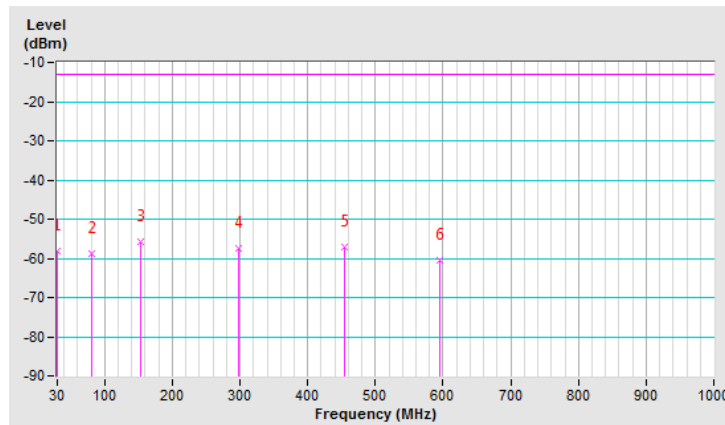

Mode	TX channel 4233 (846.6MHz)	Frequency Range	Below 1000 MHz
Environmental Conditions	23deg. C, 66%RH	Input Power	9Vdc
Tested By	Titan Hsu		

Antenna Polarity & Test Distance: Vertical at 3 M							
No.	Freq. (MHz)	Reading (dBm)	S.G Power Value (dBm)	Correction Factor (dB)	ERP (dBm)	Limit (dBm)	Margin (dB)
1	31.41	-44.9	-42.8	-12.0	-54.8	-13.0	-41.8
2	62.33	-45.6	-48.0	-7.0	-55.0	-13.0	-42.0
3	136.84	-51.2	-56.8	-0.3	-57.1	-13.0	-44.1
4	297.10	-48.9	-55.2	5.1	-50.1	-13.0	-37.1
5	627.46	-60.5	-61.7	4.6	-57.1	-13.0	-44.1
6	756.80	-63.2	-62.3	4.6	-57.7	-13.0	-44.7

Remarks:

1. ERP (dBm) = S.G Value (dBm) + Correction Factor (dB).
2. Correction Factor (dB) = Substitution Antenna Gain (dB) + Cable Loss (dB).

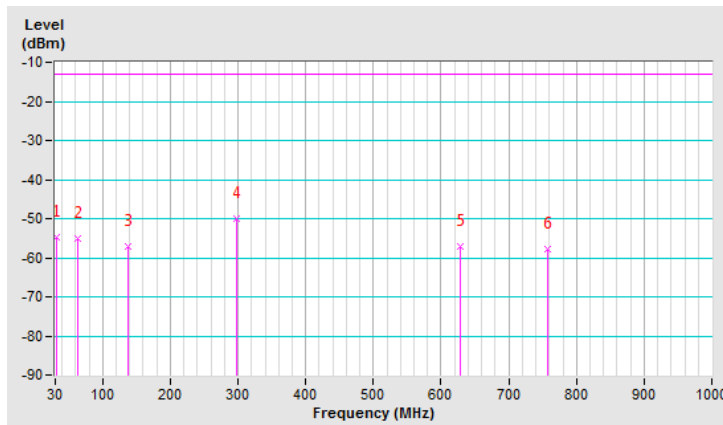

LTE Band 5, Channel Bandwidth: 1.4MHz

Mode	TX channel 20643 (848.3MHz)	Frequency Range	Below 1000 MHz
Environmental Conditions	23deg. C, 66%RH	Input Power	9Vdc
Tested By	Titan Hsu		

Antenna Polarity & Test Distance: Horizontal at 3 M							
No.	Freq. (MHz)	Reading (dBm)	S.G Power Value (dBm)	Correction Factor (dB)	ERP (dBm)	Limit (dBm)	Margin (dB)
1	30.00	-61.4	-48.3	-12.2	-60.5	-13.0	-47.5
2	76.39	-51.8	-57.1	-2.8	-59.9	-13.0	-46.9
3	114.35	-47.0	-57.8	0.3	-57.5	-13.0	-44.5
4	150.90	-51.2	-57.9	-0.1	-58.0	-13.0	-45.0
5	202.91	-48.2	-63.6	5.4	-58.2	-13.0	-45.2
6	297.10	-53.6	-63.2	5.1	-58.1	-13.0	-45.1

Remarks:

- ERP (dBm) = S.G Value (dBm) + Correction Factor (dB).
- Correction Factor (dB) = Substitution Antenna Gain (dB) + Cable Loss (dB).

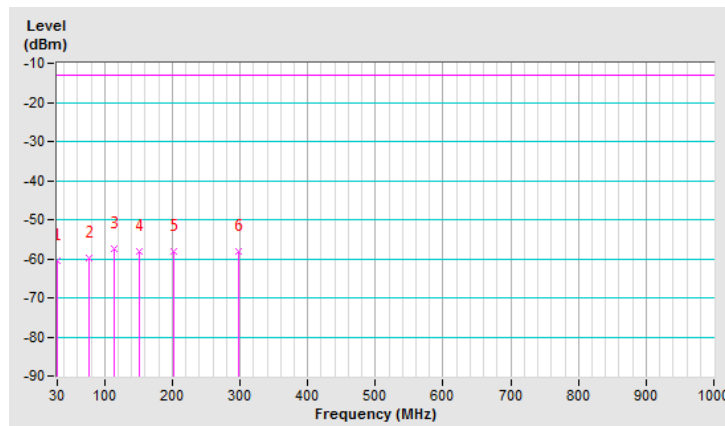

Mode	TX channel 20643 (848.3MHz)	Frequency Range	Below 1000 MHz
Environmental Conditions	23deg. C, 66%RH	Input Power	9Vdc
Tested By	Titan Hsu		

Antenna Polarity & Test Distance: Vertical at 3 M							
No.	Freq. (MHz)	Reading (dBm)	S.G Power Value (dBm)	Correction Factor (dB)	ERP (dBm)	Limit (dBm)	Margin (dB)
1	62.33	-44.4	-46.8	-7.0	-53.8	-13.0	-40.8
2	100.29	-48.8	-59.2	0.9	-58.3	-13.0	-45.3
3	142.46	-54.2	-58.8	-0.3	-59.1	-13.0	-46.1
4	191.67	-55.5	-64.6	4.4	-60.2	-13.0	-47.2
5	297.10	-52.2	-58.6	5.1	-53.5	-13.0	-40.5
6	356.14	-54.9	-62.7	5.2	-57.5	-13.0	-44.5

Remarks:

1. ERP (dBm) = S.G Value (dBm) + Correction Factor (dB).
2. Correction Factor (dB) = Substitution Antenna Gain (dB) + Cable Loss (dB).

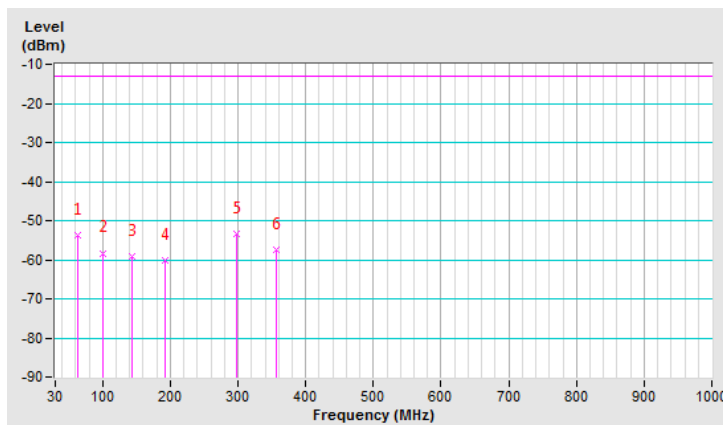

LTE Band 5, Channel Bandwidth: 5MHz

Mode	TX channel 20625 (846.5MHz)	Frequency Range	Below 1000 MHz
Environmental Conditions	23deg. C, 66%RH	Input Power	9Vdc
Tested By	Titan Hsu		

Antenna Polarity & Test Distance: Horizontal at 3 M							
No.	Freq. (MHz)	Reading (dBm)	S.G Power Value (dBm)	Correction Factor (dB)	ERP (dBm)	Limit (dBm)	Margin (dB)
1	30.00	-58.8	-45.7	-12.2	-57.9	-13.0	-44.9
2	98.88	-50.5	-62.5	0.9	-61.6	-13.0	-48.6
3	148.09	-51.9	-58.5	-0.2	-58.7	-13.0	-45.7
4	201.51	-50.0	-65.5	5.4	-60.1	-13.0	-47.1
5	297.10	-53.2	-62.8	5.1	-57.7	-13.0	-44.7
6	457.36	-57.0	-64.0	5.0	-59.0	-13.0	-46.0

Remarks:

- ERP (dBm) = S.G Value (dBm) + Correction Factor (dB).
- Correction Factor (dB) = Substitution Antenna Gain (dB) + Cable Loss (dB).

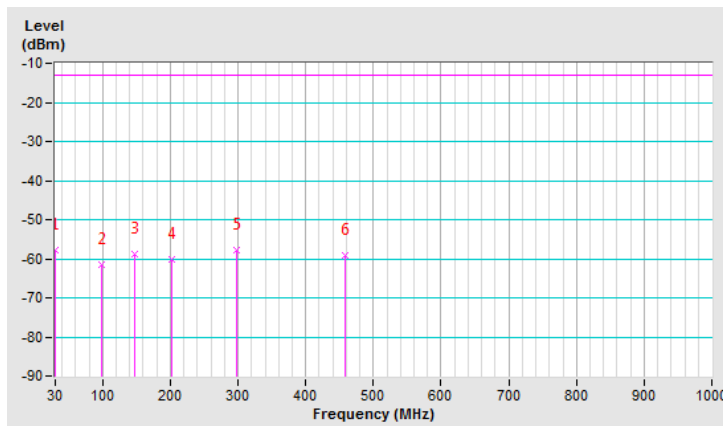

Mode	TX channel 20625 (846.5MHz)	Frequency Range	Below 1000 MHz
Environmental Conditions	23deg. C, 66%RH	Input Power	9Vdc
Tested By	Titan Hsu		

Antenna Polarity & Test Distance: Vertical at 3 M							
No.	Freq. (MHz)	Reading (dBm)	S.G Power Value (dBm)	Correction Factor (dB)	ERP (dBm)	Limit (dBm)	Margin (dB)
1	31.41	-51.2	-49.1	-12.0	-61.1	-13.0	-48.1
2	98.88	-48.4	-58.6	0.9	-57.7	-13.0	-44.7
3	143.87	-52.9	-57.5	-0.3	-57.8	-13.0	-44.8
4	231.03	-59.1	-69.9	5.4	-64.5	-13.0	-51.5
5	297.10	-49.0	-55.3	5.1	-50.2	-13.0	-37.2
6	351.93	-53.5	-61.3	5.2	-56.1	-13.0	-43.1

Remarks:

1. ERP (dBm) = S.G Value (dBm) + Correction Factor (dB).
2. Correction Factor (dB) = Substitution Antenna Gain (dB) + Cable Loss (dB).

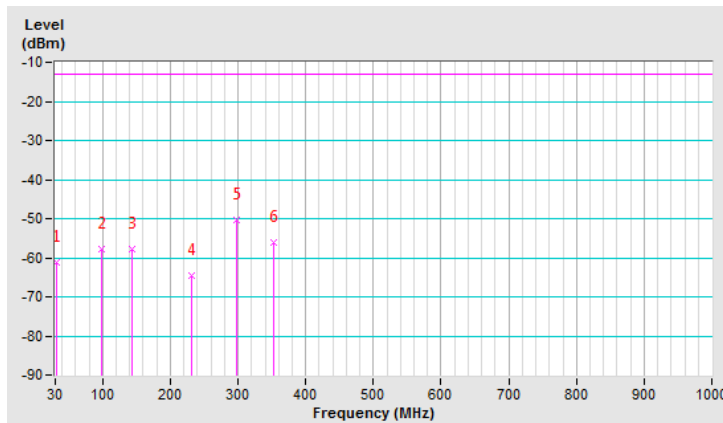

LTE Band 5, Channel Bandwidth: 10MHz

Mode	TX channel 20600 (844.0MHz)	Frequency Range	Below 1000 MHz
Environmental Conditions	23deg. C, 66%RH	Input Power	9Vdc
Tested By	Titan Hsu		

Antenna Polarity & Test Distance: Horizontal at 3 M							
No.	Freq. (MHz)	Reading (dBm)	S.G Power Value (dBm)	Correction Factor (dB)	ERP (dBm)	Limit (dBm)	Margin (dB)
1	77.80	-52.8	-58.5	-2.3	-60.8	-13.0	-47.8
2	114.35	-50.5	-61.3	0.3	-61.0	-13.0	-48.0
3	149.49	-51.8	-58.3	-0.2	-58.5	-13.0	-45.5
4	197.29	-49.6	-65.2	5.2	-60.0	-13.0	-47.0
5	298.51	-51.8	-61.3	5.1	-56.2	-13.0	-43.2
6	353.33	-52.2	-62.4	5.2	-57.2	-13.0	-44.2

Remarks:

- ERP (dBm) = S.G Value (dBm) + Correction Factor (dB).
- Correction Factor (dB) = Substitution Antenna Gain (dB) + Cable Loss (dB).

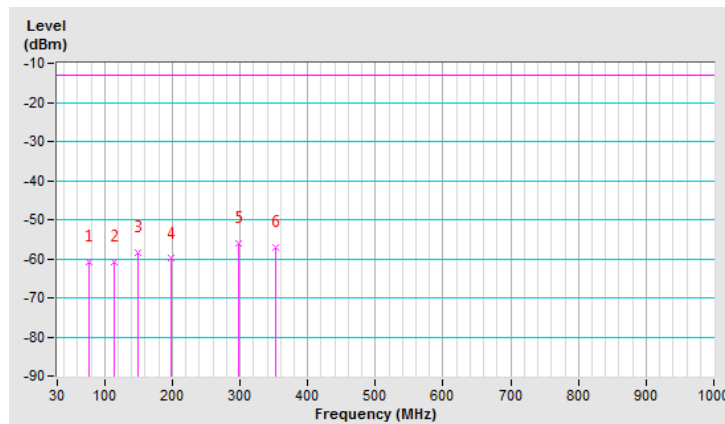

Mode	TX channel 20600 (844.0MHz)	Frequency Range	Below 1000 MHz
Environmental Conditions	23deg. C, 66%RH	Input Power	9Vdc
Tested By	Titan Hsu		

Antenna Polarity & Test Distance: Vertical at 3 M							
No.	Freq. (MHz)	Reading (dBm)	S.G Power Value (dBm)	Correction Factor (dB)	ERP (dBm)	Limit (dBm)	Margin (dB)
1	63.74	-46.8	-49.3	-6.6	-55.9	-13.0	-42.9
2	142.46	-52.0	-56.6	-0.3	-56.9	-13.0	-43.9
3	197.29	-56.6	-66.0	5.2	-60.8	-13.0	-47.8
4	297.10	-49.6	-56.0	5.1	-50.9	-13.0	-37.9
5	356.14	-53.1	-61.0	5.2	-55.8	-13.0	-42.8
6	513.59	-60.6	-66.7	4.8	-61.9	-13.0	-48.9

Remarks:

1. ERP (dBm) = S.G Value (dBm) + Correction Factor (dB).
2. Correction Factor (dB) = Substitution Antenna Gain (dB) + Cable Loss (dB).

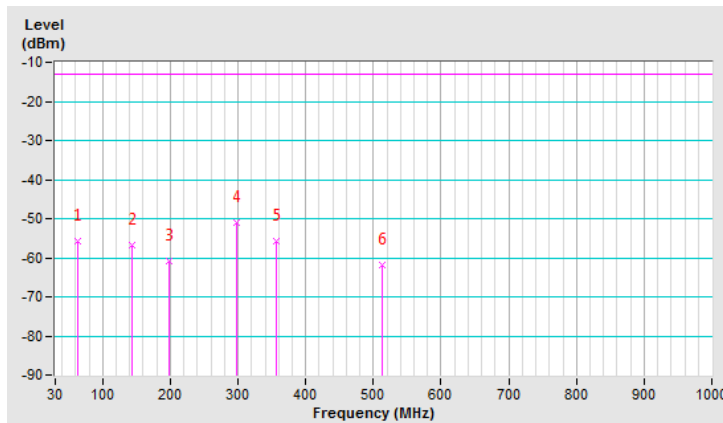

Above 1GHz
WCDMA Band 5

Mode	TX channel 4132 (826.4MHz)	Frequency Range	1GH~10GHz
Environmental Conditions	23deg. C, 66%RH	Input Power	9Vdc
Tested By	Titan Hsu		

Antenna Polarity & Test Distance: Horizontal at 3 M							
No.	Freq. (MHz)	Reading (dBm)	S.G Power Value (dBm)	Correction Factor (dB)	ERP (dBm)	Limit (dBm)	Margin (dB)
1	1652.80	-61.9	-65.4	5.5	-59.9	-13.0	-46.9
Antenna Polarity & Test Distance: Vertical at 3 M							
No.	Freq. (MHz)	Reading (dBm)	S.G Power Value (dBm)	Correction Factor (dB)	ERP (dBm)	Limit (dBm)	Margin (dB)
1	1652.80	-59.6	-61.9	5.5	-56.4	-13.0	-43.4

Remarks:

1. ERP (dBm) = S.G Value (dBm) + Correction Factor (dB).
2. Correction Factor (dB) = Substitution Antenna Gain (dB) + Cable Loss (dB).

Mode	TX channel 4182 (836.4MHz)	Frequency Range	1GH~10GHz
Environmental Conditions	23deg. C, 66%RH	Input Power	9Vdc
Tested By	Titan Hsu		

Antenna Polarity & Test Distance: Horizontal at 3 M							
No.	Freq. (MHz)	Reading (dBm)	S.G Power Value (dBm)	Correction Factor (dB)	ERP (dBm)	Limit (dBm)	Margin (dB)
1	1672.80	-61.9	-65.1	5.5	-59.6	-13.0	-46.6
Antenna Polarity & Test Distance: Vertical at 3 M							
No.	Freq. (MHz)	Reading (dBm)	S.G Power Value (dBm)	Correction Factor (dB)	ERP (dBm)	Limit (dBm)	Margin (dB)
1	1672.80	-59.9	-61.9	5.5	-56.4	-13.0	-43.4

Remarks:

1. ERP (dBm) = S.G Value (dBm) + Correction Factor (dB).
2. Correction Factor (dB) = Substitution Antenna Gain (dB) + Cable Loss (dB).

Mode	TX channel 4233 (846.6MHz)	Frequency Range	1GH~10GHz
Environmental Conditions	23deg. C, 66%RH	Input Power	9Vdc
Tested By	Titan Hsu		

Antenna Polarity & Test Distance: Horizontal at 3 M							
No.	Freq. (MHz)	Reading (dBm)	S.G Power Value (dBm)	Correction Factor (dB)	ERP (dBm)	Limit (dBm)	Margin (dB)
1	1693.20	-61.6	-64.7	5.6	-59.1	-13.0	-46.1
Antenna Polarity & Test Distance: Vertical at 3 M							
No.	Freq. (MHz)	Reading (dBm)	S.G Power Value (dBm)	Correction Factor (dB)	ERP (dBm)	Limit (dBm)	Margin (dB)
1	1693.20	-59.5	-61.5	5.6	-55.9	-13.0	-42.9

Remarks:

1. ERP (dBm) = S.G Value (dBm) + Correction Factor (dB).
2. Correction Factor (dB) = Substitution Antenna Gain (dB) + Cable Loss (dB).

LTE Band 5, Channel Bandwidth: 1.4MHz

Mode	TX channel 20407 (824.7MHz)	Frequency Range	1GH~10GHz
Environmental Conditions	23deg. C, 66%RH	Input Power	9Vdc
Tested By	Adair Peng		

Antenna Polarity & Test Distance: Horizontal at 3 M

No.	Freq. (MHz)	Reading (dBm)	S.G Power Value (dBm)	Correction Factor (dB)	ERP (dBm)	Limit (dBm)	Margin (dB)
1	1649.40	-60.8	-64.3	5.5	-58.8	-13.0	-45.8

Antenna Polarity & Test Distance: Vertical at 3 M

No.	Freq. (MHz)	Reading (dBm)	S.G Power Value (dBm)	Correction Factor (dB)	ERP (dBm)	Limit (dBm)	Margin (dB)
1	1649.40	-60.0	-63.5	5.5	-58.0	-13.0	-45.0

Remarks:

1. ERP (dBm) = S.G Value (dBm) + Correction Factor (dB).
2. Correction Factor (dB) = Substitution Antenna Gain (dB) + Cable Loss (dB).

Mode	TX channel 20525 (836.5MHz)	Frequency Range	1GH~10GHz
Environmental Conditions	23deg. C, 66%RH	Input Power	9Vdc
Tested By	Adair Peng		

Antenna Polarity & Test Distance: Horizontal at 3 M

No.	Freq. (MHz)	Reading (dBm)	S.G Power Value (dBm)	Correction Factor (dB)	ERP (dBm)	Limit (dBm)	Margin (dB)
1	1673.00	-61.6	-64.9	5.5	-59.4	-13.0	-46.4

Antenna Polarity & Test Distance: Vertical at 3 M

No.	Freq. (MHz)	Reading (dBm)	S.G Power Value (dBm)	Correction Factor (dB)	ERP (dBm)	Limit (dBm)	Margin (dB)
1	1673.00	-60.0	-63.3	5.5	-57.8	-13.0	-44.8

Remarks:

1. ERP (dBm) = S.G Value (dBm) + Correction Factor (dB).
2. Correction Factor (dB) = Substitution Antenna Gain (dB) + Cable Loss (dB).

Mode	TX channel 20643 (848.3MHz)	Frequency Range	1GH~10GHz
Environmental Conditions	23deg. C, 66%RH	Input Power	9Vdc
Tested By	Adair Peng		

Antenna Polarity & Test Distance: Horizontal at 3 M							
No.	Freq. (MHz)	Reading (dBm)	S.G Power Value (dBm)	Correction Factor (dB)	ERP (dBm)	Limit (dBm)	Margin (dB)
1	1696.60	-61.2	-64.3	5.6	-58.7	-13.0	-45.7
Antenna Polarity & Test Distance: Vertical at 3 M							
No.	Freq. (MHz)	Reading (dBm)	S.G Power Value (dBm)	Correction Factor (dB)	ERP (dBm)	Limit (dBm)	Margin (dB)
1	1696.60	-60.1	-63.2	5.6	-57.6	-13.0	-44.6

Remarks:

1. ERP (dBm) = S.G Value (dBm) + Correction Factor (dB).
2. Correction Factor (dB) = Substitution Antenna Gain (dB) + Cable Loss (dB).

LTE Band 5, Channel Bandwidth: 5MHz

Mode	TX channel 20425 (826.5MHz)	Frequency Range	1GH~10GHz
Environmental Conditions	23deg. C, 66%RH	Input Power	9Vdc
Tested By	Adair Peng		

Antenna Polarity & Test Distance: Horizontal at 3 M

No.	Freq. (MHz)	Reading (dBm)	S.G Power Value (dBm)	Correction Factor (dB)	ERP (dBm)	Limit (dBm)	Margin (dB)
1	1653.00	-61.4	-64.9	5.5	-59.4	-13.0	-46.4

Antenna Polarity & Test Distance: Vertical at 3 M

No.	Freq. (MHz)	Reading (dBm)	S.G Power Value (dBm)	Correction Factor (dB)	ERP (dBm)	Limit (dBm)	Margin (dB)
1	1653.00	-60.0	-63.5	5.5	-58.0	-13.0	-45.0

Remarks:

1. ERP (dBm) = S.G Value (dBm) + Correction Factor (dB).
2. Correction Factor (dB) = Substitution Antenna Gain (dB) + Cable Loss (dB).

Mode	TX channel 20525 (836.5MHz)	Frequency Range	1GH~10GHz
Environmental Conditions	23deg. C, 66%RH	Input Power	9Vdc
Tested By	Adair Peng		

Antenna Polarity & Test Distance: Horizontal at 3 M

No.	Freq. (MHz)	Reading (dBm)	S.G Power Value (dBm)	Correction Factor (dB)	ERP (dBm)	Limit (dBm)	Margin (dB)
1	1673.00	-61.5	-64.7	5.5	-59.2	-13.0	-46.2

Antenna Polarity & Test Distance: Vertical at 3 M

No.	Freq. (MHz)	Reading (dBm)	S.G Power Value (dBm)	Correction Factor (dB)	ERP (dBm)	Limit (dBm)	Margin (dB)
1	1673.00	-60.1	-63.4	5.5	-57.9	-13.0	-44.9

Remarks:

1. ERP (dBm) = S.G Value (dBm) + Correction Factor (dB).
2. Correction Factor (dB) = Substitution Antenna Gain (dB) + Cable Loss (dB).

Mode	TX channel 20625 (846.5MHz)	Frequency Range	1GH~10GHz
Environmental Conditions	23deg. C, 66%RH	Input Power	9Vdc
Tested By	Adair Peng		

Antenna Polarity & Test Distance: Horizontal at 3 M							
No.	Freq. (MHz)	Reading (dBm)	S.G Power Value (dBm)	Correction Factor (dB)	ERP (dBm)	Limit (dBm)	Margin (dB)
1	1693.00	-61.5	-64.6	5.6	-59.0	-13.0	-46.0
Antenna Polarity & Test Distance: Vertical at 3 M							
No.	Freq. (MHz)	Reading (dBm)	S.G Power Value (dBm)	Correction Factor (dB)	ERP (dBm)	Limit (dBm)	Margin (dB)
1	1693.00	-59.8	-62.9	5.6	-57.3	-13.0	-44.3

Remarks:

1. ERP (dBm) = S.G Value (dBm) + Correction Factor (dB).
2. Correction Factor (dB) = Substitution Antenna Gain (dB) + Cable Loss (dB).

LTE Band 5, Channel Bandwidth: 10MHz

Mode	TX channel 20450 (829.0MHz)	Frequency Range	1GH~10GHz
Environmental Conditions	23deg. C, 66%RH	Input Power	9Vdc
Tested By	Adair Peng		

Antenna Polarity & Test Distance: Horizontal at 3 M

No.	Freq. (MHz)	Reading (dBm)	S.G Power Value (dBm)	Correction Factor (dB)	ERP (dBm)	Limit (dBm)	Margin (dB)
1	1658.00	-61.0	-64.4	5.5	-58.9	-13.0	-45.9

Antenna Polarity & Test Distance: Vertical at 3 M

No.	Freq. (MHz)	Reading (dBm)	S.G Power Value (dBm)	Correction Factor (dB)	ERP (dBm)	Limit (dBm)	Margin (dB)
1	1658.00	-60.2	-63.6	5.5	-58.1	-13.0	-45.1

Remarks:

1. ERP (dBm) = S.G Value (dBm) + Correction Factor (dB).
2. Correction Factor (dB) = Substitution Antenna Gain (dB) + Cable Loss (dB).

Mode	TX channel 20525 (836.5MHz)	Frequency Range	1GH~10GHz
Environmental Conditions	23deg. C, 66%RH	Input Power	9Vdc
Tested By	Adair Peng		

Antenna Polarity & Test Distance: Horizontal at 3 M

No.	Freq. (MHz)	Reading (dBm)	S.G Power Value (dBm)	Correction Factor (dB)	ERP (dBm)	Limit (dBm)	Margin (dB)
1	1673.00	-61.1	-64.4	5.5	-58.9	-13.0	-45.9

Antenna Polarity & Test Distance: Vertical at 3 M

No.	Freq. (MHz)	Reading (dBm)	S.G Power Value (dBm)	Correction Factor (dB)	ERP (dBm)	Limit (dBm)	Margin (dB)
1	1673.00	-60.2	-63.5	5.5	-58.0	-13.0	-45.0

Remarks:

1. ERP (dBm) = S.G Value (dBm) + Correction Factor (dB).
2. Correction Factor (dB) = Substitution Antenna Gain (dB) + Cable Loss (dB).

Mode	TX channel 20600 (844.0MHz)	Frequency Range	1GH~10GHz
Environmental Conditions	23deg. C, 66%RH	Input Power	9Vdc
Tested By	Adair Peng		

Antenna Polarity & Test Distance: Horizontal at 3 M							
No.	Freq. (MHz)	Reading (dBm)	S.G Power Value (dBm)	Correction Factor (dB)	ERP (dBm)	Limit (dBm)	Margin (dB)
1	1688.00	-60.8	-63.8	5.5	-58.3	-13.0	-45.3
Antenna Polarity & Test Distance: Vertical at 3 M							
No.	Freq. (MHz)	Reading (dBm)	S.G Power Value (dBm)	Correction Factor (dB)	ERP (dBm)	Limit (dBm)	Margin (dB)
1	1688.00	-60.0	-63.0	5.5	-57.5	-13.0	-44.5

Remarks:

1. ERP (dBm) = S.G Value (dBm) + Correction Factor (dB).
2. Correction Factor (dB) = Substitution Antenna Gain (dB) + Cable Loss (dB).

5 Pictures of Test Arrangements

Please refer to the attached file (Test Setup Photo).

Appendix – Information of the Testing Laboratories

We, Bureau Veritas Consumer Products Services (H.K.) Ltd., Taoyuan Branch, were founded in 1988 to provide our best service in EMC, Radio, Telecom and Safety consultation. Our laboratories are FCC recognized accredited test firms and accredited and approved according to ISO/IEC 17025.

If you have any comments, please feel free to contact us at the following:

Lin Kou EMC/RF Lab

Tel: 886-2-26052180

Fax: 886-2-26051924

Hsin Chu EMC/RF/Telecom Lab

Tel: 886-3-6668565

Fax: 886-3-6668323

Hwa Ya EMC/RF/Safety Lab

Tel: 886-3-3183232

Fax: 886-3-3270892

Email: service.adt@tw.bureauveritas.com

Web Site: www.bureauveritas-adt.com

The address and road map of all our labs can be found in our web site also.

--- END ---