

MEASUREMENT REPORT (C2PC for FCC)

FCC ID : WIYSLM500QA
Applicant : CASTLES TECHNOLOGY CO., LTD.
Application Type : Certification
Product : Smart module
Model No. : SLM500
Brand Name : 
FCC Classification : Unlicensed National Information Infrastructure (UNII)
FCC Rule Part(s) : Part 15 Subpart E (Section 15.407)
Test Procedure(s) : ANSI C63.10-2013
Received Date : October 24, 2023
Test Date : October 26~ November 30, 2023

Tested By : *Owen Tsai*
(Owen Tsai)
Reviewed By : *Paddy Chen*
(Paddy Chen)
Approved By : *Chenz Ker*
(Chenz Ker)



The test results only relate to the tested samples.

This equipment has been shown to be capable of compliance with the applicable technical standards as indicated in the measurement report and was tested in accordance with the measurement procedures specified in ANSI C63.10. Test results reported herein relate only to the item(s) tested.

The test report shall not be reproduced except in full without the written approval of MRT Technology (Taiwan) Co., Ltd.

Revision History

| Report No. | Version | Description | Issue Date | Note |
|---------------|---------|-----------------|------------|------|
| 2310TW8705-U6 | 1.0 | Original Report | 2024-01-15 | |

Note:

1. This time, add Host ((Product Name: POS Terminal, Model No.: S1L2) and new antennas have been added, which have a higher gain compared to the original antennas., so the FCC C2PC (Conducted Output Power, Spurious Emission & Band Edge, Conduction) is executed.
2. FCC Original Report Grant Date: 02/15/2022, FCC ID: WIYSLM500QA.

CONTENTS

| Description | Page |
|---|-----------|
| §2.1033 General Information | 6 |
| 1. INTRODUCTION | 7 |
| 1.1. Scope | 7 |
| 1.2. MRT Test Location | 7 |
| 2. PRODUCT INFORMATION | 8 |
| 2.1. Equipment Description..... | 8 |
| 2.2. Operation Frequencies and Channel List..... | 9 |
| 2.3. Test Mode | 10 |
| 2.4. Test Software..... | 10 |
| 2.5. Device Capabilities | 11 |
| 2.6. Test Configuration | 13 |
| 2.7. Test System Details..... | 13 |
| 2.8. EMI Suppression Device(s)/Modifications..... | 13 |
| 2.9. Labeling Requirements..... | 14 |
| 3. DESCRIPTION OF TEST | 15 |
| 3.1. Evaluation Procedure | 15 |
| 3.2. AC Line Conducted Emissions | 15 |
| 3.3. Radiated Emissions..... | 16 |
| 4. ANTENNA REQUIREMENTS | 17 |
| 5. TEST EQUIPMENT CALIBRATION DATE | 18 |
| 6. MEASUREMENT UNCERTAINTY | 19 |
| 7. TEST RESULT | 20 |
| 7.1. Summary..... | 20 |
| 7.2. 26dB Bandwidth Measurement..... | 21 |
| 7.2.1. Test Limit | 21 |
| 7.2.2. Test Procedure used..... | 21 |
| 7.2.3. Test Setting..... | 21 |
| 7.2.4. Test Setup | 21 |
| 7.2.5. Test Result..... | 22 |
| 7.3. 6dB Bandwidth Measurement..... | 23 |
| 7.3.1. Test Limit | 23 |
| 7.3.2. Test Procedure used..... | 23 |

| | |
|---|------------|
| 7.3.3. Test Setting..... | 23 |
| 7.3.4. Test Setup | 23 |
| 7.3.5. Test Result..... | 24 |
| 7.4. Output Power Measurement..... | 25 |
| 7.4.1. Test Limit | 25 |
| 7.4.2. Test Procedure Used..... | 26 |
| 7.4.3. Test Setting..... | 26 |
| 7.4.4. Test Setup | 26 |
| 7.4.5. Test Result..... | 27 |
| 7.5. Transmit Power Control..... | 29 |
| 7.5.1. Test Limit | 29 |
| 7.5.2. Test Procedure Used..... | 29 |
| 7.5.3. Test Setting..... | 29 |
| 7.5.4. Test Setup | 29 |
| 7.5.5. Test Result..... | 30 |
| 7.6. Power Spectral Density Measurement..... | 31 |
| 7.6.1. Test Limit | 31 |
| 7.6.2. Test Procedure Used..... | 31 |
| 7.6.3. Test Setting..... | 32 |
| 7.6.4. Test Setup | 32 |
| 7.6.5. Test Result..... | 33 |
| 7.7. Radiated Spurious Emission Measurement..... | 34 |
| 7.7.1. Test Limit | 34 |
| 7.7.2. Test Procedure Used..... | 34 |
| 7.7.3. Test Setting..... | 34 |
| 7.7.4. Test Setup | 36 |
| 7.7.5. Test Result..... | 38 |
| 7.8. Radiated Restricted Band Edge Measurement..... | 112 |
| 7.8.1. Test Limit | 112 |
| 7.8.2. Test Result..... | 115 |
| 7.9. AC Conducted Emissions Measurement..... | 169 |
| 7.9.1. Test Limit | 169 |
| 7.9.2. Test Procedure | 169 |
| 7.9.3. Test Setup | 170 |
| 7.9.4. Test Result..... | 171 |
| 8. CONCLUSION | 175 |
| Appendix A : Test Photograph..... | 176 |

Appendix B : External Photograph.....176

Appendix C : Internal Photograph.....176

§2.1033 General Information

| | |
|---------------------------------|--|
| Applicant | CASTLES TECHNOLOGY CO., LTD. |
| Applicant Address | 6F, NO. 207-5, SEC. 3, BEIXIN RD., XINDIAN DISTRICT, NEW TAIPEI CITY 231632, TAIWAN (R. O. C.) |
| Manufacturer | CASTLES TECHNOLOGY CO., LTD. |
| Manufacturer Address | 6F, NO. 207-5, SEC. 3, BEIXIN RD., XINDIAN DISTRICT, NEW TAIPEI CITY 231632, TAIWAN (R. O. C.) |
| Test Site | MRT Technology (Taiwan) Co., Ltd |
| Test Site Address | No. 38, Fuxing Second Rd., Guishan Dist., Taoyuan City 333, Taiwan (R.O.C) |
| MRT FCC Registration No. | 291082 |
| FCC Rule Part(s) | Part 15 Subpart E (Section 15.407) |
| Test Device Serial No. | #1-1 <input type="checkbox"/> Production <input checked="" type="checkbox"/> Pre-Production <input type="checkbox"/> Engineering |
| FCC Classification | Unlicensed National Information Infrastructure (UNII) |

Test Facility / Accreditations

Measurements were performed at MRT Laboratory located in Fuxing Rd., Taoyuan, Taiwan (R.O.C)

- MRT facility is a FCC registered (Reg. No. 291082) test facility with the site description report on file and is designated by the FCC as an Accredited Test Firm.
- MRT facility is an IC registered (MRT Reg. No. 21723) test laboratory with the site description on file at Industry Canada.
- MRT Lab is accredited to ISO 17025 by the Taiwan Accreditation Foundation (TAF Cert. No. 3261) in EMC, Telecommunications and Radio testing for FCC (Designation Number: TW3261), Industry Canada, EU and TELECOM Rules.

1. INTRODUCTION

1.1. Scope

Measurement and determination of electromagnetic emissions (EMC) of radio frequency devices including intentional and/or unintentional radiators for compliance with the technical rules and regulations of the Federal Communications Commission and the Industry Canada Certification and Engineering Bureau.

1.2. MRT Test Location

The map below shows the location of the MRT LABORATORY, its proximity to the Taoyuan City. These measurement tests were conducted at the MRT Technology (Taiwan) Co., Ltd. Facility located at No.38, Fuxing 2nd Rd., Guishan Dist., Taoyuan City 33377, Taiwan (R.O.C).

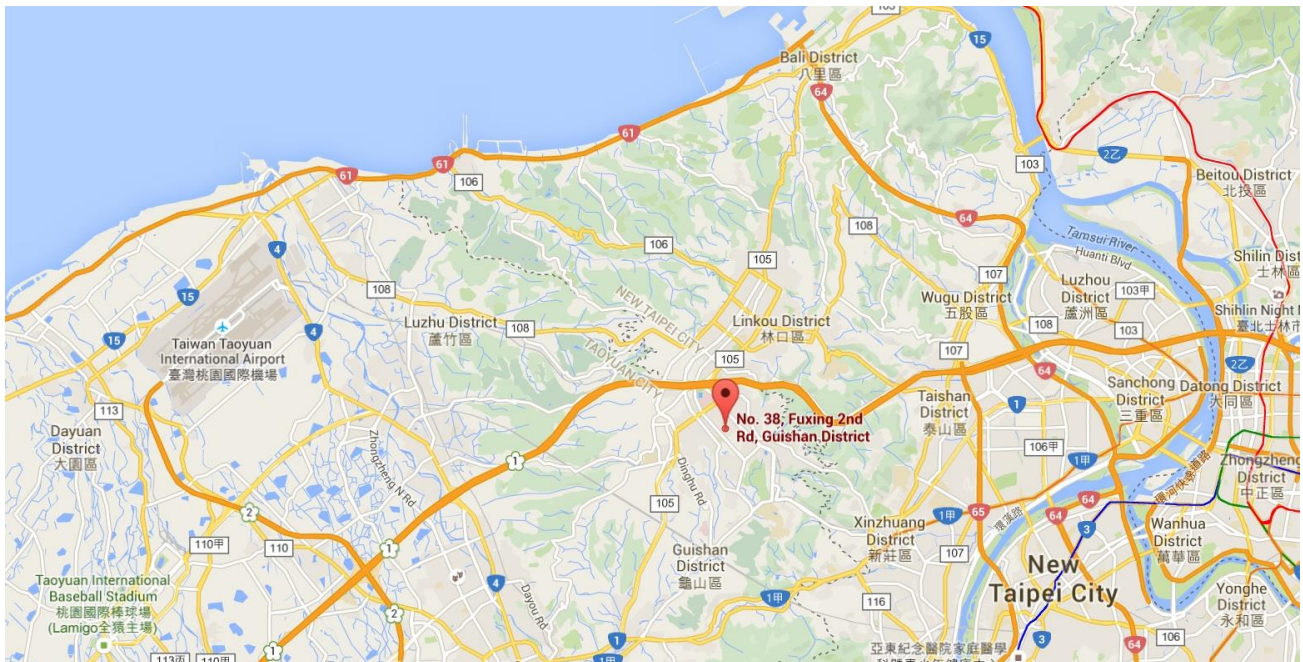

2. PRODUCT INFORMATION

2.1. Equipment Description

| | |
|-----------------------|--|
| Product Name | Smart module |
| Model No. | SLM500 |
| Brand Name |  |
| Supports Radios Spec. | <p>WLAN: 2.4G: 802.11b/g/n-20/n-40 5G: 802.11a/n-20/n-40, Band 1,2,3,4</p> <p>WPAN: Bluetooth Dual Mode: V4.2 NFC 13.56MHz</p> <p>WWAN: 2G: GPRS 850 / EGPRS 850 / GPRS 1900 / EGPRS 1900 3G: Band 2, 4, 5 4G: Band 2, 4, 5, 7, 12, 13, 17, 25, 26, 66</p> |
| Wi-Fi Specification | 802.11a/n/ac (1TX / 1RX) |
| Frequency Range: | For 802.11a/n-HT20: 5180~5240MHz, 5260~5320MHz, 5500~5720MHz, 5745~5825MHz For 802.11n-HT40: 5190~5230MHz, 5270~5310MHz, 5510~5710MHz, 5755~5795MHz |
| Modulation Type | 802.11a/n-20/n-40 OFDM (BPSK, QPSK, 16QAM, 64QAM) |
| Accessory | |
| Power Adapter | MFR: Shenzhen ABP Technology Co.,Ltd. Model No: AD0181-1201000UC Input: AC 100-240V~50-60Hz,0.5A Max Output: DC 12.0V, 1.0A 12.0w Cable Out: Non-shielding, 1.5m |

2.2. Operation Frequencies and Channel List

802.11 n-HT20

| Channel | Frequency | Channel | Frequency | Channel | Frequency |
|---------|-----------|---------|-----------|---------|-----------|
| 36 | 5180 MHz | 40 | 5200 MHz | 44 | 5220 MHz |
| 48 | 5240 MHz | 52 | 5260 MHz | 56 | 5280 MHz |
| 60 | 5300 MHz | 64 | 5320 MHz | 100 | 5500 MHz |
| 104 | 5520 MHz | 108 | 5540 MHz | 112 | 5560 MHz |
| 120 | 5600 MHz | 124 | 5620 MHz | 128 | 5640 MHz |
| 132 | 5660 MHz | 136 | 5680 MHz | 140 | 5700 MHz |
| 144 | 5720 MHz | 149 | 5745 MHz | 153 | 5765 MHz |
| 157 | 5785 MHz | 161 | 5805 MHz | 165 | 5825 MHz |

802.11 n-HT40

| Channel | Frequency | Channel | Frequency | Channel | Frequency |
|---------|-----------|---------|-----------|---------|-----------|
| 38 | 5190 MHz | 46 | 5230 MHz | 54 | 5270 MHz |
| 62 | 5310 MHz | 102 | 5510 MHz | 110 | 5550 MHz |
| 126 | 5630 MHz | 134 | 5670 MHz | 151 | 5755 MHz |
| 159 | 5795 MHz | -- | -- | -- | -- |

2.3. Test Mode

| | |
|-----------|----------------------------------|
| Test Mode | Mode 1: Transmit by 802.11a |
| | Mode 2: Transmit by 802.11n-HT20 |
| | Mode 3: Transmit by 802.11n-HT40 |

2.4. Test Software

The test utility software used during testing was “QRCT v3.0-00233”.

2.5. Device Capabilities

This device contains the following capabilities:

2.4GHz WLAN (DTS) and 5GHz WLAN (NII).

Note: 5GHz (NII) operation is possible in 20MHz, 40MHz and 80MHz channel bandwidths. The maximum achievable duty cycles for all modes were determined based on measurements performed on a spectrum analyzer in zero-span mode with RBW = 10MHz, VBW = 10MHz, and detector = average per the guidance of Section B)2)b) of KDB 789033 D02v02r01. The RBW and VBW were both greater than $50/T$, where T is the minimum transmission duration, and the number of sweep points across T was greater than 100. The duty cycles are as follows:

| Test Mode | Duty Cycle |
|--------------|------------|
| 802.11a | 87.34% |
| 802.11n-HT20 | 87.17% |
| 802.11n-HT40 | 70.94% |



2.6. Test Configuration

This device was tested per the guidance of KDB 789033 D02v02r01. ANSI C63.10-2013 was used to reference the appropriate EUT setup for radiated spurious emissions testing and AC line conducted testing.

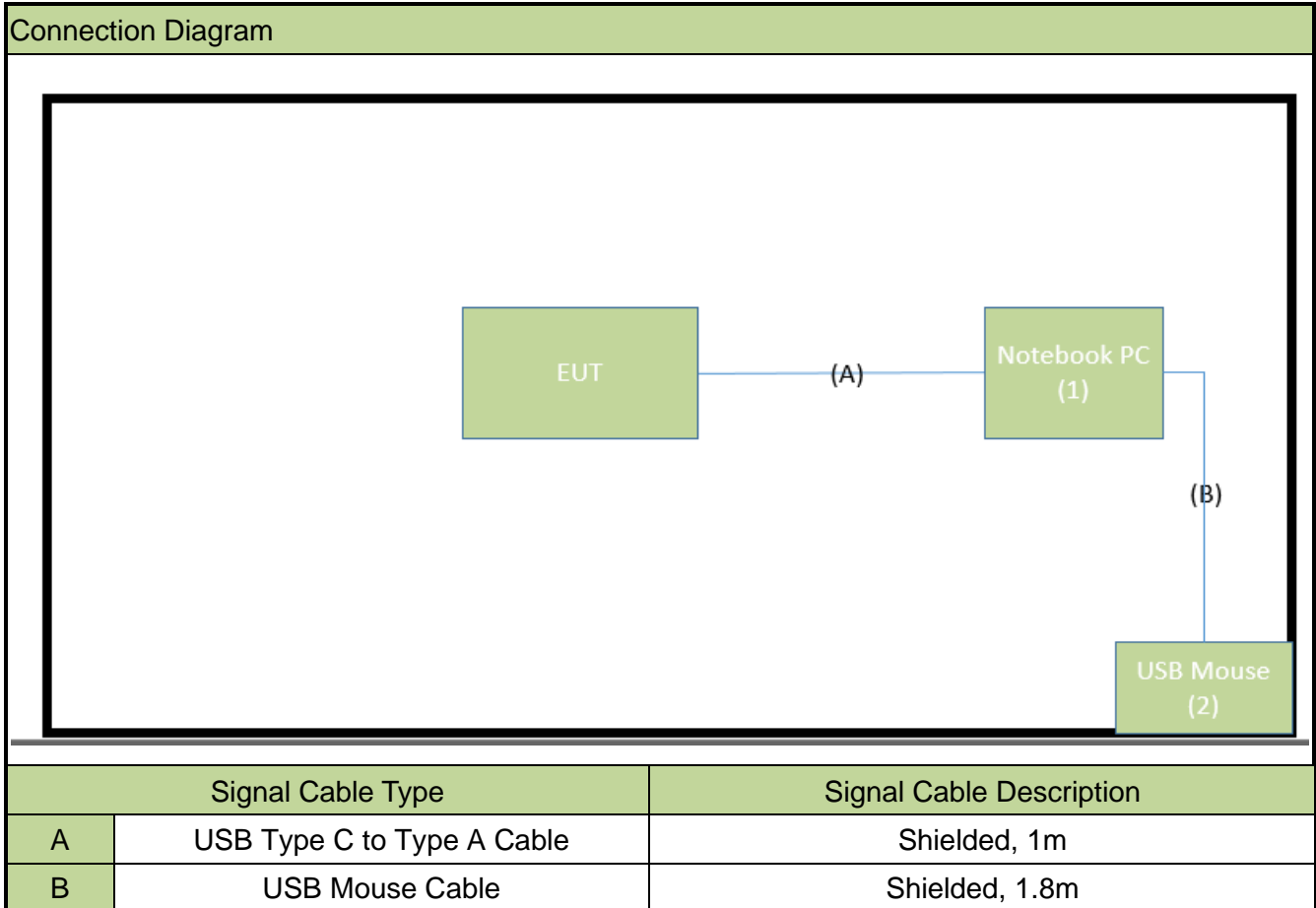

2.7. Test System Details

The types for all equipment, and descriptions of all cables used in the tested system (including inserted cards) are:

| | Product | Manufacturer | Model No. | Serial No. | Power Cord |
|---|-------------|--------------|------------|------------|--------------------|
| 1 | Notebook PC | Lenovo | 21DH00A3TW | N/A | Non-shielded, 0.8m |
| 2 | USB Mouse | Logitech | M90 | N/A | N/A |

2.8. EMI Suppression Device(s)/Modifications

No EMI suppression device(s) were added and/or no modifications were made during testing.

2.9. Labeling Requirements

Per 2.1074 & 15.19; Docket 95-19

The label shall be permanently affixed at a conspicuous location on the device; instruction manual or pamphlet supplied to the user and be readily visible to the purchaser at the time of purchase.

However, when the device is so small wherein placement of the label with specified statement is not practical, only the FCC ID must be displayed on the device per Section 15.19(a)(5). Please see attachment for FCC ID label and label location.

3. DESCRIPTION OF TEST

3.1. Evaluation Procedure

The measurement procedures described in the American National Standard for Testing Unlicensed Wireless Devices (ANSI C63.10-2013), and the guidance provided in KDB 789033 were used in the measurement of the device.

Deviation from measurement procedure.....None

3.2. AC Line Conducted Emissions

The line-conducted facility is located inside an 9'x4'x3' shielded enclosure. A 1m x 2m wooden table 80cm high is placed 40cm away from the vertical wall and 80cm away from the sidewall of the shielded room. Two 10kHz-30MHz, 50Ω/50uH Line-Impedance Stabilization Networks (LISNs) are bonded to the shielded room floor. Power to the LISNs is filtered by external high-current high-insertion loss power line filters. These filters attenuate ambient signal noise from entering the measurement lines. These filters are also bonded to the shielded enclosure.

The EUT is powered from one LISN and the support equipment is powered from the second LISN. All interconnecting cables more than 1 meter were shortened to a 1 meter length by non-inductive bundling (serpentine fashion) and draped over the back edge of the test table. All cables were at least 40cm above the horizontal reference ground-plane. Power cables for support equipment were routed down to the second LISN while ensuring that that cables were not draped over the second LISN.

Sufficient time for the EUT, support equipment, and test equipment was allowed in order for them to warm up to their normal operating condition. The RF output of the LISN was connected to the receiver and exploratory measurements were made to determine the frequencies producing the maximum emission from the EUT. The receiver was scanned from 150kHz to 30MHz. The detector function was set to peak mode for exploratory measurements while the bandwidth of the analyzer was set to 9kHz. The EUT, support equipment, and interconnecting cables were arranged and manipulated to maximize each emission. Each emission was also maximized by varying: power lines, the mode of operation or data exchange speed, or support equipment whichever determined the worst-case emission. Once the worst case emissions have been identified, the one EUT cable configuration/arrangement and mode of operation that produced these emissions are used for final measurements on the same test site. The analyzer is set to CISPR quasi-peak and average detectors with a 9kHz resolution bandwidth for final measurements.

An extension cord was used to connect to a single LISN which powered by EUT. The extension cord was calibrated with LISN, the impedance and insertion loss are compliance with the requirements as stated in ANSI C63.10-2013.

Line conducted emissions test results are shown in Section 7.10.

3.3. Radiated Emissions

The radiated test facilities consisted of an indoor 3 meter semi-anechoic chamber used for final measurements and exploratory measurements, when necessary. The measurement area is contained within the semi-anechoic chamber which is shielded from any ambient interference. For measurements above 1GHz absorbers are arranged on the floor between the turn table and the antenna mast in such a way so as to maximize the reduction of reflections. For measurements below 1GHz, the absorbers are removed. A turntable is used for radiated measurement. It is a continuously rotatable, remote controlled, metallic turntable and 2 meters (6.56 ft.) in diameter. The turn table is flush with the raised floor of the chamber in order to maintain its function as a ground plane. An 80cm high PVC support structure is placed on top of the turntable.

For all measurements, the spectrum was scanned through all EUT azimuths and from 1 to 4 meter receive antenna height using a broadband antenna from 30MHz up to the upper frequency shown in 15.33(b)(1) depending on the highest frequency generated or used in the device or on which the device operates or tunes. For frequencies above 1GHz, linearly polarized double ridge horn antennas were used. For frequencies below 30MHz, a calibrated loop antenna was used. When exploratory measurements were necessary, they were performed at 1 meter test distance inside the semi-anechoic chamber using broadband antennas, broadband amplifiers, and spectrum analyzers to determine the frequencies and modes producing the maximum emissions. Sufficient time for the EUT, support equipment, and test equipment was allowed in order for them to warm up to their normal operating condition. The test set-up for frequencies below 1GHz was placed on top of the 0.8 meter high, 1 x 1.5 meter table; and test set-up for frequencies 1-40GHz was placed on top of the 1.5 meter high, 1 x 1.5 meter table. The EUT, support equipment, and interconnecting cables were arranged and manipulated to maximize each emission. Appropriate precaution was taken to ensure that all emissions from the EUT were maximized and investigated. The system configuration, clock speed, mode of operation or video resolution, if applicable, turntable azimuth, and receive antenna height was noted for each frequency found.

Final measurements were made in the semi-anechoic chamber using calibrated, linearly polarized broadband and horn antennas. The test setup was configured to the setup that produced the worst case emissions. The spectrum analyzer was set to investigate all frequencies required for testing to compare the highest radiated disturbances with respect to the specified limits. The turntable containing the EUT was rotated through 360 degrees and the height of the receive antenna was varied 1 to 4 meters and stopped at the azimuth and height producing the maximum emission. Each emission was maximized by changing the orientation of the EUT through three orthogonal planes and changing the polarity of the receive antenna, whichever produced the worst-case emissions. According to 3dB Beam-Width of horn antenna, the horn antenna should be always directed to the EUT when rising height.

4. ANTENNA REQUIREMENTS

Excerpt from §15.203 of the FCC Rules/Regulations:

“An intentional radiator antenna shall be designed to ensure that no antenna other than that furnished by the responsible party can be used with the device. The use of a permanently attached antenna or of an antenna that uses a unique coupling to the intentional radiator shall be considered sufficient to comply with the provisions of this section.”

- The antenna of the Smart module, is permanently attached.
- There are no provisions for connection to an external antenna.

Conclusion:

The EUT unit complies with the requirement of §15.203. Antenna List

| No. | Manufacturer | Part No. | Antenna Type | Antenna Gain (dBi) | | |
|-----|---------------------------------------|--------------------------|--------------|--------------------|------------|----------|
| | | | | BT/BLE | Wi-Fi 2.4G | Wi-Fi 5G |
| 1 | ARISTOTLE (This time new addition) | RFA-25-AP217- 70W-130 | Dipole | 3.34 | 3.34 | 3.64 |

5. TEST EQUIPMENT CALIBRATION DATE

Conducted Emissions – SR2

| Instrument | Manufacturer | Type No. | Asset No. | Cali. Interval | Cali. Due Date |
|--------------------|--------------|-----------------------------|-------------|----------------|----------------|
| Two-Line V-Network | R&S | ENV216 | MRTTWA00019 | 1 year | 2024/3/7 |
| Cable | Rosnol | N1C50-RG400-B 1C50-500CM | MRTTWE00013 | 1 year | 2024/6/15 |
| EMI Test Receiver | R&S | ESR3 | MRTTWA00009 | 1 year | 2024/3/8 |

Radiated Emissions – AC2

| Instrument | Manufacturer | Type No. | Asset No. | Cali. Interval | Cali. Due Date |
|--------------------------|--------------------------------|-----------------------|-------------|----------------|----------------|
| Active Loop Antenna | SCHWARZBECK | FMZB 1519B | MRTTWA00002 | 1 year | 2024/5/22 |
| Broadband TRILOG Antenna | SCHWARZBECK | VULB 9162 | MRTTWA00001 | 1 year | 2024/10/31 |
| Broadband Hornantenna | RFSPIN | DRH18-E | MRTTWA00087 | 1 year | 2024/5/17 |
| Broadband Preampfier | EMC Instruments corporation | EMC118A45SE | MRTTWA00088 | 1 year | 2024/5/17 |
| Breitband Hornantenna | SCHWARZBECK | BBHA 9170 | MRTTWA00004 | 1 year | 2024/3/20 |
| Broadband Amplifier | SCHWARZBECK | BBV 9721 | MRTTWA00006 | 1 year | 2024/3/27 |
| EMI Test Receiver | R&S | ESR3 | MRTTWA00009 | 1 year | 2024/3/8 |
| Signal Analyzer | R&S | FSVA3044 | MRTTWA00092 | 1 year | 2024/6/29 |
| Antenna Cable | HUBERSUHNER | SF106 | MRTTWE00034 | 1 year | 2024/6/26 |
| Cable | HUBERSUHNER | EMC105-NM-NM -3000 | MRTTWE00035 | 1 year | 2024/6/26 |

Conducted Test Equipment – SR6

| Instrument | Manufacturer | Type No. | Asset No. | Cali. Interval | Cali. Due Date |
|---------------------------|--------------|----------|-------------|----------------|----------------|
| EXA Signal Analyzer | KEYSIGHT | N9010A | MRTTWA00012 | 1 year | 2024/10/17 |
| EXA Signal Analyzer | KEYSIGHT | N9010B | MRTTWA00074 | 1 year | 2024/7/19 |
| USB Wideband Power Sensor | KEYSIGHT | U2021XA | MRTTWA00015 | 1 year | 2024/3/16 |

Test Software

| Software | Version | Function |
|----------|-----------|-------------------|
| e3 | 9.160520a | EMI Test Software |
| EMI | V3 | EMI Test Software |

6. MEASUREMENT UNCERTAINTY

Where relevant, the following test uncertainty levels have been estimated for tests performed on the EUT as specified in CISPR 16-4-2. This uncertainty represents an expanded uncertainty expressed at approximately the 95% confidence level using a coverage factor of $k = 2$.

| |
|---|
| Conducted Emission- Power Line |
| Measuring Uncertainty for a Level of Confidence of 95% ($U=2Uc(y)$): 0.15MHz~30MHz: $\pm 2.53\text{dB}$ |
| Radiated Spurious Emission |
| Measuring Uncertainty for a Level of Confidence of 95% ($U=2Uc(y)$): 9kHz~30MHz: $\pm 3.92\text{dB}$ 30MHz~1GHz: $\pm 4.25\text{dB}$ 1GHz~18GHz: $\pm 4.40\text{dB}$ 18GHz~40GHz: $\pm 4.45\text{dB}$ |
| Frequency Error |
| Measuring Uncertainty for a Level of Confidence of 95% ($U=2Uc(y)$): $\pm 78.4\text{Hz}$ |
| Conducted Power |
| Measuring Uncertainty for a Level of Confidence of 95% ($U=2Uc(y)$): $\pm 0.84\text{dB}$ |
| Conducted Spurious Emission |
| Measuring Uncertainty for a Level of Confidence of 95% ($U=2Uc(y)$): $\pm 2.65\text{ dB}$ |
| Occupied Bandwidth |
| Measuring Uncertainty for a Level of Confidence of 95% ($U=2Uc(y)$): $\pm 3.3\%$ |
| Temp. / Humidity |
| Measuring Uncertainty for a Level of Confidence of 95% ($U=2Uc(y)$): $\pm 0.82^\circ\text{C} / \pm 3\%$ |
| DC Voltage |
| Measuring Uncertainty for a Level of Confidence of 95% ($U=2Uc(y)$): $\pm 0.3\%$ |

7. TEST RESULT

7.1. Summary

Product Name: POS Terminal

FCC Classification: Unlicensed National Information Infrastructure (UNII)

| FCC Section(s) | Test Description | Test Limit | Test Condition | Test Result | Reference |
|---|---|---|-------------------|-------------|----------------------|
| 15.407(a) | 26dB Bandwidth | N/A | Conducted | N/A | Section 7.2 |
| 15.407(e) | 6dB Bandwidth | $\geq 500\text{kHz}$ | | N/A | Section 7.3 |
| 15.407(a)(1)(i), (2), (3) | Maximum Conducted Output Power | Refer to Section 7.5 | | Pass | Section 7.5 |
| 15.407(h)(1) | Transmit Power Control | $\leq 24\text{ dBm}$ | | N/A | Section 7.6 |
| 15.407(a)(1)(i), (2), (3), (5) | Power Spectral Density | Refer to Section 7.7 | | N/A | Section 7.7 |
| 15.407(b)(1), (4) | Undesirable Emissions | $\leq -27\text{dBm/MHz EIRP}$ $\leq -17\text{dBm/MHz EIRP}$ | Radiated | Pass | Section 7.8 & 7.9 |
| 15.205, 15.209 15.407(b)(5), (6), (7) | General Field Strength Limits (Restricted Bands and Radiated Emission Limits) | Emissions in restricted bands must meet the radiated limits detailed in 15.209 | | Pass | |
| 15.207 | AC Conducted Emissions 150kHz - 30MHz | < FCC 15.207 limits | Line Conducted | Pass | Section 7.10 |

Notes:

- 1) Determining compliance is based on the test results met the regulation limits or requirements declared by clients, and the test results don't take into account the value of measurement uncertainty.
- 2) All channels, modes, and modulations/data rates were investigated among all UNII bands. The test results shown in the following sections represent the worst case emissions.
- 3) The analyzer plots shown in this section were all taken with a correction table loaded into the analyzer. The correction table was used to account for the losses of the cables and attenuators used as part of the system to connect the EUT to the analyzer at all frequencies of interest.

7.2. 26dB Bandwidth Measurement

7.2.1. Test Limit

N/A

7.2.2. Test Procedure used

KDB 789033 D02v02r01 - Section C.1

7.2.3. Test Setting

1. The analyzers' automatic bandwidth measurement capability was used to perform the 26dB bandwidth measurement. The "X" dB bandwidth parameter was set to $X = 26$. The automatic bandwidth measurement function also has the capability of simultaneously measuring the 99% occupied bandwidth. The bandwidth measurement was not influenced by any intermediated power nulls in the fundamental emission.
2. RBW = approximately 1% of the emission bandwidth.
3. VBW $\geq 3 \times$ RBW.
4. Detector = Peak.
5. Trace mode = max hold.

7.2.4. Test Setup

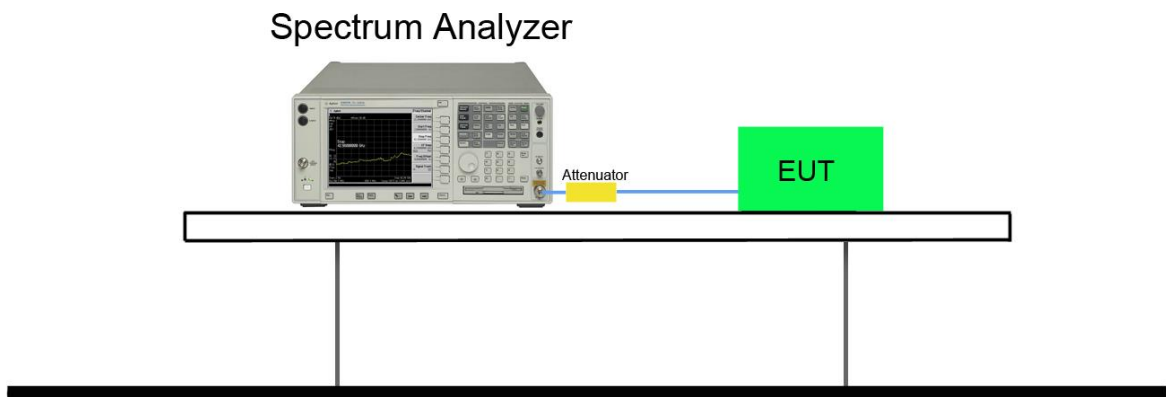

7.2.5. Test Result

Note: Reference Original Report Grant Date: 02/15/2022, FCC ID: WIYSLM500QA.

7.3. 6dB Bandwidth Measurement

7.3.1. Test Limit

The minimum 6dB bandwidth shall be at least 500 kHz.

7.3.2. Test Procedure used

KDB 789033 D02v02r01 - Section C.2

7.3.3. Test Setting

1. Set center frequency to the nominal EUT channel center frequency.
2. RBW = 100 kHz.
3. VBW $\geq 3 \times$ RBW.
4. Detector = Peak.
5. Trace mode = max hold.
6. Sweep = auto couple.
7. Allow the trace to stabilize.
8. Measure the maximum width of the emission that is constrained by the frequencies associated with the two outermost amplitude points (upper and lower frequencies) that are attenuated by 6 dB relative to the maximum level measured in the fundamental emission.

7.3.4. Test Setup

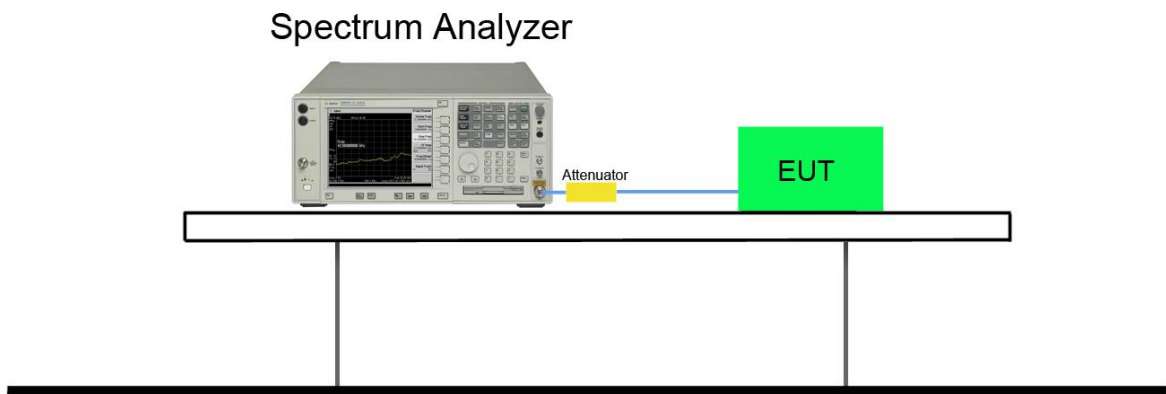

7.3.5. Test Result

Note: Reference Original Report Grant Date: 02/15/2022, FCC ID: WIYSLM500QA.

7.4. Output Power Measurement

7.4.1. Test Limit

For FCC Power Measurement Limit

For client operating in the band 5.15-5.25 GHz, the maximum conducted output power over the frequency band of operation shall not exceed 250mW.

For the 5.25-5.35 GHz and 5.47-5.725 GHz bands, the maximum conducted output power over the frequency bands of operation shall not exceed the lesser of 250 mW (23.98dBm) or $11\text{dBm} + 10 \log(26\text{dB BW})$.

For the band 5.725-5.85 GHz, the maximum conducted output power over the frequency band of operation shall not exceed 1 W (30dBm).

If transmitting antennas of directional gain greater than 6dBi are used, the maximum conducted output power shall be reduced by the amount in dB that the directional gain of the antenna exceeds 6dBi.

For IC Power Measurement Limit

For the band 5.15-5.25 GHz, the maximum e.i.r.p. shall not exceed 200 mW (23.01dBm) or $10 + 10 \cdot \log_{10} B$, dBm, whichever power is less. B is the 99% emission bandwidth in MHz.

For the 5.25-5.35 GHz and 5.47-5.725 GHz bands, the maximum conducted output power shall not exceed 250 mW (23.98dBm) or $11 + 10 \log_{10} B$, dBm, whichever power is less. The maximum e.i.r.p. shall not exceed 1.0 W (30dBm) or $17 + 10 \log_{10} B$, dBm, whichever power is less. B is the 99% emission bandwidth in MHz.

For the 5.725-5.85 GHz band, the maximum conducted output power shall not exceed 1 W.

If transmitting antennas of directional gain greater than 6dBi are used, the maximum conducted output power shall be reduced by the amount in dB that the directional gain of the antenna exceeds 6dBi.

7.4.2. Test Procedure Used

KDB 789033 D02v02r01 - Section E) 3) b) Method PM-G

7.4.3. Test Setting

Average power measurements were performed only when the EUT was transmitting at its maximum power control level using a broadband power meter with a pulse sensor. The power meter implemented triggering and gating capabilities which were set up such that power measurements were recorded only during the ON time of the transmitter. The trace was averaged over 100 traces to obtain the final measured average power.

7.4.4. Test Setup

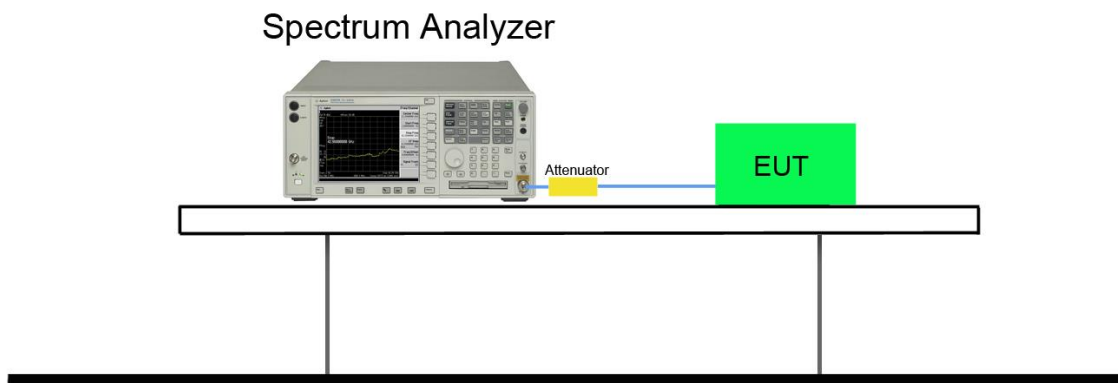

7.4.5. Test Result

| Model | Rate | Ch. | Freq. (MHz) | Average Power (dBm) | Power Limit (dBm) |
|---------------|------|-----|-------------|---------------------|-------------------|
| 802.11a Band1 | 6M | 36 | 5180 | 13.35 | ≤ 23.98 |
| | 6M | 40 | 5200 | 13.77 | ≤ 23.98 |
| | 6M | 48 | 5240 | 13.72 | ≤ 23.98 |
| 802.11a Band2 | 6M | 52 | 5260 | 14.48 | ≤ 23.98 |
| | 6M | 60 | 5300 | 13.37 | ≤ 23.98 |
| | 6M | 64 | 5320 | 13.80 | ≤ 23.98 |
| 802.11a Band3 | 6M | 100 | 5500 | 14.42 | ≤ 23.98 |
| | 6M | 116 | 5580 | 14.52 | ≤ 23.98 |
| | 6M | 120 | 5600 | 14.81 | ≤ 23.98 |
| | 6M | 140 | 5700 | 10.71 | ≤ 23.98 |
| 802.11a Band4 | 6M | 149 | 5745 | 13.30 | ≤ 30.00 |
| | 6M | 157 | 5785 | 13.03 | ≤ 30.00 |
| | 6M | 165 | 5825 | 12.64 | ≤ 30.00 |
| n-HT20 Band1 | MCS0 | 36 | 5180 | 13.34 | ≤ 23.98 |
| | MCS0 | 40 | 5200 | 13.41 | ≤ 23.98 |
| | MCS0 | 48 | 5240 | 13.51 | ≤ 23.98 |
| n-HT20 Band2 | MCS0 | 52 | 5260 | 14.19 | ≤ 23.98 |
| | MCS0 | 60 | 5300 | 13.03 | ≤ 23.98 |
| | MCS0 | 64 | 5320 | 13.43 | ≤ 23.98 |
| n-HT20 Band3 | MCS0 | 100 | 5500 | 14.42 | ≤ 23.98 |
| | MCS0 | 116 | 5580 | 14.46 | ≤ 23.98 |
| | MCS0 | 120 | 5600 | 14.87 | ≤ 23.98 |
| | MCS0 | 140 | 5700 | 10.72 | ≤ 23.98 |
| n-HT20 Band4 | MCS0 | 149 | 5745 | 13.78 | ≤ 30.00 |
| | MCS0 | 157 | 5785 | 12.99 | ≤ 30.00 |
| | MCS0 | 165 | 5825 | 12.50 | ≤ 30.00 |

| Model | Rate | Ch. | Freq. (MHz) | Average Power (dBm) | Power Limit (dBm) |
|--------------|------|-----|-------------|---------------------|-------------------|
| n-HT40 Band1 | MCS0 | 38 | 5190 | 10.57 | ≤ 23.98 |
| | MCS0 | 46 | 5230 | 13.15 | ≤ 23.98 |
| n-HT40 Band2 | MCS0 | 54 | 5270 | 13.33 | ≤ 23.98 |
| | MCS0 | 62 | 5310 | 9.95 | ≤ 23.98 |
| n-HT40 Band3 | MCS0 | 102 | 5510 | 10.88 | ≤ 23.98 |
| | MCS0 | 110 | 5550 | 14.81 | ≤ 23.98 |
| | MCS0 | 118 | 5590 | 14.64 | ≤ 23.98 |
| | MCS0 | 134 | 5670 | 12.68 | ≤ 23.98 |
| n-HT40 Band4 | MCS0 | 151 | 5755 | 13.57 | ≤ 30.00 |
| | MCS0 | 159 | 5795 | 13.01 | ≤ 30.00 |

Note 1:

Average Power (dBm)= Average Power (dBm) + Cable Loss (dB).

Note 2:

For 5250- 5350MHz and 5470 - 5725MHz Band: Average Power Limit (dBm) = 23.98 dBm.

For 5150 - 5250MHz and 5725 - 5850MHz Bands: Average Power Limit (dBm) = 23.98 dBm.

7.5. Transmit Power Control

7.5.1. Test Limit

The U-NII device is required to have the capability to operate at least 6 dB below the mean EIRP value of 30 dBm.

7.5.2. Test Procedure Used

KDB 789033 D02v02r01 - Section E) 3) b) Method PM-G

7.5.3. Test Setting

Average power measurements were performed only when the EUT was transmitting at its maximum power control level using a broadband power meter with a pulse sensor. The power meter implemented triggering and gating capabilities which were set up such that power measurements were recorded only during the ON time of the transmitter. The trace was averaged over 100 traces to obtain the final measured average power.

7.5.4. Test Setup

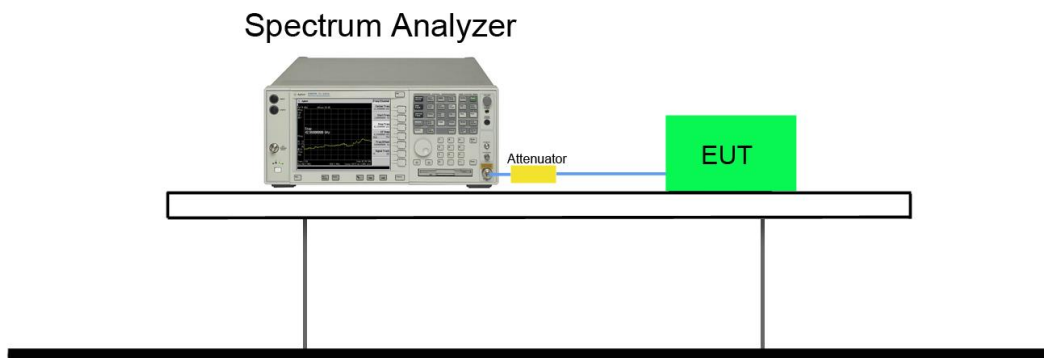

7.5.5. Test Result

Note: Reference Original Report Grant Date: 02/15/2022, FCC ID: WIYSLM500QA.

7.6. Power Spectral Density Measurement

7.6.1. Test Limit

For FCC Power Spectral Density Limit

For an outdoor access point operating in the band 5.15-5.25 GHz, the maximum power spectral density shall not exceed 17 dBm in any 1 megahertz band.

For the 5.25-5.35 GHz and 5.47-5.725 GHz bands, the maximum power spectral density shall not exceed 11 dBm in any 1 megahertz band.

For the band 5.725-5.85 GHz, the maximum power spectral density shall not exceed 30 dBm in any 500-kHz band.

If transmitting antennas of directional gain greater than 6dBi are used, the peak power spectral density shall be reduced by the amount in dB that the directional gain of the antenna exceeds 6dBi.

For IC Power Spectral Density Limit

For the band 5.15-5.25 GHz, the e.i.r.p. spectral density shall not exceed 10 dBm in any 1.0 MHz band.

For the 5.25-5.35 GHz and 5.47-5.725 GHz bands, the power spectral density shall not exceed 11 dBm in any 1.0 MHz band.

For the 5.725-5.85 GHz band, the power spectral density shall not exceed 30 dBm in any 500 kHz band.

7.6.2. Test Procedure Used

KDB 789033 D02v02r01 - Section F

7.6.3. Test Setting

1. Analyzer was set to the center frequency of the UNII channel under investigation
2. Span was set to encompass the entire 26dB EBW of the signal.
3. RBW = 1MHz, if measurement bandwidth of Maximum PSD is specified in 500 kHz,
4. RBW = 100 kHz
5. VBW = 3MHz
6. Number of sweep points $\geq 2 \times (\text{span} / \text{RBW})$
7. Detector = power averaging (Average)
8. Sweep time = auto
9. Trigger = free run
10. Use the peak search function on the instrument to find the peak of the spectrum and record its value.
11. Add $10 \cdot \log(1/x)$, where x is the duty cycle, to the measured power in order to compute the average power during the actual transmission times (because the measurement represents an average over both the on and off times of the transmission). For example, add $10 \cdot \log(1/0.25) = 6 \text{ dB}$ if the duty cycle is 25 percent.
12. When the measurement bandwidth of Maximum PSD is specified in 500 kHz, add a constant factor $10 \cdot \log(500\text{kHz}/100\text{kHz}) = 7 \text{ dB}$ to the measured result

7.6.4. Test Setup

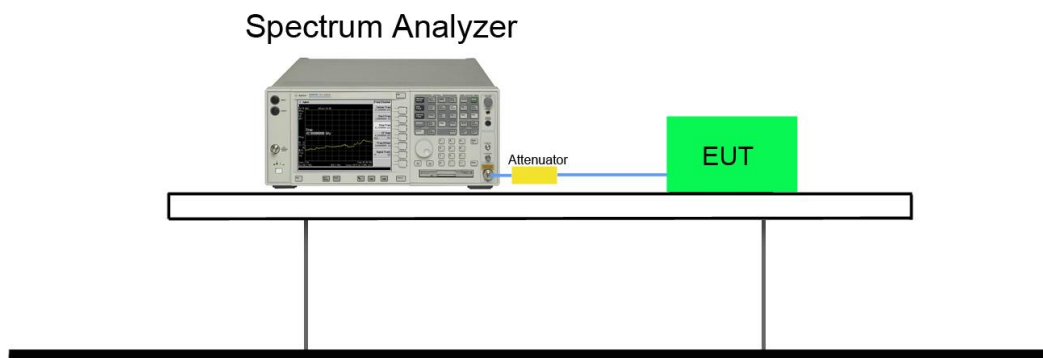

7.6.5. Test Result

Note: Reference Original Report Grant Date: 02/15/2022, FCC ID: WIYSLM500QA.

7.7. Radiated Spurious Emission Measurement

7.7.1. Test Limit

All out of band emissions appearing in a restricted band as specified in Section 15.205 of the Title 47 CFR must not exceed the limits shown in Table per Section 15.209.

| FCC Part 15 Subpart C Paragraph 15.209 | | |
|--|----------------------|----------------------------|
| Frequency [MHz] | Field Strength [V/m] | Measured Distance [Meters] |
| 0.009 – 0.490 | 2400/F (kHz) | 300 |
| 0.490 – 1.705 | 24000/F (kHz) | 30 |
| 1.705 - 30 | 30 | 30 |
| 30 - 88 | 100 | 3 |
| 88 - 216 | 150 | 3 |
| 216 - 960 | 200 | 3 |
| Above 960 | 500 | 3 |

7.7.2. Test Procedure Used

KDB 789033 D02v02r01 – Section G

7.7.3. Test Setting

Peak Measurements above 1GHz

1. Analyzer center frequency was set to the frequency of the radiated spurious emission of interest
2. RBW = 1MHz
3. VBW = 3MHz
4. Detector = peak
5. Sweep time = auto couple
6. Trace mode = max hold
7. Trace was allowed to stabilize

Quasi-Peak Measurements below 1GHz

1. Analyzer center frequency was set to the frequency of the radiated spurious emission of interest
2. Span was set greater than 1MHz
3. RBW = 120 kHz
4. Detector = CISPR quasi-peak
5. Sweep time = auto couple
6. Trace was allowed to stabilize

Average Measurements above 1GHz (Method AD)

1. Analyzer center frequency was set to the frequency of the radiated spurious emission of interest
2. RBW = 1MHz
3. VBW = 3MHz
4. Detector = power average (Average)
5. Number of measurement points = 1001 (Number of points must be $> 2 \times \text{span}/\text{RBW}$)
6. Sweep time = auto
7. Trace was averaged over at 100 sweeps

Quasi-Peak & Average Measurements below 30MHz

1. Analyzer center frequency was set to the frequency of the radiated spurious emission of interest
2. Span was set greater than 1MHz
3. RBW = 200Hz for 9kHz to 150kHz frequency; RBW = 9kHz for 0.15MHz to 30MHz frequency
4. Detector = CISPR quasi-peak or power average (Average)
5. Sweep time = auto couple
6. Trace was allowed to stabilize

7.7.4. Test Setup

9kHz ~ 30MHz Test Setup:

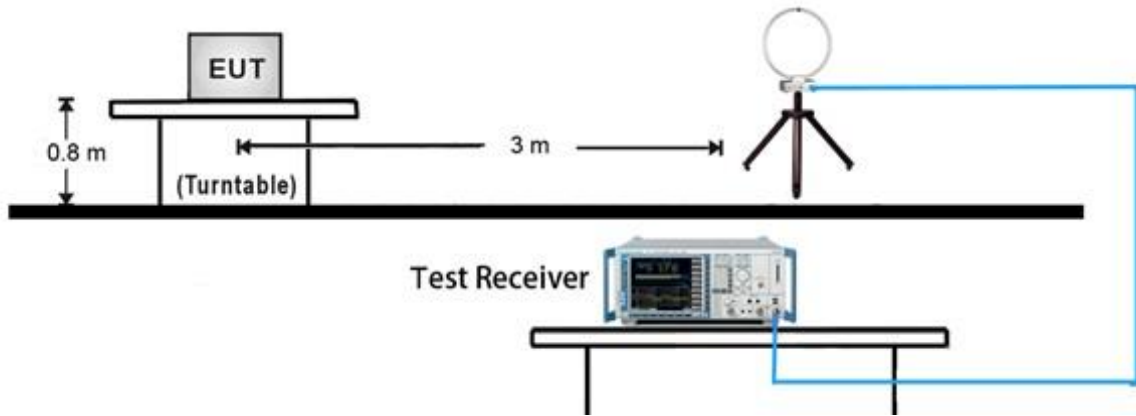

30MHz ~ 1GHz Test Setup:

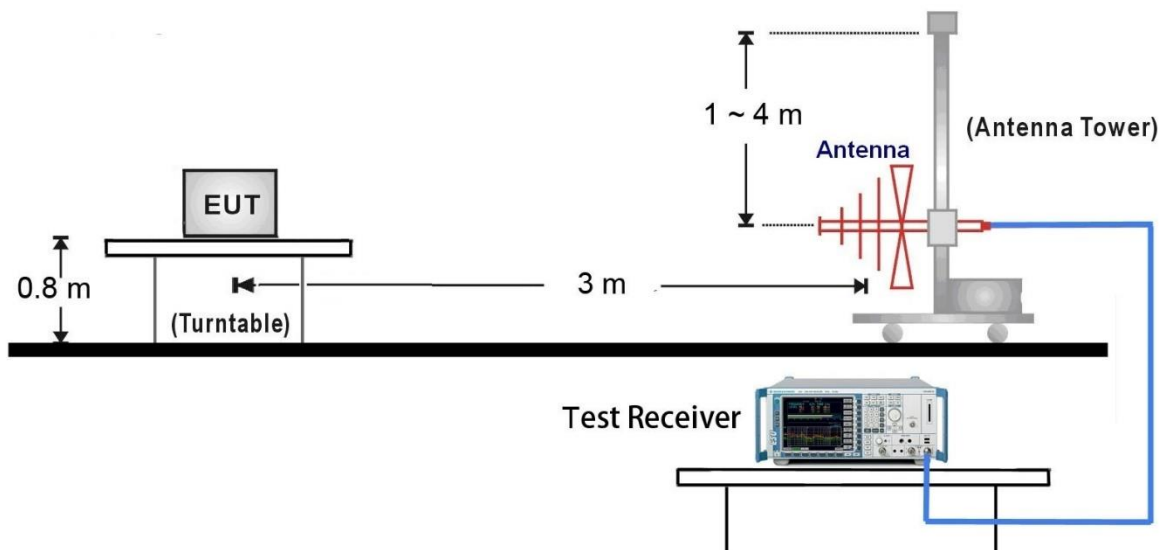

1GHz ~18GHz Test Setup:

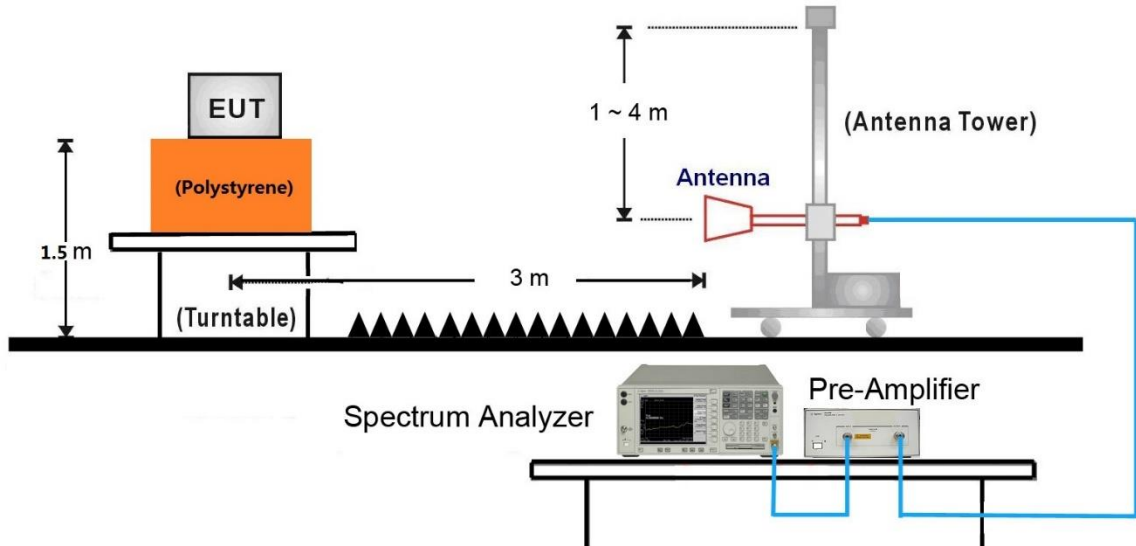

18GHz ~40GHz Test Setup:

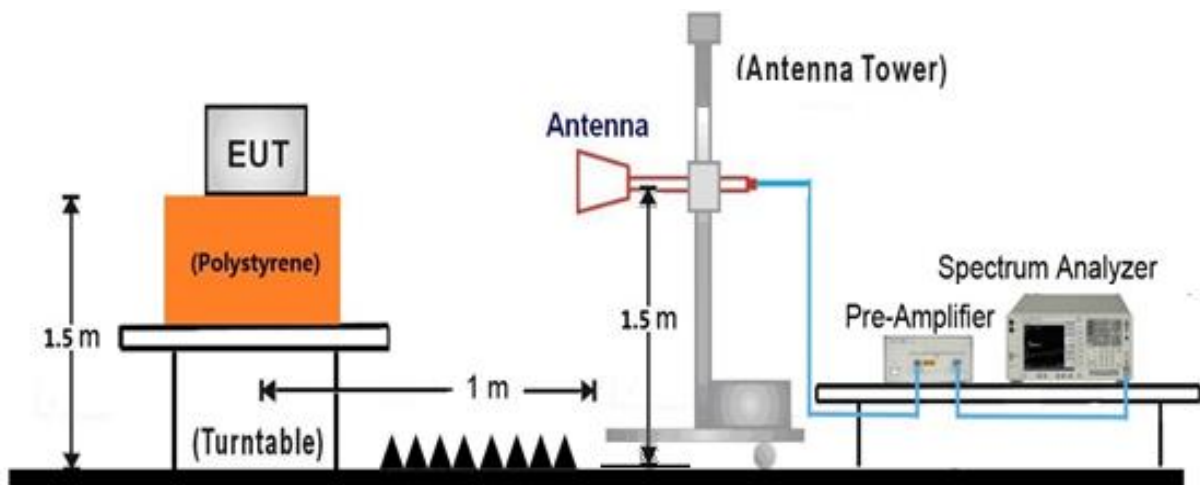

7.7.5. Test Result

| | | | |
|-----------|------------------------------------|----------------------|--------------|
| EUT | POS Terminal | Date of Test | 2023-10-27 |
| Factor | VULB 9162 | Temp. / Humidity | 23°C /61% |
| Polarity | Horizontal | Site / Test Engineer | AC2 / Marvin |
| Test Mode | 802.11n-20MHz_TX_Band1_CH 40_ANT 0 | Test Voltage | AC 120V/60Hz |

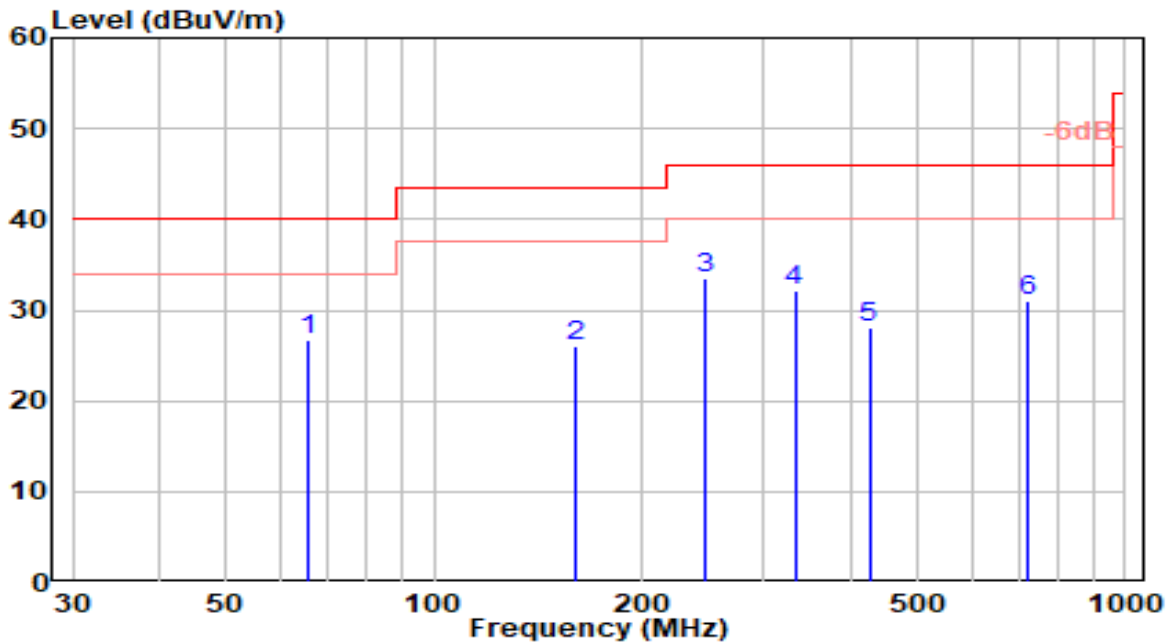

| No | Frequency (MHz) | Reading (dBuV) | C.F (dB/m) | Measurement (dBuV/m) | Margin (dB) | Limit (dBuV/m) | Height (cm) | Angle (deg) | Remark (QP/PK/AV) |
|----|-----------------|----------------|------------|----------------------|-------------|----------------|-------------|-------------|-------------------|
| 1 | 65.640 | 9.26 | 17.54 | 26.80 | -13.20 | 40.00 | 200 | 213 | QP |
| 2 | 159.900 | 10.31 | 15.79 | 26.11 | -17.39 | 43.50 | 200 | 349 | QP |
| 3 | * 247.410 | 13.35 | 20.12 | 33.47 | -12.53 | 46.00 | 100 | 285 | QP |
| 4 | 332.620 | 9.98 | 22.09 | 32.07 | -13.93 | 46.00 | 100 | 98 | QP |
| 5 | 426.120 | 4.23 | 23.74 | 27.98 | -18.02 | 46.00 | 200 | 293 | QP |
| 6 | 724.150 | 2.32 | 28.70 | 31.01 | -14.99 | 46.00 | 100 | 320 | QP |

Note:

1. " *", means this data is the worst emission level.
2. C.F (Correction Factor) = Antenna Factor (dB/m)+ Cable Loss (dB).
3. Measurement (dBuV/m) = Reading(dBuV) + C.F (Correction Factor).
4. The emission levels of other frequencies are very lower than the limit and not show in test report.

| | | | |
|-----------|------------------------------------|----------------------|--------------|
| EUT | POS Terminal | Date of Test | 2023-10-27 |
| Factor | VULB 9162 | Temp. / Humidity | 23°C /61% |
| Polarity | Vertical | Site / Test Engineer | AC2 / Marvin |
| Test Mode | 802.11n-20MHz_TX_Band1_CH 40_ANT 0 | Test Voltage | AC 120V/60Hz |

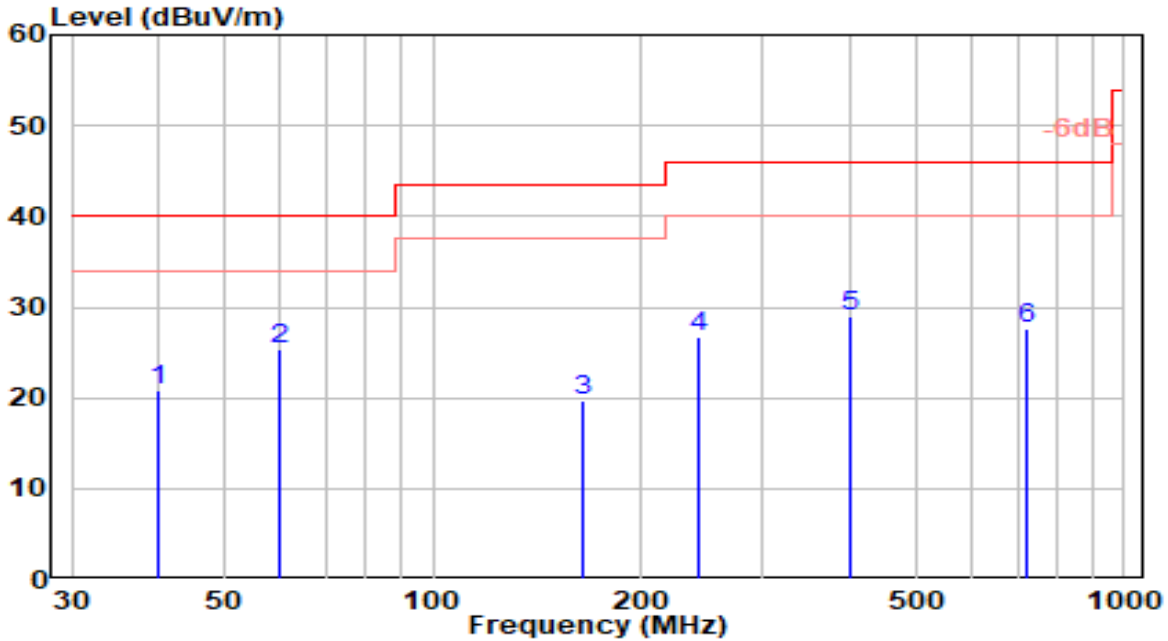

| No | Frequency (MHz) | Reading (dBuV) | C.F (dB/m) | Measurement (dBuV/m) | Margin (dB) | Limit (dBuV/m) | Height (cm) | Angle (deg) | Remark (QP/PK/AV) |
|----|-----------------|----------------|------------|----------------------|-------------|----------------|-------------|-------------|-------------------|
| 1 | 40.000 | 1.20 | 19.65 | 20.85 | -19.15 | 40.00 | 116 | 14 | QP |
| 2 | * 59.990 | 5.82 | 19.55 | 25.37 | -14.63 | 40.00 | 200 | 62 | QP |
| 3 | 163.990 | 3.73 | 15.89 | 19.63 | -23.87 | 43.50 | 200 | 28 | QP |
| 4 | 241.440 | 6.89 | 19.87 | 26.76 | -19.24 | 46.00 | 200 | 223 | QP |
| 5 | 399.930 | 5.40 | 23.54 | 28.94 | -17.06 | 46.00 | 144 | 14 | QP |
| 6 | 722.210 | -0.93 | 28.66 | 27.73 | -18.27 | 46.00 | 200 | 99 | QP |

Note:

- " *", means this data is the worst emission level.
- C.F (Correction Factor) = Antenna Factor (dB/m)+ Cable Loss (dB).
- Measurement (dBuV/m) = Reading(dBuV) + C.F (Correction Factor).
- The emission levels of other frequencies are very lower than the limit and not show in test report.

| | | | |
|-----------|------------------------------|----------------------|--------------|
| EUT | POS Terminal | Date of Test | 2023-10-28 |
| Factor | DRH18-E & BBHA 9170 | Temp. / Humidity | 23°C /61% |
| Polarity | Horizontal | Site / Test Engineer | AC2 / Marvin |
| Test Mode | 802.11a_TX_Band1_CH 36_ANT 0 | Test Voltage | AC 120V/60Hz |

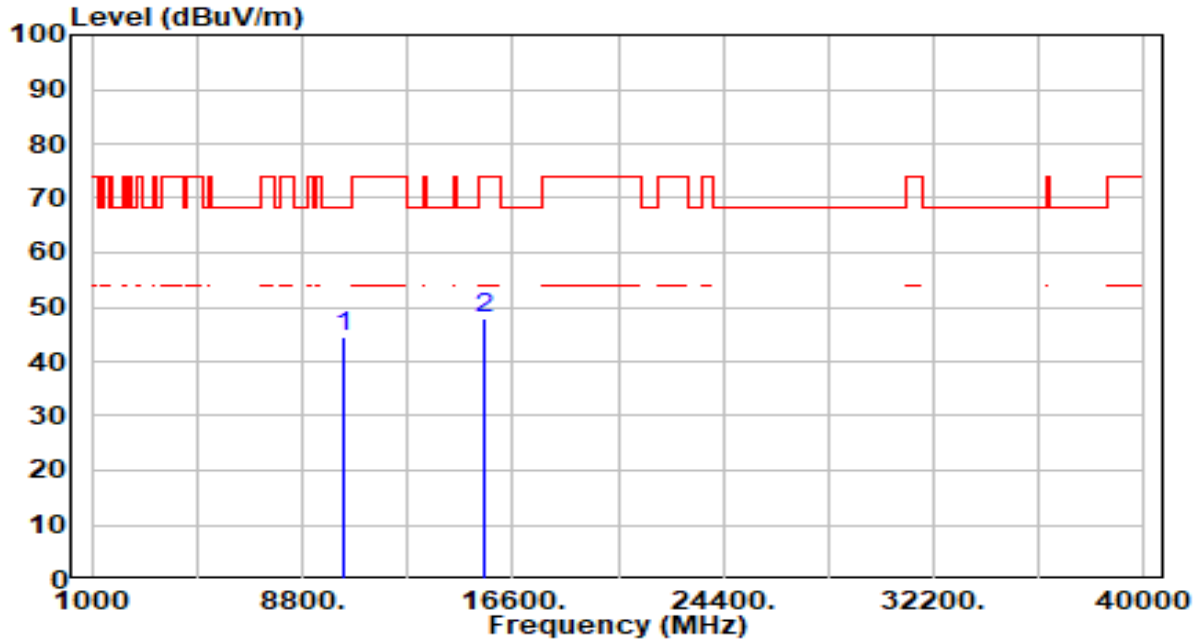

| No | Frequency (MHz) | Reading (dBuV) | C.F (dB/m) | Measurement (dBuV/m) | Margin (dB) | Limit (dBuV/m) | Height (cm) | Angle (deg) | Remark (QP/PK/AV) |
|----|-----------------|----------------|------------|----------------------|-------------|----------------|-------------|-------------|-------------------|
| 1 | * 10360.000 | 41.65 | 2.81 | 44.46 | -23.74 | 68.20 | 100 | 203 | Peak |
| 2 | 15540.000 | 43.50 | 4.52 | 48.02 | -25.98 | 74.00 | 100 | 34 | Peak |

Note:

- "*", means this data is the worst emission level.
- C.F (Correction Factor) = Antenna Factor (dB/m)+ Cable Loss (dB) – Pre-amplifier(dB).
- Measurement (dBuV/m) = Reading(dBuV) + C.F (Correction Factor).
- The emission levels of other frequencies are very lower than the limit and not show in test report.

| | | | |
|-----------|------------------------------|----------------------|--------------|
| EUT | POS Terminal | Date of Test | 2023-10-28 |
| Factor | DRH18-E & BBHA 9170 | Temp. / Humidity | 23°C /61% |
| Polarity | Vertical | Site / Test Engineer | AC2 / Marvin |
| Test Mode | 802.11a_TX_Band1_CH 36_ANT 0 | Test Voltage | AC 120V/60Hz |

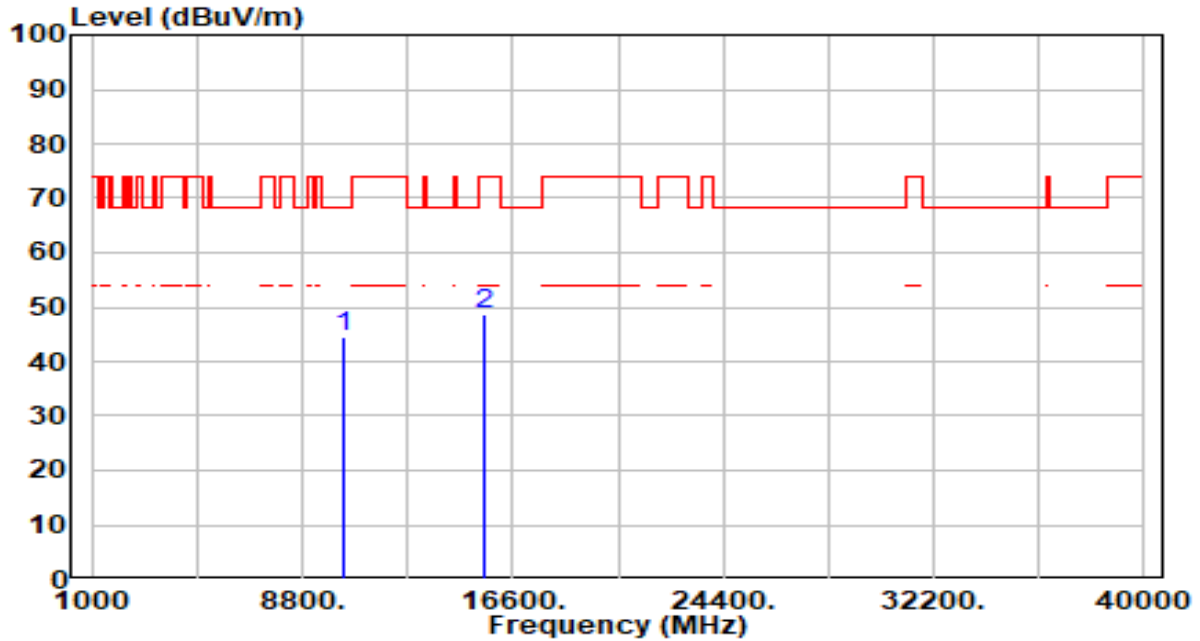

| No | Frequency (MHz) | Reading (dBuV) | C.F (dB/m) | Measurement (dBuV/m) | Margin (dB) | Limit (dBuV/m) | Height (cm) | Angle (deg) | Remark (QP/PK/AV) |
|----|-----------------|----------------|------------|----------------------|-------------|----------------|-------------|-------------|-------------------|
| 1 | * 10360.000 | 41.81 | 2.81 | 44.62 | -23.58 | 68.20 | 100 | 180 | Peak |
| 2 | 15540.000 | 44.34 | 4.52 | 48.86 | -25.14 | 74.00 | 100 | 269 | Peak |

Note:

- "*" means this data is the worst emission level.
- C.F (Correction Factor) = Antenna Factor (dB/m)+ Cable Loss (dB) – Pre-amplifier(dB).
- Measurement (dBuV/m) = Reading(dBuV) + C.F (Correction Factor).
- The emission levels of other frequencies are very lower than the limit and not show in test report.

| | | | |
|-----------|------------------------------|----------------------|--------------|
| EUT | POS Terminal | Date of Test | 2023-10-28 |
| Factor | DRH18-E & BBHA 9170 | Temp. / Humidity | 23°C /61% |
| Polarity | Horizontal | Site / Test Engineer | AC2 / Marvin |
| Test Mode | 802.11a_TX_Band1_CH 44_ANT 0 | Test Voltage | AC 120V/60Hz |

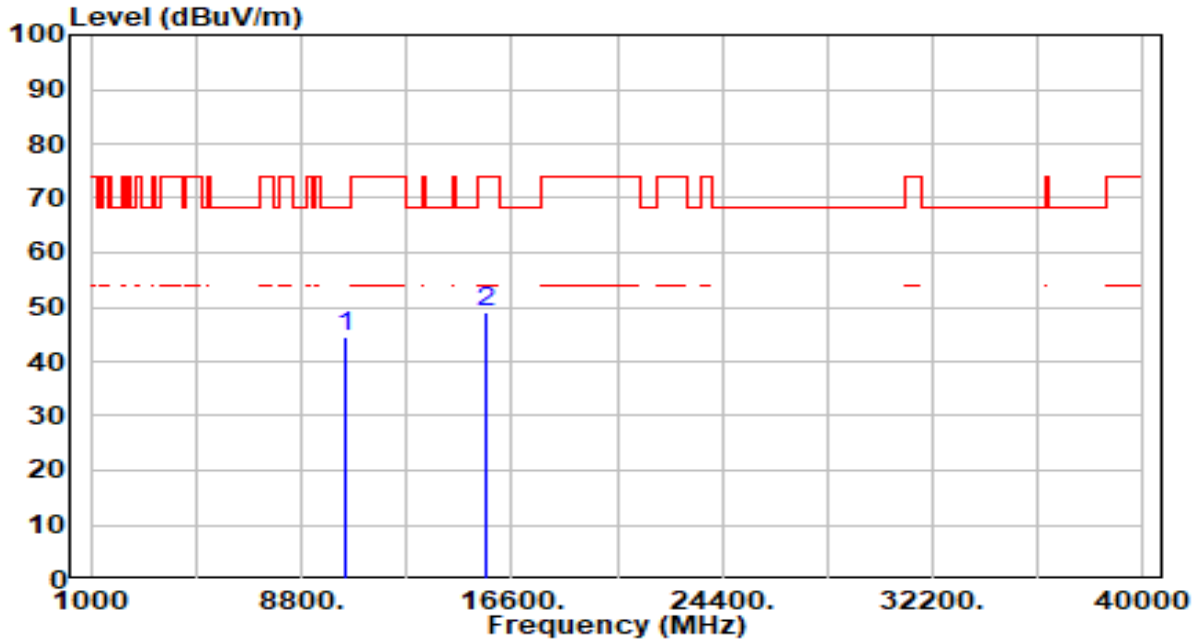

| No | Frequency (MHz) | Reading (dBuV) | C.F (dB/m) | Measurement (dBuV/m) | Margin (dB) | Limit (dBuV/m) | Height (cm) | Angle (deg) | Remark (QP/PK/AV) |
|----|-----------------|----------------|------------|----------------------|-------------|----------------|-------------|-------------|-------------------|
| 1 | * 10440.000 | 41.83 | 2.72 | 44.55 | -23.65 | 68.20 | 300 | 333 | Peak |
| 2 | 15660.000 | 44.35 | 4.67 | 49.03 | -24.97 | 74.00 | 300 | 301 | Peak |

Note:

- "*" means this data is the worst emission level.
- C.F (Correction Factor) = Antenna Factor (dB/m)+ Cable Loss (dB) – Pre-amplifier(dB).
- Measurement (dBuV/m) = Reading(dBuV) + C.F (Correction Factor).
- The emission levels of other frequencies are very lower than the limit and not show in test report.

| | | | |
|-----------|------------------------------|----------------------|--------------|
| EUT | POS Terminal | Date of Test | 2023-10-28 |
| Factor | DRH18-E & BBHA 9170 | Temp. / Humidity | 23°C /61% |
| Polarity | Vertical | Site / Test Engineer | AC2 / Marvin |
| Test Mode | 802.11a_TX_Band1_CH 44_ANT 0 | Test Voltage | AC 120V/60Hz |

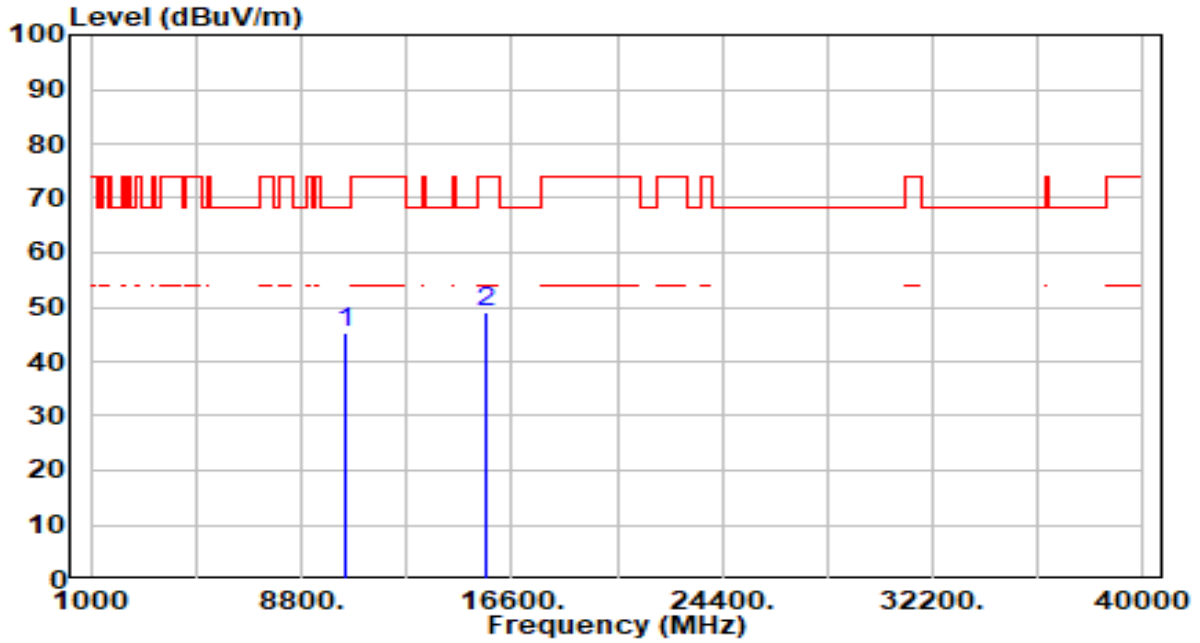

| No | Frequency (MHz) | Reading (dBuV) | C.F (dB/m) | Measurement (dBuV/m) | Margin (dB) | Limit (dBuV/m) | Height (cm) | Angle (deg) | Remark (QP/PK/AV) |
|----|-----------------|----------------|------------|----------------------|-------------|----------------|-------------|-------------|-------------------|
| 1 | * 10440.000 | 42.41 | 2.72 | 45.14 | -23.06 | 68.20 | 225 | 0 | Peak |
| 2 | 15660.000 | 44.26 | 4.67 | 48.93 | -25.07 | 74.00 | 100 | 281 | Peak |

Note:

- "*" means this data is the worst emission level.
- C.F (Correction Factor) = Antenna Factor (dB/m)+ Cable Loss (dB) – Pre-amplifier(dB).
- Measurement (dBuV/m) = Reading(dBuV) + C.F (Correction Factor).
- The emission levels of other frequencies are very lower than the limit and not show in test report.

| | | | |
|-----------|------------------------------|----------------------|--------------|
| EUT | POS Terminal | Date of Test | 2023-10-28 |
| Factor | DRH18-E & BBHA 9170 | Temp. / Humidity | 23°C /61% |
| Polarity | Horizontal | Site / Test Engineer | AC2 / Marvin |
| Test Mode | 802.11a_TX_Band1_CH 48_ANT 0 | Test Voltage | AC 120V/60Hz |

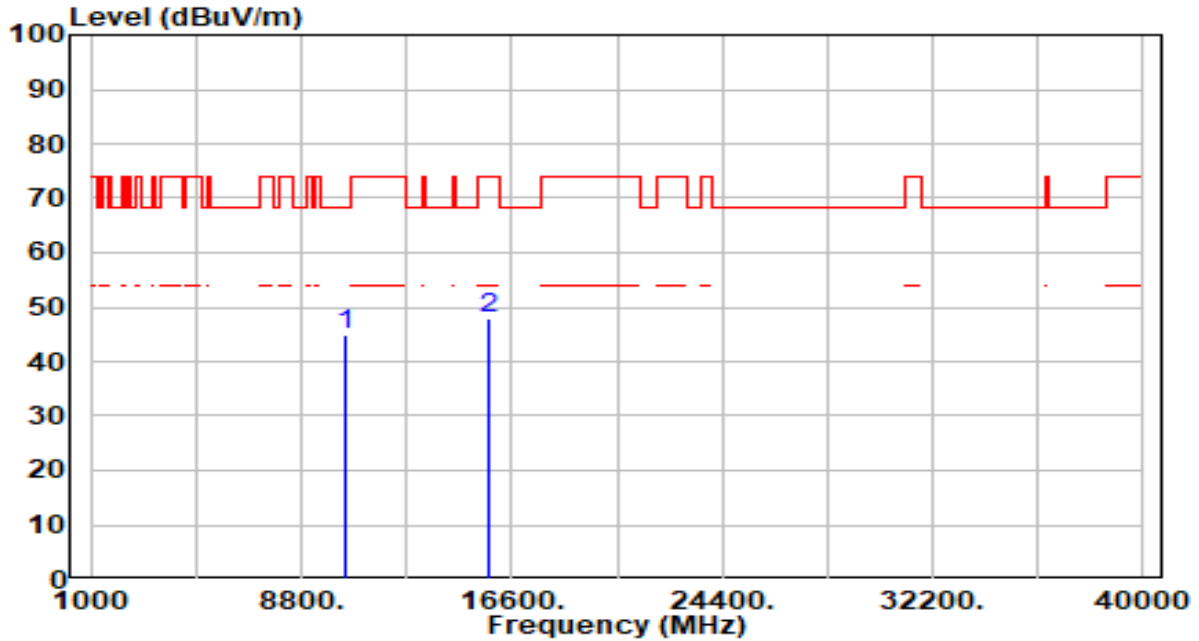

| No | Frequency (MHz) | Reading (dBuV) | C.F (dB/m) | Measurement (dBuV/m) | Margin (dB) | Limit (dBuV/m) | Height (cm) | Angle (deg) | Remark (QP/PK/AV) |
|----|-----------------|----------------|------------|----------------------|-------------|----------------|-------------|-------------|-------------------|
| 1 | * 10480.000 | 42.25 | 2.68 | 44.93 | -23.27 | 68.20 | 100 | 286 | Peak |
| 2 | 15720.000 | 43.12 | 4.84 | 47.96 | -26.04 | 74.00 | 100 | 140 | Peak |

Note:

- "*" means this data is the worst emission level.
- C.F (Correction Factor) = Antenna Factor (dB/m)+ Cable Loss (dB) – Pre-amplifier(dB).
- Measurement (dBuV/m) = Reading(dBuV) + C.F (Correction Factor).
- The emission levels of other frequencies are very lower than the limit and not show in test report.

| | | | |
|-----------|------------------------------|----------------------|--------------|
| EUT | POS Terminal | Date of Test | 2023-10-28 |
| Factor | DRH18-E & BBHA 9170 | Temp. / Humidity | 23°C /61% |
| Polarity | Vertical | Site / Test Engineer | AC2 / Marvin |
| Test Mode | 802.11a_TX_Band1_CH 48_ANT 0 | Test Voltage | AC 120V/60Hz |

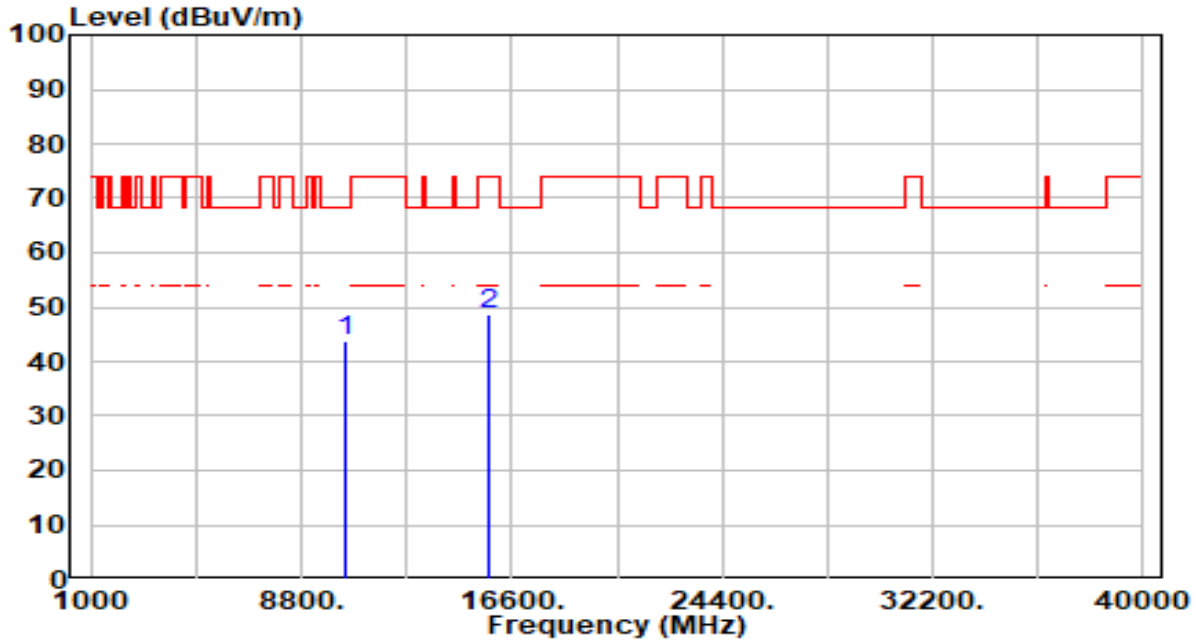

| No | Frequency (MHz) | Reading (dBuV) | C.F (dB/m) | Measurement (dBuV/m) | Margin (dB) | Limit (dBuV/m) | Height (cm) | Angle (deg) | Remark (QP/PK/AV) |
|----|-----------------|----------------|------------|----------------------|-------------|----------------|-------------|-------------|-------------------|
| 1 | * 10480.000 | 41.18 | 2.68 | 43.86 | -24.34 | 68.20 | 100 | 135 | Peak |
| 2 | 15720.000 | 43.90 | 4.84 | 48.74 | -25.26 | 74.00 | 100 | 177 | Peak |

Note:

- "*" means this data is the worst emission level.
- C.F (Correction Factor) = Antenna Factor (dB/m)+ Cable Loss (dB) – Pre-amplifier(dB).
- Measurement (dBuV/m) = Reading(dBuV) + C.F (Correction Factor).
- The emission levels of other frequencies are very lower than the limit and not show in test report.

| | | | |
|-----------|------------------------------|----------------------|--------------|
| EUT | POS Terminal | Date of Test | 2023-10-28 |
| Factor | DRH18-E & BBHA 9170 | Temp. / Humidity | 23°C /61% |
| Polarity | Horizontal | Site / Test Engineer | AC2 / Marvin |
| Test Mode | 802.11a_TX_Band2_CH 52_ANT 0 | Test Voltage | AC 120V/60Hz |

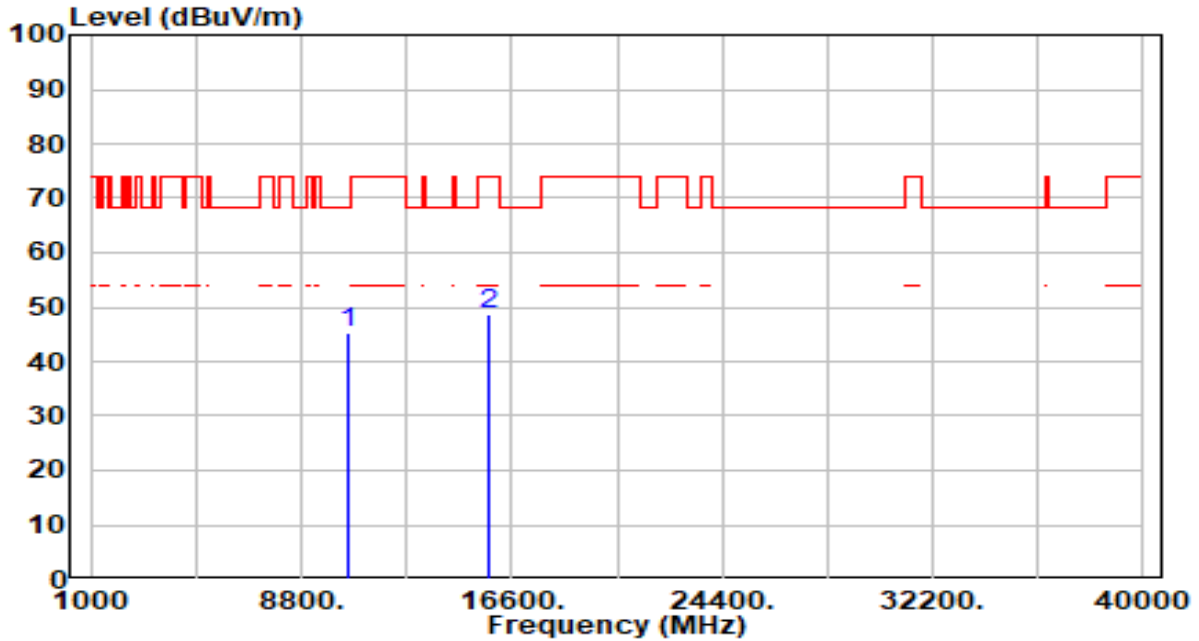

| No | Frequency (MHz) | Reading (dBuV) | C.F (dB/m) | Measurement (dBuV/m) | Margin (dB) | Limit (dBuV/m) | Height (cm) | Angle (deg) | Remark (QP/PK/AV) |
|----|-----------------|----------------|------------|----------------------|-------------|----------------|-------------|-------------|-------------------|
| 1 | * 10520.000 | 42.82 | 2.64 | 45.46 | -22.74 | 68.20 | 100 | 36 | Peak |
| 2 | 15780.000 | 43.83 | 5.00 | 48.83 | -25.17 | 74.00 | 100 | 252 | Peak |

Note:

- "*", means this data is the worst emission level.
- C.F (Correction Factor) = Antenna Factor (dB/m)+ Cable Loss (dB) – Pre-amplifier(dB).
- Measurement (dBuV/m) = Reading(dBuV) + C.F (Correction Factor).
- The emission levels of other frequencies are very lower than the limit and not show in test report.

| | | | |
|-----------|------------------------------|----------------------|--------------|
| EUT | POS Terminal | Date of Test | 2023-10-28 |
| Factor | DRH18-E & BBHA 9170 | Temp. / Humidity | 23°C /61% |
| Polarity | Vertical | Site / Test Engineer | AC2 / Marvin |
| Test Mode | 802.11a_TX_Band2_CH 52_ANT 0 | Test Voltage | AC 120V/60Hz |

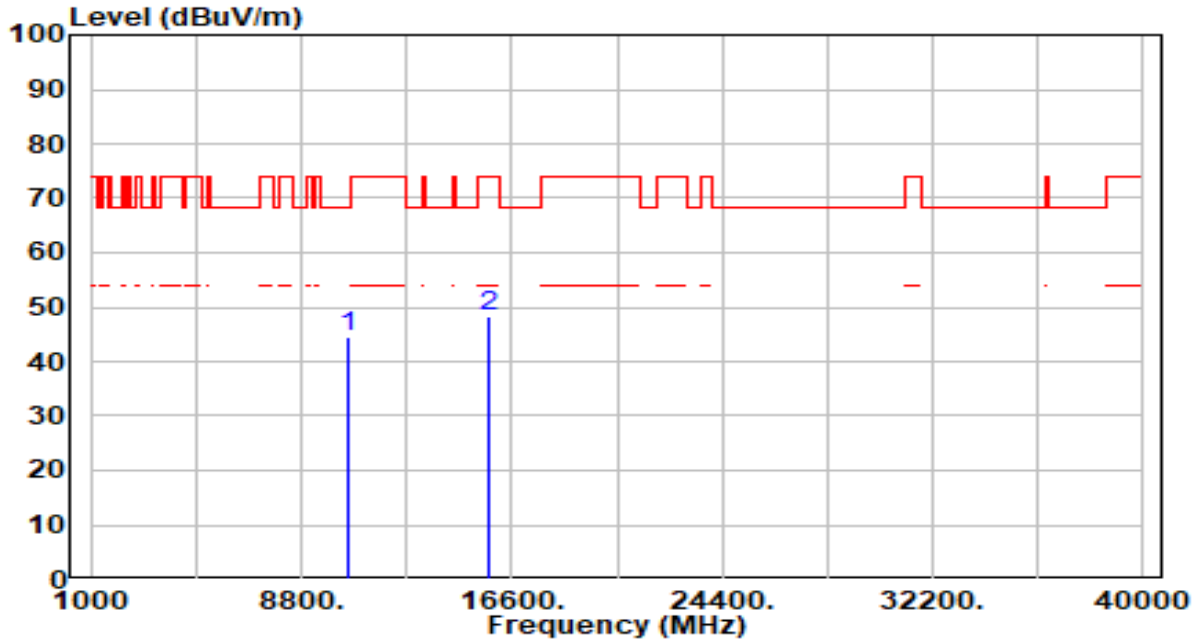

| No | Frequency (MHz) | Reading (dBuV) | C.F (dB/m) | Measurement (dBuV/m) | Margin (dB) | Limit (dBuV/m) | Height (cm) | Angle (deg) | Remark (QP/PK/AV) |
|----|-----------------|----------------|------------|----------------------|-------------|----------------|-------------|-------------|-------------------|
| 1 | * 10520.000 | 42.06 | 2.64 | 44.71 | -23.49 | 68.20 | 100 | 362 | Peak |
| 2 | 15780.000 | 43.39 | 5.00 | 48.39 | -25.61 | 74.00 | 100 | 2 | Peak |

Note:

- "*" means this data is the worst emission level.
- C.F (Correction Factor) = Antenna Factor (dB/m)+ Cable Loss (dB) – Pre-amplifier(dB).
- Measurement (dBuV/m) = Reading(dBuV) + C.F (Correction Factor).
- The emission levels of other frequencies are very lower than the limit and not show in test report.

| | | | |
|-----------|------------------------------|----------------------|--------------|
| EUT | POS Terminal | Date of Test | 2023-10-28 |
| Factor | DRH18-E & BBHA 9170 | Temp. / Humidity | 23°C /61% |
| Polarity | Horizontal | Site / Test Engineer | AC2 / Marvin |
| Test Mode | 802.11a_TX_Band2_CH 60_ANT 0 | Test Voltage | AC 120V/60Hz |

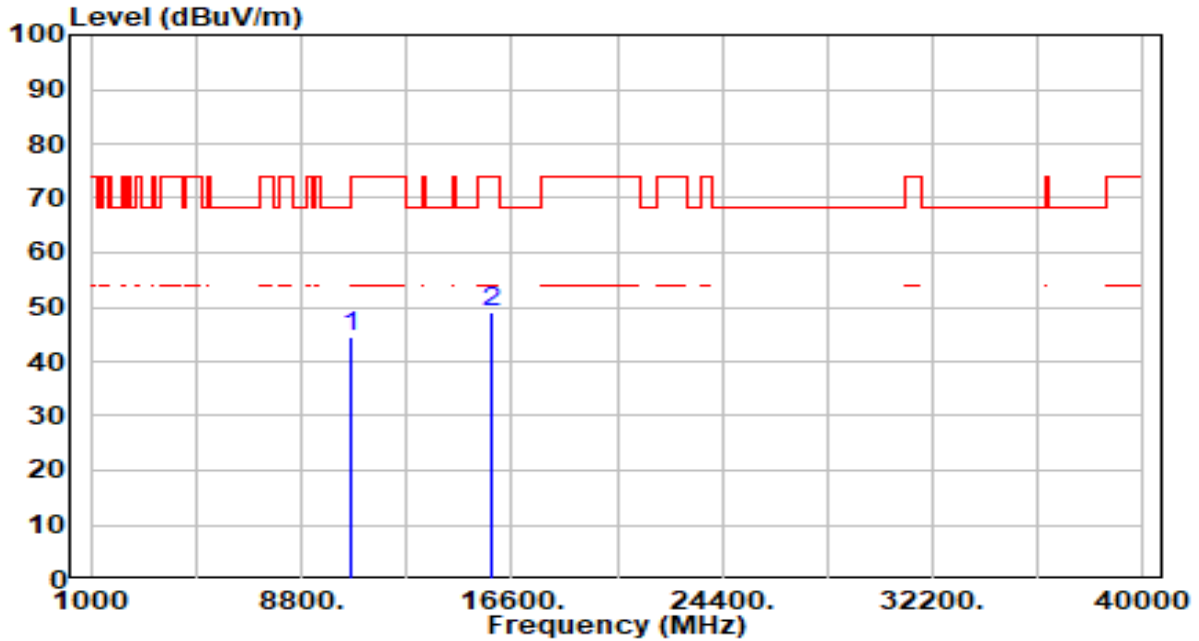

| No | Frequency (MHz) | Reading (dBuV) | C.F (dB/m) | Measurement (dBuV/m) | Margin (dB) | Limit (dBuV/m) | Height (cm) | Angle (deg) | Remark (QP/PK/AV) |
|----|-----------------|----------------|------------|----------------------|-------------|----------------|-------------|-------------|-------------------|
| 1 | * 10600.000 | 41.93 | 2.60 | 44.53 | -23.67 | 68.20 | 100 | 95 | Peak |
| 2 | 15900.000 | 43.99 | 5.13 | 49.12 | -24.88 | 74.00 | 100 | 33 | Peak |

Note:

- "*", means this data is the worst emission level.
- C.F (Correction Factor) = Antenna Factor (dB/m)+ Cable Loss (dB) – Pre-amplifier(dB).
- Measurement (dBuV/m) = Reading(dBuV) + C.F (Correction Factor).
- The emission levels of other frequencies are very lower than the limit and not show in test report.

| | | | |
|-----------|------------------------------|----------------------|--------------|
| EUT | POS Terminal | Date of Test | 2023-10-28 |
| Factor | DRH18-E & BBHA 9170 | Temp. / Humidity | 23°C /61% |
| Polarity | Vertical | Site / Test Engineer | AC2 / Marvin |
| Test Mode | 802.11a_TX_Band2_CH 60_ANT 0 | Test Voltage | AC 120V/60Hz |

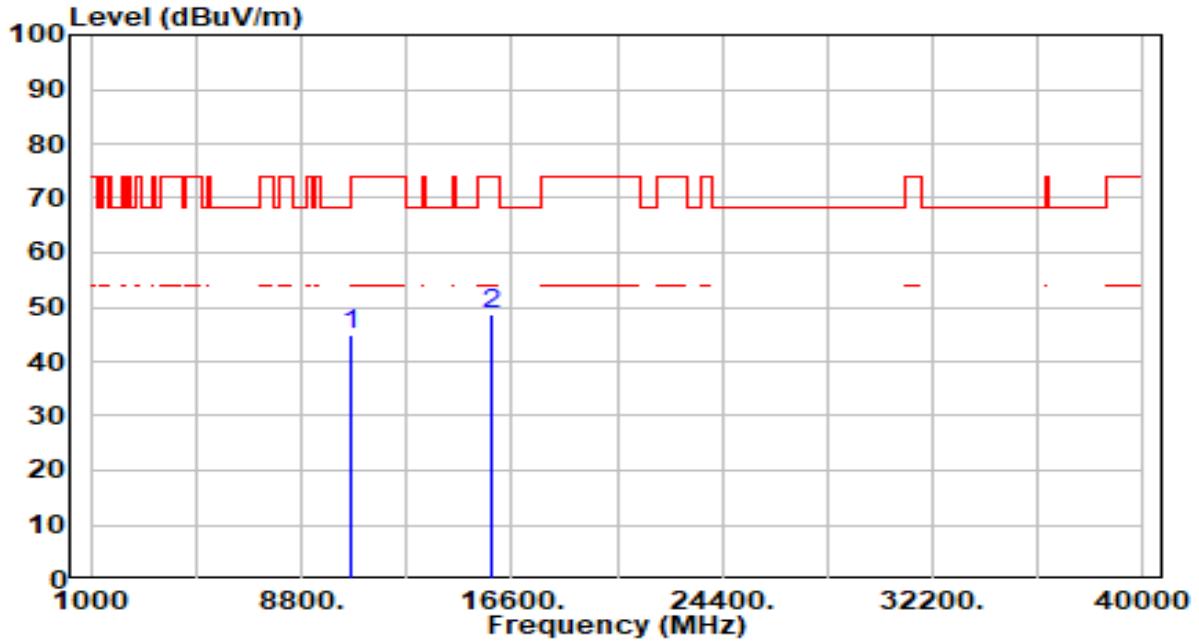

| No | Frequency (MHz) | Reading (dBuV) | C.F (dB/m) | Measurement (dBuV/m) | Margin (dB) | Limit (dBuV/m) | Height (cm) | Angle (deg) | Remark (QP/PK/AV) |
|----|-----------------|----------------|------------|----------------------|-------------|----------------|-------------|-------------|-------------------|
| 1 | * 10600.000 | 42.20 | 2.60 | 44.80 | -23.40 | 68.20 | 100 | 88 | Peak |
| 2 | 15900.000 | 43.63 | 5.13 | 48.76 | -25.24 | 74.00 | 100 | 46 | Peak |

Note:

- "*", means this data is the worst emission level.
- C.F (Correction Factor) = Antenna Factor (dB/m)+ Cable Loss (dB) – Pre-amplifier(dB).
- Measurement (dBuV/m) = Reading(dBuV) + C.F (Correction Factor).
- The emission levels of other frequencies are very lower than the limit and not show in test report.

| | | | |
|-----------|------------------------------|----------------------|--------------|
| EUT | POS Terminal | Date of Test | 2023-10-28 |
| Factor | DRH18-E & BBHA 9170 | Temp. / Humidity | 23°C /61% |
| Polarity | Horizontal | Site / Test Engineer | AC2 / Marvin |
| Test Mode | 802.11a_TX_Band2_CH 64_ANT 0 | Test Voltage | AC 120V/60Hz |

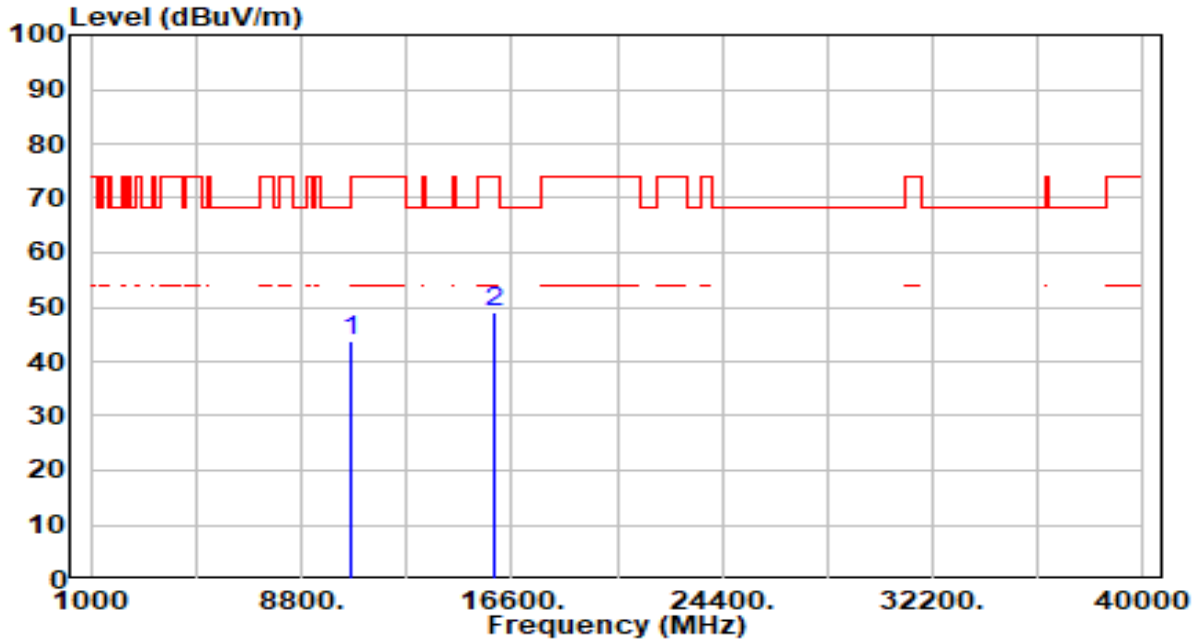

| No | Frequency (MHz) | Reading (dBuV) | C.F (dB/m) | Measurement (dBuV/m) | Margin (dB) | Limit (dBuV/m) | Height (cm) | Angle (deg) | Remark (QP/PK/AV) |
|----|-----------------|----------------|------------|----------------------|-------------|----------------|-------------|-------------|-------------------|
| 1 | 10640.000 | 41.31 | 2.62 | 43.93 | -30.07 | 74.00 | 100 | 167 | Peak |
| 2 | * 15960.000 | 43.88 | 5.17 | 49.05 | -24.95 | 74.00 | 100 | 161 | Peak |

Note:

- " *", means this data is the worst emission level.
- C.F (Correction Factor) = Antenna Factor (dB/m)+ Cable Loss (dB) – Pre-amplifier(dB).
- Measurement (dBuV/m) = Reading(dBuV) + C.F (Correction Factor).
- The emission levels of other frequencies are very lower than the limit and not show in test report.

| | | | |
|-----------|------------------------------|----------------------|--------------|
| EUT | POS Terminal | Date of Test | 2023-10-28 |
| Factor | DRH18-E & BBHA 9170 | Temp. / Humidity | 23°C /61% |
| Polarity | Vertical | Site / Test Engineer | AC2 / Marvin |
| Test Mode | 802.11a_TX_Band2_CH 64_ANT 0 | Test Voltage | AC 120V/60Hz |

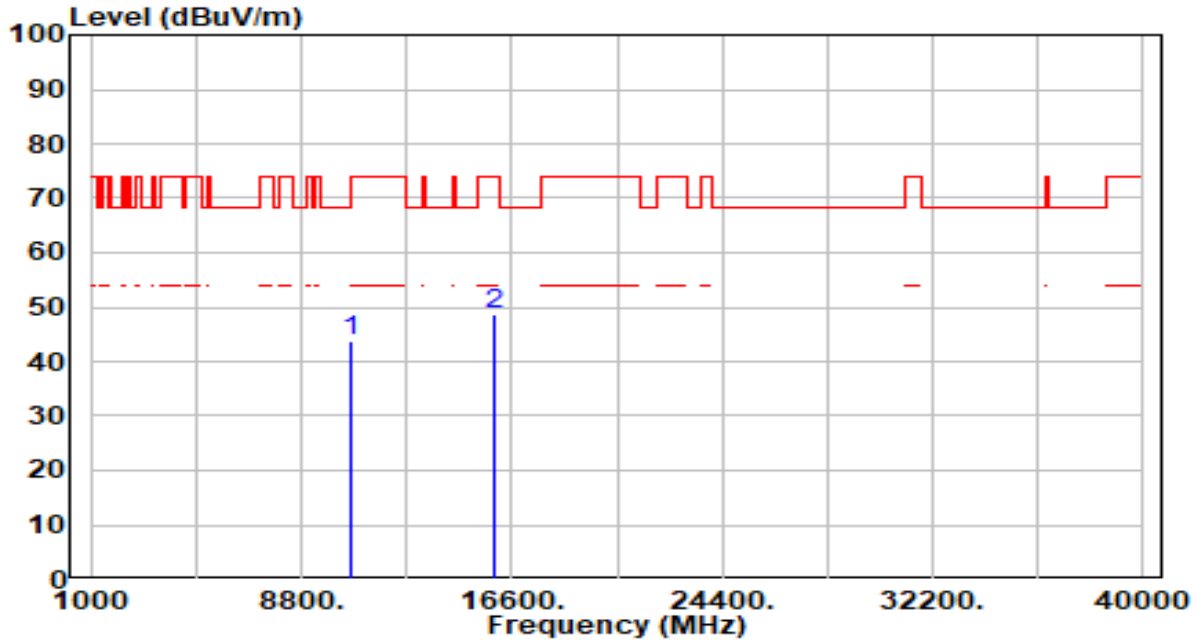

| No | Frequency (MHz) | Reading (dBuV) | C.F (dB/m) | Measurement (dBuV/m) | Margin (dB) | Limit (dBuV/m) | Height (cm) | Angle (deg) | Remark (QP/PK/AV) |
|----|-----------------|----------------|------------|----------------------|-------------|----------------|-------------|-------------|-------------------|
| 1 | 10640.000 | 41.33 | 2.62 | 43.96 | -30.04 | 74.00 | 100 | 360 | Peak |
| 2 | * 15960.000 | 43.69 | 5.17 | 48.86 | -25.14 | 74.00 | 100 | 90 | Peak |

Note:

- " *", means this data is the worst emission level.
- C.F (Correction Factor) = Antenna Factor (dB/m)+ Cable Loss (dB) – Pre-amplifier(dB).
- Measurement (dBuV/m) = Reading(dBuV) + C.F (Correction Factor).
- The emission levels of other frequencies are very lower than the limit and not show in test report.

| | | | |
|-----------|-------------------------------|----------------------|--------------|
| EUT | POS Terminal | Date of Test | 2023-10-28 |
| Factor | DRH18-E & BBHA 9170 | Temp. / Humidity | 23°C /61% |
| Polarity | Horizontal | Site / Test Engineer | AC2 / Marvin |
| Test Mode | 802.11a_TX_Band3_CH 100_ANT 0 | Test Voltage | AC 120V/60Hz |

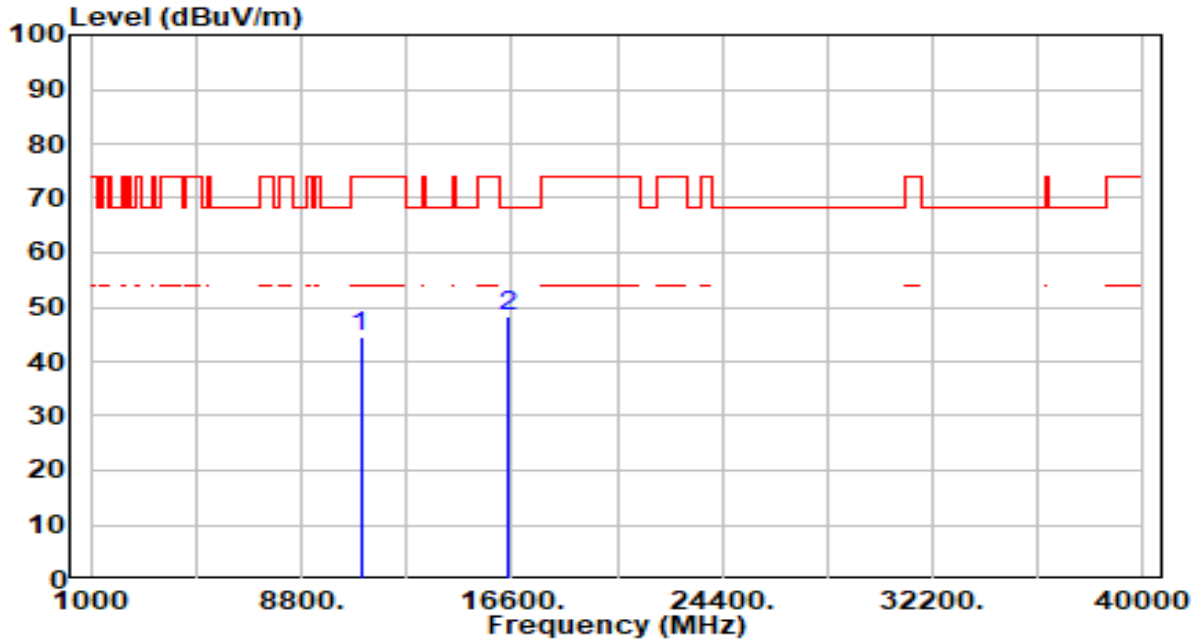

| No | Frequency (MHz) | Reading (dBuV) | C.F (dB/m) | Measurement (dBuV/m) | Margin (dB) | Limit (dBuV/m) | Height (cm) | Angle (deg) | Remark (QP/PK/AV) |
|----|-----------------|----------------|------------|----------------------|-------------|----------------|-------------|-------------|-------------------|
| 1 | 11000.000 | 42.03 | 2.60 | 44.63 | -29.37 | 74.00 | 100 | 303 | Peak |
| 2 | * 16500.000 | 43.76 | 4.63 | 48.39 | -19.81 | 68.20 | 100 | 0 | Peak |

Note:

- "*", means this data is the worst emission level.
- C.F (Correction Factor) = Antenna Factor (dB/m)+ Cable Loss (dB) – Pre-amplifier(dB).
- Measurement (dBuV/m) = Reading(dBuV) + C.F (Correction Factor).
- The emission levels of other frequencies are very lower than the limit and not show in test report.

| | | | |
|-----------|-------------------------------|----------------------|--------------|
| EUT | POS Terminal | Date of Test | 2023-10-28 |
| Factor | DRH18-E & BBHA 9170 | Temp. / Humidity | 23°C /61% |
| Polarity | Vertical | Site / Test Engineer | AC2 / Marvin |
| Test Mode | 802.11a_TX_Band3_CH 100_ANT 0 | Test Voltage | AC 120V/60Hz |

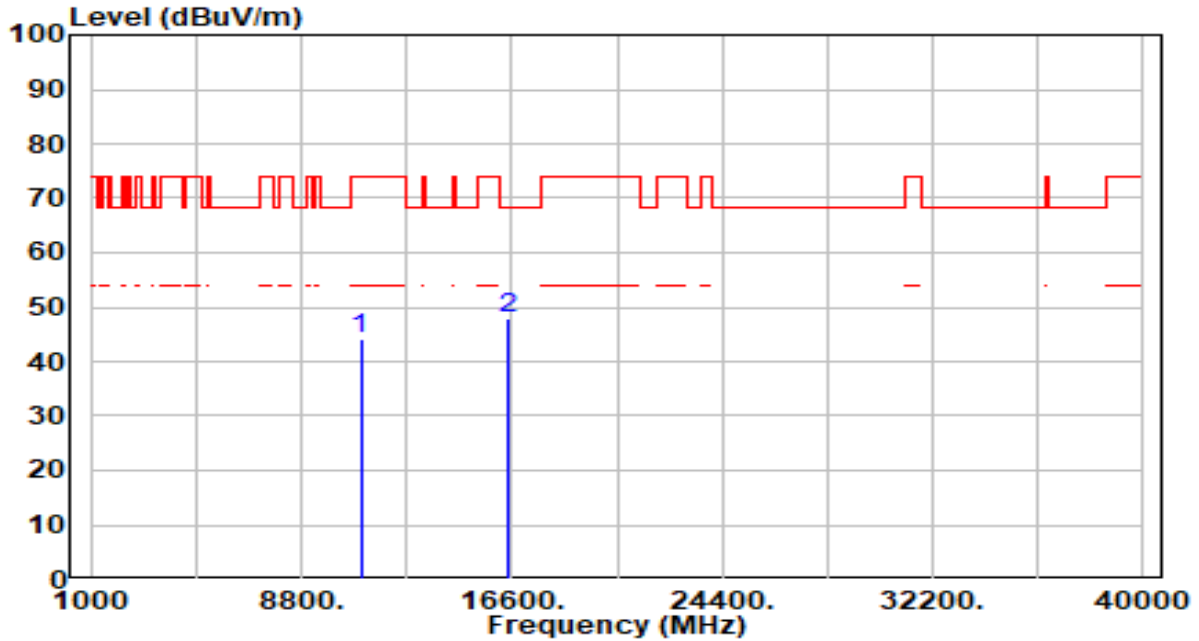

| No | Frequency (MHz) | Reading (dBuV) | C.F (dB/m) | Measurement (dBuV/m) | Margin (dB) | Limit (dBuV/m) | Height (cm) | Angle (deg) | Remark (QP/PK/AV) |
|----|-----------------|----------------|------------|----------------------|-------------|----------------|-------------|-------------|-------------------|
| 1 | 11000.000 | 41.50 | 2.60 | 44.10 | -29.90 | 74.00 | 100 | 164 | Peak |
| 2 | * 16500.000 | 43.16 | 4.63 | 47.79 | -20.41 | 68.20 | 100 | 302 | Peak |

Note:

- "*", means this data is the worst emission level.
- C.F (Correction Factor) = Antenna Factor (dB/m)+ Cable Loss (dB) – Pre-amplifier(dB).
- Measurement (dBuV/m) = Reading(dBuV) + C.F (Correction Factor).
- The emission levels of other frequencies are very lower than the limit and not show in test report.

| | | | |
|-----------|-------------------------------|----------------------|--------------|
| EUT | POS Terminal | Date of Test | 2023-10-28 |
| Factor | DRH18-E & BBHA 9170 | Temp. / Humidity | 23°C /61% |
| Polarity | Horizontal | Site / Test Engineer | AC2 / Marvin |
| Test Mode | 802.11a_TX_Band3_CH 116_ANT 0 | Test Voltage | AC 120V/60Hz |

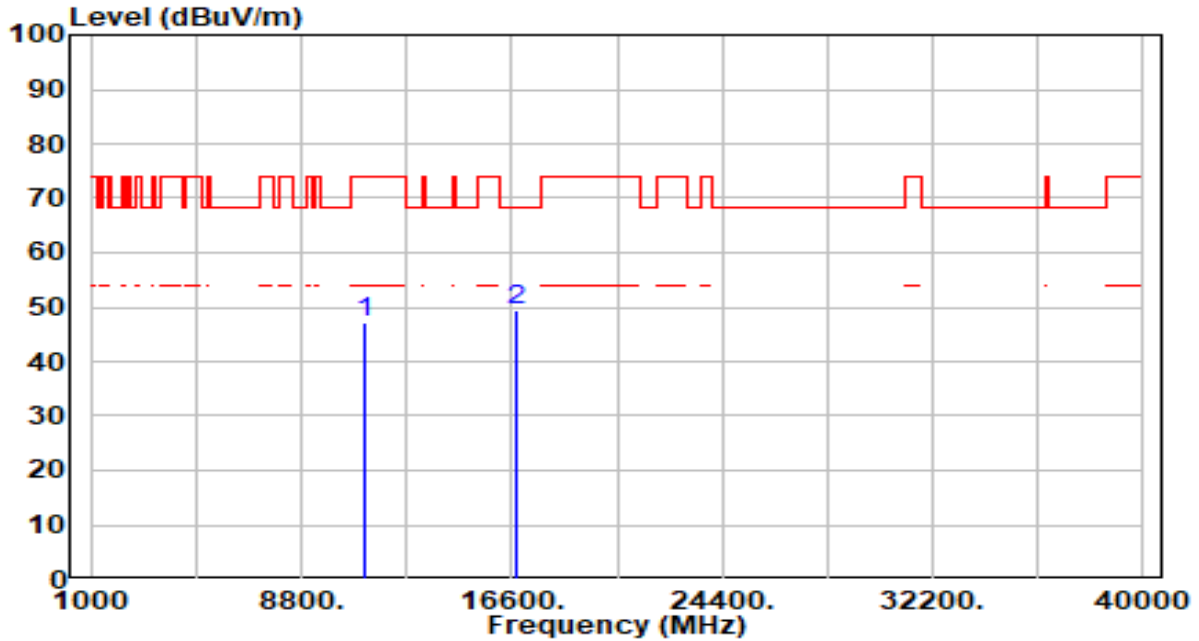

| No | Frequency (MHz) | Reading (dBuV) | C.F (dB/m) | Measurement (dBuV/m) | Margin (dB) | Limit (dBuV/m) | Height (cm) | Angle (deg) | Remark (QP/PK/AV) |
|----|-----------------|----------------|------------|----------------------|-------------|----------------|-------------|-------------|-------------------|
| 1 | 11160.000 | 43.99 | 3.07 | 47.06 | -26.94 | 74.00 | 100 | 301 | Peak |
| 2 | * 16740.000 | 44.93 | 4.66 | 49.59 | -18.61 | 68.20 | 100 | 221 | Peak |

Note:

- " *", means this data is the worst emission level.
- C.F (Correction Factor) = Antenna Factor (dB/m)+ Cable Loss (dB) – Pre-amplifier(dB).
- Measurement (dBuV/m) = Reading(dBuV) + C.F (Correction Factor).
- The emission levels of other frequencies are very lower than the limit and not show in test report.

| | | | |
|-----------|-------------------------------|----------------------|--------------|
| EUT | POS Terminal | Date of Test | 2023-10-28 |
| Factor | DRH18-E & BBHA 9170 | Temp. / Humidity | 23°C /61% |
| Polarity | Vertical | Site / Test Engineer | AC2 / Marvin |
| Test Mode | 802.11a_TX_Band3_CH 116_ANT 0 | Test Voltage | AC 120V/60Hz |

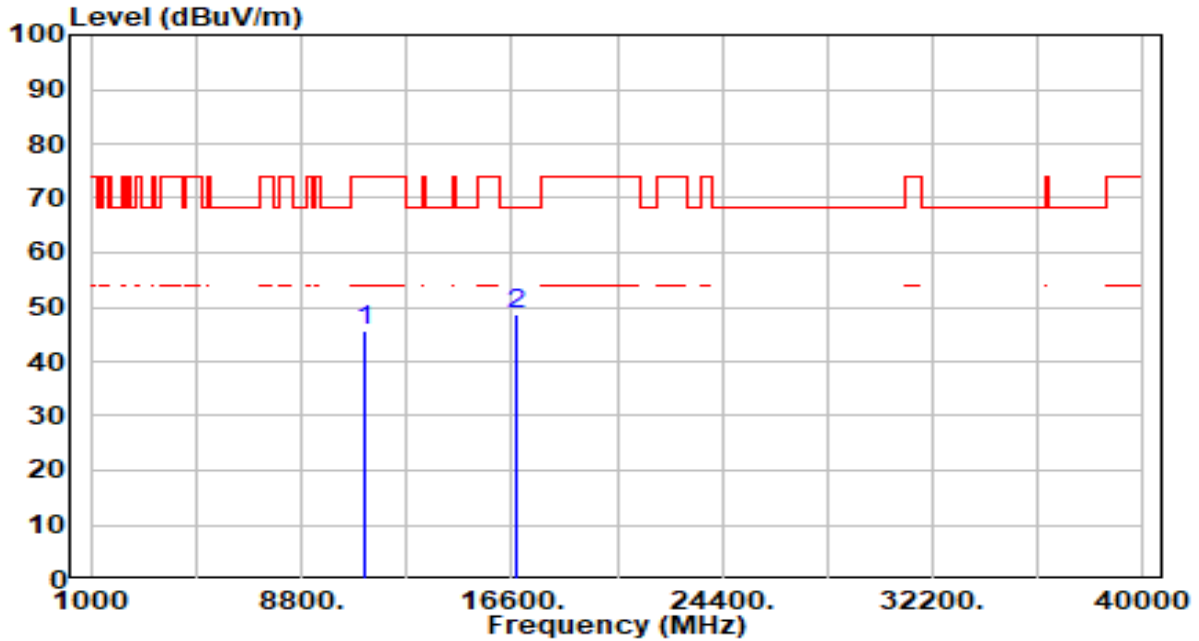

| No | Frequency (MHz) | Reading (dBuV) | C.F (dB/m) | Measurement (dBuV/m) | Margin (dB) | Limit (dBuV/m) | Height (cm) | Angle (deg) | Remark (QP/PK/AV) |
|----|-----------------|----------------|------------|----------------------|-------------|----------------|-------------|-------------|-------------------|
| 1 | 11160.000 | 42.70 | 3.07 | 45.77 | -28.23 | 74.00 | 100 | 184 | Peak |
| 2 | * 16740.000 | 43.99 | 4.66 | 48.66 | -19.54 | 68.20 | 100 | 51 | Peak |

Note:

1. " *", means this data is the worst emission level.
2. C.F (Correction Factor) = Antenna Factor (dB/m)+ Cable Loss (dB) – Pre-amplifier(dB).
3. Measurement (dBuV/m) = Reading(dBuV) + C.F (Correction Factor).
4. The emission levels of other frequencies are very lower than the limit and not show in test report.

| | | | |
|-----------|-------------------------------|----------------------|--------------|
| EUT | POS Terminal | Date of Test | 2023-10-28 |
| Factor | DRH18-E & BBHA 9170 | Temp. / Humidity | 23°C /61% |
| Polarity | Horizontal | Site / Test Engineer | AC2 / Marvin |
| Test Mode | 802.11a_TX_Band3_CH 140_ANT 0 | Test Voltage | AC 120V/60Hz |

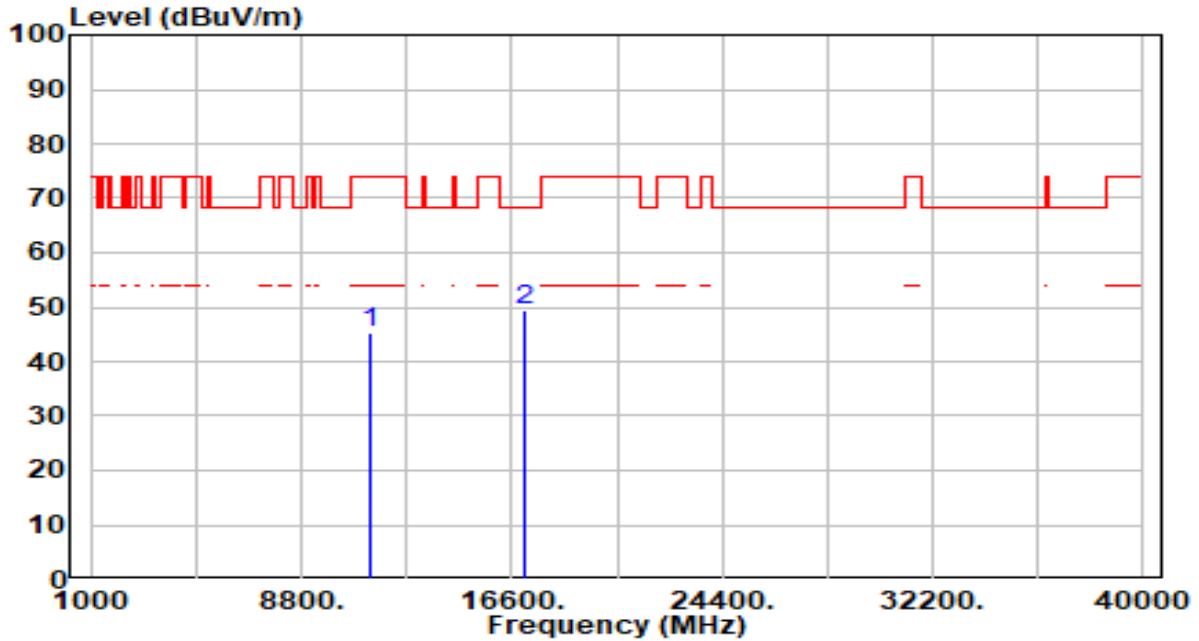

| No | Frequency (MHz) | Reading (dBuV) | C.F (dB/m) | Measurement (dBuV/m) | Margin (dB) | Limit (dBuV/m) | Height (cm) | Angle (deg) | Remark (QP/PK/AV) |
|----|-----------------|----------------|------------|----------------------|-------------|----------------|-------------|-------------|-------------------|
| 1 | 11400.000 | 41.94 | 3.48 | 45.42 | -28.58 | 74.00 | 100 | 130 | Peak |
| 2 | * 17100.000 | 44.45 | 4.79 | 49.25 | -18.95 | 68.20 | 100 | 173 | Peak |

Note:

- " *", means this data is the worst emission level.
- C.F (Correction Factor) = Antenna Factor (dB/m)+ Cable Loss (dB) – Pre-amplifier(dB).
- Measurement (dBuV/m) = Reading(dBuV) + C.F (Correction Factor).
- The emission levels of other frequencies are very lower than the limit and not show in test report.

| | | | |
|-----------|-------------------------------|----------------------|--------------|
| EUT | POS Terminal | Date of Test | 2023-10-28 |
| Factor | DRH18-E & BBHA 9170 | Temp. / Humidity | 23°C /61% |
| Polarity | Vertical | Site / Test Engineer | AC2 / Marvin |
| Test Mode | 802.11a_TX_Band3_CH 140_ANT 0 | Test Voltage | AC 120V/60Hz |

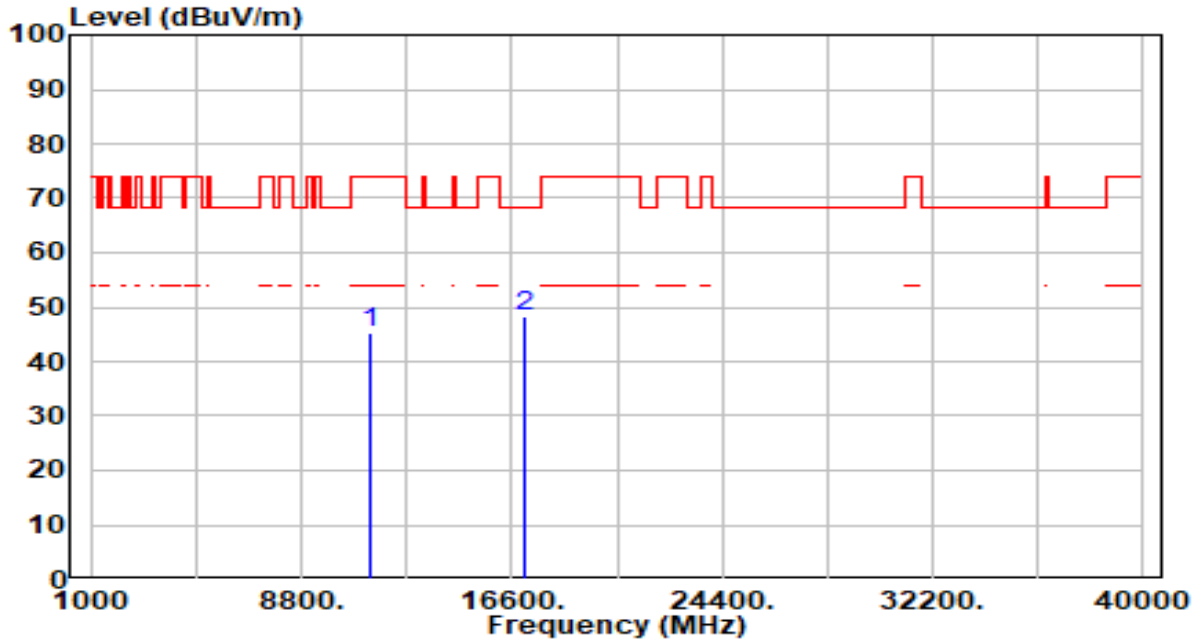

| No | Frequency (MHz) | Reading (dBuV) | C.F (dB/m) | Measurement (dBuV/m) | Margin (dB) | Limit (dBuV/m) | Height (cm) | Angle (deg) | Remark (QP/PK/AV) |
|----|-----------------|----------------|------------|----------------------|-------------|----------------|-------------|-------------|-------------------|
| 1 | 11400.000 | 41.80 | 3.48 | 45.28 | -28.72 | 74.00 | 100 | 159 | Peak |
| 2 | * 17100.000 | 43.45 | 4.79 | 48.24 | -19.96 | 68.20 | 100 | 283 | Peak |

Note:

- "*", means this data is the worst emission level.
- C.F (Correction Factor) = Antenna Factor (dB/m)+ Cable Loss (dB) – Pre-amplifier(dB).
- Measurement (dBuV/m) = Reading(dBuV) + C.F (Correction Factor).
- The emission levels of other frequencies are very lower than the limit and not show in test report.

| | | | |
|-----------|-------------------------------|----------------------|--------------|
| EUT | POS Terminal | Date of Test | 2023-10-28 |
| Factor | DRH18-E & BBHA 9170 | Temp. / Humidity | 23°C /61% |
| Polarity | Horizontal | Site / Test Engineer | AC2 / Marvin |
| Test Mode | 802.11a_TX_Band3_CH 144_ANT 0 | Test Voltage | AC 120V/60Hz |

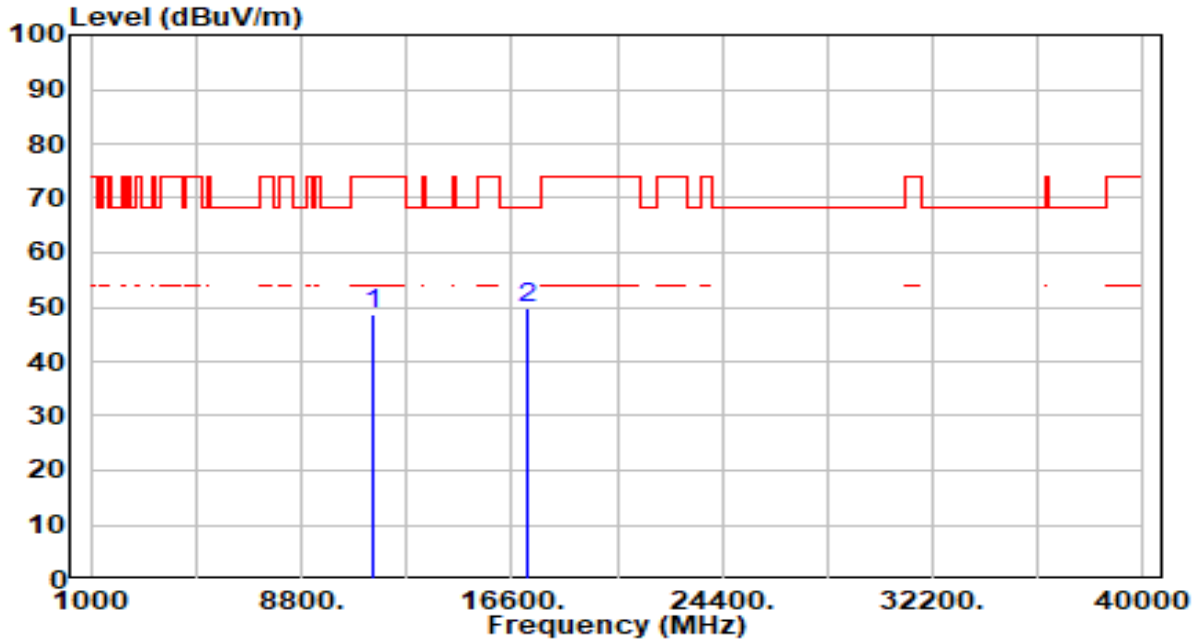

| No | Frequency (MHz) | Reading (dBuV) | C.F (dB/m) | Measurement (dBuV/m) | Margin (dB) | Limit (dBuV/m) | Height (cm) | Angle (deg) | Remark (QP/PK/AV) |
|----|-----------------|----------------|------------|----------------------|-------------|----------------|-------------|-------------|-------------------|
| 1 | 11440.000 | 45.18 | 3.52 | 48.70 | -25.30 | 74.00 | 100 | 274 | Peak |
| 2 | * 17160.000 | 45.09 | 4.66 | 49.75 | -18.45 | 68.20 | 100 | 246 | Peak |

Note:

- "*", means this data is the worst emission level.
- C.F (Correction Factor) = Antenna Factor (dB/m)+ Cable Loss (dB) – Pre-amplifier(dB).
- Measurement (dBuV/m) = Reading(dBuV) + C.F (Correction Factor).
- The emission levels of other frequencies are very lower than the limit and not show in test report.

| | | | |
|-----------|-------------------------------|----------------------|--------------|
| EUT | POS Terminal | Date of Test | 2023-10-28 |
| Factor | DRH18-E & BBHA 9170 | Temp. / Humidity | 23°C /61% |
| Polarity | Vertical | Site / Test Engineer | AC2 / Marvin |
| Test Mode | 802.11a_TX_Band3_CH 144_ANT 0 | Test Voltage | AC 120V/60Hz |

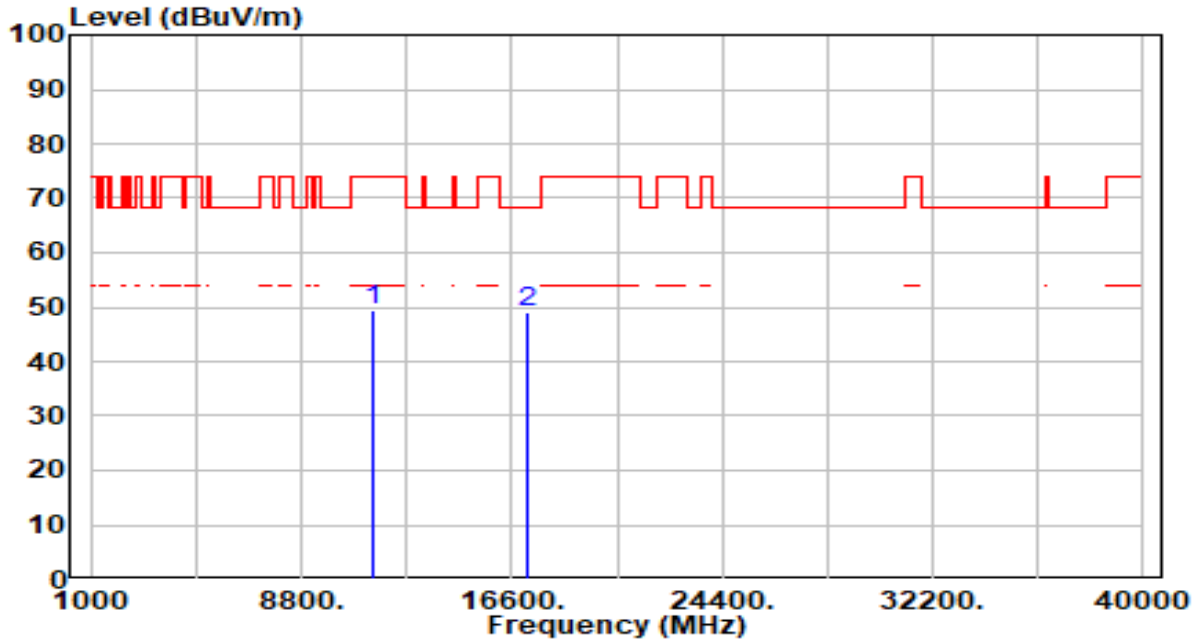

| No | Frequency (MHz) | Reading (dBuV) | C.F (dB/m) | Measurement (dBuV/m) | Margin (dB) | Limit (dBuV/m) | Height (cm) | Angle (deg) | Remark (QP/PK/AV) |
|----|-----------------|----------------|------------|----------------------|-------------|----------------|-------------|-------------|-------------------|
| 1 | 11440.000 | 45.91 | 3.52 | 49.43 | -24.57 | 74.00 | 100 | 346 | Peak |
| 2 | * 17160.000 | 44.51 | 4.66 | 49.17 | -19.03 | 68.20 | 100 | 150 | Peak |

Note:

- "*" means this data is the worst emission level.
- C.F (Correction Factor) = Antenna Factor (dB/m)+ Cable Loss (dB) – Pre-amplifier(dB).
- Measurement (dBuV/m) = Reading(dBuV) + C.F (Correction Factor).
- The emission levels of other frequencies are very lower than the limit and not show in test report.

| | | | |
|-----------|-------------------------------|----------------------|--------------|
| EUT | POS Terminal | Date of Test | 2023-10-28 |
| Factor | DRH18-E & BBHA 9170 | Temp. / Humidity | 23°C /61% |
| Polarity | Horizontal | Site / Test Engineer | AC2 / Marvin |
| Test Mode | 802.11a_TX_Band4_CH 149_ANT 0 | Test Voltage | AC 120V/60Hz |

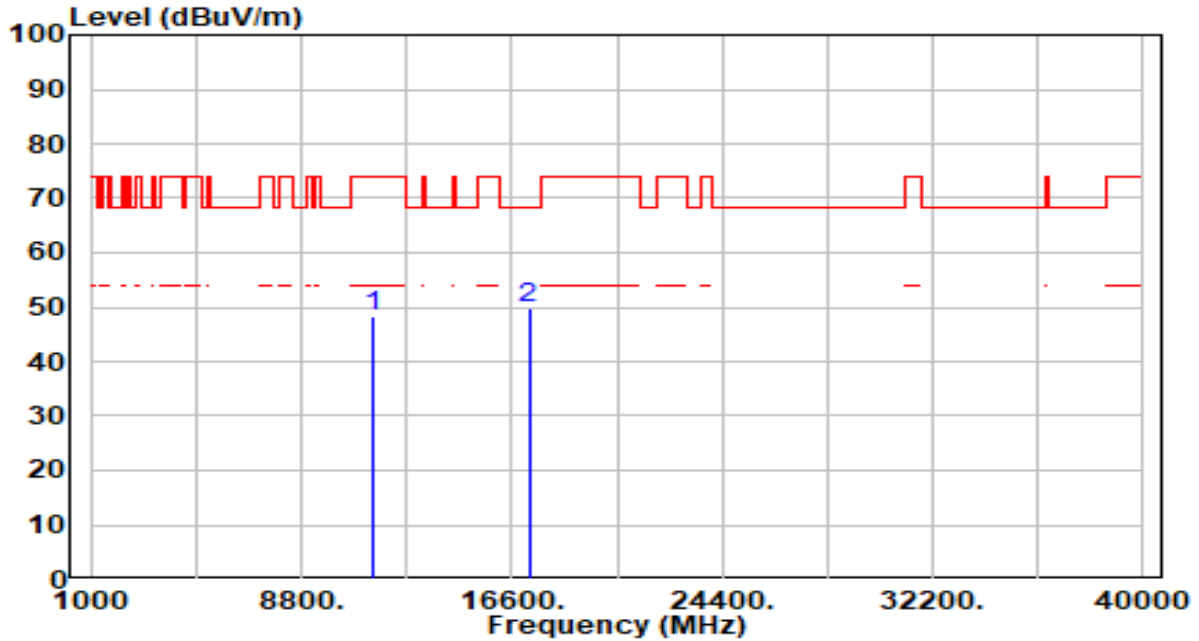

| No | Frequency (MHz) | Reading (dBuV) | C.F (dB/m) | Measurement (dBuV/m) | Margin (dB) | Limit (dBuV/m) | Height (cm) | Angle (deg) | Remark (QP/PK/AV) |
|----|-----------------|----------------|------------|----------------------|-------------|----------------|-------------|-------------|-------------------|
| 1 | 11490.000 | 44.71 | 3.57 | 48.28 | -25.72 | 74.00 | 100 | 249 | Peak |
| 2 | * 17235.000 | 45.28 | 4.45 | 49.73 | -18.47 | 68.20 | 100 | 235 | Peak |

Note:

- "*", means this data is the worst emission level.
- C.F (Correction Factor) = Antenna Factor (dB/m)+ Cable Loss (dB) – Pre-amplifier(dB).
- Measurement (dBuV/m) = Reading(dBuV) + C.F (Correction Factor).
- The emission levels of other frequencies are very lower than the limit and not show in test report.

| | | | |
|-----------|-------------------------------|----------------------|--------------|
| EUT | POS Terminal | Date of Test | 2023-10-28 |
| Factor | DRH18-E & BBHA 9170 | Temp. / Humidity | 23°C /61% |
| Polarity | Vertical | Site / Test Engineer | AC2 / Marvin |
| Test Mode | 802.11a_TX_Band4_CH 149_ANT 0 | Test Voltage | AC 120V/60Hz |

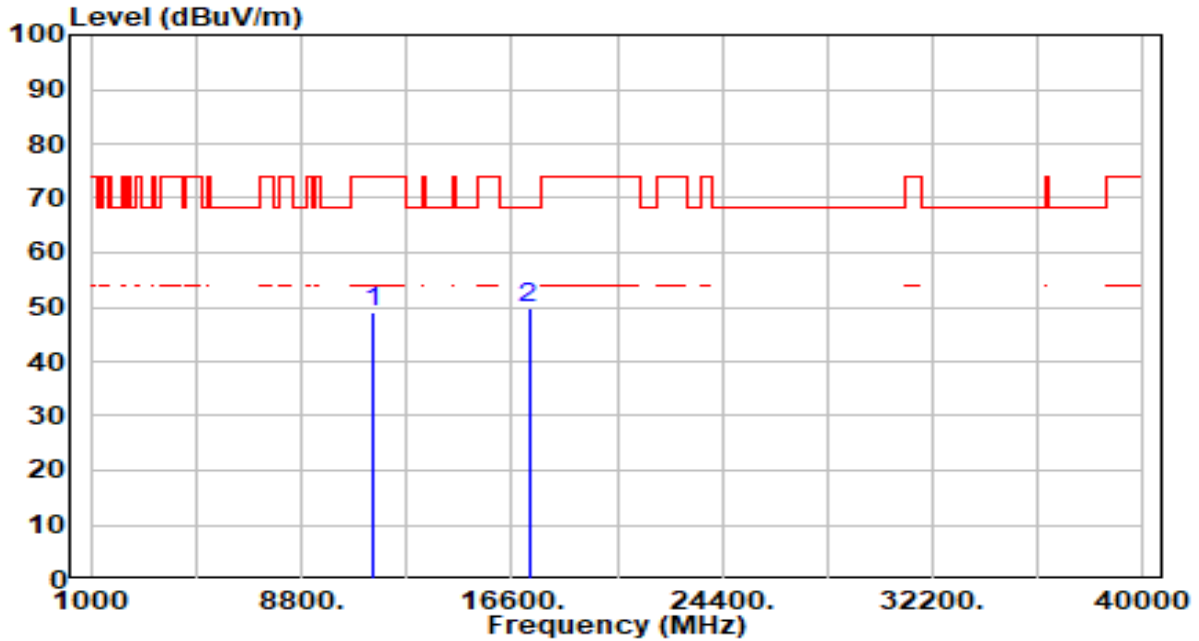

| No | Frequency (MHz) | Reading (dBuV) | C.F (dB/m) | Measurement (dBuV/m) | Margin (dB) | Limit (dBuV/m) | Height (cm) | Angle (deg) | Remark (QP/PK/AV) |
|----|-----------------|----------------|------------|----------------------|-------------|----------------|-------------|-------------|-------------------|
| 1 | 11490.000 | 45.62 | 3.57 | 49.18 | -24.82 | 74.00 | 100 | 349 | Peak |
| 2 | * 17235.000 | 45.26 | 4.45 | 49.71 | -18.49 | 68.20 | 300 | 360 | Peak |

Note:

- "*", means this data is the worst emission level.
- C.F (Correction Factor) = Antenna Factor (dB/m)+ Cable Loss (dB) – Pre-amplifier(dB).
- Measurement (dBuV/m) = Reading(dBuV) + C.F (Correction Factor).
- The emission levels of other frequencies are very lower than the limit and not show in test report.

| | | | |
|-----------|-------------------------------|----------------------|--------------|
| EUT | POS Terminal | Date of Test | 2023-10-28 |
| Factor | DRH18-E & BBHA 9170 | Temp. / Humidity | 23°C /61% |
| Polarity | Horizontal | Site / Test Engineer | AC2 / Marvin |
| Test Mode | 802.11a_TX_Band4_CH 157_ANT 0 | Test Voltage | AC 120V/60Hz |

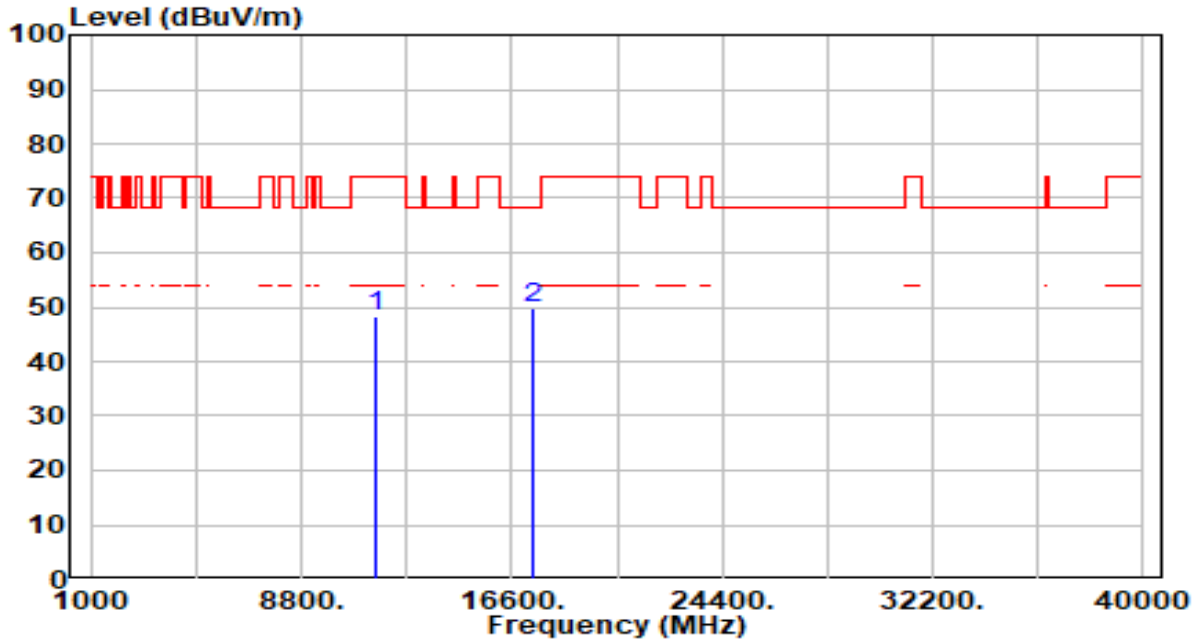

| No | Frequency (MHz) | Reading (dBuV) | C.F (dB/m) | Measurement (dBuV/m) | Margin (dB) | Limit (dBuV/m) | Height (cm) | Angle (deg) | Remark (QP/PK/AV) |
|----|-----------------|----------------|------------|----------------------|-------------|----------------|-------------|-------------|-------------------|
| 1 | 11570.000 | 44.69 | 3.65 | 48.34 | -25.66 | 74.00 | 100 | 276 | Peak |
| 2 | * 17355.000 | 45.79 | 4.06 | 49.85 | -18.35 | 68.20 | 100 | 0 | Peak |

Note:

- "*", means this data is the worst emission level.
- C.F (Correction Factor) = Antenna Factor (dB/m)+ Cable Loss (dB) – Pre-amplifier(dB).
- Measurement (dBuV/m) = Reading(dBuV) + C.F (Correction Factor).
- The emission levels of other frequencies are very lower than the limit and not show in test report.

| | | | |
|-----------|-------------------------------|----------------------|--------------|
| EUT | POS Terminal | Date of Test | 2023-10-28 |
| Factor | DRH18-E & BBHA 9170 | Temp. / Humidity | 23°C /61% |
| Polarity | Vertical | Site / Test Engineer | AC2 / Marvin |
| Test Mode | 802.11a_TX_Band4_CH 157_ANT 0 | Test Voltage | AC 120V/60Hz |

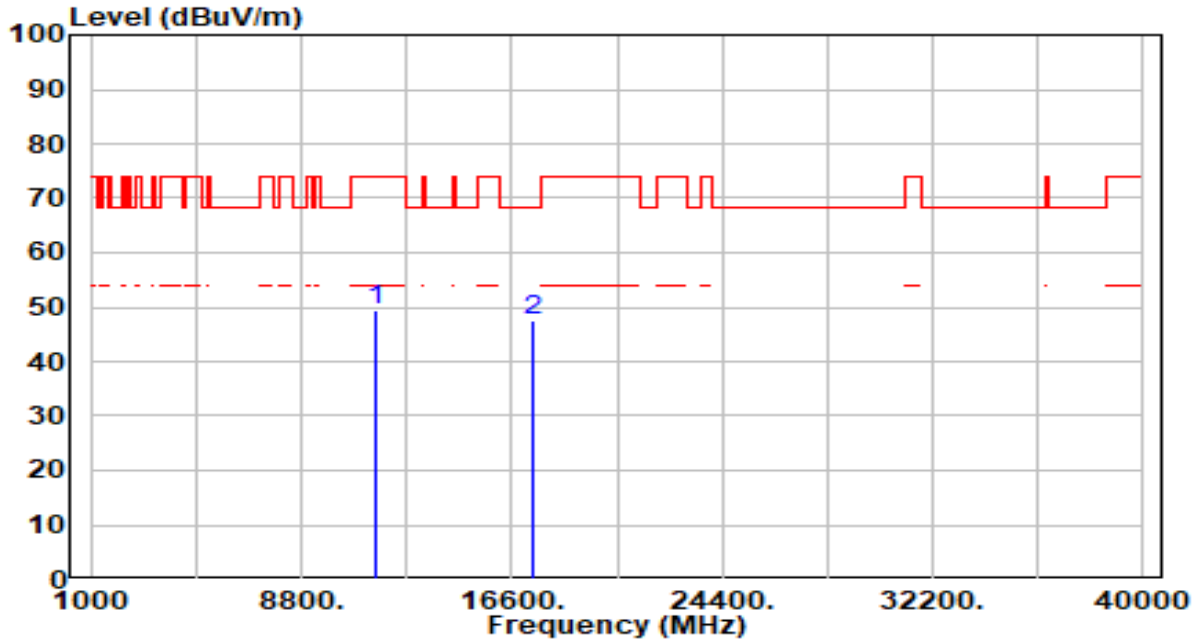

| No | Frequency (MHz) | Reading (dBuV) | C.F (dB/m) | Measurement (dBuV/m) | Margin (dB) | Limit (dBuV/m) | Height (cm) | Angle (deg) | Remark (QP/PK/AV) |
|----|-----------------|----------------|------------|----------------------|-------------|----------------|-------------|-------------|-------------------|
| 1 | 11570.000 | 45.72 | 3.65 | 49.37 | -24.63 | 74.00 | 100 | 0 | Peak |
| 2 | * 17355.000 | 43.54 | 4.06 | 47.60 | -20.60 | 68.20 | 100 | 8 | Peak |

Note:

- "*", means this data is the worst emission level.
- C.F (Correction Factor) = Antenna Factor (dB/m)+ Cable Loss (dB) – Pre-amplifier(dB).
- Measurement (dBuV/m) = Reading(dBuV) + C.F (Correction Factor).
- The emission levels of other frequencies are very lower than the limit and not show in test report.

| | | | |
|-----------|-------------------------------|----------------------|--------------|
| EUT | POS Terminal | Date of Test | 2023-10-28 |
| Factor | DRH18-E & BBHA 9170 | Temp. / Humidity | 23°C /61% |
| Polarity | Horizontal | Site / Test Engineer | AC2 / Marvin |
| Test Mode | 802.11a_TX_Band4_CH 165_ANT 0 | Test Voltage | AC 120V/60Hz |

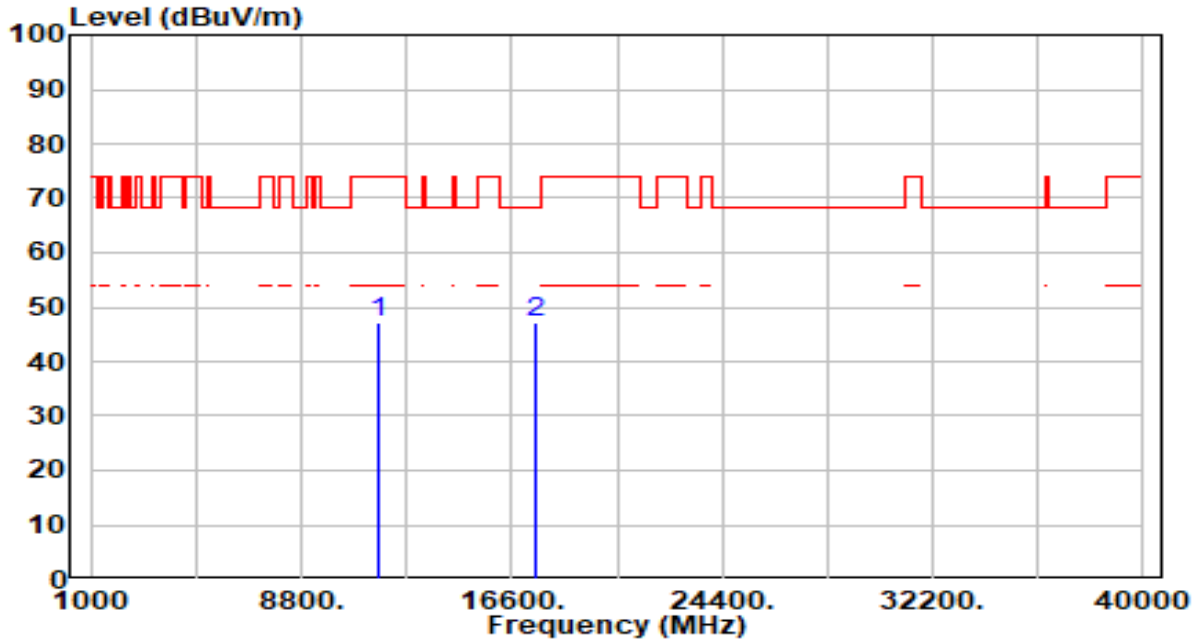

| No | Frequency (MHz) | Reading (dBuV) | C.F (dB/m) | Measurement (dBuV/m) | Margin (dB) | Limit (dBuV/m) | Height (cm) | Angle (deg) | Remark (QP/PK/AV) |
|----|-----------------|----------------|------------|----------------------|-------------|----------------|-------------|-------------|-------------------|
| 1 | 11650.000 | 43.62 | 3.66 | 47.28 | -26.72 | 74.00 | 100 | 274 | Peak |
| 2 | * 17475.000 | 43.45 | 3.89 | 47.35 | -20.85 | 68.20 | 100 | 36 | Peak |

Note:

1. " *", means this data is the worst emission level.
2. C.F (Correction Factor) = Antenna Factor (dB/m)+ Cable Loss (dB) – Pre-amplifier(dB).
3. Measurement (dBuV/m) = Reading(dBuV) + C.F (Correction Factor).
4. The emission levels of other frequencies are very lower than the limit and not show in test report.

| | | | |
|-----------|-------------------------------|----------------------|--------------|
| EUT | POS Terminal | Date of Test | 2023-10-28 |
| Factor | DRH18-E & BBHA 9170 | Temp. / Humidity | 23°C /61% |
| Polarity | Vertical | Site / Test Engineer | AC2 / Marvin |
| Test Mode | 802.11a_TX_Band4_CH 165_ANT 0 | Test Voltage | AC 120V/60Hz |

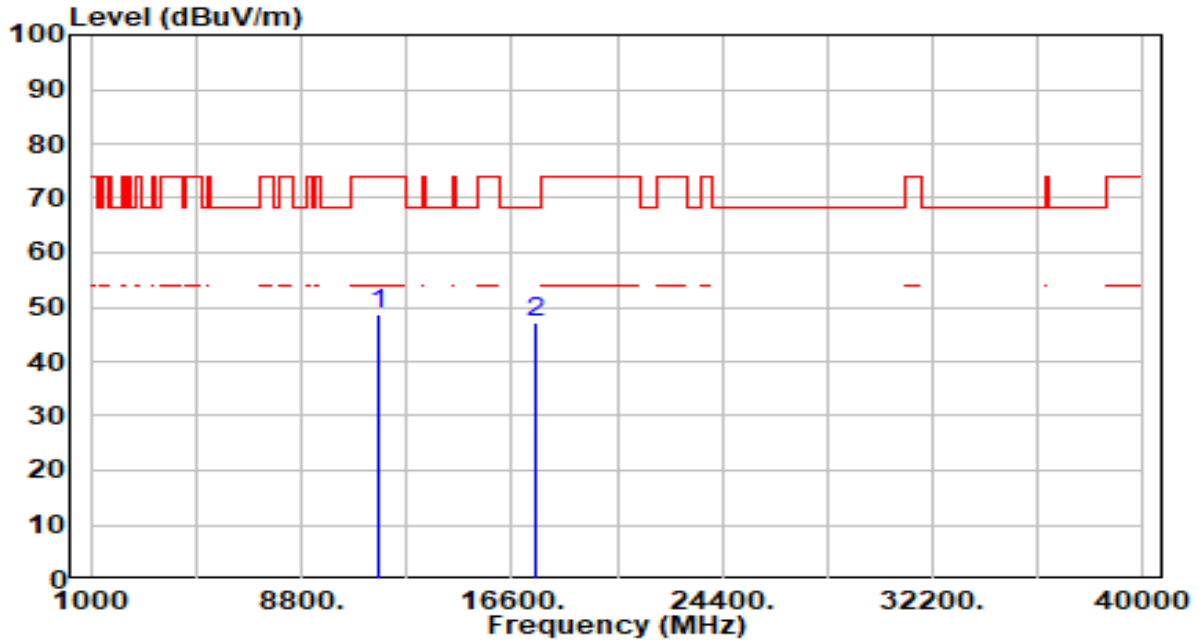

| No | Frequency (MHz) | Reading (dBuV) | C.F (dB/m) | Measurement (dBuV/m) | Margin (dB) | Limit (dBuV/m) | Height (cm) | Angle (deg) | Remark (QP/PK/AV) |
|----|-----------------|----------------|------------|----------------------|-------------|----------------|-------------|-------------|-------------------|
| 1 | 11650.000 | 45.07 | 3.66 | 48.73 | -25.27 | 74.00 | 100 | 360 | Peak |
| 2 | * 17475.000 | 43.24 | 3.89 | 47.13 | -21.07 | 68.20 | 100 | 322 | Peak |

Note:

- "*", means this data is the worst emission level.
- C.F (Correction Factor) = Antenna Factor (dB/m)+ Cable Loss (dB) – Pre-amplifier(dB).
- Measurement (dBuV/m) = Reading(dBuV) + C.F (Correction Factor).
- The emission levels of other frequencies are very lower than the limit and not show in test report.

| | | | |
|-----------|------------------------------------|----------------------|--------------|
| EUT | POS Terminal | Date of Test | 2023-10-28 |
| Factor | DRH18-E & BBHA 9170 | Temp. / Humidity | 23°C /61% |
| Polarity | Horizontal | Site / Test Engineer | AC2 / Marvin |
| Test Mode | 802.11n-20MHz_TX_Band1_CH 36_ANT 0 | Test Voltage | AC 120V/60Hz |

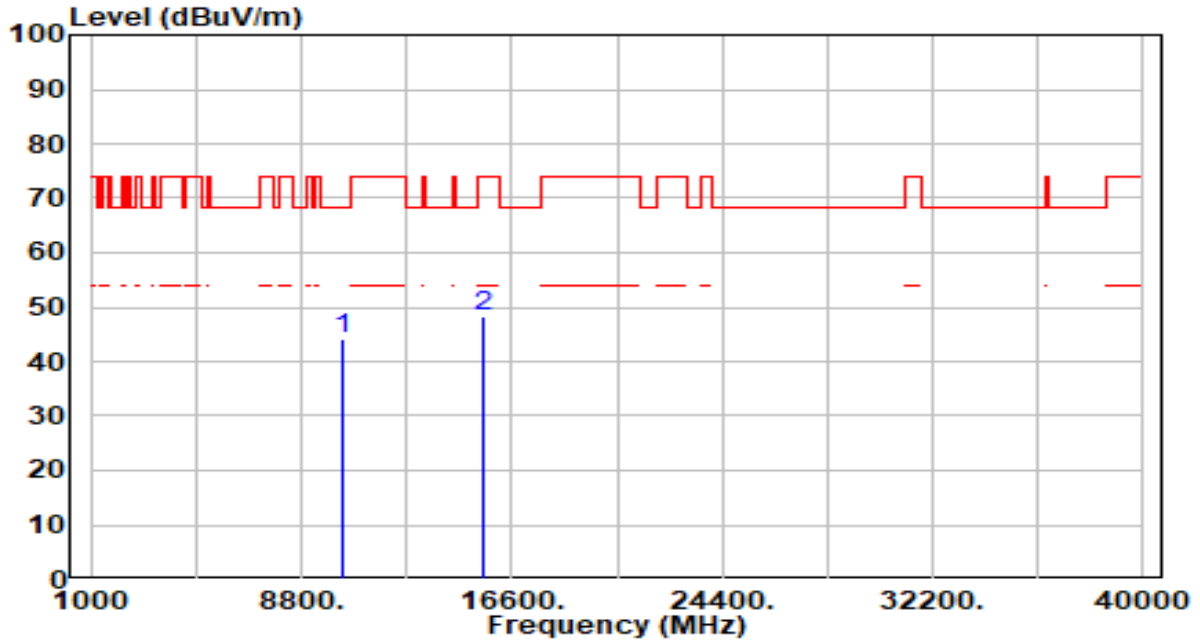

| No | Frequency (MHz) | Reading (dBuV) | C.F (dB/m) | Measurement (dBuV/m) | Margin (dB) | Limit (dBuV/m) | Height (cm) | Angle (deg) | Remark (QP/PK/AV) |
|----|-----------------|----------------|------------|----------------------|-------------|----------------|-------------|-------------|-------------------|
| 1 | * 10360.000 | 41.45 | 2.81 | 44.26 | -23.94 | 68.20 | 100 | 91 | Peak |
| 2 | 15540.000 | 43.76 | 4.52 | 48.28 | -25.72 | 74.00 | 100 | 355 | Peak |

Note:

1. " *", means this data is the worst emission level.
2. C.F (Correction Factor) = Antenna Factor (dB/m)+ Cable Loss (dB) – Pre-amplifier(dB).
3. Measurement (dBuV/m) = Reading(dBuV) + C.F (Correction Factor).
4. The emission levels of other frequencies are very lower than the limit and not show in test report.

| | | | |
|-----------|------------------------------------|----------------------|--------------|
| EUT | POS Terminal | Date of Test | 2023-10-28 |
| Factor | DRH18-E & BBHA 9170 | Temp. / Humidity | 23°C /61% |
| Polarity | Vertical | Site / Test Engineer | AC2 / Marvin |
| Test Mode | 802.11n-20MHz_TX_Band1_CH 36_ANT 0 | Test Voltage | AC 120V/60Hz |

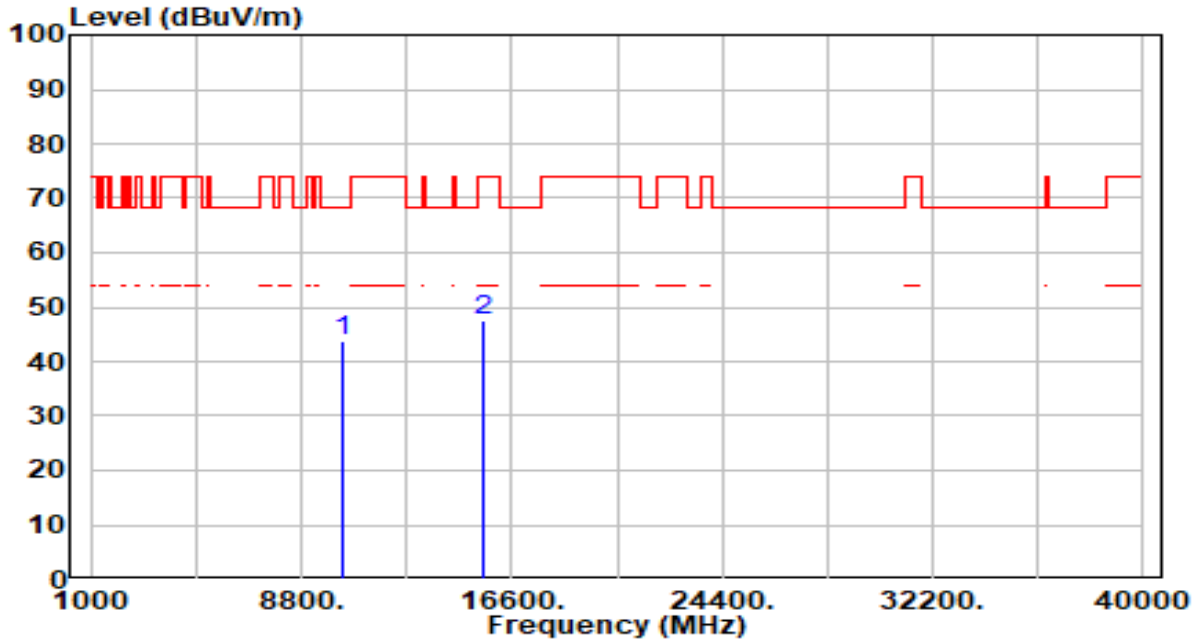

| No | Frequency (MHz) | Reading (dBuV) | C.F (dB/m) | Measurement (dBuV/m) | Margin (dB) | Limit (dBuV/m) | Height (cm) | Angle (deg) | Remark (QP/PK/AV) |
|----|-----------------|----------------|------------|----------------------|-------------|----------------|-------------|-------------|-------------------|
| 1 | * 10360.000 | 40.83 | 2.81 | 43.64 | -24.56 | 68.20 | 100 | 360 | Peak |
| 2 | 15540.000 | 42.87 | 4.52 | 47.39 | -26.61 | 74.00 | 100 | 17 | Peak |

Note:

- "*", means this data is the worst emission level.
- C.F (Correction Factor) = Antenna Factor (dB/m)+ Cable Loss (dB) – Pre-amplifier(dB).
- Measurement (dBuV/m) = Reading(dBuV) + C.F (Correction Factor).
- The emission levels of other frequencies are very lower than the limit and not show in test report.

| | | | |
|-----------|------------------------------------|----------------------|--------------|
| EUT | POS Terminal | Date of Test | 2023-10-28 |
| Factor | DRH18-E & BBHA 9170 | Temp. / Humidity | 23°C /61% |
| Polarity | Horizontal | Site / Test Engineer | AC2 / Marvin |
| Test Mode | 802.11n-20MHz_TX_Band1_CH 44_ANT 0 | Test Voltage | AC 120V/60Hz |

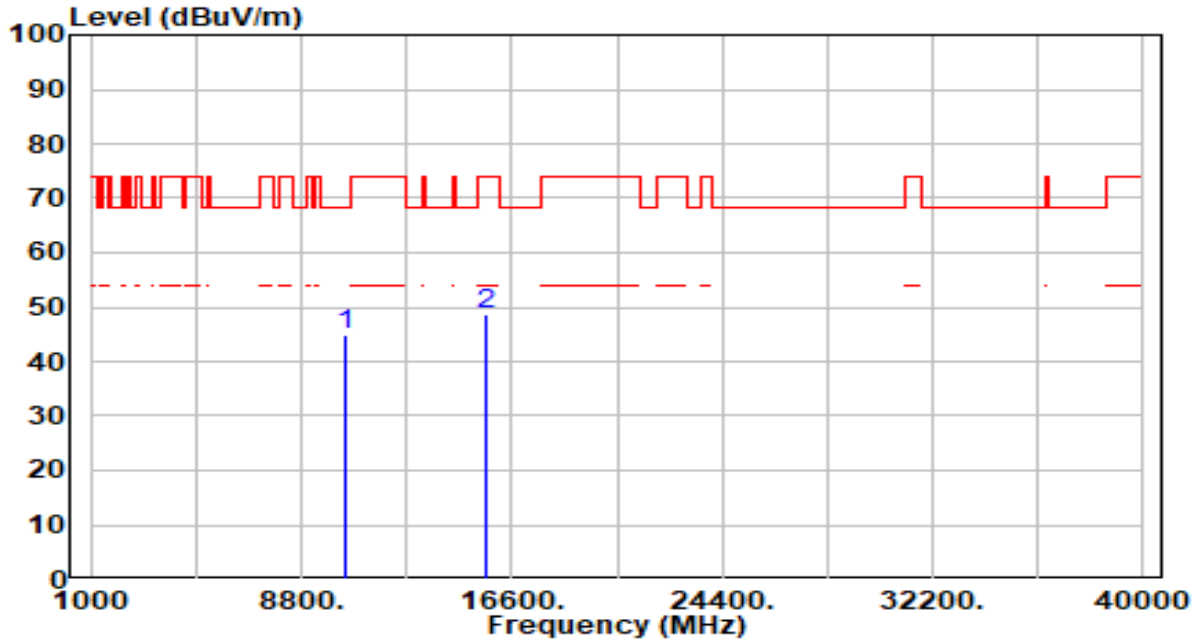

| No | Frequency (MHz) | Reading (dBuV) | C.F (dB/m) | Measurement (dBuV/m) | Margin (dB) | Limit (dBuV/m) | Height (cm) | Angle (deg) | Remark (QP/PK/AV) |
|----|-----------------|----------------|------------|----------------------|-------------|----------------|-------------|-------------|-------------------|
| 1 | * 10440.000 | 42.17 | 2.72 | 44.89 | -23.31 | 68.20 | 100 | 53 | Peak |
| 2 | 15660.000 | 43.97 | 4.67 | 48.64 | -25.36 | 74.00 | 100 | 93 | Peak |

Note:

- "*", means this data is the worst emission level.
- C.F (Correction Factor) = Antenna Factor (dB/m)+ Cable Loss (dB) – Pre-amplifier(dB).
- Measurement (dBuV/m) = Reading(dBuV) + C.F (Correction Factor).
- The emission levels of other frequencies are very lower than the limit and not show in test report.

| | | | |
|-----------|------------------------------------|----------------------|--------------|
| EUT | POS Terminal | Date of Test | 2023-10-28 |
| Factor | DRH18-E & BBHA 9170 | Temp. / Humidity | 23°C /61% |
| Polarity | Vertical | Site / Test Engineer | AC2 / Marvin |
| Test Mode | 802.11n-20MHz_TX_Band1_CH 44_ANT 0 | Test Voltage | AC 120V/60Hz |

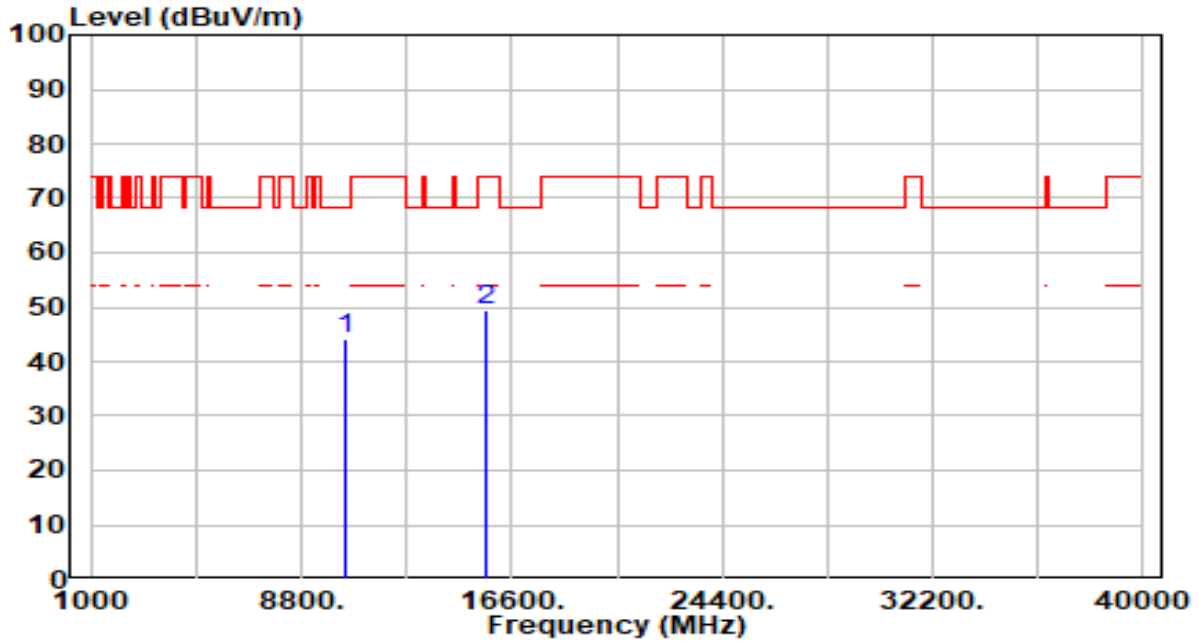

| No | Frequency (MHz) | Reading (dBuV) | C.F (dB/m) | Measurement (dBuV/m) | Margin (dB) | Limit (dBuV/m) | Height (cm) | Angle (deg) | Remark (QP/PK/AV) |
|----|-----------------|----------------|------------|----------------------|-------------|----------------|-------------|-------------|-------------------|
| 1 | * 10440.000 | 41.27 | 2.72 | 44.00 | -24.20 | 68.20 | 100 | 172 | Peak |
| 2 | 15660.000 | 44.75 | 4.67 | 49.43 | -24.57 | 74.00 | 100 | 96 | Peak |

Note:

- "*", means this data is the worst emission level.
- C.F (Correction Factor) = Antenna Factor (dB/m)+ Cable Loss (dB) – Pre-amplifier(dB).
- Measurement (dBuV/m) = Reading(dBuV) + C.F (Correction Factor).
- The emission levels of other frequencies are very lower than the limit and not show in test report.

| | | | |
|-----------|------------------------------------|----------------------|--------------|
| EUT | POS Terminal | Date of Test | 2023-10-28 |
| Factor | DRH18-E & BBHA 9170 | Temp. / Humidity | 23°C /61% |
| Polarity | Horizontal | Site / Test Engineer | AC2 / Marvin |
| Test Mode | 802.11n-20MHz_TX_Band1_CH 48_ANT 0 | Test Voltage | AC 120V/60Hz |

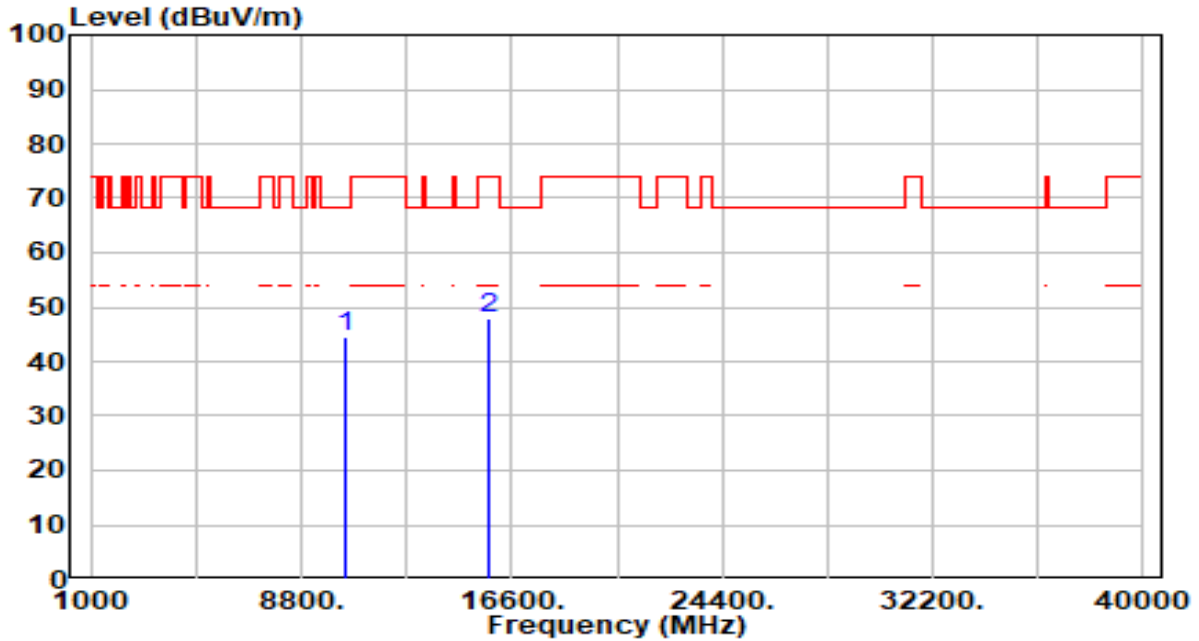

| No | Frequency (MHz) | Reading (dBuV) | C.F (dB/m) | Measurement (dBuV/m) | Margin (dB) | Limit (dBuV/m) | Height (cm) | Angle (deg) | Remark (QP/PK/AV) |
|----|-----------------|----------------|------------|----------------------|-------------|----------------|-------------|-------------|-------------------|
| 1 | * 10480.000 | 41.74 | 2.68 | 44.42 | -23.78 | 68.20 | 100 | 173 | Peak |
| 2 | 15720.000 | 43.19 | 4.84 | 48.03 | -25.97 | 74.00 | 100 | 190 | Peak |

Note:

- "*", means this data is the worst emission level.
- C.F (Correction Factor) = Antenna Factor (dB/m)+ Cable Loss (dB) – Pre-amplifier(dB).
- Measurement (dBuV/m) = Reading(dBuV) + C.F (Correction Factor).
- The emission levels of other frequencies are very lower than the limit and not show in test report.

| | | | |
|-----------|------------------------------------|----------------------|--------------|
| EUT | POS Terminal | Date of Test | 2023-10-28 |
| Factor | DRH18-E & BBHA 9170 | Temp. / Humidity | 23°C /61% |
| Polarity | Vertical | Site / Test Engineer | AC2 / Marvin |
| Test Mode | 802.11n-20MHz_TX_Band1_CH 48_ANT 0 | Test Voltage | AC 120V/60Hz |

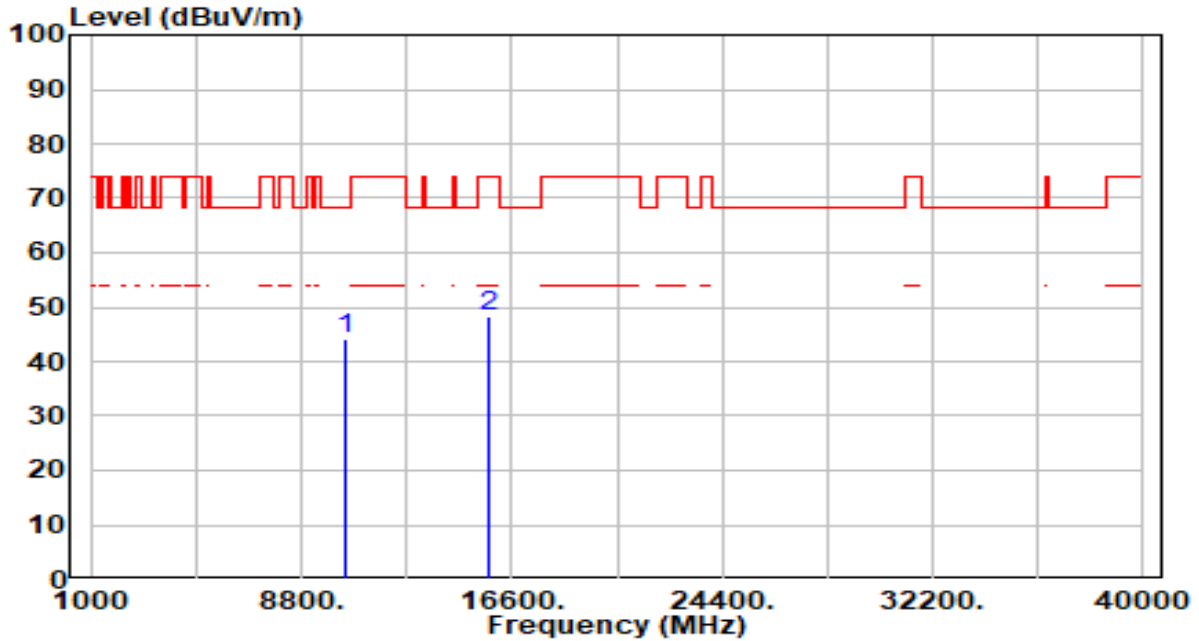

| No | Frequency (MHz) | Reading (dBuV) | C.F (dB/m) | Measurement (dBuV/m) | Margin (dB) | Limit (dBuV/m) | Height (cm) | Angle (deg) | Remark (QP/PK/AV) |
|----|-----------------|----------------|------------|----------------------|-------------|----------------|-------------|-------------|-------------------|
| 1 | * 10480.000 | 41.62 | 2.68 | 44.30 | -23.90 | 68.20 | 100 | 360 | Peak |
| 2 | 15720.000 | 43.39 | 4.84 | 48.23 | -25.77 | 74.00 | 100 | 203 | Peak |

Note:

- "*", means this data is the worst emission level.
- C.F (Correction Factor) = Antenna Factor (dB/m)+ Cable Loss (dB) – Pre-amplifier(dB).
- Measurement (dBuV/m) = Reading(dBuV) + C.F (Correction Factor).
- The emission levels of other frequencies are very lower than the limit and not show in test report.

| | | | |
|-----------|------------------------------------|----------------------|--------------|
| EUT | POS Terminal | Date of Test | 2023-10-28 |
| Factor | DRH18-E & BBHA 9170 | Temp. / Humidity | 23°C /61% |
| Polarity | Horizontal | Site / Test Engineer | AC2 / Marvin |
| Test Mode | 802.11n-20MHz_TX_Band2_CH 52_ANT 0 | Test Voltage | AC 120V/60Hz |

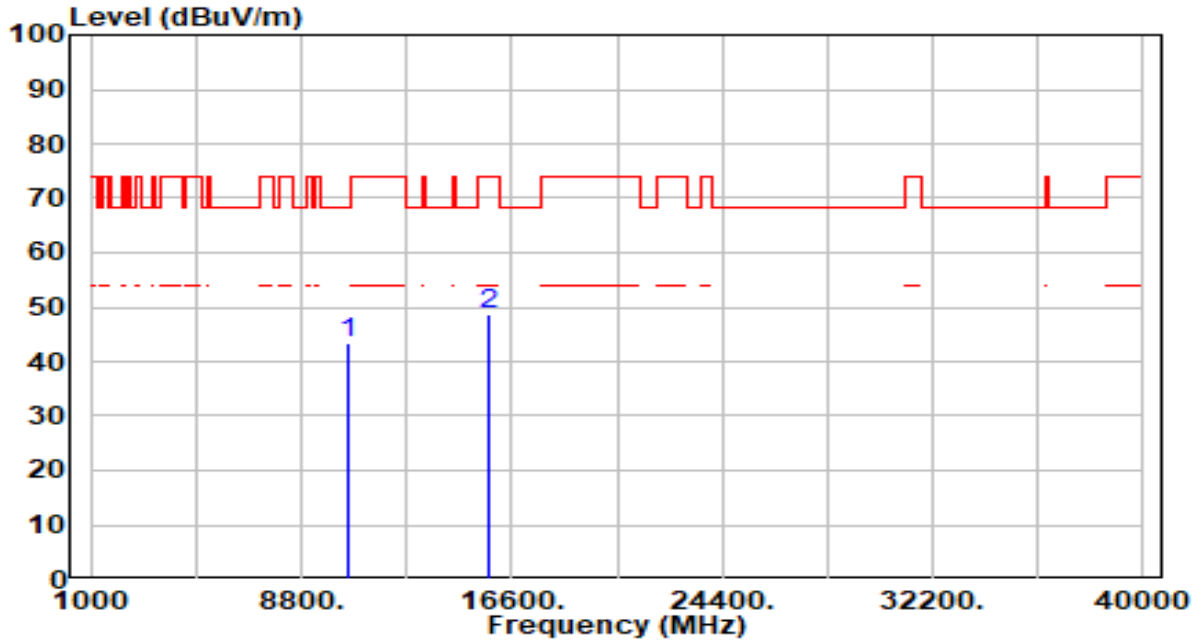

| No | Frequency (MHz) | Reading (dBuV) | C.F (dB/m) | Measurement (dBuV/m) | Margin (dB) | Limit (dBuV/m) | Height (cm) | Angle (deg) | Remark (QP/PK/AV) |
|----|-----------------|----------------|------------|----------------------|-------------|----------------|-------------|-------------|-------------------|
| 1 | * 10520.000 | 40.90 | 2.64 | 43.55 | -24.65 | 68.20 | 100 | 334 | Peak |
| 2 | 15780.000 | 43.53 | 5.00 | 48.53 | -25.47 | 74.00 | 100 | 136 | Peak |

Note:

- "*" means this data is the worst emission level.
- C.F (Correction Factor) = Antenna Factor (dB/m)+ Cable Loss (dB) – Pre-amplifier(dB).
- Measurement (dBuV/m) = Reading(dBuV) + C.F (Correction Factor).
- The emission levels of other frequencies are very lower than the limit and not show in test report.

| | | | |
|-----------|------------------------------------|----------------------|--------------|
| EUT | POS Terminal | Date of Test | 2023-10-28 |
| Factor | DRH18-E & BBHA 9170 | Temp. / Humidity | 23°C /61% |
| Polarity | Vertical | Site / Test Engineer | AC2 / Marvin |
| Test Mode | 802.11n-20MHz_TX_Band2_CH 52_ANT 0 | Test Voltage | AC 120V/60Hz |

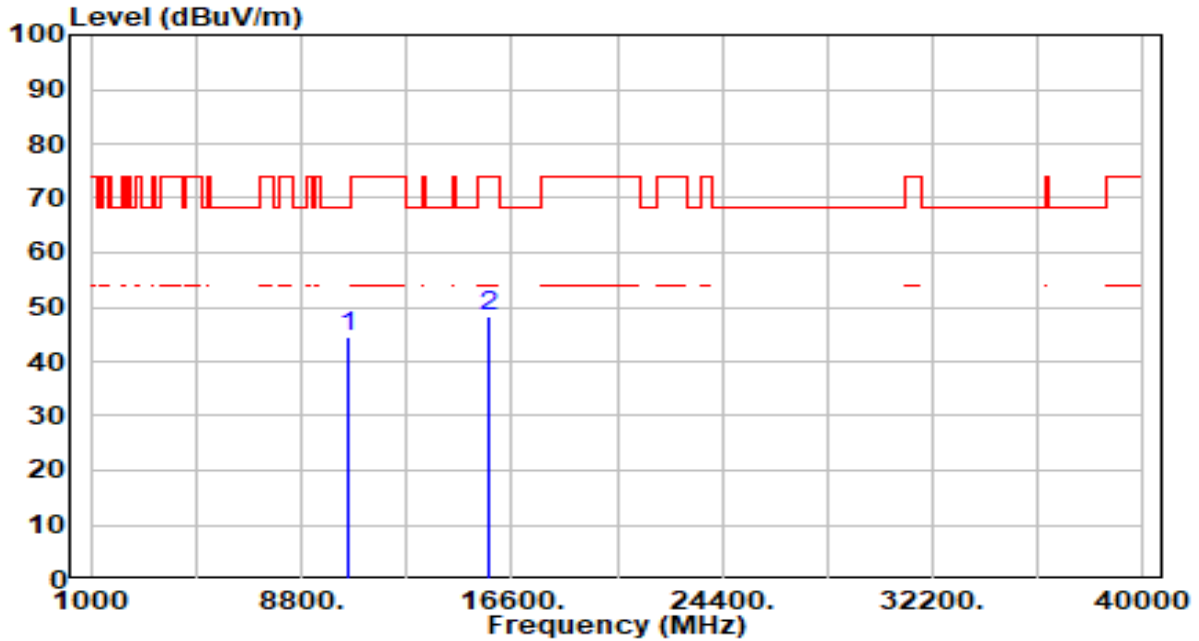

| No | Frequency (MHz) | Reading (dBuV) | C.F (dB/m) | Measurement (dBuV/m) | Margin (dB) | Limit (dBuV/m) | Height (cm) | Angle (deg) | Remark (QP/PK/AV) |
|----|-----------------|----------------|------------|----------------------|-------------|----------------|-------------|-------------|-------------------|
| 1 | * 10520.000 | 41.91 | 2.64 | 44.55 | -23.65 | 68.20 | 100 | 360 | Peak |
| 2 | 15780.000 | 43.27 | 5.00 | 48.27 | -25.73 | 74.00 | 100 | 23 | Peak |

Note:

- "*", means this data is the worst emission level.
- C.F (Correction Factor) = Antenna Factor (dB/m)+ Cable Loss (dB) – Pre-amplifier(dB).
- Measurement (dBuV/m) = Reading(dBuV) + C.F (Correction Factor).
- The emission levels of other frequencies are very lower than the limit and not show in test report.

| | | | |
|-----------|------------------------------------|----------------------|--------------|
| EUT | POS Terminal | Date of Test | 2023-10-28 |
| Factor | DRH18-E & BBHA 9170 | Temp. / Humidity | 23°C /61% |
| Polarity | Horizontal | Site / Test Engineer | AC2 / Marvin |
| Test Mode | 802.11n-20MHz_TX_Band2_CH 60_ANT 0 | Test Voltage | AC 120V/60Hz |

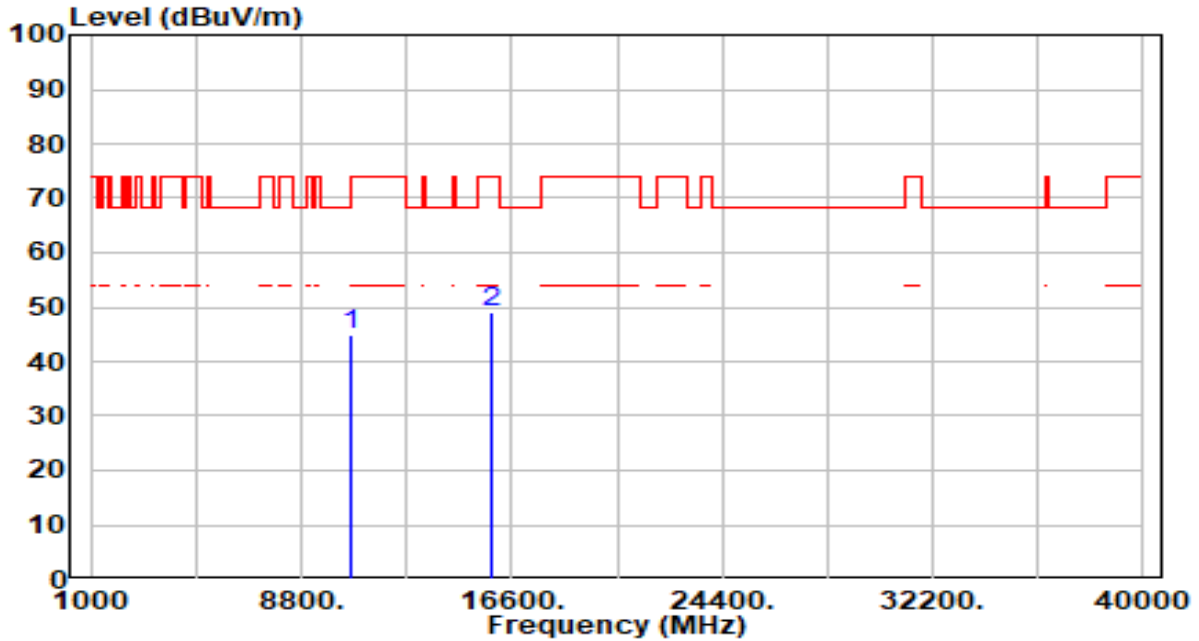

| No | Frequency (MHz) | Reading (dBuV) | C.F (dB/m) | Measurement (dBuV/m) | Margin (dB) | Limit (dBuV/m) | Height (cm) | Angle (deg) | Remark (QP/PK/AV) |
|----|-----------------|----------------|------------|----------------------|-------------|----------------|-------------|-------------|-------------------|
| 1 | * 10600.000 | 42.22 | 2.60 | 44.83 | -23.37 | 68.20 | 100 | 360 | Peak |
| 2 | 15900.000 | 44.02 | 5.13 | 49.15 | -24.85 | 74.00 | 100 | 267 | Peak |

Note:

1. " *", means this data is the worst emission level.
2. C.F (Correction Factor) = Antenna Factor (dB/m)+ Cable Loss (dB) – Pre-amplifier(dB).
3. Measurement (dBuV/m) = Reading(dBuV) + C.F (Correction Factor).
4. The emission levels of other frequencies are very lower than the limit and not show in test report.

| | | | |
|-----------|------------------------------------|----------------------|--------------|
| EUT | POS Terminal | Date of Test | 2023-10-28 |
| Factor | DRH18-E & BBHA 9170 | Temp. / Humidity | 23°C /61% |
| Polarity | Vertical | Site / Test Engineer | AC2 / Marvin |
| Test Mode | 802.11n-20MHz_TX_Band2_CH 60_ANT 0 | Test Voltage | AC 120V/60Hz |

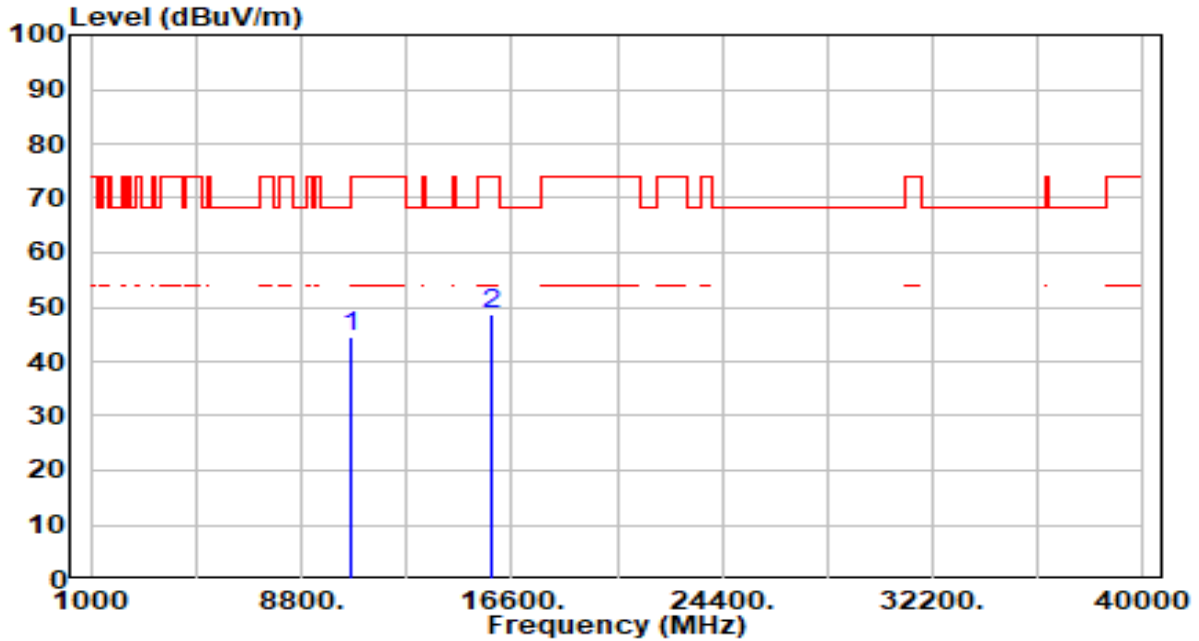

| No | Frequency (MHz) | Reading (dBuV) | C.F (dB/m) | Measurement (dBuV/m) | Margin (dB) | Limit (dBuV/m) | Height (cm) | Angle (deg) | Remark (QP/PK/AV) |
|----|-----------------|----------------|------------|----------------------|-------------|----------------|-------------|-------------|-------------------|
| 1 | * 10600.000 | 41.95 | 2.60 | 44.56 | -23.64 | 68.20 | 100 | 174 | Peak |
| 2 | 15900.000 | 43.40 | 5.13 | 48.53 | -25.47 | 74.00 | 100 | 232 | Peak |

Note:

- "*", means this data is the worst emission level.
- C.F (Correction Factor) = Antenna Factor (dB/m)+ Cable Loss (dB) – Pre-amplifier(dB).
- Measurement (dBuV/m) = Reading(dBuV) + C.F (Correction Factor).
- The emission levels of other frequencies are very lower than the limit and not show in test report.

| | | | |
|-----------|------------------------------------|----------------------|--------------|
| EUT | POS Terminal | Date of Test | 2023-10-28 |
| Factor | DRH18-E & BBHA 9170 | Temp. / Humidity | 23°C /61% |
| Polarity | Horizontal | Site / Test Engineer | AC2 / Marvin |
| Test Mode | 802.11n-20MHz_TX_Band2_CH 64_ANT 0 | Test Voltage | AC 120V/60Hz |

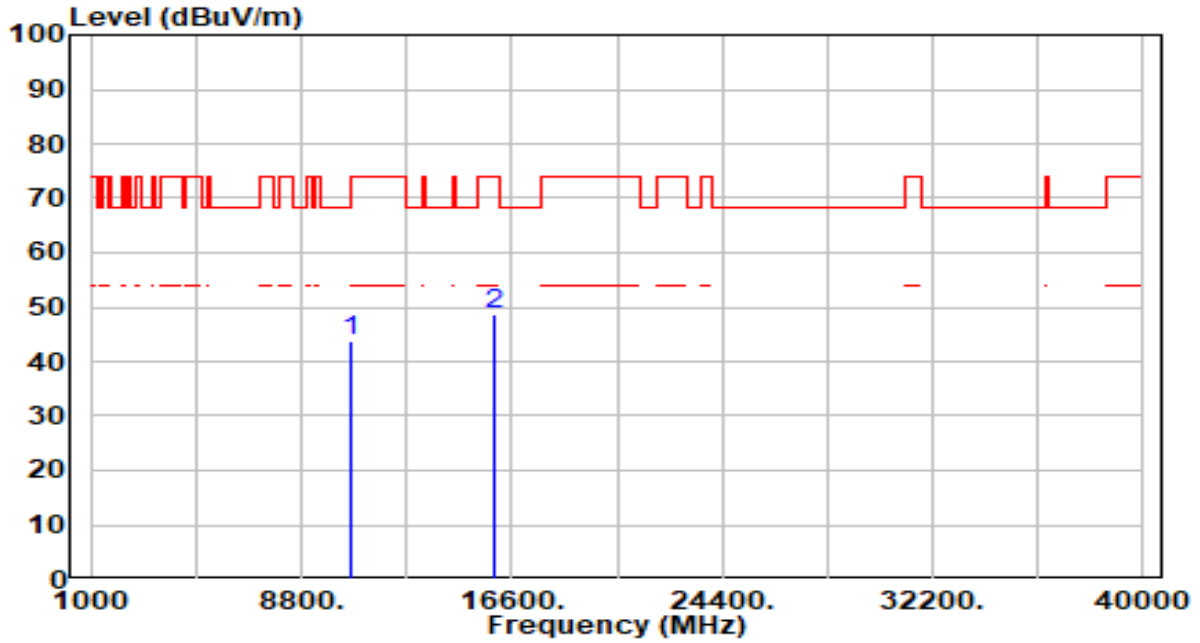

| No | Frequency (MHz) | Reading (dBuV) | C.F (dB/m) | Measurement (dBuV/m) | Margin (dB) | Limit (dBuV/m) | Height (cm) | Angle (deg) | Remark (QP/PK/AV) |
|----|-----------------|----------------|------------|----------------------|-------------|----------------|-------------|-------------|-------------------|
| 1 | 10640.000 | 41.30 | 2.62 | 43.93 | -30.07 | 74.00 | 100 | 0 | Peak |
| 2 | * 15960.000 | 43.56 | 5.17 | 48.73 | -25.27 | 74.00 | 100 | 0 | Peak |

Note:

- " *", means this data is the worst emission level.
- C.F (Correction Factor) = Antenna Factor (dB/m)+ Cable Loss (dB) – Pre-amplifier(dB).
- Measurement (dBuV/m) = Reading(dBuV) + C.F (Correction Factor).
- The emission levels of other frequencies are very lower than the limit and not show in test report.

| | | | |
|-----------|------------------------------------|----------------------|--------------|
| EUT | POS Terminal | Date of Test | 2023-10-28 |
| Factor | DRH18-E & BBHA 9170 | Temp. / Humidity | 23°C /61% |
| Polarity | Vertical | Site / Test Engineer | AC2 / Marvin |
| Test Mode | 802.11n-20MHz_TX_Band2_CH 64_ANT 0 | Test Voltage | AC 120V/60Hz |

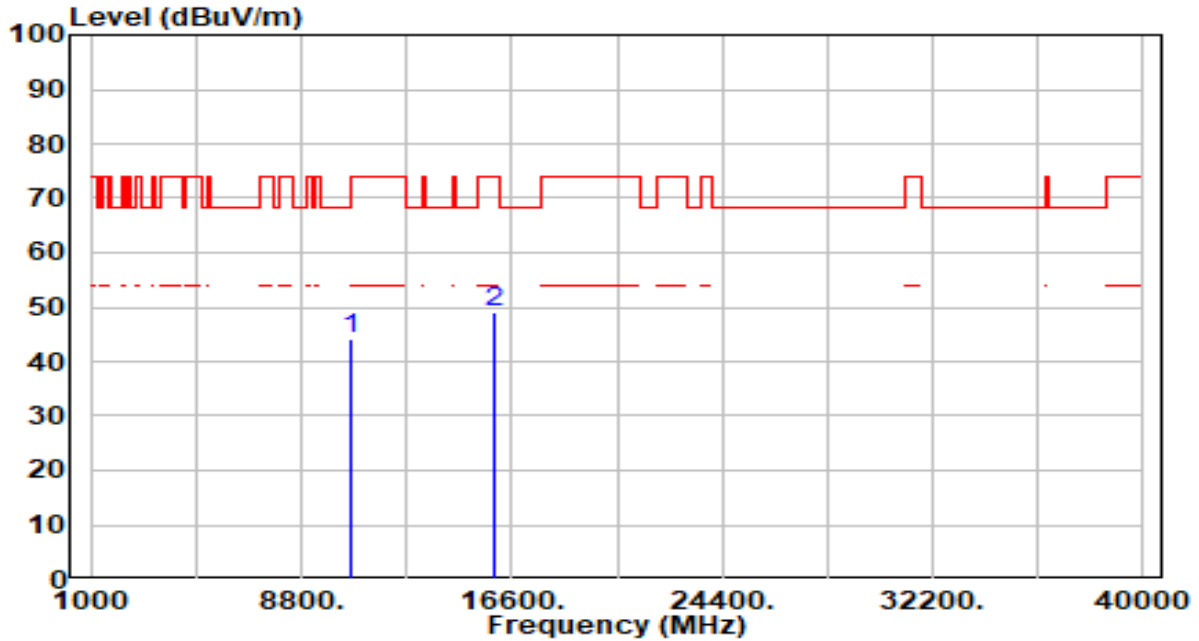

| No | Frequency (MHz) | Reading (dBuV) | C.F (dB/m) | Measurement (dBuV/m) | Margin (dB) | Limit (dBuV/m) | Height (cm) | Angle (deg) | Remark (QP/PK/AV) |
|----|-----------------|----------------|------------|----------------------|-------------|----------------|-------------|-------------|-------------------|
| 1 | 10640.000 | 41.40 | 2.62 | 44.02 | -29.98 | 74.00 | 100 | 209 | Peak |
| 2 | * 15960.000 | 43.74 | 5.17 | 48.92 | -25.08 | 74.00 | 100 | 360 | Peak |

Note:

- "*", means this data is the worst emission level.
- C.F (Correction Factor) = Antenna Factor (dB/m)+ Cable Loss (dB) – Pre-amplifier(dB).
- Measurement (dBuV/m) = Reading(dBuV) + C.F (Correction Factor).
- The emission levels of other frequencies are very lower than the limit and not show in test report.

| | | | |
|-----------|-------------------------------------|----------------------|--------------|
| EUT | POS Terminal | Date of Test | 2023-10-28 |
| Factor | DRH18-E & BBHA 9170 | Temp. / Humidity | 23°C /61% |
| Polarity | Horizontal | Site / Test Engineer | AC2 / Marvin |
| Test Mode | 802.11n-20MHz_TX_Band3_CH 100_ANT 0 | Test Voltage | AC 120V/60Hz |

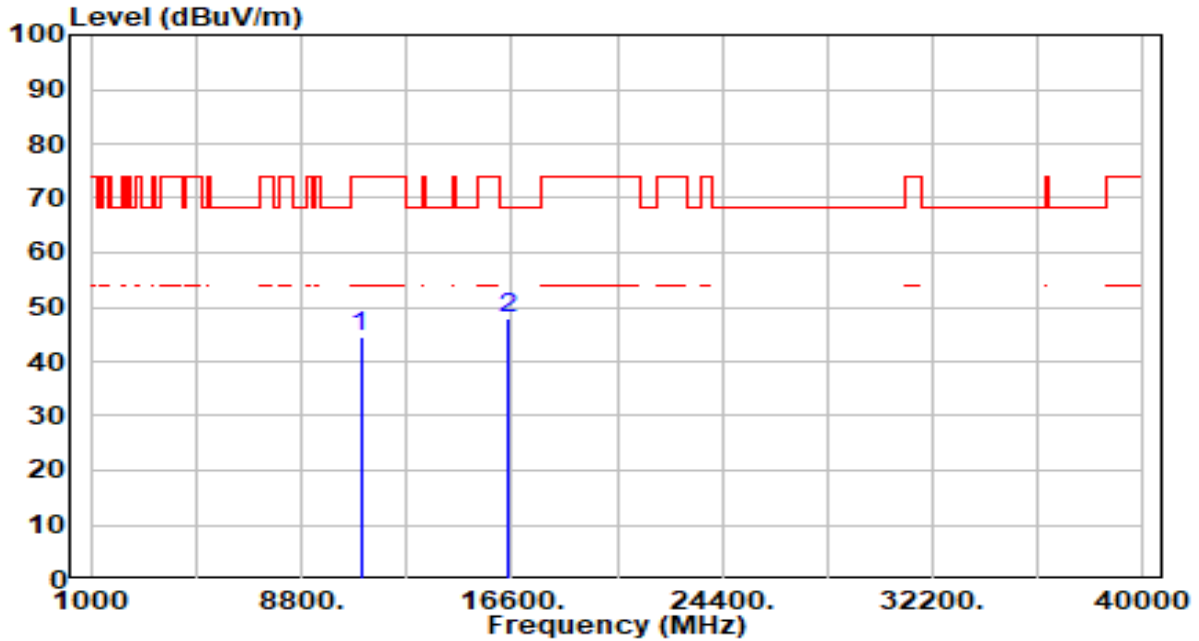

| No | Frequency (MHz) | Reading (dBuV) | C.F (dB/m) | Measurement (dBuV/m) | Margin (dB) | Limit (dBuV/m) | Height (cm) | Angle (deg) | Remark (QP/PK/AV) |
|----|-----------------|----------------|------------|----------------------|-------------|----------------|-------------|-------------|-------------------|
| 1 | 11000.000 | 41.86 | 2.60 | 44.46 | -29.54 | 74.00 | 100 | 187 | Peak |
| 2 | * 16500.000 | 43.32 | 4.63 | 47.95 | -20.25 | 68.20 | 100 | 24 | Peak |

Note:

- "*", means this data is the worst emission level.
- C.F (Correction Factor) = Antenna Factor (dB/m)+ Cable Loss (dB) – Pre-amplifier(dB).
- Measurement (dBuV/m) = Reading(dBuV) + C.F (Correction Factor).
- The emission levels of other frequencies are very lower than the limit and not show in test report.

| | | | |
|-----------|-------------------------------------|----------------------|--------------|
| EUT | POS Terminal | Date of Test | 2023-10-28 |
| Factor | DRH18-E & BBHA 9170 | Temp. / Humidity | 23°C /61% |
| Polarity | Vertical | Site / Test Engineer | AC2 / Marvin |
| Test Mode | 802.11n-20MHz_TX_Band3_CH 100_ANT 0 | Test Voltage | AC 120V/60Hz |

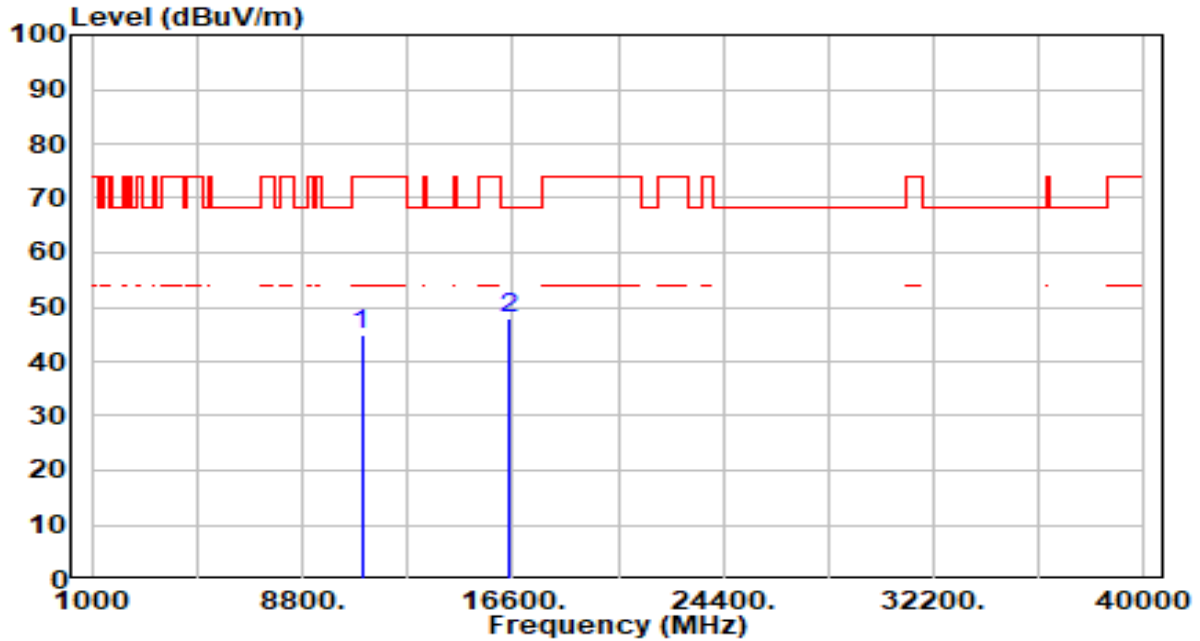

| No | Frequency (MHz) | Reading (dBuV) | C.F (dB/m) | Measurement (dBuV/m) | Margin (dB) | Limit (dBuV/m) | Height (cm) | Angle (deg) | Remark (QP/PK/AV) |
|----|-----------------|----------------|------------|----------------------|-------------|----------------|-------------|-------------|-------------------|
| 1 | 11000.000 | 42.21 | 2.60 | 44.81 | -29.19 | 74.00 | 100 | 214 | Peak |
| 2 | * 16500.000 | 43.32 | 4.63 | 47.95 | -20.25 | 68.20 | 100 | 92 | Peak |

Note:

1. " *", means this data is the worst emission level.
2. C.F (Correction Factor) = Antenna Factor (dB/m)+ Cable Loss (dB) – Pre-amplifier(dB).
3. Measurement (dBuV/m) = Reading(dBuV) + C.F (Correction Factor).
4. The emission levels of other frequencies are very lower than the limit and not show in test report.

| | | | |
|-----------|-------------------------------------|----------------------|--------------|
| EUT | POS Terminal | Date of Test | 2023-10-28 |
| Factor | DRH18-E & BBHA 9170 | Temp. / Humidity | 23°C /61% |
| Polarity | Horizontal | Site / Test Engineer | AC2 / Marvin |
| Test Mode | 802.11n-20MHz_TX_Band3_CH 116_ANT 0 | Test Voltage | AC 120V/60Hz |

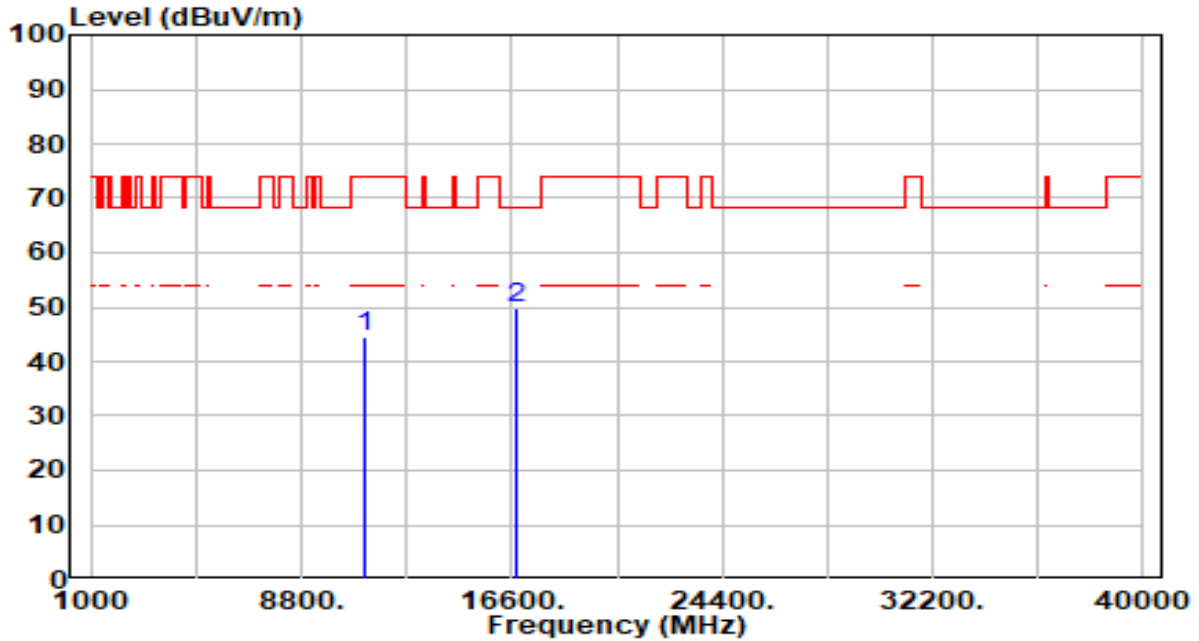

| No | Frequency (MHz) | Reading (dBuV) | C.F (dB/m) | Measurement (dBuV/m) | Margin (dB) | Limit (dBuV/m) | Height (cm) | Angle (deg) | Remark (QP/PK/AV) |
|----|-----------------|----------------|------------|----------------------|-------------|----------------|-------------|-------------|-------------------|
| 1 | 11160.000 | 41.39 | 3.07 | 44.46 | -29.54 | 74.00 | 100 | 0 | Peak |
| 2 | * 16740.000 | 45.33 | 4.66 | 49.99 | -18.21 | 68.20 | 100 | 243 | Peak |

Note:

1. " *", means this data is the worst emission level.
2. C.F (Correction Factor) = Antenna Factor (dB/m)+ Cable Loss (dB) – Pre-amplifier(dB).
3. Measurement (dBuV/m) = Reading(dBuV) + C.F (Correction Factor).
4. The emission levels of other frequencies are very lower than the limit and not show in test report.

| | | | |
|-----------|-------------------------------------|----------------------|--------------|
| EUT | POS Terminal | Date of Test | 2023-10-28 |
| Factor | DRH18-E & BBHA 9170 | Temp. / Humidity | 23°C /61% |
| Polarity | Vertical | Site / Test Engineer | AC2 / Marvin |
| Test Mode | 802.11n-20MHz_TX_Band3_CH 116_ANT 0 | Test Voltage | AC 120V/60Hz |

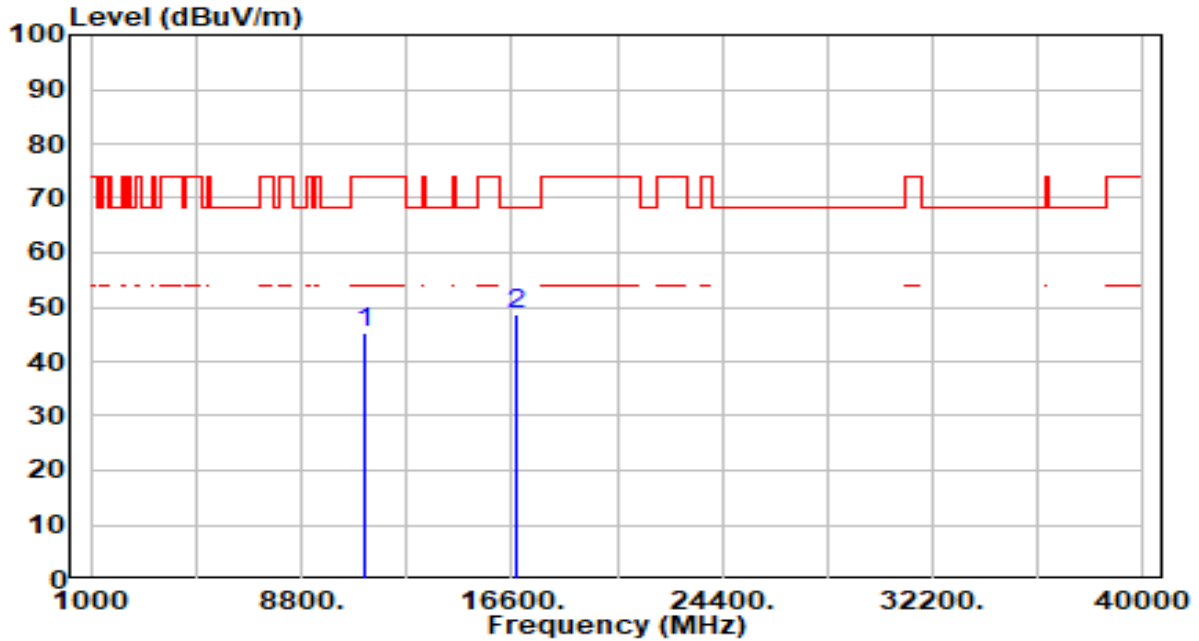

| No | Frequency (MHz) | Reading (dBuV) | C.F (dB/m) | Measurement (dBuV/m) | Margin (dB) | Limit (dBuV/m) | Height (cm) | Angle (deg) | Remark (QP/PK/AV) |
|----|-----------------|----------------|------------|----------------------|-------------|----------------|-------------|-------------|-------------------|
| 1 | 11160.000 | 42.03 | 3.07 | 45.10 | -28.90 | 74.00 | 100 | 168 | Peak |
| 2 | * 16740.000 | 43.92 | 4.66 | 48.58 | -19.62 | 68.20 | 100 | 160 | Peak |

Note:

1. " *", means this data is the worst emission level.
2. C.F (Correction Factor) = Antenna Factor (dB/m)+ Cable Loss (dB) – Pre-amplifier(dB).
3. Measurement (dBuV/m) = Reading(dBuV) + C.F (Correction Factor).
4. The emission levels of other frequencies are very lower than the limit and not show in test report.

| | | | |
|-----------|-------------------------------------|----------------------|--------------|
| EUT | POS Terminal | Date of Test | 2023-10-28 |
| Factor | DRH18-E & BBHA 9170 | Temp. / Humidity | 23°C /61% |
| Polarity | Horizontal | Site / Test Engineer | AC2 / Marvin |
| Test Mode | 802.11n-20MHz_TX_Band3_CH 140_ANT 0 | Test Voltage | AC 120V/60Hz |

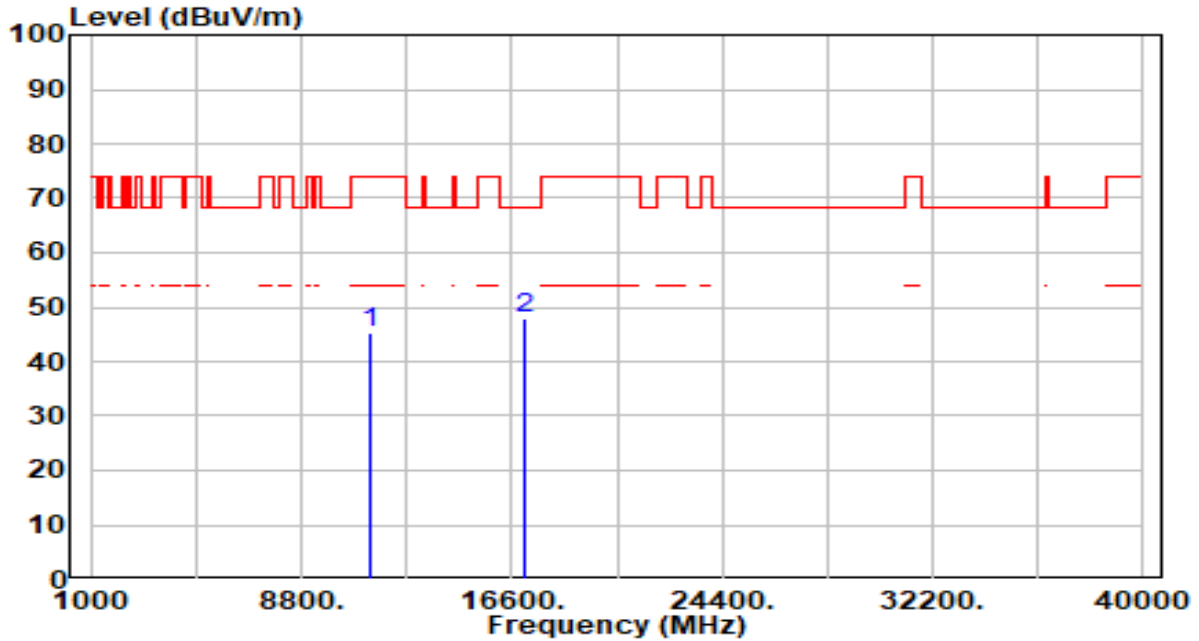

| No | Frequency (MHz) | Reading (dBuV) | C.F (dB/m) | Measurement (dBuV/m) | Margin (dB) | Limit (dBuV/m) | Height (cm) | Angle (deg) | Remark (QP/PK/AV) |
|----|-----------------|----------------|------------|----------------------|-------------|----------------|-------------|-------------|-------------------|
| 1 | 11400.000 | 41.63 | 3.48 | 45.11 | -28.89 | 74.00 | 100 | 0 | Peak |
| 2 | * 17100.000 | 43.17 | 4.79 | 47.96 | -20.24 | 68.20 | 100 | 245 | Peak |

Note:

1. " *", means this data is the worst emission level.
2. C.F (Correction Factor) = Antenna Factor (dB/m)+ Cable Loss (dB) – Pre-amplifier(dB).
3. Measurement (dBuV/m) = Reading(dBuV) + C.F (Correction Factor).
4. The emission levels of other frequencies are very lower than the limit and not show in test report.

| | | | |
|-----------|-------------------------------------|----------------------|--------------|
| EUT | POS Terminal | Date of Test | 2023-10-28 |
| Factor | DRH18-E & BBHA 9170 | Temp. / Humidity | 23°C /61% |
| Polarity | Vertical | Site / Test Engineer | AC2 / Marvin |
| Test Mode | 802.11n-20MHz_TX_Band3_CH 140_ANT 0 | Test Voltage | AC 120V/60Hz |

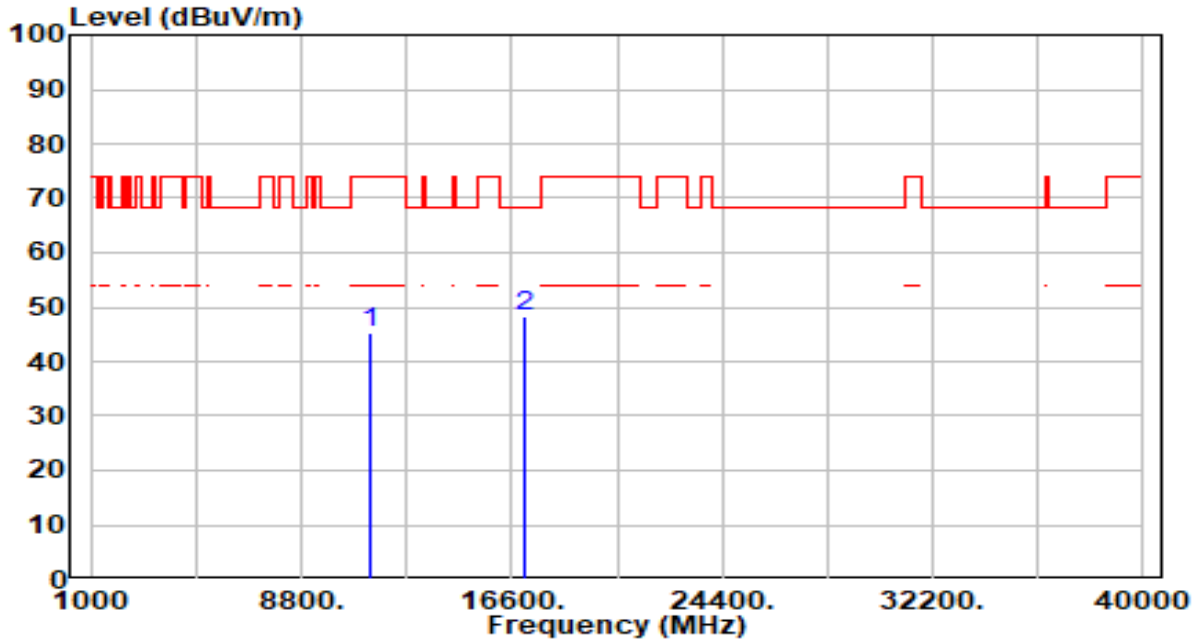

| No | Frequency (MHz) | Reading (dBuV) | C.F (dB/m) | Measurement (dBuV/m) | Margin (dB) | Limit (dBuV/m) | Height (cm) | Angle (deg) | Remark (QP/PK/AV) |
|----|-----------------|----------------|------------|----------------------|-------------|----------------|-------------|-------------|-------------------|
| 1 | 11400.000 | 41.99 | 3.48 | 45.47 | -28.53 | 74.00 | 100 | 165 | Peak |
| 2 | * 17100.000 | 43.51 | 4.79 | 48.30 | -19.90 | 68.20 | 100 | 2 | Peak |

Note:

- "*", means this data is the worst emission level.
- C.F (Correction Factor) = Antenna Factor (dB/m)+ Cable Loss (dB) – Pre-amplifier(dB).
- Measurement (dBuV/m) = Reading(dBuV) + C.F (Correction Factor).
- The emission levels of other frequencies are very lower than the limit and not show in test report.

| | | | |
|-----------|-------------------------------------|----------------------|--------------|
| EUT | POS Terminal | Date of Test | 2023-10-28 |
| Factor | DRH18-E & BBHA 9170 | Temp. / Humidity | 23°C /61% |
| Polarity | Horizontal | Site / Test Engineer | AC2 / Marvin |
| Test Mode | 802.11n-20MHz_TX_Band3_CH 144_ANT 0 | Test Voltage | AC 120V/60Hz |

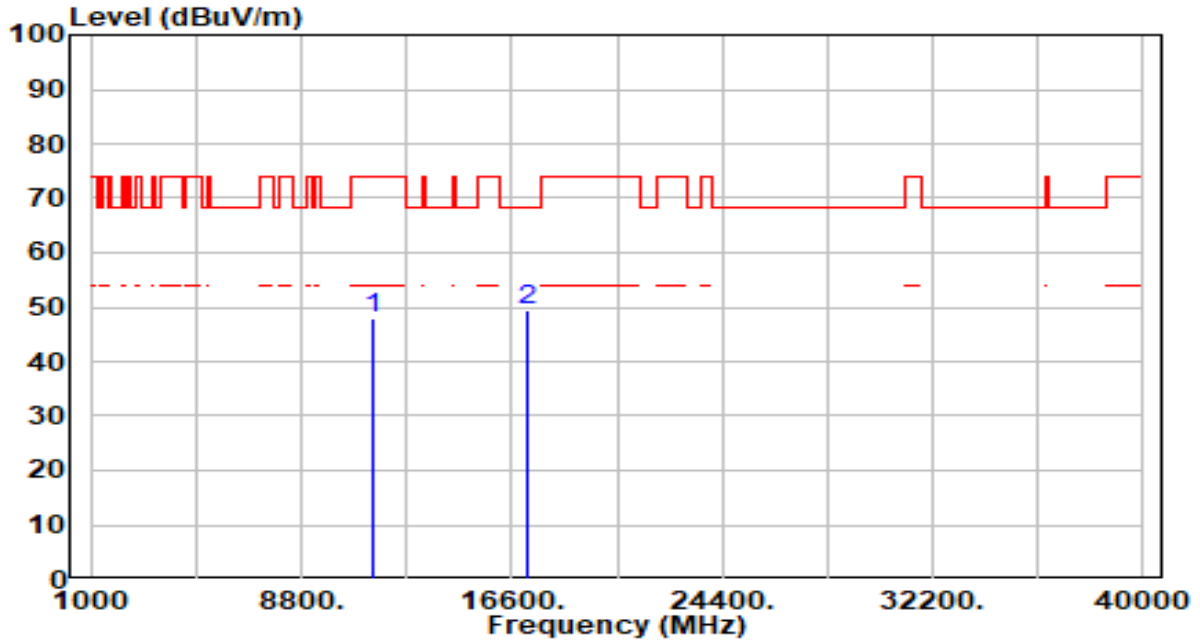

| No | Frequency (MHz) | Reading (dBuV) | C.F (dB/m) | Measurement (dBuV/m) | Margin (dB) | Limit (dBuV/m) | Height (cm) | Angle (deg) | Remark (QP/PK/AV) |
|----|-----------------|----------------|------------|----------------------|-------------|----------------|-------------|-------------|-------------------|
| 1 | 11440.000 | 44.52 | 3.52 | 48.04 | -25.96 | 74.00 | 100 | 274 | Peak |
| 2 | * 17160.000 | 44.96 | 4.66 | 49.62 | -18.58 | 68.20 | 100 | 328 | Peak |

Note:

1. " *", means this data is the worst emission level.
2. C.F (Correction Factor) = Antenna Factor (dB/m)+ Cable Loss (dB) – Pre-amplifier(dB).
3. Measurement (dBuV/m) = Reading(dBuV) + C.F (Correction Factor).
4. The emission levels of other frequencies are very lower than the limit and not show in test report.

| | | | |
|-----------|-------------------------------------|----------------------|--------------|
| EUT | POS Terminal | Date of Test | 2023-10-28 |
| Factor | DRH18-E & BBHA 9170 | Temp. / Humidity | 23°C /61% |
| Polarity | Vertical | Site / Test Engineer | AC2 / Marvin |
| Test Mode | 802.11n-20MHz_TX_Band3_CH 144_ANT 0 | Test Voltage | AC 120V/60Hz |

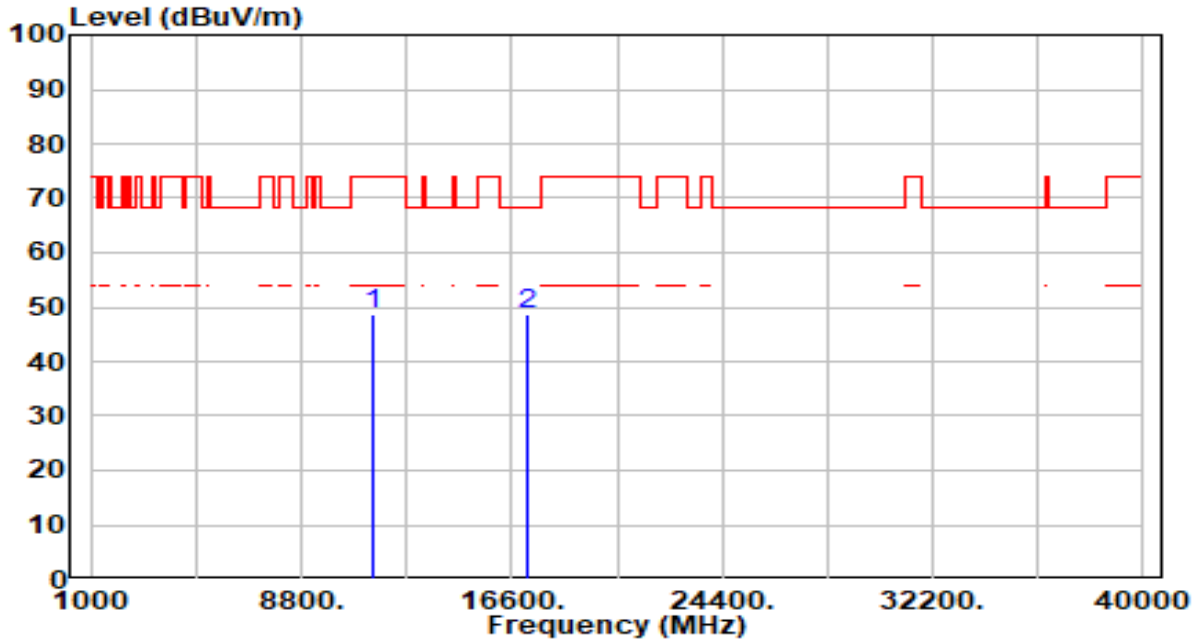

| No | Frequency (MHz) | Reading (dBuV) | C.F (dB/m) | Measurement (dBuV/m) | Margin (dB) | Limit (dBuV/m) | Height (cm) | Angle (deg) | Remark (QP/PK/AV) |
|----|-----------------|----------------|------------|----------------------|-------------|----------------|-------------|-------------|-------------------|
| 1 | 11440.000 | 45.30 | 3.52 | 48.81 | -25.19 | 74.00 | 100 | 349 | Peak |
| 2 | * 17160.000 | 44.06 | 4.66 | 48.72 | -19.48 | 68.20 | 100 | 70 | Peak |

Note:

- "*", means this data is the worst emission level.
- C.F (Correction Factor) = Antenna Factor (dB/m)+ Cable Loss (dB) – Pre-amplifier(dB).
- Measurement (dBuV/m) = Reading(dBuV) + C.F (Correction Factor).
- The emission levels of other frequencies are very lower than the limit and not show in test report.

| | | | |
|-----------|-------------------------------------|----------------------|--------------|
| EUT | POS Terminal | Date of Test | 2023-10-28 |
| Factor | DRH18-E & BBHA 9170 | Temp. / Humidity | 23°C /61% |
| Polarity | Horizontal | Site / Test Engineer | AC2 / Marvin |
| Test Mode | 802.11n-20MHz_TX_Band4_CH 149_ANT 0 | Test Voltage | AC 120V/60Hz |

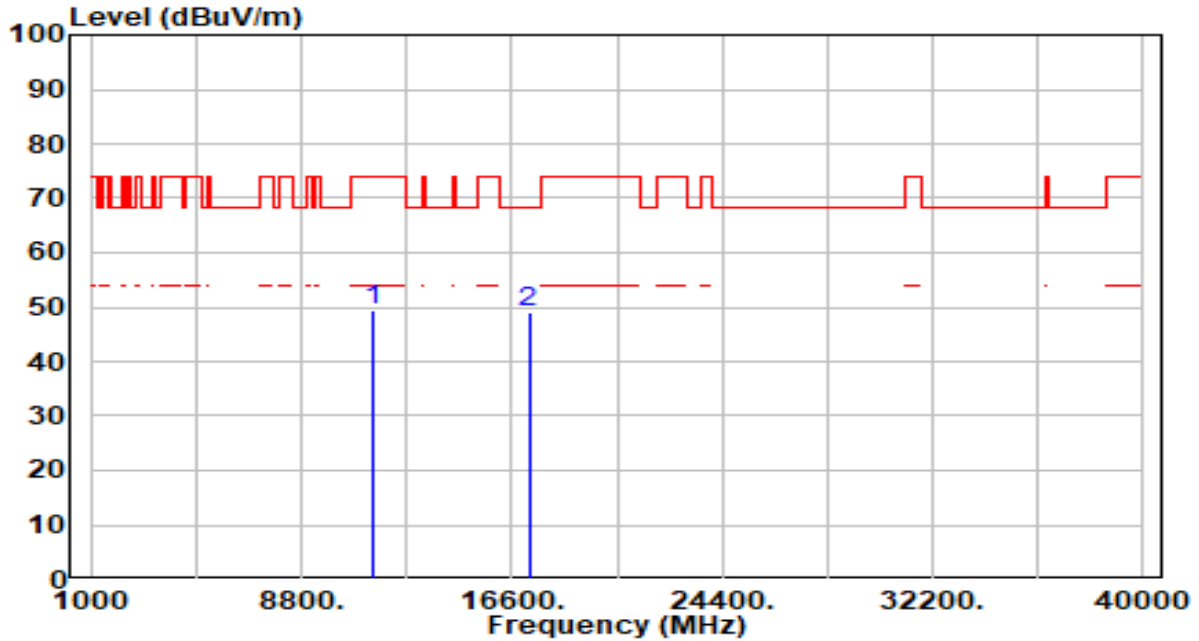

| No | Frequency (MHz) | Reading (dBuV) | C.F (dB/m) | Measurement (dBuV/m) | Margin (dB) | Limit (dBuV/m) | Height (cm) | Angle (deg) | Remark (QP/PK/AV) |
|----|-----------------|----------------|------------|----------------------|-------------|----------------|-------------|-------------|-------------------|
| 1 | 11490.000 | 45.85 | 3.57 | 49.42 | -24.58 | 74.00 | 100 | 272 | Peak |
| 2 | * 17235.000 | 44.59 | 4.45 | 49.05 | -19.15 | 68.20 | 100 | 244 | Peak |

Note:

- "*", means this data is the worst emission level.
- C.F (Correction Factor) = Antenna Factor (dB/m)+ Cable Loss (dB) – Pre-amplifier(dB).
- Measurement (dBuV/m) = Reading(dBuV) + C.F (Correction Factor).
- The emission levels of other frequencies are very lower than the limit and not show in test report.

| | | | |
|-----------|-------------------------------------|----------------------|--------------|
| EUT | POS Terminal | Date of Test | 2023-10-28 |
| Factor | DRH18-E & BBHA 9170 | Temp. / Humidity | 23°C /61% |
| Polarity | Vertical | Site / Test Engineer | AC2 / Marvin |
| Test Mode | 802.11n-20MHz_TX_Band4_CH 149_ANT 0 | Test Voltage | AC 120V/60Hz |

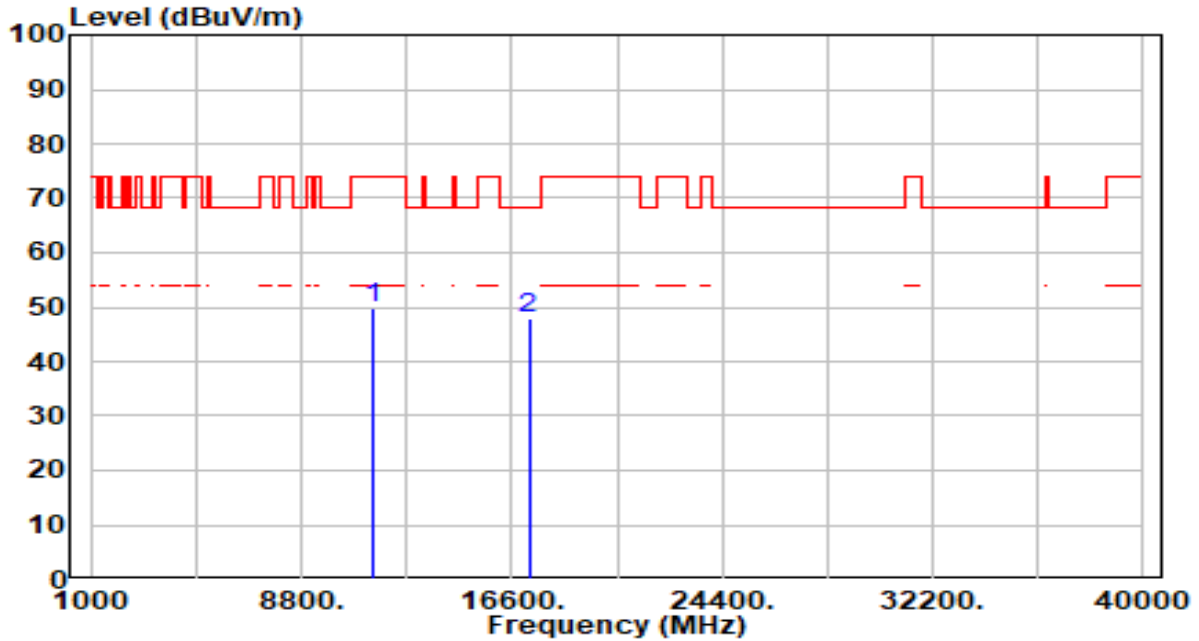

| No | Frequency (MHz) | Reading (dBuV) | C.F (dB/m) | Measurement (dBuV/m) | Margin (dB) | Limit (dBuV/m) | Height (cm) | Angle (deg) | Remark (QP/PK/AV) |
|----|-----------------|----------------|------------|----------------------|-------------|----------------|-------------|-------------|-------------------|
| 1 | 11490.000 | 46.21 | 3.57 | 49.77 | -24.23 | 74.00 | 100 | 21 | Peak |
| 2 | * 17235.000 | 43.30 | 4.45 | 47.75 | -20.45 | 68.20 | 100 | 15 | Peak |

Note:

- "*", means this data is the worst emission level.
- C.F (Correction Factor) = Antenna Factor (dB/m)+ Cable Loss (dB) – Pre-amplifier(dB).
- Measurement (dBuV/m) = Reading(dBuV) + C.F (Correction Factor).
- The emission levels of other frequencies are very lower than the limit and not show in test report.

| | | | |
|-----------|-------------------------------------|----------------------|--------------|
| EUT | POS Terminal | Date of Test | 2023-10-28 |
| Factor | DRH18-E & BBHA 9170 | Temp. / Humidity | 23°C /61% |
| Polarity | Horizontal | Site / Test Engineer | AC2 / Marvin |
| Test Mode | 802.11n-20MHz_TX_Band4_CH 157_ANT 0 | Test Voltage | AC 120V/60Hz |

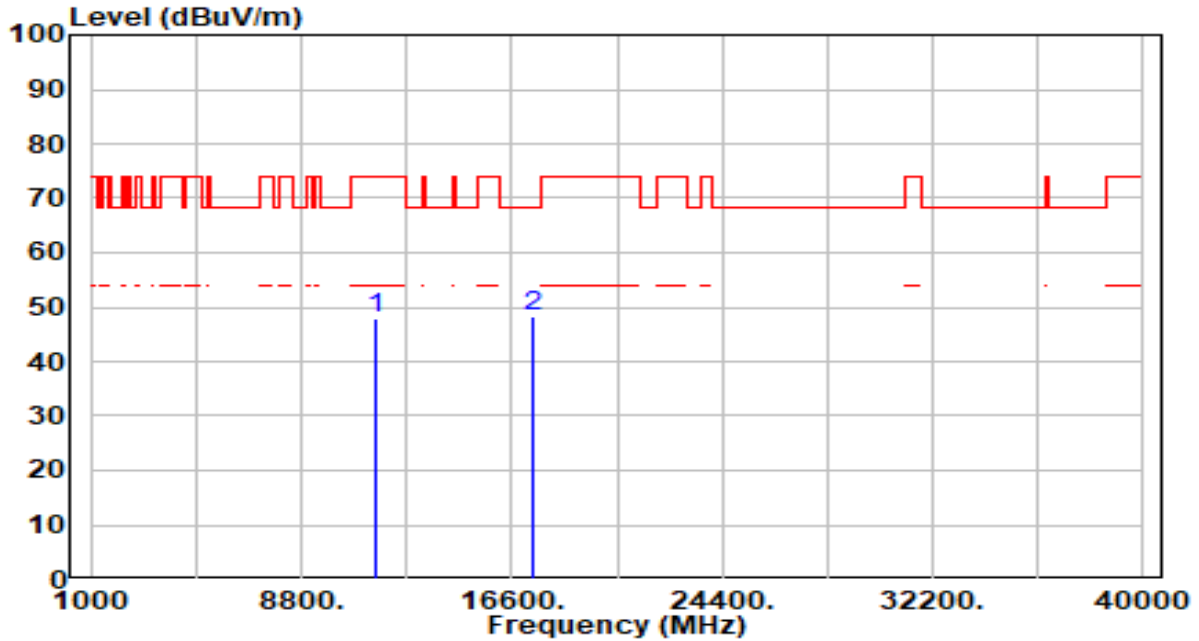

| No | Frequency (MHz) | Reading (dBuV) | C.F (dB/m) | Measurement (dBuV/m) | Margin (dB) | Limit (dBuV/m) | Height (cm) | Angle (deg) | Remark (QP/PK/AV) |
|----|-----------------|----------------|------------|----------------------|-------------|----------------|-------------|-------------|-------------------|
| 1 | 11570.000 | 44.43 | 3.65 | 48.08 | -25.92 | 74.00 | 100 | 276 | Peak |
| 2 | * 17355.000 | 44.27 | 4.06 | 48.33 | -19.87 | 68.20 | 100 | 101 | Peak |

Note:

- "*", means this data is the worst emission level.
- C.F (Correction Factor) = Antenna Factor (dB/m)+ Cable Loss (dB) – Pre-amplifier(dB).
- Measurement (dBuV/m) = Reading(dBuV) + C.F (Correction Factor).
- The emission levels of other frequencies are very lower than the limit and not show in test report.

| | | | |
|-----------|-------------------------------------|----------------------|--------------|
| EUT | POS Terminal | Date of Test | 2023-10-28 |
| Factor | DRH18-E & BBHA 9170 | Temp. / Humidity | 23°C /61% |
| Polarity | Vertical | Site / Test Engineer | AC2 / Marvin |
| Test Mode | 802.11n-20MHz_TX_Band4_CH 157_ANT 0 | Test Voltage | AC 120V/60Hz |

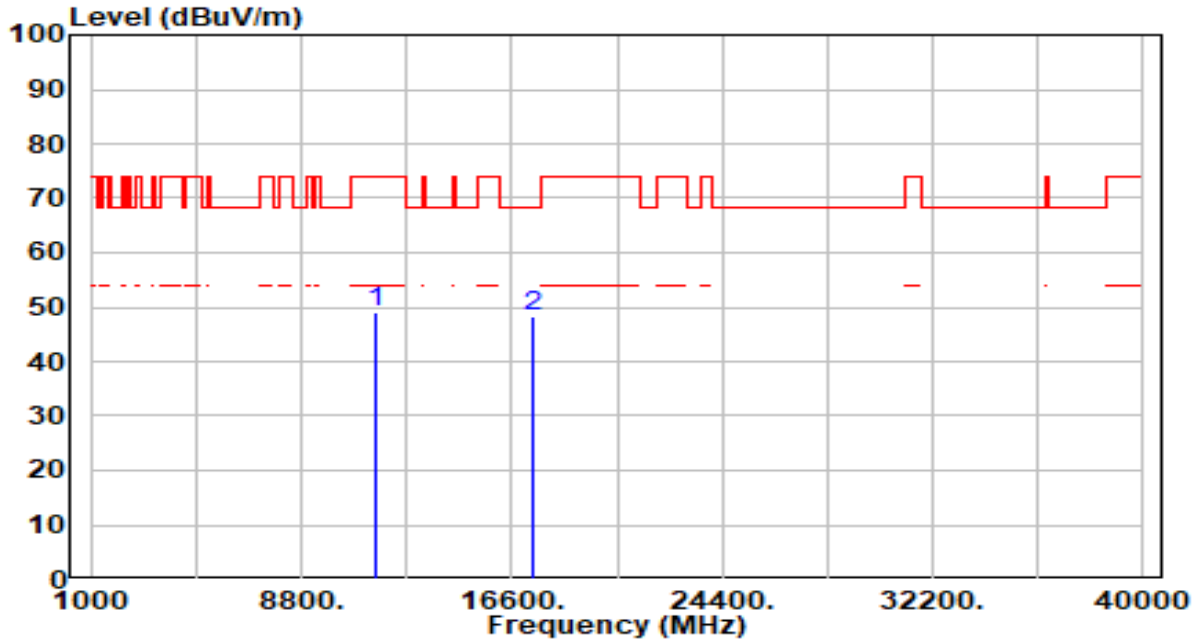

| No | Frequency (MHz) | Reading (dBuV) | C.F (dB/m) | Measurement (dBuV/m) | Margin (dB) | Limit (dBuV/m) | Height (cm) | Angle (deg) | Remark (QP/PK/AV) |
|----|-----------------|----------------|------------|----------------------|-------------|----------------|-------------|-------------|-------------------|
| 1 | 11570.000 | 45.46 | 3.65 | 49.11 | -24.89 | 74.00 | 100 | 349 | Peak |
| 2 | * 17355.000 | 44.24 | 4.06 | 48.29 | -19.91 | 68.20 | 100 | 307 | Peak |

Note:

- "*", means this data is the worst emission level.
- C.F (Correction Factor) = Antenna Factor (dB/m)+ Cable Loss (dB) – Pre-amplifier(dB).
- Measurement (dBuV/m) = Reading(dBuV) + C.F (Correction Factor).
- The emission levels of other frequencies are very lower than the limit and not show in test report.

| | | | |
|-----------|-------------------------------------|----------------------|--------------|
| EUT | POS Terminal | Date of Test | 2023-10-28 |
| Factor | DRH18-E & BBHA 9170 | Temp. / Humidity | 23°C /61% |
| Polarity | Horizontal | Site / Test Engineer | AC2 / Marvin |
| Test Mode | 802.11n-20MHz_TX_Band4_CH 165_ANT 0 | Test Voltage | AC 120V/60Hz |

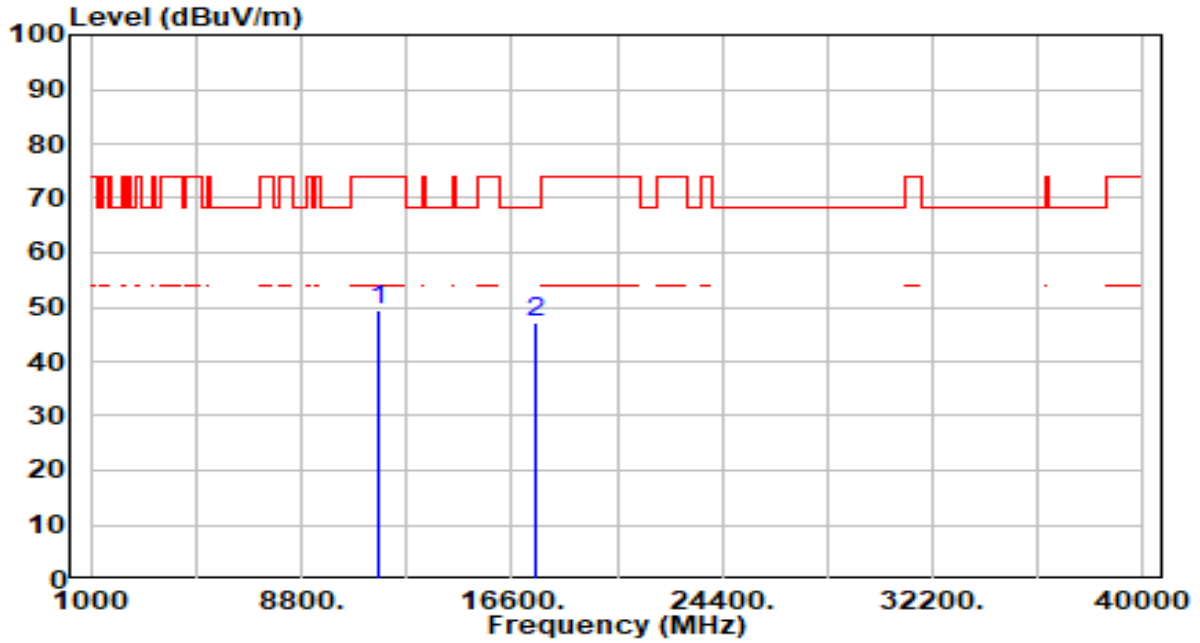

| No | Frequency (MHz) | Reading (dBuV) | C.F (dB/m) | Measurement (dBuV/m) | Margin (dB) | Limit (dBuV/m) | Height (cm) | Angle (deg) | Remark (QP/PK/AV) |
|----|-----------------|----------------|------------|----------------------|-------------|----------------|-------------|-------------|-------------------|
| 1 | 11650.000 | 45.71 | 3.66 | 49.38 | -24.62 | 74.00 | 100 | 281 | Peak |
| 2 | * 17475.000 | 43.32 | 3.89 | 47.21 | -20.99 | 68.20 | 100 | 317 | Peak |

Note:

1. " *", means this data is the worst emission level.
2. C.F (Correction Factor) = Antenna Factor (dB/m)+ Cable Loss (dB) – Pre-amplifier(dB).
3. Measurement (dBuV/m) = Reading(dBuV) + C.F (Correction Factor).
4. The emission levels of other frequencies are very lower than the limit and not show in test report.

| | | | |
|-----------|-------------------------------------|----------------------|--------------|
| EUT | POS Terminal | Date of Test | 2023-10-28 |
| Factor | DRH18-E & BBHA 9170 | Temp. / Humidity | 23°C /61% |
| Polarity | Vertical | Site / Test Engineer | AC2 / Marvin |
| Test Mode | 802.11n-20MHz_TX_Band4_CH 165_ANT 0 | Test Voltage | AC 120V/60Hz |

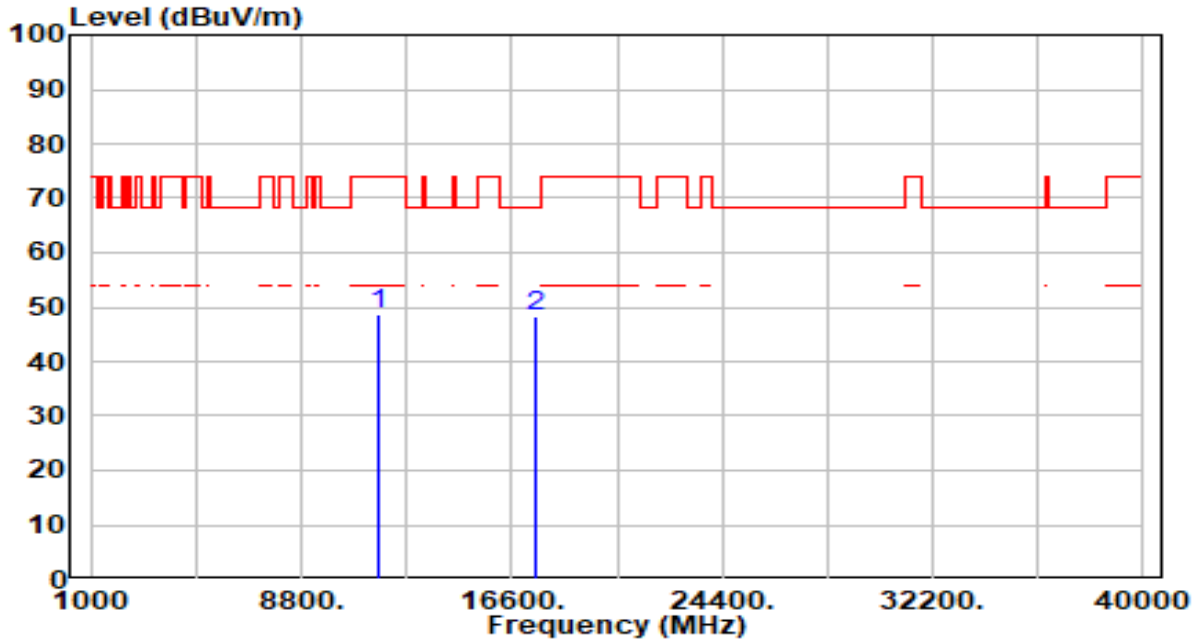

| No | Frequency (MHz) | Reading (dBuV) | C.F (dB/m) | Measurement (dBuV/m) | Margin (dB) | Limit (dBuV/m) | Height (cm) | Angle (deg) | Remark (QP/PK/AV) |
|----|-----------------|----------------|------------|----------------------|-------------|----------------|-------------|-------------|-------------------|
| 1 | 11650.000 | 45.09 | 3.66 | 48.75 | -25.25 | 74.00 | 100 | 360 | Peak |
| 2 | * 17475.000 | 44.39 | 3.89 | 48.28 | -19.92 | 68.20 | 100 | 270 | Peak |

Note:

- "*", means this data is the worst emission level.
- C.F (Correction Factor) = Antenna Factor (dB/m)+ Cable Loss (dB) – Pre-amplifier(dB).
- Measurement (dBuV/m) = Reading(dBuV) + C.F (Correction Factor).
- The emission levels of other frequencies are very lower than the limit and not show in test report.

| | | | |
|-----------|------------------------------------|----------------------|--------------|
| EUT | POS Terminal | Date of Test | 2023-10-28 |
| Factor | DRH18-E & BBHA 9170 | Temp. / Humidity | 23°C /61% |
| Polarity | Horizontal | Site / Test Engineer | AC2 / Marvin |
| Test Mode | 802.11n-40MHz_TX_Band1_CH 38_ANT 0 | Test Voltage | AC 120V/60Hz |

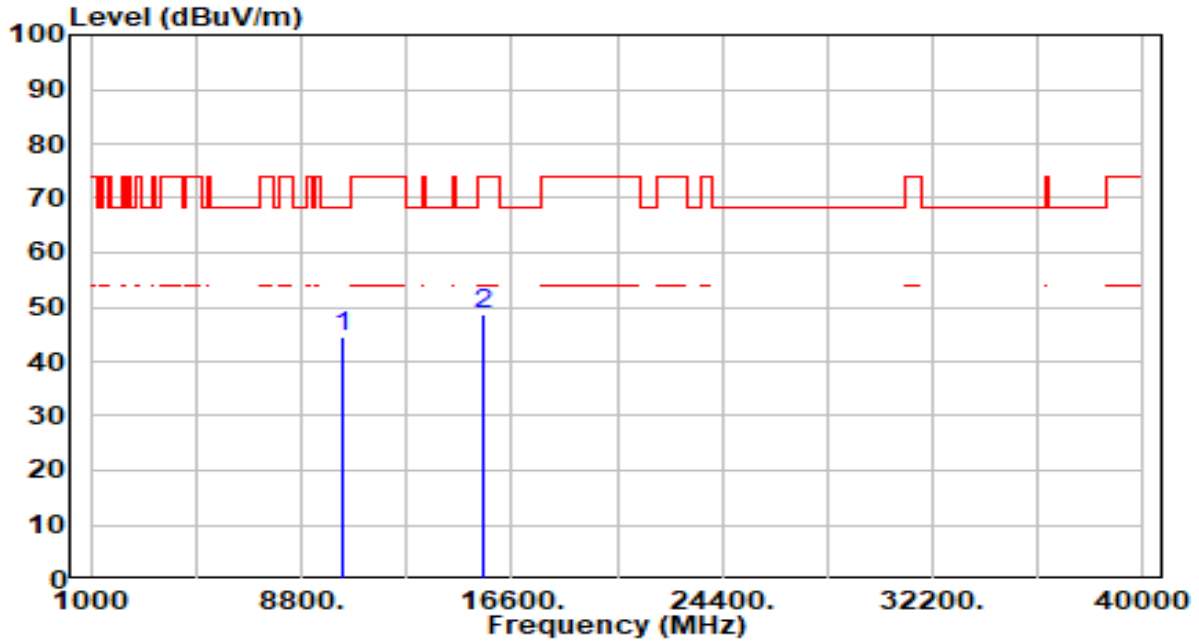

| No | Frequency (MHz) | Reading (dBuV) | C.F (dB/m) | Measurement (dBuV/m) | Margin (dB) | Limit (dBuV/m) | Height (cm) | Angle (deg) | Remark (QP/PK/AV) |
|----|-----------------|----------------|------------|----------------------|-------------|----------------|-------------|-------------|-------------------|
| 1 | * 10380.000 | 41.58 | 2.79 | 44.37 | -23.83 | 68.20 | 100 | 151 | Peak |
| 2 | 15570.000 | 44.07 | 4.52 | 48.58 | -25.42 | 74.00 | 100 | 145 | Peak |

Note:

- "*", means this data is the worst emission level.
- C.F (Correction Factor) = Antenna Factor (dB/m)+ Cable Loss (dB) – Pre-amplifier(dB).
- Measurement (dBuV/m) = Reading(dBuV) + C.F (Correction Factor).
- The emission levels of other frequencies are very lower than the limit and not show in test report.

| | | | |
|-----------|------------------------------------|----------------------|--------------|
| EUT | POS Terminal | Date of Test | 2023-10-28 |
| Factor | DRH18-E & BBHA 9170 | Temp. / Humidity | 23°C /61% |
| Polarity | Vertical | Site / Test Engineer | AC2 / Marvin |
| Test Mode | 802.11n-40MHz_TX_Band1_CH 38_ANT 0 | Test Voltage | AC 120V/60Hz |

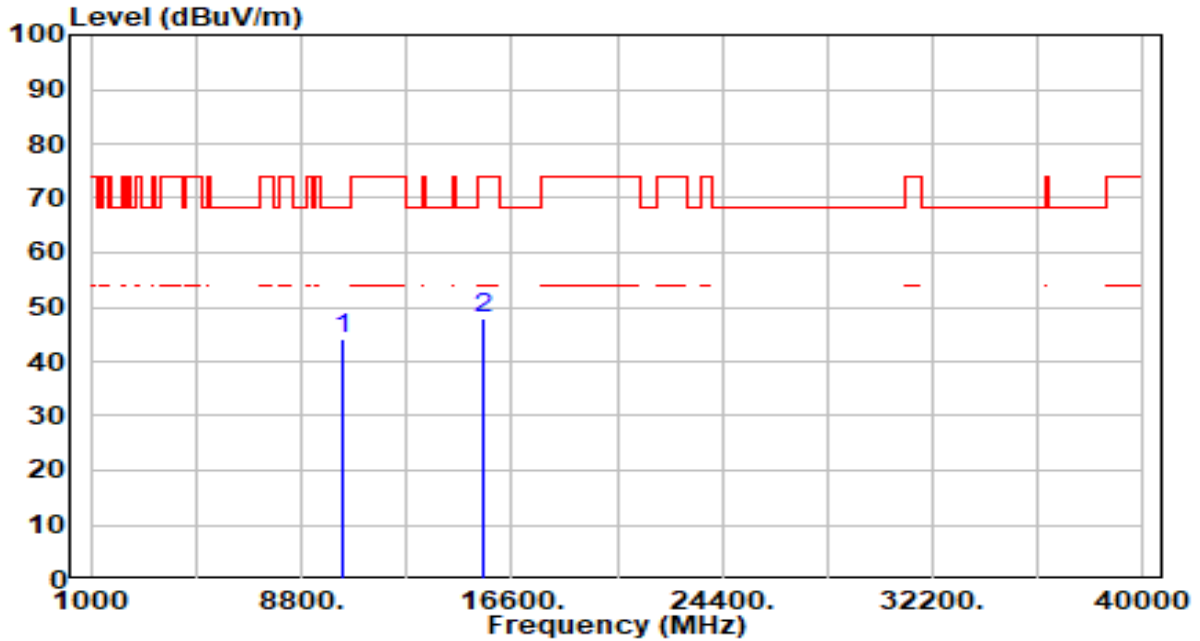

| No | Frequency (MHz) | Reading (dBuV) | C.F (dB/m) | Measurement (dBuV/m) | Margin (dB) | Limit (dBuV/m) | Height (cm) | Angle (deg) | Remark (QP/PK/AV) |
|----|-----------------|----------------|------------|----------------------|-------------|----------------|-------------|-------------|-------------------|
| 1 | * 10380.000 | 41.40 | 2.79 | 44.19 | -24.01 | 68.20 | 100 | 214 | Peak |
| 2 | 15570.000 | 43.38 | 4.52 | 47.90 | -26.10 | 74.00 | 100 | 103 | Peak |

Note:

- " *", means this data is the worst emission level.
- C.F (Correction Factor) = Antenna Factor (dB/m)+ Cable Loss (dB) – Pre-amplifier(dB).
- Measurement (dBuV/m) = Reading(dBuV) + C.F (Correction Factor).
- The emission levels of other frequencies are very lower than the limit and not show in test report.

| | | | |
|-----------|------------------------------------|----------------------|--------------|
| EUT | POS Terminal | Date of Test | 2023-10-28 |
| Factor | DRH18-E & BBHA 9170 | Temp. / Humidity | 23°C /61% |
| Polarity | Horizontal | Site / Test Engineer | AC2 / Marvin |
| Test Mode | 802.11n-40MHz_TX_Band1_CH 46_ANT 0 | Test Voltage | AC 120V/60Hz |

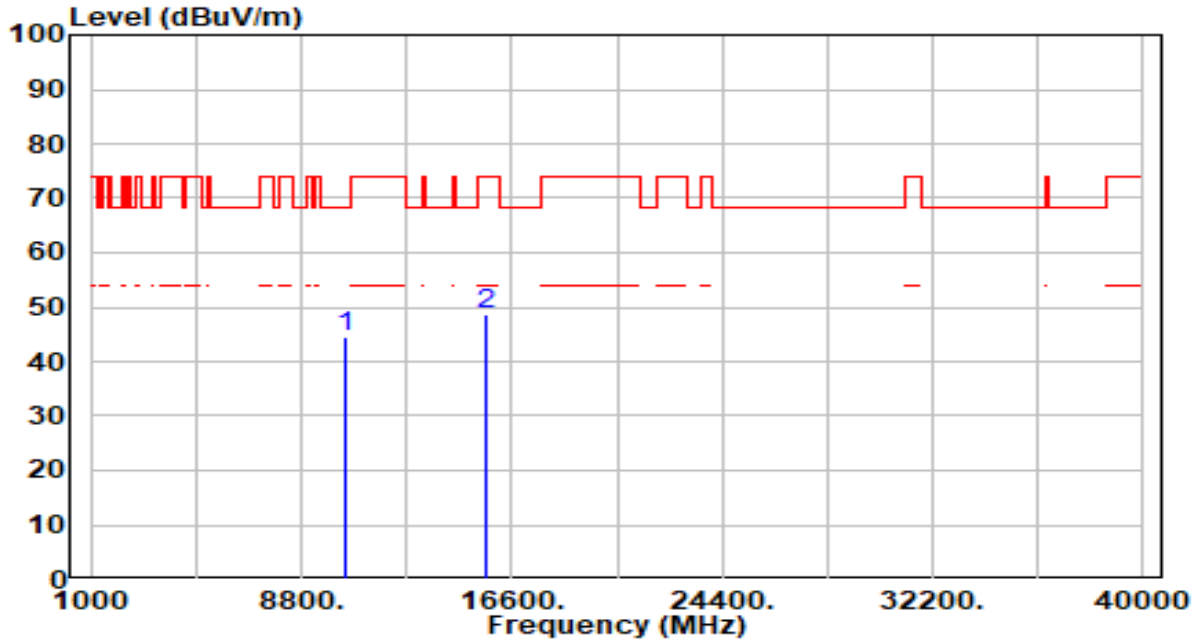

| No | Frequency (MHz) | Reading (dBuV) | C.F (dB/m) | Measurement (dBuV/m) | Margin (dB) | Limit (dBuV/m) | Height (cm) | Angle (deg) | Remark (QP/PK/AV) |
|----|-----------------|----------------|------------|----------------------|-------------|----------------|-------------|-------------|-------------------|
| 1 | * 10460.000 | 41.78 | 2.70 | 44.48 | -23.72 | 68.20 | 100 | 0 | Peak |
| 2 | 15690.000 | 44.11 | 4.75 | 48.86 | -25.14 | 74.00 | 100 | 99 | Peak |

Note:

- "*", means this data is the worst emission level.
- C.F (Correction Factor) = Antenna Factor (dB/m)+ Cable Loss (dB) – Pre-amplifier(dB).
- Measurement (dBuV/m) = Reading(dBuV) + C.F (Correction Factor).
- The emission levels of other frequencies are very lower than the limit and not show in test report.

| | | | |
|-----------|------------------------------------|----------------------|--------------|
| EUT | POS Terminal | Date of Test | 2023-10-28 |
| Factor | DRH18-E & BBHA 9170 | Temp. / Humidity | 23°C /61% |
| Polarity | Vertical | Site / Test Engineer | AC2 / Marvin |
| Test Mode | 802.11n-40MHz_TX_Band1_CH 46_ANT 0 | Test Voltage | AC 120V/60Hz |

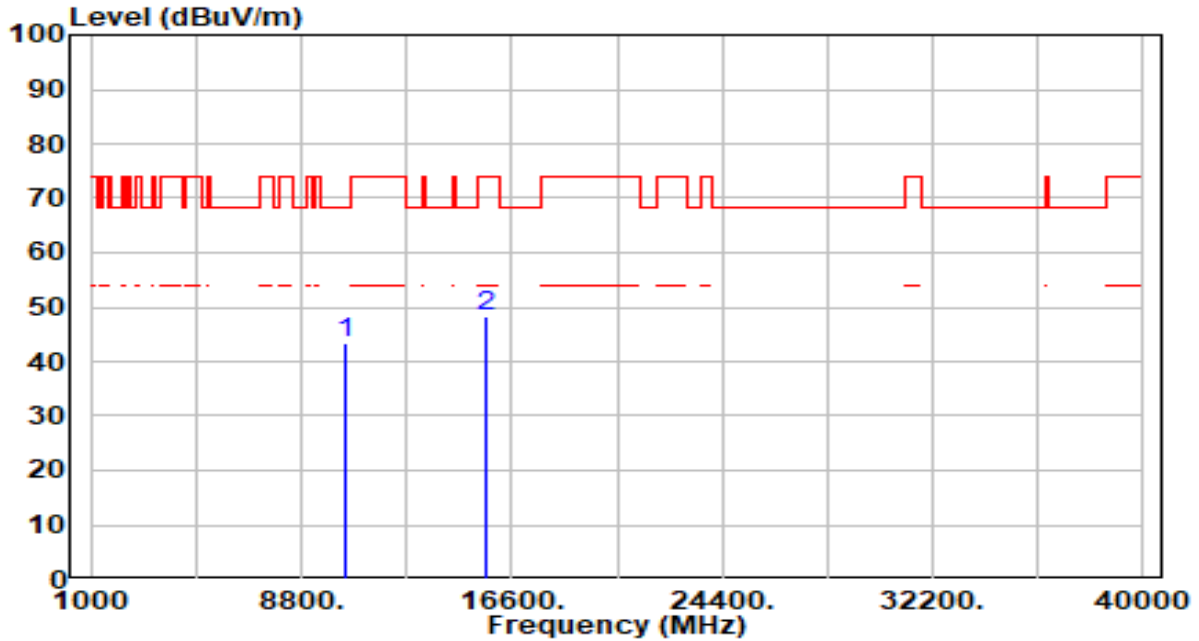

| No | Frequency (MHz) | Reading (dBuV) | C.F (dB/m) | Measurement (dBuV/m) | Margin (dB) | Limit (dBuV/m) | Height (cm) | Angle (deg) | Remark (QP/PK/AV) |
|----|-----------------|----------------|------------|----------------------|-------------|----------------|-------------|-------------|-------------------|
| 1 | * 10460.000 | 40.79 | 2.70 | 43.49 | -24.71 | 68.20 | 100 | 222 | Peak |
| 2 | 15690.000 | 43.43 | 4.75 | 48.19 | -25.81 | 74.00 | 100 | 216 | Peak |

Note:

1. " *", means this data is the worst emission level.
2. C.F (Correction Factor) = Antenna Factor (dB/m)+ Cable Loss (dB) – Pre-amplifier(dB).
3. Measurement (dBuV/m) = Reading(dBuV) + C.F (Correction Factor).
4. The emission levels of other frequencies are very lower than the limit and not show in test report.

| | | | |
|-----------|------------------------------------|----------------------|--------------|
| EUT | POS Terminal | Date of Test | 2023-10-28 |
| Factor | DRH18-E & BBHA 9170 | Temp. / Humidity | 23°C /61% |
| Polarity | Horizontal | Site / Test Engineer | AC2 / Marvin |
| Test Mode | 802.11n-40MHz_TX_Band2_CH 54_ANT 0 | Test Voltage | AC 120V/60Hz |

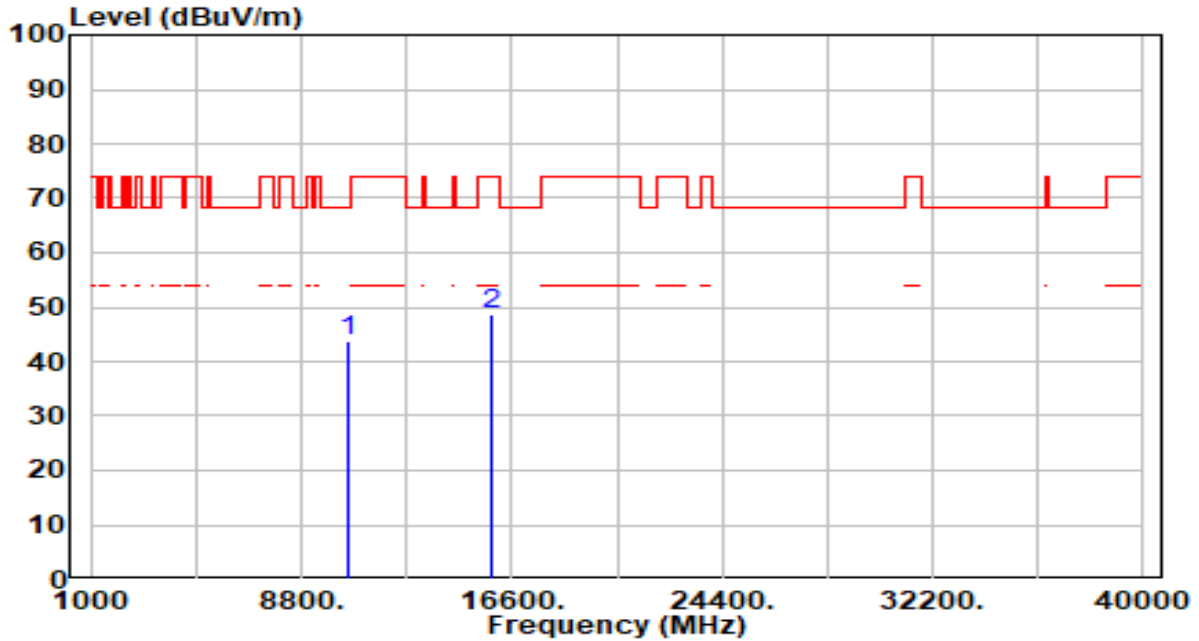

| No | Frequency (MHz) | Reading (dBuV) | C.F (dB/m) | Measurement (dBuV/m) | Margin (dB) | Limit (dBuV/m) | Height (cm) | Angle (deg) | Remark (QP/PK/AV) |
|----|-----------------|----------------|------------|----------------------|-------------|----------------|-------------|-------------|-------------------|
| 1 | * 10540.000 | 41.17 | 2.63 | 43.81 | -24.39 | 68.20 | 100 | 0 | Peak |
| 2 | 15810.000 | 43.56 | 5.06 | 48.62 | -25.38 | 74.00 | 100 | 211 | Peak |

Note:

- "*", means this data is the worst emission level.
- C.F (Correction Factor) = Antenna Factor (dB/m)+ Cable Loss (dB) – Pre-amplifier(dB).
- Measurement (dBuV/m) = Reading(dBuV) + C.F (Correction Factor).
- The emission levels of other frequencies are very lower than the limit and not show in test report.

| | | | |
|-----------|------------------------------------|----------------------|--------------|
| EUT | POS Terminal | Date of Test | 2023-10-28 |
| Factor | DRH18-E & BBHA 9170 | Temp. / Humidity | 23°C /61% |
| Polarity | Vertical | Site / Test Engineer | AC2 / Marvin |
| Test Mode | 802.11n-40MHz_TX_Band2_CH 54_ANT 0 | Test Voltage | AC 120V/60Hz |

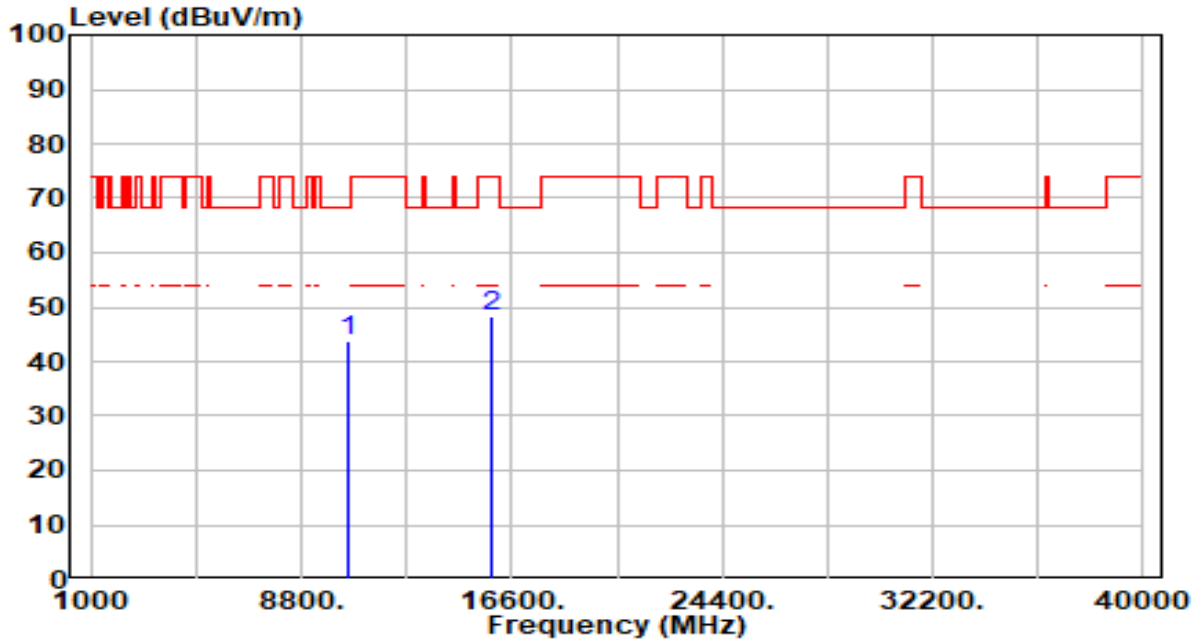

| No | Frequency (MHz) | Reading (dBuV) | C.F (dB/m) | Measurement (dBuV/m) | Margin (dB) | Limit (dBuV/m) | Height (cm) | Angle (deg) | Remark (QP/PK/AV) |
|----|-----------------|----------------|------------|----------------------|-------------|----------------|-------------|-------------|-------------------|
| 1 | * 10540.000 | 41.20 | 2.63 | 43.84 | -24.36 | 68.20 | 100 | 352 | Peak |
| 2 | 15810.000 | 43.28 | 5.06 | 48.34 | -25.66 | 74.00 | 100 | 205 | Peak |

Note:

- "*" means this data is the worst emission level.
- C.F (Correction Factor) = Antenna Factor (dB/m)+ Cable Loss (dB) – Pre-amplifier(dB).
- Measurement (dBuV/m) = Reading(dBuV) + C.F (Correction Factor).
- The emission levels of other frequencies are very lower than the limit and not show in test report.

| | | | |
|-----------|------------------------------------|----------------------|--------------|
| EUT | POS Terminal | Date of Test | 2023-10-28 |
| Factor | DRH18-E & BBHA 9170 | Temp. / Humidity | 23°C /61% |
| Polarity | Horizontal | Site / Test Engineer | AC2 / Marvin |
| Test Mode | 802.11n-40MHz_TX_Band2_CH 62_ANT 0 | Test Voltage | AC 120V/60Hz |

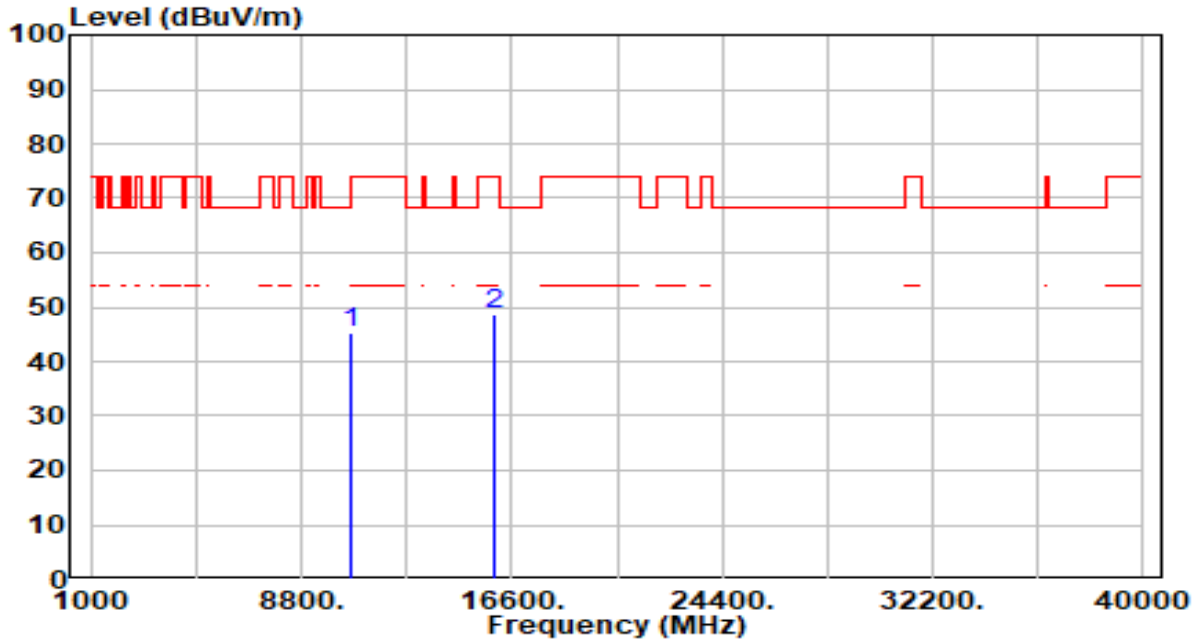

| No | Frequency (MHz) | Reading (dBuV) | C.F (dB/m) | Measurement (dBuV/m) | Margin (dB) | Limit (dBuV/m) | Height (cm) | Angle (deg) | Remark (QP/PK/AV) |
|----|-----------------|----------------|------------|----------------------|-------------|----------------|-------------|-------------|-------------------|
| 1 | 10620.000 | 42.71 | 2.61 | 45.33 | -28.67 | 74.00 | 100 | 96 | Peak |
| 2 | * 15930.000 | 43.67 | 5.15 | 48.81 | -25.19 | 74.00 | 100 | 0 | Peak |

Note:

- "*", means this data is the worst emission level.
- C.F (Correction Factor) = Antenna Factor (dB/m)+ Cable Loss (dB) – Pre-amplifier(dB).
- Measurement (dBuV/m) = Reading(dBuV) + C.F (Correction Factor).
- The emission levels of other frequencies are very lower than the limit and not show in test report.

| | | | |
|-----------|------------------------------------|----------------------|--------------|
| EUT | POS Terminal | Date of Test | 2023-10-28 |
| Factor | DRH18-E & BBHA 9170 | Temp. / Humidity | 23°C /61% |
| Polarity | Vertical | Site / Test Engineer | AC2 / Marvin |
| Test Mode | 802.11n-40MHz_TX_Band2_CH 62_ANT 0 | Test Voltage | AC 120V/60Hz |

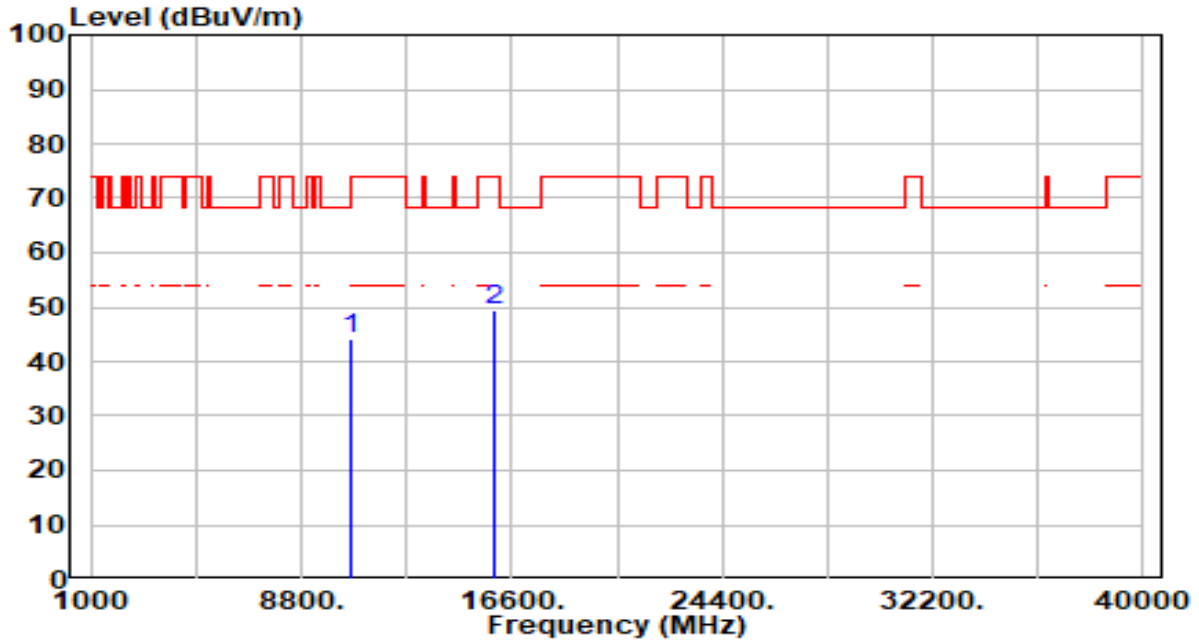

| No | Frequency (MHz) | Reading (dBuV) | C.F (dB/m) | Measurement (dBuV/m) | Margin (dB) | Limit (dBuV/m) | Height (cm) | Angle (deg) | Remark (QP/PK/AV) |
|----|-----------------|----------------|------------|----------------------|-------------|----------------|-------------|-------------|-------------------|
| 1 | 10620.000 | 41.45 | 2.61 | 44.07 | -29.93 | 74.00 | 100 | 34 | Peak |
| 2 | * 15930.000 | 44.14 | 5.15 | 49.29 | -24.71 | 74.00 | 100 | 205 | Peak |

Note:

- "*", means this data is the worst emission level.
- C.F (Correction Factor) = Antenna Factor (dB/m)+ Cable Loss (dB) – Pre-amplifier(dB).
- Measurement (dBuV/m) = Reading(dBuV) + C.F (Correction Factor).
- The emission levels of other frequencies are very lower than the limit and not show in test report.

| | | | |
|-----------|-------------------------------------|----------------------|--------------|
| EUT | POS Terminal | Date of Test | 2023-10-28 |
| Factor | DRH18-E & BBHA 9170 | Temp. / Humidity | 23°C /61% |
| Polarity | Horizontal | Site / Test Engineer | AC2 / Marvin |
| Test Mode | 802.11n-40MHz_TX_Band3_CH 102_ANT 0 | Test Voltage | AC 120V/60Hz |

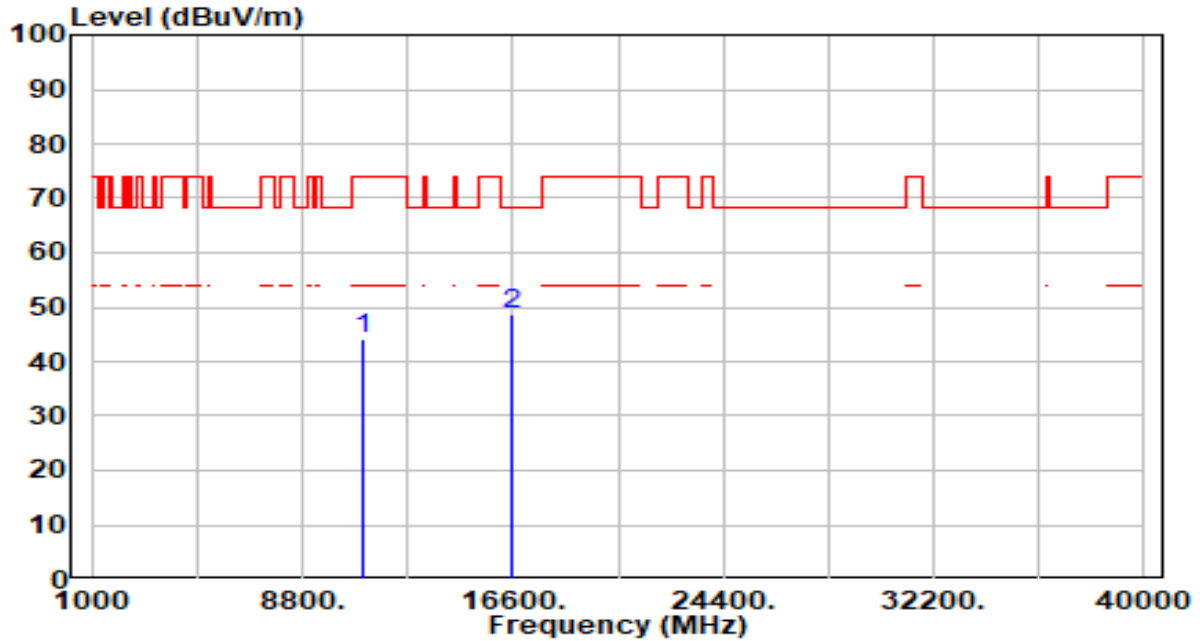

| No | Frequency (MHz) | Reading (dBuV) | C.F (dB/m) | Measurement (dBuV/m) | Margin (dB) | Limit (dBuV/m) | Height (cm) | Angle (deg) | Remark (QP/PK/AV) |
|----|-----------------|----------------|------------|----------------------|-------------|----------------|-------------|-------------|-------------------|
| 1 | 11020.000 | 41.62 | 2.66 | 44.28 | -29.72 | 74.00 | 100 | 144 | Peak |
| 2 | * 16530.000 | 43.91 | 4.63 | 48.54 | -19.66 | 68.20 | 100 | 73 | Peak |

Note:

- "*", means this data is the worst emission level.
- C.F (Correction Factor) = Antenna Factor (dB/m)+ Cable Loss (dB) – Pre-amplifier(dB).
- Measurement (dBuV/m) = Reading(dBuV) + C.F (Correction Factor).
- The emission levels of other frequencies are very lower than the limit and not show in test report.

| | | | |
|-----------|-------------------------------------|----------------------|--------------|
| EUT | POS Terminal | Date of Test | 2023-10-28 |
| Factor | DRH18-E & BBHA 9170 | Temp. / Humidity | 23°C /61% |
| Polarity | Vertical | Site / Test Engineer | AC2 / Marvin |
| Test Mode | 802.11n-40MHz_TX_Band3_CH 102_ANT 0 | Test Voltage | AC 120V/60Hz |

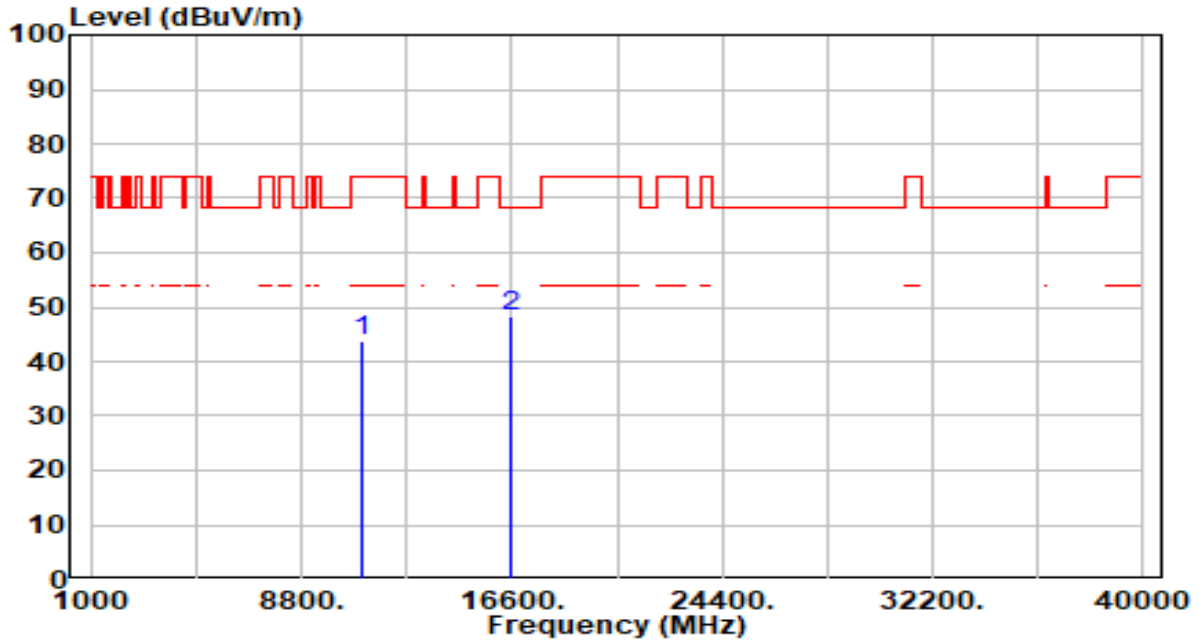

| No | Frequency (MHz) | Reading (dBuV) | C.F (dB/m) | Measurement (dBuV/m) | Margin (dB) | Limit (dBuV/m) | Height (cm) | Angle (deg) | Remark (QP/PK/AV) |
|----|-----------------|----------------|------------|----------------------|-------------|----------------|-------------|-------------|-------------------|
| 1 | 11020.000 | 41.15 | 2.66 | 43.81 | -30.19 | 74.00 | 100 | 295 | Peak |
| 2 | * 16530.000 | 43.50 | 4.63 | 48.12 | -20.08 | 68.20 | 100 | 34 | Peak |

Note:

- " *", means this data is the worst emission level.
- C.F (Correction Factor) = Antenna Factor (dB/m)+ Cable Loss (dB) – Pre-amplifier(dB).
- Measurement (dBuV/m) = Reading(dBuV) + C.F (Correction Factor).
- The emission levels of other frequencies are very lower than the limit and not show in test report.

| | | | |
|-----------|-------------------------------------|----------------------|--------------|
| EUT | POS Terminal | Date of Test | 2023-10-28 |
| Factor | DRH18-E & BBHA 9170 | Temp. / Humidity | 23°C /61% |
| Polarity | Horizontal | Site / Test Engineer | AC2 / Marvin |
| Test Mode | 802.11n-40MHz_TX_Band3_CH 110_ANT 0 | Test Voltage | AC 120V/60Hz |

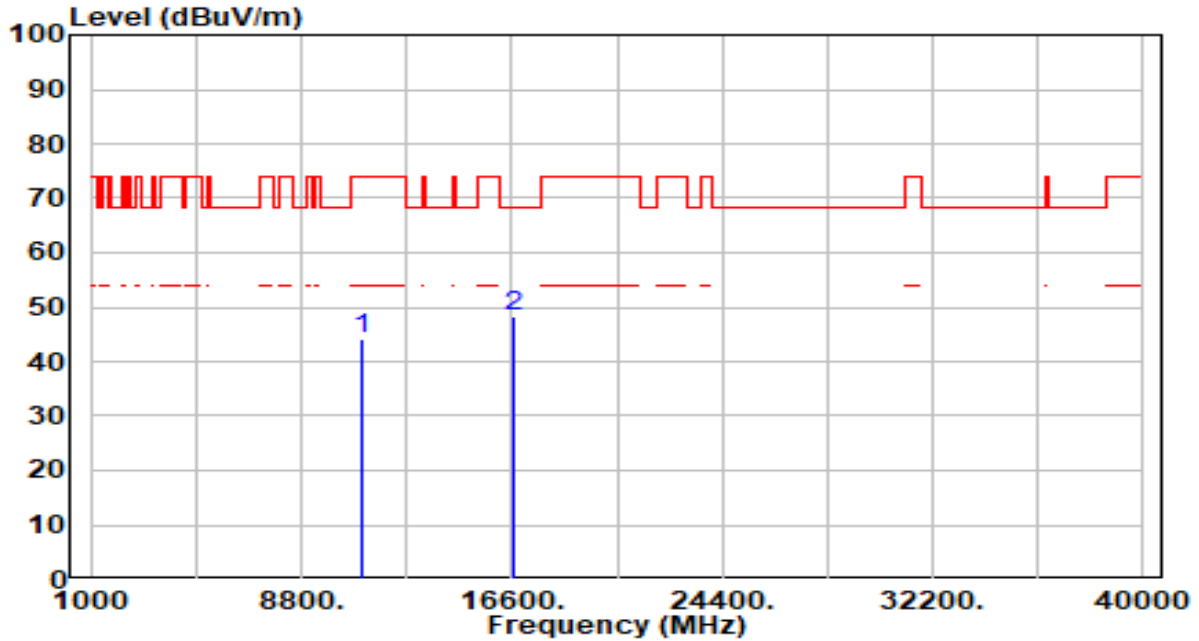

| No | Frequency (MHz) | Reading (dBuV) | C.F (dB/m) | Measurement (dBuV/m) | Margin (dB) | Limit (dBuV/m) | Height (cm) | Angle (deg) | Remark (QP/PK/AV) |
|----|-----------------|----------------|------------|----------------------|-------------|----------------|-------------|-------------|-------------------|
| 1 | 11100.000 | 41.24 | 2.90 | 44.14 | -29.86 | 74.00 | 100 | 38 | Peak |
| 2 | * 16650.000 | 43.64 | 4.63 | 48.27 | -19.93 | 68.20 | 100 | 346 | Peak |

Note:

- " *", means this data is the worst emission level.
- C.F (Correction Factor) = Antenna Factor (dB/m)+ Cable Loss (dB) – Pre-amplifier(dB).
- Measurement (dBuV/m) = Reading(dBuV) + C.F (Correction Factor).
- The emission levels of other frequencies are very lower than the limit and not show in test report.

| | | | |
|-----------|-------------------------------------|----------------------|--------------|
| EUT | POS Terminal | Date of Test | 2023-10-28 |
| Factor | DRH18-E & BBHA 9170 | Temp. / Humidity | 23°C /61% |
| Polarity | Vertical | Site / Test Engineer | AC2 / Marvin |
| Test Mode | 802.11n-40MHz_TX_Band3_CH 110_ANT 0 | Test Voltage | AC 120V/60Hz |

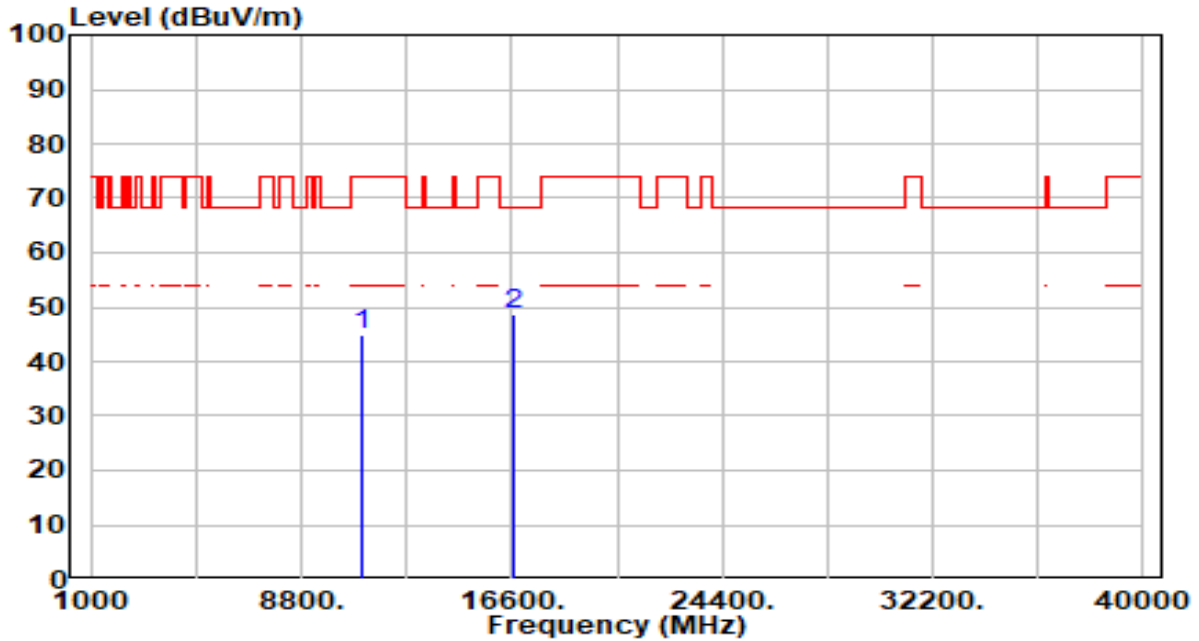

| No | Frequency (MHz) | Reading (dBuV) | C.F (dB/m) | Measurement (dBuV/m) | Margin (dB) | Limit (dBuV/m) | Height (cm) | Angle (deg) | Remark (QP/PK/AV) |
|----|-----------------|----------------|------------|----------------------|-------------|----------------|-------------|-------------|-------------------|
| 1 | 11100.000 | 42.04 | 2.90 | 44.94 | -29.06 | 74.00 | 100 | 61 | Peak |
| 2 | * 16650.000 | 44.10 | 4.63 | 48.73 | -19.47 | 68.20 | 100 | 118 | Peak |

Note:

1. " *", means this data is the worst emission level.
2. C.F (Correction Factor) = Antenna Factor (dB/m)+ Cable Loss (dB) – Pre-amplifier(dB).
3. Measurement (dBuV/m) = Reading(dBuV) + C.F (Correction Factor).
4. The emission levels of other frequencies are very lower than the limit and not show in test report.

| | | | |
|-----------|-------------------------------------|----------------------|--------------|
| EUT | POS Terminal | Date of Test | 2023-10-28 |
| Factor | DRH18-E & BBHA 9170 | Temp. / Humidity | 23°C /61% |
| Polarity | Horizontal | Site / Test Engineer | AC2 / Marvin |
| Test Mode | 802.11n-40MHz_TX_Band3_CH 134_ANT 0 | Test Voltage | AC 120V/60Hz |

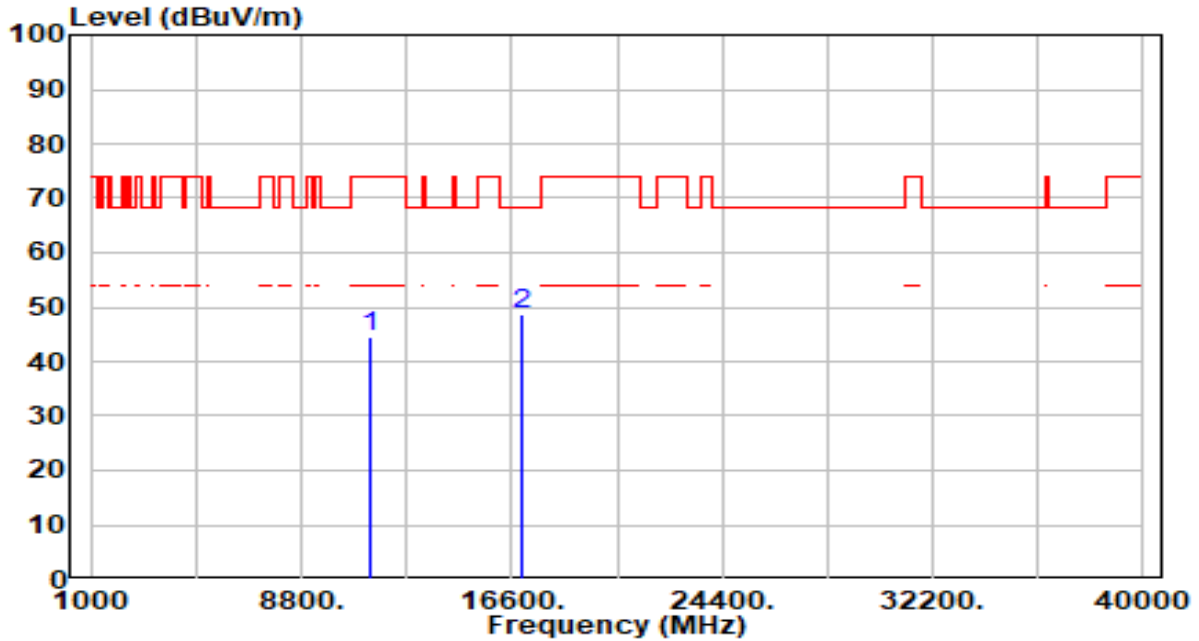

| No | Frequency (MHz) | Reading (dBuV) | C.F (dB/m) | Measurement (dBuV/m) | Margin (dB) | Limit (dBuV/m) | Height (cm) | Angle (deg) | Remark (QP/PK/AV) |
|----|-----------------|----------------|------------|----------------------|-------------|----------------|-------------|-------------|-------------------|
| 1 | 11340.000 | 41.16 | 3.39 | 44.55 | -29.45 | 74.00 | 100 | 129 | Peak |
| 2 | * 17010.000 | 43.62 | 5.00 | 48.62 | -19.58 | 68.20 | 100 | 294 | Peak |

Note:

- "*", means this data is the worst emission level.
- C.F (Correction Factor) = Antenna Factor (dB/m)+ Cable Loss (dB) – Pre-amplifier(dB).
- Measurement (dBuV/m) = Reading(dBuV) + C.F (Correction Factor).
- The emission levels of other frequencies are very lower than the limit and not show in test report.

| | | | |
|-----------|-------------------------------------|----------------------|--------------|
| EUT | POS Terminal | Date of Test | 2023-10-28 |
| Factor | DRH18-E & BBHA 9170 | Temp. / Humidity | 23°C /61% |
| Polarity | Vertical | Site / Test Engineer | AC2 / Marvin |
| Test Mode | 802.11n-40MHz_TX_Band3_CH 134_ANT 0 | Test Voltage | AC 120V/60Hz |

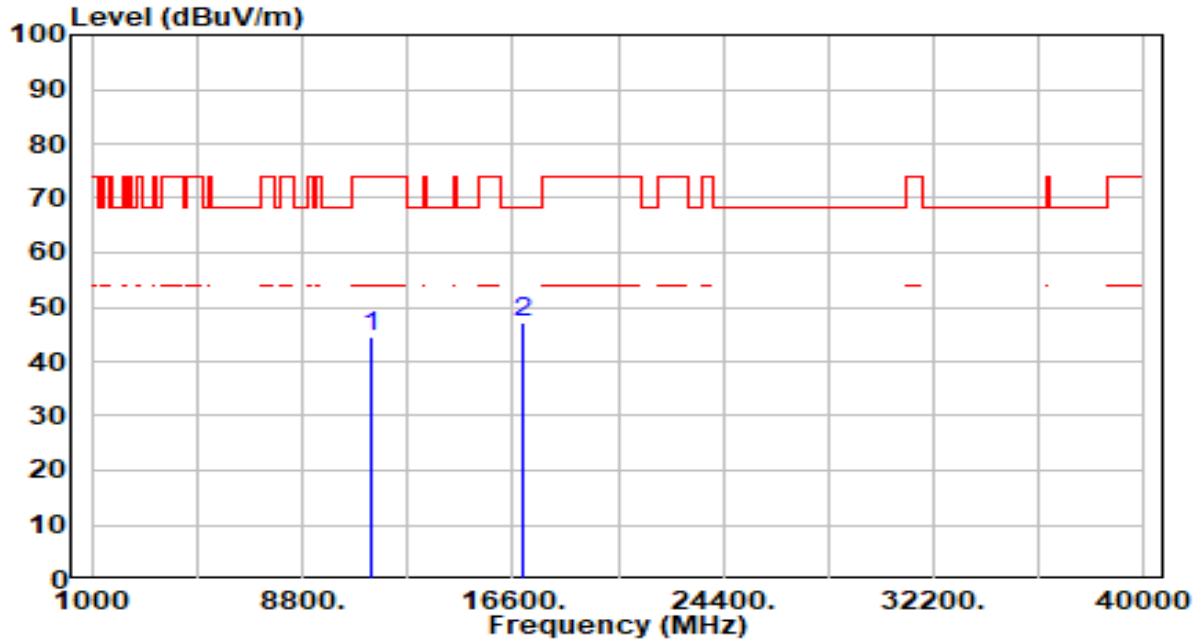

| No | Frequency (MHz) | Reading (dBuV) | C.F (dB/m) | Measurement (dBuV/m) | Margin (dB) | Limit (dBuV/m) | Height (cm) | Angle (deg) | Remark (QP/PK/AV) |
|----|-----------------|----------------|------------|----------------------|-------------|----------------|-------------|-------------|-------------------|
| 1 | 11340.000 | 41.26 | 3.39 | 44.66 | -29.34 | 74.00 | 100 | 355 | Peak |
| 2 | * 17010.000 | 42.07 | 5.00 | 47.07 | -21.13 | 68.20 | 100 | 186 | Peak |

Note:

1. " *", means this data is the worst emission level.
2. C.F (Correction Factor) = Antenna Factor (dB/m)+ Cable Loss (dB) – Pre-amplifier(dB).
3. Measurement (dBuV/m) = Reading(dBuV) + C.F (Correction Factor).
4. The emission levels of other frequencies are very lower than the limit and not show in test report.

| | | | |
|-----------|-------------------------------------|----------------------|--------------|
| EUT | POS Terminal | Date of Test | 2023-10-28 |
| Factor | DRH18-E & BBHA 9170 | Temp. / Humidity | 23°C /61% |
| Polarity | Horizontal | Site / Test Engineer | AC2 / Marvin |
| Test Mode | 802.11n-40MHz_TX_Band3_CH 142_ANT 0 | Test Voltage | AC 120V/60Hz |

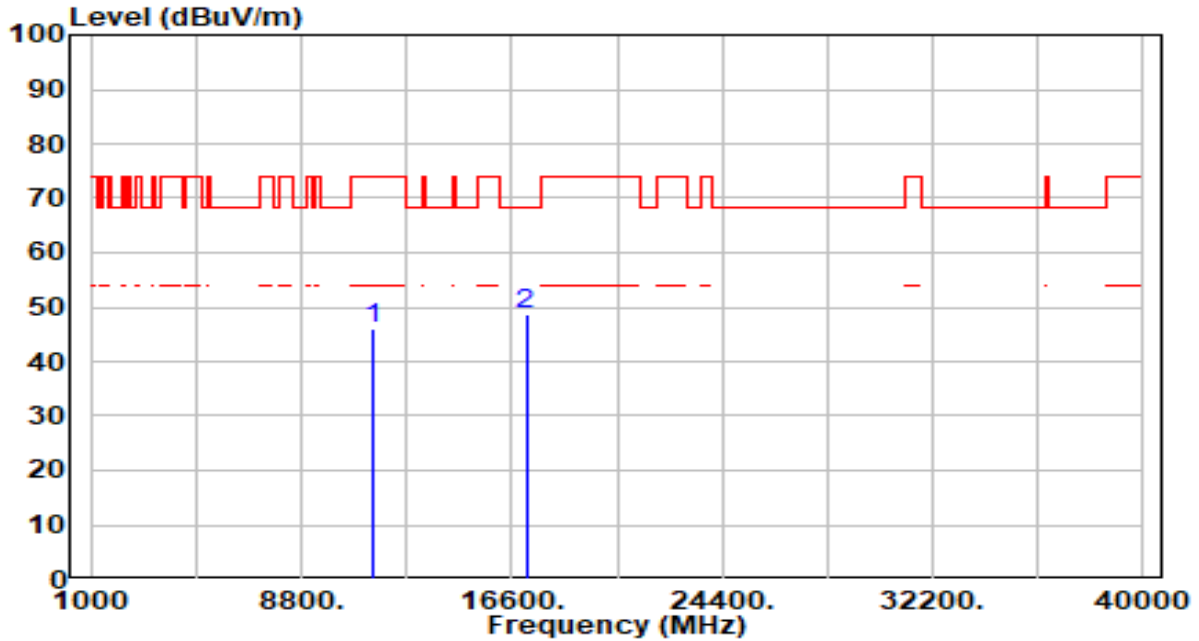

| No | Frequency (MHz) | Reading (dBuV) | C.F (dB/m) | Measurement (dBuV/m) | Margin (dB) | Limit (dBuV/m) | Height (cm) | Angle (deg) | Remark (QP/PK/AV) |
|----|-----------------|----------------|------------|----------------------|-------------|----------------|-------------|-------------|-------------------|
| 1 | 11420.000 | 42.65 | 3.50 | 46.15 | -27.85 | 74.00 | 100 | 236 | Peak |
| 2 | * 17130.000 | 43.98 | 4.72 | 48.71 | -19.49 | 68.20 | 100 | 261 | Peak |

Note:

1. " *", means this data is the worst emission level.
2. C.F (Correction Factor) = Antenna Factor (dB/m)+ Cable Loss (dB) – Pre-amplifier(dB).
3. Measurement (dBuV/m) = Reading(dBuV) + C.F (Correction Factor).
4. The emission levels of other frequencies are very lower than the limit and not show in test report.

| | | | |
|-----------|-------------------------------------|----------------------|--------------|
| EUT | POS Terminal | Date of Test | 2023-10-28 |
| Factor | DRH18-E & BBHA 9170 | Temp. / Humidity | 23°C /61% |
| Polarity | Vertical | Site / Test Engineer | AC2 / Marvin |
| Test Mode | 802.11n-40MHz_TX_Band3_CH 142_ANT 0 | Test Voltage | AC 120V/60Hz |

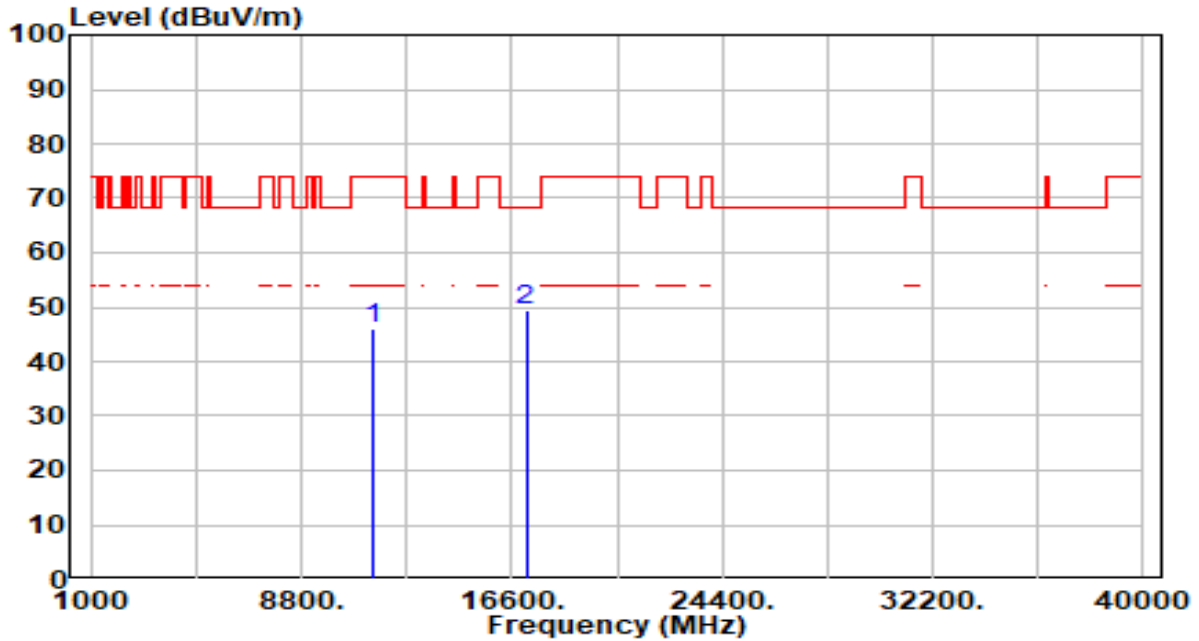

| No | Frequency (MHz) | Reading (dBuV) | C.F (dB/m) | Measurement (dBuV/m) | Margin (dB) | Limit (dBuV/m) | Height (cm) | Angle (deg) | Remark (QP/PK/AV) |
|----|-----------------|----------------|------------|----------------------|-------------|----------------|-------------|-------------|-------------------|
| 1 | 11420.000 | 42.35 | 3.50 | 45.85 | -28.15 | 74.00 | 100 | 20 | Peak |
| 2 | * 17130.000 | 44.59 | 4.72 | 49.31 | -18.89 | 68.20 | 100 | 360 | Peak |

Note:

- " *", means this data is the worst emission level.
- C.F (Correction Factor) = Antenna Factor (dB/m)+ Cable Loss (dB) – Pre-amplifier(dB).
- Measurement (dBuV/m) = Reading(dBuV) + C.F (Correction Factor).
- The emission levels of other frequencies are very lower than the limit and not show in test report.

| | | | |
|-----------|-------------------------------------|----------------------|--------------|
| EUT | POS Terminal | Date of Test | 2023-10-28 |
| Factor | DRH18-E & BBHA 9170 | Temp. / Humidity | 23°C /61% |
| Polarity | Horizontal | Site / Test Engineer | AC2 / Marvin |
| Test Mode | 802.11n-40MHz_TX_Band4_CH 151_ANT 0 | Test Voltage | AC 120V/60Hz |

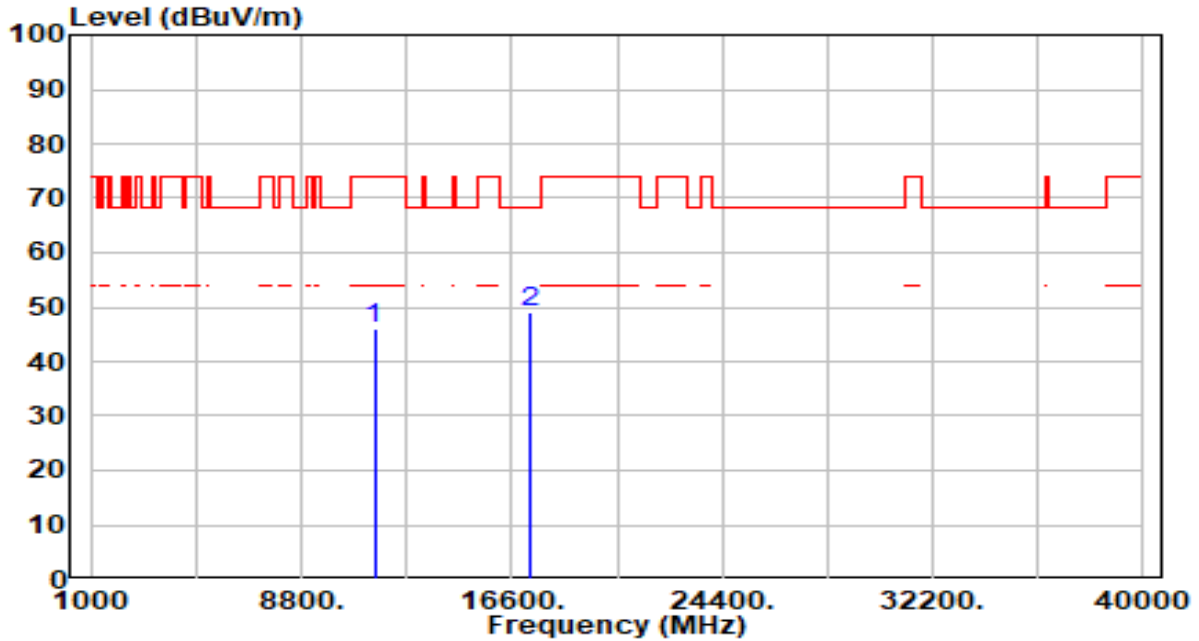

| No | Frequency (MHz) | Reading (dBuV) | C.F (dB/m) | Measurement (dBuV/m) | Margin (dB) | Limit (dBuV/m) | Height (cm) | Angle (deg) | Remark (QP/PK/AV) |
|----|-----------------|----------------|------------|----------------------|-------------|----------------|-------------|-------------|-------------------|
| 1 | 11510.000 | 42.63 | 3.59 | 46.21 | -27.79 | 74.00 | 100 | 280 | Peak |
| 2 | * 17265.000 | 44.56 | 4.35 | 48.91 | -19.29 | 68.20 | 100 | 311 | Peak |

Note:

- "*", means this data is the worst emission level.
- C.F (Correction Factor) = Antenna Factor (dB/m)+ Cable Loss (dB) – Pre-amplifier(dB).
- Measurement (dBuV/m) = Reading(dBuV) + C.F (Correction Factor).
- The emission levels of other frequencies are very lower than the limit and not show in test report.

| | | | |
|-----------|-------------------------------------|----------------------|--------------|
| EUT | POS Terminal | Date of Test | 2023-10-28 |
| Factor | DRH18-E & BBHA 9170 | Temp. / Humidity | 23°C /61% |
| Polarity | Vertical | Site / Test Engineer | AC2 / Marvin |
| Test Mode | 802.11n-40MHz_TX_Band4_CH 151_ANT 0 | Test Voltage | AC 120V/60Hz |

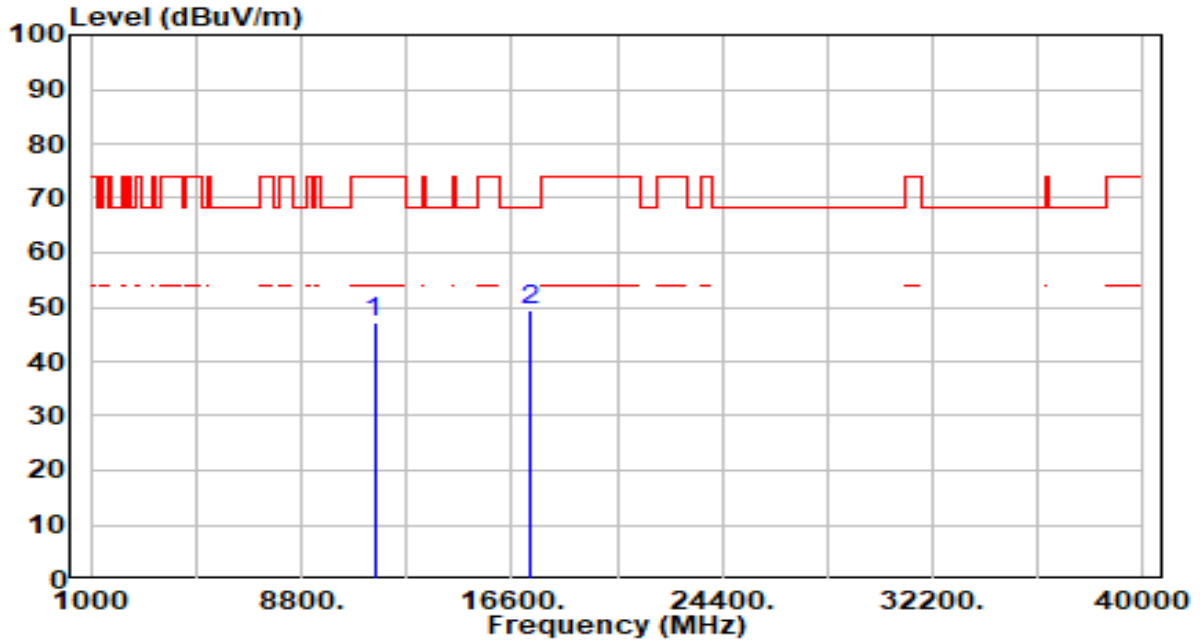

| No | Frequency (MHz) | Reading (dBuV) | C.F (dB/m) | Measurement (dBuV/m) | Margin (dB) | Limit (dBuV/m) | Height (cm) | Angle (deg) | Remark (QP/PK/AV) |
|----|-----------------|----------------|------------|----------------------|-------------|----------------|-------------|-------------|-------------------|
| 1 | 11510.000 | 43.72 | 3.59 | 47.31 | -26.69 | 74.00 | 100 | 349 | Peak |
| 2 | * 17265.000 | 44.91 | 4.35 | 49.26 | -18.94 | 68.20 | 100 | 18 | Peak |

Note:

1. " *", means this data is the worst emission level.
2. C.F (Correction Factor) = Antenna Factor (dB/m)+ Cable Loss (dB) – Pre-amplifier(dB).
3. Measurement (dBuV/m) = Reading(dBuV) + C.F (Correction Factor).
4. The emission levels of other frequencies are very lower than the limit and not show in test report.

| | | | |
|-----------|-------------------------------------|----------------------|--------------|
| EUT | POS Terminal | Date of Test | 2023-10-28 |
| Factor | DRH18-E & BBHA 9170 | Temp. / Humidity | 23°C /61% |
| Polarity | Horizontal | Site / Test Engineer | AC2 / Marvin |
| Test Mode | 802.11n-40MHz_TX_Band4_CH 159_ANT 0 | Test Voltage | AC 120V/60Hz |

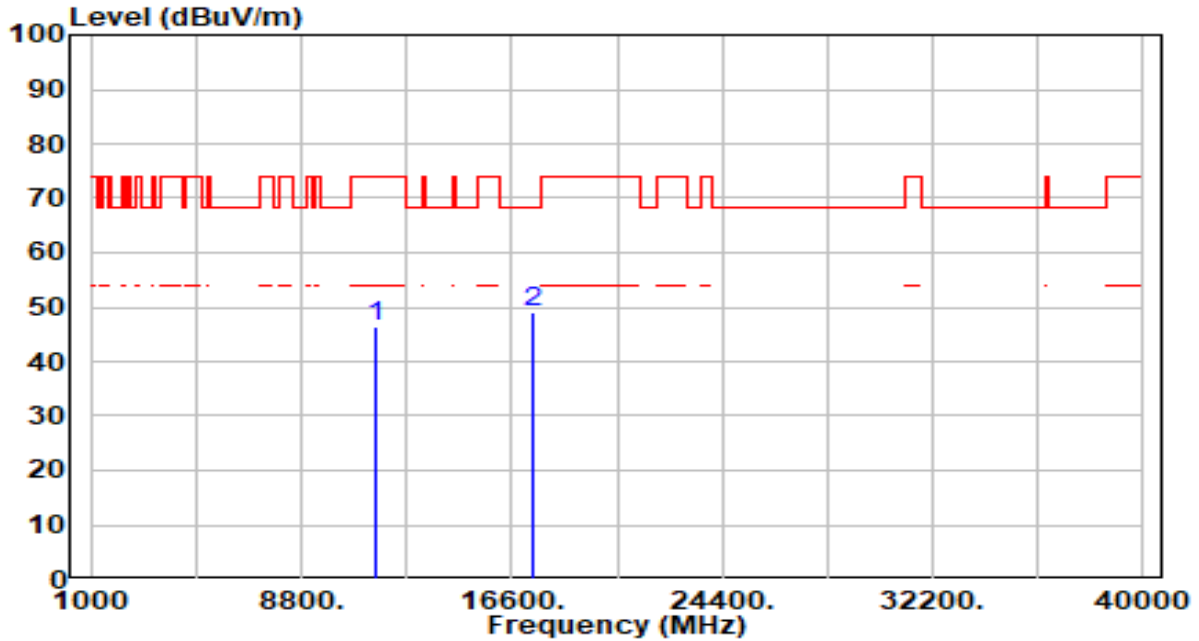

| No | Frequency (MHz) | Reading (dBuV) | C.F (dB/m) | Measurement (dBuV/m) | Margin (dB) | Limit (dBuV/m) | Height (cm) | Angle (deg) | Remark (QP/PK/AV) |
|----|-----------------|----------------|------------|----------------------|-------------|----------------|-------------|-------------|-------------------|
| 1 | 11590.000 | 42.55 | 3.67 | 46.23 | -27.77 | 74.00 | 100 | 327 | Peak |
| 2 | * 17385.000 | 45.21 | 3.96 | 49.17 | -19.03 | 68.20 | 100 | 299 | Peak |

Note:

- "*", means this data is the worst emission level.
- C.F (Correction Factor) = Antenna Factor (dB/m)+ Cable Loss (dB) – Pre-amplifier(dB).
- Measurement (dBuV/m) = Reading(dBuV) + C.F (Correction Factor).
- The emission levels of other frequencies are very lower than the limit and not show in test report.

| | | | |
|-----------|-------------------------------------|----------------------|--------------|
| EUT | POS Terminal | Date of Test | 2023-10-28 |
| Factor | DRH18-E & BBHA 9170 | Temp. / Humidity | 23°C /61% |
| Polarity | Vertical | Site / Test Engineer | AC2 / Marvin |
| Test Mode | 802.11n-40MHz_TX_Band4_CH 159_ANT 0 | Test Voltage | AC 120V/60Hz |

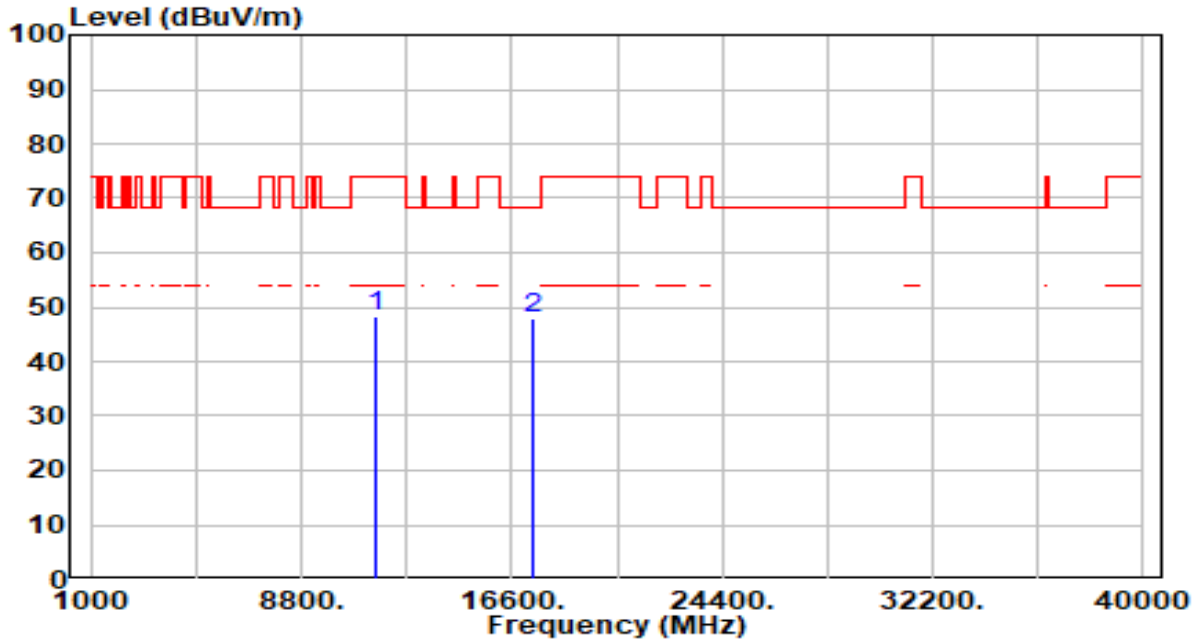

| No | Frequency (MHz) | Reading (dBuV) | C.F (dB/m) | Measurement (dBuV/m) | Margin (dB) | Limit (dBuV/m) | Height (cm) | Angle (deg) | Remark (QP/PK/AV) |
|----|-----------------|----------------|------------|----------------------|-------------|----------------|-------------|-------------|-------------------|
| 1 | 11590.000 | 44.51 | 3.67 | 48.18 | -25.82 | 74.00 | 100 | 5 | Peak |
| 2 | * 17385.000 | 43.86 | 3.96 | 47.82 | -20.38 | 68.20 | 100 | 360 | Peak |

Note:

- "*", means this data is the worst emission level.
- C.F (Correction Factor) = Antenna Factor (dB/m)+ Cable Loss (dB) – Pre-amplifier(dB).
- Measurement (dBuV/m) = Reading(dBuV) + C.F (Correction Factor).
- The emission levels of other frequencies are very lower than the limit and not show in test report.

7.8. Radiated Restricted Band Edge Measurement

7.8.1. Test Limit

For 15.205 requirement:

Radiated emissions which fall in the restricted bands, as defined in Section 15.205(a) of FCC part 15, must also comply with the radiated emission limits specified in Section 15.209(a).

| Frequency (MHz) | Frequency (MHz) | Frequency (MHz) | Frequency (GHz) |
|----------------------------|---------------------|-----------------|------------------|
| 0.090 - 0.110 | 16.42 - 16.423 | 399.9 - 410 | 4.5 - 5.15 |
| ¹ 0.495 - 0.505 | 16.69475 - 16.69525 | 608 - 614 | 5.35 - 5.46 |
| 2.1735 - 2.1905 | 16.80425 - 16.80475 | 960 - 1240 | 7.25 - 7.75 |
| 4.125 - 4.128 | 25.5 - 25.67 | 1300 - 1427 | 8.25 - 8.5 |
| 4.17725 - 4.17775 | 37.5 - 38.25 | 1435 - 1626.5 | 9.0 - 9.2 |
| 4.20725 - 4.20775 | 73 - 74.6 | 1645.5 - 1646.5 | 9.3 - 9.5 |
| 6.215 - 6.218 | 74.8 - 75.2 | 1660 - 1710 | 10.6 - 12.7 |
| 6.26775 - 6.26825 | 108 - 121.94 | 1718.8 - 1722.2 | 13.25 - 13.4 |
| 6.31175 - 6.31225 | 123 - 138 | 2200 - 2300 | 14.47 - 14.5 |
| 8.291 - 8.294 | 149.9 - 150.05 | 2310 - 2390 | 15.35 - 16.2 |
| 8.362 - 8.366 | 156.52475 - 156.525 | 2483.5 - 2500 | 17.7 - 21.4 |
| 8.37625 - 8.38675 | 156.7 - 156.9 | 2690 - 2900 | 22.01 - 23.12 |
| 8.41425 - 8.41475 | 162.0125 - 167.17 | 3260 - 3267 | 23.6 - 24.0 |
| 12.29 - 12.293 | 167.72 - 173.2 | 3332 - 3339 | 31.2 - 31.8 |
| 12.51975 - 12.52025 | 240 - 285 | 3345.8 - 3358 | 36.43 - 36.5 |
| 12.57675 - 12.57725 | 322 - 335.4 | 3600 - 4400 | (²) |
| 13.36 - 13.41 | -- | -- | -- |

For 15.407(b) requirement:

For transmitters operating in the 5.15-5.25 GHz band: All emissions outside of the 5.15-5.35 GHz band shall not exceed an e.i.r.p. of -27 dBm/MHz.

For transmitters operating in the 5.25-5.35 GHz band: All emissions outside of the 5.15-5.35 GHz band shall not exceed an e.i.r.p. of -27 dBm/MHz.

For transmitters operating in the 5.47-5.725 GHz band: All emissions outside of the 5.47-5.725 GHz band shall not exceed an e.i.r.p. of -27 dBm/MHz.

For FCC transmitters operating in the 5.725-5.85 GHz band: All emissions shall be limited to a level of -27 dBm/MHz at 75 MHz or more above or below the band edge increasing linearly to 10 dBm/MHz at 25 MHz above or below the band edge, and from 25 MHz above or below the band edge increasing linearly to a level of 15.6 dBm/MHz at 5 MHz above or below the band edge, and from 5 MHz above or below the band edge increasing linearly to a level of 27 dBm/MHz at the band edge.

For IC transmitters operating in the 5.725-5.85 GHz band: All emissions within the frequency range from the band edge to 10 MHz above or below the band edge shall not exceed an e.i.r.p. of -17 dBm/MHz; for frequencies 10 MHz or greater above or below the band edge, emissions shall not exceed an e.i.r.p. of -27 dBm/MHz.

Refer to KDB 789033 D02v02r01 G)2)c), as specified in § 15.407(b), emissions above 1000 MHz that are outside of the restricted bands are subject to a maximum emission limit of -27 dBm/MHz (or -17 dBm/MHz as specified in § 15.407(b)(4)). However, an out-of-band emission that complies with both the peak and average limits of § 15.209 is not required to satisfy the -27 dBm/MHz or -17 dBm/MHz maximum emission limit.

All out of band emissions appearing in a restricted band as specified in Section 15.205 of the Title 47 CFR must not exceed the limits shown in Table per Section 15.209.

FCC-Radiated emission limits; general requirements.

| FCC Part 15 Subpart C Paragraph 15.209 | | |
|---|---------------------------------|---------------------------------------|
| Frequency [MHz] | Field Strength [V/m] | Measured Distance [Meters] |
| 0.009 ~ 0.490 | 2400/F (kHz) | 300 |
| 0.490 ~ 1.705 | 24000/F (kHz) | 30 |
| 1.705 ~ 30 | 30 | 30 |
| 30 ~ 88 | 100 | 3 |
| 88 ~ 216 | 150 | 3 |
| 216 ~ 960 | 200 | 3 |
| Above 960 | 500 | 3 |

7.8.2. Test Result

| | | | |
|-----------|------------------------------|----------------------|--------------|
| EUT | POS Terminal | Date of Test | 2023-10-28 |
| Factor | DRH18-E | Temp. / Humidity | 23°C /61% |
| Polarity | Horizontal | Site / Test Engineer | AC2 / Marvin |
| Test Mode | 802.11a_TX_Band1_CH 36_ANT 0 | Test Voltage | AC 120V/60Hz |

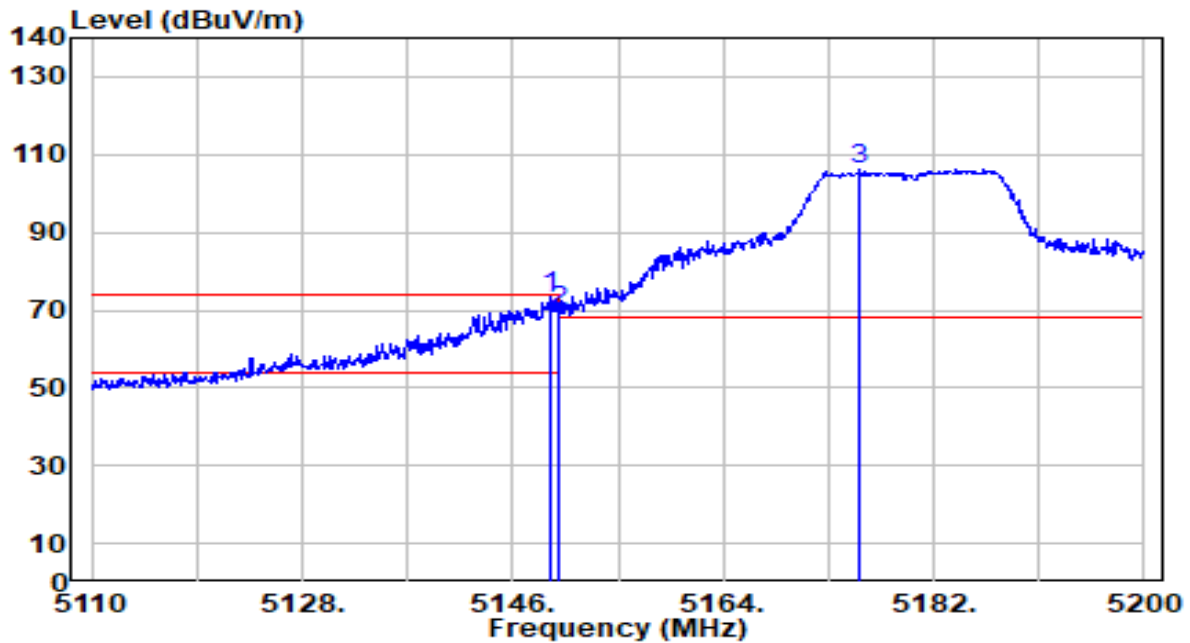

| No | Frequency (MHz) | Reading (dBuV) | C.F (dB/m) | Measurement (dBuV/m) | Margin (dB) | Limit (dBuV/m) | Height (cm) | Angle (deg) | Remark (QP/PK/AV) |
|----|-----------------|----------------|------------|----------------------|-------------|----------------|-------------|-------------|-------------------|
| 1 | * 5149.330 | 74.22 | -0.72 | 73.50 | -0.50 | 74.00 | 114 | 257 | Peak |
| 2 | 5150.000 | 70.37 | -0.72 | 69.65 | -4.35 | 74.00 | 114 | 257 | Peak |
| 3 | 5175.610 | 106.91 | -0.73 | 106.18 | N/A | N/A | 114 | 257 | Peak |

Note:

1. " *" , means this data is the worst emission level.
2. C.F (Correction Factor) = Antenna Factor (dB/m)+ Cable Loss (dB) – Preamplifier(dB) + 10dB Attenuation.
3. Measurement (dBuV/m) = Reading(dBuV) + C.F (Correction Factor).
4. The emission levels of other frequencies are very lower than the limit and not show in test report.

| | | | |
|-----------|------------------------------|----------------------|--------------|
| EUT | POS Terminal | Date of Test | 2023-10-28 |
| Factor | DRH18-E | Temp. / Humidity | 23°C /61% |
| Polarity | Horizontal | Site / Test Engineer | AC2 / Marvin |
| Test Mode | 802.11a_TX_Band1_CH 36_ANT 0 | Test Voltage | AC 120V/60Hz |

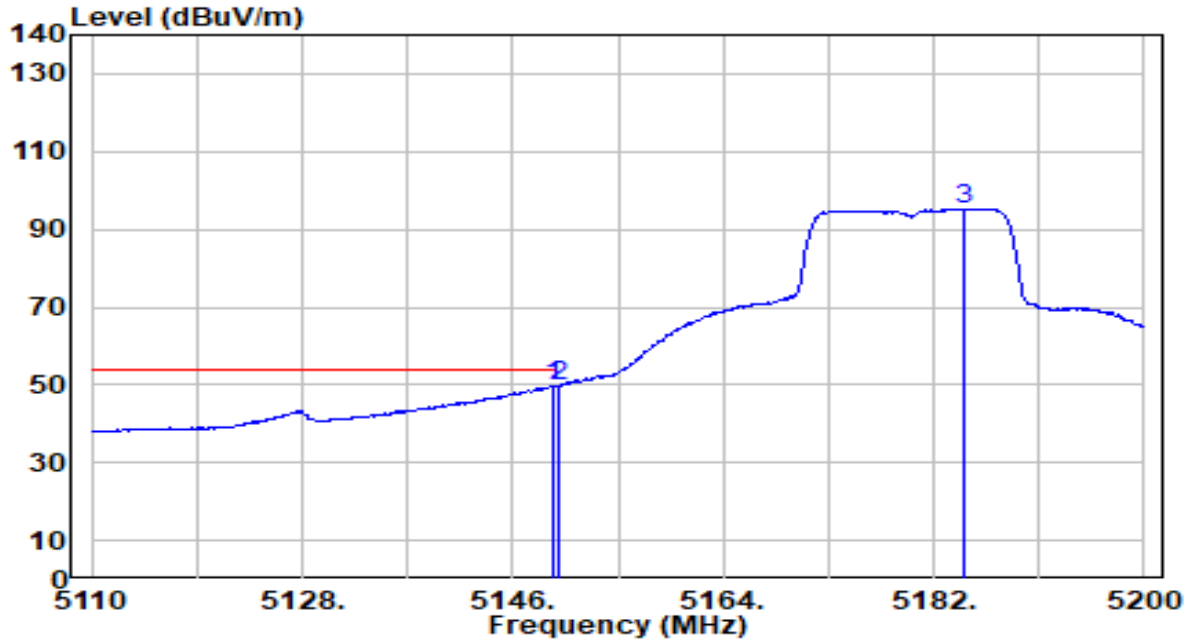

| No | Frequency (MHz) | Reading (dBuV) | C.F (dB/m) | Measurement (dBuV/m) | Margin (dB) | Limit (dBuV/m) | Height (cm) | Angle (deg) | Remark (QP/PK/AV) |
|----|-----------------|----------------|------------|----------------------|-------------|----------------|-------------|-------------|-------------------|
| 1 | 5149.420 | 50.33 | -0.72 | 49.62 | -4.38 | 54.00 | 114 | 257 | Average |
| 2 | * 5150.000 | 50.56 | -0.72 | 49.85 | -4.15 | 54.00 | 114 | 257 | Average |
| 3 | 5184.700 | 96.07 | -0.74 | 95.33 | N/A | N/A | 114 | 257 | Average |

Note:

1. " *" , means this data is the worst emission level.
2. C.F (Correction Factor) = Antenna Factor (dB/m)+ Cable Loss (dB) – Preamplifier(dB) + 10dB Attenuation.
3. Measurement (dBuV/m) = Reading(dBuV) + C.F (Correction Factor).
4. The emission levels of other frequencies are very lower than the limit and not show in test report.

| | | | |
|-----------|------------------------------|----------------------|--------------|
| EUT | POS Terminal | Date of Test | 2023-10-28 |
| Factor | DRH18-E | Temp. / Humidity | 23°C /61% |
| Polarity | Vertical | Site / Test Engineer | AC2 / Marvin |
| Test Mode | 802.11a_TX_Band1_CH 36_ANT 0 | Test Voltage | AC 120V/60Hz |

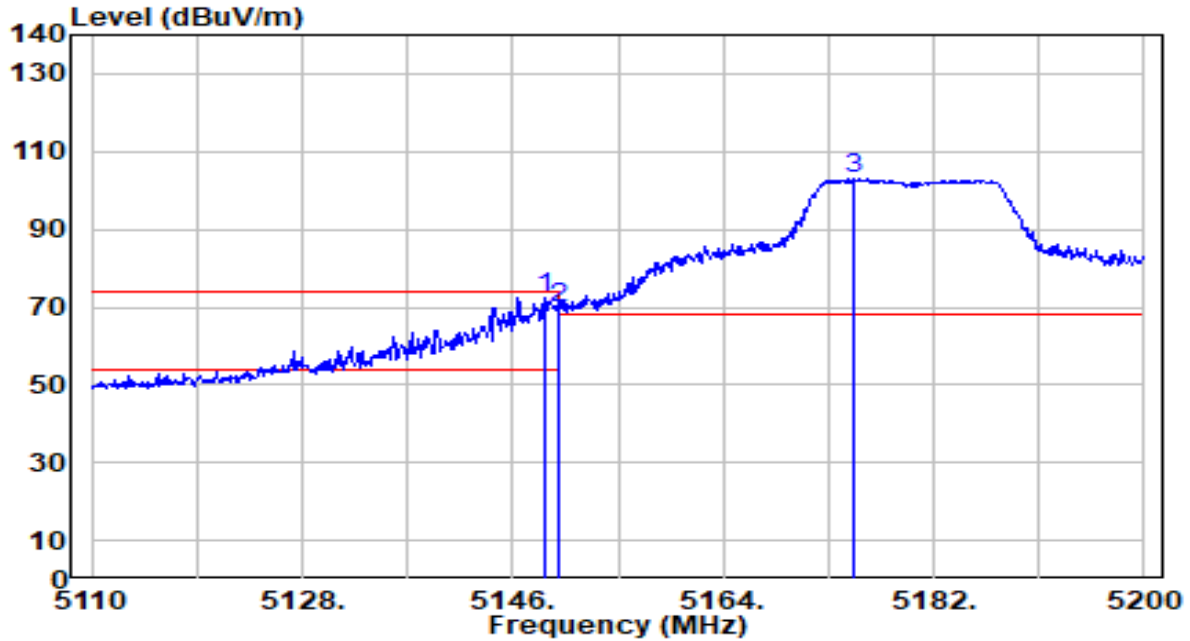

| No | Frequency (MHz) | Reading (dBuV) | C.F (dB/m) | Measurement (dBuV/m) | Margin (dB) | Limit (dBuV/m) | Height (cm) | Angle (deg) | Remark (QP/PK/AV) |
|----|-----------------|----------------|------------|----------------------|-------------|----------------|-------------|-------------|-------------------|
| 1 | * 5148.790 | 73.31 | -0.72 | 72.60 | -1.40 | 74.00 | 100 | 323 | Peak |
| 2 | 5150.000 | 70.70 | -0.72 | 69.98 | -4.02 | 74.00 | 100 | 323 | Peak |
| 3 | * 5175.160 | 103.83 | -0.73 | 103.10 | N/A | N/A | 100 | 323 | Peak |

Note:

1. " *", means this data is the worst emission level.
2. C.F (Correction Factor) = Antenna Factor (dB/m)+ Cable Loss (dB) – Preamplifier(dB) + 10dB Attenuation.
3. Measurement (dBuV/m) = Reading(dBuV) + C.F (Correction Factor).
4. The emission levels of other frequencies are very lower than the limit and not show in test report.

| | | | |
|-----------|------------------------------|----------------------|--------------|
| EUT | POS Terminal | Date of Test | 2023-10-28 |
| Factor | DRH18-E | Temp. / Humidity | 23°C /61% |
| Polarity | Vertical | Site / Test Engineer | AC2 / Marvin |
| Test Mode | 802.11a_TX_Band1_CH 36_ANT 0 | Test Voltage | AC 120V/60Hz |

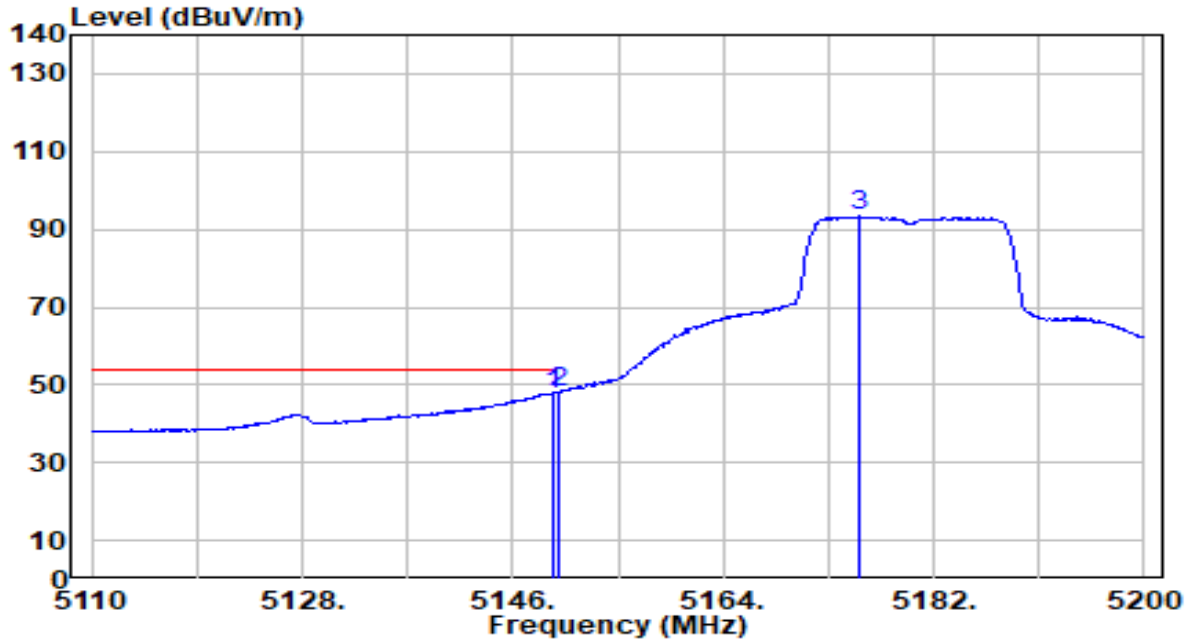

| No | Frequency (MHz) | Reading (dBuV) | C.F (dB/m) | Measurement (dBuV/m) | Margin (dB) | Limit (dBuV/m) | Height (cm) | Angle (deg) | Remark (QP/PK/AV) |
|----|-----------------|----------------|------------|----------------------|-------------|----------------|-------------|-------------|-------------------|
| 1 | 5149.420 | 48.48 | -0.72 | 47.76 | -6.24 | 54.00 | 100 | 323 | Average |
| 2 | * 5150.000 | 48.74 | -0.72 | 48.02 | -5.98 | 54.00 | 100 | 323 | Average |
| 3 | 5175.700 | 94.02 | -0.73 | 93.29 | N/A | N/A | 100 | 323 | Average |

Note:

1. " *" , means this data is the worst emission level.
2. C.F (Correction Factor) = Antenna Factor (dB/m)+ Cable Loss (dB) – Preamplifier(dB) + 10dB Attenuation.
3. Measurement (dBuV/m) = Reading(dBuV) + C.F (Correction Factor).
4. The emission levels of other frequencies are very lower than the limit and not show in test report.

| | | | |
|-----------|------------------------------|----------------------|--------------|
| EUT | POS Terminal | Date of Test | 2023-10-28 |
| Factor | DRH18-E | Temp. / Humidity | 23°C /61% |
| Polarity | Horizontal | Site / Test Engineer | AC2 / Marvin |
| Test Mode | 802.11a_TX_Band2_CH 64_ANT 0 | Test Voltage | AC 120V/60Hz |

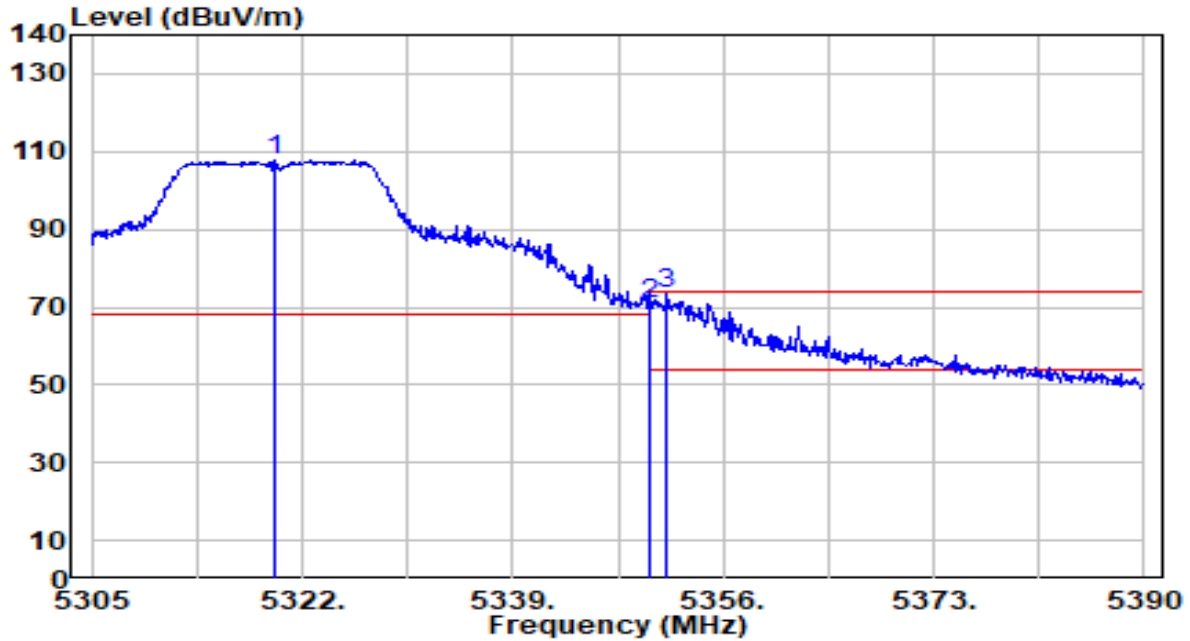

| No | Frequency (MHz) | Reading (dBuV) | C.F (dB/m) | Measurement (dBuV/m) | Margin (dB) | Limit (dBuV/m) | Height (cm) | Angle (deg) | Remark (QP/PK/AV) |
|----|-----------------|----------------|------------|----------------------|-------------|----------------|-------------|-------------|-------------------|
| 1 | 5319.790 | 108.63 | -0.93 | 107.70 | N/A | N/A | 123 | 240 | Peak |
| 2 | 5350.000 | 71.80 | -0.97 | 70.83 | -3.17 | 74.00 | 123 | 240 | Peak |
| 3 | * 5351.410 | 74.38 | -0.97 | 73.41 | -0.59 | 74.00 | 123 | 240 | Peak |

Note:

1. " *" , means this data is the worst emission level.
2. C.F (Correction Factor) = Antenna Factor (dB/m)+ Cable Loss (dB) – Preamplifier(dB) + 10dB Attenuation.
3. Measurement (dBuV/m) = Reading(dBuV) + C.F (Correction Factor).
4. The emission levels of other frequencies are very lower than the limit and not show in test report.

| | | | |
|-----------|------------------------------|----------------------|--------------|
| EUT | POS Terminal | Date of Test | 2023-10-28 |
| Factor | DRH18-E | Temp. / Humidity | 23°C /61% |
| Polarity | Horizontal | Site / Test Engineer | AC2 / Marvin |
| Test Mode | 802.11a_TX_Band2_CH 64_ANT 0 | Test Voltage | AC 120V/60Hz |

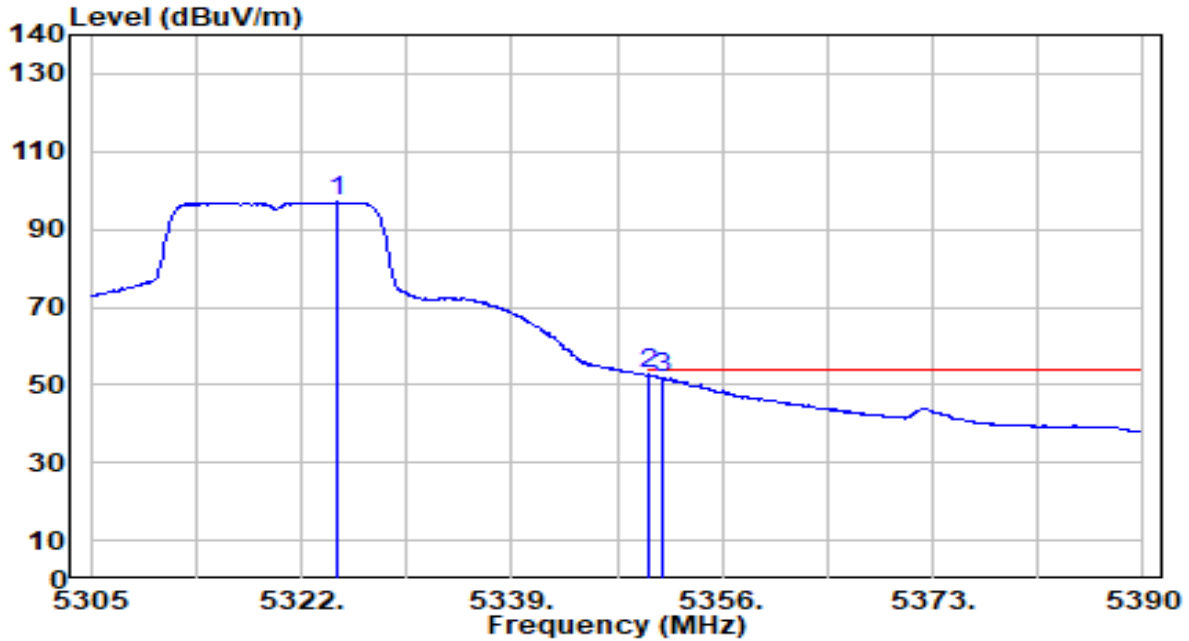

| No | Frequency (MHz) | Reading (dBuV) | C.F (dB/m) | Measurement (dBuV/m) | Margin (dB) | Limit (dBuV/m) | Height (cm) | Angle (deg) | Remark (QP/PK/AV) |
|----|-----------------|----------------|------------|----------------------|-------------|----------------|-------------|-------------|-------------------|
| 1 | 5324.890 | 97.91 | -0.93 | 96.97 | N/A | N/A | 123 | 240 | Average |
| 2 | * 5350.000 | 53.74 | -0.97 | 52.77 | -1.23 | 54.00 | 123 | 240 | Average |
| 3 | 5351.240 | 52.58 | -0.97 | 51.61 | -2.39 | 54.00 | 123 | 240 | Average |

Note:

1. " *" , means this data is the worst emission level.
2. C.F (Correction Factor) = Antenna Factor (dB/m)+ Cable Loss (dB) – Preamplifier(dB) + 10dB Attenuation.
3. Measurement (dBuV/m) = Reading(dBuV) + C.F (Correction Factor).
4. The emission levels of other frequencies are very lower than the limit and not show in test report.

| | | | |
|-----------|------------------------------|----------------------|--------------|
| EUT | POS Terminal | Date of Test | 2023-10-28 |
| Factor | DRH18-E | Temp. / Humidity | 23°C /61% |
| Polarity | Vertical | Site / Test Engineer | AC2 / Marvin |
| Test Mode | 802.11a_TX_Band2_CH 64_ANT 0 | Test Voltage | AC 120V/60Hz |

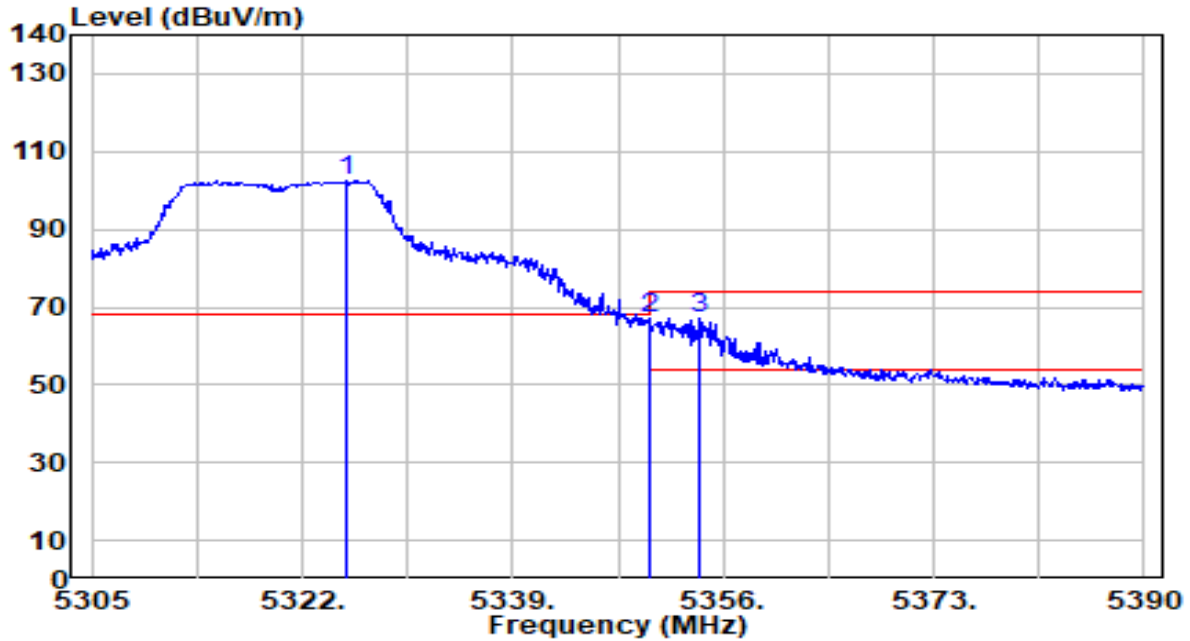

| No | Frequency (MHz) | Reading (dBuV) | C.F (dB/m) | Measurement (dBuV/m) | Margin (dB) | Limit (dBuV/m) | Height (cm) | Angle (deg) | Remark (QP/PK/AV) |
|----|-----------------|----------------|------------|----------------------|-------------|----------------|-------------|-------------|-------------------|
| 1 | 5325.485 | 103.24 | -0.93 | 102.31 | N/A | N/A | 100 | 307 | Peak |
| 2 | 5350.000 | 67.96 | -0.97 | 66.99 | -7.01 | 74.00 | 100 | 307 | Peak |
| 3 | * 5354.130 | 68.30 | -0.98 | 67.32 | -6.68 | 74.00 | 100 | 307 | Peak |

Note:

1. " *" , means this data is the worst emission level.
2. C.F (Correction Factor) = Antenna Factor (dB/m)+ Cable Loss (dB) – Preamplifier(dB) + 10dB Attenuation.
3. Measurement (dBuV/m) = Reading(dBuV) + C.F (Correction Factor).
4. The emission levels of other frequencies are very lower than the limit and not show in test report.

| | | | |
|-----------|------------------------------|----------------------|--------------|
| EUT | POS Terminal | Date of Test | 2023-10-28 |
| Factor | DRH18-E | Temp. / Humidity | 23°C /61% |
| Polarity | Vertical | Site / Test Engineer | AC2 / Marvin |
| Test Mode | 802.11a_TX_Band2_CH 64_ANT 0 | Test Voltage | AC 120V/60Hz |

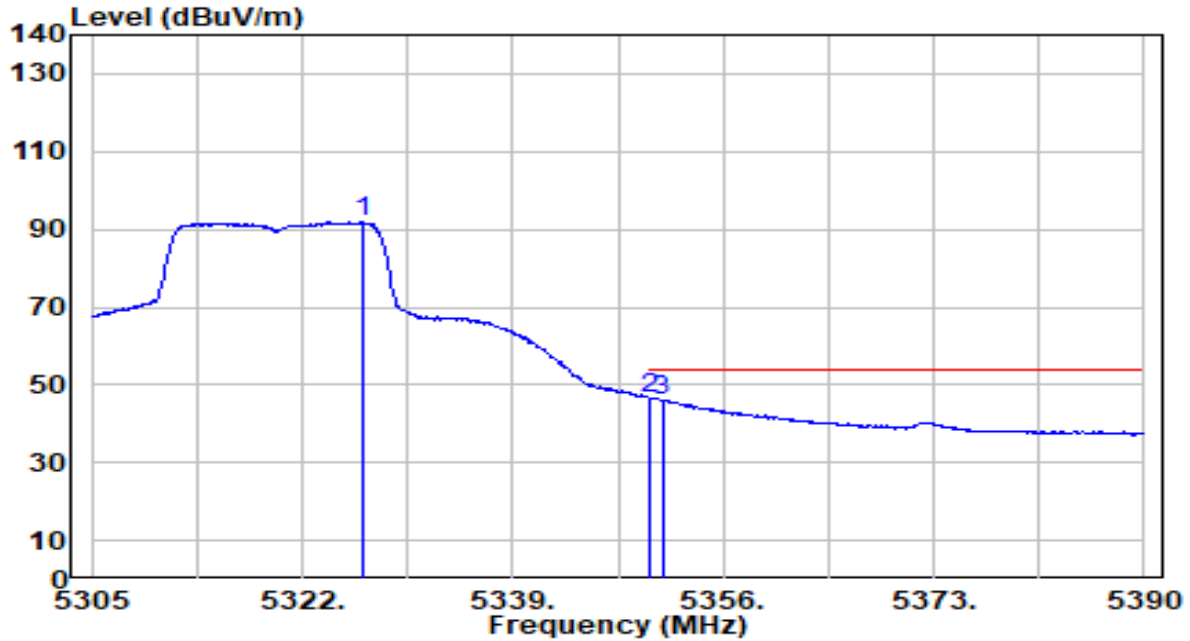

| No | Frequency (MHz) | Reading (dBuV) | C.F (dB/m) | Measurement (dBuV/m) | Margin (dB) | Limit (dBuV/m) | Height (cm) | Angle (deg) | Remark (QP/PK/AV) |
|----|-----------------|----------------|------------|----------------------|-------------|----------------|-------------|-------------|-------------------|
| 1 | 5326.845 | 92.76 | -0.94 | 91.82 | N/A | N/A | 100 | 307 | Average |
| 2 | * 5350.000 | 47.39 | -0.97 | 46.42 | -7.58 | 54.00 | 100 | 307 | Average |
| 3 | 5351.070 | 47.07 | -0.97 | 46.10 | -7.90 | 54.00 | 100 | 307 | Average |

Note:

1. " *" , means this data is the worst emission level.
2. C.F (Correction Factor) = Antenna Factor (dB/m)+ Cable Loss (dB) – Preamplifier(dB) + 10dB Attenuation.
3. Measurement (dBuV/m) = Reading(dBuV) + C.F (Correction Factor).
4. The emission levels of other frequencies are very lower than the limit and not show in test report.

| | | | |
|-----------|-------------------------------|----------------------|--------------|
| EUT | POS Terminal | Date of Test | 2023-10-28 |
| Factor | DRH18-E | Temp. / Humidity | 23°C /61% |
| Polarity | Horizontal | Site / Test Engineer | AC2 / Marvin |
| Test Mode | 802.11a_TX_Band3_CH 100_ANT 0 | Test Voltage | AC 120V/60Hz |

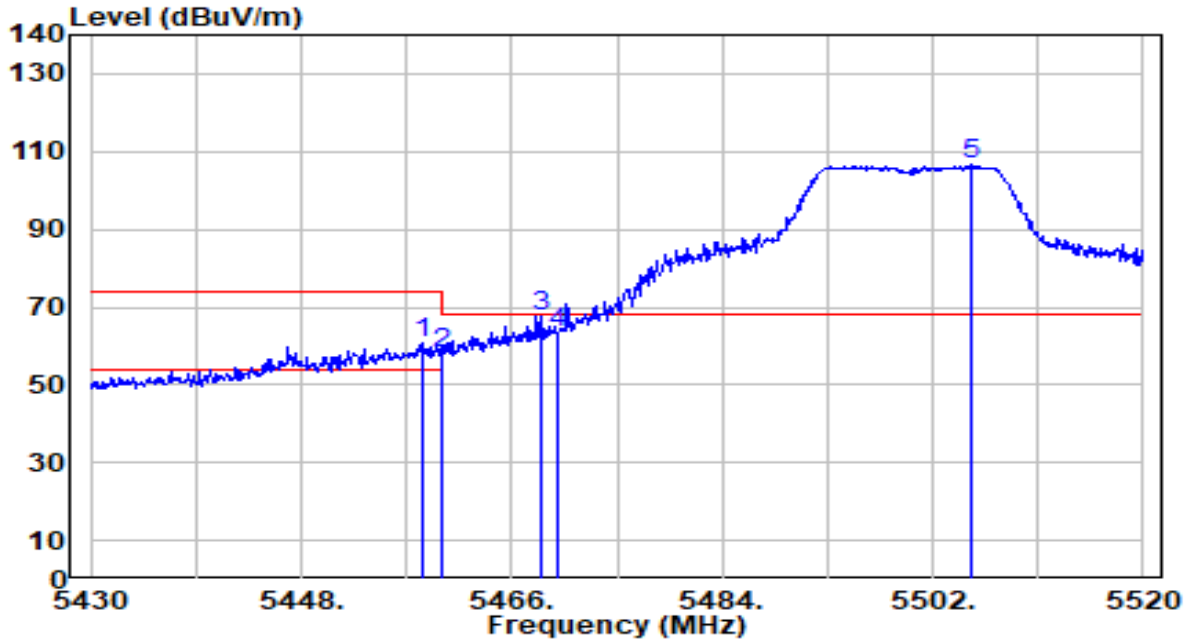

| No | Frequency (MHz) | Reading (dBuV) | C.F (dB/m) | Measurement (dBuV/m) | Margin (dB) | Limit (dBuV/m) | Height (cm) | Angle (deg) | Remark (QP/PK/AV) |
|----|-----------------|----------------|------------|----------------------|-------------|----------------|-------------|-------------|-------------------|
| 1 | 5458.350 | 61.52 | -0.87 | 60.65 | -13.35 | 74.00 | 119 | 241 | Peak |
| 2 | 5460.000 | 59.05 | -0.87 | 58.18 | -15.82 | 74.00 | 119 | 241 | Peak |
| 3 | * 5468.610 | 68.51 | -0.84 | 67.67 | -0.53 | 68.20 | 119 | 241 | Peak |
| 4 | 5470.000 | 64.07 | -0.84 | 63.23 | -4.97 | 68.20 | 119 | 241 | Peak |
| 5 | 5505.240 | 107.59 | -0.73 | 106.85 | N/A | N/A | 119 | 241 | Peak |

Note:

1. " *", means this data is the worst emission level.
2. C.F (Correction Factor) = Antenna Factor (dB/m)+ Cable Loss (dB) – Preamplifier(dB) + 10dB Attenuation.
3. Measurement (dBuV/m) = Reading(dBuV) + C.F (Correction Factor).
4. The emission levels of other frequencies are very lower than the limit and not show in test report.

| | | | |
|-----------|-------------------------------|----------------------|--------------|
| EUT | POS Terminal | Date of Test | 2023-10-28 |
| Factor | DRH18-E | Temp. / Humidity | 23°C /61% |
| Polarity | Horizontal | Site / Test Engineer | AC2 / Marvin |
| Test Mode | 802.11a_TX_Band3_CH 100_ANT 0 | Test Voltage | AC 120V/60Hz |

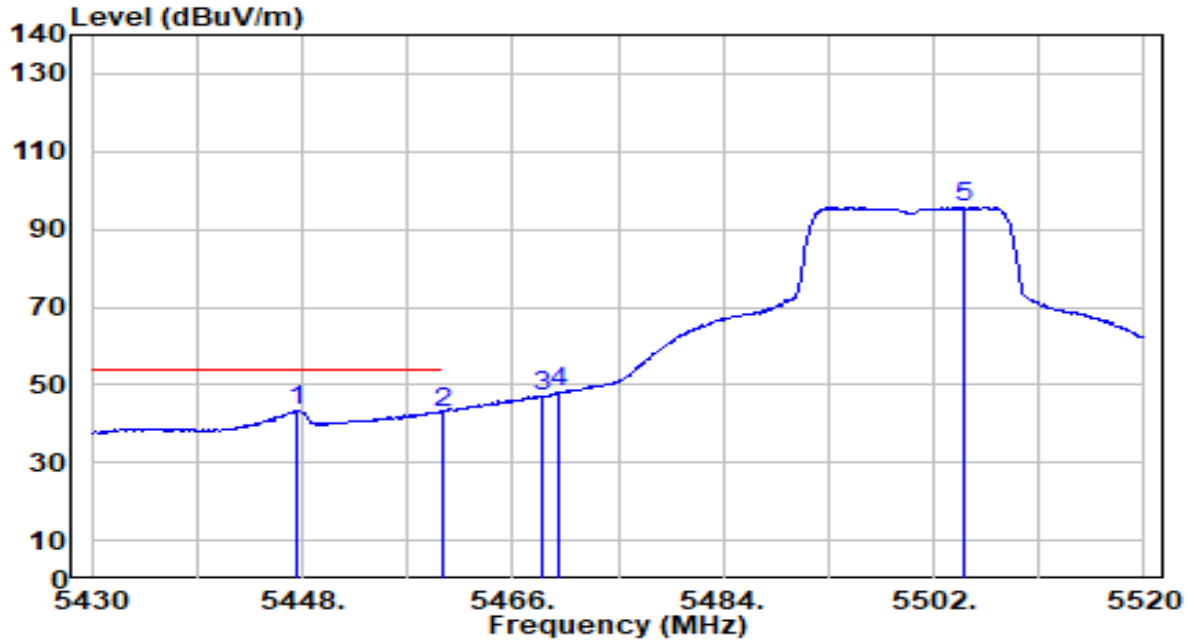

| No | Frequency (MHz) | Reading (dBuV) | C.F (dB/m) | Measurement (dBuV/m) | Margin (dB) | Limit (dBuV/m) | Height (cm) | Angle (deg) | Remark (QP/PK/AV) |
|----|-----------------|----------------|------------|----------------------|-------------|----------------|-------------|-------------|-------------------|
| 1 | * 5447.640 | 44.18 | -0.91 | 43.27 | -10.73 | 54.00 | 119 | 241 | Average |
| 2 | 5460.000 | 43.84 | -0.87 | 42.97 | -11.03 | 54.00 | 119 | 241 | Average |
| 3 | 5468.610 | 47.98 | -0.84 | 47.14 | N/A | N/A | 119 | 241 | Average |
| 4 | 5470.000 | 48.67 | -0.84 | 47.83 | N/A | N/A | 119 | 241 | Average |
| 5 | 5504.520 | 96.39 | -0.74 | 95.65 | N/A | N/A | 119 | 241 | Average |

Note:

1. " *", means this data is the worst emission level.
2. C.F (Correction Factor) = Antenna Factor (dB/m)+ Cable Loss (dB) – Preamplifier(dB) + 10dB Attenuation.
3. Measurement (dBuV/m) = Reading(dBuV) + C.F (Correction Factor).
4. The emission levels of other frequencies are very lower than the limit and not show in test report.

| | | | |
|-----------|-------------------------------|----------------------|--------------|
| EUT | POS Terminal | Date of Test | 2023-10-28 |
| Factor | DRH18-E | Temp. / Humidity | 23°C /61% |
| Polarity | Vertical | Site / Test Engineer | AC2 / Marvin |
| Test Mode | 802.11a_TX_Band3_CH 100_ANT 0 | Test Voltage | AC 120V/60Hz |

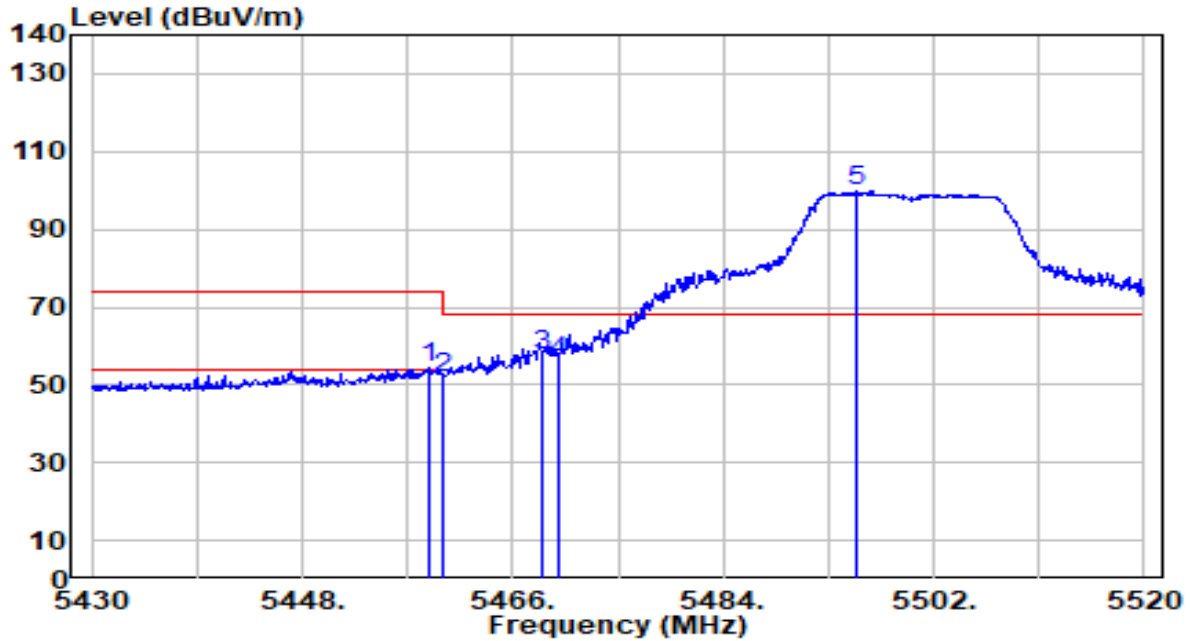

| No | Frequency (MHz) | Reading (dBuV) | C.F (dB/m) | Measurement (dBuV/m) | Margin (dB) | Limit (dBuV/m) | Height (cm) | Angle (deg) | Remark (QP/PK/AV) |
|-----|-----------------|----------------|------------|----------------------|-------------|----------------|-------------|-------------|-------------------|
| 1 | 5458.800 | 55.14 | -0.87 | 54.27 | -19.73 | 74.00 | 100 | 302 | Peak |
| 2 | 5460.000 | 52.73 | -0.87 | 51.86 | -22.14 | 74.00 | 100 | 302 | Peak |
| 3 * | 5468.610 | 58.32 | -0.84 | 57.47 | -10.73 | 68.20 | 100 | 302 | Peak |
| 4 | 5470.000 | 56.87 | -0.84 | 56.03 | -12.17 | 68.20 | 100 | 302 | Peak |
| 5 | 5495.340 | 100.72 | -0.76 | 99.96 | N/A | N/A | 100 | 302 | Peak |

Note:

- "*" means this data is the worst emission level.
- C.F (Correction Factor) = Antenna Factor (dB/m)+ Cable Loss (dB) – Preamplifier(dB) + 10dB Attenuation.
- Measurement (dBuV/m) = Reading(dBuV) + C.F (Correction Factor).
- The emission levels of other frequencies are very lower than the limit and not show in test report.

| | | | |
|-----------|-------------------------------|----------------------|--------------|
| EUT | POS Terminal | Date of Test | 2023-10-28 |
| Factor | DRH18-E | Temp. / Humidity | 23°C /61% |
| Polarity | Vertical | Site / Test Engineer | AC2 / Marvin |
| Test Mode | 802.11a_TX_Band3_CH 100_ANT 0 | Test Voltage | AC 120V/60Hz |

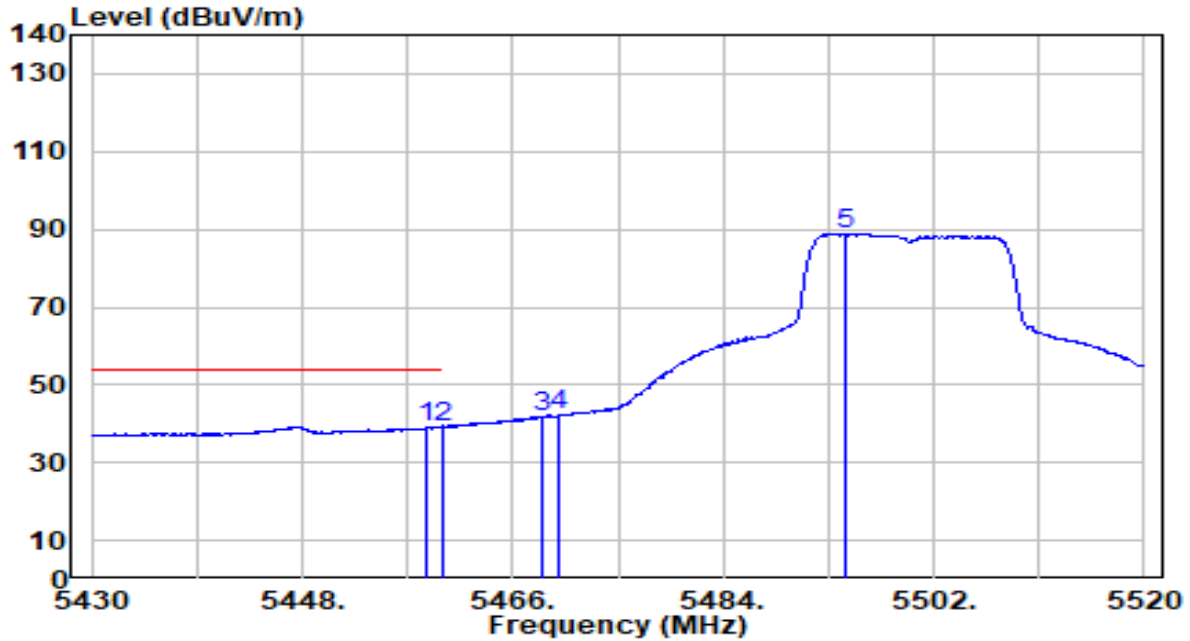

| No | Frequency (MHz) | Reading (dBUV) | C.F (dB/m) | Measurement (dBUV/m) | Margin (dB) | Limit (dBUV/m) | Height (cm) | Angle (deg) | Remark (QP/PK/AV) |
|----|-----------------|----------------|------------|----------------------|-------------|----------------|-------------|-------------|-------------------|
| 1 | * 5458.710 | 40.04 | -0.87 | 39.16 | -14.84 | 54.00 | 100 | 302 | Average |
| 2 | 5460.000 | 39.95 | -0.87 | 39.08 | -14.92 | 54.00 | 100 | 302 | Average |
| 3 | 5468.610 | 42.43 | -0.84 | 41.58 | N/A | N/A | 100 | 302 | Average |
| 4 | 5470.000 | 42.95 | -0.84 | 42.11 | N/A | N/A | 100 | 302 | Average |
| 5 | 5494.530 | 89.54 | -0.77 | 88.77 | N/A | N/A | 100 | 302 | Average |

Note:

1. " *", means this data is the worst emission level.
2. C.F (Correction Factor) = Antenna Factor (dB/m)+ Cable Loss (dB) – Preamplifier(dB) + 10dB Attenuation.
3. Measurement (dBUV/m) = Reading(dBUV) + C.F (Correction Factor).
4. The emission levels of other frequencies are very lower than the limit and not show in test report.

| | | | |
|-----------|-------------------------------|----------------------|--------------|
| EUT | POS Terminal | Date of Test | 2023-10-28 |
| Factor | DRH18-E | Temp. / Humidity | 23°C /61% |
| Polarity | Horizontal | Site / Test Engineer | AC2 / Marvin |
| Test Mode | 802.11a_TX_Band3_CH 140_ANT 0 | Test Voltage | AC 120V/60Hz |

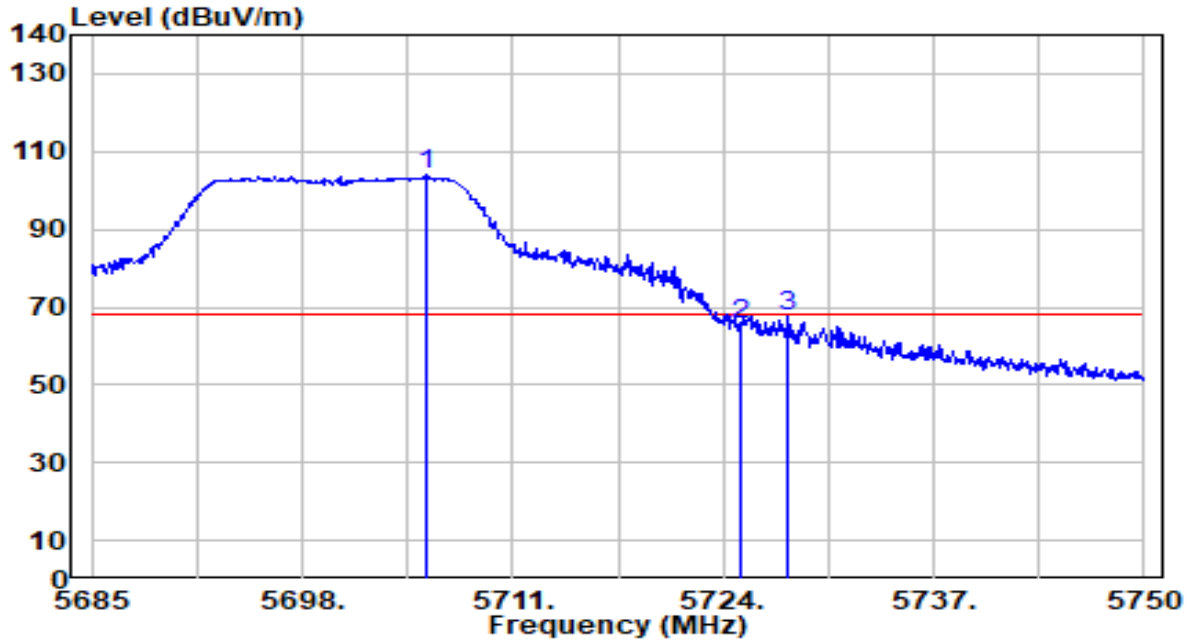

| No | Frequency (MHz) | Reading (dBuV) | C.F (dB/m) | Measurement (dBuV/m) | Margin (dB) | Limit (dBuV/m) | Height (cm) | Angle (deg) | Remark (QP/PK/AV) |
|----|-----------------|----------------|------------|----------------------|-------------|----------------|-------------|-------------|-------------------|
| 1 | 5705.605 | 103.79 | 0.13 | 103.91 | N/A | N/A | 120 | 241 | Peak |
| 2 | 5725.000 | 65.30 | 0.23 | 65.52 | -2.68 | 68.20 | 120 | 241 | Peak |
| 3 | * 5727.965 | 67.41 | 0.24 | 67.65 | -0.55 | 68.20 | 120 | 241 | Peak |

Note:

1. " *" , means this data is the worst emission level.
2. C.F (Correction Factor) = Antenna Factor (dB/m)+ Cable Loss (dB) – Preamplifier(dB) + 10dB Attenuation.
3. Measurement (dBuV/m) = Reading(dBuV) + C.F (Correction Factor).
4. The emission levels of other frequencies are very lower than the limit and not show in test report.

| | | | |
|-----------|-------------------------------|----------------------|--------------|
| EUT | POS Terminal | Date of Test | 2023-10-28 |
| Factor | DRH18-E | Temp. / Humidity | 23°C /61% |
| Polarity | Vertical | Site / Test Engineer | AC2 / Marvin |
| Test Mode | 802.11a_TX_Band3_CH 140_ANT 0 | Test Voltage | AC 120V/60Hz |

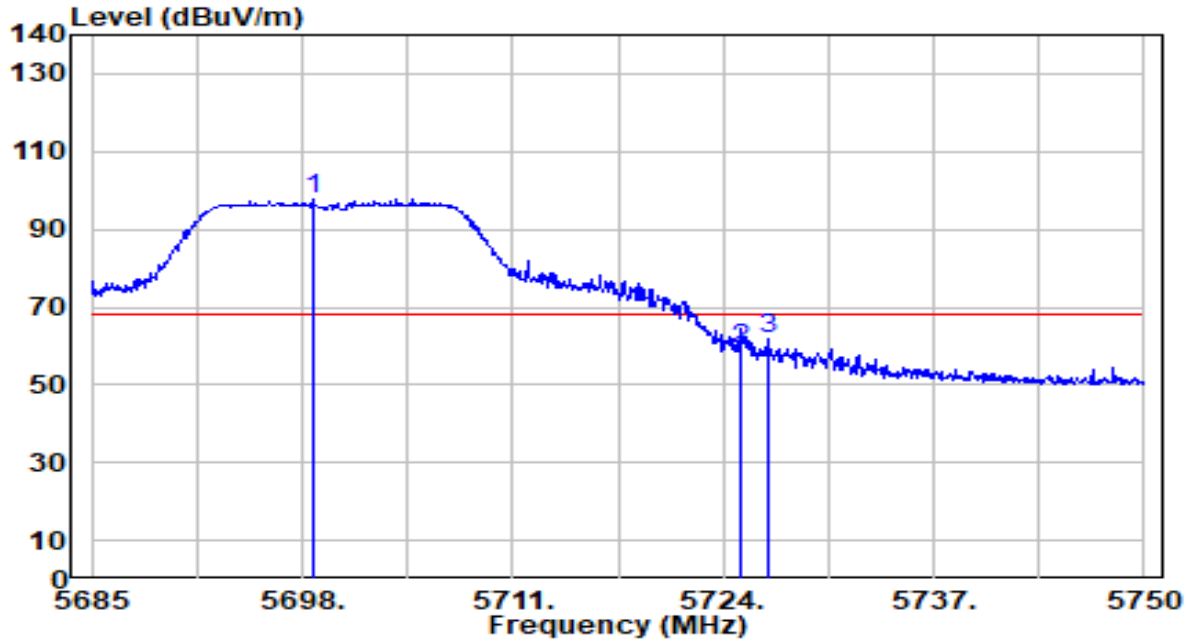

| No | Frequency (MHz) | Reading (dBuV) | C.F (dB/m) | Measurement (dBuV/m) | Margin (dB) | Limit (dBuV/m) | Height (cm) | Angle (deg) | Remark (QP/PK/AV) |
|----|-----------------|----------------|------------|----------------------|-------------|----------------|-------------|-------------|-------------------|
| 1 | 5698.650 | 97.70 | 0.09 | 97.80 | N/A | N/A | 100 | 308 | Peak |
| 2 | 5725.000 | 59.03 | 0.23 | 59.26 | -8.94 | 68.20 | 100 | 308 | Peak |
| 3 | * 5726.730 | 61.35 | 0.24 | 61.59 | -6.61 | 68.20 | 100 | 308 | Peak |

Note:

1. " *" , means this data is the worst emission level.
2. C.F (Correction Factor) = Antenna Factor (dB/m)+ Cable Loss (dB) – Preamplifier(dB) + 10dB Attenuation.
3. Measurement (dBuV/m) = Reading(dBuV) + C.F (Correction Factor).
4. The emission levels of other frequencies are very lower than the limit and not show in test report.

| | | | |
|-----------|-------------------------------|----------------------|--------------|
| EUT | POS Terminal | Date of Test | 2023-10-28 |
| Factor | DRH18-E | Temp. / Humidity | 23°C /61% |
| Polarity | Horizontal | Site / Test Engineer | AC2 / Marvin |
| Test Mode | 802.11a_TX_Band4_CH 149_ANT 0 | Test Voltage | AC 120V/60Hz |

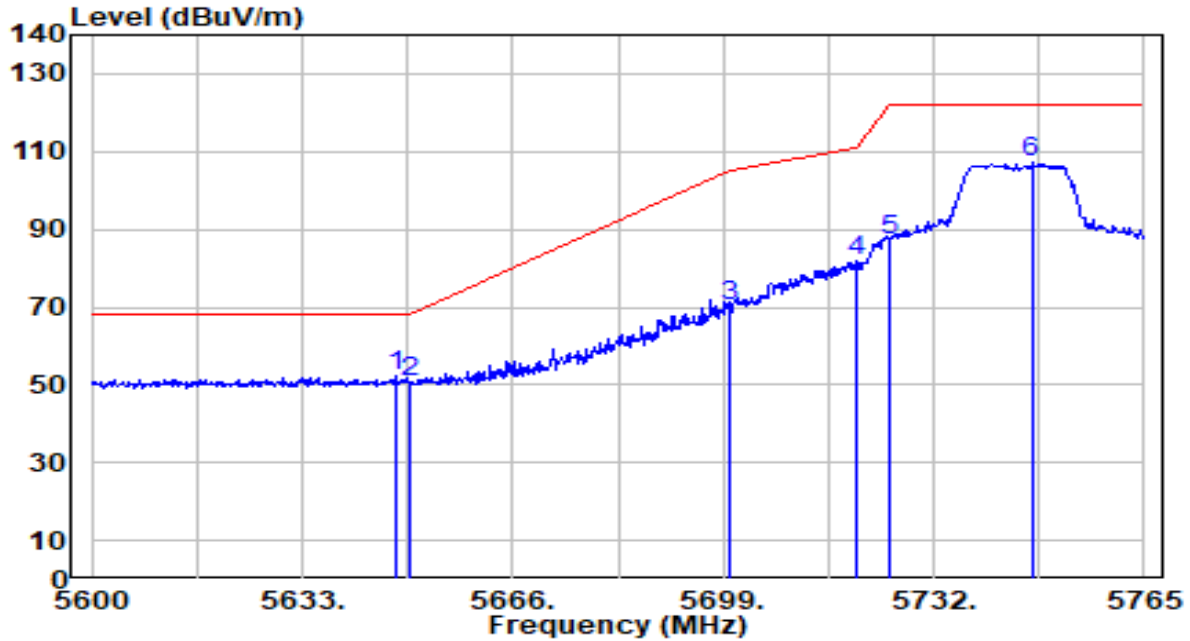

| No | Frequency (MHz) | Reading (dBuV) | C.F (dB/m) | Measurement (dBuV/m) | Margin (dB) | Limit (dBuV/m) | Height (cm) | Angle (deg) | Remark (QP/PK/AV) |
|----|-----------------|----------------|------------|----------------------|-------------|----------------|-------------|-------------|-------------------|
| 1 | * 5647.850 | 52.70 | -0.18 | 52.53 | -15.67 | 68.20 | 126 | 240 | Peak |
| 2 | 5650.000 | 50.63 | -0.16 | 50.46 | -17.74 | 68.20 | 126 | 240 | Peak |
| 3 | 5700.000 | 70.09 | 0.10 | 70.19 | -35.01 | 105.20 | 126 | 240 | Peak |
| 4 | 5720.000 | 81.47 | 0.20 | 81.68 | -29.12 | 110.80 | 126 | 240 | Peak |
| 5 | 5725.000 | 87.09 | 0.23 | 87.32 | -34.88 | 122.20 | 126 | 240 | Peak |
| 6 | 5747.345 | 106.73 | 0.35 | 107.08 | N/A | N/A | 126 | 240 | Peak |

Note:

1. " *", means this data is the worst emission level.
2. C.F (Correction Factor) = Antenna Factor (dB/m)+ Cable Loss (dB) – Pre-amplifier(dB) + 10dB Attenuation.
3. Measurement (dBuV/m) = Reading(dBuV) + C.F (Correction Factor).
4. The emission levels of other frequencies are very lower than the limit and not show in test report.

| | | | |
|-----------|-------------------------------|----------------------|--------------|
| EUT | POS Terminal | Date of Test | 2023-10-28 |
| Factor | DRH18-E | Temp. / Humidity | 23°C /61% |
| Polarity | Vertical | Site / Test Engineer | AC2 / Marvin |
| Test Mode | 802.11a_TX_Band4_CH 149_ANT 0 | Test Voltage | AC 120V/60Hz |

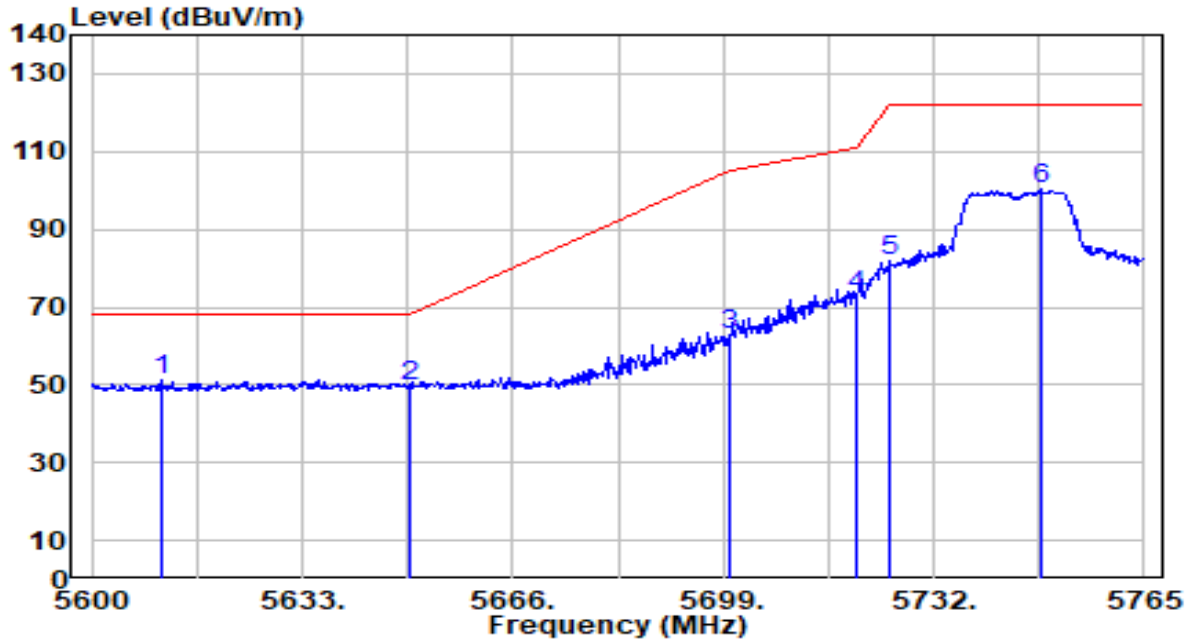

| No | Frequency (MHz) | Reading (dBUV) | C.F (dB/m) | Measurement (dBUV/m) | Margin (dB) | Limit (dBUV/m) | Height (cm) | Angle (deg) | Remark (QP/PK/AV) |
|----|-----------------|----------------|------------|----------------------|-------------|----------------|-------------|-------------|-------------------|
| 1 | * 5610.890 | 51.56 | -0.37 | 51.19 | -17.01 | 68.20 | 100 | 308 | Peak |
| 2 | 5650.000 | 49.72 | -0.16 | 49.56 | -18.64 | 68.20 | 100 | 308 | Peak |
| 3 | 5700.000 | 62.75 | 0.10 | 62.85 | -42.35 | 105.20 | 100 | 308 | Peak |
| 4 | 5720.000 | 72.57 | 0.20 | 72.77 | -38.03 | 110.80 | 100 | 308 | Peak |
| 5 | 5725.000 | 81.53 | 0.23 | 81.76 | -40.44 | 122.20 | 100 | 308 | Peak |
| 6 | 5748.995 | 99.79 | 0.35 | 100.14 | N/A | N/A | 100 | 308 | Peak |

Note:

1. " *", means this data is the worst emission level.
2. C.F (Correction Factor) = Antenna Factor (dB/m)+ Cable Loss (dB) – Pre-amplifier(dB) + 10dB Attenuation.
3. Measurement (dBUV/m) = Reading(dBUV) + C.F (Correction Factor).
4. The emission levels of other frequencies are very lower than the limit and not show in test report.

| | | | |
|-----------|-------------------------------|----------------------|--------------|
| EUT | POS Terminal | Date of Test | 2023-10-28 |
| Factor | DRH18-E | Temp. / Humidity | 23°C /61% |
| Polarity | Horizontal | Site / Test Engineer | AC2 / Marvin |
| Test Mode | 802.11a_TX_Band4_CH 165_ANT 0 | Test Voltage | AC 120V/60Hz |

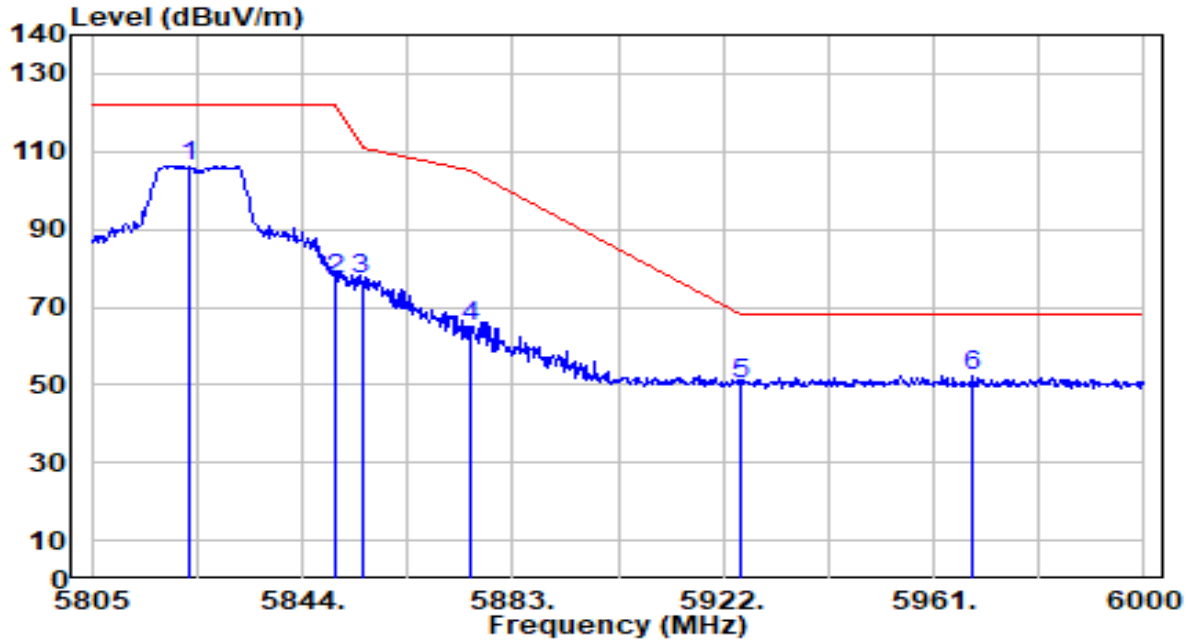

| No | Frequency (MHz) | Reading (dBuV) | C.F (dB/m) | Measurement (dBuV/m) | Margin (dB) | Limit (dBuV/m) | Height (cm) | Angle (deg) | Remark (QP/PK/AV) |
|----|-----------------|----------------|------------|----------------------|-------------|----------------|-------------|-------------|-------------------|
| 1 | 5823.135 | 105.64 | 0.60 | 106.24 | N/A | N/A | 120 | 239 | Peak |
| 2 | 5850.000 | 76.56 | 0.58 | 77.15 | -45.05 | 122.20 | 120 | 239 | Peak |
| 3 | 5855.000 | 76.68 | 0.58 | 77.26 | -33.54 | 110.80 | 120 | 239 | Peak |
| 4 | 5875.000 | 64.19 | 0.57 | 64.75 | -40.45 | 105.20 | 120 | 239 | Peak |
| 5 | 5925.000 | 49.41 | 0.53 | 49.94 | -18.26 | 68.20 | 120 | 239 | Peak |
| 6 | * 5968.215 | 51.75 | 0.49 | 52.24 | -15.96 | 68.20 | 120 | 239 | Peak |

Note:

1. " *", means this data is the worst emission level.
2. C.F (Correction Factor) = Antenna Factor (dB/m)+ Cable Loss (dB) – Pre-amplifier(dB) + 10dB Attenuation.
3. Measurement (dBuV/m) = Reading(dBuV) + C.F (Correction Factor).
4. The emission levels of other frequencies are very lower than the limit and not show in test report.

| | | | |
|-----------|-------------------------------|----------------------|--------------|
| EUT | POS Terminal | Date of Test | 2023-10-28 |
| Factor | DRH18-E | Temp. / Humidity | 23°C /61% |
| Polarity | Vertical | Site / Test Engineer | AC2 / Marvin |
| Test Mode | 802.11a_TX_Band4_CH 165_ANT 0 | Test Voltage | AC 120V/60Hz |

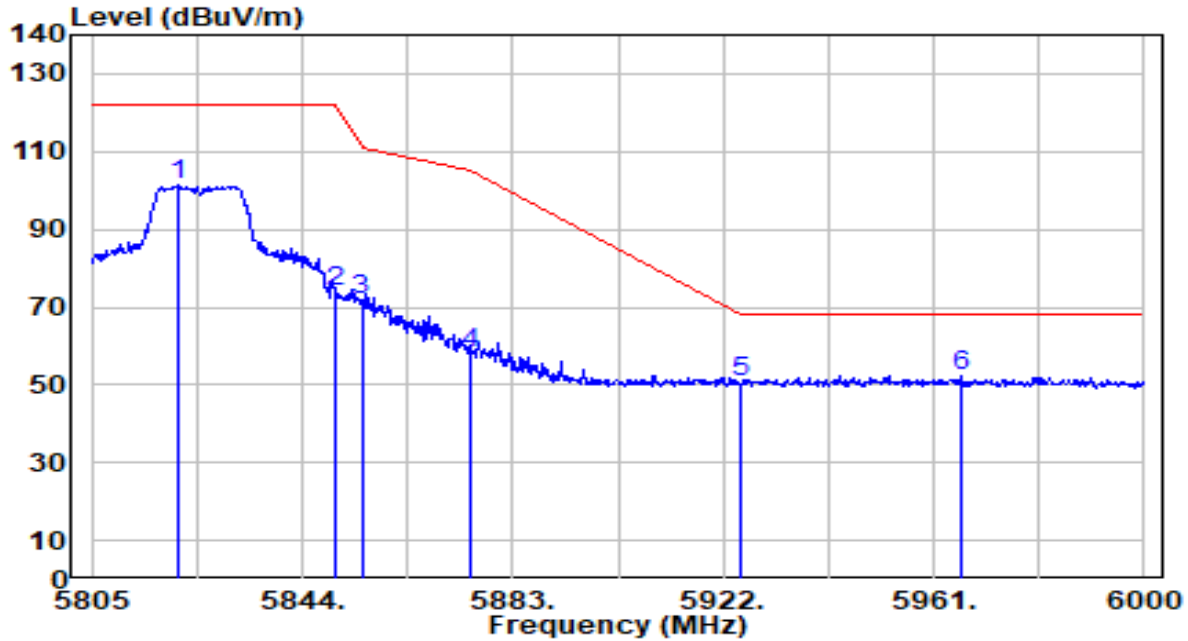

| No | Frequency (MHz) | Reading (dBuV) | C.F (dB/m) | Measurement (dBuV/m) | Margin (dB) | Limit (dBuV/m) | Height (cm) | Angle (deg) | Remark (QP/PK/AV) |
|----|-----------------|----------------|------------|----------------------|-------------|----------------|-------------|-------------|-------------------|
| 1 | 5820.795 | 100.67 | 0.61 | 101.28 | N/A | N/A | 100 | 308 | Peak |
| 2 | 5850.000 | 73.43 | 0.58 | 74.01 | -48.19 | 122.20 | 100 | 308 | Peak |
| 3 | 5855.000 | 71.17 | 0.58 | 71.75 | -39.05 | 110.80 | 100 | 308 | Peak |
| 4 | 5875.000 | 57.70 | 0.57 | 58.26 | -46.94 | 105.20 | 100 | 308 | Peak |
| 5 | 5925.000 | 50.11 | 0.53 | 50.64 | -17.56 | 68.20 | 100 | 308 | Peak |
| 6 | * 5966.070 | 51.92 | 0.50 | 52.41 | -15.79 | 68.20 | 100 | 308 | Peak |

Note:

1. " *", means this data is the worst emission level.
2. C.F (Correction Factor) = Antenna Factor (dB/m)+ Cable Loss (dB) – Pre-amplifier(dB) + 10dB Attenuation.
3. Measurement (dBuV/m) = Reading(dBuV) + C.F (Correction Factor).
4. The emission levels of other frequencies are very lower than the limit and not show in test report.

| | | | |
|-----------|------------------------------------|----------------------|--------------|
| EUT | POS Terminal | Date of Test | 2023-10-28 |
| Factor | DRH18-E | Temp. / Humidity | 23°C /61% |
| Polarity | Horizontal | Site / Test Engineer | AC2 / Marvin |
| Test Mode | 802.11n-20MHz_TX_Band1_CH 36_ANT 0 | Test Voltage | AC 120V/60Hz |

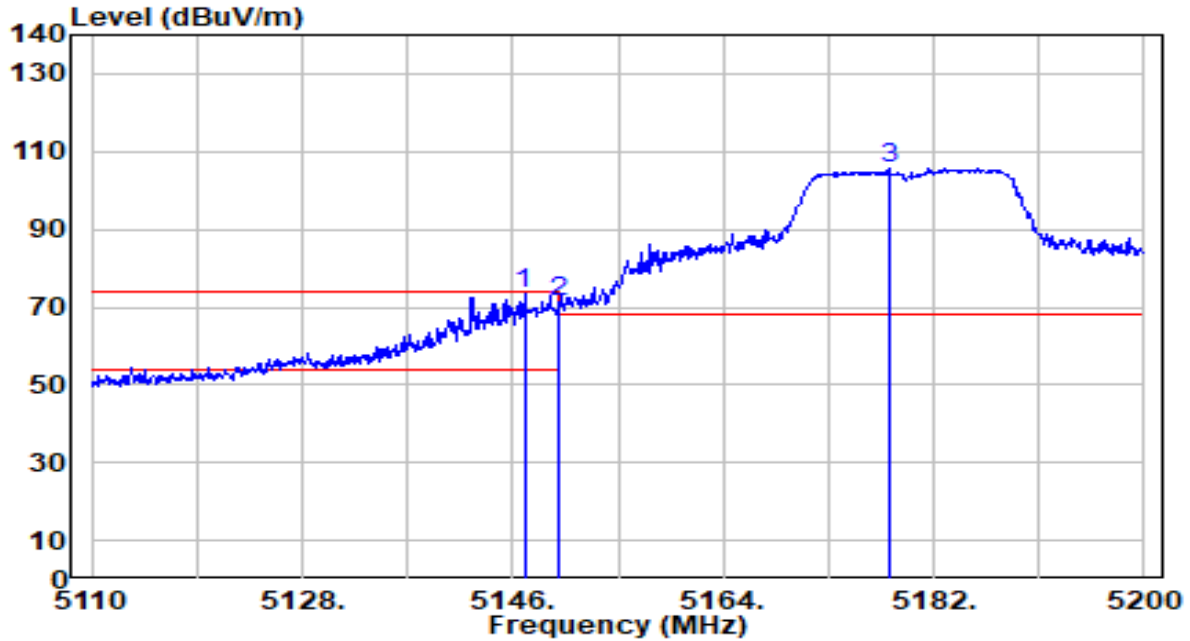

| No | Frequency (MHz) | Reading (dBuV) | C.F (dB/m) | Measurement (dBuV/m) | Margin (dB) | Limit (dBuV/m) | Height (cm) | Angle (deg) | Remark (QP/PK/AV) |
|----|-----------------|----------------|------------|----------------------|-------------|----------------|-------------|-------------|-------------------|
| 1 | * 5146.990 | 74.22 | -0.72 | 73.50 | -0.50 | 74.00 | 114 | 257 | Peak |
| 2 | 5150.000 | 71.89 | -0.72 | 71.18 | -2.82 | 74.00 | 114 | 257 | Peak |
| 3 | 5178.130 | 106.55 | -0.73 | 105.82 | N/A | N/A | 114 | 257 | Peak |

Note:

1. " *" , means this data is the worst emission level.
2. C.F (Correction Factor) = Antenna Factor (dB/m)+ Cable Loss (dB) – Preamplifier(dB) + 10dB Attenuation.
3. Measurement (dBuV/m) = Reading(dBuV) + C.F (Correction Factor).
4. The emission levels of other frequencies are very lower than the limit and not show in test report.

| | | | |
|-----------|------------------------------------|----------------------|--------------|
| EUT | POS Terminal | Date of Test | 2023-10-28 |
| Factor | DRH18-E | Temp. / Humidity | 23°C /61% |
| Polarity | Horizontal | Site / Test Engineer | AC2 / Marvin |
| Test Mode | 802.11n-20MHz_TX_Band1_CH 36_ANT 0 | Test Voltage | AC 120V/60Hz |

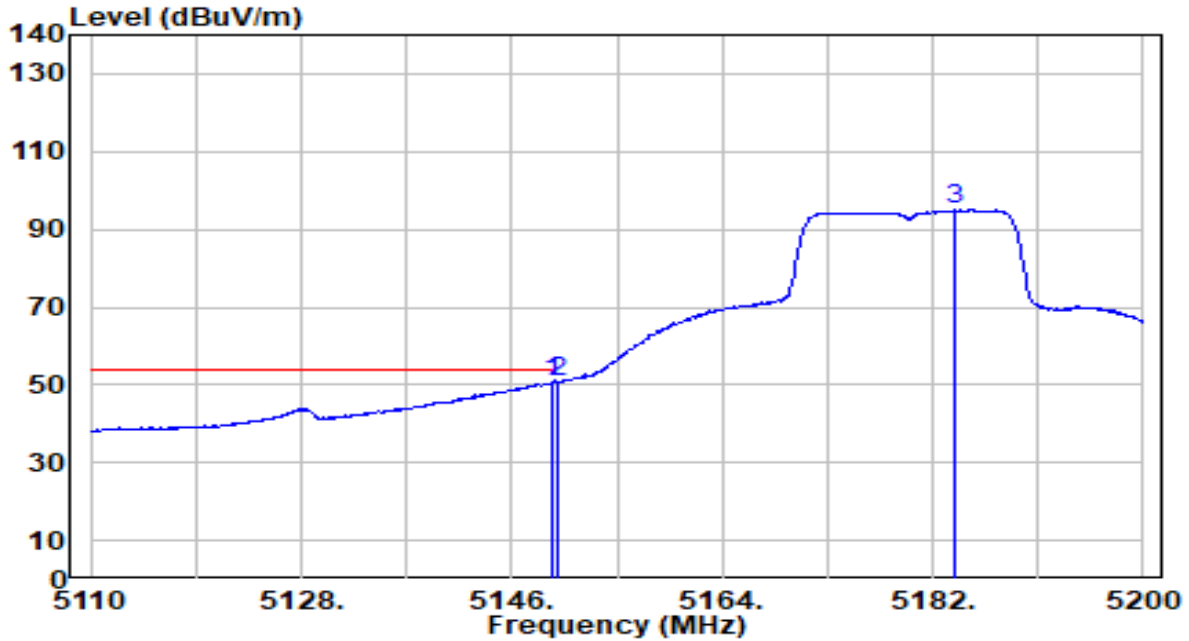

| No | Frequency (MHz) | Reading (dBuV) | C.F (dB/m) | Measurement (dBuV/m) | Margin (dB) | Limit (dBuV/m) | Height (cm) | Angle (deg) | Remark (QP/PK/AV) |
|----|-----------------|----------------|------------|----------------------|-------------|----------------|-------------|-------------|-------------------|
| 1 | 5149.420 | 51.33 | -0.72 | 50.61 | -3.39 | 54.00 | 114 | 257 | Average |
| 2 | * 5150.000 | 51.37 | -0.72 | 50.66 | -3.34 | 54.00 | 114 | 257 | Average |
| 3 | 5183.980 | 95.65 | -0.74 | 94.91 | N/A | N/A | 114 | 257 | Average |

Note:

1. " *" , means this data is the worst emission level.
2. C.F (Correction Factor) = Antenna Factor (dB/m)+ Cable Loss (dB) – Pre-amplifier(dB) + 10dB Attenuation.
3. Measurement (dBuV/m) = Reading(dBuV) + C.F (Correction Factor).
4. The emission levels of other frequencies are very lower than the limit and not show in test report.

| | | | |
|-----------|------------------------------------|----------------------|--------------|
| EUT | POS Terminal | Date of Test | 2023-10-28 |
| Factor | DRH18-E | Temp. / Humidity | 23°C /61% |
| Polarity | Vertical | Site / Test Engineer | AC2 / Marvin |
| Test Mode | 802.11n-20MHz_TX_Band1_CH 36_ANT 0 | Test Voltage | AC 120V/60Hz |

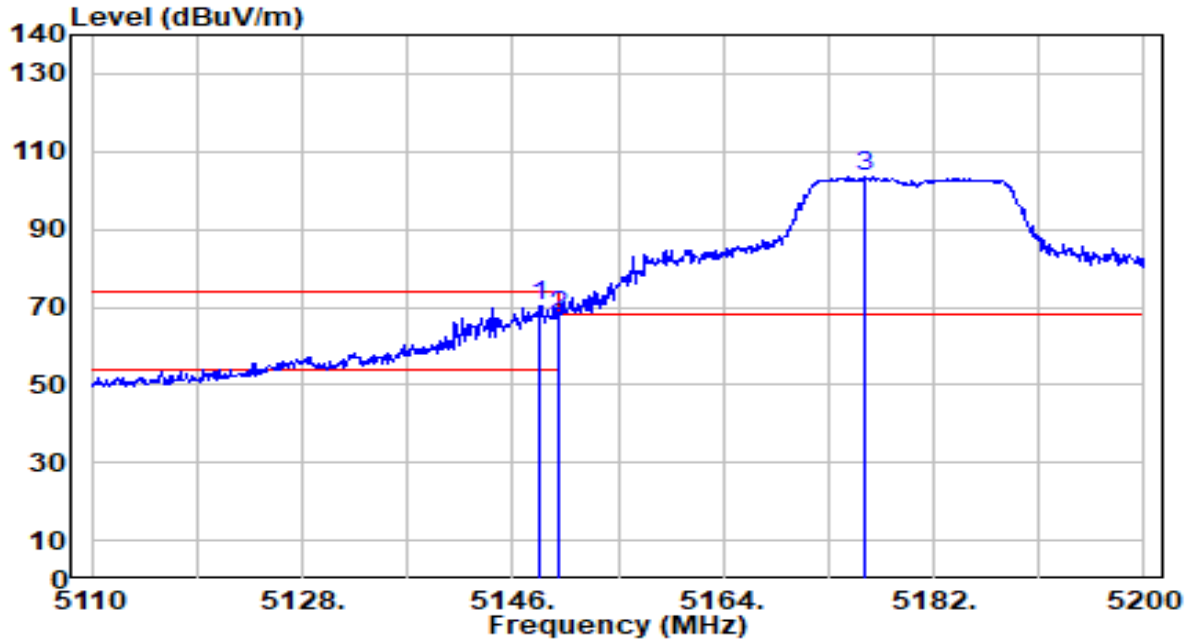

| No | Frequency (MHz) | Reading (dBuV) | C.F (dB/m) | Measurement (dBuV/m) | Margin (dB) | Limit (dBuV/m) | Height (cm) | Angle (deg) | Remark (QP/PK/AV) |
|----|-----------------|----------------|------------|----------------------|-------------|----------------|-------------|-------------|-------------------|
| 1 | * 5148.250 | 70.78 | -0.72 | 70.06 | -3.94 | 74.00 | 100 | 323 | Peak |
| 2 | 5150.000 | 68.48 | -0.72 | 67.76 | -6.24 | 74.00 | 100 | 323 | Peak |
| 3 | 5176.060 | 104.41 | -0.73 | 103.67 | N/A | N/A | 100 | 323 | Peak |

Note:

1. " *" , means this data is the worst emission level.
2. C.F (Correction Factor) = Antenna Factor (dB/m)+ Cable Loss (dB) – Preamplifier(dB) + 10dB Attenuation.
3. Measurement (dBuV/m) = Reading(dBuV) + C.F (Correction Factor).
4. The emission levels of other frequencies are very lower than the limit and not show in test report.

| | | | |
|-----------|------------------------------------|----------------------|--------------|
| EUT | POS Terminal | Date of Test | 2023-10-28 |
| Factor | DRH18-E | Temp. / Humidity | 23°C /61% |
| Polarity | Vertical | Site / Test Engineer | AC2 / Marvin |
| Test Mode | 802.11n-20MHz_TX_Band1_CH 36_ANT 0 | Test Voltage | AC 120V/60Hz |

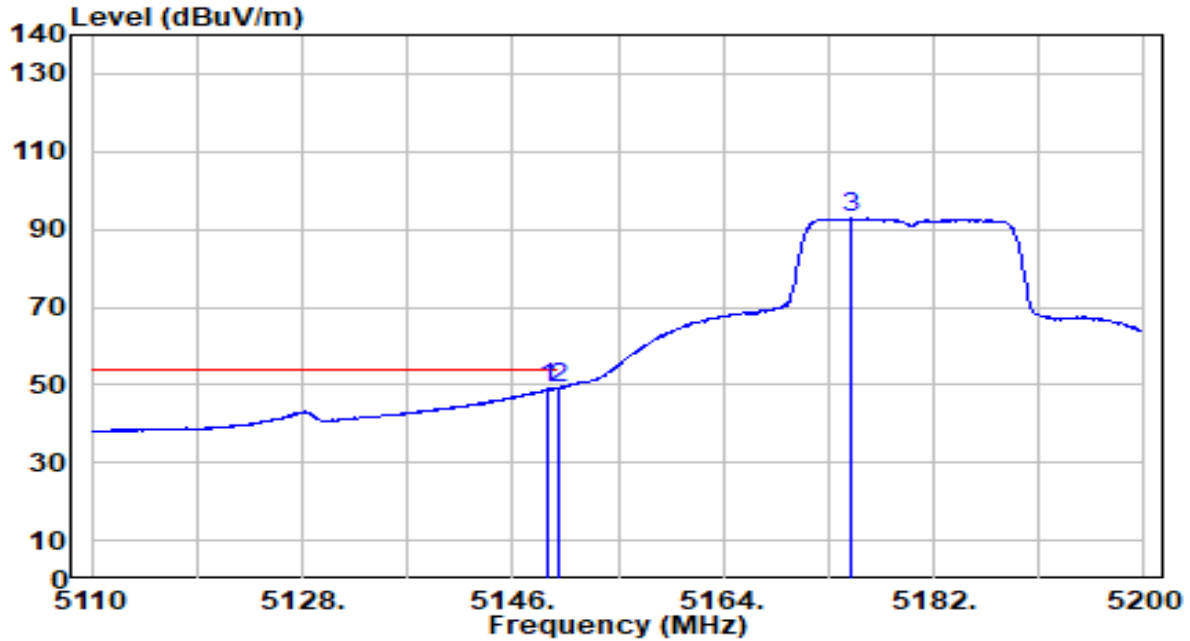

| No | Frequency (MHz) | Reading (dBuV) | C.F (dB/m) | Measurement (dBuV/m) | Margin (dB) | Limit (dBuV/m) | Height (cm) | Angle (deg) | Remark (QP/PK/AV) |
|----|-----------------|----------------|------------|----------------------|-------------|----------------|-------------|-------------|-------------------|
| 1 | 5148.970 | 49.71 | -0.72 | 48.99 | -5.01 | 54.00 | 100 | 323 | Average |
| 2 | * 5150.000 | 50.03 | -0.72 | 49.32 | -4.68 | 54.00 | 100 | 323 | Average |
| 3 | 5174.980 | 93.54 | -0.73 | 92.81 | N/A | N/A | 100 | 323 | Average |

Note:

1. " *" , means this data is the worst emission level.
2. C.F (Correction Factor) = Antenna Factor (dB/m)+ Cable Loss (dB) – Preamplifier(dB) + 10dB Attenuation.
3. Measurement (dBuV/m) = Reading(dBuV) + C.F (Correction Factor).
4. The emission levels of other frequencies are very lower than the limit and not show in test report.

| | | | |
|-----------|------------------------------------|----------------------|--------------|
| EUT | POS Terminal | Date of Test | 2023-10-28 |
| Factor | DRH18-E | Temp. / Humidity | 23°C /61% |
| Polarity | Horizontal | Site / Test Engineer | AC2 / Marvin |
| Test Mode | 802.11n-20MHz_TX_Band2_CH 64_ANT 0 | Test Voltage | AC 120V/60Hz |

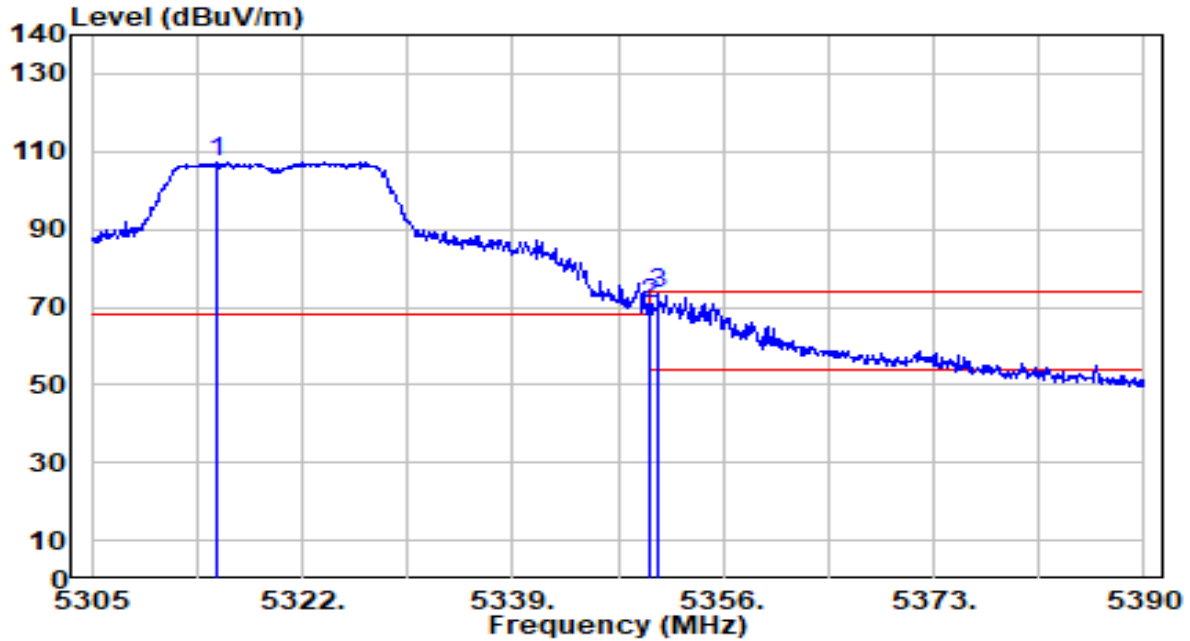

| No | Frequency (MHz) | Reading (dBuV) | C.F (dB/m) | Measurement (dBuV/m) | Margin (dB) | Limit (dBuV/m) | Height (cm) | Angle (deg) | Remark (QP/PK/AV) |
|----|-----------------|----------------|------------|----------------------|-------------|----------------|-------------|-------------|-------------------|
| 1 | 5315.200 | 108.24 | -0.92 | 107.32 | N/A | N/A | 123 | 240 | Peak |
| 2 | 5350.000 | 71.80 | -0.97 | 70.82 | -3.18 | 74.00 | 123 | 240 | Peak |
| 3 | * 5350.730 | 74.39 | -0.97 | 73.42 | -0.58 | 74.00 | 123 | 240 | Peak |

Note:

1. " *" , means this data is the worst emission level.
2. C.F (Correction Factor) = Antenna Factor (dB/m)+ Cable Loss (dB) – Preamplifier(dB) + 10dB Attenuation.
3. Measurement (dBuV/m) = Reading(dBuV) + C.F (Correction Factor).
4. The emission levels of other frequencies are very lower than the limit and not show in test report.

| | | | |
|-----------|------------------------------------|----------------------|--------------|
| EUT | POS Terminal | Date of Test | 2023-10-28 |
| Factor | DRH18-E | Temp. / Humidity | 23°C /61% |
| Polarity | Horizontal | Site / Test Engineer | AC2 / Marvin |
| Test Mode | 802.11n-20MHz_TX_Band2_CH 64_ANT 0 | Test Voltage | AC 120V/60Hz |

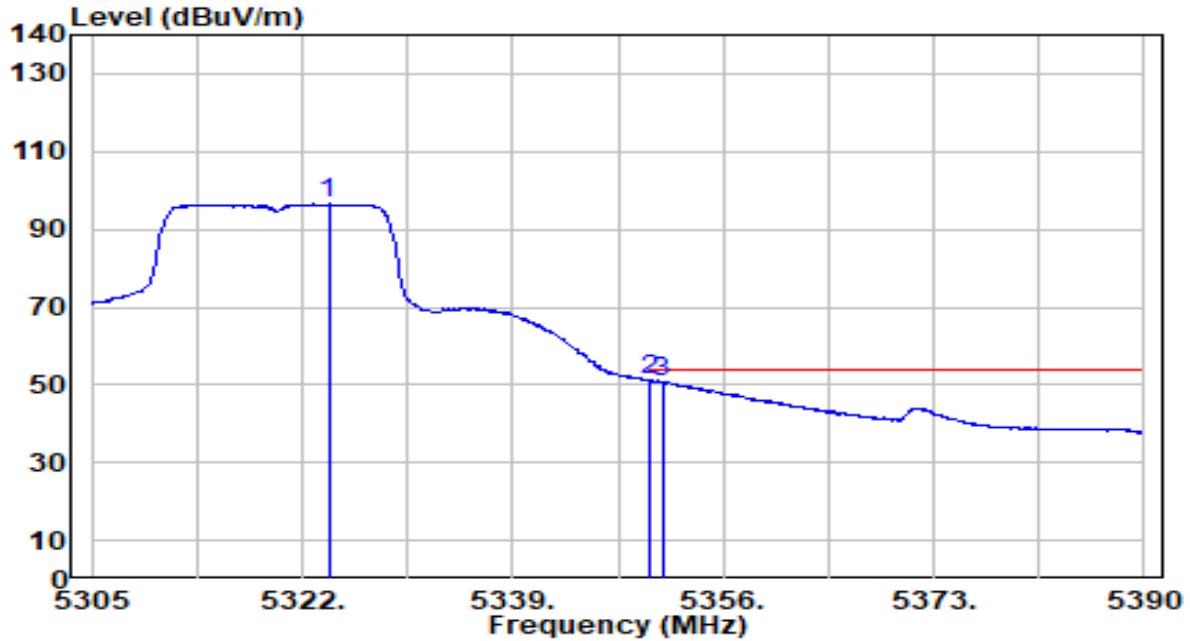

| No | Frequency (MHz) | Reading (dBuV) | C.F (dB/m) | Measurement (dBuV/m) | Margin (dB) | Limit (dBuV/m) | Height (cm) | Angle (deg) | Remark (QP/PK/AV) |
|----|-----------------|----------------|------------|----------------------|-------------|----------------|-------------|-------------|-------------------|
| 1 | 5324.125 | 97.51 | -0.93 | 96.58 | N/A | N/A | 123 | 240 | Average |
| 2 | * 5350.000 | 52.03 | -0.97 | 51.05 | -2.95 | 54.00 | 123 | 240 | Average |
| 3 | 5351.070 | 51.64 | -0.97 | 50.66 | -3.34 | 54.00 | 123 | 240 | Average |

Note:

1. " *" , means this data is the worst emission level.
2. C.F (Correction Factor) = Antenna Factor (dB/m)+ Cable Loss (dB) – Preamplifier(dB) + 10dB Attenuation.
3. Measurement (dBuV/m) = Reading(dBuV) + C.F (Correction Factor).
4. The emission levels of other frequencies are very lower than the limit and not show in test report.

| | | | |
|-----------|------------------------------------|----------------------|--------------|
| EUT | POS Terminal | Date of Test | 2023-10-28 |
| Factor | DRH18-E | Temp. / Humidity | 23°C /61% |
| Polarity | Vertical | Site / Test Engineer | AC2 / Marvin |
| Test Mode | 802.11n-20MHz_TX_Band2_CH 64_ANT 0 | Test Voltage | AC 120V/60Hz |

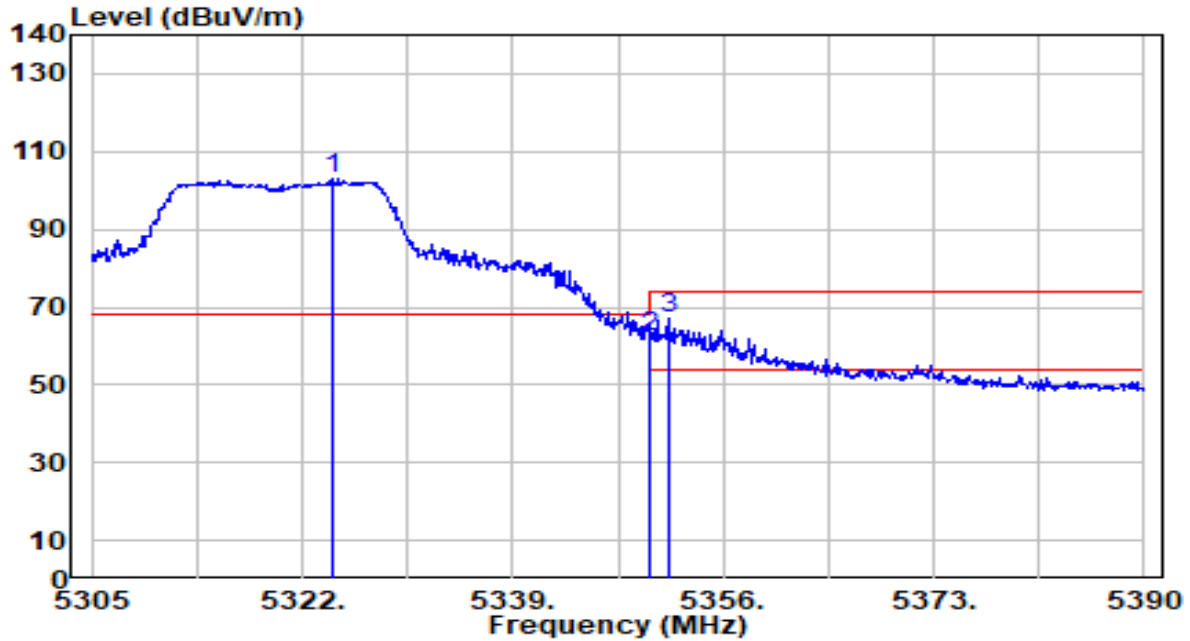

| No | Frequency (MHz) | Reading (dBuV) | C.F (dB/m) | Measurement (dBuV/m) | Margin (dB) | Limit (dBuV/m) | Height (cm) | Angle (deg) | Remark (QP/PK/AV) |
|----|-----------------|----------------|------------|----------------------|-------------|----------------|-------------|-------------|-------------------|
| 1 | 5324.380 | 104.06 | -0.93 | 103.12 | N/A | N/A | 100 | 307 | Peak |
| 2 | 5350.000 | 63.36 | -0.97 | 62.39 | -11.61 | 74.00 | 100 | 307 | Peak |
| 3 | * 5351.580 | 68.31 | -0.97 | 67.33 | -6.67 | 74.00 | 100 | 307 | Peak |

Note:

1. " *" , means this data is the worst emission level.
2. C.F (Correction Factor) = Antenna Factor (dB/m)+ Cable Loss (dB) – Preamplifier(dB) + 10dB Attenuation.
3. Measurement (dBuV/m) = Reading(dBuV) + C.F (Correction Factor).
4. The emission levels of other frequencies are very lower than the limit and not show in test report.

| | | | |
|-----------|------------------------------------|----------------------|--------------|
| EUT | POS Terminal | Date of Test | 2023-10-28 |
| Factor | DRH18-E | Temp. / Humidity | 23°C /61% |
| Polarity | Vertical | Site / Test Engineer | AC2 / Marvin |
| Test Mode | 802.11n-20MHz_TX_Band2_CH 64_ANT 0 | Test Voltage | AC 120V/60Hz |

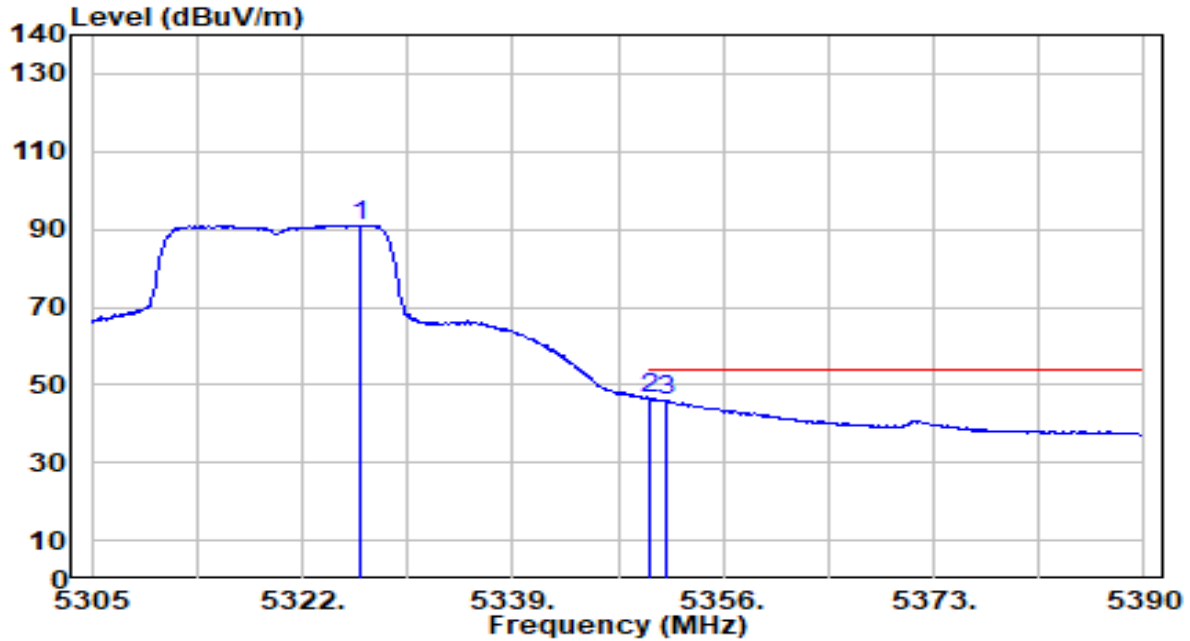

| No | Frequency (MHz) | Reading (dBuV) | C.F (dB/m) | Measurement (dBuV/m) | Margin (dB) | Limit (dBuV/m) | Height (cm) | Angle (deg) | Remark (QP/PK/AV) |
|----|-----------------|----------------|------------|----------------------|-------------|----------------|-------------|-------------|-------------------|
| 1 | 5326.590 | 92.01 | -0.94 | 91.07 | N/A | N/A | 100 | 307 | Average |
| 2 | * 5350.000 | 47.48 | -0.97 | 46.51 | -7.49 | 54.00 | 100 | 307 | Average |
| 3 | 5351.410 | 46.79 | -0.97 | 45.82 | -8.18 | 54.00 | 100 | 307 | Average |

Note:

1. " *" , means this data is the worst emission level.
2. C.F (Correction Factor) = Antenna Factor (dB/m)+ Cable Loss (dB) – Preamplifier(dB) + 10dB Attenuation.
3. Measurement (dBuV/m) = Reading(dBuV) + C.F (Correction Factor).
4. The emission levels of other frequencies are very lower than the limit and not show in test report.

| | | | |
|-----------|-------------------------------------|----------------------|--------------|
| EUT | POS Terminal | Date of Test | 2023-10-28 |
| Factor | DRH18-E | Temp. / Humidity | 23°C /61% |
| Polarity | Horizontal | Site / Test Engineer | AC2 / Marvin |
| Test Mode | 802.11n-20MHz_TX_Band3_CH 100_ANT 0 | Test Voltage | AC 120V/60Hz |

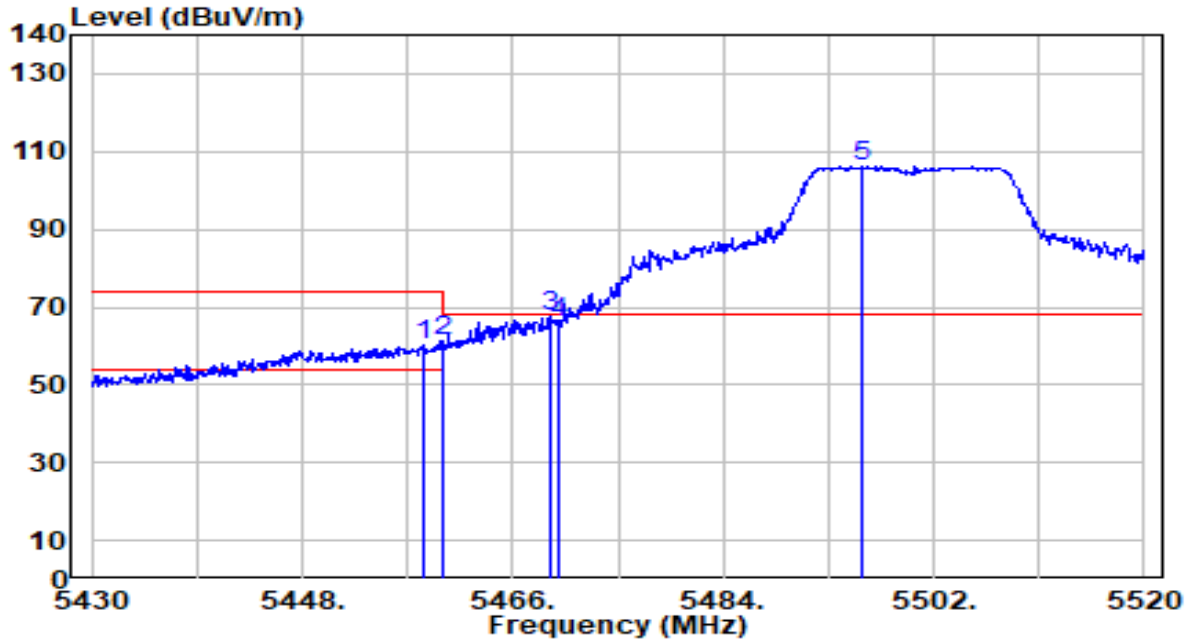

| No | Frequency (MHz) | Reading (dBuV) | C.F (dB/m) | Measurement (dBuV/m) | Margin (dB) | Limit (dBuV/m) | Height (cm) | Angle (deg) | Remark (QP/PK/AV) |
|-----|-----------------|----------------|------------|----------------------|-------------|----------------|-------------|-------------|-------------------|
| 1 | 5458.440 | 61.02 | -0.87 | 60.15 | -13.85 | 74.00 | 120 | 241 | Peak |
| 2 | 5460.000 | 61.95 | -0.87 | 61.08 | -12.92 | 74.00 | 120 | 241 | Peak |
| 3 * | 5469.330 | 68.49 | -0.84 | 67.65 | -0.55 | 68.20 | 120 | 241 | Peak |
| 4 | 5470.000 | 66.89 | -0.84 | 66.06 | -2.14 | 68.20 | 120 | 241 | Peak |
| 5 | 5495.970 | 107.10 | -0.76 | 106.34 | N/A | N/A | 120 | 241 | Peak |

Note:

- "*" , means this data is the worst emission level.
- C.F (Correction Factor) = Antenna Factor (dB/m)+ Cable Loss (dB) – Preamplifier(dB) + 10dB Attenuation.
- Measurement (dBuV/m) = Reading(dBuV) + C.F (Correction Factor).
- The emission levels of other frequencies are very lower than the limit and not show in test report.

| | | | |
|-----------|-------------------------------------|----------------------|--------------|
| EUT | POS Terminal | Date of Test | 2023-10-28 |
| Factor | DRH18-E | Temp. / Humidity | 23°C /61% |
| Polarity | Horizontal | Site / Test Engineer | AC2 / Marvin |
| Test Mode | 802.11n-20MHz_TX_Band3_CH 100_ANT 0 | Test Voltage | AC 120V/60Hz |

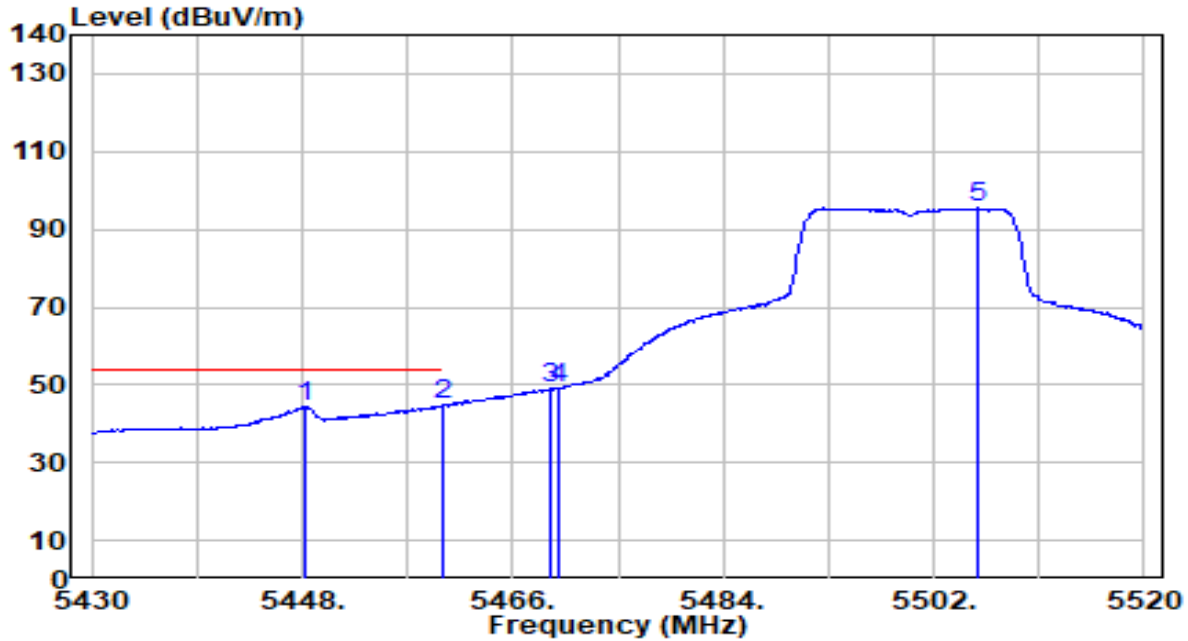

| No | Frequency (MHz) | Reading (dBuV) | C.F (dB/m) | Measurement (dBuV/m) | Margin (dB) | Limit (dBuV/m) | Height (cm) | Angle (deg) | Remark (QP/PK/AV) |
|----|-----------------|----------------|------------|----------------------|-------------|----------------|-------------|-------------|-------------------|
| 1 | 5448.270 | 45.14 | -0.90 | 44.24 | -9.76 | 54.00 | 120 | 241 | Average |
| 2 | * 5460.000 | 45.52 | -0.87 | 44.65 | -9.35 | 54.00 | 120 | 241 | Average |
| 3 | 5469.330 | 49.81 | -0.84 | 48.97 | N/A | N/A | 120 | 241 | Average |
| 4 | 5470.000 | 50.03 | -0.84 | 49.19 | N/A | N/A | 120 | 241 | Average |
| 5 | 5505.780 | 96.23 | -0.73 | 95.50 | N/A | N/A | 120 | 241 | Average |

Note:

- "*" means this data is the worst emission level.
- C.F (Correction Factor) = Antenna Factor (dB/m)+ Cable Loss (dB) – Preamplifier(dB) + 10dB Attenuation.
- Measurement (dBuV/m) = Reading(dBuV) + C.F (Correction Factor).
- The emission levels of other frequencies are very lower than the limit and not show in test report.

| | | | |
|-----------|-------------------------------------|----------------------|--------------|
| EUT | POS Terminal | Date of Test | 2023-10-28 |
| Factor | DRH18-E | Temp. / Humidity | 23°C /61% |
| Polarity | Vertical | Site / Test Engineer | AC2 / Marvin |
| Test Mode | 802.11n-20MHz_TX_Band3_CH 100_ANT 0 | Test Voltage | AC 120V/60Hz |

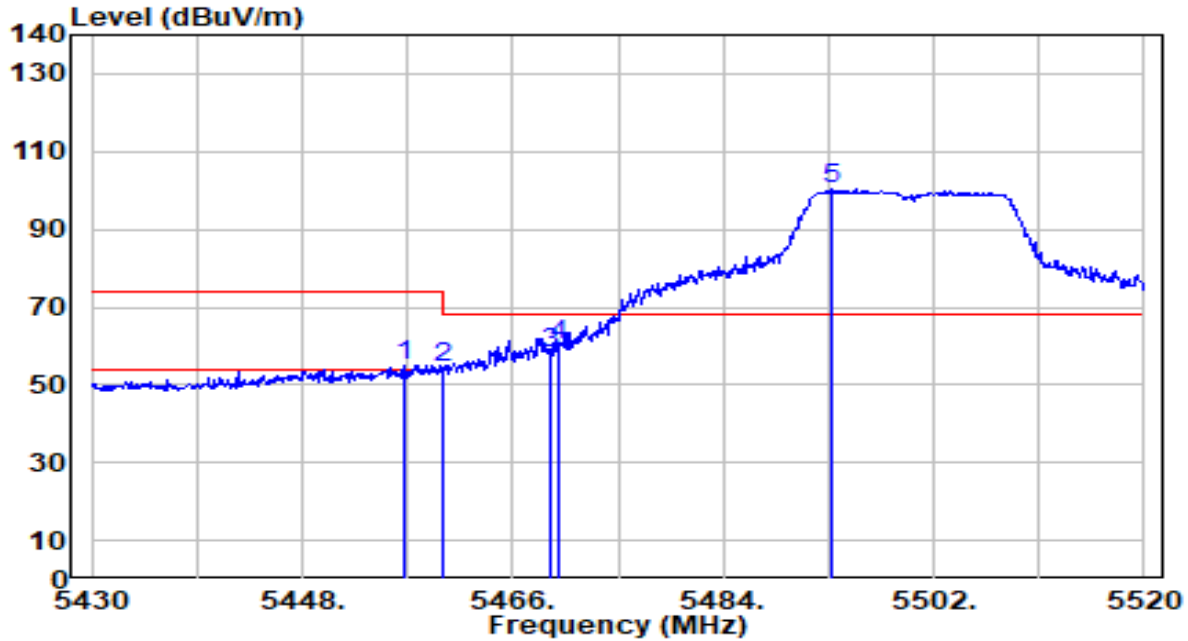

| No | Frequency (MHz) | Reading (dBuV) | C.F (dB/m) | Measurement (dBuV/m) | Margin (dB) | Limit (dBuV/m) | Height (cm) | Angle (deg) | Remark (QP/PK/AV) |
|----|-----------------|----------------|------------|----------------------|-------------|----------------|-------------|-------------|-------------------|
| 1 | 5456.640 | 55.75 | -0.88 | 54.87 | -19.13 | 74.00 | 100 | 302 | Peak |
| 2 | 5460.000 | 55.07 | -0.87 | 54.20 | -19.80 | 74.00 | 100 | 302 | Peak |
| 3 | 5469.330 | 59.18 | -0.84 | 58.34 | -9.86 | 68.20 | 100 | 302 | Peak |
| 4 | * 5470.000 | 61.33 | -0.84 | 60.49 | -7.71 | 68.20 | 100 | 302 | Peak |
| 5 | 5493.270 | 101.35 | -0.77 | 100.58 | N/A | N/A | 100 | 302 | Peak |

Note:

- "*" means this data is the worst emission level.
- C.F (Correction Factor) = Antenna Factor (dB/m)+ Cable Loss (dB) – Preamplifier(dB) + 10dB Attenuation.
- Measurement (dBuV/m) = Reading(dBuV) + C.F (Correction Factor).
- The emission levels of other frequencies are very lower than the limit and not show in test report.

| | | | |
|-----------|-------------------------------------|----------------------|--------------|
| EUT | POS Terminal | Date of Test | 2023-10-28 |
| Factor | DRH18-E | Temp. / Humidity | 23°C /61% |
| Polarity | Vertical | Site / Test Engineer | AC2 / Marvin |
| Test Mode | 802.11n-20MHz_TX_Band3_CH 100_ANT 0 | Test Voltage | AC 120V/60Hz |

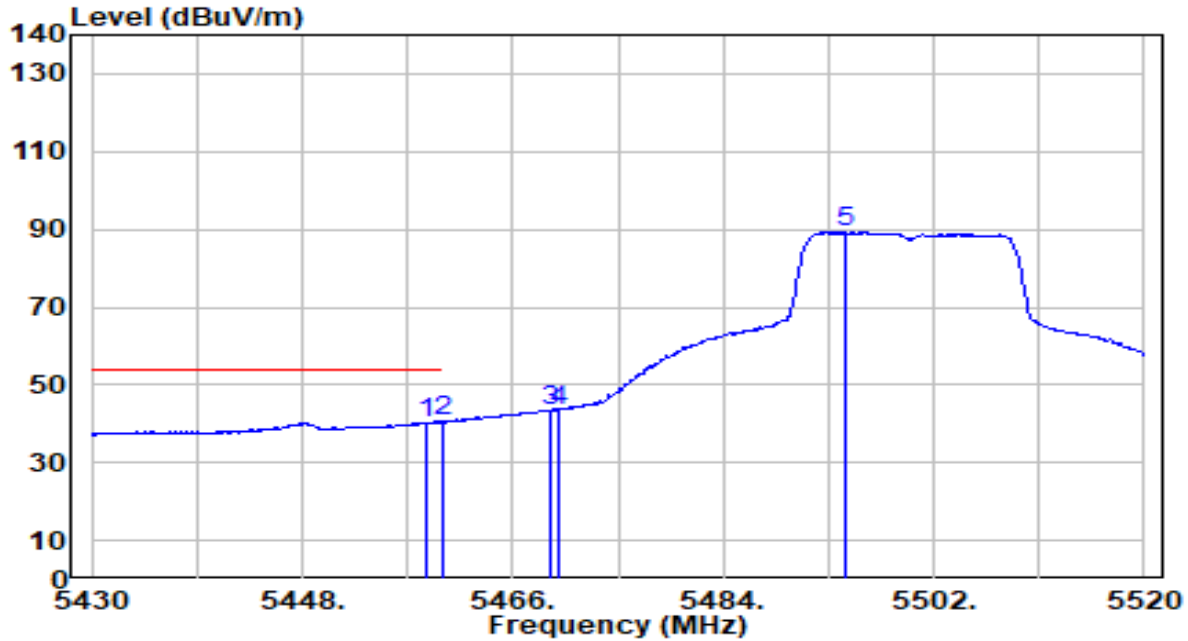

| No | Frequency (MHz) | Reading (dBuV) | C.F (dB/m) | Measurement (dBuV/m) | Margin (dB) | Limit (dBuV/m) | Height (cm) | Angle (deg) | Remark (QP/PK/AV) |
|----|-----------------|----------------|------------|----------------------|-------------|----------------|-------------|-------------|-------------------|
| 1 | 5458.710 | 41.23 | -0.87 | 40.35 | -13.65 | 54.00 | 100 | 302 | Average |
| 2 | * 5460.000 | 41.35 | -0.87 | 40.48 | -13.52 | 54.00 | 100 | 302 | Average |
| 3 | 5469.330 | 44.18 | -0.84 | 43.34 | N/A | N/A | 100 | 302 | Average |
| 4 | 5470.000 | 44.37 | -0.84 | 43.53 | N/A | N/A | 100 | 302 | Average |
| 5 | 5494.440 | 90.12 | -0.77 | 89.35 | N/A | N/A | 100 | 302 | Average |

Note:

- "*" means this data is the worst emission level.
- C.F (Correction Factor) = Antenna Factor (dB/m)+ Cable Loss (dB) – Preamplifier(dB) + 10dB Attenuation.
- Measurement (dBuV/m) = Reading(dBuV) + C.F (Correction Factor).
- The emission levels of other frequencies are very lower than the limit and not show in test report.

| | | | |
|-----------|-------------------------------------|----------------------|--------------|
| EUT | POS Terminal | Date of Test | 2023-10-28 |
| Factor | DRH18-E | Temp. / Humidity | 23°C /61% |
| Polarity | Horizontal | Site / Test Engineer | AC2 / Marvin |
| Test Mode | 802.11n-20MHz_TX_Band3_CH 140_ANT 0 | Test Voltage | AC 120V/60Hz |

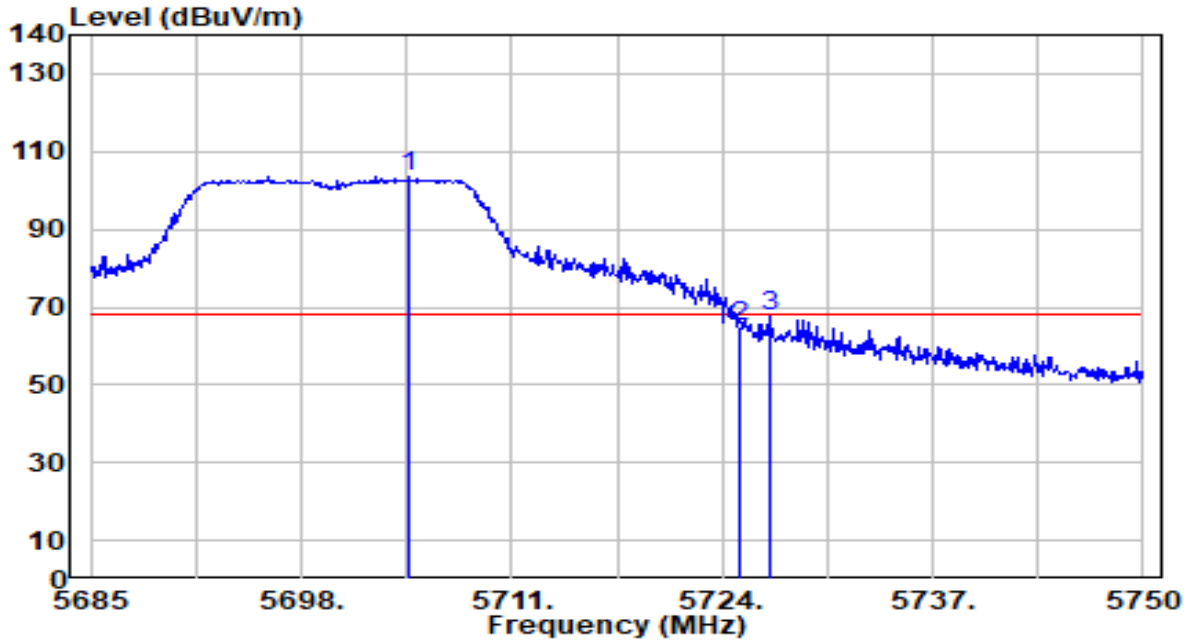

| No | Frequency (MHz) | Reading (dBuV) | C.F (dB/m) | Measurement (dBuV/m) | Margin (dB) | Limit (dBuV/m) | Height (cm) | Angle (deg) | Remark (QP/PK/AV) |
|----|-----------------|----------------|------------|----------------------|-------------|----------------|-------------|-------------|-------------------|
| 1 | 5704.630 | 103.42 | 0.12 | 103.54 | N/A | N/A | 118 | 240 | Peak |
| 2 | 5725.000 | 64.77 | 0.23 | 65.00 | -3.20 | 68.20 | 118 | 240 | Peak |
| 3 | * 5726.925 | 67.37 | 0.24 | 67.61 | -0.59 | 68.20 | 118 | 240 | Peak |

Note:

1. " *", means this data is the worst emission level.
2. C.F (Correction Factor) = Antenna Factor (dB/m)+ Cable Loss (dB) – Preamplifier(dB) + 10dB Attenuation.
3. Measurement (dBuV/m) = Reading(dBuV) + C.F (Correction Factor).
4. The emission levels of other frequencies are very lower than the limit and not show in test report.

| | | | |
|-----------|-------------------------------------|----------------------|--------------|
| EUT | POS Terminal | Date of Test | 2023-10-28 |
| Factor | DRH18-E | Temp. / Humidity | 23°C /61% |
| Polarity | Vertical | Site / Test Engineer | AC2 / Marvin |
| Test Mode | 802.11n-20MHz_TX_Band3_CH 140_ANT 0 | Test Voltage | AC 120V/60Hz |

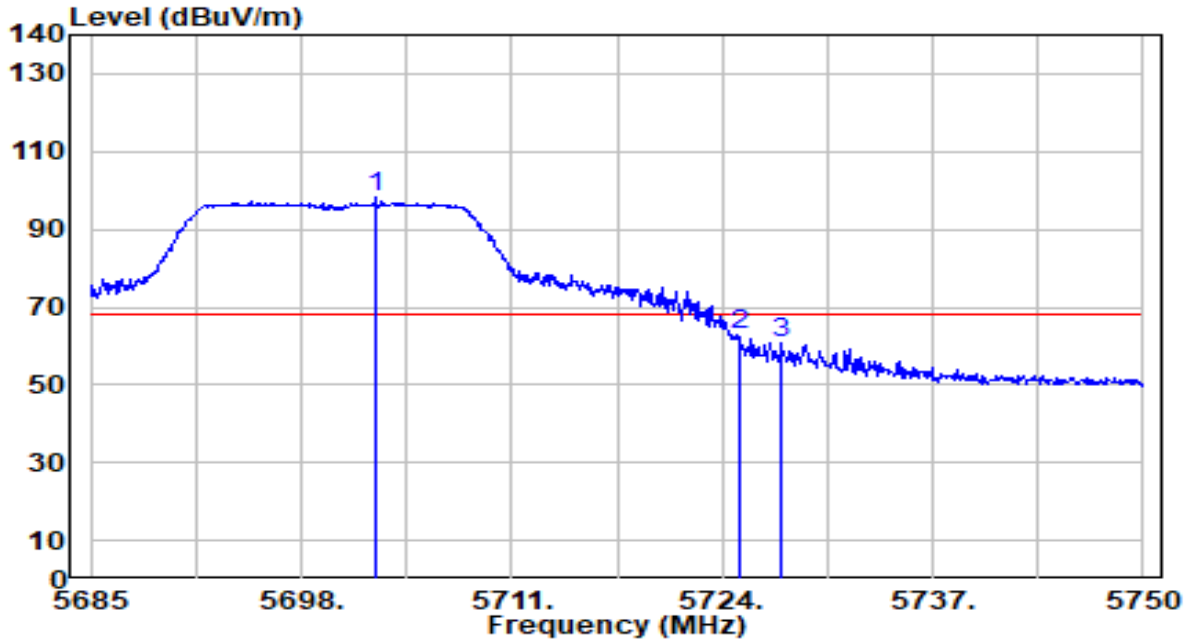

| No | Frequency (MHz) | Reading (dBuV) | C.F (dB/m) | Measurement (dBuV/m) | Margin (dB) | Limit (dBuV/m) | Height (cm) | Angle (deg) | Remark (QP/PK/AV) |
|----|-----------------|----------------|------------|----------------------|-------------|----------------|-------------|-------------|-------------------|
| 1 | 5702.615 | 97.93 | 0.11 | 98.04 | N/A | N/A | 100 | 305 | Peak |
| 2 | * 5725.000 | 62.51 | 0.23 | 62.74 | -5.46 | 68.20 | 100 | 305 | Peak |
| 3 | 5727.640 | 60.59 | 0.24 | 60.83 | -7.37 | 68.20 | 100 | 305 | Peak |

Note:

1. " *", means this data is the worst emission level.
2. C.F (Correction Factor) = Antenna Factor (dB/m)+ Cable Loss (dB) – Preamplifier(dB) + 10dB Attenuation.
3. Measurement (dBuV/m) = Reading(dBuV) + C.F (Correction Factor).
4. The emission levels of other frequencies are very lower than the limit and not show in test report.

| | | | |
|-----------|-------------------------------------|----------------------|--------------|
| EUT | POS Terminal | Date of Test | 2023-10-28 |
| Factor | DRH18-E | Temp. / Humidity | 23°C /61% |
| Polarity | Horizontal | Site / Test Engineer | AC2 / Marvin |
| Test Mode | 802.11n-20MHz_TX_Band4_CH 149_ANT 0 | Test Voltage | AC 120V/60Hz |

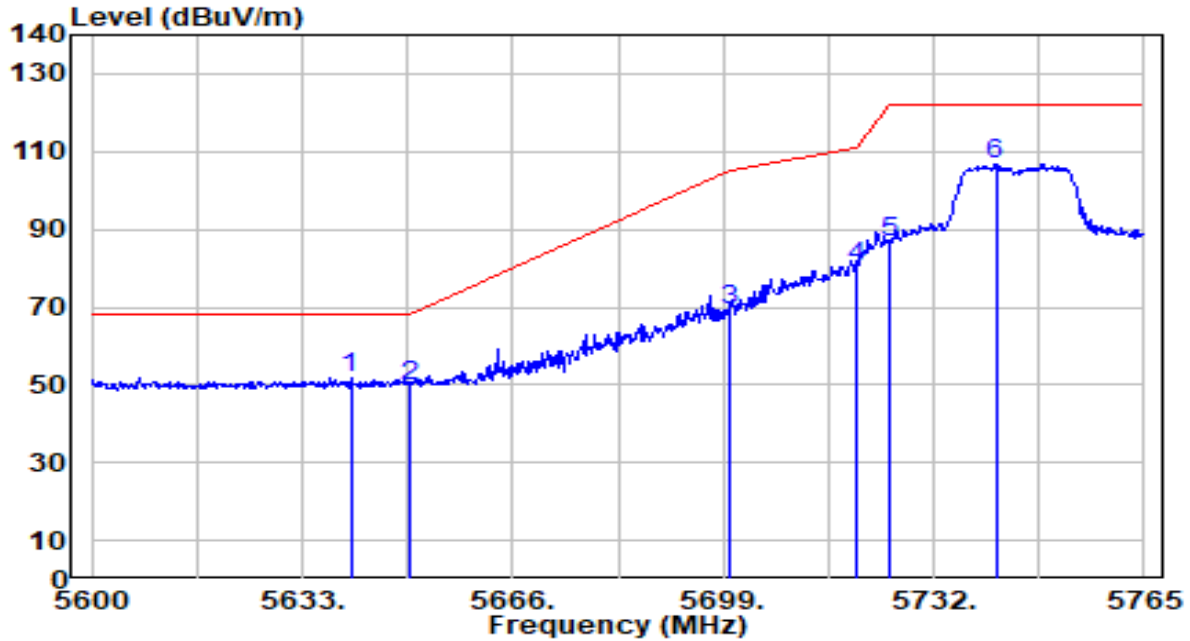

| No | Frequency (MHz) | Reading (dBuV) | C.F (dB/m) | Measurement (dBuV/m) | Margin (dB) | Limit (dBuV/m) | Height (cm) | Angle (deg) | Remark (QP/PK/AV) |
|----|-----------------|----------------|------------|----------------------|-------------|----------------|-------------|-------------|-------------------|
| 1 | * 5640.590 | 51.96 | -0.21 | 51.75 | -16.45 | 68.20 | 123 | 240 | Peak |
| 2 | 5650.000 | 49.92 | -0.16 | 49.76 | -18.44 | 68.20 | 123 | 240 | Peak |
| 3 | 5700.000 | 69.34 | 0.10 | 69.44 | -35.76 | 105.20 | 123 | 240 | Peak |
| 4 | 5720.000 | 80.35 | 0.20 | 80.55 | -30.25 | 110.80 | 123 | 240 | Peak |
| 5 | 5725.000 | 86.66 | 0.23 | 86.89 | -35.31 | 122.20 | 123 | 240 | Peak |
| 6 | 5741.735 | 106.43 | 0.32 | 106.75 | N/A | N/A | 123 | 240 | Peak |

Note:

1. " *", means this data is the worst emission level.
2. C.F (Correction Factor) = Antenna Factor (dB/m)+ Cable Loss (dB) – Pre-amplifier(dB) + 10dB Attenuation.
3. Measurement (dBuV/m) = Reading(dBuV) + C.F (Correction Factor).
4. The emission levels of other frequencies are very lower than the limit and not show in test report.

| | | | |
|-----------|-------------------------------------|----------------------|--------------|
| EUT | POS Terminal | Date of Test | 2023-10-28 |
| Factor | DRH18-E | Temp. / Humidity | 23°C /61% |
| Polarity | Vertical | Site / Test Engineer | AC2 / Marvin |
| Test Mode | 802.11n-20MHz_TX_Band4_CH 149_ANT 0 | Test Voltage | AC 120V/60Hz |

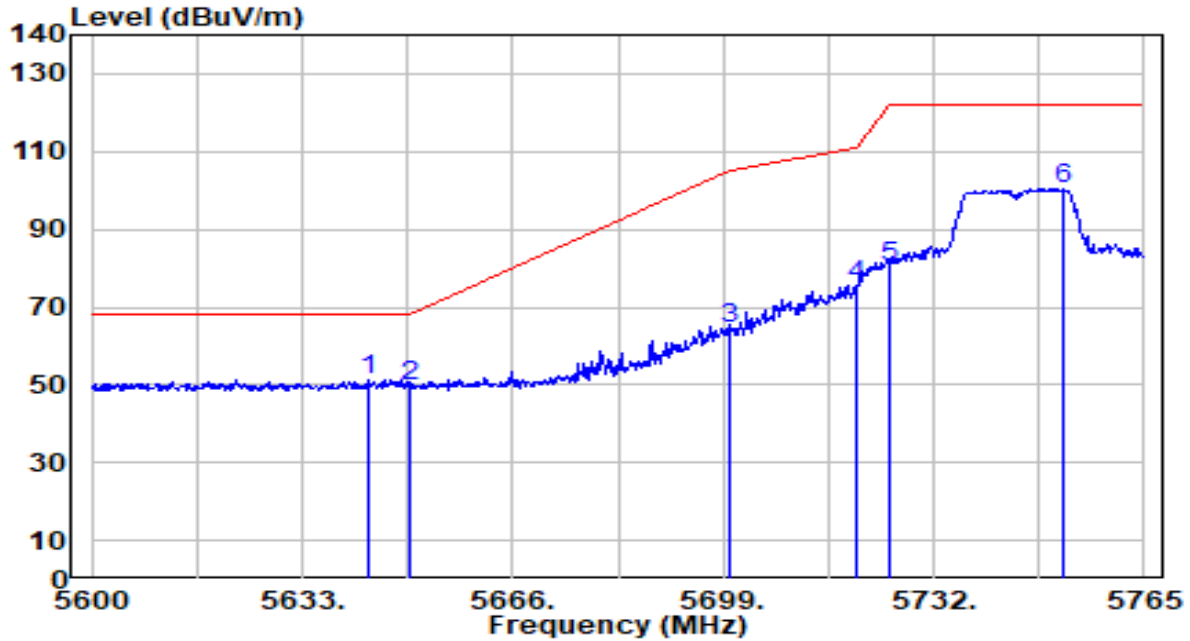

| No | Frequency (MHz) | Reading (dBuV) | C.F (dB/m) | Measurement (dBuV/m) | Margin (dB) | Limit (dBuV/m) | Height (cm) | Angle (deg) | Remark (QP/PK/AV) |
|----|-----------------|----------------|------------|----------------------|-------------|----------------|-------------|-------------|-------------------|
| 1 | * 5643.230 | 51.36 | -0.20 | 51.16 | -17.04 | 68.20 | 100 | 308 | Peak |
| 2 | 5650.000 | 49.94 | -0.16 | 49.77 | -18.43 | 68.20 | 100 | 308 | Peak |
| 3 | 5700.000 | 64.23 | 0.10 | 64.33 | -40.87 | 105.20 | 100 | 308 | Peak |
| 4 | 5720.000 | 75.51 | 0.20 | 75.71 | -35.09 | 110.80 | 100 | 308 | Peak |
| 5 | 5725.000 | 80.19 | 0.23 | 80.42 | -41.78 | 122.20 | 100 | 308 | Peak |
| 6 | 5752.295 | 100.14 | 0.37 | 100.52 | N/A | N/A | 100 | 308 | Peak |

Note:

1. " *", means this data is the worst emission level.
2. C.F (Correction Factor) = Antenna Factor (dB/m)+ Cable Loss (dB) – Pre-amplifier(dB) + 10dB Attenuation.
3. Measurement (dBuV/m) = Reading(dBuV) + C.F (Correction Factor).
4. The emission levels of other frequencies are very lower than the limit and not show in test report.

| | | | |
|-----------|-------------------------------------|----------------------|--------------|
| EUT | POS Terminal | Date of Test | 2023-10-28 |
| Factor | DRH18-E | Temp. / Humidity | 23°C /61% |
| Polarity | Horizontal | Site / Test Engineer | AC2 / Marvin |
| Test Mode | 802.11n-20MHz_TX_Band4_CH 165_ANT 0 | Test Voltage | AC 120V/60Hz |

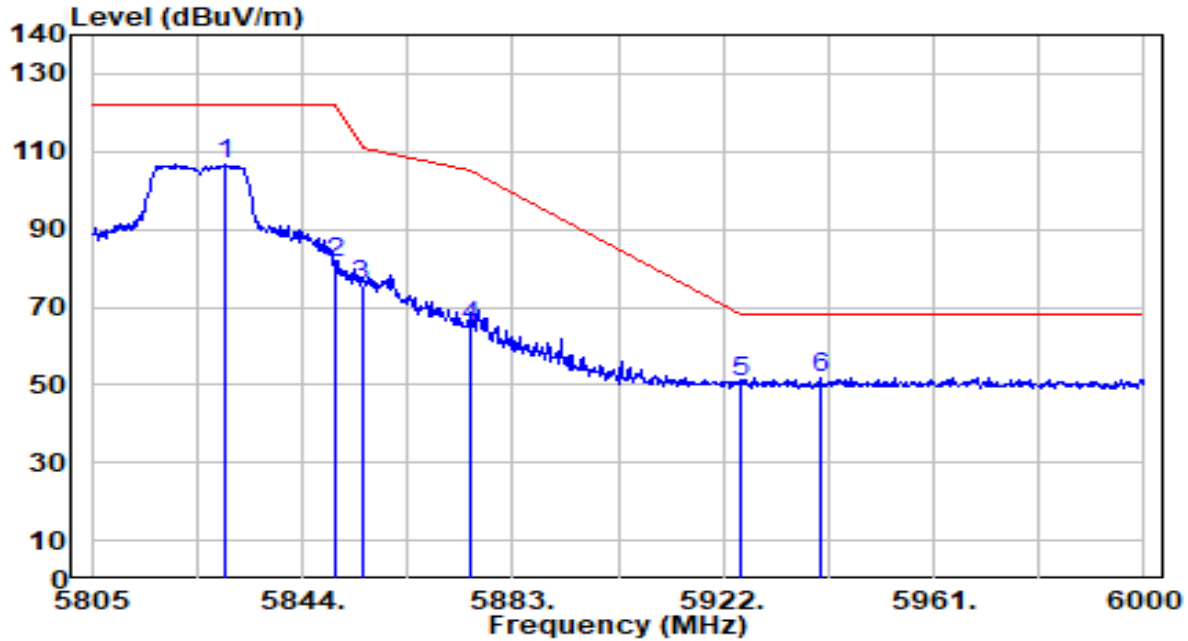

| No | Frequency (MHz) | Reading (dBuV) | C.F (dB/m) | Measurement (dBuV/m) | Margin (dB) | Limit (dBuV/m) | Height (cm) | Angle (deg) | Remark (QP/PK/AV) |
|----|-----------------|----------------|------------|----------------------|-------------|----------------|-------------|-------------|-------------------|
| 1 | 5829.765 | 105.99 | 0.60 | 106.59 | N/A | N/A | 122 | 240 | Peak |
| 2 | 5850.000 | 80.92 | 0.58 | 81.50 | -40.70 | 122.20 | 122 | 240 | Peak |
| 3 | 5855.000 | 75.16 | 0.58 | 75.74 | -35.06 | 110.80 | 122 | 240 | Peak |
| 4 | 5875.000 | 64.23 | 0.57 | 64.79 | -40.41 | 105.20 | 122 | 240 | Peak |
| 5 | 5925.000 | 50.14 | 0.53 | 50.67 | -17.53 | 68.20 | 122 | 240 | Peak |
| 6 | * 5939.940 | 51.51 | 0.52 | 52.03 | -16.17 | 68.20 | 122 | 240 | Peak |

Note:

1. " *", means this data is the worst emission level.
2. C.F (Correction Factor) = Antenna Factor (dB/m)+ Cable Loss (dB) – Pre-amplifier(dB) + 10dB Attenuation.
3. Measurement (dBuV/m) = Reading(dBuV) + C.F (Correction Factor).
4. The emission levels of other frequencies are very lower than the limit and not show in test report.

| | | | |
|-----------|-------------------------------------|----------------------|--------------|
| EUT | POS Terminal | Date of Test | 2023-10-28 |
| Factor | DRH18-E | Temp. / Humidity | 23°C /61% |
| Polarity | Vertical | Site / Test Engineer | AC2 / Marvin |
| Test Mode | 802.11n-20MHz_TX_Band4_CH 165_ANT 0 | Test Voltage | AC 120V/60Hz |

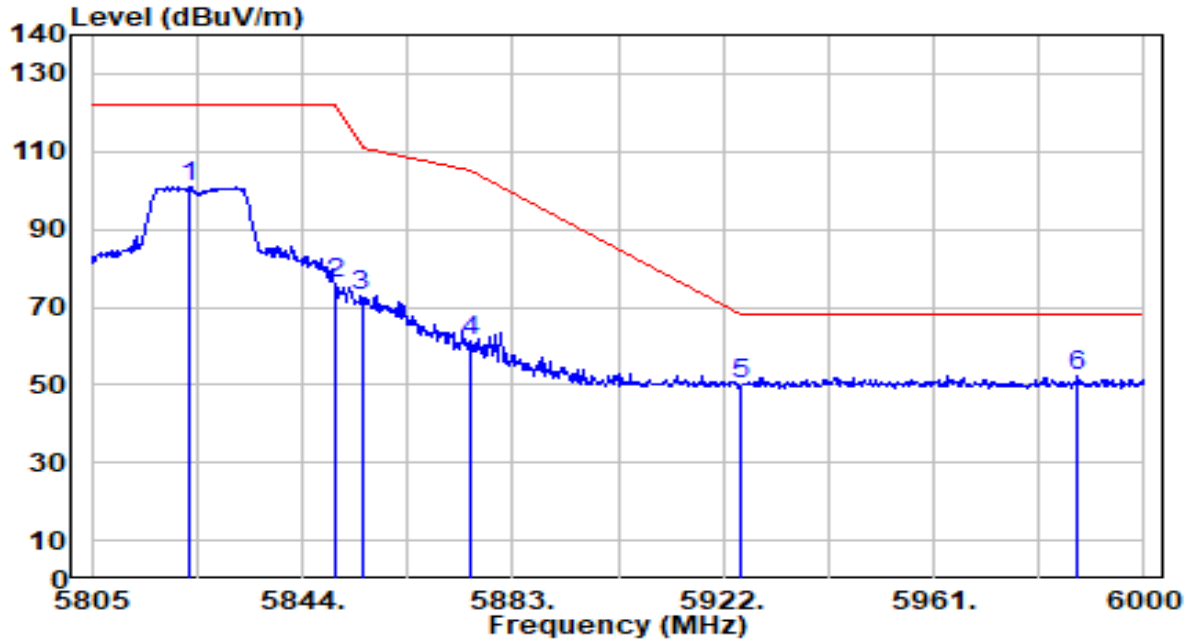

| No | Frequency (MHz) | Reading (dBuV) | C.F (dB/m) | Measurement (dBuV/m) | Margin (dB) | Limit (dBuV/m) | Height (cm) | Angle (deg) | Remark (QP/PK/AV) |
|----|-----------------|----------------|------------|----------------------|-------------|----------------|-------------|-------------|-------------------|
| 1 | 5823.135 | 100.35 | 0.60 | 100.96 | N/A | N/A | 100 | 308 | Peak |
| 2 | 5850.000 | 75.73 | 0.58 | 76.31 | -45.89 | 122.20 | 100 | 308 | Peak |
| 3 | 5855.000 | 72.38 | 0.58 | 72.96 | -37.84 | 110.80 | 100 | 308 | Peak |
| 4 | 5875.000 | 60.60 | 0.57 | 61.16 | -44.04 | 105.20 | 100 | 308 | Peak |
| 5 | 5925.000 | 49.73 | 0.53 | 50.26 | -17.94 | 68.20 | 100 | 308 | Peak |
| 6 | * 5987.715 | 51.86 | 0.48 | 52.34 | -15.86 | 68.20 | 100 | 308 | Peak |

Note:

- "*", means this data is the worst emission level.
- C.F (Correction Factor) = Antenna Factor (dB/m)+ Cable Loss (dB) – Pre-amplifier(dB) + 10dB Attenuation.
- Measurement (dBuV/m) = Reading(dBuV) + C.F (Correction Factor).
- The emission levels of other frequencies are very lower than the limit and not show in test report.

| | | | |
|-----------|------------------------------------|----------------------|--------------|
| EUT | POS Terminal | Date of Test | 2023-10-28 |
| Factor | DRH18-E | Temp. / Humidity | 23°C /61% |
| Polarity | Horizontal | Site / Test Engineer | AC2 / Marvin |
| Test Mode | 802.11n-40MHz_TX_Band1_CH 38_ANT 0 | Test Voltage | AC 120V/60Hz |

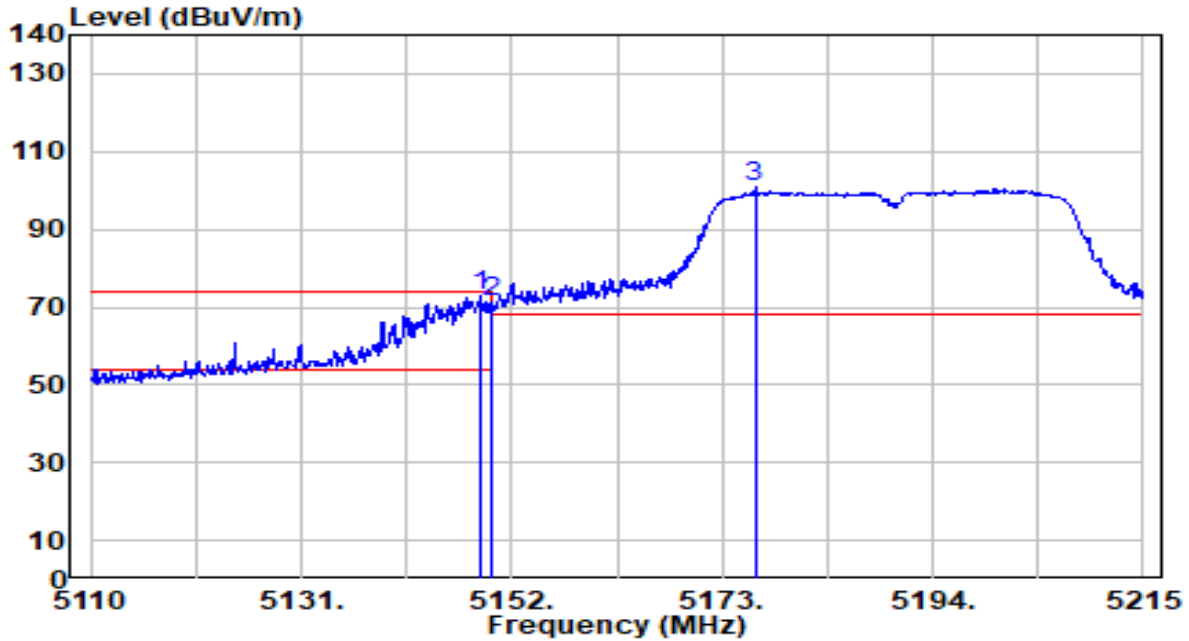

| No | Frequency (MHz) | Reading (dBuV) | C.F (dB/m) | Measurement (dBuV/m) | Margin (dB) | Limit (dBuV/m) | Height (cm) | Angle (deg) | Remark (QP/PK/AV) |
|----|-----------------|----------------|------------|----------------------|-------------|----------------|-------------|-------------|-------------------|
| 1 | * 5148.955 | 73.50 | -0.72 | 72.78 | -1.22 | 74.00 | 120 | 257 | Peak |
| 2 | 5150.000 | 72.30 | -0.72 | 71.58 | -2.42 | 74.00 | 120 | 257 | Peak |
| 3 | 5176.255 | 101.63 | -0.73 | 100.89 | N/A | N/A | 120 | 257 | Peak |

Note:

1. " *" , means this data is the worst emission level.
2. C.F (Correction Factor) = Antenna Factor (dB/m)+ Cable Loss (dB) – Preamplifier(dB) + 10dB Attenuation.
3. Measurement (dBuV/m) = Reading(dBuV) + C.F (Correction Factor).
4. The emission levels of other frequencies are very lower than the limit and not show in test report.

| | | | |
|-----------|------------------------------------|----------------------|--------------|
| EUT | POS Terminal | Date of Test | 2023-10-28 |
| Factor | DRH18-E | Temp. / Humidity | 23°C /61% |
| Polarity | Horizontal | Site / Test Engineer | AC2 / Marvin |
| Test Mode | 802.11n-40MHz_TX_Band1_CH 38_ANT 0 | Test Voltage | AC 120V/60Hz |

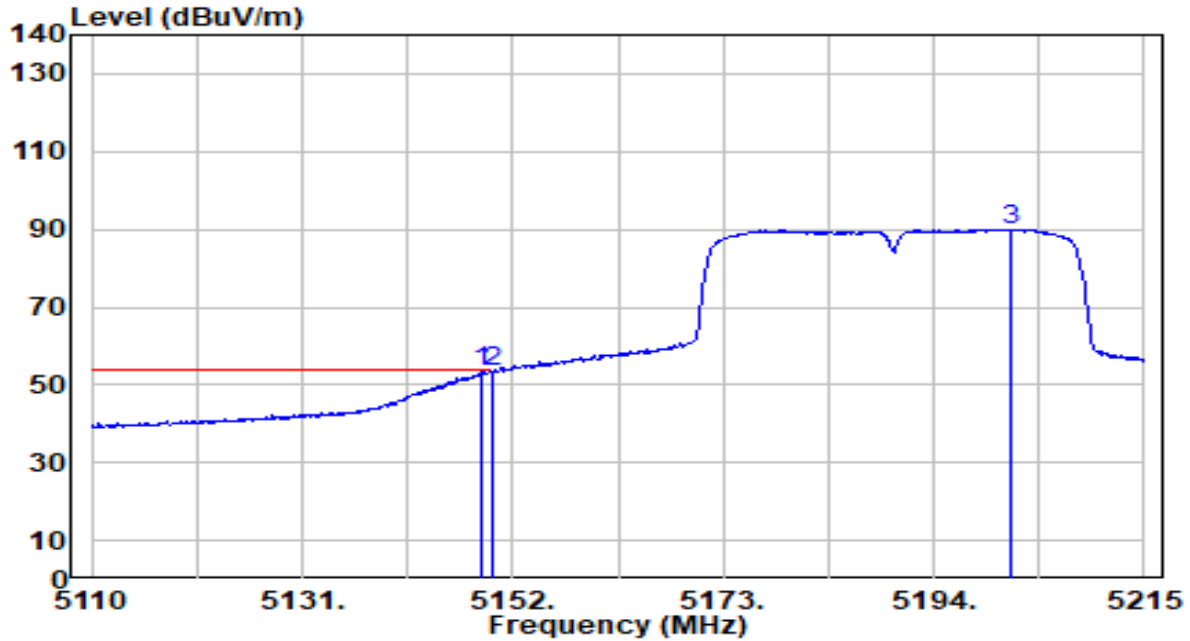

| No | Frequency (MHz) | Reading (dBuV) | C.F (dB/m) | Measurement (dBuV/m) | Margin (dB) | Limit (dBuV/m) | Height (cm) | Angle (deg) | Remark (QP/PK/AV) |
|----|-----------------|----------------|------------|----------------------|-------------|----------------|-------------|-------------|-------------------|
| 1 | 5148.955 | 53.98 | -0.72 | 53.27 | -0.73 | 54.00 | 120 | 257 | Average |
| 2 | * 5150.000 | 54.18 | -0.72 | 53.46 | -0.54 | 54.00 | 120 | 257 | Average |
| 3 | 5201.665 | 90.82 | -0.75 | 90.07 | N/A | N/A | 120 | 257 | Average |

Note:

1. " *" , means this data is the worst emission level.
2. C.F (Correction Factor) = Antenna Factor (dB/m)+ Cable Loss (dB) – Preamplifier(dB) + 10dB Attenuation.
3. Measurement (dBuV/m) = Reading(dBuV) + C.F (Correction Factor).
4. The emission levels of other frequencies are very lower than the limit and not show in test report.

| | | | |
|-----------|------------------------------------|----------------------|--------------|
| EUT | POS Terminal | Date of Test | 2023-10-28 |
| Factor | DRH18-E | Temp. / Humidity | 23°C /61% |
| Polarity | Vertical | Site / Test Engineer | AC2 / Marvin |
| Test Mode | 802.11n-40MHz_TX_Band1_CH 38_ANT 0 | Test Voltage | AC 120V/60Hz |

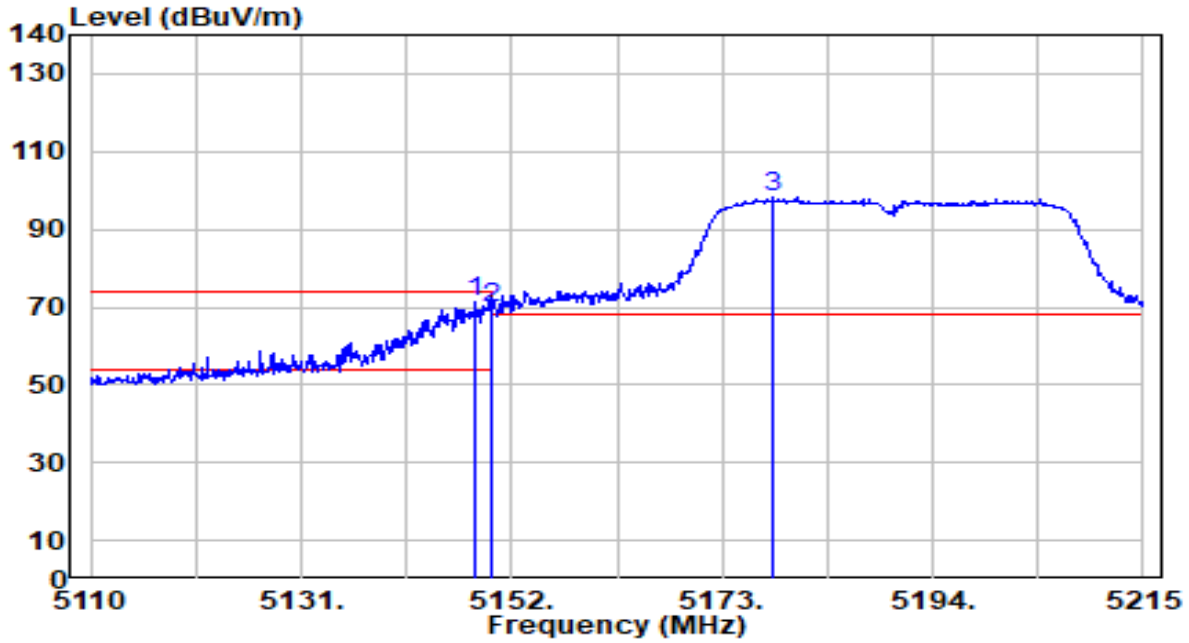

| No | Frequency (MHz) | Reading (dBuV) | C.F (dB/m) | Measurement (dBuV/m) | Margin (dB) | Limit (dBuV/m) | Height (cm) | Angle (deg) | Remark (QP/PK/AV) |
|----|-----------------|----------------|------------|----------------------|-------------|----------------|-------------|-------------|-------------------|
| 1 | * 5148.430 | 71.79 | -0.72 | 71.07 | -2.93 | 74.00 | 100 | 323 | Peak |
| 2 | 5150.000 | 70.25 | -0.72 | 69.53 | -4.47 | 74.00 | 100 | 323 | Peak |
| 3 | 5178.040 | 99.01 | -0.73 | 98.28 | N/A | N/A | 100 | 323 | Peak |

Note:

1. " *" , means this data is the worst emission level.
2. C.F (Correction Factor) = Antenna Factor (dB/m)+ Cable Loss (dB) – Preamplifier(dB) + 10dB Attenuation.
3. Measurement (dBuV/m) = Reading(dBuV) + C.F (Correction Factor).
4. The emission levels of other frequencies are very lower than the limit and not show in test report.

| | | | |
|-----------|------------------------------------|----------------------|--------------|
| EUT | POS Terminal | Date of Test | 2023-10-28 |
| Factor | DRH18-E | Temp. / Humidity | 23°C /61% |
| Polarity | Vertical | Site / Test Engineer | AC2 / Marvin |
| Test Mode | 802.11n-40MHz_TX_Band1_CH 38_ANT 0 | Test Voltage | AC 120V/60Hz |

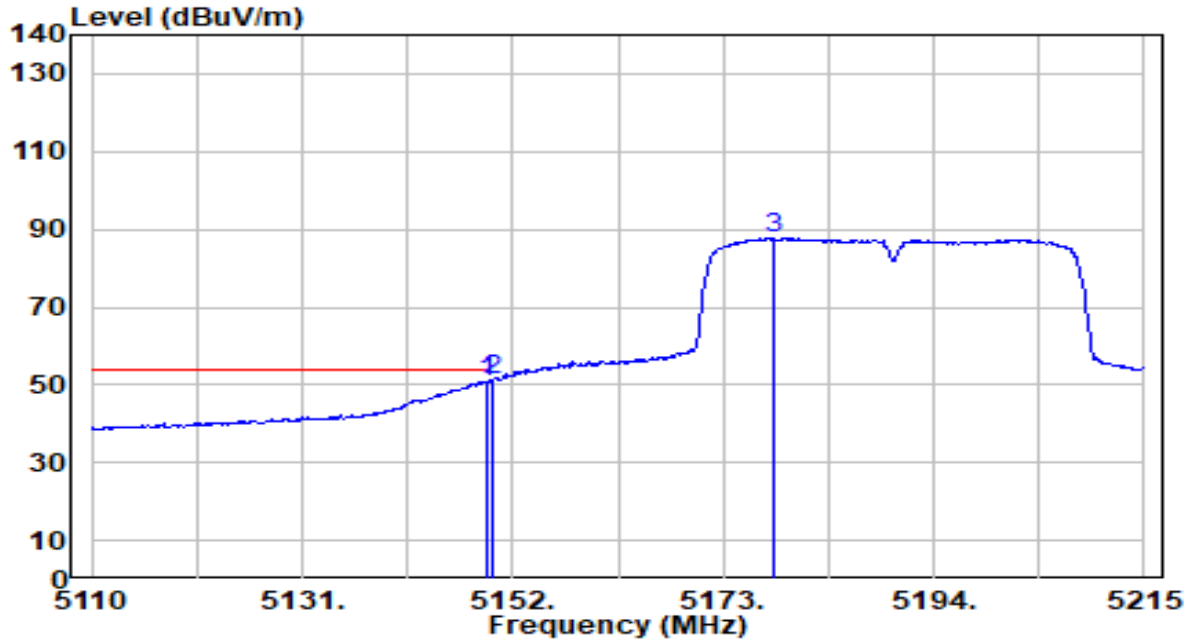

| No | Frequency (MHz) | Reading (dBuV) | C.F (dB/m) | Measurement (dBuV/m) | Margin (dB) | Limit (dBuV/m) | Height (cm) | Angle (deg) | Remark (QP/PK/AV) |
|----|-----------------|----------------|------------|----------------------|-------------|----------------|-------------|-------------|-------------------|
| 1 | 5149.480 | 51.50 | -0.72 | 50.78 | -3.22 | 54.00 | 100 | 323 | Average |
| 2 | * 5150.000 | 51.77 | -0.72 | 51.05 | -2.95 | 54.00 | 100 | 323 | Average |
| 3 | 5178.145 | 88.40 | -0.73 | 87.67 | N/A | N/A | 100 | 323 | Average |

Note:

1. " *" , means this data is the worst emission level.
2. C.F (Correction Factor) = Antenna Factor (dB/m)+ Cable Loss (dB) – Preamplifier(dB) + 10dB Attenuation.
3. Measurement (dBuV/m) = Reading(dBuV) + C.F (Correction Factor).
4. The emission levels of other frequencies are very lower than the limit and not show in test report.

| | | | |
|-----------|------------------------------------|----------------------|--------------|
| EUT | POS Terminal | Date of Test | 2023-10-28 |
| Factor | DRH18-E | Temp. / Humidity | 23°C /61% |
| Polarity | Horizontal | Site / Test Engineer | AC2 / Marvin |
| Test Mode | 802.11n-40MHz_TX_Band2_CH 62_ANT 0 | Test Voltage | AC 120V/60Hz |

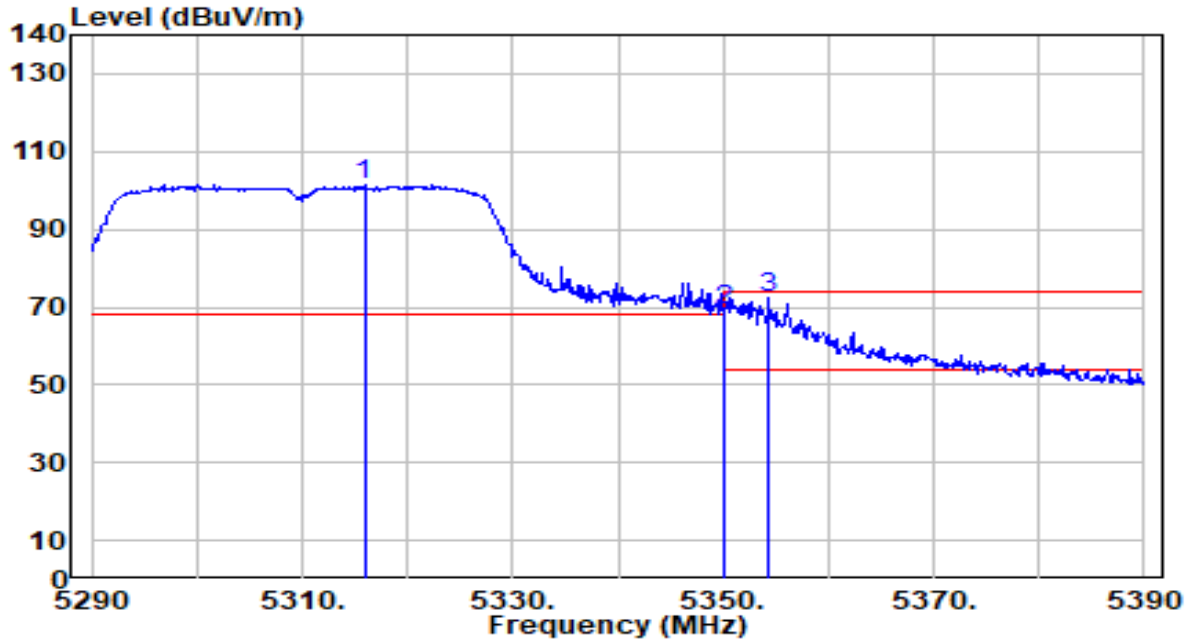

| No | Frequency (MHz) | Reading (dBuV) | C.F (dB/m) | Measurement (dBuV/m) | Margin (dB) | Limit (dBuV/m) | Height (cm) | Angle (deg) | Remark (QP/PK/AV) |
|----|-----------------|----------------|------------|----------------------|-------------|----------------|-------------|-------------|-------------------|
| 1 | 5315.900 | 102.35 | -0.92 | 101.43 | N/A | N/A | 125 | 240 | Peak |
| 2 | 5350.000 | 70.25 | -0.97 | 69.28 | -4.72 | 74.00 | 125 | 240 | Peak |
| 3 | * 5354.300 | 73.54 | -0.98 | 72.56 | -1.44 | 74.00 | 125 | 240 | Peak |

Note:

1. " *" , means this data is the worst emission level.
2. C.F (Correction Factor) = Antenna Factor (dB/m)+ Cable Loss (dB) – Preamplifier(dB) + 10dB Attenuation.
3. Measurement (dBuV/m) = Reading(dBuV) + C.F (Correction Factor).
4. The emission levels of other frequencies are very lower than the limit and not show in test report.

| | | | |
|-----------|------------------------------------|----------------------|--------------|
| EUT | POS Terminal | Date of Test | 2023-10-28 |
| Factor | DRH18-E | Temp. / Humidity | 23°C /61% |
| Polarity | Horizontal | Site / Test Engineer | AC2 / Marvin |
| Test Mode | 802.11n-40MHz_TX_Band2_CH 62_ANT 0 | Test Voltage | AC 120V/60Hz |

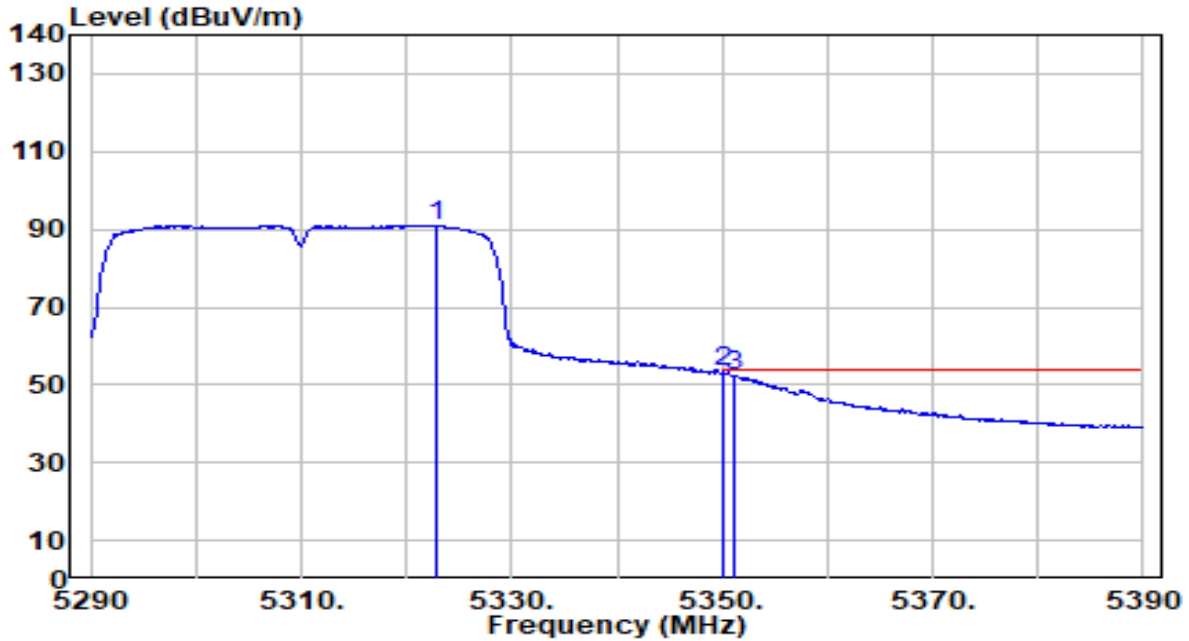

| No | Frequency (MHz) | Reading (dBuV) | C.F (dB/m) | Measurement (dBuV/m) | Margin (dB) | Limit (dBuV/m) | Height (cm) | Angle (deg) | Remark (QP/PK/AV) |
|----|-----------------|----------------|------------|----------------------|-------------|----------------|-------------|-------------|-------------------|
| 1 | 5322.900 | 92.06 | -0.93 | 91.13 | N/A | N/A | 125 | 240 | Average |
| 2 | * 5350.000 | 54.38 | -0.97 | 53.41 | -0.59 | 54.00 | 125 | 240 | Average |
| 3 | 5351.200 | 53.37 | -0.97 | 52.39 | -1.61 | 54.00 | 125 | 240 | Average |

Note:

1. " *", means this data is the worst emission level.
2. C.F (Correction Factor) = Antenna Factor (dB/m)+ Cable Loss (dB) – Preamplifier(dB) + 10dB Attenuation.
3. Measurement (dBuV/m) = Reading(dBuV) + C.F (Correction Factor).
4. The emission levels of other frequencies are very lower than the limit and not show in test report.

| | | | |
|-----------|------------------------------------|----------------------|--------------|
| EUT | POS Terminal | Date of Test | 2023-10-28 |
| Factor | DRH18-E | Temp. / Humidity | 23°C /61% |
| Polarity | Vertical | Site / Test Engineer | AC2 / Marvin |
| Test Mode | 802.11n-40MHz_TX_Band2_CH 62_ANT 0 | Test Voltage | AC 120V/60Hz |

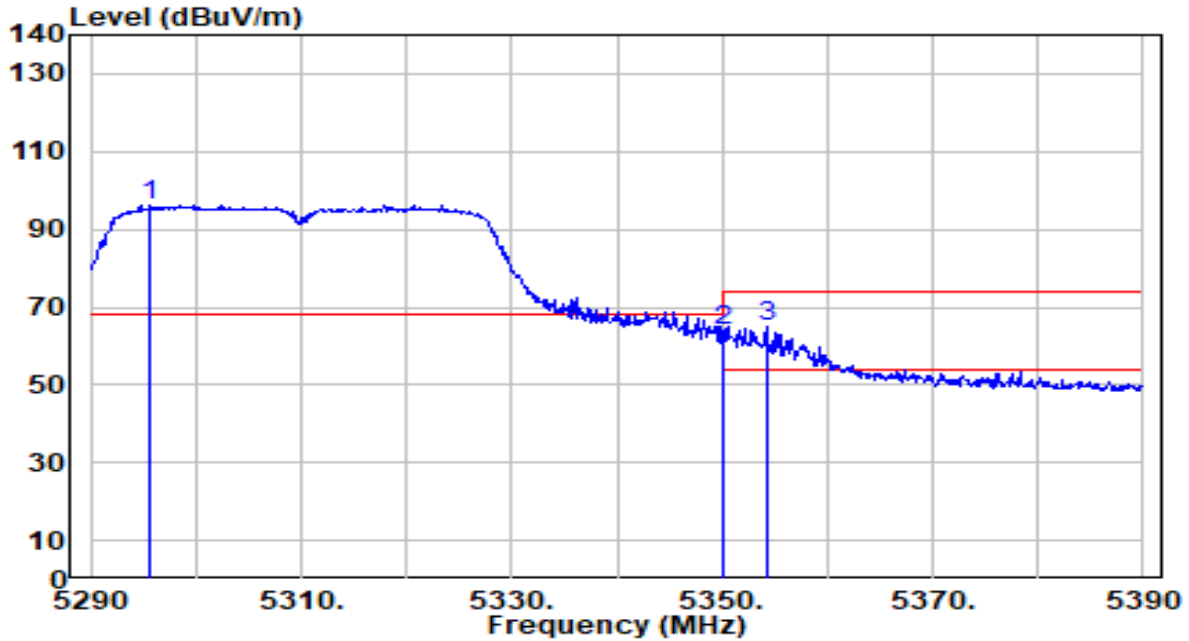

| No | Frequency (MHz) | Reading (dBuV) | C.F (dB/m) | Measurement (dBuV/m) | Margin (dB) | Limit (dBuV/m) | Height (cm) | Angle (deg) | Remark (QP/PK/AV) |
|----|-----------------|----------------|------------|----------------------|-------------|----------------|-------------|-------------|-------------------|
| 1 | 5295.600 | 97.25 | -0.89 | 96.36 | N/A | N/A | 100 | 308 | Peak |
| 2 | 5350.000 | 65.15 | -0.97 | 64.17 | -9.83 | 74.00 | 100 | 308 | Peak |
| 3 | * 5354.200 | 65.97 | -0.98 | 64.99 | -9.01 | 74.00 | 100 | 308 | Peak |

Note:

1. " *" , means this data is the worst emission level.
2. C.F (Correction Factor) = Antenna Factor (dB/m)+ Cable Loss (dB) – Preamplifier(dB) + 10dB Attenuation.
3. Measurement (dBuV/m) = Reading(dBuV) + C.F (Correction Factor).
4. The emission levels of other frequencies are very lower than the limit and not show in test report.

| | | | |
|-----------|------------------------------------|----------------------|--------------|
| EUT | POS Terminal | Date of Test | 2023-10-28 |
| Factor | DRH18-E | Temp. / Humidity | 23°C /61% |
| Polarity | Vertical | Site / Test Engineer | AC2 / Marvin |
| Test Mode | 802.11n-40MHz_TX_Band2_CH 62_ANT 0 | Test Voltage | AC 120V/60Hz |

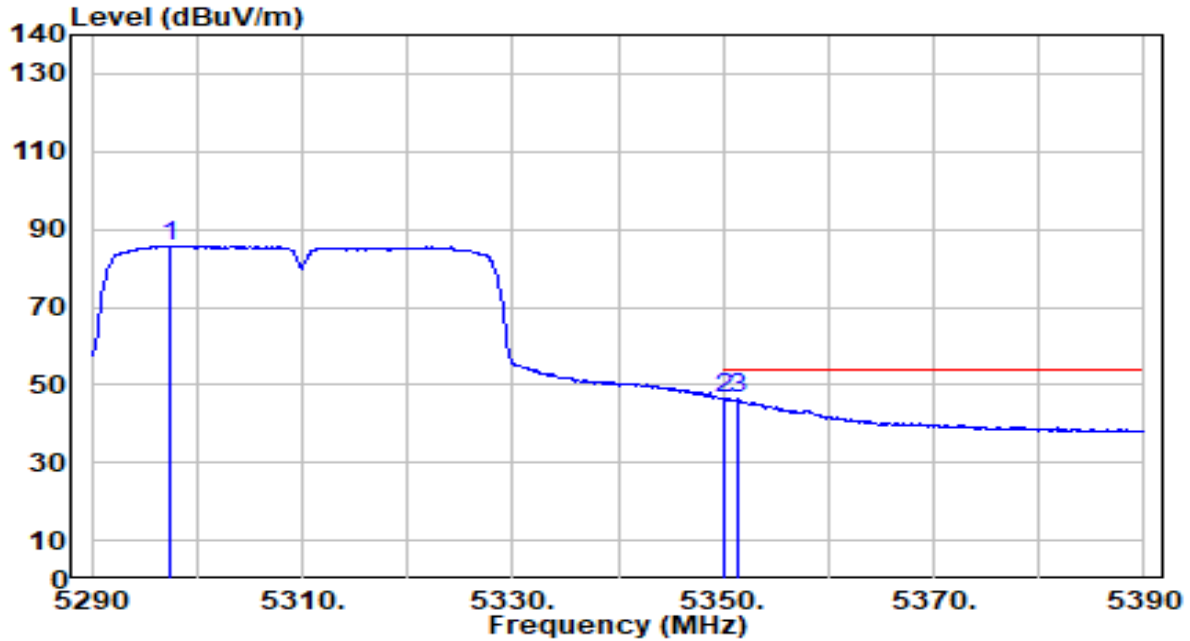

| No | Frequency (MHz) | Reading (dBuV) | C.F (dB/m) | Measurement (dBuV/m) | Margin (dB) | Limit (dBuV/m) | Height (cm) | Angle (deg) | Remark (QP/PK/AV) |
|----|-----------------|----------------|------------|----------------------|-------------|----------------|-------------|-------------|-------------------|
| 1 | 5297.400 | 86.72 | -0.89 | 85.82 | N/A | N/A | 100 | 308 | Average |
| 2 | * 5350.000 | 47.33 | -0.97 | 46.36 | -7.64 | 54.00 | 100 | 308 | Average |
| 3 | 5351.300 | 47.27 | -0.97 | 46.30 | -7.70 | 54.00 | 100 | 308 | Average |

Note:

1. " *" , means this data is the worst emission level.
2. C.F (Correction Factor) = Antenna Factor (dB/m)+ Cable Loss (dB) – Pre-amplifier(dB) + 10dB Attenuation.
3. Measurement (dBuV/m) = Reading(dBuV) + C.F (Correction Factor).
4. The emission levels of other frequencies are very lower than the limit and not show in test report.

| | | | |
|-----------|-------------------------------------|----------------------|--------------|
| EUT | POS Terminal | Date of Test | 2023-10-28 |
| Factor | DRH18-E | Temp. / Humidity | 23°C /61% |
| Polarity | Horizontal | Site / Test Engineer | AC2 / Marvin |
| Test Mode | 802.11n-40MHz_TX_Band3_CH 102_ANT 0 | Test Voltage | AC 120V/60Hz |

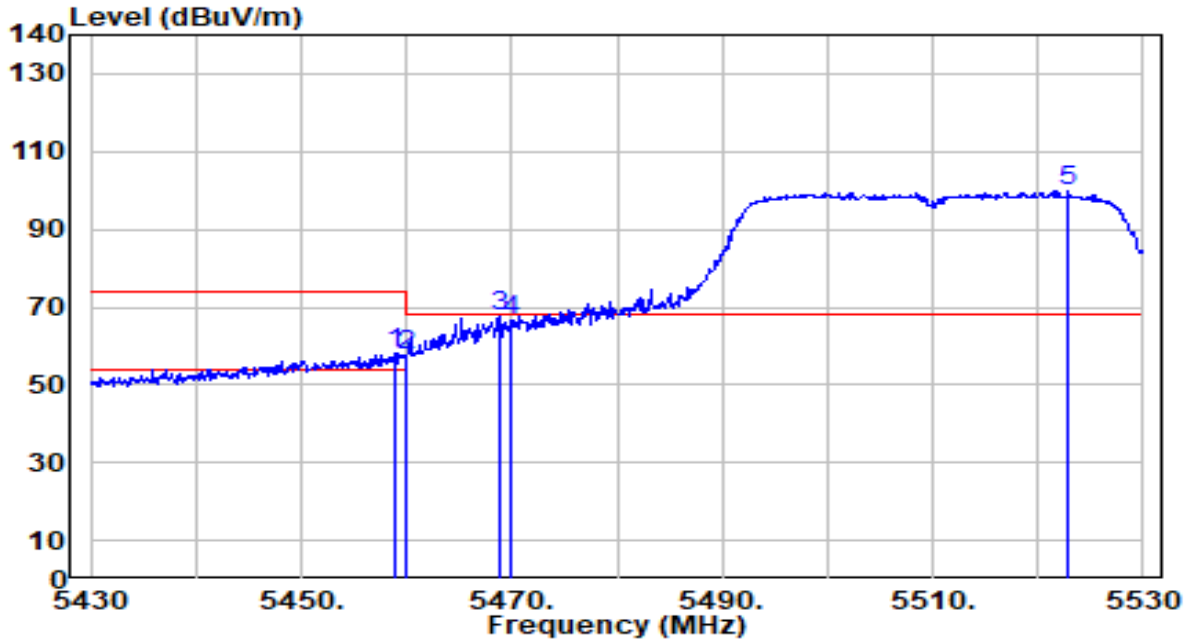

| No | Frequency (MHz) | Reading (dBuV) | C.F (dB/m) | Measurement (dBuV/m) | Margin (dB) | Limit (dBuV/m) | Height (cm) | Angle (deg) | Remark (QP/PK/AV) |
|----|-----------------|----------------|------------|----------------------|-------------|----------------|-------------|-------------|-------------------|
| 1 | 5458.800 | 58.96 | -0.87 | 58.08 | -15.92 | 74.00 | 121 | 240 | Peak |
| 2 | 5460.000 | 58.44 | -0.87 | 57.57 | -16.43 | 74.00 | 121 | 240 | Peak |
| 3 | * 5468.900 | 68.46 | -0.84 | 67.62 | -0.58 | 68.20 | 121 | 240 | Peak |
| 4 | 5470.000 | 67.24 | -0.84 | 66.40 | -1.80 | 68.20 | 121 | 240 | Peak |
| 5 | 5522.900 | 100.50 | -0.68 | 99.83 | N/A | N/A | 121 | 240 | Peak |

Note:

1. " *", means this data is the worst emission level.
2. C.F (Correction Factor) = Antenna Factor (dB/m)+ Cable Loss (dB) – Preamplifier(dB) + 10dB Attenuation.
3. Measurement (dBuV/m) = Reading(dBuV) + C.F (Correction Factor).
4. The emission levels of other frequencies are very lower than the limit and not show in test report.

| | | | |
|-----------|-------------------------------------|----------------------|--------------|
| EUT | POS Terminal | Date of Test | 2023-10-28 |
| Factor | DRH18-E | Temp. / Humidity | 23°C /61% |
| Polarity | Horizontal | Site / Test Engineer | AC2 / Marvin |
| Test Mode | 802.11n-40MHz_TX_Band3_CH 102_ANT 0 | Test Voltage | AC 120V/60Hz |

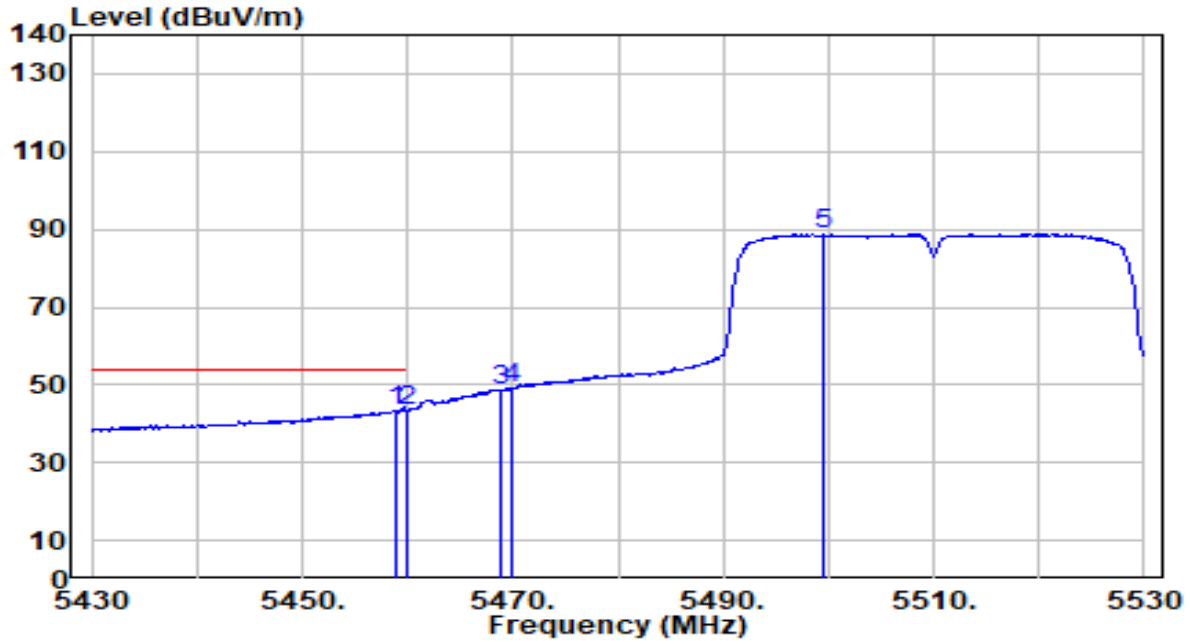

| No | Frequency (MHz) | Reading (dBuV) | C.F (dB/m) | Measurement (dBuV/m) | Margin (dB) | Limit (dBuV/m) | Height (cm) | Angle (deg) | Remark (QP/PK/AV) |
|----|-----------------|----------------|------------|----------------------|-------------|----------------|-------------|-------------|-------------------|
| 1 | 5458.900 | 44.17 | -0.87 | 43.30 | -10.70 | 54.00 | 121 | 240 | Average |
| 2 | * 5460.000 | 44.28 | -0.87 | 43.41 | -10.59 | 54.00 | 121 | 240 | Average |
| 3 | 5468.900 | 49.27 | -0.84 | 48.43 | N/A | N/A | 121 | 240 | Average |
| 4 | 5470.000 | 50.10 | -0.84 | 49.26 | N/A | N/A | 121 | 240 | Average |
| 5 | 5499.500 | 89.51 | -0.75 | 88.76 | N/A | N/A | 121 | 240 | Average |

Note:

1. " *", means this data is the worst emission level.
2. C.F (Correction Factor) = Antenna Factor (dB/m)+ Cable Loss (dB) – Preamplifier(dB) + 10dB Attenuation.
3. Measurement (dBuV/m) = Reading(dBuV) + C.F (Correction Factor).
4. The emission levels of other frequencies are very lower than the limit and not show in test report.

| | | | |
|-----------|-------------------------------------|----------------------|--------------|
| EUT | POS Terminal | Date of Test | 2023-10-28 |
| Factor | DRH18-E | Temp. / Humidity | 23°C /61% |
| Polarity | Vertical | Site / Test Engineer | AC2 / Marvin |
| Test Mode | 802.11n-40MHz_TX_Band3_CH 102_ANT 0 | Test Voltage | AC 120V/60Hz |

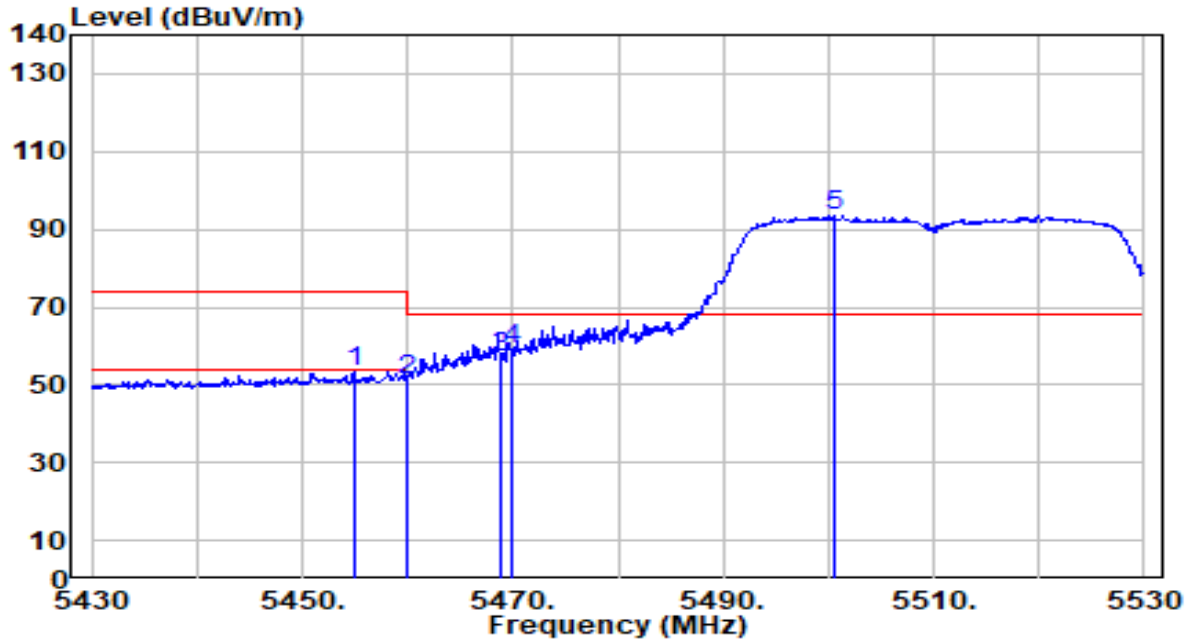

| No | Frequency (MHz) | Reading (dBuV) | C.F (dB/m) | Measurement (dBuV/m) | Margin (dB) | Limit (dBuV/m) | Height (cm) | Angle (deg) | Remark (QP/PK/AV) |
|----|-----------------|----------------|------------|----------------------|-------------|----------------|-------------|-------------|-------------------|
| 1 | 5455.000 | 54.45 | -0.88 | 53.57 | -20.43 | 74.00 | 101 | 301 | Peak |
| 2 | 5460.000 | 52.30 | -0.87 | 51.43 | -22.57 | 74.00 | 101 | 301 | Peak |
| 3 | 5468.900 | 57.95 | -0.84 | 57.11 | -11.09 | 68.20 | 101 | 301 | Peak |
| 4 | * 5470.000 | 59.90 | -0.84 | 59.06 | -9.14 | 68.20 | 101 | 301 | Peak |
| 5 | 5500.600 | 94.46 | -0.75 | 93.72 | N/A | N/A | 101 | 301 | Peak |

Note:

- "*" means this data is the worst emission level.
- C.F (Correction Factor) = Antenna Factor (dB/m)+ Cable Loss (dB) – Preamplifier(dB) + 10dB Attenuation.
- Measurement (dBuV/m) = Reading(dBuV) + C.F (Correction Factor).
- The emission levels of other frequencies are very lower than the limit and not show in test report.

| | | | |
|-----------|-------------------------------------|----------------------|--------------|
| EUT | POS Terminal | Date of Test | 2023-10-28 |
| Factor | DRH18-E | Temp. / Humidity | 23°C /61% |
| Polarity | Vertical | Site / Test Engineer | AC2 / Marvin |
| Test Mode | 802.11n-40MHz_TX_Band3_CH 102_ANT 0 | Test Voltage | AC 120V/60Hz |

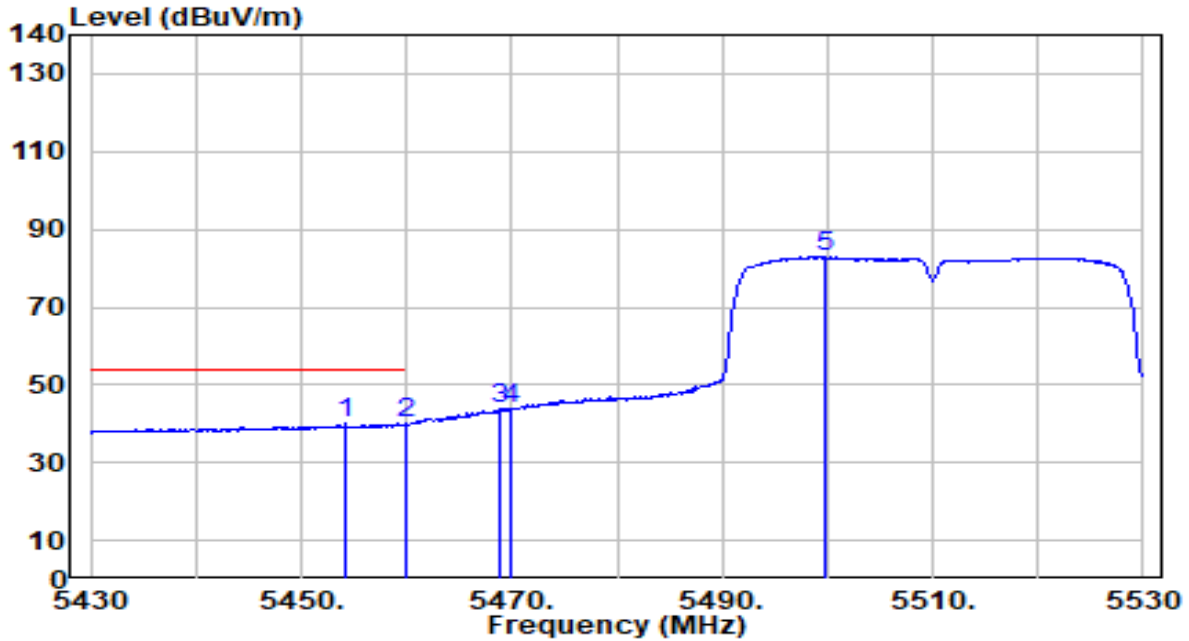

| No | Frequency (MHz) | Reading (dBuV) | C.F (dB/m) | Measurement (dBuV/m) | Margin (dB) | Limit (dBuV/m) | Height (cm) | Angle (deg) | Remark (QP/PK/AV) |
|----|-----------------|----------------|------------|----------------------|-------------|----------------|-------------|-------------|-------------------|
| 1 | 5454.300 | 40.85 | -0.89 | 39.96 | -14.04 | 54.00 | 101 | 301 | Average |
| 2 | * 5460.000 | 40.92 | -0.87 | 40.05 | -13.95 | 54.00 | 101 | 301 | Average |
| 3 | 5468.900 | 44.66 | -0.84 | 43.82 | N/A | N/A | 101 | 301 | Average |
| 4 | 5470.000 | 44.64 | -0.84 | 43.80 | N/A | N/A | 101 | 301 | Average |
| 5 | 5499.800 | 83.71 | -0.75 | 82.96 | N/A | N/A | 101 | 301 | Average |

Note:

1. " *", means this data is the worst emission level.
2. C.F (Correction Factor) = Antenna Factor (dB/m)+ Cable Loss (dB) – Preamplifier(dB) + 10dB Attenuation.
3. Measurement (dBuV/m) = Reading(dBuV) + C.F (Correction Factor).
4. The emission levels of other frequencies are very lower than the limit and not show in test report.

| | | | |
|-----------|-------------------------------------|----------------------|--------------|
| EUT | POS Terminal | Date of Test | 2023-10-28 |
| Factor | DRH18-E | Temp. / Humidity | 23°C /61% |
| Polarity | Horizontal | Site / Test Engineer | AC2 / Marvin |
| Test Mode | 802.11n-40MHz_TX_Band3_CH 134_ANT 0 | Test Voltage | AC 120V/60Hz |

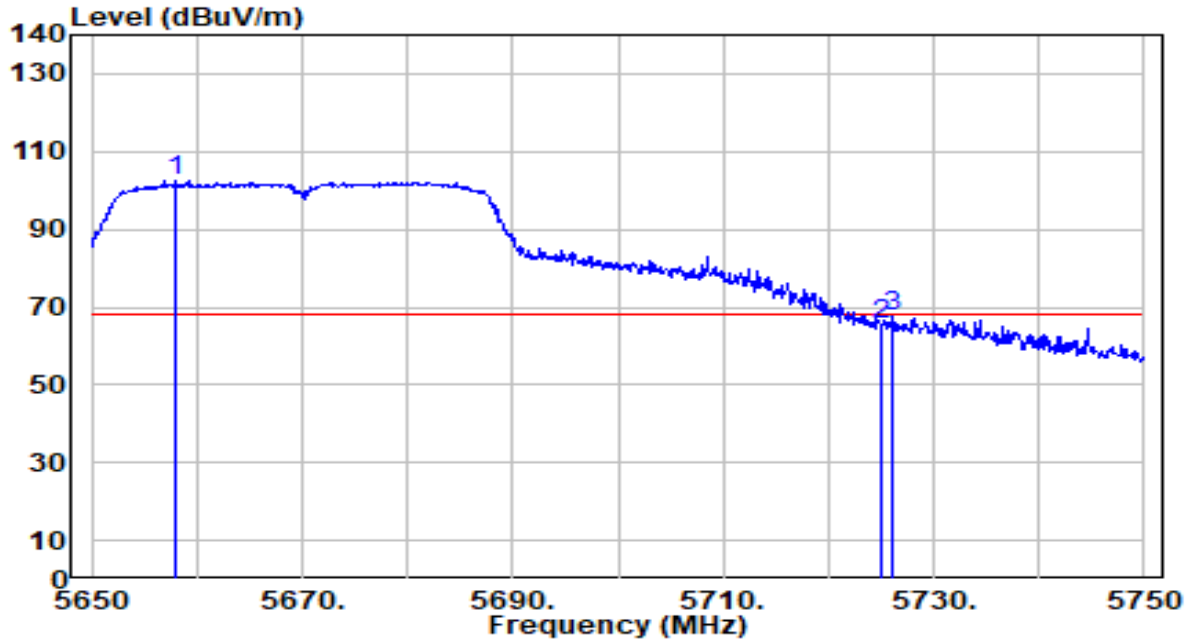

| No | Frequency (MHz) | Reading (dBuV) | C.F (dB/m) | Measurement (dBuV/m) | Margin (dB) | Limit (dBuV/m) | Height (cm) | Angle (deg) | Remark (QP/PK/AV) |
|----|-----------------|----------------|------------|----------------------|-------------|----------------|-------------|-------------|-------------------|
| 1 | 5658.000 | 102.59 | -0.12 | 102.47 | N/A | N/A | 120 | 240 | Peak |
| 2 | 5725.000 | 65.44 | 0.23 | 65.67 | -2.53 | 68.20 | 120 | 240 | Peak |
| 3 | * 5726.100 | 67.39 | 0.23 | 67.63 | -0.57 | 68.20 | 120 | 240 | Peak |

Note:

1. " *" , means this data is the worst emission level.
2. C.F (Correction Factor) = Antenna Factor (dB/m)+ Cable Loss (dB) – Preamplifier(dB) + 10dB Attenuation.
3. Measurement (dBuV/m) = Reading(dBuV) + C.F (Correction Factor).
4. The emission levels of other frequencies are very lower than the limit and not show in test report.

| | | | |
|-----------|-------------------------------------|----------------------|--------------|
| EUT | POS Terminal | Date of Test | 2023-10-28 |
| Factor | DRH18-E | Temp. / Humidity | 23°C /61% |
| Polarity | Vertical | Site / Test Engineer | AC2 / Marvin |
| Test Mode | 802.11n-40MHz_TX_Band3_CH 134_ANT 0 | Test Voltage | AC 120V/60Hz |

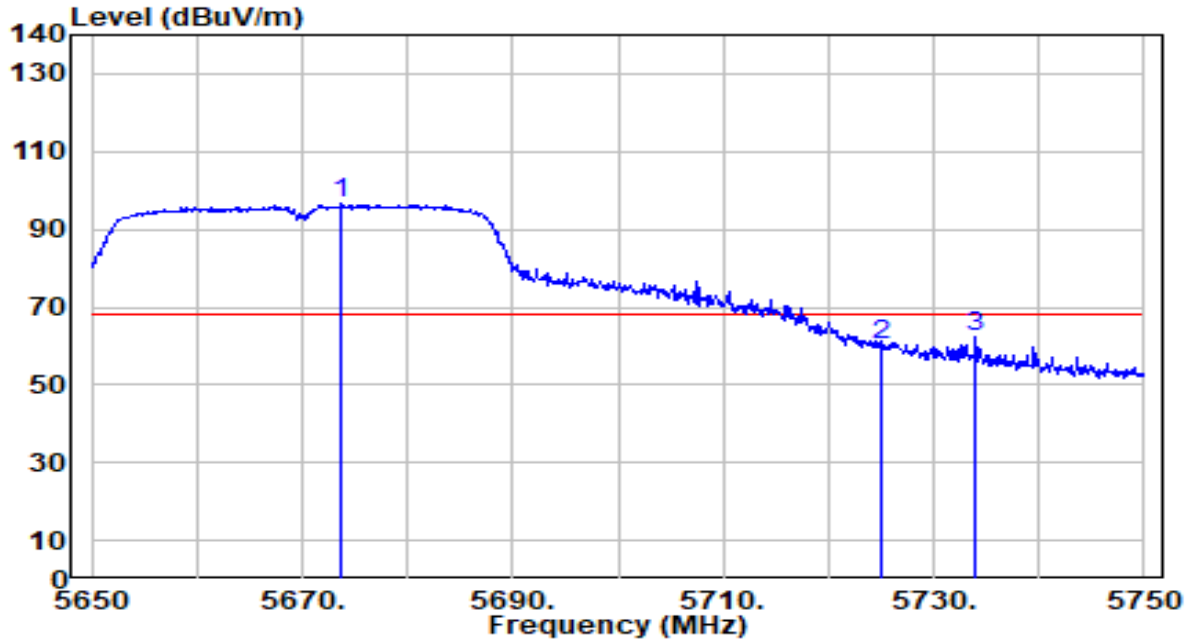

| No | Frequency (MHz) | Reading (dBuV) | C.F (dB/m) | Measurement (dBuV/m) | Margin (dB) | Limit (dBuV/m) | Height (cm) | Angle (deg) | Remark (QP/PK/AV) |
|----|-----------------|----------------|------------|----------------------|-------------|----------------|-------------|-------------|-------------------|
| 1 | 5673.700 | 96.55 | -0.04 | 96.51 | N/A | N/A | 100 | 304 | Peak |
| 2 | 5725.000 | 59.89 | 0.23 | 60.12 | -8.08 | 68.20 | 100 | 304 | Peak |
| 3 | * 5733.900 | 61.93 | 0.28 | 62.21 | -5.99 | 68.20 | 100 | 304 | Peak |

Note:

1. " *" , means this data is the worst emission level.
2. C.F (Correction Factor) = Antenna Factor (dB/m)+ Cable Loss (dB) – Preamplifier(dB) + 10dB Attenuation.
3. Measurement (dBuV/m) = Reading(dBuV) + C.F (Correction Factor).
4. The emission levels of other frequencies are very lower than the limit and not show in test report.

| | | | |
|-----------|-------------------------------------|----------------------|--------------|
| EUT | POS Terminal | Date of Test | 2023-10-28 |
| Factor | DRH18-E | Temp. / Humidity | 23°C /61% |
| Polarity | Horizontal | Site / Test Engineer | AC2 / Marvin |
| Test Mode | 802.11n-40MHz_TX_Band4_CH 151_ANT 0 | Test Voltage | AC 120V/60Hz |

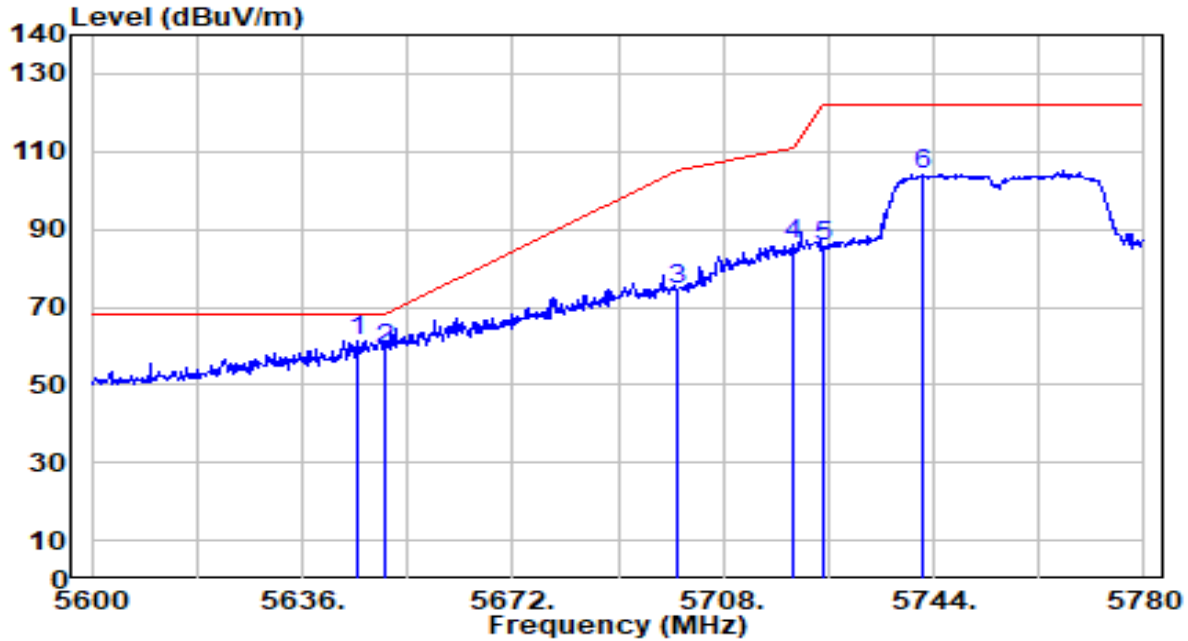

| No | Frequency (MHz) | Reading (dBuV) | C.F (dB/m) | Measurement (dBuV/m) | Margin (dB) | Limit (dBuV/m) | Height (cm) | Angle (deg) | Remark (QP/PK/AV) |
|----|-----------------|----------------|------------|----------------------|-------------|----------------|-------------|-------------|-------------------|
| 1 | * 5645.360 | 61.56 | -0.19 | 61.37 | -6.83 | 68.20 | 116 | 240 | Peak |
| 2 | 5650.000 | 59.42 | -0.16 | 59.25 | -8.95 | 68.20 | 116 | 240 | Peak |
| 3 | 5700.000 | 74.59 | 0.10 | 74.69 | -30.51 | 105.20 | 116 | 240 | Peak |
| 4 | 5720.000 | 85.81 | 0.20 | 86.02 | -24.78 | 110.80 | 116 | 240 | Peak |
| 5 | 5725.000 | 85.40 | 0.23 | 85.63 | -36.57 | 122.20 | 116 | 240 | Peak |
| 6 | 5742.020 | 103.87 | 0.32 | 104.19 | N/A | N/A | 116 | 240 | Peak |

Note:

1. " *", means this data is the worst emission level.
2. C.F (Correction Factor) = Antenna Factor (dB/m)+ Cable Loss (dB) – Pre-amplifier(dB) + 10dB Attenuation.
3. Measurement (dBuV/m) = Reading(dBuV) + C.F (Correction Factor).
4. The emission levels of other frequencies are very lower than the limit and not show in test report.

| | | | |
|-----------|-------------------------------------|----------------------|--------------|
| EUT | POS Terminal | Date of Test | 2023-10-28 |
| Factor | DRH18-E | Temp. / Humidity | 23°C /61% |
| Polarity | Vertical | Site / Test Engineer | AC2 / Marvin |
| Test Mode | 802.11n-40MHz_TX_Band4_CH 151_ANT 0 | Test Voltage | AC 120V/60Hz |

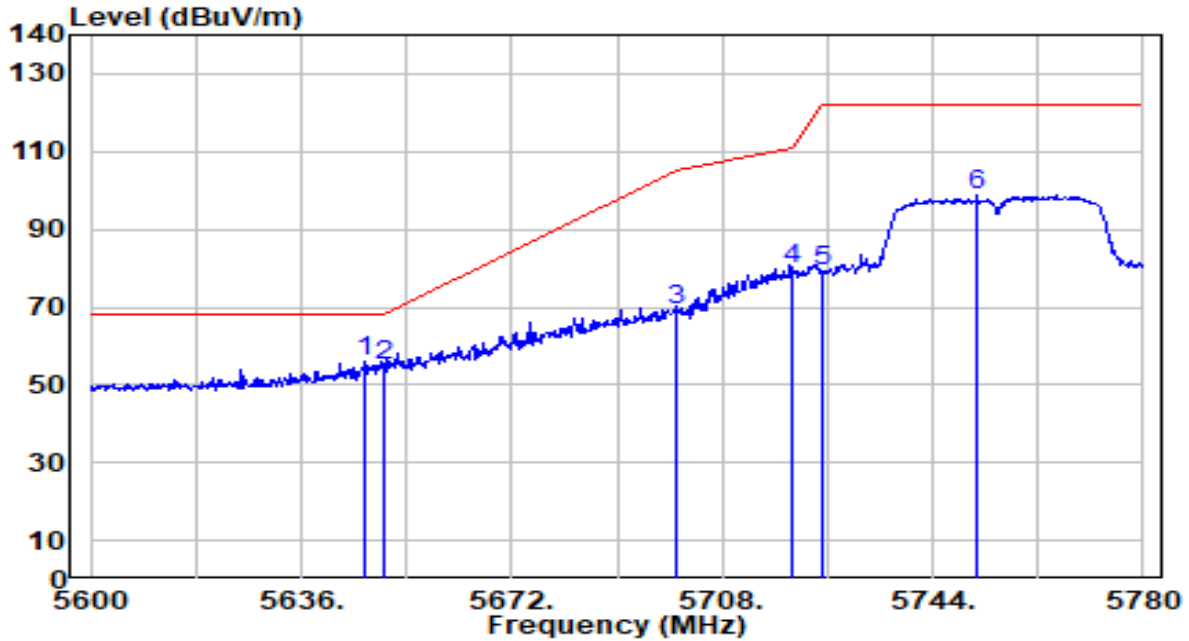

| No | Frequency (MHz) | Reading (dBUV) | C.F (dB/m) | Measurement (dBUV/m) | Margin (dB) | Limit (dBUV/m) | Height (cm) | Angle (deg) | Remark (QP/PK/AV) |
|----|-----------------|----------------|------------|----------------------|-------------|----------------|-------------|-------------|-------------------|
| 1 | * 5646.800 | 56.07 | -0.18 | 55.89 | -12.31 | 68.20 | 100 | 308 | Peak |
| 2 | 5650.000 | 54.98 | -0.16 | 54.81 | -13.39 | 68.20 | 100 | 308 | Peak |
| 3 | 5700.000 | 69.27 | 0.10 | 69.37 | -35.83 | 105.20 | 100 | 308 | Peak |
| 4 | 5720.000 | 79.43 | 0.20 | 79.63 | -31.17 | 110.80 | 100 | 308 | Peak |
| 5 | 5725.000 | 78.99 | 0.23 | 79.22 | -42.98 | 122.20 | 100 | 308 | Peak |
| 6 | 5751.560 | 98.18 | 0.37 | 98.55 | N/A | N/A | 100 | 308 | Peak |

Note:

1. " *", means this data is the worst emission level.
2. C.F (Correction Factor) = Antenna Factor (dB/m)+ Cable Loss (dB) – Pre-amplifier(dB) + 10dB Attenuation.
3. Measurement (dBUV/m) = Reading(dBUV) + C.F (Correction Factor).
4. The emission levels of other frequencies are very lower than the limit and not show in test report.

| | | | |
|-----------|-------------------------------------|----------------------|--------------|
| EUT | POS Terminal | Date of Test | 2023-10-28 |
| Factor | DRH18-E | Temp. / Humidity | 23°C /61% |
| Polarity | Horizontal | Site / Test Engineer | AC2 / Marvin |
| Test Mode | 802.11n-40MHz_TX_Band4_CH 159_ANT 0 | Test Voltage | AC 120V/60Hz |

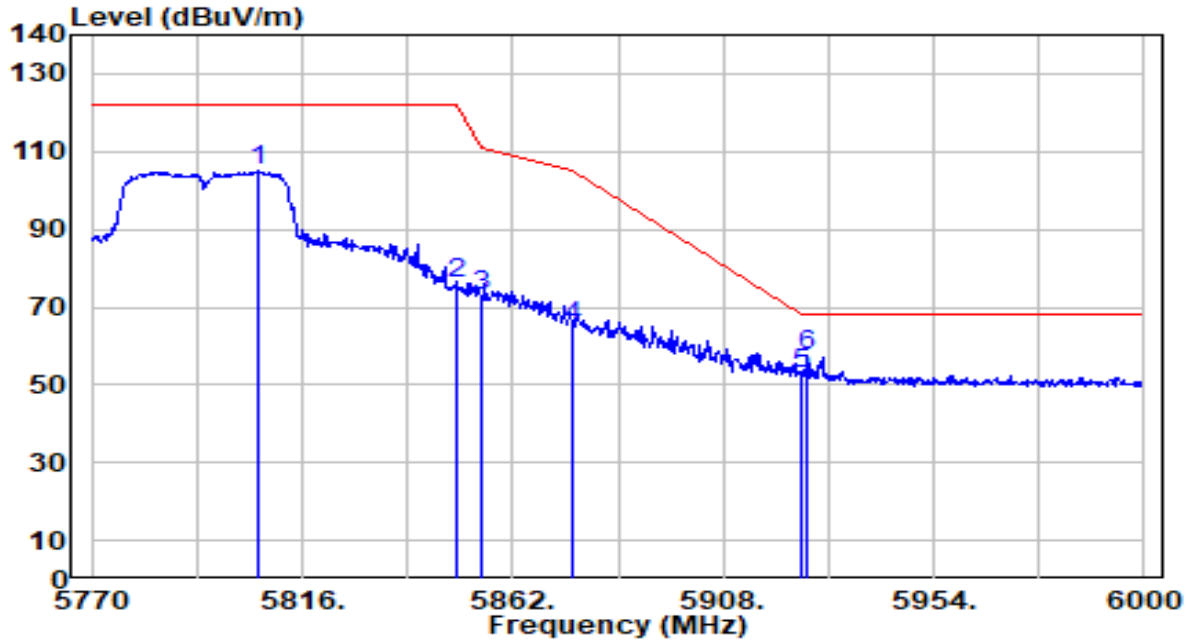

| No | Frequency (MHz) | Reading (dBuV) | C.F (dB/m) | Measurement (dBuV/m) | Margin (dB) | Limit (dBuV/m) | Height (cm) | Angle (deg) | Remark (QP/PK/AV) |
|----|-----------------|----------------|------------|----------------------|-------------|----------------|-------------|-------------|-------------------|
| 1 | 5806.340 | 104.30 | 0.62 | 104.91 | N/A | N/A | 125 | 240 | Peak |
| 2 | 5850.000 | 75.68 | 0.58 | 76.26 | -45.94 | 122.20 | 125 | 240 | Peak |
| 3 | 5855.000 | 72.07 | 0.58 | 72.65 | -38.15 | 110.80 | 125 | 240 | Peak |
| 4 | 5875.000 | 64.66 | 0.57 | 65.23 | -39.97 | 105.20 | 125 | 240 | Peak |
| 5 | 5925.000 | 52.27 | 0.53 | 52.80 | -15.40 | 68.20 | 125 | 240 | Peak |
| 6 | * 5926.400 | 57.10 | 0.53 | 57.63 | -10.57 | 68.20 | 125 | 240 | Peak |

Note:

1. " *", means this data is the worst emission level.
2. C.F (Correction Factor) = Antenna Factor (dB/m)+ Cable Loss (dB) – Pre-amplifier(dB) + 10dB Attenuation.
3. Measurement (dBuV/m) = Reading(dBuV) + C.F (Correction Factor).
4. The emission levels of other frequencies are very lower than the limit and not show in test report.

| | | | |
|-----------|-------------------------------------|----------------------|--------------|
| EUT | POS Terminal | Date of Test | 2023-10-28 |
| Factor | DRH18-E | Temp. / Humidity | 23°C /61% |
| Polarity | Vertical | Site / Test Engineer | AC2 / Marvin |
| Test Mode | 802.11n-40MHz_TX_Band4_CH 159_ANT 0 | Test Voltage | AC 120V/60Hz |

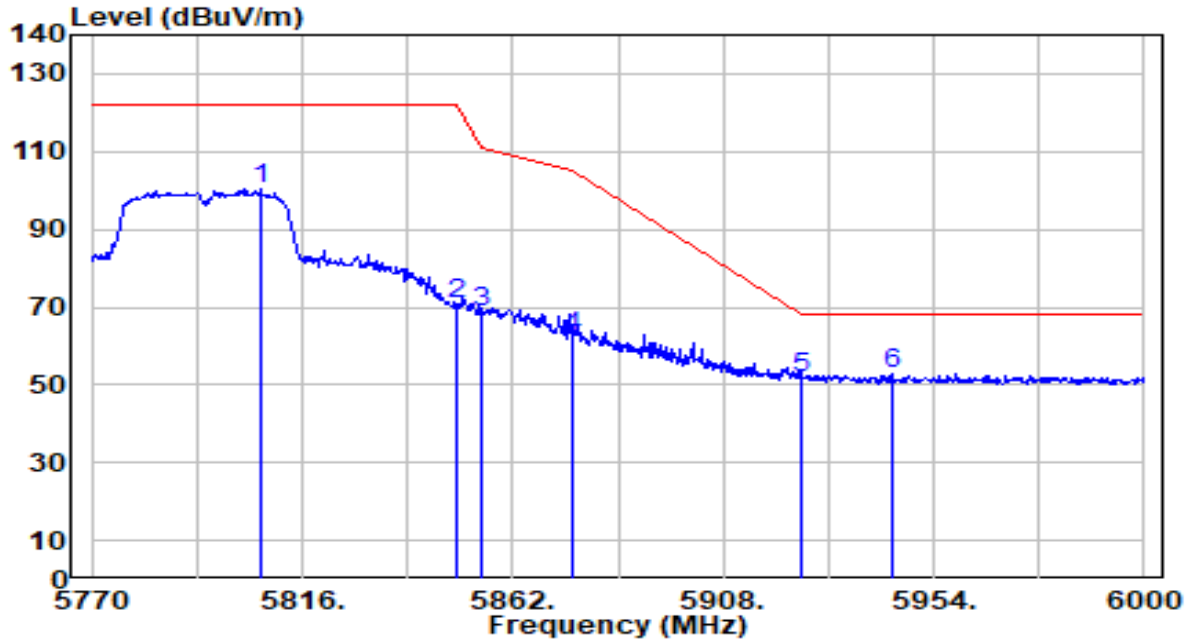

| No | Frequency (MHz) | Reading (dBuV) | C.F (dB/m) | Measurement (dBuV/m) | Margin (dB) | Limit (dBuV/m) | Height (cm) | Angle (deg) | Remark (QP/PK/AV) |
|----|-----------------|----------------|------------|----------------------|-------------|----------------|-------------|-------------|-------------------|
| 1 | 5807.030 | 99.88 | 0.62 | 100.50 | N/A | N/A | 100 | 308 | Peak |
| 2 | 5850.000 | 70.39 | 0.58 | 70.98 | -51.22 | 122.20 | 100 | 308 | Peak |
| 3 | 5855.000 | 68.00 | 0.58 | 68.58 | -42.22 | 110.80 | 100 | 308 | Peak |
| 4 | 5875.000 | 61.88 | 0.57 | 62.44 | -42.76 | 105.20 | 100 | 308 | Peak |
| 5 | 5925.000 | 51.50 | 0.53 | 52.02 | -16.18 | 68.20 | 100 | 308 | Peak |
| 6 | * 5944.800 | 52.22 | 0.51 | 52.74 | -15.46 | 68.20 | 100 | 308 | Peak |

Note:

1. " *", means this data is the worst emission level.
2. C.F (Correction Factor) = Antenna Factor (dB/m)+ Cable Loss (dB) – Pre-amplifier(dB) + 10dB Attenuation.
3. Measurement (dBuV/m) = Reading(dBuV) + C.F (Correction Factor).
4. The emission levels of other frequencies are very lower than the limit and not show in test report.

7.9. AC Conducted Emissions Measurement

7.9.1. Test Limit

| FCC Part 15.207 Limits | | |
|------------------------|-----------------|-----------------|
| Frequency (MHz) | QP (dB μ V) | AV (dB μ V) |
| 0.15 ~ 0.50 | 66 ~ 56 | 56 ~ 46 |
| 0.50 ~ 5.0 | 56 | 46 |
| 5.0 ~ 30 | 60 | 50 |

Note 1: The lower limit shall apply at the transition frequencies.

Note 2: The limit decreases linearly with the logarithm of the frequency in the range 0.15MHz to 0.5MHz.

7.9.2. Test Procedure

The EUT was setup according to ANSI C63.4, 2009 and tested according to KDB 789033 for compliance to FCC 47CFR 15.247 requirements. The EUT was placed on a platform of nominal size, 1 m by 1.5 m, raised 80 cm above the conducting ground plane. The vertical conducting plane was located 40 cm to the rear of the EUT. All other surfaces of EUT were at least 80 cm from any other grounded conducting surface. The EUT and simulators are connected to the main power through a line impedance stabilization network (LISN). The LISN provides a 50 ohm /50uH coupling impedance for the measuring equipment. The peripheral devices are also connected to the main power through a LISN. (Please refer to the block diagram of the test setup and photographs) Each current-carrying conductor of the EUT power cord, except the ground (safety) conductor, was individually connected through a LISN to the input power source.

The excess length of the power cord between the EUT and the LISN receptacle were folded back and forth at the center of the lead to form a bundle not exceeding 40 cm in length.

Conducted emissions were investigated over the frequency range from 0.15MHz to 30MHz using a receiver bandwidth of 9 kHz.

7.9.3. Test Setup

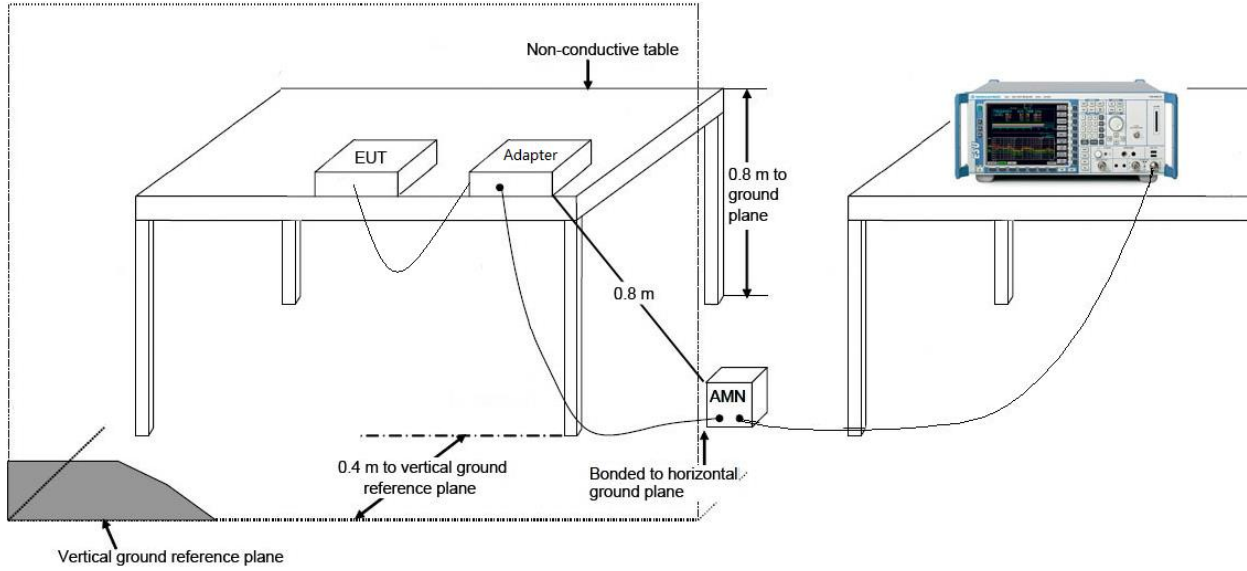

7.9.4. Test Result

| | | | |
|-----------|------------------------------------|----------------------|--------------|
| EUT | POS Terminal | Date of Test | 2023-11-30 |
| Factor | CE_ENV216-L1 (Filter ON) | Temp. / Humidity | 25.2°C /53% |
| Polarity | Line1 | Site / Test Engineer | SR2 / Bob |
| Test Mode | 802.11n-20MHz_TX_Band1_CH 40_ANT 0 | Test Voltage | AC 120V/60Hz |

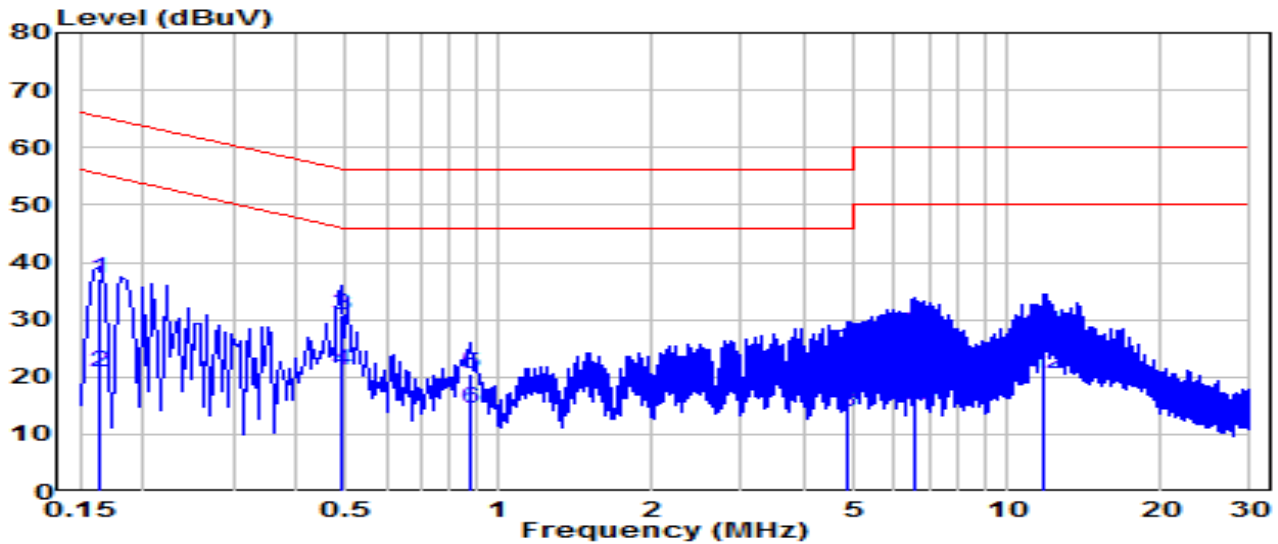

| No | Frequency (MHz) | Reading (dBuV) | C.F (dB) | Measurement (dBuV) | Margin (dB) | Limit (dBuV) | Remark (QP/PK/AV) |
|----|-----------------|----------------|----------|--------------------|-------------|--------------|-------------------|
| 1 | 0.163 | 27.58 | 9.62 | 37.20 | -28.08 | 65.28 | QP |
| 2 | 0.163 | 11.27 | 9.62 | 20.89 | -34.39 | 55.28 | Average |
| 3 | * 0.487 | 21.14 | 9.64 | 30.78 | -25.43 | 56.21 | QP |
| 4 | * 0.487 | 11.56 | 9.64 | 21.20 | -25.01 | 46.21 | Average |
| 5 | 0.874 | 10.81 | 9.66 | 20.48 | -35.52 | 56.00 | QP |
| 6 | 0.874 | 4.86 | 9.66 | 14.52 | -31.48 | 46.00 | Average |
| 7 | 4.866 | 14.60 | 9.74 | 24.35 | -31.65 | 56.00 | QP |
| 8 | 4.866 | 4.18 | 9.74 | 13.92 | -32.08 | 46.00 | Average |
| 9 | 6.544 | 18.09 | 9.78 | 27.87 | -32.13 | 60.00 | QP |
| 10 | 6.544 | 5.27 | 9.78 | 15.05 | -34.95 | 50.00 | Average |
| 11 | 11.799 | 18.00 | 9.87 | 27.87 | -32.13 | 60.00 | QP |
| 12 | 11.799 | 10.75 | 9.87 | 20.62 | -29.38 | 50.00 | Average |

Note:

1. " *", means this data is the worst emission level.
2. C.F (Correction Factor) = LISN Factor (dB)+ Cable Loss (dB).
3. Measurement (dBuV) = Reading(dBuV) + C.F (Correction Factor).

| | | | |
|-----------|------------------------------------|----------------------|--------------|
| EUT | POS Terminal | Date of Test | 2023-11-30 |
| Factor | CE_ENV216-N (Filter ON) | Temp. / Humidity | 25.2°C /53% |
| Polarity | Neutral | Site / Test Engineer | SR2 / Bob |
| Test Mode | 802.11n-20MHz_TX_Band1_CH 40_ANT 0 | Test Voltage | AC 120V/60Hz |

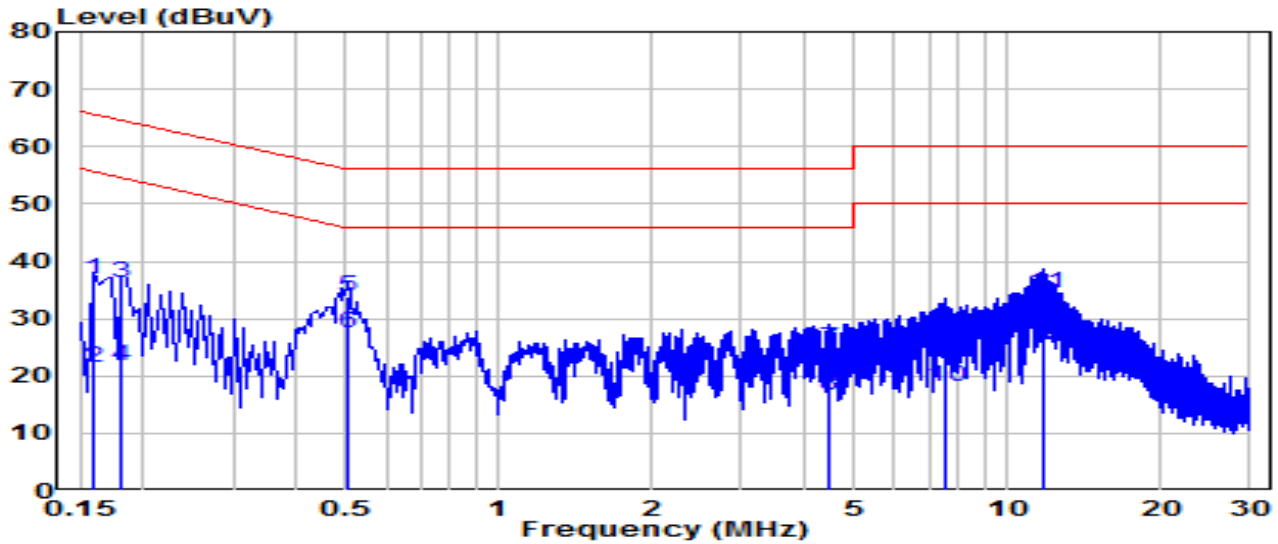

| No | Frequency (MHz) | Reading (dBuV) | C.F (dB) | Measurement (dBuV) | Margin (dB) | Limit (dBuV) | Remark (QP/PK/AV) |
|----|-----------------|----------------|----------|--------------------|-------------|--------------|-------------------|
| 1 | 0.159 | 27.17 | 9.62 | 36.79 | -28.73 | 65.52 | QP |
| 2 | 0.159 | 11.95 | 9.62 | 21.57 | -33.95 | 55.52 | Average |
| 3 | 0.181 | 26.47 | 9.62 | 36.09 | -28.33 | 64.42 | QP |
| 4 | 0.181 | 12.21 | 9.62 | 21.83 | -32.58 | 54.42 | Average |
| 5 | * 0.505 | 24.04 | 9.64 | 33.68 | -22.32 | 56.00 | QP |
| 6 | * 0.505 | 17.93 | 9.64 | 27.57 | -18.43 | 46.00 | Average |
| 7 | 4.479 | 15.02 | 9.74 | 24.75 | -31.25 | 56.00 | QP |
| 8 | 4.479 | 6.94 | 9.74 | 16.68 | -29.32 | 46.00 | Average |
| 9 | 7.525 | 18.03 | 9.81 | 27.84 | -32.16 | 60.00 | QP |
| 10 | 7.525 | 8.21 | 9.81 | 18.02 | -31.98 | 50.00 | Average |
| 11 | 11.813 | 24.64 | 9.89 | 34.53 | -25.47 | 60.00 | QP |
| 12 | 11.813 | 15.54 | 9.89 | 25.43 | -24.57 | 50.00 | Average |

Note:

1. " *", means this data is the worst emission level.
2. C.F (Correction Factor) = LISN Factor (dB)+ Cable Loss (dB).
3. Measurement (dBuV) = Reading(dBuV) + C.F (Correction Factor).

| | | | |
|-----------|------------------------------------|----------------------|--------------|
| EUT | POS Terminal | Date of Test | 2023-11-30 |
| Factor | CE_ENV216-L1 (Filter ON) | Temp. / Humidity | 25.2°C /53% |
| Polarity | Line1 | Site / Test Engineer | SR2 / Bob |
| Test Mode | 802.11n-20MHz_TX_Band1_CH 40_ANT 0 | Test Voltage | AC 240V/60Hz |

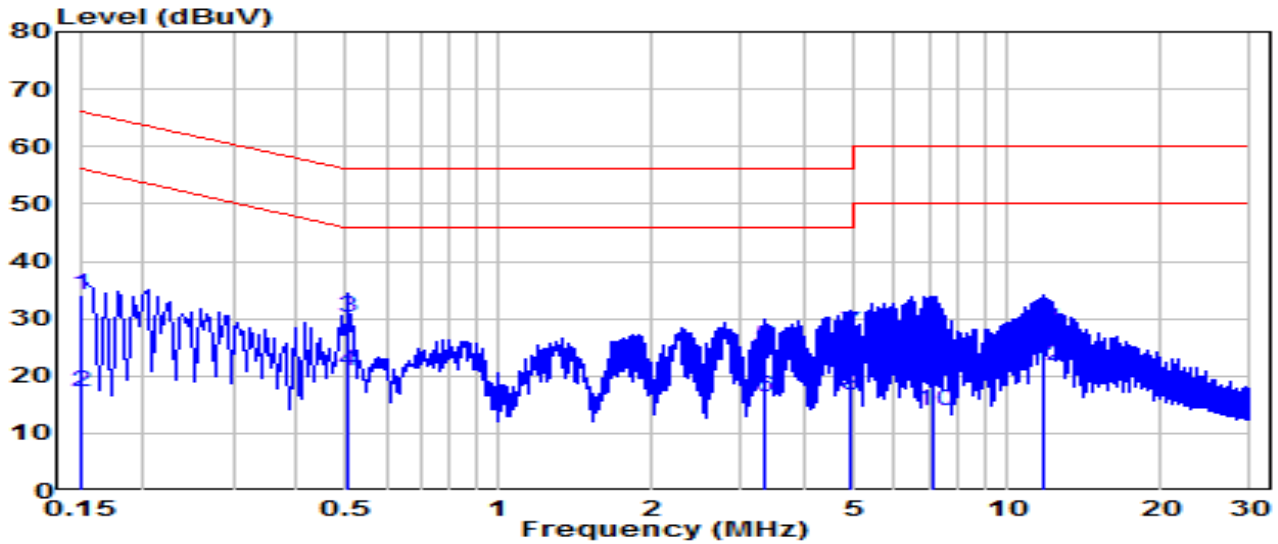

| No | Frequency (MHz) | Reading (dBuV) | C.F (dB) | Measurement (dBuV) | Margin (dB) | Limit (dBuV) | Remark (QP/PK/AV) |
|----|-----------------|----------------|----------|--------------------|-------------|--------------|-------------------|
| 1 | 0.150 | 24.59 | 9.62 | 34.21 | -31.79 | 66.00 | QP |
| 2 | 0.150 | 7.49 | 9.62 | 17.11 | -38.89 | 56.00 | Average |
| 3 | * 0.505 | 20.58 | 9.64 | 30.23 | -25.77 | 56.00 | QP |
| 4 | * 0.505 | 11.16 | 9.64 | 20.81 | -25.19 | 46.00 | Average |
| 5 | 3.327 | 15.30 | 9.72 | 25.01 | -30.99 | 56.00 | QP |
| 6 | 3.327 | 6.69 | 9.72 | 16.41 | -29.59 | 46.00 | Average |
| 7 | 4.924 | 17.60 | 9.74 | 27.34 | -28.66 | 56.00 | QP |
| 8 | 4.924 | 6.76 | 9.74 | 16.51 | -29.49 | 46.00 | Average |
| 9 | 7.120 | 17.49 | 9.79 | 27.29 | -32.71 | 60.00 | QP |
| 10 | 7.120 | 4.10 | 9.79 | 13.89 | -36.11 | 50.00 | Average |
| 11 | 11.786 | 18.26 | 9.87 | 28.13 | -31.87 | 60.00 | QP |
| 12 | 11.786 | 11.95 | 9.87 | 21.82 | -28.18 | 50.00 | Average |

Note:

1. " *", means this data is the worst emission level.
2. C.F (Correction Factor) = LISN Factor (dB)+ Cable Loss (dB).
3. Measurement (dBuV) = Reading(dBuV) + C.F (Correction Factor).

| | | | |
|-----------|------------------------------------|----------------------|--------------|
| EUT | POS Terminal | Date of Test | 2023-11-30 |
| Factor | CE_ENV216-N (Filter ON) | Temp. / Humidity | 25.2°C /53% |
| Polarity | Neutral | Site / Test Engineer | SR2 / Bob |
| Test Mode | 802.11n-20MHz_TX_Band1_CH 40_ANT 0 | Test Voltage | AC 240V/60Hz |

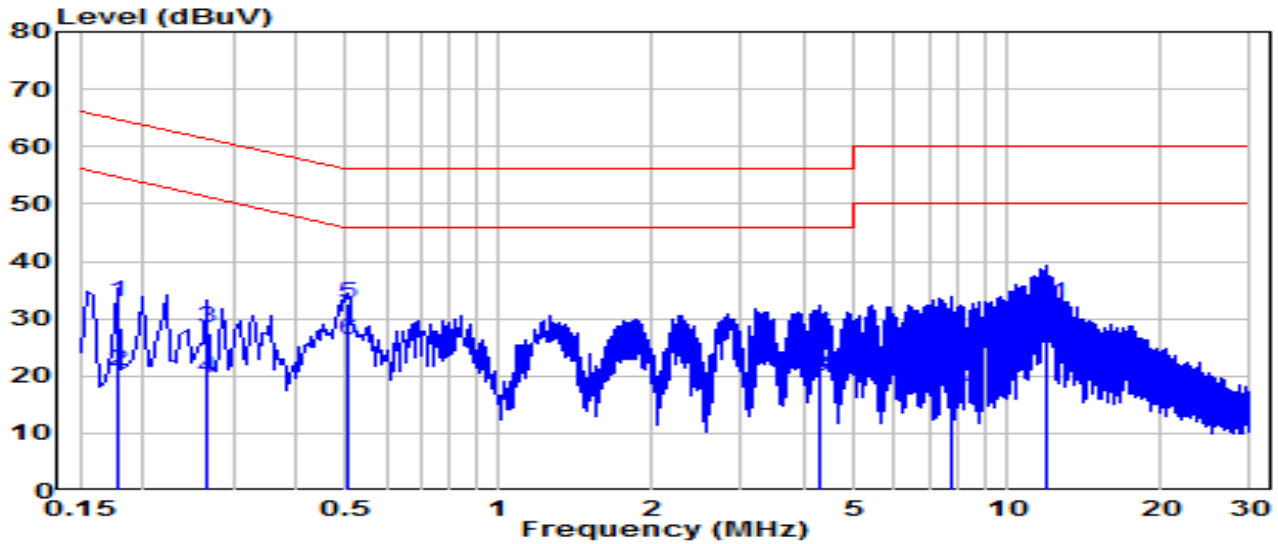

| No | Frequency (MHz) | Reading (dBuV) | C.F (dB) | Measurement (dBuV) | Margin (dB) | Limit (dBuV) | Remark (QP/PK/AV) |
|----|-----------------|----------------|----------|--------------------|-------------|--------------|-------------------|
| 1 | 0.177 | 23.20 | 9.62 | 32.82 | -31.80 | 64.63 | QP |
| 2 | 0.177 | 11.15 | 9.62 | 20.78 | -33.85 | 54.63 | Average |
| 3 | 0.267 | 18.75 | 9.63 | 28.38 | -32.84 | 61.21 | QP |
| 4 | 0.267 | 9.94 | 9.63 | 19.57 | -31.64 | 51.21 | Average |
| 5 | * 0.505 | 22.96 | 9.64 | 32.60 | -23.40 | 56.00 | QP |
| 6 | * 0.505 | 16.77 | 9.64 | 26.41 | -19.59 | 46.00 | Average |
| 7 | 4.249 | 17.34 | 9.73 | 27.07 | -28.93 | 56.00 | QP |
| 8 | 4.249 | 10.24 | 9.73 | 19.97 | -26.03 | 46.00 | Average |
| 9 | 7.786 | 16.52 | 9.82 | 26.34 | -33.66 | 60.00 | QP |
| 10 | 7.786 | 8.38 | 9.82 | 18.20 | -31.80 | 50.00 | Average |
| 11 | 11.970 | 22.82 | 9.89 | 32.71 | -27.29 | 60.00 | QP |
| 12 | 11.970 | 15.22 | 9.89 | 25.11 | -24.89 | 50.00 | Average |

Note:

1. " *", means this data is the worst emission level.
2. C.F (Correction Factor) = LISN Factor (dB)+ Cable Loss (dB).
3. Measurement (dBuV) = Reading(dBuV) + C.F (Correction Factor).

8. CONCLUSION

The data collected relate only the item(s) tested and show that the **POS Terminal** is in compliance with Part 15E & RSS-247 of the FCC & IC Rules.

Appendix A : Test Photograph

Refer to “2310TW8705-UT” file.

Appendix B : External Photograph

Refer to “2310TW8705-UE” file.

Appendix C : Internal Photograph

Refer to “2310TW8705-UI” file.

————— The End —————