







## MEASUREMENT REPORT (C2PC for FCC)

---

**FCC ID** : WIYSLM500QA  
**Applicant** : CASTLES TECHNOLOGY CO., LTD.  
**Application Type** : Certification  
**Product** : Smart module  
**Model No.** : SLM500  
**Brand Name** :   
**FCC Classification** : (DSS) FCC Part 15 Spread Spectrum Transmitter  
**FCC Rule Part(s)** : Part 15.247  
**Test Procedure(s)** : ANSI C63.10-2013  
**Received Date** : October 24, 2023  
**Test Date** : October 27~November 30, 2023

**Tested By** :   
( Owen Tsai )  
**Reviewed By** :   
( Paddy Chen )  
**Approved By** :   
( Chenz Ker )



The test results only relate to the tested sample.

This equipment has been shown to be capable of compliance with the applicable technical standards as indicated in the measurement report and was tested in accordance with the measurement procedures specified in ANSI C63.10. Test results reported herein relate only to the item(s) tested.

The test report shall not be reproduced except in full without the written approval of MRT Technology (Taiwan) Co., Ltd.

## Revision History

Report No.	Version	Description	Issue Date	Note
2310TW8705-U3	1.0	Original Report	2024-01-15	

Note:

1. This time, add Host ((Product Name: POS Terminal, Model No.: S1L2) and new antennas have been added, which have a higher gain compared to the original antennas., so the FCC C2PC (Conducted Output Power, Spurious Emission & Band Edge, Conduction) is executed.
2. FCC Original Report Grant Date: 02/15/2022, FCC ID: WIYSLM500QA.

---

## CONTENTS

Description	Page
<b>1. INTRODUCTION.....</b>	<b>7</b>
1.1. Scope.....	7
1.2. MRT Test Location.....	7
<b>2. PRODUCT INFORMATION .....</b>	<b>8</b>
2.1. Equipment Description .....	8
2.2. Product Specification Subjective to this Standard.....	9
2.3. Test Mode .....	9
2.4. Operation Frequency / Channel List .....	10
2.5. Test Configuration .....	11
2.6. Test System Details.....	11
2.7. Test Software .....	11
2.8. EMI Suppression Device(s)/Modifications.....	12
2.9. Labeling Requirements.....	12
2.10. Pseudorandom Frequency Hopping Sequence .....	13
<b>3. DESCRIPTION of TEST .....</b>	<b>14</b>
3.1. Evaluation Procedure .....	14
3.2. AC Line Conducted Emissions .....	14
3.3. Radiated Emissions.....	15
<b>4. ANTENNA REQUIREMENTS.....</b>	<b>16</b>
<b>5. TEST EQUIPMENT CALIBRATION DATE.....</b>	<b>17</b>
<b>6. MEASUREMENT UNCERTAINTY.....</b>	<b>18</b>
<b>7. TEST RESULT.....</b>	<b>19</b>
7.1. Summary.....	19
7.2. 20dB Bandwidth Measurement.....	21
7.2.1. Test Limit .....	21
7.2.2. Test Procedure used.....	21
7.2.3. Test Setting.....	21
7.2.4. Test Setup .....	21
7.2.5. Test Result.....	22
7.3. Output Power Measurement.....	23
7.3.1. Test Limit .....	23
7.3.2. Test Procedure Used .....	23

---

7.3.3.	Test Setting.....	24
7.3.4.	Test Setup .....	24
7.3.5.	Test Result.....	25
7.4.	Carrier Frequency Separation Measurement.....	26
7.4.1.	Test Limit .....	26
7.4.2.	Test Procedure Used .....	26
7.4.3.	Test Setting.....	26
7.4.4.	Test Setup .....	26
7.4.5.	Test Result.....	27
7.5.	Number of Hopping Channels Measurement.....	28
7.5.1.	Test Limit .....	28
7.5.2.	Test Procedure Used .....	28
7.5.3.	Test Settintg.....	28
7.5.4.	Test Setup .....	28
7.5.5.	Test Result.....	29
7.6.	Time of Occupancy Measurement.....	30
7.6.1.	Test Limit .....	30
7.6.2.	Test Procedure Used .....	30
7.6.3.	Test Settintg.....	30
7.6.4.	Test Setup .....	30
7.6.5.	Test Result.....	31
7.7.	Out-of-Band Spurious Emissions Emissions Measurement.....	32
7.7.1.	Test Limit .....	32
7.7.2.	Test Procedure Used .....	32
7.7.3.	Test Setting.....	33
7.7.4.	Test Setup .....	33
7.7.5.	Test Result.....	34
7.8.	Radiated Spurious Emission Measurement.....	35
7.8.1.	Test Limit .....	35
7.8.2.	Test Procedure Used .....	35
7.8.3.	Test Setting.....	35
7.8.4.	Test Setup .....	37
7.8.5.	Test Result.....	39
7.9.	Radiated Restricted Band Edge Measurement.....	53
7.9.1.	Test Limit .....	53
7.9.2.	Test Procedure Used .....	53
7.9.3.	Test Setting.....	53
7.9.4.	Test Setup .....	55

7.9.5. Test Result.....	56
7.10. AC Conducted Emissions Measurement .....	64
7.10.1. Test Limit .....	64
7.10.2. Test Setup .....	64
7.10.3. Test Result.....	65
<b>8. CONCLUSION.....</b>	<b>69</b>
<b>Appendix A : Test Photograph.....</b>	<b>70</b>
<b>Appendix B : External Photograph .....</b>	<b>70</b>
<b>Appendix C : Internal Photograph .....</b>	<b>70</b>

## §2.1033 General Information

<b>Applicant</b>	CASTLES TECHNOLOGY CO., LTD.
<b>Applicant Address</b>	6F, NO. 207-5, SEC. 3, BEIXIN RD., XINDIAN DISTRICT, NEW TAIPEI CITY 231632, TAIWAN (R. O. C.)
<b>Manufacturer</b>	CASTLES TECHNOLOGY CO., LTD.
<b>Manufacturer Address</b>	6F, NO. 207-5, SEC. 3, BEIXIN RD., XINDIAN DISTRICT, NEW TAIPEI CITY 231632, TAIWAN (R. O. C.)
<b>Test Site</b>	MRT Technology (Taiwan) Co., Ltd
<b>Test Site Address</b>	No. 38, Fuxing Second Rd., Guishan Dist., Taoyuan City 333, Taiwan (R.O.C)
<b>MRT FCC Registration No.</b>	291082
<b>FCC Rule Part(s)</b>	Part 15.247
<b>Test Device Serial No.</b>	#1-1 <input type="checkbox"/> Production <input checked="" type="checkbox"/> Pre-Production <input type="checkbox"/> Engineering

### Test Facility / Accreditations

1. MRT facility is a FCC registered (Reg. No. 291082) test facility with the site description report on file and is designated by the FCC as an Accredited Test Firm.
2. MRT facility is an IC registered (MRT Reg. No. 21723) test laboratory with the site description on file at Industry Canada.
3. MRT Lab is accredited to ISO 17025 by the Taiwan Accreditation Foundation (TAF Cert. No. 3261) in EMC, Telecommunications and Radio testing for FCC (Designation Number: TW3261), Industry Canada, EU and TELEC Rules.

# 1. INTRODUCTION

## 1.1. Scope

Measurement and determination of electromagnetic emissions (EMC) of radio frequency devices including intentional and/or unintentional radiators for compliance with the technical rules and regulations of the Federal Communications Commission and the Industry Canada Certification and Engineering Bureau.

## 1.2. MRT Test Location

The map below shows the location of the MRT LABORATORY, its proximity to the Taoyuan City. These measurement tests were conducted at the MRT Technology (Taiwan) Co., Ltd. Facility located at No.38, Fuxing 2nd Rd., Guishan Dist., Taoyuan City 33377, Taiwan (R.O.C).

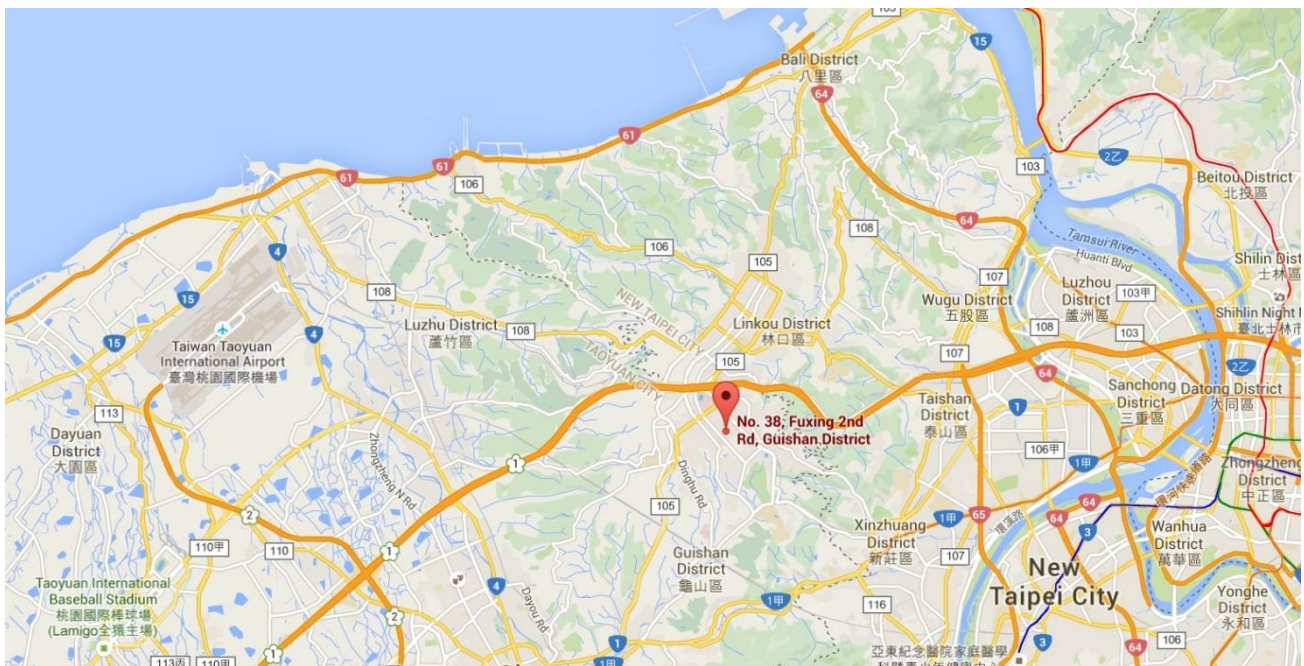

## 2. PRODUCT INFORMATION

### 2.1. Equipment Description

Product Name	Smart module
Model No.	SLM500
Brand Name	
Supports Radios Spec.	<p><b>WLAN:</b>            2.4G: 802.11b/g/n-20/n-40            5G: 802.11a/n-20/n-40, Band 1,2,3,4</p> <p><b>WPAN:</b>            Bluetooth Dual Mode: V4.2            NFC 13.56MHz</p> <p><b>WWAN:</b>            2G: GPRS 850 / EGPRS 850 / GPRS 1900 / EGPRS 1900            3G: Band 2, 4, 5            4G: Band 2, 4, 5, 7, 12, 13, 17, 25, 26, 66</p>
Bluetooth Specification	Bluetooth Dual Mode: V4.2
Accessory	
Power Adapter	MFR: Shenzhen ABP Technology Co.,Ltd. Model No: AD0181-1201000UC Input: AC 100-240V~50-60Hz,0.5A Max Output: DC 12.0V, 1.0A 12.0w Cable Out: Non-shielding, 1.5m



## 2.2. Product Specification Subjective to this Standard

Operating Frequency	2402~2480MHz
Type of modulation	FHSS (GFSK, $\pi/4$ DQPSK, 8DPSK)
Data Rate	1Mbps (GFSK), 2Mbps ( $\pi/4$ DQPSK), 3Mbps (8DPSK)

## 2.3. Test Mode

Test Mode	Mode 1: Transmit - 1Mbps (GFSK) Mode 2: Transmit - 3Mbps (8DPSK)
-----------	---

Note:

1. Regarding to the operation frequency, the lowest, middle and highest frequency are selected to perform the test.
2. Bluetooth operation was evaluated at both 1Mbps and 3Mbps data rates. Through pre-testing 2Mbps data rate was found, to produce emissions like those for 3Mbps.

## 2.4. Operation Frequency / Channel List

Channel	Frequency	Channel	Frequency	Channel	Frequency
00	2402 MHz	01	2403 MHz	02	2404 MHz
03	2405 MHz	04	2406 MHz	05	2407 MHz
06	2408 MHz	07	2409 MHz	08	2410 MHz
09	2411 MHz	10	2412 MHz	11	2413 MHz
12	2414 MHz	13	2415 MHz	14	2416 MHz
15	2417 MHz	16	2418 MHz	17	2419 MHz
18	2420 MHz	19	2421 MHz	20	2422 MHz
21	2423 MHz	22	2424 MHz	23	2425 MHz
24	2426 MHz	25	2427 MHz	26	2428 MHz
27	2429 MHz	28	2430 MHz	29	2431 MHz
30	2432 MHz	31	2433 MHz	32	2434 MHz
33	2435 MHz	34	2436 MHz	35	2437 MHz
36	2438 MHz	37	2439 MHz	38	2440 MHz
39	2441 MHz	40	2442 MHz	41	2443 MHz
42	2444 MHz	43	2445 MHz	44	2446 MHz
45	2447 MHz	46	2448 MHz	47	2449 MHz
48	2450 MHz	49	2451 MHz	50	2452 MHz
51	2453 MHz	52	2454 MHz	53	2455 MHz
54	2456 MHz	55	2457 MHz	56	2458 MHz
57	2459 MHz	58	2460 MHz	59	2461 MHz
60	2462 MHz	61	2463 MHz	62	2464 MHz
63	2465 MHz	64	2466 MHz	65	2467 MHz
66	2468 MHz	67	2469 MHz	68	2470 MHz
69	2471 MHz	70	2472 MHz	71	2473 MHz
72	2474 MHz	73	2475 MHz	74	2476 MHz
75	2477 MHz	76	2478 MHz	77	2479 MHz
78	2480 MHz	N/A	N/A	N/A	N/A

## 2.5. Test Configuration

This device was tested per the guidance of ANSI C63.10-2013. ANSI C63.10-2013 was used to reference the appropriate EUT setup for radiated spurious emissions testing and AC line conducted testing.

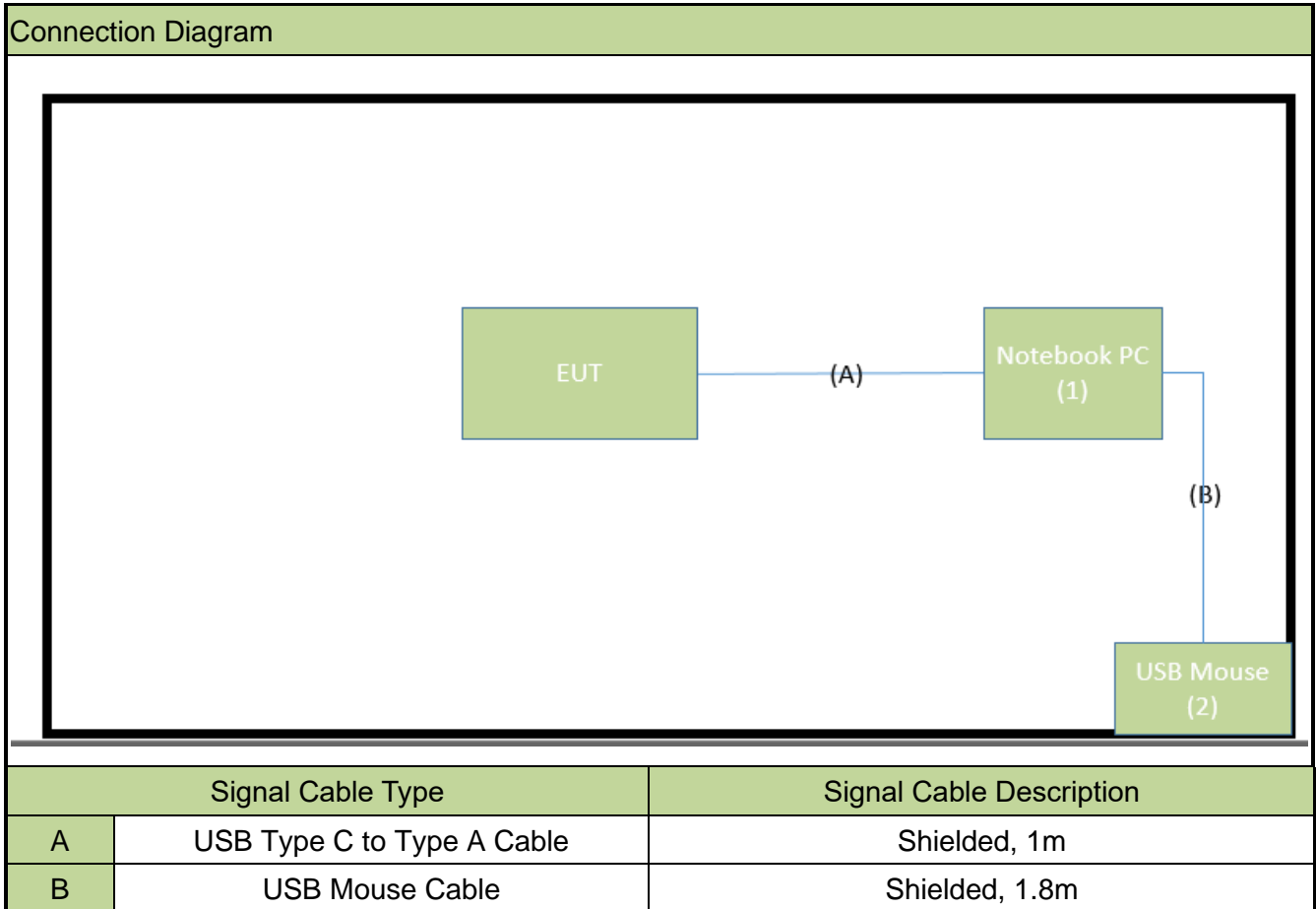

## 2.6. Test System Details

The types for all equipment, and descriptions of all cables used in the tested system (including inserted cards) are:

	Product	Manufacturer	Model No.	Serial No.	Power Cord
1	Notebook PC	Lenovo	21DH00A3TW	N/A	Non-shielded, 0.8m
2	USB Mouse	Logitech	M90	N/A	N/A

## 2.7. Test Software

The test utility software used during testing was "QRCT v3.0-00233".

## **2.8. EMI Suppression Device(s)/Modifications**

No EMI suppression device(s) were added and/or no modifications were made during testing.

## **2.9. Labeling Requirements**

Per 2.1074 & 15.19; Docket 95-19

The label shall be permanently affixed at a conspicuous location on the device; instruction manual or pamphlet supplied to the user and be readily visible to the purchaser at the time of purchase. However, when the device is so small wherein placement of the label with specified statement is not practical, only the FCC ID must be displayed on the device per Section 15.19(a)(5). Please see attachment for FCC ID label and label location.

## 2.10. Pseudorandom Frequency Hopping Sequence

The pseudorandom sequence may be generated in a nine-stage shift register whose 5<sup>th</sup> and 9<sup>th</sup> stage outputs are added in a modulo-two addition stage. And the result is fed back to the input of the first stage. The sequence begins with the first ONE of 9 consecutive ONES; i.e. the shift register is initialized with nine ones.

- Number of shift register stages: 9
- Length of pseudo-random sequence:  $2^9 - 1 = 511$  bits
- Longest sequence of zeros: 8 (non-inverted signal)

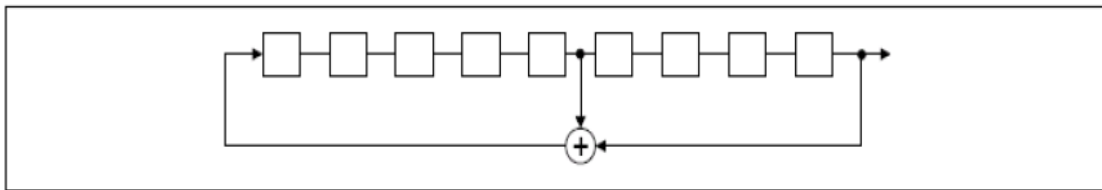

Linear Feedback Shift Register for Generation of the PRBS sequence

An example of Pseudorandom Frequency Hopping Sequence as follow:

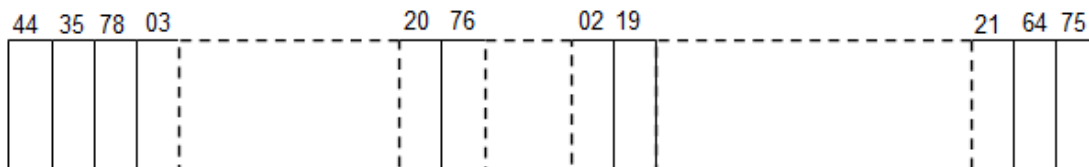

Each frequency used equally on the average by each transmitter.

The system receivers have input bandwidths that match the hopping channel bandwidths of their

Corresponding transmitters and shift frequencies in synchronization with the transmitted signals.

### 3. DESCRIPTION of TEST

#### 3.1. Evaluation Procedure

The measurement procedures described in the American National Standard for Testing Unlicensed Wireless Devices (ANSI C63.10-2013) were used in the measurement of the **Smart module**.

**Deviation from measurement procedure.....None**

#### 3.2. AC Line Conducted Emissions

The line-conducted facility is located inside an 9'x4'x3' shielded enclosure. A 1m x 2m wooden table 80cm high is placed 40cm away from the vertical wall and 80cm away from the sidewall of the shielded room. Two 10kHz-30MHz, 50Ω/50uH Line-Impedance Stabilization Networks (LISNs) are bonded to the shielded room floor. Power to the LISNs is filtered by external high-current high-insertion loss power line filters. These filters attenuate ambient signal noise from entering the measurement lines. These filters are also bonded to the shielded enclosure.

The EUT is powered from one LISN and the support equipment is powered from the second LISN. All interconnecting cables more than 1 meter were shortened to a 1 meter length by non-inductive bundling (serpentine fashion) and draped over the back edge of the test table. All cables were at least 40cm above the horizontal reference ground-plane. Power cables for support equipment were routed down to the second LISN while ensuring that that cables were not draped over the second LISN.

Sufficient time for the EUT, support equipment, and test equipment was allowed in order for them to warm up to their normal operating condition. The RF output of the LISN was connected to the receiver and exploratory measurements were made to determine the frequencies producing the maximum emission from the EUT. The receiver was scanned from 150kHz to 30MHz. The detector function was set to peak mode for exploratory measurements while the bandwidth of the analyzer was set to 9kHz. The EUT, support equipment, and interconnecting cables were arranged and manipulated to maximize each emission. Each emission was also maximized by varying: power lines, the mode of operation or data exchange speed, or support equipment whichever determined the worst-case emission. Once the worst case emissions have been identified, the one EUT cable configuration/arrangement and mode of operation that produced these emissions were used for final measurements on the same test site. The analyzer is set to CISPR quasi-peak and average detectors with a 9kHz resolution bandwidth for final measurements.

An extension cord was used to connect to a single LISN which powered by EUT. The extension cord was calibrated with LISN, the impedance and insertion loss are compliance with the requirements as stated in ANSI C63.10-2013.

Line conducted emissions test results are shown in Section 7.10.

### 3.3. Radiated Emissions

The radiated test facilities consisted of an indoor 3 meter semi-anechoic chamber used for final measurements and exploratory measurements, when necessary. The measurement area is contained within the semi-anechoic chamber which is shielded from any ambient interference. For measurements above 1GHz absorbers are arranged on the floor between the turn table and the antenna mast in such a way so as to maximize the reduction of reflections. For measurements below 1GHz, the absorbers are removed. An MF Model 210SS turntable is used for radiated measurement. It is a continuously rotatable, remote controlled, metallic turntable and 2 meters (6.56 ft.) in diameter. The turn table is flush with the raised floor of the chamber in order to maintain its function as a ground plane. An 80cm high PVC support structure is placed on top of the turntable. For all measurements, the spectrum was scanned through all EUT azimuths and from 1 to 4 meter receive antenna height using a broadband antenna from 30MHz up to the upper frequency shown in 15.33(b)(1) depending on the highest frequency generated or used in the device or on which the device operates or tunes. For frequencies above 1GHz, linearly polarized double ridge horn antennas were used. For frequencies below 30MHz, a calibrated loop antenna was used. When exploratory measurements were necessary, they were performed at 1 meter test distance inside the semi-anechoic chamber using broadband antennas, broadband amplifiers, and spectrum analyzers to determine the frequencies and modes producing the maximum emissions. Sufficient time for the EUT, support equipment, and test equipment was allowed in order for them to warm up to their normal operating condition. The test set-up for frequencies below 1GHz was placed on top of the 0.8 meter high, 1 x 1.5 meter table; and test set-up for frequencies 1-40GHz was placed on top of the 1.5 meter high, 1 x 1.5 meter table. The EUT, support equipment, and interconnecting cables were arranged and manipulated to maximize each emission. Appropriate precaution was taken to ensure that all emissions from the EUT were maximized and investigated. The system configuration, clock speed, mode of operation or video resolution, if applicable, turntable azimuth, and receive antenna height was noted for each frequency found.

Final measurements were made in the semi-anechoic chamber using calibrated, linearly polarized broadband and horn antennas. The test setup was configured to the setup that produced the worst case emissions. The spectrum analyzer was set to investigate all frequencies required for testing to compare the highest radiated disturbances with respect to the specified limits. The turntable containing the EUT was rotated through 360 degrees and the height of the receive antenna was varied 1 to 4 meters and stopped at the azimuth and height producing the maximum emission. Each emission was maximized by changing the orientation of the EUT through three orthogonal planes and changing the polarity of the receive antenna, whichever produced the worst-case emissions. According to 3dB Beamwidth of horn antenna, the horn antenna should be always directed to the EUT when rising height.

Radiated emissions test results are shown in Section 7.8 & 7.9

## 4. ANTENNA REQUIREMENTS

### Excerpt from §15.203 of the FCC Rules/Regulations:

“An intentional radiator antenna shall be designed to ensure that no antenna other than that furnished by the responsible party can be used with the device. The use of a permanently attached antenna or of an antenna that uses a unique coupling to the intentional radiator shall be considered sufficient to comply with the provisions of this section.”

- The antenna of the Smart module, is permanently attached.
- There are no provisions for connection to an external antenna.

### Conclusion:

The EUT unit complies with the requirement of §15.203. Antenna List

No.	Manufacturer	Part No.	Antenna Type	Antenna Gain (dBi)		
				BT/BLE	Wi-Fi 2.4G	Wi-Fi 5G
1	ARISTOTLE (This time new addition)	RFA-25-AP217-70W-130	Dipole	3.34	3.34	3.64



## 5. TEST EQUIPMENT CALIBRATION DATE

### Conducted Emissions – SR2

Instrument	Manufacturer	Type No.	Asset No.	Cali. Interval	Cali. Due Date
Two-Line V-Network	R&S	ENV216	MRTTWA00019	1 year	2024/3/7
Cable	Rosnol	N1C50-RG400- B1C50-500CM	MRTTWE00013	1 year	2024/6/15
EMI Test Receiver	R&S	ESR3	MRTTWA00009	1 year	2024/3/8

### Radiated Emissions – AC2

Instrument	Manufacturer	Type No.	Asset No.	Cali. Interval	Cali. Due Date
Active Loop Antenna	SCHWARZBECK	FMZB 1519B	MRTTWA00002	1 year	2024/5/22
Broadband TRILOG Antenna	SCHWARZBECK	VULB 9162	MRTTWA00001	1 year	2024/10/31
Broadband Hornantenna	RFSPIN	DRH18-E	MRTTWA00087	1 year	2024/5/17
Broadband Preamplifier	EMC Instruments corporation	EMC118A45SE	MRTTWA00088	1 year	2024/5/17
Breitband Hornantenna	SCHWARZBECK	BBHA 9170	MRTTWA00004	1 year	2024/3/20
Broadband Amplifier	SCHWARZBECK	BBV 9721	MRTTWA00006	1 year	2024/3/27
EMI Test Receiver	R&S	ESR3	MRTTWA00009	1 year	2024/3/8
Signal Analyzer	R&S	FSVA3044	MRTTWA00092	1 year	2024/6/29
Antenna Cable	HUBERSUHNER	SF106	MRTTWE00034	1 year	2024/6/26
Cable	HUBERSUHNER	EMC105-NM- NM-3000	MRTTWE00035	1 year	2024/6/26

### Conducted Test Equipment – SR6

Instrument	Manufacturer	Type No.	Asset No.	Cali. Interval	Cali. Due Date
EXA Signal Analyzer	KEYSIGHT	N9010A	MRTTWA00012	1 year	2024/10/17
EXA Signal Analyzer	KEYSIGHT	N9010B	MRTTWA00074	1 year	2024/7/19
USB Wideband Power Sensor	KEYSIGHT	U2021XA	MRTTWA00015	1 year	2024/3/16

### Test Software

Software	Version	Function
e3	9.160520a	EMI Test Software
EMI	V3	EMI Test Software

## 6. MEASUREMENT UNCERTAINTY

Where relevant, the following test uncertainty levels have been estimated for tests performed on the EUT as specified in CISPR 16-4-2. This uncertainty represents an expanded uncertainty expressed at approximately the 95% confidence level using a coverage factor of  $k = 2$ .

<b>Conducted Emission- Power Line</b>
Measuring Uncertainty for a Level of Confidence of 95% ( $U=2Uc(y)$ ): 0.15MHz~30MHz: $\pm 2.53\text{dB}$
<b>Conducted Power</b>
Measuring Uncertainty for a Level of Confidence of 95% ( $U=2Uc(y)$ ): $\pm 0.84\text{dB}$
<b>Radiated Spurious Emission</b>
Measuring Uncertainty for a Level of Confidence of 95% ( $U=2Uc(y)$ ): 9kHz~30MHz: $\pm 3.92\text{dB}$ 30MHz~1GHz: $\pm 4.25\text{dB}$ 1GHz~18GHz: $\pm 4.40\text{dB}$ 18GHz~40GHz: $\pm 4.45\text{dB}$

## 7. TEST RESULT

### 7.1. Summary

**Product Name:** POS Terminal

**FCC Classification:** (DSS) FCC Part 15 Spread Spectrum Transmitter

FCC Part Section(s)	Test Description	Test Limit	Test Condition	Test Result	Reference
15.247(a)(1)	20dB Bandwidth	N/A	Conducted	N/A	Section 7.2
15.247(b)(1)	Output Power	<1 Watt if > 75 non-overlapping channels used		PASS	Section 7.3
15.247(a)(1)	Carrier Frequency Separation	25KHz or 20 dB BW for systems with Output Power < 125mW		N/A	Section 7.4
15.247(a)(1)(iii)	Number of Hopping Channels	> 15 Channels		N/A	Section 7.5
15.247(a)(1)(iii)	Time of Occupancy	< 0.4 sec in 31.6 sec period		N/A	Section 7.6
15.247(d)	Out-of-Band Emissions	Conducted $\geq$ 20dBc		N/A	Section 7.7
15.205 15.209	Spurious Emission	< FCC 15.209 limits	Radiated	PASS	Section 7.8
15.205 15.209	Band Edge Measurement	$\leq$ 74dBuV/m(Peak) $\leq$ 54dBuV/m(Average)		PASS	Section 7.9
15.207	AC Conducted Emissions 150kHz - 30MHz	< FCC 15.207 limits	Line Conducted	PASS	Section 7.10

**Notes:**

- 1) Determining compliance is based on the test results met the regulation limits or requirements declared by clients, and the test results don't take into account the value of measurement uncertainty.
- 2) All modes of operation and data rates were investigated. For radiated emission test, every axis (X, Y, Z) was also verified when applicable. The test results shown in the following sections represent the worst case emissions.
- 3) The analyzer plots shown in this section were all taken with a correction table loaded into the analyzer. The correction table was used to account for the losses of the cables and attenuators used as part of the system to connect the EUT to the analyzer at all frequencies of interest.
- 4) All antenna port conducted emissions testing was performed on a test bench with the antenna port of the EUT connected to the spectrum analyzer through calibrated cables and attenuators.

## 7.2. 20dB Bandwidth Measurement

### 7.2.1. Test Limit

N/A

### 7.2.2. Test Procedure used

ANSI C63.10-2013 - Section 6.9.2

### 7.2.3. Test Setting

1. Set RBW  $\geq 1\%$  of the 20dB bandwidth
2. VBW  $\geq 3 \times$  RBW
3. Span = approximately 2 to 5 times the 20dB bandwidth, centered on a hopping channel
4. Detector = Peak
5. Trace mode = max hold
6. Sweep = auto couple
7. Allow the trace to stabilize
8. Measure the maximum width of the emission that is constrained by the frequencies associated with the two outermost amplitude points (upper and lower frequencies) that are attenuated by 20 dB relative to the maximum level measured in the fundamental emission.

### 7.2.4. Test Setup

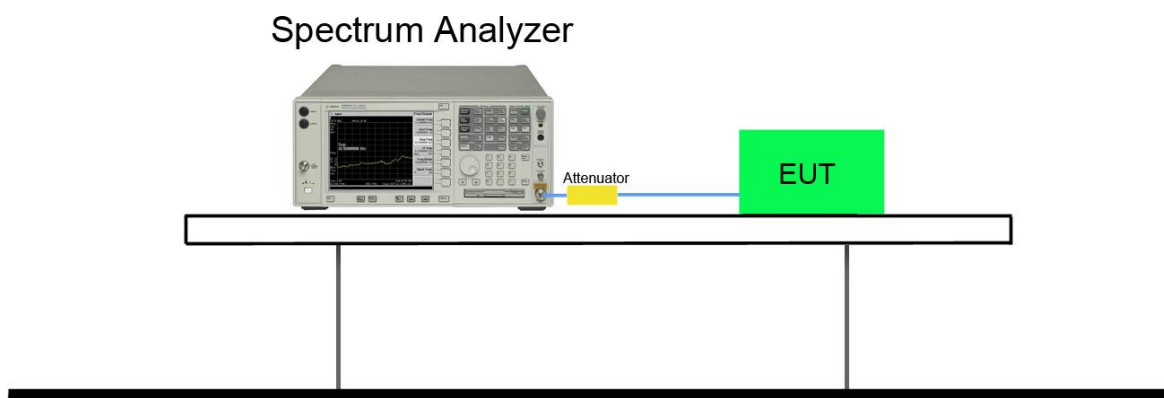

### **7.2.5. Test Result**

Note: Reference Original Report Grant Date: 02/15/2022, FCC ID: WIYSLM500QA.

## **7.3. Output Power Measurement**

### **7.3.1. Test Limit**

The maximum out power permissible output power is 1 Watt for all other frequency hopping systems operating in the 2400-2483.5 MHz band employing at least 75 non-overlapping hopping channels.

For FHSs operating in the band 2400-2483.5 MHz, the maximum peak conducted output power shall not exceed 1.0 W and the e.i.r.p. shall not exceed 4 W if the hopset uses 75 or more hopping channels.

### **7.3.2. Test Procedure Used**

ANSI C63.10-2013 - Section 7.8.5

### 7.3.3. Test Setting

1. Set RBW  $\geq$  the 20 dB bandwidth of the emission being measured.
2. VBW  $\geq 3 \times$  RBW
3. Span = approximately 2 to 3 times the 20dB bandwidth, centered on a hopping channel
4. Detector = Peak
5. Trace mode = max hold
6. Sweep = auto couple
7. Allow the trace to stabilize, Use the marker-to-peak function to set the marker to the peak of the emission. The indicated level is the peak output power (don't forget added the external attenuation and cable loss)
8. Note: A peak responding power meter may be used, where the power meter and sensor system video bandwidth is greater than the occupied bandwidth of the unlicensed wireless device, rather than a spectrum analyzer.

### 7.3.4. Test Setup

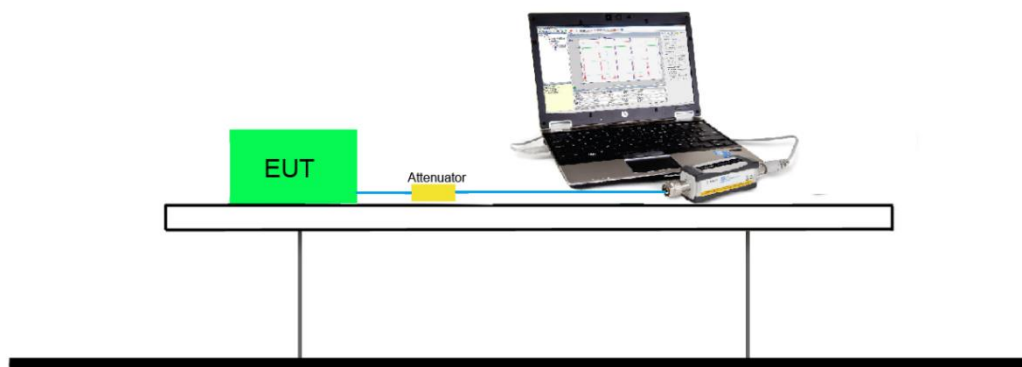



### 7.3.5. Test Result

Test Mode	Channel No.	Frequency (MHz)	Peak Power (dBm)	Peak Power Limit (dBm)
DH5	00	2402	12.45	< 21
DH5	39	2441	12.51	< 21
DH5	78	2480	11.83	< 21
2DH5	00	2402	12.33	< 21
2DH5	39	2441	12.78	< 21
2DH5	78	2480	11.95	< 21
3DH5	00	2402	10.29	< 21
3DH5	39	2441	12.55	< 21
3DH5	78	2480	11.68	< 21

Note:

1. The peak power of all test modes is less than 21dBm(125mW).
2. Peak Power (dBm)= Peak Power (dBm) + Cable Loss (dB).

## 7.4. Carrier Frequency Separation Measurement

### 7.4.1. Test Limit

The minimum permissible channel separation for this system is 2/3 the value of the 20dB BW.

### 7.4.2. Test Procedure Used

ANSI C63.10-2013 - Section 7.8.2

### 7.4.3. Test Setting

1. Span = wide enough to capture the peaks of two adjacent channels.
2. RBW  $\geq$  1 % of the span
3. VBW  $\geq$  RBW
4. Detector = peak
5. Sweep time = auto couple
6. Trace mode = max hold
7. Trace was allowed to stabilize

### 7.4.4. Test Setup

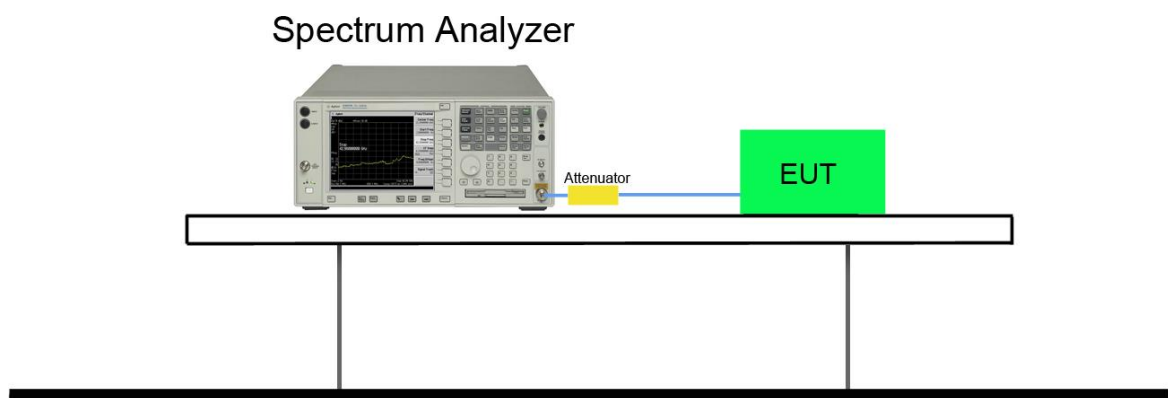

#### **7.4.5. Test Result**

Note: Reference Original Report Grant Date: 02/15/2022, FCC ID: WIYSLM500QA.

## 7.5. Number of Hopping Channels Measurement

### 7.5.1. Test Limit

This frequency hopping system must employ a minimum of 15 hopping channels.

### 7.5.2. Test Procedure Used

ANSI C63.10-2013 - Section 7.8.3

### 7.5.3. Test Setting

1. Span = the frequency band of operation.
2. RBW  $\geq$  1 % of the span
3. VBW  $\geq$  RBW
4. Detector = Peak
5. Trace mode = max hold
6. Sweep time = auto couple
7. The trace was allowed to stabilize

### 7.5.4. Test Setup

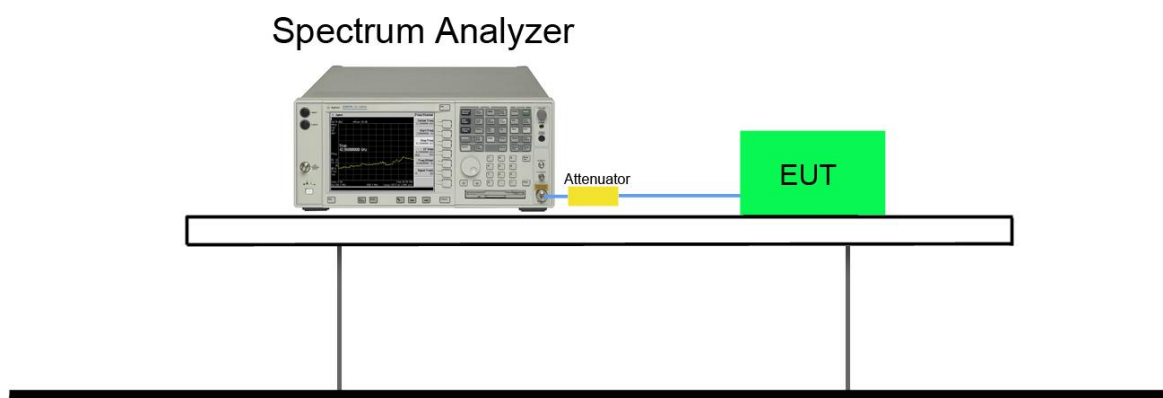

### **7.5.5. Test Result**

Note: Reference Original Report Grant Date: 02/15/2022, FCC ID: WIYSLM500QA.

## 7.6. Time of Occupancy Measurement

### 7.6.1. Test Limit

The maximum permissible time of occupancy is 400ms within a period of 400ms multiplied by the number of hopping channels employed.

### 7.6.2. Test Procedure Used

ANSI C63.10-2013 - Section 7.8.4

### 7.6.3. Test Setting

1. Span = zero span, centered on a hopping channel.
2. RBW = 1MHz
3. VBW  $\geq$  RBW
4. Sweep time = as necessary to capture the entire dwell time per hopping channel
5. Detector = Peak
6. Trace mode = max hold

If possible, use the marker-delta function to determine the dwell time. If this value varies with different modes of operation (data rate, modulation format, etc.), repeat this test for each variation. An oscilloscope may be used instead of a spectrum analyzer. The EUT shall show compliance with the appropriate regulatory limit for the number of hopping channels. A plot of the data shall be included in the test report.

### 7.6.4. Test Setup

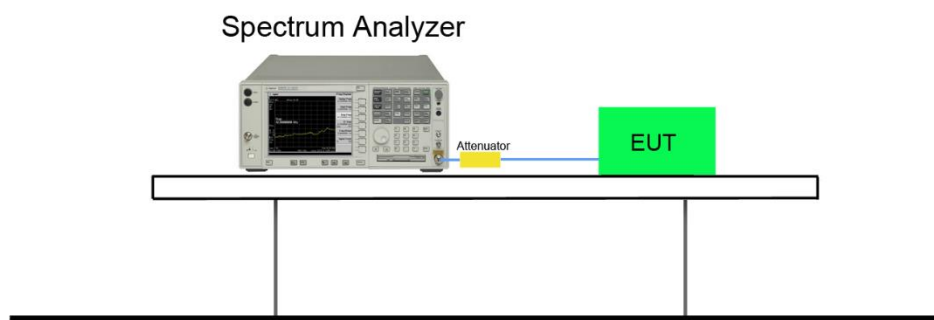

### **7.6.5. Test Result**

Note: Reference Original Report Grant Date: 02/15/2022, FCC ID: WIYSLM500QA.

## **7.7. Out-of-Band Spurious Emissions Emissions Measurement**

### **7.7.1. Test Limit**

In any 100 kHz bandwidth outside the frequency band in which the spread spectrum or digitally modulated intentional radiator is operating, the radio frequency power that is produced by the intentional radiator shall be at least 20 dB below that in the 100 kHz bandwidth within the band that contains the highest level of the desired power, based on either an RF conducted or a radiated measurement, provided the transmitter demonstrates compliance with the peak conducted or a radiated measurement, provided the transmitter demonstrates compliance with the peak conducted power limits. If the transmitter complies with the conducted power limits based on the use of RMS averaging over a time interval, the attenuation required under this paragraph shall be 30 dB instead of 20 dB.

### **7.7.2. Test Procedure Used**

ANSI C63.10-2013 - Section 7.8.8



### 7.7.3. Test Setting

1. Span = wide enough to capture the peak level of the in-band emission and all spurious emissions (e.g., harmonics) from the lowest frequency generated in the EUT up through the 10th harmonic. Typically, several plots are required to cover this entire span.
2. RBW = 100 KHz
3. VBW  $\geq$  RBW
4. Detector = peak
5. Sweep time = auto couple
6. Trace mode = max hold
7. Trace was allowed to stabilize

Set the marker on the peak of any spurious emission recorded. The level displayed must comply with the limit specified in this section.

### 7.7.4. Test Setup

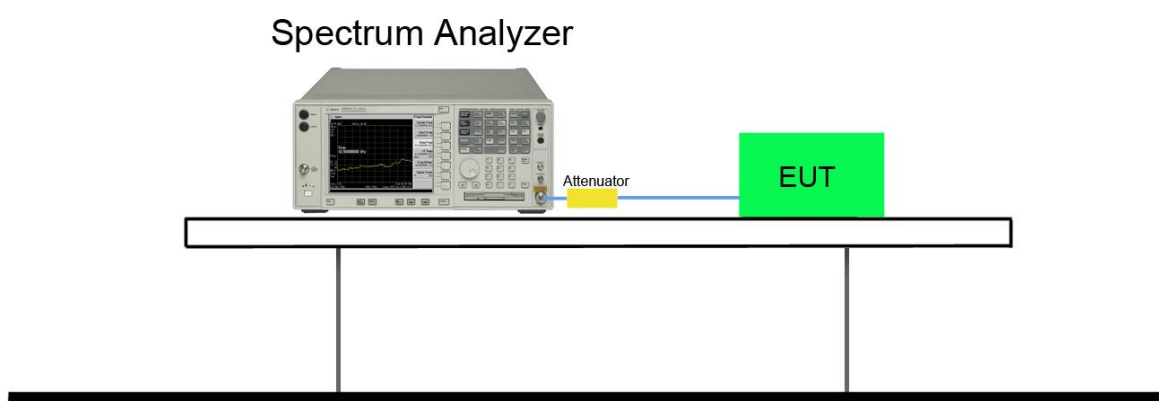

### **7.7.5. Test Result**

Note: Reference Original Report Grant Date: 02/15/2022, FCC ID: WIYSLM500QA.

## 7.8. Radiated Spurious Emission Measurement

### 7.8.1. Test Limit

All out of band emissions appearing in a restricted band as specified in Section 15.205 of the Title 47 CFR must not exceed the limits shown in Table per Section 15.209.

FCC Part 15 Subpart C Paragraph 15.209		
Frequency [MHz]	Field Strength [V/m]	Measured Distance [Meters]
0.009 - 0.490	2400/F (kHz)	300
0.490 - 1.705	24000/F (kHz)	30
1.705 – 30	30	30
30 – 88	100	3
88 – 216	150	3
216 – 960	200	3
Above 960	500	3

### 7.8.2. Test Procedure Used

ANSI C63.10-2013 - Section 11.12.1

### 7.8.3. Test Setting

#### Peak Field Strength Measurements

1. Analyzer center frequency was set to the frequency of the radiated spurious emission of interest
2. RBW = as specified in Table 1
3. VBW = 3 \* RBW
4. Detector = peak
5. Sweep time = auto couple
6. Trace mode = max hold

- Trace was allowed to stabilize

**Table 1 - RBW as a function of frequency**

Frequency	RBW
9 ~ 150 kHz	200 ~ 300 Hz
0.15 ~ 30 MHz	9 ~ 10 kHz
30 ~ 1000 MHz	100 ~ 120 kHz
> 1000 MHz	1 MHz

#### **Average Field Strength Measurements**

- Analyzer center frequency was set to the frequency of the radiated spurious emission of interest
- RBW = 1MHz
- VBW  $\geq 1/T$
- De As an alternative, the instrument may be set to linear detector mode. Ensure that video filtering is applied in linear voltage domain (rather than in a log or dB domain). Some instruments require linear display mode in order to accomplish this. Others have a setting for Average-VBW Type, which can be set to "Voltage" regardless of the display mode
- Detector = Peak
- Sweep time = auto
- Trace mode = max hold
- Allow max hold to run for at least 50 times (1/duty cycle) traces

### 7.8.4. Test Setup

#### 9kHz ~ 30MHz Test Setup:

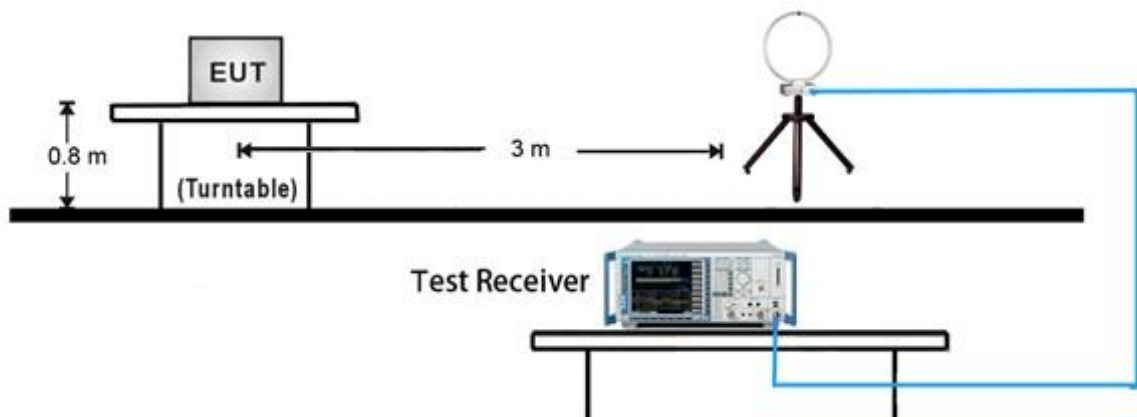

#### 30MHz ~ 1GHz Test Setup:

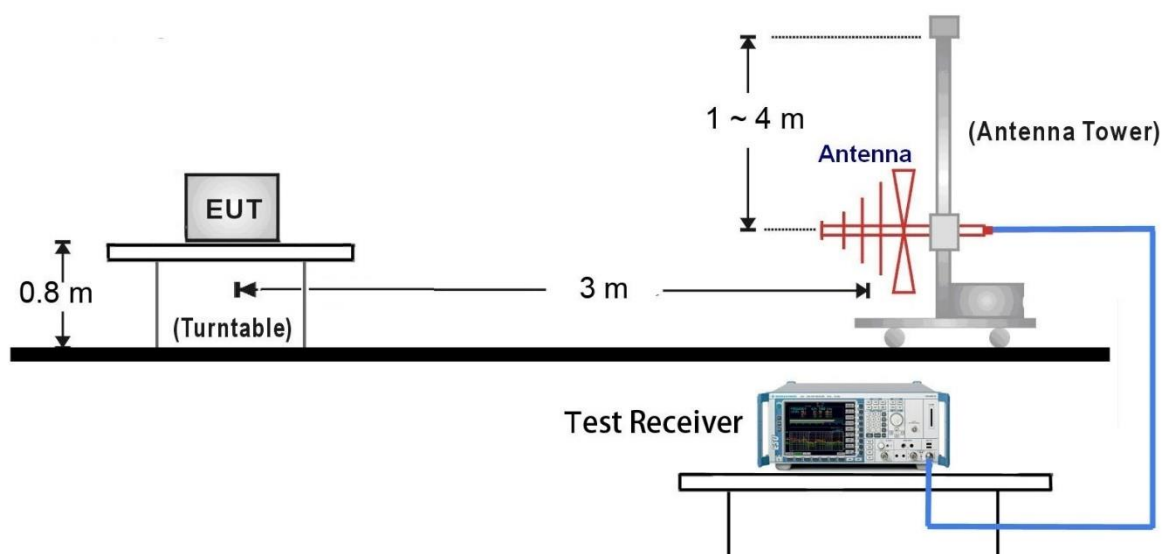

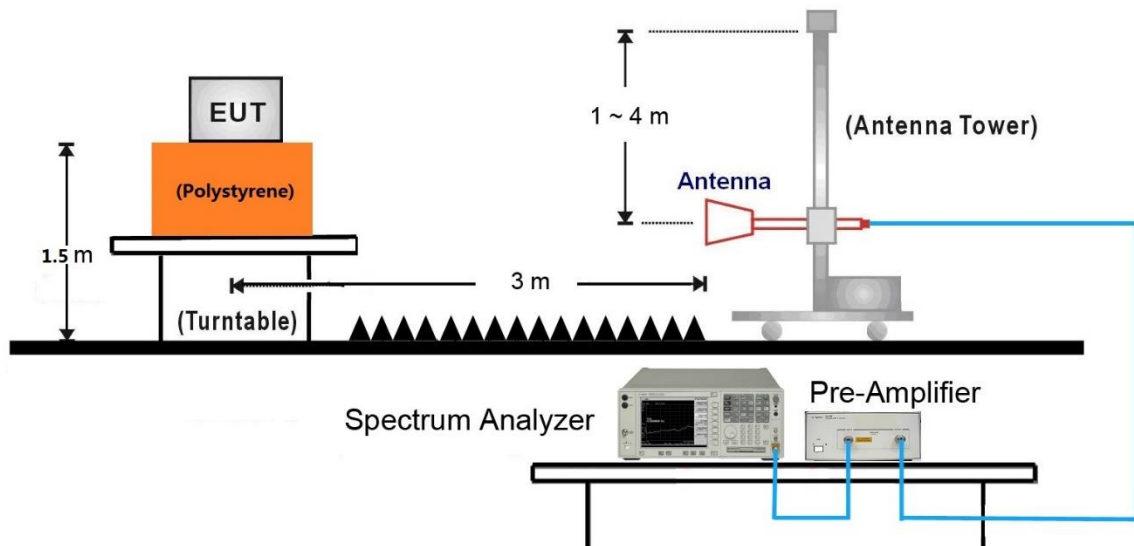
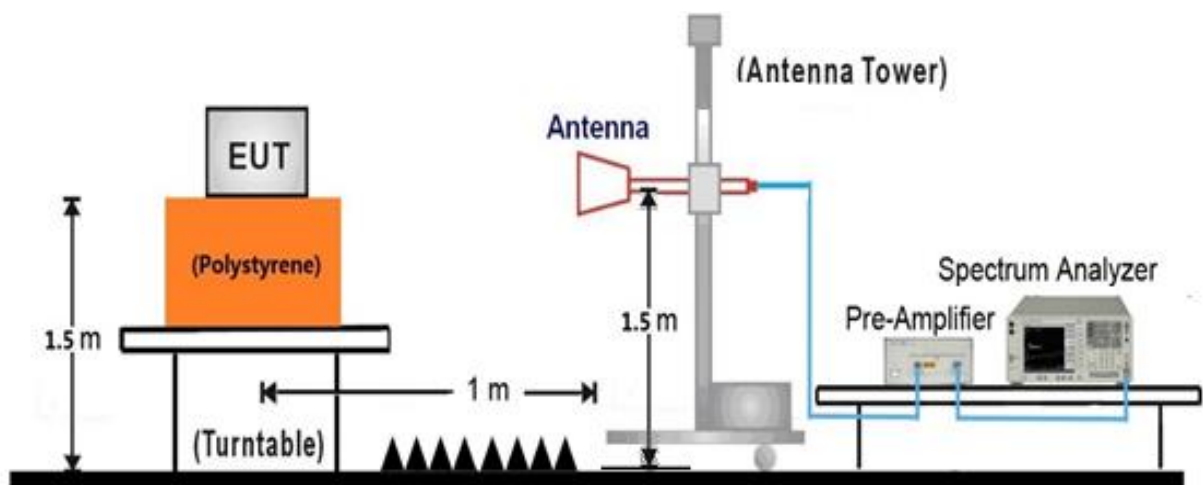
1GHz ~ 18GHz Test Setup:18GHz ~40GHz Test Setup:

### 7.8.5. Test Result

EUT	POS Terminal	Date of Test	2023-10-27
Factor	VULB 9162	Temp. / Humidity	23°C /61%
Polarity	Horizontal	Site / Test Engineer	AC2 / Marvin
Test Mode	BT_TX_DH5_CH 39	Test Voltage	AC 120V/60Hz

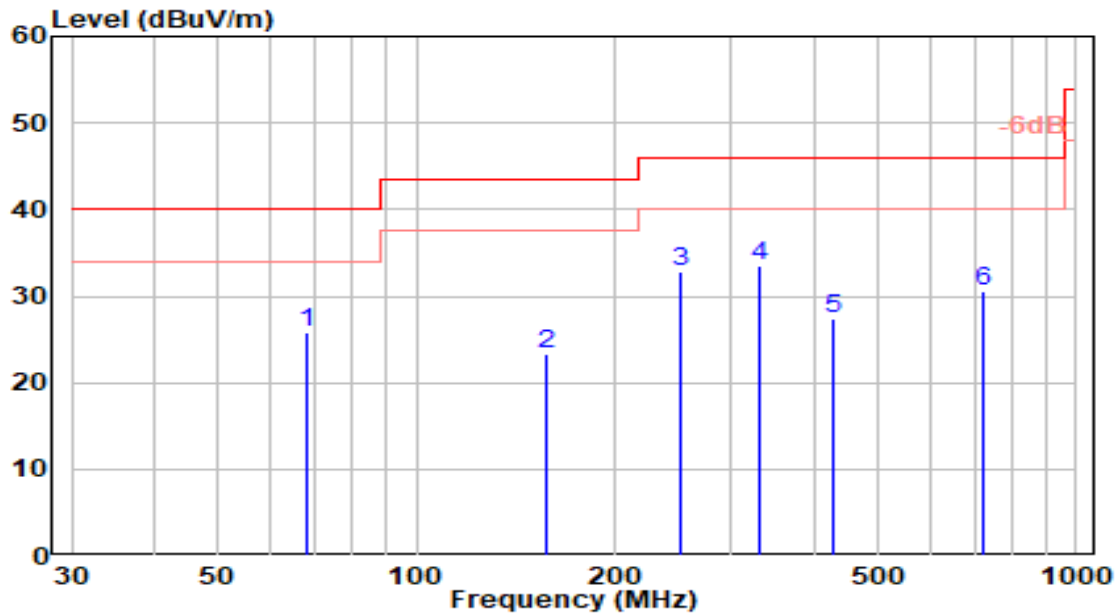

No	Frequency (MHz)	Reading (dBuV)	C.F (dB/m)	Measurement (dBuV/m)	Margin (dB)	Limit (dBuV/m)	Height (cm)	Angle (deg)	Remark (QP/PK/AV)
1	68.300	9.32	16.60	25.92	-14.08	40.00	200	257	QP
2	157.880	7.62	15.69	23.31	-20.19	43.50	200	33	QP
3	250.450	12.69	20.24	32.93	-13.07	46.00	100	329	QP
4	* 330.660	11.51	22.02	33.53	-12.47	46.00	100	142	QP
5	428.420	3.68	23.76	27.44	-18.56	46.00	200	337	QP
6	722.810	1.81	28.67	30.47	-15.53	46.00	100	4	QP

Note:

- "\*" means this data is the worst emission level.
- C.F (Correction Factor) = Antenna Factor (dB/m)+ Cable Loss (dB).
- Measurement (dBuV/m) = Reading(dBuV) + C.F (Correction Factor).
- The emission levels of other frequencies are very lower than the limit and not show in test report.

EUT	POS Terminal	Date of Test	2023-10-27
Factor	VULB 9162	Temp. / Humidity	23°C /61%
Polarity	Vertical	Site / Test Engineer	AC2 / Marvin
Test Mode	BT_TX_DH5_CH 39	Test Voltage	AC 120V/60Hz

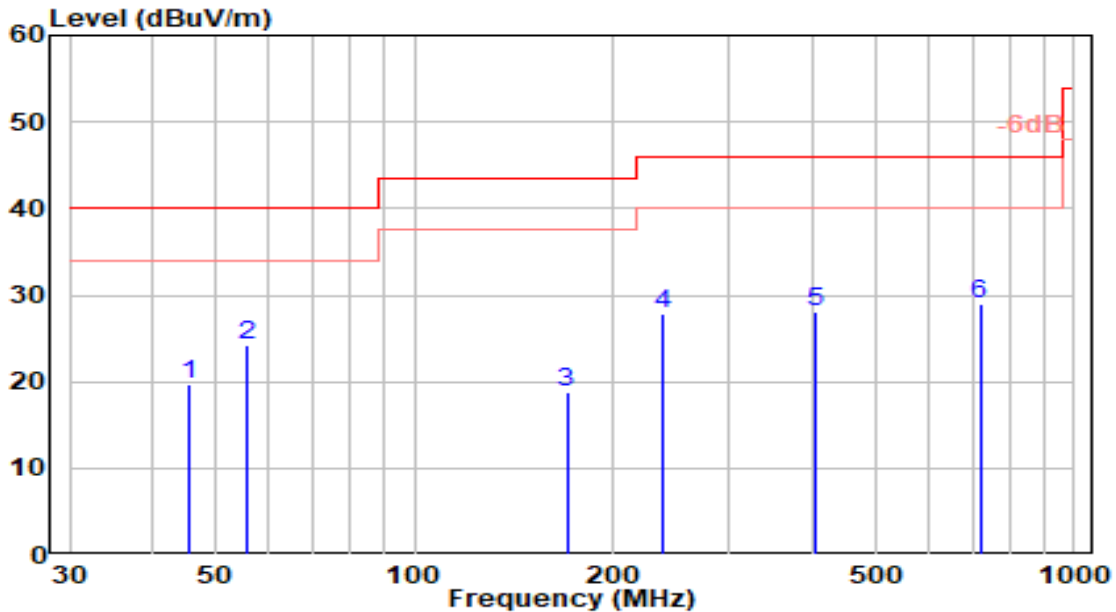

No	Frequency (MHz)	Reading (dBuV)	C.F (dB/m)	Measurement (dBuV/m)	Margin (dB)	Limit (dBuV/m)	Height (cm)	Angle (deg)	Remark (QP/PK/AV)
1	45.320	-1.10	20.80	19.70	-20.30	40.00	116	73	QP
2	* 55.950	4.12	20.18	24.30	-15.70	40.00	200	121	QP
3	170.070	2.78	16.03	18.82	-24.68	43.50	200	87	QP
4	237.520	8.27	19.68	27.95	-18.05	46.00	200	282	QP
5	404.530	4.56	23.58	28.13	-17.87	46.00	144	73	QP
6	719.530	0.32	28.60	28.92	-17.08	46.00	200	158	QP

Note:

- "\*" means this data is the worst emission level.
- C.F (Correction Factor) = Antenna Factor (dB/m)+ Cable Loss (dB).
- Measurement (dBuV/m) = Reading(dBuV) + C.F (Correction Factor).
- The emission levels of other frequencies are very lower than the limit and not show in test report.



EUT	POS Terminal	Date of Test	2023-10-27
Factor	DRH18-E & BBHA 9170	Temp. / Humidity	23°C /61%
Polarity	Horizontal	Site / Test Engineer	AC2 / Stanley
Test Mode	BT_TX_DH5_CH 0	Test Voltage	AC 120V/60Hz

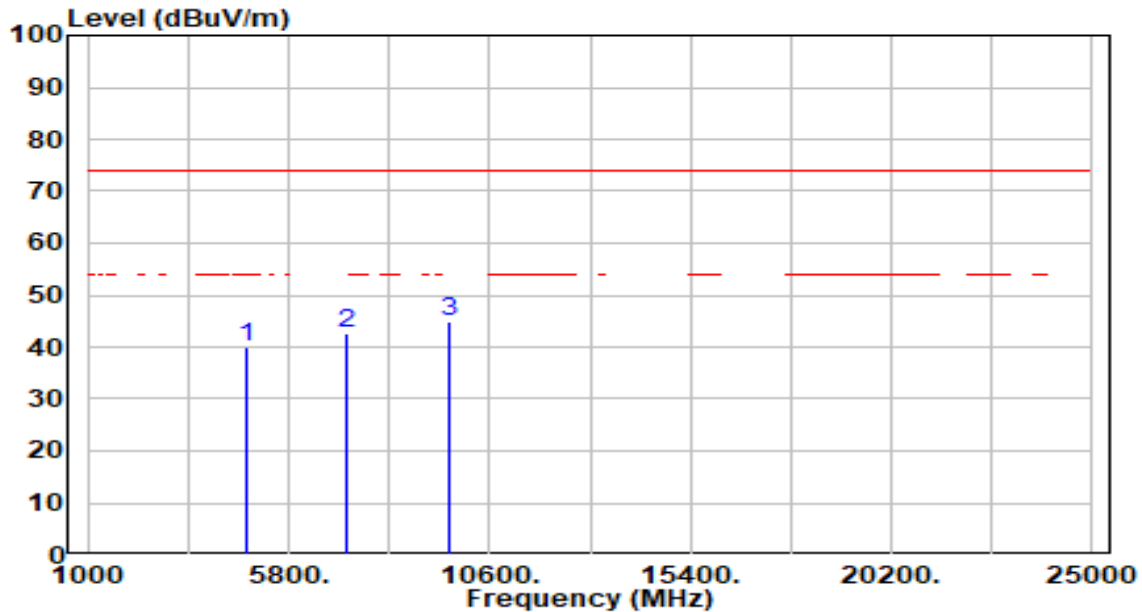

No	Frequency (MHz)	Reading (dBuV)	C.F (dB/m)	Measurement (dBuV/m)	Margin (dB)	Limit (dBuV/m)	Height (cm)	Angle (deg)	Remark (QP/PK/AV)
1	4804.000	40.99	-1.15	39.85	-34.15	74.00	100	357	Peak
2	7206.000	38.57	3.90	42.47	-31.53	74.00	100	22	Peak
3	* 9608.000	41.65	3.20	44.85	-29.15	74.00	100	196	Peak

Note:

1. " \*", means this data is the worst emission level.
2. C.F (Correction Factor) = Antenna Factor (dB/m) + Cable Loss (dB) – Pre-amplifier(dB).
3. Measurement (dBuV/m) = Reading(dBuV) + C.F (Correction Factor).
4. The emission levels of other frequencies are very lower than the limit and not show in test report.

EUT	POS Terminal	Date of Test	2023-10-27
Factor	DRH18-E & BBHA 9170	Temp. / Humidity	23°C /61%
Polarity	Vertical	Site / Test Engineer	AC2 / Stanley
Test Mode	BT_TX_DH5_CH 0	Test Voltage	AC 120V/60Hz

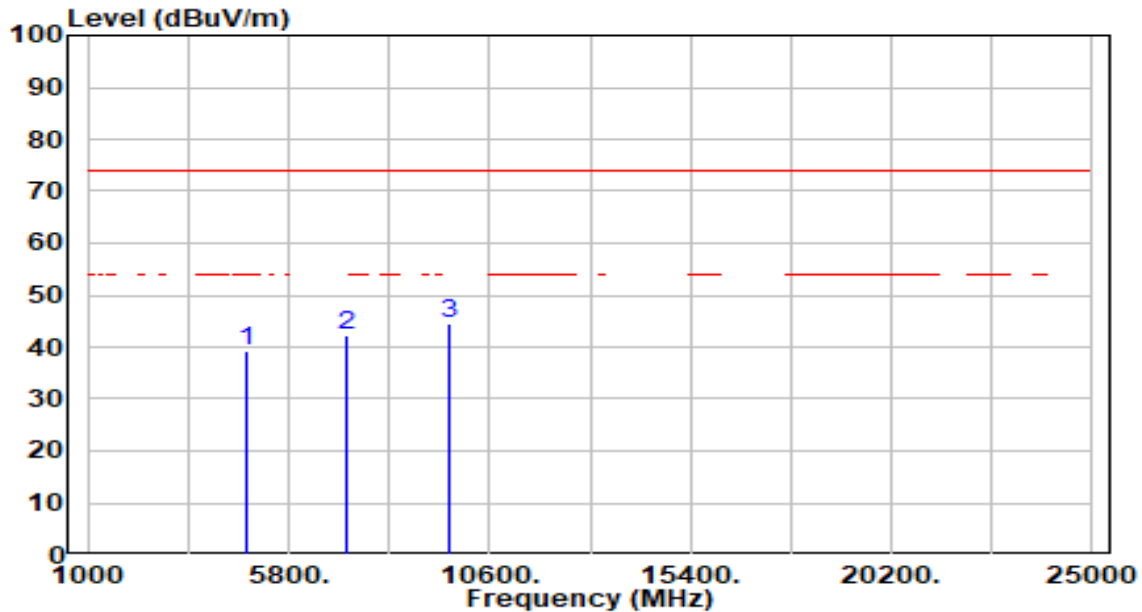

No	Frequency (MHz)	Reading (dBuV)	C.F (dB/m)	Measurement (dBuV/m)	Margin (dB)	Limit (dBuV/m)	Height (cm)	Angle (deg)	Remark (QP/PK/AV)
1	4804.000	40.45	-1.15	39.30	-34.70	74.00	100	0	Peak
2	7206.000	38.39	3.90	42.29	-31.71	74.00	100	254	Peak
3	* 9608.000	41.20	3.20	44.40	-29.60	74.00	100	177	Peak

Note:

1. " \*", means this data is the worst emission level.
2. C.F (Correction Factor) = Antenna Factor (dB/m) + Cable Loss (dB) – Pre-amplifier(dB).
3. Measurement (dBuV/m) = Reading(dBuV) + C.F (Correction Factor).
4. The emission levels of other frequencies are very lower than the limit and not show in test report.

EUT	POS Terminal	Date of Test	2023-10-27
Factor	DRH18-E & BBHA 9170	Temp. / Humidity	23°C /61%
Polarity	Horizontal	Site / Test Engineer	AC2 / Stanley
Test Mode	BT_TX_DH5_CH 39	Test Voltage	AC 120V/60Hz

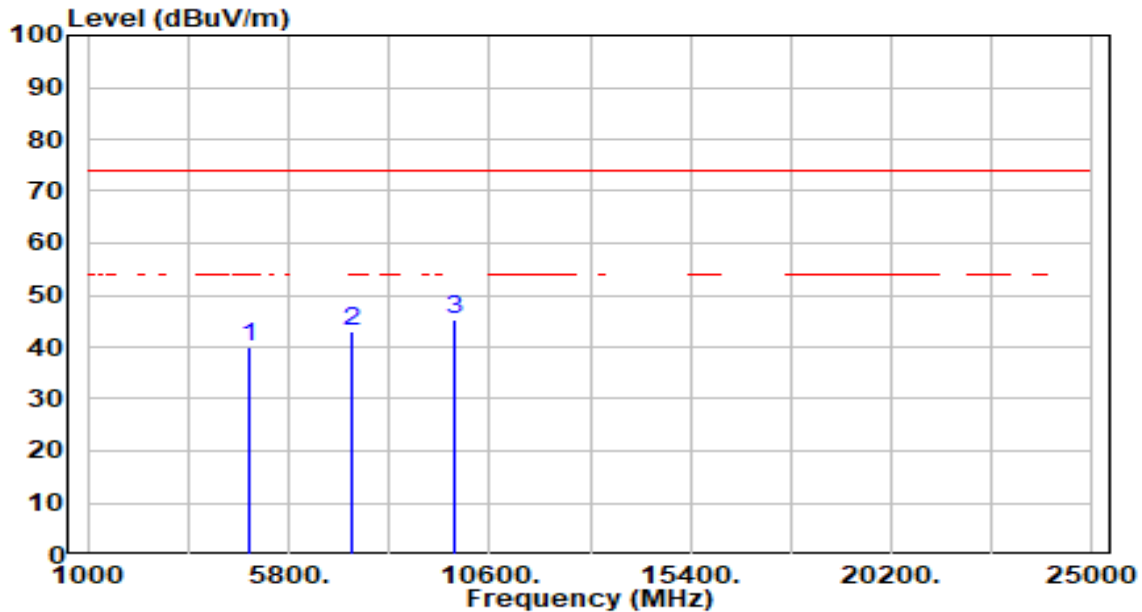

No	Frequency (MHz)	Reading (dBuV)	C.F (dB/m)	Measurement (dBuV/m)	Margin (dB)	Limit (dBuV/m)	Height (cm)	Angle (deg)	Remark (QP/PK/AV)
1	4882.000	40.77	-0.95	39.82	-34.18	74.00	100	210	Peak
2	7323.000	39.21	3.92	43.13	-30.87	74.00	200	108	Peak
3	* 9764.000	42.03	3.25	45.28	-28.72	74.00	100	360	Peak

Note:

1. " \*", means this data is the worst emission level.
2. C.F (Correction Factor) = Antenna Factor (dB/m) + Cable Loss (dB) – Preamplifier(dB).
3. Measurement (dBuV/m) = Reading(dBuV) + C.F (Correction Factor).
4. The emission levels of other frequencies are very lower than the limit and not show in test report.

EUT	POS Terminal	Date of Test	2023-10-27
Factor	DRH18-E & BBHA 9170	Temp. / Humidity	23°C /61%
Polarity	Vertical	Site / Test Engineer	AC2 / Stanley
Test Mode	BT_TX_DH5_CH 39	Test Voltage	AC 120V/60Hz

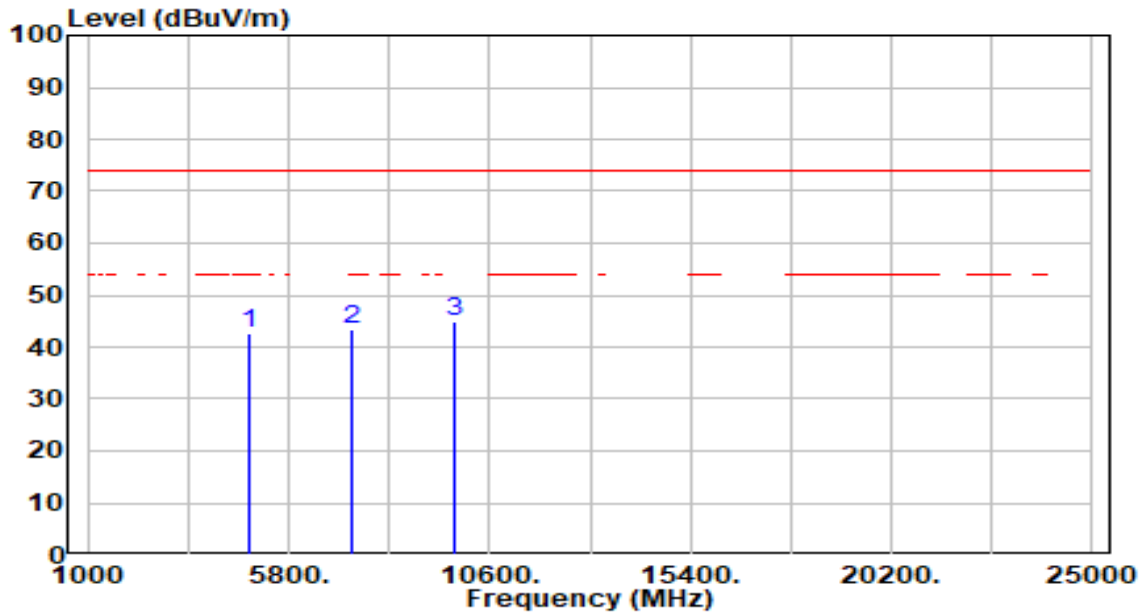

No	Frequency (MHz)	Reading (dBuV)	C.F (dB/m)	Measurement (dBuV/m)	Margin (dB)	Limit (dBuV/m)	Height (cm)	Angle (deg)	Remark (QP/PK/AV)
1	4882.000	43.44	-0.95	42.49	-31.51	74.00	300	144	Peak
2	7323.000	39.61	3.92	43.53	-30.47	74.00	300	41	Peak
3	* 9764.000	41.81	3.25	45.06	-28.94	74.00	100	329	Peak

Note:

1. " \*", means this data is the worst emission level.
2. C.F (Correction Factor) = Antenna Factor (dB/m) + Cable Loss (dB) – Preamplifier(dB).
3. Measurement (dBuV/m) = Reading(dBuV) + C.F (Correction Factor).
4. The emission levels of other frequencies are very lower than the limit and not show in test report.

EUT	POS Terminal	Date of Test	2023-10-27
Factor	DRH18-E & BBHA 9170	Temp. / Humidity	23°C /61%
Polarity	Horizontal	Site / Test Engineer	AC2 / Stanley
Test Mode	BT_TX_DH5_CH 78	Test Voltage	AC 120V/60Hz

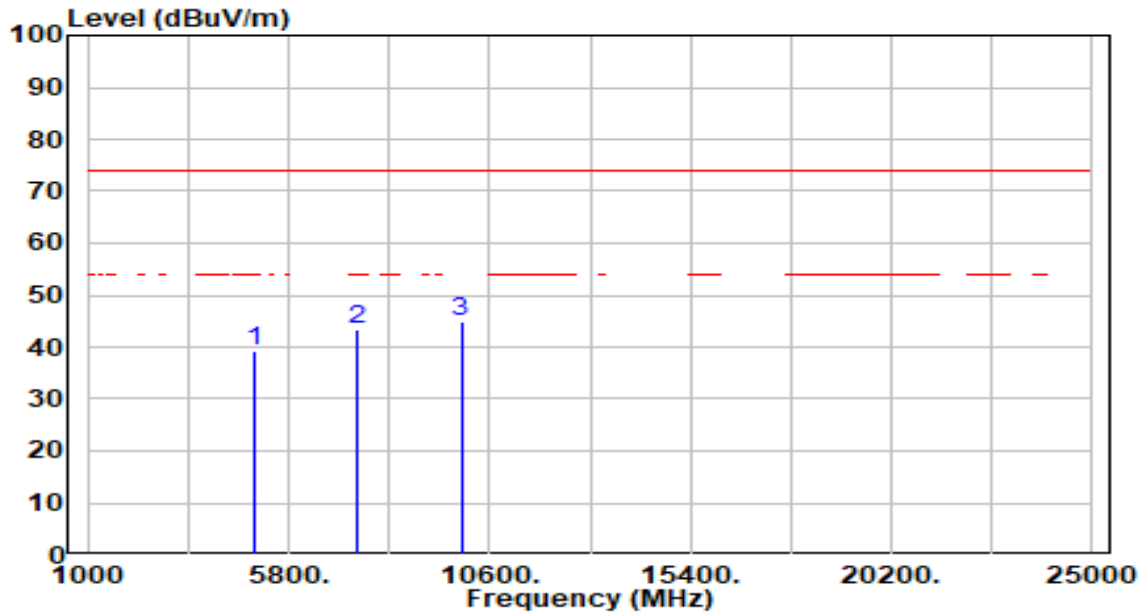

No	Frequency (MHz)	Reading (dBuV)	C.F (dB/m)	Measurement (dBuV/m)	Margin (dB)	Limit (dBuV/m)	Height (cm)	Angle (deg)	Remark (QP/PK/AV)
1	4960.000	40.11	-0.74	39.37	-34.63	74.00	100	360	Peak
2	7440.000	39.38	3.91	43.29	-30.71	74.00	100	56	Peak
3	* 9920.000	41.54	3.29	44.83	-29.17	74.00	100	81	Peak

Note:

1. " \*", means this data is the worst emission level.
2. C.F (Correction Factor) = Antenna Factor (dB/m) + Cable Loss (dB) – Pre-amplifier(dB).
3. Measurement (dBuV/m) = Reading(dBuV) + C.F (Correction Factor).
4. The emission levels of other frequencies are very lower than the limit and not show in test report.

EUT	POS Terminal	Date of Test	2023-10-27
Factor	DRH18-E & BBHA 9170	Temp. / Humidity	23°C /61%
Polarity	Vertical	Site / Test Engineer	AC2 / Stanley
Test Mode	BT_TX_DH5_CH 78	Test Voltage	AC 120V/60Hz

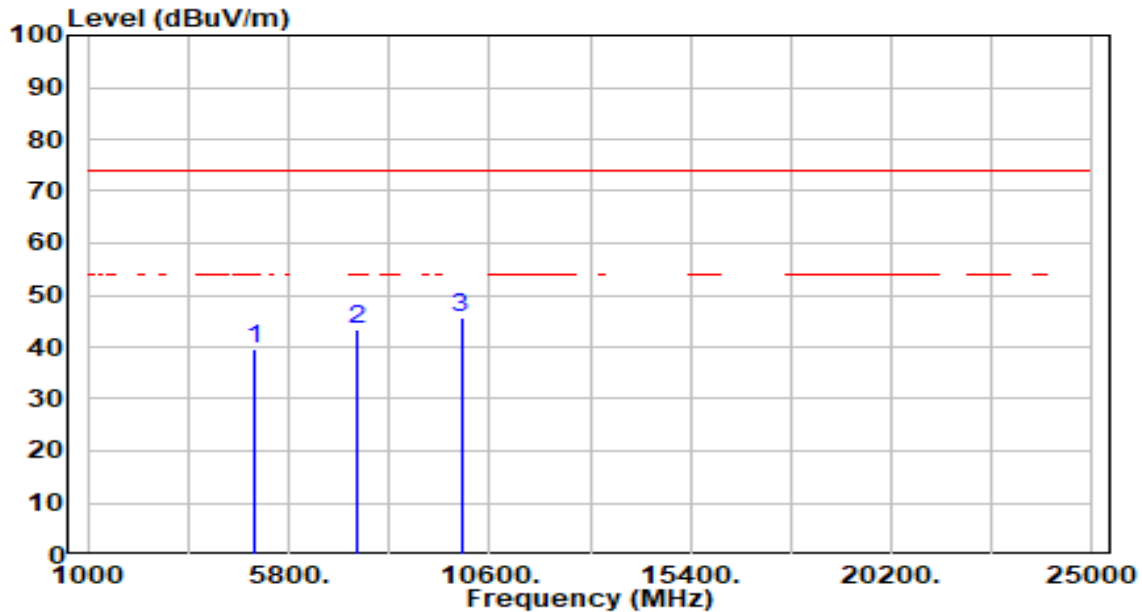

No	Frequency (MHz)	Reading (dBuV)	C.F (dB/m)	Measurement (dBuV/m)	Margin (dB)	Limit (dBuV/m)	Height (cm)	Angle (deg)	Remark (QP/PK/AV)
1	4960.000	40.30	-0.74	39.56	-34.44	74.00	100	167	Peak
2	7440.000	39.43	3.91	43.34	-30.66	74.00	100	12	Peak
3	* 9920.000	42.42	3.29	45.71	-28.29	74.00	100	255	Peak

Note:

1. " \*", means this data is the worst emission level.
2. C.F (Correction Factor) = Antenna Factor (dB/m) + Cable Loss (dB) – Pre-amplifier(dB).
3. Measurement (dBuV/m) = Reading(dBuV) + C.F (Correction Factor).
4. The emission levels of other frequencies are very lower than the limit and not show in test report.

EUT	POS Terminal	Date of Test	2023-10-27
Factor	DRH18-E & BBHA 9170	Temp. / Humidity	23°C /61%
Polarity	Horizontal	Site / Test Engineer	AC2 / Stanley
Test Mode	BT_TX_3-DH5_CH 0	Test Voltage	AC 120V/60Hz

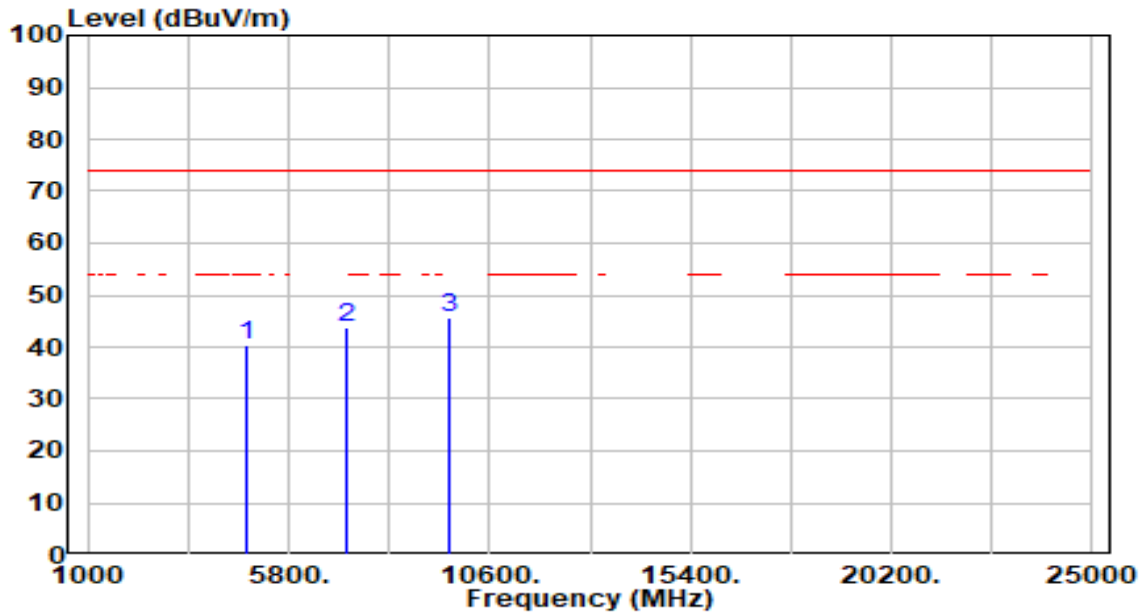

No	Frequency (MHz)	Reading (dBuV)	C.F (dB/m)	Measurement (dBuV/m)	Margin (dB)	Limit (dBuV/m)	Height (cm)	Angle (deg)	Remark (QP/PK/AV)
1	4804.000	41.55	-1.15	40.40	-33.60	74.00	100	351	Peak
2	7206.000	39.80	3.90	43.70	-30.30	74.00	100	207	Peak
3	* 9608.000	42.58	3.20	45.79	-28.21	74.00	100	22	Peak

Note:

1. " \*", means this data is the worst emission level.
2. C.F (Correction Factor) = Antenna Factor (dB/m) + Cable Loss (dB) – Pre-amplifier(dB).
3. Measurement (dBuV/m) = Reading(dBuV) + C.F (Correction Factor).
4. The emission levels of other frequencies are very lower than the limit and not show in test report.

EUT	POS Terminal	Date of Test	2023-10-27
Factor	DRH18-E & BBHA 9170	Temp. / Humidity	23°C /61%
Polarity	Vertical	Site / Test Engineer	AC2 / Stanley
Test Mode	BT_TX_3-DH5_CH 0	Test Voltage	AC 120V/60Hz

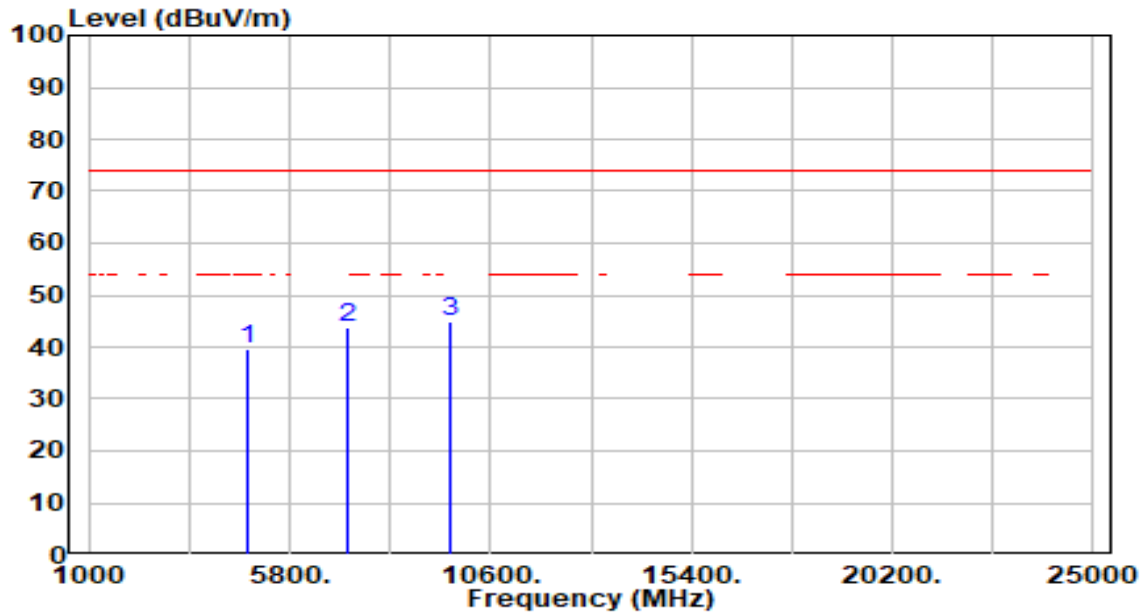

No	Frequency (MHz)	Reading (dBuV)	C.F (dB/m)	Measurement (dBuV/m)	Margin (dB)	Limit (dBuV/m)	Height (cm)	Angle (deg)	Remark (QP/PK/AV)
1	4804.000	40.66	-1.15	39.51	-34.49	74.00	100	198	Peak
2	7206.000	39.83	3.90	43.72	-30.28	74.00	100	132	Peak
3	* 9608.000	41.75	3.20	44.96	-29.04	74.00	100	58	Peak

Note:

1. " \*", means this data is the worst emission level.
2. C.F (Correction Factor) = Antenna Factor (dB/m) + Cable Loss (dB) – Preamplifier(dB).
3. Measurement (dBuV/m) = Reading(dBuV) + C.F (Correction Factor).
4. The emission levels of other frequencies are very lower than the limit and not show in test report.



EUT	POS Terminal	Date of Test	2023-10-27
Factor	DRH18-E & BBHA 9170	Temp. / Humidity	23°C /61%
Polarity	Horizontal	Site / Test Engineer	AC2 / Stanley
Test Mode	BT_TX_3-DH5_CH 39	Test Voltage	AC 120V/60Hz

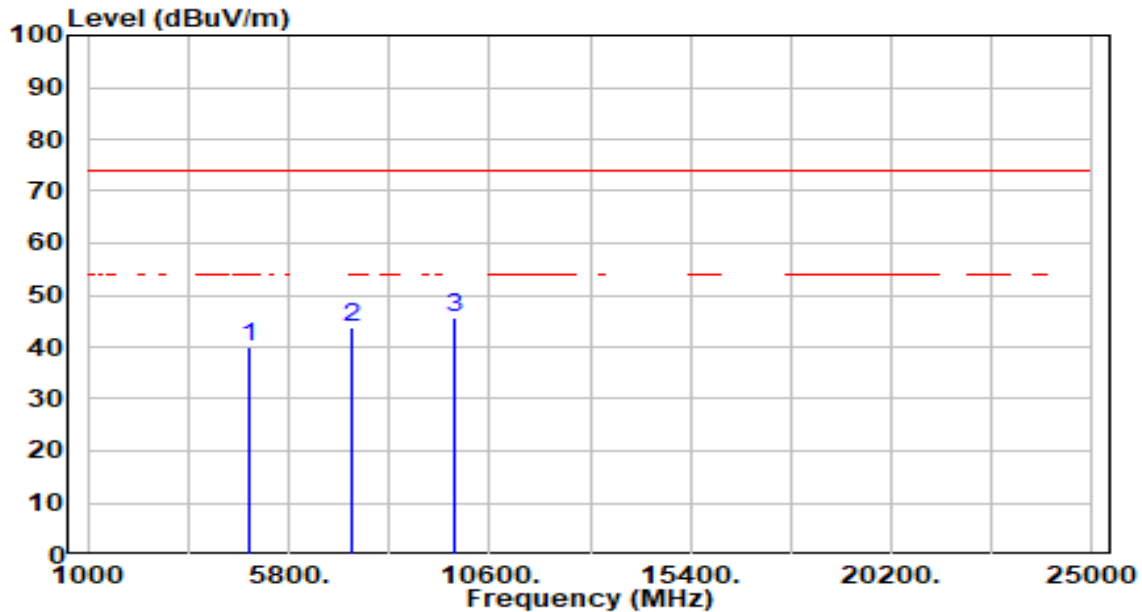

No	Frequency (MHz)	Reading (dBuV)	C.F (dB/m)	Measurement (dBuV/m)	Margin (dB)	Limit (dBuV/m)	Height (cm)	Angle (deg)	Remark (QP/PK/AV)
1	4882.000	41.00	-0.95	40.06	-33.94	74.00	300	210	Peak
2	7323.000	39.83	3.92	43.75	-30.25	74.00	200	360	Peak
3	* 9764.000	42.43	3.25	45.67	-28.33	74.00	100	17	Peak

Note:

1. " \*", means this data is the worst emission level.
2. C.F (Correction Factor) = Antenna Factor (dB/m) + Cable Loss (dB) – Preamplifier(dB).
3. Measurement (dBuV/m) = Reading(dBuV) + C.F (Correction Factor).
4. The emission levels of other frequencies are very lower than the limit and not show in test report.

EUT	POS Terminal	Date of Test	2023-10-27
Factor	DRH18-E & BBHA 9170	Temp. / Humidity	23°C /61%
Polarity	Vertical	Site / Test Engineer	AC2 / Stanley
Test Mode	BT_TX_3-DH5_CH 39	Test Voltage	AC 120V/60Hz

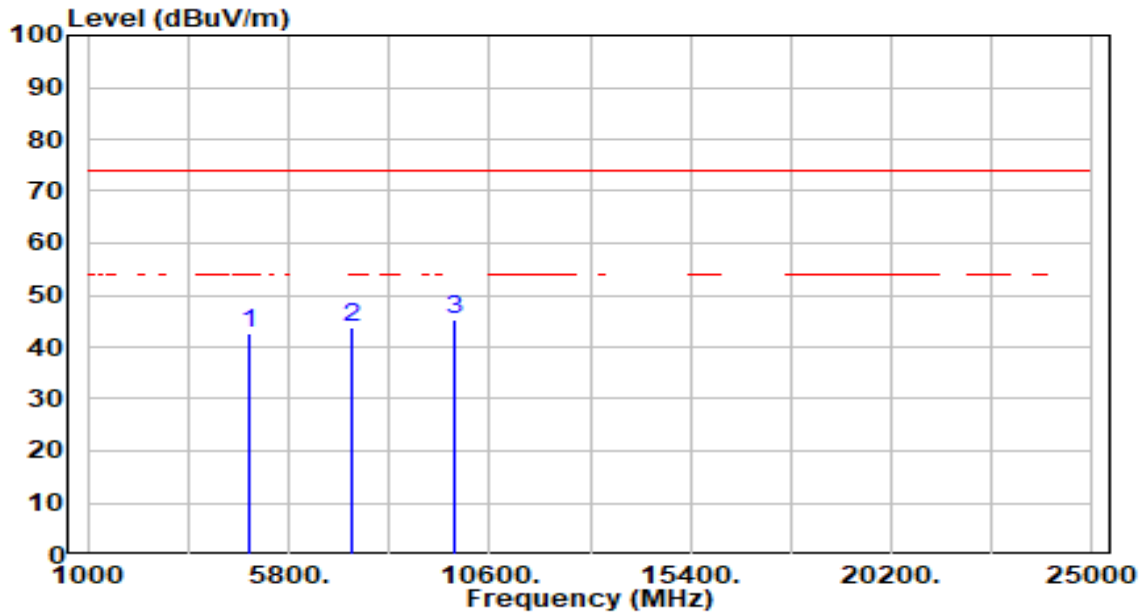

No	Frequency (MHz)	Reading (dBuV)	C.F (dB/m)	Measurement (dBuV/m)	Margin (dB)	Limit (dBuV/m)	Height (cm)	Angle (deg)	Remark (QP/PK/AV)
1	4882.000	43.44	-0.95	42.49	-31.51	74.00	300	145	Peak
2	7323.000	39.74	3.92	43.66	-30.34	74.00	100	360	Peak
3	* 9764.000	41.96	3.25	45.20	-28.80	74.00	300	18	Peak

Note:

1. " \*", means this data is the worst emission level.
2. C.F (Correction Factor) = Antenna Factor (dB/m) + Cable Loss (dB) – Pre-amplifier(dB).
3. Measurement (dBuV/m) = Reading(dBuV) + C.F (Correction Factor).
4. The emission levels of other frequencies are very lower than the limit and not show in test report.

EUT	POS Terminal	Date of Test	2023-10-27
Factor	DRH18-E & BBHA 9170	Temp. / Humidity	23°C /61%
Polarity	Horizontal	Site / Test Engineer	AC2 / Stanley
Test Mode	BT_TX_3-DH5_CH 78	Test Voltage	AC 120V/60Hz

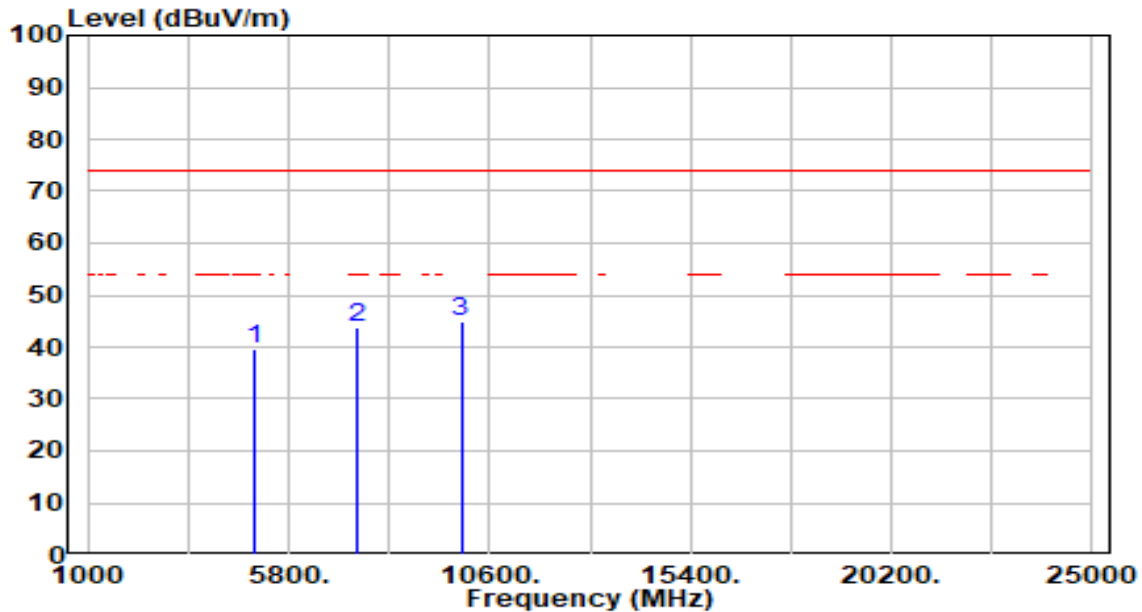

No	Frequency (MHz)	Reading (dBuV)	C.F (dB/m)	Measurement (dBuV/m)	Margin (dB)	Limit (dBuV/m)	Height (cm)	Angle (deg)	Remark (QP/PK/AV)
1	4960.000	40.36	-0.74	39.62	-34.38	74.00	100	360	Peak
2	7440.000	39.90	3.91	43.81	-30.19	74.00	100	189	Peak
3	* 9920.000	41.51	3.29	44.80	-29.20	74.00	100	360	Peak

Note:

1. " \*", means this data is the worst emission level.
2. C.F (Correction Factor) = Antenna Factor (dB/m) + Cable Loss (dB) – Pre-amplifier(dB).
3. Measurement (dBuV/m) = Reading(dBuV) + C.F (Correction Factor).
4. The emission levels of other frequencies are very lower than the limit and not show in test report.

EUT	POS Terminal	Date of Test	2023-10-27
Factor	DRH18-E & BBHA 9170	Temp. / Humidity	23°C /61%
Polarity	Vertical	Site / Test Engineer	AC2 / Stanley
Test Mode	BT_TX_3-DH5_CH 78	Test Voltage	AC 120V/60Hz

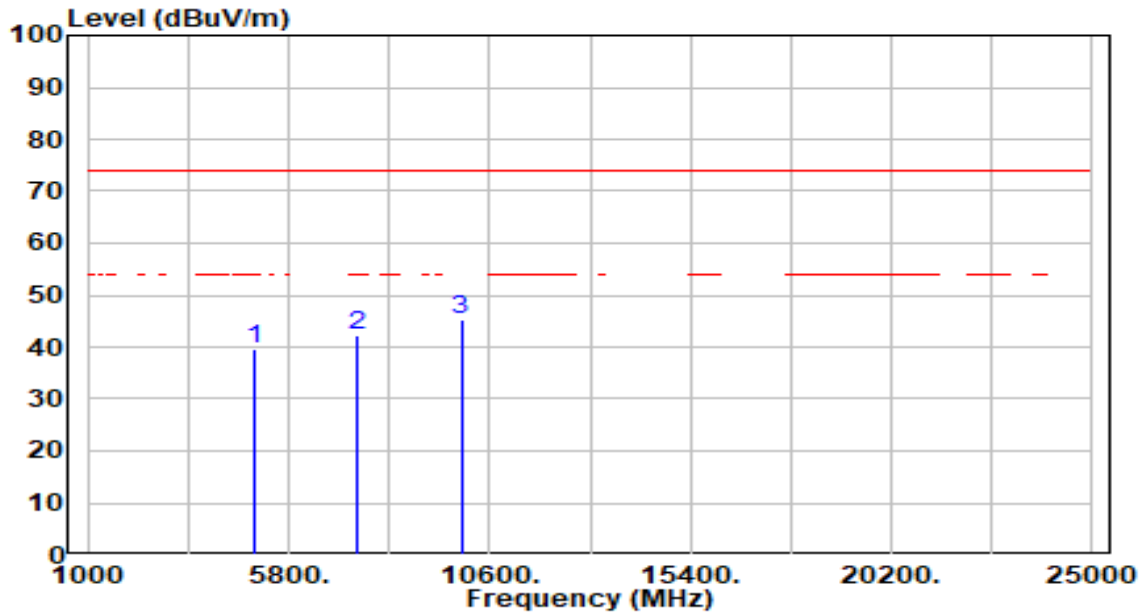

No	Frequency (MHz)	Reading (dBuV)	C.F (dB/m)	Measurement (dBuV/m)	Margin (dB)	Limit (dBuV/m)	Height (cm)	Angle (deg)	Remark (QP/PK/AV)
1	4960.000	40.20	-0.74	39.45	-34.55	74.00	100	199	Peak
2	7440.000	38.29	3.91	42.20	-31.80	74.00	100	50	Peak
3	* 9920.000	42.05	3.29	45.34	-28.66	74.00	100	340	Peak

Note:

1. " \*", means this data is the worst emission level.
2. C.F (Correction Factor) = Antenna Factor (dB/m) + Cable Loss (dB) – Pre-amplifier(dB).
3. Measurement (dBuV/m) = Reading(dBuV) + C.F (Correction Factor).
4. The emission levels of other frequencies are very lower than the limit and not show in test report.

## 7.9. Radiated Restricted Band Edge Measurement

### 7.9.1. Test Limit

All out of band emissions appearing in a restricted band as specified in Section 15.205 of the Title 47 CFR must not exceed the limits shown in Table per Section 15.209.

FCC Part 15 Subpart C Paragraph 15.209		
Frequency [MHz]	Field Strength [V/m]	Measured Distance [Meters]
0.009 - 0.490	2400/F (kHz)	300
0.490 - 1.705	24000/F (kHz)	30
1.705 – 30	30	30
30 – 88	100	3
88 – 216	150	3
216 – 960	200	3
Above 960	500	3

### 7.9.2. Test Procedure Used

ANSI C63.10-2013 - Section 11.12.1

### 7.9.3. Test Setting

#### Peak Field Strength Measurements

1. Analyzer center frequency was set to the frequency of the radiated spurious emission of interest
2. RBW = as specified in Table 1
3. VBW = 3 \* RBW
4. Detector = peak
5. Sweep time = auto couple
6. Trace mode = max hold

- Trace was allowed to stabilize

**Table 1 - RBW as a function of frequency**

Frequency	RBW
9 ~ 150 kHz	200 ~ 300 Hz
0.15 ~ 30 MHz	9 ~ 10 kHz
30 ~ 1000 MHz	100 ~ 120 kHz
> 1000 MHz	1 MHz

**Average Field Strength Measurements**

- Analyzer center frequency was set to the frequency of the radiated spurious emission of interest
- RBW = 1MHz
- VBW  $\geq 1/T$
- De As an alternative, the instrument may be set to linear detector mode. Ensure that video filtering is applied in linear voltage domain (rather than in a log or dB domain). Some instruments require linear display mode in order to accomplish this. Others have a setting for Average-VBW Type, which can be set to "Voltage" regardless of the display mode
- Detector = Peak
- Sweep time = auto
- Trace mode = max hold
- Allow max hold to run for at least 50 times (1/duty cycle) traces

### 7.9.4. Test Setup

1GHz ~ 18GHz Test Setup:

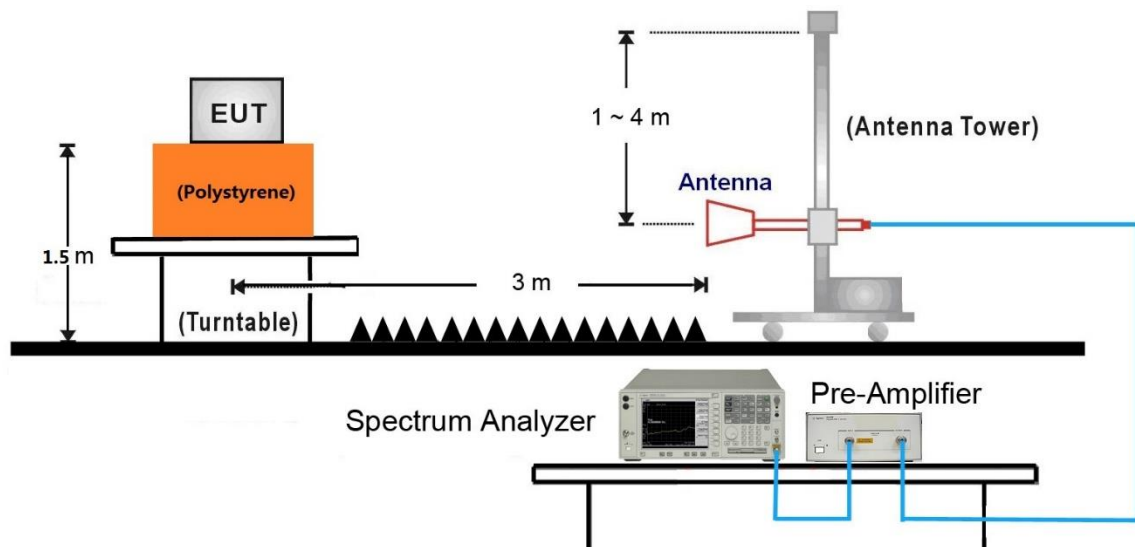

### 7.9.5. Test Result

EUT	POS Terminal	Date of Test	2023-10-27
Factor	DRH18-E	Temp. / Humidity	23°C /61%
Polarity	Horizontal	Site / Test Engineer	AC2 / Stanley
Test Mode	BT_TX_DH5_CH 0	Test Voltage	AC 120V/60Hz

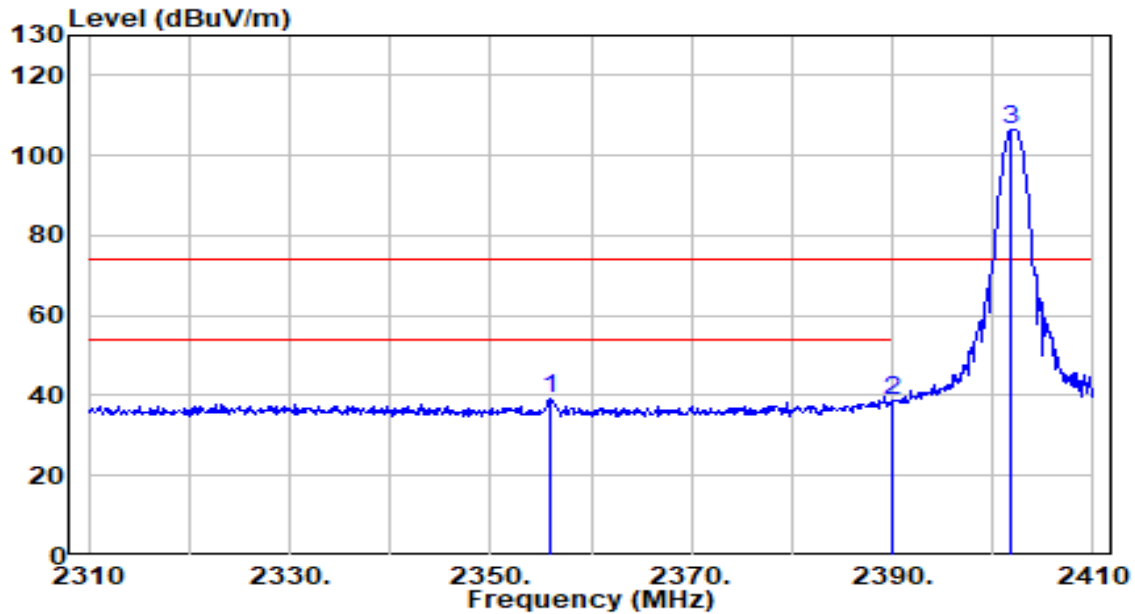

No	Frequency (MHz)	Reading (dBuV)	C.F (dB/m)	Measurement (dBuV/m)	Margin (dB)	Limit (dBuV/m)	Height (cm)	Angle (deg)	Remark (QP/PK/AV)
1	* 2355.900	44.64	-5.48	39.17	-34.83	74.00	162	237	Peak
2	2390.000	44.08	-5.41	38.67	-35.33	74.00	162	237	Peak
3	2401.900	112.05	-5.39	106.65	N/A	N/A	162	237	Peak

Note:

1. " \*", means this data is the worst emission level.
2. C.F (Correction Factor) = Antenna Factor (dB/m) + Cable Loss (dB) – Preamp( dB).
3. Measurement (dBuV/m) = Reading(dBuV) + C.F (Correction Factor).
4. The emission levels of other frequencies are very lower than the limit and not show in test report.



EUT	POS Terminal	Date of Test	2023-10-27
Factor	DRH18-E	Temp. / Humidity	23°C /61%
Polarity	Vertical	Site / Test Engineer	AC2 / Stanley
Test Mode	BT_TX_DH5_CH 0	Test Voltage	AC 120V/60Hz

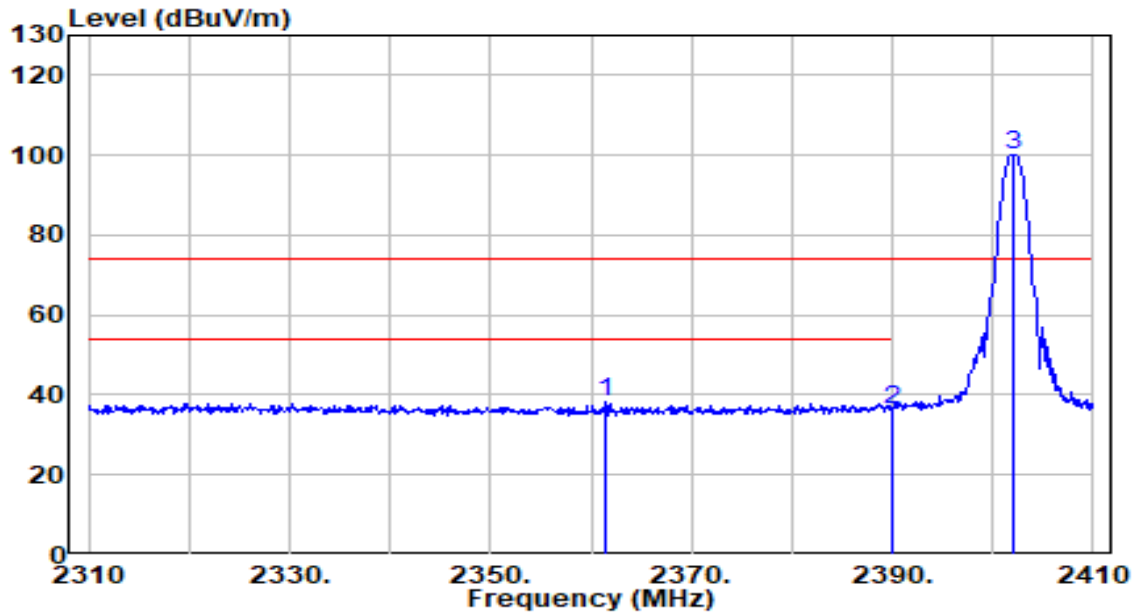

No	Frequency (MHz)	Reading (dBuV)	C.F (dB/m)	Measurement (dBuV/m)	Margin (dB)	Limit (dBuV/m)	Height (cm)	Angle (deg)	Remark (QP/PK/AV)
1	* 2361.400	43.70	-5.47	38.24	-35.76	74.00	292	0	Peak
2	2390.000	41.94	-5.41	36.53	-37.47	74.00	292	0	Peak
3	2402.000	105.63	-5.39	100.23	N/A	N/A	292	0	Peak

Note:

1. " \*", means this data is the worst emission level.
2. C.F (Correction Factor) = Antenna Factor (dB/m) + Cable Loss (dB) – Pre-amplifier(dB).
3. Measurement (dBuV/m) = Reading(dBuV) + C.F (Correction Factor).
4. The emission levels of other frequencies are very lower than the limit and not show in test report.

EUT	POS Terminal	Date of Test	2023-10-27
Factor	DRH18-E	Temp. / Humidity	23°C /61%
Polarity	Horizontal	Site / Test Engineer	AC2 / Stanley
Test Mode	BT_TX_DH5_CH 78	Test Voltage	AC 120V/60Hz

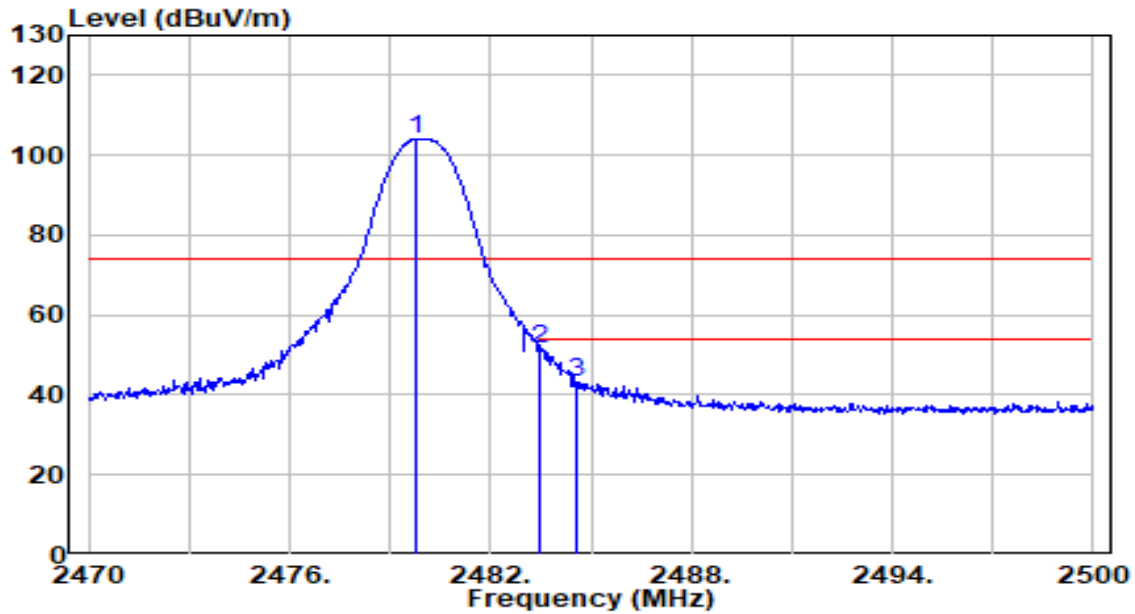

No	Frequency (MHz)	Reading (dBUV)	C.F (dB/m)	Measurement (dBUV/m)	Margin (dB)	Limit (dBUV/m)	Height (cm)	Angle (deg)	Remark (QP/PK/AV)
1	2479.810	109.40	-5.37	104.03	N/A	N/A	117	218	Peak
2	* 2483.500	57.10	-5.37	51.74	-22.26	74.00	117	218	Peak
3	2484.550	48.68	-5.37	43.32	-30.68	74.00	117	218	Peak

Note:

1. " \*", means this data is the worst emission level.
2. C.F (Correction Factor) = Antenna Factor (dB/m) + Cable Loss (dB) – Pre-amplifier(dB).
3. Measurement (dBUV/m) = Reading(dBUV) + C.F (Correction Factor).
4. The emission levels of other frequencies are very lower than the limit and not show in test report.

EUT	POS Terminal	Date of Test	2023-10-27
Factor	DRH18-E	Temp. / Humidity	23°C /61%
Polarity	Vertical	Site / Test Engineer	AC2 / Stanley
Test Mode	BT_TX_DH5_CH 78	Test Voltage	AC 120V/60Hz

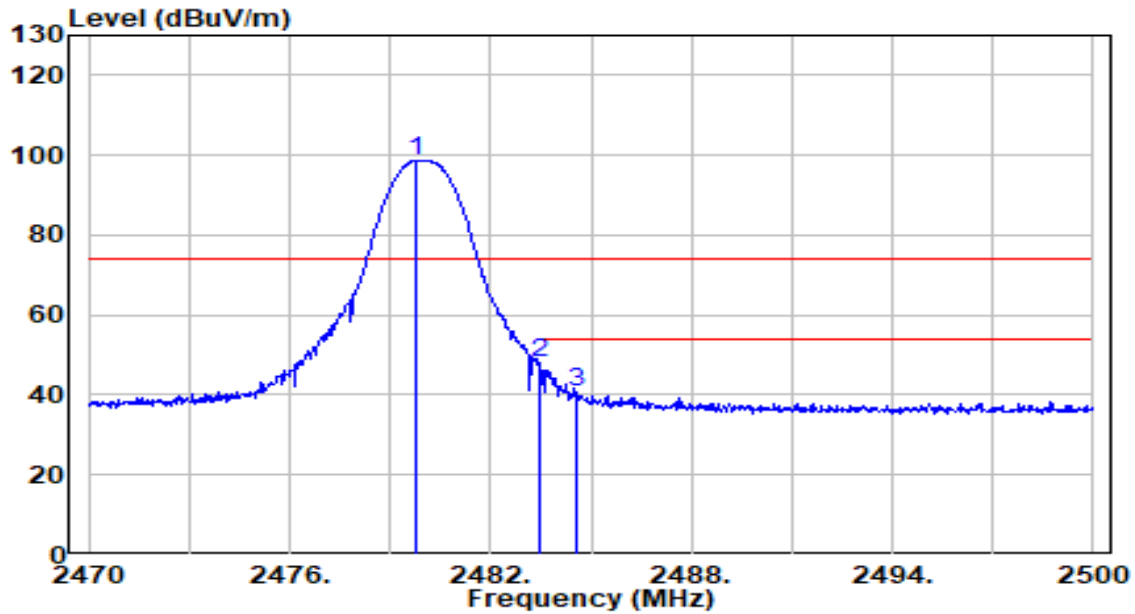

No	Frequency (MHz)	Reading (dBuV)	C.F (dB/m)	Measurement (dBuV/m)	Margin (dB)	Limit (dBuV/m)	Height (cm)	Angle (deg)	Remark (QP/PK/AV)
1	2479.780	104.01	-5.37	98.64	N/A	N/A	360	10	Peak
2	* 2483.500	53.31	-5.37	47.95	-26.05	74.00	360	10	Peak
3	2484.580	46.06	-5.37	40.70	-33.30	74.00	360	10	Peak

Note:

1. " \*", means this data is the worst emission level.
2. C.F (Correction Factor) = Antenna Factor (dB/m) + Cable Loss (dB) – Pre-amplifier(dB).
3. Measurement (dBuV/m) = Reading(dBuV) + C.F (Correction Factor).
4. The emission levels of other frequencies are very lower than the limit and not show in test report.

EUT	POS Terminal	Date of Test	2023-10-27
Factor	DRH18-E	Temp. / Humidity	23°C /61%
Polarity	Horizontal	Site / Test Engineer	AC2 / Stanley
Test Mode	BT_TX_3-DH5_CH 0	Test Voltage	AC 120V/60Hz

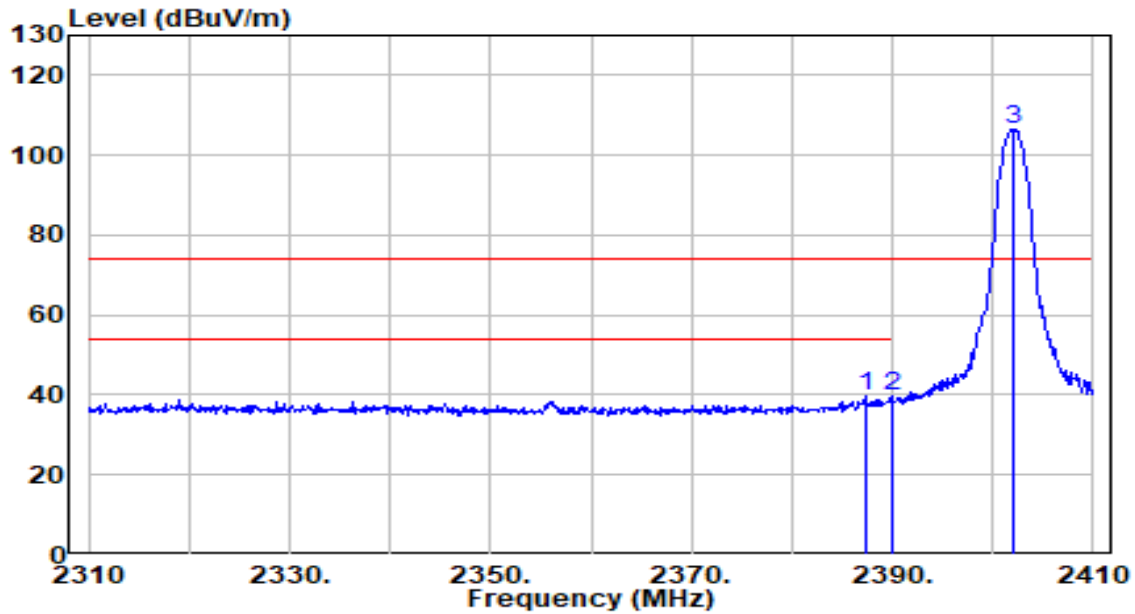

No	Frequency (MHz)	Reading (dBuV)	C.F (dB/m)	Measurement (dBuV/m)	Margin (dB)	Limit (dBuV/m)	Height (cm)	Angle (deg)	Remark (QP/PK/AV)
1	* 2387.300	45.14	-5.42	39.72	-34.28	74.00	162	237	Peak
2	2390.000	45.04	-5.41	39.63	-34.37	74.00	162	237	Peak
3	2402.100	111.91	-5.39	106.52	N/A	N/A	162	237	Peak

Note:

- "\*" means this data is the worst emission level.
- C.F (Correction Factor) = Antenna Factor (dB/m) + Cable Loss (dB) – Pre-amplifier(dB).
- Measurement (dBuV/m) = Reading(dBuV) + C.F (Correction Factor).
- The emission levels of other frequencies are very lower than the limit and not show in test report.

EUT	POS Terminal	Date of Test	2023-10-27
Factor	DRH18-E	Temp. / Humidity	23°C /61%
Polarity	Vertical	Site / Test Engineer	AC2 / Stanley
Test Mode	BT_TX_3-DH5_CH 0	Test Voltage	AC 120V/60Hz

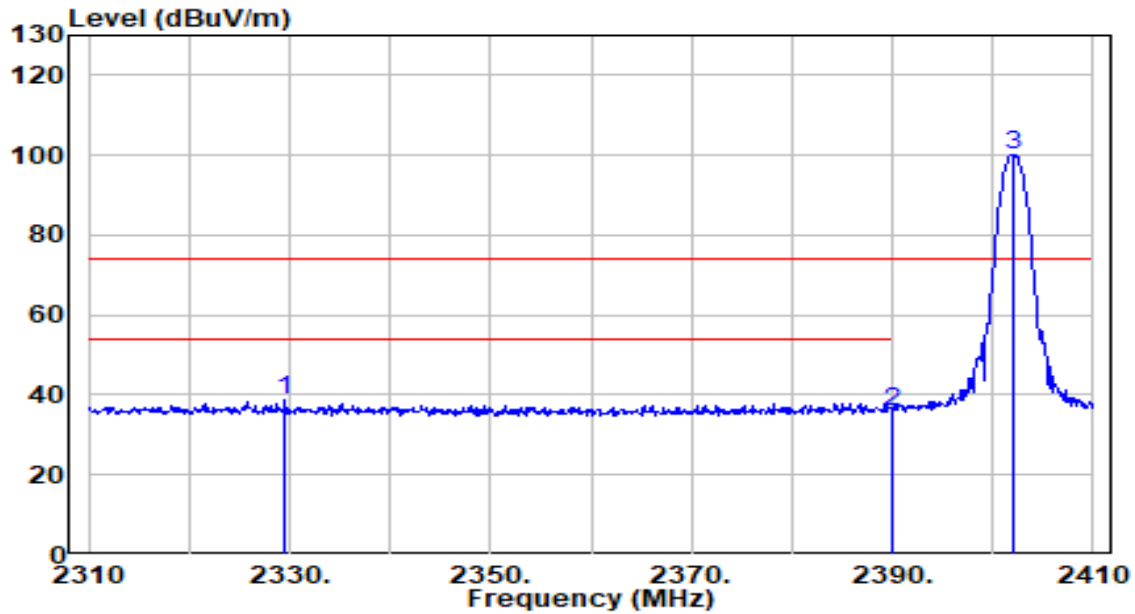

No	Frequency (MHz)	Reading (dBuV)	C.F (dB/m)	Measurement (dBuV/m)	Margin (dB)	Limit (dBuV/m)	Height (cm)	Angle (deg)	Remark (QP/PK/AV)
1	* 2329.600	44.44	-5.52	38.92	-35.08	74.00	292	0	Peak
2	2390.000	41.45	-5.41	36.04	-37.96	74.00	292	0	Peak
3	2402.000	105.71	-5.39	100.32	N/A	N/A	292	0	Peak

Note:

1. " \*", means this data is the worst emission level.
2. C.F (Correction Factor) = Antenna Factor (dB/m) + Cable Loss (dB) – Preamplifier(dB).
3. Measurement (dBuV/m) = Reading(dBuV) + C.F (Correction Factor).
4. The emission levels of other frequencies are very lower than the limit and not show in test report.

EUT	POS Terminal	Date of Test	2023-10-27
Factor	DRH18-E	Temp. / Humidity	23°C /61%
Polarity	Horizontal	Site / Test Engineer	AC2 / Stanley
Test Mode	BT_TX_3-DH5_CH 78	Test Voltage	AC 120V/60Hz

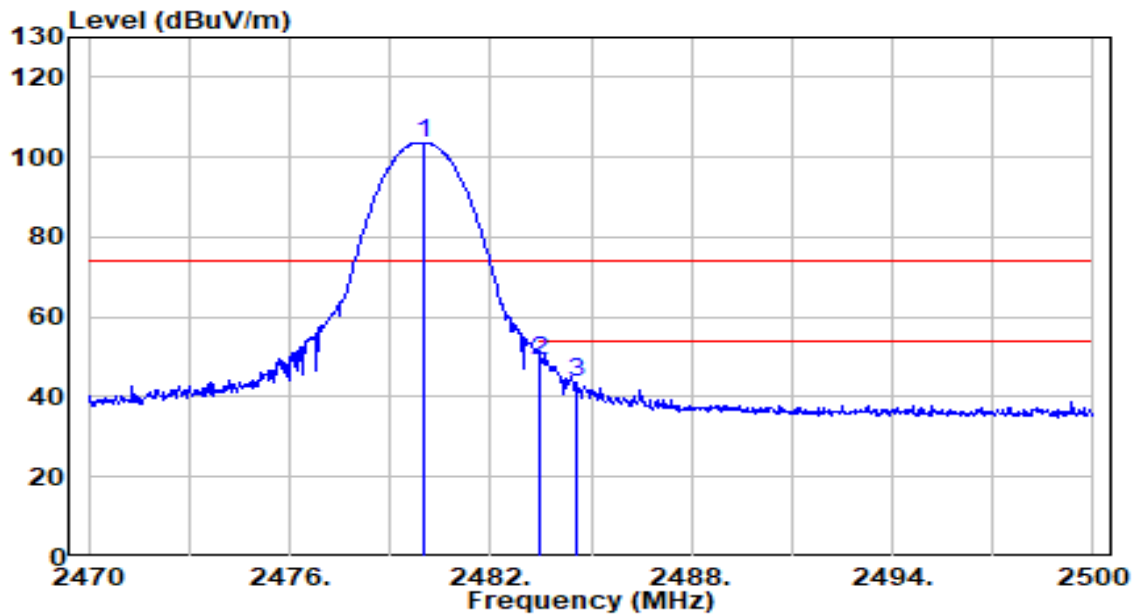

No	Frequency (MHz)	Reading (dBUV)	C.F (dB/m)	Measurement (dBUV/m)	Margin (dB)	Limit (dBUV/m)	Height (cm)	Angle (deg)	Remark (QP/PK/AV)
1	2479.990	109.06	-5.37	103.69	N/A	N/A	117	218	Peak
2	* 2483.500	54.53	-5.37	49.16	-24.84	74.00	117	218	Peak
3	2484.550	49.07	-5.37	43.70	-30.30	74.00	117	218	Peak

Note:

1. " \*", means this data is the worst emission level.
2. C.F (Correction Factor) = Antenna Factor (dB/m) + Cable Loss (dB) – Pre-amplifier(dB).
3. Measurement (dBUV/m) = Reading(dBUV) + C.F (Correction Factor).
4. The emission levels of other frequencies are very lower than the limit and not show in test report.

EUT	POS Terminal	Date of Test	2023-10-27
Factor	DRH18-E	Temp. / Humidity	23°C /61%
Polarity	Vertical	Site / Test Engineer	AC2 / Stanley
Test Mode	BT_TX_3-DH5_CH 78	Test Voltage	AC 120V/60Hz

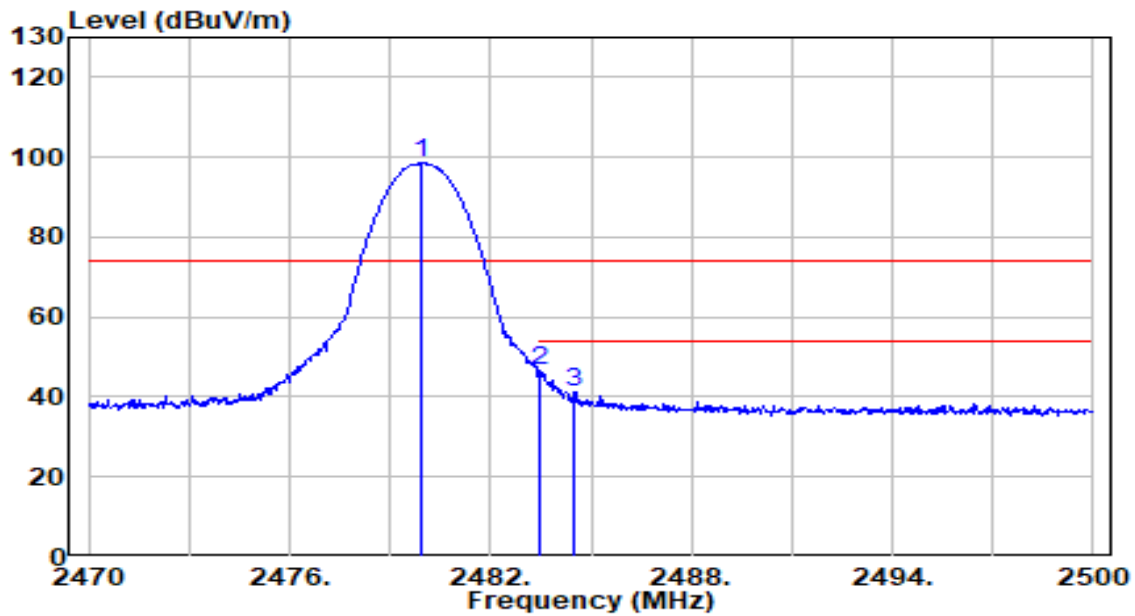

No	Frequency (MHz)	Reading (dBUV)	C.F (dB/m)	Measurement (dBUV/m)	Margin (dB)	Limit (dBUV/m)	Height (cm)	Angle (deg)	Remark (QP/PK/AV)
1	2479.930	103.84	-5.37	98.47	N/A	N/A	360	10	Peak
2	* 2483.500	51.92	-5.37	46.55	-27.45	74.00	360	10	Peak
3	2484.520	46.52	-5.37	41.16	-32.84	74.00	360	10	Peak

Note:

1. " \*", means this data is the worst emission level.
2. C.F (Correction Factor) = Antenna Factor (dB/m) + Cable Loss (dB) – Pre-amplifier(dB).
3. Measurement (dBUV/m) = Reading(dBUV) + C.F (Correction Factor).
4. The emission levels of other frequencies are very lower than the limit and not show in test report.

## 7.10. AC Conducted Emissions Measurement

### 7.10.1. Test Limit

FCC Part 15 Subpart C Paragraph 15.207 / RSS-Gen Limits		
Frequency (MHz)	QP (dB $\mu$ V)	Average (dB $\mu$ V)
0.15 - 0.50	66 - 56	56 - 46
0.50 - 5.0	56	46
5.0 - 30	60	50

Note 1: The lower limit shall apply at the transition frequencies.

Note 2: The limit decreases linearly with the logarithm of the frequency in the range 0.15MHz to 0.5MHz.

### 7.10.2. Test Setup

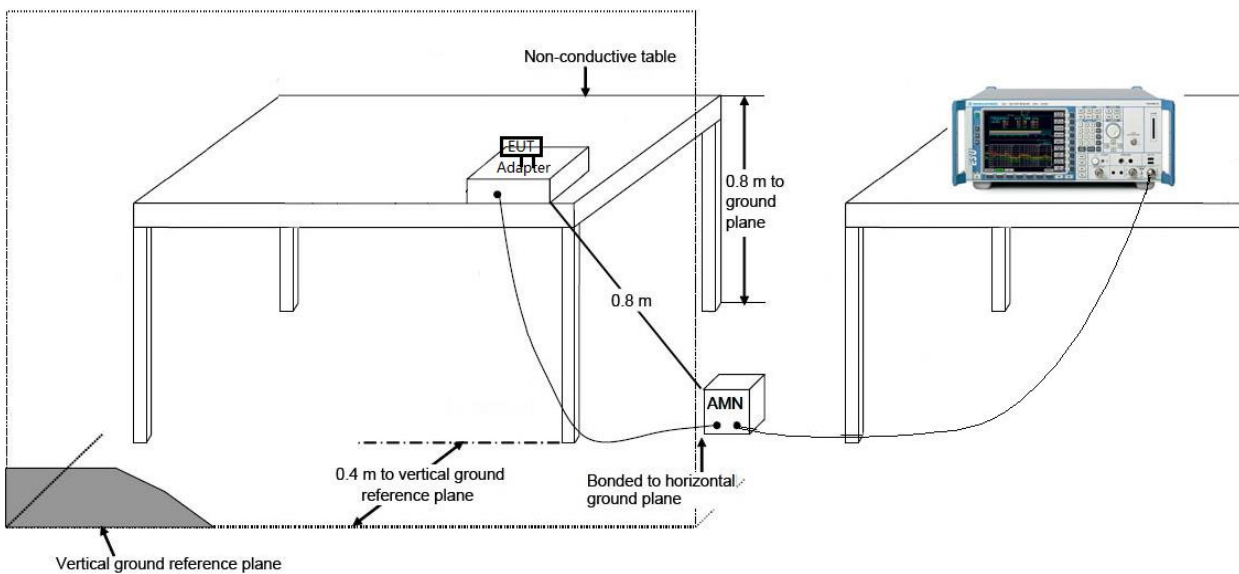



### 7.10.3. Test Result

EUT	POS Terminal	Date of Test	2023-11-30
Factor	CE_ENV216-L1 (Filter ON)	Temp. / Humidity	25.2°C /53%
Polarity	Line1	Site / Test Engineer	SR2 / Bob
Test Mode	BT_TX_DH5_CH 39	Test Voltage	AC 120V/60Hz

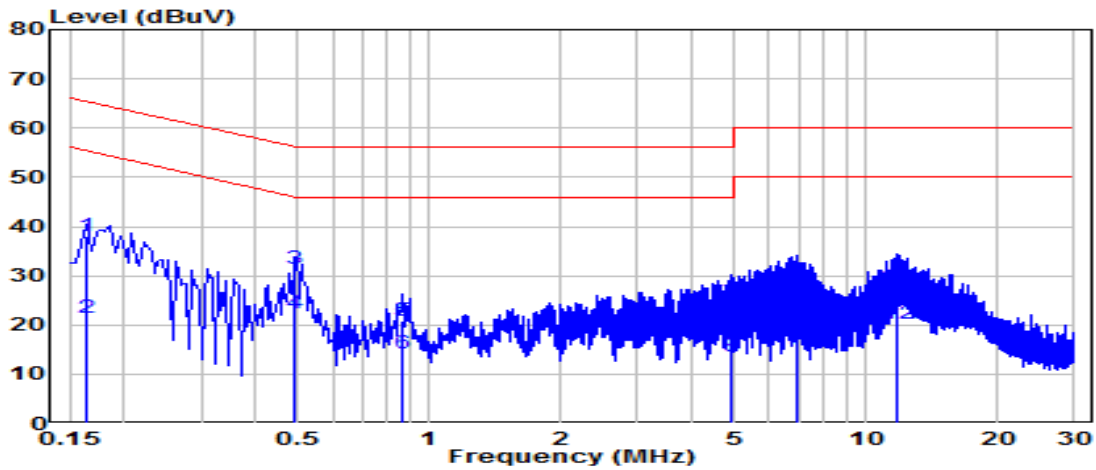

No	Frequency (MHz)	Reading (dBuV)	C.F (dB)	Measurement (dBuV)	Margin (dB)	Limit (dBuV)	Remark (QP/PK/AV)
1	0.163	28.44	9.62	38.06	-27.22	65.28	QP
2	0.163	11.93	9.62	21.55	-33.74	55.28	Average
3	* 0.492	21.76	9.64	31.40	-24.73	56.13	QP
4	* 0.492	12.60	9.64	22.24	-23.89	46.13	Average
5	0.870	11.17	9.66	20.83	-35.17	56.00	QP
6	0.870	4.60	9.66	14.27	-31.73	46.00	Average
7	4.915	14.74	9.74	24.49	-31.51	56.00	QP
8	4.915	3.93	9.74	13.68	-32.32	46.00	Average
9	6.935	18.85	9.79	28.64	-31.36	60.00	QP
10	6.935	5.39	9.79	15.18	-34.82	50.00	Average
11	11.759	18.03	9.87	27.90	-32.10	60.00	QP
12	11.759	10.48	9.87	20.35	-29.65	50.00	Average

Note:

1. " \*", means this data is the worst emission level.
2. C.F (Correction Factor) = LISN Factor (dB)+ Cable Loss (dB).
3. Measurement (dBuV) = Reading(dBuV) + C.F (Correction Factor).

EUT	POS Terminal	Date of Test	2023-11-30
Factor	CE_ENV216-N (Filter ON)	Temp. / Humidity	25.2°C /53%
Polarity	Neutral	Site / Test Engineer	SR2 / Bob
Test Mode	BT_TX_DH5_CH 39	Test Voltage	AC 120V/60Hz

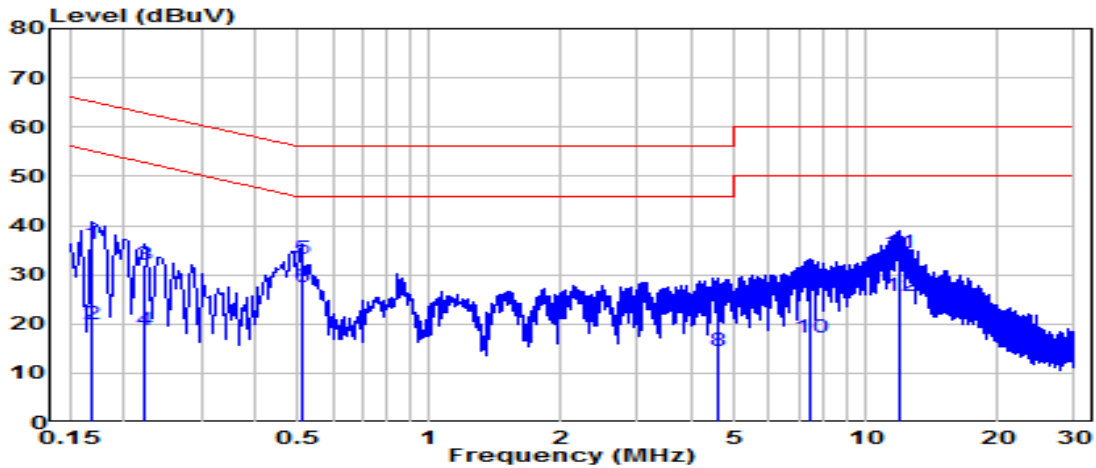

No	Frequency (MHz)	Reading (dBuV)	C.F (dB)	Measurement (dBuV)	Margin (dB)	Limit (dBuV)	Remark (QP/PK/AV)
1	0.168	26.61	9.62	36.23	-28.83	65.06	QP
2	0.168	10.16	9.62	19.79	-35.27	55.06	Average
3	0.222	22.46	9.62	32.09	-30.66	62.74	QP
4	0.222	9.19	9.62	18.82	-33.93	52.74	Average
5	* 0.510	23.69	9.64	33.34	-22.66	56.00	QP
6	* 0.510	17.68	9.64	27.32	-18.68	46.00	Average
7	4.564	12.67	9.74	22.40	-33.60	56.00	QP
8	4.564	4.84	9.74	14.58	-31.42	46.00	Average
9	7.435	18.11	9.81	27.92	-32.08	60.00	QP
10	7.435	7.51	9.81	17.32	-32.68	50.00	Average
11	11.912	24.49	9.89	34.38	-25.62	60.00	QP
12	11.912	15.91	9.89	25.81	-24.19	50.00	Average

Note:

1. " \*", means this data is the worst emission level.
2. C.F (Correction Factor) = LISN Factor (dB)+ Cable Loss (dB).
3. Measurement (dBuV) = Reading(dBuV) + C.F (Correction Factor).

EUT	POS Terminal	Date of Test	2023-11-30
Factor	CE_ENV216-L1 (Filter ON)	Temp. / Humidity	25.2°C /53%
Polarity	Line1	Site / Test Engineer	SR2 / Bob
Test Mode	BT_TX_DH5_CH 39	Test Voltage	AC 240V/60Hz

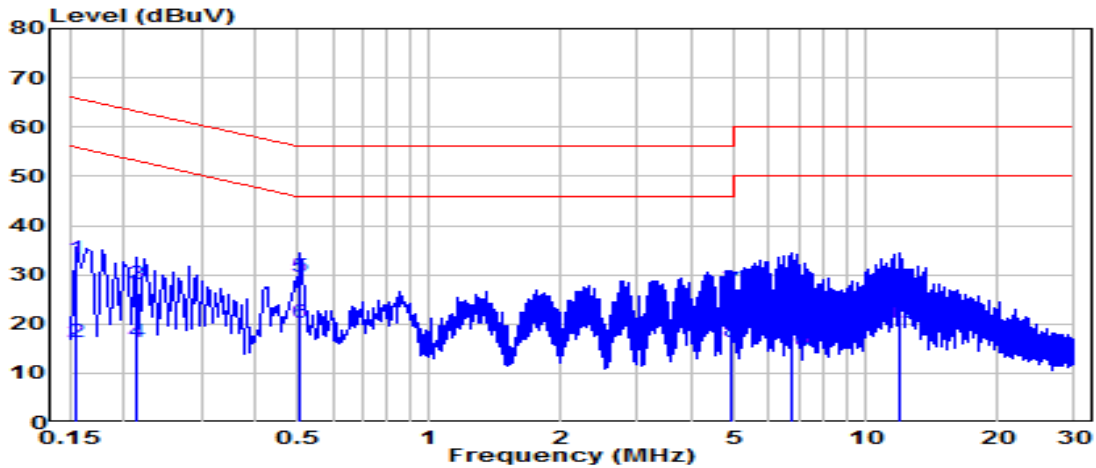

No	Frequency (MHz)	Reading (dBuV)	C.F (dB)	Measurement (dBuV)	Margin (dB)	Limit (dBuV)	Remark (QP/PK/AV)
1	0.154	23.66	9.62	33.28	-32.48	65.75	QP
2	0.154	6.75	9.62	16.37	-39.39	55.75	Average
3	0.213	18.39	9.62	28.01	-35.07	63.09	QP
4	0.213	6.53	9.62	16.15	-36.94	53.09	Average
5	* 0.505	20.02	9.64	29.66	-26.34	56.00	QP
6	* 0.505	10.64	9.64	20.28	-25.72	46.00	Average
7	4.929	17.27	9.74	27.01	-28.99	56.00	QP
8	4.929	6.49	9.74	16.24	-29.76	46.00	Average
9	6.773	17.40	9.79	27.19	-32.81	60.00	QP
10	6.773	4.72	9.79	14.51	-35.49	50.00	Average
11	11.939	17.52	9.87	27.39	-32.61	60.00	QP
12	11.939	10.39	9.87	20.26	-29.74	50.00	Average

Note:

1. " \*", means this data is the worst emission level.
2. C.F (Correction Factor) = LISN Factor (dB)+ Cable Loss (dB).
3. Measurement (dBuV) = Reading(dBuV) + C.F (Correction Factor).

EUT	POS Terminal	Date of Test	2023-11-30
Factor	CE_ENV216-N (Filter ON)	Temp. / Humidity	25.2°C /53%
Polarity	Neutral	Site / Test Engineer	SR2 / Bob
Test Mode	BT_TX_DH5_CH 39	Test Voltage	AC 240V/60Hz

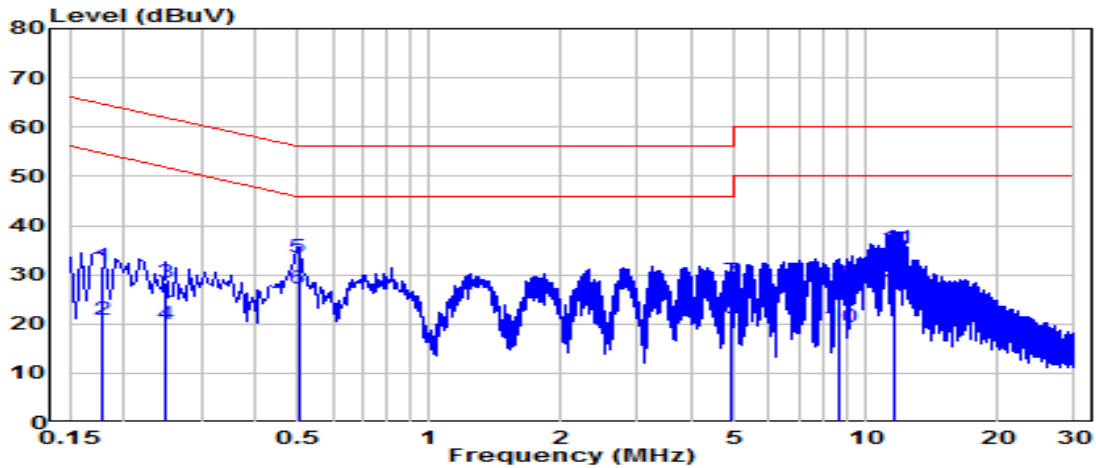

No	Frequency (MHz)	Reading (dBuV)	C.F (dB)	Measurement (dBuV)	Margin (dB)	Limit (dBuV)	Remark (QP/PK/AV)
1	0.177	21.93	9.62	31.55	-33.07	64.63	QP
2	0.177	11.22	9.62	20.84	-33.78	54.63	Average
3	0.249	18.82	9.63	28.45	-33.34	61.79	QP
4	0.249	10.19	9.63	19.82	-31.97	51.79	Average
5	*	0.501	23.79	33.43	-22.57	56.00	QP
6	*	0.501	17.42	27.06	-18.94	46.00	Average
7	4.902	18.90	9.75	28.65	-27.35	56.00	QP
8	4.902	11.45	9.75	21.20	-24.80	46.00	Average
9	8.713	18.58	9.84	28.42	-31.58	60.00	QP
10	8.713	9.52	9.84	19.36	-30.64	50.00	Average
11	11.664	25.46	9.89	35.35	-24.65	60.00	QP
12	11.664	16.77	9.89	26.66	-23.34	50.00	Average

Note:

1. " \*", means this data is the worst emission level.
2. C.F (Correction Factor) = LISN Factor (dB)+ Cable Loss (dB).
3. Measurement (dBuV) = Reading(dBuV) + C.F (Correction Factor).

## 8. CONCLUSION

The data collected relate only the item(s) tested and show that the **POS Terminal** is in compliance with Part 15C of the FCC Rules.

## **Appendix A : Test Photograph**

Refer to “2310TW8705-UT” file.

## **Appendix B : External Photograph**

Refer to “2310TW8705-UE” file.

## **Appendix C : Internal Photograph**

Refer to “2310TW8705-UI” file.

————— The End —————