

TEST REPORT

CERTIFICATE OF CONFORMITY

Standard: 47 CFR FCC Part 22, Subpart H
47 CFR FCC Part 24, Subpart E
47 CFR FCC Part 27, Subpart C, M
47 CFR FCC Part 2, Subpart C, H, F, L

Report No.: RFBBGM-WTW-P23070647

FCC ID: WIYSLM500QA

Product: Smart module

Brand:  **CASTLES**
TECHNOLOGY

Model No.: SLM500

Received Date: 2023/7/26

Test Date: 2023/8/8 ~ 2023/8/16

Issued Date: 2023/9/11

Applicant: CASTLES TECHNOLOGY CO., LTD.

Address: 6F, NO. 207-5, SEC. 3, BEIXIN RD., XINDIAN DISTRICT, NEW TAIPEI CITY 23143,
TAIWAN (R. O. C.)

Issued By: Bureau Veritas Consumer Products Services (H.K.) Ltd., Taoyuan Branch
Lin Kou Laboratories

Lab Address: No. 47-2, 14th Ling, Chia Pau Vil., Lin Kou Dist., New Taipei City, Taiwan

Test Location (1): No. 19, Hwa Ya 2nd Rd., Wen Hwa Vil., Kwei Shan Dist., Taoyuan City 33383, TAIWAN

FCC Registration / 788550 / TW0003

Designation Number:

Test Location (2): No. 70, Wenming Rd., Guishan Dist., Taoyuan City 333, Taiwan (R.O.C.)

FCC Registration / 281270 / TW0032

Designation Number:

Approved by: Jeremy Lin , **Date:** 2023/9/11
Jeremy Lin / Project Engineer

This test report consists of 232 pages in total. It may be duplicated completely for legal use with the approval of the applicant. It should not be reproduced except in full, without the written approval of our laboratory. The test results in the report only apply to the tested sample. The test results in this report are traceable to the national or international standards.



Prepared by : Gina Liu / Specialist

This report is governed by, and incorporates by reference, the Conditions of Testing as posted at the date of issuance of this report at <http://www.bureauveritas.com/home/about-us/our-business/cps/about-us/terms-conditions/> and is intended for your exclusive use. Any copying or replication of this report to or for any other person or entity, or use of our name or trademark, is permitted only with our prior written permission. This report sets forth our findings solely with respect to the test samples identified herein. The results set forth in this report are not indicative or representative of the quality or characteristics of the lot from which a test sample was taken or any similar or identical product unless specifically and expressly noted. Our report includes all of the tests requested by you and the results thereof based upon the information that you provided to us. Measurement uncertainty is only provided upon request for accredited tests. Statements of conformity are based on simple acceptance criteria without taking measurement uncertainty into account, unless otherwise requested in writing. You have 60 days from date of issuance of this report to notify us of any material error or omission caused by our negligence or if you require measurement uncertainty; provided, however, that such notice shall be in writing and shall specifically address the issue you wish to raise. A failure to raise such issue within the prescribed time shall constitute your unqualified acceptance of the completeness of this report, the tests conducted and the correctness of the report contents.

Table of Contents

Release Control Record	4
1 Certificate	5
2 Summary of Test Results	6
2.1 Measurement Uncertainty	8
2.2 Supplementary Information	8
3 General Information	9
3.1 General Description of EUT	9
3.2 Antenna Description of EUT	12
3.3 Test Mode Applicability and Tested Channel Detail	13
3.4 Test Program Used and Operation Descriptions	22
3.5 Connection Diagram of EUT and Peripheral Devices	22
3.6 Configuration of Peripheral Devices and Cable Connections	23
4 Test Instruments	24
4.1 Effective Radiated Power and Equivalent Isotropically Radiated Power	24
4.2 Radiated Spurious Emissions below 1GHz	24
4.3 Radiated Spurious Emissions above 1GHz	25
5 Limits of Test Items	26
5.1 Effective Radiated Power and Equivalent Isotropically Radiated Power	26
5.2 Radiated Spurious Emissions below 1GHz	27
5.3 Radiated Spurious Emissions above 1GHz	28
6 Test Arrangements	29
6.1 Effective Radiated Power and Equivalent Isotropically Radiated Power	29
6.1.1 Test Setup	29
6.1.2 Test Procedure	29
6.2 Radiated Spurious Emissions below 1GHz	30
6.2.1 Test Setup	30
6.2.2 Test Procedure	30
6.3 Radiated Spurious Emissions above 1GHz	31
6.3.1 Test Setup	31
6.3.2 Test Procedure	31
7 Test Results of Test Item	32
7.1 Effective Radiated Power and Equivalent Isotropically Radiated Power	32
7.1.1 GSM850	32
7.1.2 PCS1900	32
7.1.3 WCDMA Band 2	33
7.1.4 WCDMA Band 4	33
7.1.5 WCDMA Band 5	34
7.1.6 LTE Band 2	35
7.1.7 LTE Band 4	41
7.1.8 LTE Band 5	47
7.1.9 LTE Band 7	51
7.1.10 LTE Band 12	55
7.1.11 LTE Band 13	59
7.1.12 LTE Band 17	61
7.1.13 LTE Band 25	63
7.1.14 LTE Band 26 (Part 22)	69
7.1.15 LTE Band 26 (Part 90)	75
7.1.16 LTE Band 66	81
7.2 Radiated Spurious Emissions below 1GHz	87
7.2.1 GSM 850	87
7.2.2 PCS 1900	91
7.2.3 WCDMA Band 2	95



7.2.4	WCDMA Band 4	97
7.2.5	WCDMA Band 5	99
7.2.6	LTE Band 2	101
7.2.7	LTE Band 4	103
7.2.8	LTE Band 5	105
7.2.9	LTE Band 7	107
7.2.10	LTE Band 12	109
7.2.11	LTE Band 13	111
7.2.12	LTE Band 17	113
7.2.13	LTE Band 25	115
7.2.14	LTE Band 26	117
7.2.15	LTE Band 66	121
7.3	Radiated Spurious Emissions above 1GHz	123
7.3.1	GSM 850	123
7.3.2	PCS 1900	129
7.3.3	WCDMA Band 2	135
7.3.4	WCDMA Band 4	138
7.3.5	WCDMA Band 5	141
7.3.6	LTE Band 2	144
7.3.7	LTE Band 4	153
7.3.8	LTE Band 5	162
7.3.9	LTE Band 7	171
7.3.10	LTE Band 12	177
7.3.11	LTE Band 13	186
7.3.12	LTE Band 17	190
7.3.13	LTE Band 25	196
7.3.14	LTE Band 26	205
7.3.15	LTE Band 66	222
8	Pictures of Test Arrangements	231
9	Information of the Testing Laboratories	232

Release Control Record

Issue No.	Description	Date Issued
RFBBGM-WTW-P23070647	Original release.	2023/9/11

1 Certificate

Product: Smart module

Brand:  **CASTLES**
TECHNOLOGY

Test Model: SLM500

Sample Status: Identical Prototype

Applicant: CASTLES TECHNOLOGY CO., LTD.

Test Date: 2023/8/8 ~ 2023/8/16

Standard: 47 CFR FCC Part 22
47 CFR FCC Part 24
47 CFR FCC Part 27
47 CFR FCC Part 2

Measurement ANSI/TIA/EIA-603-E 2016

procedure: ANSI C63.26-2015

KDB 971168 D01 Power Meas License Digital Systems v03r01

KDB 971168 D02 Misc Rev Approv License Devices v02r02

The above equipment has been tested by **Bureau Veritas Consumer Products Services (H.K.) Ltd., Taoyuan Branch**, and found compliance with the requirement of the above standards. The test record, data evaluation & Equipment Under Test (EUT) configurations represented herein are true and accurate accounts of the measurements of the sample's RF characteristics under the conditions specified in this report.

2 Summary of Test Results

47 CFR FCC Part 22
 47 CFR FCC Part 24
 47 CFR FCC Part 27
 47 CFR FCC Part 90
 47 CFR FCC Part 2

Standard / Clause	Test Item	Result	Remark
FCC 47 CFR Part 2.1046 FCC 47 CFR Part 22.913 (a) FCC 47 CFR Part 24.232 (c) FCC 47 CFR Part 27.50(d) FCC 47 CFR Part 27.50(h) FCC 47 CFR Part 27.50(c) FCC 47 CFR Part 27.50(b) FCC 47 CFR Part 90.635(b)	Effective Radiated Power and Equivalent Isotropically Radiated Power	Pass	Meet the requirement of limit.
FCC 47 CFR Part 2.1047	Modulation Characteristics	NA	Refer to Note
FCC 47 CFR Part 22.913 (d) FCC 47 CFR Part 24.232 (d) FCC 47 CFR Part 27.50(d)	Peak to Average Ratio	NA	Refer to Note
FCC 47 CFR Part 2.1049	Bandwidth	NA	Refer to Note
FCC 47 CFR Part 2.1051 FCC 47 CFR Part 22.917 FCC 47 CFR Part 24.238 FCC 47 CFR Part 27.53(h) FCC 47 CFR Part 27.53(m) FCC 47 CFR Part 27.53(g) FCC 47 CFR Part 27.53(c)(f) FCC 47 CFR Part 90.691	Conducted Spurious Emissions	NA	Refer to Note



47 CFR FCC Part 22
47 CFR FCC Part 24
47 CFR FCC Part 27
47 CFR FCC Part 90
47 CFR FCC Part 2

Standard / Clause	Test Item	Result	Remark
FCC 47 CFR Part 2.1053 FCC 47 CFR Part 22.917 FCC 47 CFR Part 24.238 FCC 47 CFR Part 27.53(h) FCC 47 CFR Part 27.53(m) FCC 47 CFR Part 27.53(g) FCC 47 CFR Part 27.53(c)(f) FCC 47 CFR Part 90.691	Radiated Spurious Emissions below 1GHz	Pass	Minimum passing margin is -25.22 dB at 89.48 MHz
FCC 47 CFR Part 2.1053 FCC 47 CFR Part 22.917 FCC 47 CFR Part 24.238 FCC 47 CFR Part 27.53(h) FCC 47 CFR Part 27.53(m) FCC 47 CFR Part 27.53(g) FCC 47 CFR Part 27.53(c)(f) FCC 47 CFR Part 90.691	Radiated Spurious Emissions above 1GHz	Pass	Minimum passing margin is -6.85 dB at 1564.00 MHz
FCC 47 CFR Part 2.1055 FCC 47 CFR Part 22.355 FCC 47 CFR Part 24.235 FCC 47 CFR Part 27.54 FCC 47 CFR Part 90.213	Frequency Stability	NA	Refer to Note

Note:

1. This report is prepared for FCC class II permissive change. Therefore, only test item Effective Radiated Power / Equivalent Isotropically Radiated Power and Radiated Spurious Emissions were performed for this report. Other testing data please refer to SGS report no.: SZCR210300003006 & SZCR210300003007
2. Determining compliance based on the results of the compliance measurement, not taking into account measurement instrumentation uncertainty.

2.1 Measurement Uncertainty

Where relevant, the following measurement uncertainty levels have been estimated for tests performed on the EUT as specified in CISPR 16-4-2:

Measurement	Specification	Expanded Uncertainty (k=2) (±)
Radiated Spurious Emissions below 1GHz	9 kHz ~ 30 MHz	3.00 dB
	30 MHz ~ 1 GHz	2.93 dB
Radiated Spurious Emissions above 1GHz	1 GHz ~ 18 GHz	1.76 dB
	18 GHz ~ 40 GHz	1.77 dB

The other instruments specified are routine verified to remain within the calibrated levels, no measurement uncertainty is required to be calculated.

2.2 Supplementary Information

There is not any deviation from the test standards for the test method, and no modifications required for compliance.

3 General Information

3.1 General Description of EUT

Product	Smart module
Brand	 CASTLES TECHNOLOGY
Test Model	SLM500
Status of EUT	Identical Prototype
Power Supply Rating	Refer to note

Note:

1. EUT Overview

Band / Bandwidth	TX Frequency Range (MHz)	Max. EIRP Power
PCS1900	1850.2-1909.8	824.138mW (29.16dBm)
EDGE1900		
WCDMA Band 2	1852.4-1907.6	143.880mW (21.58dBm)
WCDMA Band 4	1712.4-1752.6	279.898mW (24.47dBm)

Band / Bandwidth	TX Frequency Range (MHz)	Max. ERP Power
GSM850	824.2-848.8	618.016mW (27.91dBm)
EDGE850		
WCDMA Band 5	826.4-846.6	90.365mW (19.56dBm)

Band / Bandwidth	TX Frequency Range (MHz)	Max. EIRP Power	
		QPSK	16QAM
LTE Band 2 (Channel Bandwidth 1.4MHz)	1850.7-1909.3	152.757mW (21.84dBm)	124.451mW (20.95dBm)
LTE Band 2 (Channel Bandwidth 3MHz)	1851.5-1908.5	154.170mW (21.88dBm)	129.420mW (21.12dBm)
LTE Band 2 (Channel Bandwidth 5MHz)	1852.5-1907.5	151.356mW (21.80dBm)	127.938mW (21.07dBm)
LTE Band 2 (Channel Bandwidth 10MHz)	1855.0-1905.0	151.705mW (21.81dBm)	127.350mW (21.05dBm)
LTE Band 2 (Channel Bandwidth 15MHz)	1857.5-1902.5	153.109mW (21.85dBm)	128.825mW (21.10dBm)
LTE Band 2 (Channel Bandwidth 20MHz)	1860.0-1900.0	154.882mW (21.90dBm)	130.017mW (21.14dBm)
LTE Band 4 (Channel Bandwidth 1.4MHz)	1710.7-1754.3	195.434mW (22.91dBm)	164.437mW (22.16dBm)
LTE Band 4 (Channel Bandwidth 3MHz)	1711.5-1753.5	194.089mW (22.88dBm)	165.196mW (22.18dBm)
LTE Band 4 (Channel Bandwidth 5MHz)	1712.5-1752.5	195.884mW (22.92dBm)	166.341mW (22.21dBm)
LTE Band 4 (Channel Bandwidth 10MHz)	1715.0-1750.0	195.434mW (22.91dBm)	165.959mW (22.20dBm)
LTE Band 4 (Channel Bandwidth 15MHz)	1717.5-1747.5	195.884mW (22.92dBm)	166.341mW (22.21dBm)
LTE Band 4 (Channel Bandwidth 20MHz)	1720.0-1745.0	196.789mW (22.94dBm)	160.694mW (22.06dBm)

Band / Bandwidth	TX Frequency Range (MHz)	Max. EIRP Power	
		QPSK	16QAM
LTE Band 7 (Channel Bandwidth 5MHz)	2502.5-2567.5	153.109mW (21.85dBm)	127.644mW (21.06dBm)
LTE Band 7 (Channel Bandwidth 10MHz)	2505.0-2565.0	155.597mW (21.92dBm)	127.350mW (21.05dBm)
LTE Band 7 (Channel Bandwidth 15MHz)	2507.5-2562.5	155.239mW (21.91dBm)	131.522mW (21.19dBm)
LTE Band 7 (Channel Bandwidth 20MHz)	2510.0-2560.0	157.036mW (21.96dBm)	133.352mW (21.25dBm)
LTE Band 25 (Channel Bandwidth 1.4MHz)	1850.7-1914.3	181.134mW (22.58dBm)	148.594mW (21.72dBm)
LTE Band 25 (Channel Bandwidth 3MHz)	1851.5-1913.5	179.887mW (22.55dBm)	144.877mW (21.61dBm)
LTE Band 25 (Channel Bandwidth 5MHz)	1852.5-1912.5	181.134mW (22.58dBm)	149.968mW (21.76dBm)
LTE Band 25 (Channel Bandwidth 10MHz)	1855.0-1910.0	175.792mW (22.45dBm)	142.889mW (21.55dBm)
LTE Band 25 (Channel Bandwidth 15MHz)	1857.5-1907.5	179.887mW (22.55dBm)	148.936mW (21.73dBm)
LTE Band 25 (Channel Bandwidth 20MHz)	1860.0-1905.0	176.604mW (22.47dBm)	143.549mW (21.57dBm)
LTE Band 66 (Channel Bandwidth 1.4 MHz)	1710.7-1779.3	222.844mW (23.48dBm)	184.927mW (22.67dBm)
LTE Band 66 (Channel Bandwidth 3MHz)	1711.5-1778.5	223.872mW (23.50dBm)	188.799mW (22.76dBm)
LTE Band 66 (Channel Bandwidth 5MHz)	1712.5-1777.5	225.424mW (23.53dBm)	190.985mW (22.81dBm)
LTE Band 66 (Channel Bandwidth 10MHz)	1715.0-1775.0	225.944mW (23.54dBm)	189.671mW (22.78dBm)
LTE Band 66 (Channel Bandwidth 15MHz)	1717.5-1772.5	221.309mW (23.45dBm)	185.780mW (22.69dBm)
LTE Band 66 (Channel Bandwidth 20MHz)	1720.0-1770.0	226.464mW (23.55dBm)	188.799mW (22.76dBm)

Band / Bandwidth		TX Frequency Range (MHz)	Max. ERP Power	
			QPSK	16QAM
LTE Band 5 (Channel Bandwidth 1.4MHz)		824.7-848.3	76.913mW (18.86dBm)	65.313mW (18.15dBm)
LTE Band 5 (Channel Bandwidth 3MHz)		825.5-847.5	82.414mW (19.16dBm)	69.024mW (18.39dBm)
LTE Band 5 (Channel Bandwidth 5MHz)		826.5-846.5	78.886mW (18.97dBm)	66.834mW (18.25dBm)
LTE Band 5 (Channel Bandwidth 10MHz)		829.0-844.0	92.257mW (19.65dBm)	78.343mW (18.94dBm)
LTE Band 12 (Channel Bandwidth 1.4MHz)		699.7-715.3	78.886mW (18.97dBm)	65.313mW (18.15dBm)
LTE Band 12 (Channel Bandwidth 3MHz)		700.5-714.5	76.913mW (18.86dBm)	65.013mW (18.13dBm)
LTE Band 12 (Channel Bandwidth 5MHz)		701.5-713.5	78.343mW (18.94dBm)	64.565mW (18.10dBm)
LTE Band 12 (Channel Bandwidth 10MHz)		704.0-711.0	81.846mW (19.13dBm)	68.077mW (18.33dBm)
LTE Band 13 (Channel Bandwidth 5MHz)		779.5-784.5	92.683mW (19.67dBm)	66.527mW (18.23dBm)
LTE Band 13 (Channel Bandwidth 10MHz)		782.0	92.897mW (19.68dBm)	64.121mW (18.07dBm)
LTE Band 17 (Channel Bandwidth 5MHz)		706.5-713.5	81.846mW (19.13dBm)	68.234mW (18.34dBm)
LTE Band 17 (Channel Bandwidth 10MHz)		709.0-711.0	83.176mW (19.20dBm)	70.469mW (18.48dBm)
For Part 22	LTE Band 26 (Channel Bandwidth 1.4MHz)	824.7-848.3	86.497mW (19.37dBm)	71.121mW (18.52dBm)
	LTE Band 26 (Channel Bandwidth 3MHz)	825.5-847.5	86.497mW (19.37dBm)	71.779mW (18.56dBm)
	LTE Band 26 (Channel Bandwidth 5MHz)	826.5-846.5	87.498mW (19.42dBm)	71.285mW (18.53dBm)
	LTE Band 26 (Channel Bandwidth 10MHz)	829.0-844.0	88.512mW (19.47dBm)	71.450mW (18.54dBm)
	LTE Band 26 (Channel Bandwidth 15MHz)	831.5-841.5	88.716mW (19.48dBm)	69.823mW (18.44dBm)
For Part 90	LTE Band 26 (Channel Bandwidth 1.4MHz)	814.7-823.3	84.333mW (19.26dBm)	70.795mW (18.50dBm)
	LTE Band 26 (Channel Bandwidth 3MHz)	815.5-822.5	84.723mW (19.28dBm)	70.632mW (18.49dBm)
	LTE Band 26 (Channel Bandwidth 5MHz)	816.5-821.5	84.528mW (19.27dBm)	71.285mW (18.53dBm)
	LTE Band 26 (Channel Bandwidth 10MHz)	819.0	87.902mW (19.44dBm)	72.277mW (18.59dBm)
	LTE Band 26 (Channel Bandwidth 15MHz)	821.5	85.310mW (19.31dBm)	70.632mW (18.49dBm)

2. The EUT is authorized for use in specific End-product. Please refer to below table for more details.

Product Name	Brand Name	Model No.
POS Terminal		S1P

3. The EUT uses following accessories.

AC Adapter		
Brand	Model	Specification
ABP	ABP AD0181-1201000UC	AC Input : 100-240Vac, 50-60Hz, 0.5A Max DC Output : 12.0Vdc, 1.0A, 12.0W Plug : US Plug Manufacturer : SHENZHEN ABP TECHNOLOGY CO., LTD
1 To 3 Cable		
Brand	Model	Specification
CHANG YANG	cy-as-hk0109	2.02M

4. The above EUT information is declared by manufacturer and for more detailed features description, please refers to the manufacturer's specifications or user's manual.

3.2 Antenna Description of EUT

1. The antenna information is listed as below.

Antenna Type		Monopole	
Antenna Connector		N/A	
Item	Band	Gain (dBi)	
		Main Ant. 1	Aux. Ant. 2
LTE	Band 2	1.25	1.20
	Band 4	1.25	1.20
	Band 5	-1.18	-3.01
	Band 7	1.25	1.20
	Band 12	-1.18	-3.01
	Band 13	-1.18	-3.01
	Band 17	-1.18	-3.01
	Band 25	1.25	1.20
	Band 26	-1.18	-3.01
	Band 66	1.25	1.20
WCDMA	Band 2	1.25	1.20
	Band 4	1.25	1.20
	Band 5	-1.18	-3.01
GSM	850	-1.18	-3.01
	1900	1.25	1.20

* Detail antenna specification please refer to antenna datasheet and/or antenna measurement report.

3.3 Test Mode Applicability and Tested Channel Detail

Pre-Scan:	EUT can be used in the following ways: X-axis/ Y-axis/ Z-axis. Pre-scan these ways and find the worst case as a representative test condition.
Worst Case:	X-axis/ Y-axis/ Z-axis Worst Condition: Z-axis

For GSM850

Test Item	Tested Channel	Channel Bandwidth	Modulation	Mode
ERP	128 (824.20 MHz) 189 (836.40 MHz) 251 (848.80 MHz)	-	-	GSM, EDGE
RE Below 1GHz	189 (836.40 MHz)	-	-	GSM, EDGE
RE Above 1GHz	128 (824.20 MHz) 189 (836.40 MHz) 251 (848.80 MHz)	-	-	GSM, EDGE

For PCS1900

Test Item	Tested Channel	Channel Bandwidth	Modulation	Mode
EIRP	512 (1850.20 MHz) 661 (1880.00 MHz) 810 (1909.80 MHz)	-	-	GSM, EDGE
RE Below 1GHz	512 (1850.20 MHz)	-	-	GSM, EDGE
RE Above 1GHz	512 (1850.20 MHz) 661 (1880.00 MHz) 810 (1909.80 MHz)	-	-	GSM, EDGE

For WCDMA Band 2

Test Item	Tested Channel	Channel Bandwidth	Modulation	Mode
EIRP	9262 (1852.40 MHz) 9400 (1880.00 MHz) 9538 (1907.60 MHz)	-	-	WCDMA HSDPA HSUPA
RE Below 1GHz	9538 (1907.60 MHz)	-	-	WCDMA
RE Above 1GHz	9262 (1852.40 MHz) 9400 (1880.00 MHz) 9538 (1907.60 MHz)	-	-	WCDMA

For WCDMA Band 4

Test Item	Tested Channel	Channel Bandwidth	Modulation	Mode
EIRP	1312 (1712.40 MHz) 1413 (1732.60 MHz) 1513 (1752.60 MHz)	-	-	WCDMA HSDPA HSUPA
RE Below 1GHz	1513 (1752.60 MHz)	-	-	WCDMA
RE Above 1GHz	1312 (1712.40 MHz) 1413 (1732.60 MHz) 1513 (1752.60 MHz)	-	-	WCDMA

For WCDMA Band 5

Test Item	Tested Channel	Channel Bandwidth	Modulation	Mode
ERP	4132 (826.40 MHz) 4182 (836.40 MHz) 4233 (846.60 MHz)	-	-	WCDMA HSDPA HSUPA
RE Below 1GHz	4132 (826.40 MHz)	-	-	WCDMA
RE Above 1GHz	4132 (826.40 MHz) 4182 (836.40 MHz) 4233 (846.60 MHz)	-	-	WCDMA

For LTE Band 2

Test Item	Tested Channel	Channel Bandwidth	Modulation	Mode
EIRP	18607 (1850.70 MHz) 18900 (1880.00 MHz) 19193 (1909.30 MHz)	1.4 MHz	QPSK / 16QAM	1 RB Half RB Full RB
	18615 (1851.50 MHz) 18900 (1880.00 MHz) 19185 (1908.50 MHz)	3 MHz	QPSK / 16QAM	1 RB Half RB Full RB
	18625 (1852.50 MHz) 18900 (1880.00 MHz) 19175 (1907.50 MHz)	5 MHz	QPSK / 16QAM	1 RB Half RB Full RB
	18650 (1855.00 MHz) 18900 (1880.00 MHz) 19150 (1905.00 MHz)	10 MHz	QPSK / 16QAM	1 RB Half RB Full RB
	18675 (1857.50 MHz) 18900 (1880.00 MHz) 19125 (1902.50 MHz)	15 MHz	QPSK / 16QAM	1 RB Half RB Full RB
	18700 (1860.00 MHz) 18900 (1880.00 MHz) 19100 (1900.00 MHz)	20 MHz	QPSK / 16QAM	1 RB Half RB Full RB
RE Below 1GHz	19175 (1907.50 MHz)	5 MHz	QPSK	1 RB
RE Above 1GHz	18607 (1850.70 MHz) 18900 (1880.00 MHz) 19193 (1909.30 MHz)	1.4 MHz	QPSK	1 RB
	18625 (1852.50 MHz) 18900 (1880.00 MHz) 19175 (1907.50 MHz)	5 MHz	QPSK	1 RB
	18700 (1860.00 MHz) 18900 (1880.00 MHz) 19100 (1900.00 MHz)	20 MHz	QPSK	1 RB

For LTE Band 4

Test Item	Tested Channel	Channel Bandwidth	Modulation	Mode
EIRP	19957 (1710.70 MHz) 20175 (1732.50 MHz) 20393 (1754.30 MHz)	1.4 MHz	QPSK / 16QAM	1 RB Half RB Full RB
	19965 (1711.50 MHz) 20175 (1732.50 MHz) 20385 (1753.50 MHz)	3 MHz	QPSK / 16QAM	1 RB Half RB Full RB
	19975 (1712.50 MHz) 20175 (1732.50 MHz) 20375 (1752.50 MHz)	5 MHz	QPSK / 16QAM	1 RB Half RB Full RB
	20000 (1715.00 MHz) 20175 (1732.50 MHz) 20350 (1750.00 MHz)	10 MHz	QPSK / 16QAM	1 RB Half RB Full RB
	20025 (1717.50 MHz) 20175 (1732.50 MHz) 20325 (1747.50 MHz)	15 MHz	QPSK / 16QAM	1 RB Half RB Full RB
	20050 (1720.00 MHz) 20175 (1732.50 MHz) 20300 (1745.00 MHz)	20 MHz	QPSK / 16QAM	1 RB Half RB Full RB
RE Below 1GHz	20175 (1732.50 MHz)	20 MHz	QPSK	1 RB
RE Above 1GHz	19957 (1710.70 MHz) 20175 (1732.50 MHz) 20393 (1754.30 MHz)	1.4 MHz	QPSK	1 RB
	19975 (1712.50 MHz) 20175 (1732.50 MHz) 20375 (1752.50 MHz)	5 MHz	QPSK	1 RB
	20050 (1720.00 MHz) 20175 (1732.50 MHz) 20300 (1745.00 MHz)	20 MHz	QPSK	1 RB

For LTE Band 5

Test Item	Tested Channel	Channel Bandwidth	Modulation	Mode
ERP	20407 (824.70 MHz) 20525 (836.50 MHz) 20643 (848.30 MHz)	1.4 MHz	QPSK / 16QAM	1 RB Half RB Full RB
	20415 (825.50 MHz) 20525 (836.50 MHz) 20635 (847.50 MHz)	3 MHz	QPSK / 16QAM	1 RB Half RB Full RB
	20425 (826.50 MHz) 20525 (836.50 MHz) 20625 (846.50 MHz)	5 MHz	QPSK / 16QAM	1 RB Half RB Full RB
	20450 (829.00 MHz) 20525 (836.50 MHz) 20600 (844.00 MHz)	10 MHz	QPSK / 16QAM	1 RB Half RB Full RB
RE Below 1GHz	20525 (836.50 MHz)	10 MHz	QPSK	1 RB
RE Above 1GHz	20407 (824.70 MHz) 20525 (836.50 MHz) 20643 (848.30 MHz)	1.4 MHz	QPSK	1 RB
	20425 (826.50 MHz) 20525 (836.50 MHz) 20625 (846.50 MHz)	5 MHz	QPSK	1 RB
	20450 (829.00 MHz) 20525 (836.50 MHz) 20600 (844.00 MHz)	10 MHz	QPSK	1 RB

For LTE Band 7

Test Item	Tested Channel	Channel Bandwidth	Modulation	Mode
EIRP	20775 (2502.50 MHz) 21100 (2535.00 MHz) 21425 (2567.50 MHz)	5 MHz	QPSK / 16QAM	1 RB Half RB Full RB
	20800 (2505.00 MHz) 21100 (2535.00 MHz) 21400 (2565.00 MHz)	10 MHz	QPSK / 16QAM	1 RB Half RB Full RB
	20825 (2507.50 MHz) 21100 (2535.00 MHz) 21375 (2562.50 MHz)	15 MHz	QPSK / 16QAM	1 RB Half RB Full RB
	20850 (2510.00 MHz) 21100 (2535.00 MHz) 21350 (2560.00 MHz)	20 MHz	QPSK / 16QAM	1 RB Half RB Full RB
RE Below 1GHz	21350 (2560.00 MHz)	20 MHz	QPSK	1 RB
RE Above 1GHz	20775 (2502.50 MHz) 21100 (2535.00 MHz) 21425 (2567.50 MHz)	5 MHz	QPSK	1 RB
	20850 (2510.00 MHz) 21100 (2535.00 MHz) 21350 (2560.00 MHz)	20 MHz	QPSK	1 RB

For LTE Band 12

Test Item	Tested Channel	Channel Bandwidth	Modulation	Mode
ERP	23017 (699.70 MHz) 23095 (707.50 MHz) 23173 (715.30 MHz)	1.4 MHz	QPSK / 16QAM	1 RB Half RB Full RB
	23025 (700.50 MHz) 23095 (707.50 MHz) 23165 (714.50 MHz)	3 MHz	QPSK / 16QAM	1 RB Half RB Full RB
	23035 (701.50 MHz) 23095 (707.50 MHz) 23155 (713.50 MHz)	5 MHz	QPSK / 16QAM	1 RB Half RB Full RB
	23060 (704.00 MHz) 23095 (707.50 MHz) 23130 (711.00 MHz)	10 MHz	QPSK / 16QAM	1 RB Half RB Full RB
RE Below 1GHz	23095 (707.50 MHz)	5 MHz	QPSK	1 RB
RE Above 1GHz	23017 (699.70 MHz) 23095 (707.50 MHz) 23173 (715.30 MHz)	1.4 MHz	QPSK	1 RB
	23035 (701.50 MHz) 23095 (707.50 MHz) 23155 (713.50 MHz)	5 MHz	QPSK	1 RB
	23060 (704.00 MHz) 23095 (707.50 MHz) 23130 (711.00 MHz)	10 MHz	QPSK	1 RB

For LTE Band 13

Test Item	Tested Channel	Channel Bandwidth	Modulation	Mode
ERP	23205 (779.50 MHz) 23230 (782.00 MHz) 23255 (784.50 MHz)	5 MHz	QPSK / 16QAM	1 RB Half RB Full RB
	23230 (782.00 MHz)	10 MHz	QPSK / 16QAM	1 RB Half RB Full RB
RE Below 1GHz	23230 (782.00 MHz)	10 MHz	QPSK	1 RB
RE Above 1GHz	23205 (779.50 MHz) 23230 (782.00 MHz) 23255 (784.50 MHz)	5 MHz	QPSK	1 RB
	23230 (782.00 MHz)	10 MHz	QPSK	1 RB

For LTE Band 17

Test Item	Tested Channel	Channel Bandwidth	Modulation	Mode
ERP	23755 (706.50 MHz) 23790 (710.00 MHz) 23825 (713.50 MHz)	5 MHz	QPSK / 16QAM	1 RB Half RB Full RB
	23780 (709.00 MHz) 23790 (710.00 MHz) 23800 (711.00 MHz)	10 MHz	QPSK / 16QAM	1 RB Half RB Full RB
RE Below 1GHz	23780 (709.00 MHz)	10 MHz	QPSK	1 RB
RE Above 1GHz	23755 (706.50 MHz) 23790 (710.00 MHz) 23825 (713.50 MHz)	5 MHz	QPSK	1 RB
	23780 (709.00 MHz) 23790 (710.00 MHz) 23800 (711.00 MHz)	10 MHz	QPSK	1 RB

For LTE Band 25

Test Item	Tested Channel	Channel Bandwidth	Modulation	Mode
EIRP	26047 (1850.70 MHz) 26365 (1882.50 MHz) 26683 (1914.30 MHz)	1.4 MHz	QPSK / 16QAM	1 RB Half RB Full RB
	26055 (1851.50 MHz) 26365 (1882.50 MHz) 26675 (1913.50 MHz)	3 MHz	QPSK / 16QAM	1 RB Half RB Full RB
	26065 (1852.50 MHz) 26365 (1882.50 MHz) 26665 (1912.50 MHz)	5 MHz	QPSK / 16QAM	1 RB Half RB Full RB
	26090 (1855.00 MHz) 26365 (1882.50 MHz) 26640 (1910.00 MHz)	10 MHz	QPSK / 16QAM	1 RB Half RB Full RB
	26115 (1857.50 MHz) 26365 (1882.50 MHz) 26615 (1907.50 MHz)	15 MHz	QPSK / 16QAM	1 RB Half RB Full RB
	26140 (1860.00 MHz) 26365 (1882.50 MHz) 26590 (1905.00 MHz)	20 MHz	QPSK / 16QAM	1 RB Half RB Full RB
RE Below 1GHz	26683 (1914.30 MHz)	1.4 MHz	QPSK	1 RB
RE Above 1GHz	26047 (1850.70 MHz) 26365 (1882.50 MHz) 26683 (1914.30 MHz)	1.4 MHz	QPSK	1 RB
	26065 (1852.50 MHz) 26365 (1882.50 MHz) 26665 (1912.50 MHz)	5 MHz	QPSK	1 RB
	26140 (1860.00 MHz) 26365 (1882.50 MHz) 26590 (1905.00 MHz)	20 MHz	QPSK	1 RB

For LTE Band 26 (Part 22)

Test Item	Tested Channel	Channel Bandwidth	Modulation	Mode
ERP	26797 (824.70 MHz) 26915 (836.50 MHz) 27033 (848.30 MHz)	1.4 MHz	QPSK / 16QAM	1 RB Half RB Full RB
	26805 (825.50 MHz) 26915 (836.50 MHz) 27025 (847.50 MHz)	3 MHz	QPSK / 16QAM	1 RB Half RB Full RB
	26815 (826.50 MHz) 26915 (836.50 MHz) 27015 (846.50 MHz)	5 MHz	QPSK / 16QAM	1 RB Half RB Full RB
	26840 (829.00 MHz) 26915 (836.50 MHz) 26990 (844.00 MHz)	10 MHz	QPSK / 16QAM	1 RB Half RB Full RB
	26865 (831.50 MHz) 26915 (836.50 MHz) 26965 (841.50 MHz)	15 MHz	QPSK / 16QAM	1 RB Half RB Full RB
RE Below 1GHz	26797 (824.70 MHz)	1.4 MHz	QPSK	1 RB
RE Above 1GHz	26797 (824.70 MHz) 26915 (836.50 MHz) 27033 (848.30 MHz)	1.4 MHz	QPSK	1 RB
	26815 (826.50 MHz) 26915 (836.50 MHz) 27015 (846.50 MHz)	5 MHz	QPSK	1 RB
	26865 (831.50 MHz) 26915 (836.50 MHz) 26965 (841.50 MHz)	15 MHz	QPSK	1 RB

For LTE Band 26 (Part 90)

Test Item	Tested Channel	Channel Bandwidth	Modulation	Mode
ERP	26697 (814.70 MHz) 26740 (819.00 MHz) 26783 (823.30 MHz)	1.4 MHz	QPSK / 16QAM	1 RB Half RB Full RB
	26705 (815.50 MHz) 26740 (819.00 MHz) 26775 (822.50 MHz)	3 MHz	QPSK / 16QAM	1 RB Half RB Full RB
	26715 (816.50 MHz) 26740 (819.00 MHz) 26765 (821.50 MHz)	5 MHz	QPSK / 16QAM	1 RB Half RB Full RB
	26740 (819.00 MHz)	10 MHz	QPSK / 16QAM	1 RB Half RB Full RB
	26765 (821.50 MHz)	15 MHz	QPSK / 16QAM	1 RB Half RB Full RB
RE Below 1GHz	26740 (819.00 MHz)	10 MHz	QPSK	1 RB
RE Above 1GHz	26697 (814.70 MHz) 26740 (819.00 MHz) 26783 (823.30 MHz)	1.4 MHz	QPSK	1 RB
	26715 (816.50 MHz) 26740 (819.00 MHz) 26765 (821.50 MHz)	5 MHz	QPSK	1 RB
	26740 (819.00 MHz)	10 MHz	QPSK	1 RB
	26765 (821.50 MHz)	15 MHz	QPSK / 16QAM	1 RB

For LTE Band 66

Test Item	Tested Channel	Channel Bandwidth	Modulation	Mode
EIRP	131979 (1710.70 MHz) 132322 (1745.00 MHz) 132665 (1779.30 MHz)	1.4 MHz	QPSK / 16QAM	1 RB Half RB Full RB
	131987 (1711.50 MHz) 132322 (1745.00 MHz) 132657 (1778.50 MHz)	3 MHz	QPSK / 16QAM	1 RB Half RB Full RB
	131997 (1712.50 MHz) 132322 (1745.00 MHz) 132647 (1777.50 MHz)	5 MHz	QPSK / 16QAM	1 RB Half RB Full RB
	132022 (1715.00 MHz) 132322 (1745.00 MHz) 132622 (1775.00 MHz)	10 MHz	QPSK / 16QAM	1 RB Half RB Full RB
	132047 (1717.50 MHz) 132322 (1745.00 MHz) 132597 (1772.50 MHz)	15 MHz	QPSK / 16QAM	1 RB Half RB Full RB
	132072 (1720.00 MHz) 132322 (1745.00 MHz) 132572 (1770.00 MHz)	20 MHz	QPSK / 16QAM	1 RB Half RB Full RB
RE Below 1GHz	132572 (1770.00 MHz)	20 MHz	QPSK	1 RB
RE Above 1GHz	131979 (1710.70 MHz) 132322 (1745.00 MHz) 132665 (1779.30 MHz)	1.4 MHz	QPSK	1 RB
	131997 (1712.50 MHz) 132322 (1745.00 MHz) 132647 (1777.50 MHz)	5 MHz	QPSK	1 RB
	132072 (1720.00 MHz) 132322 (1745.00 MHz) 132572 (1770.00 MHz)	20 MHz	QPSK	1 RB

3.4 Test Program Used and Operation Descriptions

There is no need to controlling software during the test, and the EUT can be paired with the Radio Communication Analyzer to test the connection when it is powered on.

3.5 Connection Diagram of EUT and Peripheral Devices

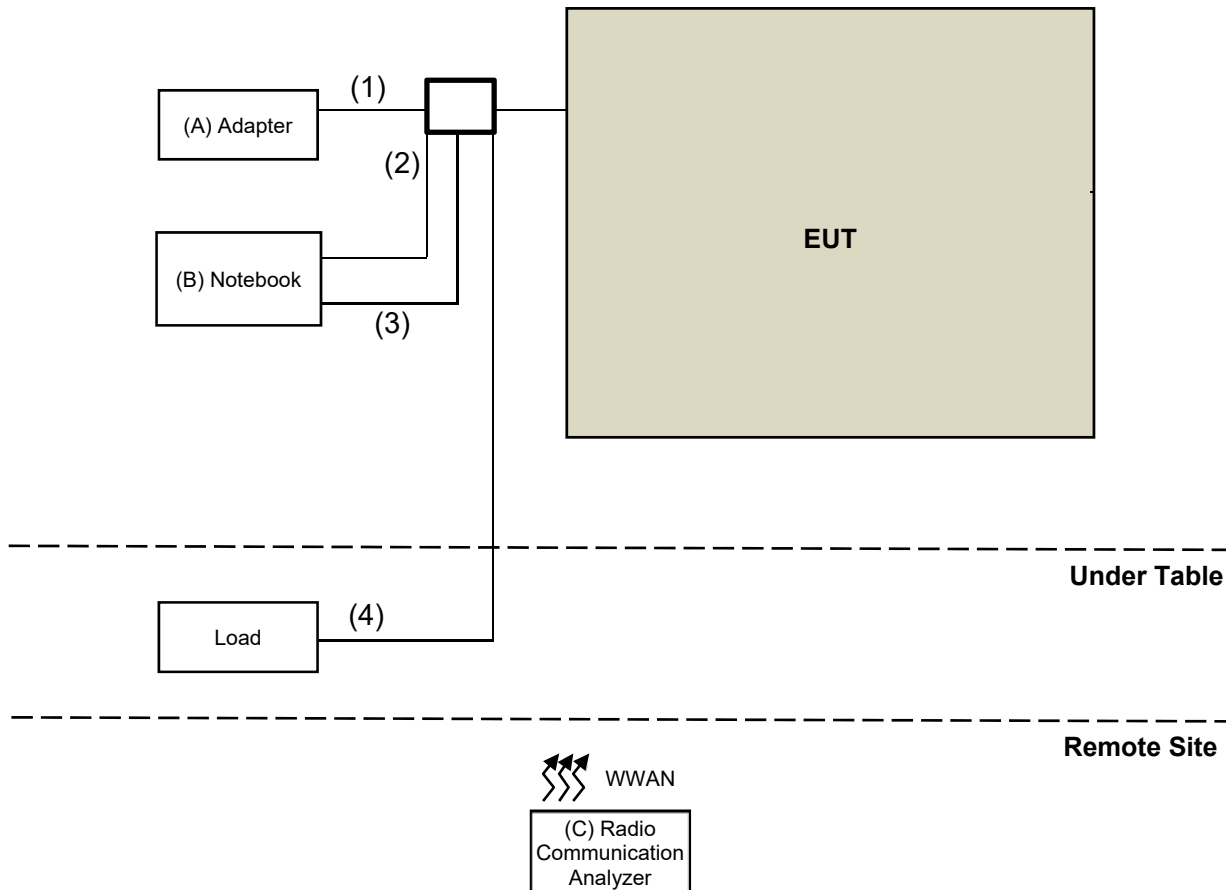

3.6 Configuration of Peripheral Devices and Cable Connections

ID	Product	Brand	Model No.	Serial No.	FCC ID	Remarks
A	Adapter	ABP	ABP AD0181-1201000UC	NA	NA	Supplied by applicant
B	Notebook	Lenono	TP00048A	NA	NA	Provided by Lab
C	Radio Communication Analyzer	Anritsu	MT8821C	6201462755	NA	Provided by Lab

ID	Cable Descriptions	Qty.	Length (m)	Shielding (Yes/No)	Cores (Qty.)	Remarks
1	1 to 3 Cable	1	2.02	YES	0	Supplied by applicant
2	RS232 to USB	1	1.2	YES	0	Supplied by applicant
3	USB Cable	1	1.8	YES	0	Supplied by applicant
4	LAN Cable	1	1.8	YES	0	Provided by Lab

4 Test Instruments

The calibration interval of the all test instruments are 12 months and the calibrations are traceable to NML/ROC and NIST/USA.

4.1 Effective Radiated Power and Equivalent Isotropically Radiated Power

Description Manufacturer	Model No.	Serial No.	Calibrated Date	Calibrated Until
N9030B - PXA Signal Analyzer KEYSIGHT	N9030B	MY57140488	2023/3/6	2024/3/5
Radio Communication Analyzer Anritsu	MT8821C	6201462755	2023/3/3	2024/3/2
Software BV	ADT_RF Test Software V6.6.5.4	N/A	N/A	N/A

Notes:

1. The test was performed in Oven room.
2. Tested Date: 2023/8/11

4.2 Radiated Spurious Emissions below 1GHz

Description Manufacturer	Model No.	Serial No.	Calibrated Date	Calibrated Until
Antenna Tower Max-Full	MFT-151SS-0.5T	N/A	N/A	N/A
Bi_Log Antenna Schwarzbeck	VULB 9168	9168-1213	2022/10/20	2023/10/19
EMI Test Receiver R&S	ESR3	102782	2022/12/12	2023/12/11
Loop Antenna Electro-Metrics	EM-6879	269	2022/9/19	2023/9/18
Loop Antenna TESEQ	HLA 6121	45745	2023/8/8	2024/8/7
Preamplifier EMCI	EMC330N	980782	2023/1/16	2024/1/15
	EMC001340	980201	2022/9/23	2023/9/22
RF Coaxial Cable EMCI	5D-NM-BM	140903+140902	2023/1/7	2024/1/6
	EMCCFD400-NM-NM- 500	201233	2023/1/16	2024/1/15
	EMCCFD400-NM-NM- 3000	201235	2023/1/16	2024/1/15
	EMCCFD400-NM-NM- 9000	201236(with PAD)	2023/1/16	2024/1/15
Signal & Spectrum Analyzer R&S	FSW43	101866	2023/1/10	2024/1/9
Software BV ADT	ADT_Radiated_ V7.6.15.9.5	N/A	N/A	N/A
Turn Table Max-Full	MF-7802BS	N/A	N/A	N/A
Turn Table Controller Max-Full	MF-7802BS	MF780208674	N/A	N/A

Notes:

1. The test was performed in WM - 966 chamber 6.
2. Tested Date: 2023/8/12

4.3 Radiated Spurious Emissions above 1GHz

Description Manufacturer	Model No.	Serial No.	Calibrated Date	Calibrated Until
Antenna Tower Max-Full	UNAT_5+	PAD-CH6-01	N/A	N/A
Antenna Tower Controller Max-Full	MF-7802	N/A	N/A	N/A
Boresight antenna tower fixture BV	BAF-02	8	N/A	N/A
Horn Antenna ETS-Lindgren	3117	00143293	2022/11/13	2023/11/12
Horn Antenna Schwarzbeck	BBHA 9170	BBHA9170241	2022/10/20	2023/10/19
Pre-Amplifier EMCI	EMC 184045	980116	2022/10/1	2023/9/30
Preamplifier Agilent	83017A	MY39501373	2023/6/13	2024/6/12
RF Coaxial Cable ETS-Lindgren	EMC104-SM-SM-10000	Cable-CH1-01(RFC-SMS-100-SMS-120+RFC-SMS-100-SMS-4)	2023/6/13	2024/6/12
	RFC-SMS-100-SMS-24-IN	Cable-CH1-02(RFC-SMS-100-SMS-24)	2023/6/13	2024/6/12
RF Coaxial Cable HUBER+SUHNER	SUCOFLEX 104	CABLE-CH9-(250795/4)	2023/1/7	2024/1/6
RF Coaxial Cable HUBER+SUHNER&EMCI	SUCOFLEX 104& EMC104-SM-SM8000	CABLE-CH9-02 (248780+171006)	2023/1/7	2024/1/6
Software BV ADT	ADT_Radiated_ V7.6.15.9.5	N/A	N/A	N/A
Test Receiver Agilent	N9038A	MY52260177	2022/9/19	2023/9/18
Turn Table Max-Full	TT-1510	N/A	N/A	N/A
Turn Table Controller Max-Full	MF-7802	N/A	N/A	N/A
Radio Communication Analyzer Anritsu	MT8821C	6201462755	2023/3/3	2024/3/2

Notes:

1. The test was performed in XD - 966 chamber 6.
2. Tested Date: 2023/8/8 ~ 2023/8/16

5 Limits of Test Items

5.1 Effective Radiated Power and Equivalent Isotropically Radiated Power

For PCS1900, WCDMA Band 2, LTE Band 2, LTE Band 25:

Mobile and portable stations are limited to 2 watts EIRP.

For WCDMA Band 4, LTE Band 4, LTE Band 66:

Fixed, mobile, and portable (hand-held) stations operating in the 1710-1755 MHz band and mobile and portable stations operating in the 1695-1710 MHz and 1755-1780 MHz bands are limited to 1 watt EIRP.

For GSM850, WCDMA Band 5, LTE Band 5, LTE Band 26 (Part 22):

The ERP of mobile transmitters and auxiliary test transmitters must not exceed 7 watts.

For LTE Band 7:

Mobile stations are limited to 2.0 watts EIRP. All user stations are limited to 2.0 watts transmitter output power.

For LTE Band 12, LTE Band 17:

Portable stations (hand-held devices) in the 600 MHz uplink band and the 698-746 MHz band, and fixed and mobile stations in the 600 MHz uplink band are limited to 3 watts ERP.

For LTE Band 13:

Portable stations (hand-held devices) transmitting in the 746-757 MHz, 776-788 MHz, and 805-806 MHz bands are limited to 3 watts ERP.

For LTE Band 26 (Part 90):

The maximum output power of the transmitter for mobile stations is 100 watts (20 dBw) ERP.

5.2 Radiated Spurious Emissions below 1GHz

For GSM850, PCS1900, WCDMA Band 2, WCDMA Band 5, LTE Band 2, LTE Band 5, LTE Band 25, LTE Band 26 (Part 22):

The power of any emission outside of the authorized operating frequency ranges must be attenuated below the transmitting power (P) by a factor of at least $43 + 10 \log(P)$ dB. The emission limit equal to -13 dBm.

For LTE Band 4, WCDMA Band 4:

According to FCC 47 CFR part 27.53(h), for operations in the 1695-1710 MHz, 1710-1755 MHz, 1755-1780 MHz bands, the power of any emission outside a licensee's frequency block shall be attenuated below the transmitter power (P) in watts by at least $43 + 10 \log(P)$ dB. The limit of emission is equal to -13 dBm.

For LTE Band 7:

According to FCC 47 CFR part 27.53(m)(4), on any frequency outside a licensee's frequency block, The power of any emission shall be attenuated below the transmitter power (P) by at least $55 + 10 \log(P)$ dB. The emission limit equal to -25 dBm.

For LTE Band 12, LTE Band 17:

According to FCC 47 CFR part 27.53(g), for operations in the 600 MHz band and the 698-746 MHz band, the power of any emission outside a licensee's frequency band(s) of operation shall be attenuated below the transmitter power (P) within the licensed band(s) of operation, measured in watts, by at least $43 + 10 \log(P)$ dB. The limit of emissions is equal to -13 dBm.

For LTE Band 13:

According to FCC 47 CFR part 27.53(c)(2), for on any frequency outside the 776-788 MHz band, the power of any emission shall be attenuated outside the band below the transmitter power (P) by at least $43 + 10 \log(P)$ dB. The limit of emissions is equal to -13 dBm.

For operations in the 775-788 MHz, emissions in the band 1559-1610 MHz shall be limited to -70 dBW/MHz (EIRP). The limit of emissions is equal to -40 dBm.

For LTE Band 26 (Part 90):

For any frequency removed from the EA licensee's frequency block greater than 37.5 kHz, the power of any emission shall be attenuated below the transmitter power (P) in watts by at least $43 + 10 \log^{10}(P)$ decibels or 80 decibels, whichever is the lesser attenuation, where f is the frequency removed from the center of the outer channel in the block in kilohertz and where f is greater than 37.5 kHz.

For §90.691(a), RBW = 100 kHz for offset greater than 37.5 kHz from channel edge is allowed.

For LTE Band 66:

According to FCC 47 CFR part 27.53(h), for operations in the 1695-1710 MHz, 1710-1755 MHz, 1755-1780 MHz bands, the power of any emission outside a licensee's frequency block shall be attenuated below the transmitter power (P) in watts by at least $43 + 10 \log(P)$ dB. The limit of emission is equal to -13 dBm.

5.3 Radiated Spurious Emissions above 1GHz

For GSM850, PCS1900, WCDMA Band 2, WCDMA Band 5, LTE Band 2, LTE Band 5, LTE Band 25, LTE Band 26 (Part 22):

The power of any emission outside of the authorized operating frequency ranges must be attenuated below the transmitting power (P) by a factor of at least $43 + 10 \log(P)$ dB. The emission limit equal to -13 dBm.

For LTE Band 4, WCDMA Band 4:

According to FCC 47 CFR part 27.53(h), for operations in the 1695-1710 MHz, 1710-1755 MHz, 1755-1780 MHz bands, the power of any emission outside a licensee's frequency block shall be attenuated below the transmitter power (P) in watts by at least $43 + 10 \log(P)$ dB. The limit of emission is equal to -13 dBm.

For LTE Band 7:

According to FCC 47 CFR part 27.53(m)(4), on any frequency outside a licensee's frequency block, The power of any emission shall be attenuated below the transmitter power (P) by at least $55 + 10 \log(P)$ dB. The emission limit equal to -25 dBm.

For LTE Band 12, LTE Band 17:

According to FCC 47 CFR part 27.53(g), for operations in the 600 MHz band and the 698-746 MHz band, the power of any emission outside a licensee's frequency band(s) of operation shall be attenuated below the transmitter power (P) within the licensed band(s) of operation, measured in watts, by at least $43 + 10 \log(P)$ dB. The limit of emissions is equal to -13 dBm.

For LTE Band 13:

According to FCC 47 CFR part 27.53(c)(2), for on any frequency outside the 776-788 MHz band, the power of any emission shall be attenuated outside the band below the transmitter power (P) by at least $43 + 10 \log(P)$ dB. The limit of emissions is equal to -13 dBm.

For operations in the 775-788 MHz, emissions in the band 1559-1610 MHz shall be limited to -70 dBW/MHz (EIRP). The limit of emissions is equal to -40 dBm.

For LTE Band 26 (Part 90):

For any frequency removed from the EA licensee's frequency block greater than 37.5 kHz, the power of any emission shall be attenuated below the transmitter power (P) in watts by at least $43 + 10 \log^{10}(P)$ decibels or 80 decibels, whichever is the lesser attenuation, where f is the frequency removed from the center of the outer channel in the block in kilohertz and where f is greater than 37.5 kHz.

For §90.691(a), RBW = 100 kHz for offset greater than 37.5 kHz from channel edge is allowed.

For LTE Band 66:

According to FCC 47 CFR part 27.53(h), for operations in the 1695-1710 MHz, 1710-1755 MHz, 1755-1780 MHz bands, the power of any emission outside a licensee's frequency block shall be attenuated below the transmitter power (P) in watts by at least $43 + 10 \log(P)$ dB. The limit of emission is equal to -13 dBm.

6 Test Arrangements

6.1 Effective Radiated Power and Equivalent Isotropically Radiated Power

6.1.1 Test Setup

Conducted Power Measurement:

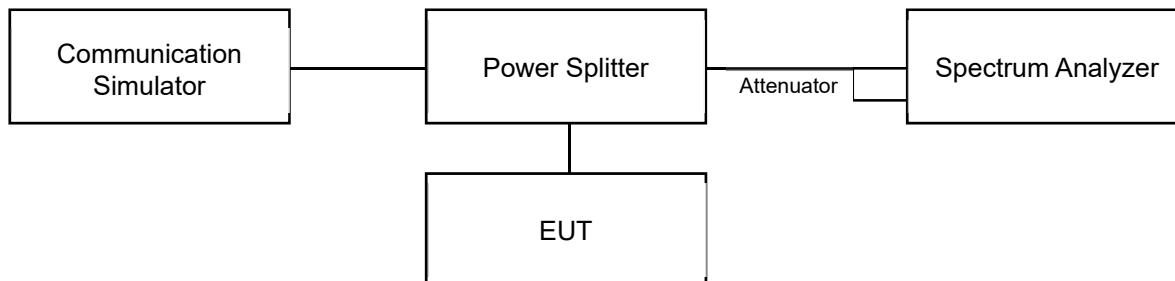

6.1.2 Test Procedure

Conducted Power Measurement:

The EUT is configured by emulator to set data modulation and maximum power using WWAN technology. The average (rms) power measurement was performed on emulator and power value was measured from power function on emulator. Set the EUT to transmit under low, middle and high channel and record the power level shown on simulator.

Maximum EIRP / ERP

The relevant equation for determining the maximum ERP or EIRP from the measured RF output power is given in Equation as follows:

$$\text{EIRP} = P_{\text{Meas}} + G_{\text{T}}$$

$$\text{ERP} = P_{\text{Meas}} + G_{\text{T}} - 2.15$$

where

ERP or EIRP effective radiated power or equivalent isotropically radiated power, respectively

(expressed in the same units as P_{Meas} , e.g., dBm or dBW)

P_{Meas} measured transmitter output power or PSD, in dBm or dBW

G_{T} gain of the transmitting antenna, in dBd (ERP) or dBi (EIRP)

6.2 Radiated Spurious Emissions below 1GHz

6.2.1 Test Setup

For radiated emission 30 MHz to 1 GHz

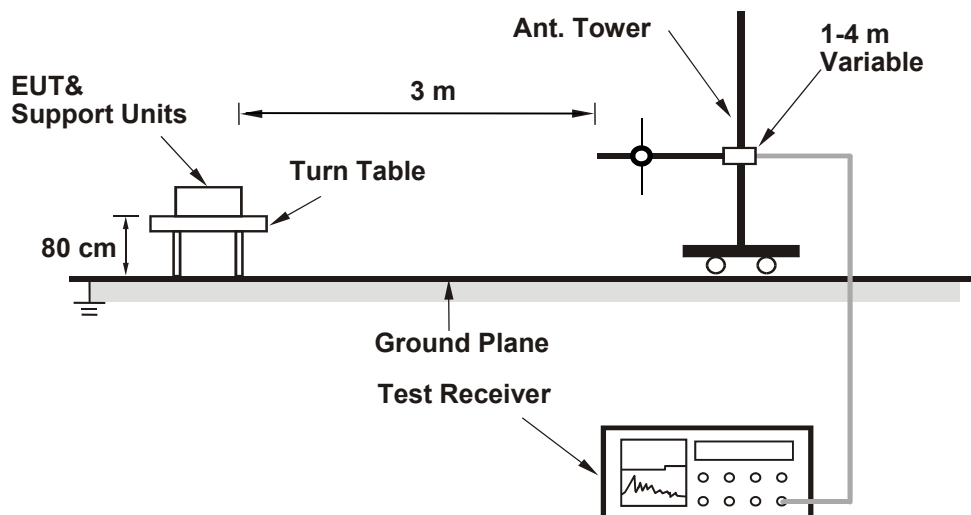

For the actual test configuration, please refer to the attached file (Test Setup Photo).

6.2.2 Test Procedure

The EUT is configured by emulator to set data modulation and maximum power using WWAN technology.

- In the semi-anechoic chamber, EUT placed on the 0.8 m (below or equal 1 GHz) height of turn table, rotated the table around 360 degrees to search the maximum radiation power and receiver antenna shall be rotated vertical and horizontal polarization and moved height from 1 m to 4 m to find the maximum polar radiated power. The "Read Value" is the spectrum reading the maximum power value.
- The height of antenna is varied from one meter to four meters above the ground to determine the maximum value of the field strength. Both horizontal and vertical polarizations of the antenna are set to make the measurement.
- Perform a field strength measurement and record the worse read value, is the field strength value via a spectrum reading obtained corrected for antenna factor, cable loss and pre-amplifier factor and then mathematically convert the measured field strength level to EIRP/ERP level.
- Following C63.26 section 5.5 and 5.2.7
- $EIRP (dBm) = E (dB\mu V/m) + 20\log(D) - 104.8$; where D is the measurement distance (in the far field region) in m.
- $ERP (dBm) = E (dB\mu V/m) + 20\log(D) - 104.8 - 2.15$; where D is the measurement distance (in the far field region) in m.

Note:

- The resolution bandwidth and video bandwidth of test receiver/spectrum analyzer is 1 MHz/3 MHz.
- The emission levels were against the limit of frequency range 9 kHz ~ 30 MHz:
The amplitude of spurious emissions attenuated more than 20 dB below the permissible value is not required to be report.

6.3 Radiated Spurious Emissions above 1GHz

6.3.1 Test Setup

For radiated emission above 1 GHz

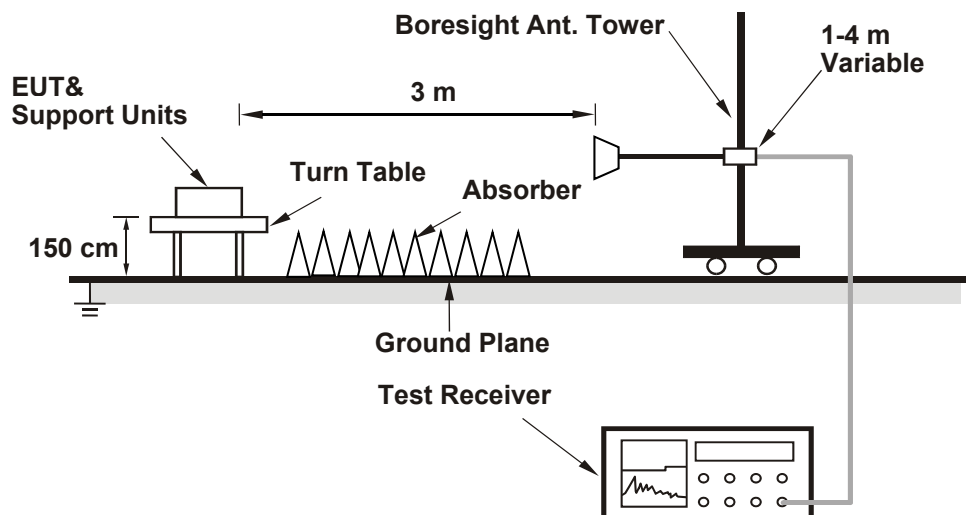

For the actual test configuration, please refer to the attached file (Test Setup Photo).

6.3.2 Test Procedure

The EUT is configured by emulator to set data modulation and maximum power using WWAN technology.

- In the semi-anechoic chamber, EUT placed on the 1.5 m height of turn table, rotated the table around 360 degrees to search the maximum radiation power and receiver antenna shall be rotated vertical and horizontal polarization and moved height from 1 m to 4 m to find the maximum polar radiated power. The "Read Value" is the spectrum reading the maximum power value.
- The height of antenna is varied from one meter to four meters above the ground to determine the maximum value of the field strength. Both horizontal and vertical polarizations of the antenna are set to make the measurement.
- Perform a field strength measurement and record the worse read value, is the field strength value via a spectrum reading obtained corrected for antenna factor, cable loss and pre-amplifier factor and then mathematically convert the measured field strength level to EIRP/ERP level.
- Following C63.26 section 5.5 and 5.2.7
- $EIRP (dBm) = E (dB\mu V/m) + 20\log(D) - 104.8$; where D is the measurement distance (in the far field region) in m.
- $ERP (dBm) = E (dB\mu V/m) + 20\log(D) - 104.8 - 2.15$; where D is the measurement distance (in the far field region) in m.

Note:

- The resolution bandwidth and video bandwidth of test receiver/spectrum analyzer is 1 MHz/3 MHz.

7 Test Results of Test Item

7.1 Effective Radiated Power and Equivalent Isotropically Radiated Power

Input Power:	12 Vdc	Environmental Conditions:	22°C, 73% RH	Tested By:	Willy Cheng
--------------	--------	---------------------------	--------------	------------	-------------

7.1.1 GSM850

Conducted Output Power (dBm)

Band	GSM850		
Channel	128	189	251
Frequency (MHz)	824.2	836.4	848.8
GPRS (GMSK, 1Tx-slot)	31.24	31.11	31.13
EDGE (8PSK, 1Tx-slot)	25.22	25.64	25.88

ERP Power (dBm)

Band	GSM850		
Channel	128	189	251
Frequency (MHz)	824.2	836.4	848.8
GPRS (GMSK, 1Tx-slot)	27.91	27.78	27.80
EDGE (8PSK, 1Tx-slot)	21.89	22.31	22.55

*ERP (dBm) = Conducted Output Power (dBm) + Antenna Gain (dBi) - 2.15

7.1.2 PCS1900

Conducted Output Power (dBm)

Band	PCS1900		
Channel	512	661	810
Frequency (MHz)	1850.2	1880	1909.8
GPRS (GMSK, 1Tx-slot)	25.57	26.28	27.91
EDGE (8PSK, 1Tx-slot)	23.12	23.69	23.51

EIRP Power (dBm)

Band	PCS1900		
Channel	512	661	810
Frequency (MHz)	1850.2	1880	1909.8
GPRS (GMSK, 1Tx-slot)	26.82	27.53	29.16
EDGE (8PSK, 1Tx-slot)	24.37	24.94	24.76

*EIRP (dBm) = Conducted Output Power (dBm) + Antenna Gain (dBi)

7.1.3 WCDMA Band 2

Conducted Output Power (dBm)

Band	WCDMA 2		
TX Channel	9262	9400	9538
Rx Channel	9662	9800	9938
Frequency	1852.4	1880	1907.6
RMC 12.2K	19.00	20.21	20.33
HSDPA Subtest-1	16.00	16.02	16.32
HSUPA Subtest-1	17.00	17.20	17.29

EIRP Power (dBm)

Band	WCDMA 2		
TX Channel	9262	9400	9538
Rx Channel	9662	9800	9938
Frequency	1852.4	1880	1907.6
RMC 12.2K	20.25	21.46	21.58
HSDPA Subtest-1	17.25	17.27	17.57
HSUPA Subtest-1	18.25	18.45	18.54

*EIRP (dBm) = Conducted Output Power (dBm) + Antenna Gain (dBi)

7.1.4 WCDMA Band 4

Conducted Output Power (dBm)

Band	WCDMA 4		
TX Channel	1312	1413	1513
Rx Channel	1537	1638	1738
Frequency	1712.4	1732.6	1752.6
RMC 12.2K	21.22	21.11	20.09
HSDPA Subtest-1	17.12	17.00	17.19
HSUPA Subtest-1	17.66	17.00	17.10

EIRP Power (dBm)

Band	WCDMA 4		
TX Channel	1312	1413	1513
Rx Channel	1537	1638	1738
Frequency	1712.4	1732.6	1752.6
RMC 12.2K	22.47	22.36	21.34
HSDPA Subtest-1	18.37	18.25	18.44
HSUPA Subtest-1	18.91	18.25	18.35

*EIRP (dBm) = Conducted Output Power (dBm) + Antenna Gain (dBi)

7.1.5 WCDMA Band 5

Conducted Output Power (dBm)

Band	WCDMA 5		
TX Channel	4132	4182	4233
Rx Channel	4357	4407	4458
Frequency	826.4	836.4	846.6
RMC 12.2K	22.18	22.80	22.89
HSDPA Subtest-1	19.12	19.65	19.10
HSUPA Subtest-1	18.88	18.63	19.01

ERP Power (dBm)

Band	WCDMA 5		
TX Channel	4132	4182	4233
Rx Channel	4357	4407	4458
Frequency	826.4	836.4	846.6
RMC 12.2K	18.85	19.47	19.56
HSDPA Subtest-1	15.79	16.32	15.77
HSUPA Subtest-1	15.55	15.30	15.68

*ERP (dBm) = Conducted Output Power (dBm) + Antenna Gain (dBi) - 2.15

7.1.6 LTE Band 2

Conducted Output Power (dBm)

BW	MCS Index	RB Size	RB Offset	Low	Mid	High
		Channel		18700	18900	19100
		Frequency (MHz)		1860	1880	1900
20M	QPSK	1	0	20.03	20.23	20.30
		1	50	20.57	20.58	20.65
		1	99	20.25	20.07	20.34
		50	0	19.26	19.28	19.51
		50	25	19.36	19.45	19.48
		50	50	19.17	19.19	19.40
		100	0	19.44	19.23	19.52
20M	16QAM	1	0	19.24	19.52	19.54
		1	50	19.86	19.79	19.89
		1	99	19.46	19.18	19.45
		50	0	18.41	18.47	18.66
		50	25	18.52	18.65	18.66
		50	50	18.44	18.44	18.51
		100	0	18.62	18.44	18.62
BW	MCS Index	RB Size	RB Offset	Low	Mid	High
		Channel		18675	18900	19125
		Frequency (MHz)		1857.5	1880	1902.5
15M	QPSK	1	0	20.25	20.38	20.51
		1	37	20.55	20.31	20.60
		1	74	19.87	20.08	20.15
		36	0	19.25	19.31	19.52
		36	19	19.08	18.92	19.13
		36	39	19.23	19.29	19.44
		75	0	19.28	19.08	19.30
15M	16QAM	1	0	19.36	19.62	19.70
		1	37	19.68	19.57	19.85
		1	74	18.98	19.27	19.37
		36	0	18.46	18.47	18.73
		36	19	18.37	18.13	18.34
		36	39	18.43	18.47	18.69
		75	0	18.57	18.24	18.48

BW	MCS Index	RB Size	RB Offset	Low	Mid	High
		Channel		18650	18900	19150
		Frequency (MHz)		1855	1880	1905
10M	QPSK	1	0	20.18	20.38	20.46
		1	24	20.28	20.54	20.56
		1	49	20.23	20.18	20.46
		25	0	19.57	19.45	19.63
		25	12	19.15	19.18	19.34
		25	25	19.06	19.16	19.26
		50	0	19.16	19.14	19.30
10M	16QAM	1	0	19.43	19.61	19.57
		1	24	19.41	19.80	19.80
		1	49	19.42	19.34	19.65
		25	0	18.79	18.69	18.86
		25	12	18.31	18.43	18.49
		25	25	18.23	18.29	18.40
		50	0	18.31	18.38	18.58
BW	MCS Index	RB Size	RB Offset	Low	Mid	High
		Channel		18625	18900	19175
		Frequency (MHz)		1852.5	1880	1907.5
5M	QPSK	1	0	20.38	20.48	20.53
		1	12	20.33	20.51	20.55
		1	24	20.38	20.15	20.41
		12	0	19.55	19.52	19.66
		12	6	19.62	19.43	19.70
		12	13	19.54	19.66	19.80
		25	0	18.96	18.98	19.11
5M	16QAM	1	0	19.67	19.62	19.81
		1	12	19.61	19.77	19.82
		1	24	19.66	19.25	19.61
		12	0	18.66	18.70	18.76
		12	6	18.75	18.55	18.92
		12	13	18.66	18.81	19.09
		25	0	18.10	18.16	18.38

BW	MCS Index	RB Size	RB Offset	Low	Mid	High
		Channel		18615	18900	19185
		Frequency (MHz)		1851.5	1880	1908.5
3M	QPSK	1	0	20.47	20.30	20.55
		1	7	20.36	20.58	20.63
		1	14	20.32	20.40	20.54
		8	0	19.41	19.53	19.66
		8	3	19.11	19.32	19.40
		8	7	19.49	19.48	19.53
		15	0	19.23	19.11	19.39
3M	16QAM	1	0	19.62	19.49	19.77
		1	7	19.65	19.71	19.87
		1	14	19.61	19.54	19.74
		8	0	18.61	18.76	18.92
		8	3	18.21	18.46	18.59
		8	7	18.63	18.73	18.78
		15	0	18.39	18.41	18.51
BW	MCS Index	RB Size	RB Offset	Low	Mid	High
		Channel		18607	18900	19193
		Frequency (MHz)		1850.7	1880	1909.3
1.4M	QPSK	1	0	20.39	20.54	20.59
		1	2	20.24	20.39	20.47
		1	5	20.20	20.16	20.43
		3	0	19.58	19.61	19.80
		3	1	19.60	19.63	19.76
		3	3	19.46	19.64	19.66
		6	0	19.47	19.49	19.53
1.4M	16QAM	1	0	19.51	19.66	19.70
		1	2	19.52	19.65	19.67
		1	5	19.49	19.42	19.67
		3	0	18.78	18.76	19.10
		3	1	18.78	18.83	18.94
		3	3	18.63	18.92	18.84
		6	0	18.70	18.64	18.77



EIRP Power (dBm)

BW	MCS Index	RB Size	RB Offset	Low	Mid	High
		Channel		18700	18900	19100
		Frequency (MHz)		1860	1880	1900
20M	QPSK	1	0	21.28	21.48	21.55
		1	50	21.82	21.83	21.90
		1	99	21.50	21.32	21.59
		50	0	20.51	20.53	20.76
		50	25	20.61	20.70	20.73
		50	50	20.42	20.44	20.65
		100	0	20.69	20.48	20.77
20M	16QAM	1	0	20.49	20.77	20.79
		1	50	21.11	21.04	21.14
		1	99	20.71	20.43	20.70
		50	0	19.66	19.72	19.91
		50	25	19.77	19.90	19.91
		50	50	19.69	19.69	19.76
		100	0	19.87	19.69	19.87
BW	MCS Index	RB Size	RB Offset	Low	Mid	High
		Channel		18675	18900	19125
		Frequency (MHz)		1857.5	1880	1902.5
15M	QPSK	1	0	21.50	21.63	21.76
		1	37	21.80	21.56	21.85
		1	74	21.12	21.33	21.40
		36	0	20.50	20.56	20.77
		36	19	20.33	20.17	20.38
		36	39	20.48	20.54	20.69
		75	0	20.53	20.33	20.55
15M	16QAM	1	0	20.61	20.87	20.95
		1	37	20.93	20.82	21.10
		1	74	20.23	20.52	20.62
		36	0	19.71	19.72	19.98
		36	19	19.62	19.38	19.59
		36	39	19.68	19.72	19.94
		75	0	19.82	19.49	19.73

*EIRP (dBm) = Conducted Output Power (dBm) + Antenna Gain (dBi)

BW	MCS Index	RB Size	RB Offset	Low	Mid	High
		Channel		18650	18900	19150
		Frequency (MHz)		1855	1880	1905
10M	QPSK	1	0	21.43	21.63	21.71
		1	24	21.53	21.79	21.81
		1	49	21.48	21.43	21.71
		25	0	20.82	20.70	20.88
		25	12	20.40	20.43	20.59
		25	25	20.31	20.41	20.51
		50	0	20.41	20.39	20.55
10M	16QAM	1	0	20.68	20.86	20.82
		1	24	20.66	21.05	21.05
		1	49	20.67	20.59	20.90
		25	0	20.04	19.94	20.11
		25	12	19.56	19.68	19.74
		25	25	19.48	19.54	19.65
		50	0	19.56	19.63	19.83
BW	MCS Index	RB Size	RB Offset	Low	Mid	High
		Channel		18625	18900	19175
		Frequency (MHz)		1852.5	1880	1907.5
5M	QPSK	1	0	21.63	21.73	21.78
		1	12	21.58	21.76	21.80
		1	24	21.63	21.40	21.66
		12	0	20.80	20.77	20.91
		12	6	20.87	20.68	20.95
		12	13	20.79	20.91	21.05
		25	0	20.21	20.23	20.36
5M	16QAM	1	0	20.92	20.87	21.06
		1	12	20.86	21.02	21.07
		1	24	20.91	20.50	20.86
		12	0	19.91	19.95	20.01
		12	6	20.00	19.80	20.17
		12	13	19.91	20.06	20.34
		25	0	19.35	19.41	19.63

*EIRP (dBm) = Conducted Output Power (dBm) + Antenna Gain (dBi)

BW	MCS Index	RB Size	RB Offset	Low	Mid	High
		Channel		18615	18900	19185
		Frequency (MHz)		1851.5	1880	1908.5
3M	QPSK	1	0	21.72	21.55	21.80
		1	7	21.61	21.83	21.88
		1	14	21.57	21.65	21.79
		8	0	20.66	20.78	20.91
		8	3	20.36	20.57	20.65
		8	7	20.74	20.73	20.78
		15	0	20.48	20.36	20.64
3M	16QAM	1	0	20.87	20.74	21.02
		1	7	20.90	20.96	21.12
		1	14	20.86	20.79	20.99
		8	0	19.86	20.01	20.17
		8	3	19.46	19.71	19.84
		8	7	19.88	19.98	20.03
		15	0	19.64	19.66	19.76
BW	MCS Index	RB Size	RB Offset	Low	Mid	High
		Channel		18607	18900	19193
		Frequency (MHz)		1850.7	1880	1909.3
1.4M	QPSK	1	0	21.64	21.79	21.84
		1	2	21.49	21.64	21.72
		1	5	21.45	21.41	21.68
		3	0	20.83	20.86	21.05
		3	1	20.85	20.88	21.01
		3	3	20.71	20.89	20.91
		6	0	20.72	20.74	20.78
1.4M	16QAM	1	0	20.76	20.91	20.95
		1	2	20.77	20.90	20.92
		1	5	20.74	20.67	20.92
		3	0	20.03	20.01	20.35
		3	1	20.03	20.08	20.19
		3	3	19.88	20.17	20.09
		6	0	19.95	19.89	20.02

*EIRP (dBm) = Conducted Output Power (dBm) + Antenna Gain (dBi)

7.1.7 LTE Band 4

Conducted Output Power (dBm)

BW	MCS Index	RB Size	RB Offset	Low	Mid	High
		Channel		20050	20175	20300
		Frequency (MHz)		1720	1732.5	1745
20M	QPSK	1	0	21.25	21.02	21.26
		1	50	21.52	21.32	21.56
		1	99	21.68	21.45	21.69
		50	0	21.14	20.85	21.12
		50	25	21.24	20.95	21.18
		50	50	21.01	20.79	21.09
		100	0	20.33	20.12	20.42
20M	16QAM	1	0	20.43	20.20	20.50
		1	50	20.76	20.54	20.72
		1	99	20.81	20.60	20.80
		50	0	20.35	20.01	20.35
		50	25	20.40	20.11	20.44
		50	50	20.20	19.95	20.34
		100	0	19.56	19.38	19.59
BW	MCS Index	RB Size	RB Offset	Low	Mid	High
		Channel		20025	20175	20325
		Frequency (MHz)		1717.5	1732.5	1747.5
15M	QPSK	1	0	21.21	20.98	21.28
		1	37	21.54	21.26	21.50
		1	74	21.67	21.39	21.62
		36	0	21.19	20.90	21.12
		36	19	21.17	20.90	21.16
		36	39	21.00	20.78	20.99
		75	0	20.35	20.07	20.32
15M	16QAM	1	0	20.50	20.09	20.39
		1	37	20.70	20.40	20.67
		1	74	20.96	20.66	20.90
		36	0	20.47	20.16	20.26
		36	19	20.28	20.17	20.45
		36	39	20.11	20.08	20.16
		75	0	19.51	19.17	19.60

BW	MCS Index	RB Size	RB Offset	Low	Mid	High
		Channel		20000	20175	20350
		Frequency (MHz)		1715	1732.5	1750
10M	QPSK	1	0	21.28	20.99	21.27
		1	24	21.52	21.31	21.51
		1	49	21.66	21.43	21.60
		25	0	21.08	20.82	21.02
		25	12	21.25	20.96	21.25
		25	25	21.00	20.79	21.03
		50	0	20.37	20.14	20.43
10M	16QAM	1	0	20.45	20.27	20.38
		1	24	20.81	20.46	20.63
		1	49	20.95	20.72	20.90
		25	0	20.35	20.10	20.25
		25	12	20.51	20.11	20.54
		25	25	20.10	19.89	20.23
		50	0	19.61	19.40	19.63
BW	MCS Index	RB Size	RB Offset	Low	Mid	High
		Channel		19975	20175	20375
		Frequency (MHz)		1712.5	1732.5	1752.5
5M	QPSK	1	0	21.34	21.05	21.27
		1	12	21.55	21.29	21.56
		1	24	21.67	21.39	21.62
		12	0	21.17	20.89	21.17
		12	6	21.24	20.95	21.20
		12	13	21.06	20.81	21.09
		25	0	20.39	20.15	20.37
5M	16QAM	1	0	20.61	20.22	20.46
		1	12	20.80	20.49	20.85
		1	24	20.96	20.61	20.84
		12	0	20.39	20.00	20.42
		12	6	20.48	20.09	20.46
		12	13	20.23	19.92	20.37
		25	0	19.53	19.25	19.51

BW	MCS Index	RB Size	RB Offset	Low	Mid	High
		Channel		19965	20175	20385
		Frequency (MHz)		1711.5	1732.5	1753.5
3M	QPSK	1	0	21.20	20.98	21.22
		1	7	21.62	21.34	21.57
		1	14	21.63	21.38	21.63
		8	0	21.03	20.82	21.02
		8	3	21.19	20.90	21.14
		8	7	21.02	20.74	21.02
		15	0	20.31	20.10	20.33
3M	16QAM	1	0	20.48	20.27	20.38
		1	7	20.84	20.58	20.79
		1	14	20.93	20.53	20.76
		8	0	20.33	20.04	20.17
		8	3	20.30	20.09	20.26
		8	7	20.17	20.00	20.12
		15	0	19.48	19.33	19.51
BW	MCS Index	RB Size	RB Offset	Low	Mid	High
		Channel		19957	20175	20393
		Frequency (MHz)		1710.7	1732.5	1754.3
1.4M	QPSK	1	0	21.27	21.03	21.30
		1	2	21.40	21.16	21.39
		1	5	21.48	21.22	21.42
		3	0	21.61	21.35	21.57
		3	1	21.65	21.40	21.66
		3	3	21.59	21.31	21.55
		6	0	20.84	20.56	20.77
1.4M	16QAM	1	0	20.42	20.20	20.58
		1	2	20.57	20.33	20.69
		1	5	20.67	20.36	20.54
		3	0	20.82	20.65	20.81
		3	1	20.91	20.52	20.84
		3	3	20.85	20.53	20.79
		6	0	20.02	19.76	19.99

EIRP Power (dBm)

BW	MCS Index	RB Size	RB Offset	Low	Mid	High
		Channel		20050	20175	20300
		Frequency (MHz)		1720	1732.5	1745
20M	QPSK	1	0	22.50	22.27	22.51
		1	50	22.77	22.57	22.81
		1	99	22.93	22.70	22.94
		50	0	22.39	22.10	22.37
		50	25	22.49	22.20	22.43
		50	50	22.26	22.04	22.34
		100	0	21.58	21.37	21.67
20M	16QAM	1	0	21.68	21.45	21.75
		1	50	22.01	21.79	21.97
		1	99	22.06	21.85	22.05
		50	0	21.60	21.26	21.60
		50	25	21.65	21.36	21.69
		50	50	21.45	21.20	21.59
		100	0	20.81	20.63	20.84
BW	MCS Index	RB Size	RB Offset	Low	Mid	High
		Channel		20025	20175	20325
		Frequency (MHz)		1717.5	1732.5	1747.5
15M	QPSK	1	0	22.46	22.23	22.53
		1	37	22.79	22.51	22.75
		1	74	22.92	22.64	22.87
		36	0	22.44	22.15	22.37
		36	19	22.42	22.15	22.41
		36	39	22.25	22.03	22.24
		75	0	21.60	21.32	21.57
15M	16QAM	1	0	21.75	21.34	21.64
		1	37	21.95	21.65	21.92
		1	74	22.21	21.91	22.15
		36	0	21.72	21.41	21.51
		36	19	21.53	21.42	21.70
		36	39	21.36	21.33	21.41
		75	0	20.76	20.42	20.85

*EIRP (dBm) = Conducted Output Power (dBm) + Antenna Gain (dBi)

BW	MCS Index	RB Size	RB Offset	Low	Mid	High
		Channel		20000	20175	20350
		Frequency (MHz)		1715	1732.5	1750
10M	QPSK	1	0	22.53	22.24	22.52
		1	24	22.77	22.56	22.76
		1	49	22.91	22.68	22.85
		25	0	22.33	22.07	22.27
		25	12	22.50	22.21	22.50
		25	25	22.25	22.04	22.28
		50	0	21.62	21.39	21.68
10M	16QAM	1	0	21.70	21.52	21.63
		1	24	22.06	21.71	21.88
		1	49	22.20	21.97	22.15
		25	0	21.60	21.35	21.50
		25	12	21.76	21.36	21.79
		25	25	21.35	21.14	21.48
		50	0	20.86	20.65	20.88
BW	MCS Index	RB Size	RB Offset	Low	Mid	High
		Channel		19975	20175	20375
		Frequency (MHz)		1712.5	1732.5	1752.5
5M	QPSK	1	0	22.59	22.30	22.52
		1	12	22.80	22.54	22.81
		1	24	22.92	22.64	22.87
		12	0	22.42	22.14	22.42
		12	6	22.49	22.20	22.45
		12	13	22.31	22.06	22.34
		25	0	21.64	21.40	21.62
5M	16QAM	1	0	21.86	21.47	21.71
		1	12	22.05	21.74	22.10
		1	24	22.21	21.86	22.09
		12	0	21.64	21.25	21.67
		12	6	21.73	21.34	21.71
		12	13	21.48	21.17	21.62
		25	0	20.78	20.50	20.76

*EIRP (dBm) = Conducted Output Power (dBm) + Antenna Gain (dBi)

BW	MCS Index	RB Size	RB Offset	Low	Mid	High
		Channel		19965	20175	20385
		Frequency (MHz)		1711.5	1732.5	1753.5
3M	QPSK	1	0	22.45	22.23	22.47
		1	7	22.87	22.59	22.82
		1	14	22.88	22.63	22.88
		8	0	22.28	22.07	22.27
		8	3	22.44	22.15	22.39
		8	7	22.27	21.99	22.27
		15	0	21.56	21.35	21.58
3M	16QAM	1	0	21.73	21.52	21.63
		1	7	22.09	21.83	22.04
		1	14	22.18	21.78	22.01
		8	0	21.58	21.29	21.42
		8	3	21.55	21.34	21.51
		8	7	21.42	21.25	21.37
		15	0	20.73	20.58	20.76
BW	MCS Index	RB Size	RB Offset	Low	Mid	High
		Channel		19957	20175	20393
		Frequency (MHz)		1710.7	1732.5	1754.3
1.4M	QPSK	1	0	22.52	22.28	22.55
		1	2	22.65	22.41	22.64
		1	5	22.73	22.47	22.67
		3	0	22.86	22.60	22.82
		3	1	22.90	22.65	22.91
		3	3	22.84	22.56	22.80
		6	0	22.09	21.81	22.02
1.4M	16QAM	1	0	21.67	21.45	21.83
		1	2	21.82	21.58	21.94
		1	5	21.92	21.61	21.79
		3	0	22.07	21.90	22.06
		3	1	22.16	21.77	22.09
		3	3	22.10	21.78	22.04
		6	0	21.27	21.01	21.24

*EIRP (dBm) = Conducted Output Power (dBm) + Antenna Gain (dBi)

7.1.8 LTE Band 5

Conducted Output Power (dBm)

BW	MCS Index	RB Size	RB Offset	Low	Mid	High
		Channel		20450	20525	20600
		Frequency (MHz)		829	836.5	844
10M	QPSK	1	0	21.66	21.90	21.82
		1	24	22.04	22.30	22.98
		1	49	21.61	21.64	21.60
		25	0	20.62	20.88	21.00
		25	12	20.16	20.40	20.46
		25	25	20.47	20.69	21.68
		50	0	20.91	20.95	20.87
10M	16QAM	1	0	20.86	21.18	21.04
		1	24	21.27	21.52	22.27
		1	49	20.82	20.93	20.84
		25	0	19.89	20.13	20.29
		25	12	19.43	19.67	19.70
		25	25	19.70	19.91	20.91
		50	0	20.20	20.16	20.10
BW	MCS Index	RB Size	RB Offset	Low	Mid	High
		Channel		20425	20525	20625
		Frequency (MHz)		826.5	836.5	846.5
5M	QPSK	1	0	21.83	22.01	21.94
		1	12	22.26	22.30	22.15
		1	24	21.59	21.70	21.65
		12	0	20.96	21.02	20.98
		12	6	20.13	20.41	20.39
		12	13	20.72	20.89	20.89
		25	0	21.02	21.11	21.04
5M	16QAM	1	0	21.04	21.23	21.15
		1	12	21.52	21.58	21.45
		1	24	20.85	20.93	20.90
		12	0	20.17	20.32	20.28
		12	6	19.37	19.62	19.64
		12	13	19.94	20.14	20.09
		25	0	20.25	20.40	20.28

BW	MCS Index	RB Size	RB Offset	Low	Mid	High
		Channel		20415	20525	20635
		Frequency (MHz)		825.5	836.5	847.5
3M	QPSK	1	0	21.98	22.07	22.02
		1	7	22.32	22.49	22.49
		1	14	21.83	21.84	21.80
		8	0	20.80	20.93	20.88
		8	3	20.40	20.55	20.48
		8	7	20.81	20.85	20.82
		15	0	20.95	21.07	20.89
3M	16QAM	1	0	21.19	21.29	21.31
		1	7	21.60	21.72	21.71
		1	14	21.11	21.05	21.07
		8	0	20.04	20.20	20.15
		8	3	19.68	19.84	19.70
		8	7	20.02	20.11	20.03
		15	0	20.22	20.35	20.10
BW	MCS Index	RB Size	RB Offset	Low	Mid	High
		Channel		20407	20525	20643
		Frequency (MHz)		824.7	836.5	848.3
1.4M	QPSK	1	0	21.82	22.06	22.01
		1	2	21.91	22.16	22.08
		1	5	22.03	22.19	22.06
		3	0	21.79	21.88	21.74
		3	1	21.81	21.98	21.91
		3	3	21.57	21.87	21.74
		6	0	20.73	20.87	20.80
1.4M	16QAM	1	0	21.07	21.36	21.25
		1	2	21.13	21.41	21.32
		1	5	21.27	21.48	21.27
		3	0	21.07	21.15	20.99
		3	1	21.06	21.19	21.13
		3	3	20.83	21.10	21.02
		6	0	20.00	20.15	20.05



ERP Power (dBm)

BW	MCS Index	RB Size	RB Offset	Low	Mid	High
		Channel		20450	20525	20600
		Frequency (MHz)		829	836.5	844
10M	QPSK	1	0	18.33	18.57	18.49
		1	24	18.71	18.97	19.65
		1	49	18.28	18.31	18.27
		25	0	17.29	17.55	17.67
		25	12	16.83	17.07	17.13
		25	25	17.14	17.36	18.35
		50	0	17.58	17.62	17.54
10M	16QAM	1	0	17.53	17.85	17.71
		1	24	17.94	18.19	18.94
		1	49	17.49	17.60	17.51
		25	0	16.56	16.80	16.96
		25	12	16.10	16.34	16.37
		25	25	16.37	16.58	17.58
		50	0	16.87	16.83	16.77
BW	MCS Index	RB Size	RB Offset	Low	Mid	High
		Channel		20425	20525	20625
		Frequency (MHz)		826.5	836.5	846.5
5M	QPSK	1	0	18.50	18.68	18.61
		1	12	18.93	18.97	18.82
		1	24	18.26	18.37	18.32
		12	0	17.63	17.69	17.65
		12	6	16.80	17.08	17.06
		12	13	17.39	17.56	17.56
		25	0	17.69	17.78	17.71
5M	16QAM	1	0	17.71	17.90	17.82
		1	12	18.19	18.25	18.12
		1	24	17.52	17.60	17.57
		12	0	16.84	16.99	16.95
		12	6	16.04	16.29	16.31
		12	13	16.61	16.81	16.76
		25	0	16.92	17.07	16.95

*ERP (dBm) = Conducted Output Power (dBm) + Antenna Gain (dBi) - 2.15

BW	MCS Index	RB Size	RB Offset	Low	Mid	High
		Channel		20415	20525	20635
		Frequency (MHz)		825.5	836.5	847.5
3M	QPSK	1	0	18.65	18.74	18.69
		1	7	18.99	19.16	19.16
		1	14	18.50	18.51	18.47
		8	0	17.47	17.60	17.55
		8	3	17.07	17.22	17.15
		8	7	17.48	17.52	17.49
		15	0	17.62	17.74	17.56
3M	16QAM	1	0	17.86	17.96	17.98
		1	7	18.27	18.39	18.38
		1	14	17.78	17.72	17.74
		8	0	16.71	16.87	16.82
		8	3	16.35	16.51	16.37
		8	7	16.69	16.78	16.70
		15	0	16.89	17.02	16.77
BW	MCS Index	RB Size	RB Offset	Low	Mid	High
		Channel		20407	20525	20643
		Frequency (MHz)		824.7	836.5	848.3
1.4M	QPSK	1	0	18.49	18.73	18.68
		1	2	18.58	18.83	18.75
		1	5	18.70	18.86	18.73
		3	0	18.46	18.55	18.41
		3	1	18.48	18.65	18.58
		3	3	18.24	18.54	18.41
		6	0	17.40	17.54	17.47
1.4M	16QAM	1	0	17.74	18.03	17.92
		1	2	17.80	18.08	17.99
		1	5	17.94	18.15	17.94
		3	0	17.74	17.82	17.66
		3	1	17.73	17.86	17.80
		3	3	17.50	17.77	17.69
		6	0	16.67	16.82	16.72

*ERP (dBm) = Conducted Output Power (dBm) + Antenna Gain (dBi) - 2.15

7.1.9 LTE Band 7

Conducted Output Power (dBm)

BW	MCS Index	RB Size	RB Offset	Low	Mid	High
		Channel		20850	21100	21350
		Frequency (MHz)		2510	2535	2560
20M	QPSK	1	0	20.65	20.71	20.66
		1	50	20.41	20.68	20.62
		1	99	20.39	20.59	20.30
		50	0	19.88	19.90	19.71
		50	25	19.76	20.05	19.77
		50	50	19.83	20.00	19.73
		100	0	19.74	19.99	19.86
20M	16QAM	1	0	19.91	20.00	19.76
		1	50	19.69	19.80	19.65
		1	99	19.60	19.84	19.30
		50	0	18.91	18.98	18.96
		50	25	18.81	19.34	18.82
		50	50	18.89	19.18	18.96
		100	0	18.92	19.17	19.11
BW	MCS Index	RB Size	RB Offset	Low	Mid	High
		Channel		20825	21100	21375
		Frequency (MHz)		2507.5	2535	2562.5
15M	QPSK	1	0	20.37	20.58	20.32
		1	37	20.58	20.66	20.55
		1	74	20.34	20.60	20.55
		36	0	19.64	19.80	19.60
		36	19	19.52	19.81	19.62
		36	39	19.69	19.78	19.61
		75	0	19.69	19.87	19.64
15M	16QAM	1	0	19.48	19.68	19.58
		1	37	19.71	19.94	19.78
		1	74	19.57	19.64	19.80
		36	0	18.78	18.88	18.71
		36	19	18.65	18.88	18.65
		36	39	18.83	19.08	18.89
		75	0	18.86	19.16	18.80

BW	MCS Index	RB Size	RB Offset	Low	Mid	High
		Channel		20800	21100	21400
		Frequency (MHz)		2505	2535	2565
10M	QPSK	1	0	20.55	20.67	20.65
		1	24	20.29	20.55	20.34
		1	49	20.40	20.59	20.47
		25	0	19.91	19.99	19.71
		25	12	19.96	20.01	19.87
		25	25	19.74	19.82	19.65
		50	0	19.67	19.88	19.83
10M	16QAM	1	0	19.69	19.68	19.72
		1	24	19.48	19.68	19.44
		1	49	19.66	19.80	19.67
		25	0	19.05	19.27	18.83
		25	12	19.26	19.24	18.93
		25	25	18.85	18.90	18.92
		50	0	18.77	19.15	18.94
BW	MCS Index	RB Size	RB Offset	Low	Mid	High
		Channel		20775	21100	21425
		Frequency (MHz)		2502.5	2535	2567.5
5M	QPSK	1	0	20.40	20.58	20.33
		1	12	20.31	20.60	20.41
		1	24	20.23	20.45	20.36
		12	0	19.84	19.97	19.79
		12	6	19.96	20.10	19.87
		12	13	19.80	19.93	19.80
		25	0	19.80	19.97	19.72
5M	16QAM	1	0	19.55	19.74	19.38
		1	12	19.45	19.81	19.69
		1	24	19.36	19.64	19.64
		12	0	18.91	19.24	18.93
		12	6	19.21	19.35	19.08
		12	13	18.83	19.23	18.92
		25	0	18.94	19.16	18.77



EIRP Power (dBm)

BW	MCS Index	RB Size	RB Offset	Low	Mid	High
		Channel		20850	21100	21350
		Frequency (MHz)		2510	2535	2560
20M	QPSK	1	0	21.90	21.96	21.91
		1	50	21.66	21.93	21.87
		1	99	21.64	21.84	21.55
		50	0	21.13	21.15	20.96
		50	25	21.01	21.30	21.02
		50	50	21.08	21.25	20.98
		100	0	20.99	21.24	21.11
20M	16QAM	1	0	21.16	21.25	21.01
		1	50	20.94	21.05	20.90
		1	99	20.85	21.09	20.55
		50	0	20.16	20.23	20.21
		50	25	20.06	20.59	20.07
		50	50	20.14	20.43	20.21
		100	0	20.17	20.42	20.36
BW	MCS Index	RB Size	RB Offset	Low	Mid	High
		Channel		20825	21100	21375
		Frequency (MHz)		2507.5	2535	2562.5
15M	QPSK	1	0	21.62	21.83	21.57
		1	37	21.83	21.91	21.80
		1	74	21.59	21.85	21.80
		36	0	20.89	21.05	20.85
		36	19	20.77	21.06	20.87
		36	39	20.94	21.03	20.86
		75	0	20.94	21.12	20.89
15M	16QAM	1	0	20.73	20.93	20.83
		1	37	20.96	21.19	21.03
		1	74	20.82	20.89	21.05
		36	0	20.03	20.13	19.96
		36	19	19.90	20.13	19.90
		36	39	20.08	20.33	20.14
		75	0	20.11	20.41	20.05

*EIRP (dBm) = Conducted Output Power (dBm) + Antenna Gain (dBi)

BW	MCS Index	RB Size	RB Offset	Low	Mid	High
		Channel		20800	21100	21400
		Frequency (MHz)		2505	2535	2565
10M	QPSK	1	0	21.80	21.92	21.90
		1	24	21.54	21.80	21.59
		1	49	21.65	21.84	21.72
		25	0	21.16	21.24	20.96
		25	12	21.21	21.26	21.12
		25	25	20.99	21.07	20.90
		50	0	20.92	21.13	21.08
10M	16QAM	1	0	20.94	20.93	20.97
		1	24	20.73	20.93	20.69
		1	49	20.91	21.05	20.92
		25	0	20.30	20.52	20.08
		25	12	20.51	20.49	20.18
		25	25	20.10	20.15	20.17
		50	0	20.02	20.40	20.19
BW	MCS Index	RB Size	RB Offset	Low	Mid	High
		Channel		20775	21100	21425
		Frequency (MHz)		2502.5	2535	2567.5
5M	QPSK	1	0	21.65	21.83	21.58
		1	12	21.56	21.85	21.66
		1	24	21.48	21.70	21.61
		12	0	21.09	21.22	21.04
		12	6	21.21	21.35	21.12
		12	13	21.05	21.18	21.05
		25	0	21.05	21.22	20.97
5M	16QAM	1	0	20.80	20.99	20.63
		1	12	20.70	21.06	20.94
		1	24	20.61	20.89	20.89
		12	0	20.16	20.49	20.18
		12	6	20.46	20.60	20.33
		12	13	20.08	20.48	20.17
		25	0	20.19	20.41	20.02

*EIRP (dBm) = Conducted Output Power (dBm) + Antenna Gain (dBi)

7.1.10 LTE Band 12

Conducted Output Power (dBm)

BW	MCS Index	RB Size	RB Offset	Low	Mid	High
		Channel		23060	23095	23130
		Frequency (MHz)		704	707.5	711
10M	QPSK	1	0	22.08	22.00	21.96
		1	24	22.46	22.33	22.28
		1	49	22.00	21.84	21.94
		25	0	21.14	21.13	21.06
		25	12	21.19	21.14	21.10
		25	25	21.18	21.02	21.15
		50	0	21.09	20.97	20.98
10M	16QAM	1	0	21.19	21.14	21.07
		1	24	21.66	21.50	21.39
		1	49	21.20	20.94	21.15
		25	0	20.30	20.23	20.35
		25	12	20.40	20.27	20.40
		25	25	20.46	20.30	20.42
		50	0	20.36	20.07	20.15
BW	MCS Index	RB Size	RB Offset	Low	Mid	High
		Channel		23035	23095	23155
		Frequency (MHz)		701.5	707.5	713.5
5M	QPSK	1	0	22.11	22.11	21.92
		1	12	22.27	22.10	22.23
		1	24	21.96	21.91	21.92
		12	0	21.22	21.22	21.12
		12	6	21.06	20.90	20.98
		12	13	21.10	20.98	20.94
		25	0	21.10	21.02	21.07
5M	16QAM	1	0	21.29	21.21	21.07
		1	12	21.38	21.21	21.43
		1	24	21.15	21.02	21.15
		12	0	20.32	20.45	20.27
		12	6	20.27	20.03	20.28
		12	13	20.27	20.19	20.18
		25	0	20.33	20.16	20.25

BW	MCS Index	RB Size	RB Offset	Low	Mid	High
		Channel		23025	23095	23165
		Frequency (MHz)		700.5	707.5	714.5
3M	QPSK	1	0	22.19	22.13	22.00
		1	7	22.17	22.17	22.10
		1	14	21.84	21.82	21.73
		8	0	21.01	21.01	20.84
		8	3	21.08	20.90	20.91
		8	7	21.15	20.99	20.97
		15	0	21.22	21.04	21.08
3M	16QAM	1	0	21.46	21.30	21.22
		1	7	21.27	21.30	21.23
		1	14	21.11	20.98	20.91
		8	0	20.20	20.29	19.96
		8	3	20.20	20.18	20.15
		8	7	20.39	20.15	20.26
		15	0	20.48	20.33	20.25
BW	MCS Index	RB Size	RB Offset	Low	Mid	High
		Channel		23017	23095	23173
		Frequency (MHz)		699.7	707.5	715.3
1.4M	QPSK	1	0	21.93	21.79	21.90
		1	2	22.30	22.17	22.15
		1	5	22.10	22.01	22.11
		3	0	22.19	22.18	22.17
		3	1	22.10	22.09	22.09
		3	3	21.98	21.96	21.96
		6	0	21.00	20.81	20.92
1.4M	16QAM	1	0	21.14	20.92	21.07
		1	2	21.48	21.39	21.42
		1	5	21.37	21.13	21.40
		3	0	21.38	21.39	21.45
		3	1	21.23	21.35	21.31
		3	3	21.25	21.24	21.12
		6	0	20.15	19.95	20.10



ERP Power (dBm)

BW	MCS Index	RB Size	RB Offset	Low	Mid	High
		Channel		23060	23095	23130
		Frequency (MHz)		704	707.5	711
10M	QPSK	1	0	18.75	18.67	18.63
		1	24	19.13	19.00	18.95
		1	49	18.67	18.51	18.61
		25	0	17.81	17.80	17.73
		25	12	17.86	17.81	17.77
		25	25	17.85	17.69	17.82
		50	0	17.76	17.64	17.65
10M	16QAM	1	0	17.86	17.81	17.74
		1	24	18.33	18.17	18.06
		1	49	17.87	17.61	17.82
		25	0	16.97	16.90	17.02
		25	12	17.07	16.94	17.07
		25	25	17.13	16.97	17.09
		50	0	17.03	16.74	16.82
BW	MCS Index	RB Size	RB Offset	Low	Mid	High
		Channel		23035	23095	23155
		Frequency (MHz)		701.5	707.5	713.5
5M	QPSK	1	0	18.78	18.78	18.59
		1	12	18.94	18.77	18.90
		1	24	18.63	18.58	18.59
		12	0	17.89	17.89	17.79
		12	6	17.73	17.57	17.65
		12	13	17.77	17.65	17.61
		25	0	17.77	17.69	17.74
5M	16QAM	1	0	17.96	17.88	17.74
		1	12	18.05	17.88	18.10
		1	24	17.82	17.69	17.82
		12	0	16.99	17.12	16.94
		12	6	16.94	16.70	16.95
		12	13	16.94	16.86	16.85
		25	0	17.00	16.83	16.92

*ERP (dBm) = Conducted Output Power (dBm) + Antenna Gain (dBi) - 2.15

BW	MCS Index	RB Size	RB Offset	Low	Mid	High
		Channel		23025	23095	23165
		Frequency (MHz)		700.5	707.5	714.5
3M	QPSK	1	0	18.86	18.80	18.67
		1	7	18.84	18.84	18.77
		1	14	18.51	18.49	18.40
		8	0	17.68	17.68	17.51
		8	3	17.75	17.57	17.58
		8	7	17.82	17.66	17.64
		15	0	17.89	17.71	17.75
3M	16QAM	1	0	18.13	17.97	17.89
		1	7	17.94	17.97	17.90
		1	14	17.78	17.65	17.58
		8	0	16.87	16.96	16.63
		8	3	16.87	16.85	16.82
		8	7	17.06	16.82	16.93
		15	0	17.15	17.00	16.92
BW	MCS Index	RB Size	RB Offset	Low	Mid	High
		Channel		23017	23095	23173
		Frequency (MHz)		699.7	707.5	715.3
1.4M	QPSK	1	0	18.60	18.46	18.57
		1	2	18.97	18.84	18.82
		1	5	18.77	18.68	18.78
		3	0	18.86	18.85	18.84
		3	1	18.77	18.76	18.76
		3	3	18.65	18.63	18.63
		6	0	17.67	17.48	17.59
1.4M	16QAM	1	0	17.81	17.59	17.74
		1	2	18.15	18.06	18.09
		1	5	18.04	17.80	18.07
		3	0	18.05	18.06	18.12
		3	1	17.90	18.02	17.98
		3	3	17.92	17.91	17.79
		6	0	16.82	16.62	16.77

*ERP (dBm) = Conducted Output Power (dBm) + Antenna Gain (dBi) - 2.15

7.1.11 LTE Band 13

Conducted Output Power (dBm)

BW	MCS Index	RB Size	RB Offset	Mid		
		Channel		23230		
		Frequency (MHz)		782		
10M	QPSK	1	0	22.87		
		1	24	23.01		
		1	49	22.49		
		25	0	21.54		
		25	12	21.64		
		25	25	21.62		
		50	0	21.59		
10M	16QAM	1	0	21.28		
		1	24	21.38		
		1	49	21.40		
		25	0	20.87		
		25	12	20.81		
		25	25	20.75		
		50	0	20.55		
BW	MCS Index	RB Size	RB Offset	Low	Mid	High
		Channel		23205	23230	23255
		Frequency (MHz)		779.5	782	784.5
5M	QPSK	1	0	22.55	22.64	22.39
		1	12	23.00	22.67	22.84
		1	24	22.82	22.42	22.85
		12	0	21.64	21.79	21.65
		12	6	22.09	21.70	21.74
		12	13	21.74	21.58	21.73
		25	0	21.68	21.60	21.70
5M	16QAM	1	0	21.23	21.10	21.07
		1	12	21.56	21.42	21.15
		1	24	21.44	21.39	21.16
		12	0	20.56	20.41	20.49
		12	6	20.59	20.55	20.77
		12	13	20.66	20.68	20.51
		25	0	20.69	20.71	20.36

ERP Power (dBm)

BW	MCS Index	RB Size	RB Offset	Mid		
		Channel		23230		
		Frequency (MHz)		782		
10M	QPSK	1	0	19.54		
		1	24	19.68		
		1	49	19.16		
		25	0	18.21		
		25	12	18.31		
		25	25	18.29		
		50	0	18.26		
10M	16QAM	1	0	17.95		
		1	24	18.05		
		1	49	18.07		
		25	0	17.54		
		25	12	17.48		
		25	25	17.42		
		50	0	17.22		
BW	MCS Index	RB Size	RB Offset	Low	Mid	High
		Channel		23205	23230	23255
		Frequency (MHz)		779.5	782	784.5
5M	QPSK	1	0	19.22	19.31	19.06
		1	12	19.67	19.34	19.51
		1	24	19.49	19.09	19.52
		12	0	18.31	18.46	18.32
		12	6	18.76	18.37	18.41
		12	13	18.41	18.25	18.40
		25	0	18.35	18.27	18.37
5M	16QAM	1	0	17.90	17.77	17.74
		1	12	18.23	18.09	17.82
		1	24	18.11	18.06	17.83
		12	0	17.23	17.08	17.16
		12	6	17.26	17.22	17.44
		12	13	17.33	17.35	17.18
		25	0	17.36	17.38	17.03

*ERP (dBm) = Conducted Output Power (dBm) + Antenna Gain (dBi) - 2.15

7.1.12 LTE Band 17

Conducted Output Power (dBm)

BW	MCS Index	RB Size	RB Offset	Low	Mid	High
		Channel		23780	23790	23800
		Frequency (MHz)		709	710	711
10M	QPSK	1	0	22.53	22.22	22.17
		1	24	22.27	22.51	22.40
		1	49	22.01	22.21	22.19
		25	0	21.27	21.38	21.23
		25	12	21.18	21.45	21.29
		25	25	21.31	21.35	21.29
		50	0	21.28	21.38	21.37
10M	16QAM	1	0	21.11	21.32	21.38
		1	24	21.46	21.81	21.56
		1	49	21.30	21.35	21.33
		25	0	20.52	20.63	20.36
		25	12	20.31	20.66	20.40
		25	25	20.42	20.65	20.49
		50	0	20.53	20.65	20.64
BW	MCS Index	RB Size	RB Offset	Low	Mid	High
		Channel		23755	23790	23825
		Frequency (MHz)		706.5	710	713.5
5M	QPSK	1	0	22.00	22.26	22.22
		1	12	22.12	22.41	22.18
		1	24	22.31	22.46	22.29
		12	0	21.22	21.45	21.31
		12	6	21.20	21.49	21.40
		12	13	21.37	21.48	21.27
		25	0	21.34	21.37	21.09
5M	16QAM	1	0	21.11	21.37	21.40
		1	12	21.39	21.60	21.30
		1	24	21.51	21.67	21.47
		12	0	20.34	20.65	20.55
		12	6	20.47	20.69	20.60
		12	13	20.60	20.67	20.48
		25	0	20.60	20.65	20.28

ERP Power (dBm)

BW	MCS Index	RB Size	RB Offset	Low	Mid	High
		Channel		23780	23790	23800
		Frequency (MHz)		709	710	711
10M	QPSK	1	0	19.20	18.89	18.84
		1	24	18.94	19.18	19.07
		1	49	18.68	18.88	18.86
		25	0	17.94	18.05	17.90
		25	12	17.85	18.12	17.96
		25	25	17.98	18.02	17.96
		50	0	17.95	18.05	18.04
10M	16QAM	1	0	17.78	17.99	18.05
		1	24	18.13	18.48	18.23
		1	49	17.97	18.02	18.00
		25	0	17.19	17.30	17.03
		25	12	16.98	17.33	17.07
		25	25	17.09	17.32	17.16
		50	0	17.20	17.32	17.31
BW	MCS Index	RB Size	RB Offset	Low	Mid	High
		Channel		23755	23790	23825
		Frequency (MHz)		706.5	710	713.5
5M	QPSK	1	0	18.67	18.93	18.89
		1	12	18.79	19.08	18.85
		1	24	18.98	19.13	18.96
		12	0	17.89	18.12	17.98
		12	6	17.87	18.16	18.07
		12	13	18.04	18.15	17.94
		25	0	18.01	18.04	17.76
5M	16QAM	1	0	17.78	18.04	18.07
		1	12	18.06	18.27	17.97
		1	24	18.18	18.34	18.14
		12	0	17.01	17.32	17.22
		12	6	17.14	17.36	17.27
		12	13	17.27	17.34	17.15
		25	0	17.27	17.32	16.95

*ERP (dBm) = Conducted Output Power (dBm) + Antenna Gain (dBi) - 2.15

7.1.13 LTE Band 25

Conducted Output Power (dBm)

BW	MCS Index	RB Size	RB Offset	Low	Mid	High
		Channel		26140	26365	26590
		Frequency (MHz)		1860	1882.5	1905
20M	QPSK	1	0	20.96	21.10	20.92
		1	50	20.99	21.13	21.11
		1	99	21.04	21.22	21.08
		50	0	20.03	20.23	20.09
		50	25	20.17	20.21	20.03
		50	50	20.25	20.43	20.42
		100	0	20.07	20.23	20.11
20M	16QAM	1	0	20.12	20.26	19.94
		1	50	20.01	20.23	20.28
		1	99	20.23	20.32	20.20
		50	0	19.14	19.34	19.10
		50	25	19.17	19.36	19.08
		50	50	19.26	19.43	19.52
		100	0	19.26	19.35	19.17
BW	MCS Index	RB Size	RB Offset	Low	Mid	High
		Channel		26115	26365	26615
		Frequency (MHz)		1857.5	1882.5	1907.5
15M	QPSK	1	0	21.20	21.30	21.20
		1	37	21.02	21.15	21.04
		1	74	20.98	21.05	21.03
		36	0	20.28	20.33	20.20
		36	19	20.14	20.25	20.07
		36	39	20.01	20.12	20.10
		75	0	20.22	20.23	20.16
15M	16QAM	1	0	20.23	20.48	20.23
		1	37	20.07	20.26	20.06
		1	74	20.06	20.20	20.05
		36	0	19.38	19.46	19.27
		36	19	19.16	19.44	19.17
		36	39	19.05	19.30	19.15
		75	0	19.24	19.36	19.32

BW	MCS Index	RB Size	RB Offset	Low	Mid	High
		Channel		26090	26365	26640
		Frequency (MHz)		1855	1882.5	1910
10M	QPSK	1	0	21.14	21.20	21.07
		1	24	20.96	21.15	21.11
		1	49	21.12	21.20	21.10
		25	0	20.15	20.21	20.17
		25	12	20.15	20.19	20.01
		25	25	20.17	20.29	20.12
		50	0	20.10	20.25	20.09
10M	16QAM	1	0	20.21	20.22	20.23
		1	24	20.05	20.29	20.20
		1	49	20.22	20.30	20.27
		25	0	19.33	19.38	19.29
		25	12	19.20	19.26	19.08
		25	25	19.27	19.46	19.18
		50	0	19.23	19.31	19.24
BW	MCS Index	RB Size	RB Offset	Low	Mid	High
		Channel		26065	26365	26665
		Frequency (MHz)		1852.5	1882.5	1912.5
5M	QPSK	1	0	20.99	21.15	20.96
		1	12	21.25	21.33	21.19
		1	24	21.03	21.22	21.10
		12	0	20.02	20.15	20.12
		12	6	20.03	20.22	20.04
		12	13	20.10	20.12	20.12
		25	0	19.96	20.16	20.12
5M	16QAM	1	0	20.03	20.24	20.14
		1	12	20.38	20.51	20.30
		1	24	20.07	20.39	20.19
		12	0	19.15	19.26	19.16
		12	6	19.18	19.24	19.04
		12	13	19.28	19.19	19.24
		25	0	19.15	19.26	19.28

BW	MCS Index	RB Size	RB Offset	Low	Mid	High
		Channel		26055	26365	26675
		Frequency (MHz)		1851.5	1882.5	1913.5
3M	QPSK	1	0	21.04	21.20	21.14
		1	7	21.10	21.30	21.28
		1	14	21.09	21.13	20.99
		8	0	20.17	20.30	20.19
		8	3	20.13	20.28	20.14
		8	7	20.08	20.25	20.14
		15	0	20.14	20.20	20.00
3M	16QAM	1	0	20.10	20.20	20.29
		1	7	20.12	20.36	20.29
		1	14	20.18	20.28	20.02
		8	0	19.32	19.41	19.20
		8	3	19.27	19.33	19.23
		8	7	19.20	19.36	19.20
		15	0	19.30	19.39	19.04
BW	MCS Index	RB Size	RB Offset	Low	Mid	High
		Channel		26047	26365	26683
		Frequency (MHz)		1850.7	1882.5	1914.3
1.4M	QPSK	1	0	20.92	20.97	20.94
		1	2	21.25	21.33	21.31
		1	5	21.06	21.15	21.04
		3	0	20.96	21.09	21.04
		3	1	21.01	21.18	21.15
		3	3	20.98	21.17	21.14
		6	0	20.06	20.22	20.03
1.4M	16QAM	1	0	20.02	20.06	20.01
		1	2	20.30	20.39	20.47
		1	5	20.20	20.16	20.22
		3	0	20.00	20.19	20.05
		3	1	20.15	20.26	20.25
		3	3	20.05	20.24	20.29
		6	0	19.22	19.26	19.21

EIRP Power (dBm)

BW	MCS Index	RB Size	RB Offset	Low	Mid	High
		Channel		26140	26365	26590
		Frequency (MHz)		1860	1882.5	1905
20M	QPSK	1	0	22.21	22.35	22.17
		1	50	22.24	22.38	22.36
		1	99	22.29	22.47	22.33
		50	0	21.28	21.48	21.34
		50	25	21.42	21.46	21.28
		50	50	21.50	21.68	21.67
		100	0	21.32	21.48	21.36
20M	16QAM	1	0	21.37	21.51	21.19
		1	50	21.26	21.48	21.53
		1	99	21.48	21.57	21.45
		50	0	20.39	20.59	20.35
		50	25	20.42	20.61	20.33
		50	50	20.51	20.68	20.77
		100	0	20.51	20.60	20.42
BW	MCS Index	RB Size	RB Offset	Low	Mid	High
		Channel		26115	26365	26615
		Frequency (MHz)		1857.5	1882.5	1907.5
15M	QPSK	1	0	22.45	22.55	22.45
		1	37	22.27	22.40	22.29
		1	74	22.23	22.30	22.28
		36	0	21.53	21.58	21.45
		36	19	21.39	21.50	21.32
		36	39	21.26	21.37	21.35
		75	0	21.47	21.48	21.41
15M	16QAM	1	0	21.48	21.73	21.48
		1	37	21.32	21.51	21.31
		1	74	21.31	21.45	21.30
		36	0	20.63	20.71	20.52
		36	19	20.41	20.69	20.42
		36	39	20.30	20.55	20.40
		75	0	20.49	20.61	20.57

*EIRP (dBm) = Conducted Output Power (dBm) + Antenna Gain (dBi)

BW	MCS Index	RB Size	RB Offset	Low	Mid	High
		Channel		26090	26365	26640
		Frequency (MHz)		1855	1882.5	1910
10M	QPSK	1	0	22.39	22.45	22.32
		1	24	22.21	22.40	22.36
		1	49	22.37	22.45	22.35
		25	0	21.40	21.46	21.42
		25	12	21.40	21.44	21.26
		25	25	21.42	21.54	21.37
		50	0	21.35	21.50	21.34
10M	16QAM	1	0	21.46	21.47	21.48
		1	24	21.30	21.54	21.45
		1	49	21.47	21.55	21.52
		25	0	20.58	20.63	20.54
		25	12	20.45	20.51	20.33
		25	25	20.52	20.71	20.43
		50	0	20.48	20.56	20.49
BW	MCS Index	RB Size	RB Offset	Low	Mid	High
		Channel		26065	26365	26665
		Frequency (MHz)		1852.5	1882.5	1912.5
5M	QPSK	1	0	22.24	22.40	22.21
		1	12	22.50	22.58	22.44
		1	24	22.28	22.47	22.35
		12	0	21.27	21.40	21.37
		12	6	21.28	21.47	21.29
		12	13	21.35	21.37	21.37
		25	0	21.21	21.41	21.37
5M	16QAM	1	0	21.28	21.49	21.39
		1	12	21.63	21.76	21.55
		1	24	21.32	21.64	21.44
		12	0	20.40	20.51	20.41
		12	6	20.43	20.49	20.29
		12	13	20.53	20.44	20.49
		25	0	20.40	20.51	20.53

*EIRP (dBm) = Conducted Output Power (dBm) + Antenna Gain (dBi)

BW	MCS Index	RB Size	RB Offset	Low	Mid	High
		Channel		26055	26365	26675
		Frequency (MHz)		1851.5	1882.5	1913.5
3M	QPSK	1	0	22.29	22.45	22.39
		1	7	22.35	22.55	22.53
		1	14	22.34	22.38	22.24
		8	0	21.42	21.55	21.44
		8	3	21.38	21.53	21.39
		8	7	21.33	21.50	21.39
		15	0	21.39	21.45	21.25
3M	16QAM	1	0	21.35	21.45	21.54
		1	7	21.37	21.61	21.54
		1	14	21.43	21.53	21.27
		8	0	20.57	20.66	20.45
		8	3	20.52	20.58	20.48
		8	7	20.45	20.61	20.45
		15	0	20.55	20.64	20.29
BW	MCS Index	RB Size	RB Offset	Low	Mid	High
		Channel		26047	26365	26683
		Frequency (MHz)		1850.7	1882.5	1914.3
1.4M	QPSK	1	0	22.17	22.22	22.19
		1	2	22.50	22.58	22.56
		1	5	22.31	22.40	22.29
		3	0	22.21	22.34	22.29
		3	1	22.26	22.43	22.40
		3	3	22.23	22.42	22.39
		6	0	21.31	21.47	21.28
1.4M	16QAM	1	0	21.27	21.31	21.26
		1	2	21.55	21.64	21.72
		1	5	21.45	21.41	21.47
		3	0	21.25	21.44	21.30
		3	1	21.40	21.51	21.50
		3	3	21.30	21.49	21.54
		6	0	20.47	20.51	20.46

*EIRP (dBm) = Conducted Output Power (dBm) + Antenna Gain (dBi)

7.1.14 LTE Band 26 (Part 22)

Conducted Output Power (dBm)

BW	MCS Index	RB Size	RB Offset	Low	Mid	High
		Channel		26865	26915	26965
		Frequency (MHz)		831.5	836.5	841.5
15M	QPSK	1	0	22.63	22.81	22.65
		1	37	22.59	22.68	22.63
		1	74	22.50	22.69	22.51
		36	0	21.85	21.93	21.87
		36	19	21.80	21.86	21.86
		36	39	21.77	21.79	21.65
		75	0	21.62	21.69	21.67
15M	16QAM	1	0	21.77	21.73	21.75
		1	37	21.63	21.72	21.69
		1	74	21.60	21.76	21.58
		36	0	20.95	21.10	21.04
		36	19	20.89	21.06	21.02
		36	39	20.90	20.82	20.68
		75	0	20.77	20.83	20.80
BW	MCS Index	RB Size	RB Offset	Low	Mid	High
		Channel		26840	26915	26990
		Frequency (MHz)		829	836.5	844
10M	QPSK	1	0	22.62	22.80	22.71
		1	24	22.62	22.71	22.64
		1	49	22.52	22.69	22.49
		25	0	21.79	21.88	21.85
		25	12	21.72	21.89	21.87
		25	25	21.92	21.93	21.90
		50	0	21.67	21.73	21.72
10M	16QAM	1	0	21.62	21.87	21.79
		1	24	21.65	21.79	21.82
		1	49	21.57	21.80	21.69
		25	0	20.84	21.03	21.03
		25	12	20.74	21.04	20.99
		25	25	21.09	21.03	20.93
		50	0	20.85	20.76	20.75

BW	MCS Index	RB Size	RB Offset	Low	Mid	High
		Channel		26815	26915	27015
		Frequency (MHz)		826.5	836.5	846.5
5M	QPSK	1	0	22.65	22.75	22.64
		1	12	22.51	22.66	22.58
		1	24	22.67	22.74	22.54
		12	0	21.73	21.81	21.78
		12	6	21.70	21.80	21.68
		12	13	21.50	21.69	21.54
		25	0	21.56	21.71	21.56
5M	16QAM	1	0	21.77	21.78	21.76
		1	12	21.67	21.72	21.75
		1	24	21.72	21.86	21.66
		12	0	20.88	20.93	20.97
		12	6	20.78	20.81	20.82
		12	13	20.54	20.87	20.56
		25	0	20.75	20.91	20.60
BW	MCS Index	RB Size	RB Offset	Low	Mid	High
		Channel		26805	26915	27025
		Frequency (MHz)		825.5	836.5	847.5
3M	QPSK	1	0	22.55	22.68	22.65
		1	7	22.60	22.65	22.48
		1	14	22.67	22.70	22.67
		8	0	21.78	21.80	21.79
		8	3	21.59	21.72	21.60
		8	7	21.70	21.77	21.75
		15	0	21.47	21.66	21.61
3M	16QAM	1	0	21.64	21.86	21.77
		1	7	21.61	21.73	21.54
		1	14	21.76	21.89	21.72
		8	0	20.93	20.97	20.80
		8	3	20.71	20.73	20.70
		8	7	20.86	20.85	20.77
		15	0	20.64	20.69	20.76



BW	MCS Index	RB Size	RB Offset	Low	Mid	High
		Channel		26797	26915	27033
		Frequency (MHz)		824.7	836.5	848.3
1.4M	QPSK	1	0	22.65	22.66	22.57
		1	2	22.65	22.70	22.60
		1	5	22.45	22.58	22.41
		3	0	22.53	22.61	22.60
		3	1	22.56	22.63	22.57
		3	3	22.58	22.58	22.55
		6	0	21.76	21.80	21.71
1.4M	16QAM	1	0	21.85	21.76	21.62
		1	2	21.79	21.85	21.78
		1	5	21.55	21.66	21.49
		3	0	21.59	21.70	21.68
		3	1	21.73	21.68	21.57
		3	3	21.63	21.75	21.58
		6	0	20.86	20.82	20.83



ERP Power (dBm)

BW	MCS Index	RB Size	RB Offset	Low	Mid	High
		Channel		26865	26915	26965
		Frequency (MHz)		831.5	836.5	841.5
15M	QPSK	1	0	19.30	19.48	19.32
		1	37	19.26	19.35	19.30
		1	74	19.17	19.36	19.18
		36	0	18.52	18.60	18.54
		36	19	18.47	18.53	18.53
		36	39	18.44	18.46	18.32
		75	0	18.29	18.36	18.34
15M	16QAM	1	0	18.44	18.40	18.42
		1	37	18.30	18.39	18.36
		1	74	18.27	18.43	18.25
		36	0	17.62	17.77	17.71
		36	19	17.56	17.73	17.69
		36	39	17.57	17.49	17.35
		75	0	17.44	17.50	17.47
BW	MCS Index	RB Size	RB Offset	Low	Mid	High
		Channel		26840	26915	26990
		Frequency (MHz)		829	836.5	844
10M	QPSK	1	0	19.29	19.47	19.38
		1	24	19.29	19.38	19.31
		1	49	19.19	19.36	19.16
		25	0	18.46	18.55	18.52
		25	12	18.39	18.56	18.54
		25	25	18.59	18.60	18.57
		50	0	18.34	18.40	18.39
10M	16QAM	1	0	18.29	18.54	18.46
		1	24	18.32	18.46	18.49
		1	49	18.24	18.47	18.36
		25	0	17.51	17.70	17.70
		25	12	17.41	17.71	17.66
		25	25	17.76	17.70	17.60
		50	0	17.52	17.43	17.42

*ERP (dBm) = Conducted Output Power (dBm) + Antenna Gain (dBi) - 2.15

BW	MCS Index	RB Size	RB Offset	Low	Mid	High
		Channel		26815	26915	27015
		Frequency (MHz)		826.5	836.5	846.5
5M	QPSK	1	0	19.32	19.42	19.31
		1	12	19.18	19.33	19.25
		1	24	19.34	19.41	19.21
		12	0	18.40	18.48	18.45
		12	6	18.37	18.47	18.35
		12	13	18.17	18.36	18.21
		25	0	18.23	18.38	18.23
5M	16QAM	1	0	18.44	18.45	18.43
		1	12	18.34	18.39	18.42
		1	24	18.39	18.53	18.33
		12	0	17.55	17.60	17.64
		12	6	17.45	17.48	17.49
		12	13	17.21	17.54	17.23
		25	0	17.42	17.58	17.27
BW	MCS Index	RB Size	RB Offset	Low	Mid	High
		Channel		26805	26915	27025
		Frequency (MHz)		825.5	836.5	847.5
3M	QPSK	1	0	19.22	19.35	19.32
		1	7	19.27	19.32	19.15
		1	14	19.34	19.37	19.34
		8	0	18.45	18.47	18.46
		8	3	18.26	18.39	18.27
		8	7	18.37	18.44	18.42
		15	0	18.14	18.33	18.28
3M	16QAM	1	0	18.31	18.53	18.44
		1	7	18.28	18.40	18.21
		1	14	18.43	18.56	18.39
		8	0	17.60	17.64	17.47
		8	3	17.38	17.40	17.37
		8	7	17.53	17.52	17.44
		15	0	17.31	17.36	17.43

*ERP (dBm) = Conducted Output Power (dBm) + Antenna Gain (dBi) - 2.15



BW	MCS Index	RB Size	RB Offset	Low	Mid	High
		Channel		26797	26915	27033
		Frequency (MHz)		824.7	836.5	848.3
1.4M	QPSK	1	0	19.32	19.33	19.24
		1	2	19.32	19.37	19.27
		1	5	19.12	19.25	19.08
		3	0	19.20	19.28	19.27
		3	1	19.23	19.30	19.24
		3	3	19.25	19.25	19.22
		6	0	18.43	18.47	18.38
1.4M	16QAM	1	0	18.52	18.43	18.29
		1	2	18.46	18.52	18.45
		1	5	18.22	18.33	18.16
		3	0	18.26	18.37	18.35
		3	1	18.40	18.35	18.24
		3	3	18.30	18.42	18.25
		6	0	17.53	17.49	17.50

*ERP (dBm) = Conducted Output Power (dBm) + Antenna Gain (dBi) - 2.15

7.1.15 LTE Band 26 (Part 90)

Conducted Output Power (dBm)

BW	MCS Index	RB Size	RB Offset	Mid
		Channel		26765
		Frequency (MHz)		821.5
15M	QPSK	1	0	22.64
		1	37	22.49
		1	74	22.51
		36	0	21.86
		36	19	21.72
		36	39	21.78
		75	0	21.58
15M	16QAM	1	0	21.82
		1	37	21.59
		1	74	21.67
		36	0	20.90
		36	19	20.82
		36	39	20.92
		75	0	20.66
BW	MCS Index	RB Size	RB Offset	Mid
		Channel		26740
		Frequency (MHz)		819
10M	QPSK	1	0	22.62
		1	24	22.77
		1	49	22.34
		25	0	21.60
		25	12	21.51
		25	25	21.44
		50	0	21.52
10M	16QAM	1	0	21.92
		1	24	21.88
		1	49	21.50
		25	0	20.86
		25	12	20.78
		25	25	20.69
		50	0	20.70

BW	MCS Index	RB Size	RB Offset	Low	Mid	High
		Channel		26715	26740	26765
		Frequency (MHz)		816.5	819	821.5
5M	QPSK	1	0	22.44	22.59	22.54
		1	12	22.52	22.60	22.40
		1	24	22.37	22.39	22.33
		12	0	21.46	21.59	21.47
		12	6	21.25	21.44	21.39
		12	13	21.31	21.40	21.32
		25	0	21.26	21.29	21.28
5M	16QAM	1	0	21.63	21.86	21.81
		1	12	21.76	21.80	21.64
		1	24	21.62	21.64	21.56
		12	0	20.73	20.83	20.57
		12	6	20.43	20.63	20.64
		12	13	20.46	20.64	20.43
		25	0	20.55	20.45	20.56
BW	MCS Index	RB Size	RB Offset	Low	Mid	High
		Channel		26705	26740	26775
		Frequency (MHz)		815.5	819	822.5
3M	QPSK	1	0	22.57	22.61	22.58
		1	7	22.33	22.49	22.35
		1	14	22.20	22.36	22.29
		8	0	21.30	21.45	21.28
		8	3	21.28	21.35	21.28
		8	7	21.22	21.33	21.18
		15	0	21.22	21.32	21.28
3M	16QAM	1	0	21.80	21.76	21.82
		1	7	21.54	21.68	21.49
		1	14	21.48	21.60	21.42
		8	0	20.52	20.66	20.44
		8	3	20.53	20.54	20.55
		8	7	20.38	20.56	20.34
		15	0	20.41	20.55	20.43



BW	MCS Index	RB Size	RB Offset	Low	Mid	High
		Channel		26697	26740	26783
		Frequency (MHz)		814.7	819	823.3
1.4M	QPSK	1	0	22.41	22.50	22.42
		1	2	22.33	22.53	22.40
		1	5	22.43	22.51	22.42
		3	0	22.46	22.55	22.53
		3	1	22.42	22.59	22.53
		3	3	22.41	22.48	22.37
		6	0	21.23	21.36	21.18
1.4M	16QAM	1	0	21.61	21.67	21.61
		1	2	21.52	21.73	21.69
		1	5	21.61	21.64	21.69
		3	0	21.62	21.83	21.64
		3	1	21.54	21.74	21.66
		3	3	21.52	21.74	21.64
		6	0	20.52	20.58	20.34

ERP Power (dBm)

BW	MCS Index	RB Size	RB Offset	Mid
		Channel		26765
		Frequency (MHz)		821.5
15M	QPSK	1	0	19.31
		1	37	19.16
		1	74	19.18
		36	0	18.53
		36	19	18.39
		36	39	18.45
		75	0	18.25
15M	16QAM	1	0	18.49
		1	37	18.26
		1	74	18.34
		36	0	17.57
		36	19	17.49
		36	39	17.59
		75	0	17.33
BW	MCS Index	RB Size	RB Offset	Mid
		Channel		26740
		Frequency (MHz)		819
10M	QPSK	1	0	19.29
		1	24	19.44
		1	49	19.01
		25	0	18.27
		25	12	18.18
		25	25	18.11
		50	0	18.19
10M	16QAM	1	0	18.59
		1	24	18.55
		1	49	18.17
		25	0	17.53
		25	12	17.45
		25	25	17.36
		50	0	17.37

BW	MCS Index	RB Size	RB Offset	Low	Mid	High
		Channel		26715	26740	26765
		Frequency (MHz)		816.5	819	821.5
5M	QPSK	1	0	19.11	19.26	19.21
		1	12	19.19	19.27	19.07
		1	24	19.04	19.06	19.00
		12	0	18.13	18.26	18.14
		12	6	17.92	18.11	18.06
		12	13	17.98	18.07	17.99
		25	0	17.93	17.96	17.95
5M	16QAM	1	0	18.30	18.53	18.48
		1	12	18.43	18.47	18.31
		1	24	18.29	18.31	18.23
		12	0	17.40	17.50	17.24
		12	6	17.10	17.30	17.31
		12	13	17.13	17.31	17.10
		25	0	17.22	17.12	17.23
BW	MCS Index	RB Size	RB Offset	Low	Mid	High
		Channel		26705	26740	26775
		Frequency (MHz)		815.5	819	822.5
3M	QPSK	1	0	19.24	19.28	19.25
		1	7	19.00	19.16	19.02
		1	14	18.87	19.03	18.96
		8	0	17.97	18.12	17.95
		8	3	17.95	18.02	17.95
		8	7	17.89	18.00	17.85
		15	0	17.89	17.99	17.95
3M	16QAM	1	0	18.47	18.43	18.49
		1	7	18.21	18.35	18.16
		1	14	18.15	18.27	18.09
		8	0	17.19	17.33	17.11
		8	3	17.20	17.21	17.22
		8	7	17.05	17.23	17.01
		15	0	17.08	17.22	17.10

*ERP (dBm) = Conducted Output Power (dBm) + Antenna Gain (dBi) - 2.15



BW	MCS Index	RB Size	RB Offset	Low	Mid	High
		Channel		26697	26740	26783
		Frequency (MHz)		814.7	819	823.3
1.4M	QPSK	1	0	19.08	19.17	19.09
		1	2	19.00	19.20	19.07
		1	5	19.10	19.18	19.09
		3	0	19.13	19.22	19.20
		3	1	19.09	19.26	19.20
		3	3	19.08	19.15	19.04
		6	0	17.90	18.03	17.85
1.4M	16QAM	1	0	18.28	18.34	18.28
		1	2	18.19	18.40	18.36
		1	5	18.28	18.31	18.36
		3	0	18.29	18.50	18.31
		3	1	18.21	18.41	18.33
		3	3	18.19	18.41	18.31
		6	0	17.19	17.25	17.01

*ERP (dBm) = Conducted Output Power (dBm) + Antenna Gain (dBi) - 2.15

7.1.16 LTE Band 66

Conducted Output Power (dBm)

BW	MCS Index	RB Size	RB Offset	Low	Mid	High
		Channel		132072	132322	132572
		Frequency (MHz)		1720	1745	1770
20M	QPSK	1	0	22.12	22.30	22.24
		1	50	21.93	22.10	21.96
		1	99	22.03	22.19	22.07
		50	0	21.01	21.20	21.06
		50	25	21.13	21.21	21.14
		50	50	21.17	21.30	21.18
		100	0	21.07	21.25	21.08
20M	16QAM	1	0	21.41	21.51	21.34
		1	50	21.10	21.26	21.08
		1	99	21.27	21.48	21.36
		50	0	20.23	20.39	20.28
		50	25	20.32	20.49	20.42
		50	50	20.39	20.59	20.31
		100	0	20.24	20.38	20.25
BW	MCS Index	RB Size	RB Offset	Low	Mid	High
		Channel		132047	132322	132597
		Frequency (MHz)		1717.5	1745	1772.5
15M	QPSK	1	0	22.16	22.19	22.00
		1	37	22.09	22.20	22.10
		1	74	22.12	22.13	22.09
		36	0	21.04	21.21	21.19
		36	19	21.26	21.30	21.14
		36	39	21.33	21.35	21.34
		75	0	21.17	21.20	21.07
15M	16QAM	1	0	21.33	21.36	21.16
		1	37	21.25	21.44	21.33
		1	74	21.23	21.35	21.32
		36	0	20.34	20.45	20.38
		36	19	20.39	20.59	20.34
		36	39	20.52	20.64	20.53
		75	0	20.28	20.31	20.24

BW	MCS Index	RB Size	RB Offset	Low	Mid	High
		Channel		132022	132322	132622
		Frequency (MHz)		1715	1745	1775
10M	QPSK	1	0	22.23	22.29	22.25
		1	24	22.13	22.18	22.15
		1	49	22.11	22.20	22.19
		25	0	21.28	21.29	21.26
		25	12	21.16	21.32	21.20
		25	25	21.28	21.33	21.22
		50	0	21.09	21.19	21.18
10M	16QAM	1	0	21.51	21.44	21.53
		1	24	21.30	21.30	21.32
		1	49	21.38	21.44	21.39
		25	0	20.39	20.46	20.43
		25	12	20.37	20.58	20.34
		25	25	20.56	20.47	20.42
		50	0	20.22	20.43	20.41
BW	MCS Index	RB Size	RB Offset	Low	Mid	High
		Channel		131997	132322	132647
		Frequency (MHz)		1712.5	1745	1777.5
5M	QPSK	1	0	22.14	22.28	22.10
		1	12	22.12	22.21	22.16
		1	24	22.23	22.25	22.17
		12	0	21.26	21.30	21.16
		12	6	21.28	21.28	21.10
		12	13	21.38	21.40	21.25
		25	0	21.17	21.23	21.15
5M	16QAM	1	0	21.37	21.56	21.24
		1	12	21.26	21.40	21.43
		1	24	21.35	21.38	21.43
		12	0	20.51	20.52	20.26
		12	6	20.55	20.52	20.39
		12	13	20.63	20.67	20.36
		25	0	20.31	20.45	20.44

BW	MCS Index	RB Size	RB Offset	Low	Mid	High
		Channel		131987	132322	132657
		Frequency (MHz)		1711.5	1745	1778.5
3M	QPSK	1	0	22.05	22.15	22.12
		1	7	21.96	22.10	22.06
		1	14	22.21	22.25	22.22
		8	0	21.20	21.35	21.23
		8	3	21.27	21.39	21.24
		8	7	21.39	21.40	21.22
		15	0	21.09	21.27	21.20
3M	16QAM	1	0	21.15	21.37	21.30
		1	7	21.25	21.26	21.17
		1	14	21.44	21.39	21.51
		8	0	20.37	20.56	20.47
		8	3	20.54	20.57	20.54
		8	7	20.62	20.57	20.43
		15	0	20.34	20.45	20.40
BW	MCS Index	RB Size	RB Offset	Low	Mid	High
		Channel		131979	132322	132665
		Frequency (MHz)		1710.7	1745	1779.3
1.4M	QPSK	1	0	22.08	22.23	22.10
		1	2	22.06	22.21	22.17
		1	5	22.02	22.20	22.08
		3	0	21.90	22.05	21.96
		3	1	21.95	22.12	21.97
		3	3	22.09	22.13	21.94
		6	0	21.19	21.24	21.05
1.4M	16QAM	1	0	21.33	21.42	21.26
		1	2	21.26	21.37	21.32
		1	5	21.30	21.32	21.29
		3	0	21.06	21.28	21.18
		3	1	21.15	21.24	21.23
		3	3	21.30	21.28	21.13
		6	0	20.30	20.48	20.32



EIRP Power (dBm)

BW	MCS Index	RB Size	RB Offset	Low	Mid	High
		Channel		132072	132322	132572
		Frequency (MHz)		1720	1745	1770
20M	QPSK	1	0	23.37	23.55	23.49
		1	50	23.18	23.35	23.21
		1	99	23.28	23.44	23.32
		50	0	22.26	22.45	22.31
		50	25	22.38	22.46	22.39
		50	50	22.42	22.55	22.43
		100	0	22.32	22.50	22.33
20M	16QAM	1	0	22.66	22.76	22.59
		1	50	22.35	22.51	22.33
		1	99	22.52	22.73	22.61
		50	0	21.48	21.64	21.53
		50	25	21.57	21.74	21.67
		50	50	21.64	21.84	21.56
		100	0	21.49	21.63	21.50
BW	MCS Index	RB Size	RB Offset	Low	Mid	High
		Channel		132047	132322	132597
		Frequency (MHz)		1717.5	1745	1772.5
15M	QPSK	1	0	23.41	23.44	23.25
		1	37	23.34	23.45	23.35
		1	74	23.37	23.38	23.34
		36	0	22.29	22.46	22.44
		36	19	22.51	22.55	22.39
		36	39	22.58	22.60	22.59
		75	0	22.42	22.45	22.32
15M	16QAM	1	0	22.58	22.61	22.41
		1	37	22.50	22.69	22.58
		1	74	22.48	22.60	22.57
		36	0	21.59	21.70	21.63
		36	19	21.64	21.84	21.59
		36	39	21.77	21.89	21.78
		75	0	21.53	21.56	21.49

*EIRP (dBm) = Conducted Output Power (dBm) + Antenna Gain (dBi)

BW	MCS Index	RB Size	RB Offset	Low	Mid	High
		Channel		132022	132322	132622
		Frequency (MHz)		1715	1745	1775
10M	QPSK	1	0	23.48	23.54	23.50
		1	24	23.38	23.43	23.40
		1	49	23.36	23.45	23.44
		25	0	22.53	22.54	22.51
		25	12	22.41	22.57	22.45
		25	25	22.53	22.58	22.47
		50	0	22.34	22.44	22.43
10M	16QAM	1	0	22.76	22.69	22.78
		1	24	22.55	22.55	22.57
		1	49	22.63	22.69	22.64
		25	0	21.64	21.71	21.68
		25	12	21.62	21.83	21.59
		25	25	21.81	21.72	21.67
		50	0	21.47	21.68	21.66
BW	MCS Index	RB Size	RB Offset	Low	Mid	High
		Channel		131997	132322	132647
		Frequency (MHz)		1712.5	1745	1777.5
5M	QPSK	1	0	23.39	23.53	23.35
		1	12	23.37	23.46	23.41
		1	24	23.48	23.50	23.42
		12	0	22.51	22.55	22.41
		12	6	22.53	22.53	22.35
		12	13	22.63	22.65	22.50
		25	0	22.42	22.48	22.40
5M	16QAM	1	0	22.62	22.81	22.49
		1	12	22.51	22.65	22.68
		1	24	22.60	22.63	22.68
		12	0	21.76	21.77	21.51
		12	6	21.80	21.77	21.64
		12	13	21.88	21.92	21.61
		25	0	21.56	21.70	21.69

*EIRP (dBm) = Conducted Output Power (dBm) + Antenna Gain (dBi)

BW	MCS Index	RB Size	RB Offset	Low	Mid	High
		Channel		131987	132322	132657
		Frequency (MHz)		1711.5	1745	1778.5
3M	QPSK	1	0	23.30	23.40	23.37
		1	7	23.21	23.35	23.31
		1	14	23.46	23.50	23.47
		8	0	22.45	22.60	22.48
		8	3	22.52	22.64	22.49
		8	7	22.64	22.65	22.47
		15	0	22.34	22.52	22.45
3M	16QAM	1	0	22.40	22.62	22.55
		1	7	22.50	22.51	22.42
		1	14	22.69	22.64	22.76
		8	0	21.62	21.81	21.72
		8	3	21.79	21.82	21.79
		8	7	21.87	21.82	21.68
		15	0	21.59	21.70	21.65
BW	MCS Index	RB Size	RB Offset	Low	Mid	High
		Channel		131979	132322	132665
		Frequency (MHz)		1710.7	1745	1779.3
1.4M	QPSK	1	0	23.33	23.48	23.35
		1	2	23.31	23.46	23.42
		1	5	23.27	23.45	23.33
		3	0	23.15	23.30	23.21
		3	1	23.20	23.37	23.22
		3	3	23.34	23.38	23.19
		6	0	22.44	22.49	22.30
1.4M	16QAM	1	0	22.58	22.67	22.51
		1	2	22.51	22.62	22.57
		1	5	22.55	22.57	22.54
		3	0	22.31	22.53	22.43
		3	1	22.40	22.49	22.48
		3	3	22.55	22.53	22.38
		6	0	21.55	21.73	21.57

*EIRP (dBm) = Conducted Output Power (dBm) + Antenna Gain (dBi)

7.2 Radiated Spurious Emissions below 1GHz

7.2.1 GSM 850

RF Mode	GSM 850	Channel	CH 189 : 836.4 MHz
Frequency Range	30 MHz ~ 1 GHz	Detector Function & Bandwidth	1 MHz/3 MHz (RMS)
Input Power	120 Vac, 60 Hz	Environmental Conditions	25°C, 60% RH
Tested By	Charles Hsiao		

Antenna Polarity & Test Distance : Horizontal at 3 m								
No	Frequency (MHz)	ERP (dBm)	Limit (dBm)	Margin (dB)	Antenna Height (m)	Table Angle (Degree)	Raw Value (dBuV)	Correction Factor (dB/m)
1	94.48	-52.16	-13.00	-39.16	1.57 H	118	68.41	-120.57
2	189.97	-52.40	-13.00	-39.40	1.45 H	2	65.57	-117.97
3	215.64	-54.71	-13.00	-41.71	1.14 H	158	63.50	-118.21
4	406.69	-60.91	-13.00	-47.91	1.16 H	211	51.12	-112.03
5	543.33	-68.71	-13.00	-55.71	1.05 H	141	40.52	-109.23
6	616.67	-68.66	-13.00	-55.66	1.15 H	11	38.77	-107.43

Remarks:

- ERP(dBm) = Raw Value(dBuV) + Correction Factor(dB/m)
- Correction Factor(dB/m) = Antenna Factor(dB/m) + Cable Factor(dB) – Pre-Amplifier Factor(dB) + 20log(D) – 104.8 – 2.15
- Margin value = ERP – Limit value
- The other ERP levels were very low against the limit of frequency range 30 MHz ~ 1 GHz.
- The frequency range 9 kHz ~ 30 MHz: all emissions are more than 20 dB below the limit, therefore do not be recorded in this report.

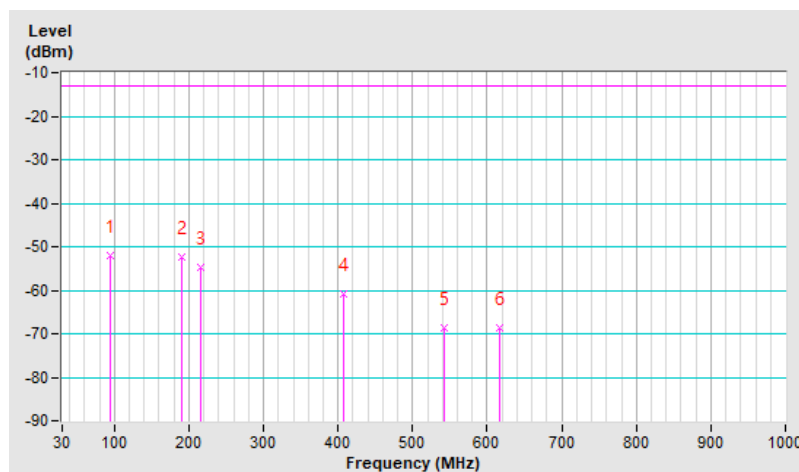

RF Mode	GSM 850	Channel	CH 189 : 836.4 MHz
Frequency Range	30 MHz ~ 1 GHz	Detector Function & Bandwidth	1 MHz/3 MHz (RMS)
Input Power	120 Vac, 60 Hz	Environmental Conditions	25°C, 60% RH
Tested By	Charles Hsiao		

Antenna Polarity & Test Distance : Vertical at 3 m								
No	Frequency (MHz)	ERP (dBm)	Limit (dBm)	Margin (dB)	Antenna Height (m)	Table Angle (Degree)	Raw Value (dBuV)	Correction Factor (dB/m)
1	91.48	-49.53	-13.00	-36.53	1.56 V	211	71.86	-121.39
2	134.48	-53.17	-13.00	-40.17	1.57 V	318	62.77	-115.94
3	188.87	-54.59	-13.00	-41.59	1.56 V	117	63.21	-117.80
4	389.98	-60.56	-13.00	-47.56	1.67 V	112	51.75	-112.31
5	604.48	-68.28	-13.00	-55.28	1.05 V	217	39.32	-107.60
6	704.48	-67.83	-13.00	-54.83	1.53 V	22	38.46	-106.29

Remarks:

1. $ERP(dBm) = Raw\ Value(dBuV) + Correction\ Factor(dB/m)$
2. $Correction\ Factor(dB/m) = Antenna\ Factor(dB/m) + Cable\ Factor(dB) - Pre-Amplifier\ Factor(dB) + 20\log(D) - 104.8 - 2.15$
3. $Margin\ value = ERP - Limit\ value$
4. The other ERP levels were very low against the limit of frequency range 30 MHz ~ 1 GHz.
5. The frequency range 9 kHz ~ 30 MHz: all emissions are more than 20 dB below the limit, therefore do not be recorded in this report.

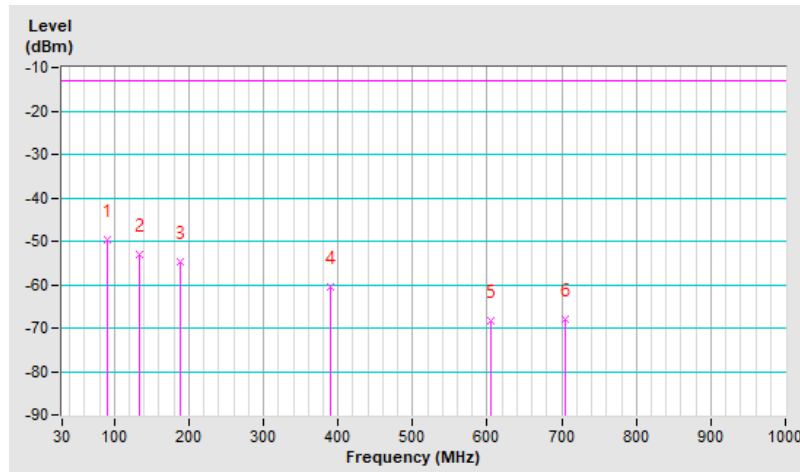

RF Mode	EDGE 850	Channel	CH 189 : 836.4 MHz
Frequency Range	30 MHz ~ 1 GHz	Detector Function & Bandwidth	1 MHz/3 MHz (RMS)
Input Power	120 Vac, 60 Hz	Environmental Conditions	25°C, 60% RH
Tested By	Charles Hsiao		

Antenna Polarity & Test Distance : Horizontal at 3 m								
No	Frequency (MHz)	ERP (dBm)	Limit (dBm)	Margin (dB)	Antenna Height (m)	Table Angle (Degree)	Raw Value (dBuV)	Correction Factor (dB/m)
1	93.67	-52.30	-13.00	-39.30	1.15 H	54	68.36	-120.66
2	184.48	-52.17	-13.00	-39.17	1.27 H	117	65.10	-117.27
3	208.98	-52.71	-13.00	-39.71	1.14 H	145	65.69	-118.40
4	403.65	-60.31	-13.00	-47.31	1.45 H	119	51.76	-112.07
5	548.87	-68.86	-13.00	-55.86	1.05 H	110	40.30	-109.16
6	615.54	-68.19	-13.00	-55.19	1.67 H	207	39.25	-107.44

Remarks:

1. $ERP(dBm) = Raw\ Value(dBuV) + Correction\ Factor(dB/m)$
2. $Correction\ Factor(dB/m) = Antenna\ Factor(dB/m) + Cable\ Factor(dB) - Pre-Amplifier\ Factor(dB) + 20\log(D) - 104.8 - 2.15$
3. $Margin\ value = ERP - Limit\ value$
4. The other ERP levels were very low against the limit of frequency range 30 MHz ~ 1 GHz.
5. The frequency range 9 kHz ~ 30 MHz: all emissions are more than 20 dB below the limit, therefore do not be recorded in this report.

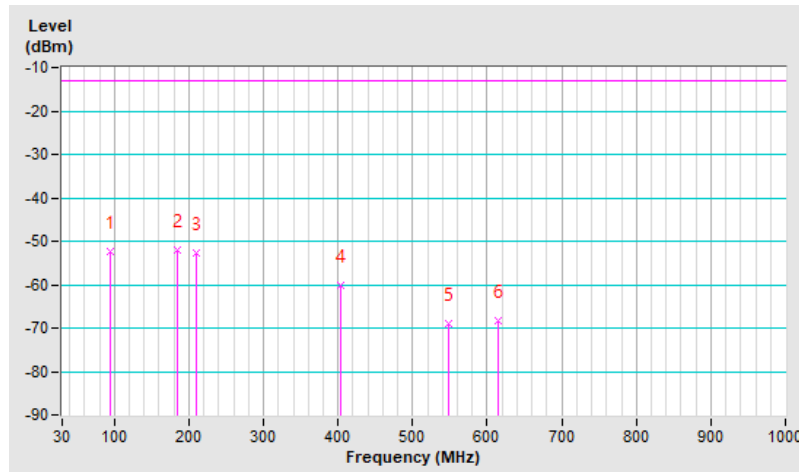

RF Mode	EDGE 850	Channel	CH 189 : 836.4 MHz
Frequency Range	30 MHz ~ 1 GHz	Detector Function & Bandwidth	1 MHz/3 MHz (RMS)
Input Power	120 Vac, 60 Hz	Environmental Conditions	25°C, 60% RH
Tested By	Charles Hsiao		

Antenna Polarity & Test Distance : Vertical at 3 m								
No	Frequency (MHz)	ERP (dBm)	Limit (dBm)	Margin (dB)	Antenna Height (m)	Table Angle (Degree)	Raw Value (dBuV)	Correction Factor (dB/m)
1	89.54	-49.61	-13.00	-36.61	1.15 V	211	71.95	-121.56
2	120.81	-52.58	-13.00	-39.58	1.55 V	246	64.66	-117.24
3	190.25	-55.02	-13.00	-42.02	1.47 V	8	62.97	-117.99
4	384.48	-60.38	-13.00	-47.38	1.48 V	112	52.04	-112.42
5	601.19	-67.81	-13.00	-54.81	1.55 V	16	39.85	-107.66
6	718.87	-68.02	-13.00	-55.02	1.53 V	299	38.06	-106.08

Remarks:

1. $ERP(dBm) = Raw\ Value(dBuV) + Correction\ Factor(dB/m)$
2. $Correction\ Factor(dB/m) = Antenna\ Factor(dB/m) + Cable\ Factor(dB) - Pre-Amplifier\ Factor(dB) + 20\log(D) - 104.8 - 2.15$
3. $Margin\ value = ERP - Limit\ value$
4. The other ERP levels were very low against the limit of frequency range 30 MHz ~ 1 GHz.
5. The frequency range 9 kHz ~ 30 MHz: all emissions are more than 20 dB below the limit, therefore do not be recorded in this report.

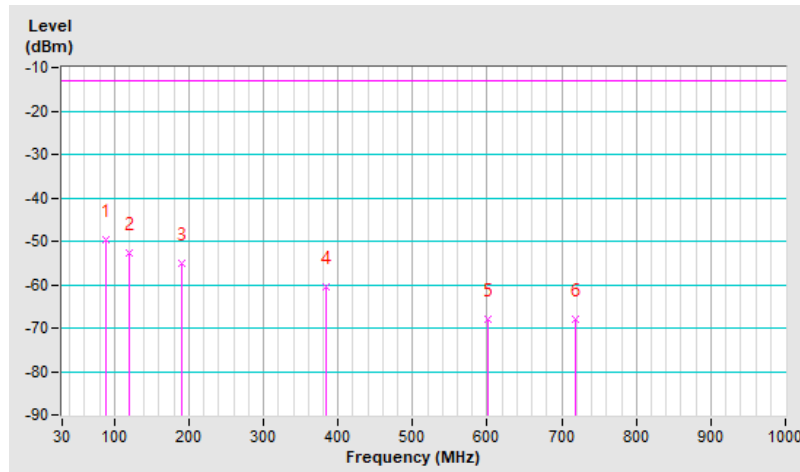

7.2.2 PCS 1900

RF Mode	PCS 1900	Channel	CH 512 : 1850.2 MHz
Frequency Range	30 MHz ~ 1 GHz	Detector Function & Bandwidth	1 MHz/3 MHz (RMS)
Input Power	120 Vac, 60 Hz	Environmental Conditions	25°C, 60% RH
Tested By	Charles Hsiao		

Antenna Polarity & Test Distance : Horizontal at 3 m								
No	Frequency (MHz)	EIRP (dBm)	Limit (dBm)	Margin (dB)	Antenna Height (m)	Table Angle (Degree)	Raw Value (dBuV)	Correction Factor (dB/m)
1	93.66	-51.84	-13.00	-38.84	1.15 H	241	66.67	-118.51
2	184.44	-52.59	-13.00	-39.59	1.59 H	64	62.52	-115.11
3	198.37	-53.09	-13.00	-40.09	1.52 H	229	63.16	-116.25
4	399.97	-60.14	-13.00	-47.14	1.09 H	17	49.85	-109.99
5	544.48	-68.81	-13.00	-55.81	1.05 H	200	38.24	-107.05
6	610.10	-68.17	-13.00	-55.17	1.17 H	348	37.14	-105.31

Remarks:

1. $EIRP(dBm) = Raw\ Value(dBuV) + Correction\ Factor(dB/m)$
2. $Correction\ Factor(dB/m) = Antenna\ Factor(dB/m) + Cable\ Factor(dB) - Pre-Amplifier\ Factor(dB) + 20\log(D) - 104.8$
3. $Margin\ value = EIRP - Limit\ value$
4. The other EIRP levels were very low against the limit of frequency range 30 MHz ~ 1 GHz.
5. The frequency range 9 kHz ~ 30 MHz: all emissions are more than 20 dB below the limit, therefore do not be recorded in this report.

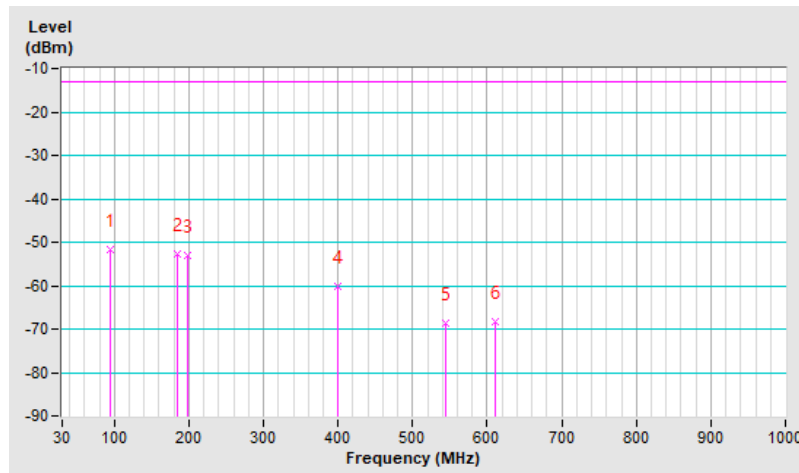

RF Mode	PCS 1900	Channel	CH 512 : 1850.2 MHz
Frequency Range	30 MHz ~ 1 GHz	Detector Function & Bandwidth	1 MHz/3 MHz (RMS)
Input Power	120 Vac, 60 Hz	Environmental Conditions	25°C, 60% RH
Tested By	Charles Hsiao		

Antenna Polarity & Test Distance : Vertical at 3 m								
No	Frequency (MHz)	EIRP (dBm)	Limit (dBm)	Margin (dB)	Antenna Height (m)	Table Angle (Degree)	Raw Value (dBuV)	Correction Factor (dB/m)
1	89.68	-49.38	-13.00	-36.38	1.15 V	219	70.04	-119.42
2	121.00	-52.40	-13.00	-39.40	1.15 V	208	62.67	-115.07
3	185.48	-55.09	-13.00	-42.09	1.39 V	99	60.15	-115.24
4	384.48	-61.17	-13.00	-48.17	1.14 V	149	49.10	-110.27
5	615.00	-69.06	-13.00	-56.06	1.20 V	285	36.24	-105.30
6	711.14	-68.89	-13.00	-55.89	1.96 V	329	35.11	-104.00

Remarks:

1. $EIRP(dBm) = Raw\ Value(dBuV) + Correction\ Factor(dB/m)$
2. $Correction\ Factor(dB/m) = Antenna\ Factor(dB/m) + Cable\ Factor(dB) - Pre-Amplifier\ Factor(dB) + 20\log(D) - 104.8$
3. $Margin\ value = EIRP - Limit\ value$
4. The other EIRP levels were very low against the limit of frequency range 30 MHz ~ 1 GHz.
5. The frequency range 9 kHz ~ 30 MHz: all emissions are more than 20 dB below the limit, therefore do not be recorded in this report.

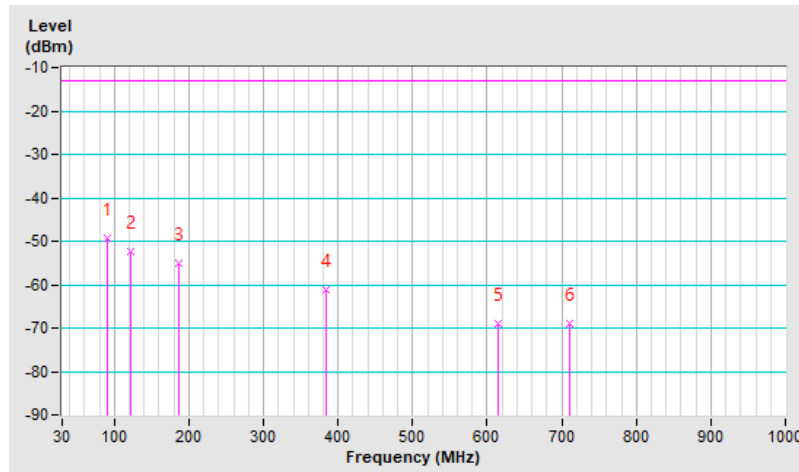

RF Mode	EDGE 1900	Channel	CH 512 : 1850.2 MHz
Frequency Range	30 MHz ~ 1 GHz	Detector Function & Bandwidth	1 MHz/3 MHz (RMS)
Input Power	120 Vac, 60 Hz	Environmental Conditions	25°C, 60% RH
Tested By	Charles Hsiao		

Antenna Polarity & Test Distance : Horizontal at 3 m								
No	Frequency (MHz)	EIRP (dBm)	Limit (dBm)	Margin (dB)	Antenna Height (m)	Table Angle (Degree)	Raw Value (dBuV)	Correction Factor (dB/m)
1	94.48	-52.08	-13.00	-39.08	1.75 H	327	66.34	-118.42
2	180.00	-51.74	-13.00	-38.74	1.15 H	196	62.80	-114.54
3	199.98	-53.32	-13.00	-40.32	1.63 H	2	62.92	-116.24
4	387.78	-60.22	-13.00	-47.22	1.12 H	251	49.99	-110.21
5	544.41	-68.90	-13.00	-55.90	1.89 H	9	38.15	-107.05
6	610.92	-68.42	-13.00	-55.42	1.43 H	118	36.89	-105.31

Remarks:

1. $EIRP(dBm) = Raw\ Value(dBuV) + Correction\ Factor(dB/m)$
2. $Correction\ Factor(dB/m) = Antenna\ Factor(dB/m) + Cable\ Factor(dB) - Pre-Amplifier\ Factor(dB) + 20\log(D) - 104.8$
3. $Margin\ value = EIRP - Limit\ value$
4. The other EIRP levels were very low against the limit of frequency range 30 MHz ~ 1 GHz.
5. The frequency range 9 kHz ~ 30 MHz: all emissions are more than 20 dB below the limit, therefore do not be recorded in this report.

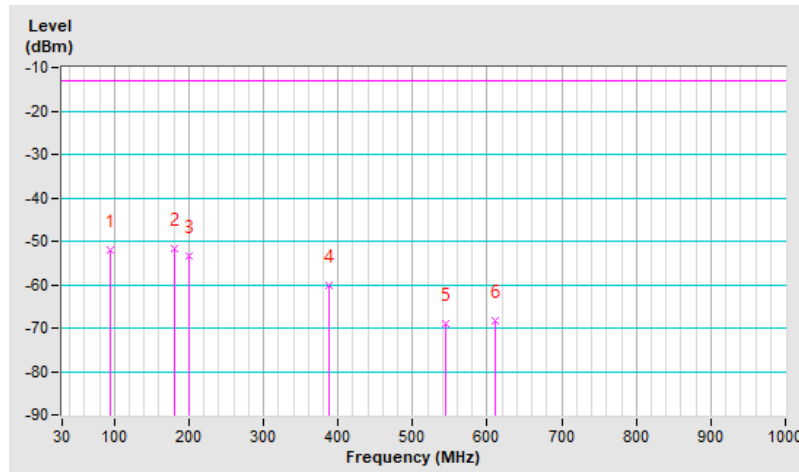

RF Mode	EDGE 1900	Channel	CH 512 : 1850.2 MHz
Frequency Range	30 MHz ~ 1 GHz	Detector Function & Bandwidth	1 MHz/3 MHz (RMS)
Input Power	120 Vac, 60 Hz	Environmental Conditions	25°C, 60% RH
Tested By	Charles Hsiao		

Antenna Polarity & Test Distance : Vertical at 3 m								
No	Frequency (MHz)	EIRP (dBm)	Limit (dBm)	Margin (dB)	Antenna Height (m)	Table Angle (Degree)	Raw Value (dBuV)	Correction Factor (dB/m)
1	90.60	-50.32	-13.00	-37.32	1.15 V	274	69.05	-119.37
2	124.48	-52.57	-13.00	-39.57	1.18 V	58	62.27	-114.84
3	189.98	-55.02	-13.00	-42.02	1.12 V	200	60.81	-115.83
4	400.00	-61.78	-13.00	-48.78	1.45 V	199	48.21	-109.99
5	619.98	-68.25	-13.00	-55.25	1.52 V	26	36.97	-105.22
6	705.54	-68.29	-13.00	-55.29	1.63 V	293	35.82	-104.11

Remarks:

1. $EIRP(dBm) = Raw\ Value(dBuV) + Correction\ Factor(dB/m)$
2. $Correction\ Factor(dB/m) = Antenna\ Factor(dB/m) + Cable\ Factor(dB) - Pre-Amplifier\ Factor(dB) + 20\log(D) - 104.8$
3. $Margin\ value = EIRP - Limit\ value$
4. The other EIRP levels were very low against the limit of frequency range 30 MHz ~ 1 GHz.
5. The frequency range 9 kHz ~ 30 MHz: all emissions are more than 20 dB below the limit, therefore do not be recorded in this report.

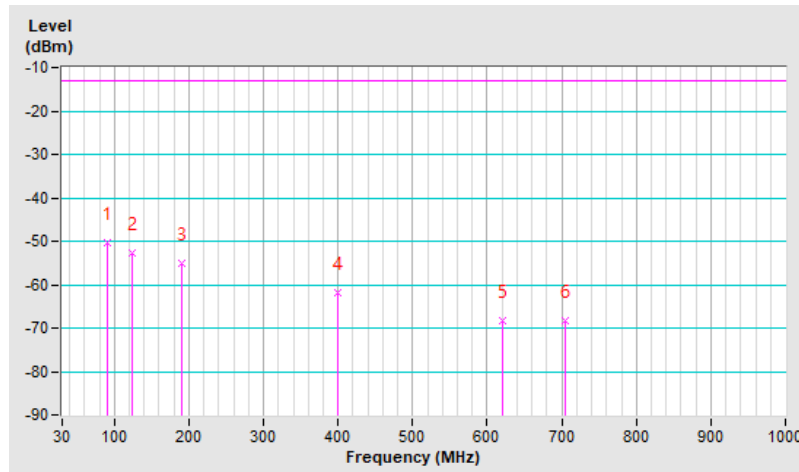

7.2.3 WCDMA Band 2

RF Mode	WCDMA Band 2	Channel	CH 9538 : 1907.6 MHz
Frequency Range	30 MHz ~ 1 GHz	Detector Function & Bandwidth	1 MHz/3 MHz (RMS)
Input Power	120 Vac, 60 Hz	Environmental Conditions	25°C, 60% RH
Tested By	Charles Hsiao		

Antenna Polarity & Test Distance : Horizontal at 3 m								
No	Frequency (MHz)	EIRP (dBm)	Limit (dBm)	Margin (dB)	Antenna Height (m)	Table Angle (Degree)	Raw Value (dBuV)	Correction Factor (dB/m)
1	94.48	-52.44	-13.00	-39.44	1.52 H	227	65.98	-118.42
2	182.45	-51.92	-13.00	-38.92	1.64 H	114	62.91	-114.83
3	201.15	-53.01	-13.00	-40.01	1.36 H	136	63.25	-116.26
4	399.52	-60.10	-13.00	-47.10	1.57 H	178	49.90	-110.00
5	538.84	-68.97	-13.00	-55.97	1.75 H	107	38.19	-107.16
6	604.10	-67.22	-13.00	-54.22	1.53 H	229	38.23	-105.45

Remarks:

- EIRP(dBm) = Raw Value(dBuV) + Correction Factor(dB/m)
- Correction Factor(dB/m) = Antenna Factor(dB/m) + Cable Factor(dB) – Pre-Amplifier Factor(dB) + 20log(D) – 104.8
- Margin value = EIRP – Limit value
- The other EIRP levels were very low against the limit of frequency range 30 MHz ~ 1 GHz.
- The frequency range 9 kHz ~ 30 MHz: all emissions are more than 20 dB below the limit, therefore do not be recorded in this report.

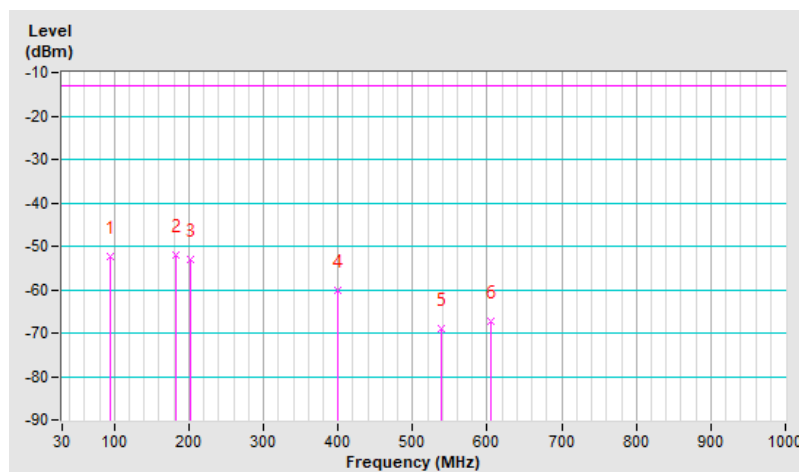

RF Mode	WCDMA Band 2	Channel	CH 9538 : 1907.6 MHz
Frequency Range	30 MHz ~ 1 GHz	Detector Function & Bandwidth	1 MHz/3 MHz (RMS)
Input Power	120 Vac, 60 Hz	Environmental Conditions	25°C, 60% RH
Tested By	Charles Hsiao		

Antenna Polarity & Test Distance : Vertical at 3 m								
No	Frequency (MHz)	EIRP (dBm)	Limit (dBm)	Margin (dB)	Antenna Height (m)	Table Angle (Degree)	Raw Value (dBuV)	Correction Factor (dB/m)
1	89.88	-50.50	-13.00	-37.50	1.19 V	142	68.93	-119.43
2	182.25	-52.67	-13.00	-39.67	1.42 V	172	62.14	-114.81
3	189.97	-55.36	-13.00	-42.36	1.35 V	229	60.46	-115.82
4	394.48	-61.87	-13.00	-48.87	1.42 V	117	48.24	-110.11
5	608.54	-68.59	-13.00	-55.59	1.15 V	209	36.75	-105.34
6	715.40	-68.80	-13.00	-55.80	1.15 V	103	35.16	-103.96

Remarks:

1. $EIRP(dBm) = Raw\ Value(dBuV) + Correction\ Factor(dB/m)$
2. $Correction\ Factor(dB/m) = Antenna\ Factor(dB/m) + Cable\ Factor(dB) - Pre-Amplifier\ Factor(dB) + 20\log(D) - 104.8$
3. $Margin\ value = EIRP - Limit\ value$
4. The other EIRP levels were very low against the limit of frequency range 30 MHz ~ 1 GHz.
5. The frequency range 9 kHz ~ 30 MHz: all emissions are more than 20 dB below the limit, therefore do not be recorded in this report.

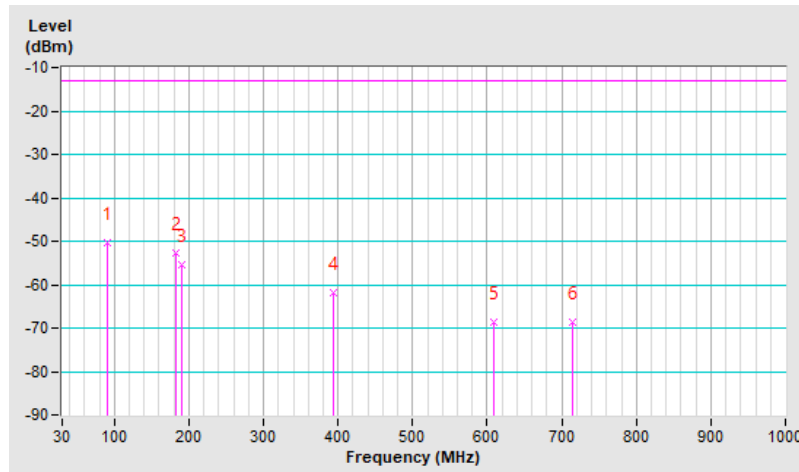

7.2.4 WCDMA Band 4

RF Mode	WCDMA Band 4	Channel	CH 1513 : 1752.6 MHz
Frequency Range	30 MHz ~ 1 GHz	Detector Function & Bandwidth	1 MHz/3 MHz (RMS)
Input Power	120 Vac, 60 Hz	Environmental Conditions	25°C, 60% RH
Tested By	Charles Hsiao		

Antenna Polarity & Test Distance : Horizontal at 3 m								
No	Frequency (MHz)	EIRP (dBm)	Limit (dBm)	Margin (dB)	Antenna Height (m)	Table Angle (Degree)	Raw Value (dBuV)	Correction Factor (dB/m)
1	91.64	-52.77	-13.00	-39.77	1.45 H	119	66.45	-119.22
2	180.15	-51.93	-13.00	-38.93	1.56 H	29	62.63	-114.56
3	214.11	-54.45	-13.00	-41.45	1.14 H	174	61.65	-116.10
4	416.32	-61.19	-13.00	-48.19	1.53 H	208	48.49	-109.68
5	521.14	-67.77	-13.00	-54.77	1.45 H	107	39.62	-107.39
6	615.59	-69.47	-13.00	-56.47	1.11 H	10	35.82	-105.29

Remarks:

- EIRP(dBm) = Raw Value(dBuV) + Correction Factor(dB/m)
- Correction Factor(dB/m) = Antenna Factor(dB/m) + Cable Factor(dB) – Pre-Amplifier Factor(dB) + 20log(D) – 104.8
- Margin value = EIRP – Limit value
- The other EIRP levels were very low against the limit of frequency range 30 MHz ~ 1 GHz.
- The frequency range 9 kHz ~ 30 MHz: all emissions are more than 20 dB below the limit, therefore do not be recorded in this report.

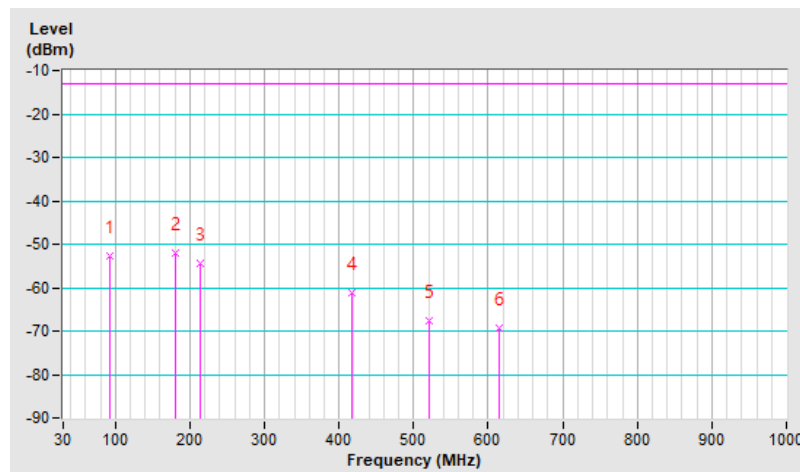

RF Mode	WCDMA Band 4	Channel	CH 1513 : 1752.6 MHz
Frequency Range	30 MHz ~ 1 GHz	Detector Function & Bandwidth	1 MHz/3 MHz (RMS)
Input Power	120 Vac, 60 Hz	Environmental Conditions	25°C, 60% RH
Tested By	Charles Hsiao		

Antenna Polarity & Test Distance : Vertical at 3 m								
No	Frequency (MHz)	EIRP (dBm)	Limit (dBm)	Margin (dB)	Antenna Height (m)	Table Angle (Degree)	Raw Value (dBuV)	Correction Factor (dB/m)
1	88.52	-49.05	-13.00	-36.05	1.24 V	4	70.31	-119.36
2	121.14	-52.82	-13.00	-39.82	1.65 V	115	62.25	-115.07
3	188.82	-55.62	-13.00	-42.62	1.95 V	309	60.02	-115.64
4	389.98	-61.77	-13.00	-48.77	1.14 V	17	48.39	-110.16
5	609.99	-68.98	-13.00	-55.98	1.53 V	2	36.33	-105.31
6	711.14	-68.71	-13.00	-55.71	1.14 V	104	35.29	-104.00

Remarks:

1. $EIRP(dBm) = Raw\ Value(dBuV) + Correction\ Factor(dB/m)$
2. $Correction\ Factor(dB/m) = Antenna\ Factor(dB/m) + Cable\ Factor(dB) - Pre-Amplifier\ Factor(dB) + 20\log(D) - 104.8$
3. $Margin\ value = EIRP - Limit\ value$
4. The other EIRP levels were very low against the limit of frequency range 30 MHz ~ 1 GHz.
5. The frequency range 9 kHz ~ 30 MHz: all emissions are more than 20 dB below the limit, therefore do not be recorded in this report.

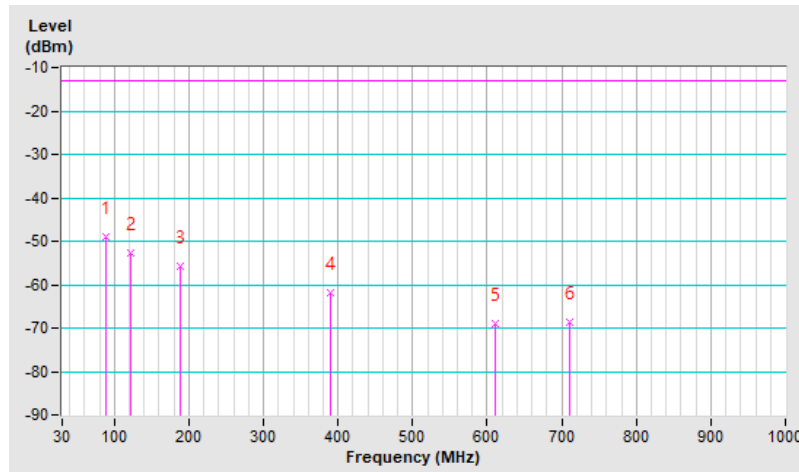

7.2.5 WCDMA Band 5

RF Mode	WCDMA Band 5	Channel	CH 4132 : 826.4 MHz
Frequency Range	30 MHz ~ 1 GHz	Detector Function & Bandwidth	1 MHz/3 MHz (RMS)
Input Power	120 Vac, 60 Hz	Environmental Conditions	25°C, 60% RH
Tested By	Charles Hsiao		

Antenna Polarity & Test Distance : Horizontal at 3 m								
No	Frequency (MHz)	ERP (dBm)	Limit (dBm)	Margin (dB)	Antenna Height (m)	Table Angle (Degree)	Raw Value (dBuV)	Correction Factor (dB/m)
1	93.36	-51.77	-13.00	-38.77	1.15 H	187	68.94	-120.71
2	186.66	-51.92	-13.00	-38.92	1.68 H	207	65.60	-117.52
3	198.89	-53.63	-13.00	-40.63	1.58 H	347	64.79	-118.42
4	402.27	-60.27	-13.00	-47.27	1.44 H	112	51.83	-112.10
5	548.84	-68.70	-13.00	-55.70	1.15 H	109	40.46	-109.16
6	609.98	-68.23	-13.00	-55.23	1.16 H	207	39.23	-107.46

Remarks:

- ERP(dBm) = Raw Value(dBuV) + Correction Factor(dB/m)
- Correction Factor(dB/m) = Antenna Factor(dB/m) + Cable Factor(dB) – Pre-Amplifier Factor(dB) + 20log(D) – 104.8 – 2.15
- Margin value = ERP – Limit value
- The other ERP levels were very low against the limit of frequency range 30 MHz ~ 1 GHz.
- The frequency range 9 kHz ~ 30 MHz: all emissions are more than 20 dB below the limit, therefore do not be recorded in this report.

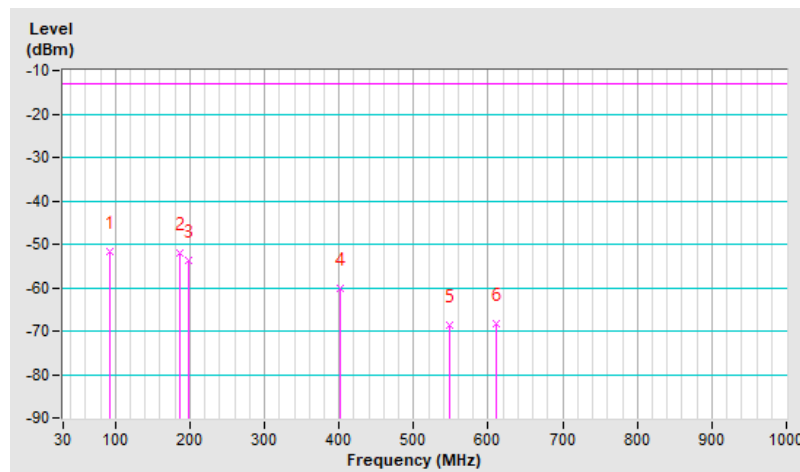

RF Mode	WCDMA Band 5	Channel	CH 4132 : 826.4 MHz
Frequency Range	30 MHz ~ 1 GHz	Detector Function & Bandwidth	1 MHz/3 MHz (RMS)
Input Power	120 Vac, 60 Hz	Environmental Conditions	25°C, 60% RH
Tested By	Charles Hsiao		

Antenna Polarity & Test Distance : Vertical at 3 m								
No	Frequency (MHz)	ERP (dBm)	Limit (dBm)	Margin (dB)	Antenna Height (m)	Table Angle (Degree)	Raw Value (dBuV)	Correction Factor (dB/m)
1	88.84	-50.02	-13.00	-37.02	1.53 V	214	71.50	-121.52
2	135.58	-53.47	-13.00	-40.47	1.30 V	119	62.36	-115.83
3	196.65	-55.38	-13.00	-42.38	1.57 V	118	62.96	-118.34
4	399.98	-61.30	-13.00	-48.30	1.48 V	7	50.84	-112.14
5	615.54	-68.11	-13.00	-55.11	1.05 V	117	39.33	-107.44
6	715.54	-69.23	-13.00	-56.23	1.53 V	229	36.88	-106.11

Remarks:

- ERP(dBm) = Raw Value(dBuV) + Correction Factor(dB/m)
- Correction Factor(dB/m) = Antenna Factor(dB/m) + Cable Factor(dB) – Pre-Amplifier Factor(dB) + 20log(D) – 104.8 – 2.15
- Margin value = ERP – Limit value
- The other ERP levels were very low against the limit of frequency range 30 MHz ~ 1 GHz.
- The frequency range 9 kHz ~ 30 MHz: all emissions are more than 20 dB below the limit, therefore do not be recorded in this report.

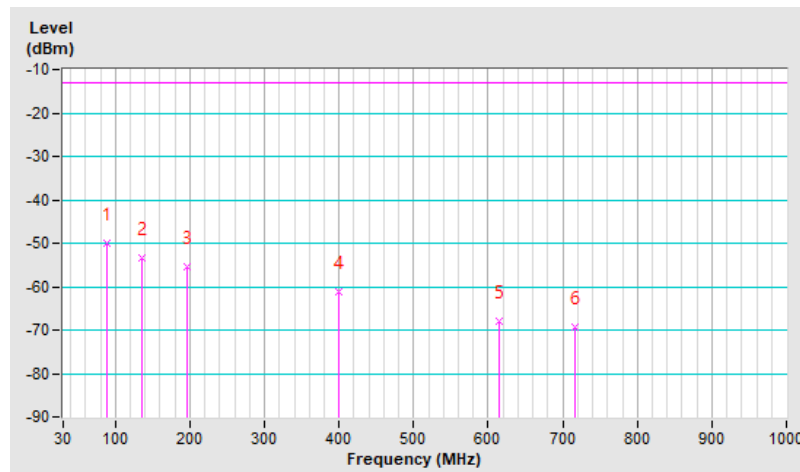

7.2.6 LTE Band 2

RF Mode	LTE Band 2 Channel Bandwidth: 5MHz	Channel	CH 19175 : 1907.5 MHz
Frequency Range	30 MHz ~ 1 GHz	Detector Function & Bandwidth	1 MHz/3 MHz (RMS)
Input Power	120 Vac, 60 Hz	Environmental Conditions	25°C, 60% RH
Tested By	Charles Hsiao		

Antenna Polarity & Test Distance : Horizontal at 3 m								
No	Frequency (MHz)	EIRP (dBm)	Limit (dBm)	Margin (dB)	Antenna Height (m)	Table Angle (Degree)	Raw Value (dBuV)	Correction Factor (dB/m)
1	95.58	-52.16	-13.00	-39.16	1.15 H	274	66.31	-118.47
2	197.74	-53.29	-13.00	-40.29	1.53 H	248	62.92	-116.21
3	198.85	-51.89	-13.00	-38.89	1.56 H	309	64.38	-116.27
4	401.14	-60.18	-13.00	-47.18	1.14 H	174	49.79	-109.97
5	548.84	-68.94	-13.00	-55.94	1.15 H	108	38.07	-107.01
6	618.54	-68.63	-13.00	-55.63	1.15 H	147	36.61	-105.24

Remarks:

- EIRP(dBm) = Raw Value(dBuV) + Correction Factor(dB/m)
- Correction Factor(dB/m) = Antenna Factor(dB/m) + Cable Factor(dB) – Pre-Amplifier Factor(dB) + 20log(D) – 104.8
- Margin value = EIRP – Limit value
- The other EIRP levels were very low against the limit of frequency range 30 MHz ~ 1 GHz.
- The frequency range 9 kHz ~ 30 MHz: all emissions are more than 20 dB below the limit, therefore do not be recorded in this report.

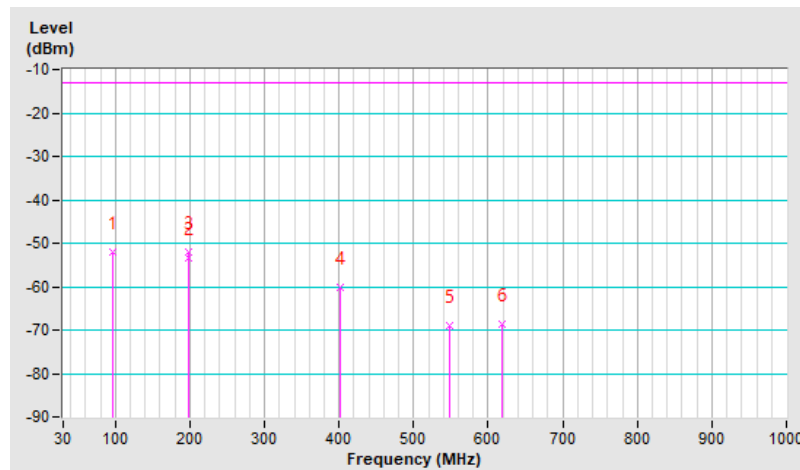

RF Mode	LTE Band 2 Channel Bandwidth: 5MHz	Channel	CH 19175 : 1907.5 MHz
Frequency Range	30 MHz ~ 1 GHz	Detector Function & Bandwidth	1 MHz/3 MHz (RMS)
Input Power	120 Vac, 60 Hz	Environmental Conditions	25°C, 60% RH
Tested By	Charles Hsiao		

Antenna Polarity & Test Distance : Vertical at 3 m								
No	Frequency (MHz)	EIRP (dBm)	Limit (dBm)	Margin (dB)	Antenna Height (m)	Table Angle (Degree)	Raw Value (dBuV)	Correction Factor (dB/m)
1	91.14	-50.29	-13.00	-37.29	1.55 V	274	69.01	-119.30
2	126.68	-52.80	-13.00	-39.80	1.15 V	322	61.78	-114.58
3	208.77	-55.00	-13.00	-42.00	1.14 V	214	61.25	-116.25
4	416.64	-61.81	-13.00	-48.81	1.42 V	105	47.86	-109.67
5	598.89	-66.82	-13.00	-53.82	1.53 V	321	38.73	-105.55
6	699.85	-67.81	-13.00	-54.81	1.05 V	217	36.41	-104.22

Remarks:

1. $EIRP(dBm) = Raw\ Value(dBuV) + Correction\ Factor(dB/m)$
2. $Correction\ Factor(dB/m) = Antenna\ Factor(dB/m) + Cable\ Factor(dB) - Pre-Amplifier\ Factor(dB) + 20\log(D) - 104.8$
3. $Margin\ value = EIRP - Limit\ value$
4. The other EIRP levels were very low against the limit of frequency range 30 MHz ~ 1 GHz.
5. The frequency range 9 kHz ~ 30 MHz: all emissions are more than 20 dB below the limit, therefore do not be recorded in this report.

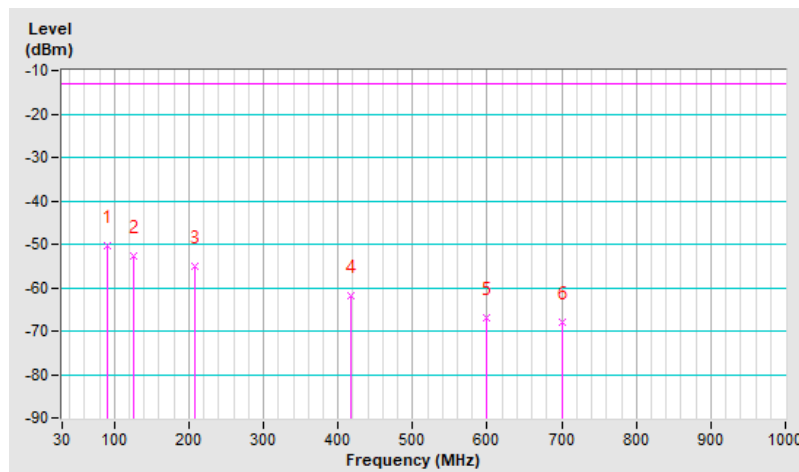

7.2.7 LTE Band 4

RF Mode	LTE Band 4 Channel Bandwidth: 20MHz	Channel	CH 20175 : 1732.5 MHz
Frequency Range	30 MHz ~ 1 GHz	Detector Function & Bandwidth	1 MHz/3 MHz (RMS)
Input Power	120 Vac, 60 Hz	Environmental Conditions	25°C, 60% RH
Tested By	Charles Hsiao		

Antenna Polarity & Test Distance : Horizontal at 3 m								
No	Frequency (MHz)	EIRP (dBm)	Limit (dBm)	Margin (dB)	Antenna Height (m)	Table Angle (Degree)	Raw Value (dBuV)	Correction Factor (dB/m)
1	95.57	-52.70	-13.00	-39.70	1.45 H	141	65.76	-118.46
2	198.87	-52.21	-13.00	-39.21	1.52 H	116	64.06	-116.27
3	208.54	-53.00	-13.00	-40.00	1.15 H	241	63.25	-116.25
4	388.89	-59.83	-13.00	-46.83	1.05 H	241	50.35	-110.18
5	516.98	-68.08	-13.00	-55.08	1.52 H	208	39.37	-107.45
6	600.03	-68.22	-13.00	-55.22	1.15 H	143	37.31	-105.53

Remarks:

- EIRP(dBm) = Raw Value(dBuV) + Correction Factor(dB/m)
- Correction Factor(dB/m) = Antenna Factor(dB/m) + Cable Factor(dB) – Pre-Amplifier Factor(dB) + 20log(D) – 104.8
- Margin value = EIRP – Limit value
- The other EIRP levels were very low against the limit of frequency range 30 MHz ~ 1 GHz.
- The frequency range 9 kHz ~ 30 MHz: all emissions are more than 20 dB below the limit, therefore do not be recorded in this report.

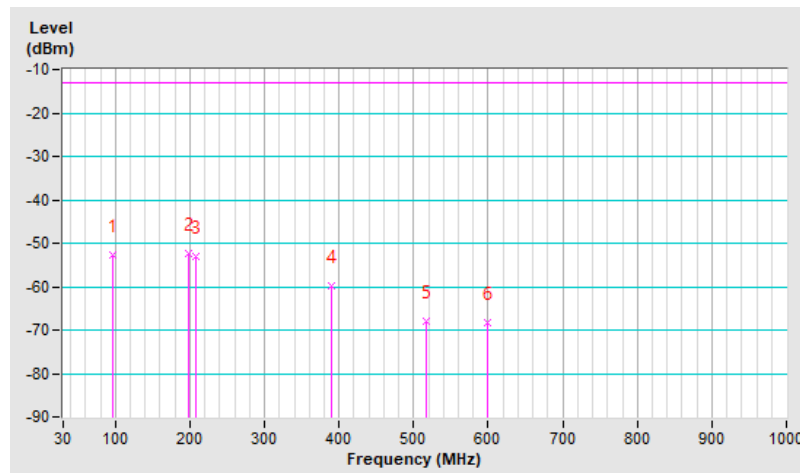

RF Mode	LTE Band 4 Channel Bandwidth: 20MHz	Channel	CH 20175 : 1732.5 MHz
Frequency Range	30 MHz ~ 1 GHz	Detector Function & Bandwidth	1 MHz/3 MHz (RMS)
Input Power	120 Vac, 60 Hz	Environmental Conditions	25°C, 60% RH
Tested By	Charles Hsiao		

Antenna Polarity & Test Distance : Vertical at 3 m								
No	Frequency (MHz)	EIRP (dBm)	Limit (dBm)	Margin (dB)	Antenna Height (m)	Table Angle (Degree)	Raw Value (dBuV)	Correction Factor (dB/m)
1	88.87	-49.62	-13.00	-36.62	1.15 V	24	69.75	-119.37
2	125.29	-52.81	-13.00	-39.81	1.05 V	241	61.87	-114.68
3	189.99	-55.03	-13.00	-42.03	1.67 V	36	60.80	-115.83
4	399.98	-61.72	-13.00	-48.72	1.42 V	236	48.27	-109.99
5	608.98	-68.59	-13.00	-55.59	1.15 V	241	36.74	-105.33
6	711.14	-68.82	-13.00	-55.82	1.15 V	69	35.18	-104.00

Remarks:

- EIRP(dBm) = Raw Value(dBuV) + Correction Factor(dB/m)
- Correction Factor(dB/m) = Antenna Factor(dB/m) + Cable Factor(dB) – Pre-Amplifier Factor(dB) + 20log(D) – 104.8
- Margin value = EIRP – Limit value
- The other EIRP levels were very low against the limit of frequency range 30 MHz ~ 1 GHz.
- The frequency range 9 kHz ~ 30 MHz: all emissions are more than 20 dB below the limit, therefore do not be recorded in this report.

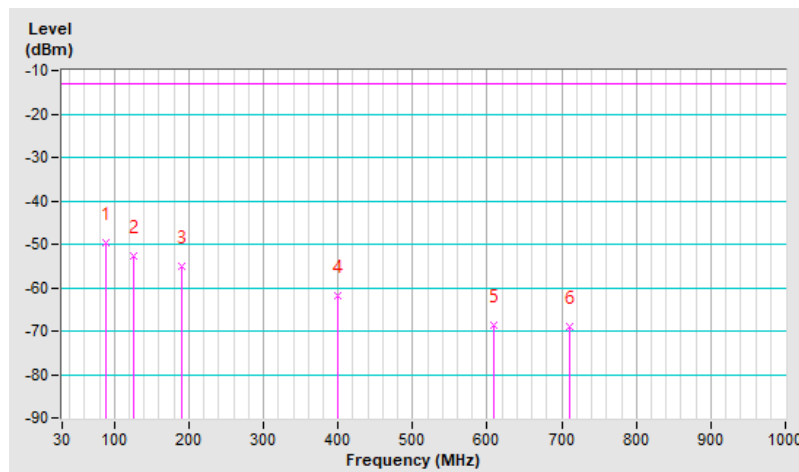

7.2.8 LTE Band 5

RF Mode	LTE Band 5 Channel Bandwidth: 10MHz	Channel	CH 20525 : 836.5 MHz
Frequency Range	30 MHz ~ 1 GHz	Detector Function & Bandwidth	1 MHz/3 MHz (RMS)
Input Power	120 Vac, 60 Hz	Environmental Conditions	25°C, 60% RH
Tested By	Charles Hsiao		

Antenna Polarity & Test Distance : Horizontal at 3 m								
No	Frequency (MHz)	ERP (dBm)	Limit (dBm)	Margin (dB)	Antenna Height (m)	Table Angle (Degree)	Raw Value (dBuV)	Correction Factor (dB/m)
1	97.77	-51.41	-13.00	-38.41	1.45 H	221	68.70	-120.11
2	189.92	-52.30	-13.00	-39.30	1.63 H	341	65.67	-117.97
3	207.48	-53.49	-13.00	-40.49	1.16 H	328	64.95	-118.44
4	409.67	-60.37	-13.00	-47.37	1.14 H	171	51.63	-112.00
5	548.81	-68.73	-13.00	-55.73	1.06 H	222	40.43	-109.16
6	613.64	-69.03	-13.00	-56.03	1.53 H	296	38.41	-107.44

Remarks:

- ERP(dBm) = Raw Value(dBuV) + Correction Factor(dB/m)
- Correction Factor(dB/m) = Antenna Factor(dB/m) + Cable Factor(dB) – Pre-Amplifier Factor(dB) + 20log(D) – 104.8 – 2.15
- Margin value = ERP – Limit value
- The other ERP levels were very low against the limit of frequency range 30 MHz ~ 1 GHz.
- The frequency range 9 kHz ~ 30 MHz: all emissions are more than 20 dB below the limit, therefore do not be recorded in this report.

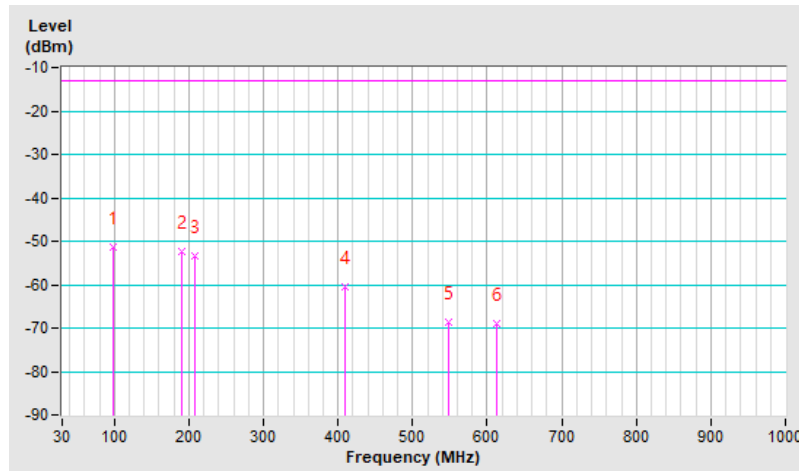

RF Mode	LTE Band 5 Channel Bandwidth: 10MHz	Channel	CH 20525 : 836.5 MHz
Frequency Range	30 MHz ~ 1 GHz	Detector Function & Bandwidth	1 MHz/3 MHz (RMS)
Input Power	120 Vac, 60 Hz	Environmental Conditions	25°C, 60% RH
Tested By	Charles Hsiao		

Antenna Polarity & Test Distance : Vertical at 3 m								
No	Frequency (MHz)	ERP (dBm)	Limit (dBm)	Margin (dB)	Antenna Height (m)	Table Angle (Degree)	Raw Value (dBuV)	Correction Factor (dB/m)
1	91.14	-52.26	-13.00	-39.26	1.15 V	274	69.19	-121.45
2	129.97	-51.41	-13.00	-38.41	1.45 V	178	64.97	-116.38
3	201.15	-52.99	-13.00	-39.99	1.68 V	299	65.42	-118.41
4	398.87	-60.87	-13.00	-47.87	1.05 V	274	51.29	-112.16
5	616.64	-68.82	-13.00	-55.82	1.53 V	334	38.61	-107.43
6	722.80	-69.17	-13.00	-56.17	1.05 V	278	36.83	-106.00

Remarks:

- ERP(dBm) = Raw Value(dBuV) + Correction Factor(dB/m)
- Correction Factor(dB/m) = Antenna Factor(dB/m) + Cable Factor(dB) – Pre-Amplifier Factor(dB) + 20log(D) – 104.8 – 2.15
- Margin value = ERP – Limit value
- The other ERP levels were very low against the limit of frequency range 30 MHz ~ 1 GHz.
- The frequency range 9 kHz ~ 30 MHz: all emissions are more than 20 dB below the limit, therefore do not be recorded in this report.

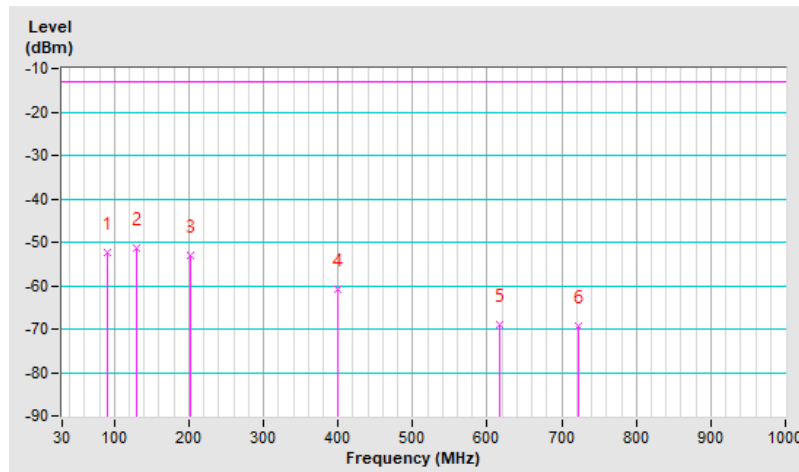

7.2.9 LTE Band 7

RF Mode	LTE Band 7 Channel Bandwidth: 20MHz	Channel	CH 21350 : 2560 MHz
Frequency Range	30 MHz ~ 1 GHz	Detector Function & Bandwidth	1 MHz/3 MHz (RMS)
Input Power	120 Vac, 60 Hz	Environmental Conditions	25°C, 60% RH
Tested By	Charles Hsiao		

Antenna Polarity & Test Distance : Horizontal at 3 m								
No	Frequency (MHz)	EIRP (dBm)	Limit (dBm)	Margin (dB)	Antenna Height (m)	Table Angle (Degree)	Raw Value (dBuV)	Correction Factor (dB/m)
1	93.64	-52.30	-25.00	-27.30	1.53 H	118	66.22	-118.52
2	190.67	-51.84	-25.00	-26.84	1.90 H	175	64.01	-115.85
3	196.74	-53.20	-25.00	-28.20	1.93 H	169	62.99	-116.19
4	407.48	-60.30	-25.00	-35.30	1.53 H	229	49.58	-109.88
5	548.84	-68.77	-25.00	-43.77	1.15 H	107	38.24	-107.01
6	618.59	-68.33	-25.00	-43.33	1.40 H	60	36.91	-105.24

Remarks:

- EIRP(dBm) = Raw Value(dBuV) + Correction Factor(dB/m)
- Correction Factor(dB/m) = Antenna Factor(dB/m) + Cable Factor(dB) – Pre-Amplifier Factor(dB) + 20log(D) – 104.8
- Margin value = EIRP – Limit value
- The other EIRP levels were very low against the limit of frequency range 30 MHz ~ 1 GHz.
- The frequency range 9 kHz ~ 30 MHz: all emissions are more than 20 dB below the limit, therefore do not be recorded in this report.

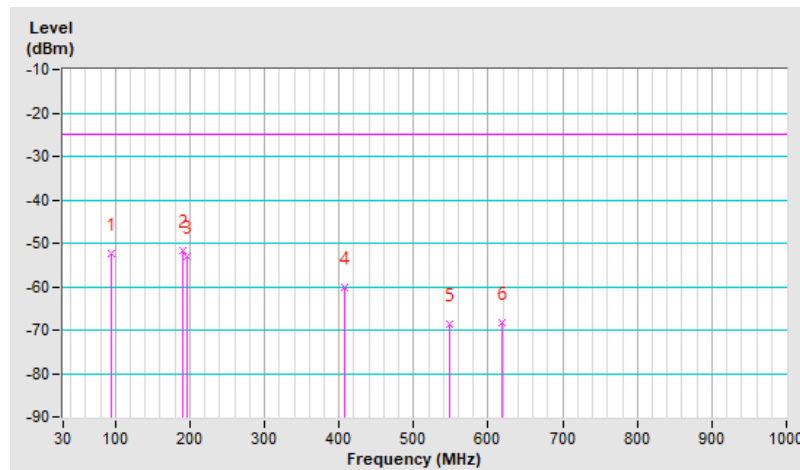

RF Mode	LTE Band 7 Channel Bandwidth: 20MHz	Channel	CH 21350 : 2560 MHz
Frequency Range	30 MHz ~ 1 GHz	Detector Function & Bandwidth	1 MHz/3 MHz (RMS)
Input Power	120 Vac, 60 Hz	Environmental Conditions	25°C, 60% RH
Tested By	Charles Hsiao		

Antenna Polarity & Test Distance : Vertical at 3 m								
No	Frequency (MHz)	EIRP (dBm)	Limit (dBm)	Margin (dB)	Antenna Height (m)	Table Angle (Degree)	Raw Value (dBuV)	Correction Factor (dB/m)
1	89.48	-50.22	-25.00	-25.22	1.15 V	247	69.19	-119.41
2	135.44	-51.69	-25.00	-26.69	1.56 V	219	62.02	-113.71
3	177.78	-52.48	-25.00	-27.48	1.45 V	8	61.75	-114.23
4	399.98	-60.63	-25.00	-35.63	1.56 V	108	49.36	-109.99
5	615.57	-69.11	-25.00	-44.11	1.05 V	111	36.18	-105.29
6	700.02	-69.08	-25.00	-44.08	1.53 V	291	35.14	-104.22

Remarks:

1. $EIRP(dBm) = Raw\ Value(dBuV) + Correction\ Factor(dB/m)$
2. $Correction\ Factor(dB/m) = Antenna\ Factor(dB/m) + Cable\ Factor(dB) - Pre-Amplifier\ Factor(dB) + 20\log(D) - 104.8$
3. $Margin\ value = EIRP - Limit\ value$
4. The other EIRP levels were very low against the limit of frequency range 30 MHz ~ 1 GHz.
5. The frequency range 9 kHz ~ 30 MHz: all emissions are more than 20 dB below the limit, therefore do not be recorded in this report.

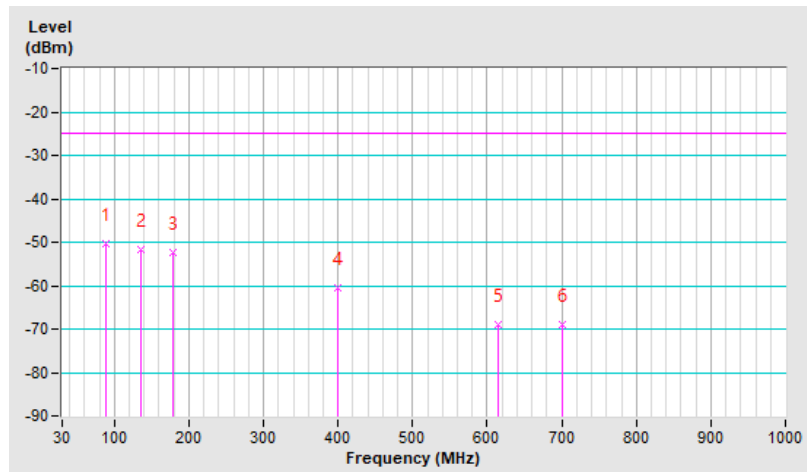

7.2.10 LTE Band 12

RF Mode	LTE Band 12 Channel Bandwidth: 5MHz	Channel	CH 23095 : 707.5 MHz
Frequency Range	30 MHz ~ 1 GHz	Detector Function & Bandwidth	1 MHz/3 MHz (RMS)
Input Power	120 Vac, 60 Hz	Environmental Conditions	25°C, 60% RH
Tested By	Charles Hsiao		

Antenna Polarity & Test Distance : Horizontal at 3 m								
No	Frequency (MHz)	ERP (dBm)	Limit (dBm)	Margin (dB)	Antenna Height (m)	Table Angle (Degree)	Raw Value (dBuV)	Correction Factor (dB/m)
1	94.48	-52.66	-13.00	-39.66	1.59 H	157	67.91	-120.57
2	190.48	-51.42	-13.00	-38.42	1.14 H	15	66.57	-117.99
3	203.65	-53.03	-13.00	-40.03	1.53 H	327	65.41	-118.44
4	404.48	-61.11	-13.00	-48.11	1.44 H	17	50.95	-112.06
5	528.87	-68.97	-13.00	-55.97	1.18 H	209	40.45	-109.42
6	642.21	-69.26	-13.00	-56.26	1.15 H	207	37.79	-107.05

Remarks:

- ERP(dBm) = Raw Value(dBuV) + Correction Factor(dB/m)
- Correction Factor(dB/m) = Antenna Factor(dB/m) + Cable Factor(dB) – Pre-Amplifier Factor(dB) + 20log(D) – 104.8 – 2.15
- Margin value = ERP – Limit value
- The other ERP levels were very low against the limit of frequency range 30 MHz ~ 1 GHz.
- The frequency range 9 kHz ~ 30 MHz: all emissions are more than 20 dB below the limit, therefore do not be recorded in this report.

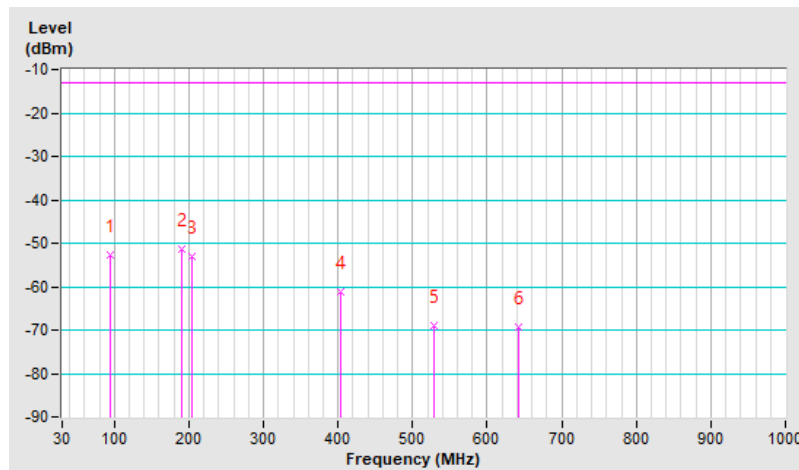

RF Mode	LTE Band 12 Channel Bandwidth: 5MHz	Channel	CH 23095 : 707.5 MHz
Frequency Range	30 MHz ~ 1 GHz	Detector Function & Bandwidth	1 MHz/3 MHz (RMS)
Input Power	120 Vac, 60 Hz	Environmental Conditions	25°C, 60% RH
Tested By	Charles Hsiao		

Antenna Polarity & Test Distance : Vertical at 3 m								
No	Frequency (MHz)	ERP (dBm)	Limit (dBm)	Margin (dB)	Antenna Height (m)	Table Angle (Degree)	Raw Value (dBuV)	Correction Factor (dB/m)
1	93.25	-50.34	-13.00	-37.34	1.15 V	214	70.39	-120.73
2	185.54	-52.69	-13.00	-39.69	1.59 V	94	64.71	-117.40
3	214.44	-53.46	-13.00	-40.46	1.57 V	118	64.78	-118.24
4	378.87	-61.00	-13.00	-48.00	1.05 V	114	51.59	-112.59
5	648.87	-68.49	-13.00	-55.49	1.53 V	207	38.56	-107.05
6	715.53	-68.42	-13.00	-55.42	1.05 V	221	37.69	-106.11

Remarks:

- ERP(dBm) = Raw Value(dBuV) + Correction Factor(dB/m)
- Correction Factor(dB/m) = Antenna Factor(dB/m) + Cable Factor(dB) – Pre-Amplifier Factor(dB) + 20log(D) – 104.8 – 2.15
- Margin value = ERP – Limit value
- The other ERP levels were very low against the limit of frequency range 30 MHz ~ 1 GHz.
- The frequency range 9 kHz ~ 30 MHz: all emissions are more than 20 dB below the limit, therefore do not be recorded in this report.

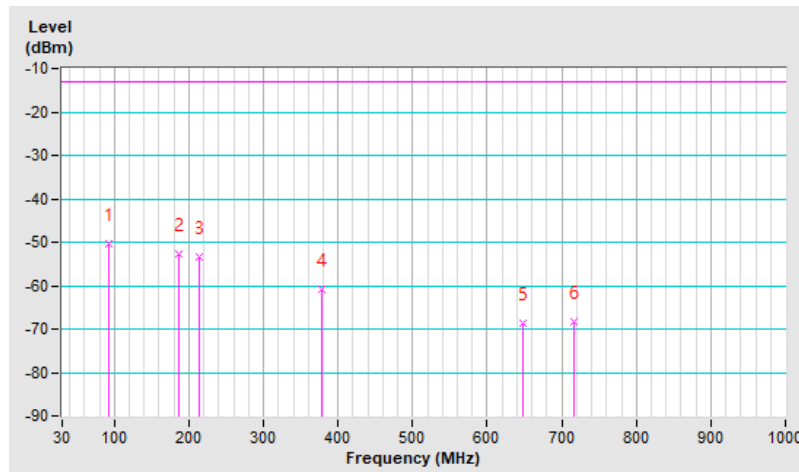

7.2.11 LTE Band 13

RF Mode	LTE Band 13 Channel Bandwidth: 10MHz	Channel	CH 23230 : 782 MHz
Frequency Range	30 MHz ~ 1 GHz	Detector Function & Bandwidth	1 MHz/3 MHz (RMS)
Input Power	120 Vac, 60 Hz	Environmental Conditions	25°C, 60% RH
Tested By	Charles Hsiao		

Antenna Polarity & Test Distance : Horizontal at 3 m								
No	Frequency (MHz)	ERP (dBm)	Limit (dBm)	Margin (dB)	Antenna Height (m)	Table Angle (Degree)	Raw Value (dBuV)	Correction Factor (dB/m)
1	92.66	-51.87	-13.00	-38.87	1.63 H	328	68.91	-120.78
2	188.87	-51.81	-13.00	-38.81	1.41 H	174	65.99	-117.80
3	200.02	-53.48	-13.00	-40.48	1.45 H	116	64.91	-118.39
4	398.87	-60.33	-13.00	-47.33	1.56 H	229	51.83	-112.16
5	548.87	-68.91	-13.00	-55.91	1.05 H	320	40.25	-109.16
6	608.87	-62.38	-13.00	-49.38	1.15 H	105	45.10	-107.48

Remarks:

- ERP(dBm) = Raw Value(dBuV) + Correction Factor(dB/m)
- Correction Factor(dB/m) = Antenna Factor(dB/m) + Cable Factor(dB) – Pre-Amplifier Factor(dB) + 20log(D) – 104.8 – 2.15
- Margin value = ERP – Limit value
- The other ERP levels were very low against the limit of frequency range 30 MHz ~ 1 GHz.
- The frequency range 9 kHz ~ 30 MHz: all emissions are more than 20 dB below the limit, therefore do not be recorded in this report.

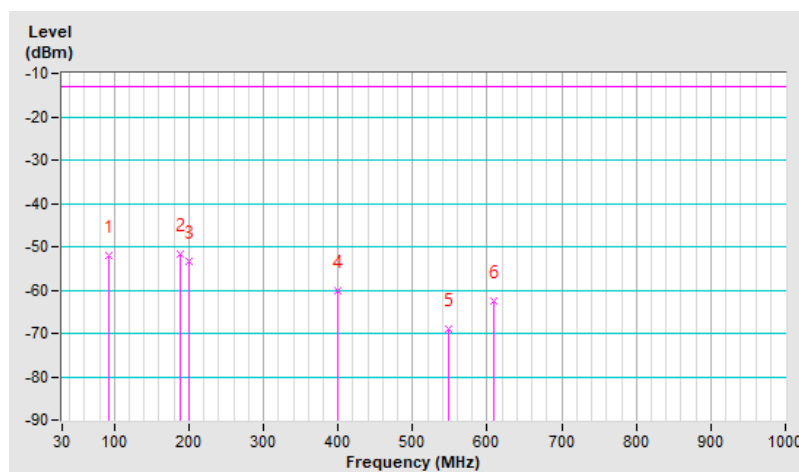

RF Mode	LTE Band 13 Channel Bandwidth: 10MHz	Channel	CH 23230 : 782 MHz
Frequency Range	30 MHz ~ 1 GHz	Detector Function & Bandwidth	1 MHz/3 MHz (RMS)
Input Power	120 Vac, 60 Hz	Environmental Conditions	25°C, 60% RH
Tested By	Charles Hsiao		

Antenna Polarity & Test Distance : Vertical at 3 m								
No	Frequency (MHz)	ERP (dBm)	Limit (dBm)	Margin (dB)	Antenna Height (m)	Table Angle (Degree)	Raw Value (dBuV)	Correction Factor (dB/m)
1	90.11	-50.13	-13.00	-37.13	1.35 V	180	71.45	-121.58
2	110.14	-53.33	-13.00	-40.33	1.63 V	327	64.97	-118.30
3	203.31	-53.27	-13.00	-40.27	1.58 V	9	65.16	-118.43
4	410.11	-61.49	-13.00	-48.49	1.43 V	217	50.51	-112.00
5	609.98	-68.29	-13.00	-55.29	1.16 V	328	39.17	-107.46
6	708.87	-68.20	-13.00	-55.20	1.04 V	164	37.97	-106.17

Remarks:

- ERP(dBm) = Raw Value(dBuV) + Correction Factor(dB/m)
- Correction Factor(dB/m) = Antenna Factor(dB/m) + Cable Factor(dB) – Pre-Amplifier Factor(dB) + 20log(D) – 104.8 – 2.15
- Margin value = ERP – Limit value
- The other ERP levels were very low against the limit of frequency range 30 MHz ~ 1 GHz.
- The frequency range 9 kHz ~ 30 MHz: all emissions are more than 20 dB below the limit, therefore do not be recorded in this report.

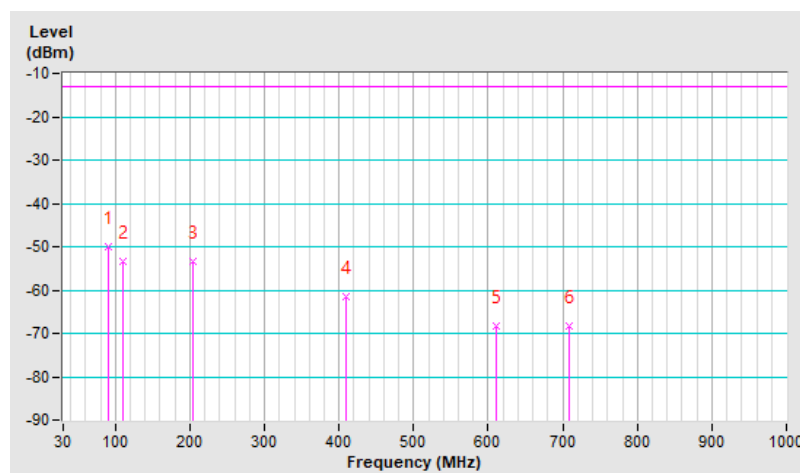

7.2.12 LTE Band 17

RF Mode	LTE Band 17 Channel Bandwidth: 10MHz	Channel	CH 23780 : 709 MHz
Frequency Range	30 MHz ~ 1 GHz	Detector Function & Bandwidth	1 MHz/3 MHz (RMS)
Input Power	120 Vac, 60 Hz	Environmental Conditions	25°C, 60% RH
Tested By	Charles Hsiao		

Antenna Polarity & Test Distance : Horizontal at 3 m								
No	Frequency (MHz)	ERP (dBm)	Limit (dBm)	Margin (dB)	Antenna Height (m)	Table Angle (Degree)	Raw Value (dBuV)	Correction Factor (dB/m)
1	94.48	-52.36	-13.00	-39.36	1.15 H	240	68.21	-120.57
2	189.98	-52.36	-13.00	-39.36	1.55 H	54	65.62	-117.98
3	198.87	-52.89	-13.00	-39.89	1.56 H	118	65.53	-118.42
4	400.14	-60.32	-13.00	-47.32	1.15 H	64	51.82	-112.14
5	548.84	-68.70	-13.00	-55.70	1.15 H	208	40.46	-109.16
6	619.98	-68.53	-13.00	-55.53	1.57 H	107	38.84	-107.37

Remarks:

- ERP(dBm) = Raw Value(dBuV) + Correction Factor(dB/m)
- Correction Factor(dB/m) = Antenna Factor(dB/m) + Cable Factor(dB) – Pre-Amplifier Factor(dB) + 20log(D) – 104.8 – 2.15
- Margin value = ERP – Limit value
- The other ERP levels were very low against the limit of frequency range 30 MHz ~ 1 GHz.
- The frequency range 9 kHz ~ 30 MHz: all emissions are more than 20 dB below the limit, therefore do not be recorded in this report.

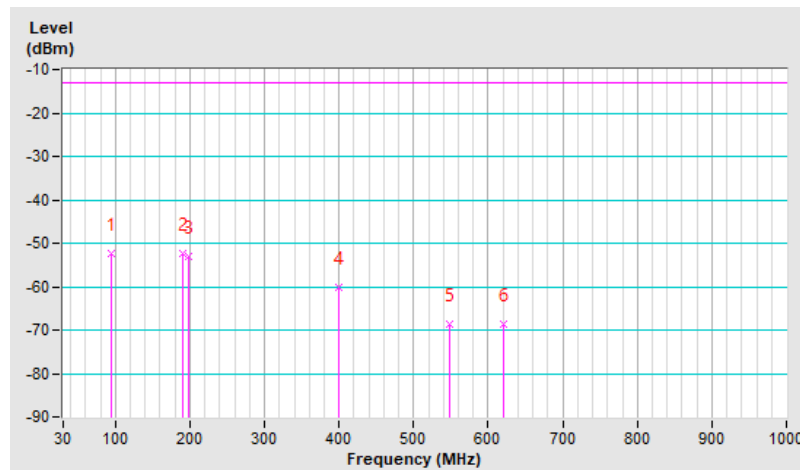

RF Mode	LTE Band 17 Channel Bandwidth: 10MHz	Channel	CH 23780 : 709 MHz
Frequency Range	30 MHz ~ 1 GHz	Detector Function & Bandwidth	1 MHz/3 MHz (RMS)
Input Power	120 Vac, 60 Hz	Environmental Conditions	25°C, 60% RH
Tested By	Charles Hsiao		

Antenna Polarity & Test Distance : Vertical at 3 m								
No	Frequency (MHz)	ERP (dBm)	Limit (dBm)	Margin (dB)	Antenna Height (m)	Table Angle (Degree)	Raw Value (dBuV)	Correction Factor (dB/m)
1	89.64	-49.19	-13.00	-36.19	1.15 V	248	72.38	-121.57
2	132.14	-54.48	-13.00	-41.48	1.17 V	178	61.75	-116.23
3	190.25	-53.88	-13.00	-40.88	1.05 V	317	64.11	-117.99
4	415.54	-61.19	-13.00	-48.19	1.53 V	14	50.68	-111.87
5	606.65	-68.46	-13.00	-55.46	1.53 V	327	39.08	-107.54
6	708.87	-68.73	-13.00	-55.73	1.15 V	106	37.44	-106.17

Remarks:

- ERP(dBm) = Raw Value(dBuV) + Correction Factor(dB/m)
- Correction Factor(dB/m) = Antenna Factor(dB/m) + Cable Factor(dB) – Pre-Amplifier Factor(dB) + 20log(D) – 104.8 – 2.15
- Margin value = ERP – Limit value
- The other ERP levels were very low against the limit of frequency range 30 MHz ~ 1 GHz.
- The frequency range 9 kHz ~ 30 MHz: all emissions are more than 20 dB below the limit, therefore do not be recorded in this report.

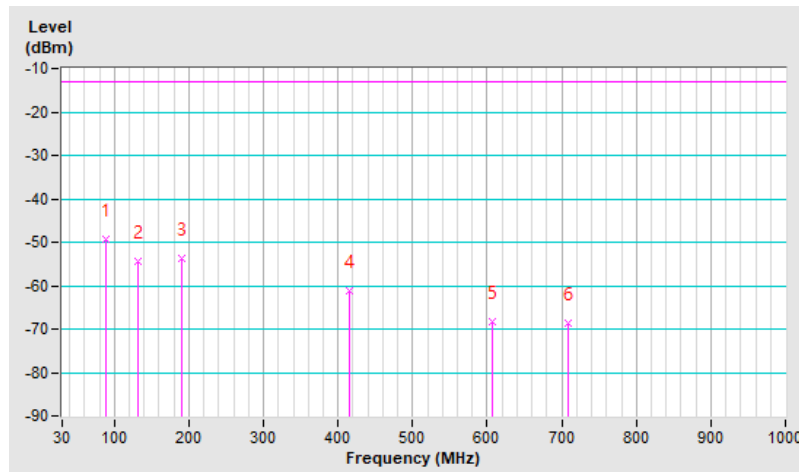

7.2.13 LTE Band 25

RF Mode	LTE Band 25 Channel Bandwidth: 1.4MHz	Channel	CH 26683 : 1914.3 MHz
Frequency Range	30 MHz ~ 1 GHz	Detector Function & Bandwidth	1 MHz/3 MHz (RMS)
Input Power	120 Vac, 60 Hz	Environmental Conditions	25°C, 60% RH
Tested By	Charles Hsiao		

Antenna Polarity & Test Distance : Horizontal at 3 m								
No	Frequency (MHz)	EIRP (dBm)	Limit (dBm)	Margin (dB)	Antenna Height (m)	Table Angle (Degree)	Raw Value (dBuV)	Correction Factor (dB/m)
1	96.65	-52.74	-13.00	-39.74	1.15 H	187	65.52	-118.26
2	178.87	-51.72	-13.00	-38.72	1.53 H	216	62.61	-114.33
3	226.64	-52.37	-13.00	-39.37	1.59 H	347	63.59	-115.96
4	405.54	-60.63	-13.00	-47.63	1.19 H	9	49.26	-109.89
5	548.48	-68.90	-13.00	-55.90	1.97 H	207	38.12	-107.02
6	610.11	-68.33	-13.00	-55.33	1.53 H	36	36.98	-105.31

Remarks:

- EIRP(dBm) = Raw Value(dBuV) + Correction Factor(dB/m)
- Correction Factor(dB/m) = Antenna Factor(dB/m) + Cable Factor(dB) – Pre-Amplifier Factor(dB) + 20log(D) – 104.8
- Margin value = EIRP – Limit value
- The other EIRP levels were very low against the limit of frequency range 30 MHz ~ 1 GHz.
- The frequency range 9 kHz ~ 30 MHz: all emissions are more than 20 dB below the limit, therefore do not be recorded in this report.

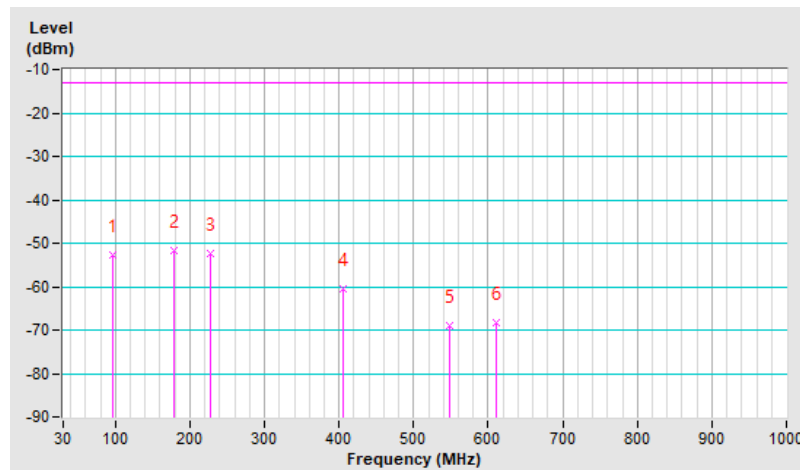

RF Mode	LTE Band 25 Channel Bandwidth: 1.4MHz	Channel	CH 26683 : 1914.3 MHz
Frequency Range	30 MHz ~ 1 GHz	Detector Function & Bandwidth	1 MHz/3 MHz (RMS)
Input Power	120 Vac, 60 Hz	Environmental Conditions	25°C, 60% RH
Tested By	Charles Hsiao		

Antenna Polarity & Test Distance : Vertical at 3 m

No	Frequency (MHz)	EIRP (dBm)	Limit (dBm)	Margin (dB)	Antenna Height (m)	Table Angle (Degree)	Raw Value (dBuV)	Correction Factor (dB/m)
1	89.15	-49.20	-13.00	-36.20	1.52 V	18	70.19	-119.39
2	127.44	-53.06	-13.00	-40.06	1.82 V	167	61.48	-114.54
3	184.48	-55.27	-13.00	-42.27	1.05 V	119	59.85	-115.12
4	394.48	-61.10	-13.00	-48.10	1.15 V	178	49.01	-110.11
5	631.14	-67.88	-13.00	-54.88	1.59 V	59	37.15	-105.03
6	721.15	-68.70	-13.00	-55.70	1.53 V	206	35.20	-103.90

Remarks:

- EIRP(dBm) = Raw Value(dBuV) + Correction Factor(dB/m)
- Correction Factor(dB/m) = Antenna Factor(dB/m) + Cable Factor(dB) – Pre-Amplifier Factor(dB) + 20log(D) – 104.8
- Margin value = EIRP – Limit value
- The other EIRP levels were very low against the limit of frequency range 30 MHz ~ 1 GHz.
- The frequency range 9 kHz ~ 30 MHz: all emissions are more than 20 dB below the limit, therefore do not be recorded in this report.

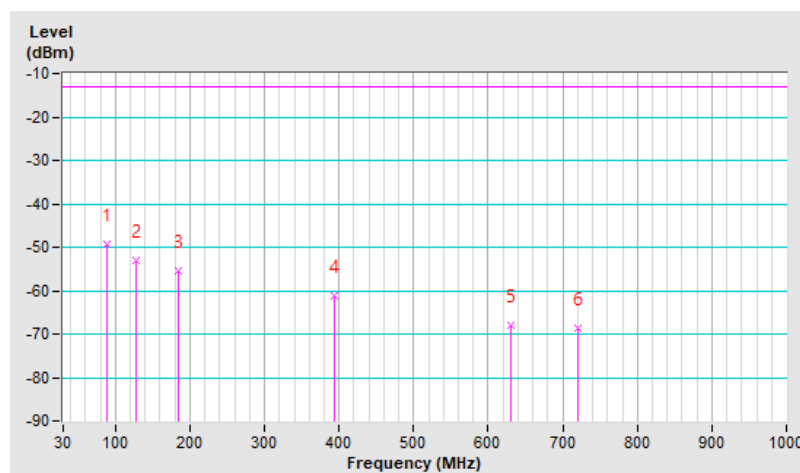

7.2.14 LTE Band 26

RF Mode	LTE Band 26 (Part 22) Channel Bandwidth: 1.4MHz	Channel	CH 26797 : 824.7 MHz
Frequency Range	30 MHz ~ 1 GHz	Detector Function & Bandwidth	1 MHz/3 MHz (RMS)
Input Power	120 Vac, 60 Hz	Environmental Conditions	25°C, 60% RH
Tested By	Charles Hsiao		

Antenna Polarity & Test Distance : Horizontal at 3 m								
No	Frequency (MHz)	ERP (dBm)	Limit (dBm)	Margin (dB)	Antenna Height (m)	Table Angle (Degree)	Raw Value (dBuV)	Correction Factor (dB/m)
1	93.78	-51.88	-13.00	-38.88	1.89 H	278	68.77	-120.65
2	189.99	-51.63	-13.00	-38.63	1.16 H	322	66.35	-117.98
3	209.65	-53.69	-13.00	-40.69	1.16 H	217	64.70	-118.39
4	400.01	-60.30	-13.00	-47.30	1.53 H	228	51.84	-112.14
5	518.87	-68.89	-13.00	-55.89	1.19 H	309	40.69	-109.58
6	616.64	-68.36	-13.00	-55.36	1.53 H	207	39.07	-107.43

Remarks:

- ERP(dBm) = Raw Value(dBuV) + Correction Factor(dB/m)
- Correction Factor(dB/m) = Antenna Factor(dB/m) + Cable Factor(dB) – Pre-Amplifier Factor(dB) + 20log(D) – 104.8 – 2.15
- Margin value = ERP – Limit value
- The other ERP levels were very low against the limit of frequency range 30 MHz ~ 1 GHz.
- The frequency range 9 kHz ~ 30 MHz: all emissions are more than 20 dB below the limit, therefore do not be recorded in this report.

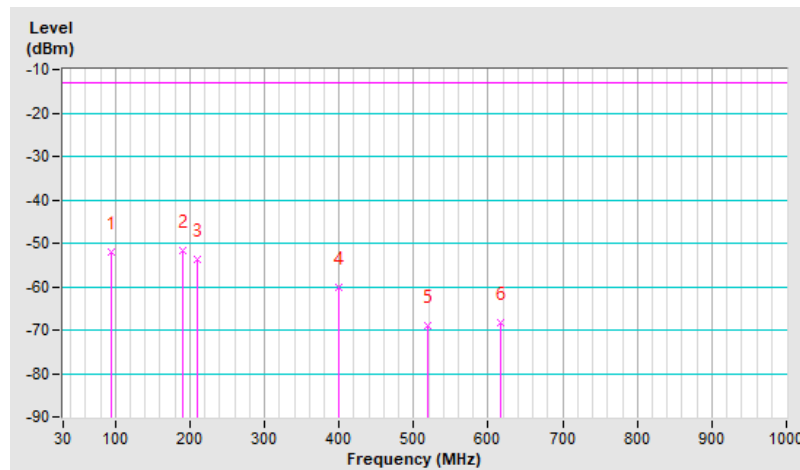

RF Mode	LTE Band 26 Channel Bandwidth: 1.4MHz	Channel	CH 26797 : 824.7 MHz
Frequency Range	30 MHz ~ 1 GHz	Detector Function & Bandwidth	1 MHz/3 MHz (RMS)
Input Power	120 Vac, 60 Hz	Environmental Conditions	25°C, 60% RH
Tested By	Charles Hsiao		

Antenna Polarity & Test Distance : Vertical at 3 m								
No	Frequency (MHz)	ERP (dBm)	Limit (dBm)	Margin (dB)	Antenna Height (m)	Table Angle (Degree)	Raw Value (dBuV)	Correction Factor (dB/m)
1	94.44	-50.28	-13.00	-37.28	1.75 V	220	70.29	-120.57
2	124.47	-52.74	-13.00	-39.74	1.42 V	317	64.25	-116.99
3	189.99	-55.02	-13.00	-42.02	1.53 V	217	62.96	-117.98
4	387.87	-60.38	-13.00	-47.38	1.15 V	141	51.98	-112.36
5	589.98	-68.30	-13.00	-55.30	1.15 V	289	39.58	-107.88
6	705.54	-68.56	-13.00	-55.56	1.56 V	66	37.70	-106.26

Remarks:

- ERP(dBm) = Raw Value(dBuV) + Correction Factor(dB/m)
- Correction Factor(dB/m) = Antenna Factor(dB/m) + Cable Factor(dB) – Pre-Amplifier Factor(dB) + 20log(D) – 104.8 – 2.15
- Margin value = ERP – Limit value
- The other ERP levels were very low against the limit of frequency range 30 MHz ~ 1 GHz.
- The frequency range 9 kHz ~ 30 MHz: all emissions are more than 20 dB below the limit, therefore do not be recorded in this report.

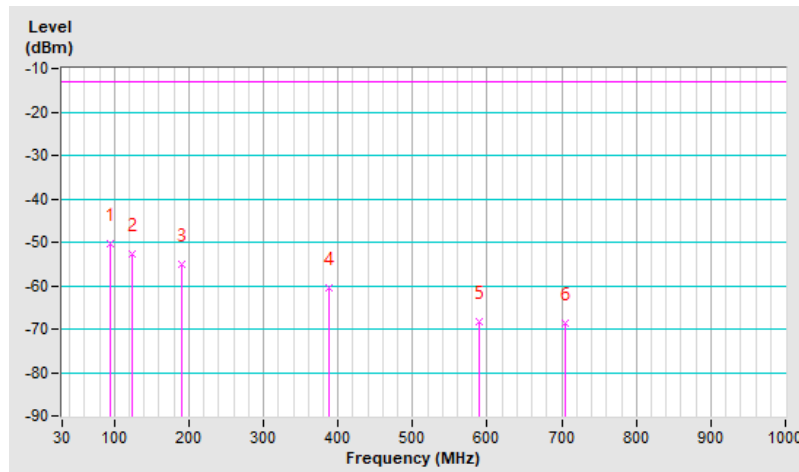

RF Mode	LTE Band 26 (Part 90) Channel Bandwidth: 10MHz	Channel	CH 26740 : 819 MHz
Frequency Range	30 MHz ~ 1 GHz	Detector Function & Bandwidth	1 MHz/3 MHz (RMS)
Input Power	120 Vac, 60 Hz	Environmental Conditions	25°C, 60% RH
Tested By	Charles Hsiao		

Antenna Polarity & Test Distance : Horizontal at 3 m								
No	Frequency (MHz)	ERP (dBm)	Limit (dBm)	Margin (dB)	Antenna Height (m)	Table Angle (Degree)	Raw Value (dBuV)	Correction Factor (dB/m)
1	91.78	-51.35	-13.00	-38.35	1.15 H	21	69.49	-120.84
2	189.98	-52.10	-13.00	-39.10	1.45 H	117	65.88	-117.98
3	198.87	-53.39	-13.00	-40.39	1.56 H	286	65.03	-118.42
4	402.21	-60.27	-13.00	-47.27	1.15 H	112	51.83	-112.10
5	527.74	-68.78	-13.00	-55.78	1.00 H	81	40.65	-109.43
6	609.98	-68.60	-13.00	-55.60	1.56 H	9	38.86	-107.46

Remarks:

- ERP(dBm) = Raw Value(dBuV) + Correction Factor(dB/m)
- Correction Factor(dB/m) = Antenna Factor(dB/m) + Cable Factor(dB) – Pre-Amplifier Factor(dB) + 20log(D) – 104.8 – 2.15
- Margin value = ERP – Limit value
- The other ERP levels were very low against the limit of frequency range 30 MHz ~ 1 GHz.
- The frequency range 9 kHz ~ 30 MHz: all emissions are more than 20 dB below the limit, therefore do not be recorded in this report.

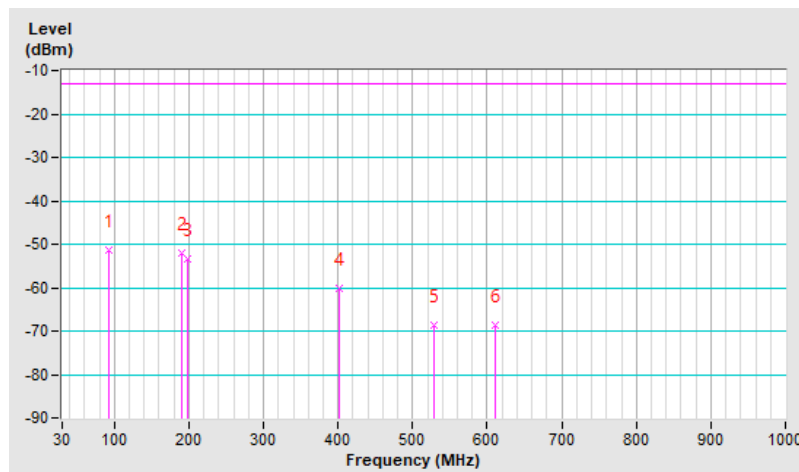

RF Mode	LTE Band 26 (Part 90) Channel Bandwidth: 10MHz	Channel	CH 26740 : 819 MHz
Frequency Range	30 MHz ~ 1 GHz	Detector Function & Bandwidth	1 MHz/3 MHz (RMS)
Input Power	120 Vac, 60 Hz	Environmental Conditions	25°C, 60% RH
Tested By	Charles Hsiao		

Antenna Polarity & Test Distance : Vertical at 3 m								
No	Frequency (MHz)	ERP (dBm)	Limit (dBm)	Margin (dB)	Antenna Height (m)	Table Angle (Degree)	Raw Value (dBuV)	Correction Factor (dB/m)
1	91.15	-49.72	-13.00	-36.72	1.16 V	241	71.73	-121.45
2	125.50	-53.03	-13.00	-40.03	1.53 V	289	63.76	-116.79
3	187.48	-53.84	-13.00	-40.84	1.15 V	274	63.81	-117.65
4	405.54	-60.99	-13.00	-47.99	1.52 V	111	51.05	-112.04
5	617.77	-69.06	-13.00	-56.06	1.53 V	2	38.34	-107.40
6	724.14	-69.07	-13.00	-56.07	1.57 V	297	36.90	-105.97

Remarks:

- ERP(dBm) = Raw Value(dBuV) + Correction Factor(dB/m)
- Correction Factor(dB/m) = Antenna Factor(dB/m) + Cable Factor(dB) – Pre-Amplifier Factor(dB) + 20log(D) – 104.8 – 2.15
- Margin value = ERP – Limit value
- The other ERP levels were very low against the limit of frequency range 30 MHz ~ 1 GHz.
- The frequency range 9 kHz ~ 30 MHz: all emissions are more than 20 dB below the limit, therefore do not be recorded in this report.

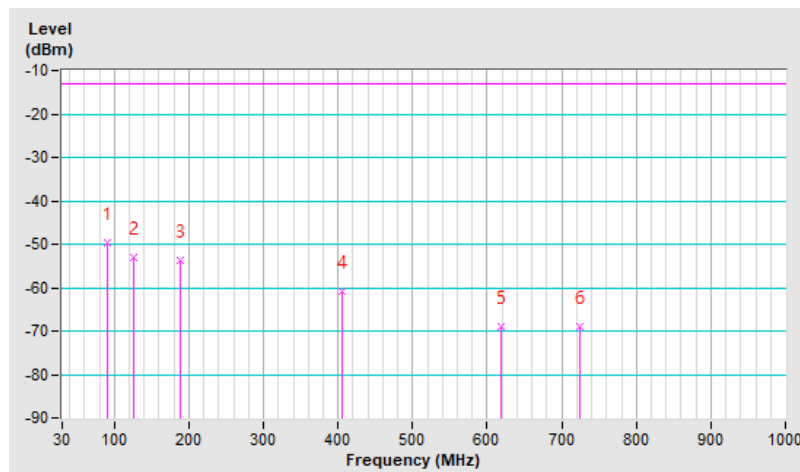

7.2.15 LTE Band 66

RF Mode	LTE Band 66 Channel Bandwidth: 20MHz	Channel	CH 132572 : 1770 MHz
Frequency Range	30 MHz ~ 1 GHz	Detector Function & Bandwidth	1 MHz/3 MHz (RMS)
Input Power	120 Vac, 60 Hz	Environmental Conditions	25°C, 60% RH
Tested By	Charles Hsiao		

Antenna Polarity & Test Distance : Horizontal at 3 m								
No	Frequency (MHz)	EIRP (dBm)	Limit (dBm)	Margin (dB)	Antenna Height (m)	Table Angle (Degree)	Raw Value (dBuV)	Correction Factor (dB/m)
1	94.44	-52.37	-13.00	-39.37	1.45 H	118	66.05	-118.42
2	189.98	-52.64	-13.00	-39.64	1.53 H	299	63.19	-115.83
3	214.44	-53.77	-13.00	-40.77	1.14 H	48	62.32	-116.09
4	398.93	-60.04	-13.00	-47.04	1.42 H	14	49.97	-110.01
5	538.87	-69.10	-13.00	-56.10	1.14 H	196	38.06	-107.16
6	615.54	-68.37	-13.00	-55.37	1.68 H	332	36.92	-105.29

Remarks:

- EIRP(dBm) = Raw Value(dBuV) + Correction Factor(dB/m)
- Correction Factor(dB/m) = Antenna Factor(dB/m) + Cable Factor(dB) – Pre-Amplifier Factor(dB) + 20log(D) – 104.8
- Margin value = EIRP – Limit value
- The other EIRP levels were very low against the limit of frequency range 30 MHz ~ 1 GHz.
- The frequency range 9 kHz ~ 30 MHz: all emissions are more than 20 dB below the limit, therefore do not be recorded in this report.

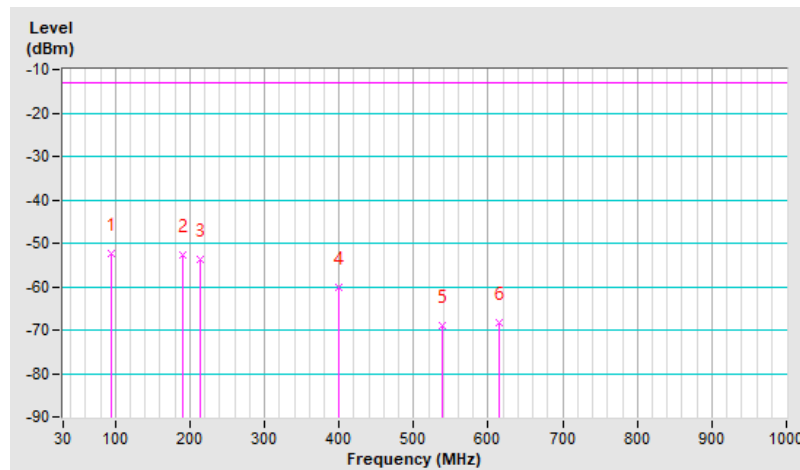

RF Mode	LTE Band 66 Channel Bandwidth: 20MHz	Channel	CH 132572 : 1770 MHz
Frequency Range	30 MHz ~ 1 GHz	Detector Function & Bandwidth	1 MHz/3 MHz (RMS)
Input Power	120 Vac, 60 Hz	Environmental Conditions	25°C, 60% RH
Tested By	Charles Hsiao		

Antenna Polarity & Test Distance : Vertical at 3 m								
No	Frequency (MHz)	EIRP (dBm)	Limit (dBm)	Margin (dB)	Antenna Height (m)	Table Angle (Degree)	Raw Value (dBuV)	Correction Factor (dB/m)
1	90.00	-49.46	-13.00	-36.46	1.15 V	119	69.98	-119.44
2	118.97	-51.73	-13.00	-38.73	1.05 V	217	63.61	-115.34
3	190.44	-54.92	-13.00	-41.92	1.53 V	288	60.92	-115.84
4	394.48	-60.88	-13.00	-47.88	1.53 V	229	49.23	-110.11
5	616.66	-68.66	-13.00	-55.66	1.15 V	59	36.62	-105.28
6	714.44	-69.03	-13.00	-56.03	1.53 V	287	34.94	-103.97

Remarks:

1. $EIRP(dBm) = Raw\ Value(dBuV) + Correction\ Factor(dB/m)$
2. $Correction\ Factor(dB/m) = Antenna\ Factor(dB/m) + Cable\ Factor(dB) - Pre-Amplifier\ Factor(dB) + 20\log(D) - 104.8$
3. $Margin\ value = EIRP - Limit\ value$
4. The other EIRP levels were very low against the limit of frequency range 30 MHz ~ 1 GHz.
5. The frequency range 9 kHz ~ 30 MHz: all emissions are more than 20 dB below the limit, therefore do not be recorded in this report.

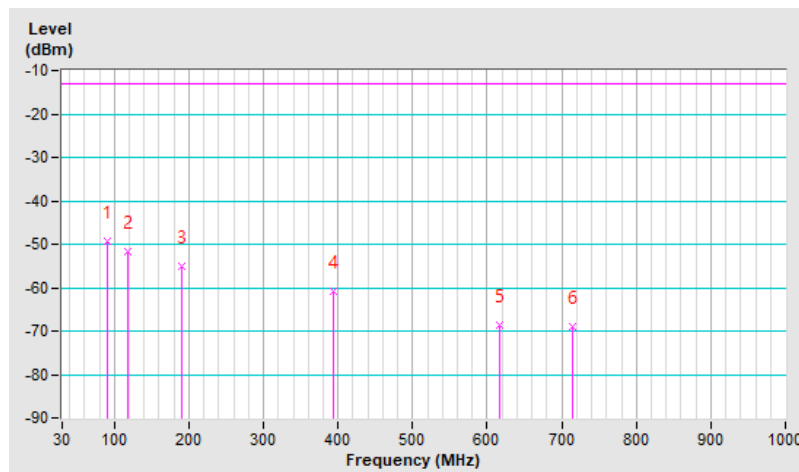

7.3 Radiated Spurious Emissions above 1GHz

7.3.1 GSM 850

RF Mode	GSM 850	Channel	CH 128 : 824.2 MHz
Frequency Range	1 GHz ~ 18 GHz	Detector Function & Bandwidth	1 MHz/3 MHz (RMS)
Input Power	120 Vac, 60 Hz	Environmental Conditions	25°C, 60% RH
Tested By	Charles Hsiao		

Antenna Polarity & Test Distance : Horizontal at 3 m

No	Frequency (MHz)	ERP (dBm)	Limit (dBm)	Margin (dB)	Antenna Height (m)	Table Angle (Degree)	Raw Value (dBuV)	Correction Factor (dB/m)
1	1648.40	-26.98	-13.00	-13.98	1.01 H	196	69.03	-96.01
2	2472.60	-36.31	-13.00	-23.31	1.97 H	8	54.03	-90.34

Antenna Polarity & Test Distance : Vertical at 3 m

No	Frequency (MHz)	ERP (dBm)	Limit (dBm)	Margin (dB)	Antenna Height (m)	Table Angle (Degree)	Raw Value (dBuV)	Correction Factor (dB/m)
1	1648.40	-27.76	-13.00	-14.76	1.15 V	164	68.25	-96.01
2	2472.60	-39.83	-13.00	-26.83	1.05 V	328	50.51	-90.34

Remarks:

- ERP(dBm) = Raw Value(dBuV) + Correction Factor(dB/m)
- Correction Factor(dB/m) = Antenna Factor(dB/m) + Cable Factor(dB) – Pre-Amplifier Factor(dB) + 20log(D) – 104.8 – 2.15
- Margin value = ERP – Limit value
- The other ERP levels were very low against the limit.



RF Mode	GSM 850	Channel	CH 189 : 836.4 MHz
Frequency Range	1 GHz ~ 18 GHz	Detector Function & Bandwidth	1 MHz/3 MHz (RMS)
Input Power	120 Vac, 60 Hz	Environmental Conditions	25°C, 60% RH
Tested By	Charles Hsiao		

Antenna Polarity & Test Distance : Horizontal at 3 m								
No	Frequency (MHz)	ERP (dBm)	Limit (dBm)	Margin (dB)	Antenna Height (m)	Table Angle (Degree)	Raw Value (dBuV)	Correction Factor (dB/m)
1	1672.80	-26.26	-13.00	-13.26	1.15 H	164	69.38	-95.64
2	2509.20	-35.50	-13.00	-22.50	1.75 H	270	54.69	-90.19
Antenna Polarity & Test Distance : Vertical at 3 m								
No	Frequency (MHz)	ERP (dBm)	Limit (dBm)	Margin (dB)	Antenna Height (m)	Table Angle (Degree)	Raw Value (dBuV)	Correction Factor (dB/m)
1	1672.80	-27.71	-13.00	-14.71	1.18 V	241	67.93	-95.64
2	2509.20	-35.91	-13.00	-22.91	1.16 V	328	54.28	-90.19

Remarks:

- ERP(dBm) = Raw Value(dBuV) + Correction Factor(dB/m)
- Correction Factor(dB/m) = Antenna Factor(dB/m) + Cable Factor(dB) – Pre-Amplifier Factor(dB) + 20log(D) – 104.8 – 2.15
- Margin value = ERP – Limit value
- The other ERP levels were very low against the limit.



RF Mode	GSM 850	Channel	CH 251 : 848.8 MHz
Frequency Range	1 GHz ~ 18 GHz	Detector Function & Bandwidth	1 MHz/3 MHz (RMS)
Input Power	120 Vac, 60 Hz	Environmental Conditions	25°C, 60% RH
Tested By	Charles Hsiao		

Antenna Polarity & Test Distance : Horizontal at 3 m								
No	Frequency (MHz)	ERP (dBm)	Limit (dBm)	Margin (dB)	Antenna Height (m)	Table Angle (Degree)	Raw Value (dBuV)	Correction Factor (dB/m)
1	1697.60	-27.18	-13.00	-14.18	1.15 H	223	68.05	-95.23
2	2546.40	-35.33	-13.00	-22.33	1.45 H	1	54.69	-90.02
Antenna Polarity & Test Distance : Vertical at 3 m								
No	Frequency (MHz)	ERP (dBm)	Limit (dBm)	Margin (dB)	Antenna Height (m)	Table Angle (Degree)	Raw Value (dBuV)	Correction Factor (dB/m)
1	1697.60	-29.39	-13.00	-16.39	1.12 V	223	65.84	-95.23
2	2546.40	-35.87	-13.00	-22.87	1.74 V	306	54.15	-90.02

Remarks:

- ERP(dBm) = Raw Value(dBuV) + Correction Factor(dB/m)
- Correction Factor(dB/m) = Antenna Factor(dB/m) + Cable Factor(dB) – Pre-Amplifier Factor(dB) + 20log(D) – 104.8 – 2.15
- Margin value = ERP – Limit value
- The other ERP levels were very low against the limit.



RF Mode	EDGE 850	Channel	CH 128 : 824.2 MHz
Frequency Range	1 GHz ~ 18 GHz	Detector Function & Bandwidth	1 MHz/3 MHz (RMS)
Input Power	120 Vac, 60 Hz	Environmental Conditions	25°C, 60% RH
Tested By	Charles Hsiao		

Antenna Polarity & Test Distance : Horizontal at 3 m								
No	Frequency (MHz)	ERP (dBm)	Limit (dBm)	Margin (dB)	Antenna Height (m)	Table Angle (Degree)	Raw Value (dBuV)	Correction Factor (dB/m)
1	1648.40	-34.99	-13.00	-21.99	1.15 H	205	61.02	-96.01
2	2472.60	-50.06	-13.00	-37.06	1.12 H	271	40.28	-90.34
Antenna Polarity & Test Distance : Vertical at 3 m								
No	Frequency (MHz)	ERP (dBm)	Limit (dBm)	Margin (dB)	Antenna Height (m)	Table Angle (Degree)	Raw Value (dBuV)	Correction Factor (dB/m)
1	1648.40	-35.63	-13.00	-22.63	1.20 V	229	60.38	-96.01
2	2472.60	-47.15	-13.00	-34.15	1.67 V	188	43.19	-90.34

Remarks:

- ERP(dBm) = Raw Value(dBuV) + Correction Factor(dB/m)
- Correction Factor(dB/m) = Antenna Factor(dB/m) + Cable Factor(dB) – Pre-Amplifier Factor(dB) + 20log(D) – 104.8 – 2.15
- Margin value = ERP – Limit value
- The other ERP levels were very low against the limit.

RF Mode	EDGE 850	Channel	CH 189 : 836.4 MHz
Frequency Range	1 GHz ~ 18 GHz	Detector Function & Bandwidth	1 MHz/3 MHz (RMS)
Input Power	120 Vac, 60 Hz	Environmental Conditions	25°C, 60% RH
Tested By	Charles Hsiao		

Antenna Polarity & Test Distance : Horizontal at 3 m								
No	Frequency (MHz)	ERP (dBm)	Limit (dBm)	Margin (dB)	Antenna Height (m)	Table Angle (Degree)	Raw Value (dBuV)	Correction Factor (dB/m)
1	1672.80	-33.14	-13.00	-20.14	1.78 H	77	62.50	-95.64
2	2509.20	-45.93	-13.00	-32.93	1.03 H	209	44.26	-90.19
Antenna Polarity & Test Distance : Vertical at 3 m								
No	Frequency (MHz)	ERP (dBm)	Limit (dBm)	Margin (dB)	Antenna Height (m)	Table Angle (Degree)	Raw Value (dBuV)	Correction Factor (dB/m)
1	1672.80	-34.80	-13.00	-21.80	1.65 V	295	60.84	-95.64
2	2509.20	-45.15	-13.00	-32.15	1.12 V	141	45.04	-90.19

Remarks:

1. $ERP(dBm) = Raw\ Value(dBuV) + Correction\ Factor(dB/m)$
2. $Correction\ Factor(dB/m) = Antenna\ Factor(dB/m) + Cable\ Factor(dB) - Pre-Amplifier\ Factor(dB) + 20\log(D) - 104.8 - 2.15$
3. Margin value = ERP – Limit value
4. The other ERP levels were very low against the limit.



RF Mode	EDGE 850	Channel	CH 251 : 848.8 MHz
Frequency Range	1 GHz ~ 18 GHz	Detector Function & Bandwidth	1 MHz/3 MHz (RMS)
Input Power	120 Vac, 60 Hz	Environmental Conditions	25°C, 60% RH
Tested By	Charles Hsiao		

Antenna Polarity & Test Distance : Horizontal at 3 m								
No	Frequency (MHz)	ERP (dBm)	Limit (dBm)	Margin (dB)	Antenna Height (m)	Table Angle (Degree)	Raw Value (dBuV)	Correction Factor (dB/m)
1	1697.60	-33.42	-13.00	-20.42	1.15 H	225	61.81	-95.23
2	2546.40	-44.89	-13.00	-31.89	1.20 H	224	45.13	-90.02
Antenna Polarity & Test Distance : Vertical at 3 m								
No	Frequency (MHz)	ERP (dBm)	Limit (dBm)	Margin (dB)	Antenna Height (m)	Table Angle (Degree)	Raw Value (dBuV)	Correction Factor (dB/m)
1	1697.60	-37.31	-13.00	-24.31	1.15 V	54	57.92	-95.23
2	2546.40	-45.73	-13.00	-32.73	1.05 V	210	44.29	-90.02

Remarks:

- ERP(dBm) = Raw Value(dBuV) + Correction Factor(dB/m)
- Correction Factor(dB/m) = Antenna Factor(dB/m) + Cable Factor(dB) – Pre-Amplifier Factor(dB) + 20log(D) – 104.8 – 2.15
- Margin value = ERP – Limit value
- The other ERP levels were very low against the limit.

7.3.2 PCS 1900

RF Mode	PCS 1900	Channel	CH 512 : 1850.2 MHz
Frequency Range	1 GHz ~ 20 GHz	Detector Function & Bandwidth	1 MHz/3 MHz (RMS)
Input Power	120 Vac, 60 Hz	Environmental Conditions	25°C, 60% RH
Tested By	Charles Hsiao		

Antenna Polarity & Test Distance : Horizontal at 3 m								
No	Frequency (MHz)	EIRP (dBm)	Limit (dBm)	Margin (dB)	Antenna Height (m)	Table Angle (Degree)	Raw Value (dBuV)	Correction Factor (dB/m)
1	3700.40	-39.11	-13.00	-26.11	1.68 H	55	46.46	-85.57
Antenna Polarity & Test Distance : Vertical at 3 m								
No	Frequency (MHz)	EIRP (dBm)	Limit (dBm)	Margin (dB)	Antenna Height (m)	Table Angle (Degree)	Raw Value (dBuV)	Correction Factor (dB/m)
1	3700.40	-41.58	-13.00	-28.58	1.57 V	229	43.99	-85.57

Remarks:

1. $EIRP(dBm) = Raw\ Value(dBuV) + Correction\ Factor(dB/m)$
2. $Correction\ Factor(dB/m) = Antenna\ Factor(dB/m) + Cable\ Factor(dB) - Pre-Amplifier\ Factor(dB) + 20\log(D) - 104.8$
3. Margin value = EIRP – Limit value
4. The other EIRP levels were very low against the limit.



RF Mode	PCS 1900	Channel	CH 661 : 1880 MHz
Frequency Range	1 GHz ~ 20 GHz	Detector Function & Bandwidth	1 MHz/3 MHz (RMS)
Input Power	120 Vac, 60 Hz	Environmental Conditions	25°C, 60% RH
Tested By	Charles Hsiao		

Antenna Polarity & Test Distance : Horizontal at 3 m								
No	Frequency (MHz)	EIRP (dBm)	Limit (dBm)	Margin (dB)	Antenna Height (m)	Table Angle (Degree)	Raw Value (dBuV)	Correction Factor (dB/m)
1	3760.00	-39.80	-13.00	-26.80	1.39 H	344	45.59	-85.39

Antenna Polarity & Test Distance : Vertical at 3 m								
No	Frequency (MHz)	EIRP (dBm)	Limit (dBm)	Margin (dB)	Antenna Height (m)	Table Angle (Degree)	Raw Value (dBuV)	Correction Factor (dB/m)
1	3760.00	-45.71	-13.00	-32.71	1.75 V	27	39.68	-85.39

Remarks:

1. $EIRP(dBm) = Raw\ Value(dBuV) + Correction\ Factor(dB/m)$
2. $Correction\ Factor(dB/m) = Antenna\ Factor(dB/m) + Cable\ Factor(dB) - Pre-Amplifier\ Factor(dB) + 20\log(D) - 104.8$
3. Margin value = EIRP – Limit value
4. The other EIRP levels were very low against the limit.



RF Mode	PCS 1900	Channel	CH 810 : 1909.8 MHz
Frequency Range	1 GHz ~ 20 GHz	Detector Function & Bandwidth	1 MHz/3 MHz (RMS)
Input Power	120 Vac, 60 Hz	Environmental Conditions	25°C, 60% RH
Tested By	Charles Hsiao		

Antenna Polarity & Test Distance : Horizontal at 3 m								
No	Frequency (MHz)	EIRP (dBm)	Limit (dBm)	Margin (dB)	Antenna Height (m)	Table Angle (Degree)	Raw Value (dBuV)	Correction Factor (dB/m)
1	3819.60	-43.83	-13.00	-30.83	1.16 H	321	41.34	-85.17

Antenna Polarity & Test Distance : Vertical at 3 m								
No	Frequency (MHz)	EIRP (dBm)	Limit (dBm)	Margin (dB)	Antenna Height (m)	Table Angle (Degree)	Raw Value (dBuV)	Correction Factor (dB/m)
1	3819.60	-47.87	-13.00	-34.87	1.17 V	157	37.30	-85.17

Remarks:

1. $EIRP(dBm) = Raw\ Value(dBuV) + Correction\ Factor(dB/m)$
2. $Correction\ Factor(dB/m) = Antenna\ Factor(dB/m) + Cable\ Factor(dB) - Pre-Amplifier\ Factor(dB) + 20\log(D) - 104.8$
3. Margin value = EIRP – Limit value
4. The other EIRP levels were very low against the limit.



RF Mode	EDGE 1900	Channel	CH 512 : 1850.2 MHz
Frequency Range	1 GHz ~ 20 GHz	Detector Function & Bandwidth	1 MHz/3 MHz (RMS)
Input Power	120 Vac, 60 Hz	Environmental Conditions	25°C, 60% RH
Tested By	Charles Hsiao		

Antenna Polarity & Test Distance : Horizontal at 3 m								
No	Frequency (MHz)	EIRP (dBm)	Limit (dBm)	Margin (dB)	Antenna Height (m)	Table Angle (Degree)	Raw Value (dBuV)	Correction Factor (dB/m)
1	3700.40	-42.50	-13.00	-29.50	1.58 H	8	43.07	-85.57

Antenna Polarity & Test Distance : Vertical at 3 m								
No	Frequency (MHz)	EIRP (dBm)	Limit (dBm)	Margin (dB)	Antenna Height (m)	Table Angle (Degree)	Raw Value (dBuV)	Correction Factor (dB/m)
1	3700.40	-49.91	-13.00	-36.91	1.16 V	284	35.66	-85.57

Remarks:

1. $EIRP(dBm) = Raw\ Value(dBuV) + Correction\ Factor(dB/m)$
2. $Correction\ Factor(dB/m) = Antenna\ Factor(dB/m) + Cable\ Factor(dB) - Pre-Amplifier\ Factor(dB) + 20\log(D) - 104.8$
3. Margin value = EIRP – Limit value
4. The other EIRP levels were very low against the limit.



RF Mode	EDGE 1900	Channel	CH 661 : 1880 MHz
Frequency Range	1 GHz ~ 20 GHz	Detector Function & Bandwidth	1 MHz/3 MHz (RMS)
Input Power	120 Vac, 60 Hz	Environmental Conditions	25°C, 60% RH
Tested By	Charles Hsiao		

Antenna Polarity & Test Distance : Horizontal at 3 m								
No	Frequency (MHz)	EIRP (dBm)	Limit (dBm)	Margin (dB)	Antenna Height (m)	Table Angle (Degree)	Raw Value (dBuV)	Correction Factor (dB/m)
1	3760.00	-46.13	-13.00	-33.13	1.14 H	185	39.26	-85.39

Antenna Polarity & Test Distance : Vertical at 3 m								
No	Frequency (MHz)	EIRP (dBm)	Limit (dBm)	Margin (dB)	Antenna Height (m)	Table Angle (Degree)	Raw Value (dBuV)	Correction Factor (dB/m)
1	3760.00	-49.16	-13.00	-36.16	1.39 V	304	36.23	-85.39

Remarks:

1. $EIRP(dBm) = Raw\ Value(dBuV) + Correction\ Factor(dB/m)$
2. $Correction\ Factor(dB/m) = Antenna\ Factor(dB/m) + Cable\ Factor(dB) - Pre-Amplifier\ Factor(dB) + 20\log(D) - 104.8$
3. Margin value = EIRP – Limit value
4. The other EIRP levels were very low against the limit.



RF Mode	EDGE 1900	Channel	CH 810 : 1909.8 MHz
Frequency Range	1 GHz ~ 20 GHz	Detector Function & Bandwidth	1 MHz/3 MHz (RMS)
Input Power	120 Vac, 60 Hz	Environmental Conditions	25°C, 60% RH
Tested By	Charles Hsiao		

Antenna Polarity & Test Distance : Horizontal at 3 m								
No	Frequency (MHz)	EIRP (dBm)	Limit (dBm)	Margin (dB)	Antenna Height (m)	Table Angle (Degree)	Raw Value (dBuV)	Correction Factor (dB/m)
1	3819.60	-53.88	-13.00	-40.88	1.15 H	174	31.29	-85.17

Antenna Polarity & Test Distance : Vertical at 3 m								
No	Frequency (MHz)	EIRP (dBm)	Limit (dBm)	Margin (dB)	Antenna Height (m)	Table Angle (Degree)	Raw Value (dBuV)	Correction Factor (dB/m)
1	3819.60	-53.04	-13.00	-40.04	1.11 V	1	32.13	-85.17

Remarks:

1. $EIRP(dBm) = Raw\ Value(dBuV) + Correction\ Factor(dB/m)$
2. $Correction\ Factor(dB/m) = Antenna\ Factor(dB/m) + Cable\ Factor(dB) - Pre-Amplifier\ Factor(dB) + 20\log(D) - 104.8$
3. Margin value = EIRP – Limit value
4. The other EIRP levels were very low against the limit.

7.3.3 WCDMA Band 2

RF Mode	WCDMA Band 2	Channel	CH 9262 : 1852.4 MHz
Frequency Range	1 GHz ~ 20 GHz	Detector Function & Bandwidth	1 MHz/3 MHz (RMS)
Input Power	120 Vac, 60 Hz	Environmental Conditions	25°C, 60% RH
Tested By	Charles Hsiao		

Antenna Polarity & Test Distance : Horizontal at 3 m								
No	Frequency (MHz)	EIRP (dBm)	Limit (dBm)	Margin (dB)	Antenna Height (m)	Table Angle (Degree)	Raw Value (dBuV)	Correction Factor (dB/m)
1	3704.80	-48.48	-13.00	-35.48	1.31 H	209	37.08	-85.56
2	5557.20	-44.71	-13.00	-31.71	1.14 H	1	37.46	-82.17
Antenna Polarity & Test Distance : Vertical at 3 m								
No	Frequency (MHz)	EIRP (dBm)	Limit (dBm)	Margin (dB)	Antenna Height (m)	Table Angle (Degree)	Raw Value (dBuV)	Correction Factor (dB/m)
1	3704.80	-46.69	-13.00	-33.69	1.69 V	166	38.87	-85.56
2	5557.20	-45.99	-13.00	-32.99	1.17 V	141	36.18	-82.17

Remarks:

- EIRP(dBm) = Raw Value(dBuV) + Correction Factor(dB/m)
- Correction Factor(dB/m) = Antenna Factor(dB/m) + Cable Factor(dB) – Pre-Amplifier Factor(dB) + 20log(D) – 104.8
- Margin value = EIRP – Limit value
- The other EIRP levels were very low against the limit.



RF Mode	WCDMA Band 2	Channel	CH 9400 : 1880 MHz
Frequency Range	1 GHz ~ 20 GHz	Detector Function & Bandwidth	1 MHz/3 MHz (RMS)
Input Power	120 Vac, 60 Hz	Environmental Conditions	25°C, 60% RH
Tested By	Charles Hsiao		

Antenna Polarity & Test Distance : Horizontal at 3 m								
No	Frequency (MHz)	EIRP (dBm)	Limit (dBm)	Margin (dB)	Antenna Height (m)	Table Angle (Degree)	Raw Value (dBuV)	Correction Factor (dB/m)
1	3760.00	-47.60	-13.00	-34.60	1.15 H	174	37.79	-85.39
2	5640.00	-45.07	-13.00	-32.07	1.57 H	88	37.19	-82.26
Antenna Polarity & Test Distance : Vertical at 3 m								
No	Frequency (MHz)	EIRP (dBm)	Limit (dBm)	Margin (dB)	Antenna Height (m)	Table Angle (Degree)	Raw Value (dBuV)	Correction Factor (dB/m)
1	3760.00	-45.26	-13.00	-32.26	1.15 V	360	40.13	-85.39
2	5640.00	-45.08	-13.00	-32.08	1.12 V	314	37.18	-82.26

Remarks:

- EIRP(dBm) = Raw Value(dBuV) + Correction Factor(dB/m)
- Correction Factor(dB/m) = Antenna Factor(dB/m) + Cable Factor(dB) – Pre-Amplifier Factor(dB) + 20log(D) – 104.8
- Margin value = EIRP – Limit value
- The other EIRP levels were very low against the limit.

RF Mode	WCDMA Band 2	Channel	CH 9538 : 1907.6 MHz
Frequency Range	1 GHz ~ 20 GHz	Detector Function & Bandwidth	1 MHz/3 MHz (RMS)
Input Power	120 Vac, 60 Hz	Environmental Conditions	25°C, 60% RH
Tested By	Charles Hsiao		

Antenna Polarity & Test Distance : Horizontal at 3 m								
No	Frequency (MHz)	EIRP (dBm)	Limit (dBm)	Margin (dB)	Antenna Height (m)	Table Angle (Degree)	Raw Value (dBuV)	Correction Factor (dB/m)
1	3815.20	-46.52	-13.00	-33.52	1.16 H	311	38.64	-85.16
2	5722.80	-43.23	-13.00	-30.23	1.01 H	83	38.88	-82.11
Antenna Polarity & Test Distance : Vertical at 3 m								
No	Frequency (MHz)	EIRP (dBm)	Limit (dBm)	Margin (dB)	Antenna Height (m)	Table Angle (Degree)	Raw Value (dBuV)	Correction Factor (dB/m)
1	3815.20	-43.51	-13.00	-30.51	1.14 V	174	41.65	-85.16
2	5722.80	-45.34	-13.00	-32.34	1.45 V	2	36.77	-82.11

Remarks:

1. $EIRP(dBm) = Raw\ Value(dBuV) + Correction\ Factor(dB/m)$
2. $Correction\ Factor(dB/m) = Antenna\ Factor(dB/m) + Cable\ Factor(dB) - Pre-Amplifier\ Factor(dB) + 20\log(D) - 104.8$
3. Margin value = EIRP – Limit value
4. The other EIRP levels were very low against the limit.

7.3.4 WCDMA Band 4

RF Mode	WCDMA Band 4	Channel	CH 1312 : 1712.4 MHz
Frequency Range	1 GHz ~ 18 GHz	Detector Function & Bandwidth	1 MHz/3 MHz (RMS)
Input Power	120 Vac, 60 Hz	Environmental Conditions	25°C, 60% RH
Tested By	Charles Hsiao		

Antenna Polarity & Test Distance : Horizontal at 3 m								
No	Frequency (MHz)	EIRP (dBm)	Limit (dBm)	Margin (dB)	Antenna Height (m)	Table Angle (Degree)	Raw Value (dBuV)	Correction Factor (dB/m)
1	3424.80	-48.02	-13.00	-35.02	1.34 H	256	38.32	-86.34
Antenna Polarity & Test Distance : Vertical at 3 m								
No	Frequency (MHz)	EIRP (dBm)	Limit (dBm)	Margin (dB)	Antenna Height (m)	Table Angle (Degree)	Raw Value (dBuV)	Correction Factor (dB/m)
1	3424.80	-48.07	-13.00	-35.07	1.86 V	117	38.27	-86.34

Remarks:

- EIRP(dBm) = Raw Value(dBuV) + Correction Factor(dB/m)
- Correction Factor(dB/m) = Antenna Factor(dB/m) + Cable Factor(dB) – Pre-Amplifier Factor(dB) + 20log(D) – 104.8
- Margin value = EIRP – Limit value
- The other EIRP levels were very low against the limit.



RF Mode	WCDMA Band 4	Channel	CH 1413 : 1732.6 MHz
Frequency Range	1 GHz ~ 18 GHz	Detector Function & Bandwidth	1 MHz/3 MHz (RMS)
Input Power	120 Vac, 60 Hz	Environmental Conditions	25°C, 60% RH
Tested By	Charles Hsiao		

Antenna Polarity & Test Distance : Horizontal at 3 m								
No	Frequency (MHz)	EIRP (dBm)	Limit (dBm)	Margin (dB)	Antenna Height (m)	Table Angle (Degree)	Raw Value (dBuV)	Correction Factor (dB/m)
1	3465.20	-47.65	-13.00	-34.65	1.97 H	8	38.60	-86.25

Antenna Polarity & Test Distance : Vertical at 3 m								
No	Frequency (MHz)	EIRP (dBm)	Limit (dBm)	Margin (dB)	Antenna Height (m)	Table Angle (Degree)	Raw Value (dBuV)	Correction Factor (dB/m)
1	3465.20	-50.05	-13.00	-37.05	1.18 V	127	36.20	-86.25

Remarks:

1. $EIRP(dBm) = Raw\ Value(dBuV) + Correction\ Factor(dB/m)$
2. $Correction\ Factor(dB/m) = Antenna\ Factor(dB/m) + Cable\ Factor(dB) - Pre-Amplifier\ Factor(dB) + 20\log(D) - 104.8$
3. Margin value = EIRP – Limit value
4. The other EIRP levels were very low against the limit.



RF Mode	WCDMA Band 4	Channel	CH 1513 : 1752.6 MHz
Frequency Range	1 GHz ~ 18 GHz	Detector Function & Bandwidth	1 MHz/3 MHz (RMS)
Input Power	120 Vac, 60 Hz	Environmental Conditions	25°C, 60% RH
Tested By	Charles Hsiao		

Antenna Polarity & Test Distance : Horizontal at 3 m								
No	Frequency (MHz)	EIRP (dBm)	Limit (dBm)	Margin (dB)	Antenna Height (m)	Table Angle (Degree)	Raw Value (dBuV)	Correction Factor (dB/m)
1	3502.20	-45.33	-13.00	-32.33	1.57 H	147	40.78	-86.11
Antenna Polarity & Test Distance : Vertical at 3 m								
No	Frequency (MHz)	EIRP (dBm)	Limit (dBm)	Margin (dB)	Antenna Height (m)	Table Angle (Degree)	Raw Value (dBuV)	Correction Factor (dB/m)
1	3502.20	-46.82	-13.00	-33.82	1.16 V	111	39.29	-86.11

Remarks:

- EIRP(dBm) = Raw Value(dBuV) + Correction Factor(dB/m)
- Correction Factor(dB/m) = Antenna Factor(dB/m) + Cable Factor(dB) – Pre-Amplifier Factor(dB) + 20log(D) – 104.8
- Margin value = EIRP – Limit value
- The other EIRP levels were very low against the limit.

7.3.5 WCDMA Band 5

RF Mode	WCDMA Band 5	Channel	CH 4132 : 826.4 MHz
Frequency Range	1 GHz ~ 18 GHz	Detector Function & Bandwidth	1 MHz/3 MHz (RMS)
Input Power	120 Vac, 60 Hz	Environmental Conditions	25°C, 60% RH
Tested By	Charles Hsiao		

Antenna Polarity & Test Distance : Horizontal at 3 m								
No	Frequency (MHz)	ERP (dBm)	Limit (dBm)	Margin (dB)	Antenna Height (m)	Table Angle (Degree)	Raw Value (dBuV)	Correction Factor (dB/m)
1	1652.80	-48.18	-13.00	-35.18	1.36 H	222	47.77	-95.95
Antenna Polarity & Test Distance : Vertical at 3 m								
No	Frequency (MHz)	ERP (dBm)	Limit (dBm)	Margin (dB)	Antenna Height (m)	Table Angle (Degree)	Raw Value (dBuV)	Correction Factor (dB/m)
1	1652.80	-47.64	-13.00	-34.64	1.15 V	295	48.31	-95.95

Remarks:

1. $ERP(dBm) = Raw\ Value(dBuV) + Correction\ Factor(dB/m)$
2. $Correction\ Factor(dB/m) = Antenna\ Factor(dB/m) + Cable\ Factor(dB) - Pre-Amplifier\ Factor(dB) + 20\log(D) - 104.8 - 2.15$
3. Margin value = ERP – Limit value
4. The other ERP levels were very low against the limit.



RF Mode	WCDMA Band 5	Channel	CH 4182 : 836.4 MHz
Frequency Range	1 GHz ~ 18 GHz	Detector Function & Bandwidth	1 MHz/3 MHz (RMS)
Input Power	120 Vac, 60 Hz	Environmental Conditions	25°C, 60% RH
Tested By	Charles Hsiao		

Antenna Polarity & Test Distance : Horizontal at 3 m								
No	Frequency (MHz)	ERP (dBm)	Limit (dBm)	Margin (dB)	Antenna Height (m)	Table Angle (Degree)	Raw Value (dBuV)	Correction Factor (dB/m)
1	1672.80	-49.90	-13.00	-36.90	1.64 H	188	45.74	-95.64

Antenna Polarity & Test Distance : Vertical at 3 m								
No	Frequency (MHz)	ERP (dBm)	Limit (dBm)	Margin (dB)	Antenna Height (m)	Table Angle (Degree)	Raw Value (dBuV)	Correction Factor (dB/m)
1	1672.80	-50.95	-13.00	-37.95	1.01 V	100	44.69	-95.64

Remarks:

1. $ERP(dBm) = Raw\ Value(dBuV) + Correction\ Factor(dB/m)$
2. $Correction\ Factor(dB/m) = Antenna\ Factor(dB/m) + Cable\ Factor(dB) - Pre-Amplifier\ Factor(dB) + 20\log(D) - 104.8 - 2.15$
3. Margin value = ERP – Limit value
4. The other ERP levels were very low against the limit.



RF Mode	WCDMA Band 5	Channel	CH 4233 : 846.6 MHz
Frequency Range	1 GHz ~ 18 GHz	Detector Function & Bandwidth	1 MHz/3 MHz (RMS)
Input Power	120 Vac, 60 Hz	Environmental Conditions	25°C, 60% RH
Tested By	Charles Hsiao		

Antenna Polarity & Test Distance : Horizontal at 3 m								
No	Frequency (MHz)	ERP (dBm)	Limit (dBm)	Margin (dB)	Antenna Height (m)	Table Angle (Degree)	Raw Value (dBuV)	Correction Factor (dB/m)
1	1693.20	-49.07	-13.00	-36.07	1.77 H	174	46.24	-95.31

Antenna Polarity & Test Distance : Vertical at 3 m								
No	Frequency (MHz)	ERP (dBm)	Limit (dBm)	Margin (dB)	Antenna Height (m)	Table Angle (Degree)	Raw Value (dBuV)	Correction Factor (dB/m)
1	1693.20	-52.92	-13.00	-39.92	1.54 V	155	42.39	-95.31

Remarks:

1. $ERP(dBm) = Raw\ Value(dBuV) + Correction\ Factor(dB/m)$
2. $Correction\ Factor(dB/m) = Antenna\ Factor(dB/m) + Cable\ Factor(dB) - Pre-Amplifier\ Factor(dB) + 20\log(D) - 104.8 - 2.15$
3. Margin value = ERP – Limit value
4. The other ERP levels were very low against the limit.

7.3.6 LTE Band 2

RF Mode	LTE Band 2 Channel Bandwidth: 1.4MHz	Channel	CH 18607 : 1850.7 MHz
Frequency Range	1 GHz ~ 20 GHz	Detector Function & Bandwidth	1 MHz/3 MHz (RMS)
Input Power	120 Vac, 60 Hz	Environmental Conditions	25°C, 60% RH
Tested By	Karl Lee		

Antenna Polarity & Test Distance : Horizontal at 3 m

No	Frequency (MHz)	EIRP (dBm)	Limit (dBm)	Margin (dB)	Antenna Height (m)	Table Angle (Degree)	Raw Value (dBuV)	Correction Factor (dB/m)
1	3701.40	-46.13	-13.00	-33.13	1.38 H	128	39.44	-85.57
2	5552.10	-46.89	-13.00	-33.89	1.29 H	28	35.27	-82.16

Antenna Polarity & Test Distance : Vertical at 3 m

No	Frequency (MHz)	EIRP (dBm)	Limit (dBm)	Margin (dB)	Antenna Height (m)	Table Angle (Degree)	Raw Value (dBuV)	Correction Factor (dB/m)
1	3701.40	-49.39	-13.00	-36.39	2.05 V	49	36.18	-85.57
2	5552.10	-48.52	-13.00	-35.52	1.73 V	45	33.64	-82.16

Remarks:

1. $EIRP(dBm) = Raw\ Value(dBuV) + Correction\ Factor(dB/m)$
2. $Correction\ Factor(dB/m) = Antenna\ Factor(dB/m) + Cable\ Factor(dB) - Pre-Amplifier\ Factor(dB) + 20\log(D) - 104.8$
3. Margin value = EIRP – Limit value
4. The other EIRP levels were very low against the limit.



RF Mode	LTE Band 2 Channel Bandwidth: 1.4MHz	Channel	CH 18900 : 1880 MHz
Frequency Range	1 GHz ~ 20 GHz	Detector Function & Bandwidth	1 MHz/3 MHz (RMS)
Input Power	120 Vac, 60 Hz	Environmental Conditions	25°C, 60% RH
Tested By	Karl Lee		

Antenna Polarity & Test Distance : Horizontal at 3 m								
No	Frequency (MHz)	EIRP (dBm)	Limit (dBm)	Margin (dB)	Antenna Height (m)	Table Angle (Degree)	Raw Value (dBuV)	Correction Factor (dB/m)
1	3760.00	-45.32	-13.00	-32.32	1.17 H	242	40.07	-85.39
2	5640.00	-46.05	-13.00	-33.05	2.28 H	147	36.21	-82.26
Antenna Polarity & Test Distance : Vertical at 3 m								
No	Frequency (MHz)	EIRP (dBm)	Limit (dBm)	Margin (dB)	Antenna Height (m)	Table Angle (Degree)	Raw Value (dBuV)	Correction Factor (dB/m)
1	3760.00	-48.92	-13.00	-35.92	2.53 V	185	36.47	-85.39
2	5640.00	-46.75	-13.00	-33.75	2.23 V	157	35.51	-82.26

Remarks:

1. $EIRP(dBm) = Raw\ Value(dBuV) + Correction\ Factor(dB/m)$
2. $Correction\ Factor(dB/m) = Antenna\ Factor(dB/m) + Cable\ Factor(dB) - Pre-Amplifier\ Factor(dB) + 20\log(D) - 104.8$
3. $Margin\ value = EIRP - Limit\ value$
4. The other EIRP levels were very low against the limit.



RF Mode	LTE Band 2 Channel Bandwidth: 1.4MHz	Channel	CH 19193 : 1909.3 MHz
Frequency Range	1 GHz ~ 20 GHz	Detector Function & Bandwidth	1 MHz/3 MHz (RMS)
Input Power	120 Vac, 60 Hz	Environmental Conditions	25°C, 60% RH
Tested By	Karl Lee		

Antenna Polarity & Test Distance : Horizontal at 3 m

No	Frequency (MHz)	EIRP (dBm)	Limit (dBm)	Margin (dB)	Antenna Height (m)	Table Angle (Degree)	Raw Value (dBuV)	Correction Factor (dB/m)
1	3818.60	-41.78	-13.00	-28.78	1.68 H	42	43.38	-85.16
2	5727.90	-47.24	-13.00	-34.24	1.82 H	341	34.86	-82.10

Antenna Polarity & Test Distance : Vertical at 3 m

No	Frequency (MHz)	EIRP (dBm)	Limit (dBm)	Margin (dB)	Antenna Height (m)	Table Angle (Degree)	Raw Value (dBuV)	Correction Factor (dB/m)
1	3818.60	-46.63	-13.00	-33.63	2.35 V	112	38.53	-85.16
2	5727.90	-44.84	-13.00	-31.84	1.72 V	153	37.26	-82.10

Remarks:

1. $EIRP(dBm) = Raw\ Value(dBuV) + Correction\ Factor(dB/m)$
2. $Correction\ Factor(dB/m) = Antenna\ Factor(dB/m) + Cable\ Factor(dB) - Pre-Amplifier\ Factor(dB) + 20\log(D) - 104.8$
3. Margin value = EIRP – Limit value
4. The other EIRP levels were very low against the limit.



RF Mode	LTE Band 2 Channel Bandwidth: 5MHz	Channel	CH 18625 : 1852.5 MHz
Frequency Range	1 GHz ~ 20 GHz	Detector Function & Bandwidth	1 MHz/3 MHz (RMS)
Input Power	120 Vac, 60 Hz	Environmental Conditions	25°C, 60% RH
Tested By	Karl Lee		

Antenna Polarity & Test Distance : Horizontal at 3 m								
No	Frequency (MHz)	EIRP (dBm)	Limit (dBm)	Margin (dB)	Antenna Height (m)	Table Angle (Degree)	Raw Value (dBuV)	Correction Factor (dB/m)
1	3705.00	-43.13	-13.00	-30.13	2.12 H	146	42.42	-85.55
2	5557.50	-47.04	-13.00	-34.04	1.72 H	235	35.14	-82.18
Antenna Polarity & Test Distance : Vertical at 3 m								
No	Frequency (MHz)	EIRP (dBm)	Limit (dBm)	Margin (dB)	Antenna Height (m)	Table Angle (Degree)	Raw Value (dBuV)	Correction Factor (dB/m)
1	3705.00	-46.40	-13.00	-33.40	1.06 V	74	39.15	-85.55
2	5557.50	-44.57	-13.00	-31.57	1.20 V	143	37.61	-82.18

Remarks:

1. $EIRP(dBm) = Raw\ Value(dBuV) + Correction\ Factor(dB/m)$
2. $Correction\ Factor(dB/m) = Antenna\ Factor(dB/m) + Cable\ Factor(dB) - Pre-Amplifier\ Factor(dB) + 20\log(D) - 104.8$
3. $Margin\ value = EIRP - Limit\ value$
4. The other EIRP levels were very low against the limit.



RF Mode	LTE Band 2 Channel Bandwidth: 5MHz	Channel	CH 18900 : 1880 MHz
Frequency Range	1 GHz ~ 20 GHz	Detector Function & Bandwidth	1 MHz/3 MHz (RMS)
Input Power	120 Vac, 60 Hz	Environmental Conditions	25°C, 60% RH
Tested By	Karl Lee		

Antenna Polarity & Test Distance : Horizontal at 3 m								
No	Frequency (MHz)	EIRP (dBm)	Limit (dBm)	Margin (dB)	Antenna Height (m)	Table Angle (Degree)	Raw Value (dBuV)	Correction Factor (dB/m)
1	3760.00	-43.00	-13.00	-30.00	1.49 H	296	42.39	-85.39
2	5640.00	-47.71	-13.00	-34.71	2.51 H	17	34.55	-82.26
Antenna Polarity & Test Distance : Vertical at 3 m								
No	Frequency (MHz)	EIRP (dBm)	Limit (dBm)	Margin (dB)	Antenna Height (m)	Table Angle (Degree)	Raw Value (dBuV)	Correction Factor (dB/m)
1	3760.00	-45.82	-13.00	-32.82	1.65 V	172	39.57	-85.39
2	5640.00	-46.12	-13.00	-33.12	2.25 V	171	36.14	-82.26

Remarks:

1. $EIRP(dBm) = Raw\ Value(dBuV) + Correction\ Factor(dB/m)$
2. $Correction\ Factor(dB/m) = Antenna\ Factor(dB/m) + Cable\ Factor(dB) - Pre-Amplifier\ Factor(dB) + 20\log(D) - 104.8$
3. $Margin\ value = EIRP - Limit\ value$
4. The other EIRP levels were very low against the limit.



RF Mode	LTE Band 2 Channel Bandwidth: 5MHz	Channel	CH 19175 : 1907.5 MHz
Frequency Range	1 GHz ~ 20 GHz	Detector Function & Bandwidth	1 MHz/3 MHz (RMS)
Input Power	120 Vac, 60 Hz	Environmental Conditions	25°C, 60% RH
Tested By	Karl Lee		

Antenna Polarity & Test Distance : Horizontal at 3 m								
No	Frequency (MHz)	EIRP (dBm)	Limit (dBm)	Margin (dB)	Antenna Height (m)	Table Angle (Degree)	Raw Value (dBuV)	Correction Factor (dB/m)
1	3815.00	-39.58	-13.00	-26.58	1.26 H	94	45.58	-85.16
2	5722.50	-44.93	-13.00	-31.93	1.51 H	280	37.18	-82.11
Antenna Polarity & Test Distance : Vertical at 3 m								
No	Frequency (MHz)	EIRP (dBm)	Limit (dBm)	Margin (dB)	Antenna Height (m)	Table Angle (Degree)	Raw Value (dBuV)	Correction Factor (dB/m)
1	3815.00	-44.97	-13.00	-31.97	2.20 V	135	40.19	-85.16
2	5722.50	-45.18	-13.00	-32.18	1.07 V	174	36.93	-82.11

Remarks:

1. $EIRP(dBm) = Raw\ Value(dBuV) + Correction\ Factor(dB/m)$
2. $Correction\ Factor(dB/m) = Antenna\ Factor(dB/m) + Cable\ Factor(dB) - Pre-Amplifier\ Factor(dB) + 20\log(D) - 104.8$
3. $Margin\ value = EIRP - Limit\ value$
4. The other EIRP levels were very low against the limit.

RF Mode	LTE Band 2 Channel Bandwidth: 20MHz	Channel	CH 18700 : 1860 MHz
Frequency Range	1 GHz ~ 20 GHz	Detector Function & Bandwidth	1 MHz/3 MHz (RMS)
Input Power	120 Vac, 60 Hz	Environmental Conditions	25°C, 60% RH
Tested By	Karl Lee		

Antenna Polarity & Test Distance : Horizontal at 3 m								
No	Frequency (MHz)	EIRP (dBm)	Limit (dBm)	Margin (dB)	Antenna Height (m)	Table Angle (Degree)	Raw Value (dBuV)	Correction Factor (dB/m)
1	3720.00	-42.05	-13.00	-29.05	1.53 H	182	43.46	-85.51
2	5580.00	-45.54	-13.00	-32.54	1.09 H	271	36.71	-82.25
Antenna Polarity & Test Distance : Vertical at 3 m								
No	Frequency (MHz)	EIRP (dBm)	Limit (dBm)	Margin (dB)	Antenna Height (m)	Table Angle (Degree)	Raw Value (dBuV)	Correction Factor (dB/m)
1	3720.00	-44.02	-13.00	-31.02	1.82 V	43	41.49	-85.51
2	5580.00	-42.07	-13.00	-29.07	1.39 V	263	40.18	-82.25

Remarks:

1. $EIRP(dBm) = Raw\ Value(dBuV) + Correction\ Factor(dB/m)$
2. $Correction\ Factor(dB/m) = Antenna\ Factor(dB/m) + Cable\ Factor(dB) - Pre-Amplifier\ Factor(dB) + 20\log(D) - 104.8$
3. $Margin\ value = EIRP - Limit\ value$
4. The other EIRP levels were very low against the limit.



RF Mode	LTE Band 2 Channel Bandwidth: 20MHz	Channel	CH 18900 : 1880 MHz
Frequency Range	1 GHz ~ 20 GHz	Detector Function & Bandwidth	1 MHz/3 MHz (RMS)
Input Power	120 Vac, 60 Hz	Environmental Conditions	25°C, 60% RH
Tested By	Karl Lee		

Antenna Polarity & Test Distance : Horizontal at 3 m

No	Frequency (MHz)	EIRP (dBm)	Limit (dBm)	Margin (dB)	Antenna Height (m)	Table Angle (Degree)	Raw Value (dBuV)	Correction Factor (dB/m)
1	3760.00	-43.61	-13.00	-30.61	2.35 H	104	41.78	-85.39
2	5640.00	-46.16	-13.00	-33.16	1.51 H	192	36.10	-82.26

Antenna Polarity & Test Distance : Vertical at 3 m

No	Frequency (MHz)	EIRP (dBm)	Limit (dBm)	Margin (dB)	Antenna Height (m)	Table Angle (Degree)	Raw Value (dBuV)	Correction Factor (dB/m)
1	3760.00	-47.00	-13.00	-34.00	1.12 V	149	38.39	-85.39
2	5640.00	-44.97	-13.00	-31.97	1.46 V	173	37.29	-82.26

Remarks:

1. $EIRP(dBm) = Raw\ Value(dBuV) + Correction\ Factor(dB/m)$
2. $Correction\ Factor(dB/m) = Antenna\ Factor(dB/m) + Cable\ Factor(dB) - Pre-Amplifier\ Factor(dB) + 20\log(D) - 104.8$
3. Margin value = EIRP – Limit value
4. The other EIRP levels were very low against the limit.



RF Mode	LTE Band 2 Channel Bandwidth: 20MHz	Channel	CH 19100 : 1900 MHz
Frequency Range	1 GHz ~ 20 GHz	Detector Function & Bandwidth	1 MHz/3 MHz (RMS)
Input Power	120 Vac, 60 Hz	Environmental Conditions	25°C, 60% RH
Tested By	Karl Lee		

Antenna Polarity & Test Distance : Horizontal at 3 m

No	Frequency (MHz)	EIRP (dBm)	Limit (dBm)	Margin (dB)	Antenna Height (m)	Table Angle (Degree)	Raw Value (dBuV)	Correction Factor (dB/m)
1	3800.00	-40.83	-13.00	-27.83	1.45 H	187	44.36	-85.19
2	5700.00	-45.84	-13.00	-32.84	2.26 H	282	36.35	-82.19

Antenna Polarity & Test Distance : Vertical at 3 m

No	Frequency (MHz)	EIRP (dBm)	Limit (dBm)	Margin (dB)	Antenna Height (m)	Table Angle (Degree)	Raw Value (dBuV)	Correction Factor (dB/m)
1	3800.00	-46.15	-13.00	-33.15	1.23 V	149	39.04	-85.19
2	5700.00	-45.09	-13.00	-32.09	1.52 V	63	37.10	-82.19

Remarks:

1. $EIRP(dBm) = Raw\ Value(dBuV) + Correction\ Factor(dB/m)$
2. $Correction\ Factor(dB/m) = Antenna\ Factor(dB/m) + Cable\ Factor(dB) - Pre-Amplifier\ Factor(dB) + 20\log(D) - 104.8$
3. Margin value = EIRP – Limit value
4. The other EIRP levels were very low against the limit.

7.3.7 LTE Band 4

RF Mode	LTE Band 4 Channel Bandwidth: 1.4MHz	Channel	CH 19957 : 1710.7 MHz
Frequency Range	1 GHz ~ 18 GHz	Detector Function & Bandwidth	1 MHz/3 MHz (RMS)
Input Power	120 Vac, 60 Hz	Environmental Conditions	25°C, 60% RH
Tested By	Charles Hsiao		

Antenna Polarity & Test Distance : Horizontal at 3 m								
No	Frequency (MHz)	EIRP (dBm)	Limit (dBm)	Margin (dB)	Antenna Height (m)	Table Angle (Degree)	Raw Value (dBuV)	Correction Factor (dB/m)
1	3421.40	-45.48	-13.00	-32.48	1.55 H	124	40.86	-86.34
Antenna Polarity & Test Distance : Vertical at 3 m								
No	Frequency (MHz)	EIRP (dBm)	Limit (dBm)	Margin (dB)	Antenna Height (m)	Table Angle (Degree)	Raw Value (dBuV)	Correction Factor (dB/m)
1	3421.40	-44.31	-13.00	-31.31	1.00 V	201	42.03	-86.34

Remarks:

1. $EIRP(dBm) = Raw\ Value(dBuV) + Correction\ Factor(dB/m)$
2. $Correction\ Factor(dB/m) = Antenna\ Factor(dB/m) + Cable\ Factor(dB) - Pre-Amplifier\ Factor(dB) + 20\log(D) - 104.8$
3. Margin value = EIRP – Limit value
4. The other EIRP levels were very low against the limit.



RF Mode	LTE Band 4 Channel Bandwidth: 1.4MHz	Channel	CH 20175 : 1732.5 MHz
Frequency Range	1 GHz ~ 18 GHz	Detector Function & Bandwidth	1 MHz/3 MHz (RMS)
Input Power	120 Vac, 60 Hz	Environmental Conditions	25°C, 60% RH
Tested By	Charles Hsiao		

Antenna Polarity & Test Distance : Horizontal at 3 m								
No	Frequency (MHz)	EIRP (dBm)	Limit (dBm)	Margin (dB)	Antenna Height (m)	Table Angle (Degree)	Raw Value (dBuV)	Correction Factor (dB/m)
1	3465.00	-46.33	-13.00	-33.33	1.58 H	8	39.93	-86.26
Antenna Polarity & Test Distance : Vertical at 3 m								
No	Frequency (MHz)	EIRP (dBm)	Limit (dBm)	Margin (dB)	Antenna Height (m)	Table Angle (Degree)	Raw Value (dBuV)	Correction Factor (dB/m)
1	3465.00	-49.12	-13.00	-36.12	1.64 V	200	37.14	-86.26

Remarks:

1. $EIRP(dBm) = Raw\ Value(dBuV) + Correction\ Factor(dB/m)$
2. $Correction\ Factor(dB/m) = Antenna\ Factor(dB/m) + Cable\ Factor(dB) - Pre-Amplifier\ Factor(dB) + 20\log(D) - 104.8$
3. $Margin\ value = EIRP - Limit\ value$
4. The other EIRP levels were very low against the limit.



RF Mode	LTE Band 4 Channel Bandwidth: 1.4MHz	Channel	CH 20393 : 1754.3 MHz
Frequency Range	1 GHz ~ 18 GHz	Detector Function & Bandwidth	1 MHz/3 MHz (RMS)
Input Power	120 Vac, 60 Hz	Environmental Conditions	25°C, 60% RH
Tested By	Charles Hsiao		

Antenna Polarity & Test Distance : Horizontal at 3 m								
No	Frequency (MHz)	EIRP (dBm)	Limit (dBm)	Margin (dB)	Antenna Height (m)	Table Angle (Degree)	Raw Value (dBuV)	Correction Factor (dB/m)
1	3508.60	-46.66	-13.00	-33.66	1.16 H	98	39.46	-86.12
Antenna Polarity & Test Distance : Vertical at 3 m								
No	Frequency (MHz)	EIRP (dBm)	Limit (dBm)	Margin (dB)	Antenna Height (m)	Table Angle (Degree)	Raw Value (dBuV)	Correction Factor (dB/m)
1	3508.60	-50.12	-13.00	-37.12	1.12 V	186	36.00	-86.12

Remarks:

1. $EIRP(dBm) = Raw\ Value(dBuV) + Correction\ Factor(dB/m)$
2. $Correction\ Factor(dB/m) = Antenna\ Factor(dB/m) + Cable\ Factor(dB) - Pre-Amplifier\ Factor(dB) + 20\log(D) - 104.8$
3. Margin value = EIRP – Limit value
4. The other EIRP levels were very low against the limit.



RF Mode	LTE Band 4 Channel Bandwidth: 5MHz	Channel	CH 19975 : 1712.5 MHz
Frequency Range	1 GHz ~ 18 GHz	Detector Function & Bandwidth	1 MHz/3 MHz (RMS)
Input Power	120 Vac, 60 Hz	Environmental Conditions	25°C, 60% RH
Tested By	Charles Hsiao		

Antenna Polarity & Test Distance : Horizontal at 3 m

No	Frequency (MHz)	EIRP (dBm)	Limit (dBm)	Margin (dB)	Antenna Height (m)	Table Angle (Degree)	Raw Value (dBuV)	Correction Factor (dB/m)
1	3425.00	-45.82	-13.00	-32.82	1.99 H	324	40.53	-86.35
2	5137.50	-43.91	-13.00	-30.91	1.14 H	17	38.76	-82.67

Antenna Polarity & Test Distance : Vertical at 3 m

No	Frequency (MHz)	EIRP (dBm)	Limit (dBm)	Margin (dB)	Antenna Height (m)	Table Angle (Degree)	Raw Value (dBuV)	Correction Factor (dB/m)
1	3425.00	-48.13	-13.00	-35.13	1.75 V	44	38.22	-86.35
2	5137.50	-45.24	-13.00	-32.24	1.95 V	320	37.43	-82.67

Remarks:

1. $EIRP(dBm) = Raw\ Value(dBuV) + Correction\ Factor(dB/m)$
2. $Correction\ Factor(dB/m) = Antenna\ Factor(dB/m) + Cable\ Factor(dB) - Pre-Amplifier\ Factor(dB) + 20\log(D) - 104.8$
3. Margin value = EIRP – Limit value
4. The other EIRP levels were very low against the limit.



RF Mode	LTE Band 4 Channel Bandwidth: 5MHz	Channel	CH 20175 : 1732.5 MHz
Frequency Range	1 GHz ~ 18 GHz	Detector Function & Bandwidth	1 MHz/3 MHz (RMS)
Input Power	120 Vac, 60 Hz	Environmental Conditions	25°C, 60% RH
Tested By	Charles Hsiao		

Antenna Polarity & Test Distance : Horizontal at 3 m

No	Frequency (MHz)	EIRP (dBm)	Limit (dBm)	Margin (dB)	Antenna Height (m)	Table Angle (Degree)	Raw Value (dBuV)	Correction Factor (dB/m)
1	3465.00	-45.97	-13.00	-32.97	1.26 H	9	40.29	-86.26
2	5197.50	-42.04	-13.00	-29.04	1.48 H	288	40.50	-82.54

Antenna Polarity & Test Distance : Vertical at 3 m

No	Frequency (MHz)	EIRP (dBm)	Limit (dBm)	Margin (dB)	Antenna Height (m)	Table Angle (Degree)	Raw Value (dBuV)	Correction Factor (dB/m)
1	3465.00	-48.81	-13.00	-35.81	1.65 V	290	37.45	-86.26
2	5197.50	-42.28	-13.00	-29.28	1.12 V	84	40.26	-82.54

Remarks:

1. $EIRP(dBm) = Raw\ Value(dBuV) + Correction\ Factor(dB/m)$
2. $Correction\ Factor(dB/m) = Antenna\ Factor(dB/m) + Cable\ Factor(dB) - Pre-Amplifier\ Factor(dB) + 20\log(D) - 104.8$
3. Margin value = EIRP – Limit value
4. The other EIRP levels were very low against the limit.



RF Mode	LTE Band 4 Channel Bandwidth: 5MHz	Channel	CH 20375 : 1752.5 MHz
Frequency Range	1 GHz ~ 18 GHz	Detector Function & Bandwidth	1 MHz/3 MHz (RMS)
Input Power	120 Vac, 60 Hz	Environmental Conditions	25°C, 60% RH
Tested By	Charles Hsiao		

Antenna Polarity & Test Distance : Horizontal at 3 m								
No	Frequency (MHz)	EIRP (dBm)	Limit (dBm)	Margin (dB)	Antenna Height (m)	Table Angle (Degree)	Raw Value (dBuV)	Correction Factor (dB/m)
1	3505.00	-44.00	-13.00	-31.00	1.45 H	111	42.11	-86.11
2	5257.50	-40.77	-13.00	-27.77	1.97 H	88	41.63	-82.40

Antenna Polarity & Test Distance : Vertical at 3 m								
No	Frequency (MHz)	EIRP (dBm)	Limit (dBm)	Margin (dB)	Antenna Height (m)	Table Angle (Degree)	Raw Value (dBuV)	Correction Factor (dB/m)
1	3505.00	-48.45	-13.00	-35.45	1.57 V	188	37.66	-86.11
2	5257.50	-41.47	-13.00	-28.47	1.44 V	137	40.93	-82.40

Remarks:

1. $EIRP(dBm) = Raw\ Value(dBuV) + Correction\ Factor(dB/m)$
2. $Correction\ Factor(dB/m) = Antenna\ Factor(dB/m) + Cable\ Factor(dB) - Pre-Amplifier\ Factor(dB) + 20\log(D) - 104.8$
3. $Margin\ value = EIRP - Limit\ value$
4. The other EIRP levels were very low against the limit.



RF Mode	LTE Band 4 Channel Bandwidth: 20MHz	Channel	CH 20050 : 1720 MHz
Frequency Range	1 GHz ~ 18 GHz	Detector Function & Bandwidth	1 MHz/3 MHz (RMS)
Input Power	120 Vac, 60 Hz	Environmental Conditions	25°C, 60% RH
Tested By	Charles Hsiao		

Antenna Polarity & Test Distance : Horizontal at 3 m								
No	Frequency (MHz)	EIRP (dBm)	Limit (dBm)	Margin (dB)	Antenna Height (m)	Table Angle (Degree)	Raw Value (dBuV)	Correction Factor (dB/m)
1	3440.00	-46.25	-13.00	-33.25	1.15 H	174	40.08	-86.33
2	5160.00	-45.07	-13.00	-32.07	1.67 H	116	37.56	-82.63
Antenna Polarity & Test Distance : Vertical at 3 m								
No	Frequency (MHz)	EIRP (dBm)	Limit (dBm)	Margin (dB)	Antenna Height (m)	Table Angle (Degree)	Raw Value (dBuV)	Correction Factor (dB/m)
1	3440.00	-50.02	-13.00	-37.02	1.15 V	274	36.31	-86.33
2	5160.00	-47.71	-13.00	-34.71	1.63 V	274	34.92	-82.63

Remarks:

1. $EIRP(dBm) = Raw\ Value(dBuV) + Correction\ Factor(dB/m)$
2. $Correction\ Factor(dB/m) = Antenna\ Factor(dB/m) + Cable\ Factor(dB) - Pre-Amplifier\ Factor(dB) + 20\log(D) - 104.8$
3. $Margin\ value = EIRP - Limit\ value$
4. The other EIRP levels were very low against the limit.



RF Mode	LTE Band 4 Channel Bandwidth: 20MHz	Channel	CH 20175 : 1732.5 MHz
Frequency Range	1 GHz ~ 18 GHz	Detector Function & Bandwidth	1 MHz/3 MHz (RMS)
Input Power	120 Vac, 60 Hz	Environmental Conditions	25°C, 60% RH
Tested By	Charles Hsiao		

Antenna Polarity & Test Distance : Horizontal at 3 m

No	Frequency (MHz)	EIRP (dBm)	Limit (dBm)	Margin (dB)	Antenna Height (m)	Table Angle (Degree)	Raw Value (dBuV)	Correction Factor (dB/m)
1	3465.00	-44.10	-13.00	-31.10	1.26 H	225	42.16	-86.26
2	5197.50	-39.98	-13.00	-26.98	1.73 H	358	42.56	-82.54

Antenna Polarity & Test Distance : Vertical at 3 m

No	Frequency (MHz)	EIRP (dBm)	Limit (dBm)	Margin (dB)	Antenna Height (m)	Table Angle (Degree)	Raw Value (dBuV)	Correction Factor (dB/m)
1	3465.00	-46.61	-13.00	-33.61	1.20 V	22	39.65	-86.26
2	5197.50	-39.57	-13.00	-26.57	1.45 V	111	42.97	-82.54

Remarks:

1. $EIRP(dBm) = Raw\ Value(dBuV) + Correction\ Factor(dB/m)$
2. $Correction\ Factor(dB/m) = Antenna\ Factor(dB/m) + Cable\ Factor(dB) - Pre-Amplifier\ Factor(dB) + 20\log(D) - 104.8$
3. Margin value = EIRP – Limit value
4. The other EIRP levels were very low against the limit.



RF Mode	LTE Band 4 Channel Bandwidth: 20MHz	Channel	CH 20300 : 1745 MHz
Frequency Range	1 GHz ~ 18 GHz	Detector Function & Bandwidth	1 MHz/3 MHz (RMS)
Input Power	120 Vac, 60 Hz	Environmental Conditions	25°C, 60% RH
Tested By	Charles Hsiao		

Antenna Polarity & Test Distance : Horizontal at 3 m								
No	Frequency (MHz)	EIRP (dBm)	Limit (dBm)	Margin (dB)	Antenna Height (m)	Table Angle (Degree)	Raw Value (dBuV)	Correction Factor (dB/m)
1	3490.00	-47.56	-13.00	-34.56	1.56 H	69	38.59	-86.15
2	5235.00	-41.10	-13.00	-28.10	1.17 H	7	41.35	-82.45
Antenna Polarity & Test Distance : Vertical at 3 m								
No	Frequency (MHz)	EIRP (dBm)	Limit (dBm)	Margin (dB)	Antenna Height (m)	Table Angle (Degree)	Raw Value (dBuV)	Correction Factor (dB/m)
1	3490.00	-48.92	-13.00	-35.92	1.15 V	14	37.23	-86.15
2	5235.00	-42.10	-13.00	-29.10	1.67 V	319	40.35	-82.45

Remarks:

1. $EIRP(dBm) = Raw\ Value(dBuV) + Correction\ Factor(dB/m)$
2. $Correction\ Factor(dB/m) = Antenna\ Factor(dB/m) + Cable\ Factor(dB) - Pre-Amplifier\ Factor(dB) + 20\log(D) - 104.8$
3. $Margin\ value = EIRP - Limit\ value$
4. The other EIRP levels were very low against the limit.

7.3.8 LTE Band 5

RF Mode	LTE Band 5 Channel Bandwidth: 1.4MHz	Channel	CH 20407 : 824.7 MHz
Frequency Range	1 GHz ~ 18 GHz	Detector Function & Bandwidth	1 MHz/3 MHz (RMS)
Input Power	120 Vac, 60 Hz	Environmental Conditions	25°C, 60% RH
Tested By	Karl Lee		

Antenna Polarity & Test Distance : Horizontal at 3 m

No	Frequency (MHz)	ERP (dBm)	Limit (dBm)	Margin (dB)	Antenna Height (m)	Table Angle (Degree)	Raw Value (dBuV)	Correction Factor (dB/m)
1	1649.40	-44.63	-13.00	-31.63	2.34 H	126	51.37	-96.00

Antenna Polarity & Test Distance : Vertical at 3 m

No	Frequency (MHz)	ERP (dBm)	Limit (dBm)	Margin (dB)	Antenna Height (m)	Table Angle (Degree)	Raw Value (dBuV)	Correction Factor (dB/m)
1	1649.40	-42.16	-13.00	-29.16	2.05 V	172	53.84	-96.00

Remarks:

- ERP(dBm) = Raw Value(dBuV) + Correction Factor(dB/m)
- Correction Factor(dB/m) = Antenna Factor(dB/m) + Cable Factor(dB) – Pre-Amplifier Factor(dB) + 20log(D) – 104.8 – 2.15
- Margin value = ERP – Limit value
- The other ERP levels were very low against the limit.



RF Mode	LTE Band 5 Channel Bandwidth: 1.4MHz	Channel	CH 20525 : 836.5 MHz
Frequency Range	1 GHz ~ 18 GHz	Detector Function & Bandwidth	1 MHz/3 MHz (RMS)
Input Power	120 Vac, 60 Hz	Environmental Conditions	25°C, 60% RH
Tested By	Karl Lee		

Antenna Polarity & Test Distance : Horizontal at 3 m

No	Frequency (MHz)	ERP (dBm)	Limit (dBm)	Margin (dB)	Antenna Height (m)	Table Angle (Degree)	Raw Value (dBuV)	Correction Factor (dB/m)
1	1673.00	-43.84	-13.00	-30.84	1.59 H	18	51.79	-95.63
2	2509.50	-53.32	-13.00	-40.32	1.55 H	196	36.87	-90.19

Antenna Polarity & Test Distance : Vertical at 3 m

No	Frequency (MHz)	ERP (dBm)	Limit (dBm)	Margin (dB)	Antenna Height (m)	Table Angle (Degree)	Raw Value (dBuV)	Correction Factor (dB/m)
1	1673.00	-44.47	-13.00	-31.47	1.40 V	241	51.16	-95.63
2	2509.50	-54.44	-13.00	-41.44	1.15 V	25	35.75	-90.19

Remarks:

- ERP(dBm) = Raw Value(dBuV) + Correction Factor(dB/m)
- Correction Factor(dB/m) = Antenna Factor(dB/m) + Cable Factor(dB) – Pre-Amplifier Factor(dB)
+ 20log(D) – 104.8 – 2.15
- Margin value = ERP – Limit value
- The other ERP levels were very low against the limit.



RF Mode	LTE Band 5 Channel Bandwidth: 1.4MHz	Channel	CH 20643 : 848.3 MHz
Frequency Range	1 GHz ~ 18 GHz	Detector Function & Bandwidth	1 MHz/3 MHz (RMS)
Input Power	120 Vac, 60 Hz	Environmental Conditions	25°C, 60% RH
Tested By	Karl Lee		

Antenna Polarity & Test Distance : Horizontal at 3 m								
No	Frequency (MHz)	ERP (dBm)	Limit (dBm)	Margin (dB)	Antenna Height (m)	Table Angle (Degree)	Raw Value (dBuV)	Correction Factor (dB/m)
1	1696.60	-45.93	-13.00	-32.93	1.24 H	248	49.32	-95.25
Antenna Polarity & Test Distance : Vertical at 3 m								
No	Frequency (MHz)	ERP (dBm)	Limit (dBm)	Margin (dB)	Antenna Height (m)	Table Angle (Degree)	Raw Value (dBuV)	Correction Factor (dB/m)
1	1696.60	-45.52	-13.00	-32.52	2.54 V	178	49.73	-95.25

Remarks:

1. ERP(dBm) = Raw Value(dBuV) + Correction Factor(dB/m)
2. Correction Factor(dB/m) = Antenna Factor(dB/m) + Cable Factor(dB) – Pre-Amplifier Factor(dB) + 20log(D) – 104.8 – 2.15
3. Margin value = ERP – Limit value
4. The other ERP levels were very low against the limit.



RF Mode	LTE Band 5 Channel Bandwidth: 5MHz	Channel	CH 20425 : 826.5 MHz
Frequency Range	1 GHz ~ 18 GHz	Detector Function & Bandwidth	1 MHz/3 MHz (RMS)
Input Power	120 Vac, 60 Hz	Environmental Conditions	25°C, 60% RH
Tested By	Karl Lee		

Antenna Polarity & Test Distance : Horizontal at 3 m								
No	Frequency (MHz)	ERP (dBm)	Limit (dBm)	Margin (dB)	Antenna Height (m)	Table Angle (Degree)	Raw Value (dBuV)	Correction Factor (dB/m)
1	1653.00	-42.67	-13.00	-29.67	1.17 H	226	53.28	-95.95
Antenna Polarity & Test Distance : Vertical at 3 m								
No	Frequency (MHz)	ERP (dBm)	Limit (dBm)	Margin (dB)	Antenna Height (m)	Table Angle (Degree)	Raw Value (dBuV)	Correction Factor (dB/m)
1	1653.00	-43.31	-13.00	-30.31	2.84 V	174	52.64	-95.95

Remarks:

1. ERP(dBm) = Raw Value(dBuV) + Correction Factor(dB/m)
2. Correction Factor(dB/m) = Antenna Factor(dB/m) + Cable Factor(dB) – Pre-Amplifier Factor(dB) + 20log(D) – 104.8 – 2.15
3. Margin value = ERP – Limit value
4. The other ERP levels were very low against the limit.



RF Mode	LTE Band 5 Channel Bandwidth: 5MHz	Channel	CH 20525 : 836.5 MHz
Frequency Range	1 GHz ~ 18 GHz	Detector Function & Bandwidth	1 MHz/3 MHz (RMS)
Input Power	120 Vac, 60 Hz	Environmental Conditions	25°C, 60% RH
Tested By	Karl Lee		

Antenna Polarity & Test Distance : Horizontal at 3 m								
No	Frequency (MHz)	ERP (dBm)	Limit (dBm)	Margin (dB)	Antenna Height (m)	Table Angle (Degree)	Raw Value (dBuV)	Correction Factor (dB/m)
1	1673.00	-40.78	-13.00	-27.78	2.36 H	48	54.85	-95.63
2	2509.50	-52.16	-13.00	-39.16	1.45 H	321	38.03	-90.19

Antenna Polarity & Test Distance : Vertical at 3 m								
No	Frequency (MHz)	ERP (dBm)	Limit (dBm)	Margin (dB)	Antenna Height (m)	Table Angle (Degree)	Raw Value (dBuV)	Correction Factor (dB/m)
1	1673.00	-41.43	-13.00	-28.43	2.45 V	134	54.20	-95.63
2	2509.50	-52.85	-13.00	-39.85	1.44 V	174	37.34	-90.19

Remarks:

1. $ERP(dBm) = Raw\ Value(dBuV) + Correction\ Factor(dB/m)$
2. $Correction\ Factor(dB/m) = Antenna\ Factor(dB/m) + Cable\ Factor(dB) - Pre-Amplifier\ Factor(dB) + 20\log(D) - 104.8 - 2.15$
3. $Margin\ value = ERP - Limit\ value$
4. The other ERP levels were very low against the limit.



RF Mode	LTE Band 5 Channel Bandwidth: 5MHz	Channel	CH 20625 : 846.5 MHz
Frequency Range	1 GHz ~ 18 GHz	Detector Function & Bandwidth	1 MHz/3 MHz (RMS)
Input Power	120 Vac, 60 Hz	Environmental Conditions	25°C, 60% RH
Tested By	Karl Lee		

Antenna Polarity & Test Distance : Horizontal at 3 m								
No	Frequency (MHz)	ERP (dBm)	Limit (dBm)	Margin (dB)	Antenna Height (m)	Table Angle (Degree)	Raw Value (dBuV)	Correction Factor (dB/m)
1	1693.00	-43.68	-13.00	-30.68	2.21 H	58	51.64	-95.32
Antenna Polarity & Test Distance : Vertical at 3 m								
No	Frequency (MHz)	ERP (dBm)	Limit (dBm)	Margin (dB)	Antenna Height (m)	Table Angle (Degree)	Raw Value (dBuV)	Correction Factor (dB/m)
1	1693.00	-43.80	-13.00	-30.80	2.60 V	82	51.52	-95.32

Remarks:

1. ERP(dBm) = Raw Value(dBuV) + Correction Factor(dB/m)
2. Correction Factor(dB/m) = Antenna Factor(dB/m) + Cable Factor(dB) – Pre-Amplifier Factor(dB) + 20log(D) – 104.8 – 2.15
3. Margin value = ERP – Limit value
4. The other ERP levels were very low against the limit.

RF Mode	LTE Band 5 Channel Bandwidth: 10MHz	Channel	CH 20450 : 829 MHz
Frequency Range	1 GHz ~ 18 GHz	Detector Function & Bandwidth	1 MHz/3 MHz (RMS)
Input Power	120 Vac, 60 Hz	Environmental Conditions	25°C, 60% RH
Tested By	Karl Lee		

Antenna Polarity & Test Distance : Horizontal at 3 m								
No	Frequency (MHz)	ERP (dBm)	Limit (dBm)	Margin (dB)	Antenna Height (m)	Table Angle (Degree)	Raw Value (dBuV)	Correction Factor (dB/m)
1	1658.00	-40.60	-13.00	-27.60	1.82 H	147	55.26	-95.86
Antenna Polarity & Test Distance : Vertical at 3 m								
No	Frequency (MHz)	ERP (dBm)	Limit (dBm)	Margin (dB)	Antenna Height (m)	Table Angle (Degree)	Raw Value (dBuV)	Correction Factor (dB/m)
1	1658.00	-41.81	-13.00	-28.81	1.73 V	226	54.05	-95.86

Remarks:

1. $ERP(dBm) = Raw\ Value(dBuV) + Correction\ Factor(dB/m)$
2. $Correction\ Factor(dB/m) = Antenna\ Factor(dB/m) + Cable\ Factor(dB) - Pre-Amplifier\ Factor(dB) + 20\log(D) - 104.8 - 2.15$
3. $Margin\ value = ERP - Limit\ value$
4. The other ERP levels were very low against the limit.

RF Mode	LTE Band 5 Channel Bandwidth: 10MHz	Channel	CH 20525 : 836.5 MHz
Frequency Range	1 GHz ~ 18 GHz	Detector Function & Bandwidth	1 MHz/3 MHz (RMS)
Input Power	120 Vac, 60 Hz	Environmental Conditions	25°C, 60% RH
Tested By	Karl Lee		

Antenna Polarity & Test Distance : Horizontal at 3 m								
No	Frequency (MHz)	ERP (dBm)	Limit (dBm)	Margin (dB)	Antenna Height (m)	Table Angle (Degree)	Raw Value (dBuV)	Correction Factor (dB/m)
1	1673.00	-38.90	-13.00	-25.90	2.71 H	115	56.73	-95.63
2	2509.50	-50.38	-13.00	-37.38	1.14 H	191	39.81	-90.19
Antenna Polarity & Test Distance : Vertical at 3 m								
No	Frequency (MHz)	ERP (dBm)	Limit (dBm)	Margin (dB)	Antenna Height (m)	Table Angle (Degree)	Raw Value (dBuV)	Correction Factor (dB/m)
1	1673.00	-39.24	-13.00	-26.24	2.53 V	338	56.39	-95.63
2	2509.50	-50.97	-13.00	-37.97	1.15 V	314	39.22	-90.19

Remarks:

1. $ERP(dBm) = Raw\ Value(dBuV) + Correction\ Factor(dB/m)$
2. $Correction\ Factor(dB/m) = Antenna\ Factor(dB/m) + Cable\ Factor(dB) - Pre-Amplifier\ Factor(dB) + 20\log(D) - 104.8 - 2.15$
3. Margin value = ERP – Limit value
4. The other ERP levels were very low against the limit.



RF Mode	LTE Band 5 Channel Bandwidth: 10MHz	Channel	CH 20600 : 844 MHz
Frequency Range	1 GHz ~ 18 GHz	Detector Function & Bandwidth	1 MHz/3 MHz (RMS)
Input Power	120 Vac, 60 Hz	Environmental Conditions	25°C, 60% RH
Tested By	Karl Lee		

Antenna Polarity & Test Distance : Horizontal at 3 m

No	Frequency (MHz)	ERP (dBm)	Limit (dBm)	Margin (dB)	Antenna Height (m)	Table Angle (Degree)	Raw Value (dBuV)	Correction Factor (dB/m)
1	1688.00	-42.14	-13.00	-29.14	1.74 H	226	53.25	-95.39

Antenna Polarity & Test Distance : Vertical at 3 m

No	Frequency (MHz)	ERP (dBm)	Limit (dBm)	Margin (dB)	Antenna Height (m)	Table Angle (Degree)	Raw Value (dBuV)	Correction Factor (dB/m)
1	1688.00	-44.44	-13.00	-31.44	2.51 V	108	50.95	-95.39

Remarks:

- ERP(dBm) = Raw Value(dBuV) + Correction Factor(dB/m)
- Correction Factor(dB/m) = Antenna Factor(dB/m) + Cable Factor(dB) – Pre-Amplifier Factor(dB) + 20log(D) – 104.8 – 2.15
- Margin value = ERP – Limit value
- The other ERP levels were very low against the limit.

7.3.9 LTE Band 7

RF Mode	LTE Band 7 Channel Bandwidth: 5MHz	Channel	CH 20775 : 2502.5 MHz
Frequency Range	1 GHz ~ 27 GHz	Detector Function & Bandwidth	1 MHz/3 MHz (RMS)
Input Power	120 Vac, 60 Hz	Environmental Conditions	25°C, 60% RH
Tested By	Charles Hsiao		

Antenna Polarity & Test Distance : Horizontal at 3 m								
No	Frequency (MHz)	EIRP (dBm)	Limit (dBm)	Margin (dB)	Antenna Height (m)	Table Angle (Degree)	Raw Value (dBuV)	Correction Factor (dB/m)
1	5005.00	-49.98	-25.00	-24.98	1.18 H	57	32.81	-82.79
Antenna Polarity & Test Distance : Vertical at 3 m								
No	Frequency (MHz)	EIRP (dBm)	Limit (dBm)	Margin (dB)	Antenna Height (m)	Table Angle (Degree)	Raw Value (dBuV)	Correction Factor (dB/m)
1	5005.00	-50.04	-25.00	-25.04	1.97 V	279	32.75	-82.79

Remarks:

- EIRP(dBm) = Raw Value(dBuV) + Correction Factor(dB/m)
- Correction Factor(dB/m) = Antenna Factor(dB/m) + Cable Factor(dB) – Pre-Amplifier Factor(dB) + 20log(D) – 104.8
- Margin value = EIRP – Limit value
- The other EIRP levels were very low against the limit.



RF Mode	LTE Band 7 Channel Bandwidth: 5MHz	Channel	CH 21100 : 2535 MHz
Frequency Range	1 GHz ~ 27 GHz	Detector Function & Bandwidth	1 MHz/3 MHz (RMS)
Input Power	120 Vac, 60 Hz	Environmental Conditions	25°C, 60% RH
Tested By	Charles Hsiao		

Antenna Polarity & Test Distance : Horizontal at 3 m								
No	Frequency (MHz)	EIRP (dBm)	Limit (dBm)	Margin (dB)	Antenna Height (m)	Table Angle (Degree)	Raw Value (dBuV)	Correction Factor (dB/m)
1	5070.00	-48.97	-25.00	-23.97	1.75 H	307	33.78	-82.75
Antenna Polarity & Test Distance : Vertical at 3 m								
No	Frequency (MHz)	EIRP (dBm)	Limit (dBm)	Margin (dB)	Antenna Height (m)	Table Angle (Degree)	Raw Value (dBuV)	Correction Factor (dB/m)
1	5070.00	-49.52	-25.00	-24.52	1.11 V	209	33.23	-82.75

Remarks:

1. $EIRP(dBm) = Raw\ Value(dBuV) + Correction\ Factor(dB/m)$
2. $Correction\ Factor(dB/m) = Antenna\ Factor(dB/m) + Cable\ Factor(dB) - Pre-Amplifier\ Factor(dB) + 20\log(D) - 104.8$
3. $Margin\ value = EIRP - Limit\ value$
4. The other EIRP levels were very low against the limit.

RF Mode	LTE Band 7 Channel Bandwidth: 5MHz	Channel	CH 21425 : 2567.5 MHz
Frequency Range	1 GHz ~ 27 GHz	Detector Function & Bandwidth	1 MHz/3 MHz (RMS)
Input Power	120 Vac, 60 Hz	Environmental Conditions	25°C, 60% RH
Tested By	Charles Hsiao		

Antenna Polarity & Test Distance : Horizontal at 3 m								
No	Frequency (MHz)	EIRP (dBm)	Limit (dBm)	Margin (dB)	Antenna Height (m)	Table Angle (Degree)	Raw Value (dBuV)	Correction Factor (dB/m)
1	5135.00	-49.42	-25.00	-24.42	1.63 H	330	33.25	-82.67
Antenna Polarity & Test Distance : Vertical at 3 m								
No	Frequency (MHz)	EIRP (dBm)	Limit (dBm)	Margin (dB)	Antenna Height (m)	Table Angle (Degree)	Raw Value (dBuV)	Correction Factor (dB/m)
1	5135.00	-49.59	-25.00	-24.59	1.75 V	228	33.08	-82.67

Remarks:

1. $EIRP(dBm) = Raw\ Value(dBuV) + Correction\ Factor(dB/m)$
2. $Correction\ Factor(dB/m) = Antenna\ Factor(dB/m) + Cable\ Factor(dB) - Pre-Amplifier\ Factor(dB) + 20\log(D) - 104.8$
3. Margin value = EIRP – Limit value
4. The other EIRP levels were very low against the limit.



RF Mode	LTE Band 7 Channel Bandwidth: 20MHz	Channel	CH 20850 : 2510 MHz
Frequency Range	1 GHz ~ 27 GHz	Detector Function & Bandwidth	1 MHz/3 MHz (RMS)
Input Power	120 Vac, 60 Hz	Environmental Conditions	25°C, 60% RH
Tested By	Charles Hsiao		

Antenna Polarity & Test Distance : Horizontal at 3 m								
No	Frequency (MHz)	EIRP (dBm)	Limit (dBm)	Margin (dB)	Antenna Height (m)	Table Angle (Degree)	Raw Value (dBuV)	Correction Factor (dB/m)
1	5020.00	-49.45	-25.00	-24.45	1.14 H	203	33.35	-82.80
Antenna Polarity & Test Distance : Vertical at 3 m								
No	Frequency (MHz)	EIRP (dBm)	Limit (dBm)	Margin (dB)	Antenna Height (m)	Table Angle (Degree)	Raw Value (dBuV)	Correction Factor (dB/m)
1	5020.00	-50.22	-25.00	-25.22	1.16 V	187	32.58	-82.80

Remarks:

1. $EIRP(dBm) = Raw\ Value(dBuV) + Correction\ Factor(dB/m)$
2. $Correction\ Factor(dB/m) = Antenna\ Factor(dB/m) + Cable\ Factor(dB) - Pre-Amplifier\ Factor(dB) + 20\log(D) - 104.8$
3. Margin value = EIRP – Limit value
4. The other EIRP levels were very low against the limit.

RF Mode	LTE Band 7 Channel Bandwidth: 20MHz	Channel	CH 21100 : 2535 MHz
Frequency Range	1 GHz ~ 27 GHz	Detector Function & Bandwidth	1 MHz/3 MHz (RMS)
Input Power	120 Vac, 60 Hz	Environmental Conditions	25°C, 60% RH
Tested By	Charles Hsiao		

Antenna Polarity & Test Distance : Horizontal at 3 m								
No	Frequency (MHz)	EIRP (dBm)	Limit (dBm)	Margin (dB)	Antenna Height (m)	Table Angle (Degree)	Raw Value (dBuV)	Correction Factor (dB/m)
1	5070.00	-49.38	-25.00	-24.38	1.67 H	332	33.37	-82.75
Antenna Polarity & Test Distance : Vertical at 3 m								
No	Frequency (MHz)	EIRP (dBm)	Limit (dBm)	Margin (dB)	Antenna Height (m)	Table Angle (Degree)	Raw Value (dBuV)	Correction Factor (dB/m)
1	5070.00	-49.20	-25.00	-24.20	1.15 V	102	33.55	-82.75

Remarks:

1. $EIRP(dBm) = Raw\ Value(dBuV) + Correction\ Factor(dB/m)$
2. $Correction\ Factor(dB/m) = Antenna\ Factor(dB/m) + Cable\ Factor(dB) - Pre-Amplifier\ Factor(dB) + 20\log(D) - 104.8$
3. Margin value = EIRP – Limit value
4. The other EIRP levels were very low against the limit.



RF Mode	LTE Band 7 Channel Bandwidth: 20MHz	Channel	CH 21350 : 2560 MHz
Frequency Range	1 GHz ~ 27 GHz	Detector Function & Bandwidth	1 MHz/3 MHz (RMS)
Input Power	120 Vac, 60 Hz	Environmental Conditions	25°C, 60% RH
Tested By	Charles Hsiao		

Antenna Polarity & Test Distance : Horizontal at 3 m								
No	Frequency (MHz)	EIRP (dBm)	Limit (dBm)	Margin (dB)	Antenna Height (m)	Table Angle (Degree)	Raw Value (dBuV)	Correction Factor (dB/m)
1	5120.00	-49.39	-25.00	-24.39	1.67 H	229	33.28	-82.67
Antenna Polarity & Test Distance : Vertical at 3 m								
No	Frequency (MHz)	EIRP (dBm)	Limit (dBm)	Margin (dB)	Antenna Height (m)	Table Angle (Degree)	Raw Value (dBuV)	Correction Factor (dB/m)
1	5120.00	-48.81	-25.00	-23.81	1.14 V	101	33.86	-82.67

Remarks:

1. $EIRP(dBm) = Raw\ Value(dBuV) + Correction\ Factor(dB/m)$
2. $Correction\ Factor(dB/m) = Antenna\ Factor(dB/m) + Cable\ Factor(dB) - Pre-Amplifier\ Factor(dB) + 20\log(D) - 104.8$
3. Margin value = EIRP – Limit value
4. The other EIRP levels were very low against the limit.

7.3.10 LTE Band 12

RF Mode	LTE Band 12 Channel Bandwidth: 1.4MHz	Channel	CH 23017 : 699.7 MHz
Frequency Range	1 GHz ~ 18 GHz	Detector Function & Bandwidth	1 MHz/3 MHz (RMS)
Input Power	120 Vac, 60 Hz	Environmental Conditions	25°C, 60% RH
Tested By	Karl Lee		

Antenna Polarity & Test Distance : Horizontal at 3 m

No	Frequency (MHz)	ERP (dBm)	Limit (dBm)	Margin (dB)	Antenna Height (m)	Table Angle (Degree)	Raw Value (dBuV)	Correction Factor (dB/m)
1	1399.40	-48.65	-13.00	-35.65	1.88 H	207	48.30	-96.95
2	2099.10	-53.87	-13.00	-40.87	1.45 H	305	37.45	-91.32

Antenna Polarity & Test Distance : Vertical at 3 m

No	Frequency (MHz)	ERP (dBm)	Limit (dBm)	Margin (dB)	Antenna Height (m)	Table Angle (Degree)	Raw Value (dBuV)	Correction Factor (dB/m)
1	1399.40	-56.33	-13.00	-43.33	2.24 V	174	40.62	-96.95
2	2099.10	-53.06	-13.00	-40.06	2.16 V	187	38.26	-91.32

Remarks:

1. $ERP(dBm) = Raw\ Value(dBuV) + Correction\ Factor(dB/m)$
2. $Correction\ Factor(dB/m) = Antenna\ Factor(dB/m) + Cable\ Factor(dB) - Pre-Amplifier\ Factor(dB) + 20\log(D) - 104.8 - 2.15$
3. Margin value = ERP – Limit value
4. The other ERP levels were very low against the limit.



RF Mode	LTE Band 12 Channel Bandwidth: 1.4MHz	Channel	CH 23095 : 707.5 MHz
Frequency Range	1 GHz ~ 18 GHz	Detector Function & Bandwidth	1 MHz/3 MHz (RMS)
Input Power	120 Vac, 60 Hz	Environmental Conditions	25°C, 60% RH
Tested By	Karl Lee		

Antenna Polarity & Test Distance : Horizontal at 3 m								
No	Frequency (MHz)	ERP (dBm)	Limit (dBm)	Margin (dB)	Antenna Height (m)	Table Angle (Degree)	Raw Value (dBuV)	Correction Factor (dB/m)
1	1415.00	-50.16	-13.00	-37.16	2.69 H	341	46.91	-97.07
2	2122.50	-54.04	-13.00	-41.04	1.05 H	28	37.42	-91.46

Antenna Polarity & Test Distance : Vertical at 3 m								
No	Frequency (MHz)	ERP (dBm)	Limit (dBm)	Margin (dB)	Antenna Height (m)	Table Angle (Degree)	Raw Value (dBuV)	Correction Factor (dB/m)
1	1415.00	-51.63	-13.00	-38.63	2.41 V	177	45.44	-97.07
2	2122.50	-54.78	-13.00	-41.78	2.93 V	154	36.68	-91.46

Remarks:

1. $ERP(dBm) = Raw\ Value(dBuV) + Correction\ Factor(dB/m)$
2. $Correction\ Factor(dB/m) = Antenna\ Factor(dB/m) + Cable\ Factor(dB) - Pre-Amplifier\ Factor(dB) + 20\log(D) - 104.8 - 2.15$
3. $Margin\ value = ERP - Limit\ value$
4. The other ERP levels were very low against the limit.



RF Mode	LTE Band 12 Channel Bandwidth: 1.4MHz	Channel	CH 23173 : 715.3 MHz
Frequency Range	1 GHz ~ 18 GHz	Detector Function & Bandwidth	1 MHz/3 MHz (RMS)
Input Power	120 Vac, 60 Hz	Environmental Conditions	25°C, 60% RH
Tested By	Karl Lee		

Antenna Polarity & Test Distance : Horizontal at 3 m								
No	Frequency (MHz)	ERP (dBm)	Limit (dBm)	Margin (dB)	Antenna Height (m)	Table Angle (Degree)	Raw Value (dBuV)	Correction Factor (dB/m)
1	1430.60	-53.31	-13.00	-40.31	1.82 H	25	43.89	-97.20
2	2145.90	-53.96	-13.00	-40.96	1.15 H	27	37.65	-91.61

Antenna Polarity & Test Distance : Vertical at 3 m								
No	Frequency (MHz)	ERP (dBm)	Limit (dBm)	Margin (dB)	Antenna Height (m)	Table Angle (Degree)	Raw Value (dBuV)	Correction Factor (dB/m)
1	1430.60	-52.16	-13.00	-39.16	2.05 V	173	45.04	-97.20
2	2145.90	-52.76	-13.00	-39.76	2.24 V	152	38.85	-91.61

Remarks:

1. $ERP(dBm) = Raw\ Value(dBuV) + Correction\ Factor(dB/m)$
2. $Correction\ Factor(dB/m) = Antenna\ Factor(dB/m) + Cable\ Factor(dB) - Pre-Amplifier\ Factor(dB) + 20\log(D) - 104.8 - 2.15$
3. $Margin\ value = ERP - Limit\ value$
4. The other ERP levels were very low against the limit.



RF Mode	LTE Band 12 Channel Bandwidth: 5MHz	Channel	CH 23035 : 701.5 MHz
Frequency Range	1 GHz ~ 18 GHz	Detector Function & Bandwidth	1 MHz/3 MHz (RMS)
Input Power	120 Vac, 60 Hz	Environmental Conditions	25°C, 60% RH
Tested By	Karl Lee		

Antenna Polarity & Test Distance : Horizontal at 3 m

No	Frequency (MHz)	ERP (dBm)	Limit (dBm)	Margin (dB)	Antenna Height (m)	Table Angle (Degree)	Raw Value (dBuV)	Correction Factor (dB/m)
1	1403.00	-47.07	-13.00	-34.07	1.28 H	294	49.90	-96.97
2	2104.50	-51.42	-13.00	-38.42	2.26 H	187	39.93	-91.35

Antenna Polarity & Test Distance : Vertical at 3 m

No	Frequency (MHz)	ERP (dBm)	Limit (dBm)	Margin (dB)	Antenna Height (m)	Table Angle (Degree)	Raw Value (dBuV)	Correction Factor (dB/m)
1	1403.00	-50.88	-13.00	-37.88	1.74 V	225	46.09	-96.97
2	2104.50	-54.79	-13.00	-41.79	1.49 V	263	36.56	-91.35

Remarks:

- ERP(dBm) = Raw Value(dBuV) + Correction Factor(dB/m)
- Correction Factor(dB/m) = Antenna Factor(dB/m) + Cable Factor(dB) – Pre-Amplifier Factor(dB) + 20log(D) – 104.8 – 2.15
- Margin value = ERP – Limit value
- The other ERP levels were very low against the limit.



RF Mode	LTE Band 12 Channel Bandwidth: 5MHz	Channel	CH 23095 : 707.5 MHz
Frequency Range	1 GHz ~ 18 GHz	Detector Function & Bandwidth	1 MHz/3 MHz (RMS)
Input Power	120 Vac, 60 Hz	Environmental Conditions	25°C, 60% RH
Tested By	Karl Lee		

Antenna Polarity & Test Distance : Horizontal at 3 m

No	Frequency (MHz)	ERP (dBm)	Limit (dBm)	Margin (dB)	Antenna Height (m)	Table Angle (Degree)	Raw Value (dBuV)	Correction Factor (dB/m)
1	1415.00	-45.67	-13.00	-32.67	1.37 H	155	51.40	-97.07
2	2122.50	-50.77	-13.00	-37.77	2.92 H	155	40.69	-91.46

Antenna Polarity & Test Distance : Vertical at 3 m

No	Frequency (MHz)	ERP (dBm)	Limit (dBm)	Margin (dB)	Antenna Height (m)	Table Angle (Degree)	Raw Value (dBuV)	Correction Factor (dB/m)
1	1415.00	-50.34	-13.00	-37.34	1.96 V	25	46.73	-97.07
2	2122.50	-52.81	-13.00	-39.81	2.74 V	153	38.65	-91.46

Remarks:

1. $ERP(dBm) = Raw\ Value(dBuV) + Correction\ Factor(dB/m)$
2. $Correction\ Factor(dB/m) = Antenna\ Factor(dB/m) + Cable\ Factor(dB) - Pre-Amplifier\ Factor(dB) + 20\log(D) - 104.8 - 2.15$
3. Margin value = ERP – Limit value
4. The other ERP levels were very low against the limit.



RF Mode	LTE Band 12 Channel Bandwidth: 5MHz	Channel	CH 23155 : 713.5 MHz
Frequency Range	1 GHz ~ 18 GHz	Detector Function & Bandwidth	1 MHz/3 MHz (RMS)
Input Power	120 Vac, 60 Hz	Environmental Conditions	25°C, 60% RH
Tested By	Karl Lee		

Antenna Polarity & Test Distance : Horizontal at 3 m

No	Frequency (MHz)	ERP (dBm)	Limit (dBm)	Margin (dB)	Antenna Height (m)	Table Angle (Degree)	Raw Value (dBuV)	Correction Factor (dB/m)
1	1427.00	-49.05	-13.00	-36.05	1.28 H	263	48.11	-97.16
2	2140.50	-53.12	-13.00	-40.12	1.49 H	107	38.46	-91.58

Antenna Polarity & Test Distance : Vertical at 3 m

No	Frequency (MHz)	ERP (dBm)	Limit (dBm)	Margin (dB)	Antenna Height (m)	Table Angle (Degree)	Raw Value (dBuV)	Correction Factor (dB/m)
1	1427.00	-50.22	-13.00	-37.22	1.72 V	226	46.94	-97.16
2	2140.50	-55.88	-13.00	-42.88	1.08 V	218	35.70	-91.58

Remarks:

1. $ERP(dBm) = Raw\ Value(dBuV) + Correction\ Factor(dB/m)$
2. $Correction\ Factor(dB/m) = Antenna\ Factor(dB/m) + Cable\ Factor(dB) - Pre-Amplifier\ Factor(dB) + 20\log(D) - 104.8 - 2.15$
3. Margin value = ERP – Limit value
4. The other ERP levels were very low against the limit.

RF Mode	LTE Band 12 Channel Bandwidth: 10MHz	Channel	CH 23060 : 704 MHz
Frequency Range	1 GHz ~ 18 GHz	Detector Function & Bandwidth	1 MHz/3 MHz (RMS)
Input Power	120 Vac, 60 Hz	Environmental Conditions	25°C, 60% RH
Tested By	Karl Lee		

Antenna Polarity & Test Distance : Horizontal at 3 m

No	Frequency (MHz)	ERP (dBm)	Limit (dBm)	Margin (dB)	Antenna Height (m)	Table Angle (Degree)	Raw Value (dBuV)	Correction Factor (dB/m)
1	1408.00	-49.18	-13.00	-36.18	2.63 H	104	47.84	-97.02
2	2112.00	-50.70	-13.00	-37.70	1.28 H	94	40.71	-91.41

Antenna Polarity & Test Distance : Vertical at 3 m

No	Frequency (MHz)	ERP (dBm)	Limit (dBm)	Margin (dB)	Antenna Height (m)	Table Angle (Degree)	Raw Value (dBuV)	Correction Factor (dB/m)
1	1408.00	-48.43	-13.00	-35.43	2.26 V	44	48.59	-97.02
2	2112.00	-55.39	-13.00	-42.39	1.48 V	187	36.02	-91.41

Remarks:

1. $ERP(dBm) = Raw\ Value(dBuV) + Correction\ Factor(dB/m)$
2. $Correction\ Factor(dB/m) = Antenna\ Factor(dB/m) + Cable\ Factor(dB) - Pre-Amplifier\ Factor(dB) + 20\log(D) - 104.8 - 2.15$
3. Margin value = ERP – Limit value
4. The other ERP levels were very low against the limit.



RF Mode	LTE Band 12 Channel Bandwidth: 10MHz	Channel	CH 23095 : 707.5 MHz
Frequency Range	1 GHz ~ 18 GHz	Detector Function & Bandwidth	1 MHz/3 MHz (RMS)
Input Power	120 Vac, 60 Hz	Environmental Conditions	25°C, 60% RH
Tested By	Karl Lee		

Antenna Polarity & Test Distance : Horizontal at 3 m

No	Frequency (MHz)	ERP (dBm)	Limit (dBm)	Margin (dB)	Antenna Height (m)	Table Angle (Degree)	Raw Value (dBuV)	Correction Factor (dB/m)
1	1415.00	-50.52	-13.00	-37.52	2.14 H	155	46.55	-97.07
2	2122.50	-51.09	-13.00	-38.09	2.17 H	262	40.37	-91.46

Antenna Polarity & Test Distance : Vertical at 3 m

No	Frequency (MHz)	ERP (dBm)	Limit (dBm)	Margin (dB)	Antenna Height (m)	Table Angle (Degree)	Raw Value (dBuV)	Correction Factor (dB/m)
1	1415.00	-50.59	-13.00	-37.59	2.18 V	247	46.48	-97.07
2	2122.50	-51.57	-13.00	-38.57	1.26 V	306	39.89	-91.46

Remarks:

- ERP(dBm) = Raw Value(dBuV) + Correction Factor(dB/m)
- Correction Factor(dB/m) = Antenna Factor(dB/m) + Cable Factor(dB) – Pre-Amplifier Factor(dB) + 20log(D) – 104.8 – 2.15
- Margin value = ERP – Limit value
- The other ERP levels were very low against the limit.

RF Mode	LTE Band 12 Channel Bandwidth: 10MHz	Channel	CH 23130 : 711 MHz
Frequency Range	1 GHz ~ 18 GHz	Detector Function & Bandwidth	1 MHz/3 MHz (RMS)
Input Power	120 Vac, 60 Hz	Environmental Conditions	25°C, 60% RH
Tested By	Karl Lee		

Antenna Polarity & Test Distance : Horizontal at 3 m								
No	Frequency (MHz)	ERP (dBm)	Limit (dBm)	Margin (dB)	Antenna Height (m)	Table Angle (Degree)	Raw Value (dBuV)	Correction Factor (dB/m)
1	1422.00	-50.68	-13.00	-37.68	1.26 H	42	46.44	-97.12
2	2133.00	-50.00	-13.00	-37.00	2.12 H	149	41.53	-91.53
Antenna Polarity & Test Distance : Vertical at 3 m								
No	Frequency (MHz)	ERP (dBm)	Limit (dBm)	Margin (dB)	Antenna Height (m)	Table Angle (Degree)	Raw Value (dBuV)	Correction Factor (dB/m)
1	1422.00	-54.66	-13.00	-41.66	1.72 V	265	42.46	-97.12
2	2133.00	-53.93	-13.00	-40.93	2.22 V	172	37.60	-91.53

Remarks:

- ERP(dBm) = Raw Value(dBuV) + Correction Factor(dB/m)
- Correction Factor(dB/m) = Antenna Factor(dB/m) + Cable Factor(dB) – Pre-Amplifier Factor(dB) + 20log(D) – 104.8 – 2.15
- Margin value = ERP – Limit value
- The other ERP levels were very low against the limit.

7.3.11 LTE Band 13

RF Mode	LTE Band 13 Channel Bandwidth: 5MHz	Channel	CH 23205 : 779.5 MHz
Frequency Range	1 GHz ~ 18 GHz	Detector Function & Bandwidth	1 MHz/3 MHz (RMS)
Input Power	120 Vac, 60 Hz	Environmental Conditions	25°C, 60% RH
Tested By	Charles Hsiao		

Antenna Polarity & Test Distance : Horizontal at 3 m								
No	Frequency (MHz)	EIRP (dBm)	Limit (dBm)	Margin (dB)	Antenna Height (m)	Table Angle (Degree)	Raw Value (dBuV)	Correction Factor (dB/m)
1	1559.00	-48.25	-40.00	-8.25	1.97 H	88	46.51	-94.76
Antenna Polarity & Test Distance : Vertical at 3 m								
No	Frequency (MHz)	EIRP (dBm)	Limit (dBm)	Margin (dB)	Antenna Height (m)	Table Angle (Degree)	Raw Value (dBuV)	Correction Factor (dB/m)
1	1559.00	-48.63	-40.00	-8.63	1.37 V	118	46.13	-94.76

Remarks:

1. $EIRP(dBm) = Raw\ Value(dBuV) + Correction\ Factor(dB/m)$
2. $Correction\ Factor(dB/m) = Antenna\ Factor(dB/m) + Cable\ Factor(dB) - Pre-Amplifier\ Factor(dB) + 20\log(D) - 104.8$
3. $Margin\ value = EIRP - Limit\ value$
4. The other EIRP levels were very low against the limit.



RF Mode	LTE Band 13 Channel Bandwidth: 5MHz	Channel	CH 23230 : 782 MHz
Frequency Range	1 GHz ~ 18 GHz	Detector Function & Bandwidth	1 MHz/3 MHz (RMS)
Input Power	120 Vac, 60 Hz	Environmental Conditions	25°C, 60% RH
Tested By	Charles Hsiao		

Antenna Polarity & Test Distance : Horizontal at 3 m								
No	Frequency (MHz)	EIRP (dBm)	Limit (dBm)	Margin (dB)	Antenna Height (m)	Table Angle (Degree)	Raw Value (dBuV)	Correction Factor (dB/m)
1	1564.00	-48.27	-40.00	-8.27	1.27 H	200	46.45	-94.72
Antenna Polarity & Test Distance : Vertical at 3 m								
No	Frequency (MHz)	EIRP (dBm)	Limit (dBm)	Margin (dB)	Antenna Height (m)	Table Angle (Degree)	Raw Value (dBuV)	Correction Factor (dB/m)
1	1564.00	-51.44	-40.00	-11.44	1.37 V	354	43.28	-94.72

Remarks:

1. $EIRP(dBm) = Raw\ Value(dBuV) + Correction\ Factor(dB/m)$
2. $Correction\ Factor(dB/m) = Antenna\ Factor(dB/m) + Cable\ Factor(dB) - Pre-Amplifier\ Factor(dB) + 20\log(D) - 104.8$
3. Margin value = EIRP – Limit value
4. The other EIRP levels were very low against the limit.



RF Mode	LTE Band 13 Channel Bandwidth: 5MHz	Channel	CH 23255 : 784.5 MHz
Frequency Range	1 GHz ~ 18 GHz	Detector Function & Bandwidth	1 MHz/3 MHz (RMS)
Input Power	120 Vac, 60 Hz	Environmental Conditions	25°C, 60% RH
Tested By	Charles Hsiao		

Antenna Polarity & Test Distance : Horizontal at 3 m								
No	Frequency (MHz)	EIRP (dBm)	Limit (dBm)	Margin (dB)	Antenna Height (m)	Table Angle (Degree)	Raw Value (dBuV)	Correction Factor (dB/m)
1	1569.00	-49.78	-40.00	-9.78	1.67 H	88	44.89	-94.67
Antenna Polarity & Test Distance : Vertical at 3 m								
No	Frequency (MHz)	EIRP (dBm)	Limit (dBm)	Margin (dB)	Antenna Height (m)	Table Angle (Degree)	Raw Value (dBuV)	Correction Factor (dB/m)
1	1569.00	-55.15	-40.00	-15.15	1.16 V	150	39.52	-94.67

Remarks:

1. $EIRP(dBm) = Raw\ Value(dBuV) + Correction\ Factor(dB/m)$
2. $Correction\ Factor(dB/m) = Antenna\ Factor(dB/m) + Cable\ Factor(dB) - Pre-Amplifier\ Factor(dB) + 20\log(D) - 104.8$
3. $Margin\ value = EIRP - Limit\ value$
4. The other EIRP levels were very low against the limit.

RF Mode	LTE Band 13 Channel Bandwidth: 10MHz	Channel	CH 23230 : 782 MHz
Frequency Range	1 GHz ~ 18 GHz	Detector Function & Bandwidth	1 MHz/3 MHz (RMS)
Input Power	120 Vac, 60 Hz	Environmental Conditions	25°C, 60% RH
Tested By	Charles Hsiao		

Antenna Polarity & Test Distance : Horizontal at 3 m								
No	Frequency (MHz)	EIRP (dBm)	Limit (dBm)	Margin (dB)	Antenna Height (m)	Table Angle (Degree)	Raw Value (dBuV)	Correction Factor (dB/m)
1	1564.00	-46.85	-40.00	-6.85	1.15 H	174	47.87	-94.72
Antenna Polarity & Test Distance : Vertical at 3 m								
No	Frequency (MHz)	EIRP (dBm)	Limit (dBm)	Margin (dB)	Antenna Height (m)	Table Angle (Degree)	Raw Value (dBuV)	Correction Factor (dB/m)
1	1564.00	-49.58	-40.00	-9.58	1.37 V	7	45.14	-94.72

Remarks:

1. $EIRP(dBm) = Raw\ Value(dBuV) + Correction\ Factor(dB/m)$
2. $Correction\ Factor(dB/m) = Antenna\ Factor(dB/m) + Cable\ Factor(dB) - Pre-Amplifier\ Factor(dB) + 20\log(D) - 104.8$
3. Margin value = EIRP – Limit value
4. The other EIRP levels were very low against the limit.

7.3.12 LTE Band 17

RF Mode	LTE Band 17 Channel Bandwidth: 5MHz	Channel	CH 23755 : 706.5 MHz
Frequency Range	1 GHz ~ 18 GHz	Detector Function & Bandwidth	1 MHz/3 MHz (RMS)
Input Power	120 Vac, 60 Hz	Environmental Conditions	25°C, 60% RH
Tested By	Charles Hsiao		

Antenna Polarity & Test Distance : Horizontal at 3 m

No	Frequency (MHz)	ERP (dBm)	Limit (dBm)	Margin (dB)	Antenna Height (m)	Table Angle (Degree)	Raw Value (dBuV)	Correction Factor (dB/m)
1	1413.00	-52.24	-13.00	-39.24	1.64 H	48	44.82	-97.06
2	2119.50	-50.08	-13.00	-37.08	1.66 H	65	41.37	-91.45

Antenna Polarity & Test Distance : Vertical at 3 m

No	Frequency (MHz)	ERP (dBm)	Limit (dBm)	Margin (dB)	Antenna Height (m)	Table Angle (Degree)	Raw Value (dBuV)	Correction Factor (dB/m)
1	1413.00	-55.71	-13.00	-42.71	1.05 V	215	41.35	-97.06
2	2119.50	-52.55	-13.00	-39.55	1.13 V	260	38.90	-91.45

Remarks:

- ERP(dBm) = Raw Value(dBuV) + Correction Factor(dB/m)
- Correction Factor(dB/m) = Antenna Factor(dB/m) + Cable Factor(dB) – Pre-Amplifier Factor(dB) + 20log(D) – 104.8 – 2.15
- Margin value = ERP – Limit value
- The other ERP levels were very low against the limit.



RF Mode	LTE Band 17 Channel Bandwidth: 5MHz	Channel	CH 23790 : 710 MHz
Frequency Range	1 GHz ~ 18 GHz	Detector Function & Bandwidth	1 MHz/3 MHz (RMS)
Input Power	120 Vac, 60 Hz	Environmental Conditions	25°C, 60% RH
Tested By	Charles Hsiao		

Antenna Polarity & Test Distance : Horizontal at 3 m								
No	Frequency (MHz)	ERP (dBm)	Limit (dBm)	Margin (dB)	Antenna Height (m)	Table Angle (Degree)	Raw Value (dBuV)	Correction Factor (dB/m)
1	1420.00	-49.50	-13.00	-36.50	1.16 H	348	47.62	-97.12
2	2130.00	-50.12	-13.00	-37.12	1.02 H	114	41.39	-91.51
Antenna Polarity & Test Distance : Vertical at 3 m								
No	Frequency (MHz)	ERP (dBm)	Limit (dBm)	Margin (dB)	Antenna Height (m)	Table Angle (Degree)	Raw Value (dBuV)	Correction Factor (dB/m)
1	1420.00	-43.34	-13.00	-30.34	1.15 V	112	53.78	-97.12
2	2130.00	-46.99	-13.00	-33.99	1.75 V	144	44.52	-91.51

Remarks:

- ERP(dBm) = Raw Value(dBuV) + Correction Factor(dB/m)
- Correction Factor(dB/m) = Antenna Factor(dB/m) + Cable Factor(dB) – Pre-Amplifier Factor(dB) + 20log(D) – 104.8 – 2.15
- Margin value = ERP – Limit value
- The other ERP levels were very low against the limit.

RF Mode	LTE Band 17 Channel Bandwidth: 5MHz	Channel	CH 23825 : 713.5 MHz
Frequency Range	1 GHz ~ 18 GHz	Detector Function & Bandwidth	1 MHz/3 MHz (RMS)
Input Power	120 Vac, 60 Hz	Environmental Conditions	25°C, 60% RH
Tested By	Charles Hsiao		

Antenna Polarity & Test Distance : Horizontal at 3 m								
No	Frequency (MHz)	ERP (dBm)	Limit (dBm)	Margin (dB)	Antenna Height (m)	Table Angle (Degree)	Raw Value (dBuV)	Correction Factor (dB/m)
1	1427.00	-52.57	-13.00	-39.57	1.16 H	197	44.59	-97.16
2	2140.50	-52.10	-13.00	-39.10	1.13 H	218	39.48	-91.58
Antenna Polarity & Test Distance : Vertical at 3 m								
No	Frequency (MHz)	ERP (dBm)	Limit (dBm)	Margin (dB)	Antenna Height (m)	Table Angle (Degree)	Raw Value (dBuV)	Correction Factor (dB/m)
1	1427.00	-46.25	-13.00	-33.25	1.96 V	348	50.91	-97.16
2	2140.50	-52.01	-13.00	-39.01	1.12 V	141	39.57	-91.58

Remarks:

1. $ERP(dBm) = Raw\ Value(dBuV) + Correction\ Factor(dB/m)$
2. $Correction\ Factor(dB/m) = Antenna\ Factor(dB/m) + Cable\ Factor(dB) - Pre-Amplifier\ Factor(dB) + 20\log(D) - 104.8 - 2.15$
3. Margin value = ERP – Limit value
4. The other ERP levels were very low against the limit.



RF Mode	LTE Band 17 Channel Bandwidth: 10MHz	Channel	CH 23780 : 709 MHz
Frequency Range	1 GHz ~ 18 GHz	Detector Function & Bandwidth	1 MHz/3 MHz (RMS)
Input Power	120 Vac, 60 Hz	Environmental Conditions	25°C, 60% RH
Tested By	Charles Hsiao		

Antenna Polarity & Test Distance : Horizontal at 3 m								
No	Frequency (MHz)	ERP (dBm)	Limit (dBm)	Margin (dB)	Antenna Height (m)	Table Angle (Degree)	Raw Value (dBuV)	Correction Factor (dB/m)
1	1418.00	-51.38	-13.00	-38.38	1.15 H	197	45.72	-97.10
2	2127.00	-50.18	-13.00	-37.18	1.05 H	300	41.32	-91.50
Antenna Polarity & Test Distance : Vertical at 3 m								
No	Frequency (MHz)	ERP (dBm)	Limit (dBm)	Margin (dB)	Antenna Height (m)	Table Angle (Degree)	Raw Value (dBuV)	Correction Factor (dB/m)
1	1418.00	-43.17	-13.00	-30.17	1.64 V	44	53.93	-97.10
2	2127.00	-49.85	-13.00	-36.85	1.05 V	217	41.65	-91.50

Remarks:

1. ERP(dBm) = Raw Value(dBuV) + Correction Factor(dB/m)
2. Correction Factor(dB/m) = Antenna Factor(dB/m) + Cable Factor(dB) – Pre-Amplifier Factor(dB) + 20log(D) – 104.8 – 2.15
3. Margin value = ERP – Limit value
4. The other ERP levels were very low against the limit.



RF Mode	LTE Band 17 Channel Bandwidth: 10MHz	Channel	CH 23790 : 710 MHz
Frequency Range	1 GHz ~ 18 GHz	Detector Function & Bandwidth	1 MHz/3 MHz (RMS)
Input Power	120 Vac, 60 Hz	Environmental Conditions	25°C, 60% RH
Tested By	Charles Hsiao		

Antenna Polarity & Test Distance : Horizontal at 3 m								
No	Frequency (MHz)	ERP (dBm)	Limit (dBm)	Margin (dB)	Antenna Height (m)	Table Angle (Degree)	Raw Value (dBuV)	Correction Factor (dB/m)
1	1420.00	-49.96	-13.00	-36.96	1.12 H	187	47.16	-97.12
2	2130.00	-50.48	-13.00	-37.48	1.44 H	101	41.03	-91.51
Antenna Polarity & Test Distance : Vertical at 3 m								
No	Frequency (MHz)	ERP (dBm)	Limit (dBm)	Margin (dB)	Antenna Height (m)	Table Angle (Degree)	Raw Value (dBuV)	Correction Factor (dB/m)
1	1420.00	-41.12	-13.00	-28.12	1.13 V	325	56.00	-97.12
2	2130.00	-43.13	-13.00	-30.13	1.05 V	244	48.38	-91.51

Remarks:

- ERP(dBm) = Raw Value(dBuV) + Correction Factor(dB/m)
- Correction Factor(dB/m) = Antenna Factor(dB/m) + Cable Factor(dB) – Pre-Amplifier Factor(dB) + 20log(D) – 104.8 – 2.15
- Margin value = ERP – Limit value
- The other ERP levels were very low against the limit.

RF Mode	LTE Band 17 Channel Bandwidth: 10MHz	Channel	CH 23800 : 711 MHz
Frequency Range	1 GHz ~ 18 GHz	Detector Function & Bandwidth	1 MHz/3 MHz (RMS)
Input Power	120 Vac, 60 Hz	Environmental Conditions	25°C, 60% RH
Tested By	Charles Hsiao		

Antenna Polarity & Test Distance : Horizontal at 3 m								
No	Frequency (MHz)	ERP (dBm)	Limit (dBm)	Margin (dB)	Antenna Height (m)	Table Angle (Degree)	Raw Value (dBuV)	Correction Factor (dB/m)
1	1422.00	-49.40	-13.00	-36.40	1.45 H	112	47.72	-97.12
2	2133.00	-49.13	-13.00	-36.13	1.37 H	28	42.40	-91.53
Antenna Polarity & Test Distance : Vertical at 3 m								
No	Frequency (MHz)	ERP (dBm)	Limit (dBm)	Margin (dB)	Antenna Height (m)	Table Angle (Degree)	Raw Value (dBuV)	Correction Factor (dB/m)
1	1422.00	-43.83	-13.00	-30.83	1.83 V	220	53.29	-97.12
2	2133.00	-47.79	-13.00	-34.79	1.05 V	217	43.74	-91.53

Remarks:

1. $ERP(dBm) = Raw\ Value(dBuV) + Correction\ Factor(dB/m)$
2. $Correction\ Factor(dB/m) = Antenna\ Factor(dB/m) + Cable\ Factor(dB) - Pre-Amplifier\ Factor(dB) + 20\log(D) - 104.8 - 2.15$
3. Margin value = ERP – Limit value
4. The other ERP levels were very low against the limit.

7.3.13 LTE Band 25

RF Mode	LTE Band 25 Channel Bandwidth: 1.4MHz	Channel	CH 26047 : 1850.7 MHz
Frequency Range	1 GHz ~ 20 GHz	Detector Function & Bandwidth	1 MHz/3 MHz (RMS)
Input Power	120 Vac, 60 Hz	Environmental Conditions	25°C, 60% RH
Tested By	Karl Lee		

Antenna Polarity & Test Distance : Horizontal at 3 m

No	Frequency (MHz)	EIRP (dBm)	Limit (dBm)	Margin (dB)	Antenna Height (m)	Table Angle (Degree)	Raw Value (dBuV)	Correction Factor (dB/m)
1	3701.40	-44.95	-13.00	-31.95	1.59 H	352	40.62	-85.57
2	5552.10	-45.17	-13.00	-32.17	1.07 H	253	36.99	-82.16

Antenna Polarity & Test Distance : Vertical at 3 m

No	Frequency (MHz)	EIRP (dBm)	Limit (dBm)	Margin (dB)	Antenna Height (m)	Table Angle (Degree)	Raw Value (dBuV)	Correction Factor (dB/m)
1	3701.40	-46.45	-13.00	-33.45	2.37 V	152	39.12	-85.57
2	5552.10	-46.07	-13.00	-33.07	2.63 V	157	36.09	-82.16

Remarks:

1. $EIRP(dBm) = Raw\ Value(dBuV) + Correction\ Factor(dB/m)$
2. $Correction\ Factor(dB/m) = Antenna\ Factor(dB/m) + Cable\ Factor(dB) - Pre-Amplifier\ Factor(dB) + 20\log(D) - 104.8$
3. Margin value = EIRP – Limit value
4. The other EIRP levels were very low against the limit.



RF Mode	LTE Band 25 Channel Bandwidth: 1.4MHz	Channel	CH 26365 : 1882.5 MHz
Frequency Range	1 GHz ~ 20 GHz	Detector Function & Bandwidth	1 MHz/3 MHz (RMS)
Input Power	120 Vac, 60 Hz	Environmental Conditions	25°C, 60% RH
Tested By	Karl Lee		

Antenna Polarity & Test Distance : Horizontal at 3 m

No	Frequency (MHz)	EIRP (dBm)	Limit (dBm)	Margin (dB)	Antenna Height (m)	Table Angle (Degree)	Raw Value (dBuV)	Correction Factor (dB/m)
1	3765.00	-43.02	-13.00	-30.02	2.51 H	188	42.34	-85.36
2	5647.50	-46.16	-13.00	-33.16	2.32 H	85	36.08	-82.24

Antenna Polarity & Test Distance : Vertical at 3 m

No	Frequency (MHz)	EIRP (dBm)	Limit (dBm)	Margin (dB)	Antenna Height (m)	Table Angle (Degree)	Raw Value (dBuV)	Correction Factor (dB/m)
1	3765.00	-43.50	-13.00	-30.50	2.84 V	134	41.86	-85.36
2	5647.50	-46.77	-13.00	-33.77	1.47 V	135	35.47	-82.24

Remarks:

1. $EIRP(dBm) = Raw\ Value(dBuV) + Correction\ Factor(dB/m)$
2. $Correction\ Factor(dB/m) = Antenna\ Factor(dB/m) + Cable\ Factor(dB) - Pre-Amplifier\ Factor(dB) + 20\log(D) - 104.8$
3. Margin value = EIRP – Limit value
4. The other EIRP levels were very low against the limit.



RF Mode	LTE Band 25 Channel Bandwidth: 1.4MHz	Channel	CH 26683 : 1914.3 MHz
Frequency Range	1 GHz ~ 20 GHz	Detector Function & Bandwidth	1 MHz/3 MHz (RMS)
Input Power	120 Vac, 60 Hz	Environmental Conditions	25°C, 60% RH
Tested By	Karl Lee		

Antenna Polarity & Test Distance : Horizontal at 3 m								
No	Frequency (MHz)	EIRP (dBm)	Limit (dBm)	Margin (dB)	Antenna Height (m)	Table Angle (Degree)	Raw Value (dBuV)	Correction Factor (dB/m)
1	3828.60	-40.16	-13.00	-27.16	1.59 H	151	44.99	-85.15
2	5742.90	-43.74	-13.00	-30.74	2.55 H	108	38.31	-82.05
Antenna Polarity & Test Distance : Vertical at 3 m								
No	Frequency (MHz)	EIRP (dBm)	Limit (dBm)	Margin (dB)	Antenna Height (m)	Table Angle (Degree)	Raw Value (dBuV)	Correction Factor (dB/m)
1	3828.60	-43.94	-13.00	-30.94	2.64 V	71	41.21	-85.15
2	5742.90	-43.99	-13.00	-30.99	2.41 V	182	38.06	-82.05

Remarks:

1. $EIRP(dBm) = Raw\ Value(dBuV) + Correction\ Factor(dB/m)$
2. $Correction\ Factor(dB/m) = Antenna\ Factor(dB/m) + Cable\ Factor(dB) - Pre-Amplifier\ Factor(dB) + 20\log(D) - 104.8$
3. $Margin\ value = EIRP - Limit\ value$
4. The other EIRP levels were very low against the limit.



RF Mode	LTE Band 25 Channel Bandwidth: 5MHz	Channel	CH 26065 : 1852.5 MHz
Frequency Range	1 GHz ~ 20 GHz	Detector Function & Bandwidth	1 MHz/3 MHz (RMS)
Input Power	120 Vac, 60 Hz	Environmental Conditions	25°C, 60% RH
Tested By	Karl Lee		

Antenna Polarity & Test Distance : Horizontal at 3 m

No	Frequency (MHz)	EIRP (dBm)	Limit (dBm)	Margin (dB)	Antenna Height (m)	Table Angle (Degree)	Raw Value (dBuV)	Correction Factor (dB/m)
1	3705.00	-46.85	-13.00	-33.85	1.53 H	283	38.70	-85.55
2	5557.50	-47.21	-13.00	-34.21	1.37 H	123	34.97	-82.18

Antenna Polarity & Test Distance : Vertical at 3 m

No	Frequency (MHz)	EIRP (dBm)	Limit (dBm)	Margin (dB)	Antenna Height (m)	Table Angle (Degree)	Raw Value (dBuV)	Correction Factor (dB/m)
1	3705.00	-47.60	-13.00	-34.60	1.42 V	73	37.95	-85.55
2	5557.50	-46.98	-13.00	-33.98	2.92 V	108	35.20	-82.18

Remarks:

1. $EIRP(dBm) = Raw\ Value(dBuV) + Correction\ Factor(dB/m)$
2. $Correction\ Factor(dB/m) = Antenna\ Factor(dB/m) + Cable\ Factor(dB) - Pre-Amplifier\ Factor(dB) + 20\log(D) - 104.8$
3. $Margin\ value = EIRP - Limit\ value$
4. The other EIRP levels were very low against the limit.



RF Mode	LTE Band 25 Channel Bandwidth: 5MHz	Channel	CH 26365 : 1882.5 MHz
Frequency Range	1 GHz ~ 20 GHz	Detector Function & Bandwidth	1 MHz/3 MHz (RMS)
Input Power	120 Vac, 60 Hz	Environmental Conditions	25°C, 60% RH
Tested By	Karl Lee		

Antenna Polarity & Test Distance : Horizontal at 3 m								
No	Frequency (MHz)	EIRP (dBm)	Limit (dBm)	Margin (dB)	Antenna Height (m)	Table Angle (Degree)	Raw Value (dBuV)	Correction Factor (dB/m)
1	3765.00	-43.73	-13.00	-30.73	1.64 H	257	41.63	-85.36
2	5647.50	-45.47	-13.00	-32.47	1.22 H	129	36.77	-82.24
Antenna Polarity & Test Distance : Vertical at 3 m								
No	Frequency (MHz)	EIRP (dBm)	Limit (dBm)	Margin (dB)	Antenna Height (m)	Table Angle (Degree)	Raw Value (dBuV)	Correction Factor (dB/m)
1	3765.00	-46.75	-13.00	-33.75	2.27 V	161	38.61	-85.36
2	5647.50	-45.23	-13.00	-32.23	1.74 V	205	37.01	-82.24

Remarks:

1. $EIRP(dBm) = Raw\ Value(dBuV) + Correction\ Factor(dB/m)$
2. $Correction\ Factor(dB/m) = Antenna\ Factor(dB/m) + Cable\ Factor(dB) - Pre-Amplifier\ Factor(dB) + 20\log(D) - 104.8$
3. Margin value = EIRP – Limit value
4. The other EIRP levels were very low against the limit.

RF Mode	LTE Band 25 Channel Bandwidth: 5MHz	Channel	CH 26665 : 1912.5 MHz
Frequency Range	1 GHz ~ 20 GHz	Detector Function & Bandwidth	1 MHz/3 MHz (RMS)
Input Power	120 Vac, 60 Hz	Environmental Conditions	25°C, 60% RH
Tested By	Karl Lee		

Antenna Polarity & Test Distance : Horizontal at 3 m								
No	Frequency (MHz)	EIRP (dBm)	Limit (dBm)	Margin (dB)	Antenna Height (m)	Table Angle (Degree)	Raw Value (dBuV)	Correction Factor (dB/m)
1	3825.00	-43.61	-13.00	-30.61	2.41 H	42	41.55	-85.16
2	5737.50	-44.33	-13.00	-31.33	1.28 H	26	37.74	-82.07
Antenna Polarity & Test Distance : Vertical at 3 m								
No	Frequency (MHz)	EIRP (dBm)	Limit (dBm)	Margin (dB)	Antenna Height (m)	Table Angle (Degree)	Raw Value (dBuV)	Correction Factor (dB/m)
1	3825.00	-41.88	-13.00	-28.88	2.73 V	154	43.28	-85.16
2	5737.50	-45.12	-13.00	-32.12	2.01 V	171	36.95	-82.07

Remarks:

1. $EIRP(dBm) = Raw\ Value(dBuV) + Correction\ Factor(dB/m)$
2. $Correction\ Factor(dB/m) = Antenna\ Factor(dB/m) + Cable\ Factor(dB) - Pre-Amplifier\ Factor(dB) + 20\log(D) - 104.8$
3. Margin value = EIRP – Limit value
4. The other EIRP levels were very low against the limit.



RF Mode	LTE Band 25 Channel Bandwidth: 20MHz	Channel	CH 26140 : 1860 MHz
Frequency Range	1 GHz ~ 20 GHz	Detector Function & Bandwidth	1 MHz/3 MHz (RMS)
Input Power	120 Vac, 60 Hz	Environmental Conditions	25°C, 60% RH
Tested By	Karl Lee		

Antenna Polarity & Test Distance : Horizontal at 3 m

No	Frequency (MHz)	EIRP (dBm)	Limit (dBm)	Margin (dB)	Antenna Height (m)	Table Angle (Degree)	Raw Value (dBuV)	Correction Factor (dB/m)
1	3720.00	-49.19	-13.00	-36.19	1.96 H	24	36.32	-85.51
2	5580.00	-47.56	-13.00	-34.56	1.21 H	148	34.69	-82.25

Antenna Polarity & Test Distance : Vertical at 3 m

No	Frequency (MHz)	EIRP (dBm)	Limit (dBm)	Margin (dB)	Antenna Height (m)	Table Angle (Degree)	Raw Value (dBuV)	Correction Factor (dB/m)
1	3720.00	-47.79	-13.00	-34.79	2.58 V	172	37.72	-85.51
2	5580.00	-42.80	-13.00	-29.80	2.50 V	170	39.45	-82.25

Remarks:

1. $EIRP(dBm) = Raw\ Value(dBuV) + Correction\ Factor(dB/m)$
2. $Correction\ Factor(dB/m) = Antenna\ Factor(dB/m) + Cable\ Factor(dB) - Pre-Amplifier\ Factor(dB) + 20\log(D) - 104.8$
3. Margin value = EIRP – Limit value
4. The other EIRP levels were very low against the limit.



RF Mode	LTE Band 25 Channel Bandwidth: 20MHz	Channel	CH 26365 : 1882.5 MHz
Frequency Range	1 GHz ~ 20 GHz	Detector Function & Bandwidth	1 MHz/3 MHz (RMS)
Input Power	120 Vac, 60 Hz	Environmental Conditions	25°C, 60% RH
Tested By	Karl Lee		

Antenna Polarity & Test Distance : Horizontal at 3 m

No	Frequency (MHz)	EIRP (dBm)	Limit (dBm)	Margin (dB)	Antenna Height (m)	Table Angle (Degree)	Raw Value (dBuV)	Correction Factor (dB/m)
1	3765.00	-45.68	-13.00	-32.68	1.53 H	327	39.68	-85.36
2	5647.50	-42.87	-13.00	-29.87	1.83 H	115	39.37	-82.24

Antenna Polarity & Test Distance : Vertical at 3 m

No	Frequency (MHz)	EIRP (dBm)	Limit (dBm)	Margin (dB)	Antenna Height (m)	Table Angle (Degree)	Raw Value (dBuV)	Correction Factor (dB/m)
1	3765.00	-42.23	-13.00	-29.23	2.04 V	181	43.13	-85.36
2	5647.50	-41.83	-13.00	-28.83	2.41 V	183	40.41	-82.24

Remarks:

1. $EIRP(dBm) = Raw\ Value(dBuV) + Correction\ Factor(dB/m)$
2. $Correction\ Factor(dB/m) = Antenna\ Factor(dB/m) + Cable\ Factor(dB) - Pre-Amplifier\ Factor(dB) + 20\log(D) - 104.8$
3. Margin value = EIRP – Limit value
4. The other EIRP levels were very low against the limit.

RF Mode	LTE Band 25 Channel Bandwidth: 20MHz	Channel	CH 26590 : 1905 MHz
Frequency Range	1 GHz ~ 20 GHz	Detector Function & Bandwidth	1 MHz/3 MHz (RMS)
Input Power	120 Vac, 60 Hz	Environmental Conditions	25°C, 60% RH
Tested By	Karl Lee		

Antenna Polarity & Test Distance : Horizontal at 3 m								
No	Frequency (MHz)	EIRP (dBm)	Limit (dBm)	Margin (dB)	Antenna Height (m)	Table Angle (Degree)	Raw Value (dBuV)	Correction Factor (dB/m)
1	3810.00	-44.60	-13.00	-31.60	1.49 H	224	40.58	-85.18
2	5715.00	-46.16	-13.00	-33.16	1.53 H	247	35.99	-82.15
Antenna Polarity & Test Distance : Vertical at 3 m								
No	Frequency (MHz)	EIRP (dBm)	Limit (dBm)	Margin (dB)	Antenna Height (m)	Table Angle (Degree)	Raw Value (dBuV)	Correction Factor (dB/m)
1	3810.00	-44.14	-13.00	-31.14	2.39 V	121	41.04	-85.18
2	5715.00	-45.06	-13.00	-32.06	1.88 V	57	37.09	-82.15

Remarks:

1. $EIRP(dBm) = Raw\ Value(dBuV) + Correction\ Factor(dB/m)$
2. $Correction\ Factor(dB/m) = Antenna\ Factor(dB/m) + Cable\ Factor(dB) - Pre-Amplifier\ Factor(dB) + 20\log(D) - 104.8$
3. Margin value = EIRP – Limit value
4. The other EIRP levels were very low against the limit.

7.3.14 LTE Band 26

RF Mode	LTE Band 26 (Part 22) Channel Bandwidth: 1.4MHz	Channel	CH 26797 : 824.7 MHz
Frequency Range	1 GHz ~ 18 GHz	Detector Function & Bandwidth	1 MHz/3 MHz (RMS)
Input Power	120 Vac, 60 Hz	Environmental Conditions	25°C, 60% RH
Tested By	Karl Lee		

Antenna Polarity & Test Distance : Horizontal at 3 m								
No	Frequency (MHz)	ERP (dBm)	Limit (dBm)	Margin (dB)	Antenna Height (m)	Table Angle (Degree)	Raw Value (dBuV)	Correction Factor (dB/m)
1	1649.40	-44.45	-13.00	-31.45	2.63 H	184	51.55	-96.00
Antenna Polarity & Test Distance : Vertical at 3 m								
No	Frequency (MHz)	ERP (dBm)	Limit (dBm)	Margin (dB)	Antenna Height (m)	Table Angle (Degree)	Raw Value (dBuV)	Correction Factor (dB/m)
1	1649.40	-41.52	-13.00	-28.52	1.46 V	29	54.48	-96.00

Remarks:

- ERP(dBm) = Raw Value(dBuV) + Correction Factor(dB/m)
- Correction Factor(dB/m) = Antenna Factor(dB/m) + Cable Factor(dB) – Pre-Amplifier Factor(dB)
+ 20log(D) – 104.8 – 2.15
- Margin value = ERP – Limit value
- The other ERP levels were very low against the limit.



RF Mode	LTE Band 26 (Part 22) Channel Bandwidth: 1.4MHz	Channel	CH 26915 : 836.5 MHz
Frequency Range	1 GHz ~ 18 GHz	Detector Function & Bandwidth	1 MHz/3 MHz (RMS)
Input Power	120 Vac, 60 Hz	Environmental Conditions	25°C, 60% RH
Tested By	Karl Lee		

Antenna Polarity & Test Distance : Horizontal at 3 m								
No	Frequency (MHz)	ERP (dBm)	Limit (dBm)	Margin (dB)	Antenna Height (m)	Table Angle (Degree)	Raw Value (dBuV)	Correction Factor (dB/m)
1	1673.00	-48.74	-13.00	-35.74	2.25 H	132	46.89	-95.63
Antenna Polarity & Test Distance : Vertical at 3 m								
No	Frequency (MHz)	ERP (dBm)	Limit (dBm)	Margin (dB)	Antenna Height (m)	Table Angle (Degree)	Raw Value (dBuV)	Correction Factor (dB/m)
1	1673.00	-44.35	-13.00	-31.35	2.39 V	104	51.28	-95.63

Remarks:

1. ERP(dBm) = Raw Value(dBuV) + Correction Factor(dB/m)
2. Correction Factor(dB/m) = Antenna Factor(dB/m) + Cable Factor(dB) – Pre-Amplifier Factor(dB) + 20log(D) – 104.8 – 2.15
3. Margin value = ERP – Limit value
4. The other ERP levels were very low against the limit.

RF Mode	LTE Band 26 (Part 22) Channel Bandwidth: 1.4MHz	Channel	CH 27033 : 848.3 MHz
Frequency Range	1 GHz ~ 18 GHz	Detector Function & Bandwidth	1 MHz/3 MHz (RMS)
Input Power	120 Vac, 60 Hz	Environmental Conditions	25°C, 60% RH
Tested By	Karl Lee		

Antenna Polarity & Test Distance : Horizontal at 3 m								
No	Frequency (MHz)	ERP (dBm)	Limit (dBm)	Margin (dB)	Antenna Height (m)	Table Angle (Degree)	Raw Value (dBuV)	Correction Factor (dB/m)
1	1696.60	-51.63	-13.00	-38.63	1.14 H	25	43.62	-95.25
Antenna Polarity & Test Distance : Vertical at 3 m								
No	Frequency (MHz)	ERP (dBm)	Limit (dBm)	Margin (dB)	Antenna Height (m)	Table Angle (Degree)	Raw Value (dBuV)	Correction Factor (dB/m)
1	1696.60	-46.81	-13.00	-33.81	2.16 V	105	48.44	-95.25

Remarks:

1. $ERP(dBm) = Raw\ Value(dBuV) + Correction\ Factor(dB/m)$
2. $Correction\ Factor(dB/m) = Antenna\ Factor(dB/m) + Cable\ Factor(dB) - Pre-Amplifier\ Factor(dB) + 20\log(D) - 104.8 - 2.15$
3. Margin value = ERP – Limit value
4. The other ERP levels were very low against the limit.



RF Mode	LTE Band 26 (Part 22) Channel Bandwidth: 5MHz	Channel	CH 26815 : 826.5 MHz
Frequency Range	1 GHz ~ 18 GHz	Detector Function & Bandwidth	1 MHz/3 MHz (RMS)
Input Power	120 Vac, 60 Hz	Environmental Conditions	25°C, 60% RH
Tested By	Karl Lee		

Antenna Polarity & Test Distance : Horizontal at 3 m

No	Frequency (MHz)	ERP (dBm)	Limit (dBm)	Margin (dB)	Antenna Height (m)	Table Angle (Degree)	Raw Value (dBuV)	Correction Factor (dB/m)
1	1653.00	-46.25	-13.00	-33.25	2.29 H	174	49.70	-95.95

Antenna Polarity & Test Distance : Vertical at 3 m

No	Frequency (MHz)	ERP (dBm)	Limit (dBm)	Margin (dB)	Antenna Height (m)	Table Angle (Degree)	Raw Value (dBuV)	Correction Factor (dB/m)
1	1653.00	-44.11	-13.00	-31.11	2.55 V	148	51.84	-95.95

Remarks:

- ERP(dBm) = Raw Value(dBuV) + Correction Factor(dB/m)
- Correction Factor(dB/m) = Antenna Factor(dB/m) + Cable Factor(dB) – Pre-Amplifier Factor(dB)
+ 20log(D) – 104.8 – 2.15
- Margin value = ERP – Limit value
- The other ERP levels were very low against the limit.



RF Mode	LTE Band 26 (Part 22) Channel Bandwidth: 5MHz	Channel	CH 26915 : 836.5 MHz
Frequency Range	1 GHz ~ 18 GHz	Detector Function & Bandwidth	1 MHz/3 MHz (RMS)
Input Power	120 Vac, 60 Hz	Environmental Conditions	25°C, 60% RH
Tested By	Karl Lee		

Antenna Polarity & Test Distance : Horizontal at 3 m								
No	Frequency (MHz)	ERP (dBm)	Limit (dBm)	Margin (dB)	Antenna Height (m)	Table Angle (Degree)	Raw Value (dBuV)	Correction Factor (dB/m)
1	1673.00	-49.58	-13.00	-36.58	2.26 H	241	46.05	-95.63
Antenna Polarity & Test Distance : Vertical at 3 m								
No	Frequency (MHz)	ERP (dBm)	Limit (dBm)	Margin (dB)	Antenna Height (m)	Table Angle (Degree)	Raw Value (dBuV)	Correction Factor (dB/m)
1	1673.00	-46.44	-13.00	-33.44	2.05 V	134	49.19	-95.63

Remarks:

1. ERP(dBm) = Raw Value(dBuV) + Correction Factor(dB/m)
2. Correction Factor(dB/m) = Antenna Factor(dB/m) + Cable Factor(dB) – Pre-Amplifier Factor(dB) + 20log(D) – 104.8 – 2.15
3. Margin value = ERP – Limit value
4. The other ERP levels were very low against the limit.



RF Mode	LTE Band 26 (Part 22) Channel Bandwidth: 5MHz	Channel	CH 27015 : 846.5 MHz
Frequency Range	1 GHz ~ 18 GHz	Detector Function & Bandwidth	1 MHz/3 MHz (RMS)
Input Power	120 Vac, 60 Hz	Environmental Conditions	25°C, 60% RH
Tested By	Karl Lee		

Antenna Polarity & Test Distance : Horizontal at 3 m								
No	Frequency (MHz)	ERP (dBm)	Limit (dBm)	Margin (dB)	Antenna Height (m)	Table Angle (Degree)	Raw Value (dBuV)	Correction Factor (dB/m)
1	1693.00	-53.85	-13.00	-40.85	2.04 H	112	41.47	-95.32
Antenna Polarity & Test Distance : Vertical at 3 m								
No	Frequency (MHz)	ERP (dBm)	Limit (dBm)	Margin (dB)	Antenna Height (m)	Table Angle (Degree)	Raw Value (dBuV)	Correction Factor (dB/m)
1	1693.00	-50.01	-13.00	-37.01	1.15 V	49	45.31	-95.32

Remarks:

1. ERP(dBm) = Raw Value(dBuV) + Correction Factor(dB/m)
2. Correction Factor(dB/m) = Antenna Factor(dB/m) + Cable Factor(dB) – Pre-Amplifier Factor(dB) + 20log(D) – 104.8 – 2.15
3. Margin value = ERP – Limit value
4. The other ERP levels were very low against the limit.



RF Mode	LTE Band 26 (Part 22) Channel Bandwidth: 15MHz	Channel	CH 26865 : 831.5 MHz
Frequency Range	1 GHz ~ 18 GHz	Detector Function & Bandwidth	1 MHz/3 MHz (RMS)
Input Power	120 Vac, 60 Hz	Environmental Conditions	25°C, 60% RH
Tested By	Karl Lee		

Antenna Polarity & Test Distance : Horizontal at 3 m								
No	Frequency (MHz)	ERP (dBm)	Limit (dBm)	Margin (dB)	Antenna Height (m)	Table Angle (Degree)	Raw Value (dBuV)	Correction Factor (dB/m)
1	1663.00	-45.31	-13.00	-32.31	1.05 H	172	50.48	-95.79
Antenna Polarity & Test Distance : Vertical at 3 m								
No	Frequency (MHz)	ERP (dBm)	Limit (dBm)	Margin (dB)	Antenna Height (m)	Table Angle (Degree)	Raw Value (dBuV)	Correction Factor (dB/m)
1	1663.00	-47.26	-13.00	-34.26	1.92 V	227	48.53	-95.79

Remarks:

1. $ERP(dBm) = Raw\ Value(dBuV) + Correction\ Factor(dB/m)$
2. $Correction\ Factor(dB/m) = Antenna\ Factor(dB/m) + Cable\ Factor(dB) - Pre-Amplifier\ Factor(dB) + 20\log(D) - 104.8 - 2.15$
3. $Margin\ value = ERP - Limit\ value$
4. The other ERP levels were very low against the limit.



RF Mode	LTE Band 26 (Part 22) Channel Bandwidth: 15MHz	Channel	CH 26915 : 836.5 MHz
Frequency Range	1 GHz ~ 18 GHz	Detector Function & Bandwidth	1 MHz/3 MHz (RMS)
Input Power	120 Vac, 60 Hz	Environmental Conditions	25°C, 60% RH
Tested By	Charles Hsiao		

Antenna Polarity & Test Distance : Horizontal at 3 m								
No	Frequency (MHz)	ERP (dBm)	Limit (dBm)	Margin (dB)	Antenna Height (m)	Table Angle (Degree)	Raw Value (dBuV)	Correction Factor (dB/m)
1	1673.00	-41.67	-13.00	-28.67	1.15 H	241	53.96	-95.63
Antenna Polarity & Test Distance : Vertical at 3 m								
No	Frequency (MHz)	ERP (dBm)	Limit (dBm)	Margin (dB)	Antenna Height (m)	Table Angle (Degree)	Raw Value (dBuV)	Correction Factor (dB/m)
1	1673.00	-42.63	-13.00	-29.63	1.16 V	317	53.00	-95.63

Remarks:

- ERP(dBm) = Raw Value(dBuV) + Correction Factor(dB/m)
- Correction Factor(dB/m) = Antenna Factor(dB/m) + Cable Factor(dB) – Pre-Amplifier Factor(dB) + 20log(D) – 104.8 – 2.15
- Margin value = ERP – Limit value
- The other ERP levels were very low against the limit.



RF Mode	LTE Band 26 (Part 22) Channel Bandwidth: 15MHz	Channel	CH 26965 : 841.5 MHz
Frequency Range	1 GHz ~ 18 GHz	Detector Function & Bandwidth	1 MHz/3 MHz (RMS)
Input Power	120 Vac, 60 Hz	Environmental Conditions	25°C, 60% RH
Tested By	Karl Lee		

Antenna Polarity & Test Distance : Horizontal at 3 m								
No	Frequency (MHz)	ERP (dBm)	Limit (dBm)	Margin (dB)	Antenna Height (m)	Table Angle (Degree)	Raw Value (dBuV)	Correction Factor (dB/m)
1	1683.00	-48.40	-13.00	-35.40	1.23 H	157	47.07	-95.47
Antenna Polarity & Test Distance : Vertical at 3 m								
No	Frequency (MHz)	ERP (dBm)	Limit (dBm)	Margin (dB)	Antenna Height (m)	Table Angle (Degree)	Raw Value (dBuV)	Correction Factor (dB/m)
1	1683.00	-44.03	-13.00	-31.03	2.59 V	26	51.44	-95.47

Remarks:

1. $ERP(dBm) = Raw\ Value(dBuV) + Correction\ Factor(dB/m)$
2. $Correction\ Factor(dB/m) = Antenna\ Factor(dB/m) + Cable\ Factor(dB) - Pre-Amplifier\ Factor(dB) + 20\log(D) - 104.8 - 2.15$
3. $Margin\ value = ERP - Limit\ value$
4. The other ERP levels were very low against the limit.



RF Mode	LTE Band 26 (Part 90) Channel Bandwidth: 1.4MHz	Channel	CH 26697 : 814.7 MHz
Frequency Range	1 GHz ~ 18 GHz	Detector Function & Bandwidth	1 MHz/3 MHz (RMS)
Input Power	120 Vac, 60 Hz	Environmental Conditions	25°C, 60% RH
Tested By	Karl Lee		

Antenna Polarity & Test Distance : Horizontal at 3 m

No	Frequency (MHz)	ERP (dBm)	Limit (dBm)	Margin (dB)	Antenna Height (m)	Table Angle (Degree)	Raw Value (dBuV)	Correction Factor (dB/m)
1	1629.40	-49.13	-13.00	-36.13	2.26 H	49	47.09	-96.22

Antenna Polarity & Test Distance : Vertical at 3 m

No	Frequency (MHz)	ERP (dBm)	Limit (dBm)	Margin (dB)	Antenna Height (m)	Table Angle (Degree)	Raw Value (dBuV)	Correction Factor (dB/m)
1	1629.40	-48.09	-13.00	-35.09	2.11 V	281	48.13	-96.22

Remarks:

- ERP(dBm) = Raw Value(dBuV) + Correction Factor(dB/m)
- Correction Factor(dB/m) = Antenna Factor(dB/m) + Cable Factor(dB) – Pre-Amplifier Factor(dB) + 20log(D) – 104.8 – 2.15
- Margin value = ERP – Limit value
- The other ERP levels were very low against the limit.



RF Mode	LTE Band 26 (Part 90) Channel Bandwidth: 1.4MHz	Channel	CH 26740 : 819 MHz
Frequency Range	1 GHz ~ 18 GHz	Detector Function & Bandwidth	1 MHz/3 MHz (RMS)
Input Power	120 Vac, 60 Hz	Environmental Conditions	25°C, 60% RH
Tested By	Karl Lee		

Antenna Polarity & Test Distance : Horizontal at 3 m

No	Frequency (MHz)	ERP (dBm)	Limit (dBm)	Margin (dB)	Antenna Height (m)	Table Angle (Degree)	Raw Value (dBuV)	Correction Factor (dB/m)
1	1638.00	-48.68	-13.00	-35.68	1.26 H	278	47.44	-96.12

Antenna Polarity & Test Distance : Vertical at 3 m

No	Frequency (MHz)	ERP (dBm)	Limit (dBm)	Margin (dB)	Antenna Height (m)	Table Angle (Degree)	Raw Value (dBuV)	Correction Factor (dB/m)
1	1638.00	-49.28	-13.00	-36.28	2.35 V	157	46.84	-96.12

Remarks:

- ERP(dBm) = Raw Value(dBuV) + Correction Factor(dB/m)
- Correction Factor(dB/m) = Antenna Factor(dB/m) + Cable Factor(dB) – Pre-Amplifier Factor(dB) + 20log(D) – 104.8 – 2.15
- Margin value = ERP – Limit value
- The other ERP levels were very low against the limit.



RF Mode	LTE Band 26 (Part 90) Channel Bandwidth: 1.4MHz	Channel	CH 26783 : 823.3 MHz
Frequency Range	1 GHz ~ 18 GHz	Detector Function & Bandwidth	1 MHz/3 MHz (RMS)
Input Power	120 Vac, 60 Hz	Environmental Conditions	25°C, 60% RH
Tested By	Karl Lee		

Antenna Polarity & Test Distance : Horizontal at 3 m								
No	Frequency (MHz)	ERP (dBm)	Limit (dBm)	Margin (dB)	Antenna Height (m)	Table Angle (Degree)	Raw Value (dBuV)	Correction Factor (dB/m)
1	1646.60	-50.10	-13.00	-37.10	1.94 H	255	45.92	-96.02
Antenna Polarity & Test Distance : Vertical at 3 m								
No	Frequency (MHz)	ERP (dBm)	Limit (dBm)	Margin (dB)	Antenna Height (m)	Table Angle (Degree)	Raw Value (dBuV)	Correction Factor (dB/m)
1	1646.60	-49.32	-13.00	-36.32	2.65 V	188	46.70	-96.02

Remarks:

1. ERP(dBm) = Raw Value(dBuV) + Correction Factor(dB/m)
2. Correction Factor(dB/m) = Antenna Factor(dB/m) + Cable Factor(dB) – Pre-Amplifier Factor(dB) + 20log(D) – 104.8 – 2.15
3. Margin value = ERP – Limit value
4. The other ERP levels were very low against the limit.



RF Mode	LTE Band 26 (Part 90) Channel Bandwidth: 5MHz	Channel	CH 26715 : 816.5 MHz
Frequency Range	1 GHz ~ 18 GHz	Detector Function & Bandwidth	1 MHz/3 MHz (RMS)
Input Power	120 Vac, 60 Hz	Environmental Conditions	25°C, 60% RH
Tested By	Karl Lee		

Antenna Polarity & Test Distance : Horizontal at 3 m								
No	Frequency (MHz)	ERP (dBm)	Limit (dBm)	Margin (dB)	Antenna Height (m)	Table Angle (Degree)	Raw Value (dBuV)	Correction Factor (dB/m)
1	1633.00	-49.95	-13.00	-36.95	1.14 H	72	46.24	-96.19
Antenna Polarity & Test Distance : Vertical at 3 m								
No	Frequency (MHz)	ERP (dBm)	Limit (dBm)	Margin (dB)	Antenna Height (m)	Table Angle (Degree)	Raw Value (dBuV)	Correction Factor (dB/m)
1	1633.00	-51.21	-13.00	-38.21	1.54 V	206	44.98	-96.19

Remarks:

- ERP(dBm) = Raw Value(dBuV) + Correction Factor(dB/m)
- Correction Factor(dB/m) = Antenna Factor(dB/m) + Cable Factor(dB) – Pre-Amplifier Factor(dB) + 20log(D) – 104.8 – 2.15
- Margin value = ERP – Limit value
- The other ERP levels were very low against the limit.

RF Mode	LTE Band 26 (Part 90) Channel Bandwidth: 5MHz	Channel	CH 26740 : 819 MHz
Frequency Range	1 GHz ~ 18 GHz	Detector Function & Bandwidth	1 MHz/3 MHz (RMS)
Input Power	120 Vac, 60 Hz	Environmental Conditions	25°C, 60% RH
Tested By	Karl Lee		

Antenna Polarity & Test Distance : Horizontal at 3 m								
No	Frequency (MHz)	ERP (dBm)	Limit (dBm)	Margin (dB)	Antenna Height (m)	Table Angle (Degree)	Raw Value (dBuV)	Correction Factor (dB/m)
1	1638.00	-49.68	-13.00	-36.68	2.32 H	142	46.44	-96.12
Antenna Polarity & Test Distance : Vertical at 3 m								
No	Frequency (MHz)	ERP (dBm)	Limit (dBm)	Margin (dB)	Antenna Height (m)	Table Angle (Degree)	Raw Value (dBuV)	Correction Factor (dB/m)
1	1638.00	-49.75	-13.00	-36.75	2.61 V	42	46.37	-96.12

Remarks:

1. $ERP(dBm) = Raw\ Value(dBuV) + Correction\ Factor(dB/m)$
2. $Correction\ Factor(dB/m) = Antenna\ Factor(dB/m) + Cable\ Factor(dB) - Pre-Amplifier\ Factor(dB) + 20\log(D) - 104.8 - 2.15$
3. $Margin\ value = ERP - Limit\ value$
4. The other ERP levels were very low against the limit.



RF Mode	LTE Band 26 (Part 90) Channel Bandwidth: 5MHz	Channel	CH 26765 : 821.5 MHz
Frequency Range	1 GHz ~ 18 GHz	Detector Function & Bandwidth	1 MHz/3 MHz (RMS)
Input Power	120 Vac, 60 Hz	Environmental Conditions	25°C, 60% RH
Tested By	Karl Lee		

Antenna Polarity & Test Distance : Horizontal at 3 m								
No	Frequency (MHz)	ERP (dBm)	Limit (dBm)	Margin (dB)	Antenna Height (m)	Table Angle (Degree)	Raw Value (dBuV)	Correction Factor (dB/m)
1	1643.00	-52.29	-13.00	-39.29	1.04 H	72	43.79	-96.08
Antenna Polarity & Test Distance : Vertical at 3 m								
No	Frequency (MHz)	ERP (dBm)	Limit (dBm)	Margin (dB)	Antenna Height (m)	Table Angle (Degree)	Raw Value (dBuV)	Correction Factor (dB/m)
1	1643.00	-48.79	-13.00	-35.79	2.32 V	157	47.29	-96.08

Remarks:

1. $ERP(dBm) = Raw\ Value(dBuV) + Correction\ Factor(dB/m)$
2. $Correction\ Factor(dB/m) = Antenna\ Factor(dB/m) + Cable\ Factor(dB) - Pre-Amplifier\ Factor(dB) + 20\log(D) - 104.8 - 2.15$
3. $Margin\ value = ERP - Limit\ value$
4. The other ERP levels were very low against the limit.

RF Mode	LTE Band 26 (Part 90) Channel Bandwidth: 10MHz	Channel	CH 26740 : 819 MHz
Frequency Range	1 GHz ~ 18 GHz	Detector Function & Bandwidth	1 MHz/3 MHz (RMS)
Input Power	120 Vac, 60 Hz	Environmental Conditions	25°C, 60% RH
Tested By	Charles Hsiao		

Antenna Polarity & Test Distance : Horizontal at 3 m								
No	Frequency (MHz)	ERP (dBm)	Limit (dBm)	Margin (dB)	Antenna Height (m)	Table Angle (Degree)	Raw Value (dBuV)	Correction Factor (dB/m)
1	1638.00	-42.72	-13.00	-29.72	1.19 H	214	53.40	-96.12
Antenna Polarity & Test Distance : Vertical at 3 m								
No	Frequency (MHz)	ERP (dBm)	Limit (dBm)	Margin (dB)	Antenna Height (m)	Table Angle (Degree)	Raw Value (dBuV)	Correction Factor (dB/m)
1	1638.00	-43.25	-13.00	-30.25	1.12 V	141	52.87	-96.12

Remarks:

- ERP(dBm) = Raw Value(dBuV) + Correction Factor(dB/m)
- Correction Factor(dB/m) = Antenna Factor(dB/m) + Cable Factor(dB) – Pre-Amplifier Factor(dB) + 20log(D) – 104.8 – 2.15
- Margin value = ERP – Limit value
- The other ERP levels were very low against the limit.



RF Mode	LTE Band 26 (Part 90) Channel Bandwidth: 15MHz	Channel	CH 26765 : 821.5 MHz
Frequency Range	1 GHz ~ 18 GHz	Detector Function & Bandwidth	1 MHz/3 MHz (RMS)
Input Power	120 Vac, 60 Hz	Environmental Conditions	25°C, 60% RH
Tested By	Karl Lee		

Antenna Polarity & Test Distance : Horizontal at 3 m								
No	Frequency (MHz)	ERP (dBm)	Limit (dBm)	Margin (dB)	Antenna Height (m)	Table Angle (Degree)	Raw Value (dBuV)	Correction Factor (dB/m)
1	1643.00	-38.96	-13.00	-25.96	1.63 H	247	57.12	-96.08
Antenna Polarity & Test Distance : Vertical at 3 m								
No	Frequency (MHz)	ERP (dBm)	Limit (dBm)	Margin (dB)	Antenna Height (m)	Table Angle (Degree)	Raw Value (dBuV)	Correction Factor (dB/m)
1	1643.00	-40.67	-13.00	-27.67	2.15 V	83	55.41	-96.08

Remarks:

1. ERP(dBm) = Raw Value(dBuV) + Correction Factor(dB/m)
2. Correction Factor(dB/m) = Antenna Factor(dB/m) + Cable Factor(dB) – Pre-Amplifier Factor(dB) + 20log(D) – 104.8 – 2.15
3. Margin value = ERP – Limit value
4. The other ERP levels were very low against the limit.

7.3.15 LTE Band 66

RF Mode	LTE Band 66 Channel Bandwidth: 1.4MHz	Channel	CH 131979 : 1710.7 MHz
Frequency Range	1 GHz ~ 18 GHz	Detector Function & Bandwidth	1 MHz/3 MHz (RMS)
Input Power	120 Vac, 60 Hz	Environmental Conditions	25°C, 60% RH
Tested By	Charles Hsiao		

Antenna Polarity & Test Distance : Horizontal at 3 m								
No	Frequency (MHz)	EIRP (dBm)	Limit (dBm)	Margin (dB)	Antenna Height (m)	Table Angle (Degree)	Raw Value (dBuV)	Correction Factor (dB/m)
1	3421.40	-48.76	-13.00	-35.76	1.13 H	334	37.58	-86.34
Antenna Polarity & Test Distance : Vertical at 3 m								
No	Frequency (MHz)	EIRP (dBm)	Limit (dBm)	Margin (dB)	Antenna Height (m)	Table Angle (Degree)	Raw Value (dBuV)	Correction Factor (dB/m)
1	3421.40	-47.87	-13.00	-34.87	1.64 V	334	38.47	-86.34

Remarks:

1. $EIRP(dBm) = Raw\ Value(dBuV) + Correction\ Factor(dB/m)$
2. $Correction\ Factor(dB/m) = Antenna\ Factor(dB/m) + Cable\ Factor(dB) - Pre-Amplifier\ Factor(dB) + 20\log(D) - 104.8$
3. Margin value = EIRP – Limit value
4. The other EIRP levels were very low against the limit.



RF Mode	LTE Band 66 Channel Bandwidth: 1.4MHz	Channel	CH 132322 : 1745 MHz
Frequency Range	1 GHz ~ 18 GHz	Detector Function & Bandwidth	1 MHz/3 MHz (RMS)
Input Power	120 Vac, 60 Hz	Environmental Conditions	25°C, 60% RH
Tested By	Charles Hsiao		

Antenna Polarity & Test Distance : Horizontal at 3 m

No	Frequency (MHz)	EIRP (dBm)	Limit (dBm)	Margin (dB)	Antenna Height (m)	Table Angle (Degree)	Raw Value (dBuV)	Correction Factor (dB/m)
1	3490.00	-45.49	-13.00	-32.49	1.19 H	119	40.66	-86.15
2	5235.00	-46.44	-13.00	-33.44	1.43 H	3	36.01	-82.45

Antenna Polarity & Test Distance : Vertical at 3 m

No	Frequency (MHz)	EIRP (dBm)	Limit (dBm)	Margin (dB)	Antenna Height (m)	Table Angle (Degree)	Raw Value (dBuV)	Correction Factor (dB/m)
1	3490.00	-46.67	-13.00	-33.67	1.15 V	85	39.48	-86.15
2	5235.00	-44.90	-13.00	-31.90	1.37 V	208	37.55	-82.45

Remarks:

1. $EIRP(dBm) = Raw\ Value(dBuV) + Correction\ Factor(dB/m)$
2. $Correction\ Factor(dB/m) = Antenna\ Factor(dB/m) + Cable\ Factor(dB) - Pre-Amplifier\ Factor(dB) + 20\log(D) - 104.8$
3. Margin value = EIRP – Limit value
4. The other EIRP levels were very low against the limit.



RF Mode	LTE Band 66 Channel Bandwidth: 1.4MHz	Channel	CH 132665 : 1779.3 MHz
Frequency Range	1 GHz ~ 18 GHz	Detector Function & Bandwidth	1 MHz/3 MHz (RMS)
Input Power	120 Vac, 60 Hz	Environmental Conditions	25°C, 60% RH
Tested By	Charles Hsiao		

Antenna Polarity & Test Distance : Horizontal at 3 m

No	Frequency (MHz)	EIRP (dBm)	Limit (dBm)	Margin (dB)	Antenna Height (m)	Table Angle (Degree)	Raw Value (dBuV)	Correction Factor (dB/m)
1	3558.60	-46.81	-13.00	-33.81	1.29 H	9	39.40	-86.21
2	5337.90	-40.99	-13.00	-27.99	1.13 H	328	41.33	-82.32

Antenna Polarity & Test Distance : Vertical at 3 m

No	Frequency (MHz)	EIRP (dBm)	Limit (dBm)	Margin (dB)	Antenna Height (m)	Table Angle (Degree)	Raw Value (dBuV)	Correction Factor (dB/m)
1	3558.60	-48.58	-13.00	-35.58	1.54 V	121	37.63	-86.21
2	5337.90	-40.50	-13.00	-27.50	1.78 V	8	41.82	-82.32

Remarks:

1. $EIRP(dBm) = Raw\ Value(dBuV) + Correction\ Factor(dB/m)$
2. $Correction\ Factor(dB/m) = Antenna\ Factor(dB/m) + Cable\ Factor(dB) - Pre-Amplifier\ Factor(dB) + 20\log(D) - 104.8$
3. Margin value = EIRP – Limit value
4. The other EIRP levels were very low against the limit.



RF Mode	LTE Band 66 Channel Bandwidth: 5MHz	Channel	CH 131997 : 1712.5 MHz
Frequency Range	1 GHz ~ 18 GHz	Detector Function & Bandwidth	1 MHz/3 MHz (RMS)
Input Power	120 Vac, 60 Hz	Environmental Conditions	25°C, 60% RH
Tested By	Charles Hsiao		

Antenna Polarity & Test Distance : Horizontal at 3 m

No	Frequency (MHz)	EIRP (dBm)	Limit (dBm)	Margin (dB)	Antenna Height (m)	Table Angle (Degree)	Raw Value (dBuV)	Correction Factor (dB/m)
1	3425.00	-45.26	-13.00	-32.26	1.85 H	19	41.09	-86.35
2	5137.50	-43.57	-13.00	-30.57	1.67 H	190	39.10	-82.67

Antenna Polarity & Test Distance : Vertical at 3 m

No	Frequency (MHz)	EIRP (dBm)	Limit (dBm)	Margin (dB)	Antenna Height (m)	Table Angle (Degree)	Raw Value (dBuV)	Correction Factor (dB/m)
1	3425.00	-45.73	-13.00	-32.73	1.13 V	328	40.62	-86.35
2	5137.50	-44.94	-13.00	-31.94	1.44 V	174	37.73	-82.67

Remarks:

1. $EIRP(dBm) = Raw\ Value(dBuV) + Correction\ Factor(dB/m)$
2. $Correction\ Factor(dB/m) = Antenna\ Factor(dB/m) + Cable\ Factor(dB) - Pre-Amplifier\ Factor(dB) + 20\log(D) - 104.8$
3. Margin value = EIRP – Limit value
4. The other EIRP levels were very low against the limit.



RF Mode	LTE Band 66 Channel Bandwidth: 5MHz	Channel	CH 132322 : 1745 MHz
Frequency Range	1 GHz ~ 18 GHz	Detector Function & Bandwidth	1 MHz/3 MHz (RMS)
Input Power	120 Vac, 60 Hz	Environmental Conditions	25°C, 60% RH
Tested By	Charles Hsiao		

Antenna Polarity & Test Distance : Horizontal at 3 m

No	Frequency (MHz)	EIRP (dBm)	Limit (dBm)	Margin (dB)	Antenna Height (m)	Table Angle (Degree)	Raw Value (dBuV)	Correction Factor (dB/m)
1	3490.00	-40.55	-13.00	-27.55	1.20 H	300	45.60	-86.15
2	5235.00	-41.40	-13.00	-28.40	1.35 H	228	41.05	-82.45

Antenna Polarity & Test Distance : Vertical at 3 m

No	Frequency (MHz)	EIRP (dBm)	Limit (dBm)	Margin (dB)	Antenna Height (m)	Table Angle (Degree)	Raw Value (dBuV)	Correction Factor (dB/m)
1	3490.00	-44.71	-13.00	-31.71	1.37 V	115	41.44	-86.15
2	5235.00	-44.90	-13.00	-31.90	1.37 V	208	37.55	-82.45

Remarks:

1. $EIRP(dBm) = Raw\ Value(dBuV) + Correction\ Factor(dB/m)$
2. $Correction\ Factor(dB/m) = Antenna\ Factor(dB/m) + Cable\ Factor(dB) - Pre-Amplifier\ Factor(dB) + 20\log(D) - 104.8$
3. $Margin\ value = EIRP - Limit\ value$
4. The other EIRP levels were very low against the limit.



RF Mode	LTE Band 66 Channel Bandwidth: 5MHz	Channel	CH 132647 : 1777.5 MHz
Frequency Range	1 GHz ~ 18 GHz	Detector Function & Bandwidth	1 MHz/3 MHz (RMS)
Input Power	120 Vac, 60 Hz	Environmental Conditions	25°C, 60% RH
Tested By	Charles Hsiao		

Antenna Polarity & Test Distance : Horizontal at 3 m

No	Frequency (MHz)	EIRP (dBm)	Limit (dBm)	Margin (dB)	Antenna Height (m)	Table Angle (Degree)	Raw Value (dBuV)	Correction Factor (dB/m)
1	3555.00	-46.07	-13.00	-33.07	1.44 H	140	40.16	-86.23
2	5332.50	-40.30	-13.00	-27.30	1.35 H	227	42.03	-82.33

Antenna Polarity & Test Distance : Vertical at 3 m

No	Frequency (MHz)	EIRP (dBm)	Limit (dBm)	Margin (dB)	Antenna Height (m)	Table Angle (Degree)	Raw Value (dBuV)	Correction Factor (dB/m)
1	3555.00	-47.55	-13.00	-34.55	1.12 V	284	38.68	-86.23
2	5332.50	-44.58	-13.00	-31.58	1.17 V	47	37.75	-82.33

Remarks:

1. $EIRP(dBm) = Raw\ Value(dBuV) + Correction\ Factor(dB/m)$
2. $Correction\ Factor(dB/m) = Antenna\ Factor(dB/m) + Cable\ Factor(dB) - Pre-Amplifier\ Factor(dB) + 20\log(D) - 104.8$
3. $Margin\ value = EIRP - Limit\ value$
4. The other EIRP levels were very low against the limit.



RF Mode	LTE Band 66 Channel Bandwidth: 20MHz	Channel	CH 132072 : 1720 MHz
Frequency Range	1 GHz ~ 18 GHz	Detector Function & Bandwidth	1 MHz/3 MHz (RMS)
Input Power	120 Vac, 60 Hz	Environmental Conditions	25°C, 60% RH
Tested By	Charles Hsiao		

Antenna Polarity & Test Distance : Horizontal at 3 m

No	Frequency (MHz)	EIRP (dBm)	Limit (dBm)	Margin (dB)	Antenna Height (m)	Table Angle (Degree)	Raw Value (dBuV)	Correction Factor (dB/m)
1	3440.00	-46.57	-13.00	-33.57	1.64 H	1	39.76	-86.33
2	5160.00	-42.66	-13.00	-29.66	1.19 H	347	39.97	-82.63

Antenna Polarity & Test Distance : Vertical at 3 m

No	Frequency (MHz)	EIRP (dBm)	Limit (dBm)	Margin (dB)	Antenna Height (m)	Table Angle (Degree)	Raw Value (dBuV)	Correction Factor (dB/m)
1	3440.00	-49.74	-13.00	-36.74	1.15 V	328	36.59	-86.33
2	5160.00	-45.31	-13.00	-32.31	1.37 V	117	37.32	-82.63

Remarks:

1. $EIRP(dBm) = Raw\ Value(dBuV) + Correction\ Factor(dB/m)$
2. $Correction\ Factor(dB/m) = Antenna\ Factor(dB/m) + Cable\ Factor(dB) - Pre-Amplifier\ Factor(dB) + 20\log(D) - 104.8$
3. $Margin\ value = EIRP - Limit\ value$
4. The other EIRP levels were very low against the limit.



RF Mode	LTE Band 66 Channel Bandwidth: 20MHz	Channel	CH 132322 : 1745 MHz
Frequency Range	1 GHz ~ 18 GHz	Detector Function & Bandwidth	1 MHz/3 MHz (RMS)
Input Power	120 Vac, 60 Hz	Environmental Conditions	25°C, 60% RH
Tested By	Charles Hsiao		

Antenna Polarity & Test Distance : Horizontal at 3 m

No	Frequency (MHz)	EIRP (dBm)	Limit (dBm)	Margin (dB)	Antenna Height (m)	Table Angle (Degree)	Raw Value (dBuV)	Correction Factor (dB/m)
1	3490.00	-42.66	-13.00	-29.66	1.19 H	317	43.49	-86.15
2	5235.00	-41.40	-13.00	-28.40	1.35 H	228	41.05	-82.45

Antenna Polarity & Test Distance : Vertical at 3 m

No	Frequency (MHz)	EIRP (dBm)	Limit (dBm)	Margin (dB)	Antenna Height (m)	Table Angle (Degree)	Raw Value (dBuV)	Correction Factor (dB/m)
1	3490.00	-47.69	-13.00	-34.69	1.15 V	150	38.46	-86.15
2	5235.00	-41.52	-13.00	-28.52	1.75 V	311	40.93	-82.45

Remarks:

1. $EIRP(dBm) = Raw\ Value(dBuV) + Correction\ Factor(dB/m)$
2. $Correction\ Factor(dB/m) = Antenna\ Factor(dB/m) + Cable\ Factor(dB) - Pre-Amplifier\ Factor(dB) + 20\log(D) - 104.8$
3. Margin value = EIRP – Limit value
4. The other EIRP levels were very low against the limit.



RF Mode	LTE Band 66 Channel Bandwidth: 20MHz	Channel	CH 132572 : 1770 MHz
Frequency Range	1 GHz ~ 18 GHz	Detector Function & Bandwidth	1 MHz/3 MHz (RMS)
Input Power	120 Vac, 60 Hz	Environmental Conditions	25°C, 60% RH
Tested By	Charles Hsiao		

Antenna Polarity & Test Distance : Horizontal at 3 m								
No	Frequency (MHz)	EIRP (dBm)	Limit (dBm)	Margin (dB)	Antenna Height (m)	Table Angle (Degree)	Raw Value (dBuV)	Correction Factor (dB/m)
1	3540.00	-44.54	-13.00	-31.54	1.17 H	174	41.67	-86.21
2	5310.00	-39.20	-13.00	-26.20	1.69 H	91	43.12	-82.32
Antenna Polarity & Test Distance : Vertical at 3 m								
No	Frequency (MHz)	EIRP (dBm)	Limit (dBm)	Margin (dB)	Antenna Height (m)	Table Angle (Degree)	Raw Value (dBuV)	Correction Factor (dB/m)
1	3540.00	-48.73	-13.00	-35.73	1.45 V	144	37.48	-86.21
2	5310.00	-45.38	-13.00	-32.38	1.68 V	99	36.94	-82.32

Remarks:

1. $EIRP(dBm) = Raw\ Value(dBuV) + Correction\ Factor(dB/m)$
2. $Correction\ Factor(dB/m) = Antenna\ Factor(dB/m) + Cable\ Factor(dB) - Pre-Amplifier\ Factor(dB) + 20\log(D) - 104.8$
3. $Margin\ value = EIRP - Limit\ value$
4. The other EIRP levels were very low against the limit.

8 Pictures of Test Arrangements

Please refer to the attached file (Test Setup Photo)

9 Information of the Testing Laboratories

We, Bureau Veritas Consumer Products Services (H.K.) Ltd., Taoyuan Branch, were founded in 1988 to provide our best service in EMC, Radio, Telecom and Safety consultation. Our laboratories are FCC recognized accredited test firms and accredited according to ISO/IEC 17025.

If you have any comments, please feel free to contact us at the following:

Lin Kou EMC/RF Lab

Tel: 886-2-26052180

Fax: 886-2-26051924

Hsin Chu EMC/RF/Telecom Lab

Tel: 886-3-6668565

Fax: 886-3-6668323

Hwa Ya EMC/RF/Safety Lab

Tel: 886-3-3183232

Fax: 886-3-3270892

Email: service.adt@bureauveritas.com

Web Site: <http://ee.bureauveritas.com.tw>

The address and road map of all our labs can be found in our web site also.

--- END ---