FCC Test Report

Report No: WD-RF-R-210317-A0

Product Name : POS Cradle
Model Name : S1FB
FCC ID : WIYS1FB
Applicant : CASTLES TECHNOLOGY CO., LTD.
Received Date : Sep. 15, 2021
Tested Date : Oct. 13, 2021 ~ Oct. 27, 2021
Applicable Standard : 47 CFR FCC Part 15, Subpart C (Section 15.247)
KDB 558074 D01 DTS Meas. Guidance v05
ANSI C63.10 : 2013



Wendell Industrial Co., Ltd
Wendell EMC & RF Laboratory

Caution:

This report sets forth our findings solely with respect to the test samples identified herein. The results set forth in this report are not indicative or representative of the quality or characteristics of the lot from which a test sample was taken or any similar or identical product unless specifically and expressly noted.

The test results shown in the test report are traceable to the national/international standard through the calibration report of the equipment.

Please note that the measurement uncertainty are provided for informational purpose only and are not used in determining the Pass/Fail results.

This report must not be used to claim product endorsement by TAF or any agency of the government.

The test report shall not be reproduced without the written approval of Wendell Industrial Co., Ltd..

Test Report

Issued Date: October 28, 2021

Project No.: 21Q091519

Product Name	POS Cradle
Trade Name	CASTLES TECHNOLOGY
Brand Trademark	
Model Name	S1FB
FCC ID	WIYS1FB
Applicant	CASTLES TECHNOLOGY CO., LTD.
Manufacturer	CASTLES TECHNOLOGY CO., LTD.
EUT Rated Voltage	AC 100 ~ 240V / 50 or 60Hz
EUT Test Voltage	AC 120V / 60Hz
EUT Supports Radios Application	WLAN 802.11b/g WLAN 802.11n (HT20)
Applicable Standard	47 CFR FCC Part 15, Subpart C (Section 15.247) KDB 558074 D01 DTS Meas. Guidance v05 ANSI C63.10 : 2013
Output Power	22.02 dBm
Test Result	Complied

Documented :



(Specialist / Emma Lu)

Technical Engineer :



(Deputy Section Manager / Jack Chang)

Approved :

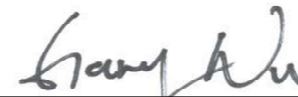

(Project Manager / Gary Wu)

Table of Contents

Document Revision History	5
Summary of Test Result	6
1 Generation Information	7
1.1 Applicant	7
1.2 Manufacturer	7
1.3 Description of Equipment under Test	7
1.4 Test Mode Applicability And Tested Channel Detail	10
1.5 Configuration of Tested System	12
1.6 EUT Exercise Software	13
1.7 Tested System Details	13
1.8 Test Facility	14
1.9 Measurement Uncertainty	15
1.10 List of Test Equipment	16
2 Test Result	19
2.1 Antenna Requirement	19
2.1.1 Applicable Standard	19
2.1.2 Antenna Connected Construction	19
2.1.3 Antenna Gain	20
2.2 Peak Output Power Measurement	21
2.2.1 Limit	21
2.2.2 Test Setup	21
2.2.3 Test Procedure	21
2.2.4 Test Result	22
2.3 6dB Bandwidth Measurement	23
2.3.1 Limit	23
2.3.2 Test Setup	23
2.3.3 Test Procedure	23
2.3.4 Test Result	24
2.4 Power Spectral Density Measurement	27
2.4.1 Limit	27
2.4.2 Test Setup	27
2.4.3 Test Procedure	27
2.4.4 Test Result	28
2.5 Conducted Band Edges and Spurious Emission Measurement	31
2.5.1 Limit	31
2.5.2 Test Setup	31
2.5.3 Test Procedure	31
2.5.4 Test Result	32
2.6 Radiated Band Edges and Spurious Emission Measurement	41
2.6.1 Limit	41
2.6.2 Test Setup	42
2.6.3 Test Procedure	43
2.6.4 Duty Cycle	44
2.6.5 Test Result of Radiated Band Edge Measurement	44
2.6.6 Test Result of Radiated Spurious Emission Measurement	57
2.7 AC Conducted Emissions Measurement	78

2.7.1	Limit	78
2.7.2	Test Setup.....	78
2.7.3	Test Procedure.....	79
2.7.4	Test Result	80

Attachment 1: EUT Test Photographs

Attachment 2: EUT Detailed Photographs

Document Revision History

Report No.	Issue date	Description
WD-RF-R-210317-A0	October 28, 2021	Initial report

Summary of Test Result

Ref. Std. Clause	Test Items	Result
15.203 15.247(C)	Antenna Requirement	Pass
15.247(b)	Peak Output Power	Pass
15.247(a)(2)	6dB Bandwidth	Pass
15.247(e)	Power Spectral Density	Pass
15.247(d)	Conducted Band Edges and Conducted Spurious Emission	Pass
15.247(d)	Radiated Band Edges and Radiated Spurious Emission	Pass
15.207	AC Conducted Emission	Pass

1 Generation Information

1.1 Applicant

CASTLES TECHNOLOGY CO., LTD.
 6F, NO. 207-5, SEC. 3, BEIXIN RD., XINDIAN DISTRICT, NEW TAIPEI CITY 23143,
 TAIWAN (R.O.C)

1.2 Manufacturer

CASTLES TECHNOLOGY CO., LTD.
 6F, NO. 207-5, SEC. 3, BEIXIN RD., XINDIAN DISTRICT, NEW TAIPEI CITY 23143,
 TAIWAN (R.O.C)

1.3 Description of Equipment under Test

Product Name	POS Cradle
Model No.	S1FB
FCC ID	WIYS1FB
Frequency Range	802.11b/g/n-20MHz: 2412~2462MHz
Number of Channels	802.11b/g/n-20MHz: 11
Data Rate	802.11b: 1-11Mbps, 802.11g: 6-54Mbps, 802.11n: up to 72.2Mbps
Channel separation	802.11b/g/n: 5 MHz
Type of Modulation	802.11b: DSSS (DBPSK, DQPSK, CCK) 802.11g/n: OFDM (BPSK, QPSK, 16QAM, 64QAM)
Antenna Information	Refer to the table "Antenna List"
EUT Supports Radios Application	WLAN 802.11b/g WLAN 802.11n (HT20)
EUT Rated Voltage	AC 100 ~ 240V / 50 or 60Hz
EUT Test Voltage	AC 120V / 60Hz

The EUT uses following adapter.

Brand Trademark	 CASTLES TECHNOLOGY
Model No.	PW04-945A
Input Power	AC 100-240V~1A max. 50/60Hz
Output Power	DC 9.0V/4.5A 40.5W
Power Line	Non-shielded, No Core, 1.5m

Antenna List

No.	Manufacturer	Model No.	Antenna Type	Peak Gain
1	ARISTOTLE ENTERPRISES INC.	RFA-25-JP292-70B-70	PCB Antenna	3.7 dBi for 2.4GHz

Remark: The antenna of EUT is conforming to FCC 15.203

Channel List

802.11b/g/n HT20	
Channel	Frequency(MHz)
01	2412
02	2417
03	2422
04	2427
05	2432
06	2437
07	2442
08	2447
09	2452
10	2457
11	2462

Test Frequencies in each operating band

Frequency range over which the device operates in each operating band (Note 1)	Number of test frequencies required	Location of test frequencies inside the operating frequency range (Note 1,2)
≤ 1 MHz	1	near centre
> 1 MHz and ≤ 10 MHz	2	1 near high end, 1 near low end
> 10 MHz	3	1 near high end, 1 near centre, and 1 near low end

Note 1: The frequency range over which the device operates in a given operating band is the difference between the highest and lowest frequencies on which the device can be tuned within that given operating band. The frequency range can be smaller than or equal to the operating band, but cannot be greater than the operating band.

Note 2: In the third column of table 1, “near” means as close as possible to or at the centre / low end / high end of the frequency range over which the device operates.

Firmware / Software Version

1	Product Name	POS Cradle
2	Model No.	S1FB
3	Test SW Version	PUTTY_Ver.0.63.0.0
4	RF power setting in TEST SW	<input type="checkbox"/> RF power setting was not able to alter during testing. <input checked="" type="checkbox"/> RF power setting was able to alter during testing. (See the following table)

Parameters of test software setting

Type of Modulation	Channel	Frequency (MHz)	Set Value
802.11b	01	2412	39
	06	2437	39
	11	2462	39
802.11g	01	2412	15
	06	2437	15
	11	2462	10
802.11n HT20	01	2412	11
	06	2437	11
	11	2462	8

1.4 Test Mode Applicability And Tested Channel Detail

1. This device is a POS Cradle with a built-in Wi-Fi transceiver.
2. These tests were performed on a sample of equipment to demonstrate compliance with 47 CFR FCC Part 15, Subpart C (Section 15.247).
3. Pre-Scan has been conducted to determine the worst-case mode from all possible combinations between available modulations, data rates, XYZ axis and antenna ports.
4. The worst case was found when positioned on X axis for radiated emission. Following test modes were selected for the final test, and the final worst case is recorded in the report:

EUT Configure Mode	RE < 1G	RE ≥ 1G	ACM	ACP	Description
--	<input checked="" type="checkbox"/>	<input checked="" type="checkbox"/>	<input checked="" type="checkbox"/>	<input type="checkbox"/>	Transmit WIFI
--	<input type="checkbox"/>	<input type="checkbox"/>	<input type="checkbox"/>	<input checked="" type="checkbox"/>	Normal Link

Note : RE<1G: Radiated Emission below 1GHz RE≥1G: Radiated Emission above 1GHz
 ACM: Antenna Port Conducted Measurement ACP: AC Power Line Conducted Emission

Following channel(s) was (were) selected for the final test as listed below:

Radiated Spurious Emission Measurement(Below 1GHz):

EUT Configure Mode	Mode	Available Channel	Tested Channel	Modulation Type	Data Rate (Mbps)
--	802.11g	1 ~ 11	06	DSSS	1

Radiated Spurious Emission Measurement(Above 1GHz):

EUT Configure Mode	Mode	Available Channel	Tested Channel	Modulation Type	Data Rate (Mbps)
--	802.11b	1 ~ 11	01, 06, 11	DSSS	1
--	802.11g	1 ~ 11	01, 06, 11	OFDM	6
--	802.11n HT20	1 ~ 11	01, 06, 11	OFDM	6.5

Radiated Band Edge Emission Measurement(Above 1GHz):

EUT Configure Mode	Mode	Available Channel	Tested Channel	Modulation Type	Data Rate (Mbps)
--	802.11b	1 ~ 11	01, 11	DSSS	1
--	802.11g	1 ~ 11	01, 11	OFDM	6
--	802.11n HT20	1 ~ 11	01, 11	OFDM	6.5

Peak Output Power, 6dB Bandwidth, Power Spectral Density, Conducted Spurious Emission:

EUT Configure Mode	Mode	Available Channel	Tested Channel	Modulation Type	Data Rate (Mbps)
--	802.11b	1 ~ 11	01, 06, 11	DSSS	1
--	802.11g	1 ~ 11	01, 06, 11	OFDM	6
--	802.11n HT20	1 ~ 11	01, 06, 11	OFDM	6.5

Conducted Band Edges:

EUT Configure Mode	Mode	Available Channel	Tested Channel	Modulation Type	Data Rate (Mbps)
--	802.11b	1 ~ 11	01, 11	DSSS	1
--	802.11g	1 ~ 11	01, 11	OFDM	6
--	802.11n HT20	1 ~ 11	01, 11	OFDM	6.5

AC Conducted Emission:

EUT Configure Mode	Mode	Available Channel	Tested Channel	Modulation Type	Data Rate (Mbps)
--	802.11b	1 ~ 11	06	DSSS	1

1.5 Configuration of Tested System

Radiation

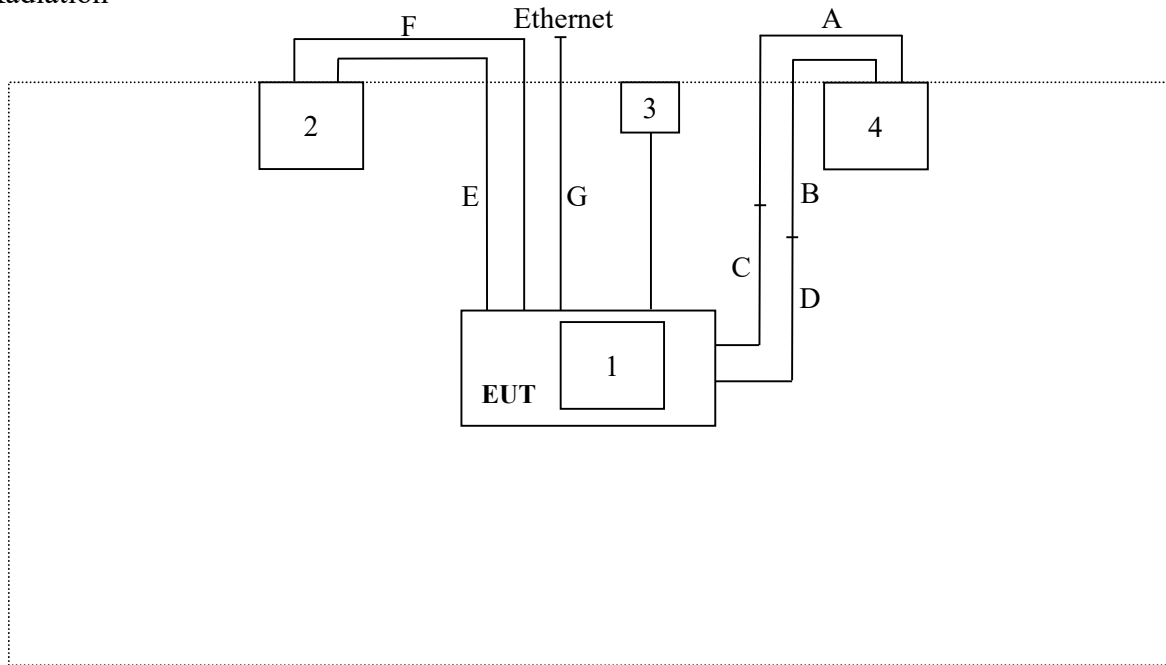

Test Table

AC Conduction

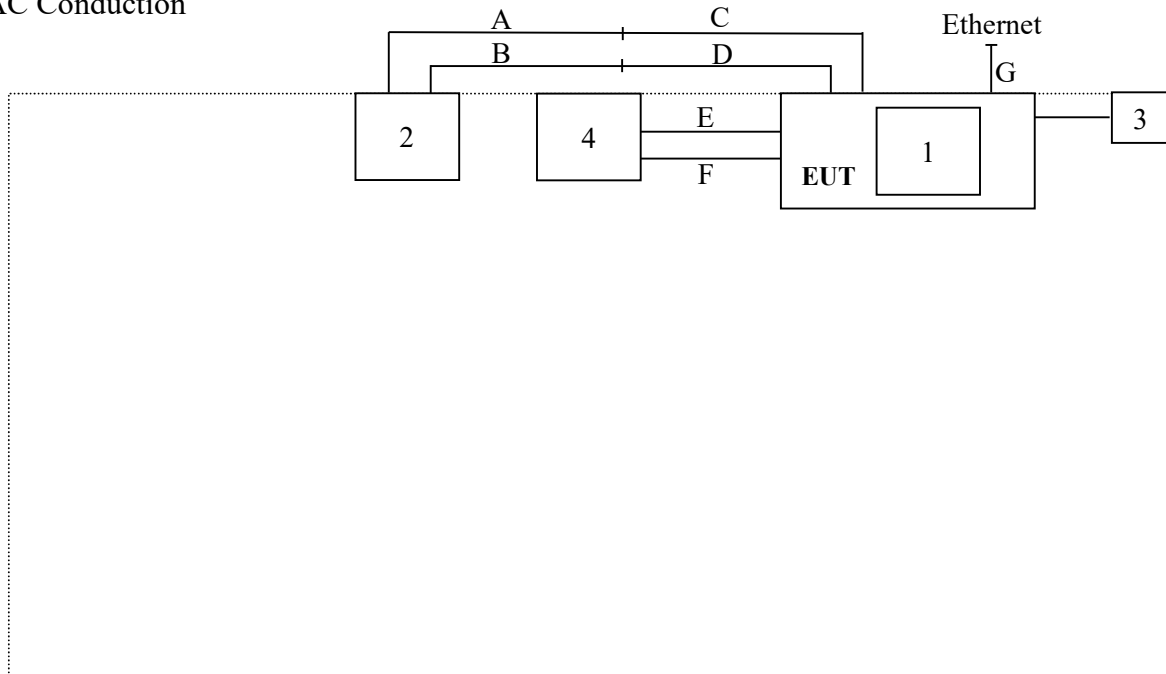

Test Table

1.6 EUT Exercise Software

1. Setup the EUT as shown in Section 1.5
2. Execute software “PUTTY_Ver.0.63.0.0”.
3. Configure the test mode, the test channel, and the data rate.
4. Press “OK” to start the continuous transmit.
5. Verify that the EUT works properly.

1.7 Tested System Details

The types for all equipment, plus descriptions of all cables used in the tested system (including inserted cards) are:

No.	Product	Manufacturer	Model No.	Serial No.	Power Cord
1	PoS	 CASTLES TECHNOLOGY	S1FB	N/A	N/A
2	Notebook PC	ASUS	PU301L	E9NXBC004630388	Non-shielded, No Core, 0.8m
3	Adapter	CASTLES TECHNOLOGY	PW04-945A	N/A	Non-shielded, No Core, 1.5m
4	Notebook PC	acer	N16Q1	NXVD4TA023742254707600	Non-shielded, 1 Core, 0.8m

No.	Signal Cable Type	Signal cable Description
A	RS232 to USB Cable	Shielded, Non-Core, 1.6m
B	RS232 to USB Cable	Shielded, Non-Core, 0.3m
C	DB9 to RJ11	Non-shielded, 1 Core, 1.7m
D	DB9 to RJ11	Non-shielded, 1 Core, 1.7m
E	USB Cable	Shielded, Non-Core, 1m
F	USB Cable	Shielded, Non-Core, 1m
G	LAN Cable	Non-shielded, Non-Core, 12m

1.8 Test Facility

Items	Required (IEC 60068-1)	Actual
Temperature (°C)	15-35	20~25
Humidity (% RH)	25-75	45~55
Barometric pressure (mbar)	860-1060	990~1020

Description: Accredited by TAF
Accredited Number: 2965

Issued by: Wendell Industrial Co., Ltd

Lab Address: 6F/6F-1, No.188, Baoqiao Rd., Xindian Dist.,
New Taipei City 23145, Taiwan R.O.C

Test Lab: Wendell EMC & RF Laboratory

Test Location: No. 119, Wugong 3rd Rd., Wugu Dist.,
New Taipei City 248, Taiwan (R.O.C.)

Designation Number: TW0025

Test Firm Registration Number: 665221

1.9 Measurement Uncertainty

ISO/IEC 17025 requires that an estimate of the measurement uncertainties associated with the emissions test results be included in the report. The measurement uncertainties given below are based on a 95% confidence (level based on a coverage factor K=2)

Measurement Project	Condition	Expended Uncertainty
AC Conducted Emission	0.150 ~ 30 MHz	2.64 dB
Radiated Emission	0.009 ~ 30 MHz	± 4.2 dB
	30 ~ 1000 MHz	± 3.9 dB
	1000 ~ 18000 MHz	± 4.1 dB
	18000 ~ 40000 MHz	± 3.9 dB
RF Power, Conducted	Conducted Measuring	± 0.5 dB
Occupied Bandwidth	Conducted Measuring	± 2.4 %
Power Density	Conducted Measuring	± 1.7 dB
Duty Cycle and Dwell Time	Conducted Measuring	± 1.3 %
Conducted Unwanted Emission Strength	Conducted Measuring	± 1.8 dB
DC Power Supply	--	± 3.2 %
Temperature	--	± 1.1 °C
Humidity	--	± 3.4 %

Note: Please note that the measurement uncertainty are provided for informational purpose only and are not used in determining the Pass/Fail results.

1.10 List of Test Equipment

For Conducted measurements / W08-Conducted Measurement

Equipment	Manufacturer	Model No.	Serial No.	Cal. Date	Due Date
✓ Spectrum analyzer	Keysight	N9010A	SG50420005	2021/08/09	2022/08/08
✓ Wideband Peak Power Meter	Anritsu	ML2495A	1733007	2021/09/07	2022/09/06
✓ Pulse Power Sensor + Precision Adaptor	Anritsu	MA2411B	1726022	2021/09/07	2022/09/06
Temperature Chamber	TAICHY	MHK-225LK	1061121	2021/4/27	2022/4/26
Wireless Connectivity Tester	R&S	CMW270	101307	2021/5/24	2022/5/23
✓ Attenuator	MVE	MVE2211-10	CT-9-056	2021/08/18	2022/08/17
Attenuator	MVE	MVE2211-20	CT-9-057	2021/08/18	2022/08/17
Attenuator	MVE	MVE2211-30	CT-9-058	2021/08/18	2022/08/17
Power Divider	MVE	MVE8546	170826003	2021/08/18	2022/08/17
Power Splitter	MVE	MVE8547	170302047	2021/08/18	2022/08/17
DC Power Supply	GW INSTEK	GPC-3060D	GER817636	2021/08/19	2022/08/18

Remark:

1. All equipments are calibrated every one year.
2. The test instruments marked with “✓” are used to measure the final test results.

For AC Conduction measurements / W08-CE

	Equipment	Manufacturer	Model No.	Serial No.	Cal. Date	Due Date
✓	EMI Test Receiver	R&S	ESR3	102309	2021/6/8	2022/6/7
✓	2-Line V-Network LISN	R&S	ENV216	101185	2021/6/11	2022/6/10
✓	LISN	SCHWARZBECK	NSLK 8127RC	05028	2021/6/11	2022/6/10
✓	Transient Limiter	EM Electronics Corporation	EM-7600	857	2021/6/10	2022/6/9
✓	50ohm Cable	EMCI	EMCCFD300-BM-BM-5000	170612	2021/6/10	2022/6/9
✓	50 ohm terminal impedance	HUBER+SUHNER	50 ohm terminal impedance	CT-1-109-1	2021/6/11	2022/6/10

Remark:

1. All equipments are calibrated every one year.
2. The test instruments marked with “✓” are used to measure the final test results.
3. Test Software version: FARAD EZ-EMC Ver.EMC-CON 3A1

For Radiated measurements / W08-996-2

Equipment	Manufacturer	Model No.	Serial No.	Cal. Date	Due Date
✓ EMI Receiver	Keysight	N9038A	MY51210173	2021/08/20	2022/08/19
✓ Spectrum Analyzer	Keysight	N9010A	MY52220228	2021/08/24	2022/08/23
✓ Loop Antenna	EMCI	LPA600	277	2021/09/02	2022/09/01
✓ TRILOG super broad Antenna	Schwarzbeck	VULB 9168	VULB 9168-700 & 1421	2021/08/11	2022/08/10
✓ Horn Antenna	Schwarzbeck	BBHA 9120D	01767	2021/08/11	2022/08/10
✓ Horn Antenna	Schwarzbeck	BBHA 9170	703	2020/12/03	2021/12/02
✓ Pre-Amplifier	EM	EMC330	060774	2021/08/24	2022/08/23
✓ Pre-Amplifier	EMEC	EM01G18G	060648	2021/08/24	2022/08/23
✓ Pre-Amplifier	JPT	JPA0118-55-303K	1910001800055003	2021/08/25	2022/08/24
✓ Pre-Amplifier	EMCI	EMC184045SE	980515	2021/08/24	2022/08/23
✓ Cable	EMEC	EM-CB400	105060103	2021/08/24	2022/08/23
✓ Cable	EMEC	EM-CB400	105060102	2021/08/24	2022/08/23
✓ Cable	EMEC	EM-CB400	105060101	2021/08/24	2022/08/23
✓ RF Cable	HUBER+SUHNER	SF102	MY2752/2	2021/08/24	2022/08/23
✓ Cable	MVE	280280.LL266.1200	B60028C	2021/08/24	2022/08/23
✓ RF Cable	HUBER+SUHNER	SF102	MY2751/2	2021/08/24	2022/08/23
✓ Cable	EMCI	EMC102-KM-KM-600	190646	2021/08/24	2022/08/23
✓ RF Filter	EMEC	BRF-2400-2500	002	2021/08/26	2022/08/25
RF Filter	EMEC	BRF-5150-5350	104	2021/08/26	2022/08/25
RF Filter	EMEC	BRF-5470-5725	092	2021/08/26	2022/08/25
RF Filter	EMEC	BRF-5725-5875	091	2021/08/26	2022/08/25
✓ RF Filter	EMEC	HPF-2800	002	2021/08/26	2022/08/25
RF Filter	EMEC	HPF-5850	059	2021/08/26	2022/08/25
SMA Notch Filter	MVE	MFN-902.928.S1	190604001	2021/09/02	2022/09/01

Remark:

1. All equipments are calibrated every one year.
2. The test instruments marked with "✓" are used to measure the final test results.
3. Test Software version: FARAD EZ-EMC Ver.WD-03A1-1

2 Test Result

2.1 Antenna Requirement

2.1.1 Applicable Standard

An intentional radiator shall be designed to ensure that no antenna other than that furnished by the responsible party shall be used with the device. The use of a permanently attached antenna or of an antenna that uses a unique coupling to the intentional radiator shall be considered sufficient to comply with the provisions of this section. The manufacturer may design the unit so that a broken antenna can be replaced by the user, but the use of a standard antenna jack or electrical connector is prohibited.

An intentional radiator shall be designed to ensure that no antenna other than as furnished by the responsible party shall be used with the device. If transmitting antennas of directional gain greater than 6dBi are using the power shall be reduced by the amount in dB that the directional gain of the antenna exceeds 6 dBi, for compliance to FCC 47CFR 15.247 (c) requirements.

2.1.2 Antenna Connected Construction

Non-standard antenna connector is used.

2.1.3 Antenna Gain

No.	Manufacturer	Model No.	Antenna Type	Peak Gain
1	ARISTOTLE ENTERPRISES INC.	RFA-25-JP292-70B-70	PCB Antenna	3.7 dBi for 2.4GHz

Description of the operating transmit modes :

- * 802.11b : Only one Antenna mode, this port is Ant-1
- * 802.11g : Only one Antenna mode, this port is Ant-1
- * 802.11n_HT20 : Only one Antenna mode, this port is Ant-1

Directional gain calculation & Conducted Output Power limit after correction :

- * 802.11b : Gain = 3.7 dBi < 6dBi ;
- * 802.11g : Gain = 3.7 dBi < 6dBi ;
- * 802.11n_HT20 : Gain = 3.7 dBi < 6dBi ;

Directional gain calculation & Power Spectral Density limit after correction :

- * 802.11b : Gain = 3.7 dBi < 6dBi ;
- * 802.11g : Gain = 3.7 dBi < 6dBi ;
- * 802.11n_HT20 : Gain = 3.7 dBi < 6dBi ;

2.2 Peak Output Power Measurement

2.2.1 Limit

For systems using digital modulation in the 2400-2483.5MHz, the limit for peak output power is 1W. If transmitting antenna of directional gain greater than 6dBi is used, the peak output power from the intentional radiator shall be reduced below the above stated value by the amount in dB that the directional gain of the antenna exceeds 6 dBi. In case of point-to-point operation, the limit has to be reduced by 1dB for every 3dB that the directional gain of the antenna exceeds 6dBi.

2.2.2 Test Setup

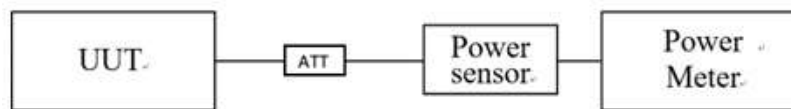

2.2.3 Test Procedure

1. Enable the EUT transmit continuously.
2. Let EUT be connected to the power meter, and record the max. reading.
3. Measurement using a gated RF average power meter, since this measurement is made only during the ON time of the transmitter, no duty cycle correction is required.

2.2.4 Test Result

802.11b

Frequency (MHz)	Peak power (dBm)			Limit (dBm)	Result
	Chain A	Chain B	Total		
2412	20.05	--	--	≤ 30	Pass
2437	20.12	--	--	≤ 30	Pass
2462	20.01	--	--	≤ 30	Pass

Remark:

1. Peak Power = Reading value on power meter + cable loss
2. $10 \text{ Log}(X/\text{mW}) = \text{dBm}$, X=1 watt (Limit)
1 watt = 30 dBm

802.11g

Frequency (MHz)	Peak power (dBm)			Limit (dBm)	Result
	Chain A	Chain B	Total		
2412	21.67	--	--	≤ 30	Pass
2437	22.02	--	--	≤ 30	Pass
2462	20.20	--	--	≤ 30	Pass

Remark:

1. Peak Power = Reading value on power meter + cable loss
2. $10 \text{ Log}(X/\text{mW}) = \text{dBm}$, X=1 watt (Limit)
1 watt = 30 dBm

802.11n HT20

Frequency (MHz)	Peak power (dBm)			Limit (dBm)	Result
	Chain A	Chain B	Total		
2412	20.33	--	--	≤ 30	Pass
2437	21.18	--	--	≤ 30	Pass
2462	19.67	--	--	≤ 30	Pass

Remark:

1. Peak Power = Reading value on power meter + cable loss
2. $10 \text{ Log}(X/\text{mW}) = \text{dBm}$, X=1 watt (Limit)
1 watt = 30 dBm

2.3 6dB Bandwidth Measurement

2.3.1 Limit

The minimum 6 dB bandwidth shall be at least 500 kHz.

2.3.2 Test Setup

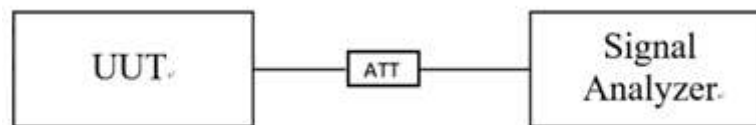

2.3.3 Test Procedure

1. Enable the EUT transmit continuously.
2. Spectrum analyzer set:
 - a) RBW = 100 kHz
 - b) VBW \geq 3 RBW
 - c) Detector = peak
 - d) Sweep time = auto couple
 - e) Trace mode = max hold.

2.3.4 Test Result

802.11b

Frequency (MHz)	6dB BW (kHz)		Limit (kHz)	Result
	Chain A	Chain B		
2412	9051	--	≥ 500	Pass
2437	9057	--	≥ 500	Pass
2462	8569	--	≥ 500	Pass



802.11g

Frequency (MHz)	6dB BW (kHz)		Limit (kHz)	Result
	Chain A	Chain B		
2412	15140	--	≥ 500	Pass
2437	15150	--	≥ 500	Pass
2462	15150	--	≥ 500	Pass

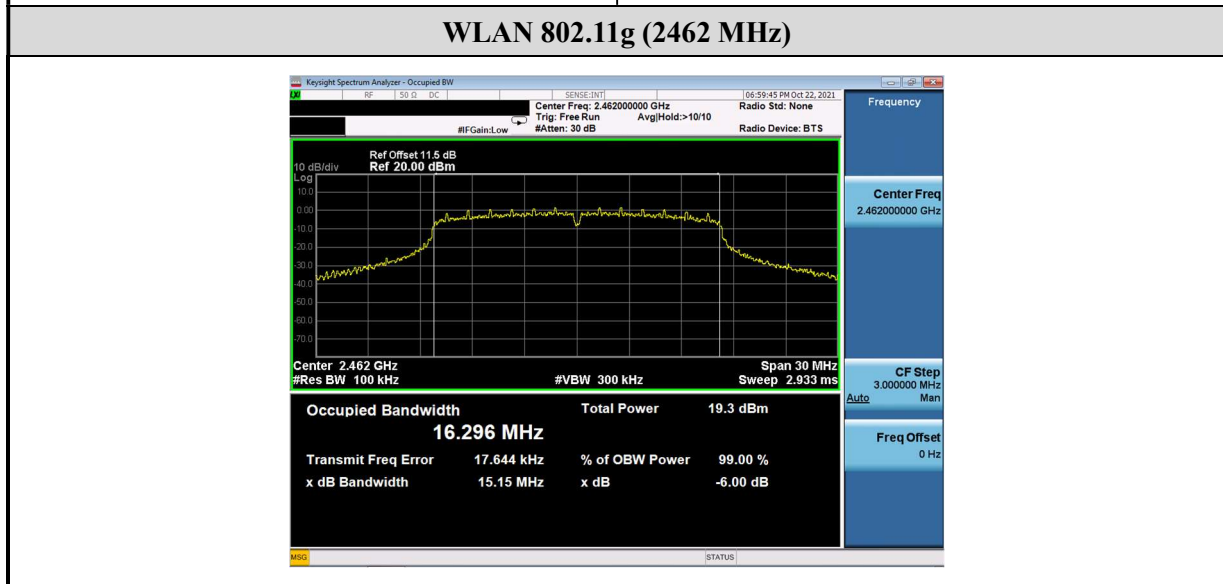

802.11n HT20

Frequency (MHz)	6dB BW (kHz)		Limit (kHz)	Result
	Chain A	Chain B		
2412	15140	--	≥ 500	Pass
2437	15140	--	≥ 500	Pass
2462	15120	--	≥ 500	Pass

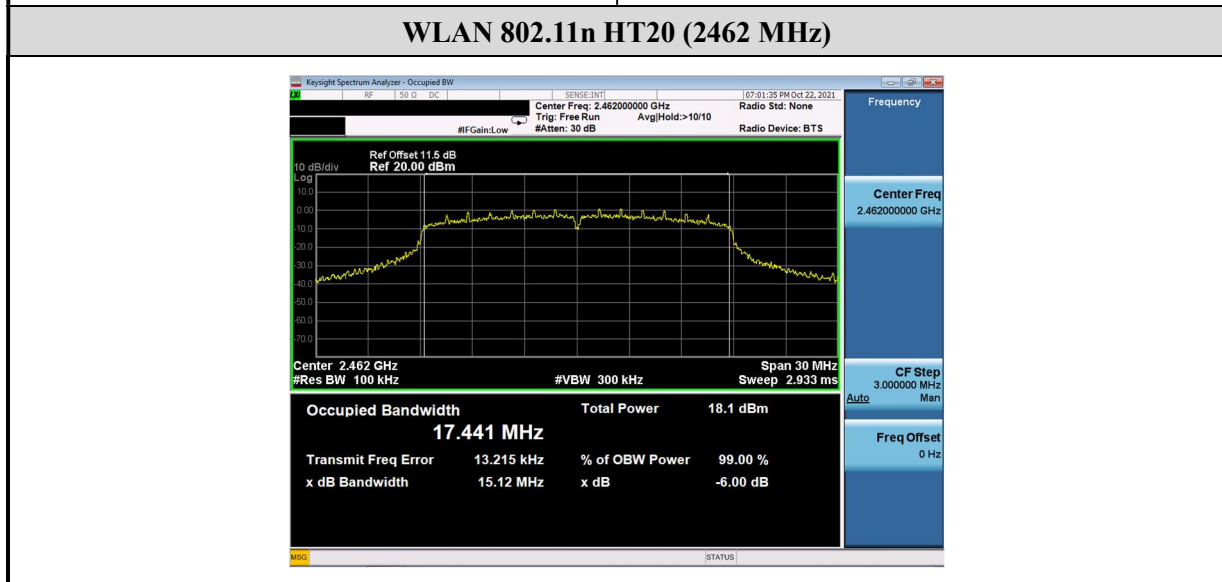
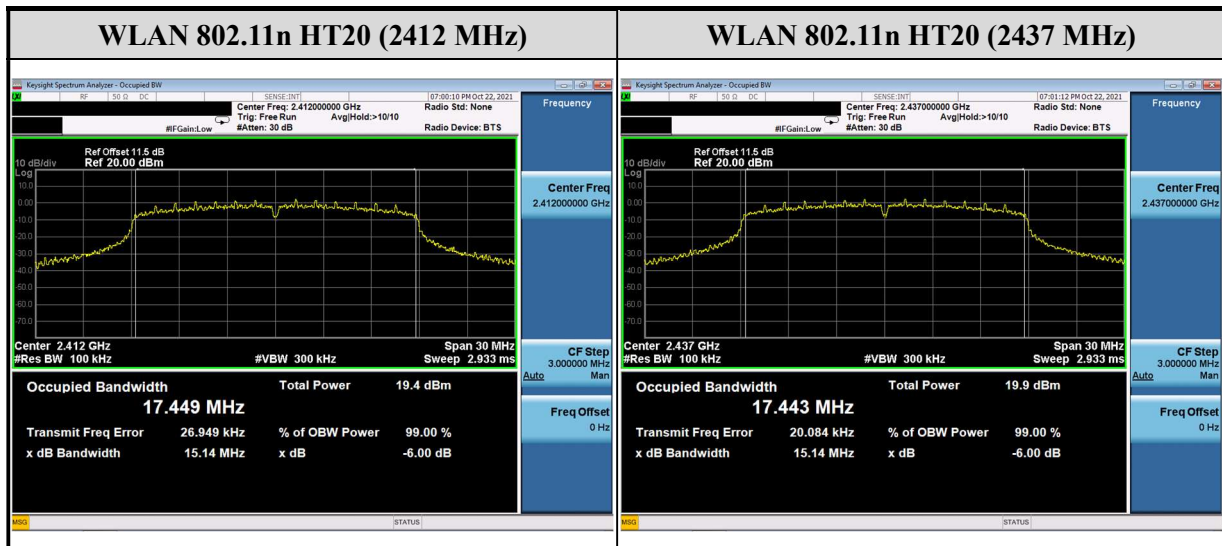

2.4 Power Spectral Density Measurement

2.4.1 Limit

The peak power spectral density shall not be greater than 8dBm in any 3kHz band at any time interval of continuous transmission.

2.4.2 Test Setup

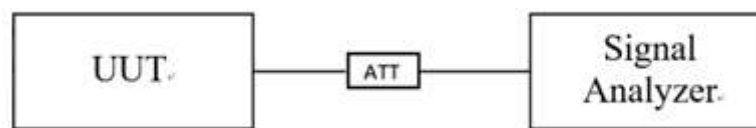

2.4.3 Test Procedure

1. Enable the EUT transmit continuously.
2. Spectrum analyzer set:
 - a) RBW = 3 kHz ~ 100 kHz
 - b) VBW \geq 3 RBW
 - c) Span = 1.5 times DTS Channel 6dB Bandwidth
 - d) Detector = peak
 - e) Sweep time = auto couple
 - f) Trace mode = max hold.

2.4.4 Test Result

802.11b

Frequency (MHz)	Power Spectral Density (dBm)			Limit (dBm)	Result
	Chain A	Chain B	Total		
2412	-2.063	--	--	≤ 8	Pass
2437	-2.648	--	--	≤ 8	Pass
2462	-3.266	--	--	≤ 8	Pass

Remark: PSD = Reading value on spectrum analyzer + cable loss

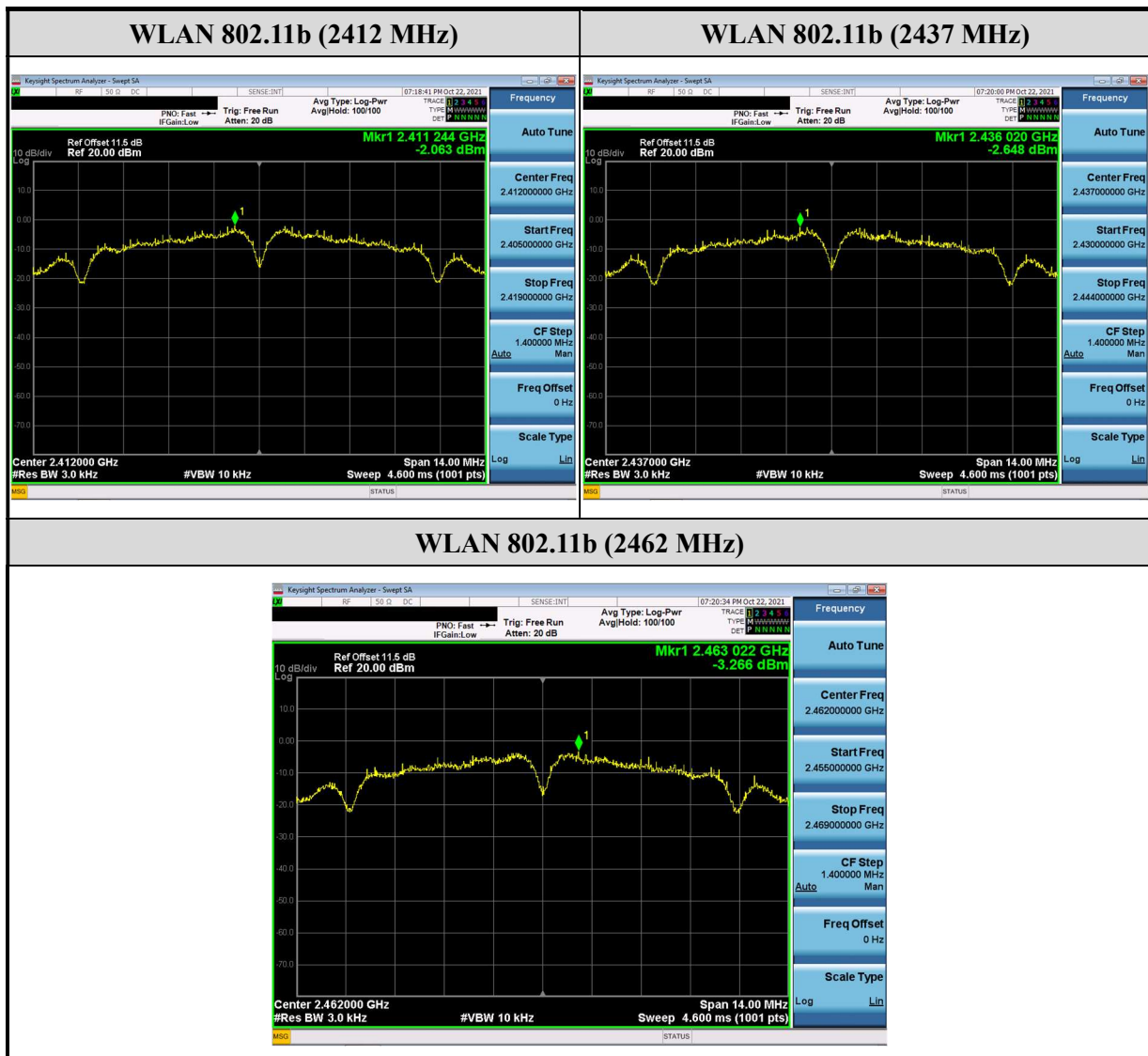

802.11g

Frequency (MHz)	Power Spectral Density (dBm)			Limit (dBm)	Result
	Chain A	Chain B	Total		
2412	-9.430	--	--	≤ 8	Pass
2437	-10.023	--	--	≤ 8	Pass
2462	-11.577	--	--	≤ 8	Pass

Remark: PSD = Reading value on spectrum analyzer + cable loss

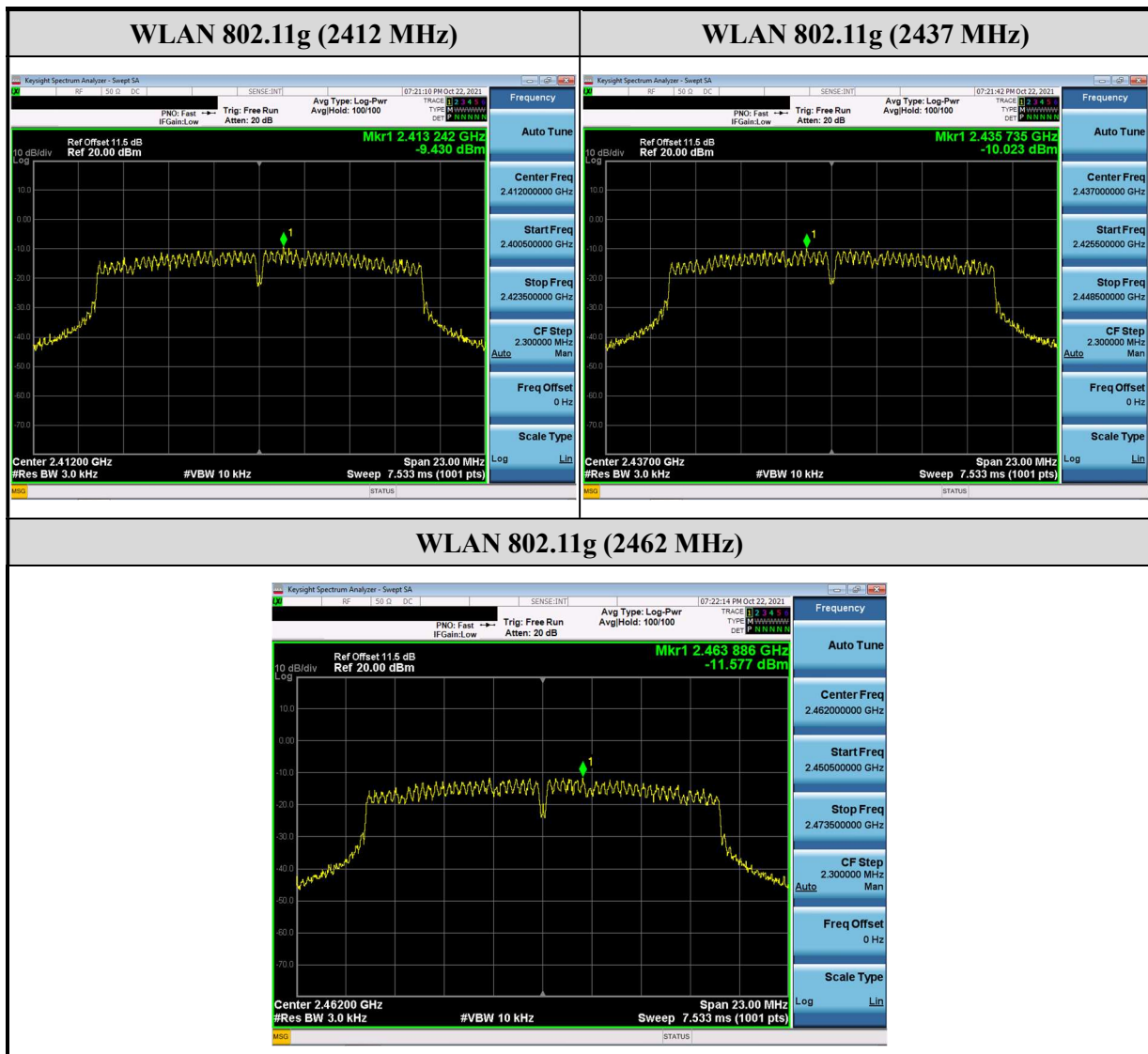

802.11n HT20

Frequency (MHz)	Power Spectral Density (dBm)			Limit (dBm)	Result
	Chain A	Chain B	Total		
2412	-10.871	--	--	≤ 8	Pass
2437	-10.834	--	--	≤ 8	Pass
2462	-12.242	--	--	≤ 8	Pass

Remark: PSD = Reading value on spectrum analyzer + cable loss



2.5 Conducted Band Edges and Spurious Emission Measurement

2.5.1 Limit

In any 100 KHz bandwidth outside the frequency bands in which the spread spectrum intentional radiator is operating, the radio frequency power that is produced by the intentional radiator shall be at least 20dB below that in the 100KHz bandwidth within the band that contains the highest level of the desired power, In addition, radiated emissions which fall in the restricted bands, as defined in must also comply with the radiated emission limits. If the transmitter complies with the conducted power limits based on the use of RMS averaging over a time interval, the attenuation required under this paragraph shall be 30 dB instead of 20 dB

2.5.2 Test Setup

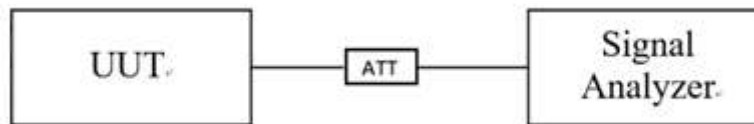

2.5.3 Test Procedure

1. Enable the EUT transmit continuously.
2. Spectrum analyzer set :
 - a) RBW = 100 kHz
 - b) VBW \geq 3 RBW
 - c) Detector = peak
 - d) Sweep time = auto couple
 - e) Trace mode = max hold.

2.5.4 Test Result

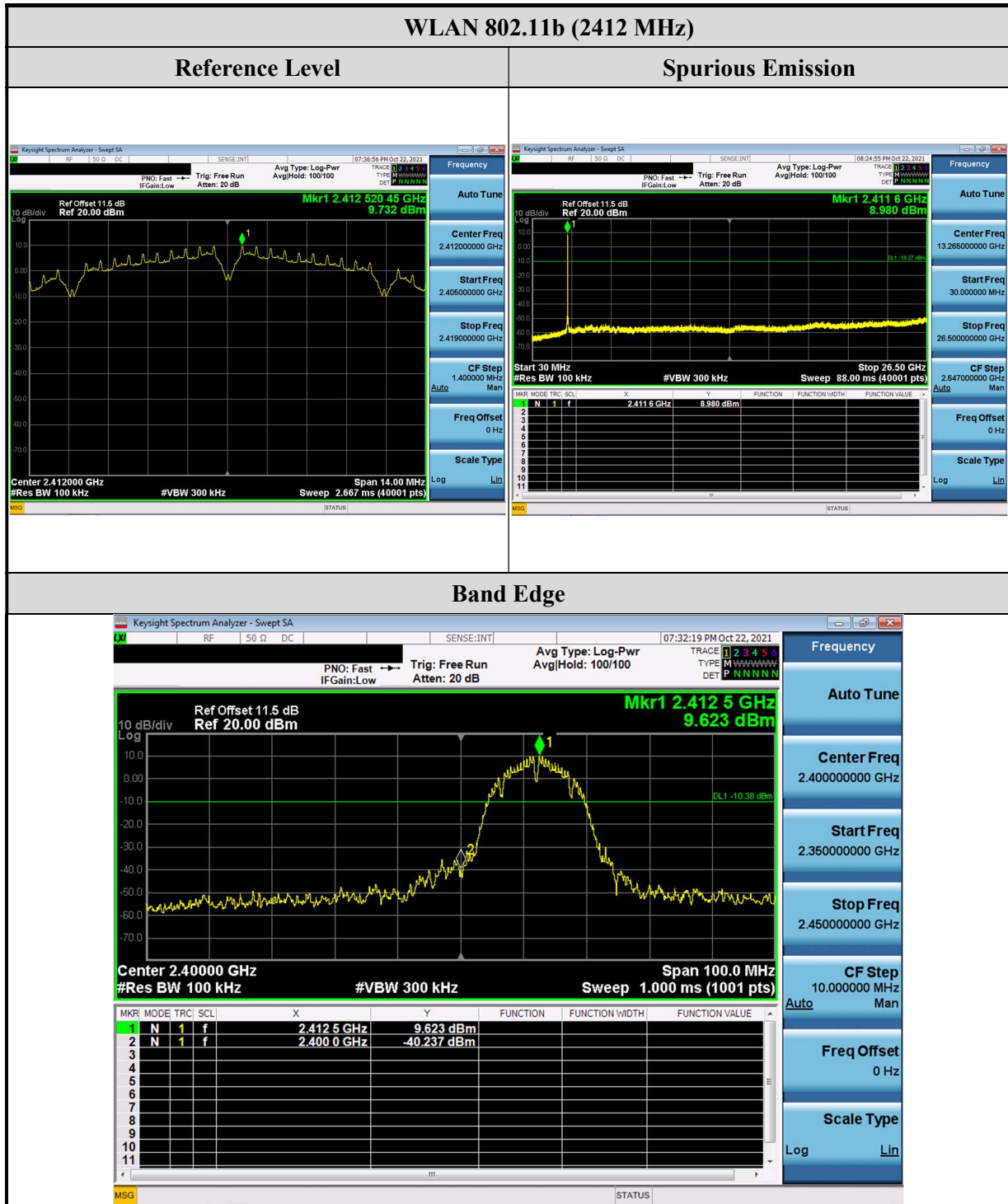

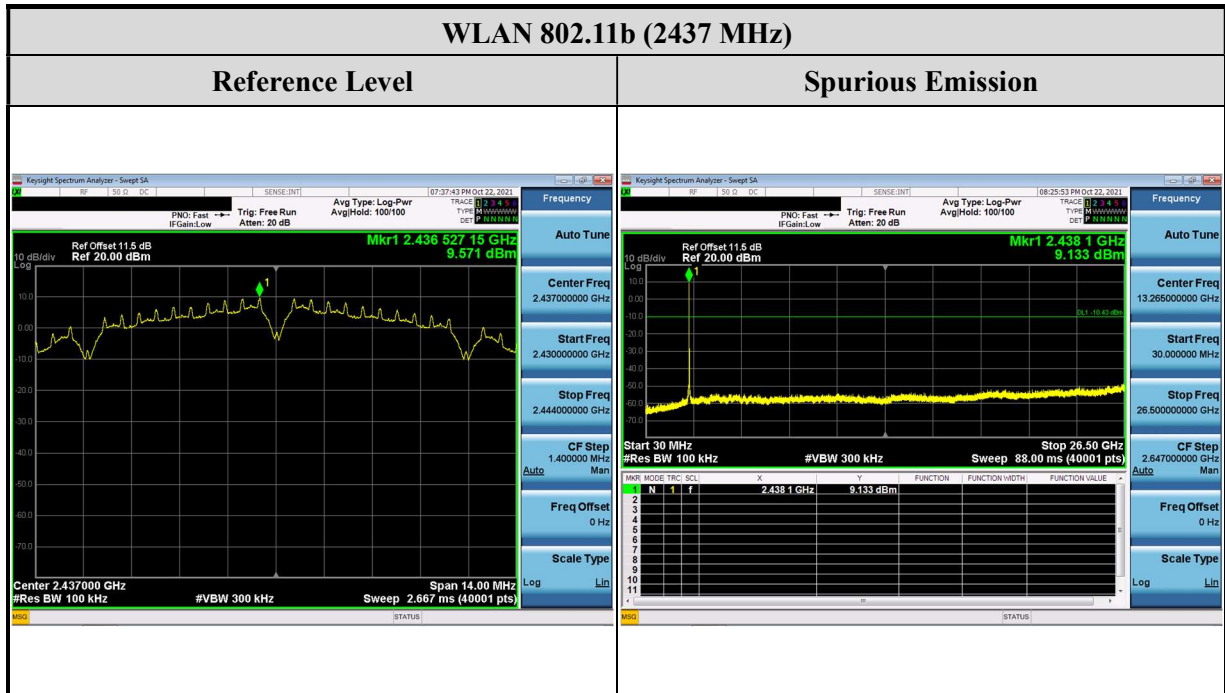

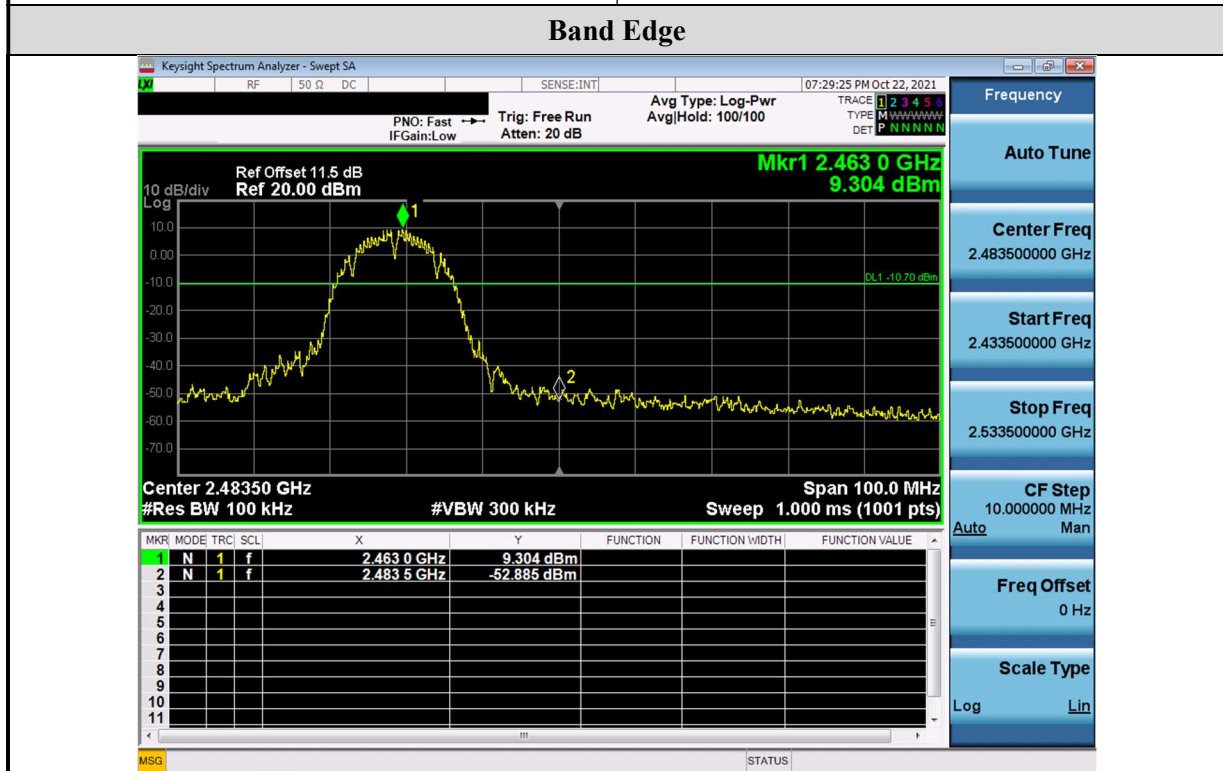
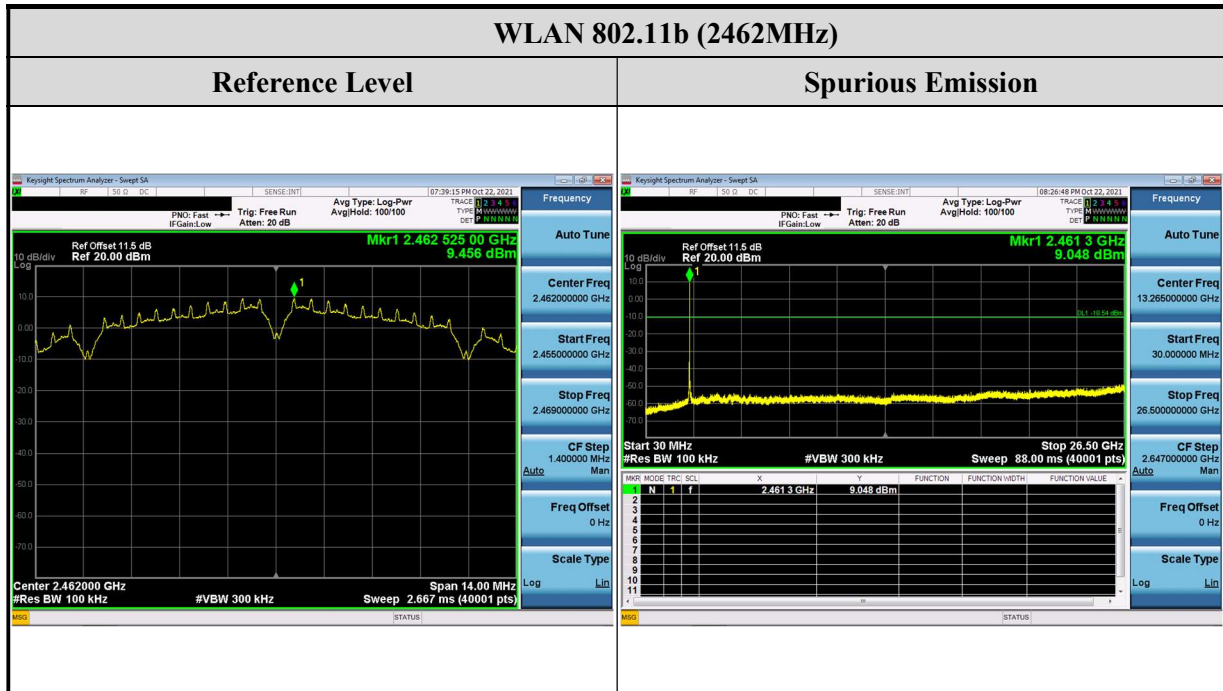

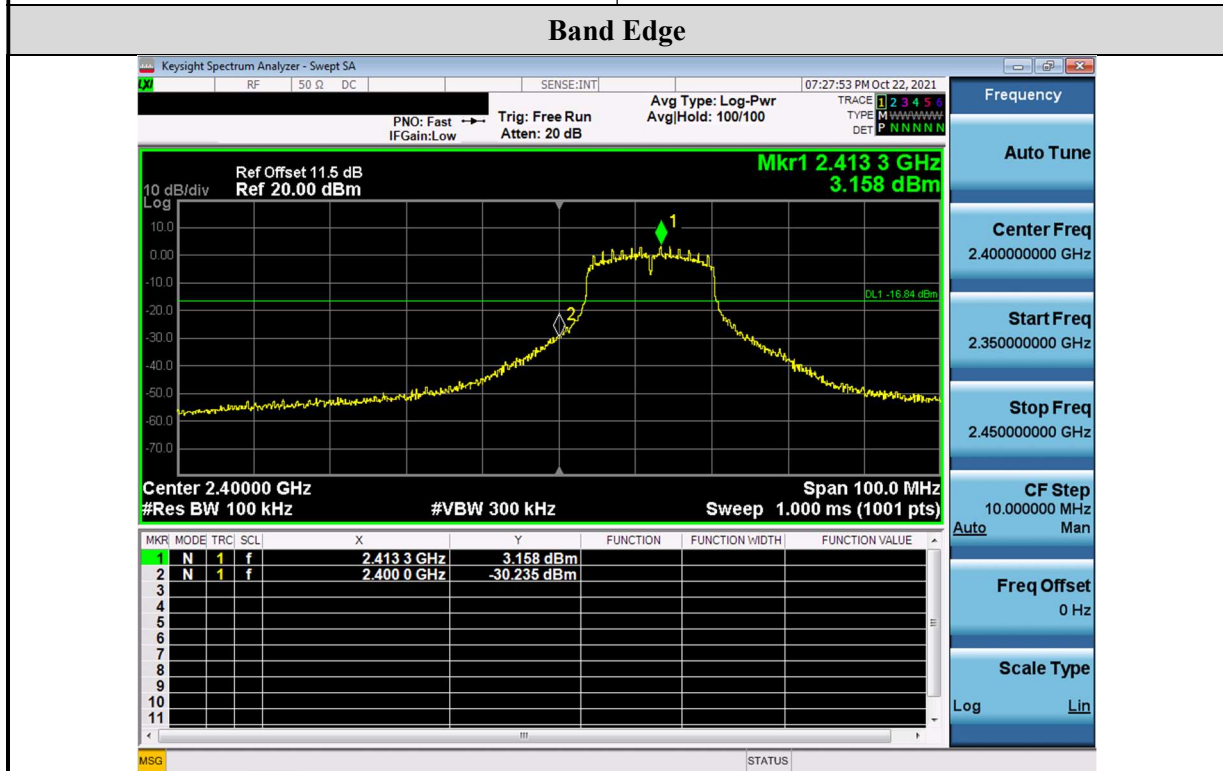
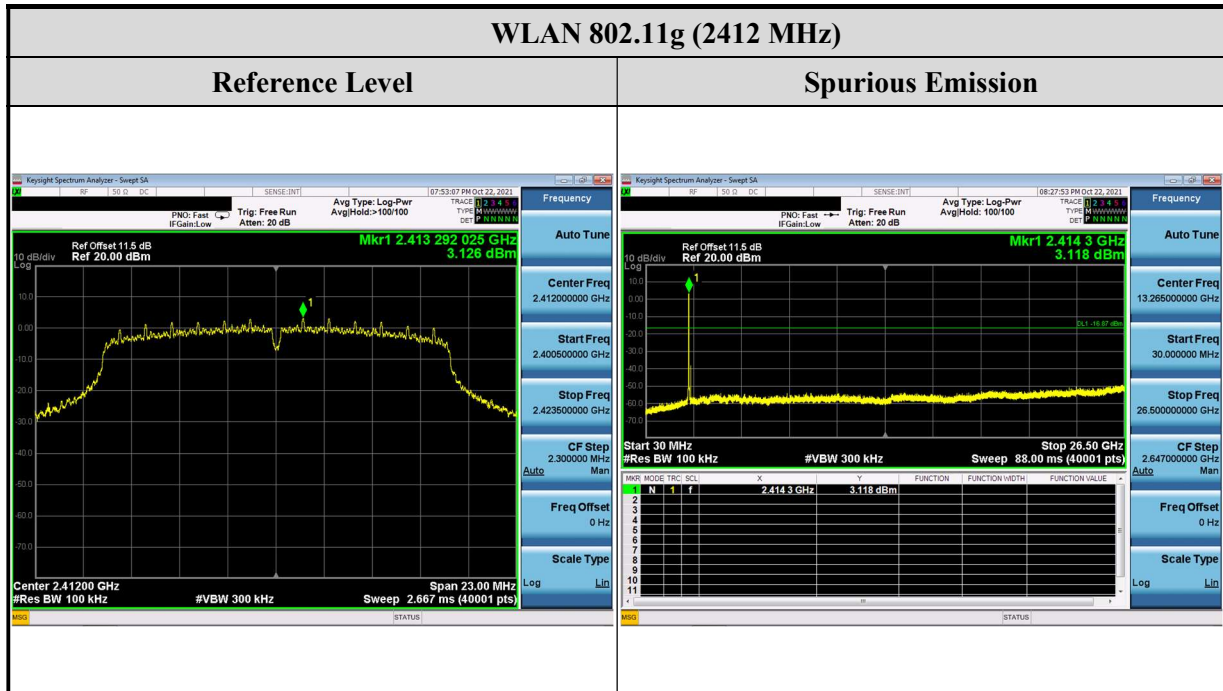

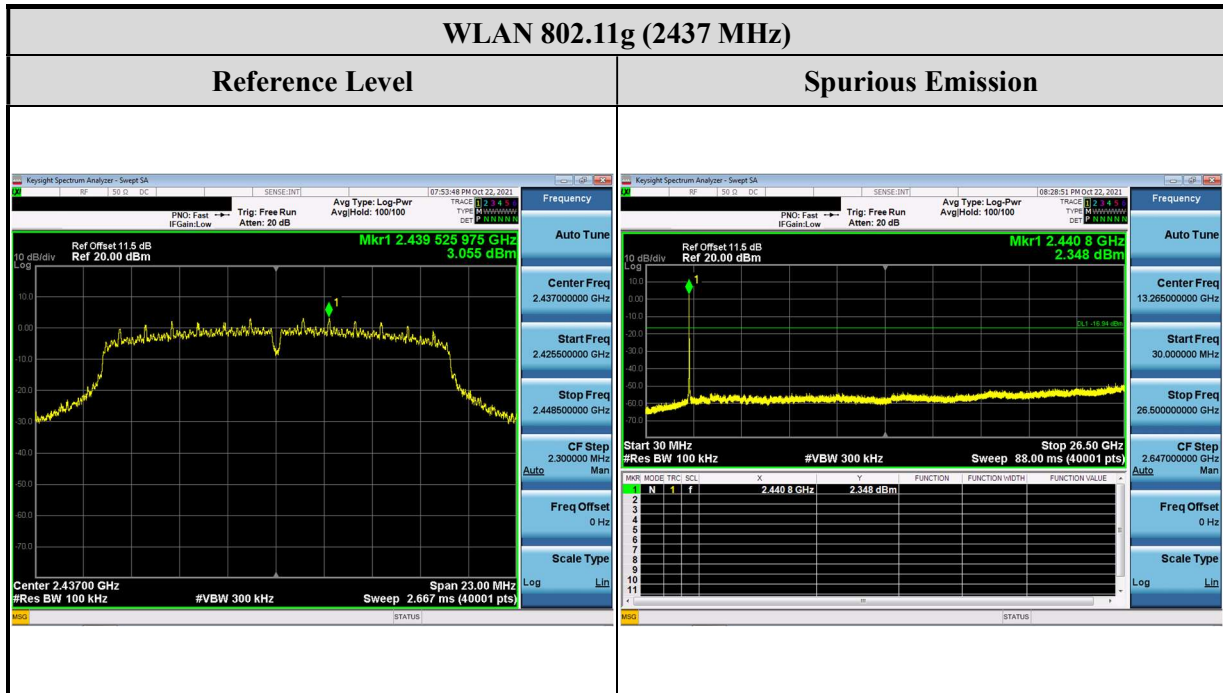

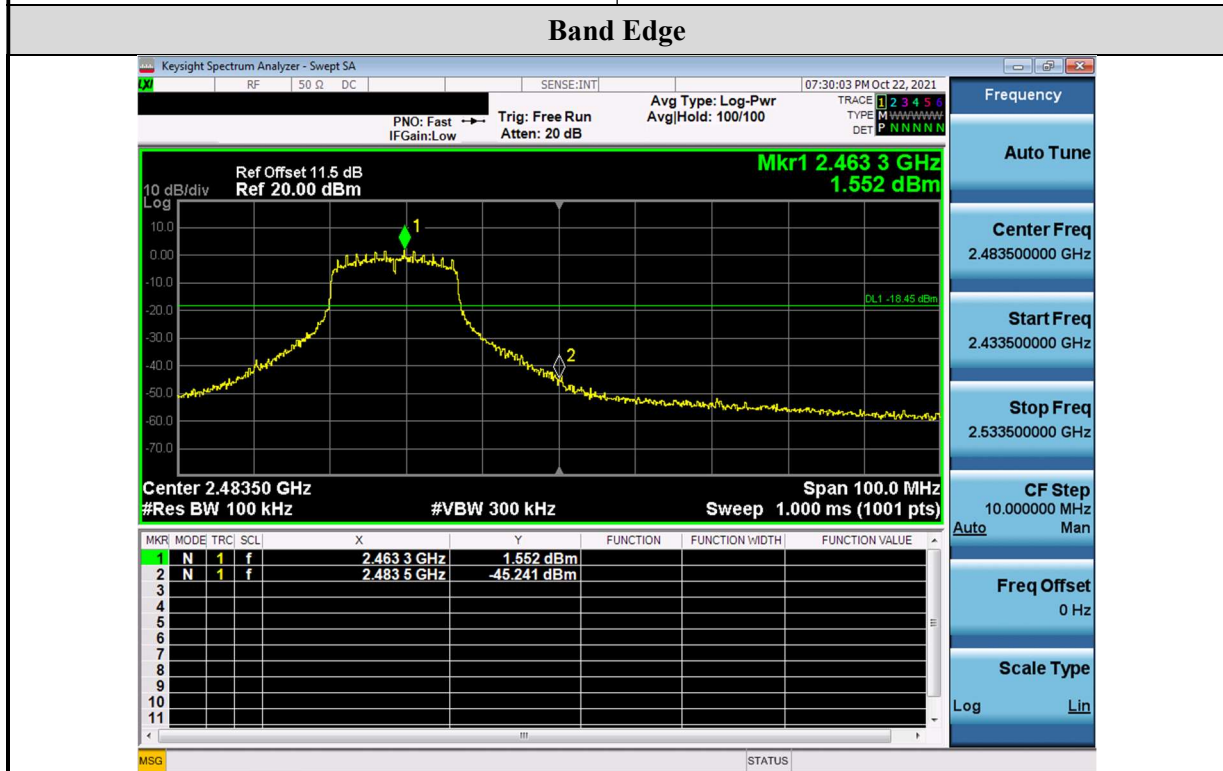
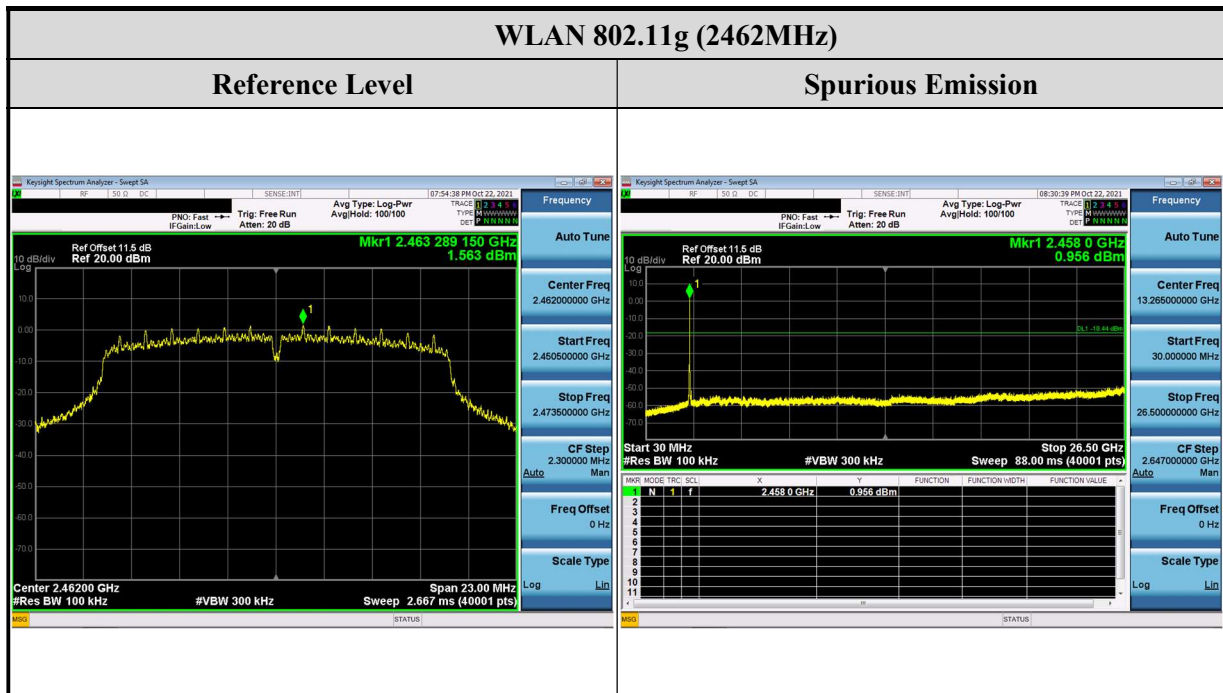

WLAN 802.11n HT20 (2412 MHz)

Reference Level

Spurious Emission

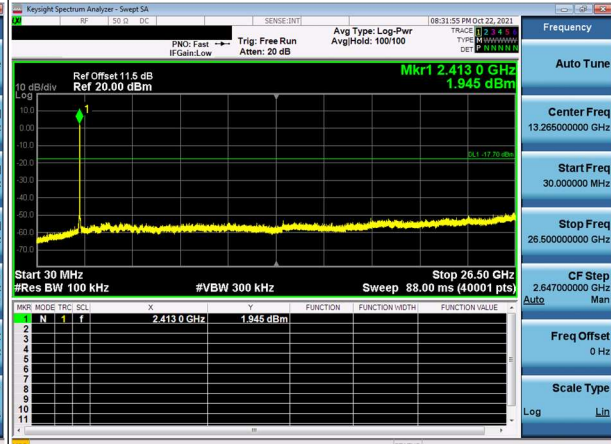

Band Edge

