

MEASUREMENT REPORT

(FCC : Part 15 Subpart C / ANSI C63.4-2003)



Testing Laboratory
1288

Product.....: EZPROX
Trade Name.....: CASTLES
Model No.....: EZProx
Applicant.....: CASTLES TECHNOLOGY CO., LTD..
Applicant Address.....: 2F, No.205, Beishin Rd Sec. 3, Hsin-Tien
City, Taopei Hsien, Taiwan 231, R.O.C.

Report Number	MLT0807P15007
Applicant	CASTLES TECHNOLOGY CO., LTD.
Product	EZPROX
Sample Received Date	2008/07/16

Report Prepared By	Jesse Tien
Signature	
Date Prepared	2008/07/17 ~ 2008/09/05

Report Authorized By	Roger Chen
Signature	
Date Authorized	2009/09/18

Test By

Max Light Technology Co., Ltd.
 Room 5, 8F, No.125, Section 3 Roosevelt Road,
 Taipei, Taiwan., R.O.C.
 Office : Tel: 886-2-2363-2447 Fax: 886-2-2363-2597
 Lab. : Tel: 886-2-2663-3486 Fax: 886-2-2663-3582

It may be duplicated completely for legal use with the allowance of the applicant.
 It shall not be reproduced except in full, without the written approval of our
 laboratory.

Table of Contents :

1. General	5.
2. Conducted Emissions Requirements	8
3. Radiated Emissions Requirements	11
4. Frequency Tolerance Requirements	16.
5. Transmitter Bandwidth Measurements	18.
Appendix I (EUT Test Setup)	21.
Appendix II (Brand / Trade Name & Model No. Multiple Listee)	23.

CERTIFICATION

We here by verify that :

The test data, data evaluation, test procedures and equipment configurations shown in this report were made in accordance with the procedures given in ANSI C63.4-2003. All test were conducted by MLT(Max Light Technology Co., Ltd) Room 5, 8F, No.125, Section 3 Roosevelt Road, Taipei, Taiwan, R.O.C Also, we attest to the accuracy of each.

We further submit that the energy emitted by the sample EUT tested as described in the report is in compliance with radiated emission limit of FCC Rules Part 15 Subpart C Section 15.225 .

Applicant Name	CASTLES TECHNOLOGY CO., LTD.
Applicant Address	2F, No.205, Beishin Rd Sec. 3, Hsin-Tien City, Taopei Hsien, Taiwan 231, R.O.C.
Manufacturer Name	CASTLES TECHNOLOGY CO., LTD.
Manufacturer Address	2F, No.205, Beishin Rd Sec. 3, Hsin-Tien City, Taopei Hsien, Taiwan 231, R.O.C.

Equipment	EZPROX
Model No	EZProx
FCC ID	WIYEZPROX

Report Prepared By	Jesse Tien
Signature	

Report Authorized By	Roger Chen
Signature	

1. GENERAL

1.1 Introduction

The following measurement report is submitted on behalf of CASTLES TECHNOLOGY CO., LTD. In support of an Intentional Periodic Radiator certification in accordance with Part 2 Subpart J and Part 15 Subpart A And C of the Commission's and Regulations.

1.2 Customer Details

Applicant Name	CASTLES TECHNOLOGY CO., LTD.
Applicant Address	2F, No.205, Beishin Rd Sec. 3, Hsin-Tien City, Taopei Hsien, Taiwan 231, R.O.C.
Manufacturer Name	CASTLES TECHNOLOGY CO., LTD.
Manufacturer Address	2F, No.205, Beishin Rd Sec. 3, Hsin-Tien City, Taopei Hsien, Taiwan 231, R.O.C.

1.3 Technical data of EUT

Equipment	EZPROX
Model No	EZProx
FCC ID	WIYEZPROX
Power Type	Powered by AC ADAPTOR

The EUT (EZProx) is card reader. The card reader operation frequency is 13.557MHz.

1.4 Summary Of Tests

Description of Standards and Results

Emission		
Test Item	Standard	Result
Conducted Emission Requirements	Part 15 15.207	PASS
Radiated Emission Requirements	Part 15 15.225(a)(b)(c)(d) Part 15 15.205 , 15.209	PASS
Frequency Tolerance Requirements	Part 15 15.225(e)	PASS
Bandwidth Emission Requirements	Part 15 15.215	PASS

47 CFR Part 15 Subpart C (1.705MHz to 30MHz Emission Limit)

Frequency (MHz)	Field Strength 30m(uV/30m)	Distance (m)	Field Strength 3m (dBuV/m)
1.705 to 13.110	30	3	69.5
13.110 to 13.410	106	3	80.5
13.410 to 13.553	334	3	90.5
13.553 to 13.567	15848	3	124.0
13.567 to 13.710	334	3	90.5
13.710 to 14.010	106	3	80.5
14.010 to 30.000	30	3	69.5

Note : Use quasi-peak meter.

$$\text{Distance Factor Limit (3m)} = \text{Limit (30m)} + 40\log(30/3)$$

15.209 Radiated Emission Limits; General Requirements.

Frequency (MHz)	Field Strength (uV/ m)	dBuV/m	Distance (m)
0.009 – 0.490	2400/F(kHz)		300
0.490 – 1.705	24000/F(kHz)		30
1.705 – 30.0	30	29.5	30
30 - 88	100**	40.0	3
88 - 216	150**	43.5	3
216 - 960	200**	46.0	3
Above 960	500	54.0	3

1.5 Description of Support Equipment

The EUT itself forms a system. No support equipment is required for its normal operation.

1.6 Configuration of System Under Test

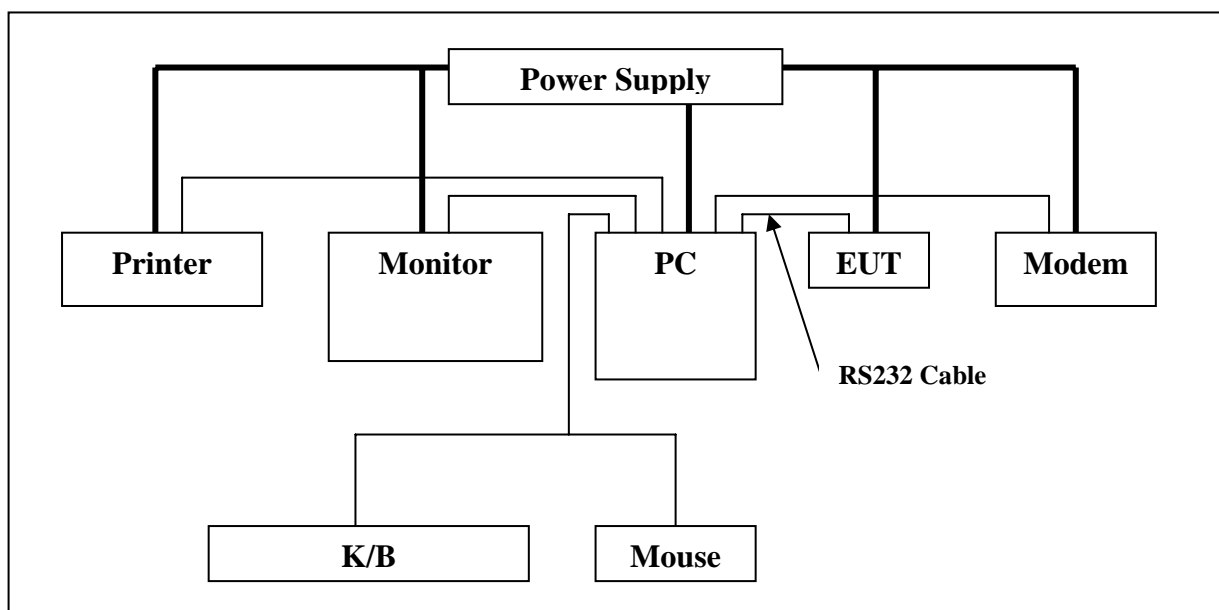

1.7 Test Procedure

All measurements contained in this report were performed according to the techniques described in Measurement procedure ANSI C63.4: 2003 "Measurement of Intentional Radiators."

1.8 General Test Condition

The conditions under which the EUT operates were varied to determine their effect on the equipment's emission characteristics. The final configuration of the test system and the mode of operation used during these tests was chosen as that which produced the highest emission levels. However, only those conditions which the EUT was considered likely to encounter in normal use were investigated.

2. Conducted Emissions Requirements

2.1 General & Setup :

The power line conducted emission measurements were performed in a shielded enclosure. The EUT was assembled on a wooden table which is 80 centimeters high, was placed 40 centimeters from the back wall and at least 1 meter from the sidewall.

Power was fed to the EUT from the public utility power grid through a line filter and EMCO Model 3825/2 Line Impedance Stabilization Networks (LISN). The LISN housing, measuring instrumentation case, ground plane, etc., were electrically bonded together at the same RF potential. The Spectrum analyzer was connected to the AC line through an isolation transformer. The 50-ohm output of the LISN was connected to the spectrum analyzer directly. Conducted emission levels were in the CISPR quasi-peak detection mode. The analyzer's 6 dB bandwidth was set to 9 KHz. No post-detector video filter was used.

The spectrum was scanned from 150 KHz to 30 MHz. The physical arrangement of the test system and associated cabling was varied (within the scope of arrangements likely to be encountered in actual use) to determine the effect on the unit's emanations in amplitude and frequency. All spurious emission frequencies were observed. The highest emission amplitudes relative to the appropriate limit were measured and have been recorded in paragraph 2.5.

2.2 Test Equipment List:

Item	Mfr/Brand	Instruments	Serial No.	Model/Type No.	Calibrated Date	Next Cali. Date
1.	Agilent	Spectrum Analyzer	US40240137	E7403A	2008/01/29	2009/01/29
2.	AFJ	EMI Receiver	55090002141	ER 55C	2008/04/11	2009/04/11
3.	EMCO	LISN	2658	3825/2	2008/03/21	2009/03/21
4.	TESEQ	ISN	24801	ISN T8	2008/02/05	2009/02/05

2.3 Test condition:

EUT tested in accordance with the specifications given by the manufacturer, and exercised in the most unfavorable manner.

2.4 Conducted Emissions Limits:

FCC Part 15

Frequency range (MHz)	Limits (dBuV)			
	Class A		Class B	
	QP	Avg.	QP	Avg.
0.15 to 0.50	79	66	66 to 56	56 to 46
0.50 to 5.0	73	60	56	46
5.0 to 30	73	60	60	50

2.5 Measurement Data Of Conducted Emissions:

2.5.1 Conducted Emissions

The following table show a summary of the highest emissions of power line conducted emissions to the HOT and NEUTRAL conductor of the EUT power.

Test Mode : Transmit

Conducted Emissions (Class B)							
Mode	Frequency (MHz)	Read (dBuV/m)	Factor (dB)	Quasi-Peak (dBuV)	Limits (dBuV)	Average (dBuV)	Limits (dBuV)
L1	0.18	46.45	1.92	48.48	64.37	--	54.37
	0.24	42.84	1.98	44.82	62.04	--	52.04
	0.30	40.39	2.00	42.39	60.15	--	50.15
	0.37	35.60	2.00	37.60	58.61	--	48.61
	0.54	36.53	1.98	38.51	56	--	46
	0.72	34.75	1.98	36.73	56	--	46
	1.21	34.20	1.97	36.17	56	--	46
L2	0.18	46.64	1.76	48.40	64.37	--	54.37
	0.25	42.77	1.73	44.50	61.91	--	51.91
	0.36	36.56	1.71	38.27	58.65	--	48.65
	0.54	36.32	1.67	37.99	56	--	46
	0.79	36.70	1.64	38.34	56	--	46
	1.03	34.68	1.62	36.30	56	--	46
	5.11	32.01	1.58	33.59	60	--	50

- Notes :**
- L1: One end & Ground L2: The other end & Ground
 - Height of table on which the EUT was placed : 0.8 m.
 - The Quasi-Peak Value have already met the Average Value Limit showed on above limits.
 - The above test results are obtained under the normal condition.
 - Amplitude(Quasi peak) = Reading Amplitude + Factor
 - Factor = Cable loss

3. Radiated Emissions Requirements

3.1 General:

Prior to open-field testing, the EUT was placed in a shielded enclosure and scanned at a close distance to determine its emission characteristics. The physical arrangement of the EUT was varied (within the scope of arrangements likely to be encountered in actual use) to determine the effect on the unit's emanations in amplitude, directivity, and frequency. The exact system configuration which produced the highest emissions was noted so it could be reproduced later during the open-field tests. This was done to ensure that the final measurements would demonstrate the worst-case interference potential of the EUT.

3.2 Test Procedure:

Final radiation measurements were made on a three-meter, open-field test site. The EUT system was placed on a nonconductive turntable which is 0.8 meters height, top surface 1.0 x 1.5 meter. The spectrum was examined from 50 kHz to 2.5 GHz in order to cover the whole spectrum below 10th harmonic which could generate from the EUT. During the test, EUT was set to transmit continuously & Measurements spectrum range from 30 MHz to 5 GHz is investigated.

For measurements from 30 MHz to 1 GHz the resolution bandwidth is set to 100 kHz for peak detection measurements or 120 kHz for quasi-peak detection measurements. Peak detection is used unless otherwise noted as quasi-peak.

For frequency range below 30MHz the Loop antenna was used at 3 m measurement distance with antenna heights of 1 m to 4 m and antenna loop front and side faced to the EUT. The axis of the antenna was rotated to maximize the emission. A CISPR quasi-peak detector is used for measurements below 30MHz and RBW/VBW is 9kHz/30kHz.

The limit 1.75MHz to 30MHz in 15.225(a)(b)(c)(d) are specified at 30 meters, and measurements were made at 3 meters, the limit is translated to 3 meters by using a formula as follows: $\text{Limit}_{3m} = \text{Limit}_{30m} + (40 \log(30m/3)) = 40\text{dB}$

A nonconductive material surrounded the EUT to supporting the EUT for standing on three orthogonal planes. At each condition, the EUT was rotated 360 degrees, and the antenna was raised and lowered from one to four meters to find the maximum emission levels. Measurements were taken using both horizontal and vertical antenna polarization.

3.3 Test Equipment List:

Item	Mfr/Brand	Instruments	Serial No.	Model/Type No.	Calibrated Date	Next Cali. Date
1.	HP	Spectrum Analyzer	73412A00110	8591EM	2008/03/27	2009/03/27
2.	HP	Pre Amplifier	2944A08954	8447D	2008/03/27	2009/03/27
3.	HP	Pre Amplifier	3113A05475	8447F	2008/03/27	2009/03/27
4.	EMCO	Biconilog Antenna	00044568	3142C	2008/08/05	2009/08/05
5.	Agilent	Spectrum Analyzer	US44300422	E4446A	2008/04/22	2009/04/22
6.	HP	Pre Amplifier	3008A01463	8449B	2008/03/21	2009/03/21
7.	SCHWARZBECK	Horn Antenna	304	BBHA 9120 D	2007/09/04	2008/09/04
8.	HP	Pre Amplifier	1937A00786	8447F	2008/04/11	2009/04/11
9.	SCHWARZBECK	Loop Antenna	9190	HFRAE 5162	2007/09/10	2008/09/10

3.4 Measurement Data Of Radiated Emissions:

3.4.1 Open Field Radiated Emissions (1.7MHz to 30MHz)

The highest peak values of radiated emissions from the EUT transmit level, at various antenna heights and antenna polarization. are recorded on the following

Test Mode : Transmitter

Radiated Emissions (HORIZONTAL)									
Frequency (MHz)	Amplitude (dBuV/m)	Read (dBuV/m)	Factor (dB)	Ant. (m)	Table (Deg)	Dist (dB)	Actual Amp (dBuV/m)	Limit (dBuV/m)	Margin (dB)
6.35	62.36	81.22	-18.86	1	120	40.0	22.36	29.5	-7.14
13.27	61.51	79.06	-17.55	1	120	40.0	21.51	40.5	-18.99
13.47	61.03	78.58	-17.55	1	120	40.0	21.03	50.5	-29.47
13.557	95.66	113.21	-17.55	1	120	40.0	55.66	84.0	-28.34
13.63	61.87	79.24	-17.55	1	120	40.0	21.87	50.5	-28.63
13.83	61.93	79.48	-17.55	1	120	40.0	21.93	40.5	-18.57
23.69	62.42	79.91	-17.49	1	120	40.0	22.42	29.5	-7.08

Radiated Emissions (VERTICAL)									
Frequency (MHz)	Amplitude (dBuV/m)	Read (dBuV/m)	Factor (dB)	Ant. (m)	Table (Deg)	Dist (dB)	Actual Amp (dBuV/m)	Limit (dBuV/m)	Margin (dB)
8.37	63.02	81.70	-18.68	1	20	40.0	23.02	29.5	-6.48
13.28	61.15	78.70	-17.55	1	20	40.0	21.15	40.5	-19.35
13.34	61.87	79.42	-17.55	1	20	40.0	21.87	50.5	-28.63
13.557	94.62	112.17	-17.55	1	20	40.0	54.62	84.0	-29.38
13.63	62.06	79.61	-17.55	1	20	40.0	22.06	50.5	-28.44
13.72	61.73	79.28	-17.55	1	20	40.0	21.73	40.5	-18.77
25.41	62.46	79.56	-17.10	1	20	40.0	22.46	29.5	-7.04

Notes : 1. Amplitude = Reading Amplitude + Factor

Factor = Amplifier gain+ Cable loss + Antenna factor
(Auto calculate in spectrum analyzer)

2. Ant (m) = Antenna height.

3. Distance of Measurement : 3 Meter

4. Dist(dB) = $40\log(30/3) = 40\text{dB}$ (30 = 30m , 3 = 3m)

5. Height of table for EUT placed: 0.8 Meter.

6. Actual Amp = Amplitude – Dist (30m to 3m)

7. Margin= .Actual Amp – Limits

3.4.2 Open Field Radiated Emissions (30MHz to 1GHz)

The highest peak values of radiated emissions from the EUT at various antenna heights, antenna polarization, EUT orientation, etc. are recorded on the following

Test Mode : Transmitter

Radiated Emissions (HORIZONTAL)							
Frequency (MHz)	Amplitude (dBuV/m)	Read (dBuV/m)	Factor (dB)	Ant. (m)	Table (Deg)	Limits (dBuV/m)	Margin (dB)
135.60	40.03	71.42	-31.39	2.5	210	43.5	-3.47
162.72	42.31	70.96	-28.65	2	220	43.5	-1.19
189.57	42.33	70.06	-27.73	2	190	43.5	-1.17
192.02	42.01	69.69	-27.68	1.5	140	43.5	-1.49
216.94	44.83	71.15	-26.32	1	300	46	-1.17
359.45	44.36	65.93	-21.57	1	130	46	-1.64
379.64	44.86	66.04	-21.18	1	320	46	-1.14
406.76	44.80	65.23	-20.43	1	290	46	-1.20
433.87	43.85	63.90	-20.05	1	200	46	-2.15
460.99	44.93	64.53	-19.60	1	160	46	-1.07
514.60	44.54	62.73	-18.19	1	150	46	-1.46

- Notes :**
1. Margin = Amplitude - Limits
 2. Distance of Measurement : 3 Meter
 3. Height of table for EUT placed: 0.8 Meter.
 4. Amplitude = Reading Amplitude + Factor
 5. Factor = Amplifier gain + Cable loss + Antenna factor
(Auto calculate in spectrum analyzer)

3.4.3 Open Field Radiated Emissions (30MHz to 1GHz)

The highest peak values of radiated emissions from the EUT at various antenna heights, antenna polarization, EUT orientation , etc. are recorded on the following

Test Mode : Transmitter

Radiated Emissions (VERTICAL)							
Frequency (MHz)	Amplitude (dBuV/m)	Read (dBuV/m)	Factor (dB)	Ant. (m)	Table (Deg)	Limits (dBuV/m)	Margin (dB)
40.70	37.58	66.94	-29.36	1	280	40	-2.42
162.72	41.07	69.57	-28.50	1	300	43.5	-2.43
192.03	42.59	70.23	-27.64	1	120	43.5	-0.91
216.92	45.43	71.62	-26.19	1	310	46	-0.57
406.75	42.96	63.30	-20.34	1	90	46	-3.04
433.87	44.60	64.64	-20.04	1.5	170	46	-1.40
461.00	44.74	64.36	-19.62	2	280	46	-1.26
474.53	45.49	64.91	-19.42	2	240	46	-0.51
488.11	45.16	64.27	-19.11	1.5	200	46	-0.84
507.20	43.17	61.53	-18.36	1.5	260	46	-2.83
515.23	44.86	62.64	-17.78	1	310	46	-1.14

- Notes :**
- 1.Margin= Amplitude - Limits
 - 2.Distance of Measurement : 3 Meter
 - 3.Height of table for EUT placed: 0.8 Meter.
 - 4.Amplitude= Reading Amplitude + Factor
 - 5.Factor = Amplifier gain+ Cable loss + Antenna factor
(Auto calculate in spectrum analyzer)

4. Frequency Tolerance Requirements

4.1 Test Condition & Setup :

15.225(e) The frequency tolerance of the carrier signal shall be maintained within $\pm 0.01\%$ of the operating frequency over a temperature variation of -20 degrees to +50 degrees C at normal supply voltage, and for a variation in the primary supply voltage from 85% to 115% of the rated supply voltage at a temperature of 20 degrees C. For battery operated equipment, the equipment tests shall be performed using a new battery.

The resolution bandwidth of the spectrum analyzer was set to 10Hz., SPAN set to 2kHz. The detector function was set to peak and hold mode read frequency.

4.2 Test Instruments Configuration:

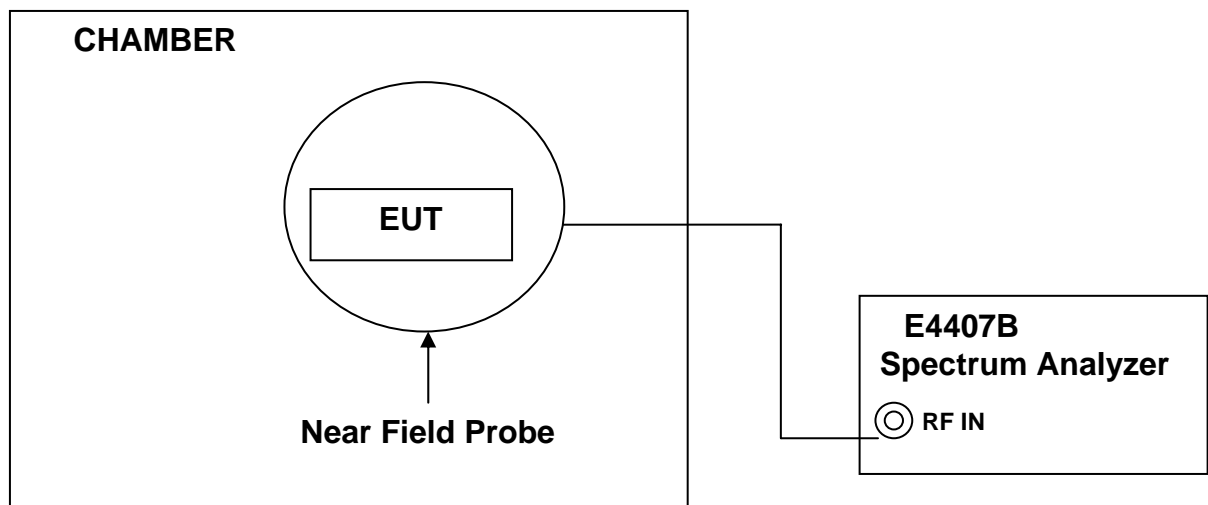

4.3 Test Equipment List:

Item	Mfr/Brand	Instruments	Serial No.	Model/Type No.	Calibrated Date	Next Cali. Date
1.	Agilent	Spectrum Analyzer	US44300422	E4446A	2008/04/22	2009/04/22
2.	Agilent	Spectrum Analyzer	US39240419	E4407B	2008/01/22	2009/01/22
3.	HP	Pre Amplifier	1937A00786	8447F	2008/04/11	2009/04/11
4.	EM	Probe	107328	EM-6992	N/A	N/A
5.	GIANT FORCE	CHAMBER	GP-94272-1	GTH-064S	2008/07/30	2009/07/30

4.4 Test Result:

Test Conditions		Result		Limit
Temperature (°C)	Voltage (AC)	Frequency (MHz)	Tolerance ±%	<0.01%
+20°C	120V	13.557490	0.004	PASS
	102V	13.557480	0.004	PASS
	138V	13.557480	0.004	PASS
-20°C	120V	13.557410	0.003	PASS
	102V	13.557410	0.003	PASS
	138V	13.557415	0.003	PASS
+50°C	120V	13.557485	0.004	PASS
	102V	13.557485	0.004	PASS
	138V	13.557485	0.004	PASS

Note :1. AC input : 120V/60Hz (100%)
: 102V/60Hz (85%)
: 138V/60Hz (115%)

2. Operation frequency 13.557MHz

5. Transmitter Bandwidth Measurement

4.1 Test Condition & Setup :

The transmitter bandwidth measurements were performed in a shielded enclosure. The EUT was placed on a wooded table which is 0.8 meters height and a near field probe was used at a testing, EUT was set to transmit continuously.

The resolution bandwidth of the spectrum analyzer was set to 1kHz. The detector function was set to peak and hold mode to clearly observe the components. The maximum permitted bandwidth at 13.553MHz to 13.567MHz with respect to the reference level specified of the center frequency of the EUT.

4.2 Test Instruments Configuration:

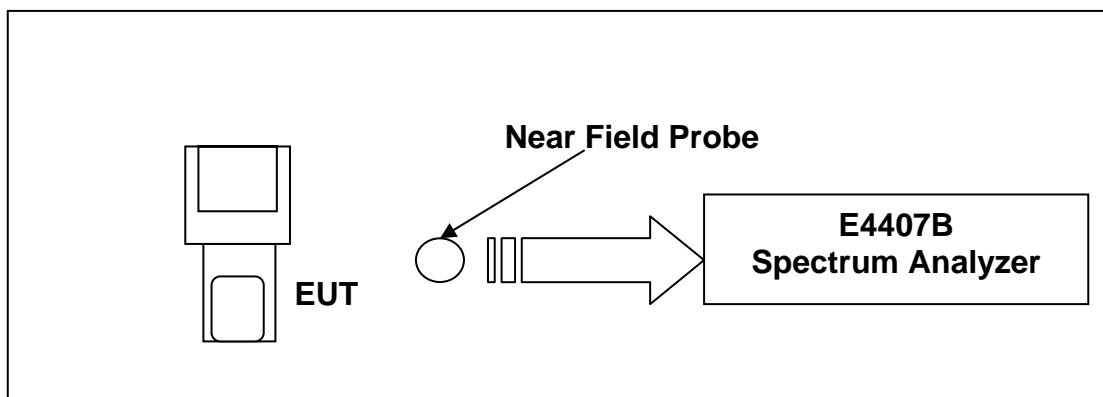

4.3 Test Equipment List:

Item	Mfr/Brand	Instruments	Serial No.	Model/Type No.	Calibrated Date	Next Cali. Date
1.	Agilent	Spectrum Analyzer	US44300422	E4446A	2008/04/22	2009/04/22
2.	Agilent	Spectrum Analyzer	US39240419	E4407B	2008/01/22	2009/01/22
3.	HP	Pre Amplifier	1937A00786	8447F	2008/04/11	2009/04/11
4.	EMCO	Biconilog Antenna	00044568	3142C	2008/08/05	2009/08/05
5.	EM	Probe	107328	EM-6992	N/A	N/A

4.4 Test Result:

Operation Frequency	13.557	MHz
20dB Bandwidth Measurement	3.500	kHz
99% Occupied Bandwidth	3.0662	kHz

4.5 Test Graphs:

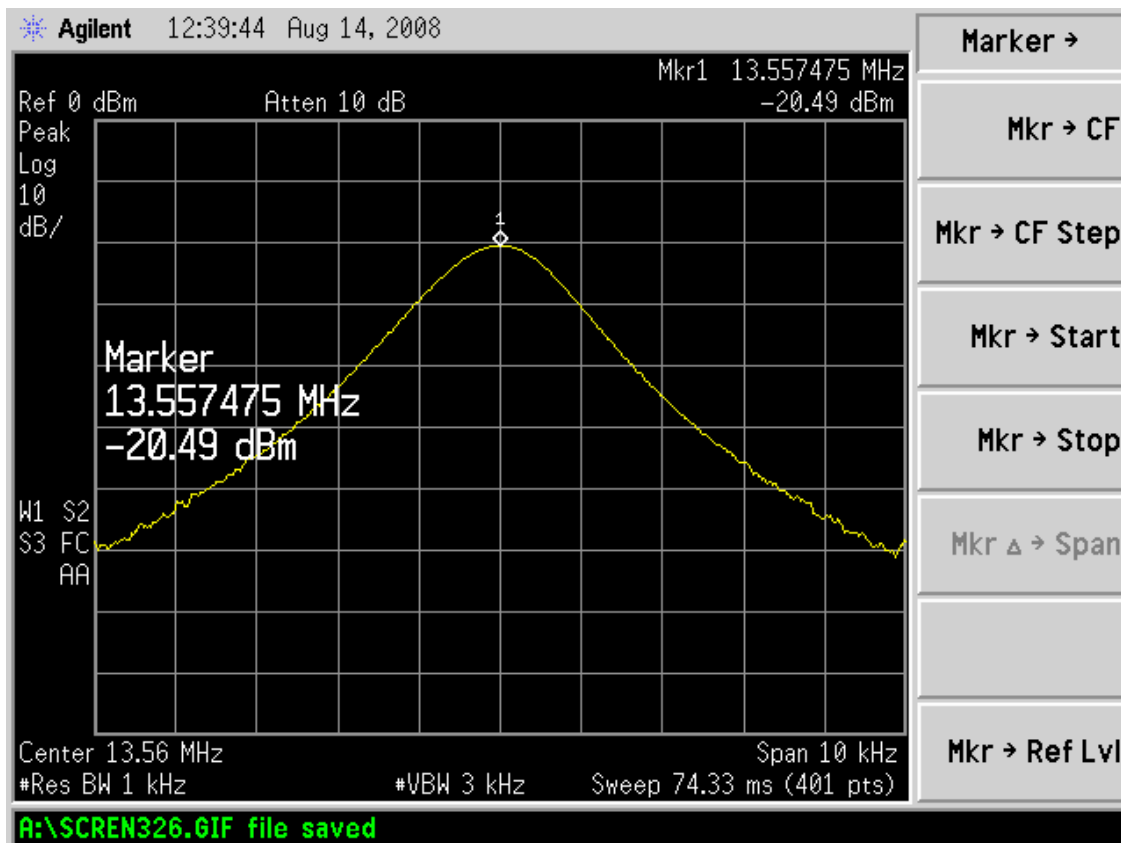

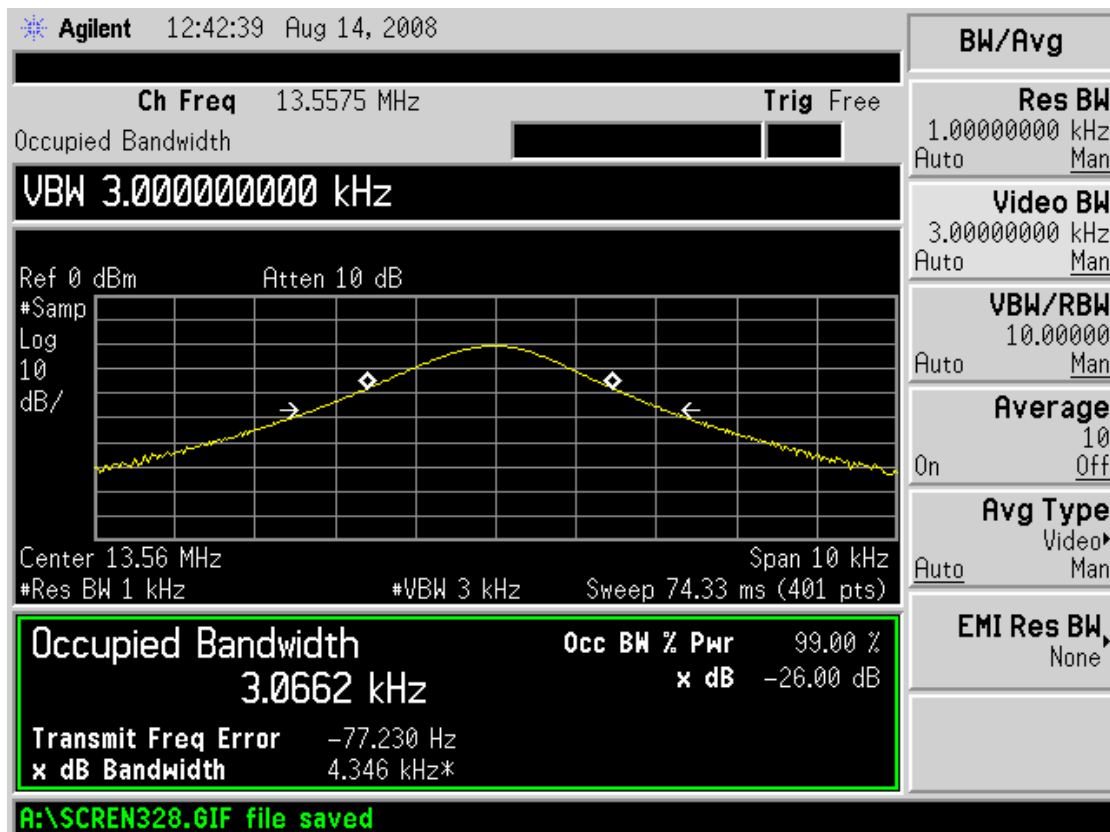
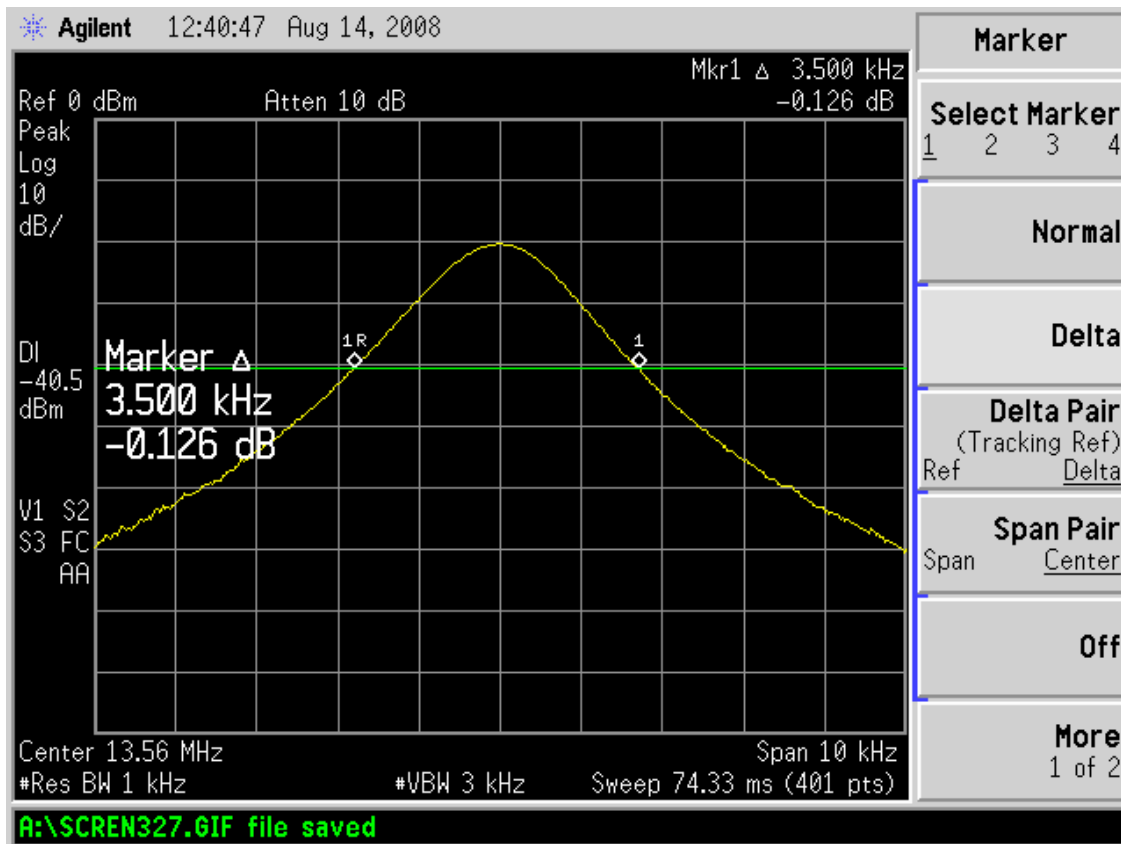

Appendix I- EUT Test SETUP

MEASUREMENT OF POWER LINE CONDUCTED RFI VOLTAGE

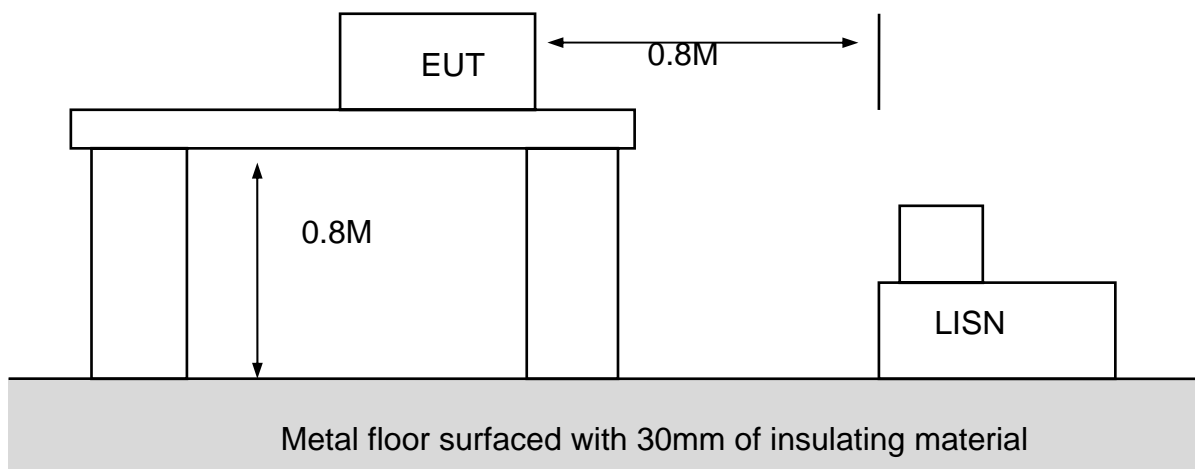

MEASUREMENT OF RADIATED EMISSION

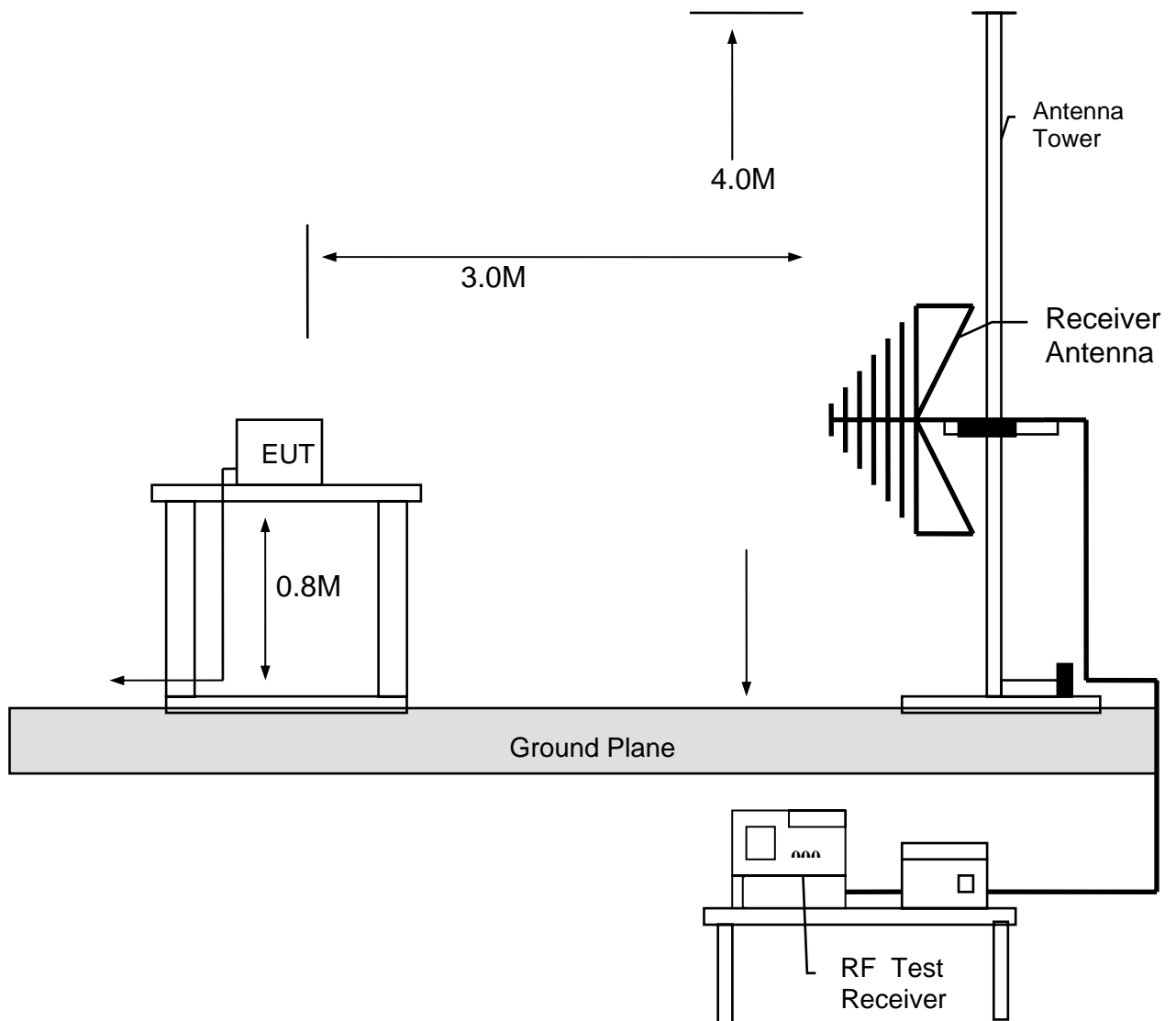

Appendix II- Brand /Trade Name & Model No. Multiple Listee

Brand /Trade Name	Model Name
N/A	N/A