

# Operating Instruction for Thermal Imager



Please read this manual before switching the unit on.  
Important safety information inside.



<b>Content</b>	<b>Page</b>
1.Introduction.....	5
2.Safety.....	5
2-1.Safety Infomation.....	5
2-2.CAUTIONS.....	5
3.Quick Start Guide.....	6
3-1.Basic Step.....	6
3-2.Powering and Charging the Thermal Imager.....	6
3-3.The IR Thermal Imaging Display.....	7
3-4.Control Buttons and Trigger .....	7
3-5.Measure, Save, Delete and Review IR Images.....	7
4.Discriptions.....	8
4-1.Structure Description.....	8
4-2.Display Icon and Indicator Description.....	9
5.Opertion.....	10
5-1.Switch ON the Thermal Imager.....	10
5-2.Lock/Unlock Scene Temperature Level-Span.....	10
5-3.Screening Mode for Surface Temperature Measurement.....	11
5-4.Capture/Save Images Using The Internal Memory.....	11
5-5.Share Images Using Bluetooth.....	11
5-5-1.Instant Share.....	11
5-5-2.Transfer the Saved Images.....	12
5-6.Review/Delete Images.....	12
5-7.Lens and Imager Field of View.....	13
6.Settings Menus.....	14
6-1.Using Settings Menus.....	14
6-2.Settings Details.....	14
6-2-1.Palette Mode.....	14
6-2-2.Temp Unit.....	15
6-2-3.Measure.....	15
6-2-4.Emissivity.....	16
6-2-5.Language.....	16
6-2-6.Setup.....	17
6-2-7.Bluetooth Connect.....	17
6-2-8.Time/Date.....	19
6-2-9.Memory.....	19
6-2-10.Infomation.....	20
6-2-11.Factory Set.....	20

<b>Content</b>	<b>Page</b>
7. Image Browser.....	21
7-1. Image Browser.....	21
7-2. How to Capture Screen.....	21
8. Tablet.....	22
8-1. Introduction.....	22
8-2. Thermalguard App.....	22
8-2-1. Connect to Thermal Imager.....	22
8-2-2. Face Detection.....	23
8-2-3. Image Review and Edit.....	23
8-2-4. Setting Menu.....	24
9. Technical Specifications.....	25
9-1. Thermal Imager Technical characteristics.....	25
9-2. Tablet Technical Characteristics.....	26

## 1. Introduction

- The Thermal Imager is handheld imaging camera used for predictive maintenance, equipment troubleshooting and verification.
- Thermal images are displayed on the LCD and can be saved to internal memories.
- Link with tablet via Bluetooth for powerful face detection and temperature measurement.

### Key Features

- 80x80 pixel thermal imaging system.
- 6400 points real temperature fast measurements
- Hot,Cold,Center three temperature tracking function.
- Large, easy-to-read, bright graphical TFT display
- 50Hz fast Thermal image frame rate
- Bluetooth image instant share & save with iOS and Android smart device
- Scene temperature range Lock function.
- With Buzzer alarm.
- Long running time up to 8 hours with rechargeable battery.
- Smart and compact design
- Rugged industrial design
- Face detection on tablet

## 2. Safety

### 2-1. Safety Information

- ⚠ This symbol adjacent to another symbol, terminal or operating device indicates that the operator must refer to an explanation in the Operating Instructions to avoid personal injury or damage to the meter.

### 2-2. CAUTIONS

- Improper use can damage the meter, please read and understand all of the information provided in this User Guide and other included documentation before use.
- Refer to the CAUTION statement label (shown below) for critical safety information.



### 3.Quick Start Guide

#### 3-1.Basic Step

The thermal imager is intuitive and easy to use; here are the basic steps (Covered in more detail later in this Guide):

- 1.Press and hold the **Power** Button for >2 seconds to power ON, the logo startup screen will appear followed by the thermal image display, if the battery requires recharging, refer to Section 3.2 below.
- 2.Point the unit toward the area or object of interest and view the thermal image, Relative temperature is represented by color, hot to cold (light to dark, respectively), the IR Temperature reading represents the temperature of the spot targeted by the Crosshairs, at the same time the hot and cold point temperature will displayed on the screen.
- 3.Short trigger to freeze/capture the image, press "**OK**" to save image or press "**SHARE**" to share the image with smart devices, Trigger again to discard the image.
- 4.Press "**LOCK**" to Lock current scene temperature range, press "**LOCK**" again to discard.

#### 3-2.Powering and Charging the Thermal Imager

- Press and hold the **Power** Button for >2 seconds to switch ON the unit, A start-up screen (a thermal image) will appear, The unit is now ready to use; to switch OFF, press and hold the **Power** Button for >2 seconds, Note that the Auto Power OFF function switches the unit OFF automatically after a programmed period of time.
- With the power ON, the battery status icon "  " is located at the top left of the display, When battery power is low, connect to an AC source or a computer USB port using the supplied USB cable (USB port is located at top of the unit).
- With power OFF, the battery charging red led is on when connected to an AC source or connected to a computer USB port, If the red led is off, it indicate the battery is full.
- The unit can also be powered up and in use while charging in which case the battery symbol "  " is animated on the full screen.

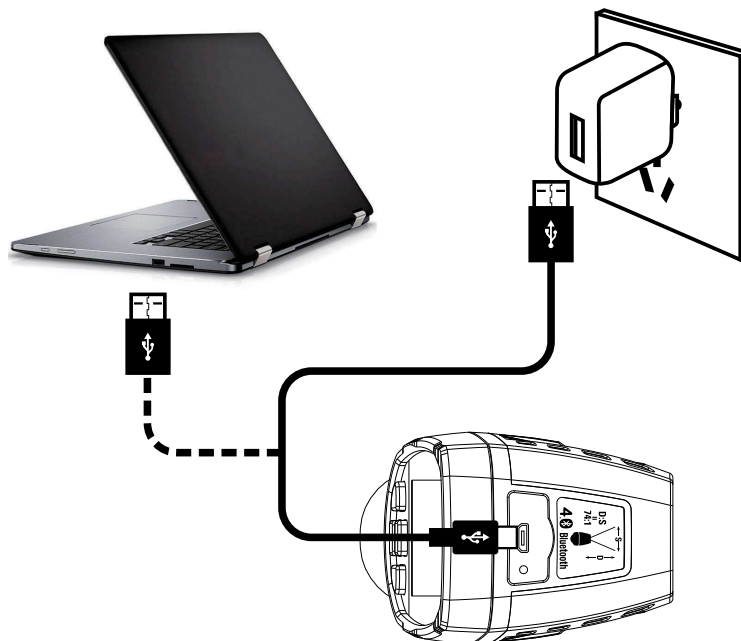

### 3-3.The IR Thermal Imaging Display

- 1-Current Emiisivity Setting
- 2-Battery Indicator
- 3-Hot Temperature Point Reading
- 4-Cold Temperature Point Reading
- 5-Centre Crosshair
- 6-Cold Temperature Crosshair
- 7-Hot Temperature Crosshair
- 8-Image Freezed Icon
- 9-Centre Temperature Point Reading
- 10-“OK” Button
- 11-“LOCK” Button
- 12-Current Temperature Unit
- 13-Scene Low Temperature
- 14-Palette Scale
- 15-Scene High Temperature
- 16-Time Clock

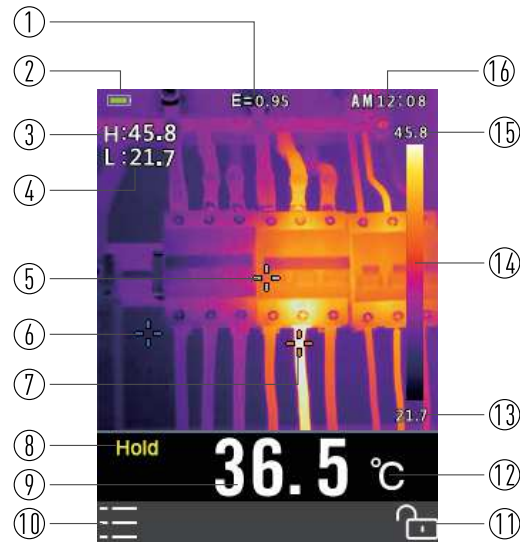

### 3-4.Control Buttons and Trigger

Became familiar with the operation of the control buttons and trigger as described below:

- **POWER/BACK/LOCK** Button Press and hold >2 seconds to cycle the meter power ON or OFF; Short press to exit a menu screen. Also used to lock the current scene temperature range (a soft “” Button will appear on the display above the button when this option is available).
- **OK/MENU** Button Short press to access the Settings Menu, to confirm an edit, and to save an image when prompted (a soft “**SAVE**” button will appear on the display above the button when this option is available).
- **UP and DOWN NAVIGATION ARROW** Button Scroll the Settings Menu and select a menu item setting.
- **TRIGGER/LED Flashlight** Short press will take a snapshot of the current image. Short press again to discard image and return to live image mode. Long press will open the LED flashlight, Long press again will close the LED flashlight.

### 3-5.Measure, Save, Delete and Review IR Images

- Point the thermal imager toward the object or area of interest.
- Pull the trigger to capture the image, Press “**SAVE**” to save image; Press “**SHARE**” to share the image.
- To review an image, either access the Settings Menu.
- To delete images from the internal memory, access the Settings Menu and delete the stored images as described in **Section 6 Settings Menu**.

**WARNING:** All images are deleted when the internal memory is erased.

## 4. Discriptions





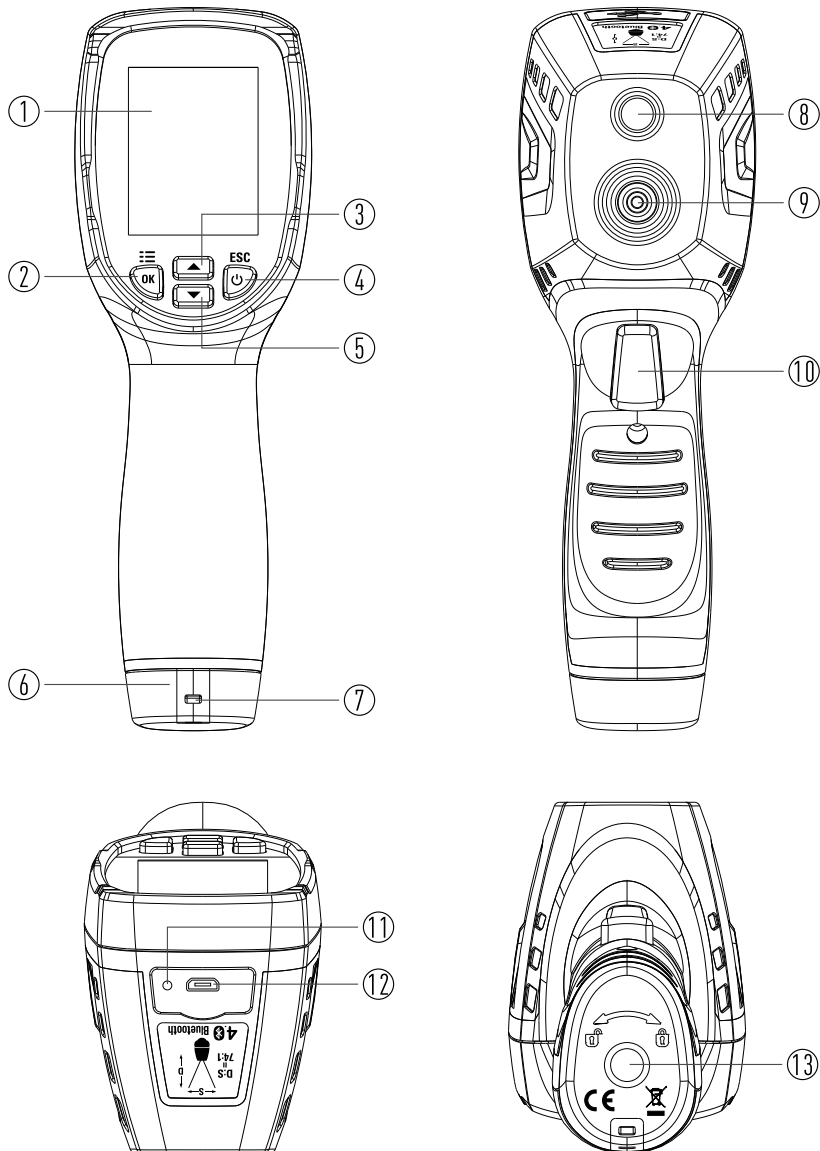





### 4-1. Structure Description

- |                     |                   |                                   |
|---------------------|-------------------|-----------------------------------|
| 1-TFT Color Display | 6-Battery Cover   | 10-Trigger                        |
| 2-Menu/OK Button    | 7-Lanyard Access  | 11-Battery Charging LED Indicator |
| 3-Up Arrow Button   | 8-LED Flash Light | 12-USB Battery Charging Interface |
| 4-Power/Back Button | 9-IR Imaging Len  | 13-Hole for Tripod Insertion      |
| 5-Down Arrow Button |                   |                                   |





#### 4-2. Display Icon and Indicator Description

°C/°F/k	Temperature Units		Centre Crosshair
H:	Max Temperature Readings		Hot Crosshair
C:	Minimum Temperature Readings		Cold Crosshair
Hold	Freezing Image Icon		Bluetooth Icon
AM	12 Time Format		Battery Empty
	IRON Color Palette		Battery Full
	Unlock Icon		Battery Charging
	Lock Icon		

## 5. Operation

### 5-1. Switch ON the Thermal Imager

- Press and hold for >2 seconds to switch the unit ON.
- If the unit is sufficiently charged, the meter will display the start-up screen as shown below.
- The initial displayed image will show until the shutter resets the image.
- After the startup period, the unit will show a real time IR thermal image along with an IR Temperature reading.
- If the meter does not switch ON, please refer to Section 3.2 Powering and charging the thermal imager, for information regarding battery charging.

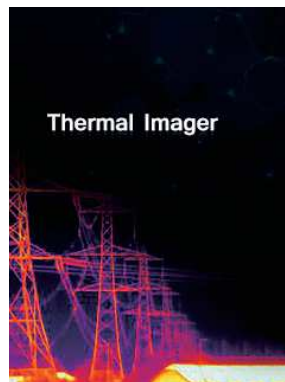

### 5-2. Lock/Unlock Scene Temperature Level-Span

The unit is real 80x80 pixels thermal imager, for better get the object temperature problem, It can locks the current scene temperature range, if the temperature higher than lock temperature, the corresponding color is white; if the current scene temperature lower than the lock temperature range, the corresponding color is black.

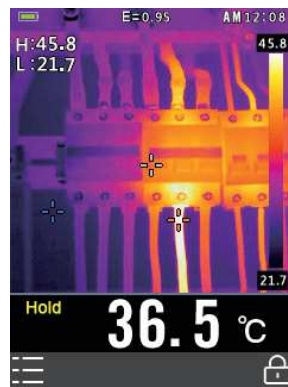

Lock Mode

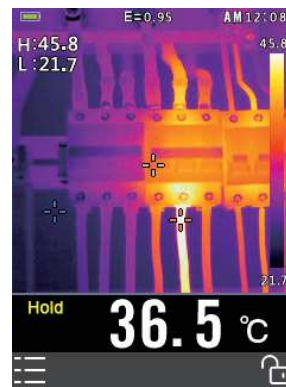

Unlock Mode

1. Point the unit at an object or an area of interest.
2. Short press the "🔒" to lock the scene temperature range; the back color of the temperature readings will turn grey.
3. Short press the "🔓" button again, it will unlock the scene temperature range.

### 5-3. Screening Mode for Surface Temperature Measurement

The unit can work in screening mode for surface temperature measurement.

1. Switch "**Screening Mode**" option on in "**Measure**" menus.
2. Set the Alarm temperature to appropriate value.
3. Set the Temperature compensation to appropriate value.
4. Switch "**Center Spot**" or "**Temp. Max**" on for surface temperature measurement.
5. If surface temperature is higher than the set alarm threshold it will be shown in red color in the lower part of the display.

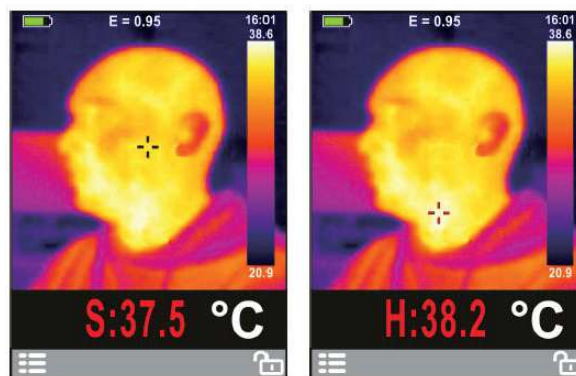

### 5-4. Capture/Save Images Using The Internal Memory

The unit can store 20 images on internal memory. The saved images can be transferred to iOS, android and PC device through Bluetooth.

1. Point the unit at an object or an area of interest.
2. Short press the trigger to capture the image; the image will freeze.
3. If don't want to save the current image, Short press the trigger again, the image will unfreeze.
4. Press "**SAVE**" to save the image
5. If the image is stored successfully on the internal memory, the image will unfreeze.
6. To erase/format internal memory please refer to Section 6 Settings Menu.

### 5-5. Share Images Using Bluetooth

#### 5-5-1. Instant Share

For quick analyse and report the thermal images, The unit has Bluetooth instant share function, corresponding there are three softwares for iOS, Android.

1. Enable the Bluetooth on the thermal imager
2. Run Apps on smart devices, connect unit with smart device or PC.
3. Point the unit at an object or an area of interest.
4. Short press the trigger to capture the image; the image will freeze. And the "hold" icon will display.
5. If don't want the current image, Short press the trigger again, the image will unfreeze.
6. Press "**SHARE**" to transfer the image

## Operating Instruction for Thermal Imager

- 7.If the image is transferred successfully to the smart devices, the image will unfreeze.
- 8.Save,analyse,share or report the thermal images on smart devices.

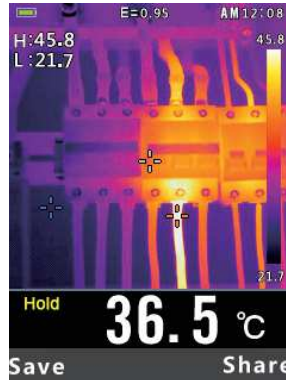

Hold The Image

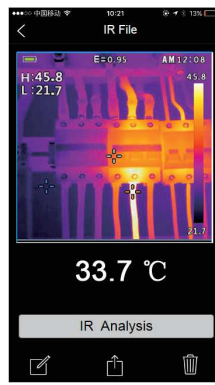
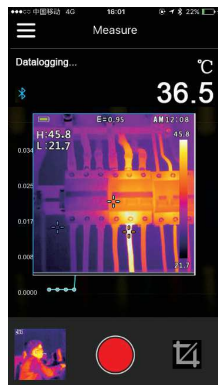

Receive, Analyse and Save The Image

### 5-5-2. Transfer the Saved Images

- 1.Enable the Bluetooth on the unit
- 2.Run Apps on smart devices, connect unit with smart device or PC.
- 3.To access the Image Review mode, access the Settings Menu to review and delete images.
- 4.Press Trigger to share the current picture.
- 5.Press "**SHARE**" to transfer the image
- 6.Save, analyse, share or report the thermal images on smart devices.

### 5-6. Review/Delete Images

Use the Review Mode to view or delete stored images.

- 1.To access the Settings Menu to review and delete images.
- 2.Press the back button to exit the image review mode
- 3.To delete all images, please access the Settings Menu as described in Section 6 and reformat the SD card.

### 5-7. Lens and Imager Field of View

This table lists the horizontal FOV, vertical FOV and IFOV for lens.

Focal Length	Horizontal FOV	Vertical FOV	IFOV
7.5mm	21°	21°	4.53mrad

**IFOV** (Instantaneous Field of View) is the smallest detail within the FOV that can be detected or seen at a set distance, the unit is rad.

The formula is this:

- $IFOV = (\text{Pixel Size}) / (\text{Lens focal length})$ .
- D:S theoretical (=  $1/IFOV$  theoretical) is the calculated spot size based on the pixel size of the Thermal Imager detector array and lens focal length.

**Example:** If Thermal Imager uses 9mm lens, because the Pixel Size of detector is 34 $\mu$ m. Horizontal FOV is 17°, Vertical FOV is 17°, the IFOV is  $34\mu\text{m}/7.5\text{mm} = 4.53\text{mrad}$ ;

D:S theoretical (=  $1/IFOV$  theoretical) = 220:1

D:S measure = D:S theoretical/3 = 74:1

- D:S measure (=  $1/IFOV$  measure) is the spot size needed to provide an accurate temperature measure.
- Typically D:S measure is 2 to 3 times smaller than D:S theoretical, which means the temperature measurement area of the target need to be 2 to 3 times larger than that determined by the calculated theoretical D:S.

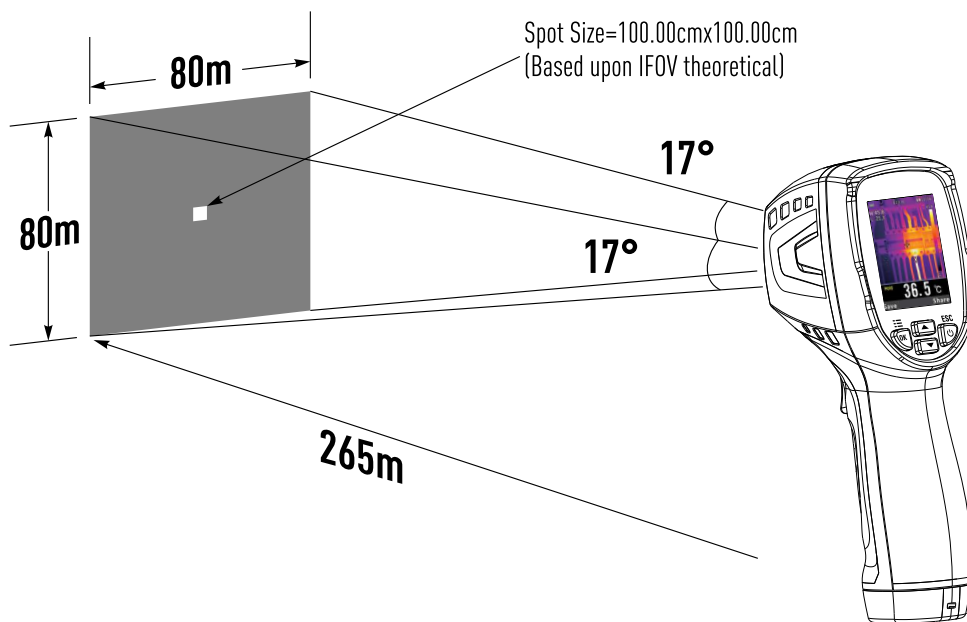

## 6.Settings Menu

### 6-1.Using Settings Menu

- Press **OK** Button to open the Settings Menus, as show below.

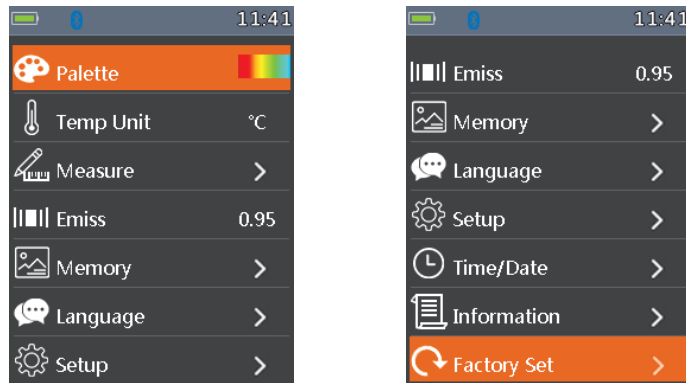

- Press **UP/DOWN** Button to select menu item or change the value of current focus item.
- Press **OK** Button to enter the submenu or set focus on the current selected item, Press **ESC** Button to return to the previous menu.
- If want to exit settings menus, can press **HOLD** Button or press **ESC** Button in root menu.

### 6-2.Settings Details

#### 6-2-1.Palette Mode

- Thermal imager has five kinds of palette, such as: "  ".
- Press **OK** Button to select on of display color palettes.



### 6-2-2.Temp Unit

- Press **OK** Button to set focus on this option and the color of option value will change to black **°C**.
- In focus state, use the **RIGHT/MENU** Button to toggle **°C**, **°F** and **k**, use **ESC/OK** Button to exit focus state and the color of option value will change white **k**.

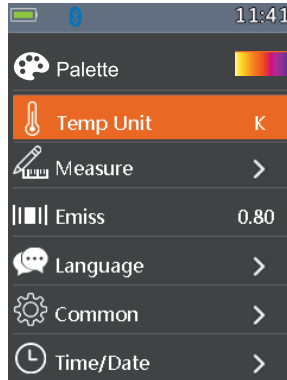

### 6-2-3.Measure

Press **OK** Button to enter measure menu two selections are available: Temp.Max and Temp.Min, Press **OK** Button to set cur select item on or off.

- **Screening Mode:** This option enables thermal imager measure surface temperature.
- **Alarm Temperature:** In screening mode, if surface temperature is higher than alarm temperature, then buzzer alarm will be triggered.
- **Temperature Compensation:** In screening mode, the surface temperature will be compensated.
- **Center Spot:** This option enables thermal imager detect the temperature of center spot.
- **Temp. Max:** This option enables thermal imager automatically detect the highest temperature point.
- **Temp. Min:** This option enables thermal imager automatically detect the lowest temperature point.

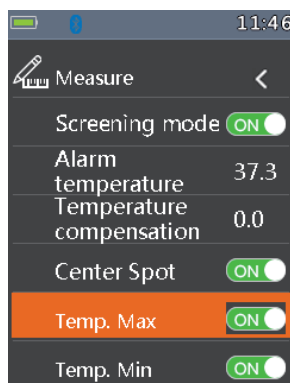

#### 6-2-4.Emissivity ||■||

- Press **OK** Button to set focus on this option.
- In focus state, use **UP/DOWN** Button to increase or decrease emissivity's value, use **ESC/OK** Button to exit focus state.
- The available range is 0.01 to 0.99 in 0.01 steps.



#### 6-2-5.Language ☰

- Press **OK** Button to enter language menu.
- Three options are available: Simplified Chinese, Traditional Chinese and English.
- Use **UP/DOWN** Button to select language and use **OK** Button to set selected language to be valid.

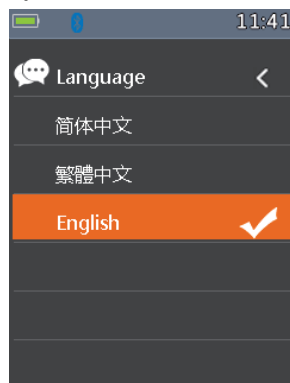



### 6-2-6.Setup

Press **OK** Button to enter setup menu, three options are available: Bluetooth, Brightness and Auto Off.

- **Bluetooth:** Use **OK** Button to set bluetooth power on or off.
- **Brightness:** Press **OK** Button to set focus on this option, In focus state, use **UP/DOWN** Button to change LCD's brightness, use **ESC/OK** Button to exit focus state, the available brightness's range is 100% to 10% in 10% steps.
- **Auto Off:** Press **OK** Button to set focus on this option, In focus state, use **UP/DOWN** Button to choose the time period after which the meter enters the sleep mode.

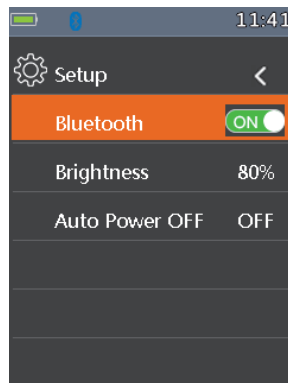

### 6-2-7. Bluetooth Connect

1. Turn on the Bluetooth function on the instrument.

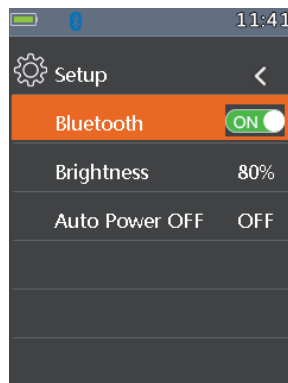

## Operating Instruction for Thermal Imager

2. Turn on the bluetooth of smartphone, press the icon "Thermview+" and enter into the home interface, Then press Connect Device icon on the Home interface, bluetooth device name will appear.

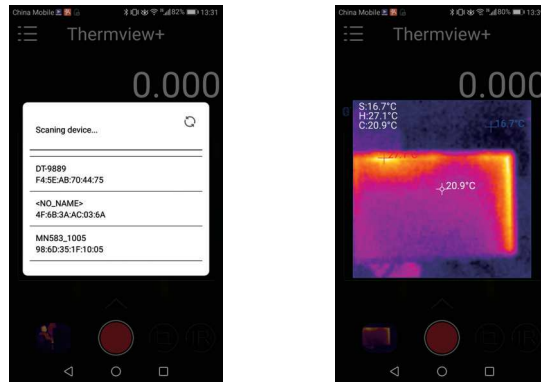

3. Touch the device name listed in bluetooth sheet, it will be transmitted to laser distance meter measuring interface after connection.

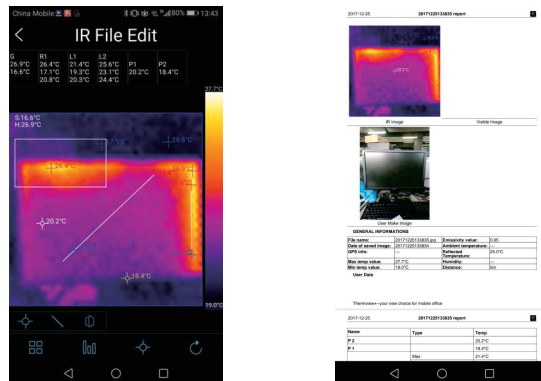

The detail information about Thermview+, please refer to MeterBox Pro APP help file.

- **Thermview+** for Android : Please search in Google Play with keyword "**Thermview+**", download and run.
- **Thermview+** for iOS: Please search in Apple store with keyword "**Thermview+**", download and run.

### 6-2-8. Time/Date ⌚

- Press **OK** Button to enter time menu.
- In this menu/years/month/day/hour/minute and time formate can be set.
- The changes take effect after exiting settings menus.

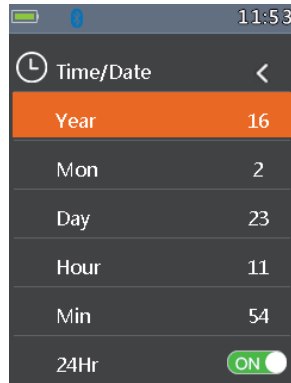

### 6-2-9. Memory 🖼️

- Press **OK** Button to enter memory menu.
  - Two options are available: **Photo Review** and **Delete Photo**.
- Photo Review:** Press **OK** Button to enter image browser function, and exit settings menus immediately.  
**Delete Photo:** After Press **OK** Button, dialog box will be displayed as show below.  
**WARNING:** Select **"YES"**, will delete all the photos in **"RECORD"** folder of the memory card.

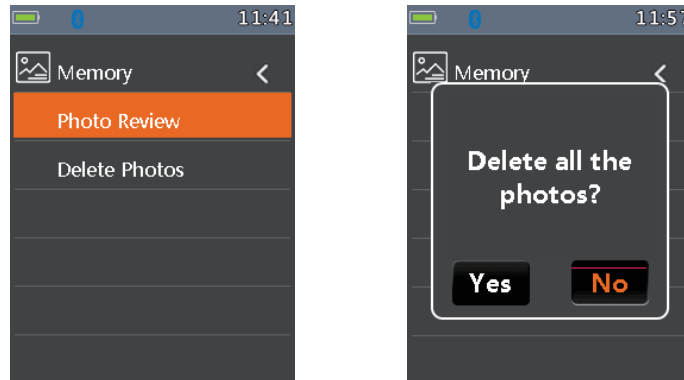

### 6-2-10. Information

- Press **OK** Button to enter system information menu.
- This menu contains software's version, hardware's version and thermal imager's version.

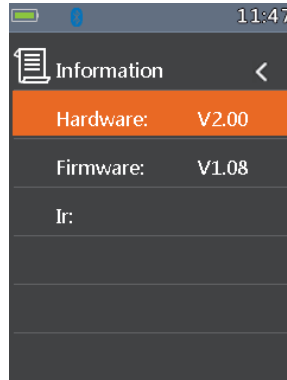

### 6-2-11. Factory Set

- When select Factory Set option, after press **OK** Button, the dialog box will be displayed as show below.
- Select **YES** Button, system parameter will be reset.



## 7. Image Browser

### 7-1. Image Browser

- In Image Browser mode, User can browse the pictures in "RECORD" folder of the memory card.
- Press **UP/DOWN** Button to select prev or next picture.
- Press any other keys to exit Image Browser mode.
  - 1-Current displayed picture's file name
  - 2-Picture display area
  - 3-Temperature of center point
  - 4-Current picture's index and total number of pictures

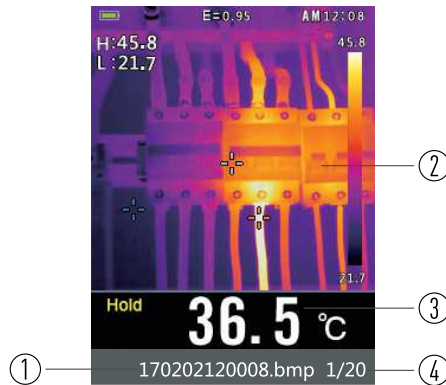

### 7-2. How to Capture Screen

- When in Thermal imaging mode, use **HOLD** Button to enter hold mode, as show below.
- Then press **OK** Button to capture screen.
- After saving to memory completely, screen will exit hold mode.

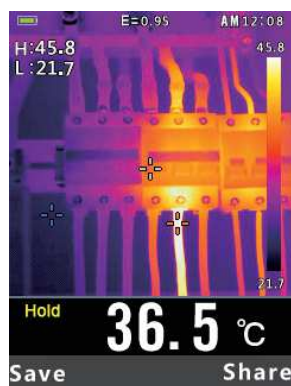

## 8. Tablet

### 8-1. Introduction

- As Thermal Imager expansion device, the tablet had installed "Thermalguard" APP.
- It supports fast and multiple face detection through the front camera.
- At the same time, Thermal Imager quickly measures the temperature of the corresponding face and synchronizes to the tablet.

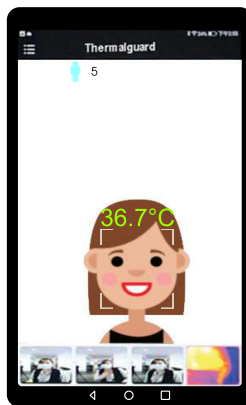

### 8-2. Thermalguard App

APP communicates with the Thermal Imager through Bluetooth 4.0, please keep the Bluetooth open both on the tablet and Thermal Imager.

#### 8-2-1. Connect to Thermal Imager

After running Thermalguard, the BT devices will be listed, then select Bluetooth name.



### 8-2-2.Face Detection

After successfully connecting to the Thermal Imager, Thermalguard will enter face detection mode and capture the detected faces.

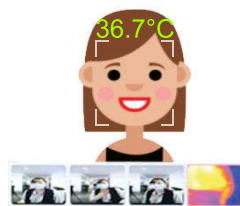
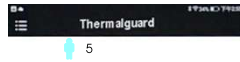

### 8-2-3.Image Review and Edit

Thermalguard supports review and editing the pictures of captured face.

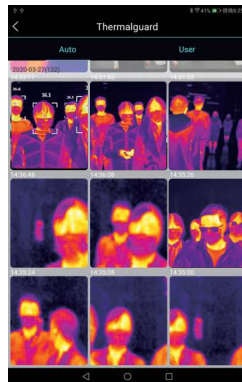

### 8-2-4. Setting Menu

In Thermalguard's setting menu, user can set the parameter of Thermalguard and Thermal Imager.

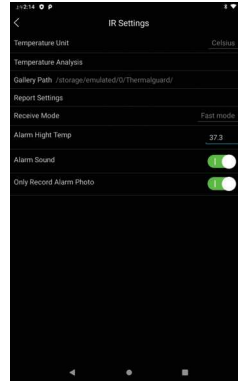
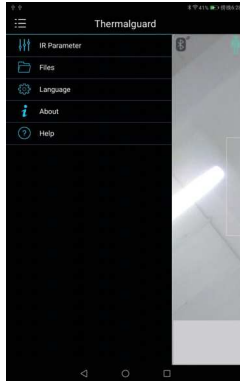



## 9. Technical Specifications

### 9-1. Thermal Imager Technical Characteristics

Field of View (FOV)/Minimum Focus Distance	21°x 21°/0.5m
Spatial Resolution (IFOV)	4.53mrad
Thermal Sensitivity/NETD	< 0.1°C at 30°C(86°F)/100mK
Image Frequency	50Hz
Focus Mode	Focus free
Focal Length	7.5mm
Focal Plane Array (FPA)/Spectral Range	Uncooledmicrobolometer/8-14μm
Object Temperature Range	-20 to 380°C (-4 to 716°F)
Accuracy In Normal Mode	±2°C(±3.6°F) or ±2% of reading (Environment temperature 10 to 35°C, object temperature >0°C)
Display	2" color TFT LCD screen
Display Resolution	240x320 pixels resolution
Battery	Rechargeable 3.7V(1300mA) lithium ion battery(Not user serviceable)
Battery Life	>6hours, typical
Battery Charger	5V 1A USB charger (Not include)
Drop Proof	Designed for up to 2 meters
Connect	Bluetooth BLE4.0, thermal image transfer and data logger.
Save Image Format	Bitmap (.bmp) with 6400 points temperature analyse and emissivity
Operating Temperature	-10 to 45°C (14 to 113°F)
Storage Temperature	-30 to 55°C (-22 to 131°F)
Allowable Relative Humidity	<80%HR
Storage Temperature	-20 to 60°C (-4 to 140°F)
Storage Humidity	<80%HR

### 9-2. Tablet Technical Characteristics

Screen Size	10.1"
Display Resolution	800x1280 pixels resolution
Ram Capacity	2G
Flash Capacity	32G
Front Camer	2M
Rear Camera	8M
Speaker	Built-in 8 $\Omega$ /0.8W speaker x 2
Battery	Rechargeable 3.7V (5000mA) lithium ion battery (Not user-serviceable)
Battery Lift	>4hours, typical
Battery Charger	5V/2A with USB
Operating System	Andriod 9.0



#### FCC STATEMENT

This device complies with part 15 of the FCC Rules. Operation is subject to the following two conditions: (1) This device may not cause harmful interference, and (2) this device must accept any interference received, including interference that may cause undesired operation. This device must not be co-located or operating in conjunction with any other antenna or transmitter.

This equipment has been tested and found to comply with the limits for a Class B digital device, pursuant to part 15 of the FCC Rules. These limits are designed to provide reasonable protection against harmful interference in a residential installation. This equipment generates, uses and can radiate radio frequency energy and, if not installed and used in accordance with the instructions, may cause harmful interference to radio communications. However, there is no guarantee that interference will not occur in a particular installation. If this equipment does cause harmful interference to radio or television reception, which can be determined by turning the equipment off and on, the user is encouraged to try to correct the interference by one or more of the following measures:

- Reorient or relocate the receiving antenna.
- Increase the separation between the equipment and receiver.
- Connect the equipment into an outlet on a circuit different from that to which the receiver is connected.
- Consult the dealer or an experienced radio/TV technician for help.

#### Portable devices:

This device complies with FCC's radiation exposure limits set forth for an uncontrolled environment

#### WARNING:

Any changes or modifications to this unit not expressly approved by the party responsible for compliance could void the user's authority to operate the equipment. This device must not be collocated or operating in conjunction with any other antenna or transmitter.



Operating Instruction for Thermal Imager



Rev.200402