



PHOENIX
TESTLAB

Königswinkel 10
32825 Blomberg, Germany
Phone: +49 (0) 52 35 / 95 00-0
Fax: +49 (0) 52 35 / 95 00-10
office@phoenix-testlab.de
www.phoenix-testlab.de

Test Report

Report Number:

F172189E1

Equipment under Test (EUT):

**uniFLOW Release Station PLUS-2 V2
URSPLUS02**

Applicant:

NT-ware Systemprogrammierungs-GmbH

Manufacturer:

NT-ware Systemprogrammierungs-GmbH



Deutsche
Akkreditierungsstelle
D-PL-17186-01-01
D-PL-17186-01-02
D-PL-17186-01-03



References

- [1] **ANSI C63.10: 2013** American National Standard of Procedures for Compliance Testing of Unlicensed Wireless Devices
- [2] **FCC CFR 47 Part 15** Radio Frequency Devices
- [3] **RSS-210 Issue 9 (August 2016)** Licence-Exempt Radio Apparatus: Category I Equipment
- [4] **RSS-Gen Issue 4 (November 2014)** General Requirements for Compliance of Radio Apparatus

Test result

The requirements of the tests performed as shown in the overview (clause 4 of this test report) were fulfilled by the equipment under test.

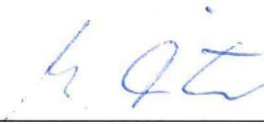
The complete test results are presented in the following.

Test engineer:	Michael DINTER		16.02.2018
	Name	Signature	Date
Authorized reviewer:	Thomas KÜHN		16.02.2018
	Name	Signature	Date

This test report is only valid in its original form.

Any reproduction of its contents in extracts without written permission of the accredited test laboratory PHOENIX TESTLAB GmbH is prohibited.

The test results herein refer only to the tested sample. PHOENIX TESTLAB GmbH is not responsible for any generalisations or conclusions drawn from these test results concerning further samples. Any modification of the tested samples is prohibited and leads to the invalidity of this test report. Each page necessarily contains the PHOENIX TESTLAB Logo and the TEST REPORT NUMBER.

This test report is valid in hardcopy form as well as in electronic form.

Contents:	Page
1 Identification	4
1.1 Applicant	4
1.2 Manufacturer	4
1.3 Test Laboratory	4
1.4 EUT (Equipment Under Test)	5
1.5 Technical data of equipment	5
1.6 Dates	7
2 Operational states and test setup	8
3 Additional information	8
4 Overview	9
5 Results	10
5.1 Conducted emissions on power supply lines (150 kHz to 30 MHz)	10
5.1.1 Method of measurement	10
5.1.2 Test results (conducted emissions on power supply lines)	11
5.2 Radiated emissions	13
5.2.1 Method of measurement (radiated emissions)	13
5.2.2 Test results (radiated emissions)	20
5.2.2.1 Preliminary radiated emission measurement 9 kHz to 1 GHz	20
5.2.2.2 Preliminary radiated emission measurement 1 GHz to 5 GHz	23
5.2.2.3 Final radiated emission measurement from 9 kHz to 30 MHz	24
5.2.2.4 Final radiated emission measurement from 30 MHz to 1 GHz	26
5.2.2.5 Final radiated emission measurement 1 GHz to 5 GHz	28
5.3 99 % bandwidth	29
5.3.1 Method of measurement	29
5.3.2 Test results 99 % bandwidth	30
6 Test equipment	33
7 Report history	34
8 List of annexes	35

1 Identification

1.1 Applicant

Name:	NT-ware Systemprogrammierungs-GmbH
Address:	Niedersachsenstr. 6 49186 Bad Iburg
Country:	Germany
Name for contact purposes:	Mr. Holger BAUSZUS
Phone:	+49 5403 7243 220
Fax:	+49 5403 7801 03
eMail Address:	hbauszus@nt-ware.com
Applicant represented during the test by the following person:	-

1.2 Manufacturer

Name:	NT-ware Systemprogrammierungs-GmbH
Address:	Niedersachsenstr. 6 49186 Bad Iburg
Country:	Germany
Name for contact purposes:	Mr. Holger BAUSZUS
Phone:	+49 5403 7243 220
Fax:	+49 5403 7801 03
eMail Address:	hbauszus@nt-ware.com
Applicant represented during the test by the following person:	-

1.3 Test Laboratory

The tests were carried out at:

PHOENIX TESTLAB GmbH
Königswinkel 10
32825 Blomberg
Germany

accredited by Deutsche Akkreditierungsstelle GmbH (DAkkS) in compliance with DIN EN ISO/IEC 17025 under Reg. No. D-PL-17186-01-02, FCC Test Firm Accreditation with the registration number 469623, designation number DE0004 and Industry Canada Test site registration SITE# IC3469A-1.

1.4 EUT (Equipment Under Test)

Type of equipment	Universal LCD touch device with integrated RF-card reader and printer interface
Product model name (PMN):*	uniFLOW Release Station PLUS-2 V2
Model name (HVIN):*	URSPLUS02
Order No.:	--
Serial No.:	60640539617B
UPN No.:	--
FCC ID:*	WG7URSPLUS02
IC certification number:*	7900A-URSPLUS02
PCB identifier:*	--
Hardware version:*	1.0
Software version (FVIN):*	16.7.0
Lowest internal frequency:*	125 kHz
Highest internal frequency:*	720 MHz
Antenna type:*	integral

*: declared by the applicant.

1.5 Technical data of equipment

RFID 125 kHz

Power supply: *	AC Adapter 120 V AC 60 Hz to 12 V DC GlobTek model GT-41080-1817.9-5.9		
Supply voltage AC Adapter: *	U _{nom} = 120 V AC	U _{min} = 100 V AC	U _{max} = 240 V AC
Supply voltage EUT: *	U _{nom} = 12 V DC	U _{min} = 10 V DC	U _{max} = 14 V DC
Supply voltage RFID module: *	USB 5 V DC stabilised (internal)		
Type of modulation: *	ASK, FSK, PSK (FSK was used for the test refer 2 operational states)		
Frequency deviation: *	± 1000 Hz		
Operating frequency range: *	125 KHz		
Number of channels: *	1		
Antenna type: *	Internal loop antenna average loop area 2052 mm ²		
Duty cycle: *	100 %		
Rated RF power: *	< 250 mW		
Data rate: *	2.5 kBaud to 3.94 KBaud (FSK used 2.5 kBaud for the test)		
Temperature range: *	0 °C to +35 °C.		

* declared by the applicant.

RFID 13.56 MHz

Power supply: *	AC Adapter 120 V AC 60 Hz to 12 V DC GlobTek model GT-41080-1817.9-5.9		
Supply voltage AC Adapter: *	U _{nom} = 120 V AC	U _{min} = 100 V AC	U _{max} = 240 V AC
Supply voltage EUT: *	U _{nom} = 12 V DC	U _{min} = 10 V DC	U _{max} = 14 V DC
Supply voltage RFID module: *	USB 5 V DC stabilised (internal)		
Type of modulation: *	ASK		
Frequency deviation: *	± 1000 Hz		
Operating frequency range: *	13.56 MHz		
Number of channels: *	1		
Antenna type: *	Internal loop antenna average loop area 2385 mm ²		
Duty cycle: *	100 %		
Rated RF power: *	< 250 mW		
Data rate: *	26.4 kBaud to 106 kBaud		
Temperature range: *	0 °C to +35 °C.		

* declared by the applicant.

Ports / Connectors				
Identification	Connector		Length during test	Shielding (Yes / No)
	EUT	Ancillary		
Power connection cable (1-phase) with AC adapter *	Customized	AC plug	1.9 m	No
Ethernet 1	RJ 45	RJ 45	3 m	Yes
Ethernet 2	RJ 45	Terminated	3 m	Yes
I/O *	D-sub DA-15	D-sub DA-15 cable	1.2 m	No
I/O	D-sub DE-15	Left open (identical to D-sub DA-15)	-	-
Production interface	RJ 45	Closed, not in use	-	-
USB	USB	Left open	-	-

Remark*: These cables were already delivered with fixed snap ferrites Würth 7420711011 and 742 711 42 as seen in Annex B by the applicant.

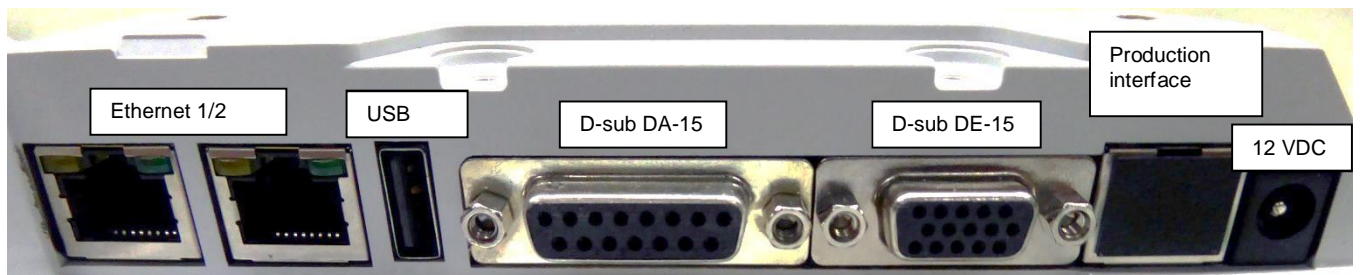

Ancillary equipment used for all tests	
TAG 125 kHz:	HID PC Prox (FSK modulation was used for the test)
TAG 13.56 MHz:	HID iClass 13.56 MHz

Ancillary equipment used for the 99% modulation bandwidth		
TAG 125 kHz:	Hitag 2	ASK modulation
TAG 125 kHz:	Indala	PSK modulation

Software used for the test		
Software	Device V1.0	Reader Orig. Firmware Version 16.7.0
Test Software	Yes	No

1.6 Dates

Date of receipt of test sample:	08.11.2017
Start of test:	08.11.2017
End of test:	21.12.2017

2 Operational states and test setup

Description of function of the EUT:

The EUT is a RFID System used for Print, Scan and Device Management.

The following states were defined as the operating conditions:

During the tests the EUT was powered with 12 VDC by the GlobTek model GT-41080-1817.9-5.9, which was itself supplied with 120 VAC / 60 Hz. The RFID reader part of the EUT was supplied by an internal stabilized 5 Volt USB port.

The tests were carried out with an unmodified sample, which continuously reading a TAG positioned in front of the EUT. Pre-tests were performed with and without reading a TAG. The worst case emissions were caused with the TAG in front of the reader.

Because the EUT could not identify two TAG´s simultaneously, the tests were carried out reading either a 125 kHz (FSK modulation) or 13.56 MHz (ASK modulation) TAG.

As pre-tests have shown, reading a 13.56 MHz TAG causes higher emissions above 30 MHz. Therefore the tests above 30 MHz were carried out with this TAG

As pre-tests have shown different modulations kinds (FSK, PSK and ASK for different 125 kHz TAG´s) causes no significant differences of the transmitter operating frequency ranges, modulation bandwidth and transmitter level. Therefore the tests were carried out with the 125 kHz TAG from HID PC Prox (FSK modulation) as representative set up. Only the outdoor test for the transmitter @ 125 kHz was carried out with all types of modulation.

Physical boundaries of the equipment

The physical boundaries of the EUT are shown below.



3 Additional information

None.

4 Overview

Application	Frequency range [MHz]	FCC 47 CFR Part 15 section [2]	RSS-Gen, Issue 4 [4] and RSS-210, Issue 9 [3]	Status	Refer page
Conducted emissions on supply line	0.15 – 30	15.207 (a)	8.8 [4]	Passed	10 et seq.
Radiated emissions	0.009 – 5.000**	15.205 (a) 15.209 (a)	8.9, 8.10 [4] 4.1 [3]	Passed	13 et seq.
99 % bandwidth	13.56	-	6.6 [4]	-	29 et seq.
99 % bandwidth	0.125	-	6.6 [4]	-	29 et seq.
Antenna requirement	-	15.203 [2]	-	Passed *	-

*: Integrated antenna only, requirement fulfilled.

** : As declared by the applicant the highest internal frequency of 720 MHz was caused by the digital device the radiated emission measurement was carried out up to 5 GHz only.

5 Results

5.1 Conducted emissions on power supply lines (150 kHz to 30 MHz)

5.1.1 Method of measurement

This test will be carried out in a shielded chamber. Tabletop devices will set up on a non-conducting support with a size of 1 m by 1.5 m and a height of 80 cm above the ground plane. Floor-standing devices will be placed directly on the ground plane. The setup of the Equipment under test will be in accordance to [1].

The frequency range 150 kHz to 30 MHz will be measured with an EMI Receiver set to MAX Hold mode with peak and average detector and a resolution bandwidth of 9 kHz. A scan will be carried out on the phase (or plus pole in case of DC powered devices) of the AC mains network. If levels detected 10 dB below the appropriable limit, this emission will be measured with the average and quasi-peak detector on all lines.

Frequency range	Resolution bandwidth
150 kHz to 30 MHz	9 kHz

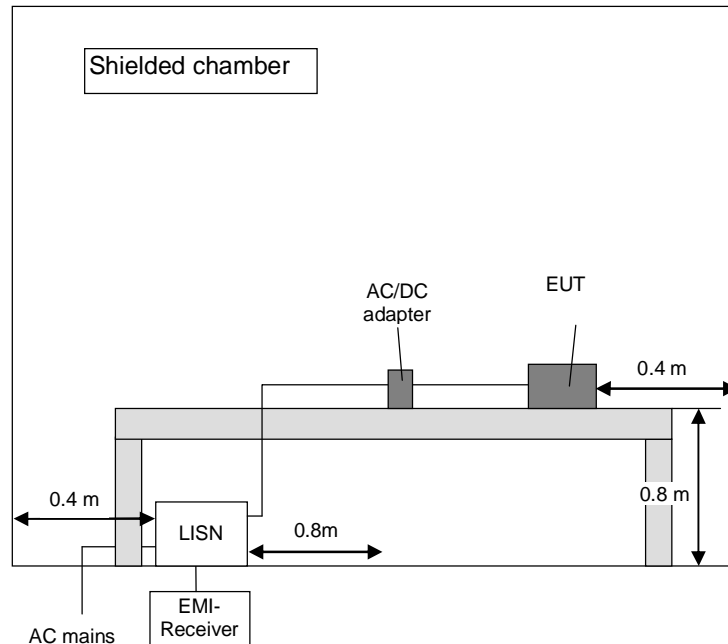

5.1.2 Test results (conducted emissions on power supply lines)

Ambient temperature	21 °C	Relative humidity	59 %
---------------------	-------	-------------------	------

Position of EUT: The EUT was set-up on a non-conducting table of a height of 0.8 m.

Cable guide: The cables of the EUT were fixed on the non-conducting table. For further information of the cable guide refer to the pictures in annex A of this test report.

Test record: The test was carried out reading a TAG continuously (refer also clause 2 of this test report). All results are shown in the following.

Supply voltage: During this test the EUT was powered with 12 V_{DC} by the GlobTek model GT-41080-1817.9-5.9, which was itself supplied by an AC mains Network with 120 V_{AC} / 60 Hz.

EUT Information

Test description:	Conducted emission measurement
EUT:	Release Station Plus 2 V2
Manufacturer:	NT-ware Systemprogrammierungs-GmbH
Operating conditions:	Cyclic TAG reading 125 kHz, Ethernet active (Fping)
Test site:	Phoenix TESTLAB GmbH, shielded room M4
Operator:	R. BRAUN
Comment:	120 VAC / 60 Hz

The curves in the diagrams below only represent for each frequency point the maximum measured value of all preliminary measurements which were made for each power supply line. The top measured curve represents the peak measurement and the bottom measured curve the average measurement. The quasi-peak measured points are marked by ◆ and the average measured points by ▼.

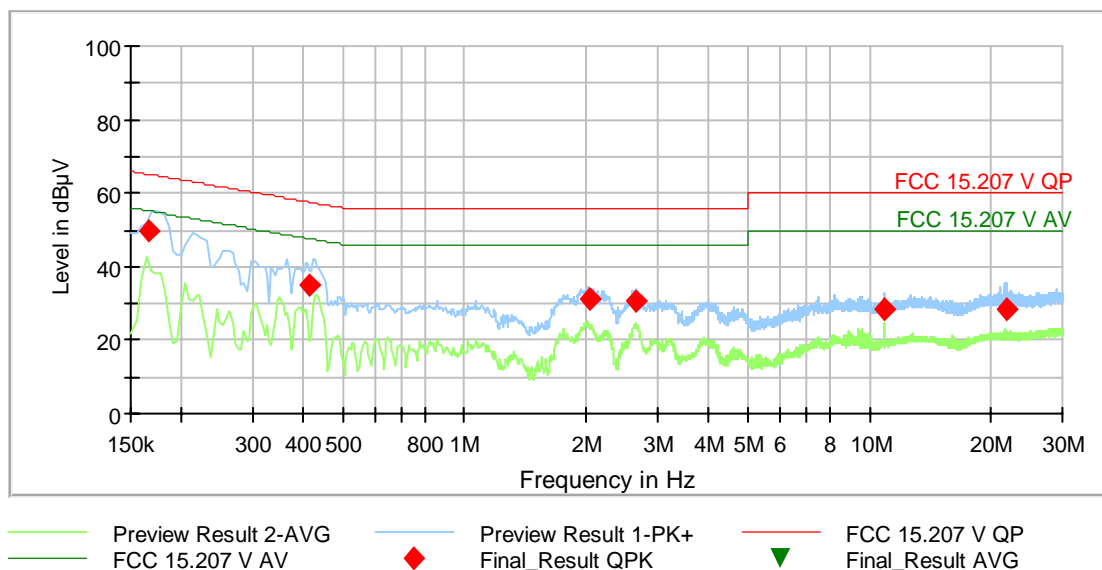

Final_Result

Frequency (MHz)	QuasiPeak (dBµV)	Average (dBµV)	Limit (dBµV)	Margin (dB)	Meas. Time (ms)	Bandwidth (kHz)	Line	PE	Transducer (dB)
0.167100	49.52	---	65.10	15.58	5000.0	9.000	N	GND	9.8
0.412800	35.09	---	57.59	22.50	5000.0	9.000	N	GND	9.9
2.043600	31.17	---	56.00	24.84	5000.0	9.000	N	FLO	10.1
2.651100	30.62	---	56.00	25.38	5000.0	9.000	N	FLO	10.2
10.878000	28.66	---	60.00	31.34	5000.0	9.000	L1	FLO	10.6
21.794100	28.15	---	60.00	31.85	5000.0	9.000	L1	GND	10.9
Measurement uncertainty					+2.78 dB / -2.78 dB				

EUT Information

Test description: Conducted emission measurement
 EUT: Release Station Plus 2 V2
 Manufacturer: NT-ware Systemprogrammierungs-GmbH
 Operating conditions: Cyclic TAG reading 13.56 MHz, Ethernet active (Fping)
 Test site: Phoenix TESTLAB GmbH, shielded room M4
 Operator: R. BRAUN
 Comment: 120 VAC / 60 Hz

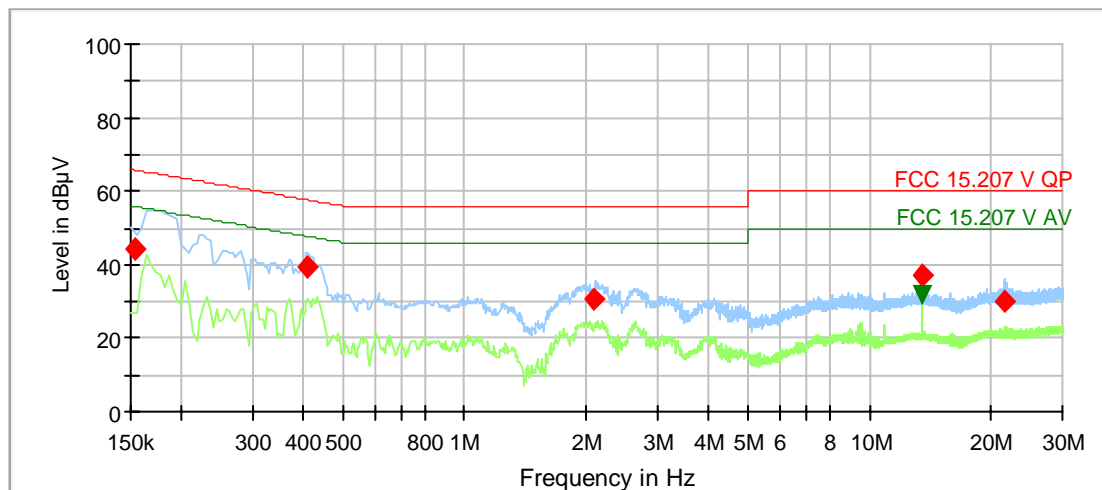

— Preview Result 2-AVG — Preview Result 1-PK+ — FCC 15.207 V QP
— FCC 15.207 V AV ◆ Final_Result QPK ▼ Final_Result AVG

Final_Result

Frequency (MHz)	QuasiPeak (dBµV)	Average (dBµV)	Limit (dBµV)	Margin (dB)	Meas. Time (ms)	Bandwidth (kHz)	Line	PE	Transducer (dB)
0.153600	44.37	---	65.80	21.43	5000.0	9.000	N	FLO	9.8
0.409200	39.41	---	57.66	18.25	5000.0	9.000	N	GND	9.9
2.094000	30.68	---	56.00	25.32	5000.0	9.000	N	FLO	10.1
13.560000	---	31.91	50.00	18.09	5000.0	9.000	N	FLO	10.8
13.560900	36.93	---	60.00	23.07	5000.0	9.000	L1	GND	10.7
21.598800	29.81	---	60.00	30.19	5000.0	9.000	L1	FLO	10.9
Measurement uncertainty					+2.78 dB / -2.78 dB				

Test: Passed

Test equipment used (refer clause 6)

1 - 5

5.2 Radiated emissions

5.2.1 Method of measurement (radiated emissions)

The radiated emission measurement is subdivided into six stages.

- A preliminary measurement carried out in a fully anechoic chamber with a fixed antenna height in the frequency range 9 kHz to 1 GHz.
- A final measurement carried out on an outdoor test site without reflecting ground plane and a fixed antenna height in the frequency range 9 kHz to 30 MHz.
- A preliminary measurement carried out in a fully anechoic chamber with a fixed antenna height in the frequency range 30 MHz to 1 GHz.
- A final measurement carried out on an open area test site with reflecting ground plane and various antenna heights in the frequency range 30 MHz to 1 GHz.
- A preliminary measurement carried out in a fully anechoic chamber with a fixed antenna height in the frequency range 1 GHz to 40 GHz.
- A final measurement carried out in a fully anechoic chamber with a fixed antenna height in the frequency range 1 GHz to 40 GHz.

Preliminary measurement (9 kHz to 30 MHz):

In the first stage a preliminary measurement will be performed in a shielded room with a measuring distance of 3 meters. Table-top devices will set up on a non-conducting support with a size of 1 m by 1.5 m and a height of 80 cm. Floor-standing devices will be placed directly on the turntable/ground plane. The set up of the Equipment under test will be in accordance to [1].

The frequency range 9 kHz to 30 MHz will be monitored with a spectrum analyser while the system and its cables will be manipulated to find out the configuration with the maximum emission levels if applicable. The EMI Receiver will be set to MAX Hold mode. The EUT and the measuring antenna will be rotated around their vertical axis to found the maximum emissions.

The resolution bandwidth of the spectrum analyser will be set to the following values:

Frequency range	Resolution bandwidth
9 kHz to 150 kHz	200 Hz
150 kHz to 30 MHz	10 kHz

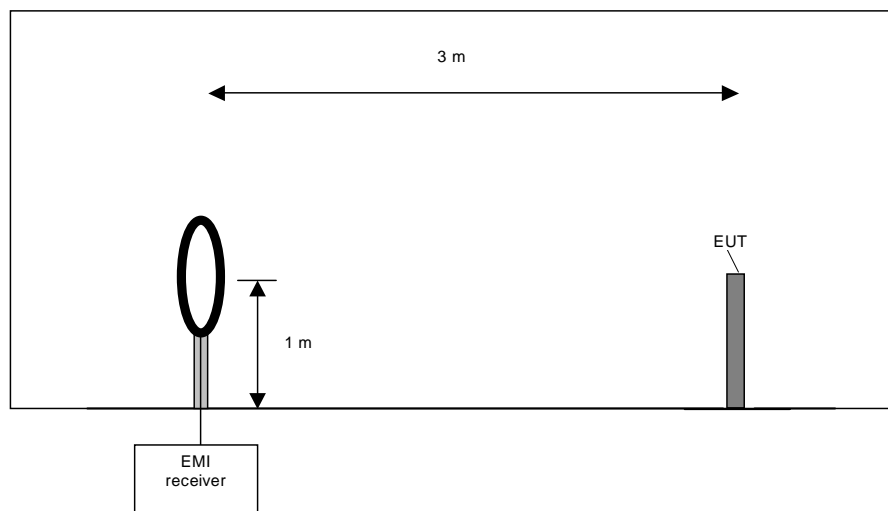

Preliminary measurement procedure:

Prescans were performed in the frequency range 9 kHz to 150 kHz and 150 kHz to 30 MHz.

The following procedure will be used:

- 1) Monitor the frequency range at horizontal polarisation and a EUT azimuth of 0 °.
- 2) Manipulate the system cables within the range to produce the maximum level of emission.
- 3) Rotate the EUT by 360 ° to maximize the detected signals.
- 4) Make a hardcopy of the spectrum.
- 5) Measure the frequencies of highest detected emission with a lower span and resolution bandwidth to increase the accuracy and note the frequency value.
- 6) Repeat steps 1) to 5) with the other orthogonal axes of the EUT (because of EUT is a module and might be used in a handheld equipment application).
- 7) Rotate the measuring antenna and repeat steps 1) to 5).

Final measurement (9 kHz to 30 MHz):

In the second stage a final measurement will be performed on an open area test site with no conducting ground plane in a measuring distances of 3 m, 10 m and 30 m. In the case where larger measuring distances are required the results will be extrapolated based on the values measured on the closer distances according to Section 15.31 (f) (2) [2]. The final measurement will be performed with a EMI Receiver set to Quasi Peak detector except for the frequency bands 9 kHz to 90 kHz and 110 kHz to 490 kHz where an average detector will be used according Section 15.209 (d) [2].

On the frequencies, which were detected during the preliminary measurements, the final measurement will be performed while rotating the EUT and the measuring antenna in the range of 0 ° to 360 ° around their vertical axis until the maximum value is found.

The resolution bandwidth of the EMI Receiver will be set to the following values:

Frequency range	Resolution bandwidth
9 kHz to 150 kHz	200 Hz
150 kHz to 30 MHz	9 kHz

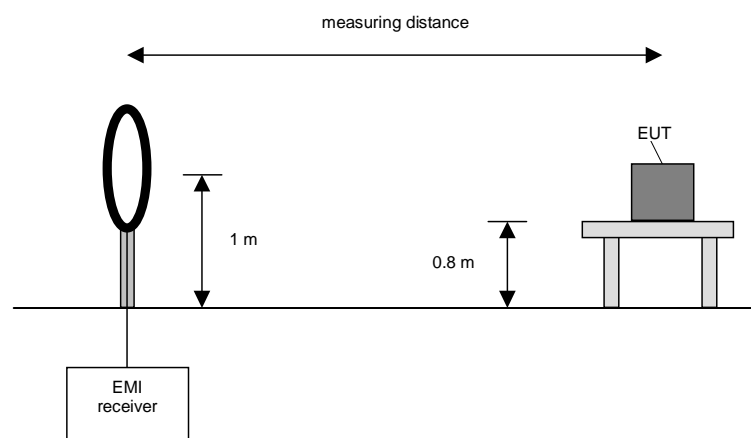

Final measurement procedure:

The following procedure will be used:

- 1) Monitor the frequency range with the measuring antenna at vertical orientation parallel to the EUT at an azimuth of 0 °.
- 2) Rotate the EUT by 360 ° to maximize the detected signals and note the azimuth and orientation.
- 3) Rotate the measuring antenna to find the maximum and note the value.
- 4) Rotate the measuring antenna and repeat steps 1) to 3) until the maximum value is found.
- 5) Repeat steps 1) to 4) with the other orthogonal axes of the EUT (if the EUT is a module and might be used in a handheld equipment application).

Preliminary measurement (30 MHz to 1 GHz)

In the first stage a preliminary measurement will be performed in a fully anechoic chamber with a measuring distance of 3 meter. Tabletop devices will set up on a non-conducting support with a size of 1 m by 1.5 m and a height of 80 cm. Floor-standing devices will be placed directly on the turntable/ground plane. The set up of the Equipment under test will be in accordance to [1].

The frequency range 30 MHz to 1 GHz will be measured with an EMI Receiver set to MAX Hold mode and a resolution bandwidth of 120 kHz. The measurement will be performed in horizontal and vertical polarisation of the measuring antenna and while rotating the EUT in its vertical axis in the range of 0 ° to 360 °.

The resolution bandwidth of the EMI Receiver will be set to the following values:

Frequency range	Resolution bandwidth
30 MHz to 1 GHz	120 kHz

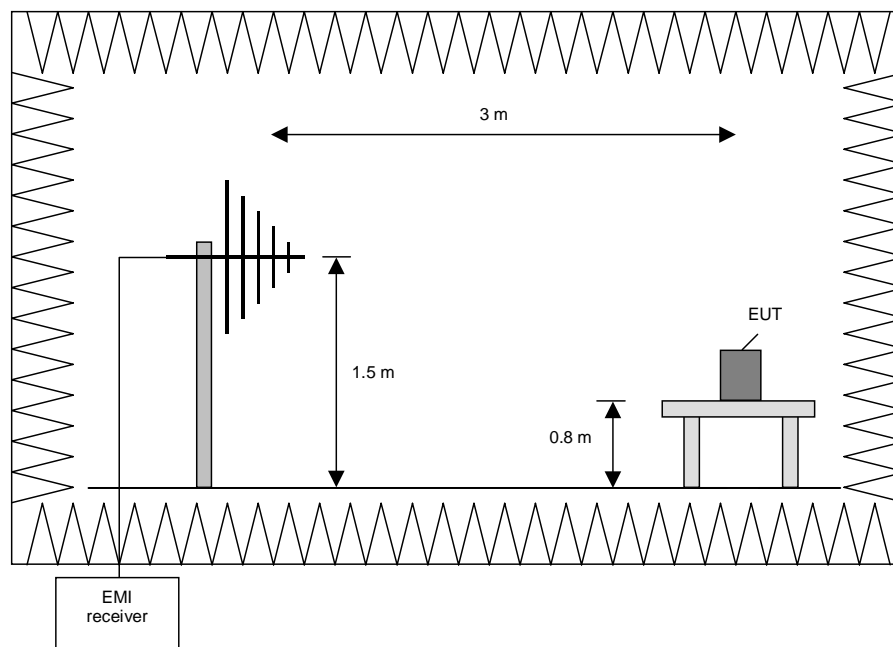

Procedure preliminary measurement:

Prescans were performed in the frequency range 30 MHz to 1 GHz.

The following procedure will be used:

1. Monitor the frequency range at horizontal polarisation and a EUT azimuth of 0 °.
2. Manipulate the system cables within the range to produce the maximum level of emission.
3. Rotate the EUT by 360 ° to maximize the detected signals.
4. Make a hardcopy of the spectrum.
5. Measure the frequency of the detected emissions with a lower span and resolution bandwidth to increase the accuracy and note the frequency value.
6. Repeat 1) to 4) with the other orthogonal axes of the EUT if handheld equipment.
7. Repeat 1) to 5) with the vertical polarisation of the measuring antenna.

Final measurement (30 MHz to 1 GHz)

A final measurement on an open area test site will be performed on selected frequencies found in the preliminary measurement. During this test the EUT will be rotated in the range of 0 ° to 360 °, the measuring antenna will be set to horizontal and vertical polarisation and raised and lowered in the range from 1 m to 4 m to find the maximum level of emissions.

The resolution bandwidth of the EMI Receiver will be set to the following values:

Frequency range	Resolution bandwidth
30 MHz to 1 GHz	120 kHz

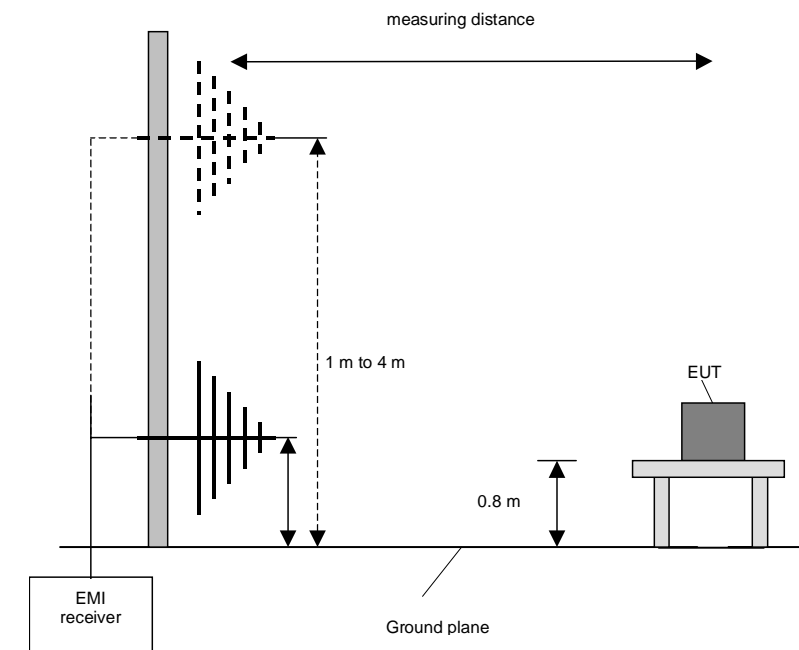

Procedure final measurement:

The following procedure will be used:

- 1) Measure on the selected frequencies at an antenna height of 1 m and a EUT azimuth of 23 °.
- 2) Move the antenna from 1 m to 4 m and note the maximum value at each frequency.
- 3) Rotate the EUT by 45 ° and repeat 2) until an azimuth of 337 ° is reached.
- 4) Repeat 1) to 3) for the other orthogonal antenna polarization.
- 5) Move the antenna and the turntable to the position where the maximum value is detected.
- 6) Measure while moving the antenna slowly +/- 1 m.
- 7) Set the antenna to the position where the maximum value is found.
- 8) Measure while moving the turntable +/- 45 °.
- 9) Set the turntable to the azimuth where the maximum value is found.
- 10) Measure with Final detector (QP and AV) and note the value.
- 11) Repeat 5) to 10) for each frequency.
- 12) Repeat 1) to 11) for each orthogonal axes of the EUT if handheld equipment.

Preliminary and final measurement (1 GHz to 110 GHz)

This measurement will be performed in a fully anechoic chamber. Table top devices will set up on a non-conducting turn device on the height of 1.5 m. The set-up of the Equipment under test will be in accordance to [1].

Preliminary measurement (1 GHz to 110 GHz)

The frequency range will be divided into different sub ranges depending of the frequency range of the used horn antenna. The spectrum analyser set to MAX Hold mode and a resolution bandwidth of 100 kHz. The measurement will be performed in horizontal and vertical polarisation of the measuring antenna and while rotating the EUT in its vertical axis in the range of 0 ° to 360 °. This measurement is repeated after raising the EUT in 30 ° steps according 6.6.5.4 in [1].

The resolution bandwidth of the EMI Receiver will be set to the following values:

Frequency range	Resolution bandwidth
1 GHz to 4 GHz	1 MHz
4 GHz to 12 GHz	1 MHz
12 GHz to 18 GHz	1 MHz
18 GHz to 26.5 GHz	1 MHz
26.5 GHz to 40 GHz	1 MHz
40 GHz to 60 GHz	1 MHz
50 GHz to 75 GHz	1 MHz
75 GHz to 110 GHz	1 MHz

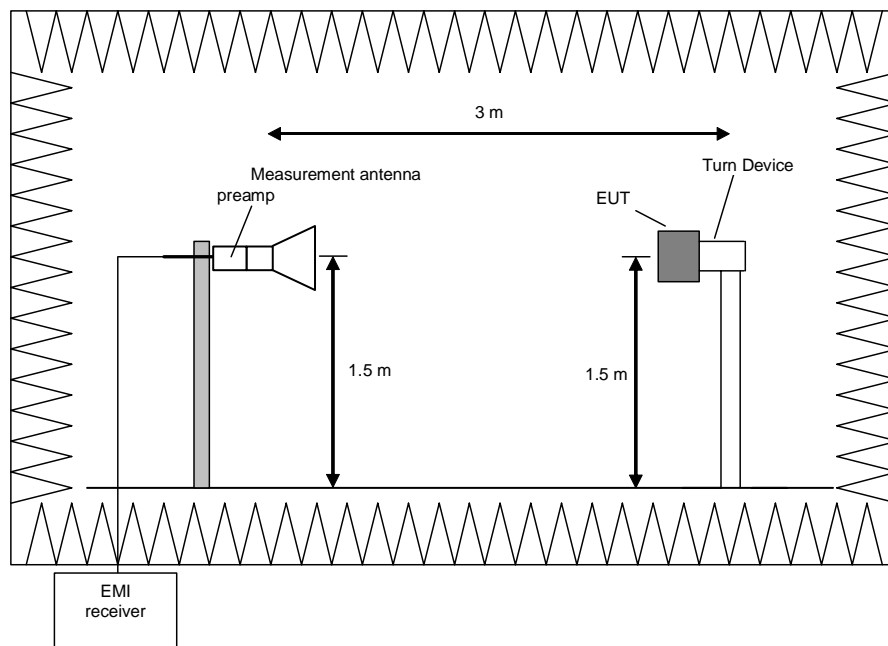

Procedure preliminary measurement:

Prescans were performed in the frequency range 1 to 40 GHz.

The following procedure will be used:

1. Monitor the frequency range at horizontal polarisation and a EUT azimuth of 0 °.
2. Rotate the EUT by 360° to maximize the detected signals.
3. Repeat 1) to 2) with the vertical polarisation of the measuring antenna.
4. Make a hardcopy of the spectrum.
5. Repeat 1) to 4) with the EUT raised by an angle of 30° (60°, 90°, 120° and 150°) according to 6.6.5.4 in [1].
6. Measure the frequency of the detected emissions with a lower span and resolution bandwidth to increase the accuracy and note the frequency value.
7. The measurement antenna polarisation, with the according EUT position (Turntable and Turn device) which produces the highest emission for each frequency will be used for the final measurement. The six closest values to the applicable limit will be used for the final measurement.

Final measurement (1 GHz to 110 GHz)

The frequency range will be divided into different sub ranges depending of the frequency range of the used antenna. The EMI Receiver set to peak and average mode and a resolution bandwidth of 1 MHz. The measurement will be performed by rotating the turntable through 0 to 360° in the worst-case EUT orientation which was obtained during the preliminary measurements.

The resolution bandwidth of the EMI Receiver will be set to the following values:

Frequency range	Resolution bandwidth
1 GHz to 4 GHz	1 MHz
4 GHz to 12 GHz	1 MHz
12 GHz to 18 GHz	1 MHz
18 GHz to 26.5 GHz	1 MHz
26.5 GHz to 40 GHz	1 MHz
40 GHz to 60 GHz	1 MHz
50 GHz to 75 GHz	1 MHz
75 GHz to 110 GHz	1 MHz

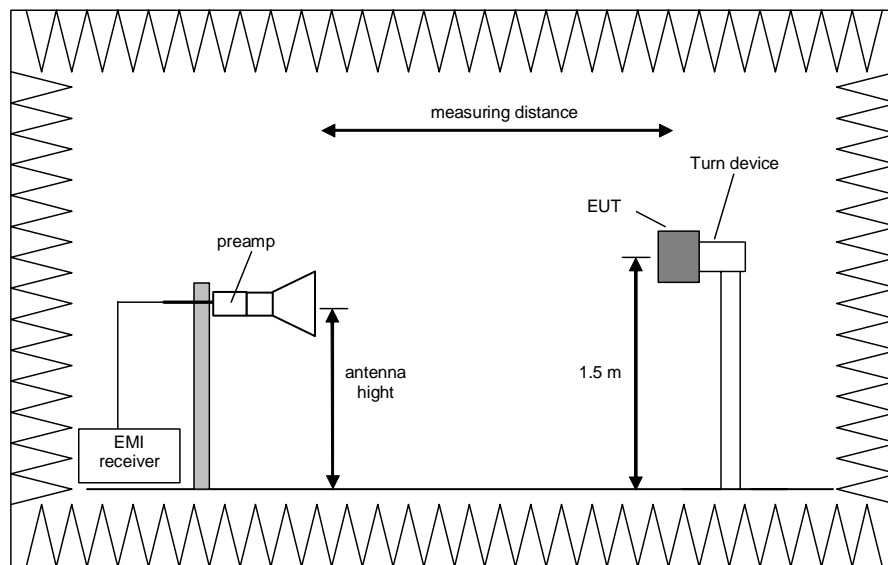

Procedure of measurement:

The measurements were performed in the frequency range 1 GHz to 110 GHz.

The following procedure will be used:

- 1) Set the turntable and the turn device to obtain the worst-case emission for the first frequency identified in the preliminary measurements.
- 2) Set the measurement antenna polarisation to the orientation with the highest emission for the first frequency identified in the preliminary measurements.
- 3) Set the spectrum analyser to EMI mode with peak and average detector activated.
- 4) Rotate the turntable from 0° to 360° to find the EUT angle that produces the highest emissions.
- 5) Note the highest displayed peak and average values
- 6) Repeat the steps 1) to 5) for each frequency detected during the preliminary measurements.

5.2.2 Test results (radiated emissions)

5.2.2.1 Preliminary radiated emission measurement 9 kHz to 1 GHz

Ambient temperature	22 °C	Relative humidity	62 %
---------------------	-------	-------------------	------

Position of EUT:	The EUT was set-up on a non-conducting table.
Cable guide:	The cables of the EUT were fixed on the non-conducting table. For further information of the cable guide refer to the pictures in annex A of this test report.
Test record:	The test was carried out reading a TAG continuously (refer also clause 2 of this test report). The tests were carried out in normal positions as declared by the applicant.
Power supply:	During this test the EUT was powered with 12 V _{DC} by the GlobTek model GT-41080-1817.9-5.9, which was itself supplied by an AC mains Network with 120 V _{AC} / 60 Hz.
Frequency range:	According to [2] from 9 kHz to 1 GHz.

172189magFCC 125.Rtf: Emissions from 9 kHz to 30 MHz reading a 125 kHz TAG

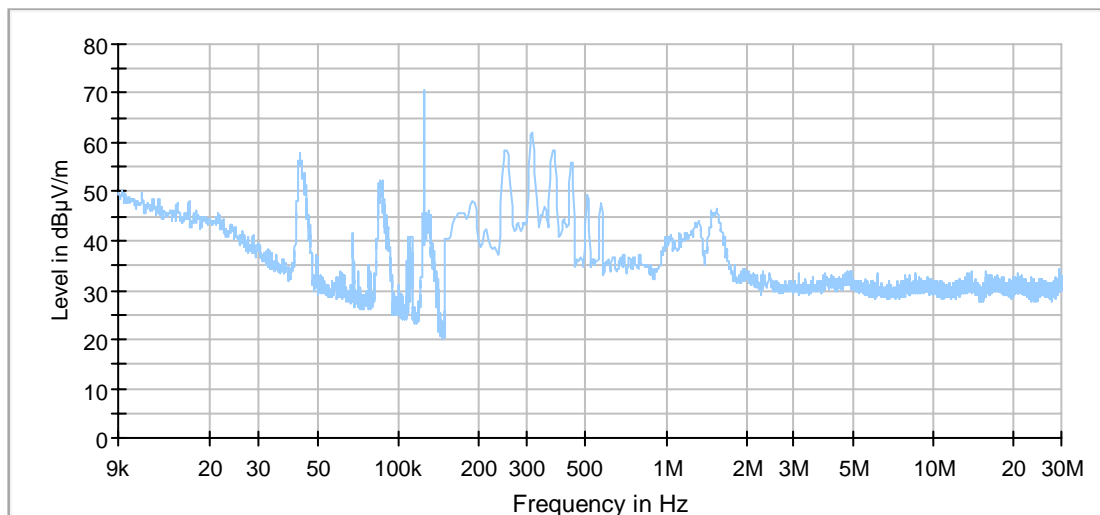

— Preview Result 1-PK+ ◆ Final_Result PK+

The following emissions were found according to [2] and [3].

Frequency (MHz)
0.042910*
0.125001
0.317160*

Remark*: These frequencies has to be not rated because they were caused by the digital device also as seen in the plot of the Emissions from 9 kHz to 30 MHz reading a 13.56 MHz TAG.

These frequencies have to be measured on the outdoor test site. The result is presented in the following.

172189magFCC 1356.Rtf: Emissions from 9 kHz to 30 MHz reading a 13.56 MHz TAG

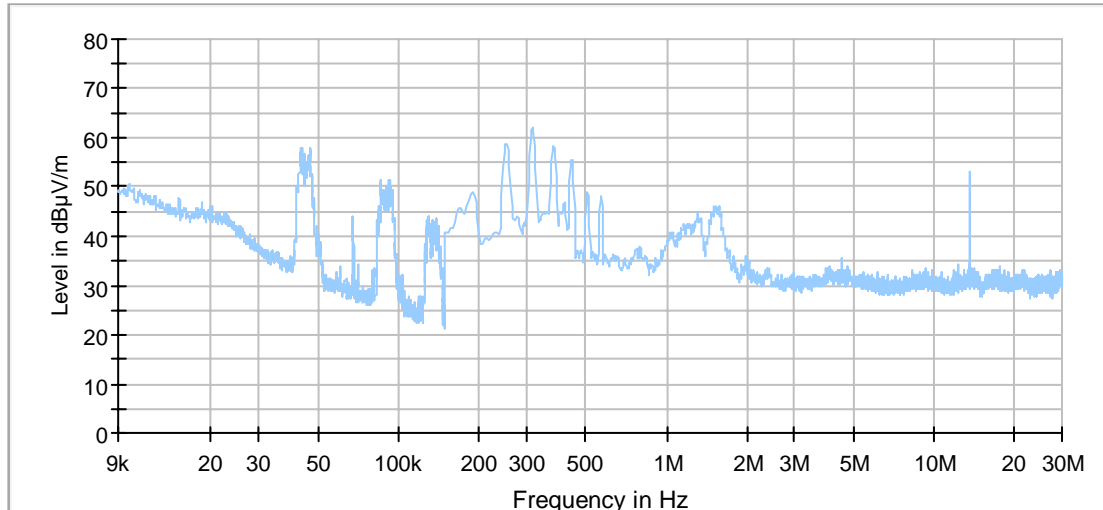

— Preview Result 1-PK+ ◆ Final_Result PK+

The following emissions were found according to [2] and [3].

Frequency (MHz)
0.046746*
0.31716*
13.558620

Remark*: These frequencies has to be not rated because they were caused by the digital device also as seen in the plot of the Emissions from 9 kHz to 30 MHz reading a 125 kHz TAG.

These frequencies have to be measured on the outdoor test site. The result is presented in the following.

172189ahFCC.Rtf: Emissions from 30 MHz to 1000 MHz reading a 13.56 MHz TAG

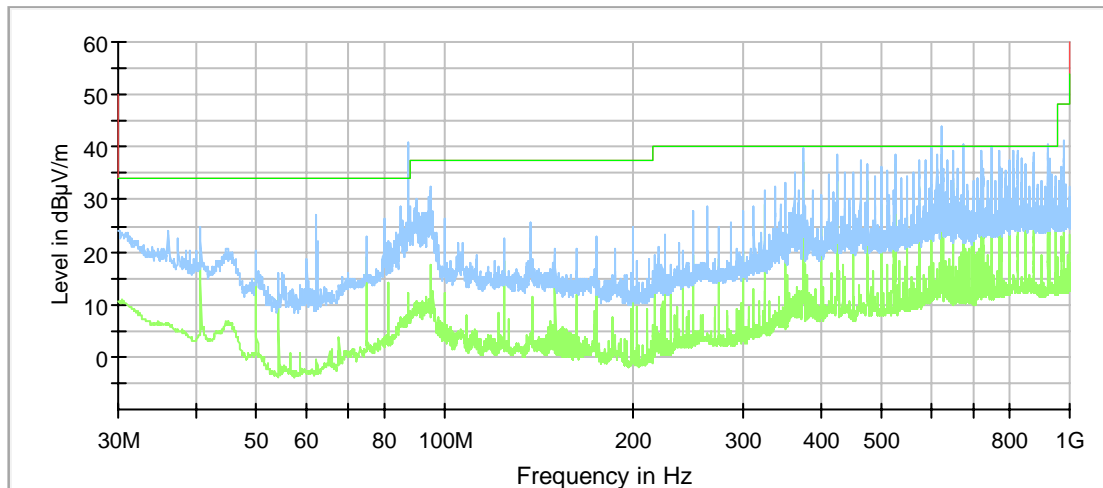

— Preview Result 2-AVG — Preview Result 1-PK+ — FCC 15_209 AH QP
— FCC 15_209 AHAV ◆ Final_Result QPK

Remark: As pre-test have shown, reading a 13.56 MHz TAG causes higher emissions above 30 MHz. Therefore the tests above 30 MHz were carried out with this TAG

The following frequencies were found emission test outside and inside restricted bands during the preliminary radiated:

Frequency (MHz)
40.680000
49.980000
62.460000
87.480000
375.000000
425.040000
600.000000
625.020000
675.000000
750.000000
825.060000

These frequencies have to be measured on the open area test site. The results were presented in the following.

Test equipment used (refer clause 6)

12 – 17, 21 – 22, 26, 29

5.2.2.2 Preliminary radiated emission measurement 1 GHz to 5 GHz

Ambient temperature	22 °C	Relative humidity	62 %
---------------------	-------	-------------------	------

- Position of EUT: The EUT was set-up on a non-conducting table.
- Cable guide: The cables of the EUT were fixed on the turn device. For further information of the cable guide refer to the pictures in annex A of this test report.
- Test record: The test was carried out reading a TAG continuously (refer also clause 2 of this test report). The tests were carried out in normal positions as declared by the applicant.
- Power supply: During this test the EUT was powered with 12 V_{DC} by the GlobTek model GT-41080-1817.9-5.9, which was itself supplied by an AC mains Network with 120 V_{AC} / 60 Hz.
- Frequency range: According to [2] from 1 GHz to 5 GHz.

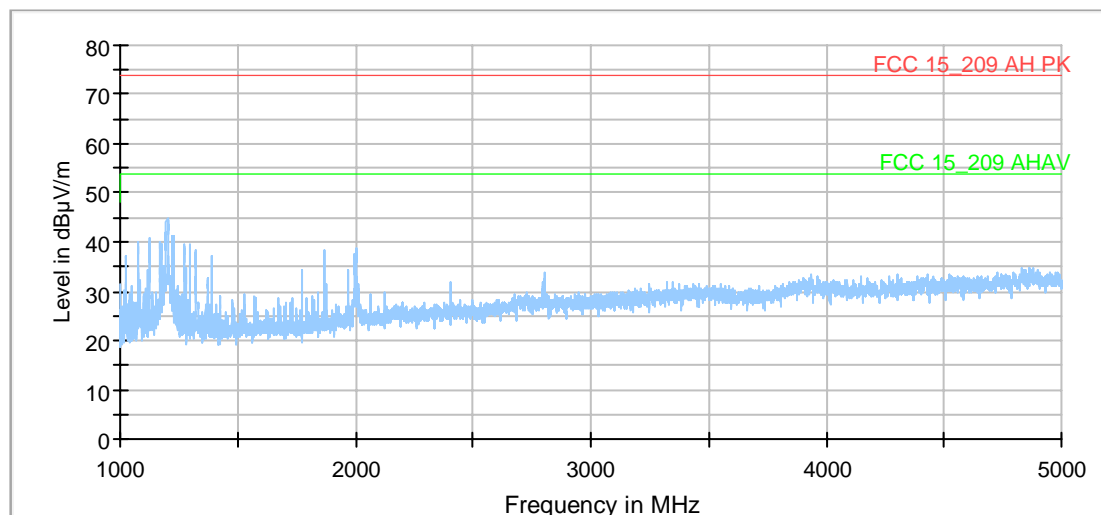

— PK+_MAXH — FCC 15_209 AH PK — FCC 15_209 AHAV

Remark: As pretest has shown, reading a 13.56 MHz TAG causes higher emissions above 30 MHz. Therefore the tests above 30 MHz were carried out with this TAG

The following frequencies were found emission test outside and inside restricted bands during the preliminary radiated:

Frequency (MHz)
1075.342857
1173.942857
1200.000000
1226.000000
2001.200000
2401.257143
2804.371429

On these frequencies a final measurement has to be carried out. The results were presented in the following.

Test equipment used (refer clause 6)

12 - 20, 23, 29, 31

5.2.2.3 Final radiated emission measurement from 9 kHz to 30 MHz

Ambient temperature	10 °C	Relative humidity	72 %
---------------------	-------	-------------------	------

Position of EUT: The EUT was set-up on a non-conducting table.

Cable guide: The cables of the EUT were fixed on the non-conducting table. For further information of the cable guide refer to the pictures in annex A of this test report.

Test record: The test was carried out reading a TAG continuously (refer also clause 2 of this test report). The tests were carried out in normal positions as declared by the applicant.

Power supply: During this test the EUT was powered with 12 V_{DC} by the GlobTek model GT-41080-1817.9-5.9, which was itself supplied by an AC mains Network with 120 V_{AC} / 60 Hz.

Test results: The test results were calculated with the following formula:

Reading a 125 kHz TAG Original

Frequency	Reading	Result*	Limit acc. 15.209	Margin	Detector (acc to §15.209 (d))	Antenna factor	Measuring Distance	Distance corection factor**
[MHz]	[dBµV]	[dBµV/m]	[dBµV/m]	[dB]		[dB/m]	[m]	[dB]
0.042910 ***	37.6	-22 @ 300m	35.0	57.0	AV	20.4	3	80.0
0.125001	50.6	-9.2 @ 300m	25.7	34.9	AV	20.2	3	80.0
0.317160 ***	41.8	-18 @ 300m	17.6	35.6	AV	20.2	3	80.0
Measurement uncertainty: +4.69 dB / -4.69 dB								

Note *Result @ norm dist = Reading + Antenna factor - Distance Extrapolation Factor

** 40dB/decade according Part §15.31 (f) (2) Cable loss included

¹⁾: Wanted signal 125 kHz RFID system

Remark***: These frequencies has to be not rated because they were caused by the digital device also as seen in the plot of the emissions from 9 kHz to 30 MHz reading a 13.56 MHz TAG.

Reading a 125 kHz FSK TAG

Frequency	Reading	Result*	Limit acc. 15.209	Margin	Detector (acc to §15.209 (d))	Antenna factor	Measuring Distance	Distance corection factor**
[MHz]	[dBµV]	[dBµV/m]	[dBµV/m]	[dB]		[dB/m]	[m]	[dB]
0.125001	50.6	-9.2 @ 300m	25.7	34.9	AV	20.2	3	80.0
Measurement uncertainty: +4.69 dB / -4.69 dB								

Reading a 125 kHz PSK TAG

Frequency	Reading	Result*	Limit acc. 15.209	Margin	Detector (acc to §15.209 (d))	Antenna factor	Measuring Distance	Distance corection factor**
[MHz]	[dBµV]	[dBµV/m]	[dBµV/m]	[dB]		[dB/m]	[m]	[dB]
0.125001	50.8	-9 @ 300m	25.7	34.7	AV	20.2	3	80.0
Measurement uncertainty: +4.69 dB / -4.69 dB								

Reading a 125 kHz ASK TAG

Frequency	Reading	Result*	Limit acc. 15.209	Margin	Detector (acc to §15.209 (d))	Antenna factor	Measuring Distance	Distance corection factor**
[MHz]	[dBµV]	[dBµV/m]	[dBµV/m]	[dB]		[dB/m]	[m]	[dB]
0.125001	50.6	-9.2 @ 300m	25.7	34.9	AV	20.2	3	80.0

Reading a 13.56 MHz TAG

Frequency	Reading	Result*	Limit acc. 15.209	Margin	Detector (acc to §15.209 (d))	Antenna factor	Measuring Distance	Distance corection factor**
[MHz]	[dBµV]	[dBµV/m]	[dBµV/m]	[dB]		[dB/m]	[m]	[dB]
0.046746	37.1	-22.5 @ 300m	34.2	56.7	AV	20.4	3	80.0
0.317160	41.8	-18 @ 300m	17.6	35.6	AV	20.2	3	80.0
13.558620	33.1	13.4 @ 30m	29.5	16.1	QP	20.3	3	40.0
Measurement uncertainty: +4.69 dB / -4.69 dB								

Note *Result @ norm dist = Reading + Antenna factor - Distance Extrapolation Factor

** 40dB/decade according Part §15.31 (f) (2) Cable loss included

¹⁾: Wanted signal 13.56 MHz RFID system

Remark***: These frequencies has to be not rated because they were caused by the digital device also as seen in the plot of the emissions from 9 kHz to 30 MHz reading a 125 kHz TAG.

Test: Passed

Test equipment used (refer clause 6)

12, 21, 24 , 32

5.2.2.4 Final radiated emission measurement from 30 MHz to 1 GHz

Ambient temperature	22 °C	Relative humidity	60 %
---------------------	-------	-------------------	------

- Position of EUT:** The EUT was set-up on a non-conducting table.
- Cable guide:** The cables of the EUT were fixed on the non-conducting table. For further information of the cable guide refer to the pictures in annex A of this test report.
- Test record:** The test was carried out reading a TAG continuously (refer also clause 2 of this test report). The tests were carried out in normal positions as declared by the applicant.
- Power supply:** During this test the EUT was powered with 24 V_{DC} by the GlobTek model GT-41080-1817.9-5.9, which was itself supplied by an AC mains Network with 120 V_{AC} / 60 Hz.
- Remark:** As pretest has shown, reading a 13.56 MHz TAG causes higher emissions above 30 MHz. Therefore the tests above 30 MHz were carried out with this TAG
- Test results:** The test results were calculated with the following formula:
Result [dBμV/m] = reading [dBμV] + antenna factor [dB/m]

The measured points and the limit line in the following diagrams refer to the standard measurement of the emitted interference in compliance with the above-mentioned standard. The measured points marked with an **◆** are the measured results of the standard final measurement on the open area test site.

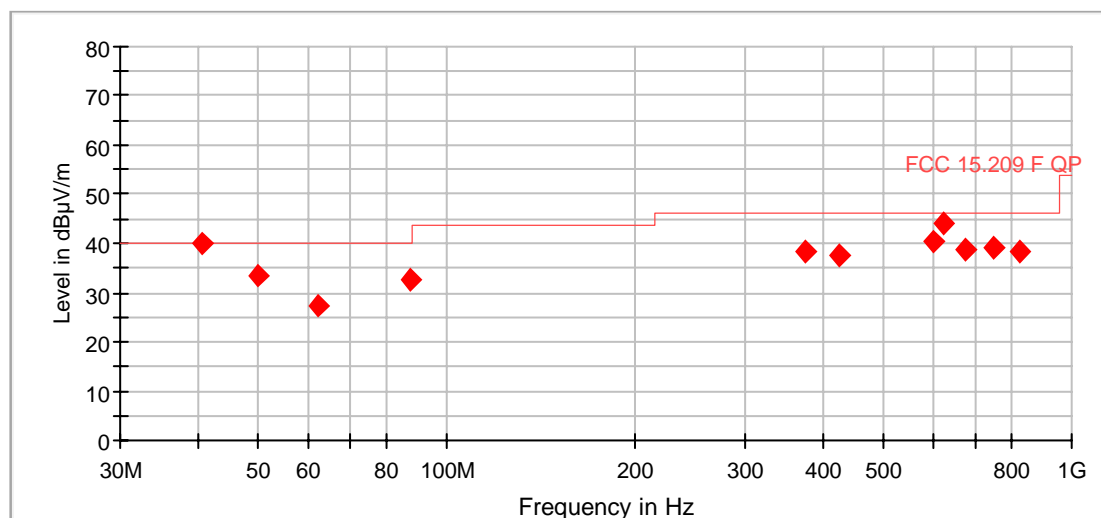

— FCC 15.209 F QP ◆ Final_Result QPK

The results of the standard subsequent measurement on the open area test site are indicated in the table below. The limits as well as the measured results (levels) refer to the above mentioned standard while taking account of the specified requirements for a 3 m measuring distance. The measurement time with the quasi-peak measuring detector is 1 seconds.

Final_Result

Frequency (MHz)	QuasiPeak (dB μ V/m)	Limit (dB μ V/m)	Margin (dB)	Meas. Time (ms)	Bandwidth (kHz)	Height (cm)	Pol	Azimuth (deg)	Corr. (dB)
40.680000	39.84	40.00	0.16	1000.0	120.000	104.0	V	271.0	21.7
49.980000	33.39	40.00	6.61	1000.0	120.000	102.0	V	188.0	16.4
62.460000	27.51	40.00	12.49	1000.0	120.000	181.0	V	0.0	12.2
87.480000	32.85	40.00	7.15	1000.0	120.000	126.0	V	13.0	17.2
375.000000	38.37	46.00	7.63	1000.0	120.000	194.0	H	86.0	24.3
425.040000	37.67	46.00	8.33	1000.0	120.000	111.0	V	161.0	26.0
600.000000	40.29	46.00	5.71	1000.0	120.000	126.0	H	337.0	29.3
625.020000	44.25	46.00	1.75	1000.0	120.000	121.0	H	331.0	30.2
675.000000	38.61	46.00	7.39	1000.0	120.000	105.0	H	328.0	30.3
750.000000	39.06	46.00	6.94	1000.0	120.000	102.0	H	1.0	32.6
825.060000	38.44	46.00	7.56	1000.0	120.000	119.0	V	46.0	33.4
Measurement uncertainty ± 4.78 dB									

Result: Passed

Test equipment used (refer clause 6)

5 - 12

5.2.2.5 Final radiated emission measurement from 1 GHz to 5 GHz

Ambient temperature	22 °C	Relative humidity	62 %
---------------------	-------	-------------------	------

- Position of EUT: The EUT was set-up on a turn device.
- Cable guide: The cables of the EUT were fixed on the turn device. For further information of the cable guide refer to the pictures in annex A of this test report.
- Test record: The test was carried out reading a TAG continuously (refer also clause 2 of this test report). The tests were carried out in normal positions as declared by the applicant.
- Power supply: During this test the EUT was powered with 12 V_{DC} by the GlobTek model GT-41080-1817.9-5.9, which was itself supplied by an AC mains Network with 120 V_{AC} / 60 Hz.
- Remark: As pretest has shown, reading a 13.56 MHz TAG causes higher emissions above 30 MHz. Therefore the tests above 30 MHz were carried out with this TAG
- Frequency range: According to [2] from 1 GHz to 5 GHz.

Final_Result

Frequency (MHz)	MaxPeak (dB μ V/m)	CAverage (dB μ V/m)	Limit (dB μ V/m)	Margin (dB)	Pol	Azimuth (deg)	Elevation (deg)	Corr. (dB)
1075.342857	---	33.65	54.00	20.35	V	281.0	120.0	-17.1
1075.342857	45.41	---	74.00	28.59	V	281.0	120.0	-17.1
1173.942857	---	40.88	54.00	13.12	H	285.0	90.0	-16.5
1173.942857	47.93	---	74.00	26.07	H	285.0	90.0	-16.5
1200.000000	---	27.93	54.00	26.07	H	256.0	150.0	-16.1
1200.000000	51.58	---	74.00	22.42	H	256.0	150.0	-16.1
1226.000000	---	36.11	54.00	17.89	H	304.0	90.0	-16.3
1226.000000	46.63	---	74.00	27.37	H	304.0	90.0	-16.3
2001.200000	---	26.90	54.00	27.10	V	265.0	120.0	-11.6
2001.200000	48.95	---	74.00	25.05	V	265.0	120.0	-11.6
2401.257143	---	25.18	54.00	28.82	V	310.0	120.0	-9.7
2401.257143	40.16	---	74.00	33.84	V	310.0	120.0	-9.7
2804.371429	---	25.63	54.00	28.37	V	293.0	120.0	-8.1
2804.371429	40.27	---	74.00	33.73	V	293.0	120.0	-8.1
Measurement uncertainty				+5.1 dB / -5.1 dB				

The correction factor was calculated as follows.

$$\text{Corr. (dB)} = \text{cable attenuation (dB)} + \text{amplifier (dB)} + \text{antenna factor (dB}\mu\text{V/m)}$$

Test result: Passed

Test equipment used (refer clause 6)

12 – 20, 23, 29, 31

5.3 99 % bandwidth

5.3.1 Method of measurement

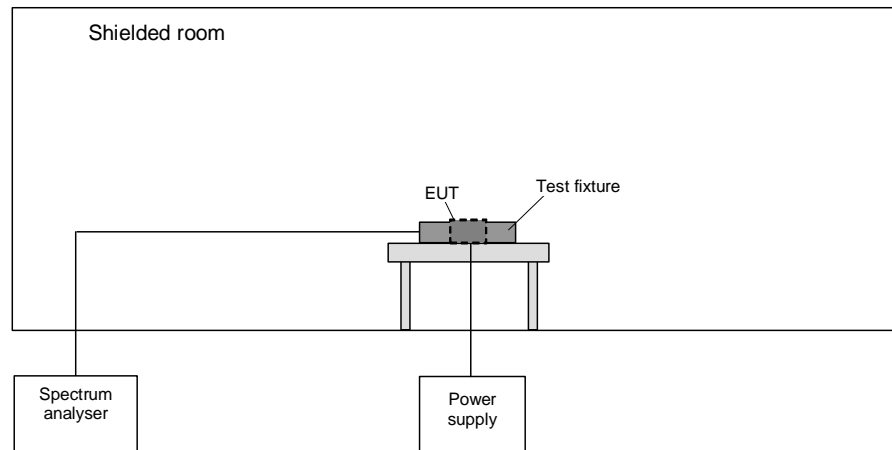

The following procedure will be used for the occupied bandwidth measurement according to [1]:

The span of the analyzer shall be set to capture all products of the modulation process including the emission skirts. The resolution bandwidth shall be set to as close to 1% of the selected span as is possible without being below 1%. The video bandwidth shall be set to 3 times the resolution bandwidth. Video averaging is not permitted. Where practical a sampling detector shall be used since a peak or peak hold may produce a wider bandwidth than actual.

The trace data points are recovered and are directly summed in linear terms. The recovered amplitude data points beginning at the lowest frequency are placed in a running sum until 0.5% of the total is reached and that frequency recorded. The process is repeated for the highest frequency data points. This frequency is recorded.

The span between the two recorded frequencies is the occupied bandwidth.

5.3.2 Test results 99 % bandwidth

Ambient temperature:	21 °C
----------------------	-------

Relative humidity:	45 %
--------------------	------

Test record: The test was carried out reading a TAG continuously (refer also clause 2 of this test report). The tests were carried out in normal positions as declared by the applicant.

Power supply: During this test the EUT was powered with 12 V_{DC} by the GlobTek model GT-41080-1817.9-5.9, which was itself supplied by an AC mains Network with 120 V_{AC} / 60 Hz.

172189 125kHz 99 PSK with TAG.JPEG: 99 % bandwidth reading a 125 kHz PSK TAG

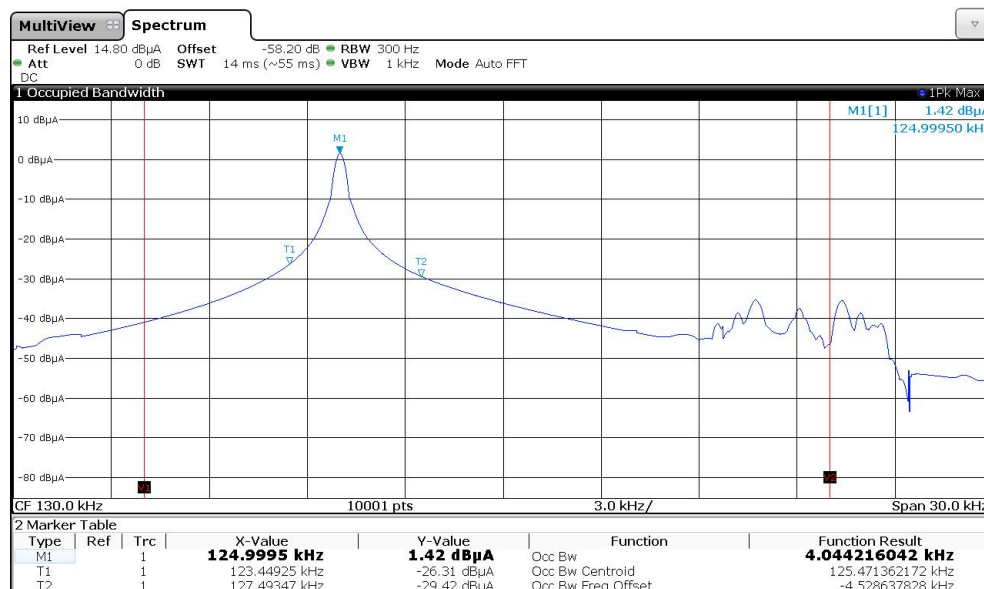

F _L	F _U	BW (F _U - F _L)
123.449 kHz	127.493 kHz	4.0442 kHz
Measurement uncertainty		< 1*10 ⁻⁷

172189 125kHz 99 ASK with TAG.JPEG: 99 % bandwidth reading a 125 kHz ASK TAG

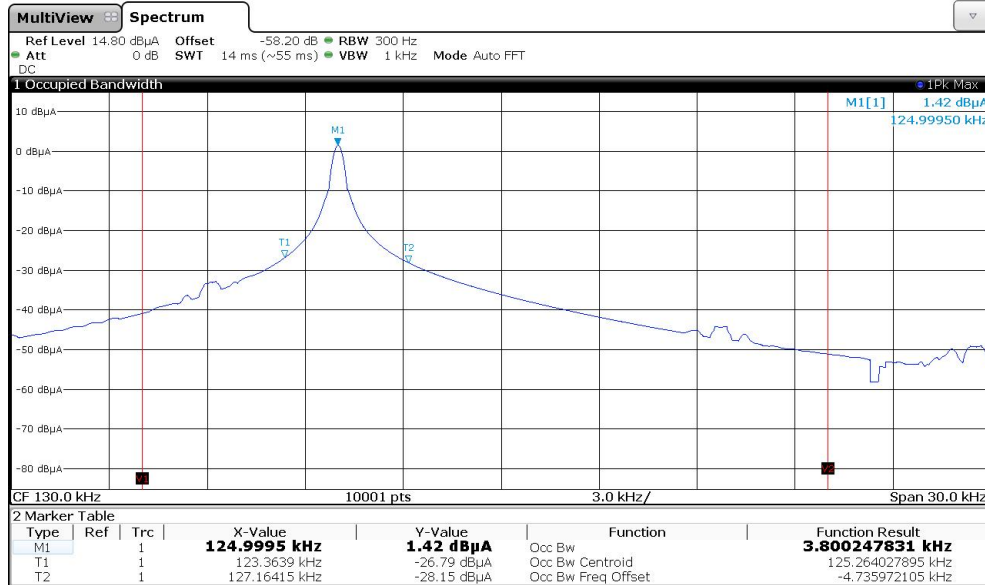

F_L	F_U	BW ($F_U - F_L$)
123.364 kHz	127.164 kHz	3.800 kHz
Measurement uncertainty		$< 1 \cdot 10^{-7}$

172189 125kHz 99 FSK with TAG.JPEG: 99 % bandwidth reading a 125 kHz FSK TAG

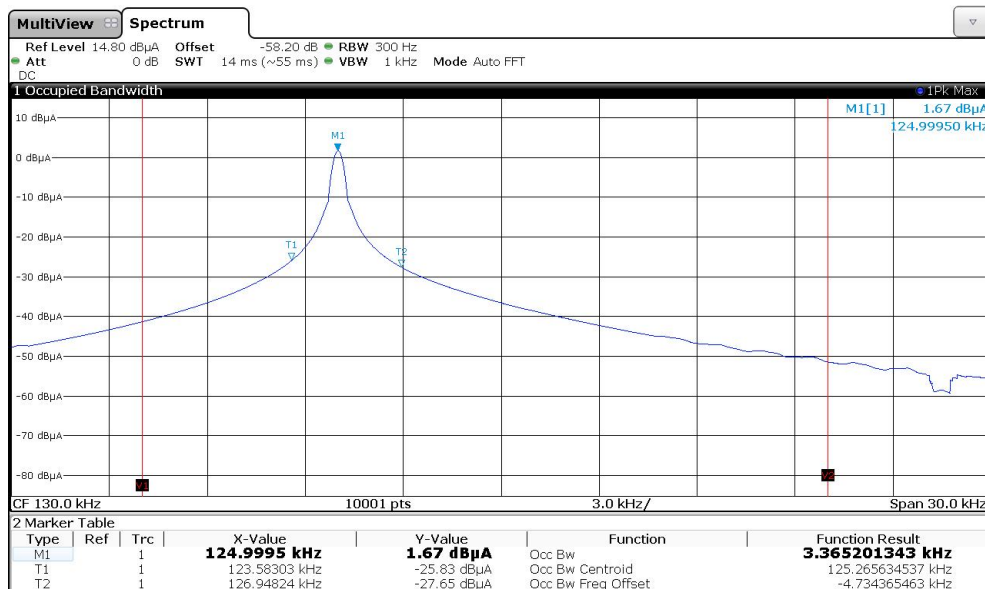

F_L	F_U	BW ($F_U - F_L$)
123.583 kHz	127.948 kHz	3.365 kHz
Measurement uncertainty		$< 1 \cdot 10^{-7}$

172189 1356MHz 99fcc1.JPEG: 99 % bandwidth reading a 13.56 MHz TAG

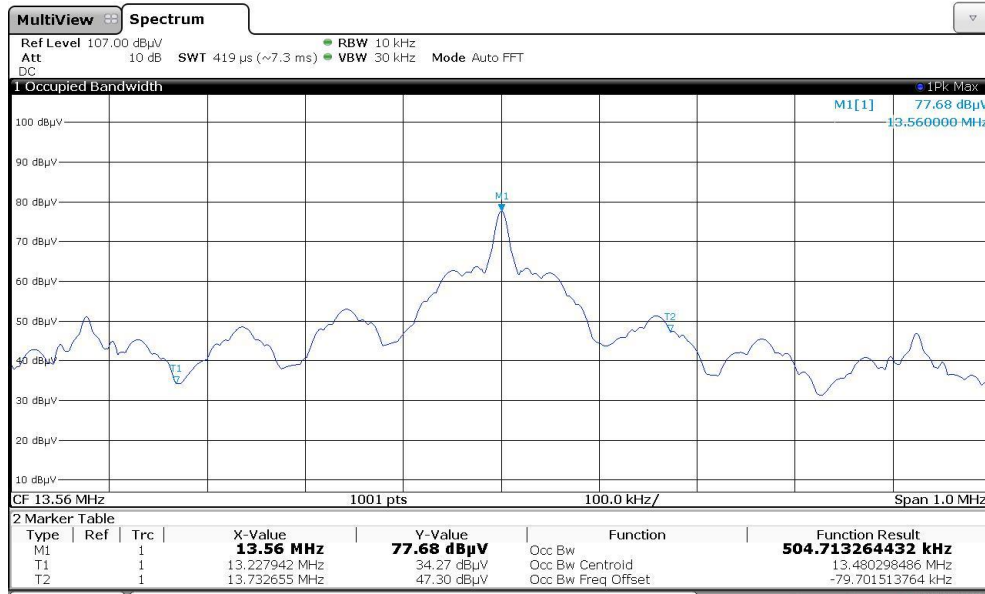

F_L	F_U	BW ($F_U - F_L$)
13.227942 MHz	13.732655 MHz	504.713 kHz
Measurement uncertainty		$< 1 \cdot 10^{-7}$

Test equipment used (refer clause 6)

12, 28, 30

6 Test equipment

No.	Test equipment	Type	Manufacturer	Serial No.	PM. No.	Cal. Date	Cal Due
1	Shielded chamber M4	B83117-S1-X158	Siemens	190075	480088	Calibration not necessary	
2	EMI Receiver / Spectrum Analyser	ESIB 26	Rohde & Schwarz	100292	481182	15.02.2016	02.2018
3	LISN	NSLK8128	Schwarzbeck	8128155	480058	Calibration not necessary	
4	Transient Filter Limiter	CFL 9206A	Teseq GmbH	38268	481982	Calibration not necessary	
5	Software	EMC32	Rohde & Schwarz	100061	481022	Calibration not necessary	
6	Open area test site M6	Freifeld M6	Phoenix Contact	-	480085	Calibration not necessary	
7	EMI Receiver / Spectrum Analyser	ESR7	Rohde & Schwarz	101939	482558	19.09.2017	09.2019
8	Controller	HD100	Deisel	100/349	480139	Calibration not necessary	
9	Turntable	DS412	Deisel	412/316	480087	Calibration not necessary	
10	Antenna mast	MA240-0	Inn-Co GmbH	MA240-0/030/6600603	480086	Calibration not necessary	
11	Antenna (Bilog)	CBL6111D	Schaffner Elektrotest GmbH / Teseq GmbH	25761	480894	19.10.2017	10.2020
12	AC Powersupply	AC6803A AC Quelle 2000VA	Keysight	JPVJ002509	482350	Calibration not necessary	
13	EMI Receiver / Spectrum Analyser	ESW44	Rohde & Schwarz	101635	482467	22.06.2017	06.2019
14	Fully anechoic chamber M20	B83117-E2439-T232	Albatross Projects	103	480303	Calibration not necessary	
15	Multiple Control Unit	MCU	Maturo GmbH	MCU/043/9711 07	480832	Calibration not necessary	
16	Turntable	DS420 HE	Deisel	420/620/00	480315	Calibration not necessary	
17	Antenna mast	AS615P	Deisel	615/310	480187	Calibration not necessary	
18	Antenna (Log.Per.)	HL050	Rohde & Schwarz	100438	481170	09.10.2017	10.2020
19	RF-cable No.3	Sucoflex 106B	Suhner	0563/6B / Kabel 3	480670	Calibration not necessary	
20	RF-cable No.38	Sucoflex 106B	Suhner	0709/6B / Kabel 38	481328	Calibration not necessary	
21	Loop antenna	HFH2-Z2	Rohde & Schwarz	832609/014	480059	29.02.2016	02.2018
22	Antenna (Bilog)	CBL6112B	Schaffner EMV GmbH (-Chase)	2688	480328	19.06.2017	06.2020
23	Preamplifier 100 MHz - 16 GHz	AFS6-00101600-23-10P-6-R	Narda MITEQ	2011215	482333	23.11.2016	11.2018
24	Outdoor test site	-	PHOENIX TESTLAB GmbH	-	480293	Calibration not necessary	
25	Attenuator 6 dB	R412706000	Radiall	9833	410082	Calibration not necessary	
26	RF-cable No.36	Sucoflex 106B	Suhner	0587/6B / Kabel 36	480865	Calibration not necessary	
27	Loop antenna	Loop antenna 11cm	PHOENIX TESTLAB GmbH	-	410084	Calibration not necessary	
28	Signal & Spectrum Analyzer	FSW43	Rohde & Schwarz	100586 & 100926	481720	24.02.2016	02.2018

No.	Test equipment	Type	Manufacturer	Serial No.	PM. No.	Cal. Date	Cal Due
29	Software	EMC32	Rohde & Schwarz		481800	Calibration not necessary	
30	Loop antenna	Loop antenna 22.5cm	PHOENIX TESTLAB GmbH	-	410085	Calibration not necessary	
31	Positioner	Positioner TDF 1.5- 10Kg	Maturo	15920215	482034	Calibration not necessary	
32	EMI Receiver / Spectrum Analyser	ESI 40	Rohde & Schwarz	100064/040	480355	15.02.2017	02.2018

7 Report history

Report Number	Date	Comment
F172189E1	16.02.2018	Document created
-	-	-

8 List of annexes

Annex A Test setup photos

7 pages

- 172189_fcc_07: Test setup shielded chamber
- 172189_fcc_01: Test setup fully anechoic chamber > 30 MHz
- 172189_fcc_03: Test setup fully anechoic chamber > 1GHz
- 172189_fcc_02: Test setup outdoor test site
- 172189_fcc_04: Test setup open area test site
- 172189_fcc_05: Test setup fully anechoic chamber > 1GHz
- 172189_fcc_06: Test setup fully anechoic chamber < 1GHz

Annex B External photos

8 pages

- 172189_eut1: Top view
- 172189_eut2: 3D view
- 172189_eut3: Bottom view
- 172189_eut4: Bottom view cover removed
- 172189_eut5: View type plate
- 172189_eut6: View connectors
- 172189_eut30: Top view connectors
- 172189_eut32: View type plate AC adapter

Annex C Internal photos

21 pages

- 172189_eut7: Internal view 1
- 172189_eut8: Internal view 2
- 172189_eut9: Internal view 3
- 172189_eut10: Internal view 4
- 172189_eut11: Bottom view main PCB and Display
- 172189_eut12: Bottom view main PCB
- 172189_eut13: Bottom view Display
- 172189_eut13a: Bottom view PCB Display (this photo was delivered by the applicant)
- 172189_eut14: Top view main PCB with sub PCB
- 172189_eut15: Top view main PCB without sub PCB
- 172189_eut16: Top view sub PCB
- 172189_eut17: Bottom view sub PCB
- 172189_eut18: Internal view 5
- 172189_eut19: Internal view 6
- 172189_eut20: Bottom view connector PCB
- 172189_eut21: Top view connector PCB
- 172189_eut22: Top view RFID PCB
- 172189_eut23: Bottom view RFID PCB
- 172189_eut24: Top view 2 RFID PCB
- 172189_eut25: Bottom view 2 RFID PCB
- 172189_eut26: Detail bottom view RFID PCB