

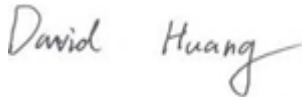

RF TEST REPORT



Report No.: 18070773-FCC-R1-PP

Supersede Report No.: N/A

Applicant	DASAN ELECTRON	
Product Name	Wireless Headset(Headset)	
Model No.	DW-800H	
Serial No.	DW-800, X500, X500H, DW-800M, X500M	
Test Standard	FCC Part 15 Subpart D; ANSI C63.4: 2014; ANSI C63.17: 2013	
Test Date	July 10 to September 05, 2018	
Issue Date	November 20, 2018	
Test Result	<input checked="" type="checkbox"/> Pass <input type="checkbox"/> Fail	
Equipment complied with the specification	<input checked="" type="checkbox"/>	
Equipment did not comply with the specification	<input type="checkbox"/>	
		
Aaron Liang Test Engineer	David Huang Checked By	
This test report may be reproduced in full only Test result presented in this test report is applicable to the tested sample only		

Issued by:

SIEMIC (SHENZHEN-CHINA) LABORATORIES

Zone A, Floor 1, Building 2 Wan Ye Long Technology Park

South Side of Zhoushi Road, Bao' an District, Shenzhen, Guangdong China 518108

Phone: +86 0755 2601 4629801 Email: China@siemic.com.cn

Laboratories Introduction

SIEMIC, headquartered in the heart of Silicon Valley, with superior facilities in US and Asia, is one of the leading independent testing and certification facilities providing customers with one-stop shop services for Compliance Testing and Global Certifications.



In addition to testing and certification, SIEMIC provides initial design reviews and compliance management throughout a project. Our extensive experience with China, Asia Pacific, North America, European, and International compliance requirements, assures the fastest, most cost effective way to attain regulatory compliance for the global markets.

Accreditations for Conformity Assessment

Country/Region	Scope
USA	EMC, RF/Wireless, SAR, Telecom
Canada	EMC, RF/Wireless, SAR, Telecom
Taiwan	EMC, RF, Telecom, SAR, Safety
Hong Kong	RF/Wireless, SAR, Telecom
Australia	EMC, RF, Telecom, SAR, Safety
Korea	EMI, EMS, RF, SAR, Telecom, Safety
Japan	EMI, RF/Wireless, SAR, Telecom
Singapore	EMC, RF, SAR, Telecom
Europe	EMC, RF, SAR, Telecom, Safety

Test Report	18070773-FCC-R1-PP
Page	3 of 51

This page has been left blank intentionally.

CONTENTS

1. REPORT REVISION HISTORY.....	6
2. CUSTOMER INFORMATION	6
3. TEST SITE INFORMATION.....	6
4. EQUIPMENT UNDER TEST (EUT) INFORMATION	7
5. TEST SUMMARY	9
6. MEASUREMENTS, EXAMINATION AND DERIVED RESULTS.....	11
6.1 ANTENNA REQUIREMENT.....	11
6.2 AC POWER LINE CONDUCTED EMISSION	12
6.3 EMISSION BANDWIDTH	14
6.4 PEAK TRANSMIT POWER.....	17
6.5 POWER SPECTRAL DENSITY.....	19
6.6 IN-BAND AND OUT-OF-BAND EMISSIONS	22
6.7 CARRIER FREQUENCY STABILITY	27
6.8 FRAME REPETITION STABILITY, PERIOD AND JITTER.....	28
6.9 AUTOMATICALLY DISCONTINUE TRANSMISSION.....	29
6.10 SPECIFIC REQUIREMENTS FOR DEVICES OPERATING IN THE 1920-1930MHZ SUB-BAND	31
6.10.1 MONITORING TIME	31
6.10.2 MONITORING THRESHOLD, LEASE INTERFERED CHANNEL	33
6.10.3 MONITORING THRESHOLD BANDWIDTH.....	35
6.10.4 REACTION TIME AND MONITORING INTERVAL	37
6.10.5 TIME AND SPECTRUM WINDOW ACCESS PROCEDURE.....	39

Test Report	18070773-FCC-R1-PP
Page	5 of 51

6.10.6 ACKNOWLEDGEMENTS AND TRANSMISSION DURATION.....	41
6.10.7 DUAL ACCESS CRITERIA CHECK.....	43
6.10.8 ALTERNATIVE MONITORING INTERVAL.....	44
6.10.9 FAIR ACCESS.....	45
ANNEX A. TEST INSTRUMENT.....	46
ANNEX C. TEST SETUP AND SUPPORTING EQUIPMENT.....	47
ANNEX D. USER MANUAL / BLOCK DIAGRAM / SCHEMATICS / PARTLIST.....	50
ANNEX E. DECLARATION OF SIMILARITY.....	51

1. Report Revision History

Report No.	Report Version	Description	Issue Date
18070771-FCC-R1-PP	NONE	Original	September 05, 2018
18070773-FCC-R1-PP	V1	Updated the report No. from “ 18070771 to 18070773” and applicant name	November 13, 2018
18070773-FCC-R1-PP	V2	Updated the product name	November 20, 2018

2. Customer information

Applicant Name	DASAN ELECTRON
Applicant Address	606, GODOWHADONG, KYUNGGI TECHONO PARK,1271-11, SA-DONG, ANSAN-SI, KYUNGGI-DO
Manufacturer Name	DASAN ELECTRON
Manufacturer Address	606, GODOWHADONG, KYUNGGI TECHONO PARK,1271-11, SA-DONG, ANSAN-SI, KYUNGGI-DO

3. Test site information

Lab performing tests	SIEMIC (Shenzhen-China) LABORATORIES
Lab Address	Zone A, Floor 1, Building 2 Wan Ye Long Technology Park South Side of Zhoushi Road, Bao' an District, Shenzhen, Guangdong China 518108
FCC Test Site No.	535293
IC Test Site No.	4842E-1

4. Equipment under Test (EUT) Information

Description of EUT:	Wireless Headset(Headset)
Main Model:	DW-800H
Serial Model:	DW-800, X500, X500H, DW-800M, X500M
Date EUT received:	July 09, 2018
Test Date(s):	July 10 to September 05, 2018
Antenna Gain:	PP: -1.5dBi
Antenna Type:	DECT: Monopole antenna
Type of Modulation:	DECT:GFSK
RF Operating Frequency (ies):	DECT:1921.536 MHz~1928.448 MHz (Tx/Rx)
Number of Channels:	DECT: 5CH
ERP/EIRP:	16.17 dBm
Port:	Please see the user' s manual
Input Power:	<p>Adapter: Model: SK01G-0900050U INPUT: AC 100-240V, 50/60Hz,0.2A Max OUTPUT: 9V, 0.5A</p> <p>Battery: Spec: LiPo 300mA</p>
Trade Name :	Freemate



Test Report	18070773-FCC-R1-PP
Page	8 of 51

FCC ID: WF2DW-800H

Hardware Version: Rev0.1

Software Version: Ver1.0

5. Test Summary

The product was tested in accordance with the following specifications.

All testing has been performed according to below product classification:

GFSK Modulation Product

Test Results Summary for *PP

Test Standard	Description	Result
FCC part 15.203	Antenna Requirement	Compliance
FCC part 15.315, 15.207(a)	AC Power Line Conducted Emission	N/A
FCC part 15.323(a)	Emission Bandwidth	Compliance
FCC part 15.319(c) (e)	Peak transmit power	Compliance
FCC part 15.319(d)	Power spectral density	Compliance
FCC part 15.323(d)	In-band and Out-of-band emissions	Compliance
FCC part 15.323(f)	Carrier Frequency Stability	Compliance
FCC part 15.323(e)	Frame repetition Stability, period and jitter	Compliance
FCC part 15.319(f)	Automatically discontinue transmission	Compliance
Specific requirements for devices operating in the 1920-1930MHz sub-band		
FCC part 15.323(c)(1)	Monitoring time	Compliance
FCC part 15.323(c)(2)(5)	Monitoring Threshold, Lease Interfered Channel	Compliance
FCC part 15.323(c)(7)	Monitoring Threshold Bandwidth	Compliance
FCC part 15.323(c)(1)(5)(7)	Reaction Time and Monitoring Interval	Compliance
FCC part 15.323(c)(4)(6)	Time and Spectrum Window Access Procedure	Compliance
FCC part 15.323(c)(3)(4)	Acknowledgements and Transmission Duration	Compliance
FCC part 15.323(c)(10)	Dual Access Criteria Check	N/A**
FCC part 15.323(c)(11)	Alternative Monitoring Interval	N/A**
FCC part 15.323(c)(12)	Fair Access	N/A**

All measurement uncertainty is taken into consideration for all presented test result.

Note: *FP: This measurement is necessary only for Fixed Part.

Test Report	18070773-FCC-R1-PP
Page	10 of 51

*PP: This measurement is necessary only for Portable Part.

N/A**: The manufacturer declares that this device does not use any mechanisms as provided by Part15.323 (c) (10) or (c) (11) to extend the range of spectrum occupied over space or time for the purpose of denying fail access to spectrum to other device.

6. MEASUREMENTS, EXAMINATION AND DERIVED RESULTS

6.1 Antenna Requirement

Applicable Standard

According to FCC § 15.203, an intentional radiator shall be designed to ensure that no antenna other than that furnished by the responsible party shall be used with the device. The use of a permanently attached antenna or of an antenna that uses a unique coupling to the intentional radiator shall be considered sufficient to comply with the provisions of this Section. The manufacturer may design the unit so that a broken antenna can be replaced by the user, but the use of a standard antenna jack or electrical connector is prohibited.

Antenna Connector Construction

The EUT has 2 antennas:

A permanently attached Monopole antenna for DECT, the gain is -1.42dBi for FP.

A permanently attached Patch antenna for DECT, the gain is -1.5dBi for PP.

The antenna meets up with the ANTENNA REQUIREMENT.

Result: Compliance.

6.2 AC Power Line Conducted Emission

Temperature	24°C
Relative Humidity	55%
Atmospheric Pressure	1015mbar
Test date :	August 05, 2018
Tested By :	Aaron Liang

Requirement(s):

Spec	Requirement	Applicable														
FCC part 15.315, 15.207(a)	<p>For Low-power radio-frequency devices that is designed to be connected to the public utility (AC) power line, the radio frequency voltage that is conducted back onto the AC power line on any frequency or frequencies, within the band 150 kHz to 30 MHz, shall not exceed the limits in the following table, as measured using a 50 [mu]H/50 ohms line impedance stabilization network (LISN). The lower limit applies at the boundary between the frequencies ranges.</p> <table border="1"> <thead> <tr> <th rowspan="2">Frequency ranges (MHz)</th> <th colspan="2">Limit (dBµV)</th> </tr> <tr> <th>QP</th> <th>Average</th> </tr> </thead> <tbody> <tr> <td>0.15 ~ 0.5</td> <td>66 – 56</td> <td>56 – 46</td> </tr> <tr> <td>0.5 ~ 5</td> <td>56</td> <td>46</td> </tr> <tr> <td>5 ~ 30</td> <td>60</td> <td>50</td> </tr> </tbody> </table>	Frequency ranges (MHz)	Limit (dBµV)		QP	Average	0.15 ~ 0.5	66 – 56	56 – 46	0.5 ~ 5	56	46	5 ~ 30	60	50	<input checked="" type="checkbox"/>
Frequency ranges (MHz)	Limit (dBµV)															
	QP	Average														
0.15 ~ 0.5	66 – 56	56 – 46														
0.5 ~ 5	56	46														
5 ~ 30	60	50														

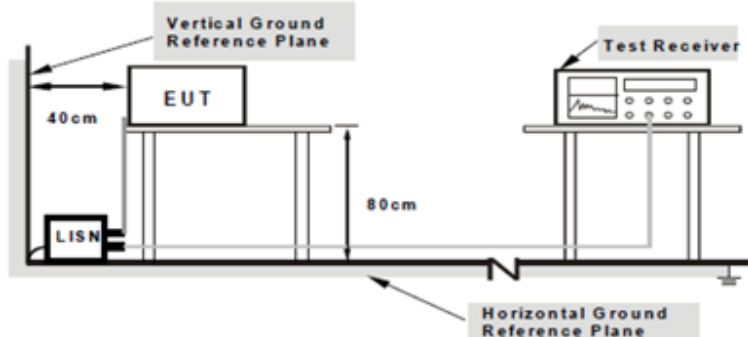
Test Setup	 <p>Note: 1.Support units were connected to second LISN. 2.Both of LISNs (AMN) are 80cm from EUT and at least 80cm from other units and other metal planes support units.</p>
Test Procedure	<ol style="list-style-type: none"> The EUT and supporting equipment were set up in accordance with the requirements of the standard on top of a 1.5m x 1m x 0.8m high, non-metallic table. The power supply for the EUT was fed through a 50W/50mH EUT LISN, connected to filtered mains.

	<ol style="list-style-type: none"> 3. The RF OUT of the EUT LISN was connected to the EMI test receiver via a low-loss coaxial cable. 4. All other supporting equipment were powered separately from another main supply. 5. The EUT was switched on and allowed to warm up to its normal operating condition. 6. A scan was made on the NEUTRAL line (for AC mains) or Earth line (for DC power) over the required frequency range using an EMI test receiver. 7. High peaks, relative to the limit line, The EMI test receiver was then tuned to the selected frequencies and the necessary measurements made with a receiver bandwidth setting of 10 kHz. 8. Step 7 was then repeated for the LIVE line (for AC mains) or DC line (for DC power).
Remark	BATTERY ONLY
Result	<input type="checkbox"/> Pass <input checked="" type="checkbox"/> Fail

Test Data Yes N/A
 Test Plot Yes (See below) N/A

6.3 Emission Bandwidth

Temperature	25°C
Relative Humidity	57%
Atmospheric Pressure	1016mbar
Test date :	August 06, 2018
Tested By :	Aaron Liang

Requirement(s):

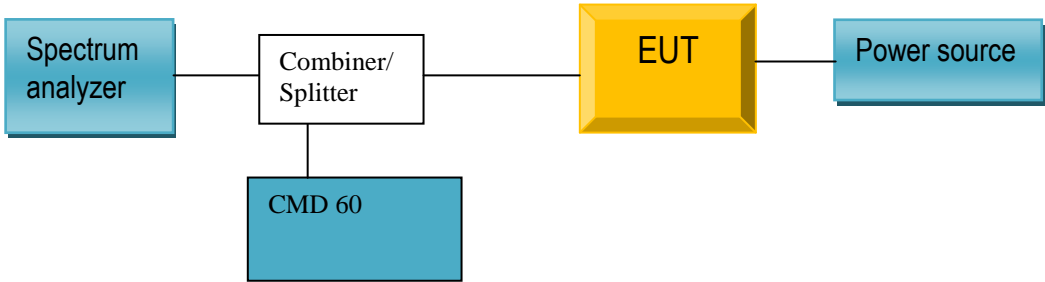
Spec	Requirement	Applicable
FCC part 15.323(a)	The 26 dB and 99% Bandwidth B shall be larger than 50 kHz and less than 2.5 MHz	<input checked="" type="checkbox"/>
Test Setup		
Test method	According to ANSI 63.17: 2013 clause 6.1.3	
Remark	N/A	
Result	<input checked="" type="checkbox"/> Pass <input type="checkbox"/> Fail	

Test Data Yes N/A

Test Plot Yes (See below) N/A

Test data

Channel	Frequency (MHz)	99% Occupied Bandwidth (MHz)	26 dB Bandwidth (MHz)
4	1921.189	1.1796	1.3772
2	1924.651	1.1677	1.4431
0	1928.101	1.1677	1.4731

Test Plots

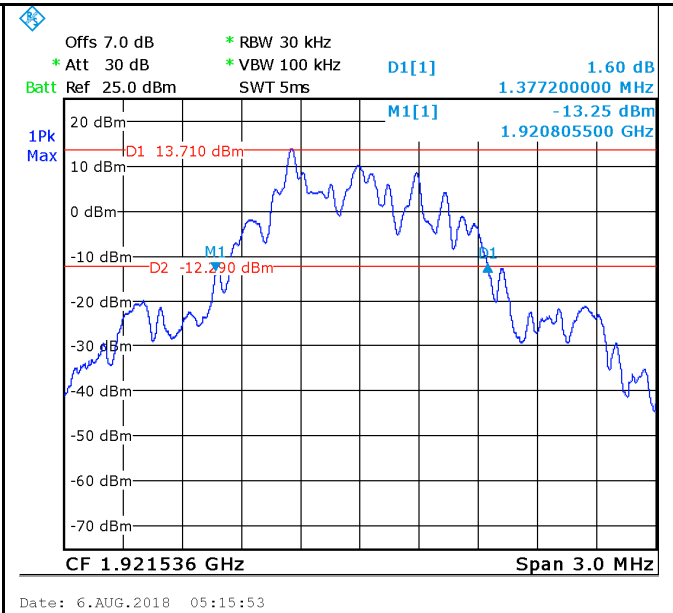
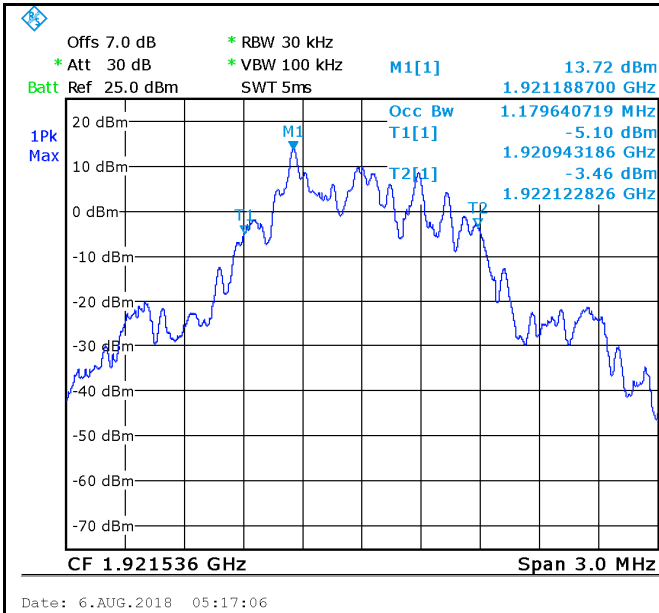

GFSK - Low Channel 99%

GFSK - Low Channel 26dB

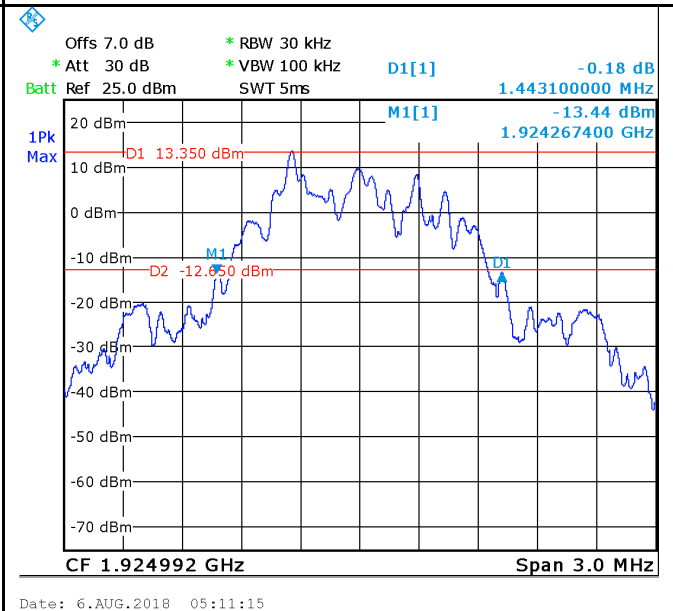
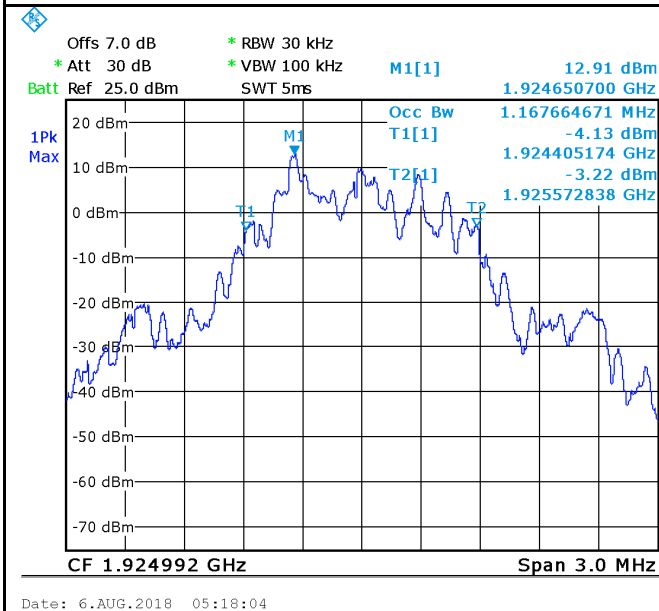

GFSK - Middle Channel 99%

GFSK - Middle Channel 26dB

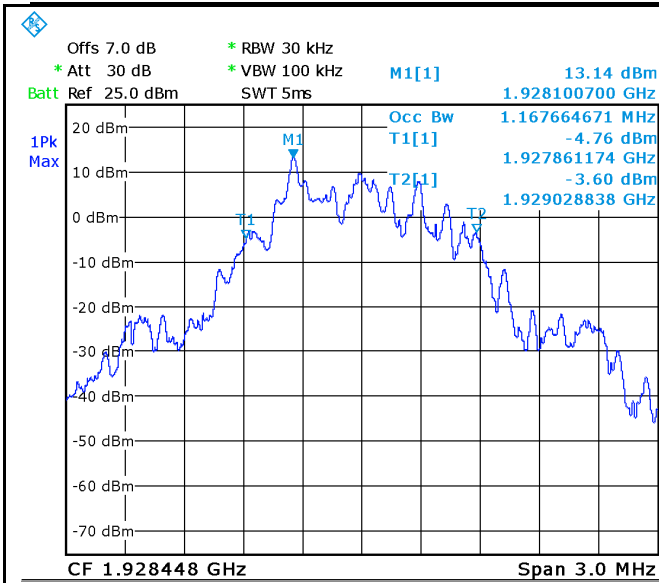

Date: 6.AUG.2018 05:19:18

GFSK - High Channel 99%

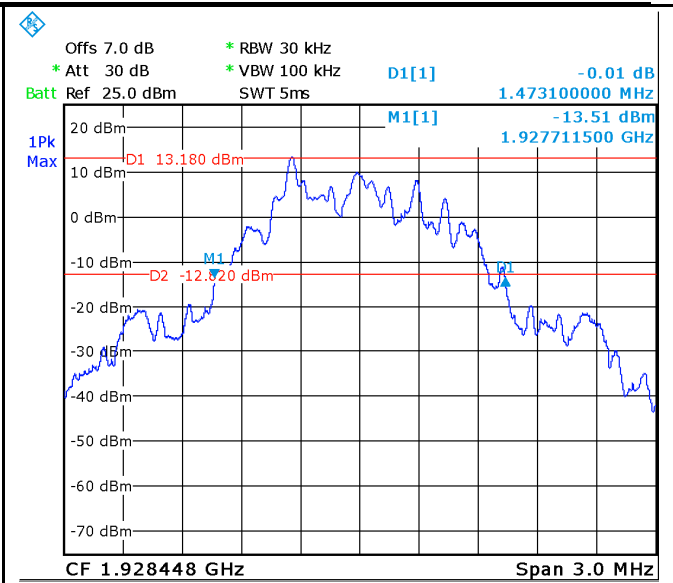

Date: 6.AUG.2018 05:09:06

GFSK - High Channel 26dB

6.4 Peak transmit power

Temperature	24°C
Relative Humidity	60%
Atmospheric Pressure	1010mbar
Test date :	September 04, 2018
Tested By :	Aaron Liang

Requirement(s):

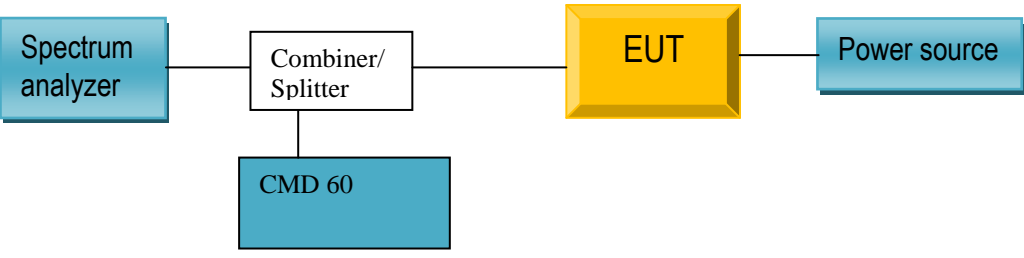
Spec	Requirement	Applicable
FCC part 15.319(c) (e)	Conducted: 100 μ W x SQRT (B) where B is the measured Emission Bandwidth in Hz FCC 15.319(c)(e): <u>20.87 dBm (122.23 mW)</u> The antenna gain is below 3 dBi, no reduction in transmit power is necessary	<input checked="" type="checkbox"/>
Test Setup	 <pre> graph LR SA[Spectrum analyzer] --- CS[Combiner/ Splitter] CS --- CMD60[CMD 60] CS --- EUT[EUT] EUT --- PS[Power source] </pre>	
Test Procedure	According to ANSI 63.17: 2013 clause 6.1.2	
Remark	N/A	
Result	<input checked="" type="checkbox"/> Pass <input type="checkbox"/> Fail	

Test Data Yes N/A
 Test Plot Yes (See below) N/A

Test data

Type	CH	Freq (MHz)	Power (dBm)	Limit (dBm)	Result
Power	4	1921.536	16.17	20.87	Pass
	2	1924.992	16.48	20.87	Pass
	0	1928.448	16.00	20.87	Pass

Test Plots

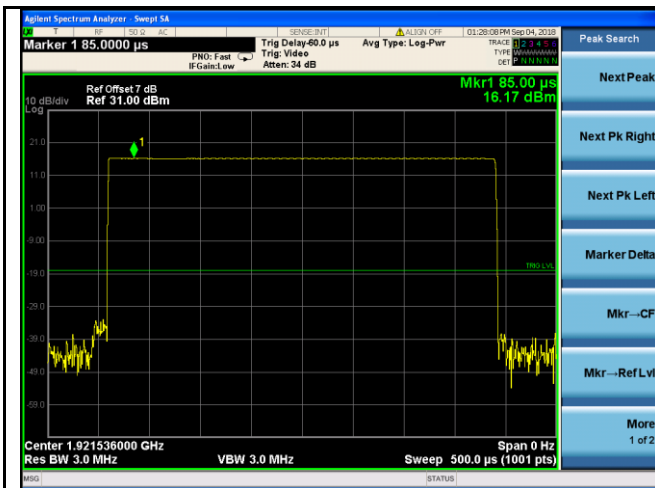

GFSK - Low Channel

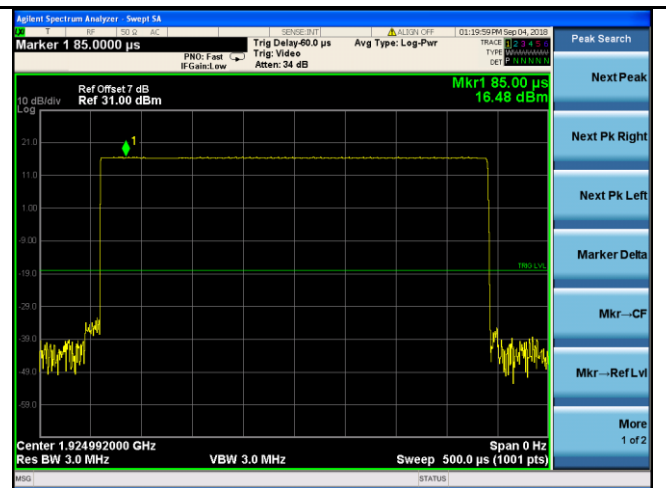

GFSK - Middle Channel

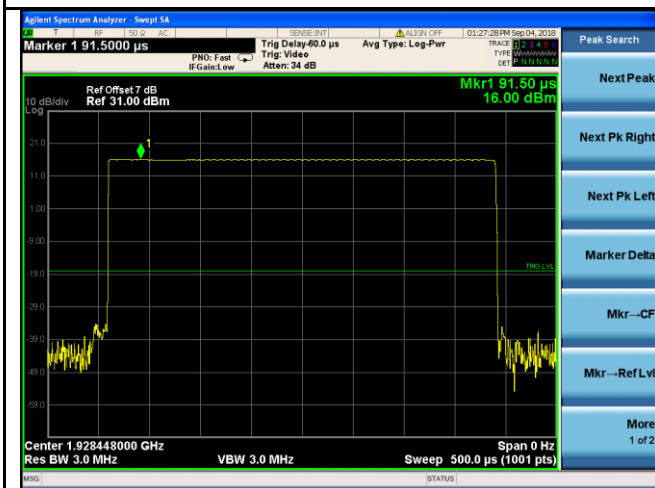

GFSK - High Channel

6.5 Power spectral density

Temperature	24°C
Relative Humidity	60%
Atmospheric Pressure	1010mbar
Test date :	September 04, 2018
Tested By :	Aaron Liang

Requirement(s):

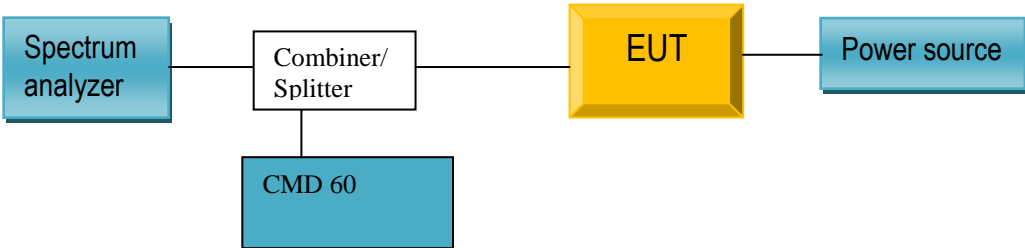
Spec	Requirement	Applicable
FCC part 15.319(d)	The Power Spectral Density shall be less than 3 mW (4.77 dBm) when averaged over at least 100 sweeps.	<input checked="" type="checkbox"/>
Test Setup		
Test Procedure	According to ANSI 63.17: 2013 clause 6.1.5	
Remark	N/A	
Result	<input checked="" type="checkbox"/> Pass <input type="checkbox"/> Fail	

Test Data Yes N/A
 Test Plot Yes (See below) N/A

Test data

Type	CH	Freq (MHz)	PSD (dBm)	Limit (dBm)	Result
PSD	4	1921.536	3.21	4.77	Pass
	2	1924.992	3.55	4.77	Pass
	0	1928.448	3.76	4.77	Pass

Test Plots

Test Plots

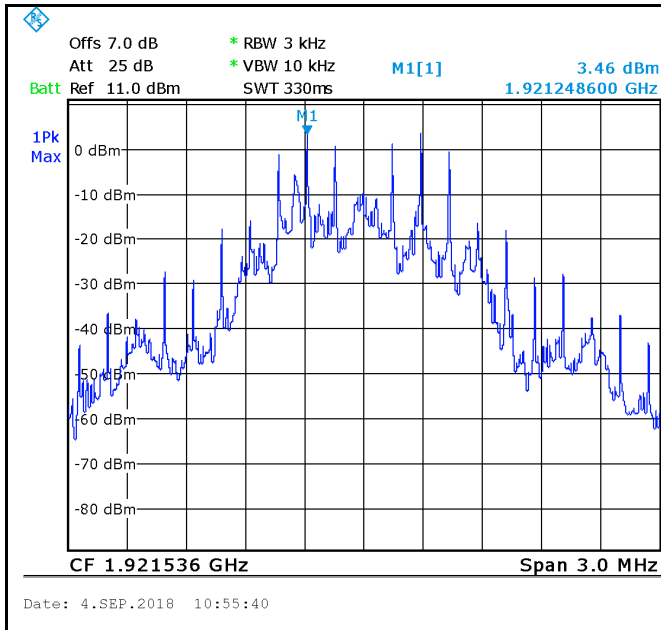

GFSK - Low Channel 1

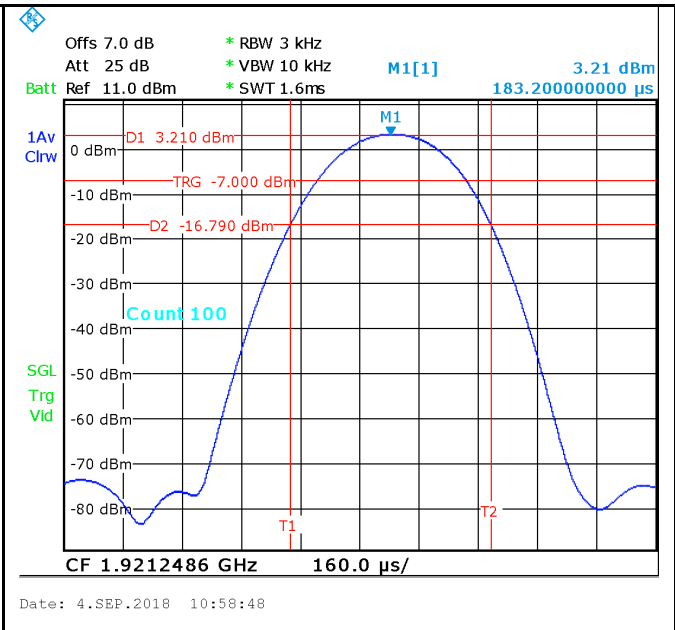

GFSK - Low Channel 2

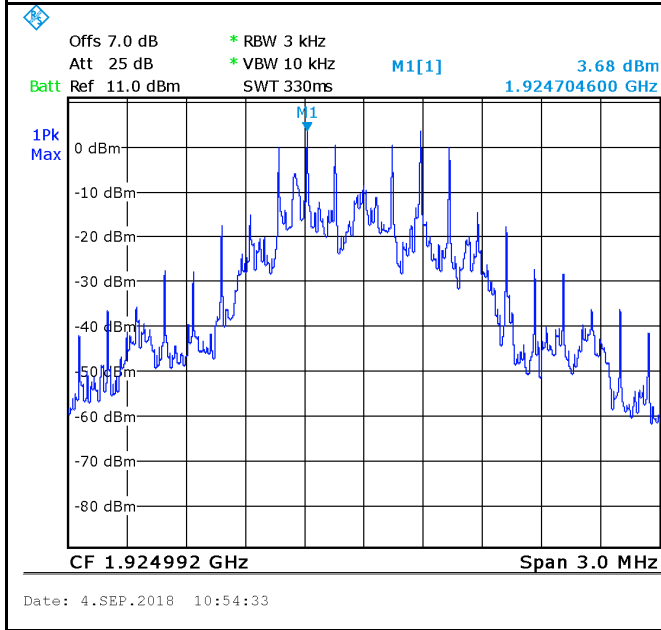

GFSK - Middle Channel 1

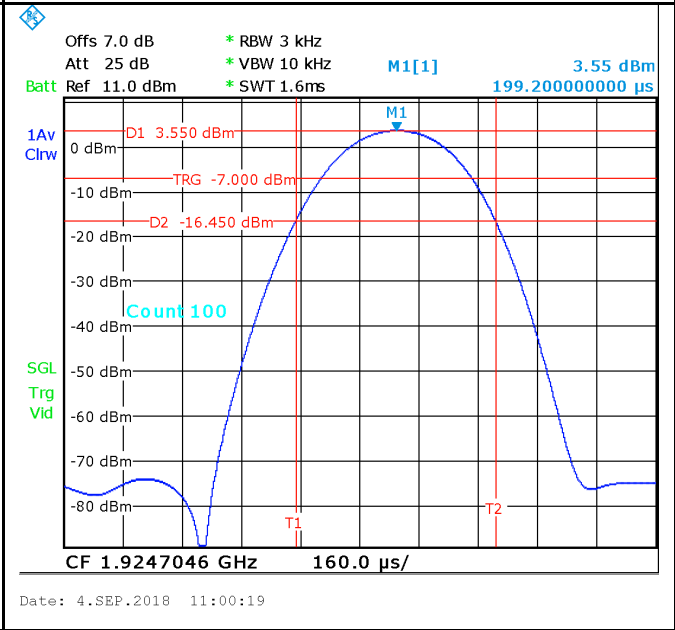

GFSK - Middle Channel 2

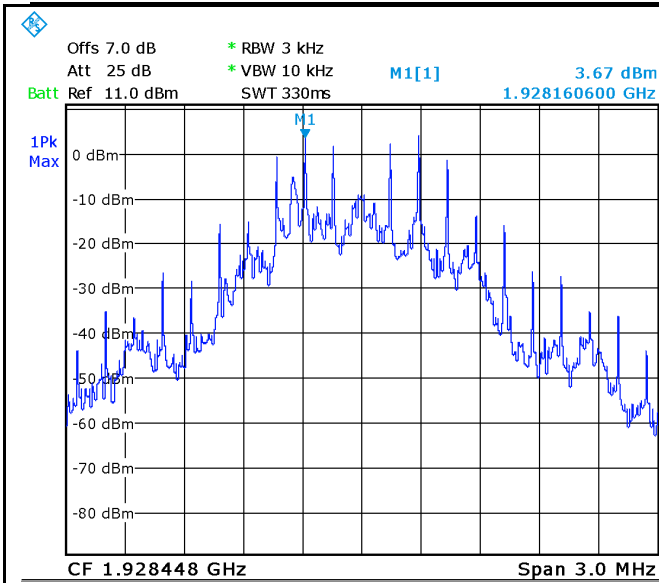

GFSK - High Channel 1

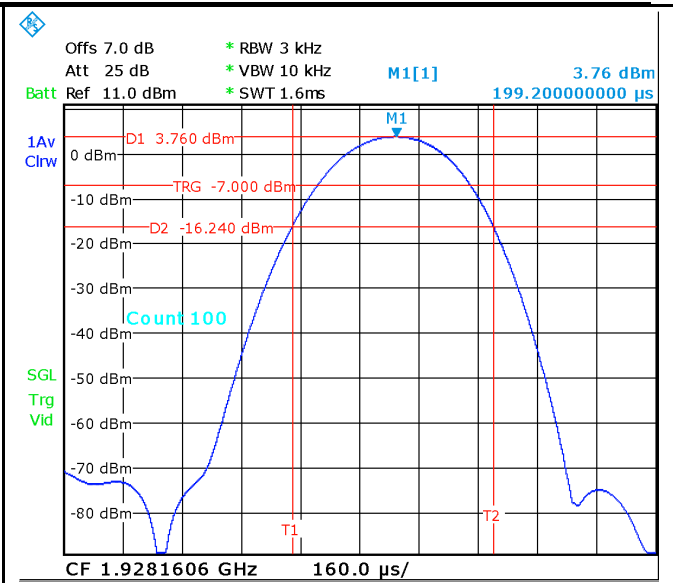

GFSK - High Channel 2

6.6 In-band and Out-of-band emissions

Temperature	24°C
Relative Humidity	60%
Atmospheric Pressure	1010mbar
Test date :	September 04, 2018
Tested By :	Aaron Liang

Requirement(s):

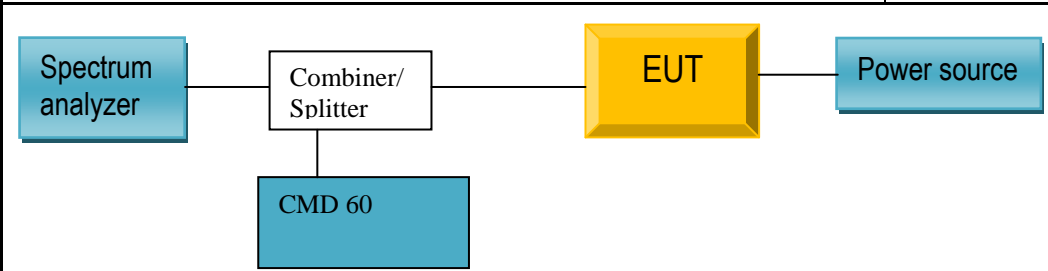
Spec	Requirement	Applicable
FCC part 15.323(d)	<p>In-Band Emissions:</p> <p>$B < f \leq 2B$: at least 30 dB below max. permitted peak power</p> <p>$2B < f \leq 3B$: at least 50 dB below max. permitted peak power</p> <p>$3B < f \leq$ UPCS Band Edge: at least 60 dB below max. permitted peak power</p> <p>Out-of-Band Emissions:</p> <p>$f \leq 1.25\text{MHz}$ outside UPCS band: $\leq -9.5\text{dBm}$</p> <p>$1.25\text{MHz} \leq f \leq 2.5\text{MHz}$ outside UPCS band: $\leq -29.5\text{ dBm}$</p> <p>$f \geq 2.5\text{MHz}$ outside UPCS band: $\leq -39.5\text{ dBm}$</p>	<input checked="" type="checkbox"/>
Test Setup		
Test Procedure	According to ANSI 63.17: 2013 clause 6.1.6	
Result	<input checked="" type="checkbox"/> Pass <input type="checkbox"/> Fail	

Test Data Yes N/A

Test Plot Yes (See below) N/A

Test Plots

In-band emissions

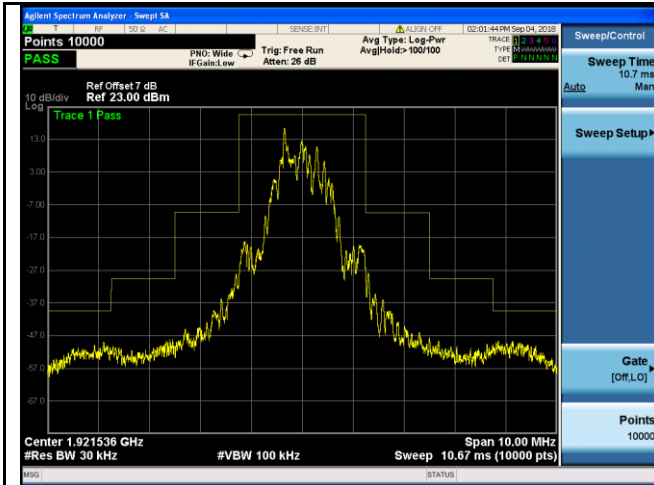

In-band emissions - Low Channel

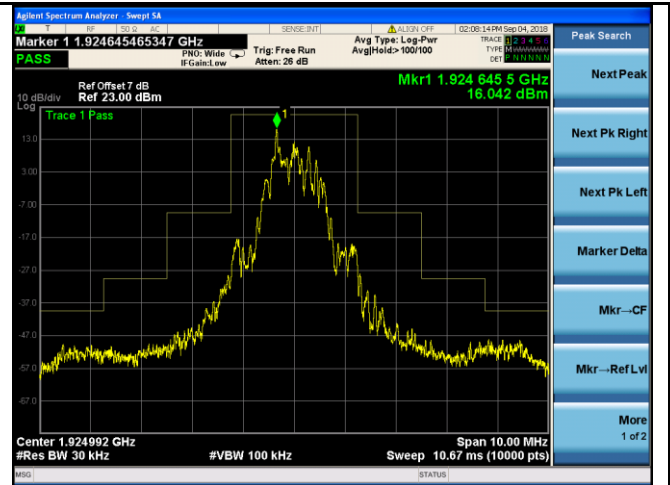

In-band emissions - Middle Channel

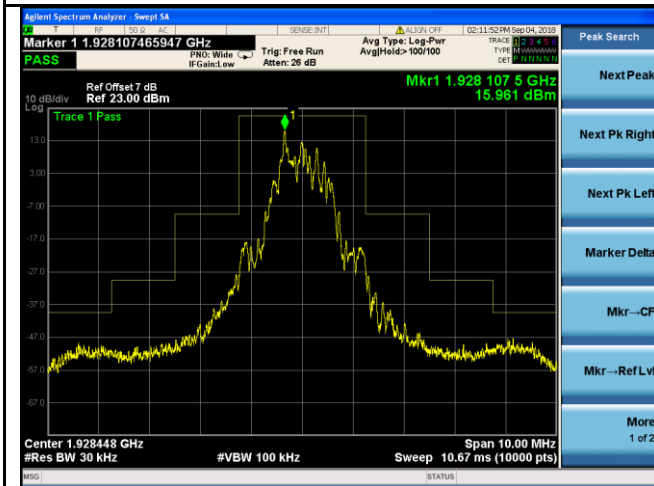

In-band emissions - High Channel

Test Plots

Out of band emissions

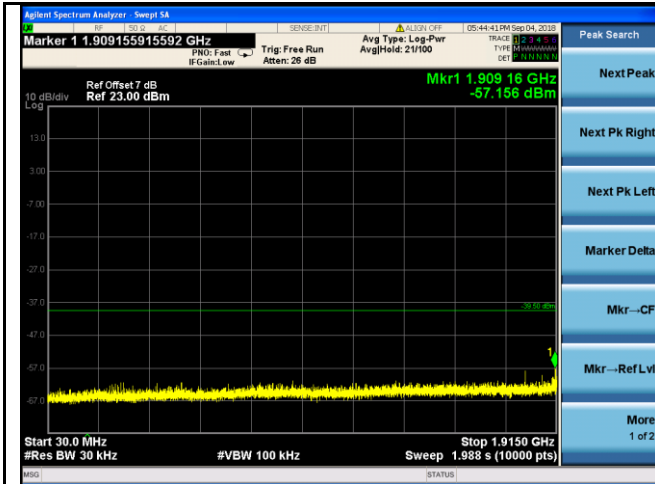

Out of band emission - 30-1915 MHz



Out of band emission - 1915-1920 MHz

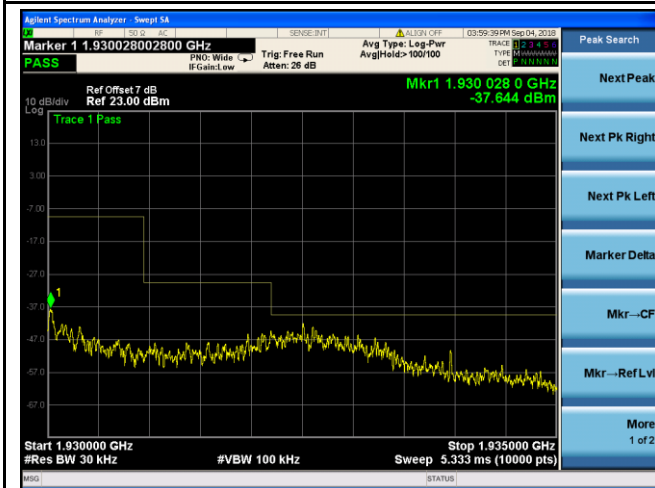

Out of band emission - 1930-1935 MHz

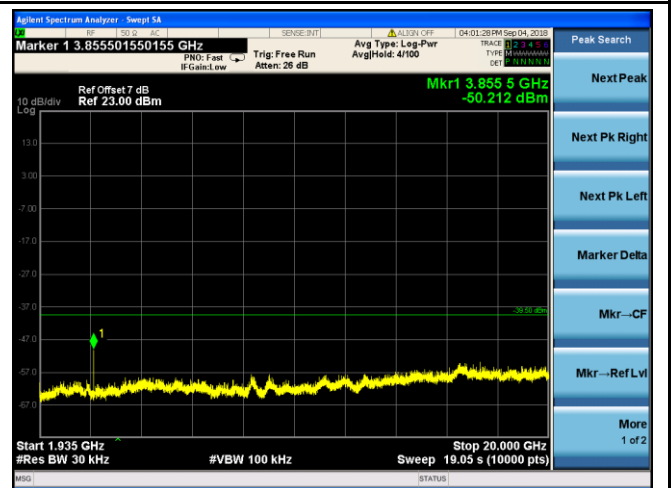

Out of band emission - 1935-20000 MHz

Note: we have tested low, middle, high channel of Out of band emissions, but we only show the middle channel.

Test Report	18070773-FCC-R1-PP
Page	25 of 51

Test data:

Test Mode:	Transmitting Mode
-------------------	--------------------------

(Above 1GHz)

Note: Other modes were verified, only the result of worst case basic rate mode was presented.

High Channel (1928.448 MHz)

Frequency (MHz)	S.A. Reading (dB μ V)	Detector (PK/AV)	Polarity (H/V)	Ant. Factor (dB/m)	Cable Loss (dB)	Pre-Amp. Gain (dB)	Cord. Amp. (dB μ V/m)	Limit (dB μ V/m)	Margin (dB)
3856.9	27.78	AV	V	31.66	3.86	28.72	34.58	54	-19.42
3856.9	27.45	AV	H	31.66	3.86	28.72	34.25	54	-19.75
3856.9	62.26	PK	V	31.66	3.86	28.72	69.06	74	-4.94
3856.9	50.06	PK	H	31.66	3.86	28.72	56.86	74	-17.14

Low Channel (1921.536 MHz)

Frequency (MHz)	S.A. Reading (dB μ V)	Detector (PK/AV)	Polarity (H/V)	Ant. Factor (dB/m)	Cable Loss (dB)	Pre-Amp. Gain (dB)	Cord. Amp. (dB μ V/m)	Limit (dB μ V/m)	Margin (dB)
3843.07	27.72	AV	V	31.66	3.86	28.72	34.52	54	-19.48
3843.07	28.61	AV	H	31.66	3.86	28.72	35.41	54	-18.59
3843.07	60.57	PK	V	31.66	3.86	28.72	67.37	74	-6.63
3843.07	60.29	PK	H	31.66	3.86	28.72	67.09	74	-6.91

6.7 Carrier Frequency Stability

Temperature	24°C
Relative Humidity	55%
Atmospheric Pressure	1015mbar
Test date :	August 05, 2018
Tested By :	Aaron Liang

Requirement(s):

Spec	Requirement	Applicable
FCC part 15.323(f)	±10 ppm	<input checked="" type="checkbox"/>
Test Setup	 <pre> graph LR A[CMD 60] --- B[EUT] B --- C[Power source] </pre>	
Test Procedure	According to ANSI 63.17: 2013 clause 6.2.1	
Result	<input checked="" type="checkbox"/> Pass <input type="checkbox"/> Fail	

Test Data Yes N/A
 Test Plot Yes (See below) N/A

Test Data:

Frequency Stability over Power Supply Voltage at Nominal Temperature

Voltage	Channel Frequency	Difference	Deviation	Limits
Vnom	1924.992 MHz	2 kHz	1.0 ppm	±10 ppm
85% of Vnom	1924.992 MHz	-3 kHz	-1.6 ppm	
115% of Vnom	1924.992 MHz	2 kHz	1.0 ppm	

Note: Deviation ppm = ((Mean - Measured Frequency) / Mean) x 10⁶

Frequency Stability over Temperature

Temp.	Channel Frequency	Difference	Deviation	Limits
+20°C	1924.992 MHz	2 kHz	1.0 ppm	±10 ppm
-20°C	1924.992 MHz	-3 kHz	-1.6 ppm	
+50°C	1924.992 MHz	4 kHz	2.1 ppm	

6.8 Frame repetition Stability, period and jitter

Temperature	24°C
Relative Humidity	55%
Atmospheric Pressure	1015mbar
Test date :	August 05, 2018
Tested By :	Aaron Liang

Requirement(s):

Spec	Requirement	Applicable
FCC part 15.323(e)	±10 ppm for Frame Repetition Stability, 20 or 10 ms for frame period, 25 μ s for max jitter.	<input checked="" type="checkbox"/>
Test Setup	 <pre> graph LR A[CMD 60] --- B[EUT] B --- C[Power source] </pre>	
Test Procedure	According to ANSI 63.17: 2013 clause 6.2.2	
Result	<input checked="" type="checkbox"/> Pass <input type="checkbox"/> Fail	

Test Data Yes N/A

Test Plot Yes (See below) N/A

Test Data:

Carrier Frequency (MHz)	Frame repetition (ppm)	Frame period (ms)	Max. pos. jitter (μ s)	Max. neg.jiter (μ s)
1924.992	0.97	10	0.05	-0.05

6.9 Automatically discontinue transmission

Temperature	24°C
Relative Humidity	55%
Atmospheric Pressure	1015mbar
Test date :	August 05, 2018
Tested By :	Aaron Liang

Requirement(s):

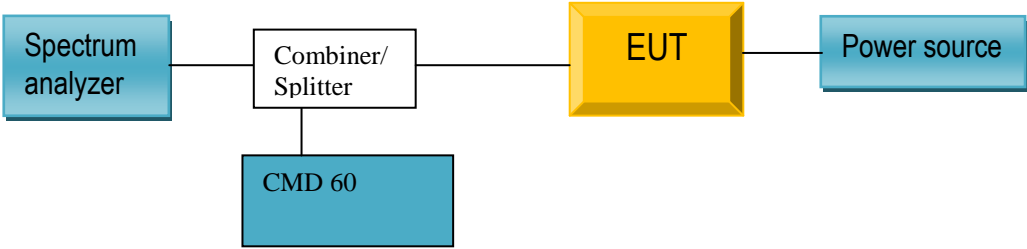
Spec	Requirement	Applicable
FCC part 15.319(f)	The device shall automatically discontinue transmission in case of either absence of information to transmit or operational failure. The provisions in this section are not intended to preclude transmission of control and signaling information or use of repetitive codes used by certain digital technologies to complete frame or burst intervals.	<input checked="" type="checkbox"/>
Test Setup	 <pre> graph LR SA[Spectrum analyzer] --- CS[Combiner/Splitter] CS --- EUT[EUT] CS --- PS[Power source] CS --- CMD60[CMD 60] </pre>	
Test Procedure		
Result	<input checked="" type="checkbox"/> Pass <input type="checkbox"/> Fail	

Test Data Yes N/A
Test Plot Yes (See below) N/A

Measurement Data:

The EUT is a responding device, and can transmit control and signaling information. The following tests simulate the reaction of the EUT in case of either absence of information to transmit or operational failure after a connection with the companion device is established.

Number	Test Items	EUT Reaction	Verdict
1	Power removed from EUT	A	Pass
2	Switch off EUT	N/A	Pass
3	Hook-on by EUT	N/A	Pass
4	Power removed from companion device	B	Pass
5	Switch off companion device	B	Pass
6	Hook-on by companion device	B	Pass

A - Connection breakdown, cease of all transmissions

B - Connection breakdown, EUT transmits control and signaling information

C - Connection breakdown, companion device transmits control and signaling information

N/A - Not Applicable (EUT does not have On/ Off switch and cannot perform Hook-on)

6.10 Specific requirements for devices operating in the 1920-1930MHz sub-band

6.10.1 Monitoring time

Temperature	24°C
Relative Humidity	55%
Atmospheric Pressure	1015mbar
Test date :	August 05, 2018
Tested By :	Aaron Liang

Requirement(s):

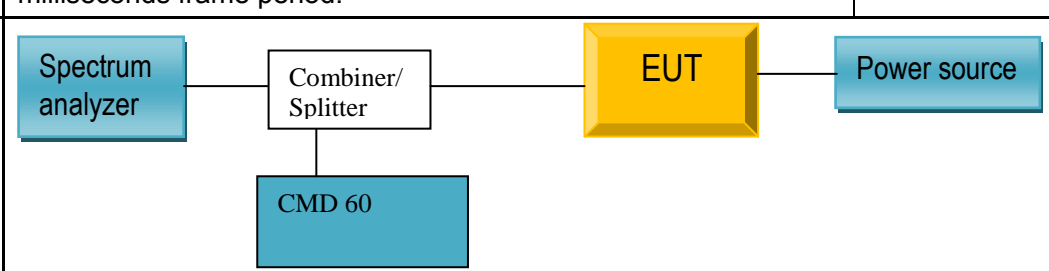
Spec	Requirement	Applicable
FCC part 15.323(c) (1)	Immediately prior to initiating transmission, devices must monitor the combined time and spectrum windows in which they intend to transmit for a period of at least 10 milliseconds for systems designed to use a 10 milliseconds or shorter frame period or at least 20 milliseconds for systems designed to use a 20 milliseconds frame period.	<input checked="" type="checkbox"/>
Test Setup	 <pre> graph LR SA[Spectrum analyzer] --- CS[Combiner/Splitter] CS --- EUT[EUT] CS --- PS[Power source] CS --- CMD60[CMD 60] </pre>	
Test Procedure	According to ANSI 63.17: 2013 clause 7.3.4	
Result	<input checked="" type="checkbox"/> Pass <input type="checkbox"/> Fail	

Test Data Yes N/A
 Test Plot Yes (See below) N/A

Measurement Data:

EUT monitors the combined time and spectrum window prior to initiation of transmission. The observation results as below

Channel Selection	Observation result	Verdict
1. Apply the interference on f1 at level TU +UM, and no interference on f2. Initiate transmission and verify the transmission on f2.	EUT transmission on f2	Pass
2. Apply interference on f2 at a level of TU + UM, in-band, and immediately remove all interference from f1 and immediately (but not sooner than 20 ms after the interference on f2 is applied) cause the EUT to attempt transmission.	EUT transmission on f1	Pass

6.10.2 Monitoring Threshold, Lease Interfered Channel

Temperature	24°C
Relative Humidity	55%
Atmospheric Pressure	1015mbar
Test date :	August 05, 2018
Tested By :	Aaron Liang

Requirement(s):

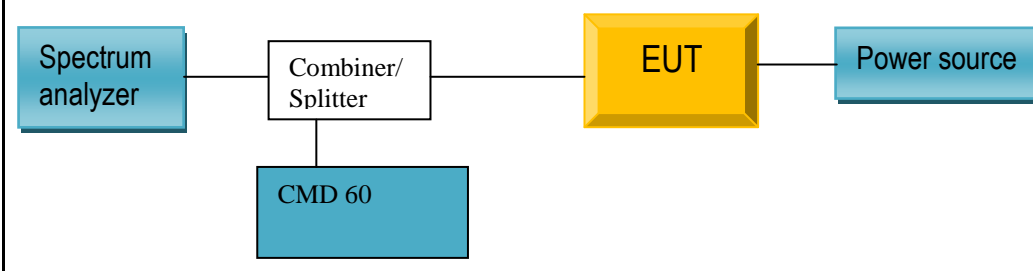
Spec	Requirement	Applicable
FCC part 15.323(c) (2) (5)	The monitoring threshold must not be more than 30 dB above the thermal noise power for a bandwidth equivalent to the emission bandwidth used by the device. If access to spectrum is not available as determined by the above, and a minimum of 40 duplex system access channels are defined for the system, the time and spectrum windows with the lowest power level below a monitoring threshold of 50 dB above the thermal noise power determined for the emission bandwidth may be accessed.	<input checked="" type="checkbox"/>
Test Setup	 <pre> graph LR SA[Spectrum analyzer] --- CS[Combiner/Splitter] CS --- EUT[EUT] CS --- PS[Power source] CS --- CMD60[CMD 60] </pre>	
Test Procedure	According to ANSI 63.17: 2013 clause 7.3.1, 7.3.2, 7.3.3 and 7.3.4	
Result	<input checked="" type="checkbox"/> Pass <input type="checkbox"/> Fail	

Test Data Yes N/A
 Test Plot Yes (See below) N/A

Measurement Data:

Lower threshold: $TL = -174 + 10\log_{10}B + MU + P_{MAX-PEUT}$ (dBm)

Upper threshold: $TU = -174 + 10\log_{10}B + Mu + P_{MAX-PEUT}$ (dBm)

Where: B=Emission bandwidth (Hz)

MU=dB the threshold may exceed thermal noise (30 for TL & 50 for TU)

Calculated values

Threshold	FCC part 15D	RSS-213
Lower threshold	-81.5	-83.3
Upper threshold	N/A	-63.7

The Lower Threshold is applicable for systems which have defined less than 40 duplex system access channels. The Upper Threshold is applicable for systems with more than 40 duplex system access channels and that implements the Least Interfered Channel Procedure (LIC).

Upper Threshold has been removed from FCC 15D but still exists in the current Industry Canada RSS-213.

Limit

Threshold	FCC part 15D	RSS-213
Lower threshold + 6 dB	-75.8	-77.1
Upper threshold + 6 dB	N/A	-57.1

The Upper or Lower Threshold is found by the procedure defined in ANSI C63.17: 2013 clause 7.3.1 or 7.3.2.

Monitor Threshold	Measured level	FCC part 15D	RSS-213
Lower threshold	N/A	-75.8	-77.1
Upper threshold	-61.3	N/A	-57.1

For the EUT which support LIC there is no need to measure lower threshold because it is automatically met by LIC procedure

Least Interfered Channel (LIC) Procedure Test, FCC 15.323(c)(2) and (c)(5)

ANSI C63.17: 2013 clause 7.3.3 ref. Observation Verdict	ANSI C63.17: 2013 clause 7.3.3 ref. Observation Verdict	ANSI C63.17: 2013 clause 7.3.3 ref. Observation Verdict
b) f1 TL + 13 dB, f2 at TL + 6 dB	Transmission always on f2	Pass
c) f1TL + 6 dB, f2 at TL + 13 dB	Transmission always on f1	Pass
d) f1 TL + 7 dB, f2 at TL	Transmission always on f1	Pass
e) f1 TL, f2 at TL + 7 dB	Transmission always on f1	Pass

6.10.3 Monitoring Threshold Bandwidth

Temperature	25°C
Relative Humidity	57%
Atmospheric Pressure	1016mbar
Test date :	August 06, 2018
Tested By :	Aaron Liang

Requirement(s):

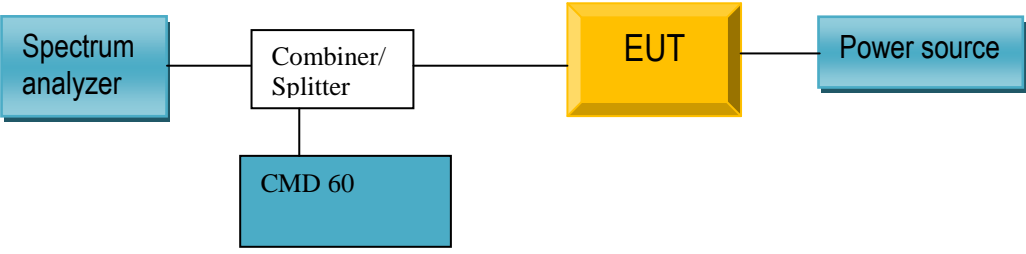
Spec	Requirement	Applicable
FCC part 15.323(c) (7)	The monitoring system bandwidth must be equal to or greater than the emission bandwidth of the intended transmission.	<input checked="" type="checkbox"/>
Test Setup		
Test Procedure	According to ANSI 63.17: 2013 clause 7. 4	
Result	<input checked="" type="checkbox"/> Pass <input type="checkbox"/> Fail	

Test Data Yes N/A
 Test Plot Yes (See below) N/A

Measurement Data:

The monitoring system bandwidth must be equal to or greater than the emission bandwidth of the intended transmission.

Test performed	Observation result	Verdict
Simple Compliance test, at $\pm 30\%$ of B	No transmissions	Pass
More Detailed Test, at -6 dB points	N/A	N/A
More Detailed Test, at -12 dB points	N/A	N/A

Notes:

- The more detailed test must be pass at both the -6 and -12 dB points if the Simple Compliance test fails.
- The Simple Compliance Test was performed with the level at $T_U + U_M + 10$ dB to check that the EUT did not transmit at all.

Test Report	18070773-FCC-R1-PP
Page	36 of 51

3. The tested EUT uses the same receiver for monitoring and communication, this test is therefore not required. However the test has been performed nonetheless and the test is passed.

6.10.4 Reaction Time and Monitoring Interval

Temperature	25°C
Relative Humidity	57%
Atmospheric Pressure	1016mbar
Test date :	August 06, 2018
Tested By :	Aaron Liang

Requirement(s):

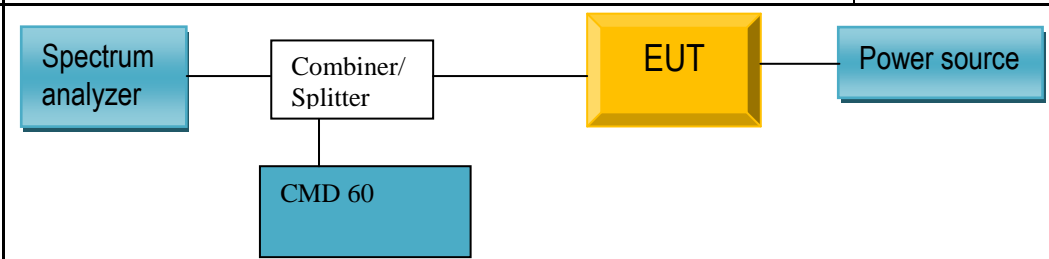
Spec	Requirement	Applicable
FCC part 15.323(c) (1) (5) (7)	<p>The monitoring system bandwidth must be equal to or greater than the emission bandwidth of the intended transmission and have a maximum reaction time less than $50 \times \text{SQRT}(1.25/\text{emission bandwidth in MHz})$ microseconds for signals at the applicable threshold level but shall not be required to be less than 50 microseconds.</p> <p>If a signal is detected that is 6 dB or more above the applicable threshold level, the maximum reaction time shall be $35 \times \text{SQRT}(1.25/\text{emission bandwidth in MHz})$ microseconds but shall not be required to be less than 35 microseconds.</p>	<input checked="" type="checkbox"/>
Test Setup		
Test Procedure	According to ANSI 63.17: 2013 clause 7.5	
Result	<input checked="" type="checkbox"/> Pass <input type="checkbox"/> Fail	

Test Data Yes N/A
 Test Plot Yes (See below) N/A

Measurement Data:

By administrative commands and out-of-operating region interference, the EUT is restricted to operate on a single carrier frequency.

Time-synchronized pulsed interference was then applied on the carrier at pulsed levels $T_U + U_M$ to check that the EUT does not transmit at all. The level was raised 6 dB for part d) with 35 μ s pulses.

The pulses are synchronized with the EUT timeslots and applied centered within all timeslots.

Pulse Width, ref. to ANSI C63.17: 2013 clause 7.5	Observation result	Verdict
c) > largest of 50 μ s and $50 \cdot \text{SQRT}(1.25/B)$	No transmissions	Pass
d) > largest of 35 μ s and $35 \cdot \text{SQRT}(1.25/B)$, and with interference level raised 6 dB	No transmissions	Pass

Notes:

Since B is larger than 1.25 MHz the test was performed with pulse lengths of 50 μ s and 35 μ s.

6.10.5 Time and Spectrum Window Access Procedure

Temperature	25°C
Relative Humidity	57%
Atmospheric Pressure	1016mbar
Test date :	August 06, 2018
Tested By :	Aaron Liang

Requirement(s):

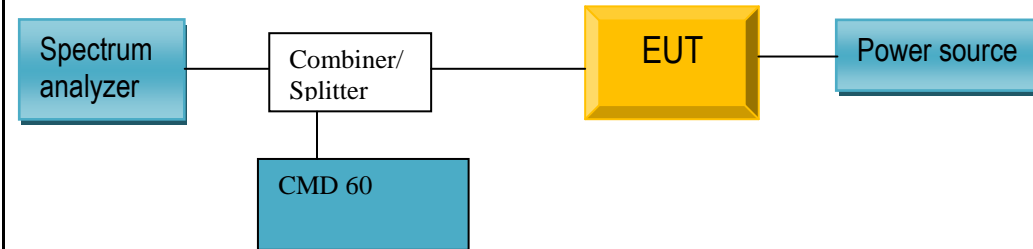
Spec	Requirement	Applicable
FCC part 15.323(c) (4) (6)	<p>FCC 15.323(c)(4): Once access to specific combined time and spectrum windows is obtained an acknowledgement from a system participant must be received by the initiating transmitter within one second or transmission must cease. Periodic acknowledgements must be received at least every 30 seconds or transmission must cease. Channels used exclusively for control and signaling information may transmit continuously for 30 seconds without receiving an acknowledgement, at which time the access criteria must be repeated.</p> <p>FCC 15.323(c)(6): If the selected combined time and spectrum windows are unavailable, the device may either monitor and select different windows or seek to use the same windows after waiting an amount of time, randomly chosen from a uniform random distribution between 10 and 150 milliseconds, commencing when the channel becomes available</p>	<input checked="" type="checkbox"/>
Test Setup	 <pre> graph LR SA[Spectrum analyzer] --- CS[Combiner/Splitter] CS --- EUT[EUT] CS --- PS[Power source] CS --- CMD60[CMD 60] </pre>	
Test Procedure	According to ANSI 63.17: 2013 clause 8.1	
Result	<input checked="" type="checkbox"/> Pass <input type="checkbox"/> Fail	

Test Data Yes N/A
 Test Plot Yes (See below) N/A

Measurement Data:

This requirement is only for EUTs which transmit unacknowledged control and signaling information.

Access Criteria, ref. to ANSI C63.17: 2013 clause 8.1.1	Observation result	Verdict
b) Check that the EUT transmits on the interference free time-slot	N/A	N/A
b) The EUT must terminate or pause in its repetitive transmission of the control and signaling channel on the open channel to repeat the access criteria not less frequently than every 30 s	N/A	N/A

If FCC 15.323(c)(6) option, **If Random Waiting Interval is NOT implemented**

Access Criteria, ref. to ANSI C63.17: 2013 clause 8.1.1	Observation result	Verdict
b) Check that the EUT transmits on the interference free time-slot	N/A	N/A
b) The EUT must terminate or pause in its repetitive transmission of the control and signaling channel on the open channel to repeat the access criteria not less frequently than every 30 s	N/A	N/A

If FCC 15.323(c)(6) option, **Only if Random Waiting Interval is implemented**

Access Criteria, ref. to ANSI C63.17: 2013 clause 8.1.1	Observation result	Verdict
b) Check that the EUT transmits on the interference free time-slot	N/A	N/A
b) The EUT must terminate or pause in its repetitive transmission of the control and signaling channel on the open channel to repeat the access criteria not less frequently than every 30 s	N/A	N/A

Notes:

The tested EUT does not transmit unacknowledged control and signaling information.

6.10.6 Acknowledgements and Transmission Duration

Temperature	25°C
Relative Humidity	57%
Atmospheric Pressure	1016mbar
Test date :	August 06, 2018
Tested By :	Aaron Liang

Requirement(s):

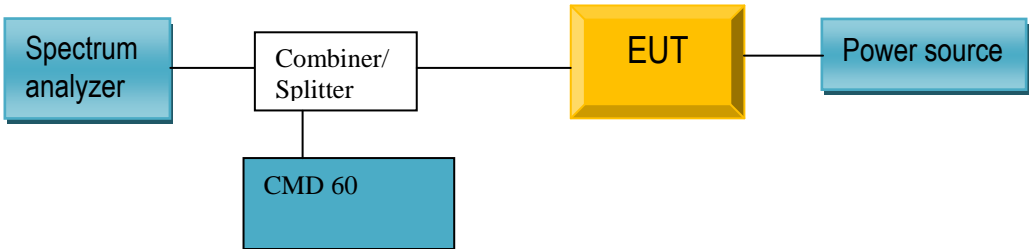
Spec	Requirement	Applicable
FCC part 15.323(c) (3) (4)	<p>Occupation of the same combined time and spectrum windows by a device or group of cooperating devices continuously over a period of time longer than 8 hours is not permitted without repeating the access criteria.</p> <p>Once access to specific combined time and spectrum windows is obtained an acknowledgement from a system participant must be received by the initiating transmitter within one second or transmission must cease.</p> <p>Periodic acknowledgements must be received at least every 30 seconds or transmission must cease. Channels used exclusively for control and signaling information may transmit continuously for 30 seconds without receiving an acknowledgement, at which time the access criteria must be repeated.</p>	<input checked="" type="checkbox"/>
Test Setup	 <pre> graph LR SA[Spectrum analyzer] --- CS[Combiner/Splitter] CS --- EUT[EUT] CS --- PS[Power source] CS --- CMD60[CMD 60] </pre>	
Test Procedure	According to ANSI 63.17: 2013 clause 8.2	
Result	<input checked="" type="checkbox"/> Pass <input type="checkbox"/> Fail	

Test Data Yes

N/A

Test Plot Yes (See below) N/A

Measurement Data:

During the test **Initial transmission without acknowledgements** the signal from the EUT to the companion device is blocked by circulators in addition to the tunable attenuator.

The test **Transmission time after loss of acknowledgements** is performed by cutting-off the signal from the companion device by a RF switch and measuring the time until the EUT stops transmitting.

The **Transmission Duration** test is performed by monitoring the slot in use and measuring the time until the EUT changes to a different slot.

Acknowledgements

Test ref. to ANSI C63.17: 2013 clause 8.2.1	Observation result	Verdict
a) Initial transmission without acknowledgements	0.61s	Pass
c) Transmission time after loss of acknowledgements	9.5s	Pass

Transmission Duration

Test ref. to ANSI C63.17: 2013 clause 8.2.2	Observation	Verdict
b) Transmission duration on same time and frequency window	1 hour	Pass

6.10.7 Dual Access Criteria Check

Temperature	25°C
Relative Humidity	57%
Atmospheric Pressure	1016mbar
Test date :	August 06, 2018
Tested By :	Aaron Liang

Requirement(s):

Spec	Requirement	Applicable
FCC part 15.323(c) (10)	An initiating device may attempt to establish a duplex connection by monitoring both its intended transmits and receive time and spectrum windows. If both the intended transmit and receive time and spectrum windows meet the access criteria, then the initiating device can initiate a transmission in the intended transmit time and spectrum window. If the power detected by the responding device can be decoded as a duplex connection signal from the initiating device, then the responding device may immediately begin transmitting on the receive time and spectrum window monitored by the initiating device.	<input checked="" type="checkbox"/>
Test Setup		
Test Procedure	According to ANSI 63.17: 2013 clause 8.3	
Result	<input type="checkbox"/> Pass <input type="checkbox"/> Fail	

Test Data Yes N/A
 Test Plot Yes (See below) N/A

Not tested.

The manufacturer declares that this provision is not utilized by the EUT.

6.10.8 Alternative Monitoring Interval

Temperature	25°C
Relative Humidity	57%
Atmospheric Pressure	1016mbar
Test date :	August 06, 2018
Tested By :	Aaron Liang

Requirement(s):

Spec	Requirement	Applicable
FCC part 15.323(c) (11)	An initiating device that is prevented from monitoring during its intended transmit window due to monitoring system blocking from the transmissions of a co-located (within one meter) transmitter of the same system, may monitor the portions of the time and spectrum windows in which they intend to receive over a period of at least 10 milliseconds. The monitored time and spectrum window must total at least 50 percent of the 10 millisecond frame interval and the monitored spectrum must be within 1.25 MHz of the center frequency of channel(s) already occupied by that device or co-located co-operating devices. If the access criteria is met for the intended receive time and spectrum window under the above conditions, then transmission in the intended transmit window by the initiating device may commence.	<input checked="" type="checkbox"/>
Test Setup		
Test Procedure	According to ANSI 63.17: 2013 clause 8.4	
Result	<input type="checkbox"/> Pass <input type="checkbox"/> Fail	

Test Data Yes N/A
Test Plot Yes (See below) N/A

Not tested.

The manufacturer declares that this provision is not utilized by the EUT.

6.10.9 Fair Access

Temperature	25°C
Relative Humidity	57%
Atmospheric Pressure	1016mbar
Test date :	August 06, 2018
Tested By :	Aaron Liang

Requirement(s):

Spec	Requirement	Applicable
FCC part 15.323(c) (12)	The provisions of (c)(10) or (c)(11) shall not be used to extend the range of spectrum occupied over space or time for the purpose of denying fair access to spectrum to other devices.	<input checked="" type="checkbox"/>
Test Setup		
Test Procedure		
Result	<input checked="" type="checkbox"/> Pass <input type="checkbox"/> Fail	

Test Data Yes N/A
Test Plot Yes (See below) N/A

Test Result:

The manufacturer declares that this device does not use any mechanisms as provided by Part 15.323 (c) (10) or (c) (11) to extend the range of spectrum occupied over space or time for the purpose of denying fair access to spectrum to other device.

Annex A. TEST INSTRUMENT

Instrument	Model	Serial #	Cal Date	Cal Due	In use
Agilent ESA-E SERIES SPECTRUM ANALYZER	E4407B	MY45108319	09/15/2017	09/14/2018	<input checked="" type="checkbox"/>
EMI test receiver	ESL6	100262	09/15/2017	09/14/2018	<input checked="" type="checkbox"/>
Power Splitter	1#	1#	08/30/2017	08/29/2018	<input checked="" type="checkbox"/>
SYNTHESIZED SIGNAL GENERATOR	8665B	3744A01293	09/15/2017	09/14/2018	<input checked="" type="checkbox"/>
DC Power Supply	E3640A	MY40004013	09/15/2017	09/14/2018	<input checked="" type="checkbox"/>
Bilog Antenna (30MHz~6GHz)	JB6	A110712	09/19/2017	09/18/2018	<input checked="" type="checkbox"/>
Bilog Antenna (30MHz~2GHz)	JB1	A112017	09/19/2017	09/18/2018	<input checked="" type="checkbox"/>
A-INFOMW Horn Antenna (1~18GHz)	AH-118	71259	09/24/2017	09/23/2018	<input checked="" type="checkbox"/>
EMCO Horn Antenna (1~18GHz)	AH-118	71283	09/22/2017	09/21/2018	<input checked="" type="checkbox"/>
OPT 010 AMPLIFIER(0.1~1300MHz)	8447E	2727A02430	08/30/2017	08/29/2018	<input checked="" type="checkbox"/>
Microwave Preamplifier(0.5 ~ 18GHz)	PAM-118	443008	08/30/2017	08/29/2018	<input checked="" type="checkbox"/>
Temperature/Humidity Chamber	UHL-270	001	10/07/2017	10/06/2018	<input checked="" type="checkbox"/>
R&S Digital Radio communication Tester	CMD60	CCIS0149	09/19/2017	09/18/2018	<input checked="" type="checkbox"/>

Annex C. TEST SETUP AND SUPPORTING EQUIPMENT

Annex C.i. TEST SET UP BLOCK

Block Configuration Diagram for Conducted Emissions

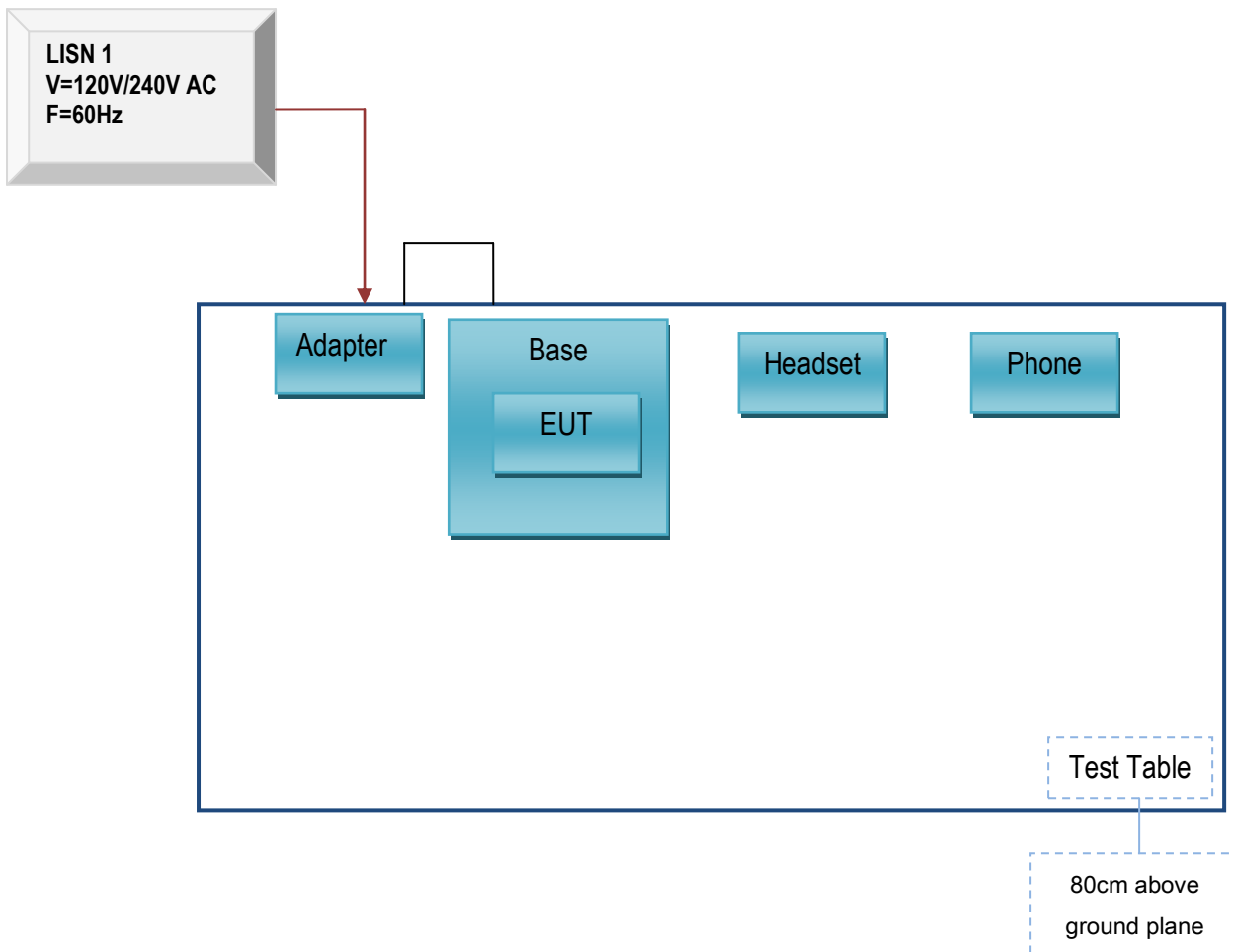

Block Configuration Diagram for Radiated Emissions

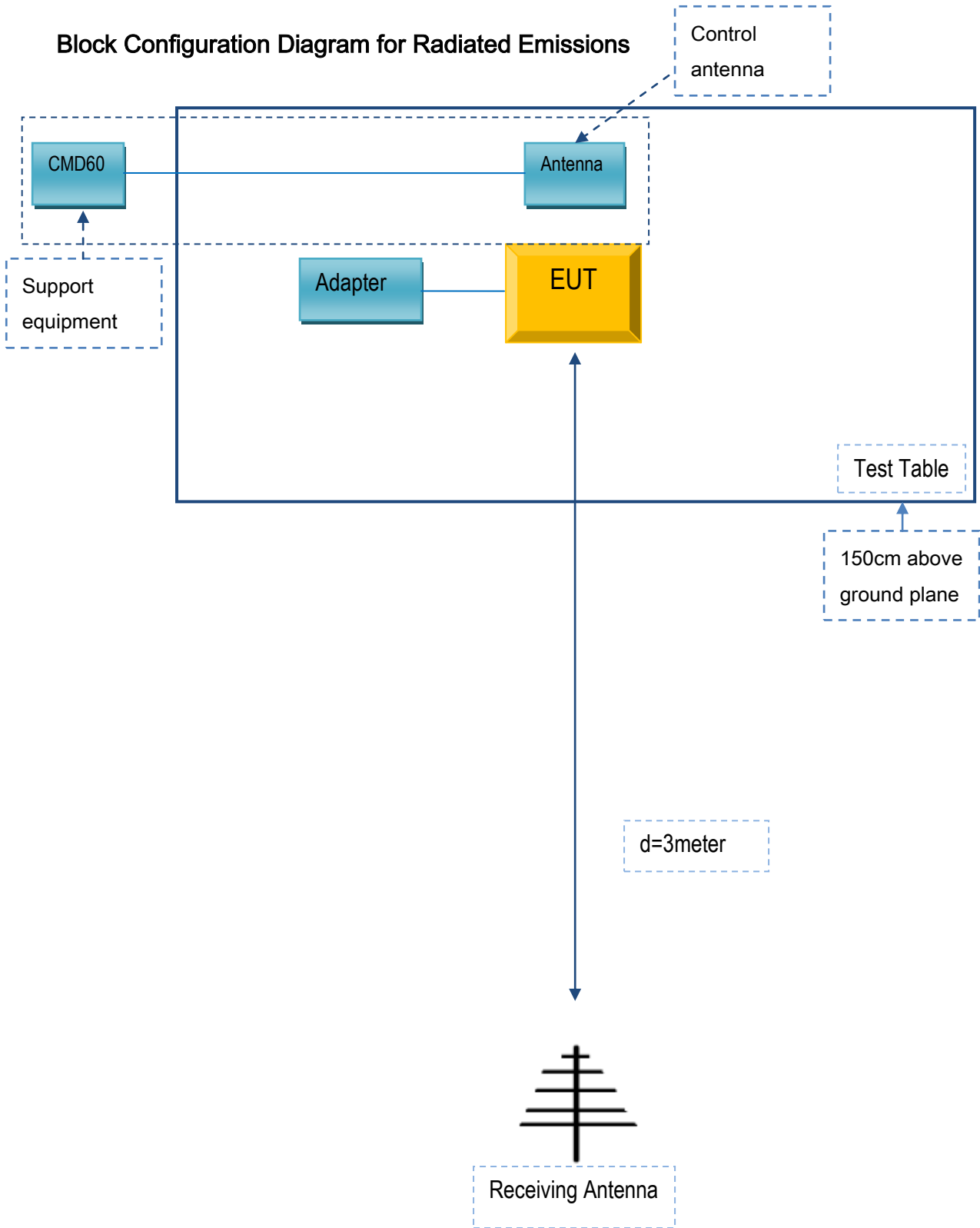

Annex C. ii. SUPPORTING EQUIPMENT DESCRIPTION

The following is a description of supporting equipment and details of cables used with the EUT.

Supporting Equipment:

Manufacturer	Equipment Description	Model	Serial No
Lenovo	Laptop	E40	LR-1EHRX
Huawei	Phone	honor 9	N/A
DASAN ELECTRON CO., LTD.	Adapter	SK01G-0900050U	N/A

Supporting Cable:

Cable type	Shield Type	Ferrite Core	Length	Serial No
USB Cable	Un-shielding	No	0.8m	N/A

Test Report	18070773-FCC-R1-PP
Page	50 of 51

Annex D. User Manual / Block Diagram / Schematics / Partlist

Please see attachment

Annex E. DECLARATION OF SIMILARITY

DASAN ELECTRON

Date: 2018. 07. 13.

SUBJECT: Declaration of differences in tested devices

To Whom It May Concern:

We, DASAN ELECTRON, declare on our sole responsibility for the product model named DW-800H as below:

The differences between DW-800H (DECT Headset)

1. Product Set Model Name: DW-800, X500 (DECT Base + DECT Headset(Double type))
2. Add model name according to buyer request: X500H
((DECT Base + DECT Headset(Double type)))
3. Multi List Model Name: DW-800M, X500M (Headset(single type))

Except listings above, the others are all the same as previous version.

Sincerely,
Kyung Ryong, Hong / Director

