

FCC TEST REPORT

FCC ID : WC2P400
Applicant : Wonders Technology Co., Ltd.
Address : Doss Industrial Zone, Qiping Kengdu Industrial ARE Guihua Village, Guanlan Town, Baoan District, Shenzhen, China.

Equipment Under Test (EUT) :

Product Name : Portable Bluetooth wireless speaker
Model No. : P400, ESI-P400

Standards : FCC CFR47 Part 15 Section 15.247:2010

Date of Test : June 13 ~ June 17, 2012

Date of Issue : June 21, 2012

Tested By : Zero Zhou / Engineer



Reviewed By : Philo zhong / Manager



Test Result	: PASS
--------------------	---------------

Prepared By:

Waltek Services (Shenzhen) Co., Ltd.

1/F, Fukangtai Building, West Baima Rd., Songgang Street, Baoan District, Shenzhen 518105, China

Tel :+86-755-83551033

Fax:+86-755-83552400

✧ The sample detailed above has been tested to the requirements of Council Directives ANSI C63.4:2003. The test results have been reviewed against the Directives above and found to meet their essential requirements.

The results shown in this test report refer only to the sample(s) tested , This Test report cannot be reproduced, except in full, without prior written permission of the Company.

2 Test Summary

Test Items	Test Requirement	Result
Conducted Emissions (150kHz to 30MHz)	15.207	PASS
Radiated Spurious Emissions (12MHz to 25GHz)	15.205(a) 15.209 15.247(d)	PASS
20dB Bandwidth	15.247(a)(1)	PASS
Maximum Peak Output Power	15.247(b)(1)	PASS
Frequency Separation	15.247(a)(1)	PASS
Number of Hopping Frequency	15.247(a)(1)(iii)	PASS
Dwell time	15.247(a)(1)(iii)	PASS
Maximum Permissible Exposure (Exposure of Humans to RF Fields)	1.1307(b)(1)	PASS

The results shown in this test report refer only to the sample(s) tested , This Test report cannot be reproduced, except in full, without prior written permission of the Company.

3 Contents

	Page
1 COVER PAGE	1
2 TEST SUMMARY	2
3 CONTENTS	3
4 GENERAL INFORMATION	5
4.1 CLIENT INFORMATION.....	5
4.2 GENERAL DESCRIPTION OF E.U.T.	5
4.3 DETAILS OF E.U.T.....	5
4.4 DESCRIPTION OF SUPPORT UNITS.....	5
4.5 STANDARDS APPLICABLE FOR TESTING	5
4.6 TEST MODE.....	5
4.7 TEST FACILITY	6
4.8 TEST LOCATION	6
5 EQUIPMENT USED DURING TEST	7
6 CONDUCTED EMISSION	8
6.1 E.U.T. OPERATION.....	8
6.2 EUT SETUP	9
6.3 CONDUCTED EMISSION TEST RESULT	9
6.4 PHOTOGRAPH – CONDUCTED EMISSION TEST SETUP	12
7 RADIATED SPURIOUS EMISSIONS	13
7.1 EUT OPERATION :	13
7.2 MEASUREMENT UNCERTAINTY	13
7.3 TEST SETUP.....	14
7.4 SPECTRUM ANALYZER SETUP	16
7.5 TEST PROCEDURE.....	17
7.6 CORRECTED AMPLITUDE & MARGIN CALCULATION.....	17
7.7 SUMMARY OF TEST RESULTS	17
7.8 PHOTOGRAPH – RADIATION SPURIOUS EMISSION TEST SETUP	29
8 BAND EDGE MEASUREMENTS	31
9 20 DB BANDWIDTH MEASUREMENT	34
9.1 TEST PROCEDURE:.....	34
9.2 TEST RESULT:	34
10 MAXIMUM PEAK OUTPUT POWER	36
10.1 TEST PROCEDURE:.....	36
10.2 TEST RESULT:.....	36
11 HOPPING CHANNEL SEPARATION	37
11.1 TEST PROCEDURE:.....	37
11.2 TEST RESULT:.....	37
12 NUMBER OF HOPPING FREQUENCY	40
12.1 TEST PROCEDURE:.....	40
12.2 TEST RESULT:.....	40
13 DWELL TIME	41
13.1 TEST PROCEDURE:.....	41
13.2 TEST RESULT:.....	41
14 ANTENNA REQUIREMENT	48

The results shown in this test report refer only to the sample(s) tested , This Test report cannot be reproduced, except in full, without prior written permission of the Company.

15 RF EXPOSURE 49
15.1 REQUIMENTS: 49
15.2 MEASUREMENT RESULT: 49
16 PHOTOGRAPHS - CONSTRUCTIONAL DETAILS..... 50
16.1 EUT – APPEARANCE VIEW 50
16.2 EUT- OPEN VIEW 51
16.3 EUT – PCB VIEW 52
17 FCC LABEL..... 54

The results shown in this test report refer only to the sample(s) tested , This Test report cannot be reproduced, except in full, without prior written permission of the Company.

4 General Information

4.1 Client Information

Applicant : Wonders Technology Co., Ltd.
Address of Applicant : Doss Industrial Zone, Qiping Kengdu Industrial ARE Guihua Village, Guanlan Town, Baoan District, Shenzhen, China.

Manufacturer : Wonders Technology Co., Ltd.
Address of Manufacturer : Doss Industrial Zone, Qiping Kengdu Industrial ARE Guihua Village, Guanlan Town, Baoan District, Shenzhen, China.

4.2 General Description of E.U.T.

Product Name : Portable Bluetooth wireless speaker
Model No. : P400, ESI-P400
Difference Description : All models are exactly the same except for different color and appearance.

4.3 Details of E.U.T.

Technical Data : Internal Li-ion Battery: 3.7V
 Charging Voltage: 100-240VAC, 60Hz, 0.2A Max
Operation Frequency : 2402MHz ~ 2480MHz
Crystal Frequency : 12MHz
Antenna Gain : 0dBi

4.4 Description of Support Units

The EUT has been tested as an independent unit.

4.5 Standards Applicable for Testing

The customer requested FCC tests for a Portable Bluetooth wireless speaker . The rules used were FCC CFR47 Part 15 Section 15.203, Section 15.207, Section 15.209 and Section 15.247.

4.6 Test Mode

Mode 1: charging and normal link, Mode 2: charging and AUX IN mode, Mode 3: normal link used by battery, Mode 4: AUX IN mode used by battery.

This report may show one mode data only which is the worst mode.

4.7 Test Facility

The test facility has a test site registered with the following organizations:

- **IC – Registration No.: IC7760A**

Waltek Services(Shenzhen) Co., Ltd. has been registered and fully described in a report filed with the Industry Canada. The acceptance letter from the Industry Canada is maintained in our files. Registration 7760A, August 3, 2010.

- **FCC – Registration No.: 880581**

Waltek Services(Shenzhen) Co., Ltd. EMC Laboratory has been registered and fully described in a report filed with the (FCC) Federal Communications Commission. The acceptance letter from the FCC is maintained in our files. Registration 880581, May 26, 2011.

4.8 Test Location

All the tests were performed at:

Waltek Services(Shenzhen) Co., Ltd. at 1/F, Fukangtai Building, West Baima Rd., Songgang Street, Baoan District, Shenzhen, China

5 Equipment Used during Test

Equipment Name	Manufacturer Model	Equipment No	Internal No	Specification	Cal. Date	Due Date	Uncertainty
EMC Analyzer	Agilent/ E7405A	MY45114943	W2008001	9k-26.5GHz	Aug. 2, 2011	Aug. 1, 2012	±1dB
Trilog Broadband Antenne	SCHWARZECK MESS-ELEKTROM / VULB9163	336	W2008002	25-3000 MHz	Aug. 2, 2011	Aug. 1, 2012	±1dB
Broad-band Horn Antenna	SCHWARZECK MESS-ELEKTROM / BBHA 9120D(1201)	667	W2008003	1-18GHz	Aug. 2, 2011	Aug. 1, 2012	f < 10 GHz : ±1dB 10GHz < f < 18 GHz : ±1.5dB
Active Loop Antenna	Beijing Dazhi / ZN30900A	-	-	0.009-30MHz	Aug. 2, 2011	Aug. 1, 2012	±1Db
Broadband Preamplicifier	SCHWARZECK MESS-ELEKTROM / BBV 9718	9718-148	W2008004	0.5-18GHz	Aug. 2, 2011	Aug. 1, 2012	±1.2dB
10m Coaxial Cable with N-male Connectors	SCHWARZECK MESS-ELEKTROM / AK 9515 H	-	-	-	Aug. 2, 2011	Aug. 1, 2012	-
10m 50 Ohm Coaxial Cable	SCHWARZECK MESS-ELEKTROM / AK 9513	-	-	-	Aug. 2, 2011	Aug. 1, 2012	-
Positioning Controller	C&C LAB/ CC-C-IF	-	-	-	Aug. 2, 2011	Aug. 1, 2012	-
Color Monitor	SUNSP0/ SP-14C	-	-	-	Aug. 2, 2011	Aug. 1, 2012	-
Test Receiver	ROHDE&SCHWARZ/ ESPI	101155	W2005001	9k-3GHz	Aug. 2, 2011	Aug. 1, 2012	±1dB
Two-Line V-Network	ROHDE&SCHWARZ/ ENV216	100115	W2005002	50Ω/50μH	Aug. 2, 2011	Aug. 1, 2012	±10%
RF Generator	TESEQ GmbH/ NSG4070	25781	W2008008	Fraq-range : 9K-1GHz RF voltage : -60 dBm-+10dBm	Aug. 2, 2011	Aug. 1, 2012	Power_freq distinguish0.1Hz RFelectricity distinguish 0.1B
MP3 Player	Ipod Player/A1285	5K85004U3R0	-	-	Aug. 2, 2011	Aug. 1, 2012	±0.5dB

The results shown in this test report refer only to the sample(s) tested , This Test report cannot be reproduced, except in full, without prior written permission of the Company.

6 Conducted Emission

Test Requirement:	FCC CFR 47 Part 15 Section 15.207
Test Method:	ANSI C63.4:2003
Test Result:	PASS
Frequency Range:	150kHz to 30MHz
Class:	Class B
Limit:	66-56 dB μ V between 0.15MHz & 0.5MHz 56 dB μ V between 0.5MHz & 5MHz 60 dB μ V between 5MHz & 30MHz
Detector:	Peak for pre-scan (9kHz Resolution Bandwidth) Quasi-Peak & Average if maximised peak within 6dB of Average Limit

6.1 E.U.T. Operation

Operating Environment:

Temperature:	25.5 °C
Humidity:	51 % RH
Atmospheric Pressure:	1012 mbar

EUT Operation:

The EUT was tested in mode 1 and mode 2 . The worst was mode 1.

The EUT was tested according to ANSI C63.4:2003. The frequency spectrum from 150kHz to 30MHz was investigated.

The maximised peak emissions from the EUT was scanned and measured for both the Live and Neutral Lines. Quasi-peak & average measurements were performed if peak emissions were within 6dB of the average limit line.

6.2 EUT Setup

The conducted emission tests were performed using the setup accordance with the ANSI C63.4:2003, The specification used in this report was the FCC Part15.207 limits.

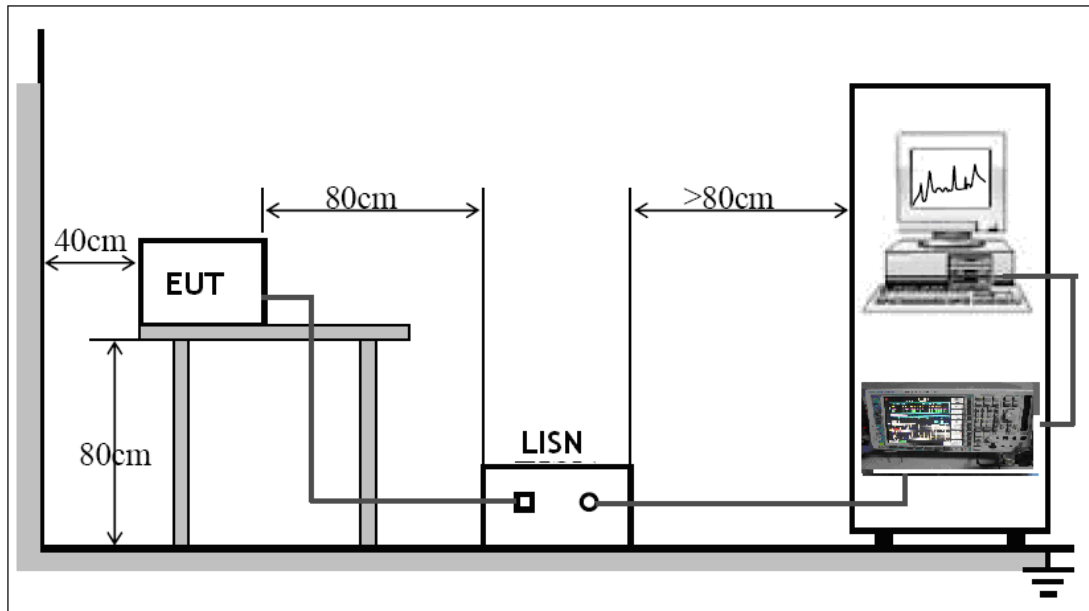

The EUT was placed on the test table in shielding room

6.3 Conducted Emission Test Result

An initial pre-scan was performed on the live and neutral lines.

Live line:

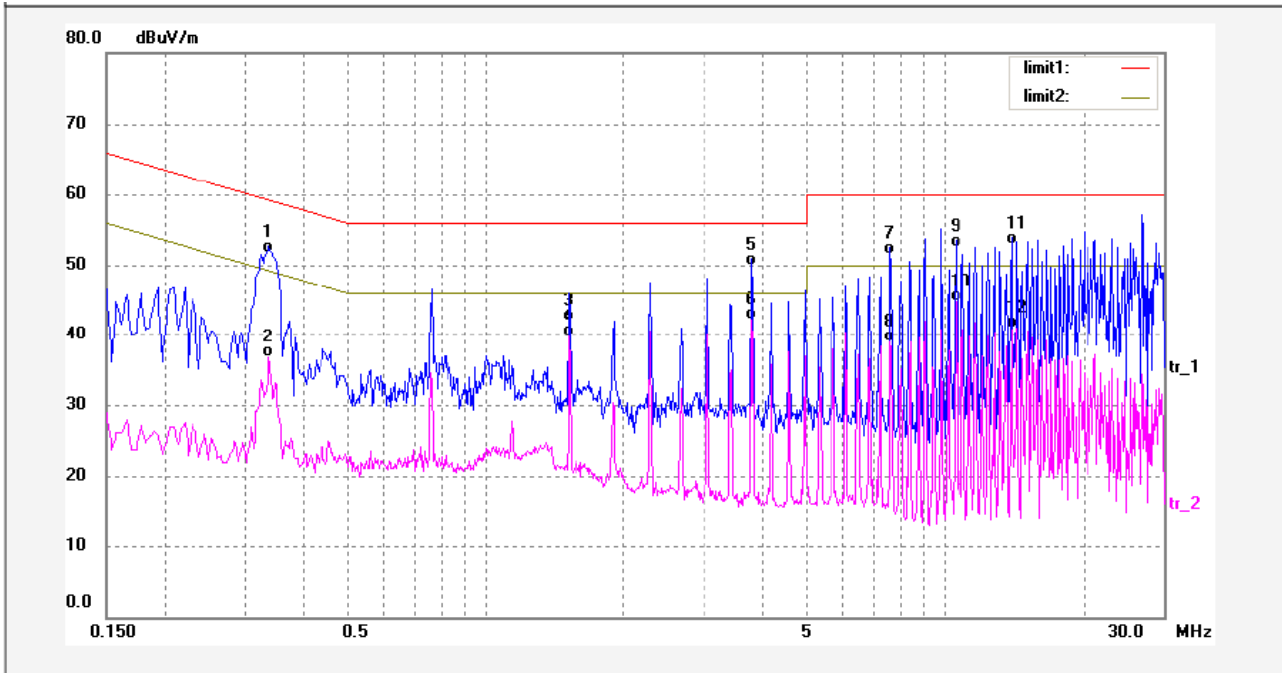

No.	Freq. (MHz)	Reading (dBuV/m)	Factor (dB)	Result (dBuV/m)	Limit dBuV/	Margin (dB)	Detector	Remark
1	0.3379	41.43	10.34	51.77	59.25	-7.48	QP	
2	0.3379	26.35	10.34	36.69	49.25	-12.56	AVG	
3	1.5260	31.32	10.58	41.90	56.00	-14.10	QP	
4	1.5260	29.04	10.58	39.62	46.00	-6.38	AVG	
5	3.8180	39.02	10.79	49.81	56.00	-6.19	QP	
6	3.8180	31.38	10.79	42.17	46.00	-3.83	AVG	
7	7.6460	40.71	10.86	51.57	60.00	-8.43	QP	
8	7.6460	28.05	10.86	38.91	50.00	-11.09	AVG	
9	10.5860	41.62	10.93	52.55	60.00	-7.45	QP	
10	10.5860	33.84	10.93	44.77	50.00	-5.23	AVG	
11	14.0140	41.76	11.08	52.84	60.00	-7.16	QP	
12	14.0140	29.87	11.08	40.95	50.00	-9.05	AVG	

The results shown in this test report refer only to the sample(s) tested , This Test report cannot be reproduced, except in full, without prior written permission of the Company.

Neutral line:

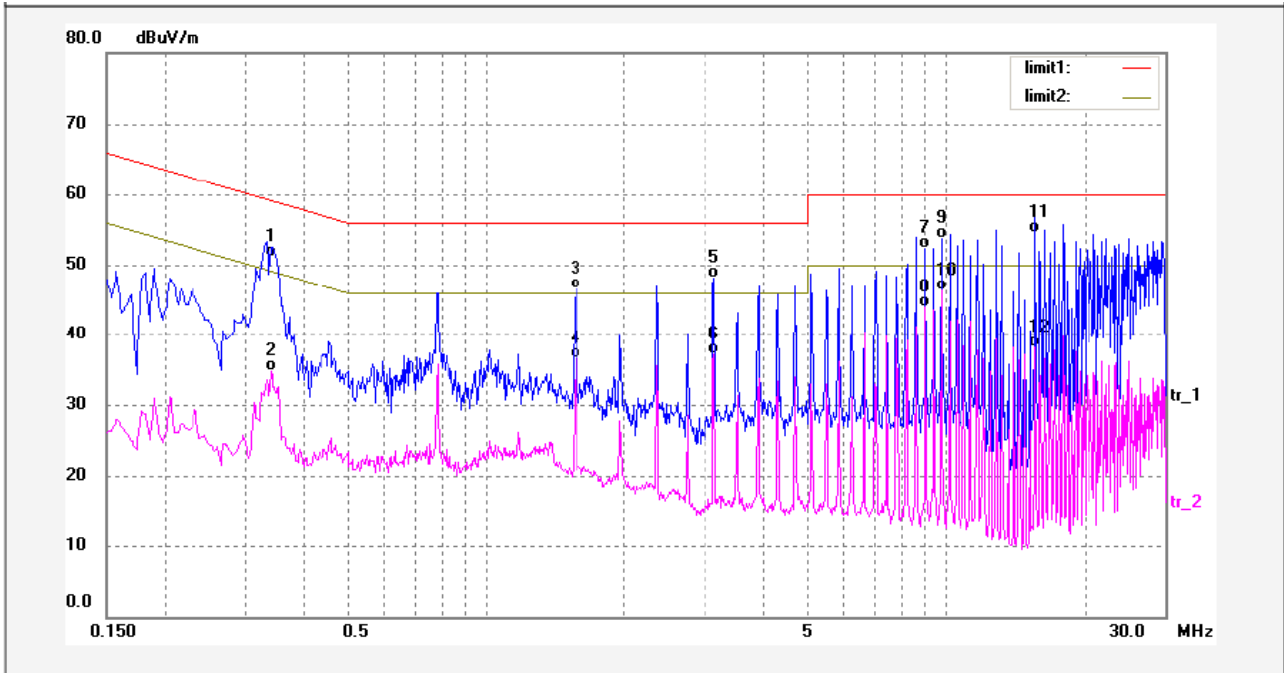

No.	Freq. (MHz)	Reading (dBuV/m)	Factor (dB)	Result (dBuV/m)	Limit dBuV/	Margin (dB)	Detector	Remark
1	0.3420	40.86	10.34	51.20	59.15	-7.95	QP	
2	0.3420	24.39	10.34	34.73	49.15	-14.42	AVG	
3	1.5700	35.95	10.59	46.54	56.00	-9.46	QP	
4	1.5700	25.88	10.59	36.47	46.00	-9.53	AVG	
5	3.1420	37.30	10.76	48.06	56.00	-7.94	QP	
6	3.1420	26.34	10.76	37.10	46.00	-8.90	AVG	
7	9.0219	41.44	10.88	52.32	60.00	-7.68	QP	
8	9.0219	33.11	10.88	43.99	50.00	-6.01	AVG	
9	9.8020	42.84	10.90	53.74	60.00	-6.26	QP	
10	9.8020	35.44	10.90	46.34	50.00	-3.66	AVG	
11	15.6660	43.48	11.12	54.60	60.00	-5.40	QP	
12	15.6660	26.98	11.12	38.10	50.00	-11.90	AVG	

The results shown in this test report refer only to the sample(s) tested , This Test report cannot be reproduced, except in full, without prior written permission of the Company.

6.4 Photograph – Conducted Emission Test Setup



The results shown in this test report refer only to the sample(s) tested , This Test report cannot be reproduced, except in full, without prior written permission of the Company.

WALTEK SERVICES

Reference No.: WT12063820-D-S-F

7 Radiated Spurious Emissions

Test Requirement:	FCC CFR47 Part 15 Section 15.209 & 15.247
Test Method:	Based on DA 00-705
Test Result:	PASS
Frequency Range:	12MHz to 25GHz
Measurement Distance:	3m
15.209 Limit:	40.0 dBuV/m between 30MHz & 88MHz 43.5 dBuV/m between 88MHz & 216MHz 46.0 dBuV/m between 216MHz & 960MHz 54.0 dBuV/m above 960MHz
15.247 (d) Limit:	(d) In any 100 kHz bandwidth outside the frequency band in which the spread spectrum or digitally modulated intentional radiator is operating. The radio frequency power that is produced by the intentional radiator shall be at least 20 dB below that in the 100 kHz bandwidth within the band that Contains the highest level of the desired power, based on either an RF conducted or a radiated measurement, provided the transmitter demonstrates compliance with the peak conducted power limits.
Test mode:	The EUT was tested in continuously Transmit mode.

7.1 EUT Operation :

Operating Environment:

Temperature:	25.5 °C
Humidity:	51 % RH
Atmospheric Pressure:	1012 mbar

7.2 Measurement Uncertainty

All measurements involve certain levels of uncertainties, especially in the field of EMC. The factors contributing to uncertainties are spectrum analyzer, cable loss, antenna factor calibration, antenna directivity, antenna factor variation with height, antenna phase center variation, antenna factor frequency interpolation, measurement distance variation, site imperfections, mismatch (average), and system repeatability.

Based on NIS 81, The Treatment of Uncertainty in EMC Measurements, the best estimate of the uncertainty of a radiation emissions measurement at Waltek EMC Lab is ± 5.03 dB.

7.3 Test Setup

The radiated emission tests were performed in the 3m Semi- Anechoic Chamber test site, using the setup accordance with the ANSI C63.4:2003.

The test setup for emission measurement below 30MHz.

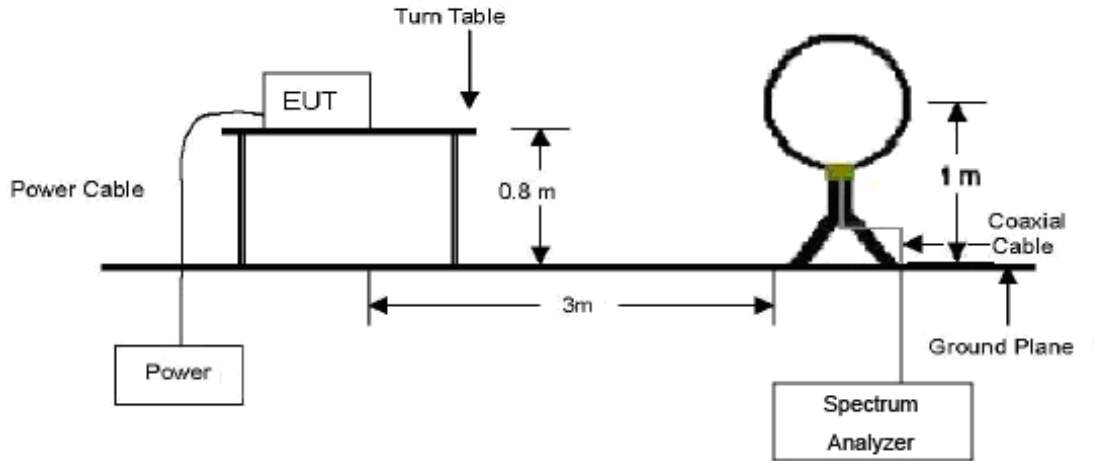

The test setup for emission measurement from 30 MHz to 1 GHz.

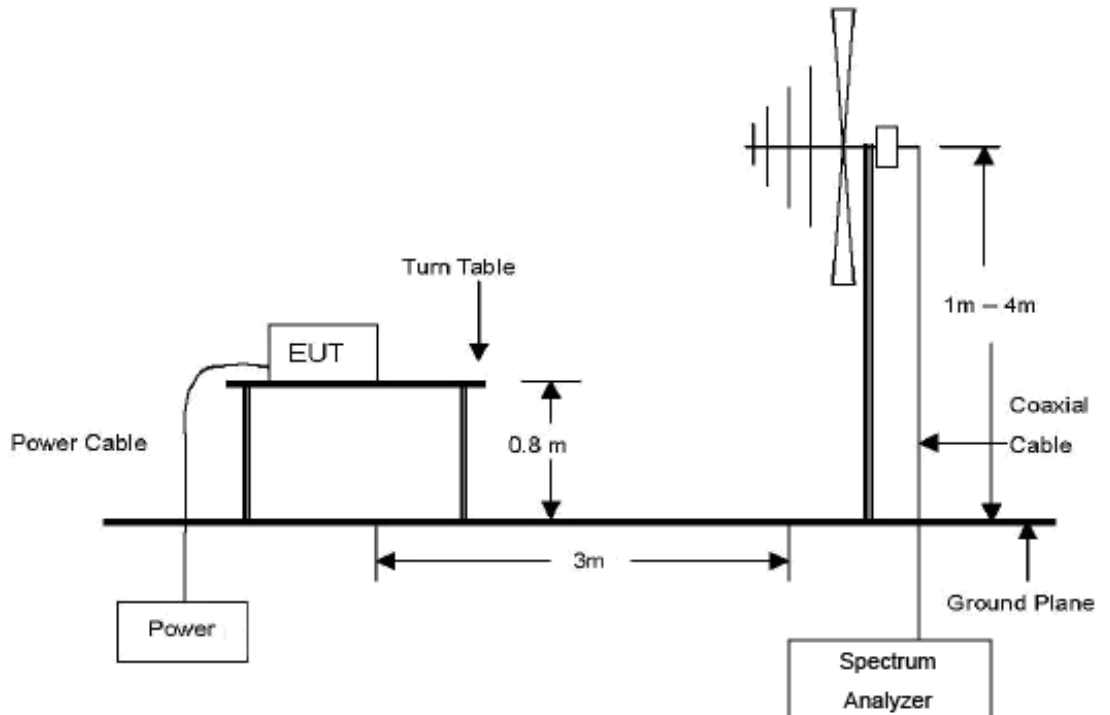

The results shown in this test report refer only to the sample(s) tested , This Test report cannot be reproduced, except in full, without prior written permission of the Company.

The test setup for emission measurement above 1 GHz.

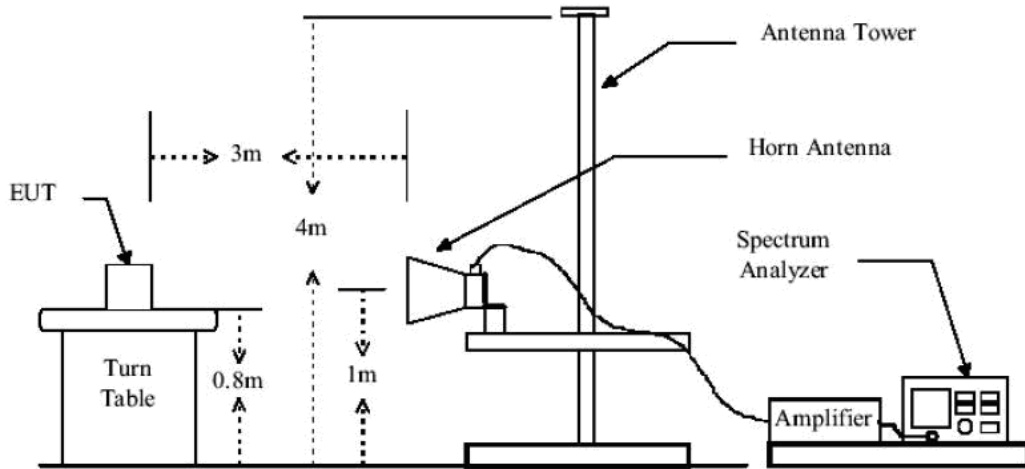

The results shown in this test report refer only to the sample(s) tested , This Test report cannot be reproduced, except in full, without prior written permission of the Company.

7.4 Spectrum Analyzer Setup

According to FCC Part15 Rules, the system was tested from 12MHz to 25000MHz.

Below 30MHz

Start Frequency	12MHz
Stop Frequency.....	30MHz
Sweep Speed.....	Auto
IF Bandwidth.....	10KHz
Video Bandwidth.....	10KHz
Resolution Bandwidth.....	10KHz

30MHz ~ 1GHz

Start Frequency	30 MHz
Stop Frequency.....	1000MHz
Sweep Speed.....	Auto
IF Bandwidth.....	120 KHz
Video Bandwidth.....	100KHz
Quasi-Peak Adapter Bandwidth	120 KHz
Quasi-Peak Adapter Mode	Normal
Resolution Bandwidth	100KHz

Above 1GHz

Start Frequency	1000 MHz
Stop Frequency.....	25000MHz
Sweep Speed.....	Auto
IF Bandwidth.....	120 KHz
Video Bandwidth.....	3MHz
Quasi-Peak Adapter Bandwidth	120 KHz
Quasi-Peak Adapter Mode	Normal
Resolution Bandwidth	1MHz

7.5 Test Procedure

1. The EUT is placed on a turntable, which is 0.8m above ground plane.
2. The turntable shall be rotated for 360 degrees to determine the position of maximum emission level.
3. EUT is set 3m away from the receiving antenna, which is moved from 1m to 4m to find out the maximum emissions.
4. Maximum procedure was performed on the six highest emissions to ensure EUT compliance.
5. And also, each emission was to be maximized by changing the polarization of receiving antenna both horizontal and vertical.
6. Repeat above procedures until the measurements for all frequencies are complete.
7. The radiation measurements are tested under 3-axes(X,Y,Z) position(X denotes lying on the table, Y denotes side stand and Z denotes vertical stand), After pre-test, It was found that the worse radiation emission was get at the X position. So the data shown was the X position only.

7.6 Corrected Amplitude & Margin Calculation

The Corrected Amplitude is calculated by adding the Antenna Factor and Cable Factor, and subtracting the Amplifier Gain from the Amplitude reading. The basic equation is as follows:

$$\text{Corr. Ampl.} = \text{Indicated Reading} + \text{Antenna Factor} + \text{Cable Factor} - \text{Amplifier Gain}$$

The “**Margin**” column of the following data tables indicates the degree of compliance with the applicable limit. For example, a margin of -7dB means the emission is 7dB below the maximum limit for Class B. The equation for margin calculation is as follows:

$$\text{Margin} = \text{Corr. Ampl.} - \text{Limit}$$

7.7 Summary of Test Results

According to the data in this section, the EUT complied with the FCC CFR47 Part 15 Section 15.209 & 15.247 rules. The EUT was tested in mode 1, mode 2, mode 3, mode 4. The worse case was in mode 1 and mode 2. The worst data is show this report.

Continuously receive mode

Remark: the EUT was pretested at the high, middle and low channel, and the worst case was the middle Channel, so the data show was the low channel only.

Because the emissions below 30MHz are more than 20dB below the limit, the data is not show in the report.

Test Frequency : 30MHz ~ 1000MHz

Antenna polarization: Vertical

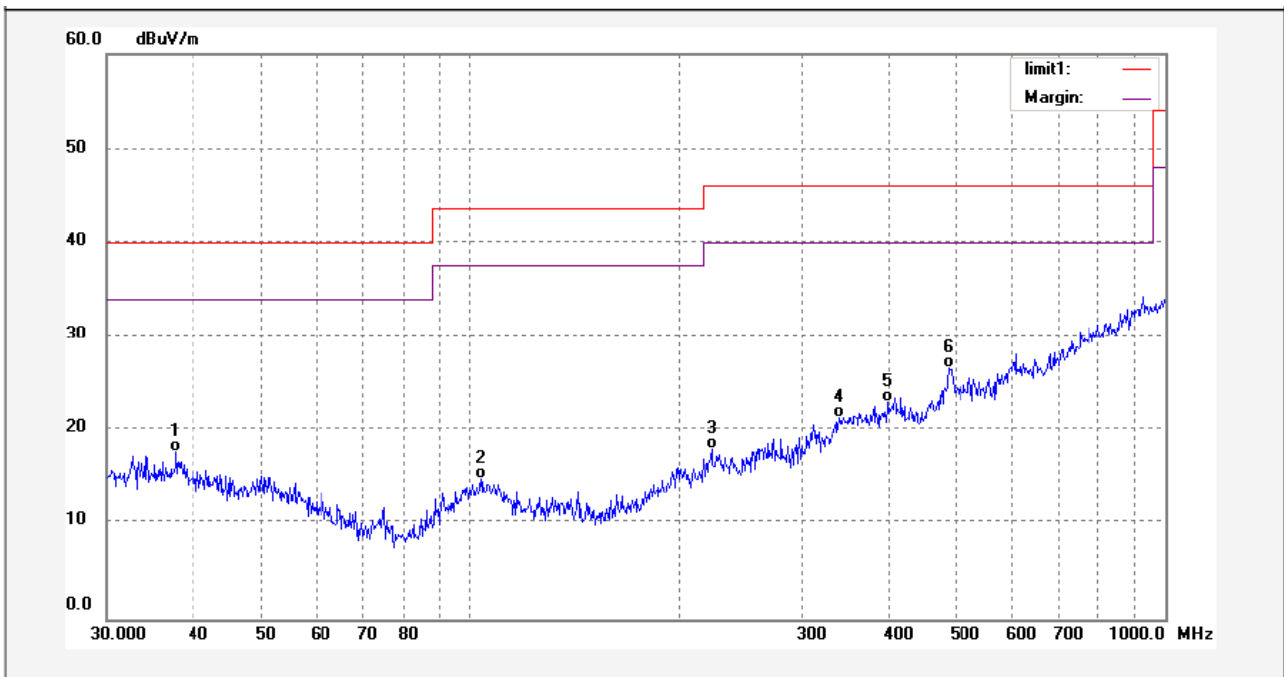

No.	Freq. (MHz)	Reading (dBuV/m)	Factor (dB)	Result (dBuV/m)	Limit (dBuV/m)	Margin (dB)	Detector	Remark
1	37.6970	1.18	16.64	17.82	40.00	-22.18	QP	
2	103.6990	0.80	14.19	14.99	43.50	-28.51	QP	
3	223.0630	1.86	16.27	18.13	46.00	-27.87	QP	
4	340.0473	1.22	20.23	21.45	46.00	-24.55	QP	
5	399.6981	2.18	20.91	23.09	46.00	-22.91	QP	
6	488.3263	1.36	25.25	26.61	46.00	-19.39	QP	

The results shown in this test report refer only to the sample(s) tested , This Test report cannot be reproduced, except in full, without prior written permission of the Company.

Antenna polarization: Horizontal

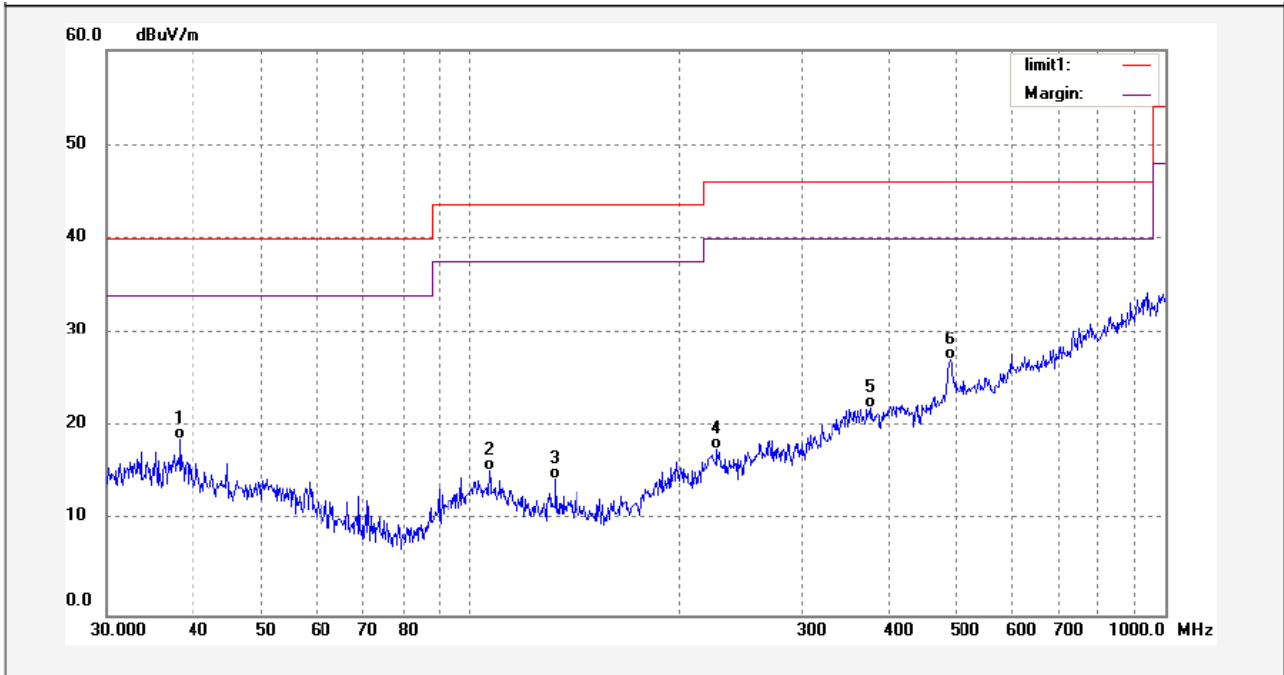

No.	Freq. (MHz)	Reading (dBuV/m)	Factor (dB)	Result (dBuV/m)	Limit (dBuV/m)	Margin (dB)	Detector	Remark
1	38.2305	1.98	16.63	18.61	40.00	-21.39	QP	
2	106.6552	1.21	14.09	15.30	43.50	-28.20	QP	
3	132.6142	2.40	12.05	14.45	43.50	-29.05	QP	
4	227.0164	1.41	16.29	17.70	46.00	-28.30	QP	
5	377.8481	1.91	20.12	22.03	46.00	-23.97	QP	
6	490.0451	1.32	25.75	27.07	46.00	-18.93	QP	

The results shown in this test report refer only to the sample(s) tested , This Test report cannot be reproduced, except in full, without prior written permission of the Company.

Test Frequency: Above 1GHz radiation test data:

Remark: No any emissions were found from 18GHz to 25 GHz, So the radiated emissions from 18GHz to 25GHz were not record.

Antenna polarization: Vertical

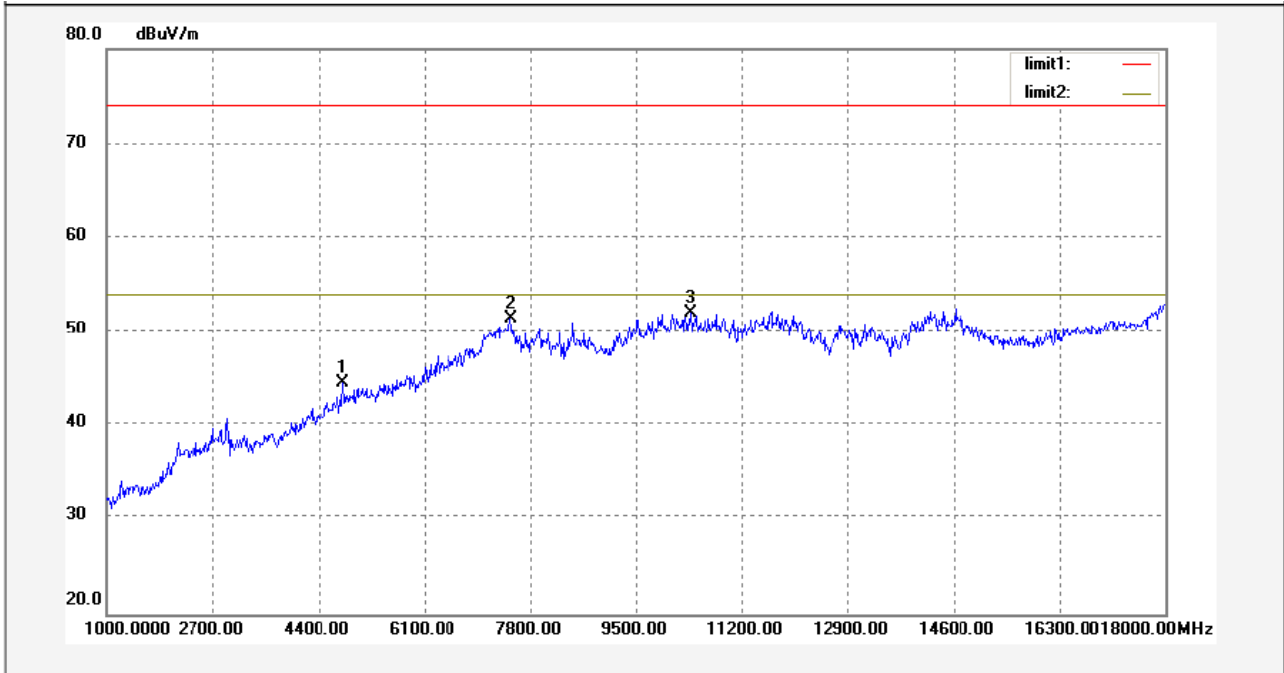

No.	Freq. (MHz)	Reading (dBuV/m)	Factor (dB)	Result (dBuV/m)	Limit (dBuV/m)	Margin (dB)	Detector	Remark
1	4798.597	48.71	-4.23	44.48	74.00	-29.52	peak	
2	7472.946	48.10	3.25	51.35	74.00	-22.65	peak	
3	10368.737	43.48	8.61	52.09	74.00	-21.91	peak	

The results shown in this test report refer only to the sample(s) tested , This Test report cannot be reproduced, except in full, without prior written permission of the Company.

Antenna polarization: Horizontal

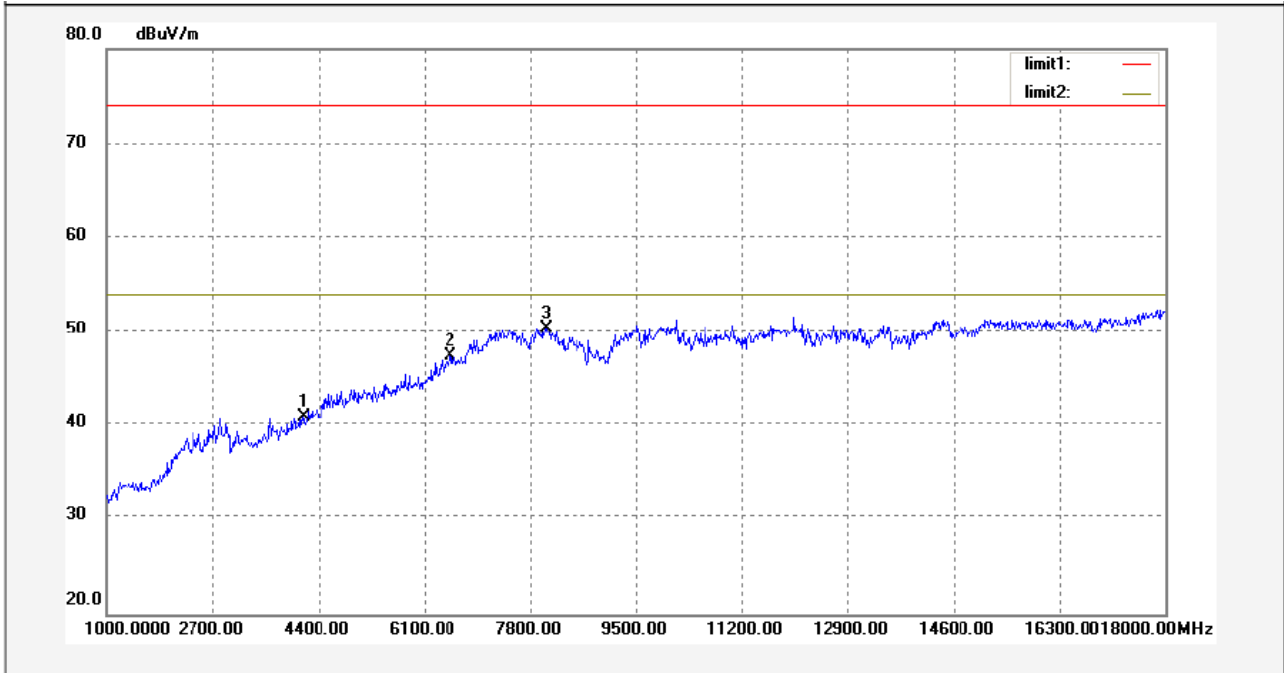

No.	Freq. (MHz)	Reading (dBuV/m)	Factor (dB)	Result (dBuV/m)	Limit (dBuV/m)	Margin (dB)	Detector	Remark
1	4134.269	47.20	-6.21	40.99	74.00	-33.01	peak	
2	6519.038	47.18	0.20	47.38	74.00	-26.62	peak	
3	8052.104	46.02	4.42	50.44	74.00	-23.56	peak	

The results shown in this test report refer only to the sample(s) tested , This Test report cannot be reproduced, except in full, without prior written permission of the Company.

Continuously transmit mode

Remark: The pre-test was performed in continuously transmit mode, normal link mode, and the continuously transmit mode was pretested at the high, middle and low channel. The worst mode is normal link mode, so the data show was that mode's only.

Because the emissions below 30MHz are more than 20dB below the limit, the data is not show in the report.

Test Frequency : 30MHz ~ 1000MHz

Antenna polarization: Vertical

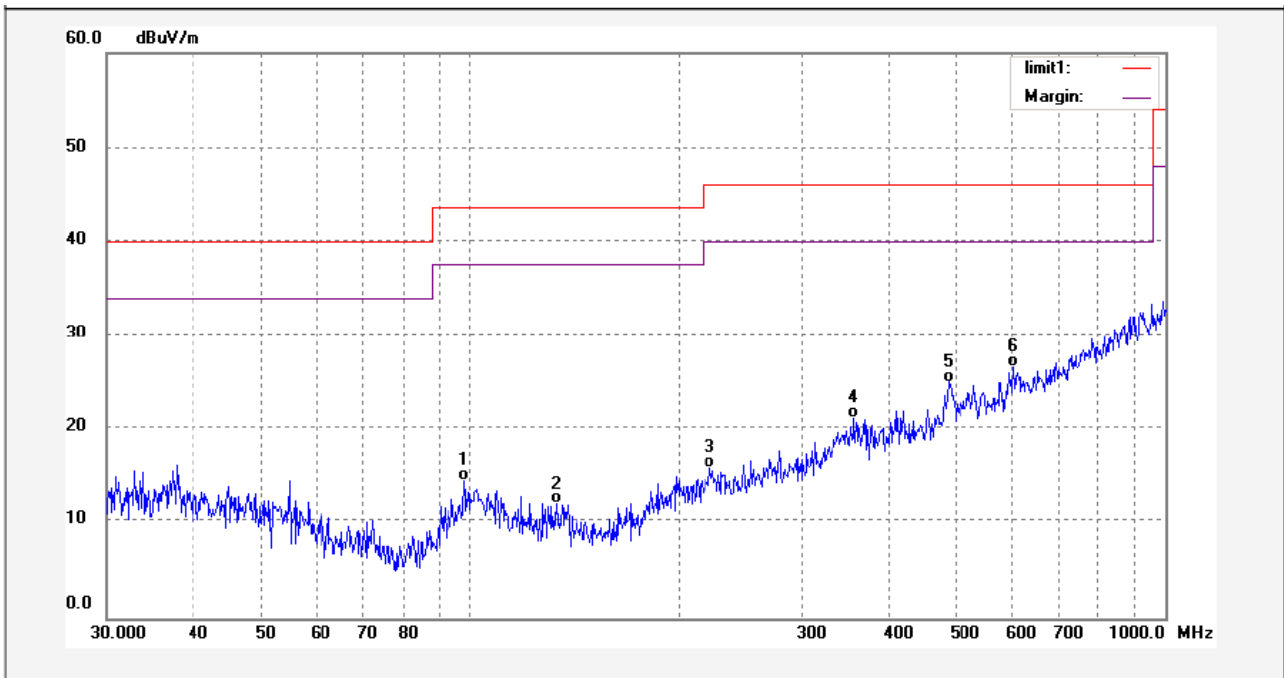

No.	Freq. (MHz)	Reading (dBuV/m)	Factor (dB)	Result (dBuV/m)	Limit (dBuV/m)	Margin (dB)	Detector	Remark
1	98.0302	0.97	13.65	14.62	43.50	-28.88	QP	
2	133.0809	-0.04	12.06	12.02	43.50	-31.48	QP	
3	221.5010	-0.19	16.20	16.01	46.00	-29.99	QP	
4	357.1925	0.70	20.59	21.29	46.00	-24.71	QP	
5	488.3263	-0.20	25.25	25.05	46.00	-20.95	QP	
6	605.0509	0.70	25.87	26.57	46.00	-19.43	QP	

The results shown in this test report refer only to the sample(s) tested , This Test report cannot be reproduced, except in full, without prior written permission of the Company.

Antenna polarization: Horizontal

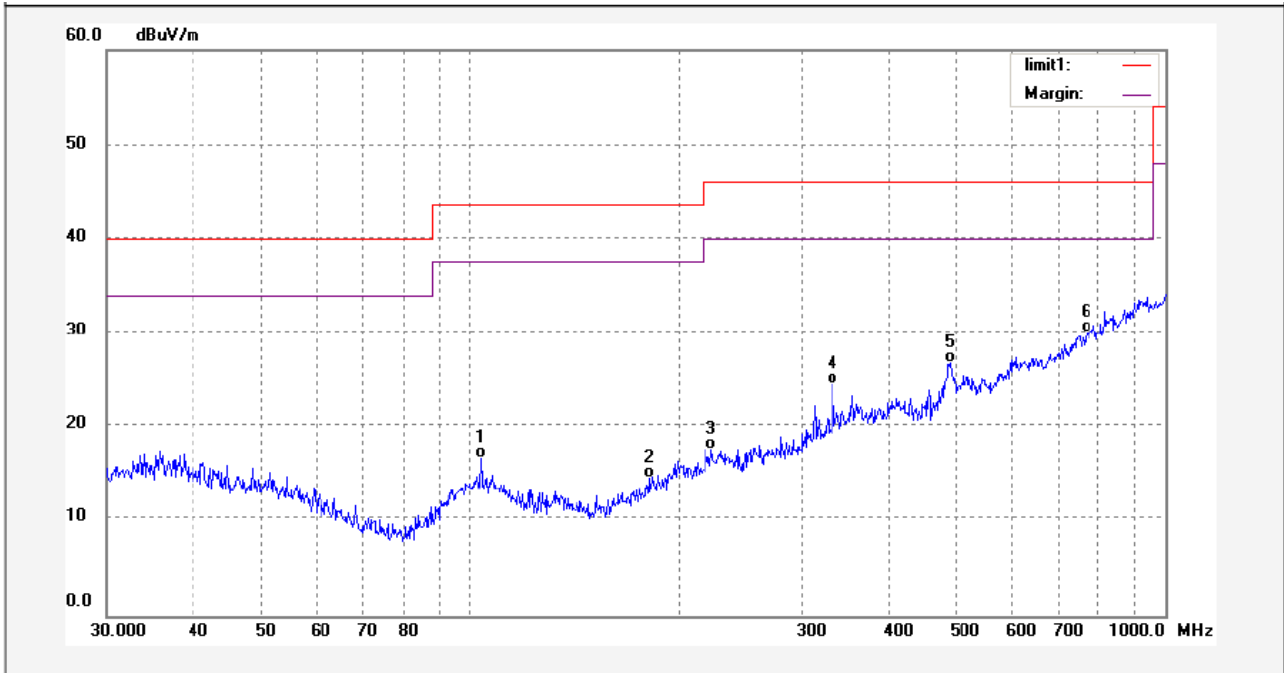

No.	Freq. (MHz)	Reading (dBuV/m)	Factor (dB)	Result (dBuV/m)	Limit (dBuV/m)	Margin (dB)	Detector	Remark
1	103.6990	2.52	14.19	16.71	43.50	-26.79	QP	
2	180.6641	1.37	13.19	14.56	43.50	-28.94	QP	
3	222.2807	1.43	16.23	17.66	46.00	-28.34	QP	
4	332.9536	5.09	19.47	24.56	46.00	-21.44	QP	
5	490.0451	1.06	25.75	26.81	46.00	-19.19	QP	
6	771.0475	1.69	28.38	30.07	46.00	-15.93	QP	

The results shown in this test report refer only to the sample(s) tested , This Test report cannot be reproduced, except in full, without prior written permission of the Company.

Test Frequency: 1GHz ~ 25GHz radiation test data

And the below is the Fundamental and Harmonic

Frequency (MHz)	Detector	Antenna Polarization	Emission Level (dBuV/m)	Limit (dBuV/m)	Margin (dB)	Antenna Height (m)	Turntable Angle (°)
Low frequency							
2402.00	AV	Vertical	95.35		(Fund.)	1.1	110
4804.00	AV	Vertical	38.61	54.00	-15.39	1.4	140
7206.00	AV	Vertical	39.48	54.00	-14.52	1.6	170
9608.00	AV	Vertical	35.78	54.00	-18.22	1.4	130
12010.00	AV	Vertical	33.50	54.00	-20.50	1.8	185
14412.00	AV	Vertical	35.36	54.00	-18.64	1.2	195
16814.00	AV	Vertical	34.67	54.00	-19.33	1.9	160
19216.00	AV	Vertical	29.67	54.00	-24.33	1.4	140
21618.00	AV	Vertical	26.79	54.00	-27.21	1.4	30
24020.00	AV	Vertical	30.00	54.00	-24.00	1.1	145
2402.00	AV	Horizontal	89.03		(Fund.)	1.7	70
4804.00	AV	Horizontal	35.50	54.00	-18.50	1.2	180
7206.00	AV	Horizontal	33.91	54.00	-20.09	1.4	100
9608.00	AV	Horizontal	36.34	54.00	-17.66	1.4	195
12010.00	AV	Horizontal	34.71	54.00	-19.29	1.6	110
14412.00	AV	Horizontal	31.41	54.00	-22.59	1.2	190
16814.00	AV	Horizontal	34.28	54.00	-19.72	1.7	150
19216.00	AV	Horizontal	26.87	54.00	-27.13	1.6	175
21618.00	AV	Horizontal	27.69	54.00	-26.31	1.4	160
24020.00	AV	Horizontal	26.44	54.00	-27.56	1.4	90
2402.00	PK	Vertical	106.25		(Fund.)	1.3	30
4804.00	PK	Vertical	57.46	74.00	-16.54	1.7	145
7206.00	PK	Vertical	58.48	74.00	-15.52	2.1	160
9608.00	PK	Vertical	55.09	74.00	-18.91	1.2	240
12010.00	PK	Vertical	51.58	74.00	-22.42	1.1	100
14412.00	PK	Vertical	52.72	74.00	-21.28	1.4	155
16814.00	PK	Vertical	49.59	74.00	-24.41	1.5	185
19216.00	PK	Vertical	47.95	74.00	-26.05	1.1	190
21618.00	PK	Vertical	45.61	74.00	-28.39	1.9	110
24020.00	PK	Vertical	46.89	74.00	-27.11	1.2	165
2402.00	PK	Horizontal	100.54		(Fund.)	2.0	120
4804.00	PK	Horizontal	55.77	74.00	-18.23	1.7	170
7206.00	PK	Horizontal	53.60	74.00	-20.40	1.6	90
9608.00	PK	Horizontal	50.59	74.00	-23.41	1.1	85
12010.00	PK	Horizontal	52.70	74.00	-21.30	1.7	205
14412.00	PK	Horizontal	47.46	74.00	-26.54	1.0	60
16814.00	PK	Horizontal	53.62	74.00	-20.38	1.7	220
19216.00	PK	Horizontal	45.55	74.00	-28.45	1.7	155

The results shown in this test report refer only to the sample(s) tested , This Test report cannot be reproduced, except in full, without prior written permission of the Company.

21618.00	PK	Horizontal	46.76	74.00	-27.24	1.3	170
24020.00	PK	Horizontal	48.66	74.00	-25.34	1.5	140
Middle frequency							
2441.00	AV	Vertical	94.70		(Fund.)	1.7	70
4882.00	AV	Vertical	41.13	54.00	-12.87	1.4	185
7323.00	AV	Vertical	39.42	54.00	-14.58	1.1	140
9764.00	AV	Vertical	35.21	54.00	-18.79	1.5	70
12205.00	AV	Vertical	39.93	54.00	-14.07	1.7	50
14646.00	AV	Vertical	33.60	54.00	-20.40	1.4	225
17087.00	AV	Vertical	35.46	54.00	-18.54	1.6	60
19528.00	AV	Vertical	32.33	54.00	-21.67	1.5	80
21969.00	AV	Vertical	30.34	54.00	-23.66	1.9	210
24410.00	AV	Vertical	34.56	54.00	-19.44	1.7	175
2441.00	AV	Horizontal	90.70		(Fund.)	1.5	190
4882.00	AV	Horizontal	37.60	54.00	-16.40	1.7	150
7323.00	AV	Horizontal	38.89	54.00	-15.11	1.7	310
9764.00	AV	Horizontal	33.68	54.00	-20.32	1.0	215
12205.00	AV	Horizontal	31.50	54.00	-22.50	1.2	200
14646.00	AV	Horizontal	35.25	54.00	-18.75	1.7	250
17087.00	AV	Horizontal	34.54	54.00	-19.46	2.1	185
19528.00	AV	Horizontal	29.30	54.00	-24.70	1.3	165
21969.00	AV	Horizontal	30.23	54.00	-23.77	1.3	210
24410.00	AV	Horizontal	28.54	54.00	-25.46	1.7	200
2441.00	PK	Vertical	105.98		(Fund.)	1.3	30
4882.00	PK	Vertical	62.36	74.00	-11.64	1.7	175
7323.00	PK	Vertical	60.55	74.00	-13.45	1.8	170
9764.00	PK	Vertical	56.29	74.00	-17.71	1.4	180
12205.00	PK	Vertical	59.66	74.00	-14.34	1.9	220
14646.00	PK	Vertical	52.18	74.00	-21.82	1.0	95
17087.00	PK	Vertical	55.49	74.00	-18.51	1.4	50
19528.00	PK	Vertical	50.38	74.00	-23.62	1.9	190
21969.00	PK	Vertical	54.25	74.00	-19.75	2.0	185
24410.00	PK	Vertical	47.44	74.00	-26.56	1.4	195
2441.00	PK	Horizontal	101.94		(Fund.)	1.7	60
4882.00	PK	Horizontal	57.43	74.00	-16.57	1.7	125
7323.00	PK	Horizontal	59.24	74.00	-14.76	1.7	120
9764.00	PK	Horizontal	53.23	74.00	-20.77	1.7	145
12205.00	PK	Horizontal	56.11	74.00	-17.89	1.8	220
14646.00	PK	Horizontal	51.36	74.00	-22.64	1.1	210
17087.00	PK	Horizontal	48.61	74.00	-25.39	1.3	160
19528.00	PK	Horizontal	51.38	74.00	-22.62	1.3	245
21969.00	PK	Horizontal	52.49	74.00	-21.51	1.1	50
24410.00	PK	Horizontal	47.30	74.00	-26.70	1.3	215
High frequency							

The results shown in this test report refer only to the sample(s) tested , This Test report cannot be reproduced, except in full, without prior written permission of the Company.

2480.00	AV	Vertical	95.69		(Fund.)	1.2	220
4960.00	AV	Vertical	41.40	54.00	-12.60	1.4	95
7440.00	AV	Vertical	40.44	54.00	-13.56	1.3	170
9920.00	AV	Vertical	38.80	54.00	-15.20	1.1	130
12400.00	AV	Vertical	37.49	54.00	-16.51	2.0	140
14880.00	AV	Vertical	40.88	54.00	-13.12	1.5	195
17360.00	AV	Vertical	34.33	54.00	-19.67	1.2	160
19840.00	AV	Vertical	31.70	54.00	-22.30	1.1	260
22320.00	AV	Vertical	38.35	54.00	-15.65	1.5	150
24800.00	AV	Vertical	30.44	54.00	-23.56	1.0	220
2480.00	AV	Horizontal	91.79		(Fund.)	1.5	190
4960.00	AV	Horizontal	39.69	54.00	-14.31	2.3	210
7440.00	AV	Horizontal	35.14	54.00	-18.86	1.4	160
9920.00	AV	Horizontal	35.59	54.00	-18.41	1.3	275
12400.00	AV	Horizontal	36.99	54.00	-17.01	1.2	185
14880.00	AV	Horizontal	33.39	54.00	-20.61	1.5	190
17360.00	AV	Horizontal	30.61	54.00	-23.39	1.9	230
19840.00	AV	Horizontal	33.32	54.00	-20.68	1.5	135
22320.00	AV	Horizontal	28.46	54.00	-25.54	1.4	150
24800.00	AV	Horizontal	29.44	54.00	-24.56	2.4	170
2480.00	PK	Vertical	105.66		(Fund.)	1.3	210
4960.00	PK	Vertical	60.93	74.00	-13.07	1.0	115
7440.00	PK	Vertical	57.44	74.00	-16.56	2.5	180
9920.00	PK	Vertical	59.78	74.00	-14.22	1.1	160
12400.00	PK	Vertical	55.01	74.00	-18.99	1.6	130
14880.00	PK	Vertical	61.41	74.00	-12.59	1.0	155
17360.00	PK	Vertical	55.50	74.00	-18.50	1.2	140
19840.00	PK	Vertical	56.45	74.00	-17.55	1.6	190
22320.00	PK	Vertical	54.65	74.00	-19.35	2.1	170
24800.00	PK	Vertical	48.40	74.00	-25.60	1.0	210
2480.00	PK	Horizontal	99.14		(Fund.)	1.8	240
4960.00	PK	Horizontal	57.32	74.00	-16.68	1.4	140
7440.00	PK	Horizontal	55.71	74.00	-18.29	1.6	150
9920.00	PK	Horizontal	56.41	74.00	-17.59	1.5	265
12400.00	PK	Horizontal	54.40	74.00	-19.60	1.6	160
14880.00	PK	Horizontal	48.44	74.00	-25.56	1.6	150
17360.00	PK	Horizontal	52.71	74.00	-21.29	2.1	190
19840.00	PK	Horizontal	47.46	74.00	-26.54	1.3	245
22320.00	PK	Horizontal	50.17	74.00	-23.83	1.9	170
24800.00	PK	Horizontal	45.68	74.00	-28.32	1.6	260

The results shown in this test report refer only to the sample(s) tested , This Test report cannot be reproduced, except in full, without prior written permission of the Company.

Charging and AUX IN mode

Test Frequency : 30MHz ~ 1000MHz

Antenna polarization: Vertical

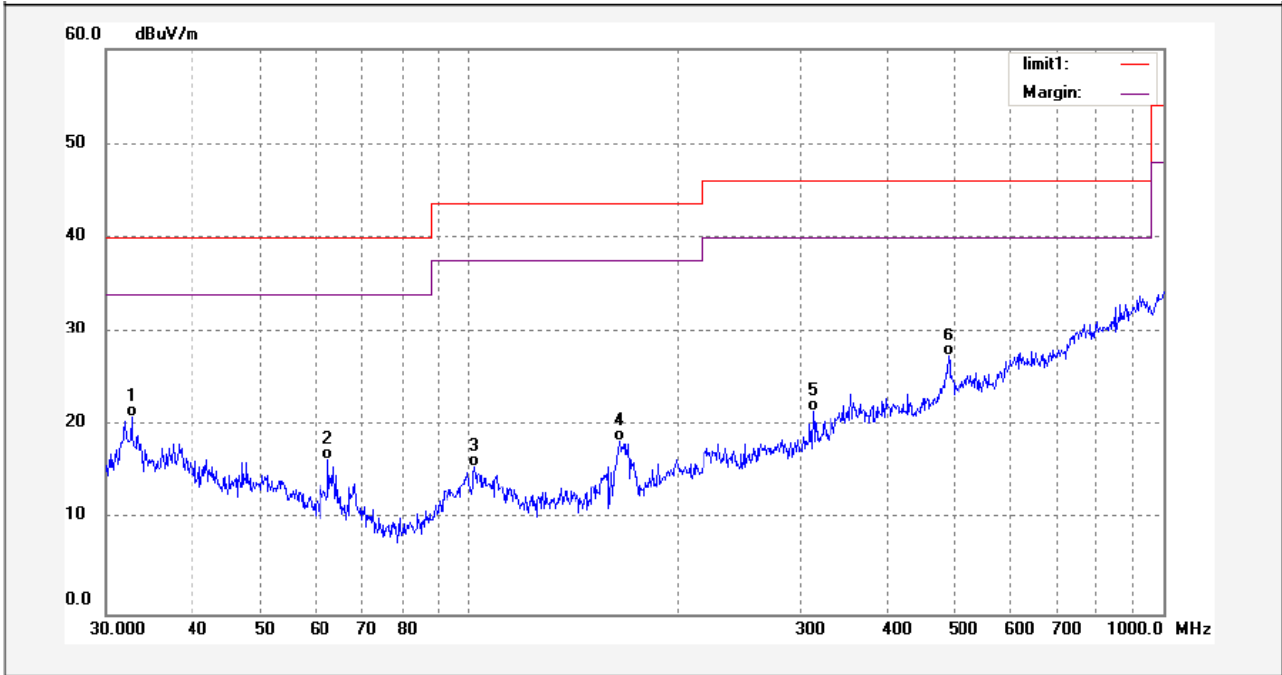

No.	Freq. (MHz)	Reading (dBuV/m)	Factor (dB)	Result (dBuV/m)	Limit (dBuV/m)	Margin (dB)	Detector	Remark
1	32.6395	4.34	16.58	20.92	40.00	-19.08	QP	
2	62.7432	4.75	11.71	16.46	40.00	-23.54	QP	
3	101.8932	1.62	14.09	15.71	43.50	-27.79	QP	
4	164.8912	6.42	11.94	18.36	43.50	-25.14	QP	
5	312.5482	3.27	18.29	21.56	46.00	-24.44	QP	
6	490.0451	1.70	25.75	27.45	46.00	-18.55	QP	

The results shown in this test report refer only to the sample(s) tested , This Test report cannot be reproduced, except in full, without prior written permission of the Company.

Antenna polarization: Horizontal

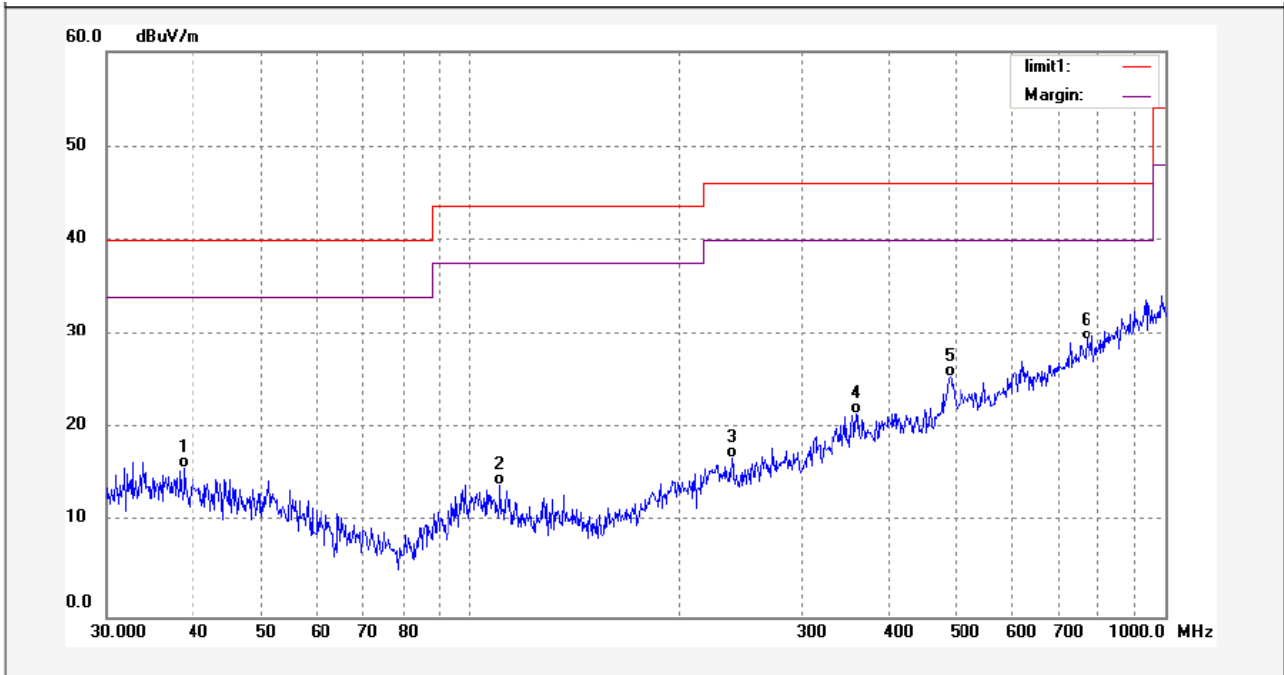

No.	Freq. (MHz)	Reading (dBuV/m)	Factor (dB)	Result (dBuV/m)	Limit (dBuV/m)	Margin (dB)	Detector	Remark
1	38.7716	-0.69	16.45	15.76	40.00	-24.24	QP	
2	110.4693	0.34	13.64	13.98	43.50	-29.52	QP	
3	238.4626	1.31	15.58	16.89	46.00	-29.11	QP	
4	359.7114	0.83	20.76	21.59	46.00	-24.41	QP	
5	490.0451	-0.35	25.75	25.40	46.00	-20.60	QP	
6	771.0475	1.02	28.38	29.40	46.00	-16.60	QP	

The results shown in this test report refer only to the sample(s) tested , This Test report cannot be reproduced, except in full, without prior written permission of the Company.

7.8 Photograph – Radiation Spurious Emission Test Setup

Below 30MHz

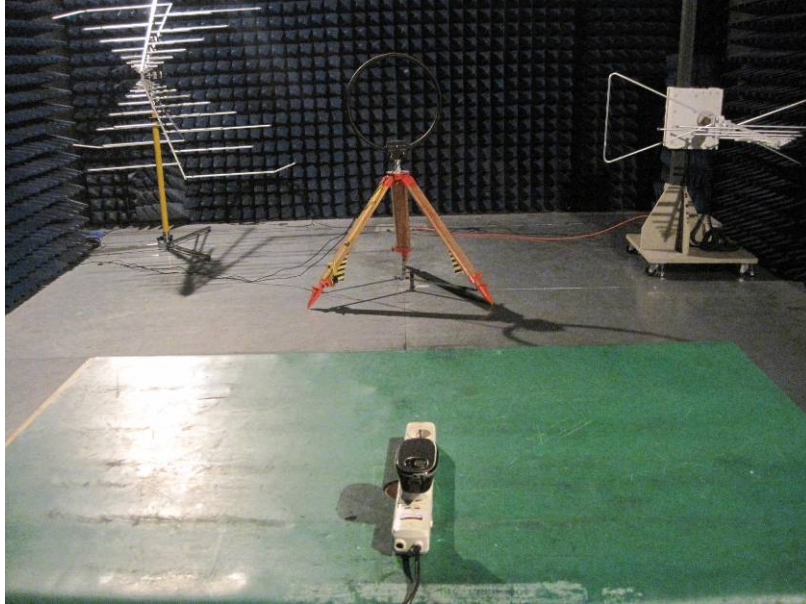

From 30-1000MHz

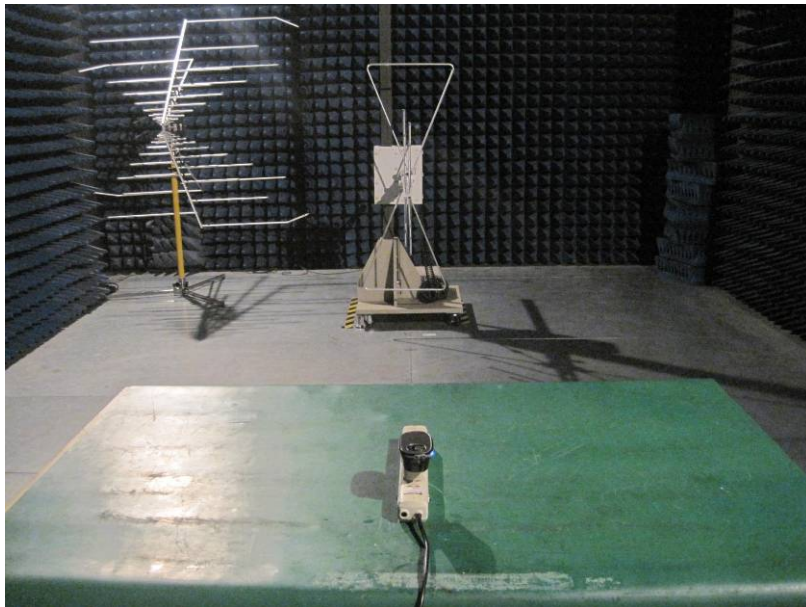

The results shown in this test report refer only to the sample(s) tested , This Test report cannot be reproduced, except in full, without prior written permission of the Company.

WALTEK SERVICES

Reference No.: WT12063820-D-S-F

Above 1GHz

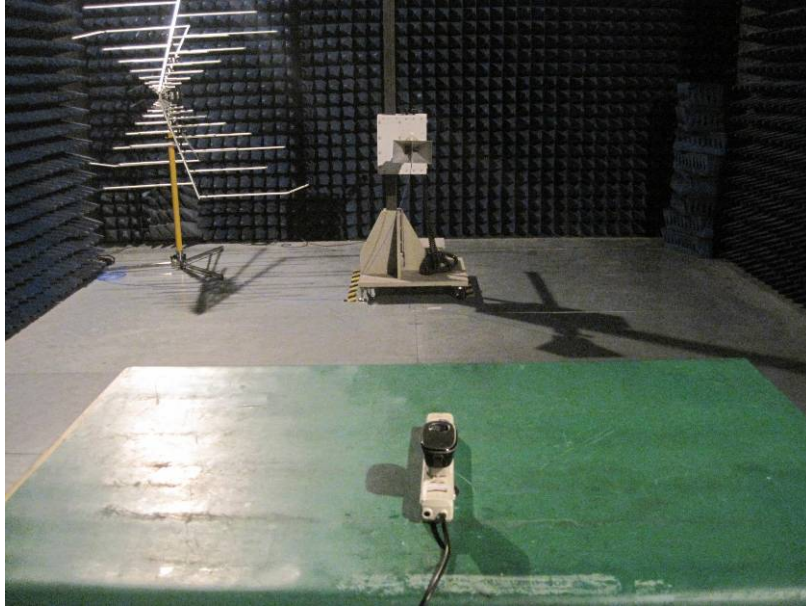

The results shown in this test report refer only to the sample(s) tested , This Test report cannot be reproduced, except in full, without prior written permission of the Company.

WALTEK SERVICES

Reference No.: WT12063820-D-S-F

8 Band Edge Measurements

Test Requirement:	Section 15.247(d) In addition, radiated emissions which fall in the restricted bands. as defined in Section 15.205(a), must also comply with the radiated emission limits specified in Section 15.209(a) (see Section 15.205(c)).
Test Method:	Based on DA 00-705
Measurement Distance:	3m
Limit:	40.0 dBuV/m between 30MHz & 88MHz; 43.5 dBuV/m between 88MHz & 216MHz; 46.0 dBuV/m between 216MHz & 960MHz; 54.0 dBuV/m above 960MHz. 74.0 dBuV/m for peak above 1GHz 54.0 dBuV/m for AVG above 1GHz
Detector:	For Peak value: RBW = 1 MHz for $f \geq 1$ GHz VBW \geq RBW; Sweep = auto Detector function = peak Trace = max hold For AVG value: RBW = 1 MHz for $f \geq 1$ GHz VBW = 10Hz; Sweep = auto Detector function = AVG Trace = max hold

Test Result:
Low Channel – Peak

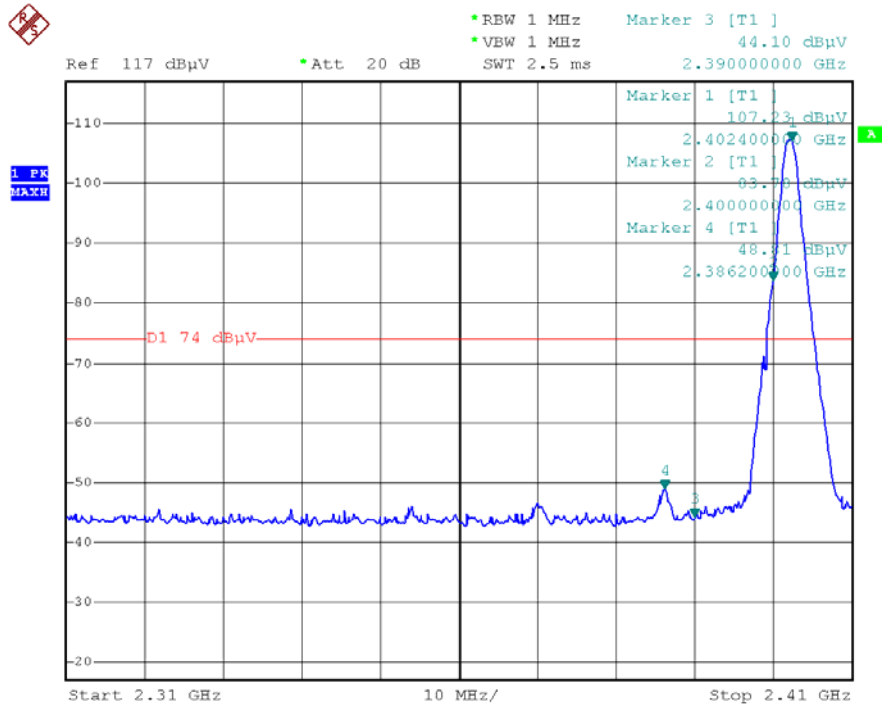

Low Channel – AV

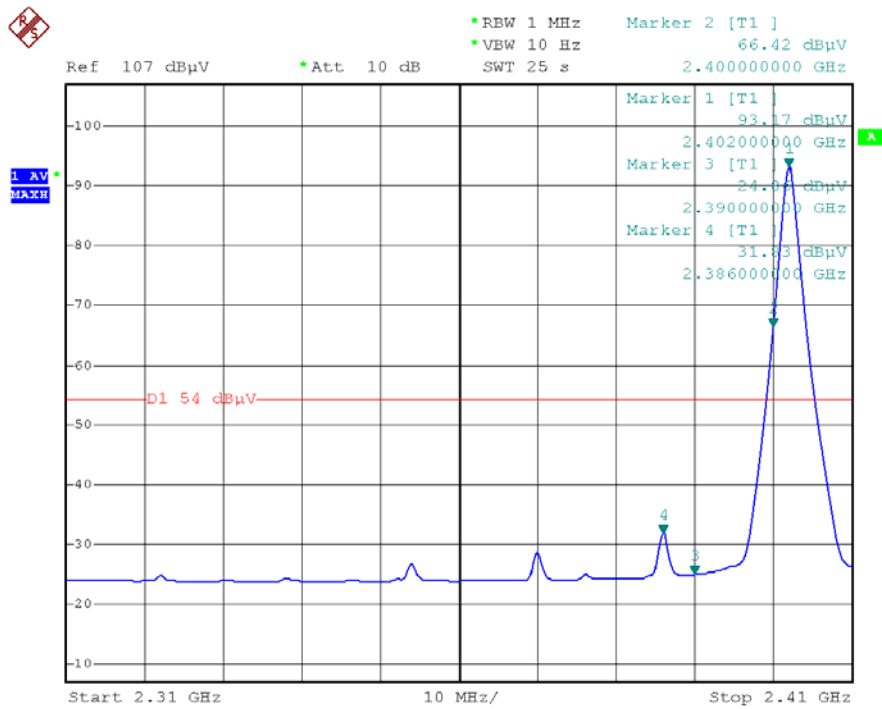

The results shown in this test report refer only to the sample(s) tested , This Test report cannot be reproduced, except in full, without prior written permission of the Company.

High Channel – Peak

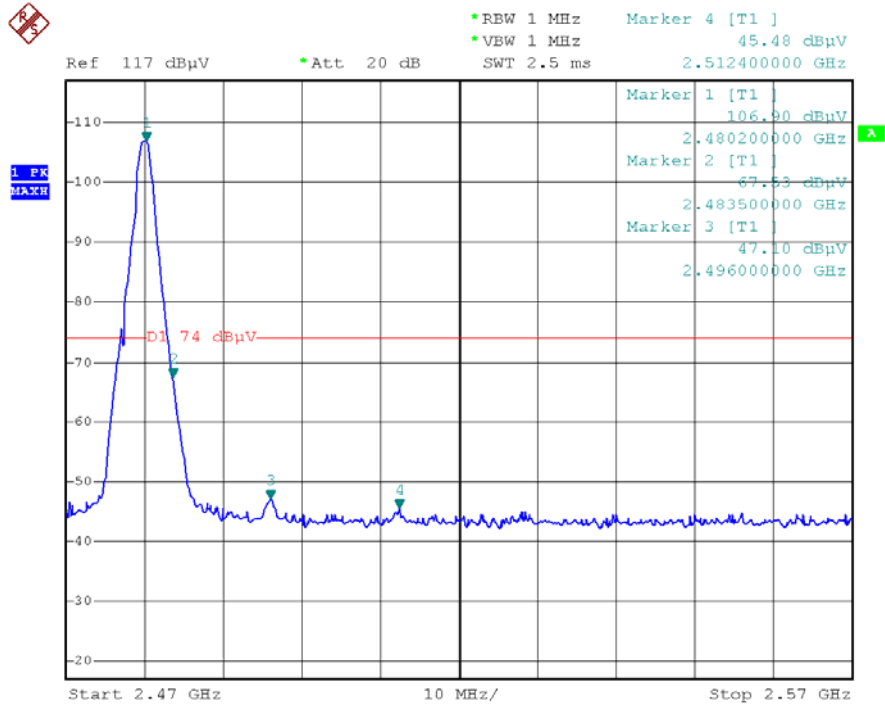

High Channel – AV

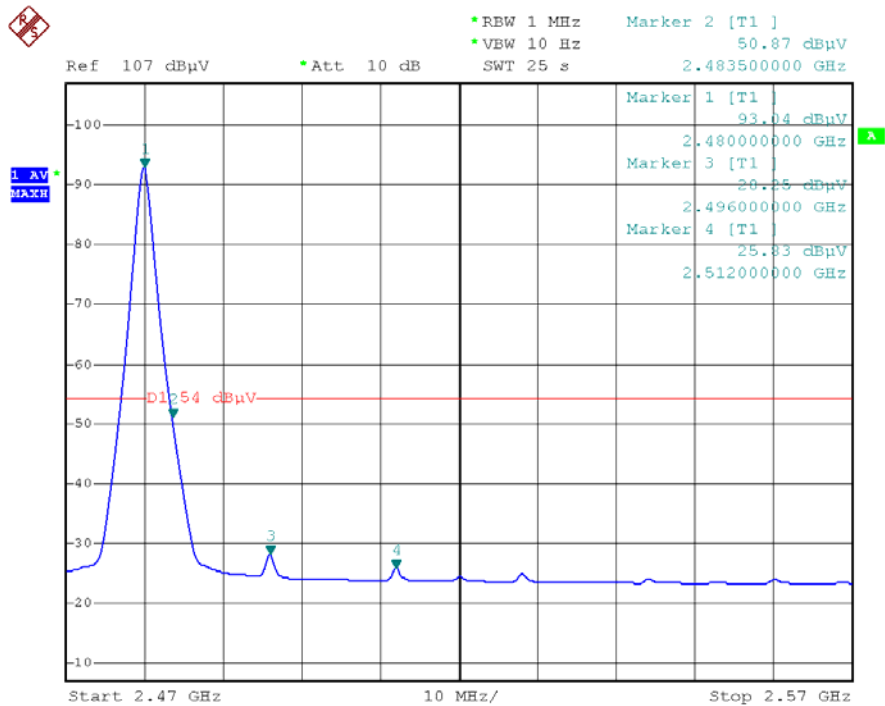

The results shown in this test report refer only to the sample(s) tested, This Test report cannot be reproduced, except in full, without prior written permission of the Company.

9 20 dB Bandwidth Measurement

Test Requirement: FCC CFR47 Part 15 Section 15.247
 Test Method: Based on DA 00-705
 Test Mode: Test in fixing operating frequency at low, Middle, high channel.

9.1 Test Procedure:

1. Remove the antenna from the EUT and then connect a low RF cable from the antenna port to the spectrum;
2. Set the spectrum analyzer: Span = 4MHz, RBW = 100kHz, VBW = 100kHz

9.2 Test Result:

Test Channel	Bandwidth
Low	1.112MHz
Middle	1.112MHz
High	1.112MHz

Test result plot as follows:

Low Channel

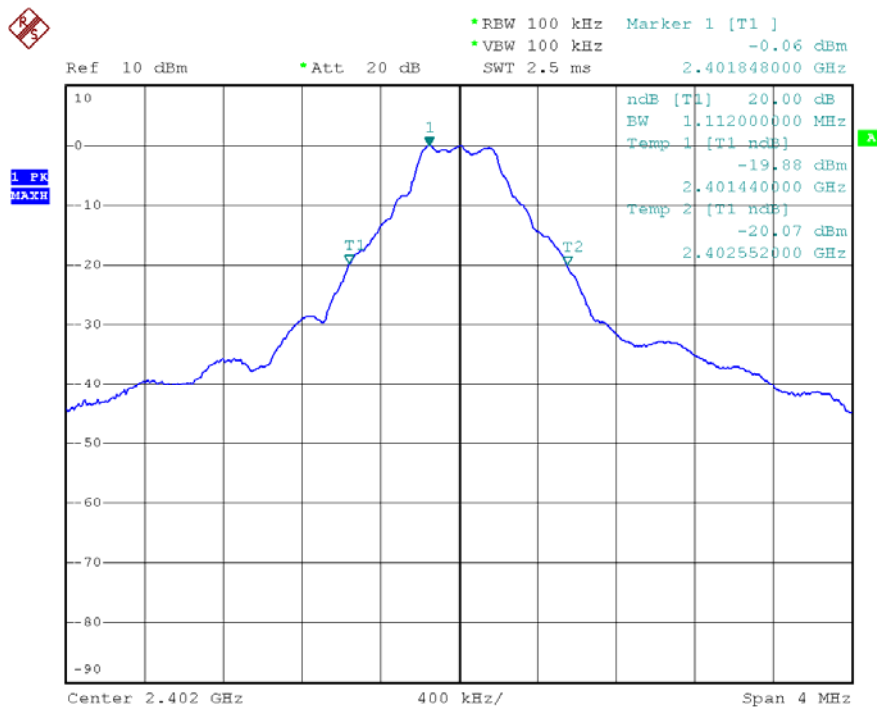

The results shown in this test report refer only to the sample(s) tested, This Test report cannot be reproduced, except in full, without prior written permission of the Company.

Middle Channel

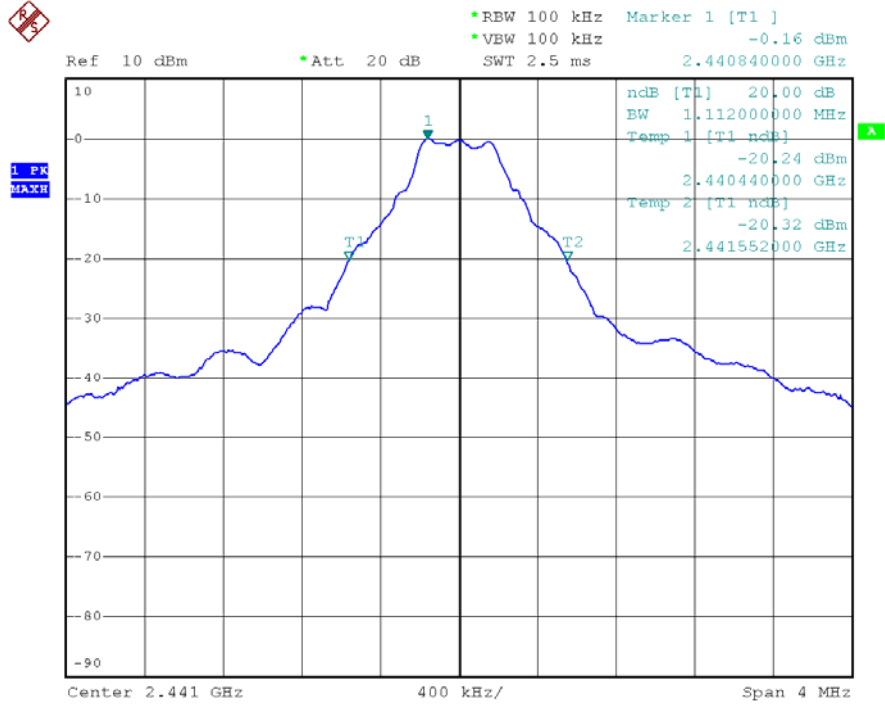

High Channel

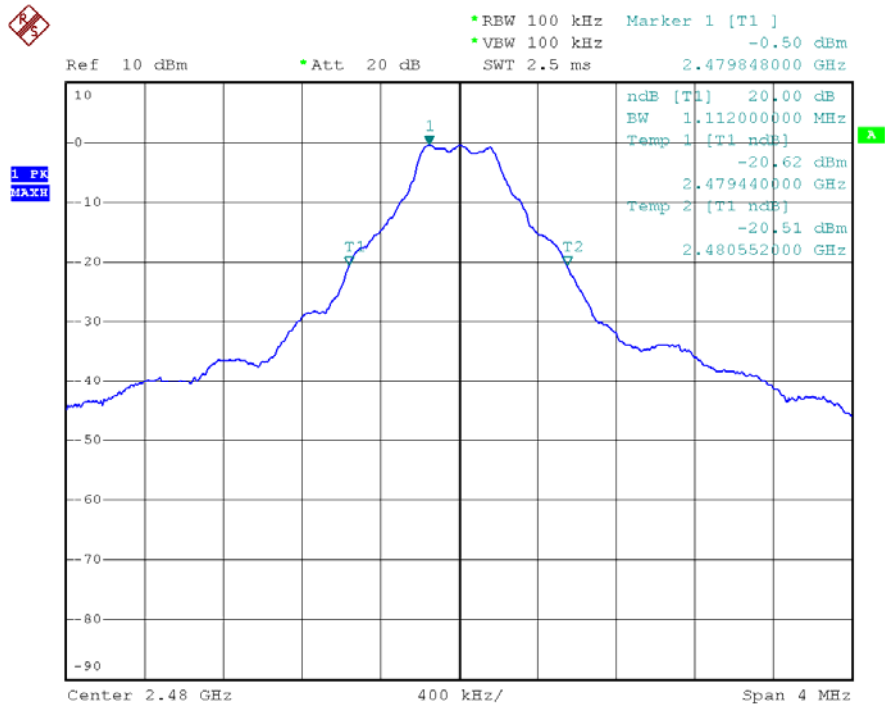

The results shown in this test report refer only to the sample(s) tested , This Test report cannot be reproduced, except in full, without prior written permission of the Company.

10 Maximum Peak Output Power

Test Requirement:	FCC CFR47 Part 15 Section 15.247
Test Method:	Based on ANSI C63.4:2003
Test Limit:	Regulation 15.247 (b)(1)For frequency hopping systems operating in the 2400-2483.5 MHz band employing at least 75 non-overlapping hopping channels, and all frequency hopping systems in the 5725-5850 MHz band: 1 watt. For all other frequency hopping systems in the 2400-2483.5 MHz band: 0.125 watts. Refer to the result “Number of Hopping Frequency” of this document. The 1 watts (30 dBm) limit applies.
Test mode:	Test in fixing frequency transmitting mode.

10.1 Test Procedure:

1. Remove the antenna from the EUT and then connect a low RF cable from the antenna port to the spectrum.
2. Set the spectrum analyzer: RBW = 3 MHz. VBW = 10 MHz. Sweep = auto; Detector Function = Peak.
3. Keep the EUT in transmitting at lowest, medium and highest channel individually. Record the max value.

10.2 Test Result:

Test Channel	Output Power (dBm)	Limit (dBm)
Low	0.26	30
Middle	0.22	30
High	-0.06	30

11 Hopping Channel Separation

Test Requirement:	FCC CFR47 Part 15 Section 15.247
Test Method:	Based on DA 00-705
Test Limit:	Regulation 15.247(a)(1) Frequency hopping systems shall have hopping channel carrier frequencies separated by a minimum of 25 kHz or the 20 dB bandwidth of the hopping channel, whichever is greater. Alternatively, frequency hopping systems operating in the 2400-2483.5 MHz band may have hopping channel carrier frequencies that are separated by 25 kHz or two-thirds of the 20 dB bandwidth of the hopping channel, whichever is greater, provided the systems operate with an output power no greater than 125 mW.
Test Mode:	Test in hopping transmitting operating mode.

11.1 Test Procedure:

1. Remove the antenna from the EUT and then connect a low RF cable from the antenna port to the spectrum.
2. Set the spectrum analyzer: RBW = 30kHz. VBW = 100kHz , Span = 2MHz. Sweep = auto; Detector Function = Peak. Trace = Max hold.
3. Allow the trace to stabilize. Use the marker-delta function to determine the separation between the peaks of the adjacent channels. The limit is specified in one of the subparagraphs of this Section Submit this plot.

11.2 Test Result:

Test Channel	Separation (MHz)	Result
Low	1.000	PASS
Middle	1.000	PASS
High	1.004	PASS

Test result plot as follows:

Low Channel:

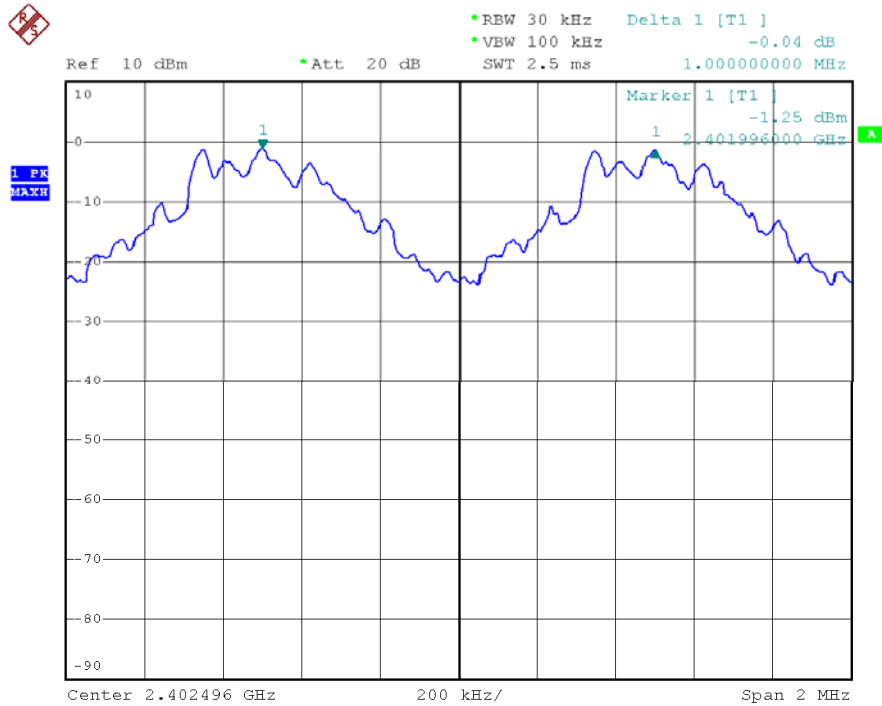

Middle Channel

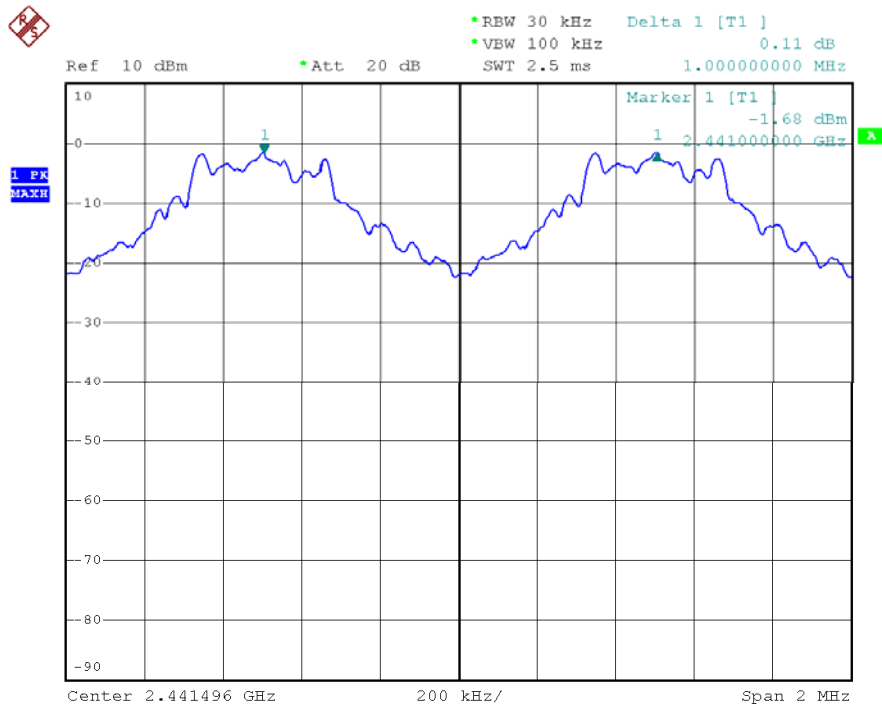

The results shown in this test report refer only to the sample(s) tested , This Test report cannot be reproduced, except in full, without prior written permission of the Company.

High Channel

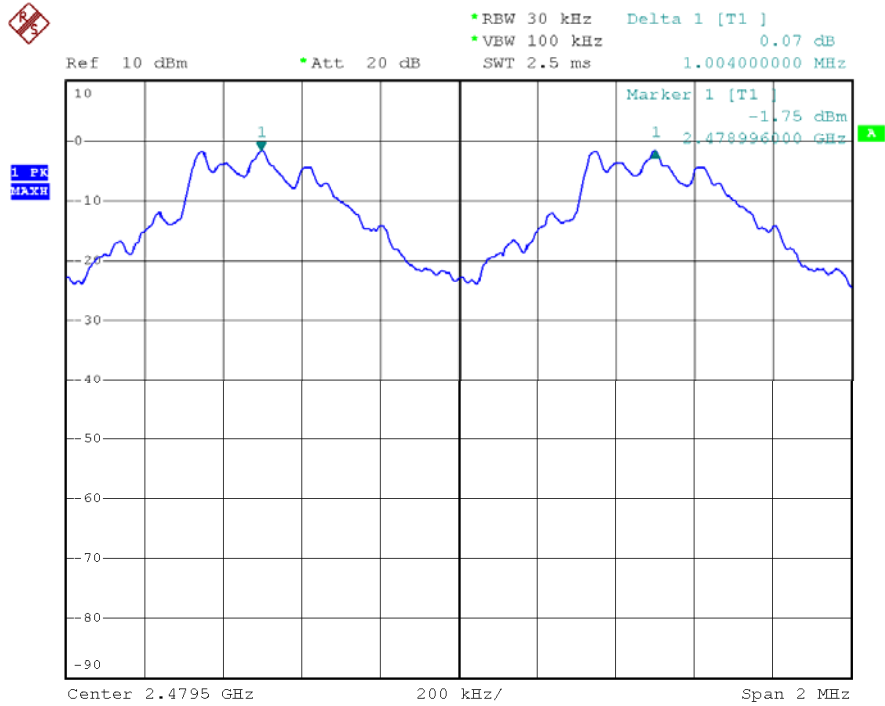

The results shown in this test report refer only to the sample(s) tested , This Test report cannot be reproduced, except in full, without prior written permission of the Company.

12 Number of Hopping Frequency

Test Requirement:	FCC CFR47 Part 15 Section 15.247
Test Method:	Based on DA 00-705
Test Limit:	Regulation 15.247 (a)(1)(iii) Frequency hopping systems in the 2400-2483.5 MHz band shall use at least 15 channels.
Test Mode:	Test in hopping transmitting operating mode.

12.1 Test Procedure:

1. Remove the antenna from the EUT and then connect a low RF cable from the antenna port to the spectrum.
2. Set the spectrum analyzer: RBW = 100 kHz. VBW = 100 kHz. Sweep = auto; Detector Function = Peak. Trace = Max hold.
3. Allow the trace to stabilize. It may prove necessary to break the span up to sections. in order to clearly show all of the hopping frequencies. The limit is specified in one of the subparagraphs of this Section.
4. Set the spectrum analyzer: Center Frequency = 2441MHz, Span = 86MHz. Submit the test result graph.

12.2 Test Result:

Total Channels are 79 Channels

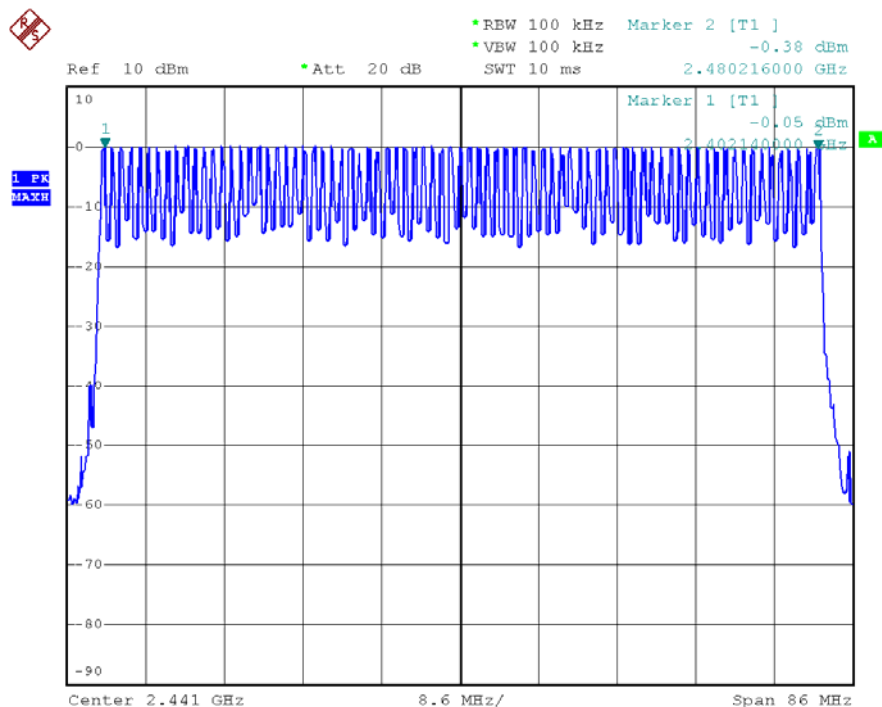

The results shown in this test report refer only to the sample(s) tested , This Test report cannot be reproduced, except in full, without prior written permission of the Company.

13 Dwell Time

Test Requirement:	FCC CFR47 Part 15 Section 15.247
Test Method:	Based on DA 00-705
Test Limit:	Regulation 15.247(a)(1)(iii) Frequency hopping systems in the 2400-2483.5 MHz band shall use at least 15 channels. The average time of occupancy on any channel shall not be greater than 0.4 seconds within a period of 0.4 seconds multiplied by the number of hopping channels employed.
Test Mode:	Test in hopping transmitting operating mode.

13.1 Test Procedure:

- 1.Remove the antenna from the EUT and then connect a low RF cable from the antenna port to the spectrum.
- 2.Set spectrum analyzer span = 0. centered on a hopping channel;
- 3.Set RBW = 1MHz and VBW = 1MHz.Sweep = as necessary to capture the entire dwell time per hopping channel.
- 4.Use the marker-delta function to determine the dwell time. If this value varies with different modes of operation (e.g.. data rate. modulation format. etc.). repeat this test for each variation. The limit is specified in one of the subparagraphs of this Section. Submit this plot(s).

13.2 Test Result:

Dwell time = Pulse wide x (Hopping rate / Number of channels) x Period

The test period: $T = 0.4(s) * 79 = 31.6 (s)$

DH5 Packet permit maximum $1600 / 79 / 6$ hops per second in each channel (5 time slots RX, 1 time slot TX).

DH3 Packet permit maximum $1600 / 79 / 4$ hops per second in each channel (3 time slots RX, 1 time slot TX).

DH1 Packet permit maximum $1600 / 79 / 2$ hops per second in each channel (1 time slot RX, 1 time slot TX). So,the Dwell Time can be calculated as follows:

Data Packet	Dwell Time(s)
DH5	$1600/79/6*31.6*(MkrDelta)/1000$
DH3	$1600/79/4*31.6*(MkrDelta)/1000$
DH1	$1600/79/2*31.6*(MkrDelta)/1000$

Note : Mkr Delta is once pulse time .

Low Channel: 2402MHz

Dwell time of each occupation in this channel as follows:

Data Packet	Frequency	Mkr Delta(ms)	Dwell Time(s)	Limits(s)	Result
DH5	2402 MHz	2.942	0.314	0.400	Pass
DH3	2402 MHz	1.686	0.270	0.400	Pass
DH1	2402 MHz	0.414	0.132	0.400	Pass

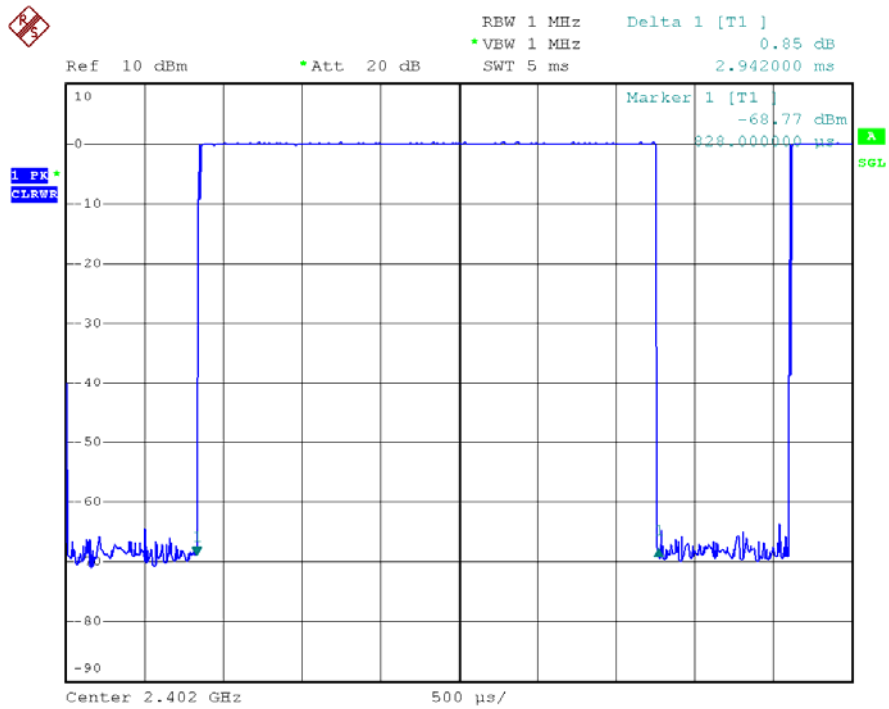

(DH5)

The results shown in this test report refer only to the sample(s) tested , This Test report cannot be reproduced, except in full, without prior written permission of the Company.

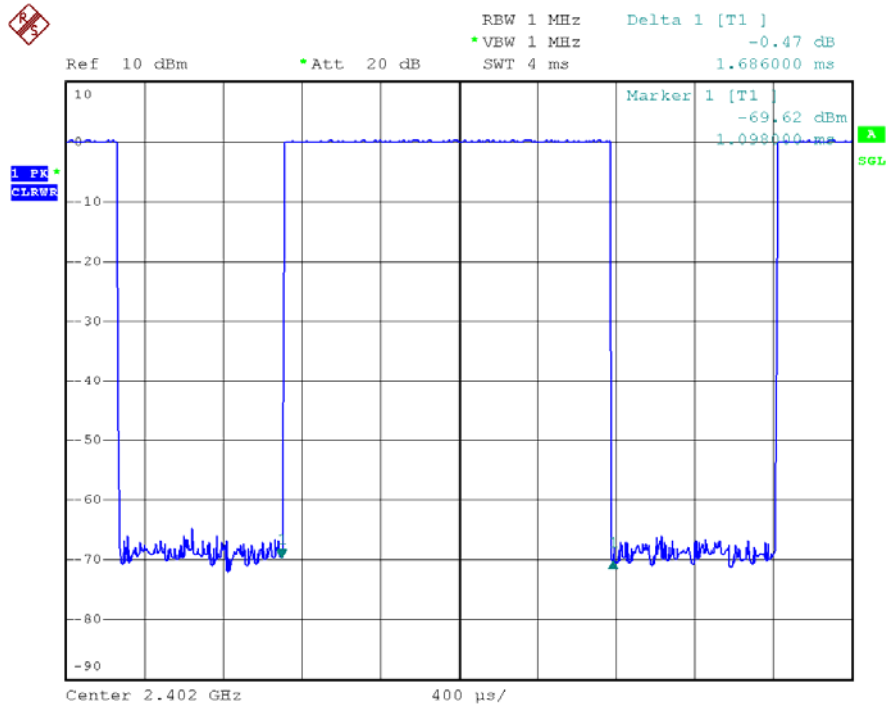

(DH3)

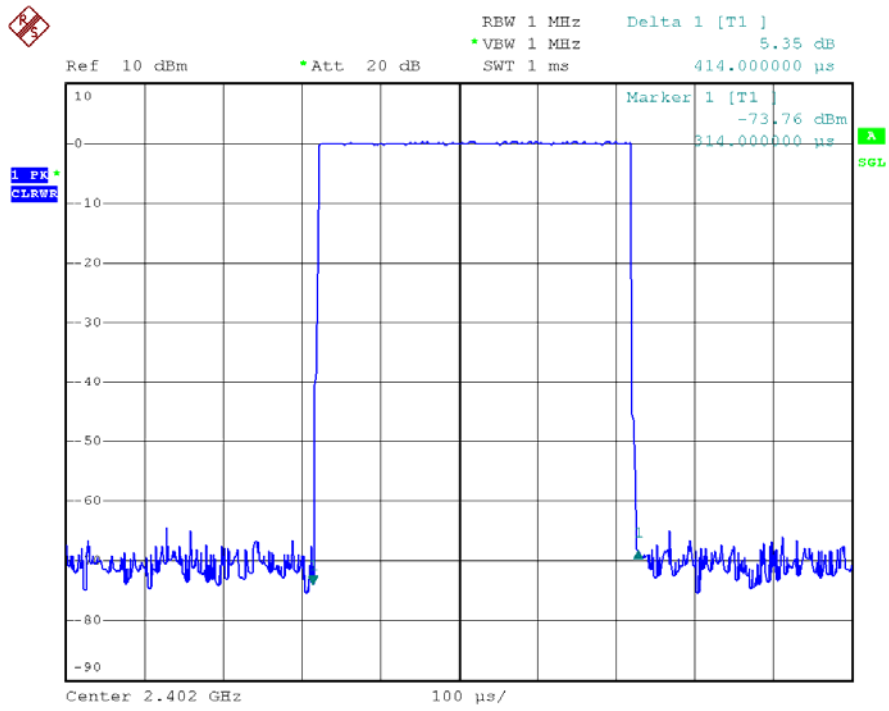

(DH1)

The results shown in this test report refer only to the sample(s) tested , This Test report cannot be reproduced, except in full, without prior written permission of the Company.

Middle Channel: 2441MHz

Dwell time of each occupation in this channel as follows:

Data Packet	Frequency	Mkr Delta(ms)	Dwell Time(s)	Limits(s)	Result
DH5	2441 MHz	2.936	0.313	0.400	Pass
DH3	2441 MHz	1.690	0.270	0.400	Pass
DH1	2441 MHz	0.422	0.135	0.400	Pass

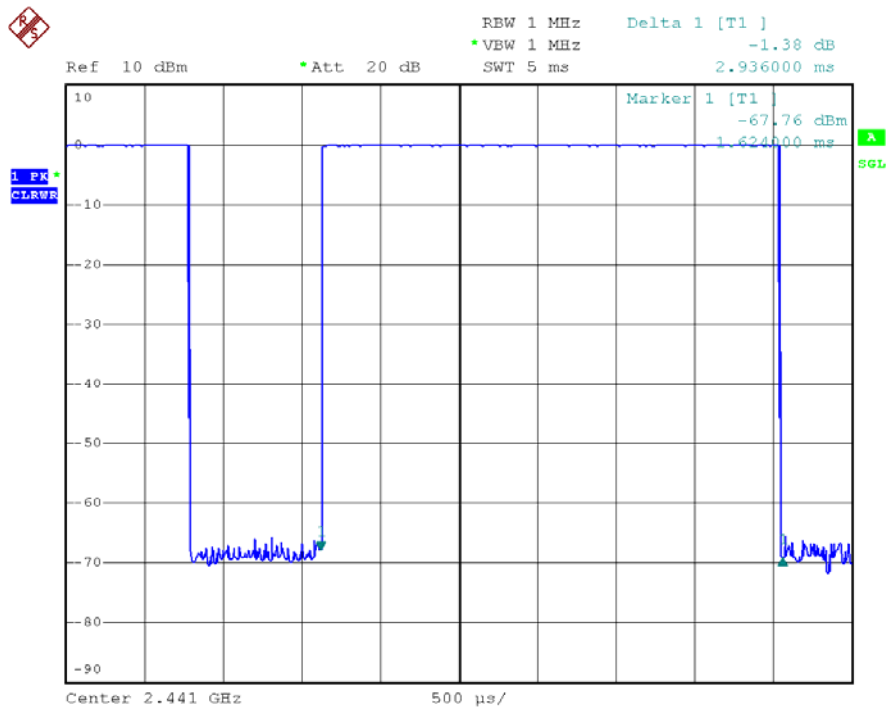

(DH5)

The results shown in this test report refer only to the sample(s) tested , This Test report cannot be reproduced, except in full, without prior written permission of the Company.

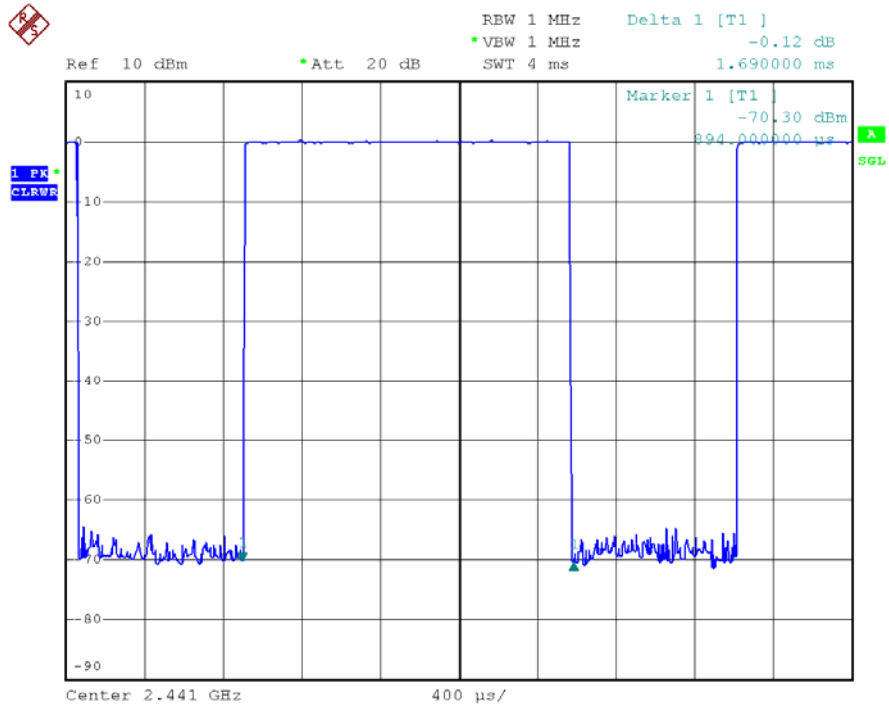

(DH3)

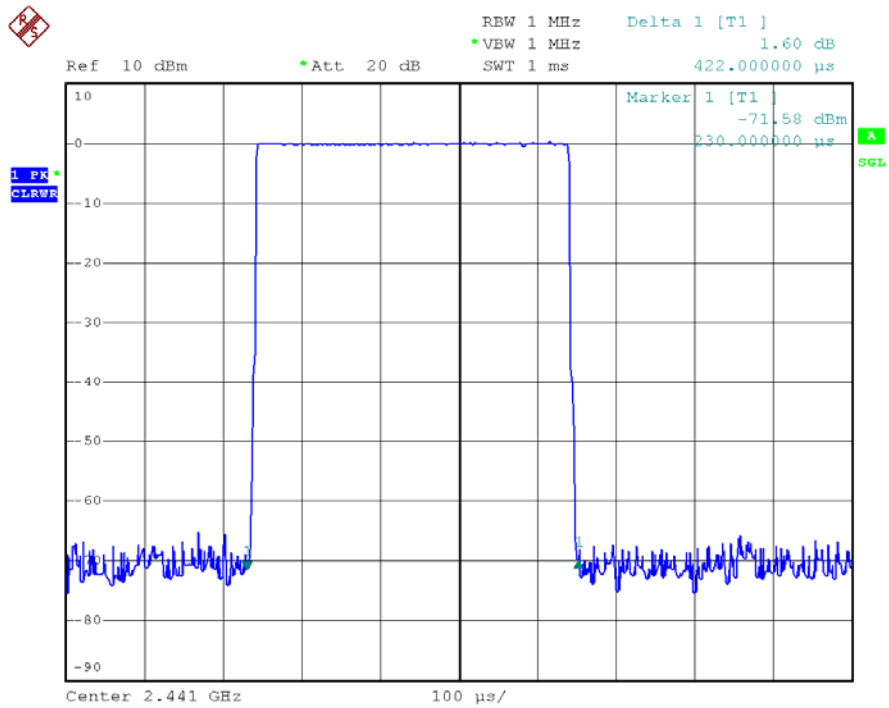

(DH1)

The results shown in this test report refer only to the sample(s) tested , This Test report cannot be reproduced, except in full, without prior written permission of the Company.

High Channel: 2480MHz

Dwell time of each occupation in this channel as follows:

Data Packet	Frequency	Mkr Delta(ms)	Dwell Time(s)	Limits(s)	Result
DH5	2480 MHz	2.954	0.315	DH5	Pass
DH3	2480 MHz	1.716	0.275	DH3	Pass
DH1	2480 MHz	0.418	0.134	DH1	Pass

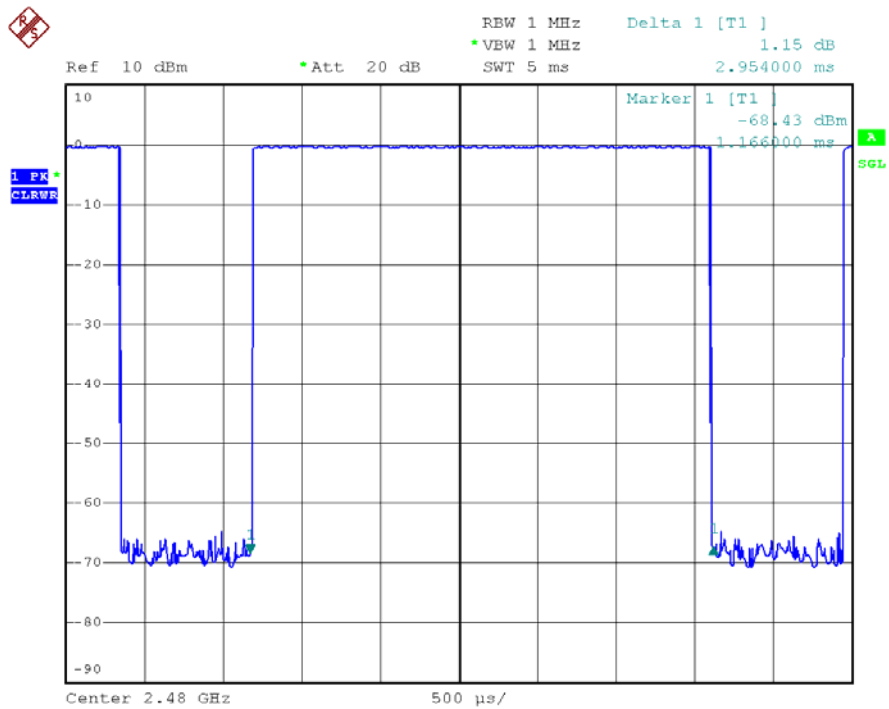

(DH5)

The results shown in this test report refer only to the sample(s) tested , This Test report cannot be reproduced, except in full, without prior written permission of the Company.

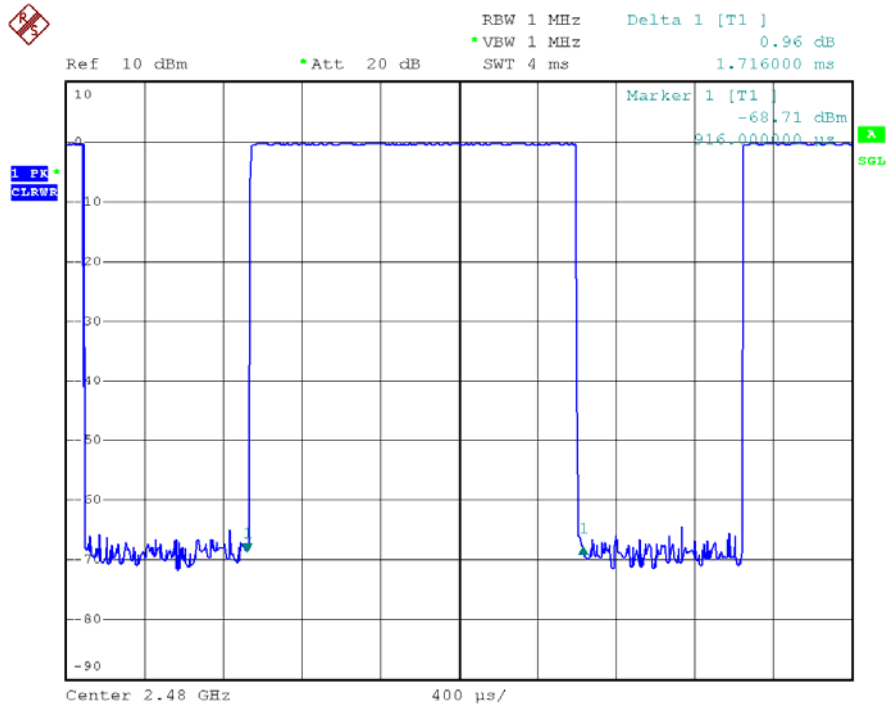

(DH3)

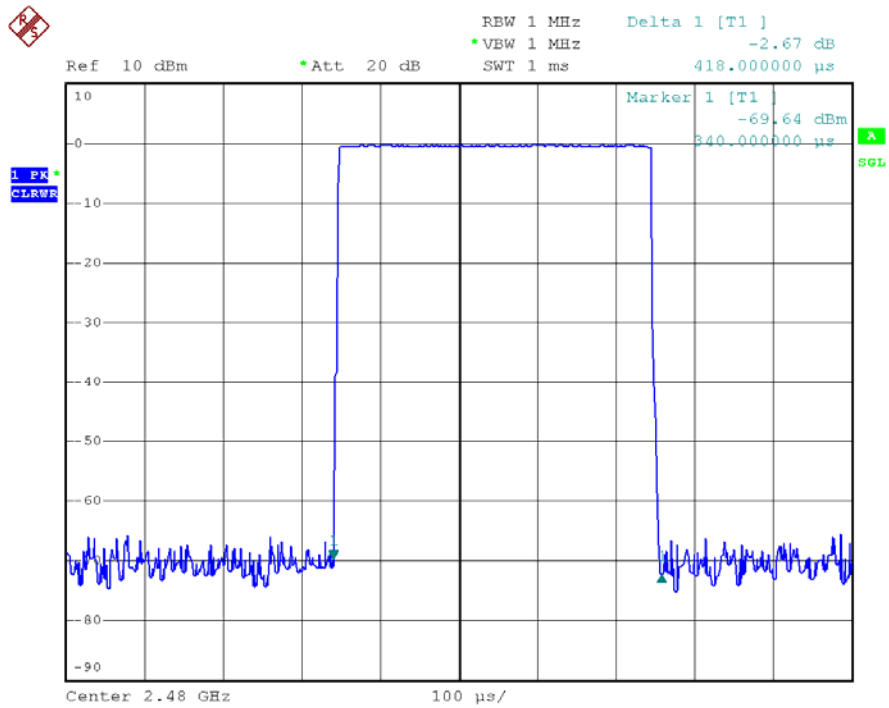

(DH1)

The results shown in this test report refer only to the sample(s) tested , This Test report cannot be reproduced, except in full, without prior written permission of the Company.

14 Antenna Requirement

According to the FCC Part 15 Paragraph 15.203, an intentional radiator shall be designed to ensure that no antenna other than that furnished by the responsible party shall be used with the device. The use of a permanently attached antenna or of an antenna that uses a unique coupling to the intentional radiator shall be considered sufficient to comply with the provisions of this section. This product has a permanent PCB antenna, fulfill the requirement of this section.

15 RF Exposure

15.1 Requirments:

According to §1.1307(b)(1), systems operating under the provisions of this section shall be operated in a manner that ensure that the public is not exposed to radio frequency energy level in excess of the Commission's guideline.

This is a portable device.

15.2 Measurement Result:

Antenna Gain (dBi)	Antenna Gain (numeric)	Conducted Power (dBm)	Conducted Power (mW)	Radiated Power (e.i.r.p) (mW)
0	1	0.26	1.062	1.062
0	1	0.22	1.052	1.052
0	1	-0.06	0.986	0.986

The EUT works on the 2.4G ISM band, and the max output power (conducted) of which is 1.062 mW lower than low threshold 60/f (GHz) mW (24.48mW), d < 2.5cm in general population category.

The SAR evaluation is not required.

16 Photographs - Constructional Details

16.1 EUT – Appearance View



The results shown in this test report refer only to the sample(s) tested , This Test report cannot be reproduced, except in full, without prior written permission of the Company.

WALTEK SERVICES

Reference No.: WT12063820-D-S-F



16.2 EUT- Open View

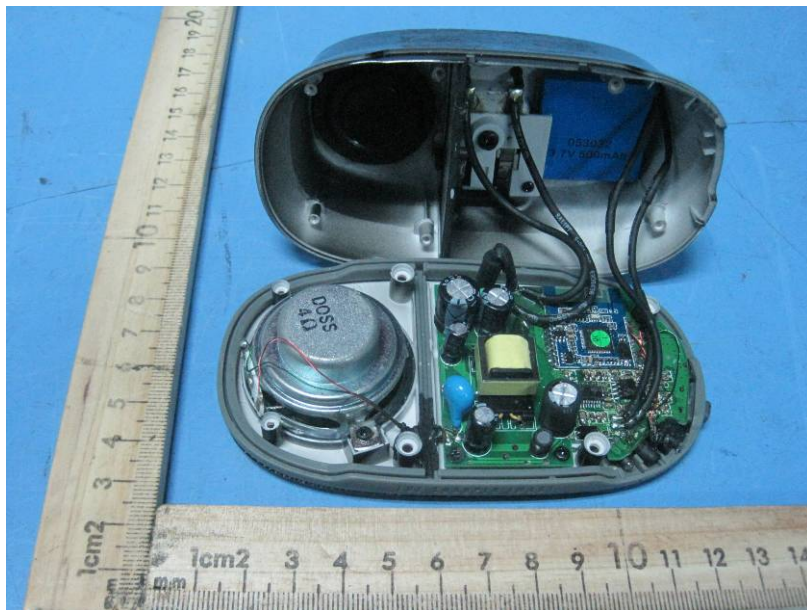

The results shown in this test report refer only to the sample(s) tested , This Test report cannot be reproduced, except in full, without prior written permission of the Company.

16.3 EUT – PCB View

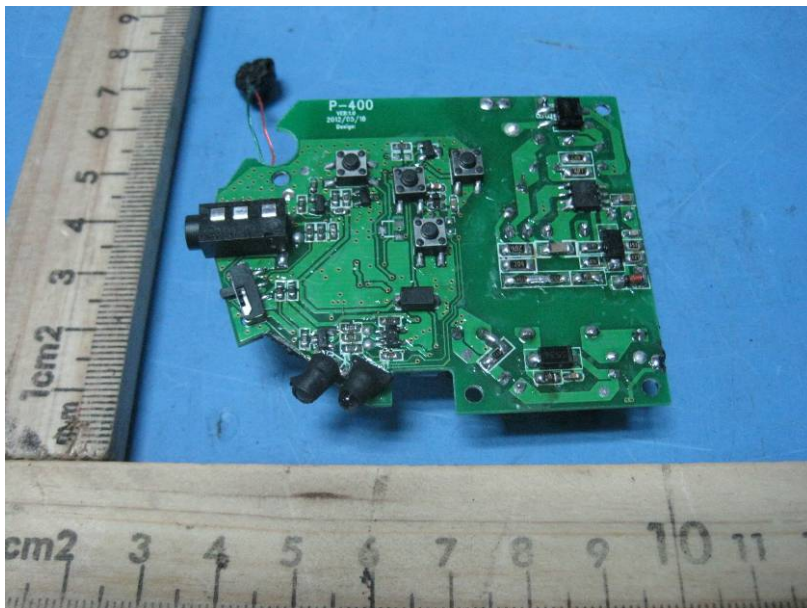
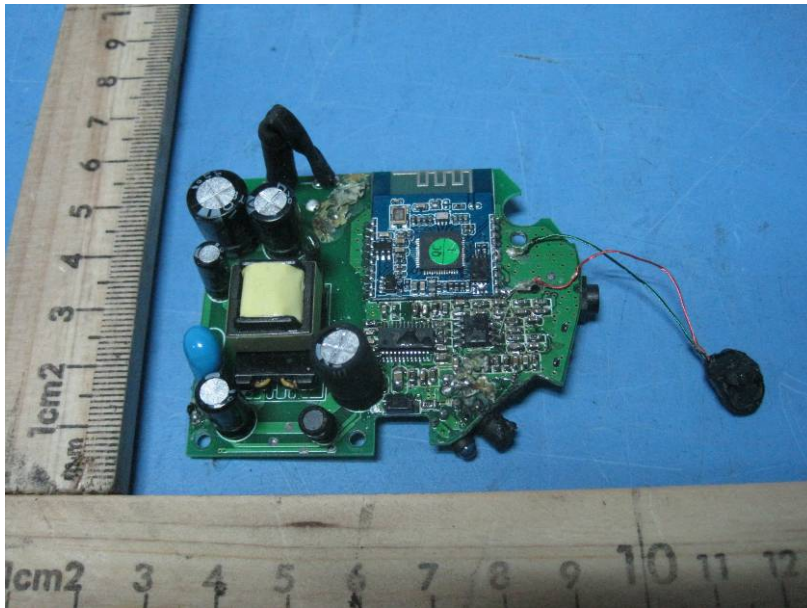

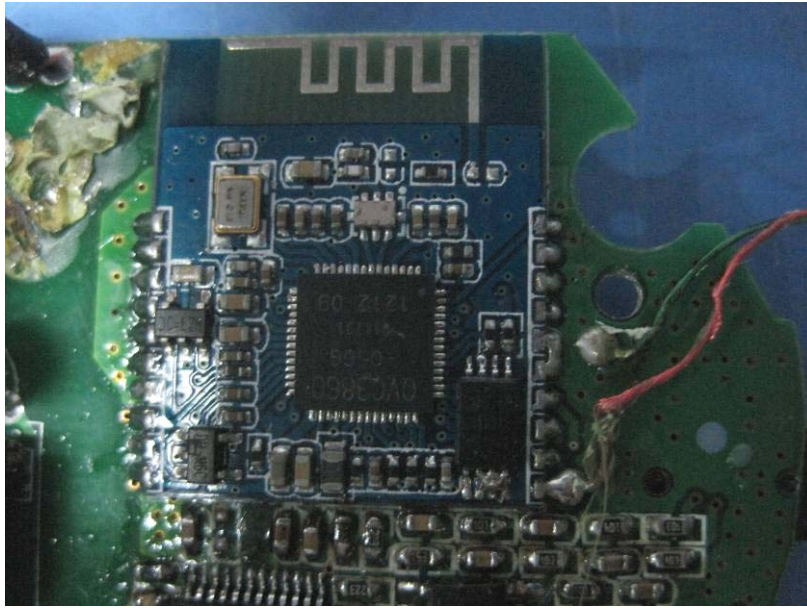

The results shown in this test report refer only to the sample(s) tested , This Test report cannot be reproduced, except in full, without prior written permission of the Company.

WALTEK SERVICES

Reference No.: WT12063820-D-S-F

17 FCC Label

This device complies with Part 15 of the FCC Rules. Operation is subject to the following two conditions:(1)this device may not cause harmful interference,and (2) this device must accept any interference received, including interference that may cause undesired operation.

The Label must not be a stick-on paper. The Label on these products must be permanently affixed to the product and readily visible at the time of purchase and must last the expected lifetime of the equipment not be readily detachable.

Proposed Label Location on EUT
EUT Top View/ proposed FCC Label Location

