



# FCC 47 CFR PART 15 SUBPART C

## TEST REPORT

*For*

**Applicant:** Wonders Technology Co., Ltd.

**Address:** DOSS Industrial Zone, Qiping Kengdu Industrial Area Guihua Village, Guanlan Town Baoan District, Shenzhen, China

**Product Name:** Bluetooth Speaker

**Model Name:** DS-1176, SP-58030

**Brand Name:** N/A

**FCC ID:** WC2DS-1176

**Report No.:** MTE/CLY/T13010002

**Date of Issue:** Jan. 07, 2013

**Issued by:** Most Technology Service Co., Ltd.

**Address :** No.5, Langshan 2nd Road, North District, Hi-tech Industrial Park, Nanshan, Shenzhen, Guangdong, China

**Tel :** 86-755-8617 0306

**Fax :** 86-755-8617 0310

*The report consists 42 pages in total. It may be duplicated completely for legal use with the approval of the applicant. It should not be reproduced except in full, without the written approval of our laboratory. The client should not use it to claim product endorsement by MOST. The test results in the report only apply to the tested sample. The test report shall be invalid without all the signatures of testing engineers, reviewer and approver.*

**TABLE OF CONTENTS**

4. VERIFICATION OF CONFORMITY ..... 4

2. GENERAL INFORMATION..... 5

2.1 Product Information ..... 5

2.2 Objective ..... 6

2.3 Test Standards and Results ..... 6

2.4 Environmental Conditions..... 6

2.5 MEASUREMENT UNCERTAINTY ..... 6

3. TEST FACILITY ..... 7

3.1 TEST FACILITY ..... 7

3.2 Test Conditions ..... 7

3.3 Channel List ..... 8

3.4 Description of Test Modes ..... 8

3.5 Table of Parameters of Text Software Setting..... 9

3.6 FCC PART 15.205 RESTRICTED BANDS OF OPERATIONS..... 10

4. SETUP OF EQUIPMENT UNDER TEST..... 11

4.1 SUPPORT EQUIPMENT ..... 11

4.2 TEST EQUIPMENT LIST..... 12

5. 47 CFR Part 15C 15.249 Requirements..... 13

5.1 Spurious Emission Test ..... 13

5.1.1 Requirement..... 13

5.1.2 Test Description..... 14

5.1.3 Test Description..... 15

5.1.4 Test Result ..... 16

5.2 Band Edge..... 28

5.2.1 Requirement..... 28

5.2.2 Test Description..... 28

5.2.3 Test Result..... 28

5.3 LINE CONDUCTED EMISSION TEST ..... 33

5.3.1. LIMITS OF LINE CONDUCTED EMISSION TEST..... 33

5.3.2. BLOCK DIAGRAM OF TEST SETUP..... 33

5.3.3. PRELIMINARY PROCEDURE OF LINE CONDUCTED EMISSION TEST ..... 34

5.3.4. FINAL PROCEDURE OF LINE CONDUCTED EMISSION TEST ..... 34

5.3.5. Test result ..... 34

5.3.5. TEST RESULT OF LINE CONDUCTED EMISSION TEST ..... 34

5.4 20 dB Bandwidth ..... 37

5.4.1 Definition ..... 37

5.4.2 Block Diagram Of Test Setup ..... 37

5.4.3 Test Result..... 37

APPENDIX 1 ..... 43

PHOTOGRAPHS OF TEST SETUP..... 43

4. VERIFICATION OF CONFORMITY

**Equipment Under Test:** Bluetooth Speaker  
**Brand Name:** N/A  
**Model Number:** DS-1176,  
**Series Number:** SP-58030  
**Description of Differences:** DS-1176 and SP-58030 are the same in all respects, there is only difference in model name.  
**FCC ID:** WC2DS-1176  
**Applicant:** Wonders Technology Co., Ltd.  
 DOSS Industrial Zone, Qiping Kengdu Industrial Area Guihua Village,  
 Guanlan Town Baoan District, Shenzhen, China  
**Manufacturer:** Wonders Technology Co., Ltd.  
 DOSS Industrial Zone, Qiping Kengdu Industrial Area Guihua Village,  
 Guanlan Town Baoan District, Shenzhen, China  
**Technical Standards:** 47 CFR Part 15 Subpart C  
**File Number:** MTE/CLY/T13010002  
**Date of test:** Jan. 04, 2013  
**Deviation:** None  
**Condition of Test Sample:** Normal  
**Test Result:** PASS

The above equipment was tested by MOST for compliance with the requirements set forth in FCC rules and the Technical Standards mentioned above. This said equipment in the configuration described in this report shows the maximum emission levels emanating from equipment and the level of the immunity endurance of the equipment are within the compliance requirements.

The test results of this report relate only to the tested sample identified in this report.

Prepare by (+ signature):  \_\_\_\_\_

Carol Yin Jan. 05, 2013

Review by (+ signature):  \_\_\_\_\_

Elva Wong Jan.06, 2013

Approved by (+ signature):  \_\_\_\_\_

Yvette Zhou(Manager) Jan. 07. 2013



## 2. GENERAL INFORMATION

### 2.1 Product Information

<b>Product:</b>	Bluetooth Speaker
<b>Trade Name:</b>	N/A
<b>Model Number:</b>	DS-1176
<b>Series Number:</b>	SP-58030
<b>Description of Differences:</b>	DS-1176 and SP-58030 are same in all respects, there is only difference in model name.
<b>Power Supply:</b>	DC 5V by USB Port Input AC 120V/60Hz
<b>Frequency Range:</b>	2402MHz -2480MHz
<b>Modulation Type:</b>	GFSK, $\pi/4$ -DQPSK, 8-DPSK
<b>Modulation Technique:</b>	FHSS
<b>Antenna Type:</b>	Internal Fixed
<b>Antenna Gain:</b>	4.0dBi
<b>Channel Spacing:</b>	1MHz
<b>Channel Number:</b>	79
<b>Temperature Range:</b>	-40°C ~ +80°C

**NOTE:**

1. For a more detailed features description about the EUT, please refer to User's Manual.
2. USB Port only has charging function without data transmission.

**2.2 Objective**

Perform FCC Part 15 Subpart C tests for FCC Marking.

**2.3 Test Standards and Results**

Test items and the results are as bellow:

No.	Section	Description	Result	Date of Test
1	15.249(a)	Spurious Emission	PASS	2013-01-04
2	15.249(a)	Band Edge	PASS	2013-01-04
3	15.207	Power Line Conducted Emission Test	PASS	2013-01-04
4	15.249	20Db Bandwidth	PASS	2013-01-04

Note: 1. The test result judgment is decided by the limit of measurement standard  
 2. The information of measurement uncertainty is available upon the customer’s request.

**2.4 Environmental Conditions**

During the measurement the environmental conditions were within the listed ranges:

- Temperature: 15-35°C
- Humidity: 30-60 %
- Atmospheric pressure: 86-106 kPa

**2.5 MEASUREMENT UNCERTAINTY**

The uncertainty is calculated using the methods suggested in the “Guide to the Expression of Uncertainty in Measurement” (GUM) published by ISO.

The report uncertainty of measurement  $y \pm U$ , where expended uncertainty U is based on a standard uncertainty multiplied by a coverage factor of k=2, Providing a level of confidence of approximately 95%

- Uncertainty of Conducted Emission,  $U_c = \pm 1.8\text{Db}$
- Uncertainty of Radiated Emission,  $U_c = \pm 3.2\text{Db}$

### 3. TEST FACILITY

#### 3.1 TEST FACILITY

Test Site:	Most Technology Service Co., Ltd.
Location:	No.5, Langshan 2 <sup>nd</sup> Rd., North Hi-Tech Industrial park, Nanshan, Shenzhen, Guangdong, China
Description:	<p>There is one 3m semi-anechoic an area test sites and two line conducted labs for final test. The Open Area Test Sites and the Line Conducted labs are constructed and calibrated to meet the FCC requirements in documents ANSI C63.4:2009 and CISPR 16 requirements.</p> <p>The FCC Registration Number is <b>490827</b>.</p> <p>The <b>IC</b> Registration Number is <b>46405-7103</b>.</p> <p>The <b>CNAS</b> Registration Number is <b>CNAS L3573</b>.</p>
Site Filing:	The site description is on file with the Federal Communications Commission, 7435 Oakland Mills Road, Columbia, MD 21046.
Instrument Tolerance:	All measuring equipment is in accord with ANSI C63.4:2009 and CISPR 16 requirements that meet industry regulatory agency and accreditation agency requirement.
Ground Plane:	Two conductive reference ground planes were used during the Line Conducted Emission, one in vertical and the other in horizontal. The dimensions of these ground planes are as below. The vertical ground plane was placed distancing 40 cm to the rear of the wooden test table on where the EUT and the support equipment were placed during test. The horizontal ground plane projected 50 cm beyond the footprint of the EUT system and distanced 80 cm to the wooden test table. For Radiated Emission Test, one horizontal conductive ground plane extended at least 1m beyond the periphery of the EUT and the largest measuring antenna, and covered the entire area between the EUT and the antenna.

#### 3.2 Test Conditions

The EUT has been tested under normal operating (TX) and standby (RX) condition.

The field strength of radiation emission was measured in the following position: EUT stand-up position (Y axis), lie-down position (X, Z axis).

The following data show only with the worst case setup.

The worst case of Y axis was reported.

Based on client request, all normal using modes of the normal function were tested but only the worst test data of the worst mode is reported by this report.

**3.3 Channel List**

Channel List for GFSK Mode					
Channel	Frequency (MHz)	Channel	Frequency (MHz)	Channel	Frequency (MHz)
01	2402MHz	28	2429MHz	55	2456MHz
02	2403MHz	29	2430MHz	56	2457MHz
03	2404MHz	30	2431MHz	57	2458MHz
04	2405MHz	31	2432MHz	58	2459MHz
05	2406MHz	32	2433MHz	59	2460MHz
06	2407MHz	33	2434MHz	60	2461MHz
07	2408MHz	34	2435MHz	61	2462MHz
08	2409MHz	35	2436MHz	62	2463MHz
09	2410MHz	36	2437MHz	63	2464MHz
10	2411MHz	37	2438MHz	64	2465MHz
11	2412MHz	38	2439MHz	65	2466MHz
12	2413MHz	39	2440MHz	66	2467MHz
13	2414MHz	40	2441MHz	67	2468MHz
14	2415MHz	41	2442MHz	68	2469MHz
15	2416MHz	42	2443MHz	69	2470MHz
16	2417MHz	43	2444MHz	70	2471MHz
17	2418MHz	44	2445MHz	71	2472MHz
18	2419MHz	45	2446MHz	72	2473MHz
19	2420MHz	46	2447MHz	73	2474MHz
20	2421MHz	47	2448MHz	74	2475MHz
21	2422MHz	48	2449MHz	75	2476MHz
22	2423MHz	49	2450MHz	76	2477MHz
23	2424MHz	50	2451MHz	77	2478MHz
24	2425MHz	51	2452MHz	78	2479MHz
25	2426MHz	52	2453MHz	79	2480MHz
26	2427MHz	53	2454MHz		
27	2428MHz	54	2455MHz		

**3.4 Description of Test Modes**

To investigate the maximum EMI emission characteristics generates from EUT, the test system was pre-scanning tested base on the consideration of following EUT operation mode or test configuration mode which possible have effect on EMI emission level, Each of these EUT operation mode(s) or test configuration mode(s) mentioned above was evaluated respectively

Pre-test Mode	Description
Mode 1	GFSK CH01/CH40/CH79
Mode 2	Pi/4-DQPSK CH01/CH40/CH79
Mode 3	8-DPSK CH01/CH40/CH79



Note:

The measurements are performed at the highest, middle, lowest available channels.

The measurements are performed at all bit rate of transmitter, the worst data was reported.

**3.5 Table of Parameters of Text Software Setting**

During testing channel & power controlling software provided by the customer was used to control the operating channel as well as the output power level, the RF output power selection is for the setting of RF output power expected by the customer and is going to be fixed on the firmware of the final end product power parameters of Bluetooth.

Test software Version	Test channels		
GFSK Mode	2402MHz	2441MHz	2480MHz
$\pi/4$ -DQPSK	2402MHz	2441MHz	2480MHz
8-DPSK	2402MHz	2441MHz	2480MHz

Conducted Emissions

The EUT is placed on the turntable, which is 0.8 m above ground plane. According to the requirements in Section 13.1.4.1 of ANSI C63.4:2009,Conducted emissions from the EUT measured in the frequency range between 0.15 MHz and 30MHz using CISPR Quasi-peak and average detector modes.

Radiated Emissions

The EUT is placed on a turn table, which is 0.8 m above ground plane. The turntable shall rotate 360 degrees to determine the position of maximum emission level. EUT is set 3m away from the receiving antenna, which varied from 1m to 4m to find out the highest emission. And also, each emission was to be maximized by changing the polarization of receiving antenna both horizontal and vertical. In order to find out the maximum emissions, exploratory radiated emission measurements were made according to the requirements in Section 13.1.4.1 of ANSI C63.4:2009.

**3.6 FCC PART 15.205 RESTRICTED BANDS OF OPERATIONS**

(a) Except as shown in paragraph (d) of this section, only spurious emissions are permitted in any of the frequency bands listed below:

MHz	MHz	MHz	GHz
0.090 – 0.110	16.42 – 16.423	399.9 – 410	4.5 – 5.15
<sup>1</sup> 0.495 – 0.505	16.69475 – 16.69525	608 – 614	5.35 – 5.46
2.1735 – 2.1905	16.80425 – 16.80475	960 – 1240	7.25 – 7.75
4.125 – 4.128	25.5 – 25.67	1300 – 1427	8.025 – 8.5
4.17725 – 4.17775	37.5 – 38.25	1435 – 1626.5	9.0 – 9.2
4.20725 – 4.20775	73 – 74.6	1645.5 – 1646.5	9.3 – 9.5
6.215 – 6.218	74.8 – 75.2	1660 – 1710	10.6 – 12.7
6.26775 – 6.26825	108 – 121.94	1718.8 – 1722.2	13.25 – 13.4
6.31175 – 6.31225	123 – 138	2200 – 2300	14.47 – 14.5
8.291 – 8.294	149.9 – 150.05	2310 – 2390	15.35 – 16.2
8.362 – 8.366	156.52475 – 156.52525	2483.5 – 2500	17.7 – 21.4
8.37625 – 8.38675	156.7 – 156.9	2655 – 2900	22.01 – 23.12
8.41425 – 8.41475	162.0125 – 167.17	3260 – 3267	23.6 – 24.0
12.29 – 12.293	167.72 – 173.2	3332 – 3339	31.2 – 31.8
12.51975 – 12.52025	240 – 285	3345.8 – 3358	36.43 – 36.5
12.57675 – 12.57725	322 – 335.4	3600 – 4400	( <sup>2</sup> )
13.36 – 13.41			

<sup>1</sup> Until February 1, 1999, this restricted band shall be 0.490-0.510 MHz.

<sup>2</sup> Above 38.6

(b) Except as provided in paragraphs (d) and (e), the field strength of emissions appearing within these frequency bands shall not exceed the limits shown in Section 15.209. At frequencies equal to or less than 1000 MHz, compliance with the limits in Section 15.209 shall be demonstrated using measurement instrumentation employing a CISPR quasi-peak detector. Above 1000 MHz, compliance with the emission limits in Section 15.209 shall be demonstrated based on the average value of the measured emissions. The provisions in Section 15.35 apply to these measurements.

#### 4. SETUP OF EQUIPMENT UNDER TEST

##### 4.1 SUPPORT EQUIPMENT

Device Type	Manufacturer	Model Name	Serial No.	Data Cable	Power Cable
iPhone 4S	Apple	A1332	---	30cm	30cm
Notebook	Lenovo	E425	R9-KZL4B	1.6m Un-shielded	1.8m Un-shielded

*Remark:*

*All the equipment/cables were placed in the worst-case configuration to maximize the emission during the test. Grounding was established in accordance with the manufacturer's requirements and conditions for the intended use.*

## 4.2 TEST EQUIPMENT LIST

**Instrumentation:** The following list contains equipment used at Most for testing. The equipment conforms to the CISPR 16-1 / ANSI C63.2 Specifications for Electromagnetic Interference and Field Strength Instrumentation from 10 kHz to 1.0 GHz or above.

No.	Equipment	Manufacturer	Model No.	S/N	Calculator date	Calculator Interval
1	Test Receiver	Rohde & Schwarz	ESCI	100492	2012/03/14	1 Year
2	L.I.S.N.	Rohde & Schwarz	ENV216	100093	2012/03/14	1 Year
3	Coaxial Switch	Anritsu Corp	MP59B	6200283933	2012/03/14	1 Year
4	Terminator	Hubersuhner	50Ω	No.1	2012/03/14	1 Year
5	RF Cable	SchwarzBeck	N/A	No.1	2012/03/14	1 Year
6	Test Receiver	Rohde & Schwarz	ESPI	101202	2012/03/14	1 Year
7	Bilog Antenna	SCHWARZBECK	BBHA9120D	D69250	2012/03/14	1 Year
8	8 Loop Antenna	ARA	PLA-1030/B	1029	2012/02/19	1 Year
9	Cable	Resenberger	N/A	NO.1	2012/03/14	1 Year
10	Cable	SchwarzBeck	N/A	NO.2	2012/03/14	1 Year
11	Cable	SchwarzBeck	N/A	NO.3	2012/03/14	1 Year
12	DC Power Filter	DuoJi	DL2×30B	N/A	2012/03/14	1 Year
13	Single Phase Power Line Filter	DuoJi	FNF 202B30	N/A	2012/03/14	1 Year
14	3 Phase Power Line Filter	DuoJi	FNF 402B30	N/A	2012/03/14	1 Year
15	Test Receiver	Rohde & Schwarz	ESCI	100492	2012/03/14	1 Year
16	Absorbing Clamp	Luthi	MDS21	3635	2012/03/14	1 Year
17	Coaxial Switch	Anritsu Corp	MP59B	6200283933	2012/03/14	1 Year
18	AC Power Source	Kikusui	AC40MA	LM003232	2012/03/14	1 Year
19	Test Analyzer	Kikusui	KHA1000	LM003720	2012/03/14	1 Year
20	Line Impedance Network	Kikusui	LIN40MA-PCR-L	LM002352	2012/03/14	1 Year
21	ESD Tester	Kikusui	KES4021	LM003537	2012/03/14	1 Year
22	EMCPRO System	EM Test	UCS-500-M4	V0648102026	2012/03/14	1 Year
23	Signal Generator	IFR	2032	203002/100	2012/03/14	1 Year
24	Amplifier	A&R	150W1000	301584	2012/03/14	1 Year
25	CDN	FCC	FCC-801-M2-25	47	2012/03/14	1 Year
26	CDN	FCC	FCC-801-M3-25	107	2012/03/14	1 Year
27	EM Injection Clamp	FCC	F-203I-23mm	403	2012/03/14	1 Year
28	RF Cable	MIYAZAKI	N/A	No.1/No.2	2012/03/14	1 Year
29	Universal Radio Communication Tester	ROHDE&SCHWARZ	CMU200	0304789	2012/03/14	1 Year
30	Telecommunication Antenna	European Antennas	PSA 75301R/170	0304213	2012/03/14	1 Year
31	Telecommunication Test Equipment	R&S	CMU200	N/A	2012/03/14	1 Year
32	HORN Antenna	ETS LINDGREN	3117	N/A	2012/02/17	1 Year
33	HORN Antenna	ETS LINDGREN	3160	N/A	2012/02/17	1 Year

**NOTE:** Equipments listed above have been calibrated and are in the period of validation.

## 5. 47 CFR Part 15C 15.249 Requirements

### 5.1 Spurious Emission Test

#### 5.1.1 Requirement

According to FCC section 15.249(a):

Except as provided in paragraph (a) of this section, the field strength of emissions from intentional radiators operated within these frequency bands shall comply with the following:

Fundamental Frequency (MHz)	Field Strength of Fundamental (mV/m)	Field Strength of Harmonics ( $\mu$ V/m)
902-928	50	500
2400-2483.5	50	500
5725-5875	50	500
24000-24250	250	2500

According to FCC section 15.109 (a), except as provided elsewhere in this subpart, the emissions from an intentional radiator shall not exceed the field strength levels specified in the following table:

Frequency (MHz)	Field Strength ( $\mu$ V/m)	Measurement Distance (m)
1.705 – 30.0	30	30
30 – 88	100	3
88 – 216	150	3
216 – 960	200	3
Above 960	500	3

**Remark:** Except as provided in paragraph (g), fundamental emissions from intentional radiators operating under this Section shall not be located in the frequency bands 54-72 MHz, 76-88 MHz, 174-216 MHz or 470-806 MHz. However, operation within these frequency bands is permitted under other sections of this Part, e.g., Sections 15.231 and 15.241.

In the above emission table, the tighter limit applies at the band edges.

Frequency (MHz)	Field Strength ( $\mu$ V/m)	Measurement Distance (m)
30 – 88	100	3
88 – 216	150	3
216 – 960	200	3
Above 960	500	3

### 5.1.2 Test Description

#### Test Setup:

#### From 9KHz to 30MHz:

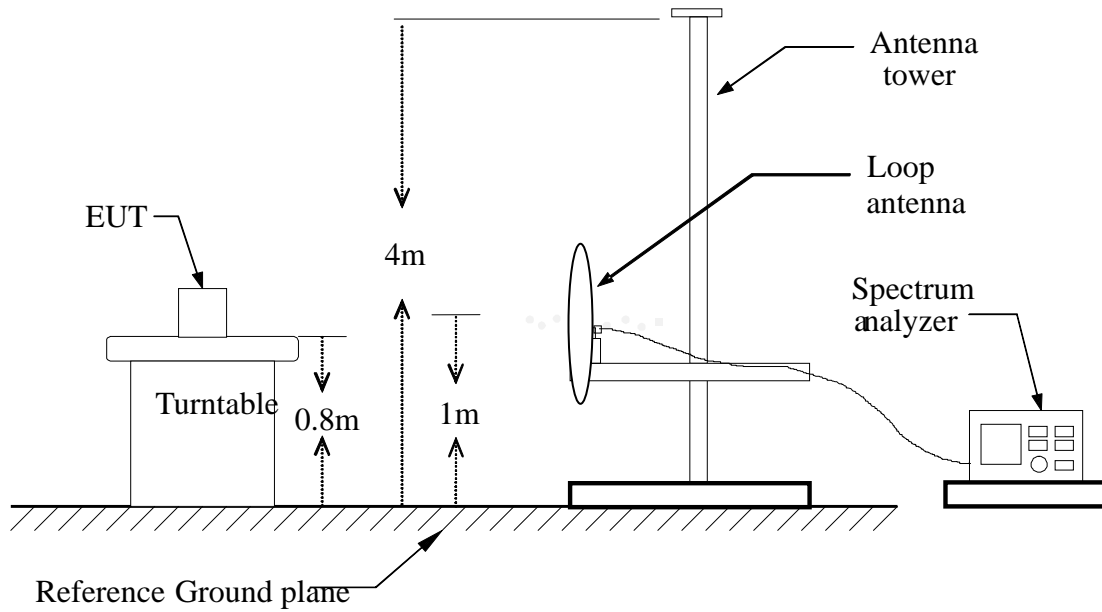

#### From 30MHz to 1GHz:

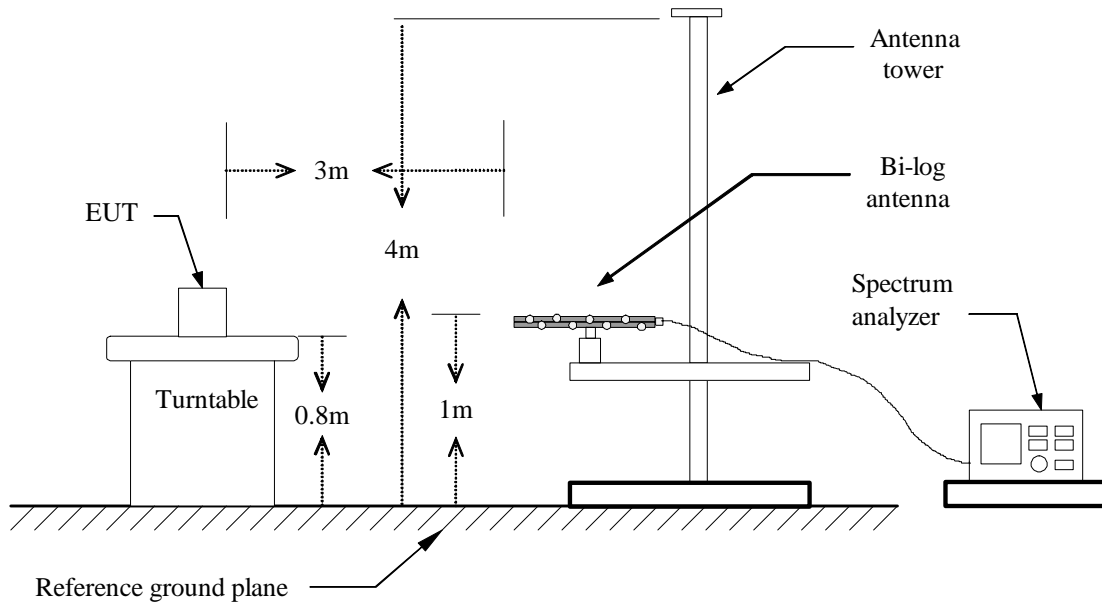

**Above 1GHz:**

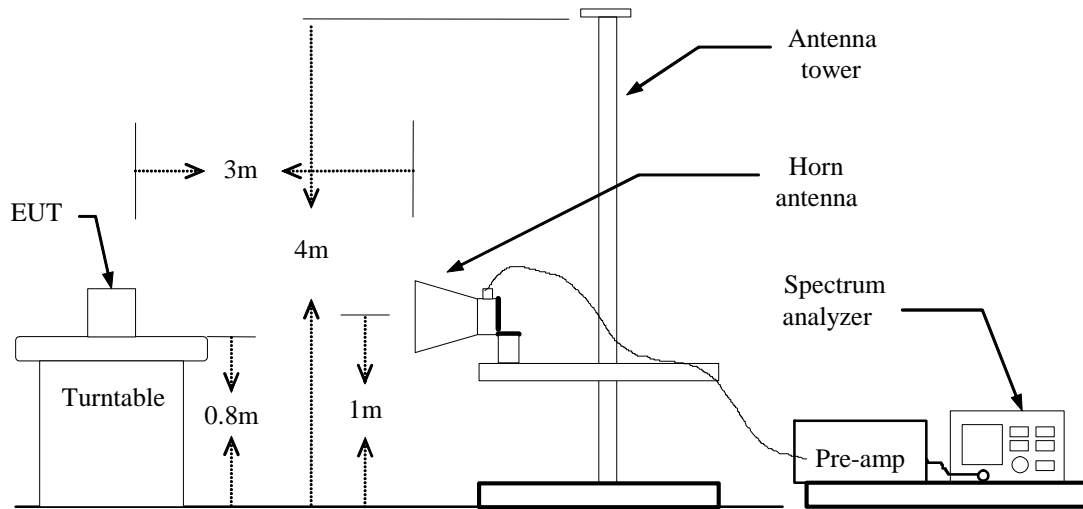

**5.1.3 Test Description**

1. The EUT is placed on a turntable, which is 0.8m above ground plane.
2. The turntable shall be rotated for 360 degrees to determine the position of maximum emission level.
3. EUT is set 3m away from the receiving antenna, which is varied from 1m to 4m to find out the highest emissions.
4. Maximum procedure was performed on the six highest emissions to ensure EUT compliance.
5. And also, each emission was to be maximized by changing the polarization of receiving antenna both horizontal and vertical.
6. Set the spectrum analyzer in the following setting as:  
 Below 1GHz: RBW=100 kHz / VBW=300 kHz / Sweep=AUTO  
 Above 1GHz ☹ a) PEAK: RBW=VBW=1MHz / Sweep=AUTO  
 AVERAGE: RBW=1MHz / VBW=10Hz / Sweep=AUTO
7. Repeat above procedures until the measurements for all frequencies are complete.

**5.1.4 Test Result**

**From 9 KHz to 30MHz:**

Freq. (MHz)	Ant. Pol H/V	Peak Reading (dBuV)	AV Reading (dBuV)	Ant. / CL CF (dB)	Actual Fs		Peak Limit (dBuV/m)	AV Limit (dBuV/m)	AV Margin (dB)
					Peak (dBuV/m)	AV (dBuV/m)			
N/A	H								>20
N/A	V								>20

**-Note: No test data was detected in below 30MHz.**

**From 30MHz to 1GHz:**

The following test mode(s) were scanned during the preliminary test:

Preliminary Radiated Emission Test				
Frequency Range Investigated		9KHz TO 26 GHz		
Mode of operation	Date	Report No.	Data#	Worst Mode
Bluetooth Mode	2013-01-04	MTE/CLY/T13010002	DS-1176_1_(V, H)	<input checked="" type="checkbox"/>
AUX IN Playing	2013-01-04	MTE/CLY/T13010002	DS-1176_2_(V, H)	<input type="checkbox"/>

**Note:**

The Bluetooth model was carried out for GFSK modulation types, GFSK Low channel modulation type was the worst case condition, The test data was shown on the summary data page.





Address: No. 5, Langshan 2nd Rd., North Hi-Tech Industrial park  
 Guangdong, China  
 Tel: 0755-86170306 Fax: 0755-86170310

**Radiated Emission Measurement**

File: DS-1176

Data: #1

Date: 2013-1-4

Time: 8:23:16

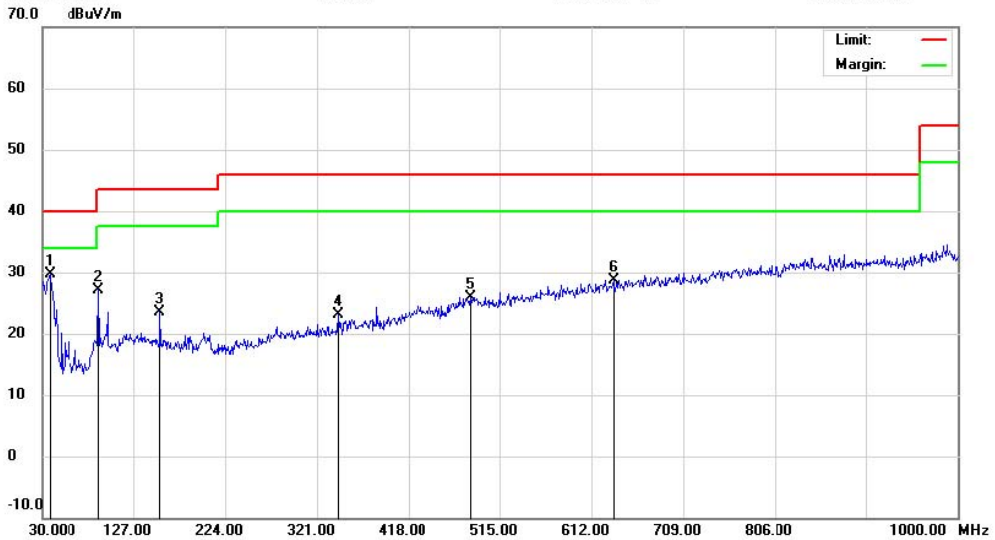

Site: site MOST 3M  
 Limit: FCC Part15 B 3M Radiation  
 EUT: Bluetooth Speaker  
 M/N: DS-1176  
 Mode: BT Mode  
 Note:

Polarization: **Vertical**  
 Power: DC 5V by USB Port  
 Temperature: 26  
 Humidity: 61 %  
 Distance:

No.	Mk.	Freq. MHz	Reading Level dBuV	Correct Factor dB	Measure- ment dBuV/m	Limit dBuV/m	Over dB	Detector	Antenna Height cm	Table Degree	Comment
1	*	37.7599	13.22	16.44	29.66	40.00	-10.34	QP			
2		90.1400	17.60	9.42	27.02	43.50	-16.48	QP			
3		155.1299	9.13	14.30	23.43	43.50	-20.07	QP			
4		343.3100	5.79	17.30	23.09	46.00	-22.91	QP			
5		483.9599	4.21	21.78	25.99	46.00	-20.01	QP			
6		635.2799	4.95	23.81	28.76	46.00	-17.24	QP			

\*:Maximum data    x:Over limit    !:over margin

Engineer Signature:      Allen



Address: No. 5, Langshan 2nd Rd., North Hi-Tech Industrial park  
 Guangdong, China  
 Tel: 0755-86170306 Fax: 0755-86170310

**Radiated Emission Measurement**

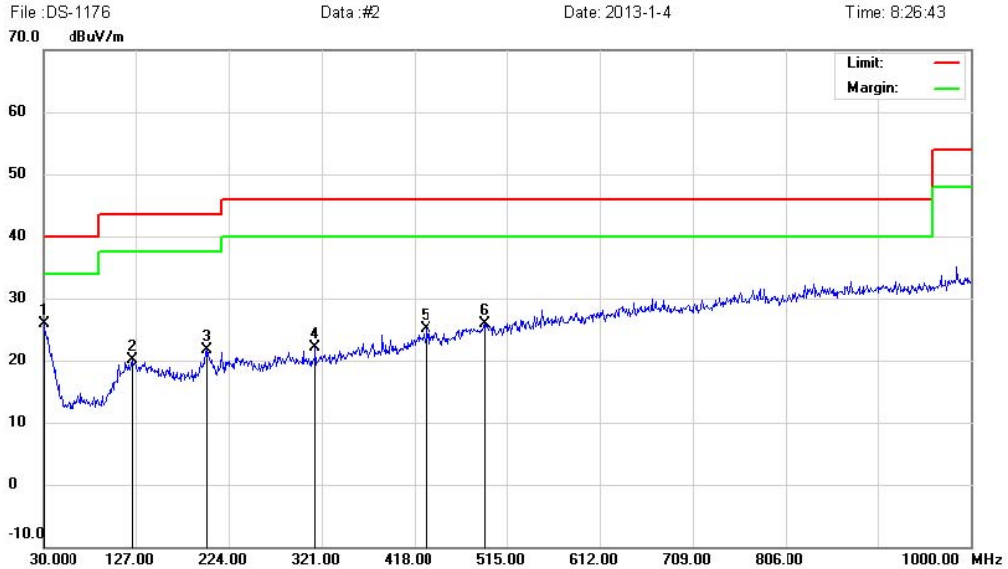

Site: site MOST 3M Polarization: **Horizontal** Temperature: 26  
 Limit: FCC Part15 B 3M Radiation Power: DC 5V by USB Port Humidity: 61 %  
 EUT: Bluetooth Speaker Distance:  
 M/N: DS-1176  
 Mode: BT Mode  
 Note:

No.	Mk.	Freq. MHz	Reading Level dBuV	Correct Factor dB	Measure- ment dBuV/m	Limit dBuV/m	Over dB	Detector	Antenna Height cm	Table Degree	Comment
1	*	30.0000	4.01	21.80	25.81	40.00	-14.19	QP			
2		123.1200	4.43	15.62	20.05	43.50	-23.45	QP			
3		201.6899	7.34	14.32	21.66	43.50	-21.84	QP			
4		314.2099	5.40	16.77	22.17	46.00	-23.83	QP			
5		430.6100	4.76	20.31	25.07	46.00	-20.93	QP			
6		491.7200	4.20	21.63	25.83	46.00	-20.17	QP			

\*:Maximum data x:Over limit l:over margin

Engineer Signature: Allen

**From 30MHz to 1GHz**

**Above 1 GHz**

<b>Operation Mode:</b>	GFSK Mode/CH Low	<b>Test Date:</b>	Jan. 04, 2013
<b>Temperature:</b>	20°C	<b>Tested by:</b>	Sky Guo
<b>Humidity:</b>	70 % RH	<b>Polarity:</b>	Ver. / Hor.

Freq. (MHz)	Ant. Pol H/V	Peak Reading (dBuV)	AV Reading (dBuV)	Ant. / CL CF (dB)	Actual Fs		Peak Limit (dBuV/m)	AV Limit (dBuV/m)	AV Margin (dB)
					Peak (dBuV/m)	AV (dBuV/m)			
2402.00	H	90.13	69.09	16.25	106.38	85.34	114.00	94.00	-8.66
4804.00	H	47.30	25.67	20.18	67.48	45.85	74.00	54.00	-8.15
N/A									>20
2402.00	V	91.25	70.03	16.25	107.50	86.28	114.00	94.00	-7.72
4804.00	V	50.08	29.80	20.18	70.26	49.98	74.00	54.00	-4.02
N/A									>20

**Notes:**

1. Measuring frequencies from 1 GHz to the 10th harmonic of highest fundamental frequency.
2. Measurements above show only up to 6 maximum emissions noted, or would be lesser if no specific emissions from the EUT are recorded (ie: margin>20dB from the applicable limit) and considered that's already beyond the background noise floor.
3. Radiated emissions measured in frequency above 1000MHz were made with an instrument using Peak detector mode and average detector mode of the emission shown in Actual FS column.
4. Spectrum setting:
  - a. Peak Setting 1GHz - 26GHz, RBW = 1MHz, VBW = 1MHz, Sweep time = 200 ms.
  - b. AV Setting 1GHz - 26GHz, RBW = 1MHz, VBW = 10Hz, Sweep time = 200 ms.

**Operation Mode:** GFSK Mode/CH Mid  
**Temperature:** 20°C  
**Humidity:** 70 % RH

**Test Date:** Jan. 04, 2013  
**Tested by:** Sky Guo  
**Polarity:** Ver. / Hor.

Freq. (MHz)	Ant. Pol H/V	Peak Reading (dBuV)	AV Reading (dBuV)	Ant. / CL CF (dB)	Actual Fs		Peak Limit (dBuV/m)	AV Limit (dBuV/m)	AV Margin (dB)
					Peak (dBuV/m)	AV (dBuV/m)			
2441.00	H	89.52	65.01	17.01	106.53	82.02	114.00	94.00	-11.98
4882.00	H	46.84	24.86	21.57	68.41	46.43	74.00	54.00	-7.57
N/A									>20
2441.00	V	88.34	65.28	17.01	105.35	82.29	114.00	94.00	-11.71
4882.00	V	46.19	24.93	21.57	67.76	46.50	74.00	54.00	-7.50
N/A									>20

**Notes:**

1. Measuring frequencies from 1 GHz to the 10th harmonic of highest fundamental frequency.
2. Measurements above show only up to 6 maximum emissions noted, or would be lesser if no specific emissions from the EUT are recorded (ie: margin>20dB from the applicable limit) and considered that's already beyond the background noise floor.
3. Radiated emissions measured in frequency above 1000MHz were made with an instrument using Peak detector mode and average detector mode of the emission shown in Actual FS column.
4. Spectrum setting:
  - a. Peak Setting 1GHz - 26GHz, RBW = 1MHz, VBW = 1MHz, Sweep time = 200 ms.
  - b. AV Setting 1GH z- 26GHz, RBW = 1MHz, VBW = 10Hz, Sweep time = 200 ms.

**Operation Mode:** GFSK Mode/CH High  
**Temperature:** 20°C  
**Humidity:** 70 % RH

**Test Date:** Jan. 04, 2013  
**Tested by:** Sky Guo  
**Polarity:** Ver. / Hor.

Freq. (MHz)	Ant. Pol H/V	Peak Reading (dBuV)	AV Reading (dBuV)	Ant. / CL CF (dB)	Actual Fs		Peak Limit (dBuV/m)	AV Limit (dBuV/m)	AV Margin (dB)
					Peak (dBuV/m)	AV (dBuV/m)			
2480.00	H	87.69	65.02	17.24	104.93	82.26	114.00	94.00	-11.74
4960.00	H	46.11	25.91	22.64	68.75	48.55	74.00	54.00	-5.45
N/A									>20
2480.00	V	87.00	63.41	17.24	104.24	80.65	114.00	94.00	-13.35
4960.00	V	45.16	23.84	22.64	67.80	46.48	74.00	54.00	-7.52
N/A									>20

**Notes:**

1. Measuring frequencies from 1 GHz to the 10th harmonic of highest fundamental frequency.
2. Measurements above show only up to 6 maximum emissions noted, or would be lesser if no specific emissions from the EUT are recorded (ie: margin>20dB from the applicable limit) and considered that's already beyond the background noise floor.
3. Radiated emissions measured in frequency above 1000MHz were made with an instrument using Peak detector mode and average detector mode of the emission shown in Actual FS column.
4. Spectrum setting:
  - a. Peak Setting 1GHz - 26GHz, RBW = 1MHz, VBW = 1MHz, Sweep time = 200 ms.
  - b. AV Setting 1GH z- 26GHz, RBW = 1MHz, VBW = 10Hz, Sweep time = 200 ms.

**Operation Mode:** π / 4-DQPSK/CH Low  
**Temperature:** 20°C  
**Humidity:** 70 % RH

**Test Date:** Jan. 04, 2013  
**Tested by:** Sky Guo  
**Polarity:** Ver. / Hor.

Freq. (MHz)	Ant. Pol H/V	Peak Reading (dBuV)	AV Reading (dBuV)	Ant. / CL CF (dB)	Actual Fs		Peak Limit (dBuV/m)	AV Limit (dBuV/m)	AV Margin (dB)
					Peak (dBuV/m)	AV (dBuV/m)			
2402.00	H	87.32	66.55	16.25	103.57	82.80	114.00	94.00	-11.20
4804.00	H	46.23	24.71	20.18	66.41	44.89	74.00	54.00	-9.11
N/A									>20
2402.00	V	87.23	65.47	16.25	103.48	81.72	114.00	94.00	-12.28
4804.00	V	45.06	24.87	20.18	65.24	45.05	74.00	54.00	-8.95
N/A									>20

**Notes:**

1. Measuring frequencies from 1 GHz to the 10th harmonic of highest fundamental frequency.
2. Measurements above show only up to 6 maximum emissions noted, or would be lesser if no specific emissions from the EUT are recorded (ie: margin>20dB from the applicable limit) and considered that's already beyond the background noise floor.
3. Radiated emissions measured in frequency above 1000MHz were made with an instrument using Peak detector mode and average detector mode of the emission shown in Actual FS column.
4. Spectrum setting:
  - a. Peak Setting 1GHz - 26GHz, RBW = 1MHz, VBW = 1MHz, Sweep time = 200 ms.
  - b. AV Setting 1GHz - 26GHz, RBW = 1MHz, VBW = 10Hz, Sweep time = 200 ms.

**Operation Mode:**  $\pi$  / 4-DQPSK/CH Mid  
**Temperature:** 20°C  
**Humidity:** 70 % RH

**Test Date:** Jan. 04, 2013  
**Tested by:** Sky Guo  
**Polarity:** Ver. / Hor.

Freq. (MHz)	Ant. Pol H/V	Peak Reading (dBuV)	AV Reading (dBuV)	Ant. / CL CF (dB)	Actual Fs		Peak Limit (dBuV/m)	AV Limit (dBuV/m)	AV Margin (dB)
					Peak (dBuV/m)	AV (dBuV/m)			
2441.00	H	85.76	63.34	17.01	102.77	80.35	114.00	94.00	-13.65
4882.00	H	44.25	22.91	21.57	65.82	44.48	74.00	54.00	-9.52
N/A									>20
2441.00	V	85.97	62.58	17.01	102.98	79.59	114.00	94.00	-14.41
4882.00	V	44.86	21.76	21.57	66.43	43.33	74.00	54.00	-10.67
N/A									>20

**Notes:**

1. Measuring frequencies from 1 GHz to the 10th harmonic of highest fundamental frequency.
2. Measurements above show only up to 6 maximum emissions noted, or would be lesser if no specific emissions from the EUT are recorded (ie: margin>20dB from the applicable limit) and considered that's already beyond the background noise floor.
3. Radiated emissions measured in frequency above 1000MHz were made with an instrument using Peak detector mode and average detector mode of the emission shown in Actual FS column.
4. Spectrum setting:
  - a. Peak Setting 1GHz - 26GHz, RBW = 1MHz, VBW = 1MHz, Sweep time = 200 ms.
  - b. AV Setting 1GH z- 26GHz, RBW = 1MHz, VBW = 10Hz, Sweep time = 200 ms.

**Operation Mode:**  $\pi$  / 4-DQPSK Mode /CH High      **Test Date:** Jan. 04, 2013  
**Temperature:** 20°C      **Tested by:** Sky Guo  
**Humidity:** 70 % RH      **Polarity:** Ver. / Hor.

Freq. (MHz)	Ant. Pol H/V	Peak Reading (dBuV)	AV Reading (dBuV)	Ant. / CL CF (dB)	Actual Fs		Peak Limit (dBuV/m)	AV Limit (dBuV/m)	AV Margin (dB)
					Peak (dBuV/m)	AV (dBuV/m)			
2480.00	H	86.04	63.72	17.24	103.28	80.96	114.00	94.00	-13.04
4960.00	H	45.12	23.36	21.57	66.69	44.93	74.00	54.00	-9.07
N/A									>20
2480.00	V	85.84	63.88	17.24	103.08	81.12	114.00	94.00	-12.88
4960.00	V	45.00	22.51	21.57	66.57	44.08	74.00	54.00	-9.92
N/A									>20

**Notes:**

1. Measuring frequencies from 1 GHz to the 10th harmonic of highest fundamental frequency.
2. Measurements above show only up to 6 maximum emissions noted, or would be lesser if no specific emissions from the EUT are recorded (ie: margin>20dB from the applicable limit) and considered that's already beyond the background noise floor.
3. Radiated emissions measured in frequency above 1000MHz were made with an instrument using Peak detector mode and average detector mode of the emission shown in Actual FS column.
4. Spectrum setting:
  - a. Peak Setting 1GHz - 26GHz, RBW = 1MHz, VBW = 1MHz, Sweep time = 200 ms.
  - b. AV Setting 1GH z- 26GHz, RBW = 1MHz, VBW = 10Hz, Sweep time = 200 ms.



**Operation Mode:** 8-DPSK Mode /CH Low      **Test Date:** Jan. 04, 2013  
**Temperature:** 20°C      **Tested by:** Sky Guo  
**Humidity:** 70 % RH      **Polarity:** Ver. / Hor.

Freq. (MHz)	Ant. Pol H/V	Peak Reading (dBuV)	AV Reading (dBuV)	Ant. / CL CF (dB)	Actual Fs		Peak Limit (dBuV/m)	AV Limit (dBuV/m)	AV Margin (dB)
					Peak (dBuV/m)	AV (dBuV/m)			
2402.00	H	85.63	59.96	16.25	101.88	76.21	114.00	94.00	-17.79
4804.00	H	45.16	19.54	20.18	65.34	39.72	74.00	54.00	-14.28
N/A									>20
2402.00	V	85.90	59.28	16.25	102.15	75.53	114.00	94.00	-18.47
4804.00	V	45.24	19.01	20.18	65.42	39.19	74.00	54.00	-14.81
N/A									>20

**Notes:**

1. Measuring frequencies from 1 GHz to the 10th harmonic of highest fundamental frequency.
2. Measurements above show only up to 6 maximum emissions noted, or would be lesser if no specific emissions from the EUT are recorded (ie: margin>20dB from the applicable limit) and considered that's already beyond the background noise floor.
3. Radiated emissions measured in frequency above 1000MHz were made with an instrument using Peak detector mode and average detector mode of the emission shown in Actual FS column.
4. Spectrum setting:
  - a. Peak Setting 1GHz - 26GHz, RBW = 1MHz, VBW = 1MHz, Sweep time = 200 ms.
  - b. AV Setting 1GH z- 26GHz, RBW = 1MHz, VBW = 10Hz, Sweep time = 200 ms.

**Operation Mode:** 8-DPSK Mode /CH Mid  
**Temperature:** 20°C  
**Humidity:** 70 % RH

**Test Date:** Jan. 04, 2013  
**Tested by:** Sky Guo  
**Polarity:** Ver. / Hor.

Freq. (MHz)	Ant. Pol H/V	Peak Reading (dBuV)	AV Reading (dBuV)	Ant. / CL CF (dB)	Actual Fs		Peak Limit (dBuV/m)	AV Limit (dBuV/m)	AV Margin (dB)
					Peak (dBuV/m)	AV (dBuV/m)			
2441.00	H	85.63	63.44	17.01	102.64	80.45	114.00	94.00	-13.55
4882.00	H	45.24	22.30	21.57	66.81	43.87	74.00	54.00	-10.13
N/A									>20
2441.00	V	84.95	59.62	17.01	101.96	76.63	114.00	94.00	-17.37
4882.00	V	43.20	18.99	21.57	64.77	40.56	74.00	54.00	-13.44
N/A									>20

**Notes:**

1. Measuring frequencies from 1 GHz to the 10th harmonic of highest fundamental frequency.
2. Measurements above show only up to 6 maximum emissions noted, or would be lesser if no specific emissions from the EUT are recorded (ie: margin>20dB from the applicable limit) and considered that's already beyond the background noise floor.
3. Radiated emissions measured in frequency above 1000MHz were made with an instrument using Peak detector mode and average detector mode of the emission shown in Actual FS column.
4. Spectrum setting:
  - a. Peak Setting 1GHz - 26GHz, RBW = 1MHz, VBW = 1MHz, Sweep time = 200 ms.
  - b. AV Setting 1GH z- 26GHz, RBW = 1MHz, VBW = 10Hz, Sweep time = 200 ms.

**Operation Mode:** 8-DPSK Mode /CH High      **Test Date:** Jan. 04, 2013  
**Temperature:** 20°C      **Tested by:** Sky Guo  
**Humidity:** 70 % RH      **Polarity:** Ver. / Hor.

Freq. (MHz)	Ant. Pol H/V	Peak Reading (dBuV)	AV Reading (dBuV)	Ant. / CL CF (dB)	Actual Fs		Peak Limit (dBuV/m)	AV Limit (dBuV/m)	AV Margin (dB)
					Peak (dBuV/m)	AV (dBuV/m)			
2480.00	H	84.72	62.65	17.24	101.96	79.89	114.00	94.00	-14.11
4960.00	H	44.37	21.53	22.64	67.01	44.17	74.00	54.00	-9.83
N/A									>20
2480.00	V	85.53	63.29	17.24	102.77	80.53	114.00	94.00	-13.47
4960.00	V	44.07	22.16	22.64	66.71	44.80	74.00	54.00	-9.20
N/A									>20

**Notes:**

1. Measuring frequencies from 1 GHz to the 10th harmonic of highest fundamental frequency.
2. Measurements above show only up to 6 maximum emissions noted, or would be lesser if no specific emissions from the EUT are recorded (ie: margin>20dB from the applicable limit) and considered that's already beyond the background noise floor.
3. Radiated emissions measured in frequency above 1000MHz were made with an instrument using Peak detector mode and average detector mode of the emission shown in Actual FS column.
4. Spectrum setting:
  - a. Peak Setting 1GHz - 26GHz, RBW = 1MHz, VBW = 1MHz, Sweep time = 200 ms.
  - b. AV Setting 1GH z- 26GHz, RBW = 1MHz, VBW = 10Hz, Sweep time = 200 ms.

## 5.2 Band Edge

### 5.2.1 Requirement

Emission radiated outside of the specified frequency bands, except for harmonics, shall be attenuated by at least 50dB below the level of the fundamental or to the general radiated emission limits in section 15.209, whichever is the lesser attenuation, Low, mid and high channel all have been tested, only worse case is reported.

### 5.2.2 Test Description

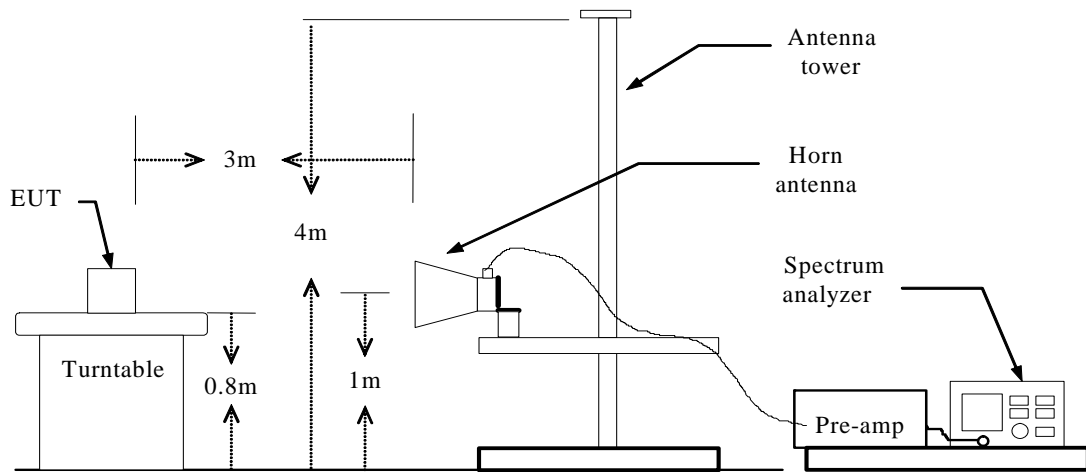

### 5.2.3 Test Result

The EUT operates at hopping-off test mode. The lowest and highest channels are tested to verify the band edge emissions.



Address: No. 5, Langshan 2nd Rd., North Hi-Tech Industrial park  
 Guangdong, China  
 Tel: 0755-86170306 Fax: 0755-86170310

**Radiated Emission Measurement**

File : DS-1176      Data : #57      Date : 2013-1-7      Time : 15:09:41

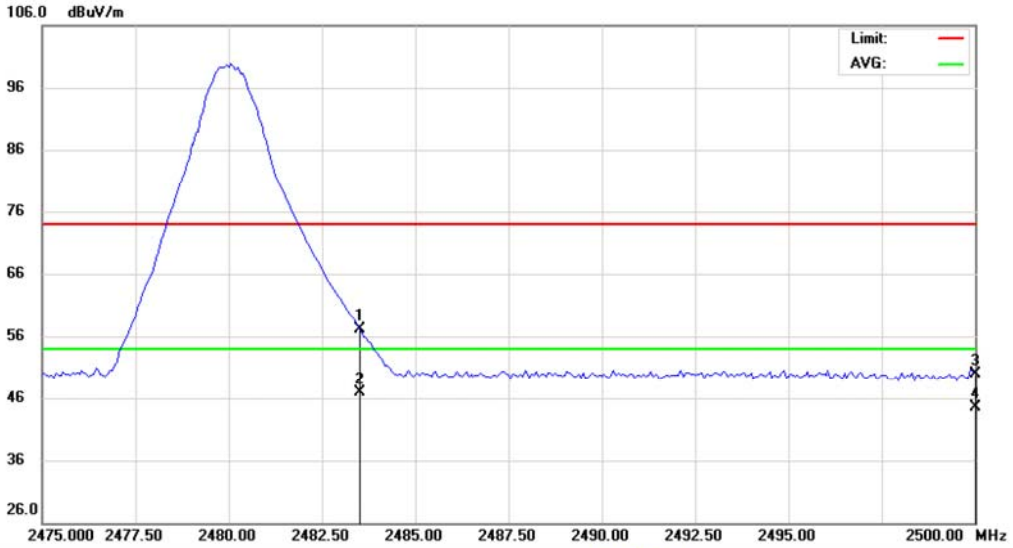

Site Chamber #1      Polarization: **Vertical**      Temperature: 26  
 Limit: 1000M-6000M FCC      Power: DC 5V by USB Port      Humidity: 61 %  
 EUT: Bluetooth Speaker      Distance:  
 M/N: DS-1176  
 Mode: Highest Channel Model  
 Note:

No.	Mk.	Freq.	Reading Level	Correct Factor	Measurement	Limit	Over	Antenna Height	Table Degree	Comment
		MHz	dBuV	dB	dBuV/m	dBuV/m	dB	cm	degree	
1		2483.500	35.71	21.45	57.16	74.00	-16.84	peak		
2	*	2483.500	25.50	21.45	46.95	54.00	-7.05	AVG		
3		2500.000	28.58	21.30	49.88	74.00	-24.12	peak		
4		2500.000	23.30	21.30	44.60	54.00	-9.40	AVG		

\*:Maximum data    x:Over limit    !:over margin

Engineer Signature:      Allen



Address: No. 5, Langshan 2nd Rd., North Hi-Tech Industrial park  
 Guangdong, China  
 Tel: 0755-86170306 Fax: 0755-86170310

**Radiated Emission Measurement**

File : DS-1176      Data : #58      Date : 2013-1-7      Time : 15:20:58



Site Chamber #1      Polarization: **Horizontal**      Temperature: 26  
 Limit: 1000M-6000M FCC      Power: DC 5V by USB Port      Humidity: 61 %  
 EUT: Bluetooth Speaker      Distance:  
 M/N: DS-1176  
 Mode: Highest Channel Model  
 Note:

No.	Mk.	Freq.	Reading Level	Correct Factor	Measurement	Limit	Over	Antenna Height	Table Degree	Comment
		MHz	dBuV	dB	dBuV/m	dBuV/m	dB	cm	degree	
1		2483.500	37.21	21.45	58.66	74.00	-15.34	peak		
2	*	2483.500	26.50	21.45	47.95	54.00	-6.05	AVG		
3		2500.000	29.08	21.30	50.38	74.00	-23.62	peak		
4		2500.000	23.50	21.30	44.80	54.00	-9.20	AVG		

\*:Maximum data    x:Over limit    !:over margin

Engineer Signature:      Allen



Address: No. 5, Langshan 2nd Rd., North Hi-Tech Industrial park  
 Guangdong, China  
 Tel: 0755-86170306 Fax: 0755-86170310

**Radiated Emission Measurement**

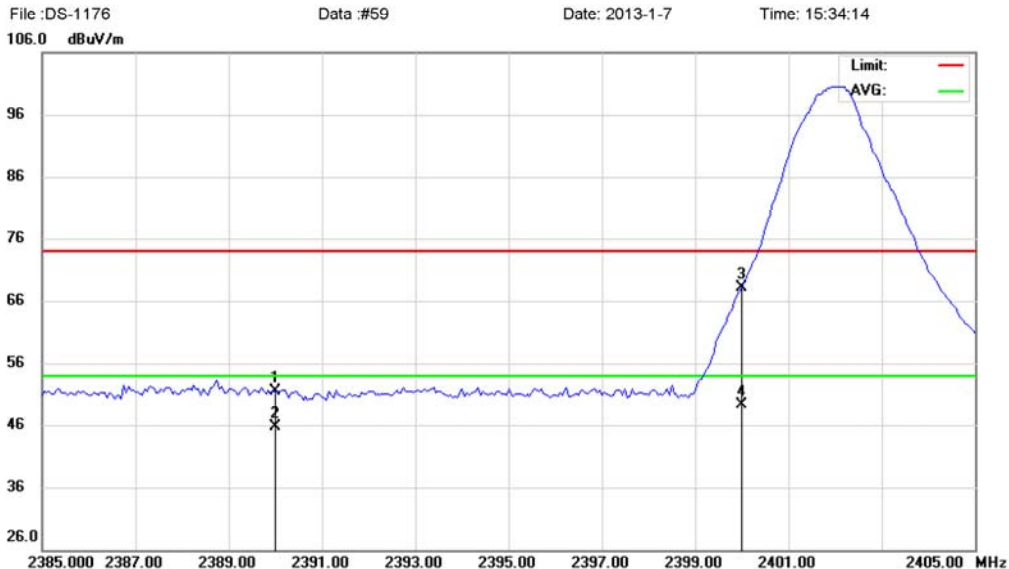

Site Chamber #1      Polarization: **Vertical**      Temperature: 26  
 Limit: 1000M-6000M FCC      Power: DC 5V by USB Port      Humidity: 61 %  
 EUT: Bluetooth Speaker      Distance:  
 M/N: DS-1176  
 Mode: Lowest Channel Model  
 Note:

No.	Mk.	Freq.	Reading Level	Correct Factor	Measurement	Limit	Over	Antenna Height	Table Degree	Comment
		MHz	dBuV	dB	dBuV/m	dBuV/m	dB	cm	degree	
1		2390.000	29.35	22.07	51.42	74.00	-22.58	peak		
2		2390.000	23.70	22.07	45.77	54.00	-8.23	AVG		
3		2400.000	45.92	22.20	68.12	74.00	-5.88	peak		
4	*	2400.000	27.20	22.20	49.40	54.00	-4.60	AVG		

\*:Maximum data    x:Over limit    !:over margin

Engineer Signature:      Allen



Address: No. 5, Langshan 2nd Rd., North Hi-Tech Industrial park  
 Guangdong, China  
 Tel: 0755-86170306 Fax: 0755-86170310

**Radiated Emission Measurement**

File : DS-1176      Data : #60      Date : 2013-1-7      Time : 15:45:29

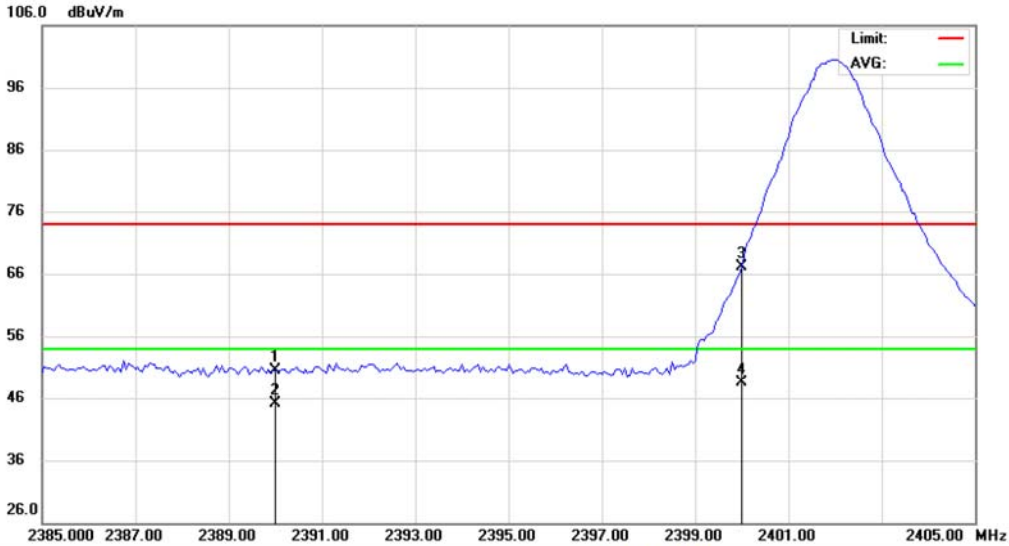

Site Chamber #1      Polarization: **Horizontal**      Temperature: 26  
 Limit: 1000M-6000M FCC      Power: DC 5V by USB Port      Humidity: 61 %  
 EUT: Bluetooth Speaker      Distance:  
 M/N: DS-1176  
 Mode: Lowest Channel Model  
 Note:

No.	Mk.	Freq.	Reading Level	Correct Factor	Measurement	Limit	Over	Antenna Height	Table Degree	Comment
		MHz	dBuV	dB	dBuV/m	dBuV/m	dB	cm	degree	
1		2390.000	28.35	22.07	50.42	74.00	-23.58			peak
2		2390.000	23.00	22.07	45.07	54.00	-8.93			AVG
3		2400.000	44.92	22.20	67.12	74.00	-6.88			peak
4	*	2400.000	26.40	22.20	48.60	54.00	-5.40			AVG

\*:Maximum data    x:Over limit    !:over margin

Engineer Signature:      Allen



### 5.3 LINE CONDUCTED EMISSION TEST

#### 5.3.1. LIMITS OF LINE CONDUCTED EMISSION TEST

Frequency	Maximum RF Line Voltage	
	Q.P.( dBuV)	Average( dBuV)
150kHz-500kHz	66-56	56-46
500kHz-5MHz	56	46
5MHz-30MHz	60	50

- \*\*Note:** 1. the lower limit shall apply at the transition frequency.  
 2. The limit decreases linearly with the logarithm of the frequency in the range 0.15 MHz to 0.50 MHz

#### 5.3.2. BLOCK DIAGRAM OF TEST SETUP

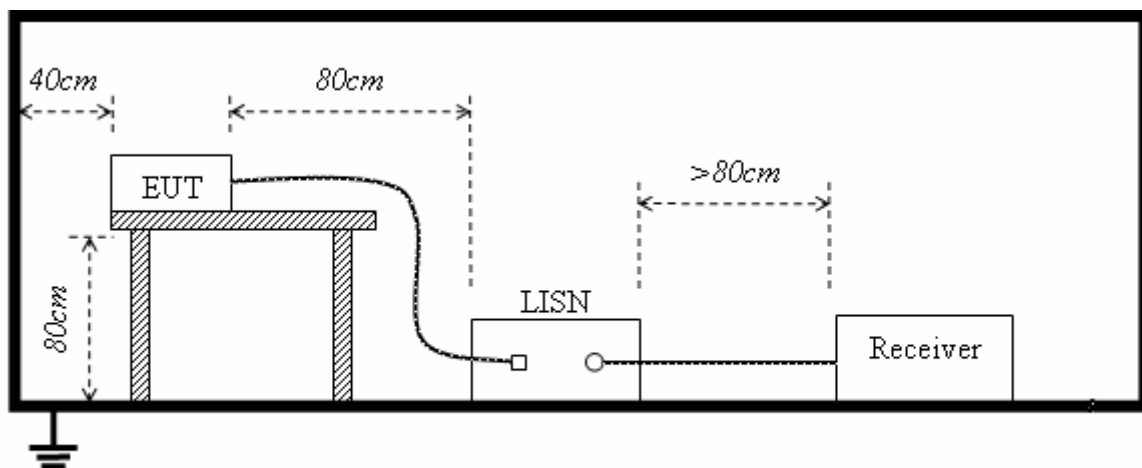

**5.3.3. PRELIMINARY PROCEDURE OF LINE CONDUCTED EMISSION TEST**

- 1) The equipment was set up as per the test configuration to simulate typical actual usage per the user’s manual. When the EUT is a tabletop system, a wooden table with a height of 0.8 meters is used and is placed on the ground plane as per FCC Part 15 (see Test Facility for the dimensions of the ground plane used). When the EUT is floor-standing equipment, it is placed on the ground plane which has a 3-12 mm non-conductive covering to insulate the EUT from the ground plane.
- 2) Support equipment, if needed, was placed as per FCC Part 15.
- 3) All I/O cables were positioned to simulate typical actual usage as per FCC Part 15.
- 4) The EUT received DC 5V by Adapter which received AC120V/60Hz power through a Line Impedance Stabilization Network (LISN) which supplied power source and was grounded to the ground plane.
- 5) All support equipments received power from a second LISN supplying power of AC 120V/60Hz, if any.
- 6) The EUT test program was started. Emissions were measured on each current carrying line of the EUT using a spectrum Analyzer / Receiver connected to the LISN powering the EUT. The LISN has two monitoring points: Line 1 (Hot Side) and Line 2 (Neutral Side). Two scans were taken: one with Line 1 connected to Analyzer / Receiver and Line 2 connected to a 50 ohm load; the second scan had Line 1 connected to a 50 ohm load and Line 2 connected to the Analyzer / Receiver.
- 7) Analyzer / Receiver scanned from 150 kHz to 30 MHz for emissions in each of the test modes.
- 8) During the above scans, the emissions were maximized by cable manipulation.

**5.3.4. FINAL PROCEDURE OF LINE CONDUCTED EMISSION TEST**

EUT and support equipment was set up on the test bench as per step 9 of the preliminary test. A scan was taken on both power lines, Line 1 and Line 2, recording at least the six highest emissions. Emission frequency and amplitude were recorded into a computer in which correction factors were used to calculate the emission level and compare reading to the applicable limit. If EUT emission level was less -2dB to the A.V. limit in Peak mode, then the emission signal was re-checked using Q.P and Average detector.

**5.3.5. Test result**

The following test mode(s) were scanned during the preliminary test:

Preliminary Conducted Emission Test				
Frequency Range Investigated		150KHz TO 30 MHz		
Mode of operation	Date	Report No.	Data#	Worst Mode
Bluetooth Mode	2013-01-04	MTE/CLY/T13010002	DS-1176_1_(V, H)	<input checked="" type="checkbox"/>
AUX IN Playing	2013-01-04	MTE/CLY/T13010002	DS-1176_2_(V, H)	<input type="checkbox"/>

Then, the EUT configuration and cable configuration of the above highest emission level were recorded for reference of final testing.

**Note:**

The Bluetooth model was carried out for GFSK, π / 4-DOPSK and 8-DPSK modulation types, GFSK Low channel modulation type was the worst case condition, The test data was shown on the summary data page.

**5.3.5. TEST RESULT OF LINE CONDUCTED EMISSION TEST**



Address: No. 5, Langshan 2nd Rd., North Hi-Tech Industrial park  
 Guangdong, China  
 Tel: 0755-86170306 Fax: 0755-86170310

**Conducted Emission Measurement**

File: DS-1176

Data #9

Date: 2013/01/04

Time: 16:20:56

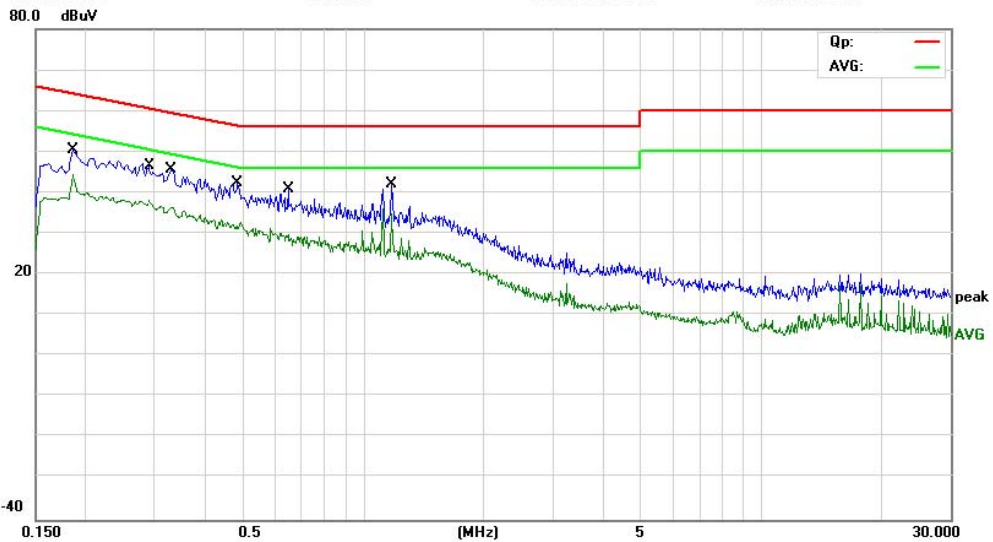

Site: site #1  
 Limit: FCC Part 15 B Class B QP  
 EUT: Bluetooth Speaker  
 M/N: DS-1176  
 Mode: BT Mode  
 Note:

Phase: **L1**  
 Power: DC 5V by USB Port  
 Temperature: 26  
 Humidity: 60 %

No.	Mk.	Freq. MHz	Reading Level dBuV	Correct Factor dB	Measure- ment dBuV	Limit dBuV	Over dB	Detector	Comment
1	*	0.1860	39.37	11.16	50.53	64.21	-13.68	QP	
2		0.2908	34.40	11.39	45.79	60.50	-14.71	QP	
3		0.3300	34.38	11.13	45.51	59.45	-13.94	QP	
4		0.4860	32.36	10.09	42.45	56.24	-13.79	QP	
5		0.6500	30.97	10.00	40.97	56.00	-15.03	QP	
6		1.1820	32.17	9.82	41.99	56.00	-14.01	QP	

\*:Maximum data    x:Over limit    l:over margin

Engineer Signature: Allen



Address: No. 5, Langshan 2nd Rd., North Hi-Tech Industrial park  
 Guangdong, China  
 Tel: 0755-86170306 Fax: 0755-86170310

**Conducted Emission Measurement**

File: DS-1176 Data #10 Date: 2013/01/04 Time: 16:23:51

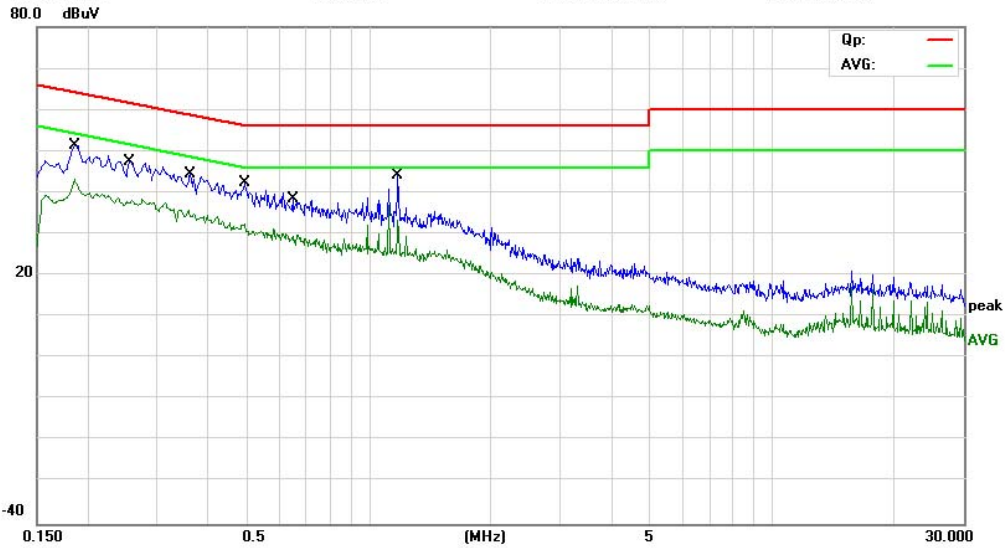

Site site #1 Phase: **N** Temperature: 26  
 Limit: FCC Part15 B Class B QP Power: DC 5V by USB Port Humidity: 60 %  
 EUT: Bluetooth Speaker  
 M/N: DS-1176  
 Mode: BT Mode  
 Note:

No.	Mk.	Freq. MHz	Reading Level dBuV	Correct Factor dB	Measure- ment dBuV	Limit dBuV	Over dB	Detector	Comment
1		0.1860	40.31	11.16	51.47	64.21	-12.74	QP	
2		0.2540	35.92	11.64	47.56	61.63	-14.07	QP	
3		0.3620	33.66	10.92	44.58	58.68	-14.10	QP	
4		0.4940	32.43	10.04	42.47	56.10	-13.63	QP	
5		0.6500	28.39	10.00	38.39	56.00	-17.61	QP	
6	*	1.1820	34.35	9.82	44.17	56.00	-11.83	QP	

\*: Maximum data x: Over limit l: over margin

Engineer Signature: Allen

### 5.4 20 dB Bandwidth

#### 5.4.1 Definition

Intentional radiators operating under the alternative provisions to the general emission limits, as Contained in §§15.217 through 15.257 and in sub-part E of this part, must be designed to ensure that the 20 dB Bandwidth of the emission, or whatever bandwidth may otherwise be specified in the specific Rule section under which the equipment operates, is contained within the frequency band designated in the rule section under which the equipment is operated.

#### 5.4.2 Block Diagram Of Test Setup

The EUT is powered by the Battery, is coupled to the Spectrum Analyzer (SA) through the Attenuator/DC Block. The path loss as the factor is calibrated to correct the reading. During the measurement, the EUT is activated and is set to operate at maximum power. The RF load attached to the EUT antenna terminal is 50Ohm.

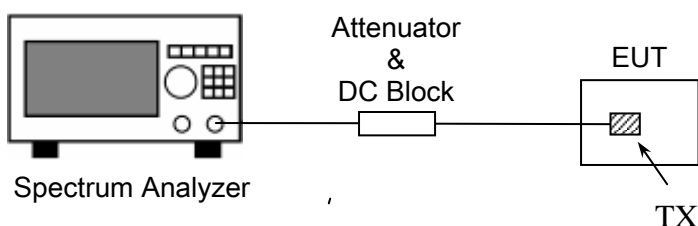

#### 5.4.3 Test Result

GFSK Modulation test result:

Channel	Frequency (MHz)	Test Result(kHz)
1	2402	357.446
41	2441	370.232
79	2480	364.005

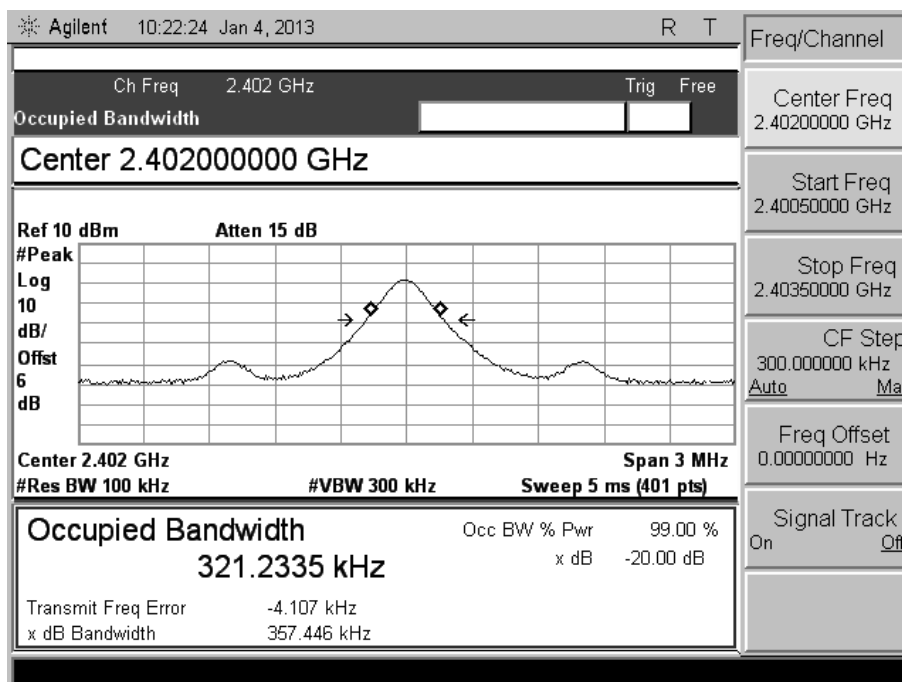

CH Low

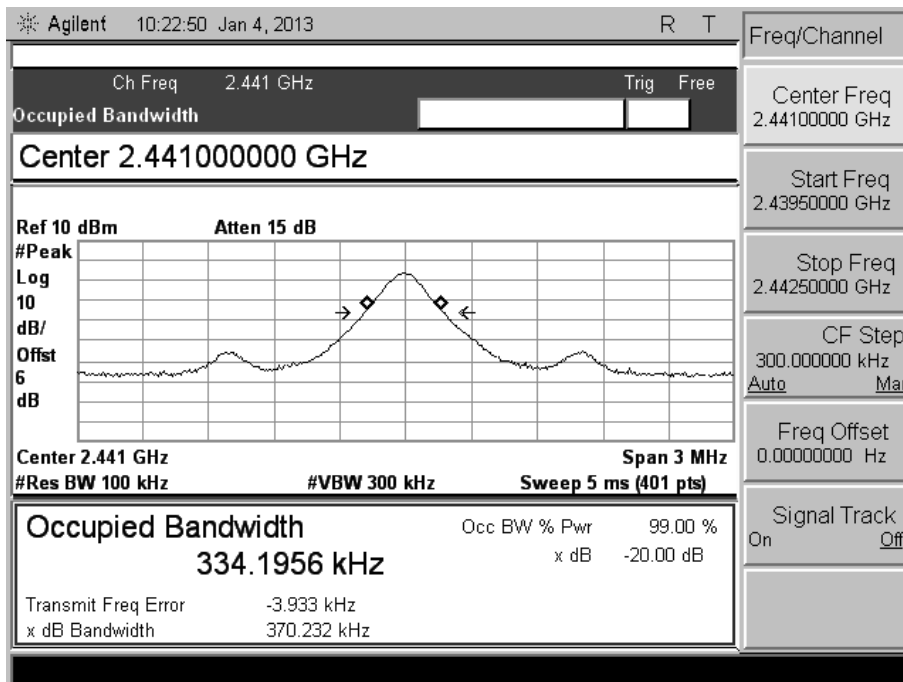

CH MID

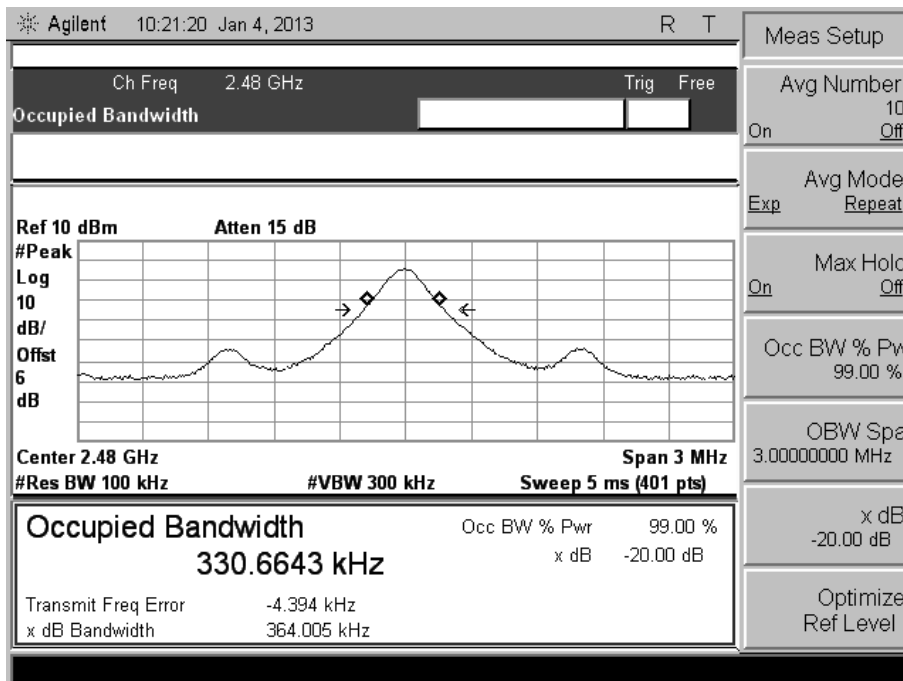

CH High

$\pi$  / 4-DOPSK Modulation test result:

Channel	Frequency (MHz)	Test Result(MHz)
1	2402	1.385
41	2441	1.361
79	2480	1.368

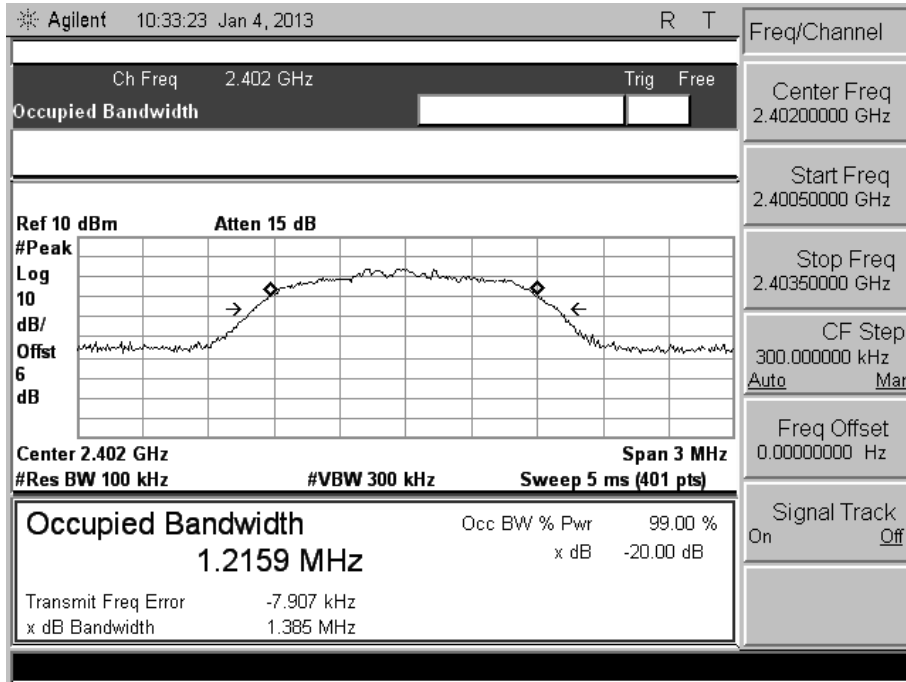

CH Low

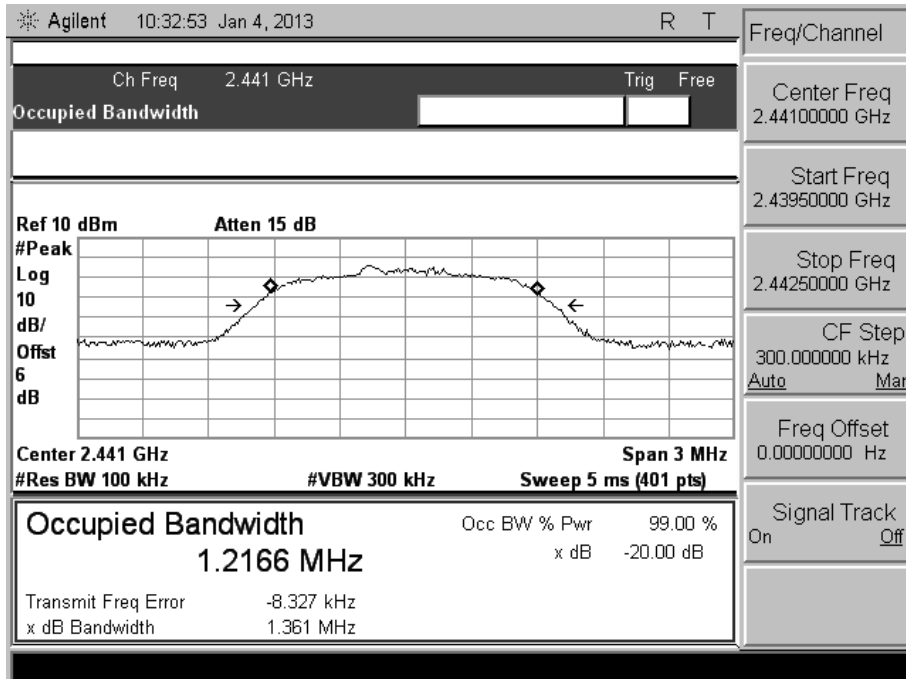

CH MID

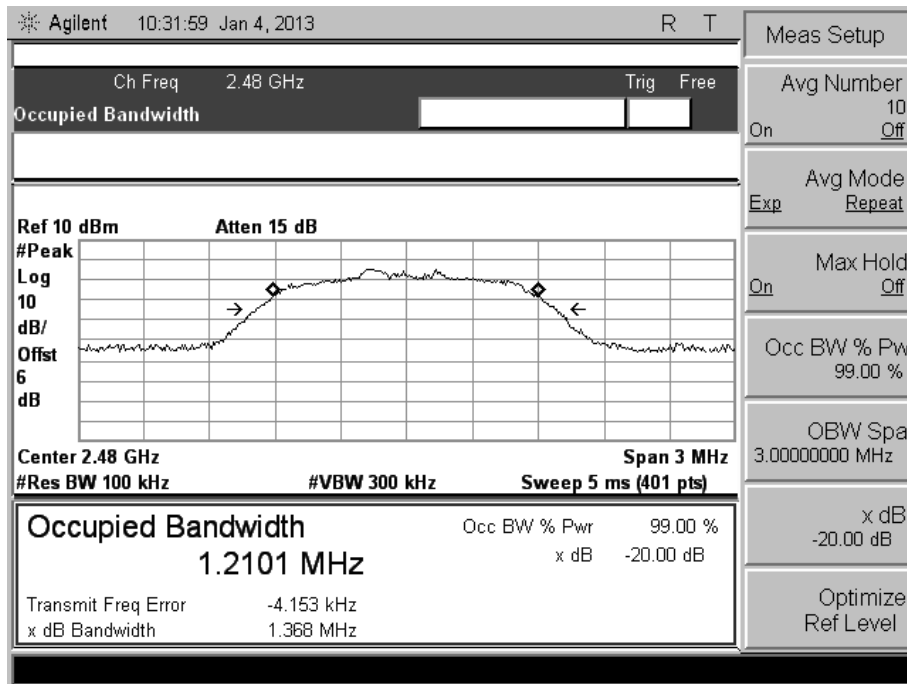

CH High

**8DPSK Modulation test result:**

Channel	Frequency (MHz)	Test Result(MHz)
1	2402	1.416
41	2442	1.381
79	2480	1.395



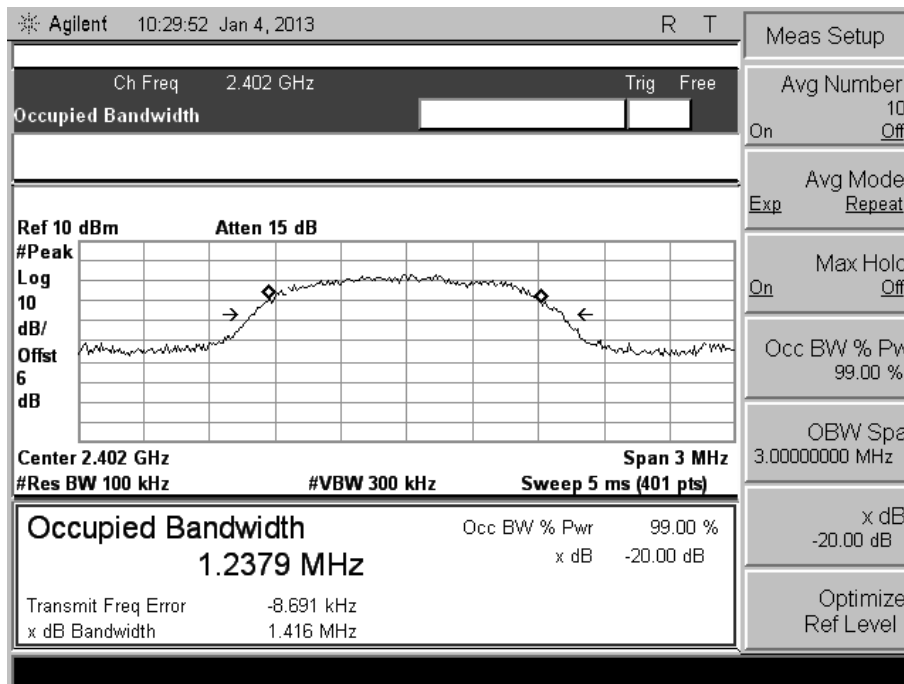

CH Low

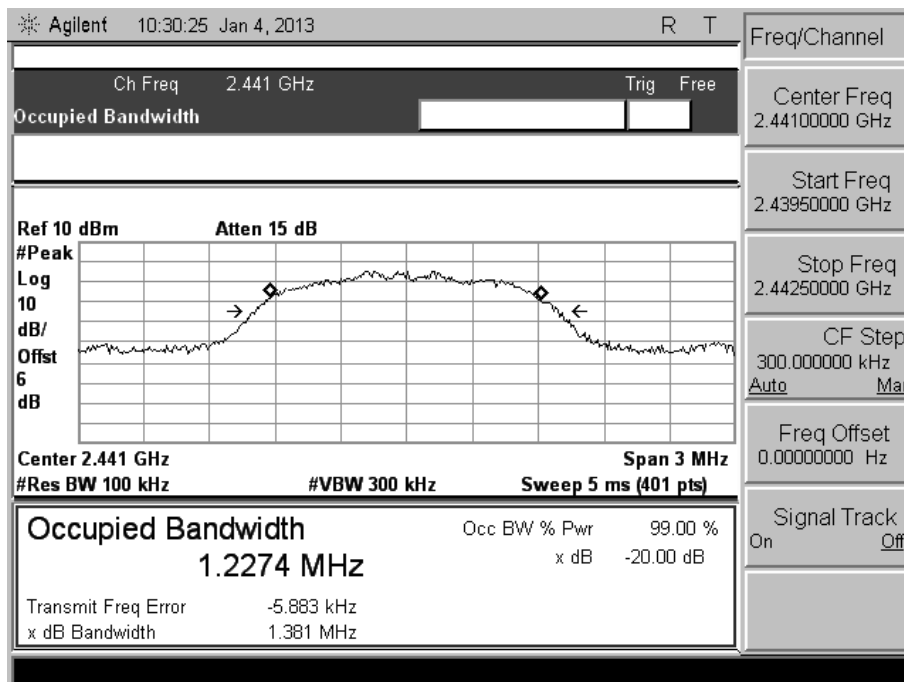

CH MID

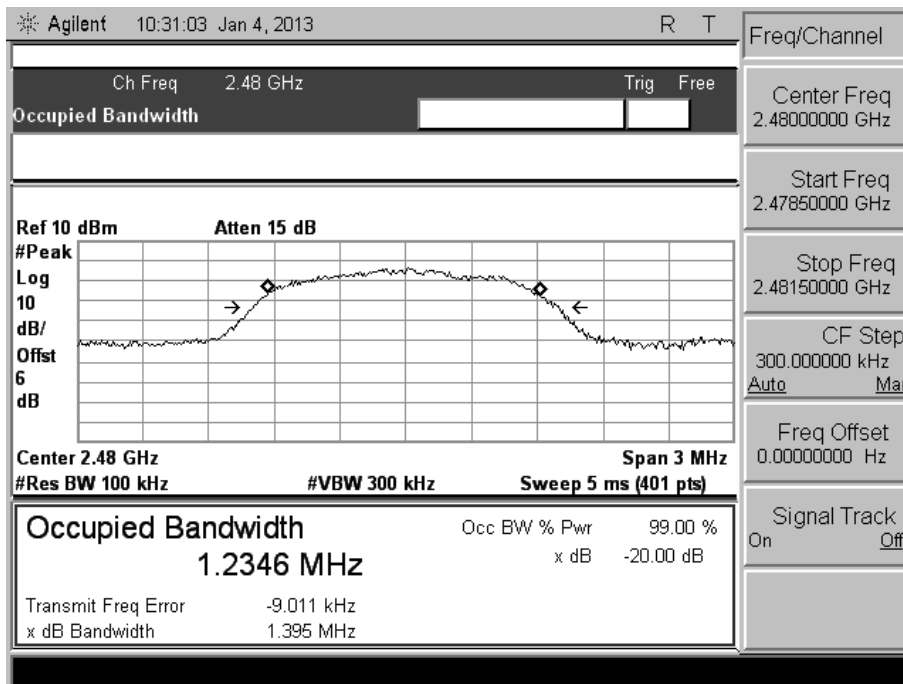

CH High

**APPENDIX 1**  
**PHOTOGRAPHS OF TEST SETUP**

CONDUCTED TEST SETUP



CE TEST SETUP



RE TEST SETUP

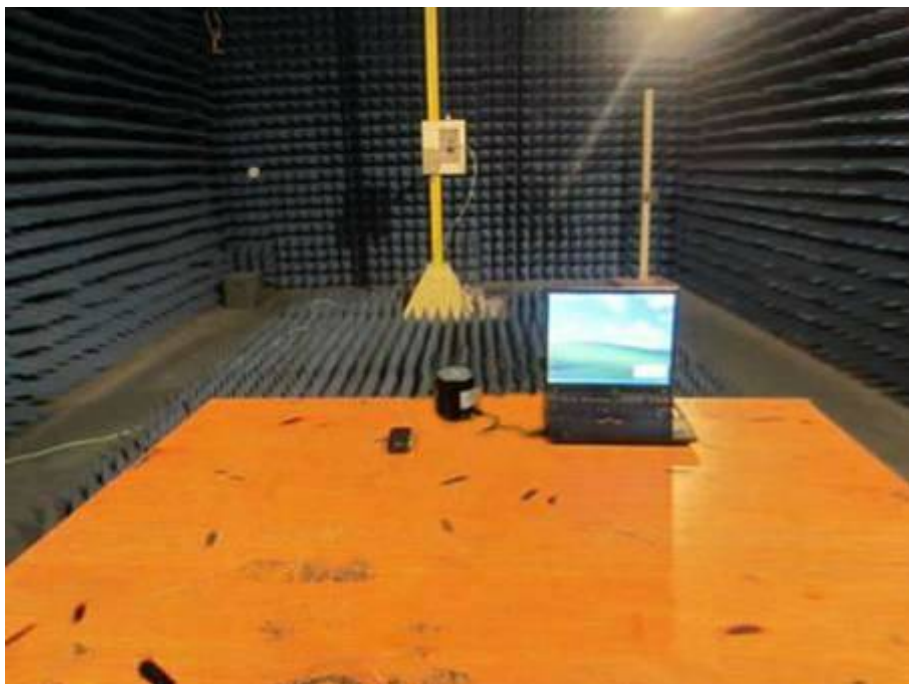
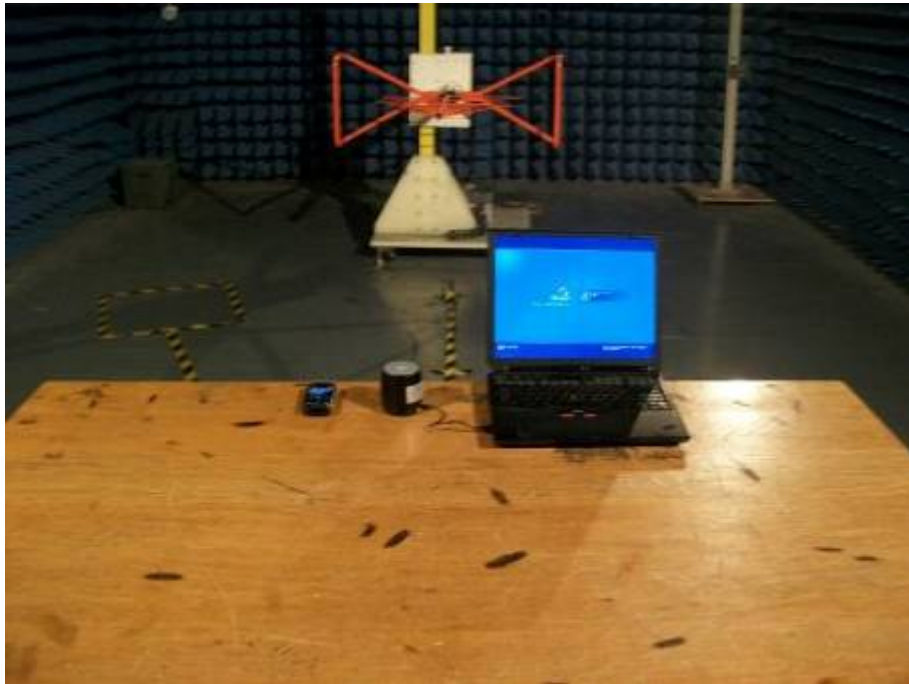

-----END OF REPORT-----