



# FCC TEST REPORT (15.407)

**REPORT NO.:** RF110412C06-1  
**MODEL NO.:** HiveAP 350  
**FCC ID:** WBV-HIVEAP350  
**RECEIVED:** Apr. 11, 2011  
**TESTED:** Apr. 12 ~ Jun. 23, 2011  
**ISSUED:** Jun. 30, 2011

**APPLICANT:** Aerohive Networks Inc.

**ADDRESS:** 330 Gibraltar Drive Sunnyvale, CA 94089 United States

**ISSUED BY:** Bureau Veritas Consumer Products Services (H.K.) Ltd., Taoyuan Branch

**LAB ADDRESS:** No. 47, 14th Ling, Chia Pau Tsuen, Lin Kou Hsiang, Taipei Hsien 244, Taiwan, R.O.C.

**TEST LOCATION:** No. 19, Hwa Ya 2nd Rd, Wen Hwa Tsuen, Kwei Shan Hsiang, Taoyuan Hsien 333, Taiwan, R.O.C.

This test report consists of 89 pages in total. It may be duplicated completely for legal use with the approval of the applicant. It should not be reproduced except in full, without the written approval of our laboratory. The client should not use it to claim product, certification, approval or endorsement by TAF or any government agency. The test results in the report only apply to the tested sample.





## TABLE OF CONTENTS

|   |    |
|---|----|
| RELEASE CONTROL RECORD .....  | 4  |
| 1. CERTIFICATION .....  | 5  |
| 2. SUMMARY OF TEST RESULTS .....                                    | 6  |
| 2.1 MEASUREMENT UNCERTAINTY .....                                   | 6  |
| 3. GENERAL INFORMATION .....  | 7  |
| 3.1 GENERAL DESCRIPTION OF EUT .....                                | 7  |
| 3.2 DESCRIPTION OF TEST MODES .....                                 | 9  |
| 3.2.1 CONFIGURATION OF SYSTEM UNDER TEST .....                      | 10 |
| 3.2.2 TEST MODE APPLICABILITY AND TESTED CHANNEL DETAIL .....       | 11 |
| 3.3 GENERAL DESCRIPTION OF APPLIED STANDARDS .....                  | 13 |
| 3.4 DESCRIPTION OF SUPPORT UNITS .....                              | 13 |
| 4. TEST TYPES AND RESULTS .....                                     | 14 |
| 4.1 RADIATED EMISSION MEASUREMENT .....                             | 14 |
| 4.1.1 LIMITS OF RADIATED EMISSION MEASUREMENT .....                 | 14 |
| 4.1.2 LIMITS OF UNWANTED EMISSION OUT OF THE RESTRICTED BANDS ..... | 14 |
| 4.1.3 TEST INSTRUMENTS .....  | 15 |
| 4.1.4 TEST PROCEDURES .....   | 16 |
| 4.1.5 DEVIATION FROM TEST STANDARD .....                            | 16 |
| 4.1.6 TEST SETUP .....  | 17 |
| 4.1.7 EUT OPERATING CONDITION .....                                 | 17 |
| 4.1.8 TEST RESULTS .....  | 18 |
| 4.2 CONDUCTED EMISSION MEASUREMENT .....                            | 28 |
| 4.2.1 LIMITS OF CONDUCTED EMISSION MEASUREMENT .....                | 28 |
| 4.2.2 TEST INSTRUMENTS .....  | 28 |
| 4.2.3 TEST PROCEDURES .....   | 29 |
| 4.2.4 DEVIATION FROM TEST STANDARD .....                            | 29 |
| 4.2.5 TEST SETUP .....  | 30 |
| 4.2.6 EUT OPERATING CONDITIONS .....                                | 30 |
| 4.2.7 TEST RESULTS .....  | 31 |
| 4.3 MAXIMUM CONDUCTED OUTPUT POWER MEASUREMENT .....                | 35 |
| 4.3.1 LIMITS OF MAXIMUM CONDUCTED OUTPUT POWER MEASUREMENT .....    | 35 |
| 4.3.2 TEST INSTRUMENTS .....  | 35 |
| 4.3.3 TEST PROCEDURE .....  | 36 |
| 4.3.4 DEVIATION FROM TEST STANDARD .....                            | 36 |
| 4.3.5 TEST SETUP .....  | 36 |
| 4.3.6 EUT OPERATING CONDITIONS .....                                | 36 |
| 4.3.7 TEST RESULTS .....  | 37 |
| 4.4 PEAK POWER EXCURSION MEASUREMENT .....                          | 41 |
| 4.4.1 LIMITS OF PEAK POWER EXCURSION MEASUREMENT .....              | 41 |
| 4.4.2 TEST INSTRUMENTS .....  | 41 |
| 4.4.3 TEST PROCEDURE .....  | 41 |
| 4.4.4 DEVIATION FROM TEST STANDARD .....                            | 42 |
| 4.4.5 TEST SETUP .....  | 42 |
| 4.4.6 EUT OPERATING CONDITIONS .....                                | 42 |
| 4.4.7 TEST RESULTS .....  | 43 |
| 4.5 PEAK POWER SPECTRAL DENSITY MEASUREMENT .....                   | 49 |
| 4.5.1 LIMITS OF PEAK POWER SPECTRAL DENSITY MEASUREMENT .....       | 49 |
| 4.5.2 TEST INSTRUMENTS .....  | 49 |



A D T

|       |  |    |
|-------|--|----|
| 4.5.3 | TEST PROCEDURES .....  | 49 |
| 4.5.4 | DEVIATION FROM TEST STANDARD.....  | 50 |
| 4.5.5 | TEST SETUP.....  | 50 |
| 4.5.6 | EUT OPERATING CONDITIONS .....   | 50 |
| 4.5.7 | TEST RESULTS .....   | 51 |
| 4.6   | FREQUENCY STABILITY.....   | 54 |
| 4.6.1 | LIMITS OF FREQUENCY STABILITY MEASUREMENT .....  | 54 |
| 4.6.2 | TEST INSTRUMENTS.....  | 54 |
| 4.6.3 | TEST PROCEDURE.....  | 54 |
| 4.6.4 | DEVIATION FROM TEST STANDARD.....  | 55 |
| 4.6.5 | TEST SETUP.....  | 55 |
| 4.6.6 | EUT OPERATING CONDITION.....   | 55 |
| 4.6.7 | TEST RESULTS .....   | 56 |
| 4.7   | BAND EDGES MEASUREMENT .....   | 57 |
| 4.7.1 | TEST INSTRUMENTS.....  | 57 |
| 4.7.2 | TEST PROCEDURE.....  | 58 |
| 4.7.3 | EUT OPERATING CONDITION.....   | 58 |
| 4.7.4 | TEST RESULTS .....   | 59 |
| 5.    | PHOTOGRAPHS OF THE TEST CONFIGURATION.....   | 87 |
| 6.    | INFORMATION ON THE TESTING LABORATORIES .....  | 88 |
| 7.    | APPENDIX A - MODIFICATIONS RECORDERS FOR ENGINEERING CHANGES<br>TO THE EUT BY THE LAB..... | 89 |



A D T

## RELEASE CONTROL RECORD

| ISSUE NO.        | REASON FOR CHANGE | DATE ISSUED   |
|------------------|-------------------|---------------|
| Original release | NA                | Jun. 30, 2011 |



## 1. CERTIFICATION

**PRODUCT:** Wireless Access Points  
**MODEL NO.:** HiveAP 350  
**BRAND:** Aerohive  
**APPLICANT:** Aerohive Networks Inc.  
**TEST SAMPLE:** ENGINEERING SAMPLE  
**TESTED:** Apr. 12 ~ Jun. 23, 2011  
**STANDARDS:** **FCC Part 15, Subpart E (Section 15.407)**  
ANSI C63.4-2003  
ANSI C63.10-2009

The above equipment (Model: HiveAP 350) has been tested by **Bureau Veritas Consumer Products Services (H.K.) Ltd., Taoyuan Branch**, and found compliance with the requirement of the above standards. The test record, data evaluation & Equipment Under Test (EUT) configurations represented herein are true and accurate accounts of the measurements of the sample's EMC characteristics under the conditions specified in this report.

PREPARED BY : Andrea Hsia , DATE: Jun. 30, 2011  
Andrea Hsia / Specialist

APPROVED BY : Gary Chang , DATE: Jun. 30, 2011  
Gary Chang / Assistant Manager

## 2. SUMMARY OF TEST RESULTS

The EUT has been tested according to the following specifications:

| APPLIED STANDARD: FCC PART 15, SUBPART E (SECTION 15.407) |   |        |   |
|---|---|--------|---|
| STANDARD SECTION  | TEST TYPE AND LIMIT   | RESULT | REMARK  |
| 15.407(b)(5)  | AC Power Conducted Emission                                     | PASS   | Meet the requirement of limit. Minimum passing margin is -13.92dB at 0.400MHz.          |
| 15.407(b)(1/2/3)<br>(b)(5)                                | Electric Field Strength Spurious Emissions,<br>30MHz ~ 40000MHz | PASS   | Meet the requirement of limit. Minimum passing margin is -1.0dB at 146.56 & 5150.00MHz. |
| 15.407(a)(1/2/3)  | Peak Transmit Power   | PASS   | Meet the requirement of limit.  |
| 15.407(a)(6)  | Peak Power Excursion  | PASS   | Meet the requirement of limit.  |
| 15.407(a)(1/2/3)  | Peak Power Spectral Density                                     | PASS   | Meet the requirement of limit.  |
| 15.407(g)   | Frequency Stability   | PASS   | Meet the requirement of limit.  |
| 15.203  | Antenna Requirement   | PASS   | Antenna connector is R-SMA.   |

### 2.1 MEASUREMENT UNCERTAINTY

Where relevant, the following measurement uncertainty levels have been estimated for tests performed on the EUT as specified in CISPR 16-4-2:

| MEASUREMENT         | FREQUENCY       | UNCERTAINTY |
|---------------------|-----------------|-------------|
| Conducted emissions | 9kHz~30MHz      | 2.44 dB     |
| Radiated emissions  | 30MHz ~ 200MHz  | 3.34 dB     |
|                     | 200MHz ~1000MHz | 3.35 dB     |
|                     | 1GHz ~ 18GHz    | 2.26 dB     |
|                     | 18GHz ~ 40GHz   | 1.94 dB     |

This uncertainty represents an expanded uncertainty expressed at approximately the 95% confidence level using a coverage factor of  $k = 2$ .



### 3. GENERAL INFORMATION

#### 3.1 GENERAL DESCRIPTION OF EUT

|                              |   |
|------------------------------|---|
| <b>PRODUCT</b>               | Wireless Access Points  |
| <b>MODEL NO.</b>             | HiveAP 350  |
| <b>FCC ID</b>                | WBV-HIVEAP350   |
| <b>NOMINAL VOLTAGE</b>       | 12Vdc (Adapter)<br>48Vdc (POE)  |
| <b>MODULATION TYPE</b>       | 64QAM, 16QAM, QPSK, BPSK  |
| <b>MODULATION TECHNOLOGY</b> | OFDM  |
| <b>TRANSFER RATE</b>         | 802.11a: 54.0/ 48.0/ 36.0/ 24.0/ 18.0/ 12.0/ 9.0/ 6.0Mbps<br>802.11n: up to 450.0Mbps |
| <b>OPERATING FREQUENCY</b>   | 5180.0 ~ 5240.0MHz  |
| <b>NUMBER OF CHANNEL</b>     | 4 for 802.11a, 802.11n (20MHz)<br>2 for 802.11n (40MHz)                               |
| <b>OUTPUT POWER</b>          | 47.2mW  |
| <b>ANTENNA TYPE</b>          | Dipole antenna with 4dBi gain   |
| <b>ANTENNA CONNECTER</b>     | R-SMA   |
| <b>DATA CABLE</b>            | NA  |
| <b>I/O PORTS</b>             | Refer to user's manual  |
| <b>ACCESSORY DEVICES</b>     | NA  |

**NOTE:**

1. The EUT is a Wireless Access Points. The test data are separated into following test reports.

|  | <b>TEST STANDARD</b>                       | <b>REFERENCE REPORT</b> |
|--|--|-------------------------|
| <b>WLAN 802.11b/g, 802.11n</b>                   | FCC Part 15, Subpart C<br>(Section 15.247) | RF110412C06             |
| <b>WLAN 802.11a, 802.11n<br/>(5745~5825 MHz)</b> |  |                         |
| <b>WLAN 802.11a, 802.11n<br/>(5180~ 5240MHz)</b> | FCC Part 15, Subpart E<br>(Section 15.407) | RF110412C06-1           |

2. The frequency bands used in this EUT are listed as follows:

| <b>FREQUENCY BAND (MHz)</b> | <b>2412~2462</b> | <b>5180~5240</b> | <b>5745~5825</b> |
|-----------------------------|------------------|------------------|------------------|
| <b>802.11b</b>              | √                |                  |                  |
| <b>802.11g</b>              | √                |                  |                  |
| <b>802.11a</b>              |                  | √                | √                |
| <b>802.11n (20MHz)</b>      | √                | √                | √                |
| <b>802.11n (40MHz)</b>      | √                | √                | √                |



3. The EUT incorporates a MIMO function. Physically, the EUT provides three completed transmitters and three receivers.

| MODULATION MODE | TX FUNCTION |
|-----------------|-------------|
| 802.11b         | 1TX         |
| 802.11g         | 1TX         |
| 802.11a         | 1TX         |
| 802.11n (20MHz) | 3TX         |
| 802.11n (40MHz) | 3TX         |

4. The EUT were powered by the following adapter and POE.

| Adapter     |                                       |
|-------------|---------------------------------------|
| BRAND:      | DVE                                   |
| MODEL:      | DSA-30W-12 EU                         |
| INPUT:      | 100-240Vac, 50/60Hz, 0.8A             |
| OUTPUT:     | 12Vdc, 2.0A                           |
| POWER LINE: | 1.73m non-shielded cable without core |

| POE     |                           |
|---------|---------------------------|
| BRAND:  | SL POWER and AULT         |
| MODEL:  | PENB1032E4800F02          |
| INPUT:  | 100-240Vac, 50/60Hz, 1.0A |
| OUTPUT: | 48Vdc, 0.67A              |

\*\*Adapter & POE were for the optional accessories.

5. The above EUT information is declared by manufacturer and for more detailed features description, please refer to the manufacturer's specifications or user's manual.





A D T

### 3.2 DESCRIPTION OF TEST MODES

4 channels are provided for 802.11a and 802.11n (20MHz):

| CHANNEL | FREQUENCY | CHANNEL | FREQUENCY |
|---------|-----------|---------|-----------|
| 36      | 5180MHz   | 44      | 5220MHz   |
| 40      | 5200MHz   | 48      | 5240MHz   |

2 channels are provided for 802.11n (40MHz):

| CHANNEL | FREQUENCY | CHANNEL | FREQUENCY |
|---------|-----------|---------|-----------|
| 38      | 5190MHz   | 46      | 5230MHz   |



### 3.2.1 CONFIGURATION OF SYSTEM UNDER TEST

#### TEST MODE A

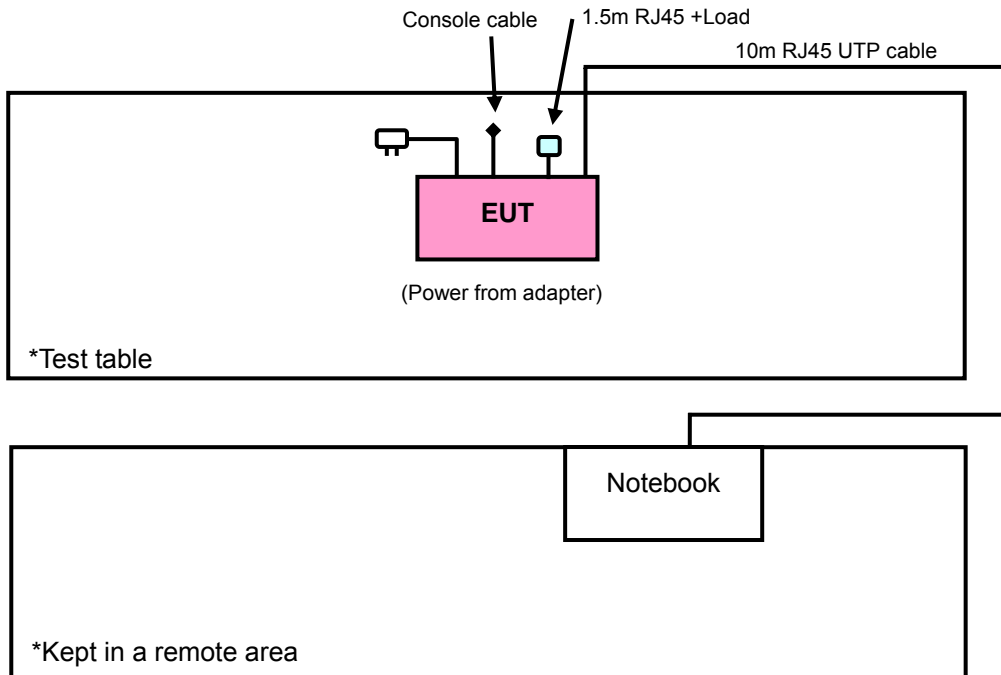

#### TEST MODE B

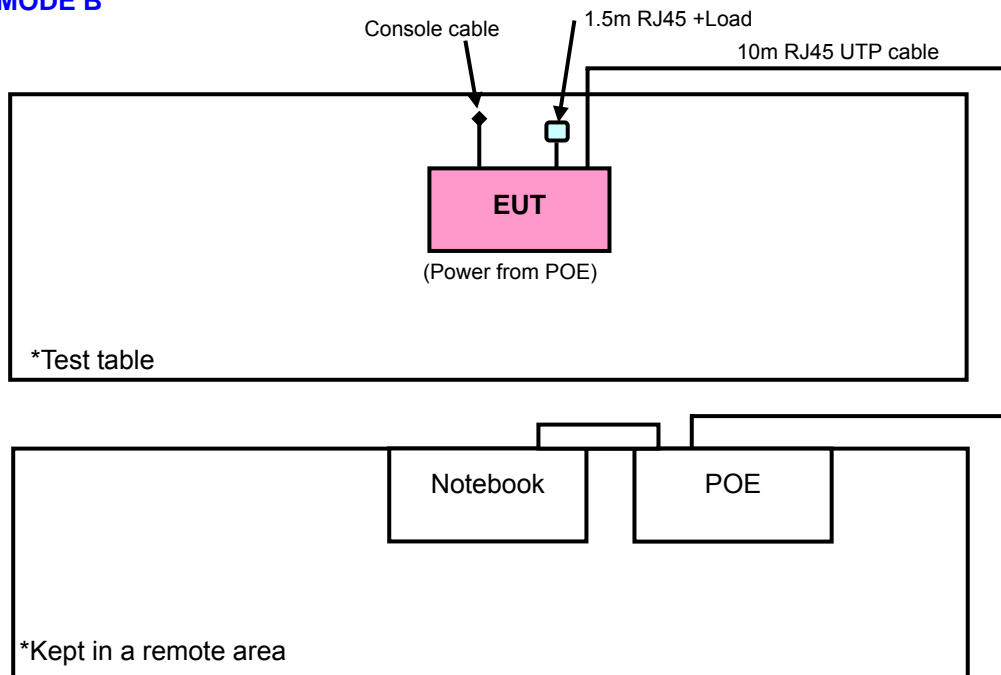

### 3.2.2 TEST MODE APPLICABILITY AND TESTED CHANNEL DETAIL

| EUT CONFIGURE MODE | APPLICABLE TO |       |     |      | DESCRIPTION        |
|--------------------|---------------|-------|-----|------|--------------------|
|                    | RE $\geq$ 1G  | RE<1G | PLC | APCM |                    |
| A                  | √             | √     | √   | √    | Power from adapter |
| B                  | -             | √     | √   | -    | Power from POE     |

Where **RE $\geq$ 1G**: Radiated Emission above 1GHz      **RE<1G**: Radiated Emission below 1GHz  
**PLC**: Power Line Conducted Emission      **APCM**: Antenna Port Conducted Measurement

**NOTE**: "-": Means no effect.

#### **RADIATED EMISSION TEST (ABOVE 1GHz):**

- Pre-Scan has been conducted to determine the worst-case mode from all possible combinations between available modulations, data rates and antenna ports (if EUT with antenna diversity architecture).
- Following channel(s) was (were) selected for the final test as listed below.

| EUT CONFIGURE MODE | MODE            | AVAILABLE CHANNEL | TESTED CHANNEL | MODULATION TECHNOLOGY | MODULATION TYPE | DATA RATE (Mbps) | AXIS |
|--------------------|-----------------|-------------------|----------------|-----------------------|-----------------|------------------|------|
| A                  | 802.11a         | 36 to 48          | 36, 40, 48     | OFDM                  | BPSK            | 6.0              | Z    |
| A                  | 802.11n (20MHz) | 36 to 48          | 36, 40, 48     | OFDM                  | BPSK            | 7.2              | Z    |
| A                  | 802.11n (40MHz) | 38 to 46          | 38, 46         | OFDM                  | BPSK            | 15.0             | Z    |

#### **RADIATED EMISSION TEST (BELOW 1GHz):**

- Pre-Scan has been conducted to determine the worst-case mode from all possible combinations between available modulations, data rates and antenna ports (if EUT with antenna diversity architecture).
- Following channel(s) was (were) selected for the final test as listed below.

| EUT CONFIGURE MODE | MODE            | AVAILABLE CHANNEL | TESTED CHANNEL | MODULATION TECHNOLOGY | MODULATION TYPE | DATA RATE (Mbps) | AXIS |
|--------------------|-----------------|-------------------|----------------|-----------------------|-----------------|------------------|------|
| A & B              | 802.11n (20MHz) | 36 to 48          | 36             | OFDM                  | BPSK            | 7.2              | Z    |

#### **POWER LINE CONDUCTED EMISSION TEST:**

- Pre-Scan has been conducted to determine the worst-case mode from all possible combinations between available modulations, data rates and antenna ports (if EUT with antenna diversity architecture).
- Following channel(s) was (were) selected for the final test as listed below.

| EUT CONFIGURE MODE | MODE            | AVAILABLE CHANNEL | TESTED CHANNEL | MODULATION TECHNOLOGY | MODULATION TYPE | DATA RATE (Mbps) |
|--------------------|-----------------|-------------------|----------------|-----------------------|-----------------|------------------|
| A & B              | 802.11n (20MHz) | 36 to 48          | 36             | OFDM                  | BPSK            | 7.2              |

**BANDEDGE MEASUREMENT:**

- Pre-Scan has been conducted to determine the worst-case mode from all possible combinations between available modulations, data rates and antenna ports (if EUT with antenna diversity architecture).
- Following channel(s) was (were) selected for the final test as listed below.

| EUT CONFIGURE MODE | MODE            | AVAILABLE CHANNEL | TESTED CHANNEL | MODULATION TECHNOLOGY | MODULATION TYPE | DATA RATE (Mbps) |
|--------------------|-----------------|-------------------|----------------|-----------------------|-----------------|------------------|
| A                  | 802.11a         | 36 to 48          | 36, 48         | OFDM                  | BPSK            | 6.0              |
| A                  | 802.11n (20MHz) | 36 to 48          | 36, 48         | OFDM                  | BPSK            | 7.2              |
| A                  | 802.11n (40MHz) | 38 to 46          | 38, 46         | OFDM                  | BPSK            | 15.0             |

**ANTENNA PORT CONDUCTED MEASUREMENT:**

- This item includes all test value of each mode, but only includes spectrum plot of worst value of each mode.
- Pre-Scan has been conducted to determine the worst-case mode from all possible combinations between available modulations, data rates and antenna ports (if EUT with antenna diversity architecture).
- Following channel(s) was (were) selected for the final test as listed below.

| EUT CONFIGURE MODE | MODE            | AVAILABLE CHANNEL | TESTED CHANNEL | MODULATION TECHNOLOGY | MODULATION TYPE | DATA RATE (Mbps) |
|--------------------|-----------------|-------------------|----------------|-----------------------|-----------------|------------------|
| A                  | 802.11a         | 36 to 48          | 36, 40, 48     | OFDM                  | BPSK            | 6.0              |
| A                  | 802.11n (20MHz) | 36 to 48          | 36, 40, 48     | OFDM                  | BPSK            | 7.2              |
| A                  | 802.11n (40MHz) | 38 to 46          | 38, 46         | OFDM                  | BPSK            | 15.0             |

**TEST CONDITION:**

| APPLICABLE TO | ENVIRONMENTAL CONDITIONS                                 | INPUT POWER (SYSTEM) | TESTED BY              |
|---------------|--|----------------------|------------------------|
| RE≥1G         | 25deg. C, 68%RH, 1008 hPa,<br>21deg. C, 60%RH, 1008 hPa, | 120Vac, 60Hz         | David Huang<br>Sun Lin |
| RE<1G         | 25deg. C, 60%RH, 1010 hPa                                | 120Vac, 60Hz         | Mitch Jen              |
| PLC           | 25deg. C, 68%RH, 1007 hPa                                | 120Vac, 60Hz         | David Huang            |
| APCM          | 25deg. C, 65%RH, 1007 hPa                                | 120Vac, 60Hz         | David Huang            |



### 3.3 GENERAL DESCRIPTION OF APPLIED STANDARDS

The EUT is a RF Product. According to the specifications of the manufacturer, it must comply with the requirements of the following standards:

**FCC Part 15, Subpart E (15.407)**

**ANSI C63.4-2003**

**ANSI C63.10-2009**

All test items have been performed and recorded as per the above standards.

### 3.4 DESCRIPTION OF SUPPORT UNITS

The EUT has been tested as an independent unit together with other necessary accessories or support units. The following support units or accessories were used to form a representative test configuration during the tests.

| NO. | PRODUCT  | BRAND             | MODEL NO.         | SERIAL NO.  | FCC ID           |
|-----|----------|-------------------|-------------------|-------------|------------------|
| 1   | NOTEBOOK | DELL              | D820              | 21498926752 | FCC DoC Approved |
| 2   | ADAPTER  | DVE               | DSA-30W-12EU      | NA          | NA               |
| 3   | POE      | SL POWER and AULT | PENB1032E480 0F02 | NA          | NA               |

| NO. | SIGNAL CABLE DESCRIPTION OF THE ABOVE SUPPORT UNITS |
|-----|---|
| 1   | 10m RJ45 UTP cable without core                     |
| 2   | NA  |
| 3   | NA  |

**NOTE:**

- 1. All power cords of the above support units are non-shielded (1.8 m).
- 2. Item 1 act as a communication partner to transfer data.
- 3. Item 2 & 3 were provided by client.

## 4. TEST TYPES AND RESULTS

### 4.1 RADIATED EMISSION MEASUREMENT

#### 4.1.1 LIMITS OF RADIATED EMISSION MEASUREMENT

Emissions radiated outside of the specified bands, shall be according to the general radiated limits in 15.209 as following:

| FREQUENCIES (MHz) | FIELD STRENGTH (microvolts/meter) | MEASUREMENT DISTANCE (meters) |
|-------------------|-----------------------------------|-------------------------------|
| 0.009 ~ 0.490     | 2400/F(kHz)                       | 300                           |
| 0.490 ~ 1.705     | 24000/F(kHz)                      | 30                            |
| 1.705 ~ 30.0      | 30                                | 30                            |
| 30 ~ 88           | 100                               | 3                             |
| 88 ~ 216          | 150                               | 3                             |
| 216 ~ 960         | 200                               | 3                             |
| Above 960         | 500                               | 3                             |

**NOTE:**

1. The lower limit shall apply at the transition frequencies.
2. Emission level (dBuV/m) = 20 log Emission level (uV/m).
3. As shown in 15.35(b), for frequencies above 1000MHz, the field strength limits are based on average detector, however, the peak field strength of any emission shall not exceed the maximum permitted average limits, specified above by more than 20dB under any condition of modulation.

#### 4.1.2 LIMITS OF UNWANTED EMISSION OUT OF THE RESTRICTED BANDS

| FREQUENCIES (MHz) | EIRP LIMIT (dBm) | EQUIVALENT FIELD STRENGTH AT 3m (dBμV/m) *NOTE 3 |
|-------------------|------------------|--|
|                   | PK               | PK   |
| 5150 ~ 5250       | -27              | 68.3   |

**NOTE:** The following formula is used to convert the equipment isotropic radiated power (eirp) to field strength:

$$E = \frac{1000000\sqrt{30P}}{3} \mu\text{V/m, where P is the eirp (Watts).}$$



### 4.1.3 TEST INSTRUMENTS

| DESCRIPTION & MANUFACTURER              | MODEL NO.                    | SERIAL NO.  | DATE OF CALIBRATION | DUE DATE OF CALIBRATION |
|---|------------------------------|-------------|---------------------|-------------------------|
| Test Receiver<br>ROHDE & SCHWARZ        | ESIB7                        | 100212      | Jul. 22, 2010       | Jul. 21, 2011           |
| Spectrum Analyzer<br>Agilent            | E4446A                       | MY48250266  | Aug. 11, 2010       | Aug. 10, 2011           |
| BILOG Antenna<br>SCHWARZBECK            | VULB9168                     | 9168-153    | Apr. 11, 2011       | Apr. 10, 2012           |
| HORN Antenna<br>SCHWARZBECK             | 9120D                        | 9120D-405   | Feb. 08, 2011       | Feb. 07, 2012           |
| HORN Antenna<br>SCHWARZBECK             | BBHA 9170                    | BBHA9170243 | Dec. 27, 2010       | Dec. 26, 2011           |
| Preamplifier<br>Agilent                 | 8447D                        | 2944A10633  | Nov. 02, 2010       | Nov. 01, 2011           |
| Preamplifier<br>Agilent                 | 8449B                        | 3008A01964  | Nov. 02, 2010       | Nov. 01, 2011           |
| RF signal cable<br>HUBER+SUHNNER        | SUCOFLEX 104                 | 295014/4    | Sep 03, 2010        | Sep 02, 2011            |
| RF signal cable<br>HUBER+SUHNNER        | SUCOFLEX 104                 | 12738/6     | Sep 03, 2010        | Sep 02, 2011            |
| Software<br>ADT.                        | ADT_Radiated_<br>V7.6.15.9.2 | NA          | NA                  | NA                      |
| Antenna Tower<br>inn-co GmbH            | MA 4000                      | 013303      | NA                  | NA                      |
| Antenna Tower Controller<br>inn-co GmbH | CO2000                       | 017303      | NA                  | NA                      |
| Turn Table<br>ADT.                      | TT100.                       | TT93021703  | NA                  | NA                      |
| Turn Table Controller<br>ADT.           | SC100.                       | SC93021703  | NA                  | NA                      |
| 26GHz ~ 40GHz Amplifier                 | EM26400                      | 07026401    | Aug. 25, 2010       | Aug. 24, 2011           |

- NOTE:**
1. The calibration interval of the above test instruments is 12 months and the calibrations are traceable to NML/ROC and NIST/USA.
  2. The test was performed in HwaYa Chamber 3.
  3. The horn antenna and HP preamplifier (model: 8449B) are used only for the measurement of emission frequency above 1GHz if tested.
  4. The FCC Site Registration No. is 988962.
  5. The IC Site Registration No. is IC 7450F-3.

#### 4.1.4 TEST PROCEDURES

- a. The EUT was placed on the top of a rotating table 0.8 meters above the ground at a 3 meter semi-anechoic chamber. The table was rotated 360 degrees to determine the position of the highest radiation.
- b. The EUT was set 3 meters away from the interference-receiving antenna, which was mounted on the top of a variable-height antenna tower.
- c. The antenna is a broadband antenna, and its height is varied from one meter to four meters above the ground to determine the maximum value of the field strength. Both horizontal and vertical polarizations of the antenna are set to make the measurement.
- d. For each suspected emission, the EUT was arranged to its worst case and then the antenna was tuned to heights from 1 meter to 4 meters and the rotatable table was turned from 0 degrees to 360 degrees to find the maximum reading.
- e. The test-receiver system was set to Peak Detect Function and Specified Bandwidth with Maximum Hold Mode.
- f. If the emission level of the EUT in peak mode was 10dB lower than the limit specified, then testing could be stopped and the peak values of the EUT would be reported. Otherwise the emissions that did not have 10dB margin would be re-tested one by one using peak, quasi-peak or average method as specified and then reported in a data sheet.

**NOTE:**

1. The resolution bandwidth and video bandwidth of test receiver/spectrum analyzer is 120kHz for Peak detection (PK) and Quasi-peak detection (QP) at frequency below 1GHz.
2. The resolution bandwidth of test receiver/spectrum analyzer is 1MHz and video bandwidth is 3MHz for Peak detection at frequency above 1GHz.
3. The resolution bandwidth of test receiver/spectrum analyzer is 1MHz and the video bandwidth is 10Hz for Average detection (AV) at frequency above 1GHz.
4. All modes of operation were investigated and the worst-case emissions are reported.

#### 4.1.5 DEVIATION FROM TEST STANDARD

No deviation.



#### 4.1.6 TEST SETUP

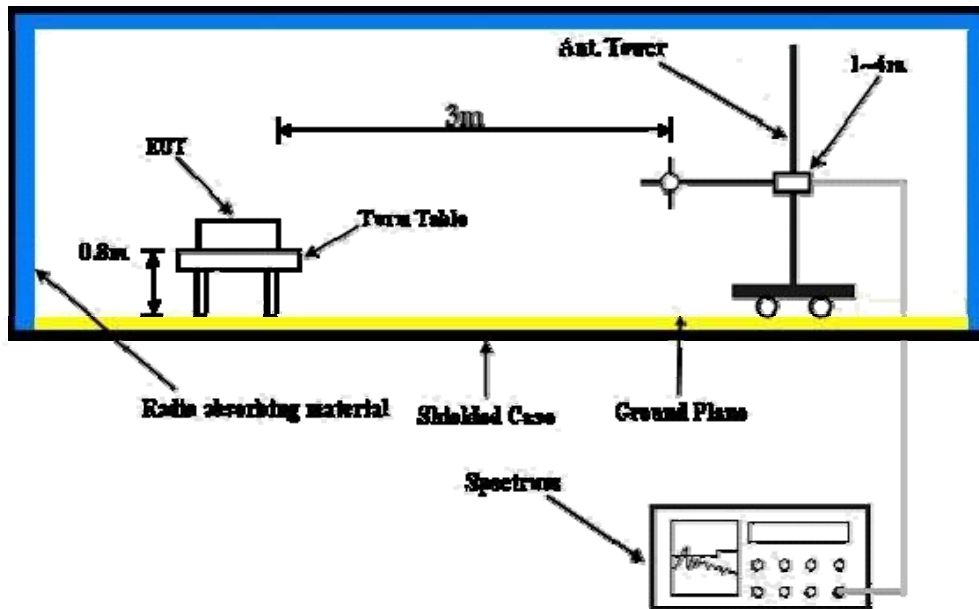

For the actual test configuration, please refer to the attached file (Test Setup Photo).

#### 4.1.7 EUT OPERATING CONDITION

- a. Placed the EUT on the testing table.
- b. Prepared notebook systems to act as a communication partner and placed them outside of testing area.
- c. The communication partners connected with EUT via a UTP cable and run a test program (provided by manufacturer) to enable EUT under transmission condition continuously at specific channel frequency.
- d. The communication partners sent data to EUT by command "PING".



## 4.1.8 TEST RESULTS

### 802.11a

| EUT TEST CONDITION       |                             | MEASUREMENT DETAIL |                           |
|--------------------------|-----------------------------|--------------------|---------------------------|
| CHANNEL                  | Channel 36                  | FREQUENCY RANGE    | 1 ~ 40GHz                 |
| INPUT POWER (SYSTEM)     | 120Vac, 60 Hz               | DETECTOR FUNCTION  | Peak (PK)<br>Average (AV) |
| ENVIRONMENTAL CONDITIONS | 25deg. C, 60%RH<br>1010 hPa | TESTED BY          | David Huang               |

| ANTENNA POLARITY & TEST DISTANCE: HORIZONTAL AT 3 M |             |                         |                |             |                    |                      |                  |                          |
|---|-------------|-------------------------|----------------|-------------|--------------------|----------------------|------------------|--------------------------|
| NO.   | FREQ. (MHz) | EMISSION LEVEL (dBuV/m) | LIMIT (dBuV/m) | MARGIN (dB) | ANTENNA HEIGHT (m) | TABLE ANGLE (Degree) | RAW VALUE (dBuV) | CORRECTION FACTOR (dB/m) |
| 1   | 5000.00     | 53.9 PK                 | 74.0           | -20.1       | 1.00 H             | 153                  | 16.90            | 37.00                    |
| 2   | 5000.00     | 43.9 AV                 | 54.0           | -10.1       | 1.00 H             | 153                  | 6.90             | 37.00                    |
| 3   | 5150.00     | 53.6 PK                 | 74.0           | -20.4       | 1.05 H             | 330                  | 16.30            | 37.30                    |
| 4   | 5150.00     | 40.7 AV                 | 54.0           | -13.3       | 1.05 H             | 330                  | 3.40             | 37.30                    |
| 5   | *5180.00    | 101.6 PK                |                |             | 1.05 H             | 330                  | 64.30            | 37.30                    |
| 6   | *5180.00    | 89.5 AV                 |                |             | 1.05 H             | 330                  | 52.20            | 37.30                    |
| 7   | #10360.00   | 56.3 PK                 | 68.3           | -12.0       | 1.00 H             | 255                  | 8.10             | 48.20                    |
| ANTENNA POLARITY & TEST DISTANCE: VERTICAL AT 3 M   |             |                         |                |             |                    |                      |                  |                          |
| NO.   | FREQ. (MHz) | EMISSION LEVEL (dBuV/m) | LIMIT (dBuV/m) | MARGIN (dB) | ANTENNA HEIGHT (m) | TABLE ANGLE (Degree) | RAW VALUE (dBuV) | CORRECTION FACTOR (dB/m) |
| 1   | 5000.00     | 58.7 PK                 | 74.0           | -15.3       | 1.07 V             | 160                  | 21.70            | 37.00                    |
| 2   | 5000.00     | 52.6 AV                 | 54.0           | -1.4        | 1.07 V             | 160                  | 15.60            | 37.00                    |
| 3   | 5150.00     | 62.0 PK                 | 74.0           | -12.0       | 1.24 V             | 320                  | 24.70            | 37.30                    |
| 4   | 5150.00     | 46.7 AV                 | 54.0           | -7.3        | 1.24 V             | 320                  | 9.40             | 37.30                    |
| 5   | *5180.00    | 112.7 PK                |                |             | 1.24 V             | 320                  | 75.40            | 37.30                    |
| 6   | *5180.00    | 99.4 AV                 |                |             | 1.24 V             | 320                  | 62.10            | 37.30                    |
| 7   | #10360.00   | 59.5 PK                 | 68.3           | -8.8        | 1.00 V             | 159                  | 11.30            | 48.20                    |

- REMARKS:**
1. Emission level (dBuV/m) = Raw Value (dBuV) + Correction Factor (dB/m).
  2. Correction Factor (dB/m) = Antenna Factor (dB/m) + Cable Factor (dB).
  3. The other emission levels were very low against the limit.
  4. Margin value = Emission level – Limit value.
  5. “ \* “: Fundamental frequency.
  6. “#”:The radiated frequency is out the restricted band.



A D T

| EUT TEST CONDITION       |                             | MEASUREMENT DETAIL |                           |
|--------------------------|-----------------------------|--------------------|---------------------------|
| CHANNEL                  | Channel 40                  | FREQUENCY RANGE    | 1 ~ 40GHz                 |
| INPUT POWER (SYSTEM)     | 120Vac, 60 Hz               | DETECTOR FUNCTION  | Peak (PK)<br>Average (AV) |
| ENVIRONMENTAL CONDITIONS | 25deg. C, 60%RH<br>1010 hPa | TESTED BY          | David Huang               |

| ANTENNA POLARITY & TEST DISTANCE: HORIZONTAL AT 3 M |             |                         |                |             |                    |                      |                  |                          |
|---|-------------|-------------------------|----------------|-------------|--------------------|----------------------|------------------|--------------------------|
| NO.   | FREQ. (MHz) | EMISSION LEVEL (dBuV/m) | LIMIT (dBuV/m) | MARGIN (dB) | ANTENNA HEIGHT (m) | TABLE ANGLE (Degree) | RAW VALUE (dBuV) | CORRECTION FACTOR (dB/m) |
| 1   | 5000.00     | 52.4 PK                 | 74.0           | -21.6       | 1.00 H             | 294                  | 15.50            | 36.90                    |
| 2   | 5000.00     | 46.1 AV                 | 54.0           | -7.9        | 1.00 H             | 294                  | 9.20             | 36.90                    |
| 3   | *5200.00    | 102.2 PK                |                |             | 1.00 H             | 291                  | 64.90            | 37.30                    |
| 4   | *5200.00    | 90.3 AV                 |                |             | 1.00 H             | 291                  | 53.00            | 37.30                    |
| 5   | #10400.00   | 62.0 PK                 | 68.3           | -6.3        | 1.12 H             | 192                  | 13.70            | 48.30                    |

| ANTENNA POLARITY & TEST DISTANCE: VERTICAL AT 3 M |             |                         |                |             |                    |                      |                  |                          |
|---|-------------|-------------------------|----------------|-------------|--------------------|----------------------|------------------|--------------------------|
| NO.   | FREQ. (MHz) | EMISSION LEVEL (dBuV/m) | LIMIT (dBuV/m) | MARGIN (dB) | ANTENNA HEIGHT (m) | TABLE ANGLE (Degree) | RAW VALUE (dBuV) | CORRECTION FACTOR (dB/m) |
| 1   | 5000.00     | 57.7 PK                 | 74.0           | -16.3       | 1.24 V             | 339                  | 20.80            | 36.90                    |
| 2   | 5000.00     | 51.9 AV                 | 54.0           | -2.1        | 1.24 V             | 339                  | 15.00            | 36.90                    |
| 3   | *5200.00    | 112.8 PK                |                |             | 1.13 V             | 194                  | 75.50            | 37.30                    |
| 4   | *5200.00    | 100.8 AV                |                |             | 1.13 V             | 194                  | 63.50            | 37.30                    |
| 5   | #10400.00   | 61.0 PK                 | 68.3           | -7.3        | 1.03 V             | 167                  | 12.70            | 48.30                    |

- REMARKS:**
1. Emission level (dBuV/m) = Raw Value (dBuV) + Correction Factor (dB/m).
  2. Correction Factor (dB/m) = Antenna Factor (dB/m) + Cable Factor (dB).
  3. The other emission levels were very low against the limit.
  4. Margin value = Emission level – Limit value.
  5. “ \* “: Fundamental frequency.
  6. “#”:The radiated frequency is out the restricted band.



A D T

| EUT TEST CONDITION       |                             | MEASUREMENT DETAIL |                           |
|--------------------------|-----------------------------|--------------------|---------------------------|
| CHANNEL                  | Channel 48                  | FREQUENCY RANGE    | 1 ~ 40GHz                 |
| INPUT POWER (SYSTEM)     | 120Vac, 60 Hz               | DETECTOR FUNCTION  | Peak (PK)<br>Average (AV) |
| ENVIRONMENTAL CONDITIONS | 25deg. C, 60%RH<br>1010 hPa | TESTED BY          | David Huang               |

| ANTENNA POLARITY & TEST DISTANCE: HORIZONTAL AT 3 M |             |                         |                |             |                    |                      |                  |                          |
|---|-------------|-------------------------|----------------|-------------|--------------------|----------------------|------------------|--------------------------|
| NO.   | FREQ. (MHz) | EMISSION LEVEL (dBuV/m) | LIMIT (dBuV/m) | MARGIN (dB) | ANTENNA HEIGHT (m) | TABLE ANGLE (Degree) | RAW VALUE (dBuV) | CORRECTION FACTOR (dB/m) |
| 1   | 5000.00     | 50.6 PK                 | 74.0           | -23.4       | 1.04 H             | 291                  | 13.70            | 36.90                    |
| 2   | 5000.00     | 43.2 AV                 | 54.0           | -10.8       | 1.04 H             | 291                  | 6.30             | 36.90                    |
| 3   | *5240.00    | 103.0 PK                |                |             | 1.02 H             | 299                  | 65.70            | 37.30                    |
| 4   | *5240.00    | 90.9 AV                 |                |             | 1.02 H             | 299                  | 53.60            | 37.30                    |
| 5   | 5350.00     | 48.0 PK                 | 74.0           | -26.0       | 1.05 H             | 291                  | 10.50            | 37.50                    |
| 6   | 5350.00     | 34.4 AV                 | 54.0           | -19.6       | 1.05 H             | 291                  | -3.10            | 37.50                    |
| 7   | #10480.00   | 62.1 PK                 | 68.3           | -6.2        | 1.08 H             | 197                  | 13.70            | 48.40                    |
| ANTENNA POLARITY & TEST DISTANCE: VERTICAL AT 3 M   |             |                         |                |             |                    |                      |                  |                          |
| NO.   | FREQ. (MHz) | EMISSION LEVEL (dBuV/m) | LIMIT (dBuV/m) | MARGIN (dB) | ANTENNA HEIGHT (m) | TABLE ANGLE (Degree) | RAW VALUE (dBuV) | CORRECTION FACTOR (dB/m) |
| 1   | 5000.00     | 57.6 PK                 | 74.0           | -16.4       | 1.22 V             | 335                  | 20.70            | 36.90                    |
| 2   | 5000.00     | 52.1 AV                 | 54.0           | -1.9        | 1.22 V             | 335                  | 15.20            | 36.90                    |
| 3   | *5240.00    | 112.4 PK                |                |             | 1.23 V             | 196                  | 75.10            | 37.30                    |
| 4   | *5240.00    | 100.3 AV                |                |             | 1.23 V             | 196                  | 63.00            | 37.30                    |
| 5   | 5350.00     | 57.2 PK                 | 74.0           | -16.8       | 1.21 V             | 209                  | 19.70            | 37.50                    |
| 6   | 5350.00     | 41.8 AV                 | 54.0           | -12.2       | 1.21 V             | 209                  | 4.30             | 37.50                    |
| 7   | #10480.00   | 60.4 PK                 | 68.3           | -7.9        | 1.07 V             | 168                  | 12.00            | 48.40                    |

- REMARKS:**
1. Emission level (dBuV/m) = Raw Value (dBuV) + Correction Factor (dB/m).
  2. Correction Factor (dB/m) = Antenna Factor (dB/m) + Cable Factor (dB).
  3. The other emission levels were very low against the limit.
  4. Margin value = Emission level – Limit value.
  5. “ \* “: Fundamental frequency.
  6. “#”:The radiated frequency is out the restricted band.



A D T

802.11n (20MHz)

| EUT TEST CONDITION       |                             | MEASUREMENT DETAIL |                           |
|--------------------------|-----------------------------|--------------------|---------------------------|
| CHANNEL                  | Channel 36                  | FREQUENCY RANGE    | 1 ~ 40GHz                 |
| INPUT POWER (SYSTEM)     | 120Vac, 60 Hz               | DETECTOR FUNCTION  | Peak (PK)<br>Average (AV) |
| ENVIRONMENTAL CONDITIONS | 21deg. C, 60%RH<br>1010 hPa | TESTED BY          | Sun Lin                   |

| ANTENNA POLARITY & TEST DISTANCE: HORIZONTAL AT 3 M |             |                         |                |             |                    |                      |                  |                          |
|---|-------------|-------------------------|----------------|-------------|--------------------|----------------------|------------------|--------------------------|
| NO.   | FREQ. (MHz) | EMISSION LEVEL (dBuV/m) | LIMIT (dBuV/m) | MARGIN (dB) | ANTENNA HEIGHT (m) | TABLE ANGLE (Degree) | RAW VALUE (dBuV) | CORRECTION FACTOR (dB/m) |
| 1   | 5120.00     | 55.0 PK                 | 74.0           | -19.0       | 1.00 H             | 223                  | 17.80            | 37.20                    |
| 2   | 5120.00     | 42.0 AV                 | 54.0           | -12.0       | 1.00 H             | 223                  | 4.80             | 37.20                    |
| 3   | *5180.00    | 99.1 PK                 |                |             | 1.00 H             | 223                  | 61.80            | 37.30                    |
| 4   | *5180.00    | 87.2 AV                 |                |             | 1.00 H             | 223                  | 49.90            | 37.30                    |
| 5   | 5360.00     | 56.1 PK                 | 74.0           | -17.9       | 1.23 H             | 240                  | 18.50            | 37.60                    |
| 6   | 5360.00     | 42.7 AV                 | 54.0           | -11.3       | 1.23 H             | 240                  | 5.10             | 37.60                    |
| 7   | #10360.00   | 57.7 PK                 | 68.3           | -10.6       | 1.08 H             | 128                  | 9.50             | 48.20                    |
| ANTENNA POLARITY & TEST DISTANCE: VERTICAL AT 3 M   |             |                         |                |             |                    |                      |                  |                          |
| NO.   | FREQ. (MHz) | EMISSION LEVEL (dBuV/m) | LIMIT (dBuV/m) | MARGIN (dB) | ANTENNA HEIGHT (m) | TABLE ANGLE (Degree) | RAW VALUE (dBuV) | CORRECTION FACTOR (dB/m) |
| 1   | 5120.00     | 49.2 PK                 | 74.0           | -24.8       | 1.12 V             | 0                    | 12.00            | 37.20                    |
| 2   | 5120.00     | 39.8 AV                 | 54.0           | -14.2       | 1.12 V             | 0                    | 2.60             | 37.20                    |
| 3   | *5180.00    | 111.7 PK                |                |             | 1.00 V             | 15                   | 74.40            | 37.30                    |
| 4   | *5180.00    | 99.9 AV                 |                |             | 1.00 V             | 15                   | 62.60            | 37.30                    |
| 5   | 5360.00     | 60.7 PK                 | 74.0           | -13.3       | 1.56 V             | 208                  | 23.10            | 37.60                    |
| 6   | 5360.00     | 52.8 AV                 | 54.0           | -1.2        | 1.56 V             | 208                  | 15.20            | 37.60                    |
| 7   | #10360.00   | 59.8 PK                 | 68.3           | -8.5        | 1.22 V             | 328                  | 11.60            | 48.20                    |

- REMARKS:**
1. Emission level (dBuV/m) = Raw Value (dBuV) + Correction Factor (dB/m).
  2. Correction Factor (dB/m) = Antenna Factor (dB/m) + Cable Factor (dB).
  3. The other emission levels were very low against the limit.
  4. Margin value = Emission level – Limit value.
  5. “ \* “: Fundamental frequency.
  6. "#":The radiated frequency is out the restricted band.



A D T

| EUT TEST CONDITION       |                             | MEASUREMENT DETAIL |                           |
|--------------------------|-----------------------------|--------------------|---------------------------|
| CHANNEL                  | Channel 40                  | FREQUENCY RANGE    | 1 ~ 40GHz                 |
| INPUT POWER (SYSTEM)     | 120Vac, 60 Hz               | DETECTOR FUNCTION  | Peak (PK)<br>Average (AV) |
| ENVIRONMENTAL CONDITIONS | 22deg. C, 61%RH<br>1010 hPa | TESTED BY          | Sun Lin                   |

| ANTENNA POLARITY & TEST DISTANCE: HORIZONTAL AT 3 M |             |                         |                |             |                    |                      |                  |                          |
|---|-------------|-------------------------|----------------|-------------|--------------------|----------------------|------------------|--------------------------|
| NO.   | FREQ. (MHz) | EMISSION LEVEL (dBuV/m) | LIMIT (dBuV/m) | MARGIN (dB) | ANTENNA HEIGHT (m) | TABLE ANGLE (Degree) | RAW VALUE (dBuV) | CORRECTION FACTOR (dB/m) |
| 1   | 5080.00     | 50.9 PK                 | 74.0           | -23.1       | 1.02 H             | 106                  | 14.20            | 36.70                    |
| 2   | 5080.00     | 40.0 AV                 | 54.0           | -14.0       | 1.02 H             | 106                  | 3.30             | 36.70                    |
| 3   | *5200.00    | 100.8 PK                |                |             | 1.19 H             | 218                  | 64.00            | 36.80                    |
| 4   | *5200.00    | 88.3 AV                 |                |             | 1.19 H             | 218                  | 51.50            | 36.80                    |
| 5   | #10400.00   | 57.9 PK                 | 68.3           | -10.4       | 1.00 H             | 332                  | 10.30            | 47.60                    |

| ANTENNA POLARITY & TEST DISTANCE: VERTICAL AT 3 M |             |                         |                |             |                    |                      |                  |                          |
|---|-------------|-------------------------|----------------|-------------|--------------------|----------------------|------------------|--------------------------|
| NO.   | FREQ. (MHz) | EMISSION LEVEL (dBuV/m) | LIMIT (dBuV/m) | MARGIN (dB) | ANTENNA HEIGHT (m) | TABLE ANGLE (Degree) | RAW VALUE (dBuV) | CORRECTION FACTOR (dB/m) |
| 1   | 5080.00     | 58.5 PK                 | 74.0           | -15.5       | 1.00 V             | 231                  | 21.80            | 36.70                    |
| 2   | 5080.00     | 51.3 AV                 | 54.0           | -2.7        | 1.00 V             | 231                  | 14.60            | 36.70                    |
| 3   | *5200.00    | 112.9 PK                |                |             | 1.00 V             | 13                   | 76.10            | 36.80                    |
| 4   | *5200.00    | 100.8 AV                |                |             | 1.00 V             | 13                   | 64.00            | 36.80                    |
| 5   | #10400.00   | 57.2 PK                 | 68.3           | -11.1       | 1.00 V             | 7                    | 9.60             | 47.60                    |

- REMARKS:**
1. Emission level (dBuV/m) = Raw Value (dBuV) + Correction Factor (dB/m).
  2. Correction Factor (dB/m) = Antenna Factor (dB/m) + Cable Factor (dB).
  3. The other emission levels were very low against the limit.
  4. Margin value = Emission level – Limit value.
  5. “ \* “: Fundamental frequency.
  6. “#“: The radiated frequency is out the restricted band.



A D T

| EUT TEST CONDITION       |                             | MEASUREMENT DETAIL |                           |
|--------------------------|-----------------------------|--------------------|---------------------------|
| CHANNEL                  | Channel 48                  | FREQUENCY RANGE    | 1 ~ 40GHz                 |
| INPUT POWER (SYSTEM)     | 120Vac, 60 Hz               | DETECTOR FUNCTION  | Peak (PK)<br>Average (AV) |
| ENVIRONMENTAL CONDITIONS | 21deg. C, 60%RH<br>1010 hPa | TESTED BY          | Sun Lin                   |

| ANTENNA POLARITY & TEST DISTANCE: HORIZONTAL AT 3 M |             |                         |                |             |                    |                      |                  |                          |
|---|-------------|-------------------------|----------------|-------------|--------------------|----------------------|------------------|--------------------------|
| NO.   | FREQ. (MHz) | EMISSION LEVEL (dBuV/m) | LIMIT (dBuV/m) | MARGIN (dB) | ANTENNA HEIGHT (m) | TABLE ANGLE (Degree) | RAW VALUE (dBuV) | CORRECTION FACTOR (dB/m) |
| 1   | 5040.00     | 56.5 PK                 | 74.0           | -17.5       | 1.28 H             | 235                  | 19.40            | 37.10                    |
| 2   | 5040.00     | 43.4 AV                 | 54.0           | -10.6       | 1.28 H             | 235                  | 6.30             | 37.10                    |
| 3   | *5240.00    | 99.8 PK                 |                |             | 1.02 H             | 247                  | 62.40            | 37.40                    |
| 4   | *5240.00    | 87.9 AV                 |                |             | 1.02 H             | 247                  | 50.50            | 37.40                    |
| 5   | 5350.00     | 55.2 PK                 | 74.0           | -18.8       | 1.08 H             | 247                  | 17.60            | 37.60                    |
| 6   | 5350.00     | 42.3 AV                 | 54.0           | -11.7       | 1.08 H             | 247                  | 4.70             | 37.60                    |
| 7   | #10480.00   | 57.8 PK                 | 68.3           | -10.5       | 1.17 H             | 135                  | 9.40             | 48.40                    |

| ANTENNA POLARITY & TEST DISTANCE: VERTICAL AT 3 M |             |                         |                |             |                    |                      |                  |                          |
|---|-------------|-------------------------|----------------|-------------|--------------------|----------------------|------------------|--------------------------|
| NO.   | FREQ. (MHz) | EMISSION LEVEL (dBuV/m) | LIMIT (dBuV/m) | MARGIN (dB) | ANTENNA HEIGHT (m) | TABLE ANGLE (Degree) | RAW VALUE (dBuV) | CORRECTION FACTOR (dB/m) |
| 1   | 5040.00     | 59.7 PK                 | 74.0           | -14.3       | 1.53 V             | 141                  | 22.60            | 37.10                    |
| 2   | 5040.00     | 51.5 AV                 | 54.0           | -2.5        | 1.53 V             | 141                  | 14.40            | 37.10                    |
| 3   | *5240.00    | 112.3 PK                |                |             | 1.41 V             | 32                   | 74.90            | 37.40                    |
| 4   | *5240.00    | 100.9 AV                |                |             | 1.41 V             | 32                   | 63.50            | 37.40                    |
| 5   | 5350.00     | 57.8 PK                 | 74.0           | -16.2       | 1.22 V             | 31                   | 20.20            | 37.60                    |
| 6   | 5350.00     | 48.3 AV                 | 54.0           | -5.7        | 1.22 V             | 31                   | 10.70            | 37.60                    |
| 7   | #10480.00   | 59.7 PK                 | 68.3           | -8.6        | 1.37 V             | 68                   | 11.30            | 48.40                    |

- REMARKS:**
1. Emission level (dBuV/m) = Raw Value (dBuV) + Correction Factor (dB/m).
  2. Correction Factor (dB/m) = Antenna Factor (dB/m) + Cable Factor (dB).
  3. The other emission levels were very low against the limit.
  4. Margin value = Emission level – Limit value.
  5. “ \* “: Fundamental frequency.
  6. “#”: The radiated frequency is out the restricted band.



A D T

## 802.11n (40MHz)

| EUT TEST CONDITION       |                             | MEASUREMENT DETAIL |                           |
|--------------------------|-----------------------------|--------------------|---------------------------|
| CHANNEL                  | Channel 38                  | FREQUENCY RANGE    | 1 ~ 40GHz                 |
| INPUT POWER (SYSTEM)     | 120Vac, 60 Hz               | DETECTOR FUNCTION  | Peak (PK)<br>Average (AV) |
| ENVIRONMENTAL CONDITIONS | 21deg. C, 60%RH<br>1010 hPa | TESTED BY          | Sun Lin                   |

| ANTENNA POLARITY & TEST DISTANCE: HORIZONTAL AT 3 M |                |                         |                |             |                    |                      |                  |                          |
|---|----------------|-------------------------|----------------|-------------|--------------------|----------------------|------------------|--------------------------|
| NO.   | FREQ. (MHz)    | EMISSION LEVEL (dBuV/m) | LIMIT (dBuV/m) | MARGIN (dB) | ANTENNA HEIGHT (m) | TABLE ANGLE (Degree) | RAW VALUE (dBuV) | CORRECTION FACTOR (dB/m) |
| 1   | 5040.00        | 54.7 PK                 | 74.0           | -19.3       | 1.02 H             | 268                  | 17.60            | 37.10                    |
| 2   | 5040.00        | 41.5 AV                 | 54.0           | -12.5       | 1.02 H             | 268                  | 4.40             | 37.10                    |
| 3   | 5150.00        | 54.5 PK                 | 74.0           | -19.5       | 1.00 H             | 255                  | 17.20            | 37.30                    |
| 4   | 5150.00        | 41.7 AV                 | 54.0           | -12.3       | 1.00 H             | 255                  | 4.40             | 37.30                    |
| 5   | *5190.00       | 95.8 PK                 |                |             | 1.03 H             | 212                  | 58.50            | 37.30                    |
| 6   | *5190.00       | 83.4 AV                 |                |             | 1.03 H             | 212                  | 46.10            | 37.30                    |
| 7   | #10380.00      | 56.8 PK                 | 68.3           | -11.5       | 1.12 H             | 153                  | 8.50             | 48.30                    |
| ANTENNA POLARITY & TEST DISTANCE: VERTICAL AT 3 M   |                |                         |                |             |                    |                      |                  |                          |
| NO.   | FREQ. (MHz)    | EMISSION LEVEL (dBuV/m) | LIMIT (dBuV/m) | MARGIN (dB) | ANTENNA HEIGHT (m) | TABLE ANGLE (Degree) | RAW VALUE (dBuV) | CORRECTION FACTOR (dB/m) |
| 1   | 5040.00        | 59.9 PK                 | 74.0           | -14.1       | 1.44 V             | 138                  | 22.80            | 37.10                    |
| 2   | 5040.00        | 51.4 AV                 | 54.0           | -2.6        | 1.44 V             | 138                  | 14.30            | 37.10                    |
| 3   | 5150.00        | 67.2 PK                 | 74.0           | -6.8        | 1.00 V             | 23                   | 29.90            | 37.30                    |
| 4   | <b>5150.00</b> | <b>53.0 AV</b>          | <b>54.0</b>    | <b>-1.0</b> | <b>1.00 V</b>      | <b>23</b>            | <b>15.70</b>     | <b>37.30</b>             |
| 5   | *5190.00       | 107.7 PK                |                |             | 1.09 V             | 24                   | 70.40            | 37.30                    |
| 6   | *5190.00       | 96.2 AV                 |                |             | 1.09 V             | 24                   | 58.90            | 37.30                    |
| 7   | #10380.00      | 60.0 PK                 | 68.3           | -8.3        | 1.12 V             | 335                  | 11.70            | 48.30                    |

- REMARKS:**
1. Emission level (dBuV/m) = Raw Value (dBuV) + Correction Factor (dB/m).
  2. Correction Factor (dB/m) = Antenna Factor (dB/m) + Cable Factor (dB).
  3. The other emission levels were very low against the limit.
  4. Margin value = Emission level – Limit value.
  5. “ \* “: Fundamental frequency.
  6. “#”:The radiated frequency is out the restricted band.





A D T

| EUT TEST CONDITION       |                             | MEASUREMENT DETAIL |                           |
|--------------------------|-----------------------------|--------------------|---------------------------|
| CHANNEL                  | Channel 46                  | FREQUENCY RANGE    | 1 ~ 40GHz                 |
| INPUT POWER (SYSTEM)     | 120Vac, 60 Hz               | DETECTOR FUNCTION  | Peak (PK)<br>Average (AV) |
| ENVIRONMENTAL CONDITIONS | 21deg. C, 60%RH<br>1010 hPa | TESTED BY          | Sun Lin                   |

| ANTENNA POLARITY & TEST DISTANCE: HORIZONTAL AT 3 M |             |                         |                |             |                    |                      |                  |                          |
|---|-------------|-------------------------|----------------|-------------|--------------------|----------------------|------------------|--------------------------|
| NO.   | FREQ. (MHz) | EMISSION LEVEL (dBuV/m) | LIMIT (dBuV/m) | MARGIN (dB) | ANTENNA HEIGHT (m) | TABLE ANGLE (Degree) | RAW VALUE (dBuV) | CORRECTION FACTOR (dB/m) |
| 1   | 5000.00     | 55.2 PK                 | 74.0           | -18.8       | 1.00 H             | 238                  | 18.20            | 37.00                    |
| 2   | 5000.00     | 42.3 AV                 | 54.0           | -11.7       | 1.00 H             | 238                  | 5.30             | 37.00                    |
| 3   | *5230.00    | 96.1 PK                 |                |             | 1.00 H             | 247                  | 58.70            | 37.40                    |
| 4   | *5230.00    | 83.8 AV                 |                |             | 1.00 H             | 247                  | 46.40            | 37.40                    |
| 5   | 5360.00     | 55.6 PK                 | 74.0           | -18.4       | 1.02 H             | 258                  | 18.00            | 37.60                    |
| 6   | 5360.00     | 42.7 AV                 | 54.0           | -11.3       | 1.02 H             | 258                  | 5.10             | 37.60                    |
| 7   | #10460.00   | 57.5 PK                 | 68.3           | -10.8       | 1.07 H             | 168                  | 9.10             | 48.40                    |

| ANTENNA POLARITY & TEST DISTANCE: VERTICAL AT 3 M |             |                         |                |             |                    |                      |                  |                          |
|---|-------------|-------------------------|----------------|-------------|--------------------|----------------------|------------------|--------------------------|
| NO.   | FREQ. (MHz) | EMISSION LEVEL (dBuV/m) | LIMIT (dBuV/m) | MARGIN (dB) | ANTENNA HEIGHT (m) | TABLE ANGLE (Degree) | RAW VALUE (dBuV) | CORRECTION FACTOR (dB/m) |
| 1   | 5000.00     | 58.1 PK                 | 74.0           | -15.9       | 1.00 V             | 101                  | 21.10            | 37.00                    |
| 2   | 5000.00     | 48.9 AV                 | 54.0           | -5.1        | 1.00 V             | 101                  | 11.90            | 37.00                    |
| 3   | *5230.00    | 107.8 PK                |                |             | 1.27 V             | 34                   | 70.40            | 37.40                    |
| 4   | *5230.00    | 96.7 AV                 |                |             | 1.27 V             | 34                   | 59.30            | 37.40                    |
| 5   | 5360.00     | 59.0 PK                 | 74.0           | -15.0       | 1.37 V             | 43                   | 21.40            | 37.60                    |
| 6   | 5360.00     | 50.6 AV                 | 54.0           | -3.4        | 1.37 V             | 43                   | 13.00            | 37.60                    |
| 7   | #10460.00   | 59.6 PK                 | 68.3           | -8.7        | 1.27 V             | 353                  | 11.20            | 48.40                    |

- REMARKS:**
1. Emission level (dBuV/m) = Raw Value (dBuV) + Correction Factor (dB/m).
  2. Correction Factor (dB/m) = Antenna Factor (dB/m) + Cable Factor (dB).
  3. The other emission levels were very low against the limit.
  4. Margin value = Emission level – Limit value.
  5. “ \* “: Fundamental frequency.
  6. “#“: The radiated frequency is out the restricted band.



A D T

**BELOW 1GHz WORST-CASE DATA : 802.11n (20MHz)**

| EUT TEST CONDITION       |                             | MEASUREMENT DETAIL |               |
|--------------------------|-----------------------------|--------------------|---------------|
| CHANNEL                  | Channel 36                  | FREQUENCY RANGE    | Below 1000MHz |
| INPUT POWER (SYSTEM)     | 120Vac, 60 Hz               | DETECTOR FUNCTION  | Quasi-Peak    |
| ENVIRONMENTAL CONDITIONS | 25deg. C, 60%RH<br>1010 hPa | TEST MODE          | A             |
| TESTED BY                | Mitch Jen                   |                    |               |

| ANTENNA POLARITY & TEST DISTANCE: HORIZONTAL AT 3 M |             |                         |                |             |                    |                      |                  |                          |
|---|-------------|-------------------------|----------------|-------------|--------------------|----------------------|------------------|--------------------------|
| NO.   | FREQ. (MHz) | EMISSION LEVEL (dBuV/m) | LIMIT (dBuV/m) | MARGIN (dB) | ANTENNA HEIGHT (m) | TABLE ANGLE (Degree) | RAW VALUE (dBuV) | CORRECTION FACTOR (dB/m) |
| 1   | 82.40       | 36.2 QP                 | 40.0           | -3.8        | 2.00 H             | 151                  | 27.10            | 9.10                     |
| 2   | 146.56      | 42.2 QP                 | 43.5           | -1.3        | 2.00 H             | 304                  | 27.80            | 14.40                    |
| 3   | 162.11      | 38.5 QP                 | 43.5           | -5.0        | 2.00 H             | 307                  | 24.00            | 14.50                    |
| 4   | 374.04      | 44.6 QP                 | 46.0           | -1.4        | 2.00 H             | 7                    | 27.80            | 16.80                    |
| 5   | 467.36      | 44.9 QP                 | 46.0           | -1.1        | 2.00 H             | 58                   | 25.60            | 19.30                    |
| 6   | 932.05      | 38.4 QP                 | 46.0           | -7.6        | 2.00 H             | 64                   | 11.00            | 27.40                    |

| ANTENNA POLARITY & TEST DISTANCE: VERTICAL AT 3 M |             |                         |                |             |                    |                      |                  |                          |
|---|-------------|-------------------------|----------------|-------------|--------------------|----------------------|------------------|--------------------------|
| NO.   | FREQ. (MHz) | EMISSION LEVEL (dBuV/m) | LIMIT (dBuV/m) | MARGIN (dB) | ANTENNA HEIGHT (m) | TABLE ANGLE (Degree) | RAW VALUE (dBuV) | CORRECTION FACTOR (dB/m) |
| 1   | 30.00       | 38.8 QP                 | 40.0           | -1.2        | 2.00 V             | 28                   | 26.20            | 12.60                    |
| 2   | 74.62       | 38.2 QP                 | 40.0           | -1.8        | 2.00 V             | 28                   | 27.40            | 10.80                    |
| 3   | 125.17      | 39.8 QP                 | 43.5           | -3.7        | 1.00 V             | 130                  | 26.80            | 13.00                    |
| 4   | 140.72      | 42.1 QP                 | 43.5           | -1.4        | 1.00 V             | 124                  | 27.90            | 14.20                    |
| 5   | 420.70      | 42.1 QP                 | 46.0           | -3.9        | 1.00 V             | 10                   | 24.10            | 18.00                    |
| 6   | 467.36      | 44.6 QP                 | 46.0           | -1.4        | 1.00 V             | 52                   | 25.30            | 19.30                    |

- REMARKS:**
1. Emission level (dBuV/m) = Raw Value (dBuV) + Correction Factor (dB/m).
  2. Correction Factor (dB/m) = Antenna Factor (dB/m) + Cable Factor (dB).
  3. The other emission levels were very low against the limit.
  4. Margin value = Emission level – Limit value.



A D T

| EUT TEST CONDITION       |                             | MEASUREMENT DETAIL |               |
|--------------------------|-----------------------------|--------------------|---------------|
| CHANNEL                  | Channel 36                  | FREQUENCY RANGE    | Below 1000MHz |
| INPUT POWER (SYSTEM)     | 120Vac, 60 Hz               | DETECTOR FUNCTION  | Quasi-Peak    |
| ENVIRONMENTAL CONDITIONS | 25deg. C, 60%RH<br>1010 hPa | TEST MODE          | B             |
| TESTED BY                | Mitch Jen                   |                    |               |

| ANTENNA POLARITY & TEST DISTANCE: HORIZONTAL AT 3 M |             |                         |                |             |                    |                      |                  |                          |
|---|-------------|-------------------------|----------------|-------------|--------------------|----------------------|------------------|--------------------------|
| NO.   | FREQ. (MHz) | EMISSION LEVEL (dBuV/m) | LIMIT (dBuV/m) | MARGIN (dB) | ANTENNA HEIGHT (m) | TABLE ANGLE (Degree) | RAW VALUE (dBuV) | CORRECTION FACTOR (dB/m) |
| 1   | 82.40       | 33.0 QP                 | 40.0           | -7.0        | 2.00 H             | 145                  | 23.90            | 9.10                     |
| 2   | 99.89       | 41.2 QP                 | 43.5           | -2.3        | 2.00 H             | 58                   | 30.90            | 10.30                    |
| 3   | 146.56      | 42.5 QP                 | 43.5           | -1.0        | 2.00 H             | 307                  | 28.10            | 14.40                    |
| 4   | 374.04      | 42.0 QP                 | 46.0           | -4.0        | 2.00 H             | 19                   | 25.20            | 16.80                    |
| 5   | 467.36      | 44.5 QP                 | 46.0           | -1.5        | 2.00 H             | 58                   | 25.20            | 19.30                    |
| 6   | 897.05      | 41.7 QP                 | 46.0           | -4.3        | 2.00 H             | 25                   | 14.80            | 26.90                    |
| ANTENNA POLARITY & TEST DISTANCE: VERTICAL AT 3 M   |             |                         |                |             |                    |                      |                  |                          |
| NO.   | FREQ. (MHz) | EMISSION LEVEL (dBuV/m) | LIMIT (dBuV/m) | MARGIN (dB) | ANTENNA HEIGHT (m) | TABLE ANGLE (Degree) | RAW VALUE (dBuV) | CORRECTION FACTOR (dB/m) |
| 1   | 45.45       | 38.6 QP                 | 40.0           | -1.4        | 1.00 V             | 136                  | 24.10            | 14.50                    |
| 2   | 74.62       | 37.7 QP                 | 40.0           | -2.3        | 2.00 V             | 70                   | 26.90            | 10.80                    |
| 3   | 144.61      | 41.7 QP                 | 43.5           | -1.8        | 1.00 V             | 121                  | 27.40            | 14.30                    |
| 4   | 467.36      | 44.6 QP                 | 46.0           | -1.4        | 1.00 V             | 49                   | 25.30            | 19.30                    |
| 5   | 830.95      | 43.8 QP                 | 46.0           | -2.2        | 2.00 V             | 205                  | 18.00            | 25.80                    |
| 6   | 875.67      | 36.9 QP                 | 46.0           | -9.1        | 2.00 V             | 55                   | 10.30            | 26.60                    |

- REMARKS:**
1. Emission level (dBuV/m) = Raw Value (dBuV) + Correction Factor (dB/m).
  2. Correction Factor (dB/m) = Antenna Factor (dB/m) + Cable Factor (dB).
  3. The other emission levels were very low against the limit.
  4. Margin value = Emission level – Limit value.

## 4.2 CONDUCTED EMISSION MEASUREMENT

### 4.2.1 LIMITS OF CONDUCTED EMISSION MEASUREMENT

| FREQUENCY OF EMISSION (MHz) | CONDUCTED LIMIT (dB $\mu$ V) |          |
|-----------------------------|------------------------------|----------|
|                             | Quasi-peak                   | Average  |
| 0.15 ~ 0.5                  | 66 to 56                     | 56 to 46 |
| 0.5 ~ 5                     | 56                           | 46       |
| 5 ~ 30                      | 60                           | 50       |

- NOTE:**
1. The lower limit shall apply at the transition frequencies.
  2. The limit decreases in line with the logarithm of the frequency in the range of 0.15 to 0.50MHz.
  3. All emanations from a class A/B digital device or system, including any network of conductors and apparatus connected thereto, shall not exceed the level of field strengths specified above.

### 4.2.2 TEST INSTRUMENTS

| DESCRIPTION & MANUFACTURER       | MODEL NO.           | SERIAL NO.     | DATE OF CALIBRATION | DUE DATE OF CALIBRATION |
|----------------------------------|---------------------|----------------|---------------------|-------------------------|
| Test Receiver<br>ROHDE & SCHWARZ | ESCS30              | 100291         | Nov. 30, 2010       | Nov. 29, 2011           |
| RF signal cable<br>Woken         | 5D-FB               | Cable-HYC01-01 | Dec. 30, 2010       | Dec. 29, 2011           |
| LISN<br>ROHDE & SCHWARZ          | ESH3-Z5             | 100311         | Jul. 08, 2010       | Jul. 07, 2011           |
| LISN<br>ROHDE & SCHWARZ          | ESH3-Z5             | 835239/001     | Feb. 22, 2011       | Feb. 21, 2012           |
| V-LISN<br>SCHWARZBECK            | NNBL 8226-2         | 8226-142       | Jul. 12, 2010       | Jul. 11, 2011           |
| LISN<br>ROHDE & SCHWARZ          | ENV216              | 100072         | Jun. 10, 2011       | Jun. 09, 2012           |
| Software<br>ADT                  | ADT_Cond_<br>V7.3.7 | NA             | NA                  | NA                      |

- NOTE:**
1. The calibration interval of the above test instruments is 12 months and the calibrations are traceable to NML/ROC and NIST/USA.
  2. The test was performed in HwaYa Shielded Room 1.
  3. The VCCI Site Registration No. is C-2040.

#### 4.2.3 TEST PROCEDURES

- a. The EUT was placed 0.4 meters from the conducting wall of the shielded room with EUT being connected to the power mains through a line impedance stabilization network (LISN). Other support units were connected to the power mains through another LISN. The two LISNs provide 50 ohm/ 50uH of coupling impedance for the measuring instrument.
- b. Both lines of the power mains connected to the EUT were checked for maximum conducted interference.
- c. The frequency range from 150kHz to 30MHz was searched. Emission levels under (Limit - 20dB) was not recorded.

**NOTE:** All modes of operation were investigated and the worst-case emissions are reported.

#### 4.2.4 DEVIATION FROM TEST STANDARD

No deviation.

#### 4.2.5 TEST SETUP

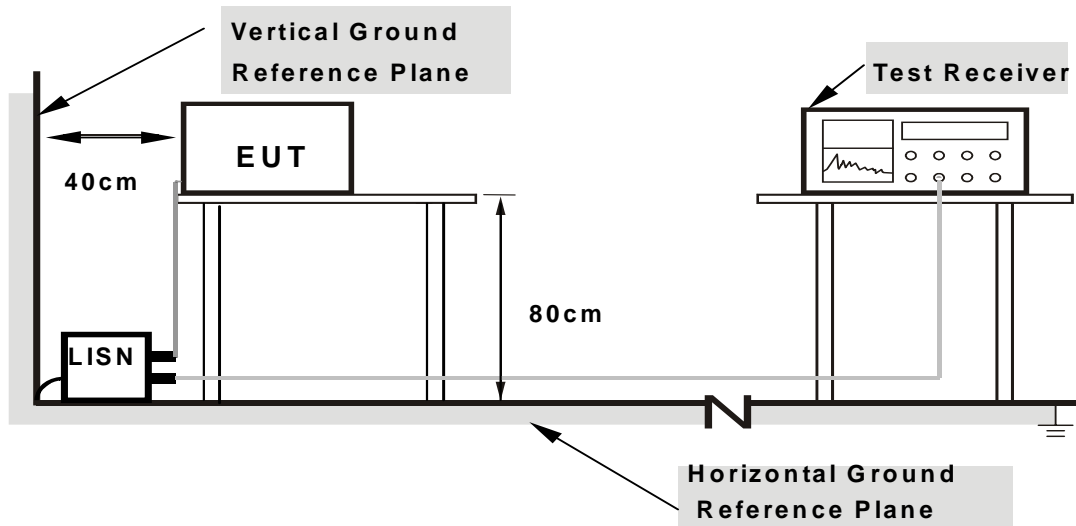

**Note: 1.Support units were connected to second LISN.**

**2.Both of LISNs (AMN) are 80 cm from EUT and at least 80 from other units and other metal planes**

For the actual test configuration, please refer to the attached file (Test Setup Photo).

#### 4.2.6 EUT OPERATING CONDITIONS

Same as 4.1.6.



A D T

### 4.2.7 TEST RESULTS

#### CONDUCTED WORST-CASE DATA : 802.11n (40MHz)

|           |        |               |      |
|-----------|--------|---------------|------|
| PHASE     | Line 1 | 6dB BANDWIDTH | 9kHz |
| TEST MODE | A      |               |      |

| No | Freq.<br>[MHz] | Corr.<br>Factor<br>(dB) | Reading Value<br>[dB (uV)] |     | Emission Level<br>[dB (uV)] |     | Limit<br>[dB (uV)] |       | Margin<br>(dB) |     |
|----|----------------|-------------------------|----------------------------|-----|-----------------------------|-----|--------------------|-------|----------------|-----|
|    |                |                         | Q.P.                       | AV. | Q.P.                        | AV. | Q.P.               | AV.   | Q.P.           | AV. |
| 1  | 0.166          | 0.14                    | 48.09                      | -   | 48.23                       | -   | 65.18              | 55.18 | -16.94         | -   |
| 2  | 0.193          | 0.14                    | 31.16                      | -   | 31.30                       | -   | 63.91              | 53.91 | -32.61         | -   |
| 3  | 0.224          | 0.14                    | 36.42                      | -   | 36.56                       | -   | 62.66              | 52.66 | -26.10         | -   |
| 4  | 0.283          | 0.14                    | 39.10                      | -   | 39.24                       | -   | 60.73              | 50.73 | -21.49         | -   |
| 5  | 0.529          | 0.16                    | 34.60                      | -   | 34.76                       | -   | 56.00              | 46.00 | -21.24         | -   |
| 6  | 1.113          | 0.19                    | 28.38                      | -   | 28.57                       | -   | 56.00              | 46.00 | -27.43         | -   |

- REMARKS:**
1. Q.P. and AV. are abbreviations of quasi-peak and average individually.
  2. "-": The Quasi-peak reading value also meets average limit and measurement with the average detector is unnecessary.
  3. The emission levels of other frequencies were very low against the limit.
  4. Margin value = Emission level - Limit value
  5. Correction factor = Insertion loss + Cable loss
  6. Emission Level = Correction Factor + Reading Value.

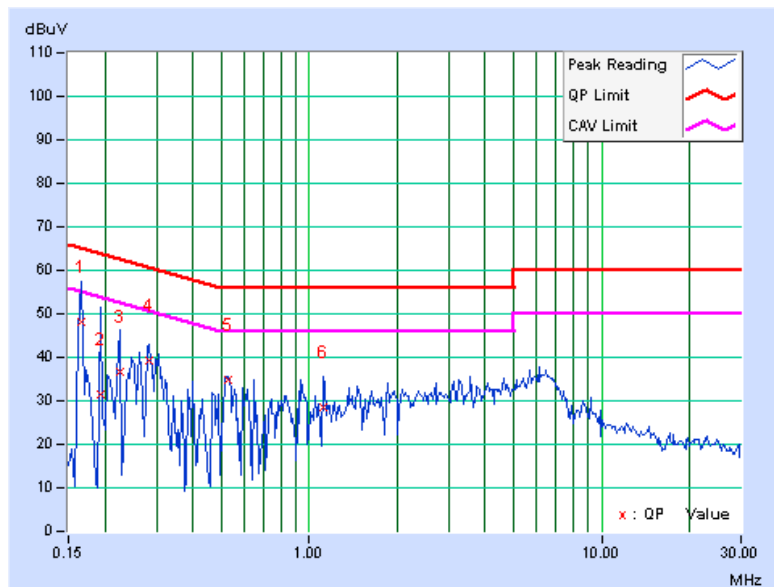



A D T

|           |        |               |      |
|-----------|--------|---------------|------|
| PHASE     | Line 2 | 6dB BANDWIDTH | 9kHz |
| TEST MODE | A      |               |      |

| No | Freq.<br>[MHz] | Corr.<br>Factor<br>(dB) | Reading Value<br>[dB (uV)] |     | Emission Level<br>[dB (uV)] |     | Limit<br>[dB (uV)] |       | Margin<br>(dB) |     |
|----|----------------|-------------------------|----------------------------|-----|-----------------------------|-----|--------------------|-------|----------------|-----|
|    |                |                         | Q.P.                       | AV. | Q.P.                        | AV. | Q.P.               | AV.   | Q.P.           | AV. |
| 1  | 0.150          | 0.12                    | 44.75                      | -   | 44.87                       | -   | 66.00              | 56.00 | -21.13         | -   |
| 2  | 0.170          | 0.13                    | 44.13                      | -   | 44.26                       | -   | 64.98              | 54.98 | -20.73         | -   |
| 3  | 0.259          | 0.13                    | 39.86                      | -   | 39.99                       | -   | 61.45              | 51.45 | -21.46         | -   |
| 4  | 0.603          | 0.15                    | 32.50                      | -   | 32.65                       | -   | 56.00              | 46.00 | -23.35         | -   |
| 5  | 0.869          | 0.17                    | 23.03                      | -   | 23.20                       | -   | 56.00              | 46.00 | -32.80         | -   |
| 6  | 6.219          | 0.47                    | 29.82                      | -   | 30.29                       | -   | 60.00              | 50.00 | -29.71         | -   |

- REMARKS:**
1. Q.P. and AV. are abbreviations of quasi-peak and average individually.
  2. "-": The Quasi-peak reading value also meets average limit and measurement with the average detector is unnecessary.
  3. The emission levels of other frequencies were very low against the limit.
  4. Margin value = Emission level - Limit value
  5. Correction factor = Insertion loss + Cable loss
  6. Emission Level = Correction Factor + Reading Value.

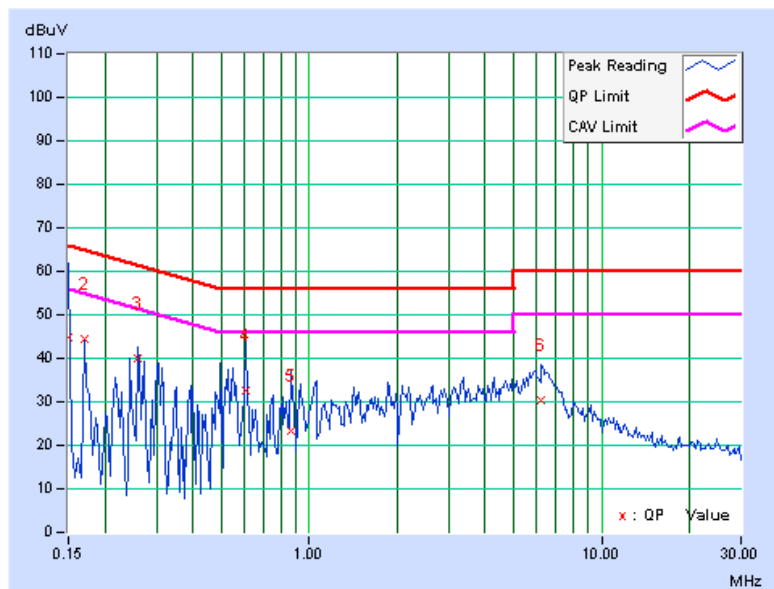





A D T

|           |        |               |      |
|-----------|--------|---------------|------|
| PHASE     | Line 1 | 6dB BANDWIDTH | 9kHz |
| TEST MODE | B      |               |      |

| No       | Freq.<br>[MHz] | Corr.<br>Factor<br>(dB) | Reading Value<br>[dB (uV)] |     | Emission Level<br>[dB (uV)] |     | Limit<br>[dB (uV)] |              | Margin<br>(dB) |     |
|----------|----------------|-------------------------|----------------------------|-----|-----------------------------|-----|--------------------|--------------|----------------|-----|
|          |                |                         | Q.P.                       | AV. | Q.P.                        | AV. | Q.P.               | AV.          | Q.P.           | AV. |
| 1        | 0.154          | 0.14                    | 50.10                      | -   | 50.24                       | -   | 65.79              | 55.79        | -15.54         | -   |
| 2        | 0.205          | 0.14                    | 42.26                      | -   | 42.40                       | -   | 63.42              | 53.42        | -21.02         | -   |
| 3        | 0.259          | 0.14                    | 37.83                      | -   | 37.97                       | -   | 61.45              | 51.45        | -23.48         | -   |
| <b>4</b> | <b>0.400</b>   | <b>0.15</b>             | <b>43.78</b>               | -   | <b>43.93</b>                | -   | <b>57.85</b>       | <b>47.85</b> | <b>-13.92</b>  | -   |
| 5        | 1.191          | 0.20                    | 34.50                      | -   | 34.70                       | -   | 56.00              | 46.00        | -21.30         | -   |
| 6        | 24.906         | 1.89                    | 33.44                      | -   | 35.33                       | -   | 60.00              | 50.00        | -24.67         | -   |

- REMARKS:**
1. Q.P. and AV. are abbreviations of quasi-peak and average individually.
  2. "-": The Quasi-peak reading value also meets average limit and measurement with the average detector is unnecessary.
  3. The emission levels of other frequencies were very low against the limit.
  4. Margin value = Emission level - Limit value
  5. Correction factor = Insertion loss + Cable loss
  6. Emission Level = Correction Factor + Reading Value.

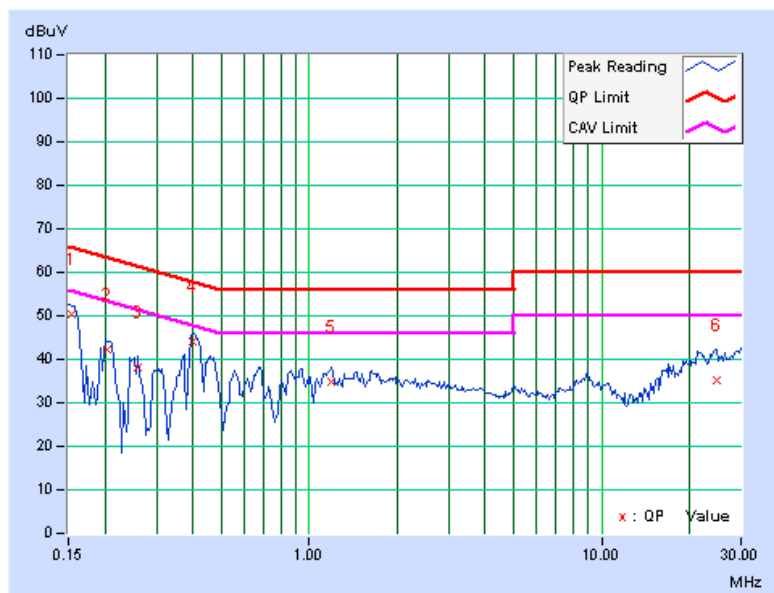



A D T

|           |        |               |      |
|-----------|--------|---------------|------|
| PHASE     | Line 2 | 6dB BANDWIDTH | 9kHz |
| TEST MODE | B      |               |      |

| No | Freq.<br>[MHz] | Corr.<br>Factor<br>(dB) | Reading Value |     | Emission Level |     | Limit     |       | Margin |     |
|----|----------------|-------------------------|---------------|-----|----------------|-----|-----------|-------|--------|-----|
|    |                |                         | [dB (uV)]     |     | [dB (uV)]      |     | [dB (uV)] |       | (dB)   |     |
|    |                |                         | Q.P.          | AV. | Q.P.           | AV. | Q.P.      | AV.   | Q.P.   | AV. |
| 1  | 0.154          | 0.13                    | 50.04         | -   | 50.17          | -   | 65.79     | 55.79 | -15.62 | -   |
| 2  | 0.197          | 0.13                    | 40.91         | -   | 41.04          | -   | 63.74     | 53.74 | -22.70 | -   |
| 3  | 0.255          | 0.13                    | 37.31         | -   | 37.44          | -   | 61.58     | 51.58 | -24.13 | -   |
| 4  | 0.400          | 0.14                    | 42.65         | -   | 42.79          | -   | 57.85     | 47.85 | -15.06 | -   |
| 5  | 0.662          | 0.16                    | 34.09         | -   | 34.25          | -   | 56.00     | 46.00 | -21.75 | -   |
| 6  | 22.148         | 1.46                    | 33.35         | -   | 34.81          | -   | 60.00     | 50.00 | -25.19 | -   |

- REMARKS:**
1. Q.P. and AV. are abbreviations of quasi-peak and average individually.
  2. "-": The Quasi-peak reading value also meets average limit and measurement with the average detector is unnecessary.
  3. The emission levels of other frequencies were very low against the limit.
  4. Margin value = Emission level - Limit value
  5. Correction factor = Insertion loss + Cable loss
  6. Emission Level = Correction Factor + Reading Value.

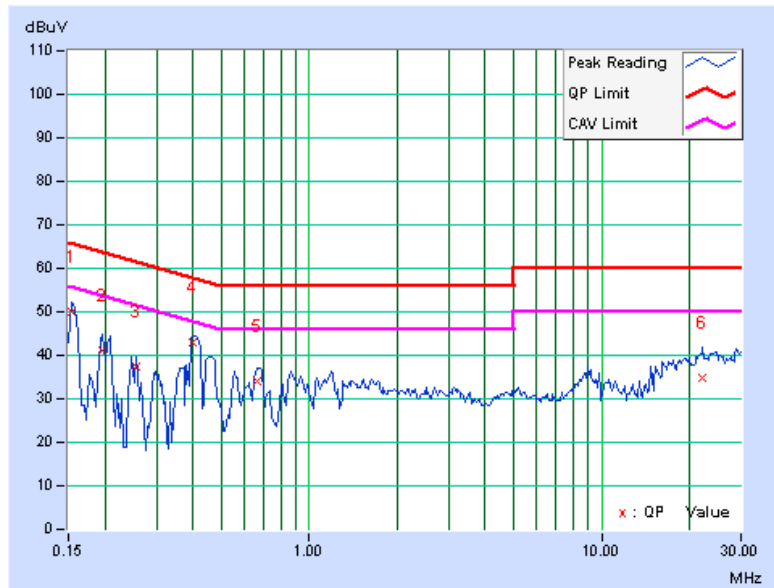



### 4.3 MAXIMUM CONDUCTED OUTPUT POWER MEASUREMENT

#### 4.3.1 LIMITS OF MAXIMUM CONDUCTED OUTPUT POWER MEASUREMENT

| FREQUENCY BAND | LIMIT                                       |
|----------------|---|
| 5.15 ~ 5.25GHz | The lesser of 50mW (17dBm) or 4dBm + 10logB |

**NOTE:** Where B is the 26dB emission bandwidth in MHz.

#### 4.3.2 TEST INSTRUMENTS

##### FOR POWER OUTPUT MEASUREMENT

| DESCRIPTION & MANUFACTURER  | MODEL NO. | SERIAL NO. | DATE OF CALIBRATION | DUE DATE OF CALIBRATION |
|-----------------------------|-----------|------------|---------------------|-------------------------|
| High Speed Peak Power Meter | ML2495A   | 0824011    | Aug. 02, 2010       | Aug. 01, 2011           |
| Power Sensor                | MA2411B   | 0738171    | Aug. 02, 2010       | Aug. 01, 2011           |

**NOTE:** 1. The calibration interval of the above test instruments is 12 months and the calibrations are traceable to NML/ROC and NIST/USA.  
2. Measurement Bandwidth of ML2495A is 65MHz greater than 26dB bandwidth of emission.

##### FOR 26dB OCCUPIED BANDWIDTH

| DESCRIPTION & MANUFACTURER | MODEL NO. | SERIAL NO. | DATE OF CALIBRATION | DUE DATE OF CALIBRATION |
|----------------------------|-----------|------------|---------------------|-------------------------|
| SPECTRUM ANALYZER R&S      | FSP40     | 100040     | Jul. 17, 2010       | Jul. 16, 2011           |

**NOTE:** The calibration interval of the above test instruments is 12 months and the calibrations are traceable to NML/ROC and NIST/USA.

### 4.3.3 TEST PROCEDURE

#### FOR POWER OUTPUT MEASUREMENT

A power sensor was used on the output port of the EUT. A power meter was used to read the response of the power sensor. Record the power level.

#### FOR 26dB OCCUPIED BANDWIDTH

The transmitter output was connected to the spectrum analyzer through an attenuator. The bandwidth of the fundamental frequency was measured by spectrum analyzer with 300kHz RBW and 1MHz VBW. The 26dB bandwidth is defined as the total spectrum the power of which is higher than peak power minus 26dB.

### 4.3.4 DEVIATION FROM TEST STANDARD

No deviation.

### 4.3.5 TEST SETUP

#### FOR POWER OUTPUT MEASUREMENT

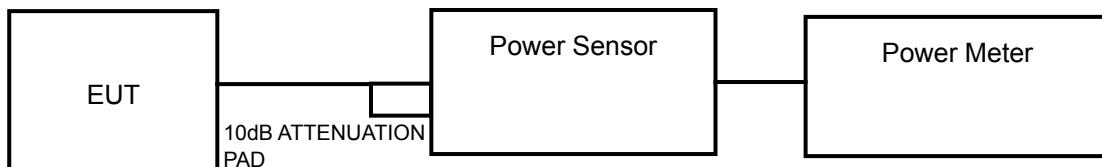

#### FOR 26dB OCCUPIED BANDWIDTH

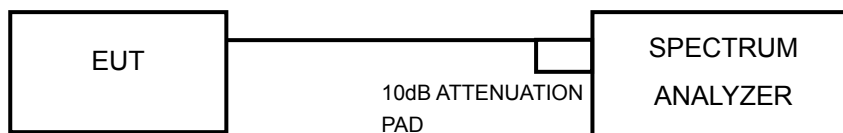

### 4.3.6 EUT OPERATING CONDITIONS

The software provided by client to enable the EUT under transmission condition continuously at specific channel frequencies individually.



### 4.3.7 TEST RESULTS

#### POWER OUTPUT: 802.11a

| CHANNEL | CHANNEL FREQUENCY (MHz) | POWER OUTPUT (dBm) | POWER OUTPUT (mW) | POWER LIMIT (dBm) | PASS/FAIL |
|---------|-------------------------|--------------------|-------------------|-------------------|-----------|
| 36      | 5180                    | 15.1               | 32.4              | 17                | PASS      |
| 40      | 5200                    | 16.3               | 42.7              | 17                | PASS      |
| 48      | 5240                    | 16.2               | 41.7              | 17                | PASS      |

#### 802.11n (20MHz)

| CHAN. | CHAN. FREQ. (MHz) | POWER OUTPUT (dBm) |         |         | TOTAL POWER (mW) | TOTAL POWER (dBm) | POWER LIMIT (dBm) | PASS / FAIL |
|-------|-------------------|--------------------|---------|---------|------------------|-------------------|-------------------|-------------|
|       |                   | CHAIN 0            | CHAIN 1 | CHAIN 2 |                  |                   |                   |             |
| 36    | 5180              | 10.5               | 11.8    | 13.2    | 47.2             | 16.7              | 17                | PASS        |
| 40    | 5200              | 11.0               | 10.1    | 13.0    | 42.8             | 16.3              | 17                | PASS        |
| 48    | 5240              | 11.0               | 10.1    | 12.6    | 41.0             | 16.1              | 17                | PASS        |

#### 802.11n (40MHz)

| CHAN. | CHAN. FREQ. (MHz) | POWER OUTPUT (dBm) |         |         | TOTAL POWER (mW) | TOTAL POWER (dBm) | POWER LIMIT (dBm) | PASS / FAIL |
|-------|-------------------|--------------------|---------|---------|------------------|-------------------|-------------------|-------------|
|       |                   | CHAIN 0            | CHAIN 1 | CHAIN 2 |                  |                   |                   |             |
| 38    | 5190              | 11.1               | 10.2    | 12.9    | 42.9             | 16.3              | 17                | PASS        |
| 46    | 5230              | 11.2               | 10.1    | 12.4    | 40.8             | 16.1              | 17                | PASS        |



A D T

### 26dB OCCUPIED BANDWIDTH: 802.11a

| CHANNEL | CHANNEL FREQUENCY (MHz) | 26dBc OCCUPIED BANDWIDTH (MHz) | PASS / FAIL |
|---------|-------------------------|--------------------------------|-------------|
| 36      | 5180                    | 24.77                          | PASS        |
| 40      | 5200                    | 24.91                          | PASS        |
| 48      | 5240                    | 24.99                          | PASS        |

### CH 48

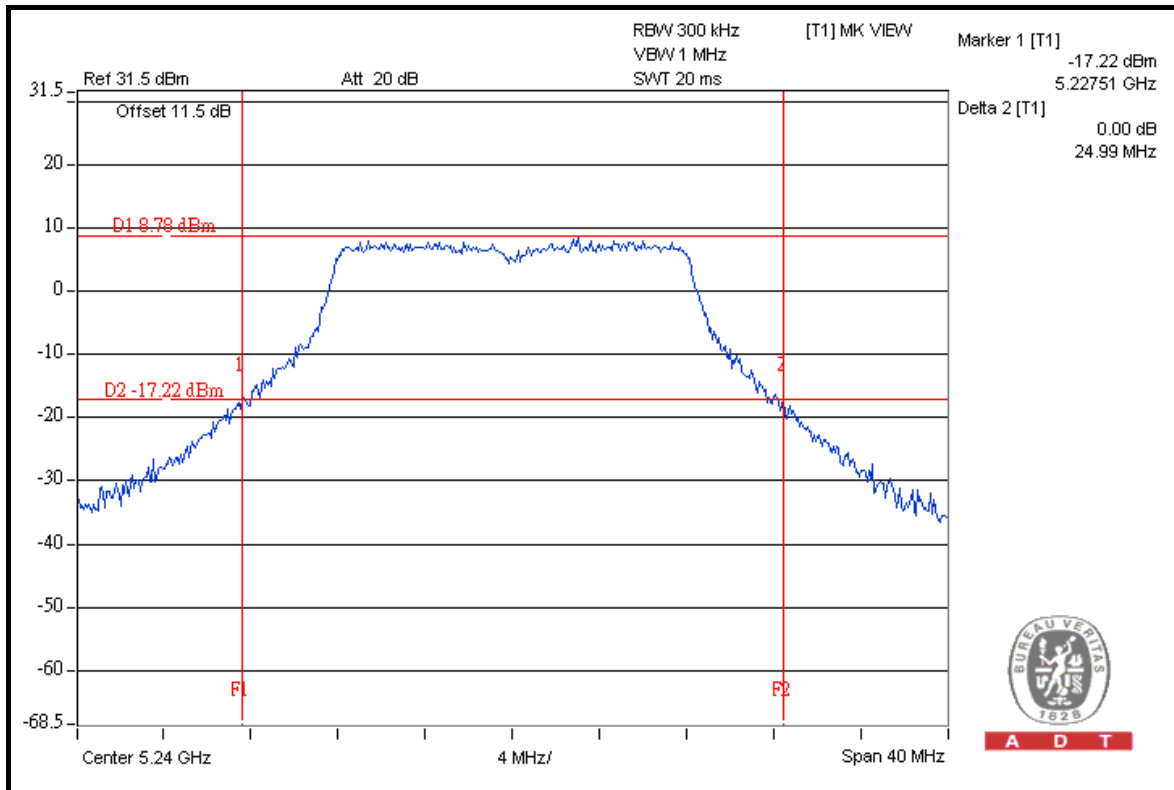

A D T



A D T

### 802.11n (20MHz)

| CHANNEL | CHANNEL FREQUENCY (MHz) | 26dBc OCCUPIED BANDWIDTH (MHz) |         |         | PASS / FAIL |
|---------|-------------------------|--------------------------------|---------|---------|-------------|
|         |                         | CHAIN 0                        | CHAIN 1 | CHAIN 2 |             |
| 36      | 5180                    | 25.53                          | 25.72   | 25.29   | PASS        |
| 40      | 5200                    | 25.68                          | 25.33   | 25.10   | PASS        |
| 48      | 5240                    | 25.67                          | 24.58   | 25.30   | PASS        |

### FOR CHAIN 0: CH 40

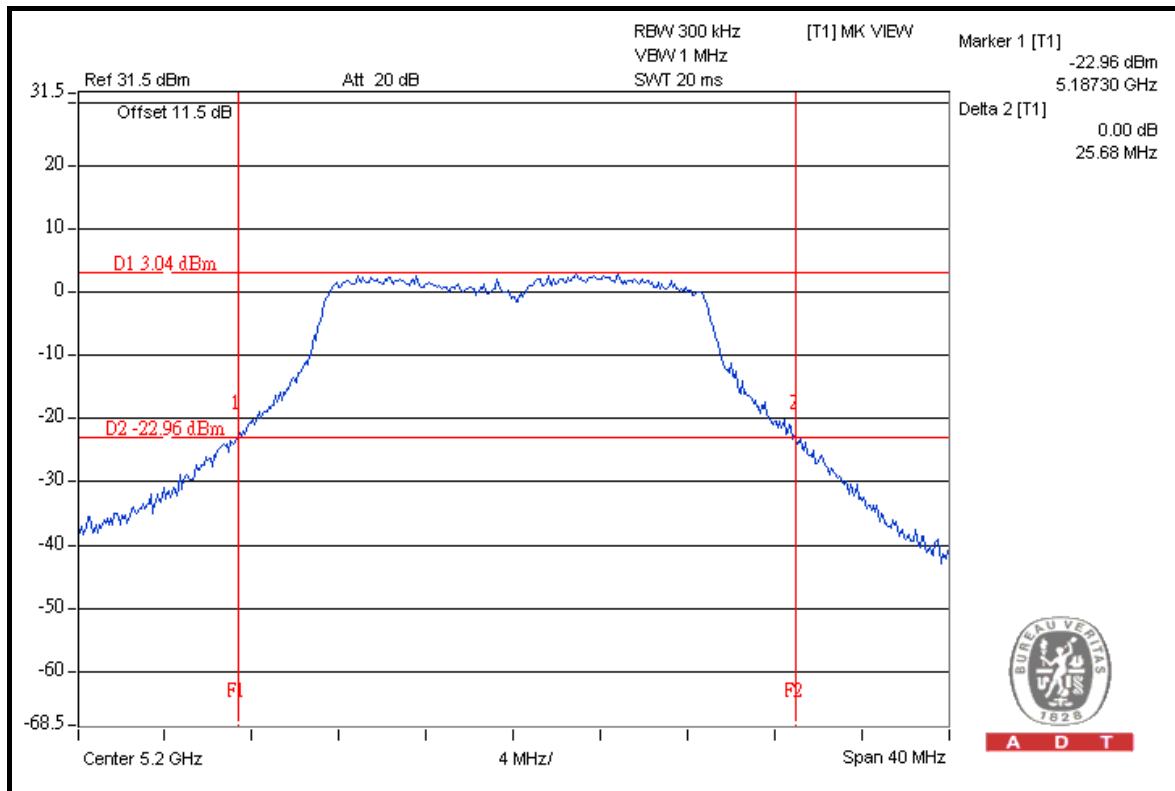



A D T

### 802.11n (40MHz)

| CHANNEL | CHANNEL FREQUENCY (MHz) | 26dBc OCCUPIED BANDWIDTH (MHz) |         |         | PASS / FAIL |
|---------|-------------------------|--------------------------------|---------|---------|-------------|
|         |                         | CHAIN 0                        | CHAIN 1 | CHAIN 2 |             |
| 38      | 5190                    | 49.34                          | 48.90   | 47.70   | PASS        |
| 46      | 5230                    | 48.74                          | 48.68   | 48.63   | PASS        |

### FOR CHAIN 0: CH 36

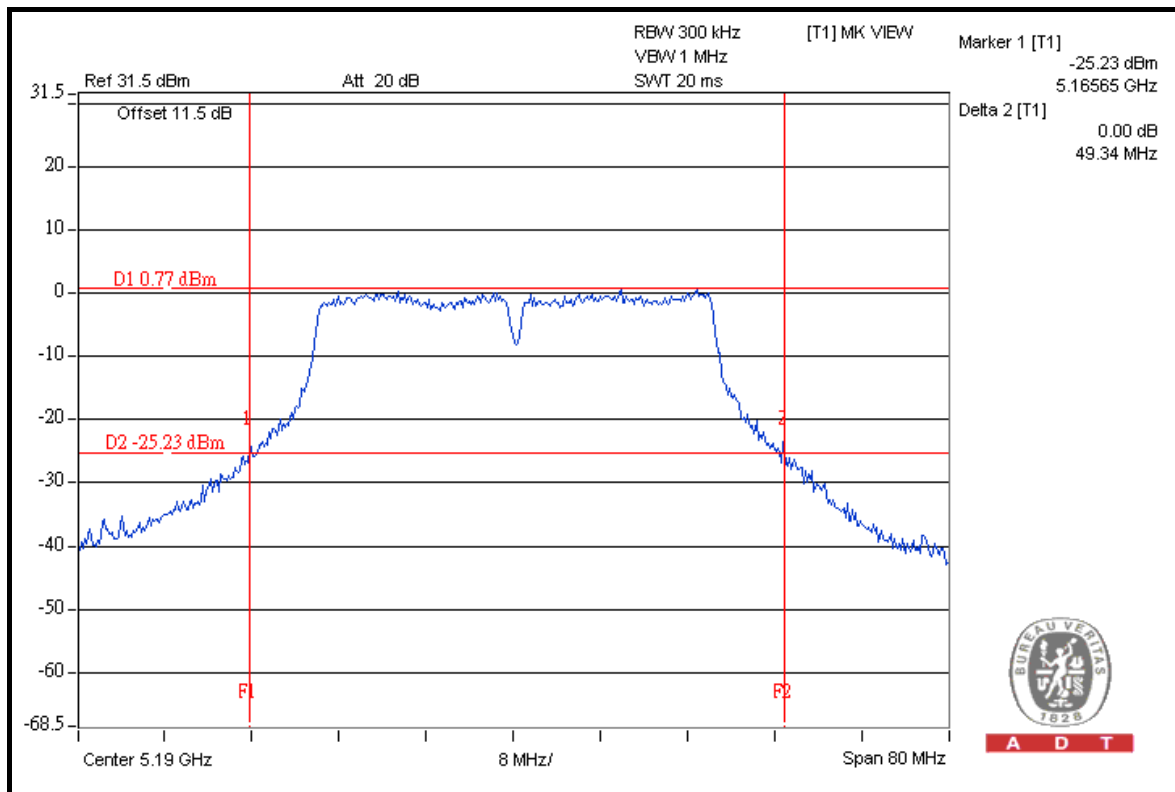



#### 4.4 PEAK POWER EXCURSION MEASUREMENT

##### 4.4.1 LIMITS OF PEAK POWER EXCURSION MEASUREMENT

| FREQUENCY BAND | LIMIT |
|----------------|-------|
| 5.15 ~ 5.25GHz | 13dB  |

##### 4.4.2 TEST INSTRUMENTS

| DESCRIPTION & MANUFACTURER | MODEL NO. | SERIAL NO. | DATE OF CALIBRATION | DUE DATE OF CALIBRATION |
|----------------------------|-----------|------------|---------------------|-------------------------|
| SPECTRUM ANALYZER<br>R&S   | FSP40     | 100039     | Jul. 09, 2010       | Jul. 08, 2011           |

**NOTE:** The calibration interval of the above test instruments is 12 months and the calibrations are traceable to NML/ROC and NIST/USA.

##### 4.4.3 TEST PROCEDURE

- a. The transmitter output was connected to the spectrum analyzer.
- b. Set the spectrum bandwidth span to view the entire spectrum.
- c. Using peak detector and Max-hold function for Trace 1 (RB = 1MHz, VB = 3MHz) and 2 (RB = 1MHz, VB = 300kHz).
- d. The differences between Trace1 and Trace 2 in any 1MHz band at f1 to f2 range were recorded and showed to another trace.

#### 4.4.4 DEVIATION FROM TEST STANDARD

No deviation.

#### 4.4.5 TEST SETUP

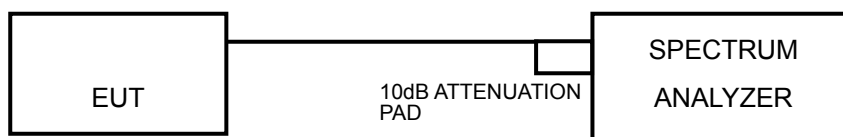

#### 4.4.6 EUT OPERATING CONDITIONS

The software provided by client to enable the EUT under transmission condition continuously at specific channel frequencies individually.



A D T

#### 4.4.7 TEST RESULTS

##### 802.11a

| CHANNEL | CHANNEL FREQUENCY (MHz) | PEAK POWER EXCURSION (dB) | PEAK to AVERAGE EXCURSION LIMIT (dB) | PASS/FAIL |
|---------|-------------------------|---------------------------|--------------------------------------|-----------|
| 36      | 5180                    | 9.52                      | 13                                   | PASS      |
| 40      | 5200                    | 9.37                      | 13                                   | PASS      |
| 48      | 5240                    | 8.50                      | 13                                   | PASS      |



A D T

### CH 36

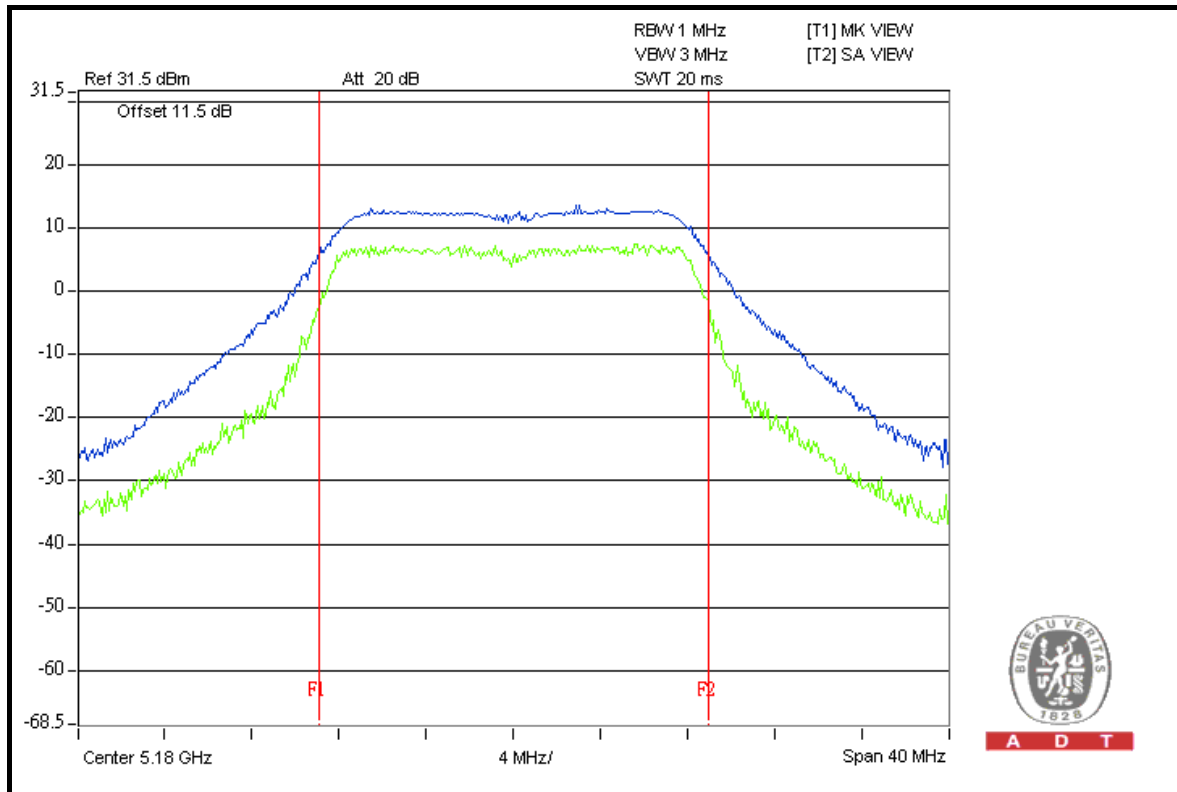

A D T

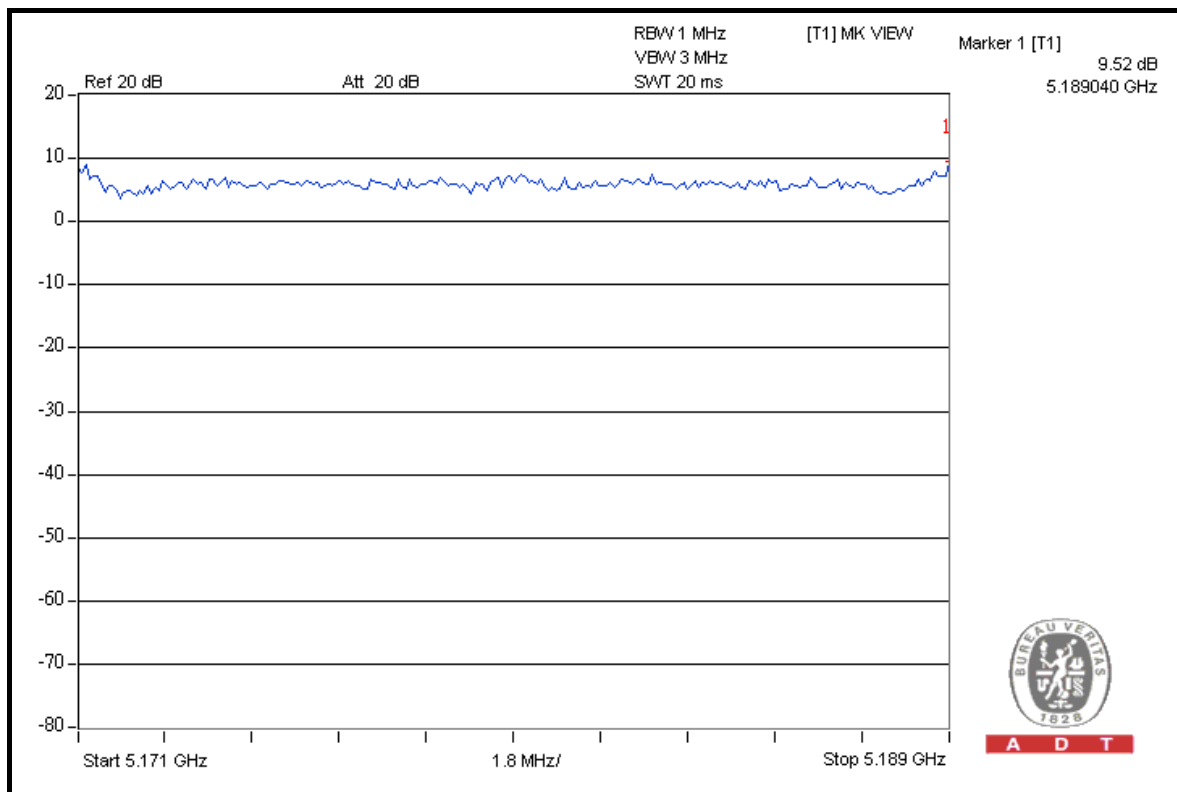

A D T



802.11n (20MHz)

| CHANNEL | CHANNEL FREQUENCY (MHz) | PEAK POWER EXCURSION (dB) |         |         | PEAK to AVERAGE EXCURSION LIMIT (dB) | PASS/FAIL |
|---------|-------------------------|---------------------------|---------|---------|--------------------------------------|-----------|
|         |                         | CHAIN 0                   | CHAIN 1 | CHAIN 2 |                                      |           |
| 36      | 5180                    | 8.36                      | 7.47    | 8.33    | 13                                   | PASS      |
| 40      | 5200                    | 7.75                      | 7.36    | 8.29    | 13                                   | PASS      |
| 48      | 5240                    | 7.75                      | 8.29    | 7.97    | 13                                   | PASS      |



A D T

### FOR CHAIN 0: CH 36

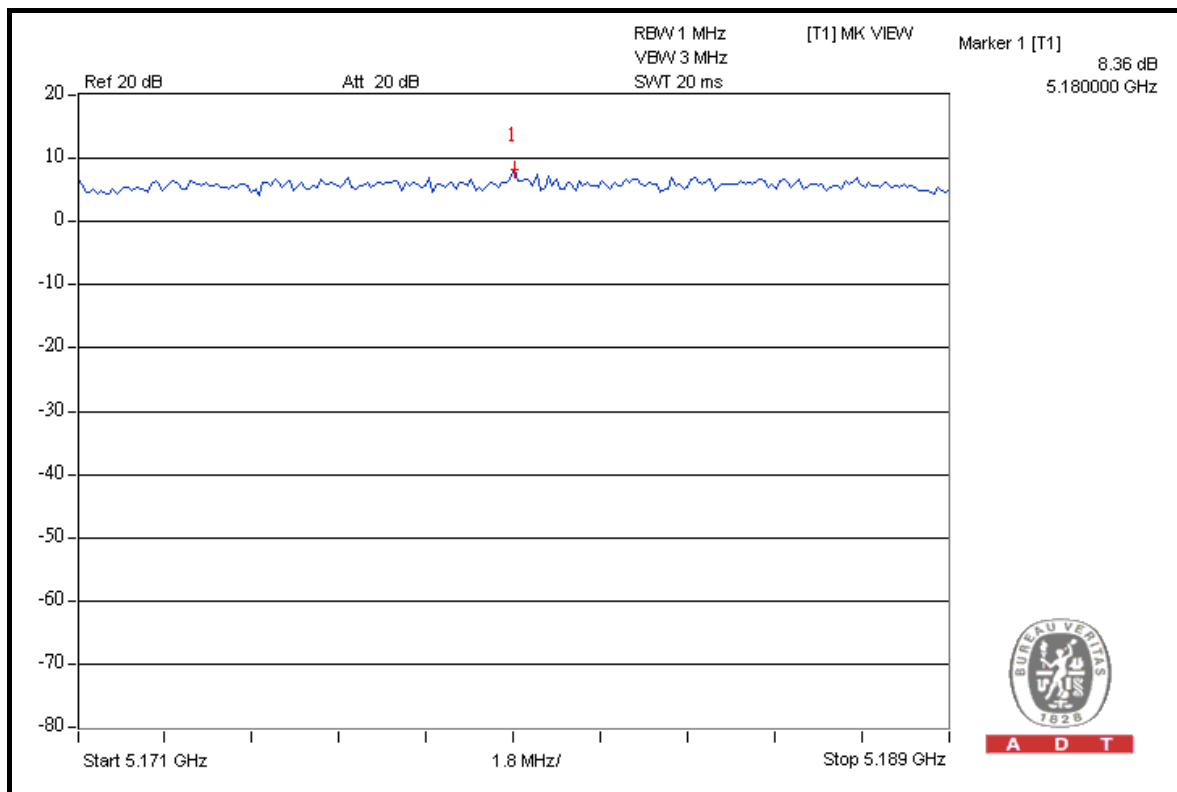
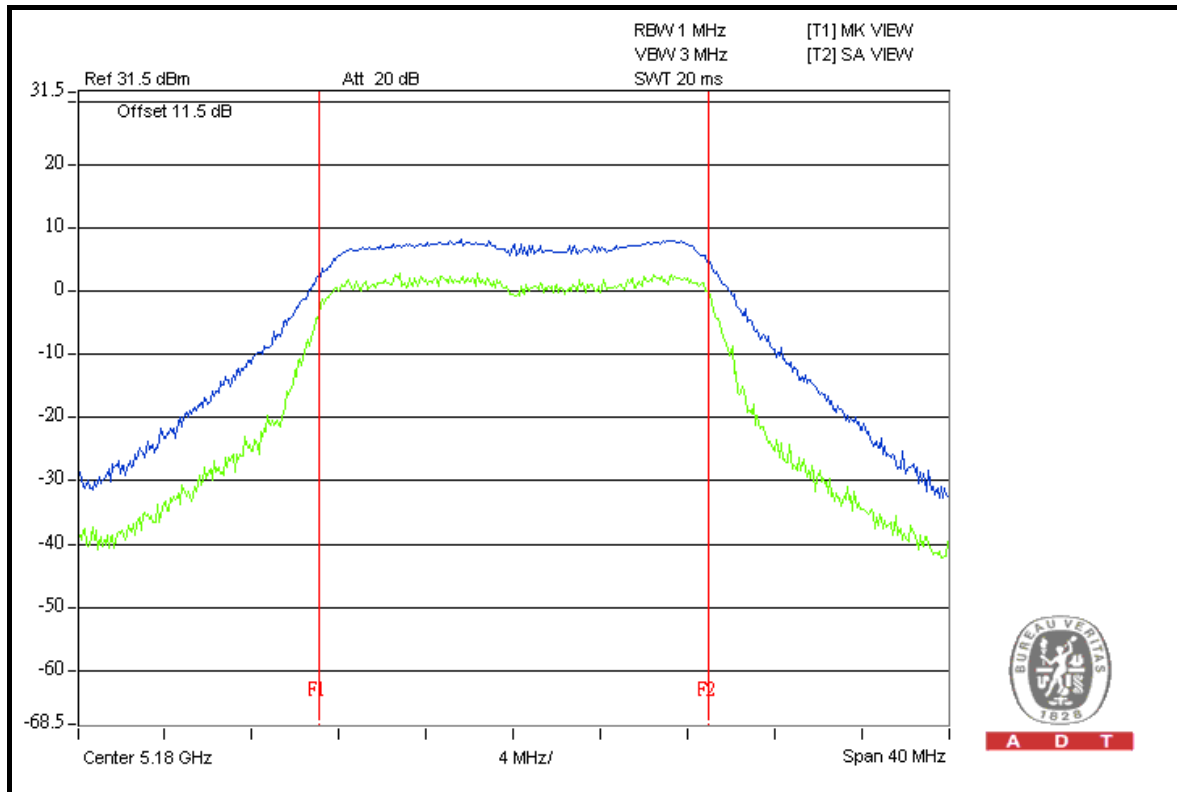



802.11n (40MHz)

| CHANNEL | CHANNEL FREQUENCY (MHz) | PEAK POWER EXCURSION (dB) |         |         | PEAK to AVERAGE EXCURSION LIMIT (dB) | PASS/FAIL |
|---------|-------------------------|---------------------------|---------|---------|--------------------------------------|-----------|
|         |                         | CHAIN 0                   | CHAIN 1 | CHAIN 3 |                                      |           |
| 38      | 5190                    | 9.17                      | 11.43   | 9.09    | 13                                   | PASS      |
| 46      | 5230                    | 9.79                      | 9.76    | 10.25   | 13                                   | PASS      |



A D T

### FOR CHAIN 1: CH 38

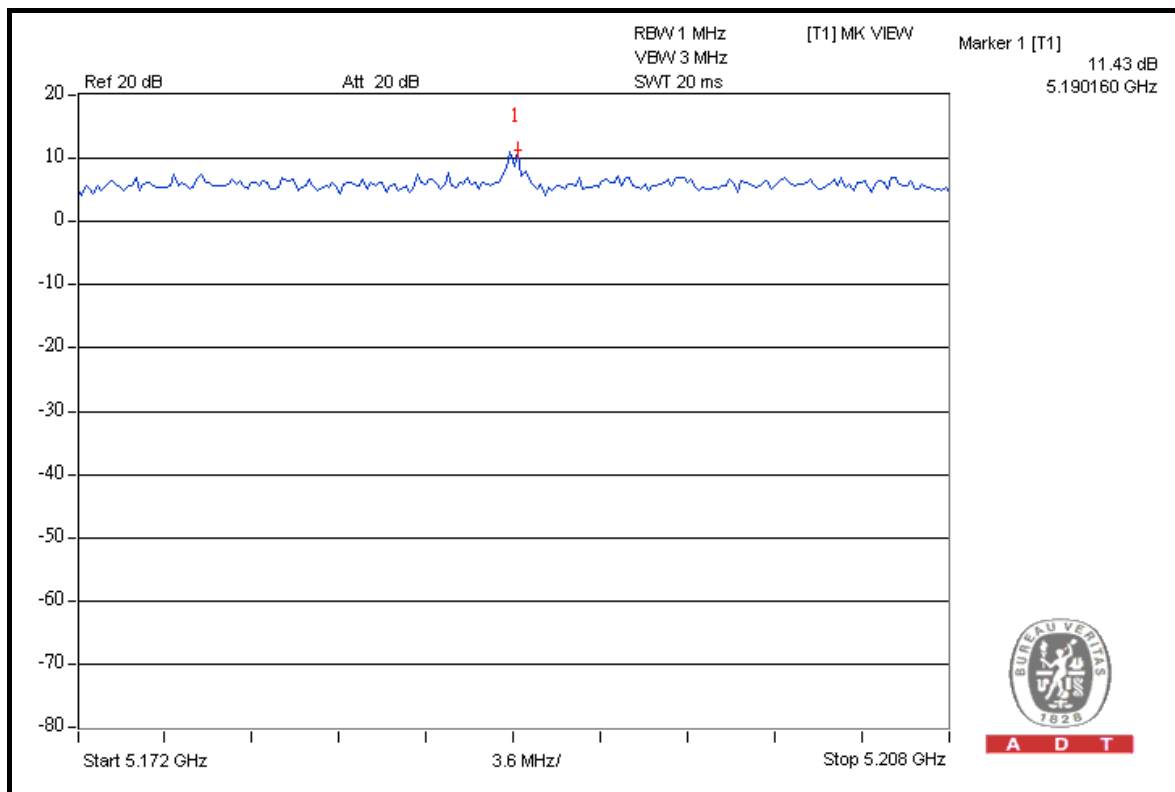
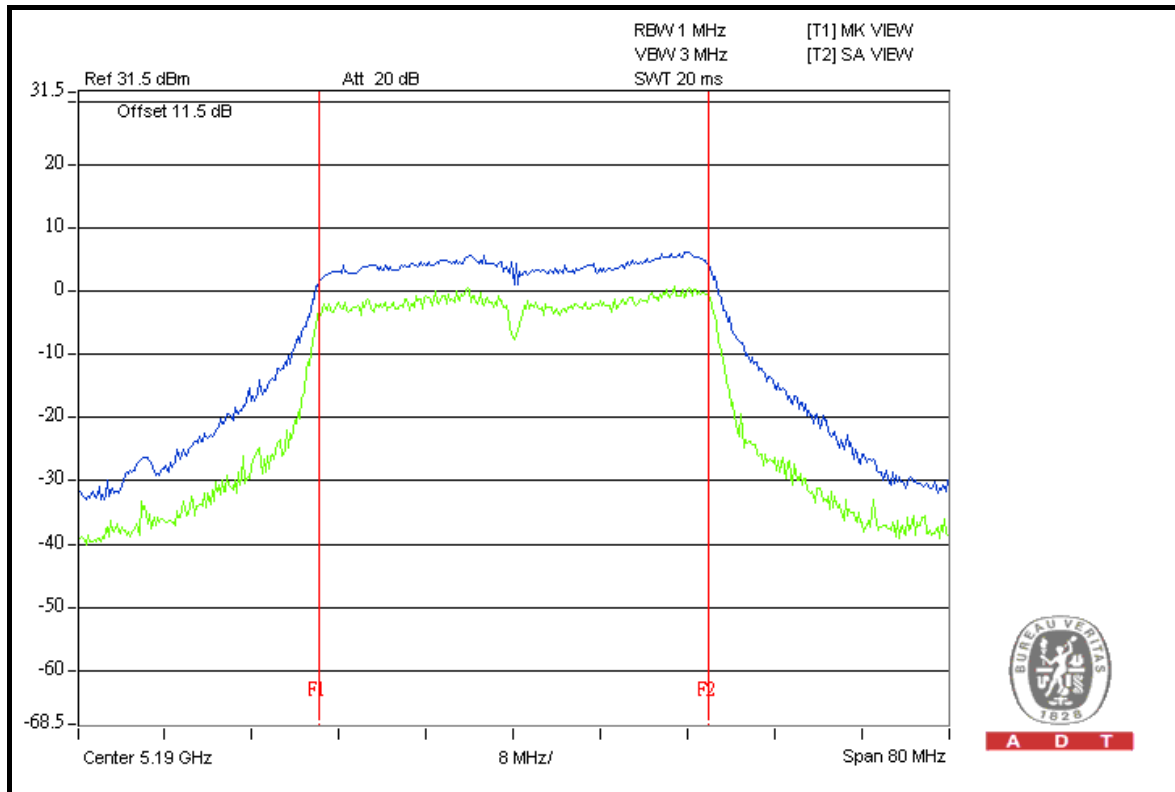



## 4.5 PEAK POWER SPECTRAL DENSITY MEASUREMENT

### 4.5.1 LIMITS OF PEAK POWER SPECTRAL DENSITY MEASUREMENT

| FREQUENCY BAND | LIMIT |
|----------------|-------|
| 5.15 ~ 5.25GHz | 4dBm  |

### 4.5.2 TEST INSTRUMENTS

| DESCRIPTION & MANUFACTURER | MODEL NO. | SERIAL NO. | DATE OF CALIBRATION | DUE DATE OF CALIBRATION |
|----------------------------|-----------|------------|---------------------|-------------------------|
| SPECTRUM ANALYZER<br>R&S   | FSP40     | 100039     | Jul. 09, 2010       | Jul. 08, 2011           |

**NOTE:** The calibration interval of the above test instruments is 12 months and the calibrations are traceable to NML/ROC and NIST/USA.

### 4.5.3 TEST PROCEDURES

- a. The transmitter output was connected to the spectrum analyzer.
- b. Set RBW = 1MHz, VBW = 3MHz. The PPSD is the highest level found across the emission in any 1MHz band.
- c. Follow method 2 of KDB 662911 D01 Multiple Transmitter Output v01 to calculate total power density of 2 TX port.

#### 4.5.4 DEVIATION FROM TEST STANDARD

No deviation.

#### 4.5.5 TEST SETUP

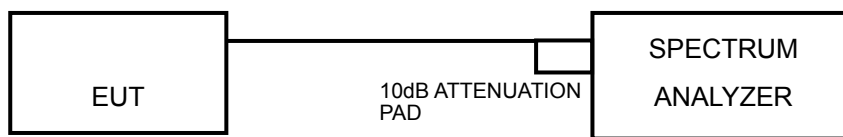

#### 4.5.6 EUT OPERATING CONDITIONS

Same as 5.3.6.



A D T

## 4.5.7 TEST RESULTS

### 802.11a

| CHANNEL | CHANNEL FREQUENCY (MHz) | RF POWER LEVEL IN 1kHz BW (dBm) | MAXIMUM LIMIT (dBm) | PASS/FAIL |
|---------|-------------------------|---------------------------------|---------------------|-----------|
| 36      | 5180                    | 1.8                             | 4                   | PASS      |
| 40      | 5200                    | 2.9                             | 4                   | PASS      |
| 48      | 5240                    | 3.0                             | 4                   | PASS      |

### CH 48

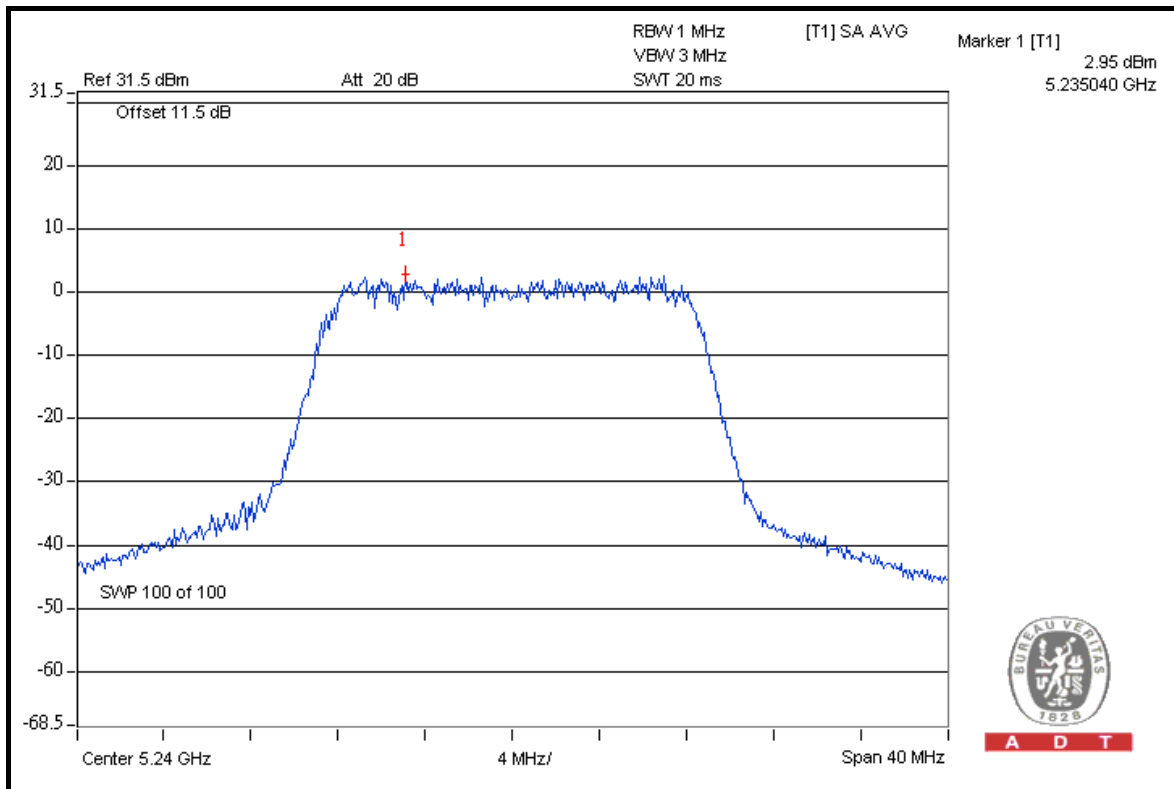



A D T

### 802.11n (20MHz)

| CHAN. | CHAN. FREQ. (MHz) | RF POWER LEVEL IN 1kHz BW (dBm) |         |         | TOTAL POWER DENSITY (dBm) | MAX. LIMIT (dBm) | PASS / FAIL |
|-------|-------------------|---------------------------------|---------|---------|---------------------------|------------------|-------------|
|       |                   | CHAIN 0                         | CHAIN 1 | CHAIN 2 |                           |                  |             |
| 36    | 5180              | -3.3                            | -1.6    | -0.7    | 3.0                       | 4                | PASS        |
| 40    | 5200              | -2.9                            | -3.5    | -0.7    | 2.6                       | 4                | PASS        |
| 48    | 5240              | -2.9                            | -3.5    | -1.3    | 2.3                       | 4                | PASS        |

### FOR CHAIN 2: CH 36

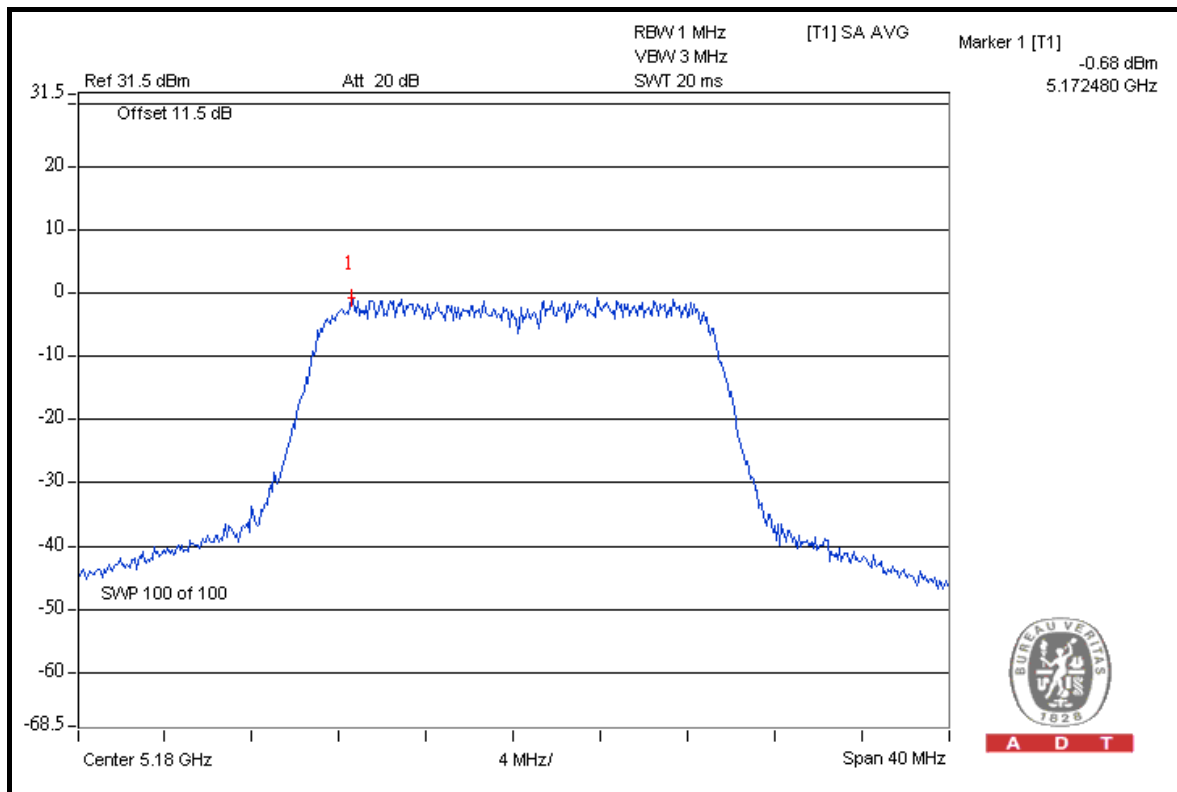

A D T



A D T

### 802.11n (40MHz)

| CHAN. | CHAN. FREQ. (MHz) | RF POWER LEVEL IN 1kHz BW (dBm) |         |         | TOTAL POWER DENSITY (dBm) | MAX. LIMIT (dBm) | PASS / FAIL |
|-------|-------------------|---------------------------------|---------|---------|---------------------------|------------------|-------------|
|       |                   | CHAIN 0                         | CHAIN 1 | CHAIN 2 |                           |                  |             |
| 38    | 5190              | -5.3                            | -6.3    | -4.5    | -0.5                      | 4                | PASS        |
| 46    | 5230              | -5.0                            | -6.2    | -4.8    | -0.5                      | 4                | PASS        |

### FOR CHAIN 2: CH 38

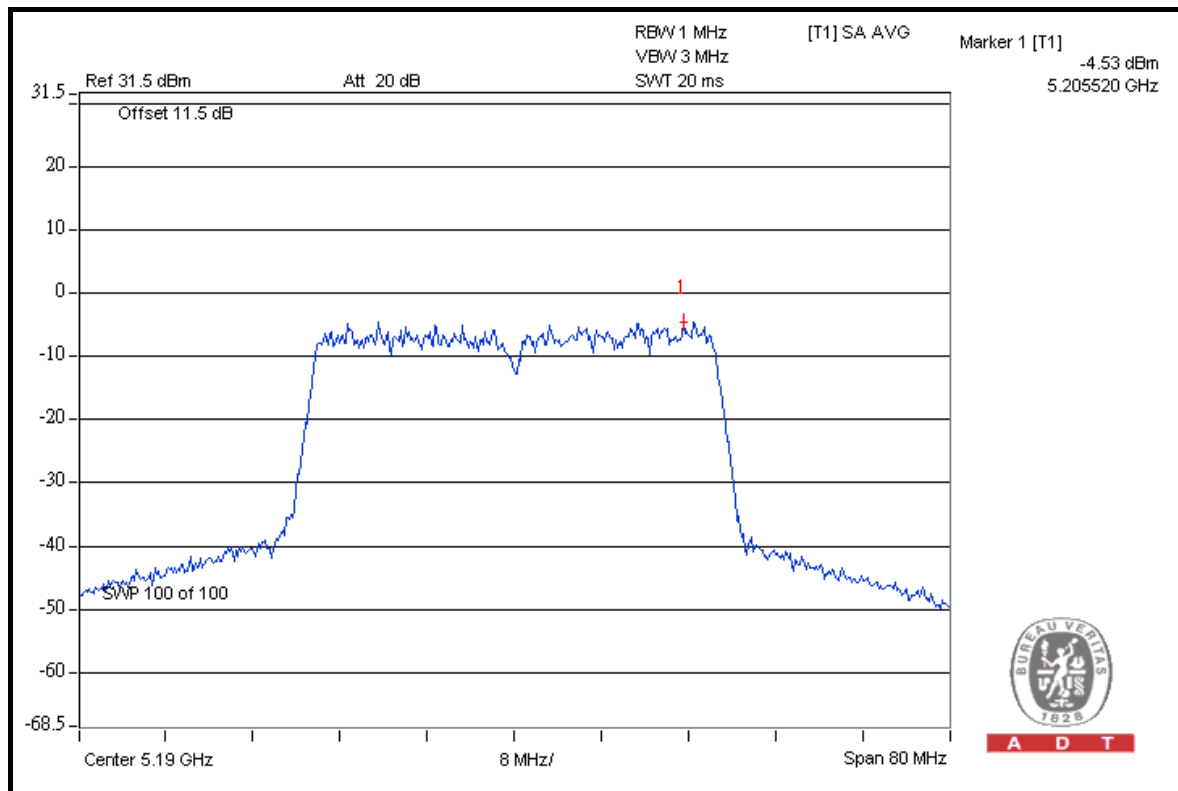

A D T

## 4.6 FREQUENCY STABILITY

### 4.6.1 LIMITS OF FREQUENCY STABILITY MEASUREMENT

The frequency tolerance of the carrier signal shall be maintained within +/- 0.02% of the operating frequency over a temperature variation of -20 degrees to 55 degrees C at normal supply voltage, and for a variation in the primary supply voltage from 85% to 115% of the rated supply voltage at a temperature of 20 degrees C.

### 4.6.2 TEST INSTRUMENTS

| DESCRIPTION & MANUFACTURER                          | MODEL NO. | SERIAL NO. | DATE OF CALIBRATION | DUE DATE OF CALIBRATION |
|---|-----------|------------|---------------------|-------------------------|
| SPECTRUM ANALYZER<br>R&S                            | FSP40     | 100039     | Jul. 09, 2010       | Jul. 08, 2011           |
| WIT STANDARD<br>TEMPERATURE AND<br>HUMIDITY CHAMBER | TH-4S-C   | W981030    | Jun. 28, 2010       | Jun. 27, 2011           |

**NOTE:** The calibration interval of the above test instruments is 12 months and the calibrations are traceable to NML/ROC and NIST/USA.

### 4.6.3 TEST PROCEDURE

- a. The EUT was placed inside the environmental test chamber and powered by nominal DC voltage.
- b. Turn the EUT on and couple its output to a spectrum analyzer.
- c. Turn the EUT off and set the chamber to the highest temperature specified.
- d. Allow sufficient time (approximately 30 min) for the temperature of the chamber to stabilize, turn the EUT on and measure the operating frequency after 2, 5, and 10 minutes.
- e. Repeat step 2 and 3 with the temperature chamber set to the lowest temperature.
- f. The test chamber was allowed to stabilize at +20 degree C for a minimum of 30 minutes. The supply voltage was then adjusted on the EUT from 85% to 115% and the frequency record.

#### 4.6.4 DEVIATION FROM TEST STANDARD

No deviation.

#### 4.6.5 TEST SETUP

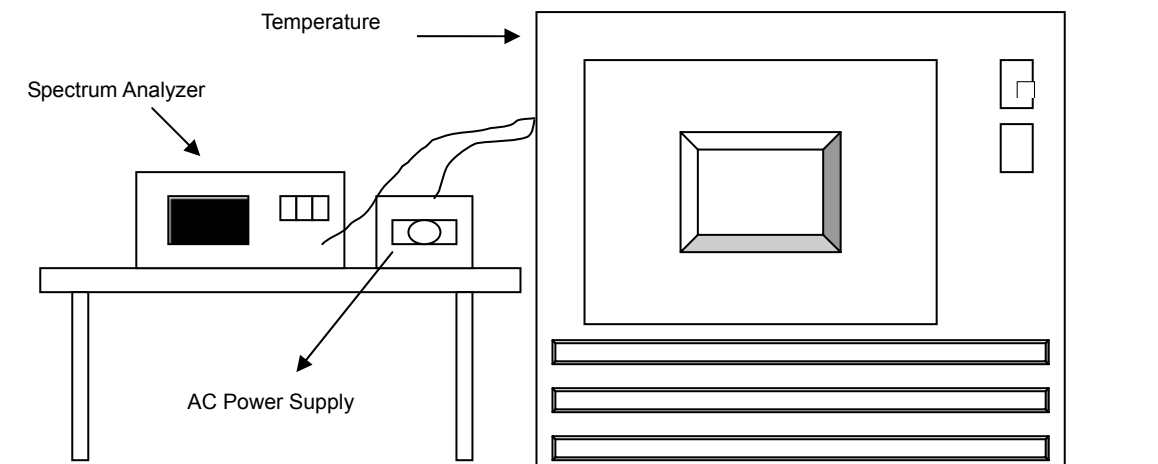

#### 4.6.6 EUT OPERATING CONDITION

Same as Item 4.1.6.



### 4.6.7 TEST RESULTS

| FREQUENCY STABILITY VERSUS TEMP. |                       |                    |                 |                    |                 |                    |                 |                    |                 |
|----------------------------------|-----------------------|--------------------|-----------------|--------------------|-----------------|--------------------|-----------------|--------------------|-----------------|
| OPERATING FREQUENCY: 5200MHz     |                       |                    |                 |                    |                 |                    |                 |                    |                 |
| TEMP.<br>( )                     | POWER SUPPLY<br>(Vac) | 0 MINUTE           |                 | 2 MINUTE           |                 | 5 MINUTE           |                 | 10 MINUTE          |                 |
|                                  |                       | Measured Frequency | Frequency Drift | Measured Frequency | Frequency Drift | Measured Frequency | Frequency Drift | Measured Frequency | Frequency Drift |
|                                  |                       | (MHz)              | ppm             | (MHz)              | ppm             | (MHz)              | ppm             | (MHz)              | ppm             |
| 50                               | 110.0                 | 5199.988211        | -2.267          | 5199.988168        | -2.275          | 5199.988317        | -2.247          | 5199.988302        | -2.250          |
| 40                               | 110.0                 | 5199.988581        | -2.196          | 5199.988738        | -2.166          | 5199.988459        | -2.219          | 5199.988757        | -2.162          |
| 30                               | 110.0                 | 5199.990125        | -1.899          | 5199.990284        | -1.868          | 5199.989811        | -1.959          | 5199.989866        | -1.949          |
| 20                               | 110.0                 | 5199.991589        | -1.617          | 5199.991872        | -1.563          | 5199.991711        | -1.594          | 5199.991637        | -1.608          |
| 10                               | 110.0                 | 5199.992357        | -1.470          | 5199.992235        | -1.493          | 5199.992744        | -1.395          | 5199.992355        | -1.470          |
| 0                                | 110.0                 | 5199.991293        | -1.674          | 5199.991553        | -1.624          | 5199.991456        | -1.643          | 5199.991507        | -1.633          |
| -10                              | 110.0                 | 5199.989492        | -2.021          | 5199.989848        | -1.952          | 5199.989784        | -1.965          | 5199.989571        | -2.006          |
| -20                              | 110.0                 | 5199.989228        | -2.072          | 5199.989051        | -2.106          | 5199.989495        | -2.020          | 5199.989372        | -2.044          |
| -30                              | 110.0                 | 5199.988253        | -2.259          | 5199.988297        | -2.251          | 5199.988541        | -2.204          | 5199.987965        | -2.314          |

| FREQUENCY STABILITY VERSUS VOLTAGE |                       |                    |                 |                    |                 |                    |                 |                    |                 |
|------------------------------------|-----------------------|--------------------|-----------------|--------------------|-----------------|--------------------|-----------------|--------------------|-----------------|
| OPERATING FREQUENCY: 5200MHz       |                       |                    |                 |                    |                 |                    |                 |                    |                 |
| TEMP.<br>( )                       | POWER SUPPLY<br>(Vac) | 0 MINUTE           |                 | 2 MINUTE           |                 | 5 MINUTE           |                 | 10 MINUTE          |                 |
|                                    |                       | Measured Frequency | Frequency Drift | Measured Frequency | Frequency Drift | Measured Frequency | Frequency Drift | Measured Frequency | Frequency Drift |
|                                    |                       | (MHz)              | ppm             | (MHz)              | ppm             | (MHz)              | ppm             | (MHz)              | ppm             |
| 20                                 | 93.5                  | 5199.990236        | -1.878          | 5199.990151        | -1.894          | 5199.990701        | -1.788          | 5199.990645        | -1.799          |
|                                    | 110.0                 | 5199.991589        | -1.617          | 5199.991872        | -1.563          | 5199.991711        | -1.594          | 5199.991637        | -1.608          |
|                                    | 126.5                 | 5199.992836        | -1.378          | 5199.992437        | -1.454          | 5199.992514        | -1.440          | 5199.992776        | -1.389          |





## 4.7 BAND EDGES MEASUREMENT

### 4.7.1 TEST INSTRUMENTS

| DESCRIPTION & MANUFACTURER           | MODEL NO.                | SERIAL NO.  | DATE OF CALIBRATION | DUE DATE OF CALIBRATION |
|--------------------------------------|--------------------------|-------------|---------------------|-------------------------|
| <b>FOR CONDUCTED MEASUREMENT</b>     |                          |             |                     |                         |
| SPECTRUM ANALYZER R&S                | FSP40                    | 100040      | Jul. 17, 2010       | Jul. 16, 2011           |
| <b>FOR RADIATED MEASUREMENT</b>      |                          |             |                     |                         |
| Test Receiver ROHDE & SCHWARZ        | ESIB7                    | 100212      | Jul. 22, 2010       | Jul. 21, 2011           |
| Spectrum Analyzer Agilent            | E4446A                   | MY48250266  | Aug. 11, 2010       | Aug. 10, 2011           |
| BILOG Antenna SCHWARZBECK            | VULB9168                 | 9168-153    | Apr. 11, 2011       | Apr. 10, 2012           |
| HORN Antenna SCHWARZBECK             | 9120D                    | 9120D-405   | Feb. 08, 2011       | Feb. 07, 2012           |
| HORN Antenna SCHWARZBECK             | BBHA 9170                | BBHA9170243 | Dec. 27, 2010       | Dec. 26, 2011           |
| Preamplifier Agilent                 | 8447D                    | 2944A10633  | Nov. 02, 2010       | Nov. 01, 2011           |
| Preamplifier Agilent                 | 8449B                    | 3008A01964  | Nov. 02, 2010       | Nov. 01, 2011           |
| RF signal cable HUBER+SUHNNER        | SUCOFLEX 104             | 295014/4    | Sep 03, 2010        | Sep 02, 2011            |
| RF signal cable HUBER+SUHNNER        | SUCOFLEX 104             | 12738/6     | Sep 03, 2010        | Sep 02, 2011            |
| Software ADT.                        | ADT_Radiated_V7.6.15.9.2 | NA          | NA                  | NA                      |
| Antenna Tower inn-co GmbH            | MA 4000                  | 013303      | NA                  | NA                      |
| Antenna Tower Controller inn-co GmbH | CO2000                   | 017303      | NA                  | NA                      |
| Turn Table ADT.                      | TT100.                   | TT93021703  | NA                  | NA                      |
| Turn Table Controller ADT.           | SC100.                   | SC93021703  | NA                  | NA                      |
| 26GHz ~ 40GHz Amplifier              | EM26400                  | 07026401    | Aug. 25, 2010       | Aug. 24, 2011           |

**NOTE:** The calibration interval of the above test instruments is 12 months and the calibrations are traceable to NML/ROC and NIST/USA.

#### 4.7.2 TEST PROCEDURE

- a. The EUT was placed on the top of a rotating table 0.8 meters above the ground at a 3 meter semi-anechoic chamber. The table was rotated 360 degrees to determine the position of the highest radiation.
- b. The EUT was set 3 meters away from the interference-receiving antenna, which was mounted on the top of a variable-height antenna tower.
- c. The antenna is a broadband antenna, and its height is varied from one meter to four meters above the ground to determine the maximum value of the field strength. Both horizontal and vertical polarizations of the antenna are set to make the measurement.
- d. For each suspected emission, the EUT was arranged to its worst case and then the antenna was tuned to heights from 1 meter to 4 meters and the rotatable table was turned from 0 degrees to 360 degrees to find the maximum reading.
- e. Set both RBW and VBW of spectrum analyzer to 1MHz and 3MHz with suitable frequency span including 100MHz bandwidth from band edge. The band edges was measured and recorded.

**NOTE:** The resolution bandwidth of test receiver/spectrum analyzer is 1MHz and the video bandwidth is 10Hz for Average detection (AV) at frequency above 1GHz

#### 4.7.3 EUT OPERATING CONDITION

The software provided by client to enable the EUT under transmission condition continuously at specific channel frequencies individually.

#### 4.7.4 TEST RESULTS

For signals in the restricted bands above and below the 5.15 to 5.25GHz allocated band a measurement was made of the amplitude of the spurious emissions with respect to the intentional signals. The relative amplitude, in dBc, was applied to the average and peak field strength of the intentional signal made on the OATS to calculate the field strength of the unintentional signals.

The spectrum plots (Peak RBW = 1MHz, VBW = 3MHz) are attached on the following pages.

#### 802.11a

##### RESTRICT BAND (4500 ~ 5150 MHz)

| FREQUENCY (MHz) | FUNDAMENTAL EMISSION (dBuV/m) | DELTA (dB) | MAXIMUM FIELD STRENGTH IN RESTRICT BAND (dBuV/m) | LIMIT (dBuV/m) |
|-----------------|-------------------------------|------------|--|----------------|
| 5180.00 (PK)    | 112.7                         | 45.87      | 66.83  | 74.00          |
| 5180.00 (AV)    | 99.4                          | 52.07      | 47.33  | 54.00          |

##### RESTRICT BAND (5350 ~ 5460 MHz)

| FREQUENCY (MHz) | FUNDAMENTAL EMISSION (dBuV/m) | DELTA (dB) | MAXIMUM FIELD STRENGTH IN RESTRICT BAND (dBuV/m) | LIMIT (dBuV/m) |
|-----------------|-------------------------------|------------|--|----------------|
| 5240.00 (PK)    | 112.4                         | 54.07      | 58.33  | 74.00          |
| 5240.00 (AV)    | 100.3                         | 56.47      | 43.83  | 54.00          |

#### NOTE:

1. Delta = Amplitude between the peak of the fundamental and the peak of the band edge emission. Please check following 3 pages.
2. Maximum field strength in restrict band = Fundamental emission – Delta.



A D T

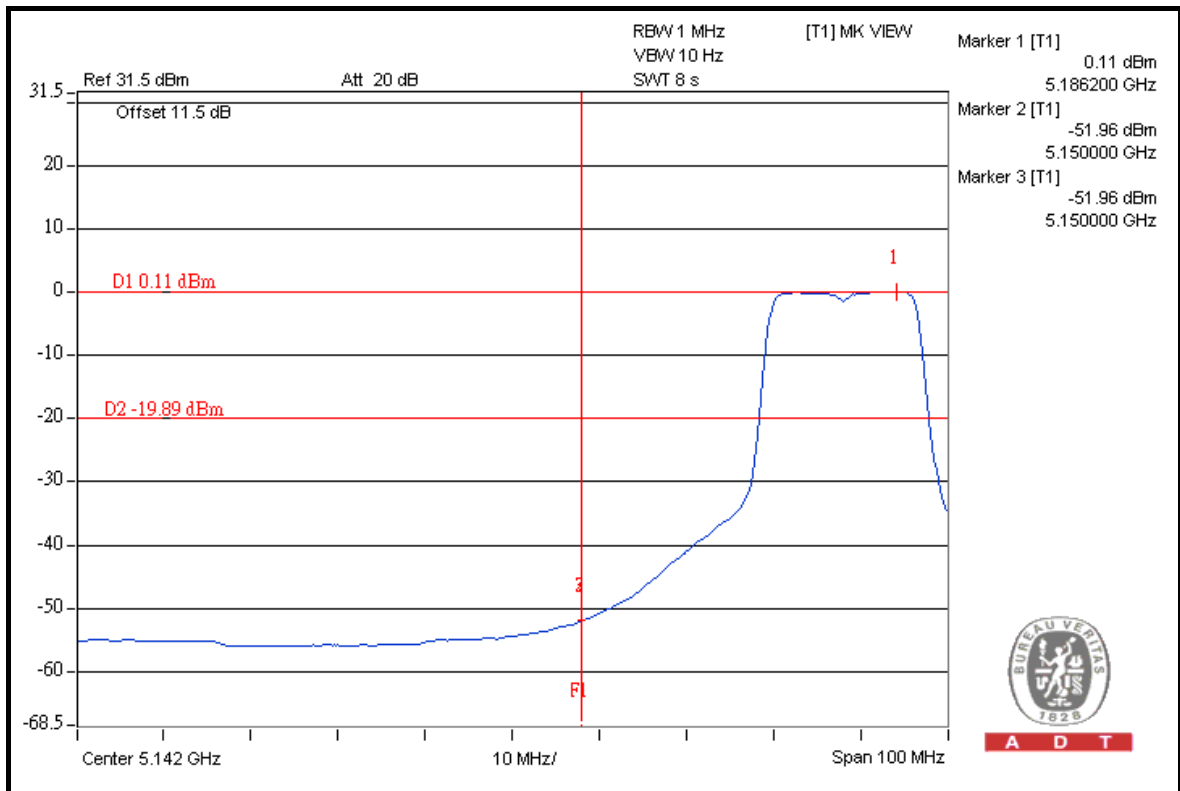
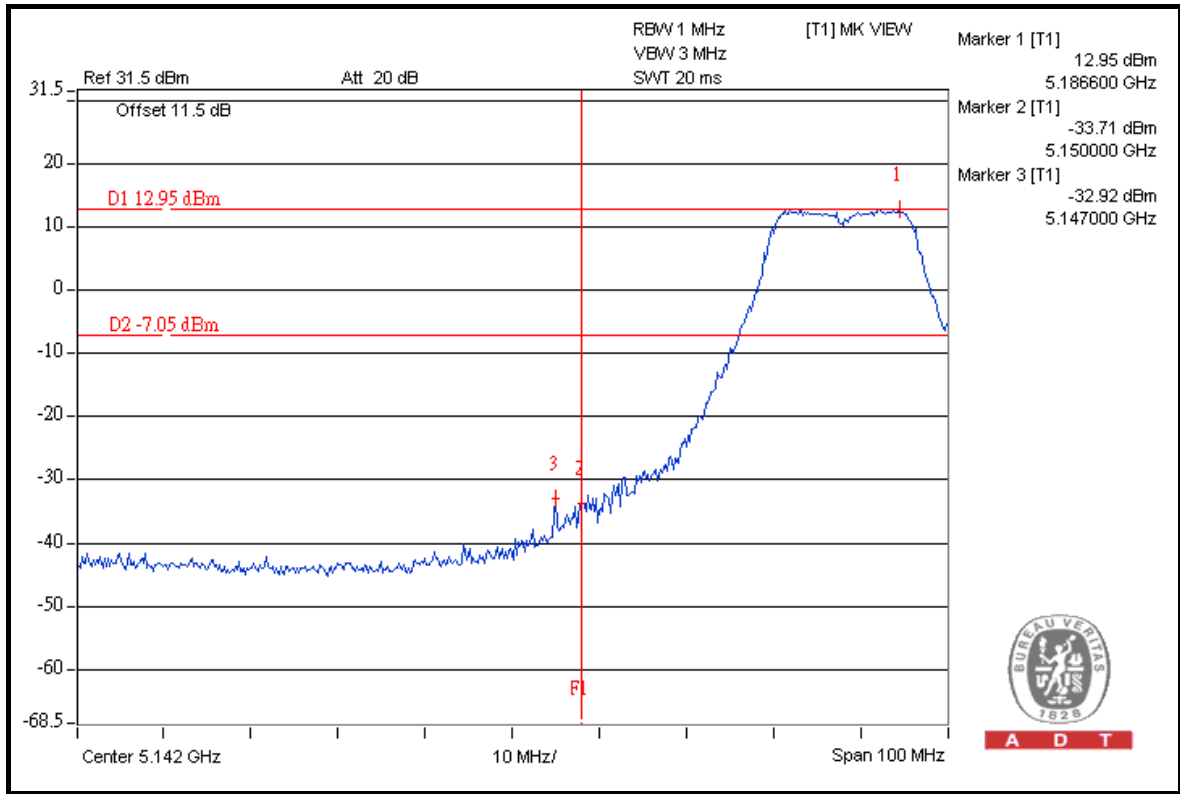



A D T

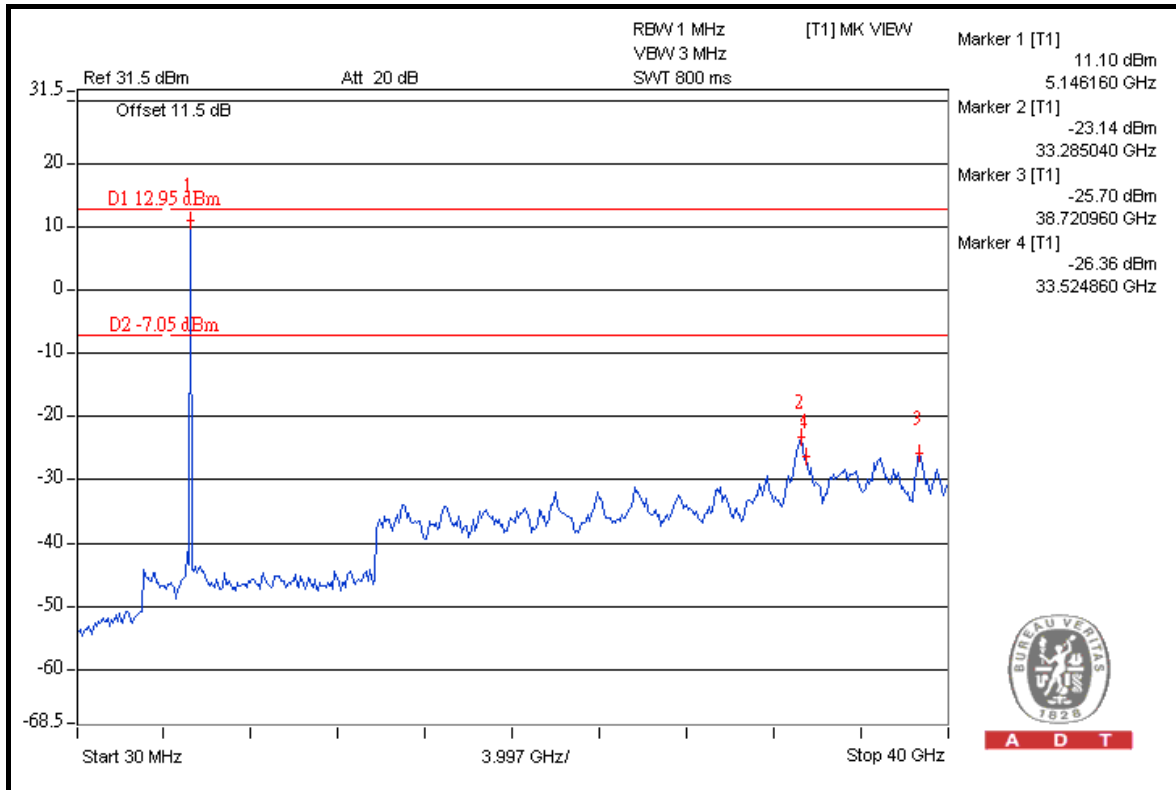

A D T

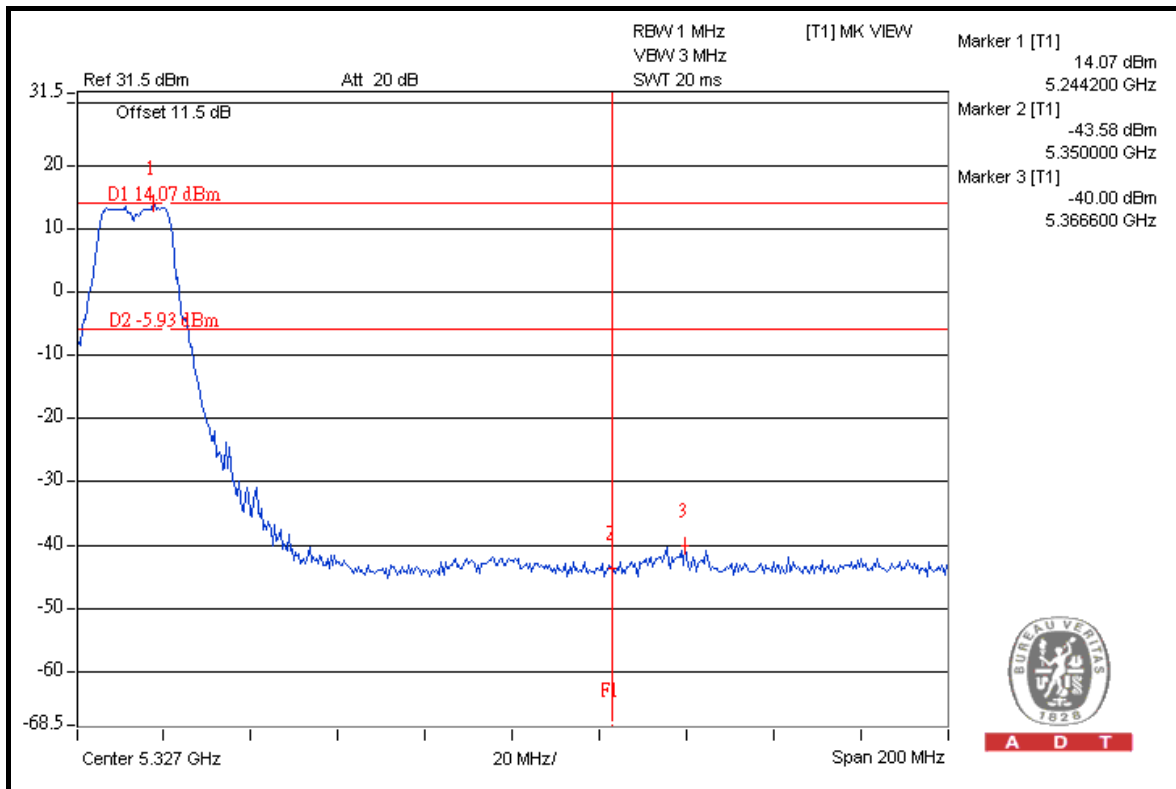

A D T



A D T

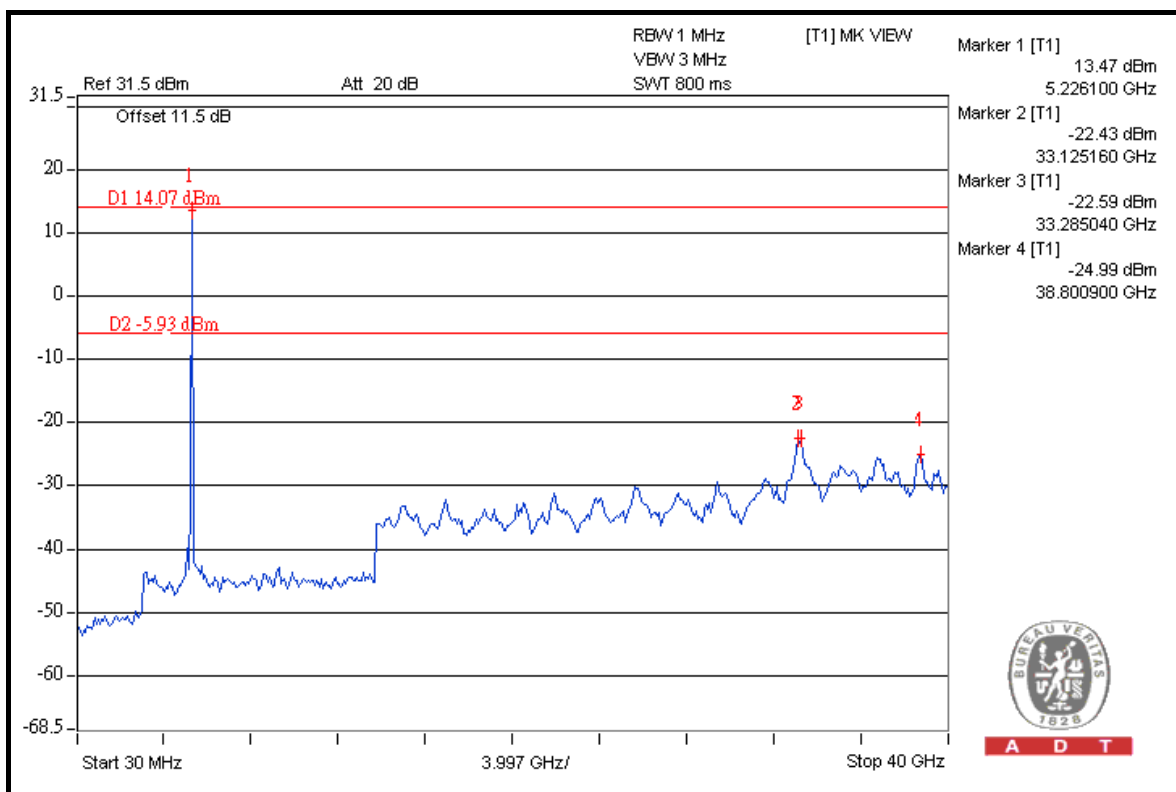
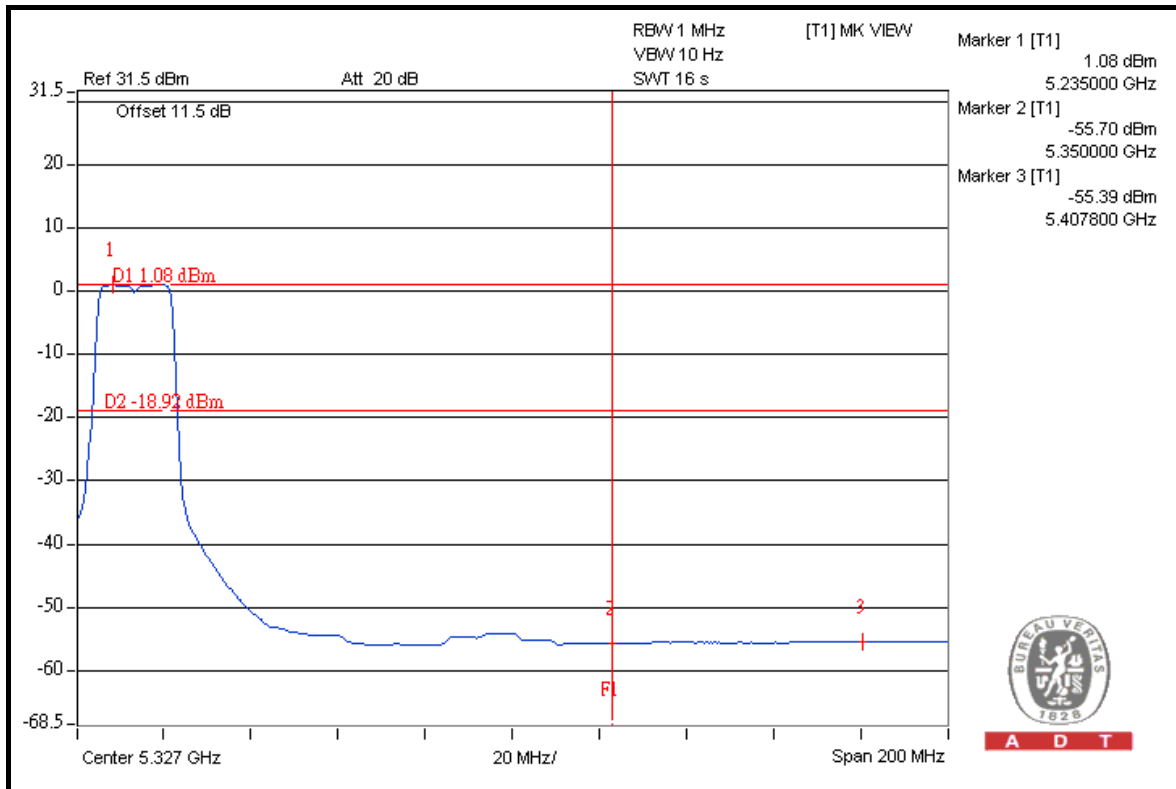

### 802.11n (20MHz)

#### RESTRICT BAND (4500 ~ 5150 MHz)

| FREQUENCY (MHz) | FUNDAMENTAL EMISSION (dBuV/m) | DELTA (dB) | MAXIMUM FIELD STRENGTH IN RESTRICT BAND (dBuV/m) | LIMIT (dBuV/m) |
|-----------------|-------------------------------|------------|--|----------------|
| 5180.00 (PK)    | 111.7                         | 45.41      | 66.29  | 74.00          |
| 5180.00 (AV)    | 99.9                          | 47.29      | 52.61  | 54.00          |

#### RESTRICT BAND (5350 ~ 5460 MHz)

| FREQUENCY (MHz) | FUNDAMENTAL EMISSION (dBuV/m) | DELTA (dB) | MAXIMUM FIELD STRENGTH IN RESTRICT BAND (dBuV/m) | LIMIT (dBuV/m) |
|-----------------|-------------------------------|------------|--|----------------|
| 5240.00 (PK)    | 112.3                         | 52.10      | 60.20  | 74.00          |
| 5240.00 (AV)    | 100.9                         | 48.81      | 52.09  | 54.00          |

**NOTE:**

- Delta = Amplitude between the peak of the fundamental and the peak of the band edge emission. Please check following 2 pages.
- Maximum field strength in restrict band = Fundamental emission – Delta.



A D T

### FOR RADIATED MEASURED (3 CHAINS ON)

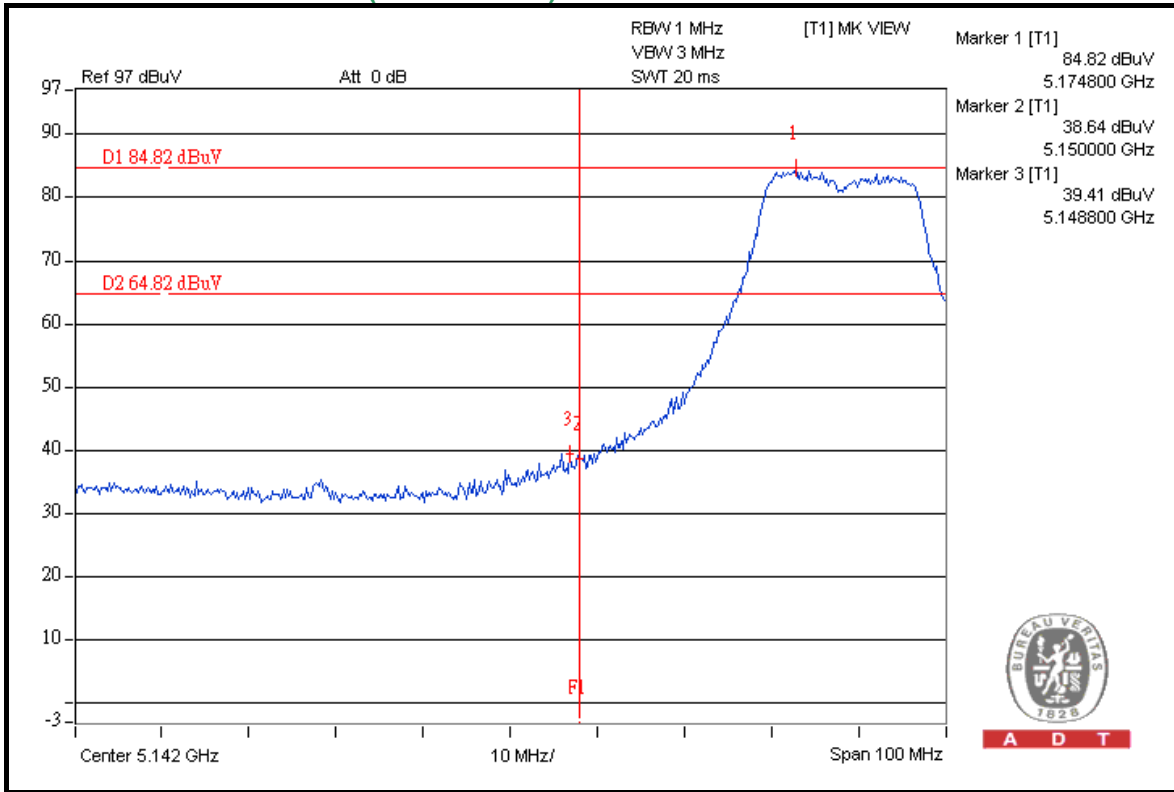

A D T

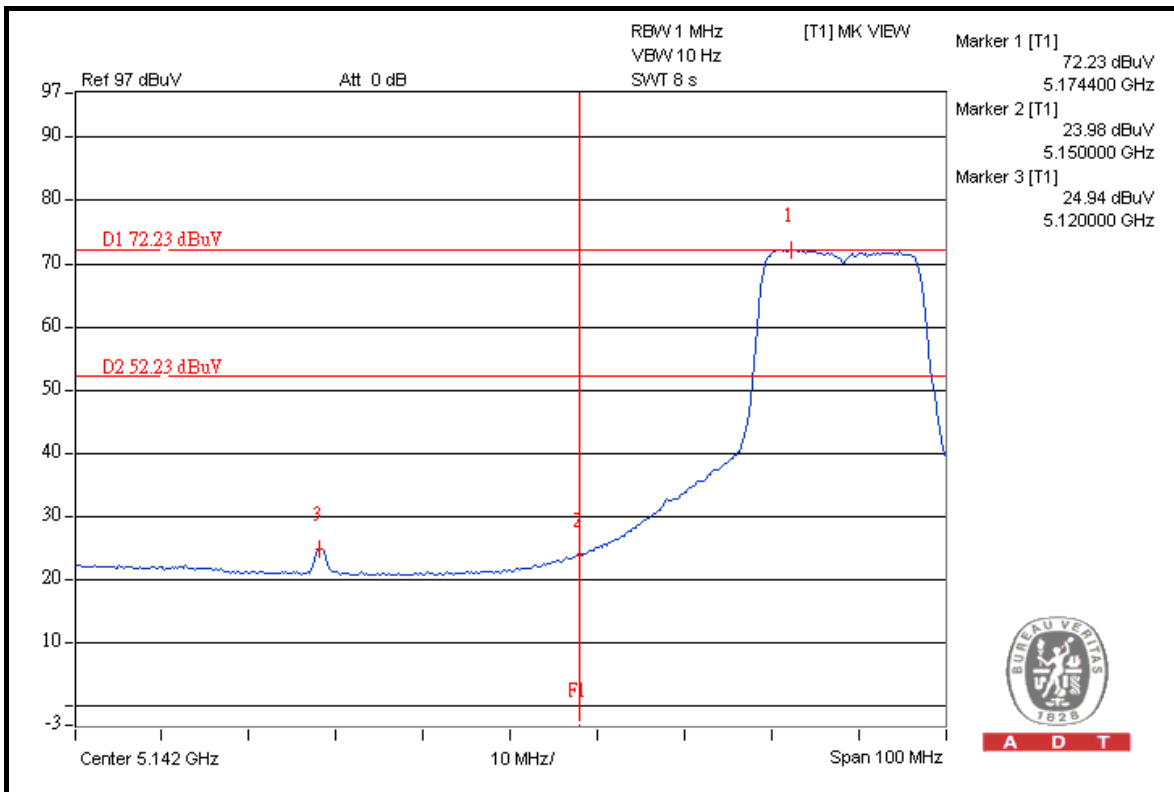

A D T





A D T

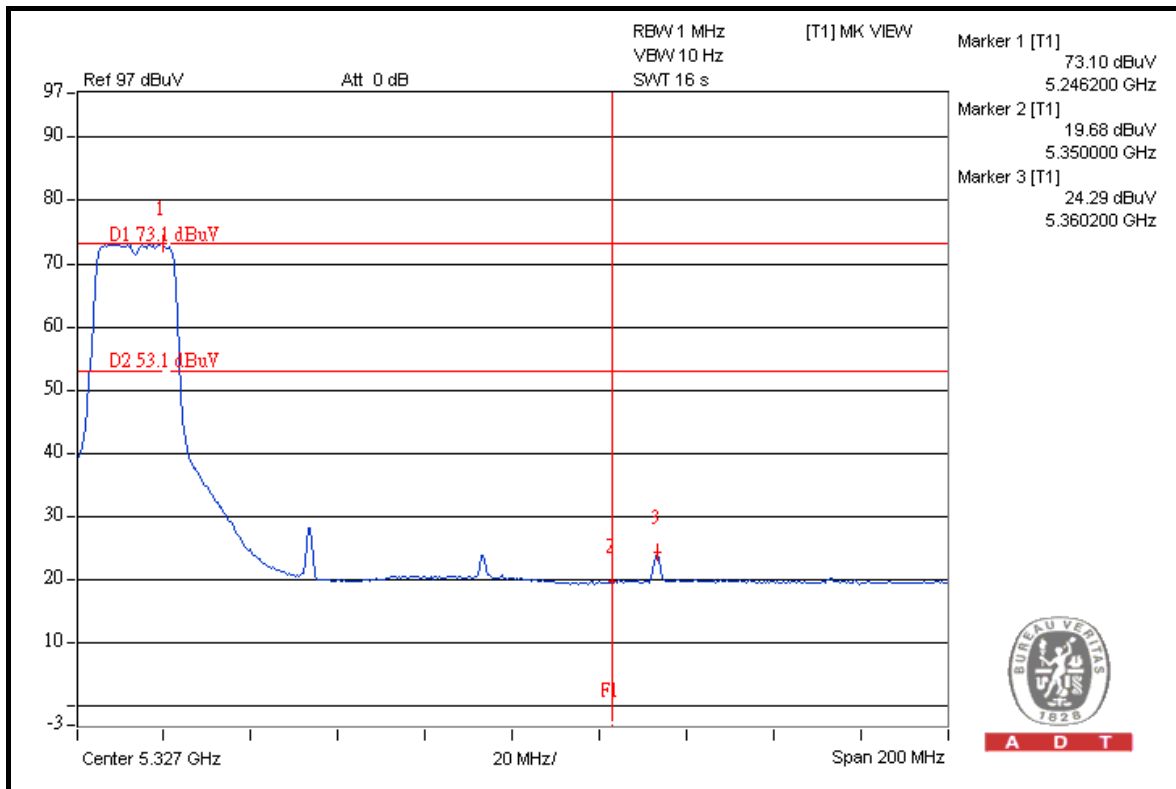
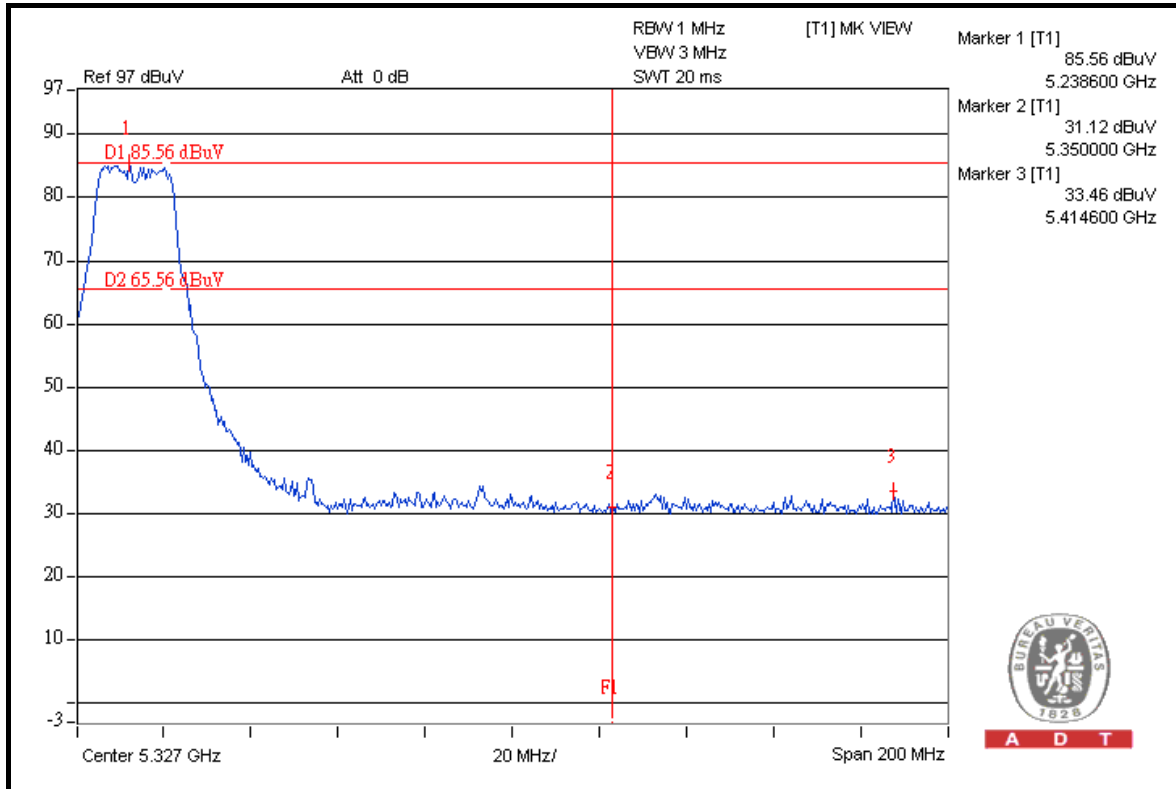



A D T

### FOR CONDUCTED MEASURED CHAIN 0

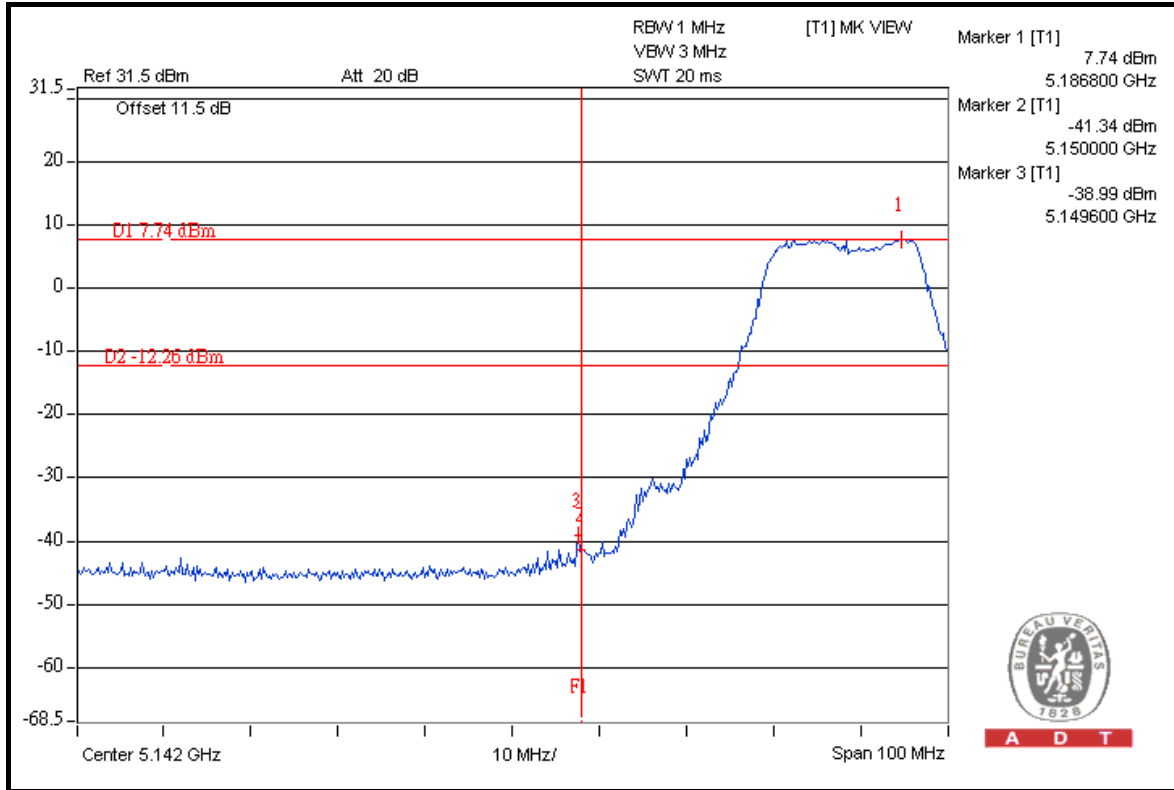

A D T

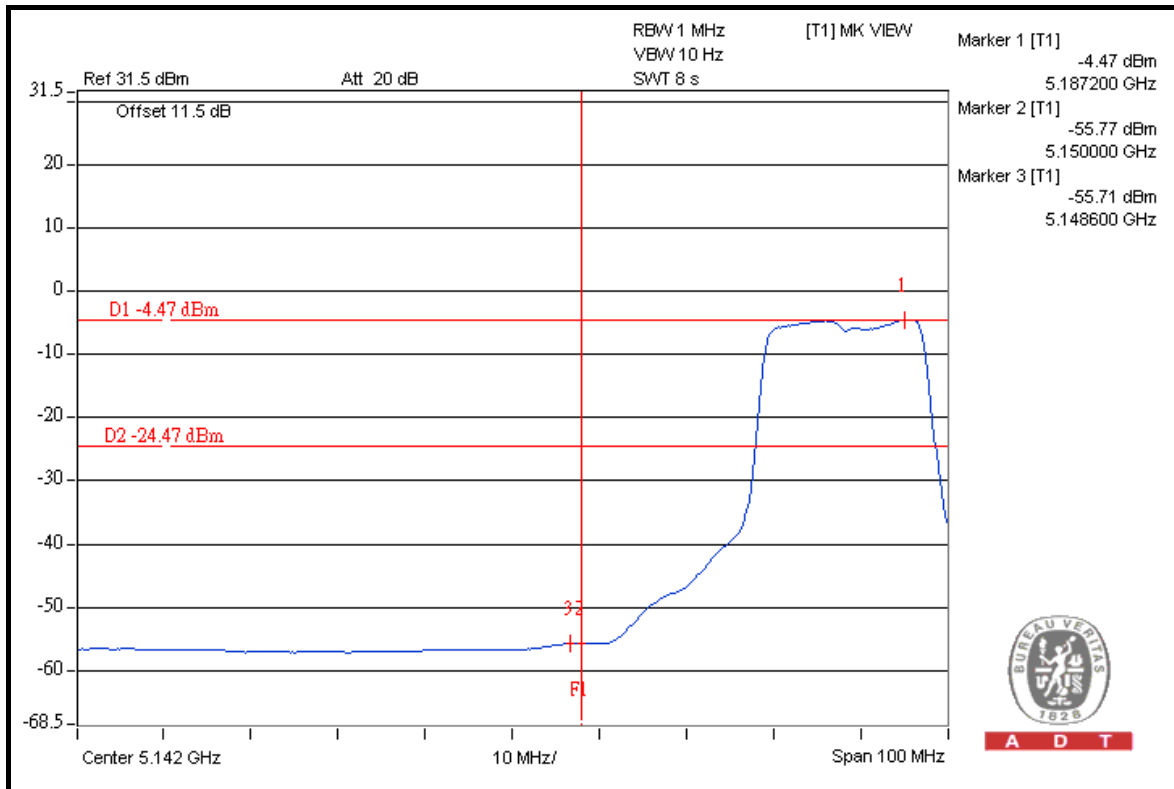

A D T



A D T

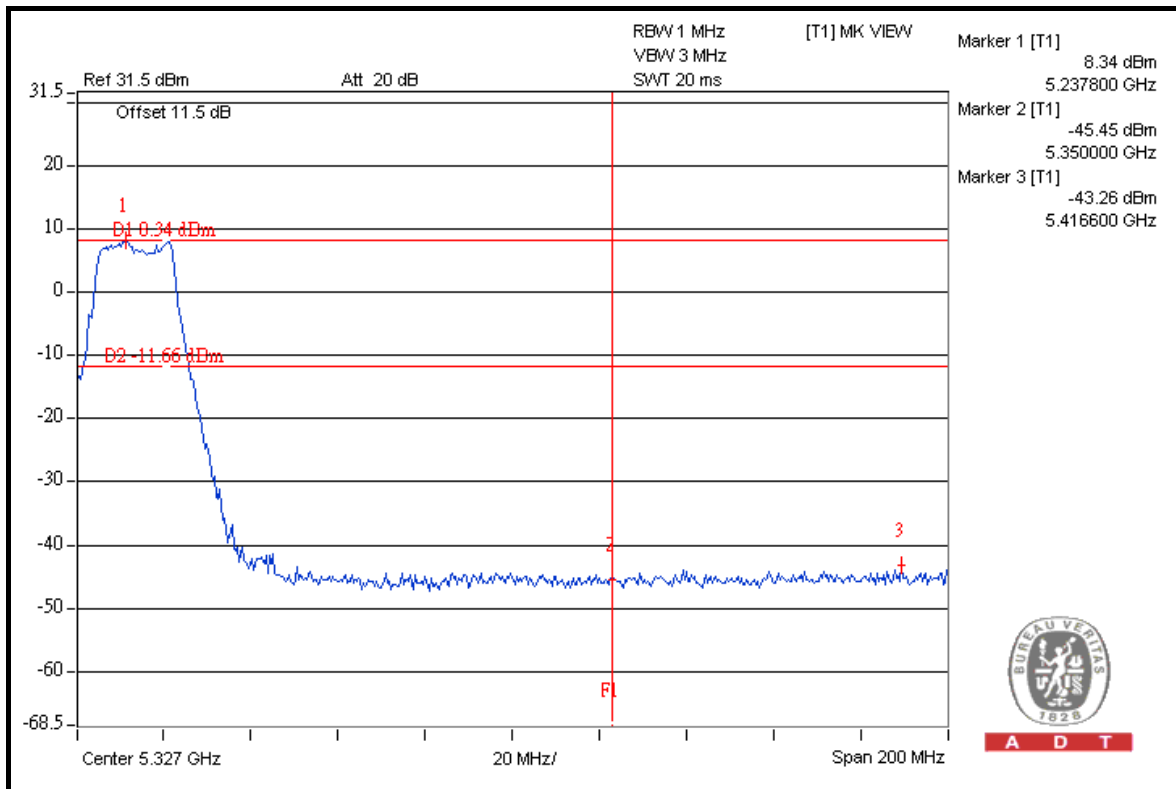
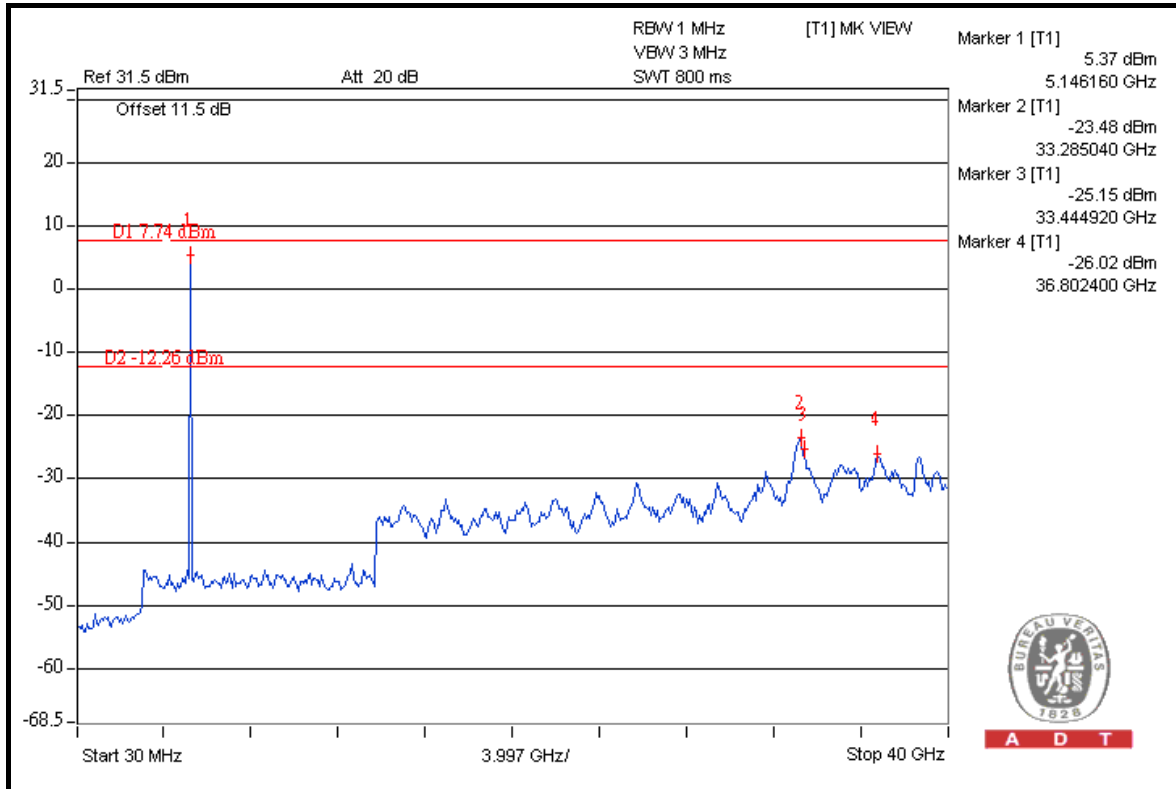



A D T

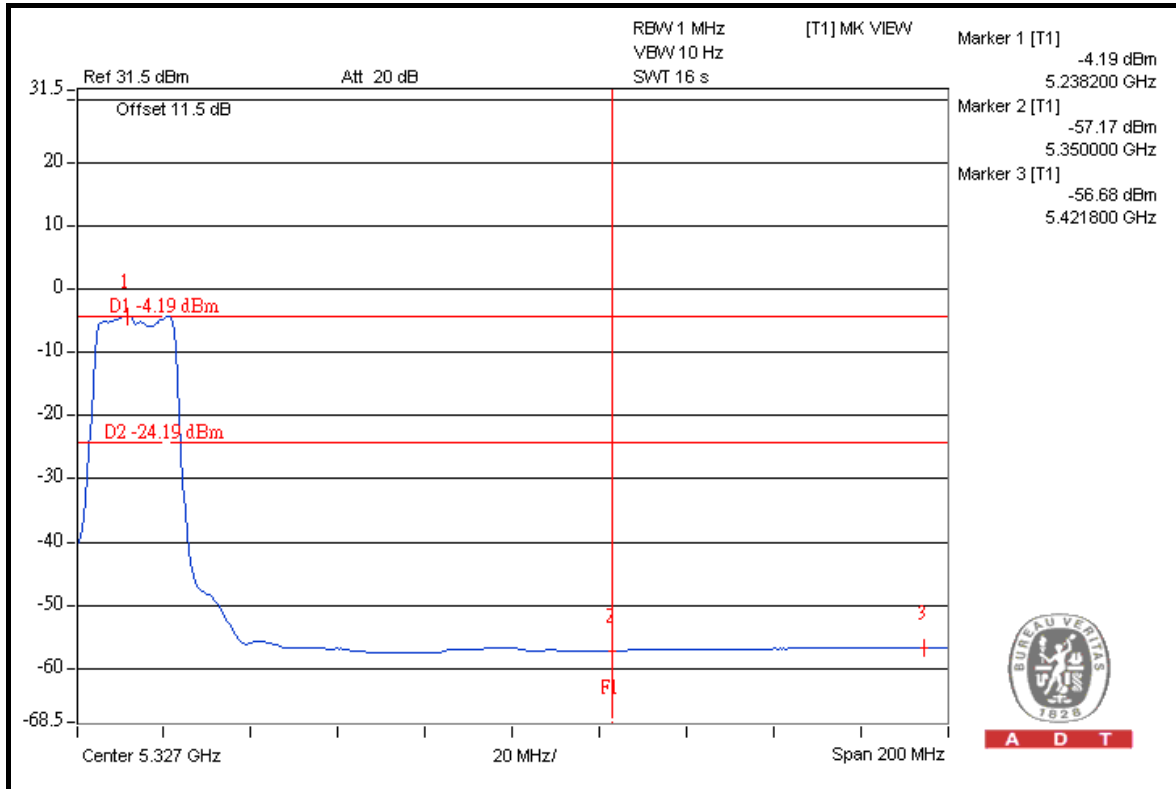

A D T

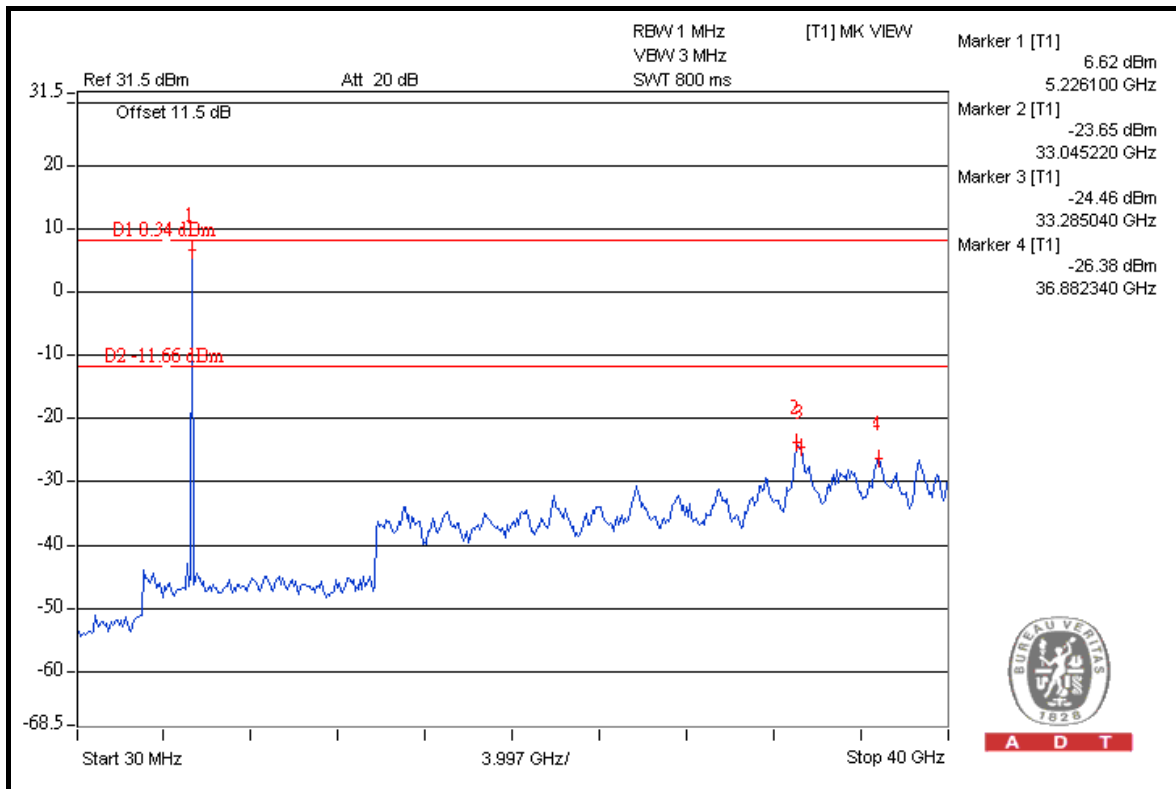

A D T



A D T

### CHAIN 1

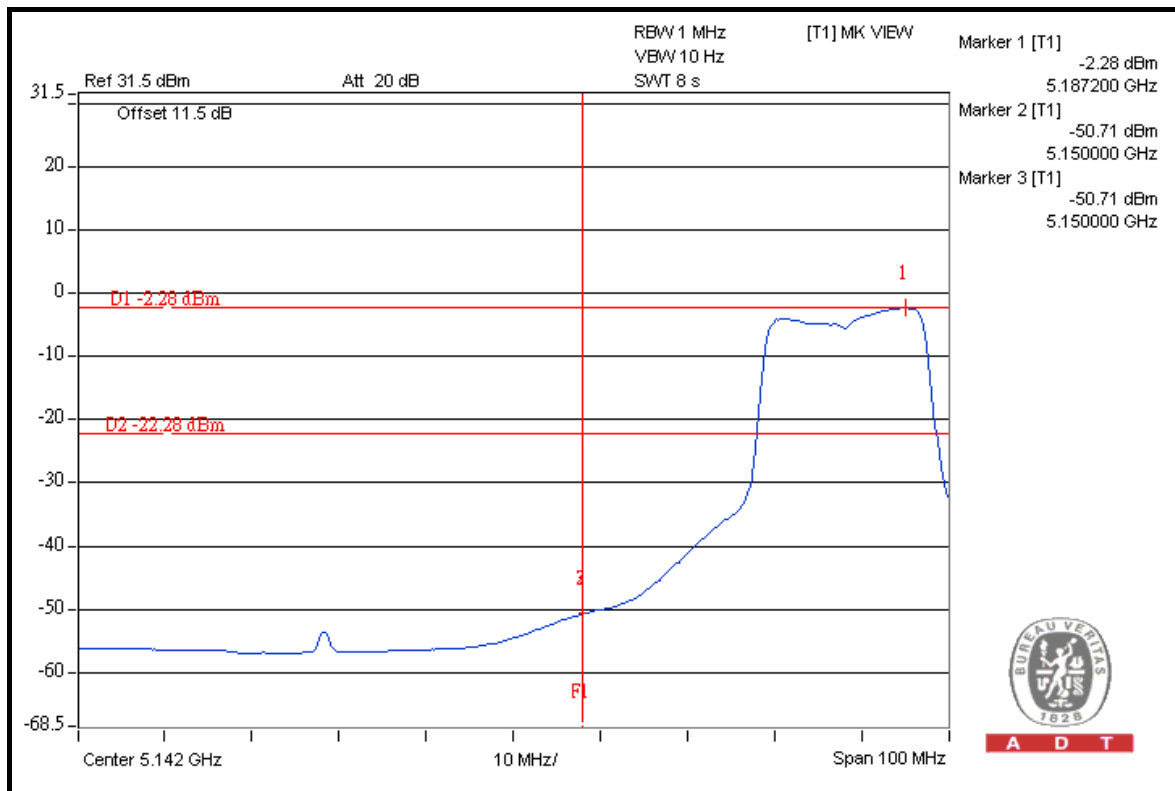
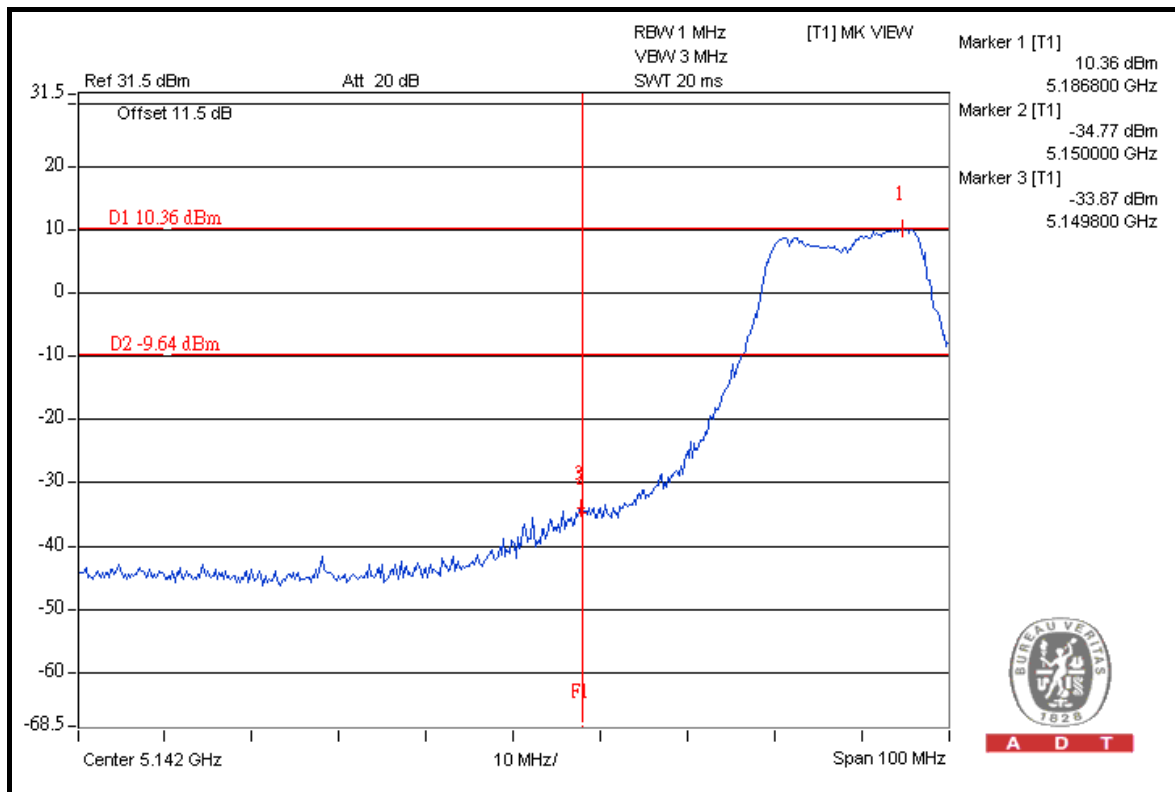



A D T

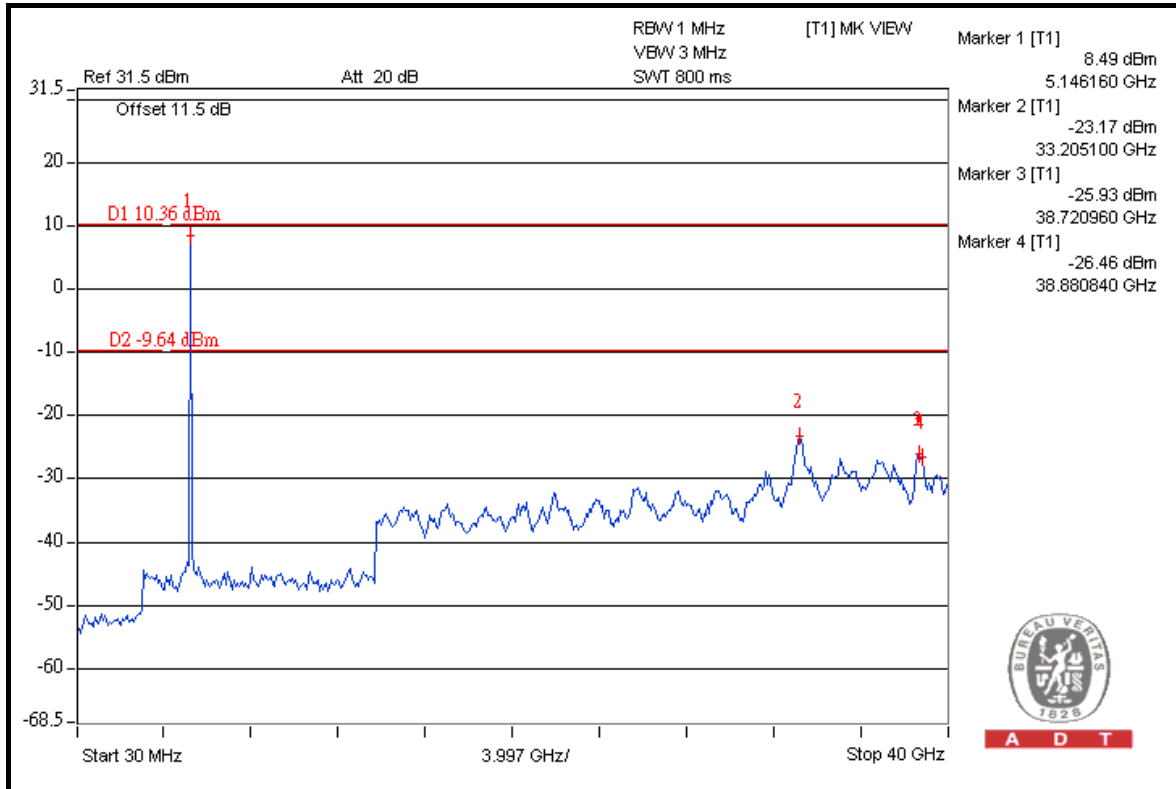

A D T

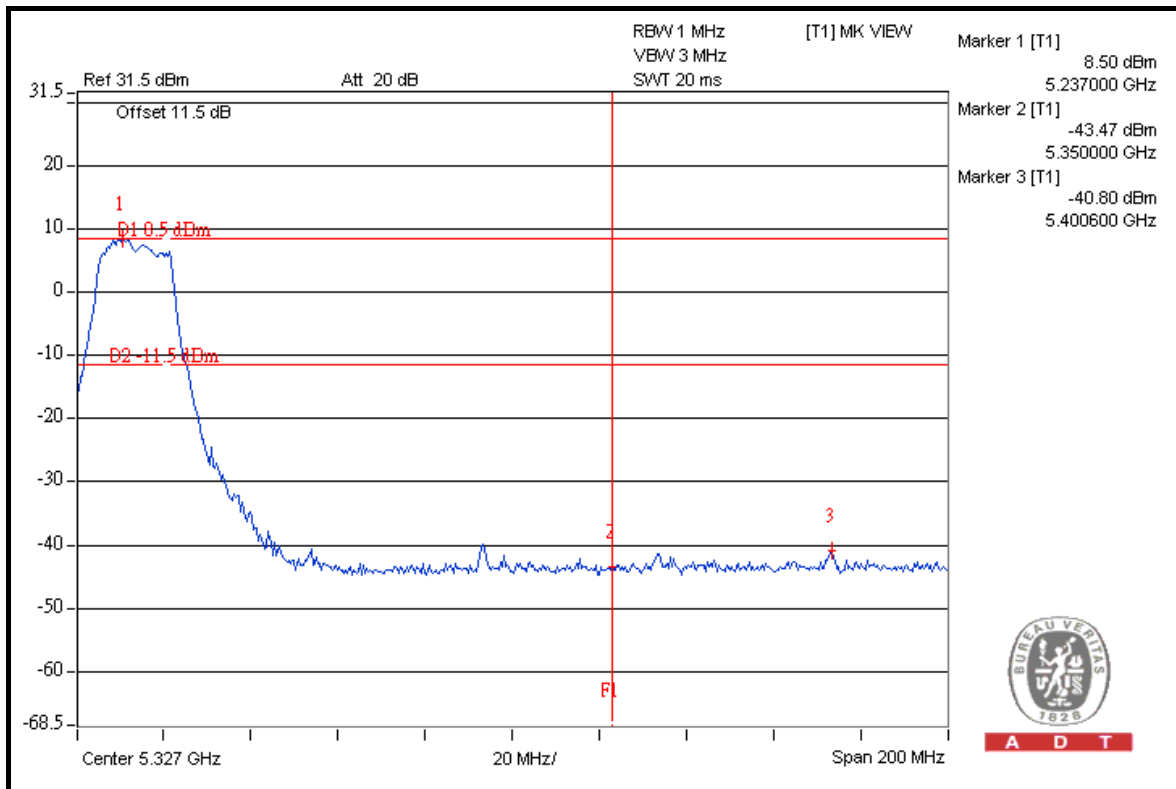

A D T



A D T

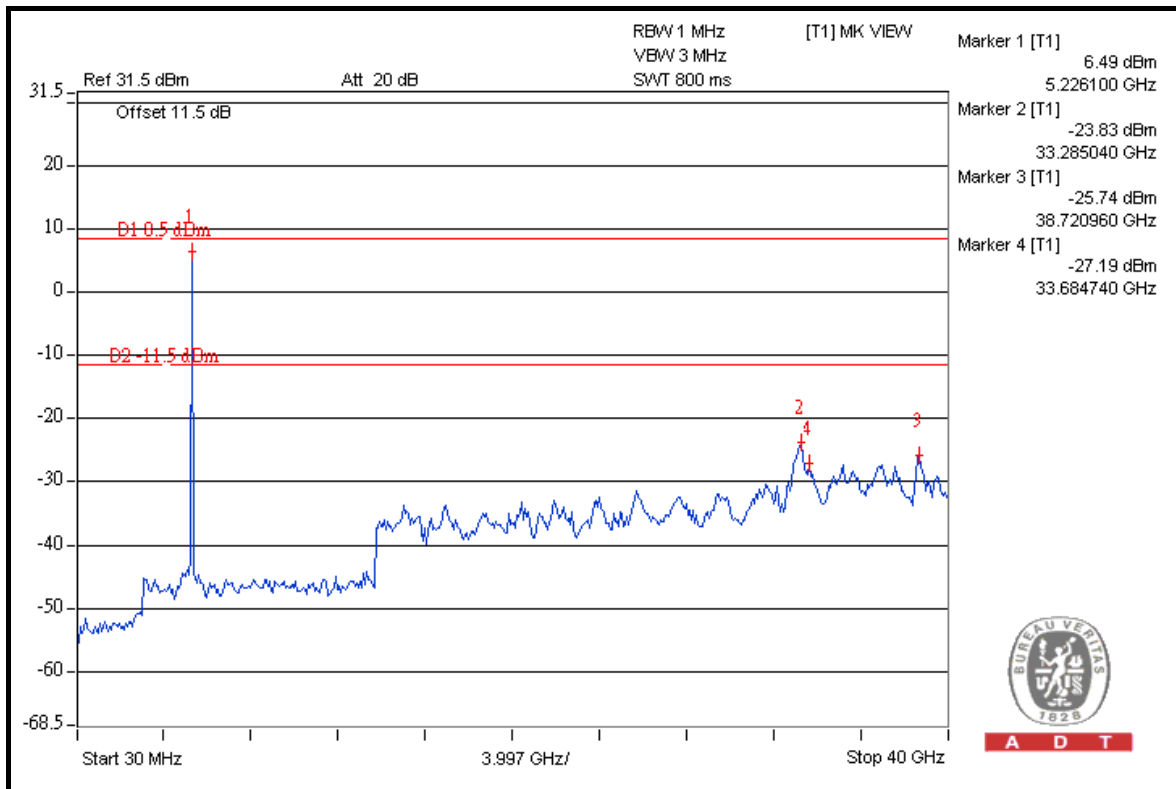
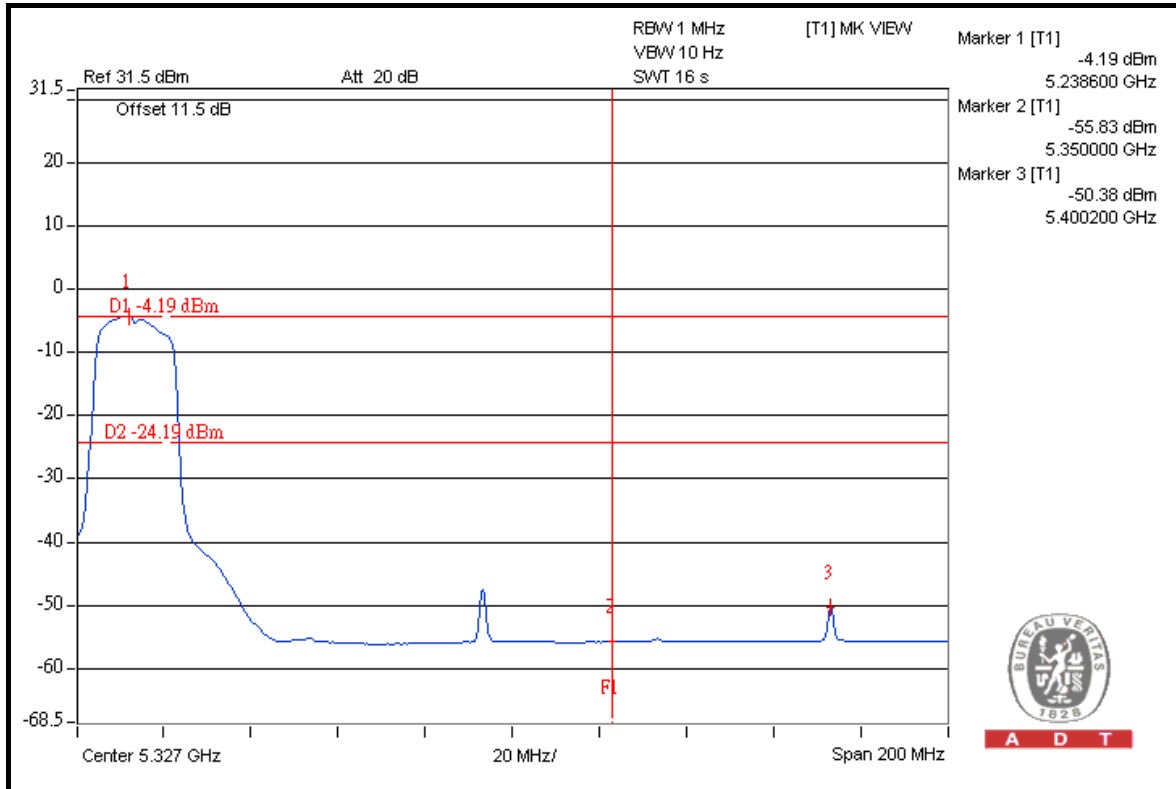



A D T

### CHAIN 2

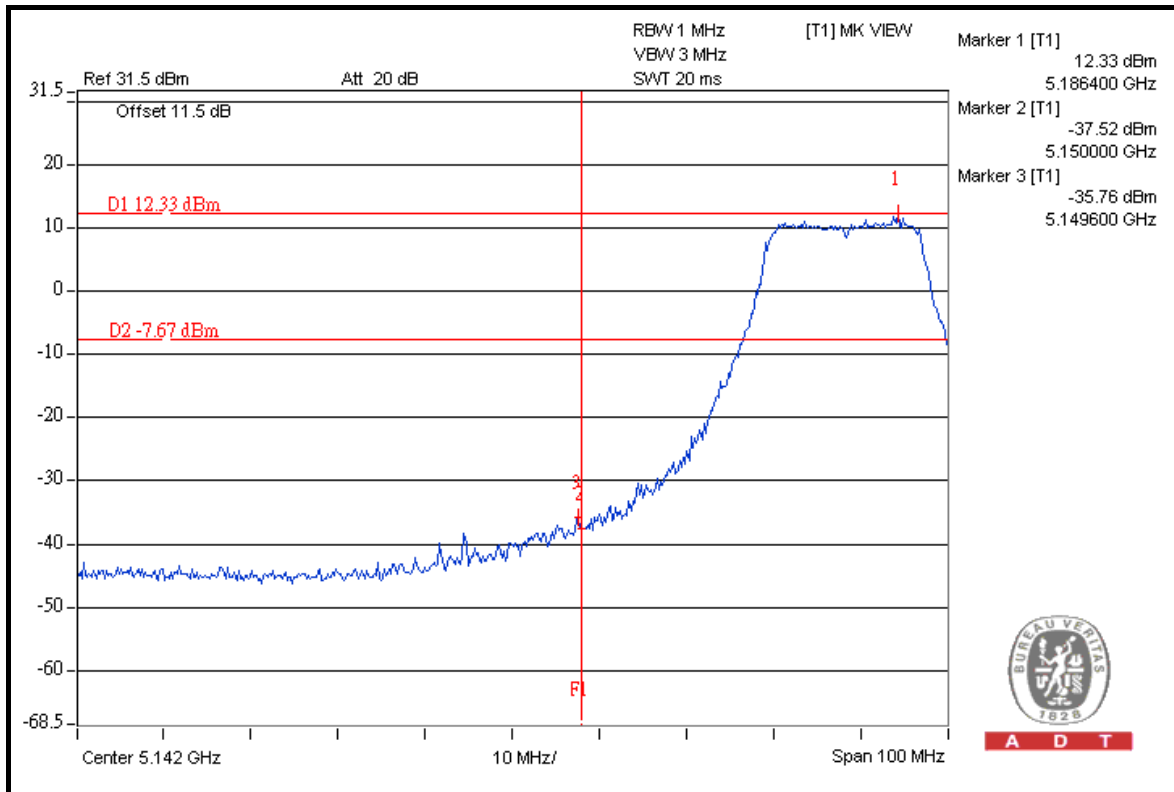

A D T

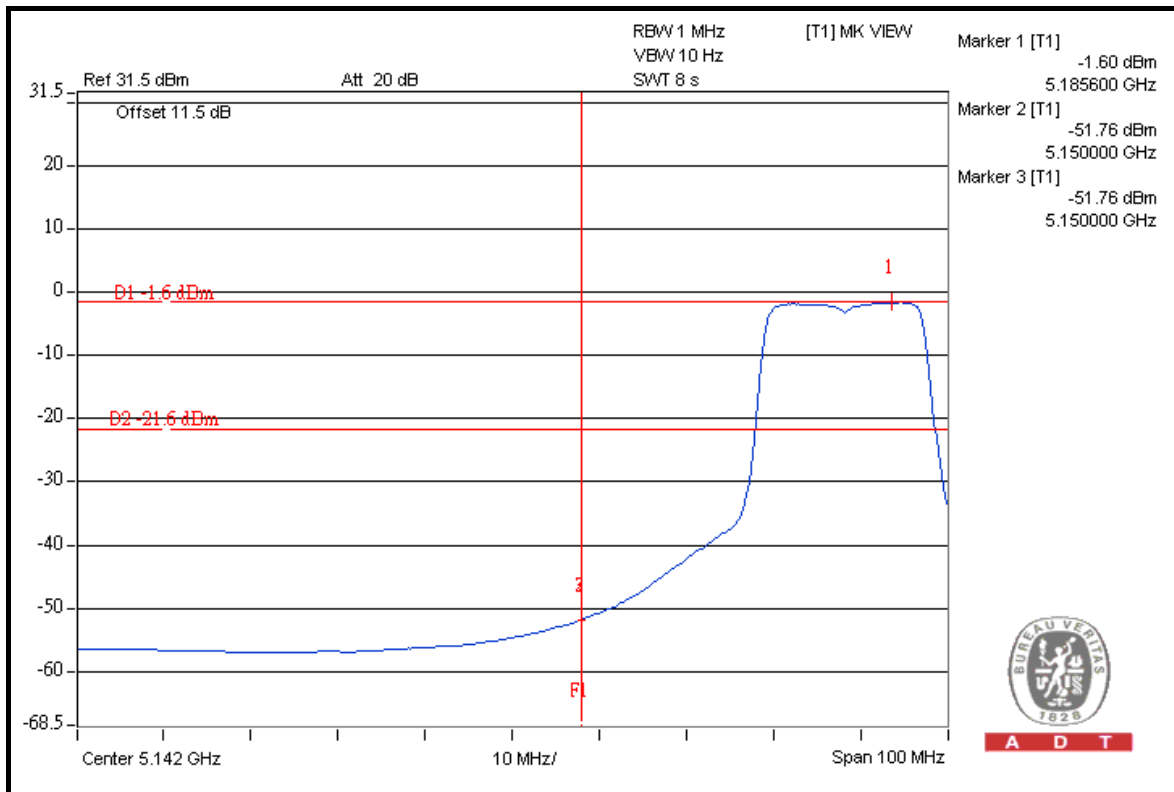

A D T





A D T

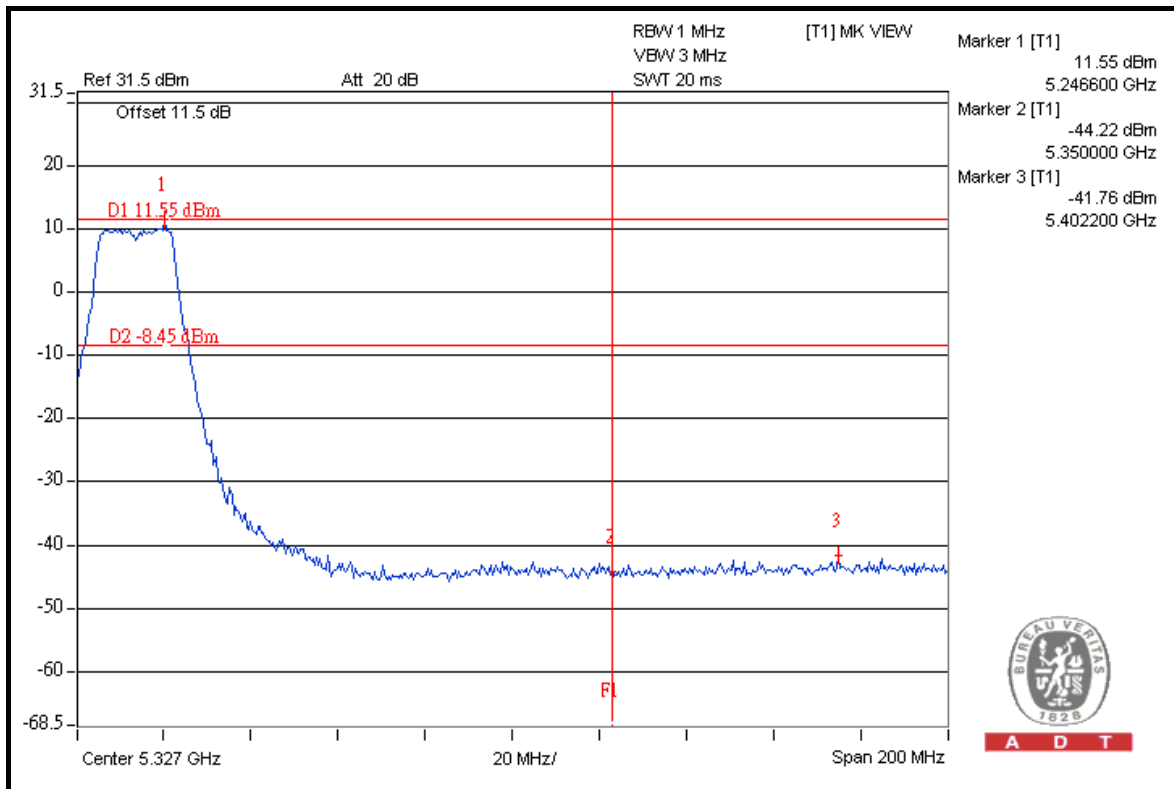
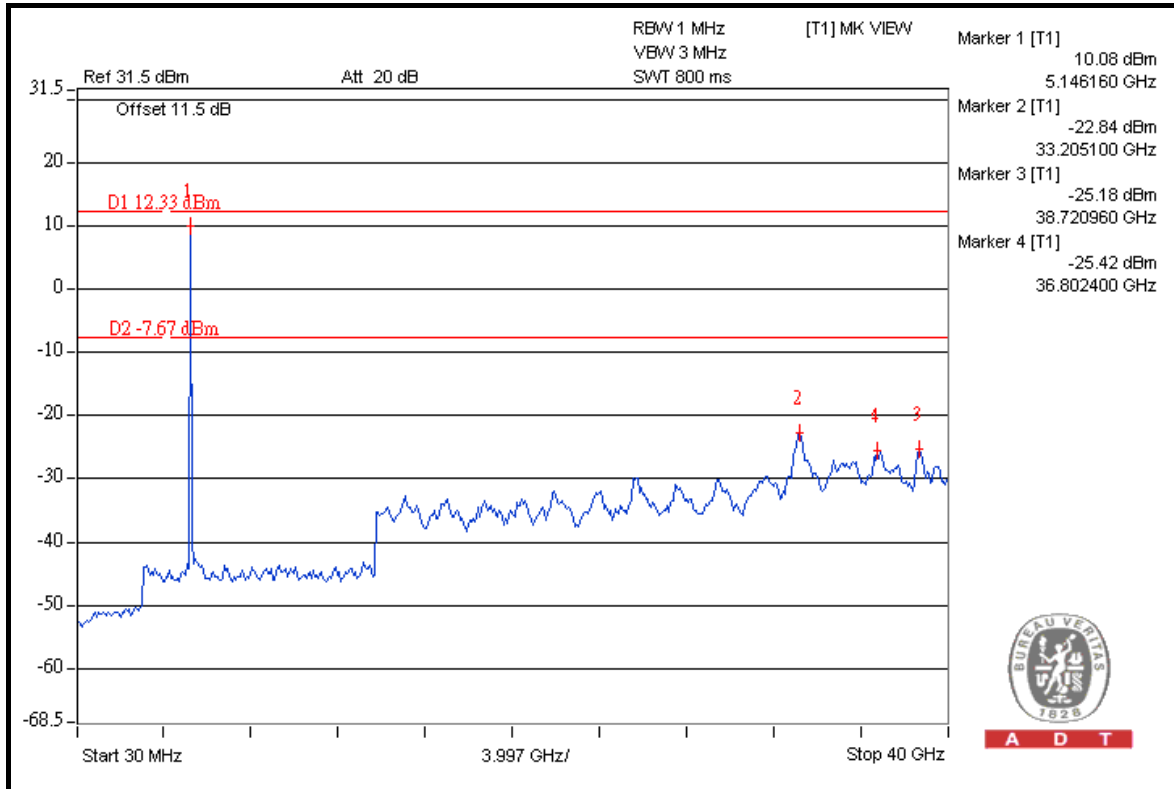



A D T

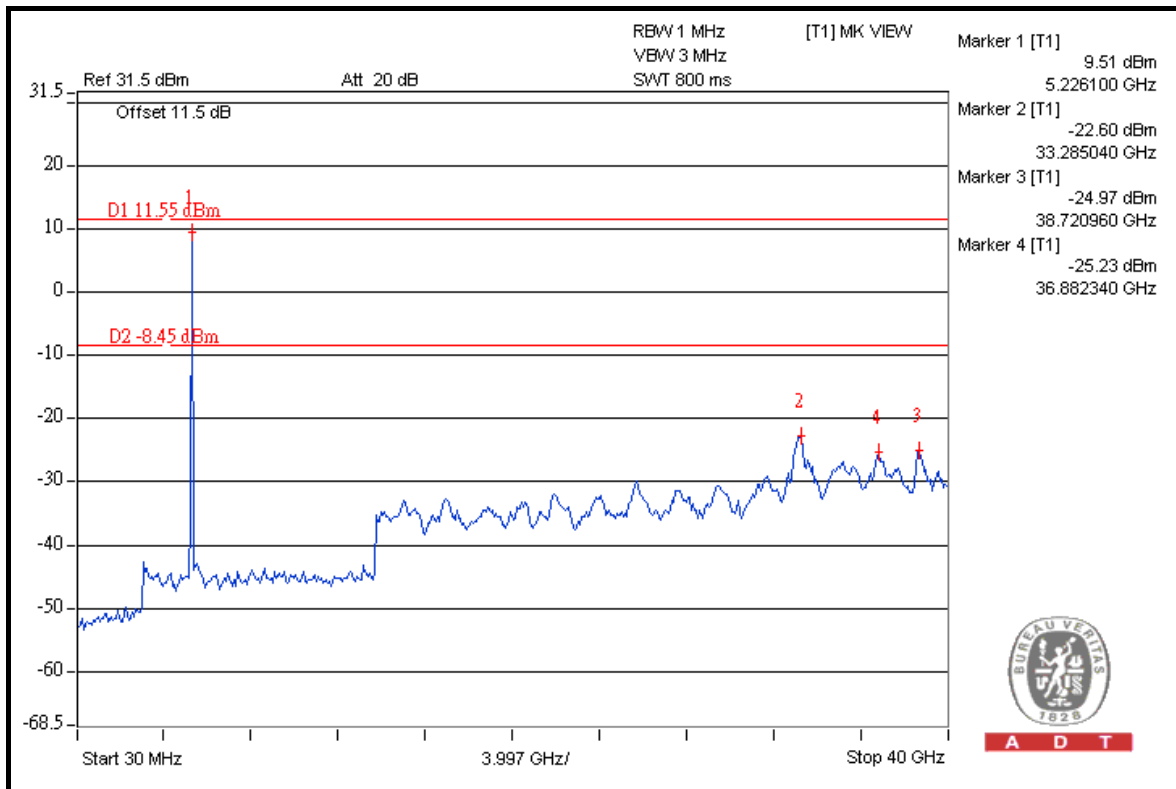
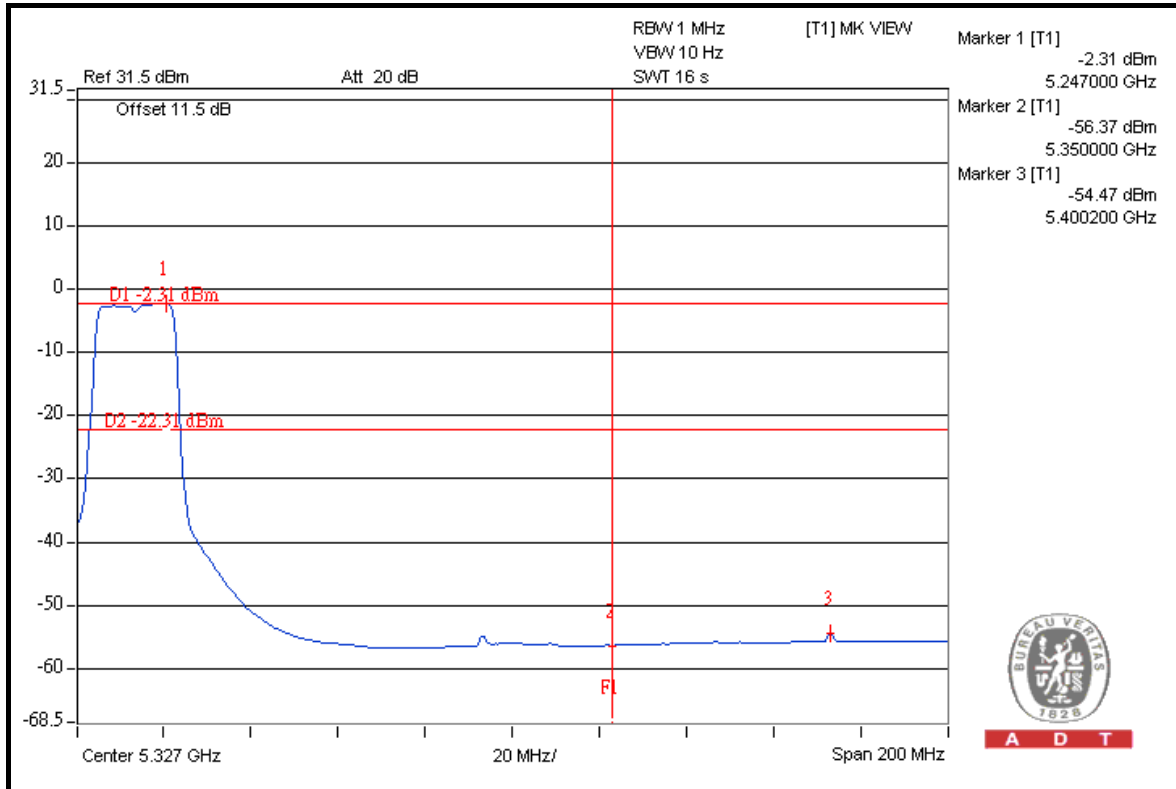



## 802.11n (40MHz)

### RESTRICT BAND (4500 ~ 5150 MHz)

| FREQUENCY (MHz) | FUNDAMENTAL EMISSION (dBuV/m) | DELTA (dB) | MAXIMUM FIELD STRENGTH IN RESTRICT BAND (dBuV/m) | LIMIT (dBuV/m) |
|-----------------|-------------------------------|------------|--|----------------|
| 5190.00 (PK)    | 107.7                         | 39.49      | 68.21  | 74.00          |
| 5190.00 (AV)    | 96.2                          | 43.47      | 52.73  | 54.00          |

### RESTRICT BAND (5350 ~ 5460 MHz)

| FREQUENCY (MHz) | FUNDAMENTAL EMISSION (dBuV/m) | DELTA (dB) | MAXIMUM FIELD STRENGTH IN RESTRICT BAND (dBuV/m) | LIMIT (dBuV/m) |
|-----------------|-------------------------------|------------|--|----------------|
| 5230.00 (PK)    | 107.8                         | 49.68      | 58.12  | 74.00          |
| 5230.00 (AV)    | 96.7                          | 46.53      | 50.17  | 54.00          |

#### NOTE:

1. Delta = Amplitude between the peak of the fundamental and the peak of the band edge emission. Please check following 2 pages.
2. Maximum field strength in restrict band = Fundamental emission – Delta.



A D T

### FOR RADIATED MEASURED (3 CHAINS ON)

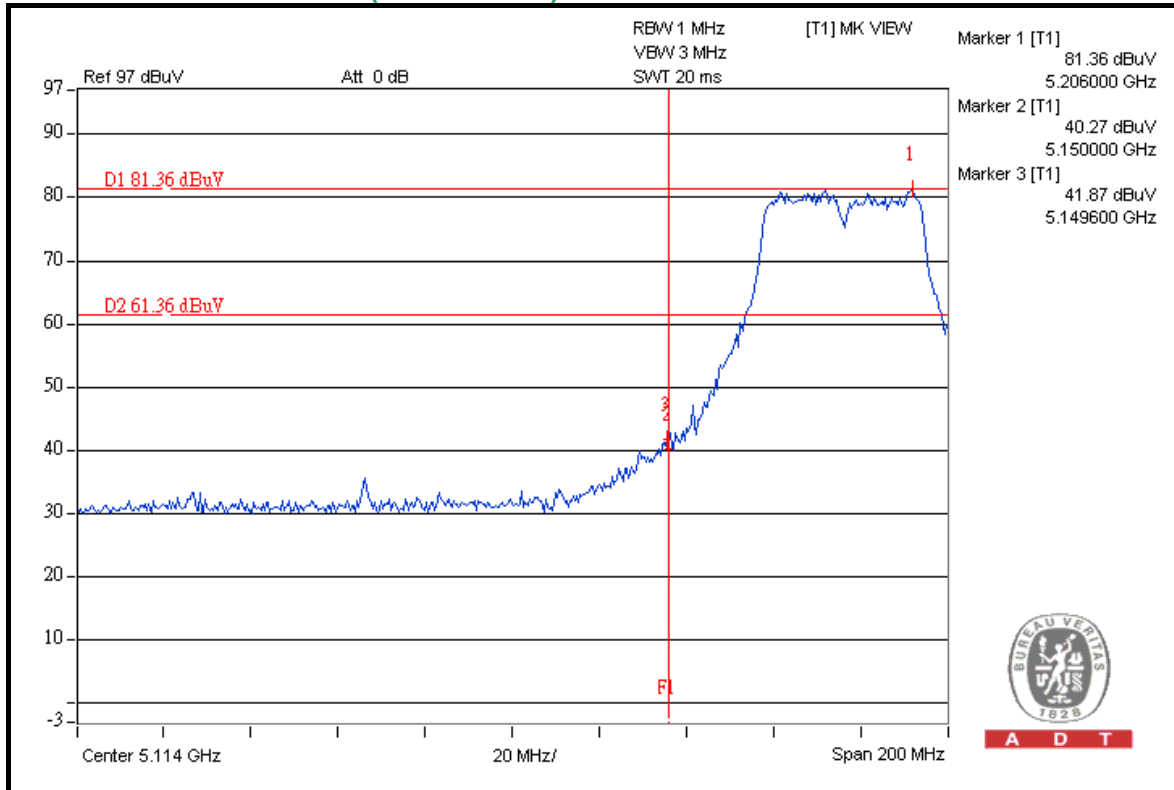

A D T

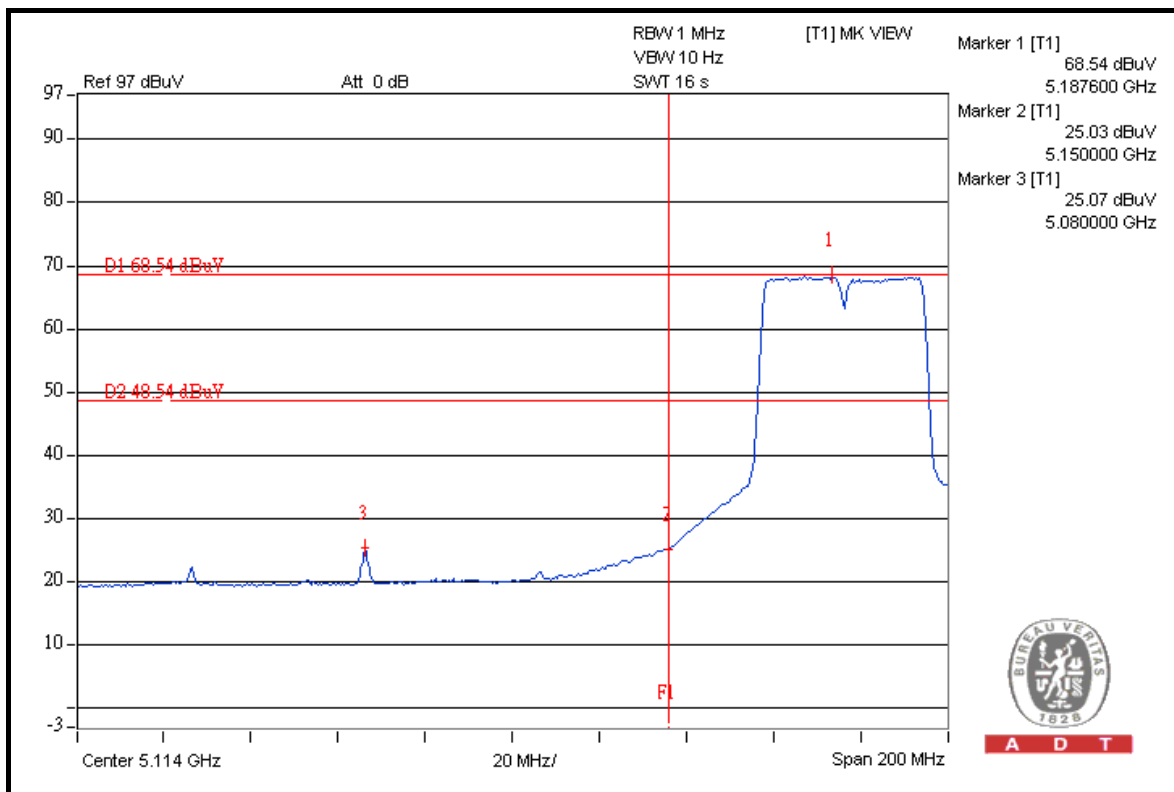

A D T



A D T

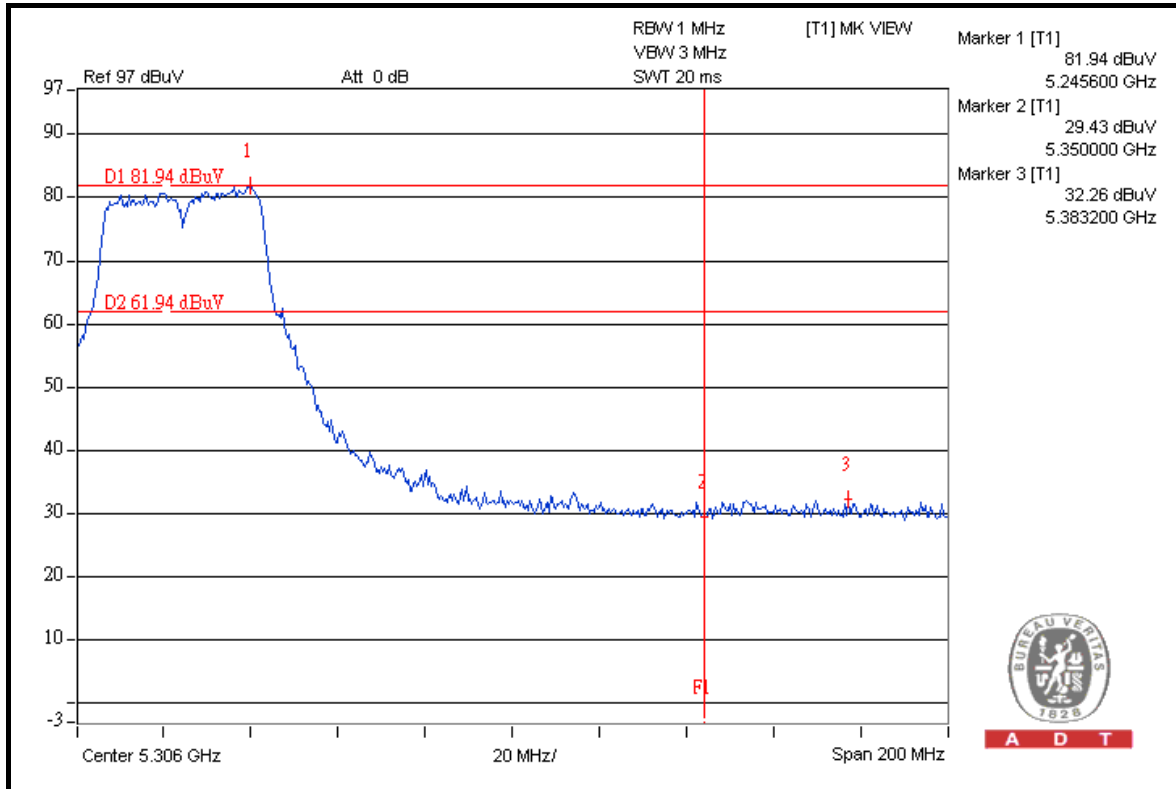

A D T

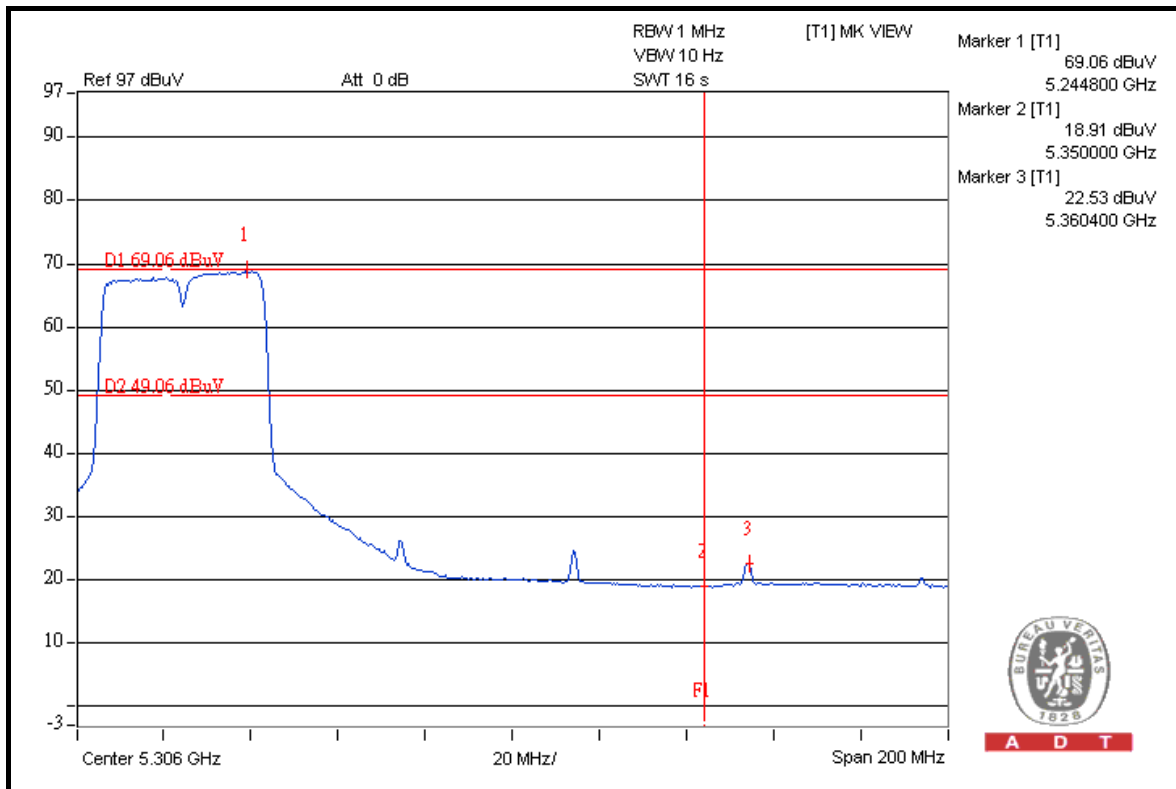

A D T



A D T

### FOR CONDUCTED MEASURED

### CHAIN 0

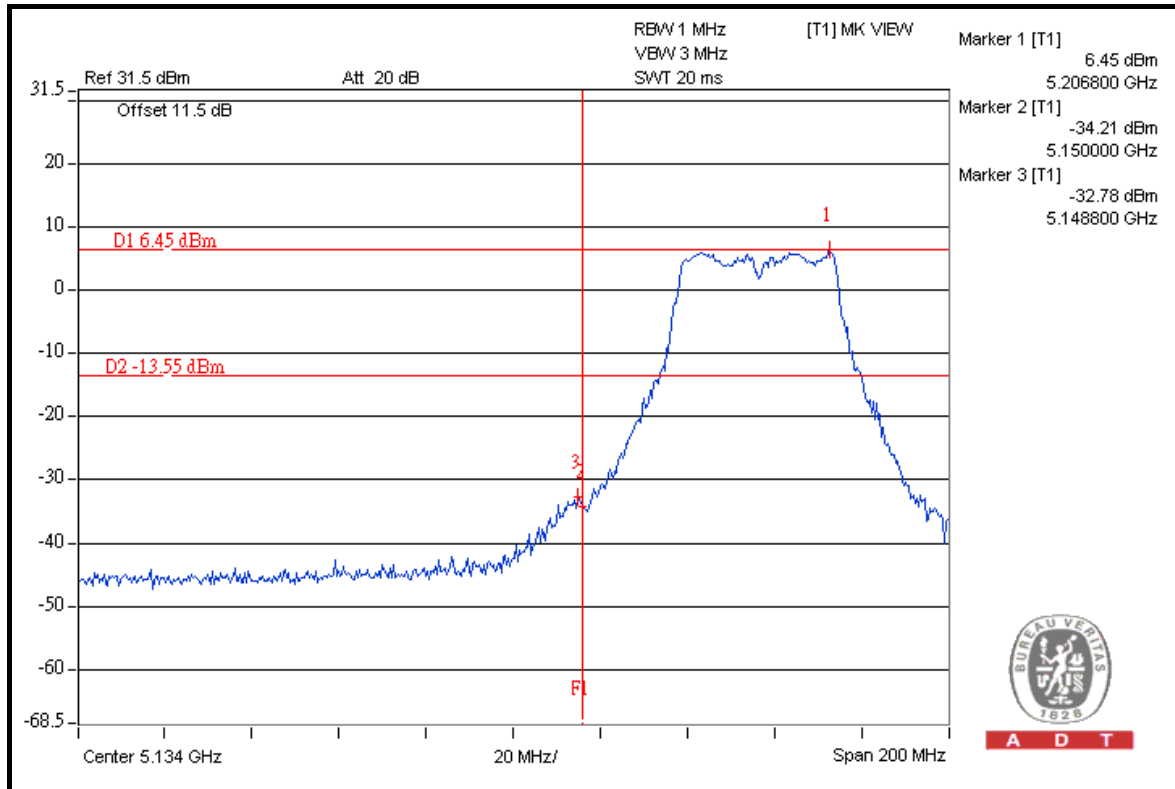

A D T

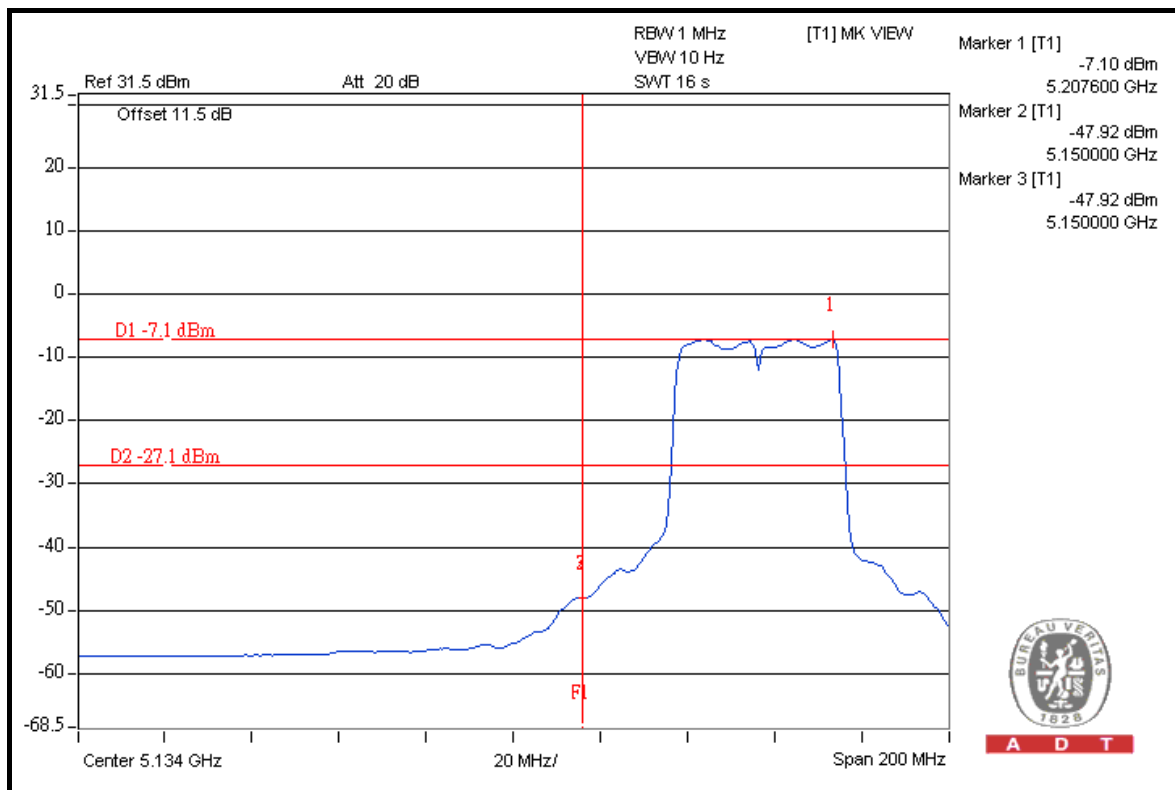

A D T



A D T

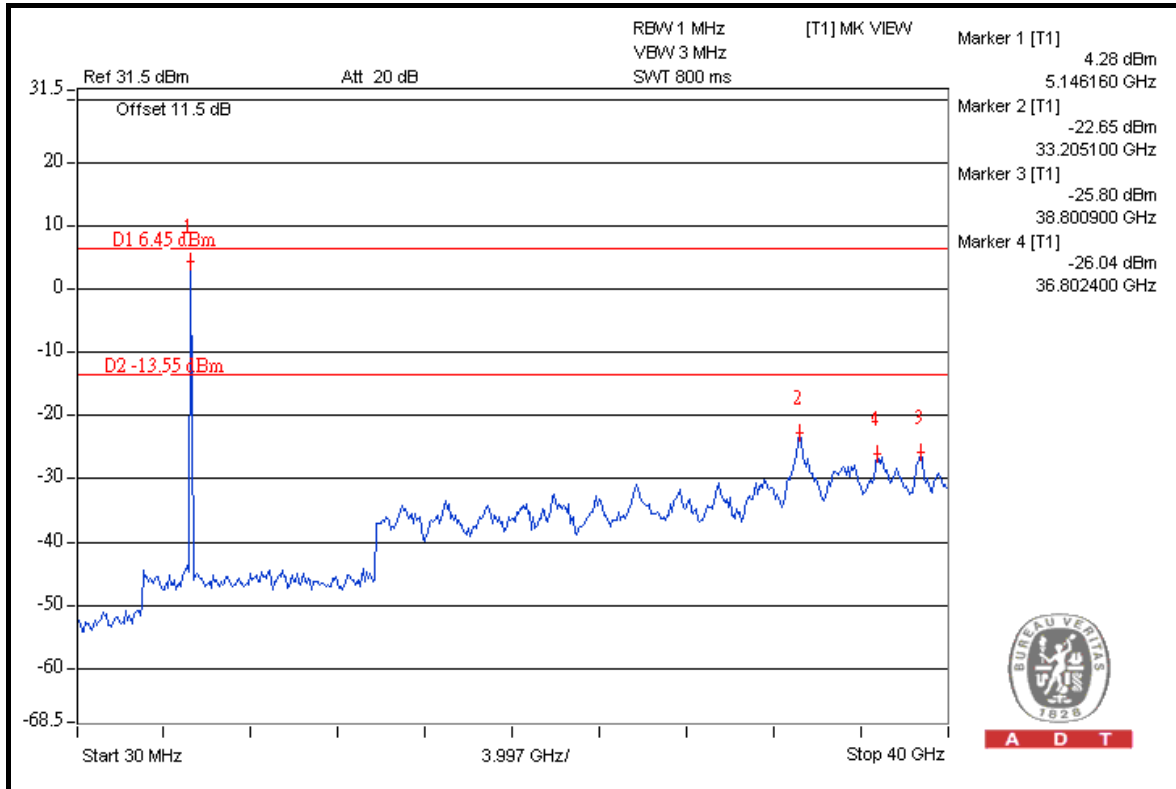

A D T

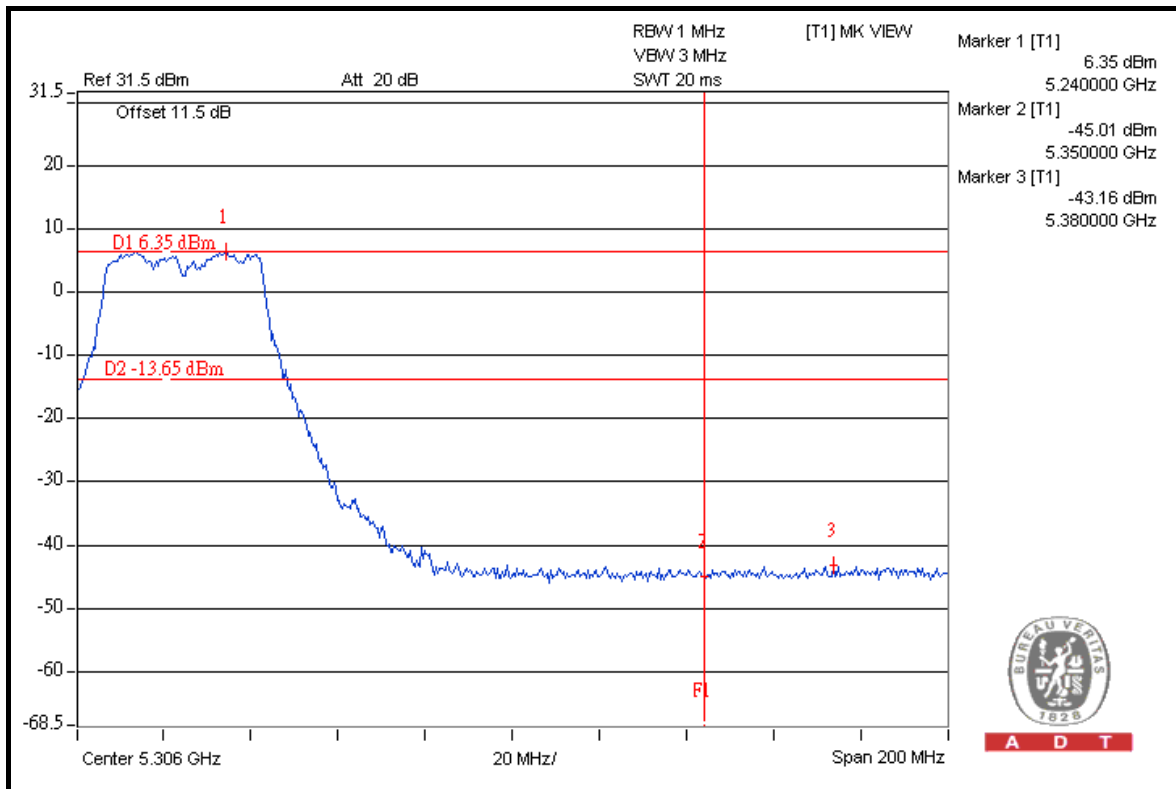

A D T



A D T

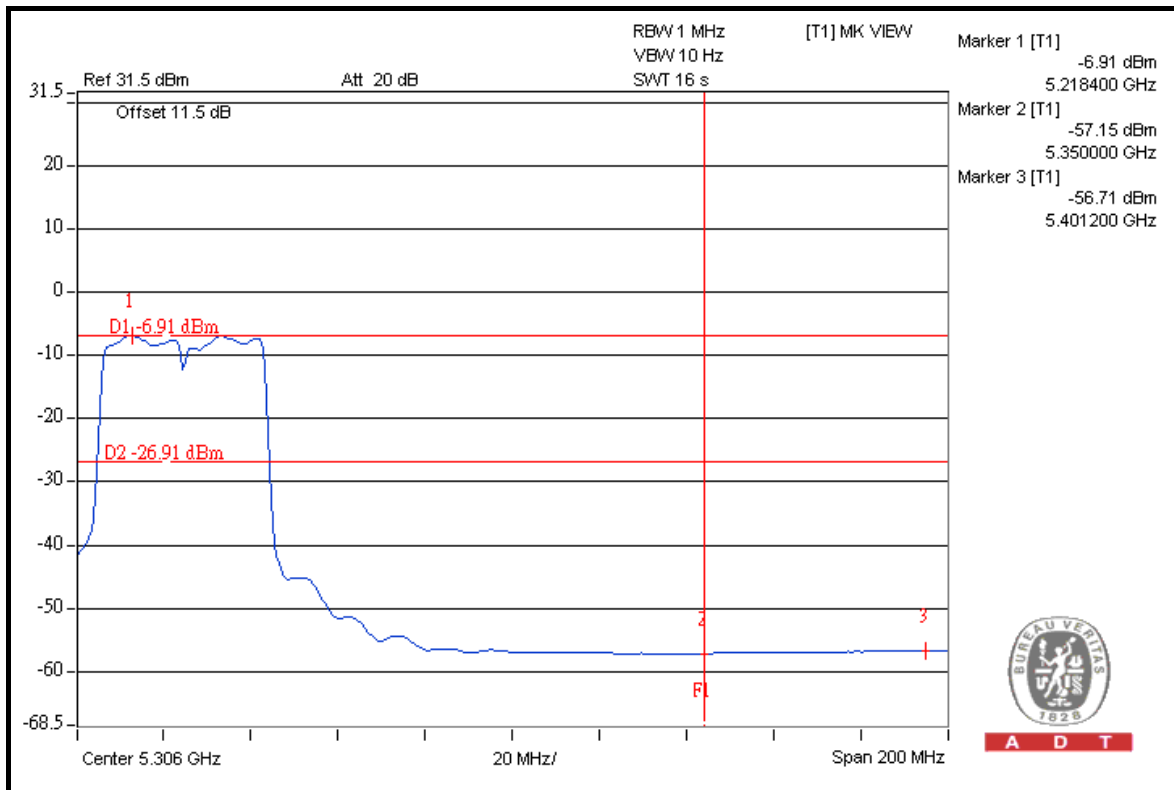

A D T

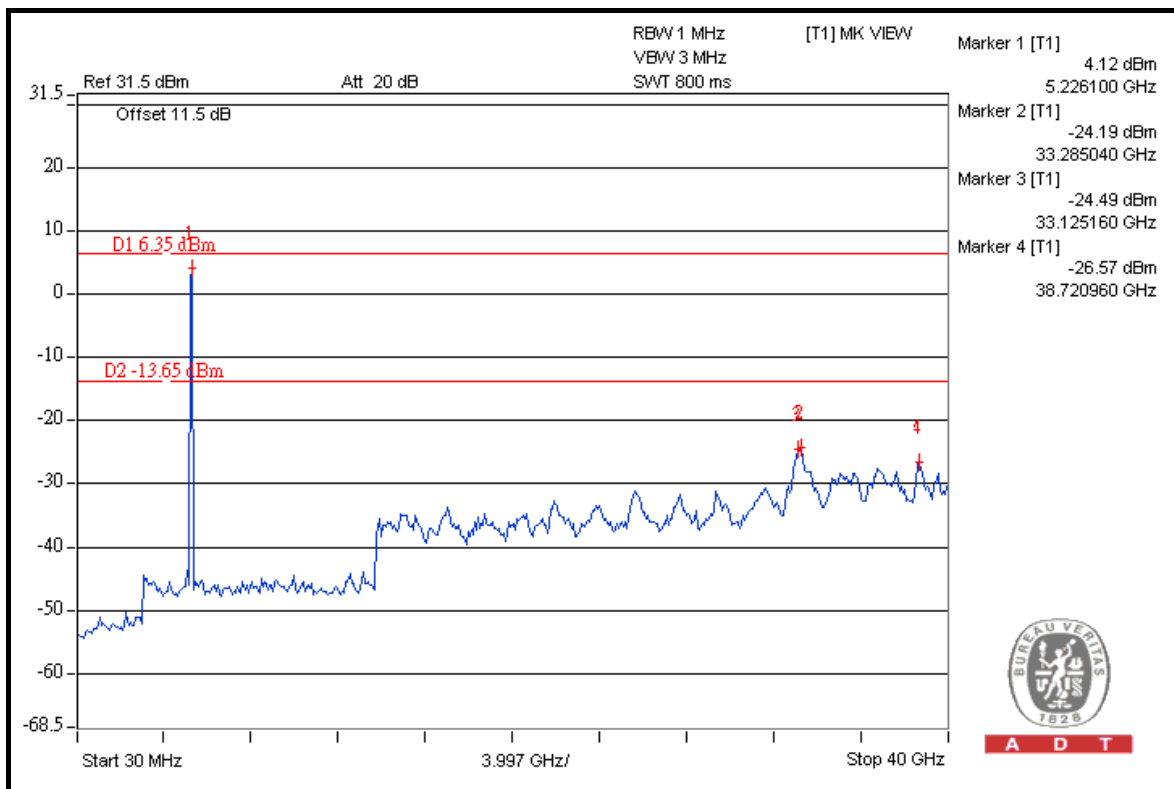

A D T





A D T

### CHAIN 1

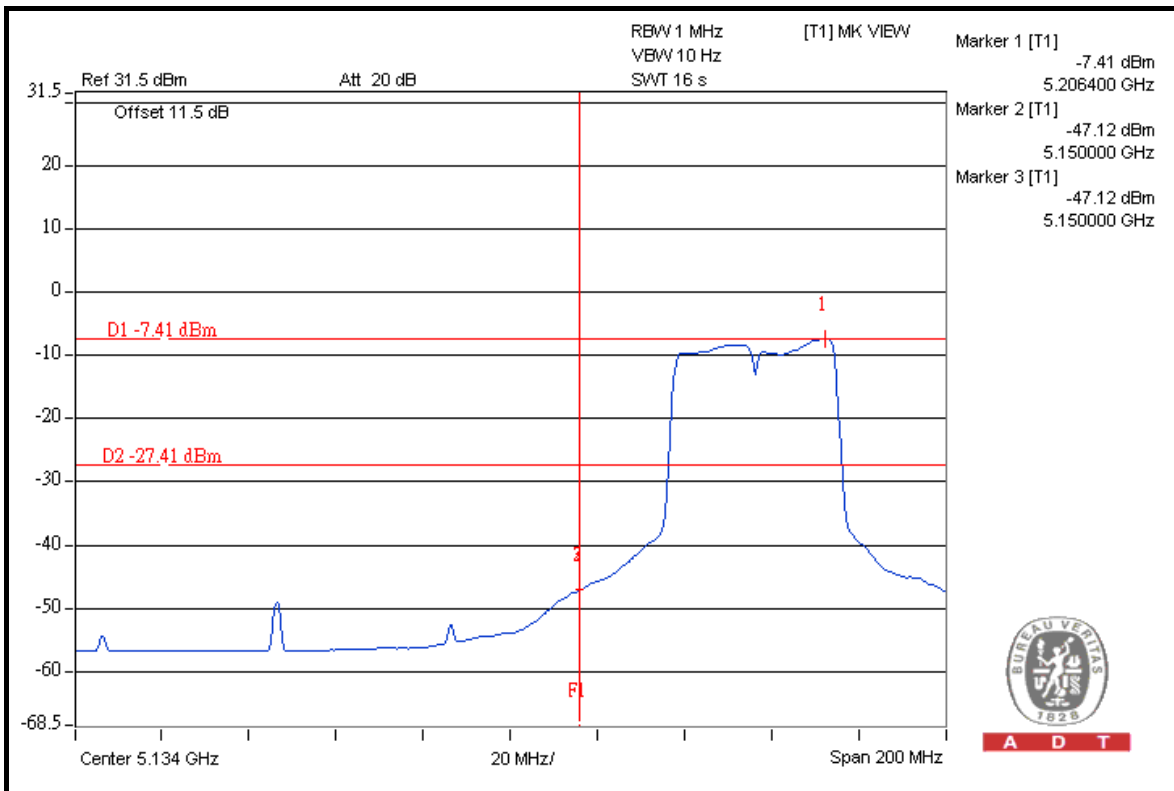
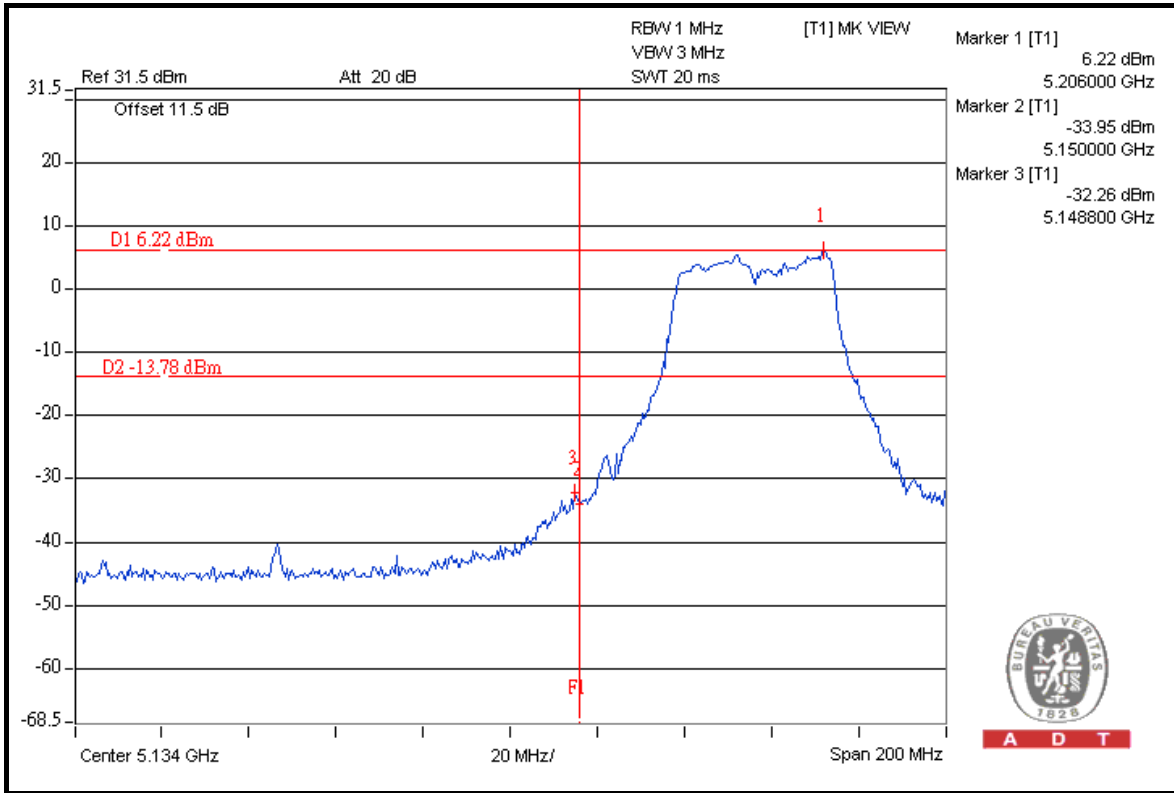



A D T

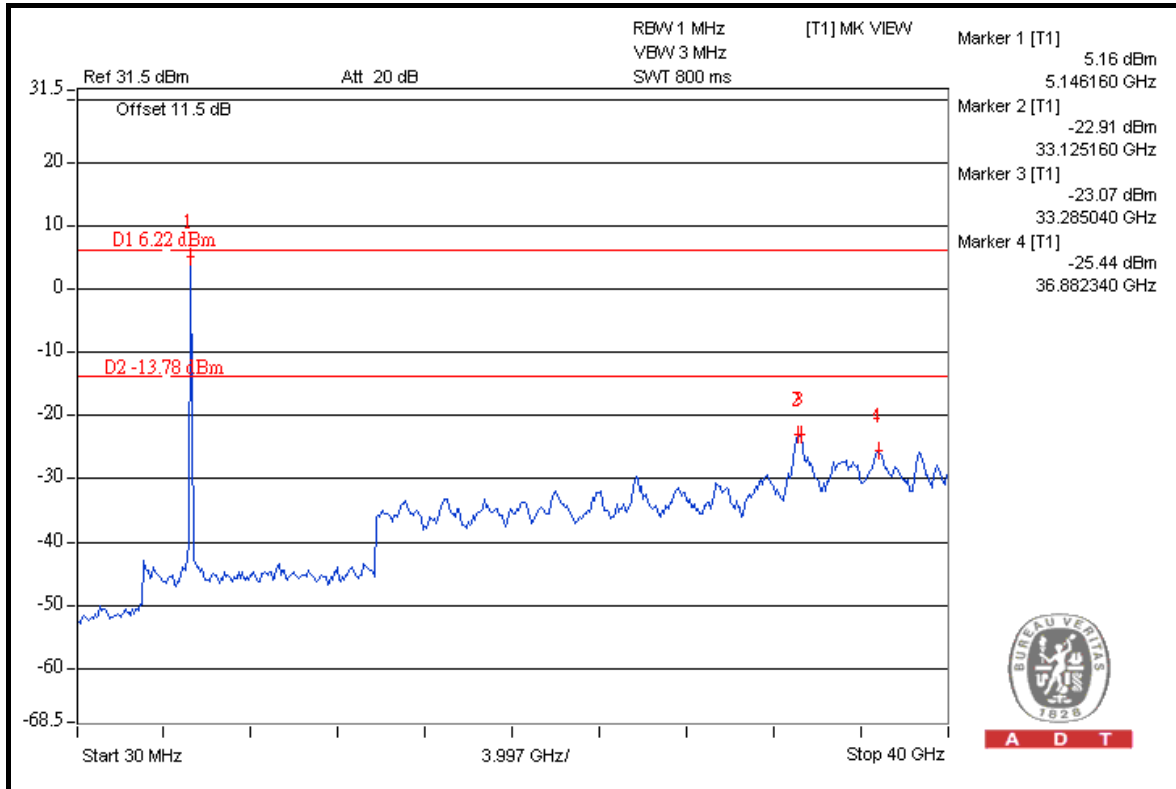

A D T

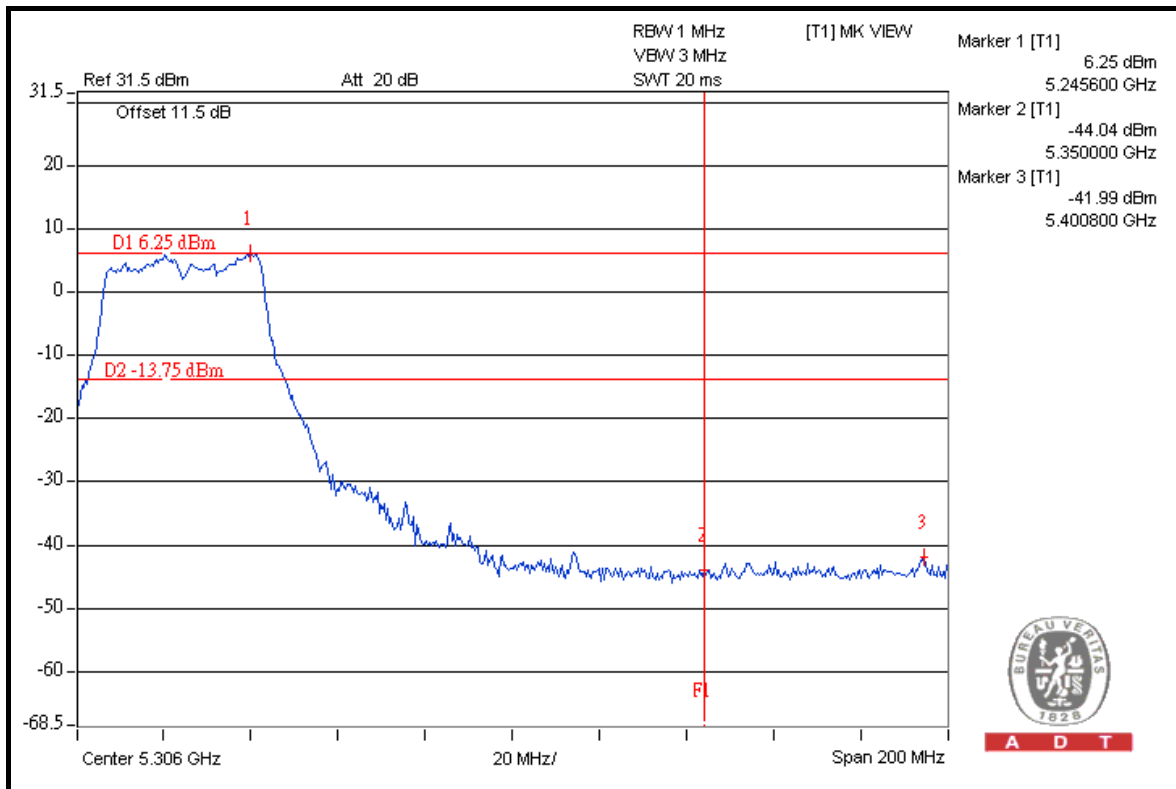

A D T



A D T

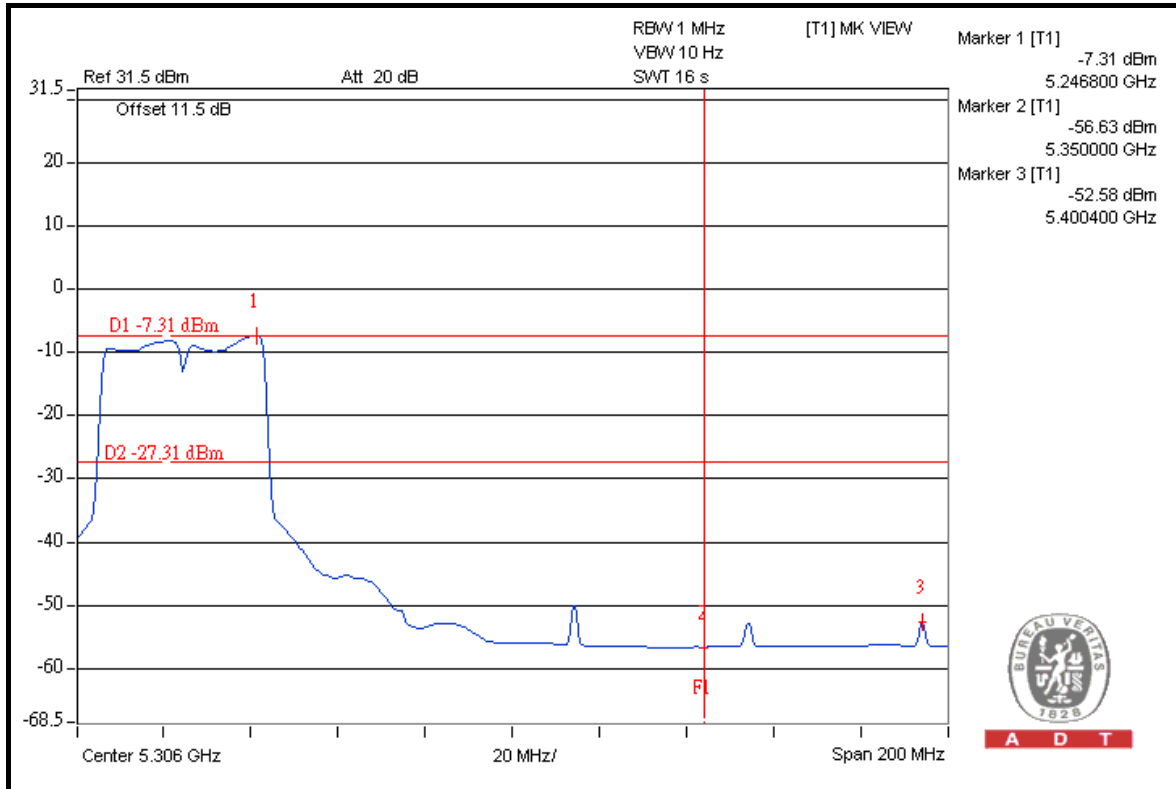

A D T

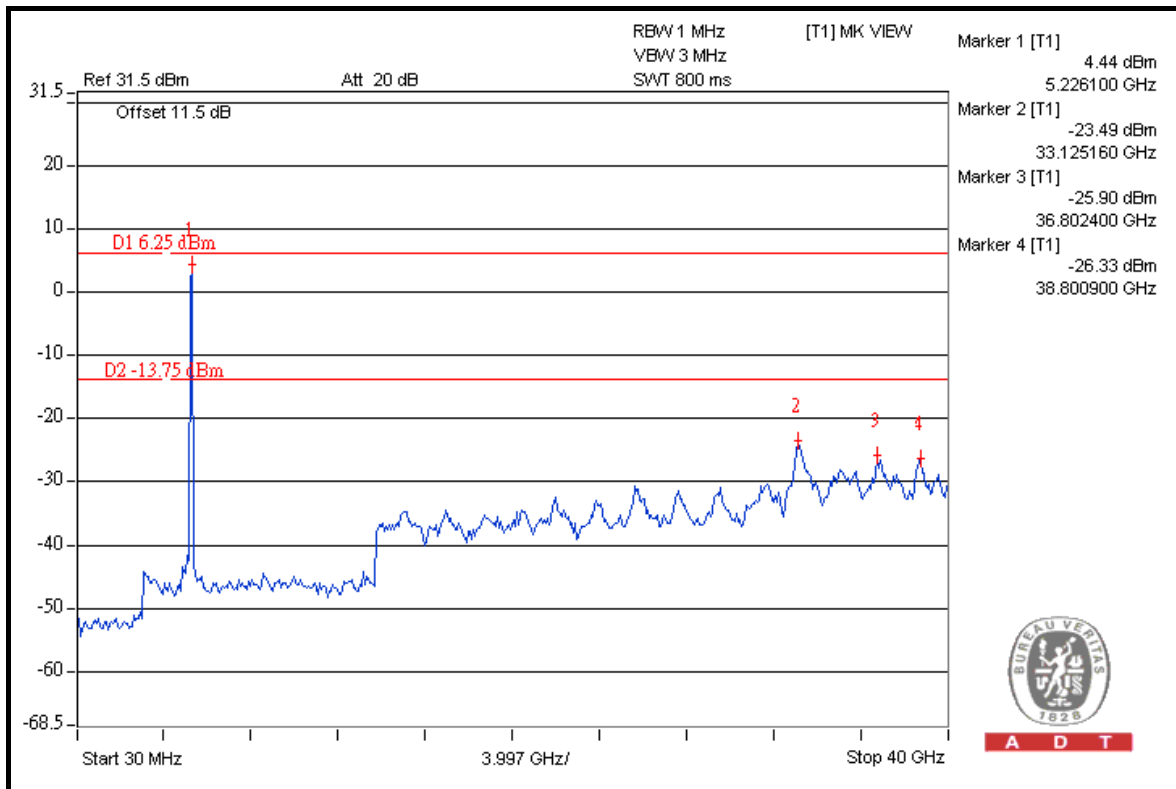

A D T



A D T

## CHAIN 2

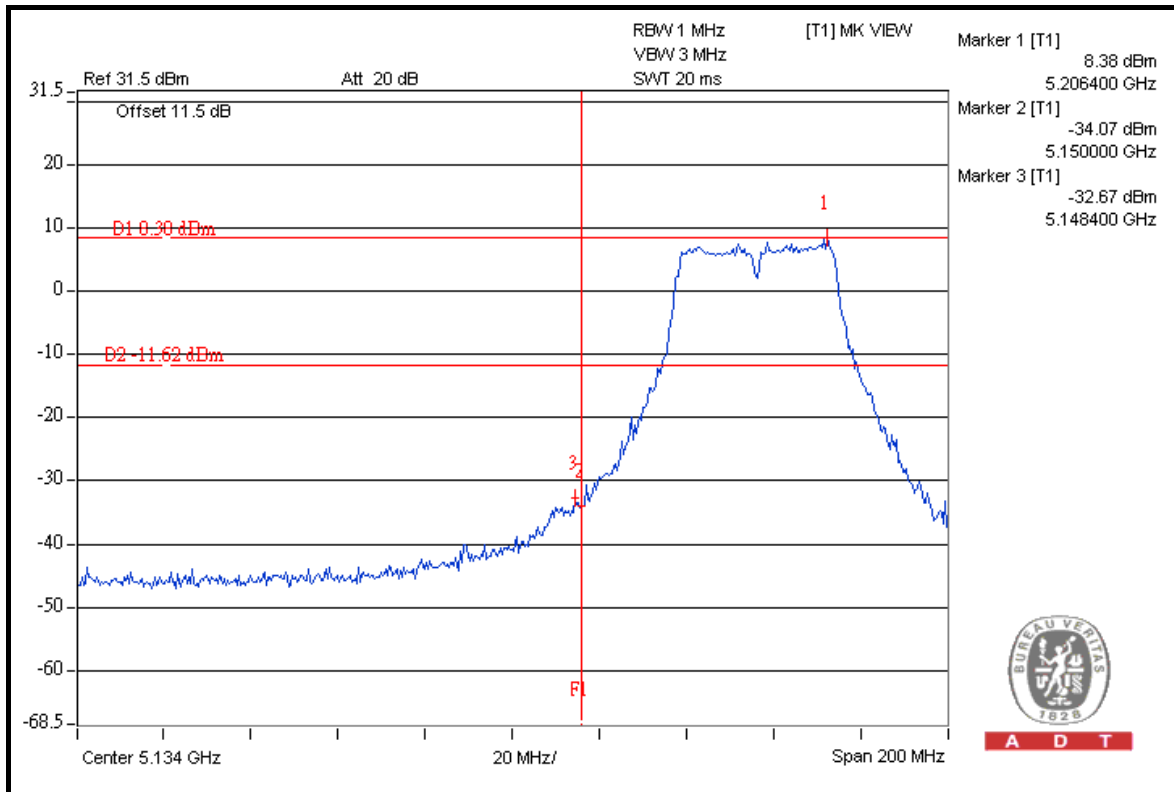

A D T

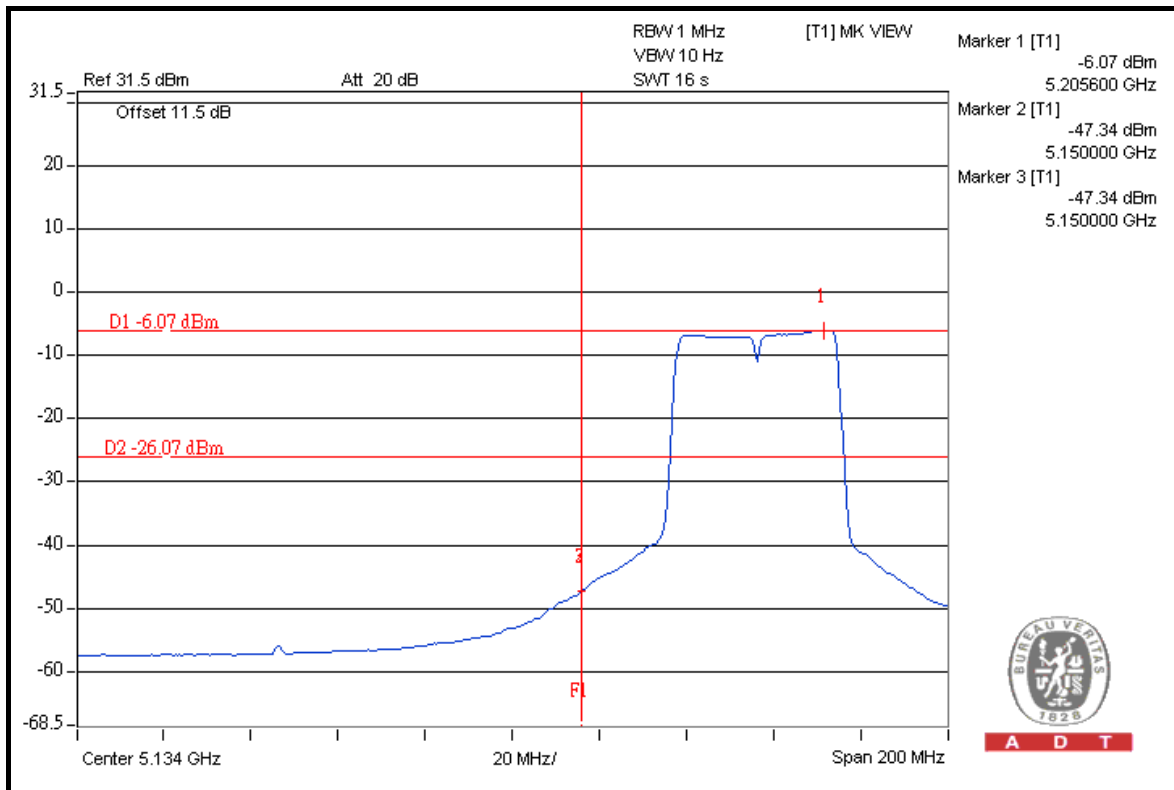

A D T



A D T

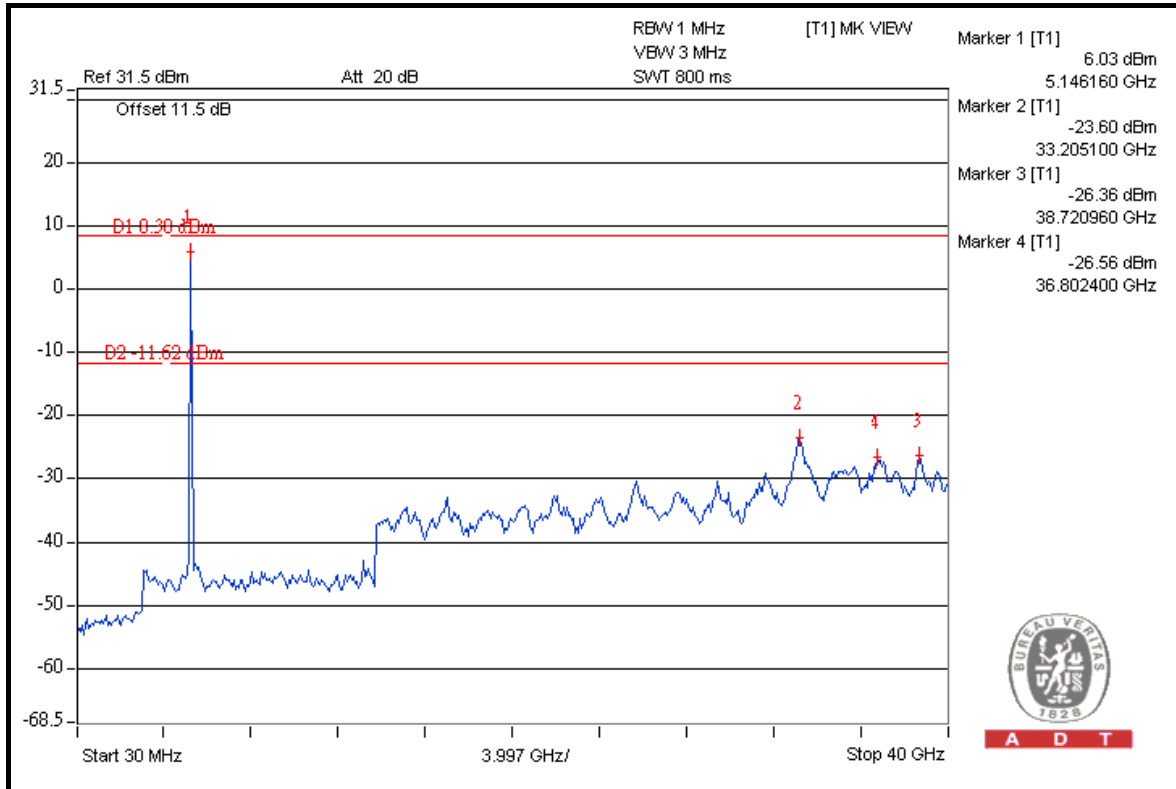

A D T

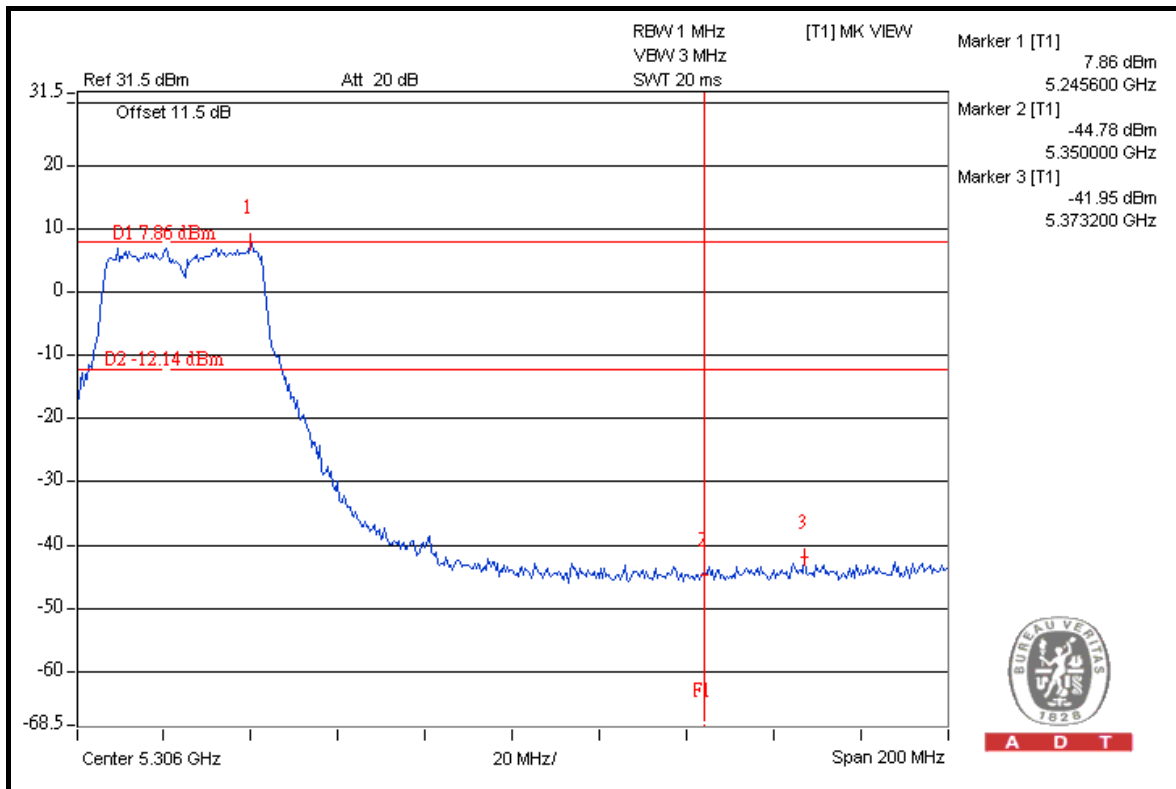

A D T



A D T

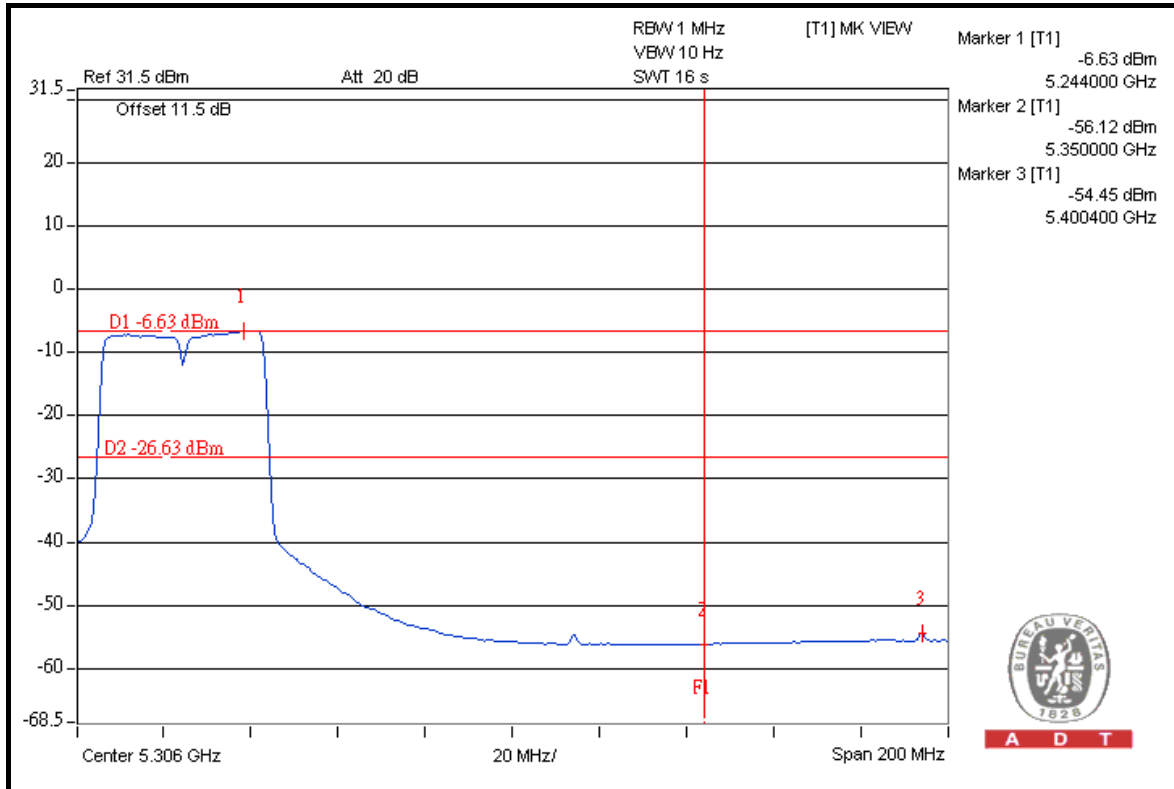

A D T

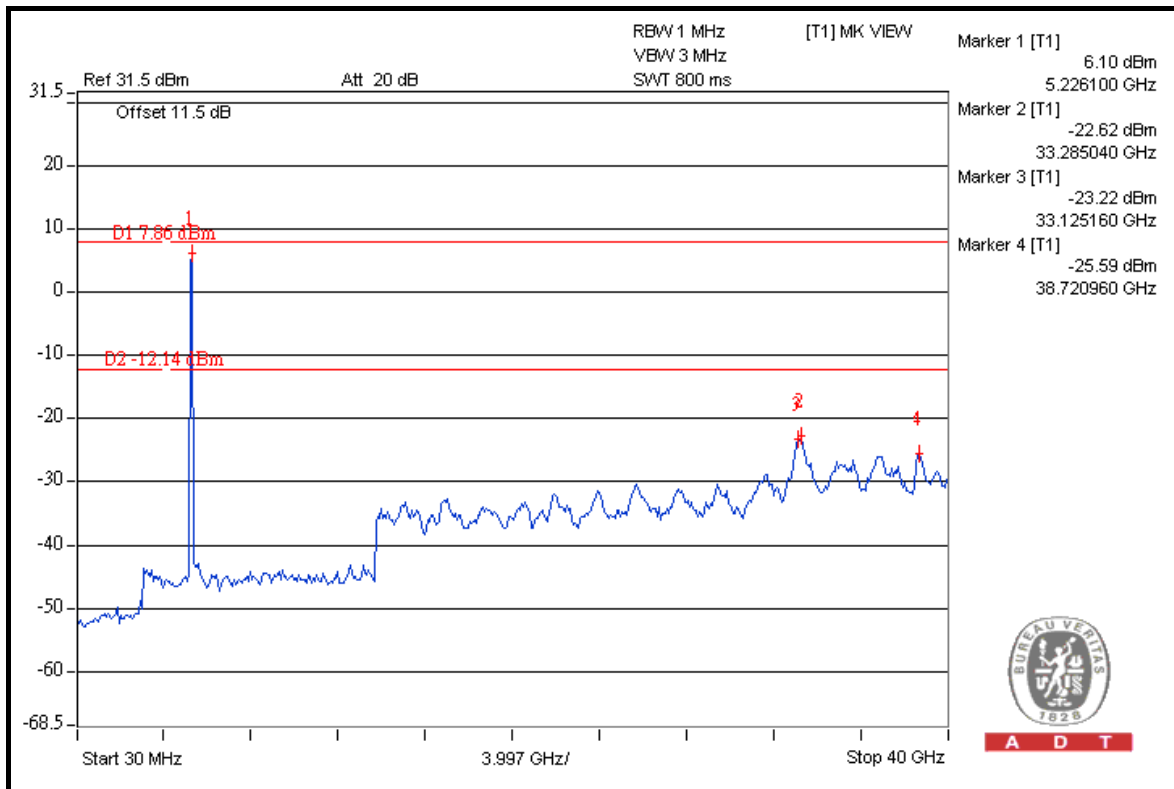

A D T



## 5. PHOTOGRAPHS OF THE TEST CONFIGURATION

Please refer to the attached file (Test Setup Photo).



## 6. INFORMATION ON THE TESTING LABORATORIES

We, Bureau Veritas Consumer Products Services (H.K.) Ltd., Taoyuan Branch, were founded in 1988 to provide our best service in EMC, Radio, Telecom and Safety consultation. Our laboratories are accredited and approved according to ISO/IEC 17025.

Copies of accreditation certificates of our laboratories obtained from approval agencies can be downloaded from our web site:

[www.adt.com.tw/index.5.phtml](http://www.adt.com.tw/index.5.phtml). If you have any comments, please feel free to contact us at the following:

**Linko EMC/RF Lab:**

Tel: 886-2-26052180

Fax: 886-2-26051924

**Hsin Chu EMC/RF Lab:**

Tel: 886-3-5935343

Fax: 886-3-5935342

**Hwa Ya EMC/RF/Safety/Telecom Lab:**

Tel: 886-3-3183232

Fax: 886-3-3185050

**Email:** [service.adt@tw.bureauveritas.com](mailto:service.adt@tw.bureauveritas.com)

**Web Site:** [www.adt.com.tw](http://www.adt.com.tw)

The address and road map of all our labs can be found in our web site also.





## **7. APPENDIX A - MODIFICATIONS RECORDERS FOR ENGINEERING CHANGES TO THE EUT BY THE LAB**

No any modifications are made to the EUT by the lab during the test.

**---END---**