



FCC/ IC DFS TEST REPORT

For

Wireless AP

Model: HiveAP 141, HiveAP 121

Trade Name: Aerohive

Issued to

**Aerohive Networks, Inc.
330 Gibraltar Drive Sunnyvale, CA 94089 United States**

Issued by

**Compliance Certification Services Inc.
Kun shan Laboratory
No.10 Weiye Rd., Innovation park, Eco&Tec,
Development Zone, Kunshan City, Jiangsu, China**

TEL: 86-512-57355888

FAX: 86-512-57370818



***Note:** This report shall not be reproduced except in full, without the written approval of Compliance Certification Services Inc. This document may be altered or revised by Compliance Certification Services Inc. personnel only, and shall be noted in the revision section of the document.*



Compliance Certification Services Inc.

Report No: C131118R01-RPB

FCC ID: WBV-HIVEAP1X1

Date of Issue :Nov 19, 2013

IC: 7774A-HIVEAP1X1

Revision History

Rev.	Issue Data	Revisions	Effect Page	Revised By
00	November 19, 2013	Initial Issue	ALL	Jeff.Fang



TABLE OF CONTENTS

1. TEST RESULT CERTIFICATION.....	4
2. EUT DESCRIPTION	5
EQUIPMENT MODIFICATIONS:.....	6
SPECIAL ACCESSORIES:	6
LOCAL SUPPORT EQUIPMENT:.....	6
EUT INTERNAL CONFIGURATION:.....	6
INTERFACE PORTS:	6
POWER SUPPLY LIST AND DETAILS:	6
EUT EXERCISE SOFTWARE:.....	6
EUT OPERATION FREQUENCY:	7
3. FACILITIES AND ACCREDITATIONS	8
FACILITIES	8
TABLE OF ACCREDITATIONS AND LISTINGS.....	8
4. SUMMARY OF TEST RESULTS	9
5. TEST METHODOLOGY	10
CONDUCTED METHOD SYSTEM BLOCK DIAGRAM	13
RADIATED METHOD SYSTEM BLOCK DIAGRAM	14
TEST PROCEDURE.....	15
DESCRIPTION OF EUT	15
6. INSTRUMENT CALIBRATION	16
MEASUREMENT EQUIPMENT USED	16
TEST AND MEASUREMENT SYSTEM	16
7. TEST RESULT.....	17
RADAR WAVEFORM CALIBRATION.....	17
CHANNEL AVAILABILITY CHECK TIME.....	25
CHANNEL MOVE TIME AND CHANNEL CLOSING TRANSMISSION TIME.....	30
NON-OCCUPANCY PERIOD	44
DETECTION BANDWIDTH	46
RADAR DETECTION	57
APPENDIX 1 - PHOTOGRAPHS OF EUT SETUP	64



1. TEST RESULT CERTIFICATION

Applicant: Aerohive Networks, Inc.

330 Gibraltar Drive Sunnyvale, CA 94089 United States

Equipment Under Test: Wireless AP

Trade Name: Aerohive

Model: HiveAP 141, HiveAP 121

Date of Test: November 8, 2013 ~November 14, 2013

APPLICABLE STANDARDS	
STANDARD	TEST RESULT
FCC 47 CFR Part 15 Subpart E	No non-compliance noted
Canada RSS-210 : 2010	No non-compliance noted

Statement:

Compliance Certification Services Inc. tested the above equipment. The test data, data evaluation, test procedures, and equipment configurations shown in this report were made in accordance with the procedures given in ANSI C63.4: 2009 and the energy emitted by the sample EUT tested as described in this report is in compliance with conducted and radiated emission limits of FCC Rules Part 15.407.

The test results of this report relate only to the tested sample identified in this report.

Approved by:

Reviewed by:

Test by: Blent.Wang

Compliance Certification Services Inc.

Approved by: Jeff.Fang

Compliance Certification Services Inc.



2. EUT DESCRIPTION

Product	Wireless AP			
Trade Name	Aerohive			
Model Number	HiveAP 141, HiveAP 121			
Model Discrepancy	N/A			
Received Date	November 6, 2013			
Power Adapter Power Rating	Description Model:PA1024-2HU Input: 100~240Vac 50/60Hz 0.6A Output:DC12Vac 2.0A			
POE Power Rating	Brand: CISCO Model: DPSN-35FBA Input: 100-240Vac~0.8A, 50/60Hz Output: 48V,0.55A			
Operating Frequency Range & Number of Channels		Mode	Frequency Range (MHz)	Number of Channels
	UNII Band II	IEEE 802.11a	5260 - 5320	4 Channels
		IEEE 802.11n HT 20 MHz	5260 - 5320	4 Channels
		IEEE 802.11n HT 40 MHz	5270 - 5310	2 Channels
	UNII Band III	IEEE 802.11a	5500 - 5700	11 Channels
		IEEE 802.11n HT 20 MHz	5500 - 5700	11 Channels
IEEE 802.11n HT 40 MHz		5510 - 5670	5 Channels	
Transmit Power	802.11a mode: 12.97dBm 802.11an Standard-20 MHz Channel mode: 16.13 dBm 802.11an Wide-40 MHz Channel mode: 16.29 dBm (the EUT transmittin and receiving with two antennas simultaneously working at n mode)			
Modulation Technique	OFDM (QPSK, BPSK, 16-QAM, 64-QAM)			
Transmit Data Rate	IEEE 802.11a mode: 54, 48, 36, 24, 18, 12, 9, 6 Mbps IEEE 802.11an HT 20 MHz mode: OFDM (6.5, 7.2, 13, 14.4, 14.44, 19.5, 21.7, 26, 28.89, 28.9, 39, 43.3, 43.33 52, 57.78, 57.8, 58.5, 65.0, 72.2, 78, 86.67, 104, 115.56, 117, 130, 144.44 Mbps) IEEE 802.11an HT 40 MHz mode: OFDM (13.5, 15, 27, 30, 40.5, 45, 54, 60, 81, 90, 108, 120, 121.5, 135, 150, 162, 180, 216, 240, 243, 270, 300 Mbps)			
Antenna Gain	AP141: 3.00 dBi AP121: 6.00 dBi			
Antenna Type	AP141:dipole Antenna (external antenna) AP121:PCB dipole Antenna (internal antenna)			

**EQUIPMENT MODIFICATIONS:**

No modifications were made to the EUT.

SPECIAL ACCESSORIES:

There were no special accessories were required, included, or intended for use with EUT during these tests.

LOCAL SUPPORT EQUIPMENT:

No.	Device Type	Brand	Model	Series No.	FCC ID	Data Cable	Power Cord
1.	Notebook PC	Dell	E5430	CN8YYW1	FCC DoC	N/A	AC I/P: Unshielded, 1m with a core DC O/P: Unshielded, 1.8m
2	Notebook PC	LENOVO	E430	MP1DZ54	FCC DoC	N/A	AC I/P: Unshielded, 1m with a core DC O/P: Unshielded, 1.8m

EUT INTERNAL CONFIGURATION:

Description	Manufacturer	Model	Serial Number
Motherboard	Senao	AP330/AP350 CPU	5816A0443000
(2.4 GHz)	Senao	A2HP01	5816A0474000
(5 GHz)	Senao	A5HP01	5816A0475000

INTERFACE PORTS:

Description	From
USB	EUT
LAPTOP	EUT
POE	EUT
LAN to COM Port	EUT

POWER SUPPLY LIST AND DETAILS:

Description	Model	Input	output
Power Adapter	PA1024-2HU	100~240Vac 50/60Hz 0.6A,	DC12Vac 2.0A

EUT EXERCISE SOFTWARE:

Version:Hive OS 6.0r2 Essen buildE0981

Bootloader ver:v1.0.3.29



EUT OPERATION FREQUENCY:

UNLICENSED NATIONAL INFORMATION INFRASTRUCTURE (U-NII)	
CHANNEL	MHz
36	5180
38	5190
40	5200
44	5220
46	5230
48	5240
52	5260
54	5270
56	5280
60	5300
62	5310
64	5320
100	5500
102	5510
104	5520
108	5540
110	5550
112	5560
116	5580
118	5590
120	5600
124	5620
126	5630
128	5640
132	5660
134	5670
136	5680
140	5700
149	5745
153	5765
157	5785
161	5805
165	5825



3. FACILITIES AND ACCREDITATIONS

FACILITIES

All measurement facilities used to collect the measurement data are located at

No.10Weiyue Rd., Innovation park, Eco&Tec, Development Zone, Kunshan City, Jiangsu, China.

The sites are constructed in conformance with the requirements of ANSI C63.4:2003 and CISPR Publication 22. All receiving equipment conforms to CISPR Publication 16-1, "Radio Interference Measuring Apparatus and Measurement Methods."

TABLE OF ACCREDITATIONS AND LISTINGS

Our laboratories are accredited and approved by the following accreditation body according to ISO/IEC 17025.

USA	A2LA
China	CNAS

The measuring facility of laboratories has been authorized or registered by the following approval agencies.

Canada	Industry Canada
Japan	VCCI
Taiwan	BSMI
USA	FCC

Copies of granted accreditation certificates are available for downloading from our web site, <http://www.ccsrf.com>.



4. SUMMARY OF TEST RESULTS

The following result table represents the list of measurements required under the CFR 47 Part15.407 (h), FCC06-96 and IC RSS-210.

Items	Description of Test	Items
Detection Bandwidth	UNII Detection Bandwidth	Compliant
Performance Requirements Check	Initial Channel Availability Check Time (CAC)	Compliant
	Radar Burst at the Beginning of the CAC	Compliant
	Radar Burst at the End of the CAC	Compliant
In-service Mointoring	Channel Move Time	Compliant
	Channel Closing Transmission Time	Compliant
	Non-Occupancy Period	Compliant
Radar Detection	Statistical Performance Check	Compliant



5. TEST METHODOLOGY

FCC CFR47 Part 2 , Part 15.407(h)

FCC 09-96 APPENDIX "COMPLIANCE MEASUREMENT PROCEDURES FOR UNLICENSEDNATIONAL INFORMATION INFRASTRUCTURE DEVICES OPERATING IN THE 5250-5350 MHz AND 5470-5725 MHz BANDS INCORPORATING DYNAMIC FREQUENCY SELECTION"

Test Requirement

Table 1: Applicability of DFS requirements prior to use of a channel

Requirement	Operational Mode		
	Master	Client (without radar detection)	Client(with radar detection)
Non-Occupancy Period	Yes	Not required	Yes
DFS Detection Threshold	Yes	Not required	Yes
Channel Availability Check Time	Yes	Not required	Not required
Uniform Spreading	Yes	Not required	Not required

Table 2: Applicability of DFS requirements during normal operation

Requirement	Operational Mode		
	Master	Client (without radar detection)	Client(with radar detection)
DFS Detection Threshold	Yes	Not required	Yes
Channel Closing Transmission Time	Yes	Yes	Yes
Channel Move Time	Yes	Yes	Yes

Table 3: Interference Threshold values, Master or Client incorporating In-Service

Maximum Transmit Power	Value (see note)
>=200 Milliwatt	-64 dBm
< 200 Milliwatt	-62 dBm

Note 1: This is the level at the input of the receiver assuming a 0 dBi receive antenna.

Note 2: Throughout these test procedures an additional 1 dB has been added to the amplitude of the test transmission waveforms to account for variations in measurement equipment. This will ensure that the test signal is at or above the detection threshold level to trigger a DFS response.



Table 4: DFS Response requirement values

Parameter	Value
Non-occupancy period	30 minutes
Channel Availability Check Time	60 seconds
Channel Move Time	10 seconds
Channel Closing Transmission Time	200 milliseconds + approx. 60 milliseconds over remaining 10 second period

The instant that the Channel Move Time and the Channel Closing Transmission Time begins is as follows:

- For the Short pulse radar Test Signals this instant is the end of the Burst.
- For the Frequency Hopping radar Test Signal, this instant is the end of the last radar burst generated.
- For the Long Pulse radar Test Signal this instant is the end of the 12 second period defining the radar transmission.

The Channel Closing Transmission Time is comprised of 200 milliseconds starting at the beginning of the Channel Move Time plus any additional intermittent control signals required to facilitate channel changes (an aggregate of approximately 60 milliseconds) during the remainder of the 10 second period. The aggregate duration of control signals will not count quiet periods in between transmissions.

Table 5 – Short Pulse Radar Test Waveforms

Radar Type	Pulse Width (Microseconds)	PRI (Microseconds)	Pulses	Minimum Percentage of Successful Detection	Minimum Trials
1	1	1428	18	60%	30
2	1-5	150-230	23-29	60%	30
3	6-10	200-500	16-18	60%	30
4	11-20	200-500	12-16	60%	30
Aggregate (Radar Types 1-4)				80%	120

FCC Radar Types (1~4) System Diagram

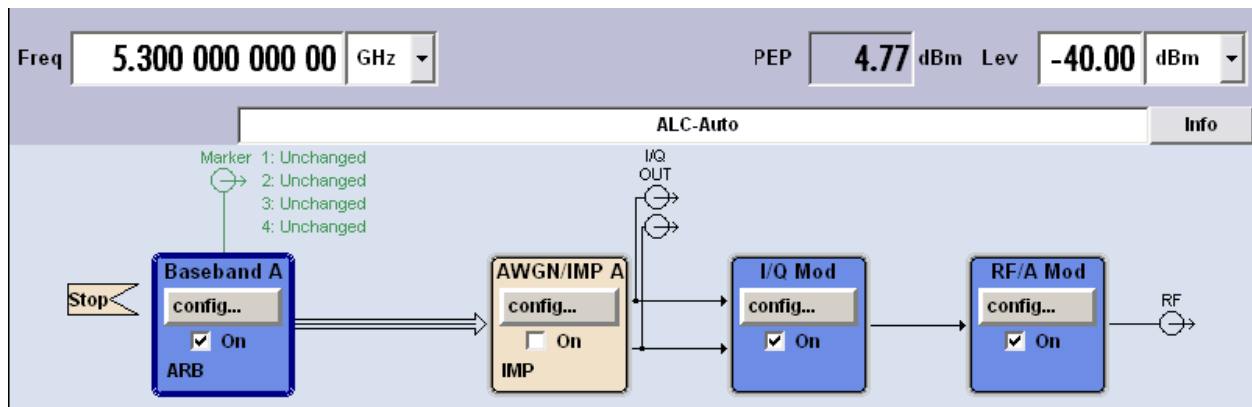

Table 6 – Long Pulse Radar Test Signal



Radar Waveform	Bursts	Pulses per Burst	Pulse Width (µsec)	Chirp Width (µsec)	PRI (µsec)	Minimum Percentage of Successful Detection	Minimum Trials
5	8-20	1-3	50-100	5-20	1000-2000	80%	30

FCC Radar Types (5) System Diagram

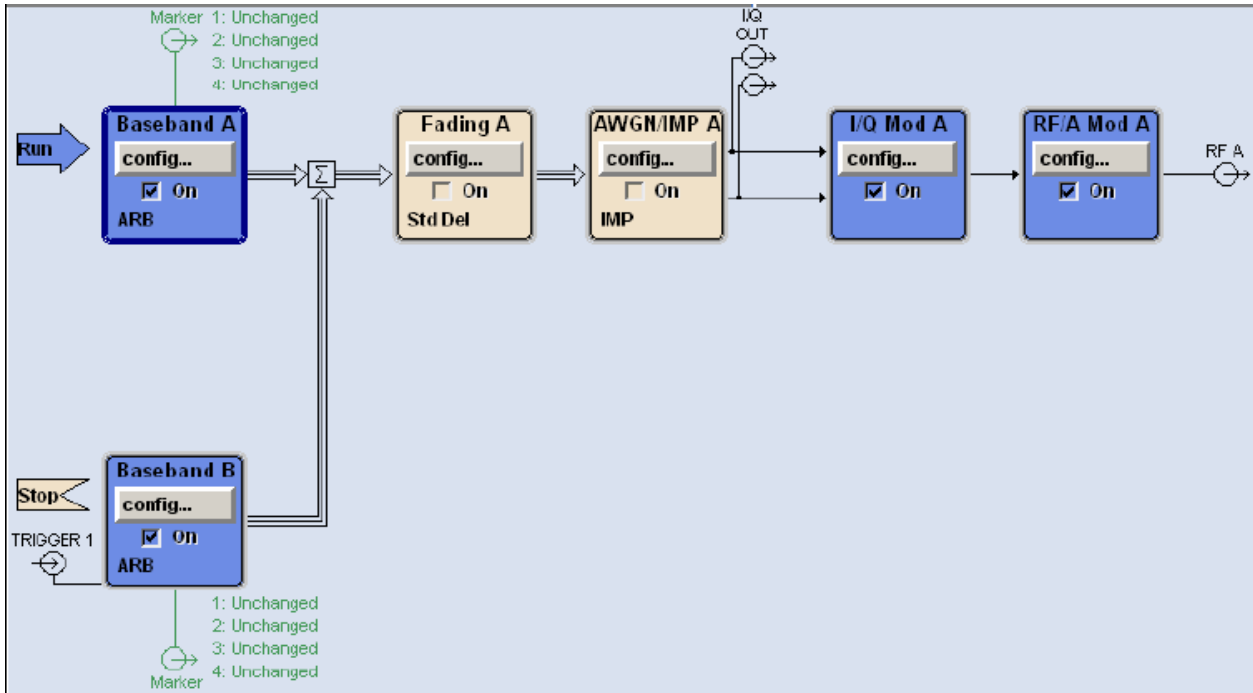
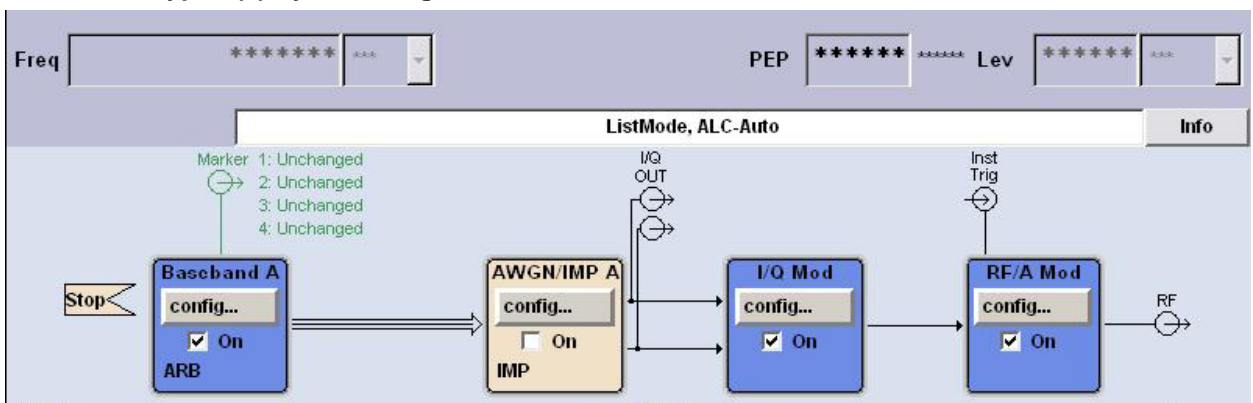

Table 7 – Frequency Hopping Radar Test Signal

Radar Waveform	Pulse Width (µsec)	PRI (µsec)	Burst Length (ms)	Pulses Per Hop	Hopping Rate (kHz)	Minimum Percentage of Successful Detection	Minimum Trials
6	1	333	300	9	0.33	70%	30

FCC Radar Types (6) System Diagram





CONDUCTED METHOD SYSTEM BLOCK DIAGRAM

Setup for Master with injection at the Master

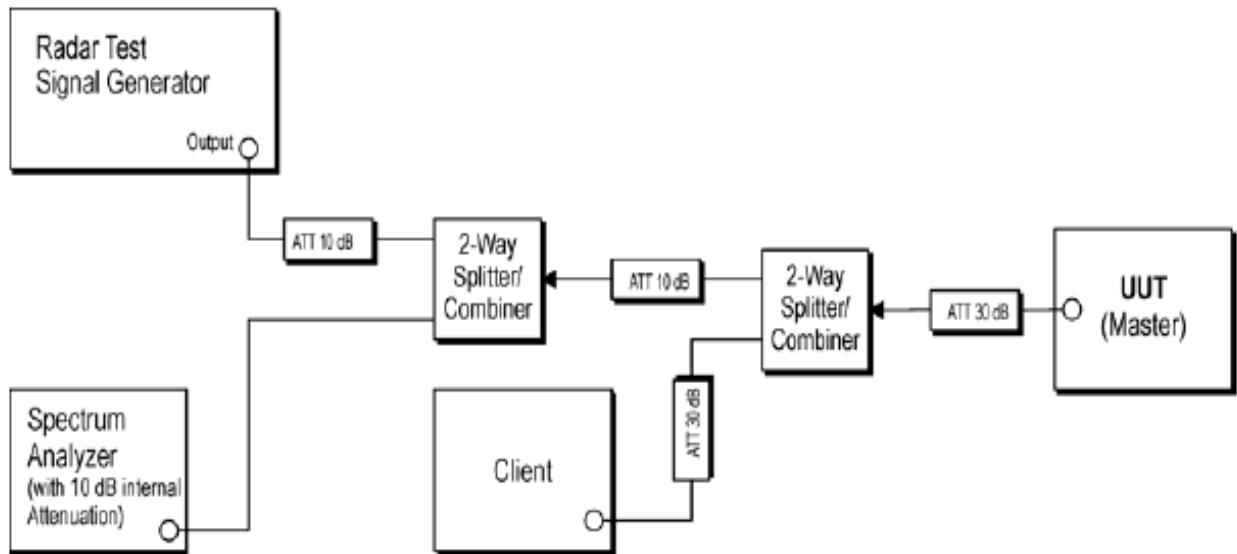

Conducted Setup where UUT is a Master and Radar Test Waveforms are injected into the Master

Setup for Client with injection at the Master

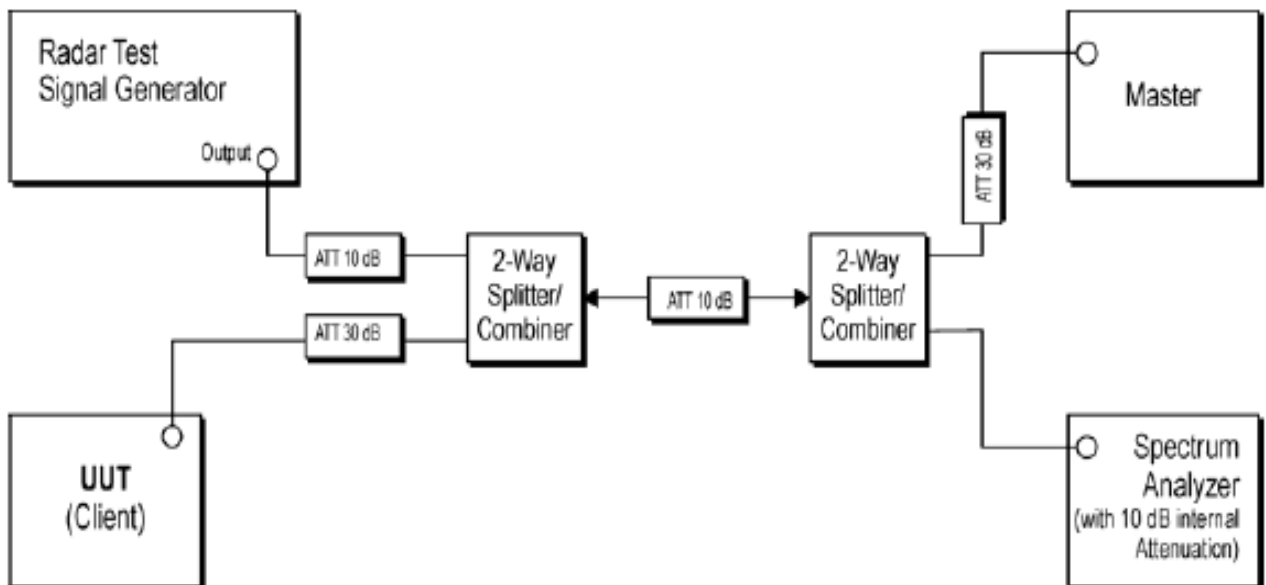

Conducted Setup where UUT is a Client and Radar Test Waveforms are injected into the Master



Setup for Client with injection at the Client

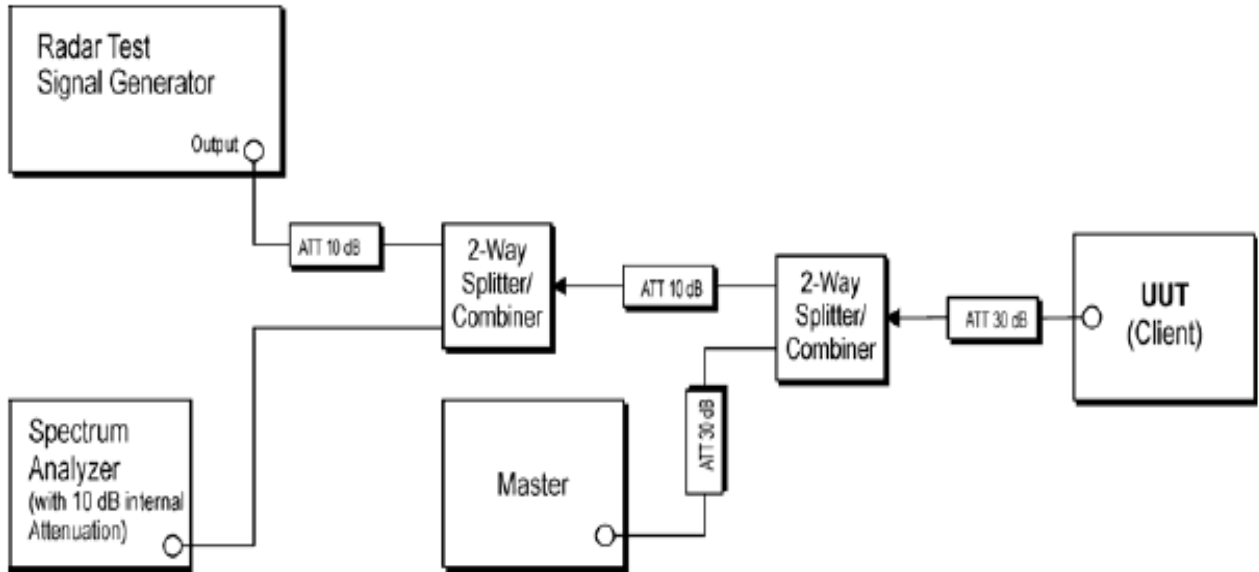

Conducted Setup where UUT is a Client and Radar Test Waveforms are injected into the Client

RADIATED METHOD SYSTEM BLOCK DIAGRAM

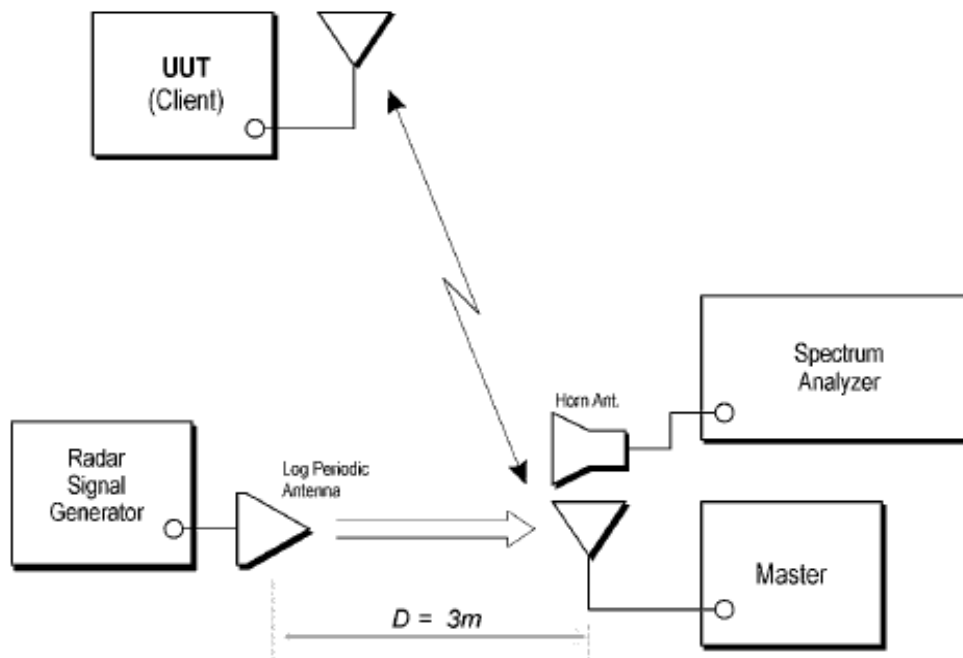



TEST PROCEDURE

A spectrum analyzer is used as a monitor verifies that the EUT status including Channel Closing Transmission Time and Channel Move Time, and does not transmit on a Channel during the Non-Occupancy Period after the diction and Channel move. It is also used to monitor EUT transmissions during the Channel Availability Check Time.

DESCRIPTION OF EUT

Overview Of EUT With Respect To §15.407 (H) Requirements

The EUT operates over the 5250-5350 MHz and 5470-5725 MHz ranges.

The EUT is a Master Device without Ad-Hoc function.

The highest power level within these bands is 16.29 dBm(EIRP:19.29dBm) in the 5250-5350 MHz band and 15.93 dBm(EIRP:18.93dBm) in the 5470-5725 MHz band.

The rated output power of the Master unit is < 23dBm . Therefore the required interference threshold level is -62 dBm. After correction for antenna gain and procedural adjustments, the required conducted threshold at the antenna port is $-62+3 = -59$ dBm.

The calibrated conducted DFS Detection Threshold level is set to -62 dBm. The tested level is lower than the required level hence it provides margin to the limit.

The Slave device associated with the EUT during these tests does not have radar detection capability.

WLAN traffic is generated by streaming the video file TestFile.mpg "6 ½ Magic Hours" from the Master to the Slave in full motion video mode using the media player with the V2.6.1.0 version.

TPC is not required since the maximum EIRP is less than 500 mW (27 dBm)

The EUT utilizes the 802.11a architecture, with a nominal channel bandwidth of 20&40 MHz.

Test results show that the EUT requires 89.4 seconds to complete its initial power-up cycle.

Manufacturer's Statement Regarding Uniform Channel Spreading

The end product implements an automatic channel selection feature at startup such that operation commences on channels distributed across the entire set of allowed 5GHz channels. This feature will ensure uniform spreading is achieved while avoiding non-allowed channels due to prior radar events.



6. INSTRUMENT CALIBRATION

MEASUREMENT EQUIPMENT USED

Test Equipment List

Dynamic Frequency Selection				
Name of Equipment	Manufacturer	Model	Serial Number	Calibration Due
Spectrum Analyzer	Agilent	E4446A	MY44020154	2014-05-12
Vector Signal Generator	R&S	SMU200A	US42340162	2014-08-06
Horn-antenna	Schwarzbeck	BBHA9120D	D267	2014-05-02
Horn-antenna	ETS LINDGREN	3117	00143290	2014-04-04

Remark: Each piece of equipment is scheduled for calibration once a year.

TEST AND MEASUREMENT SYSTEM

System Overview

The measurement system is based on a radiated test method.

The short pulse and long pulse signal generating system utilizes the NTIA software and the same manufacturer / model Vector Signal Generator as the NTIA. The hopping signal generating system utilizes the simulated hopping method.

The software selects waveform parameters from within the bounds of the signal type on a random basis using uniform distribution. The short pulse types 2, 3 and 4, and the long pulse type 5 parameters are randomized at run-time. The hopping type 6 pulse parameters are fixed while the hopping sequence is based on the August 2005 NTIA Hopping Frequency List, with the initial starting point randomized at run-time.



7. TEST RESULT

RADAR WAVEFORM CALIBRATION

PLOTS OF RADAR WAVEFORMS, AND WLAN SIGNALS

PLOTS OF RADAR WAVEFORMS (5280MHz)

Sample of Short Pulse Radar Type 1

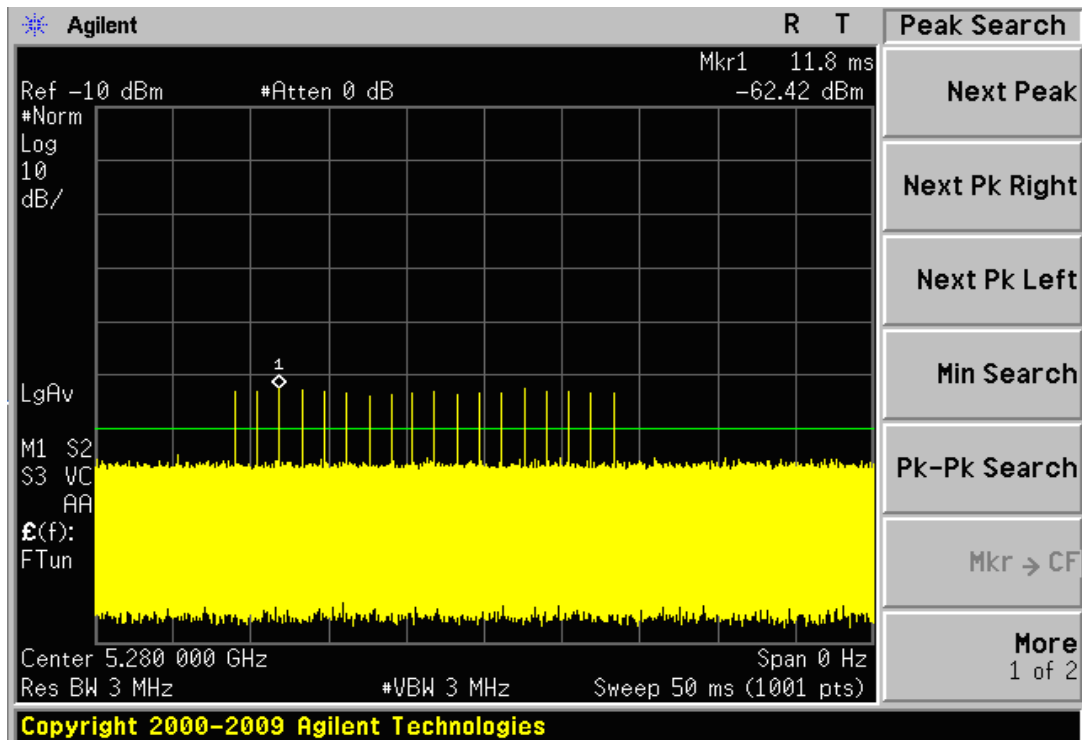

Sample of Short Pulse Radar Type 2

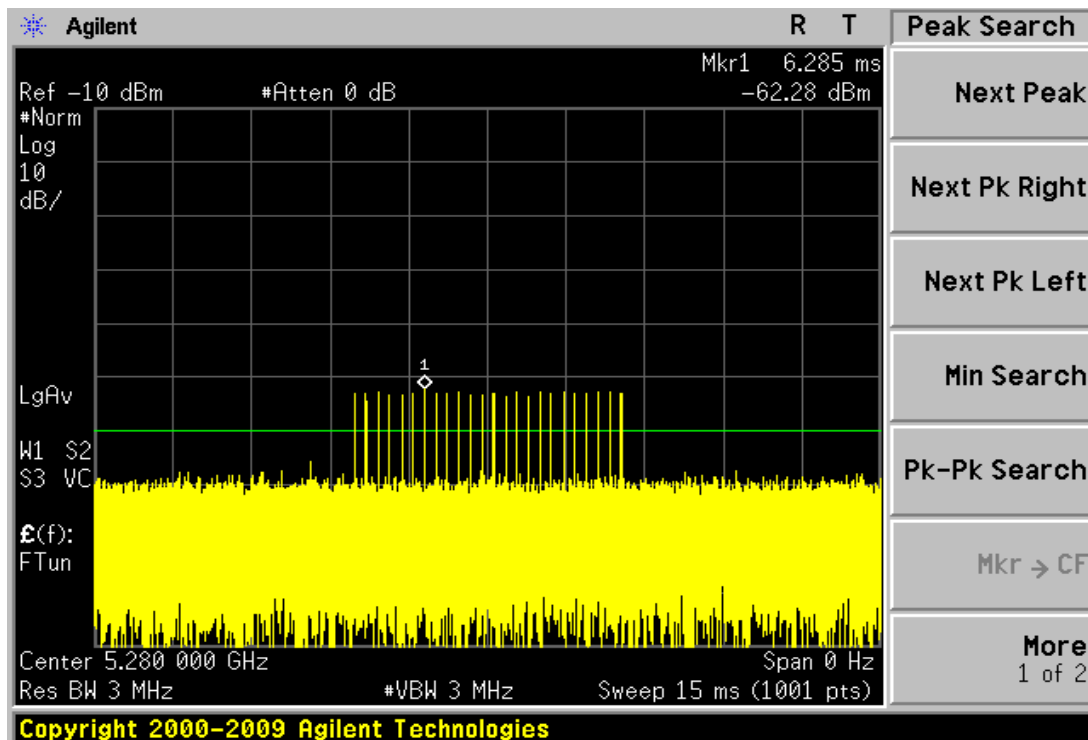



Sample of Short Pulse Radar Type 3

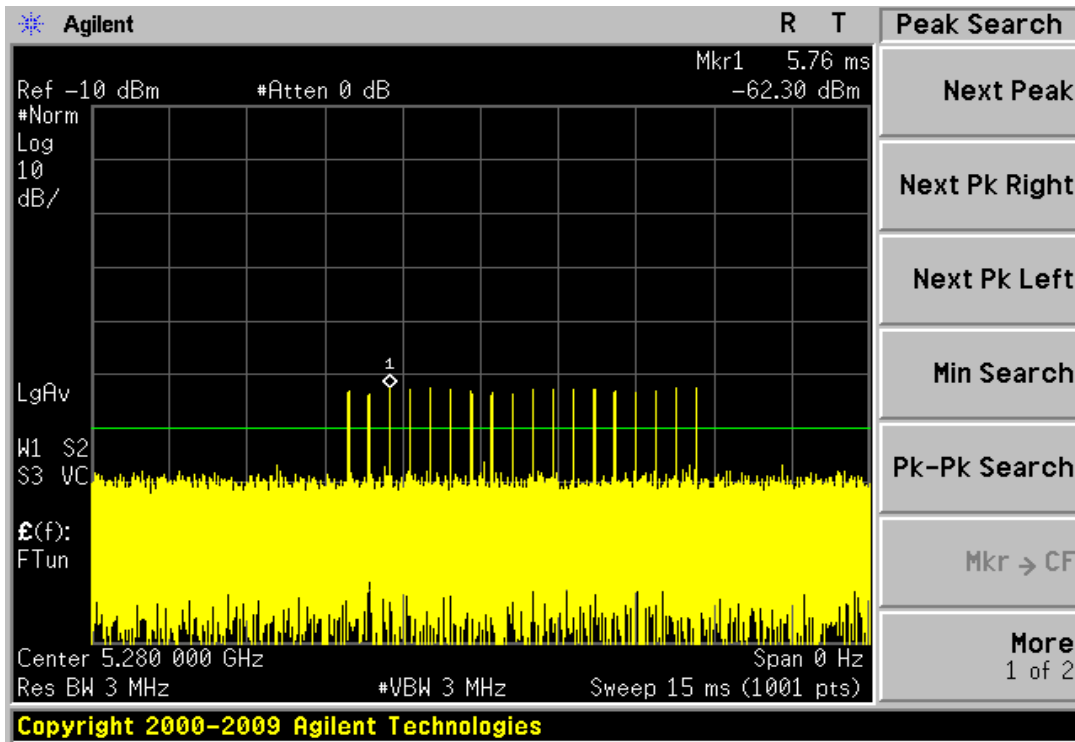

Sample of Short Pulse Radar Type 4

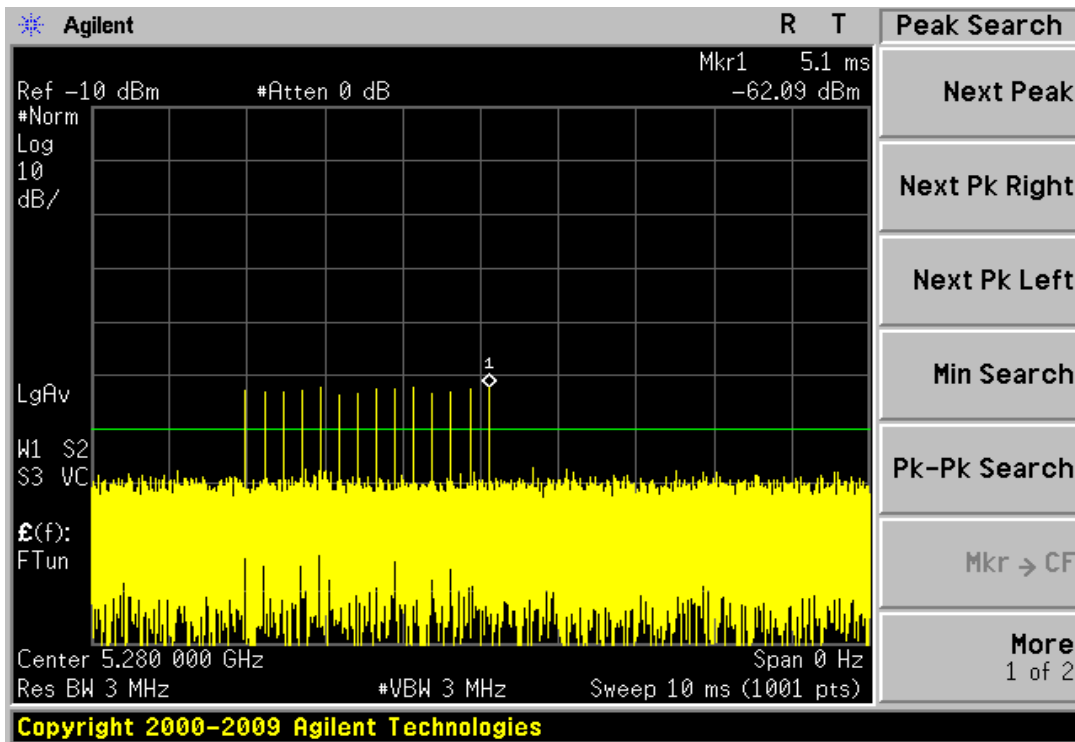



Sample of Long Pulse Radar Type 5

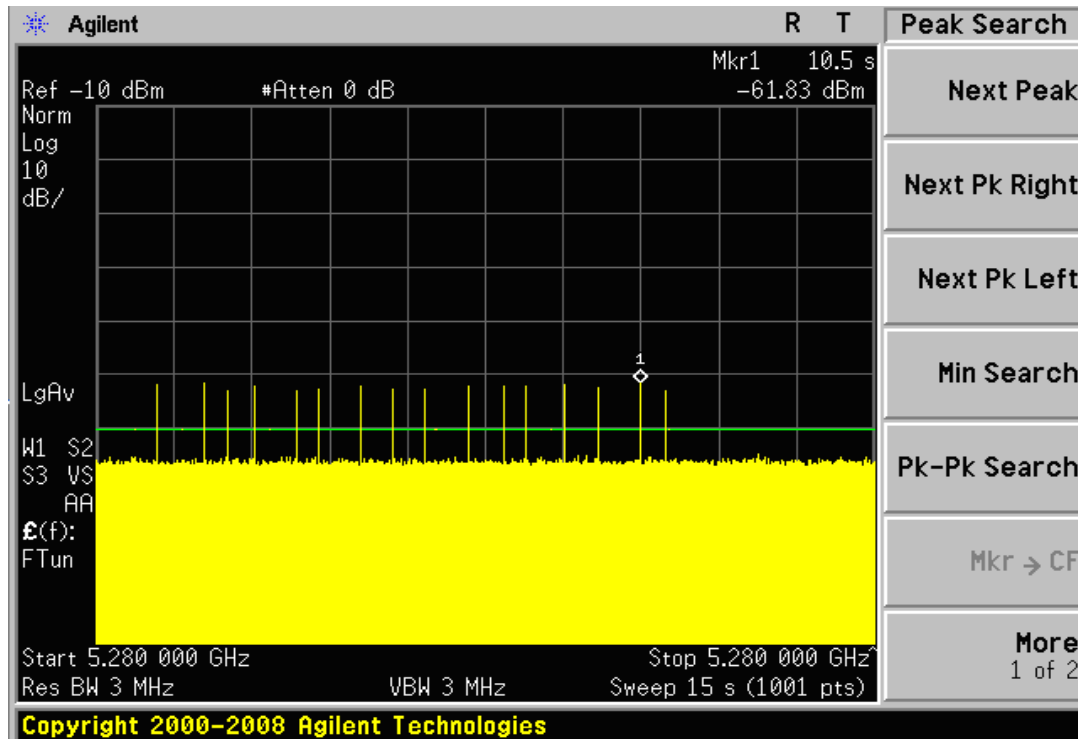

Sample of Frequency Hopping Radar Type 6

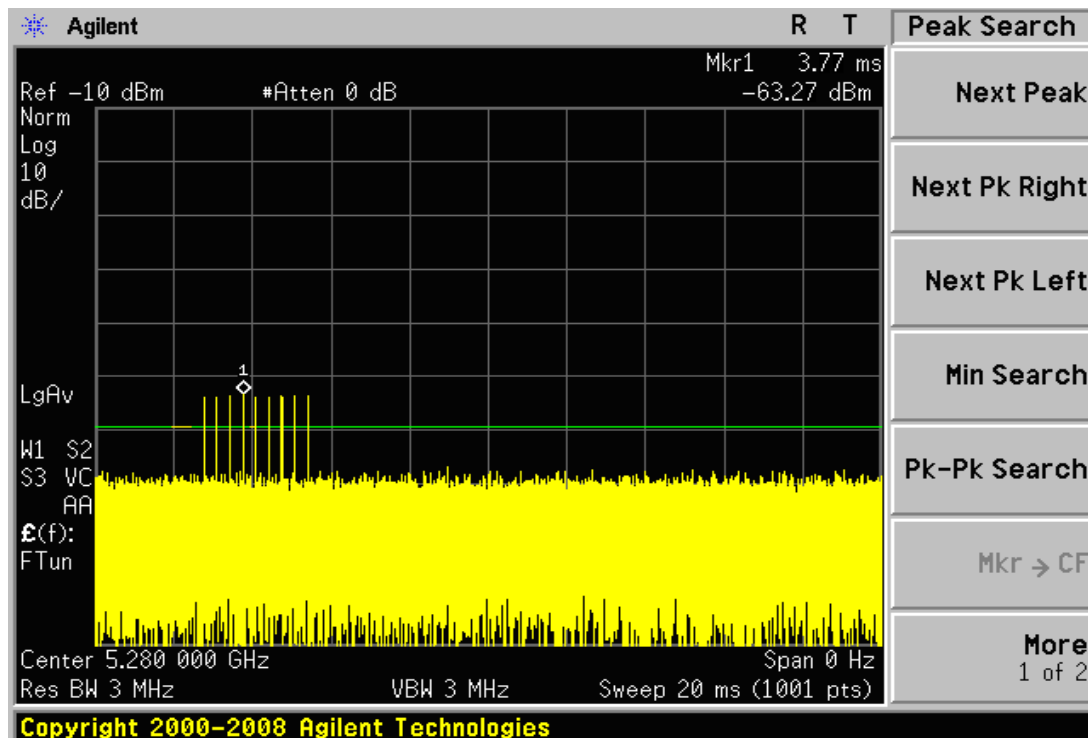



PLOTS OF RADAR WAVEFORMS (5510MHz)

Sample of Short Pulse Radar Type 1

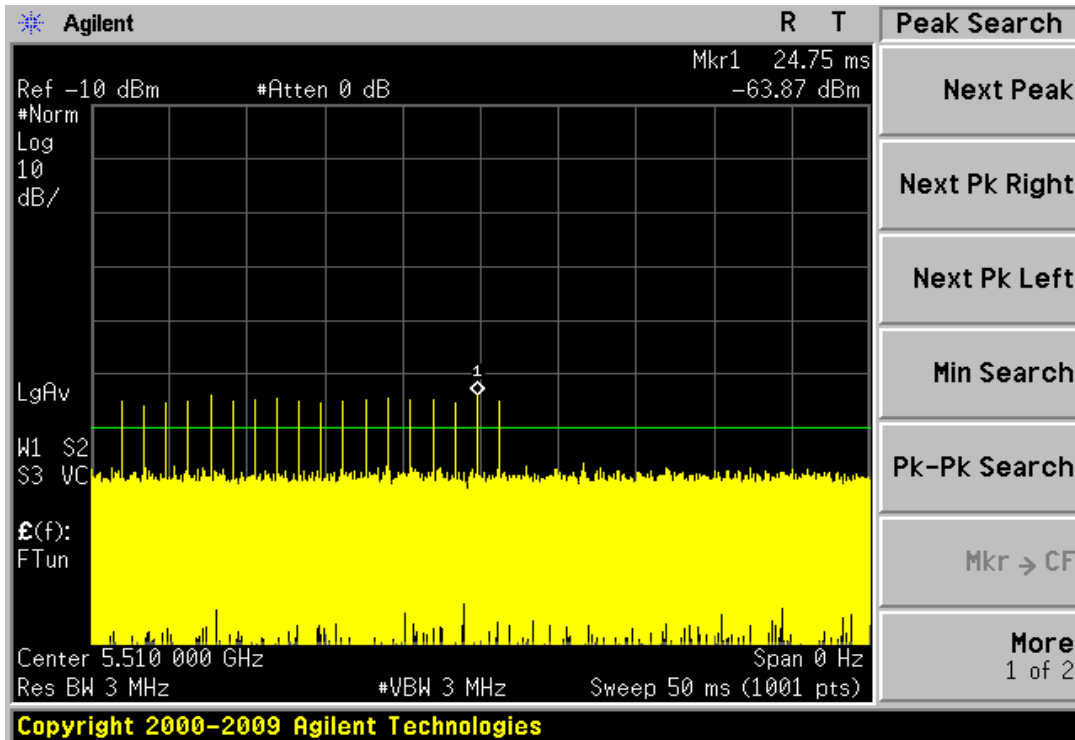

Sample of Short Pulse Radar Type 2

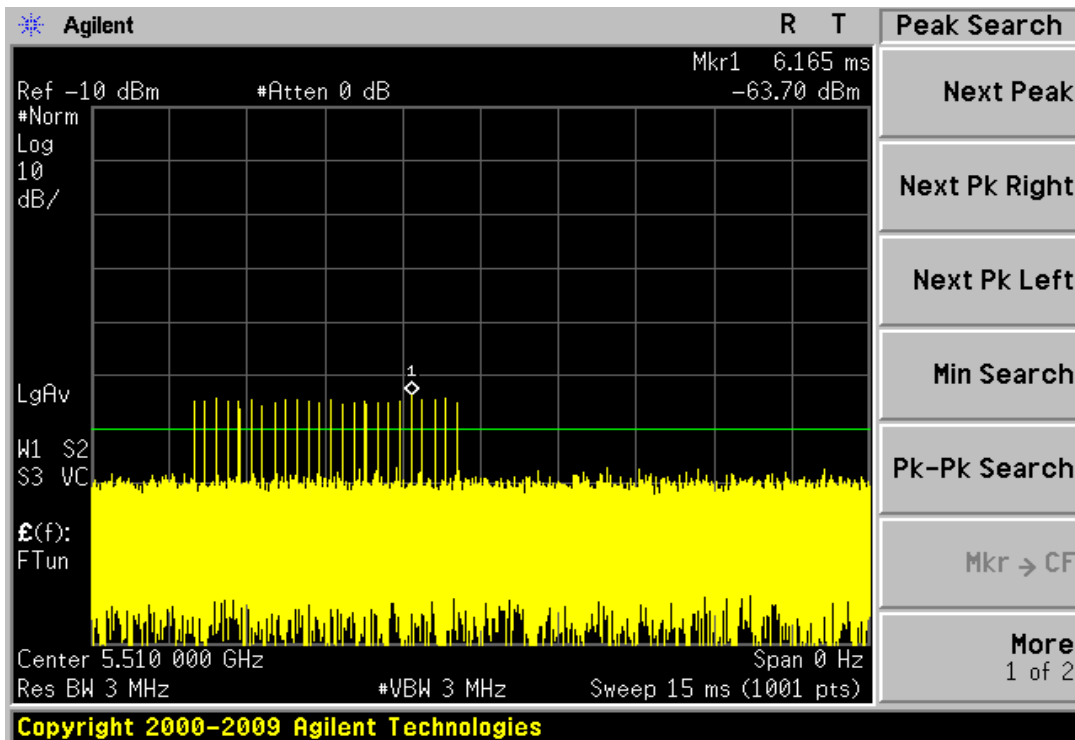



Sample of Short Pulse Radar Type 3

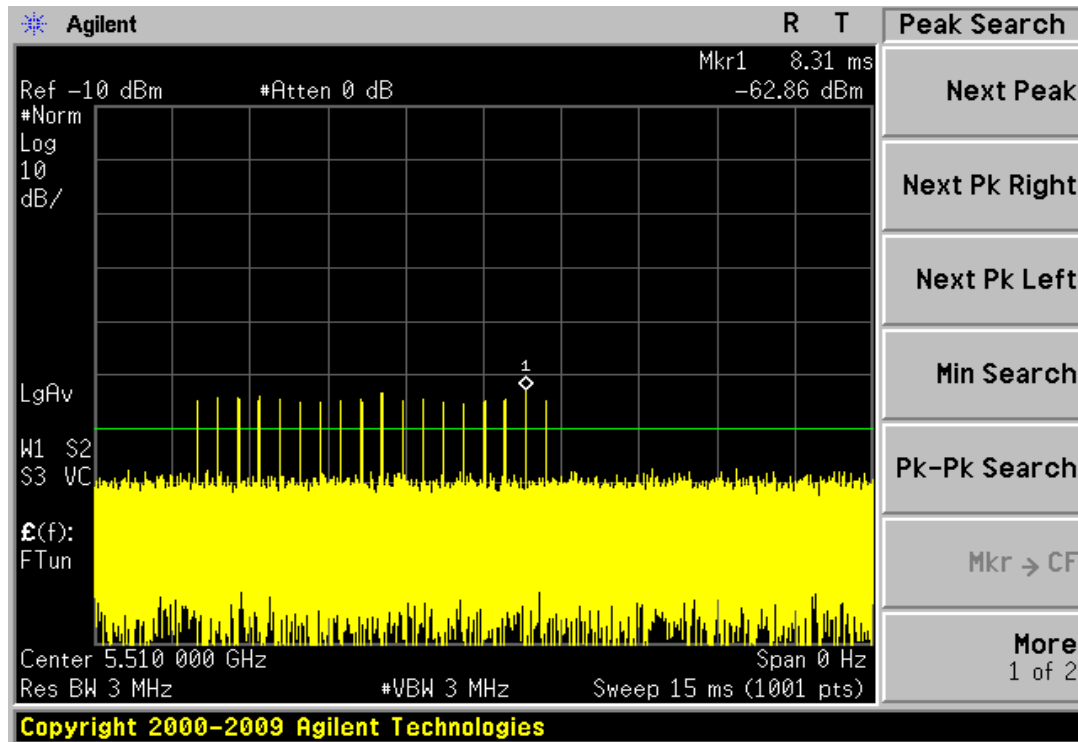

Sample of Short Pulse Radar Type 4

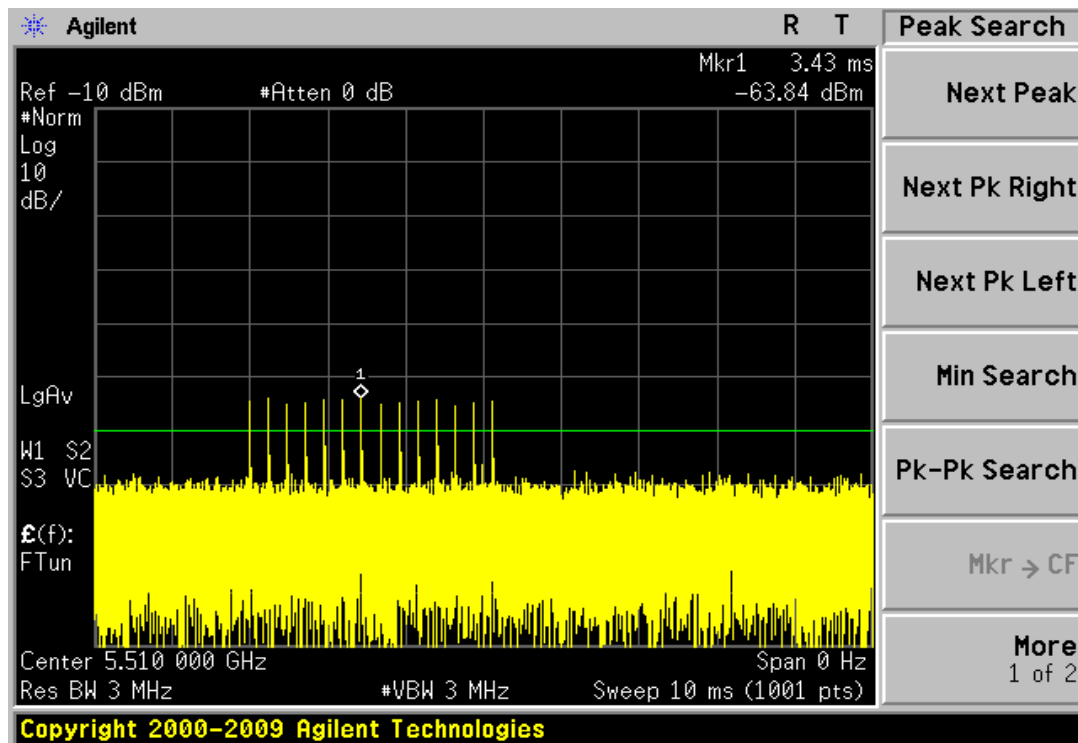



Sample of Long Pulse Radar Type 5

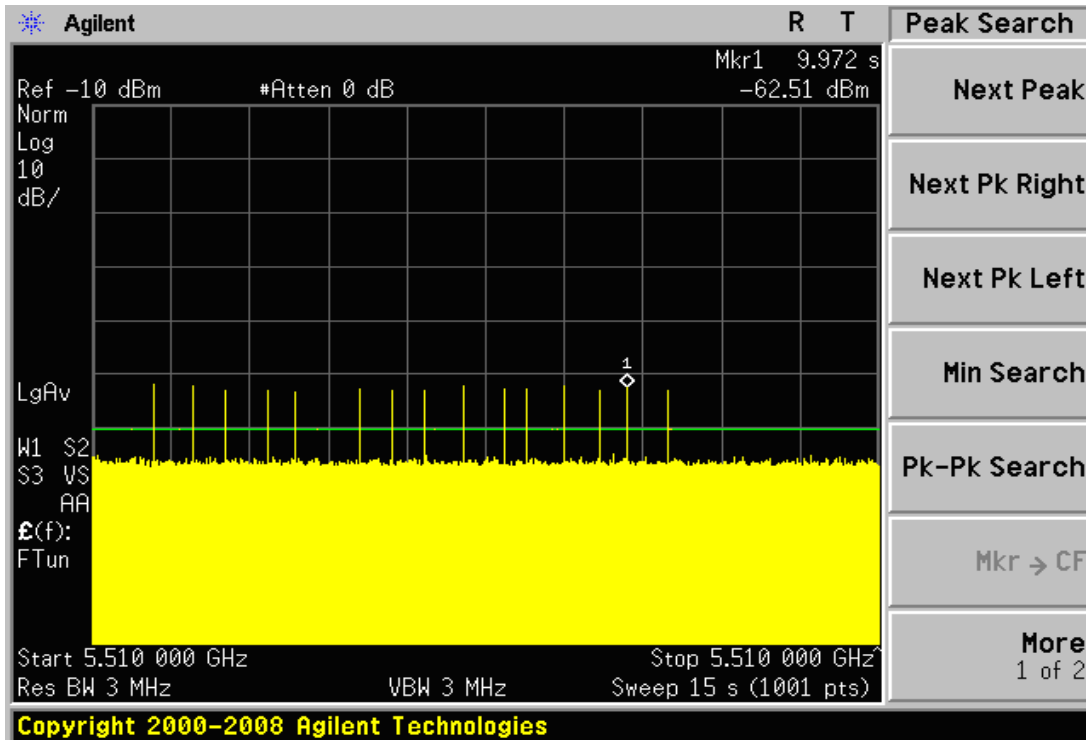

Sample of Frequency Hopping Radar Type 6

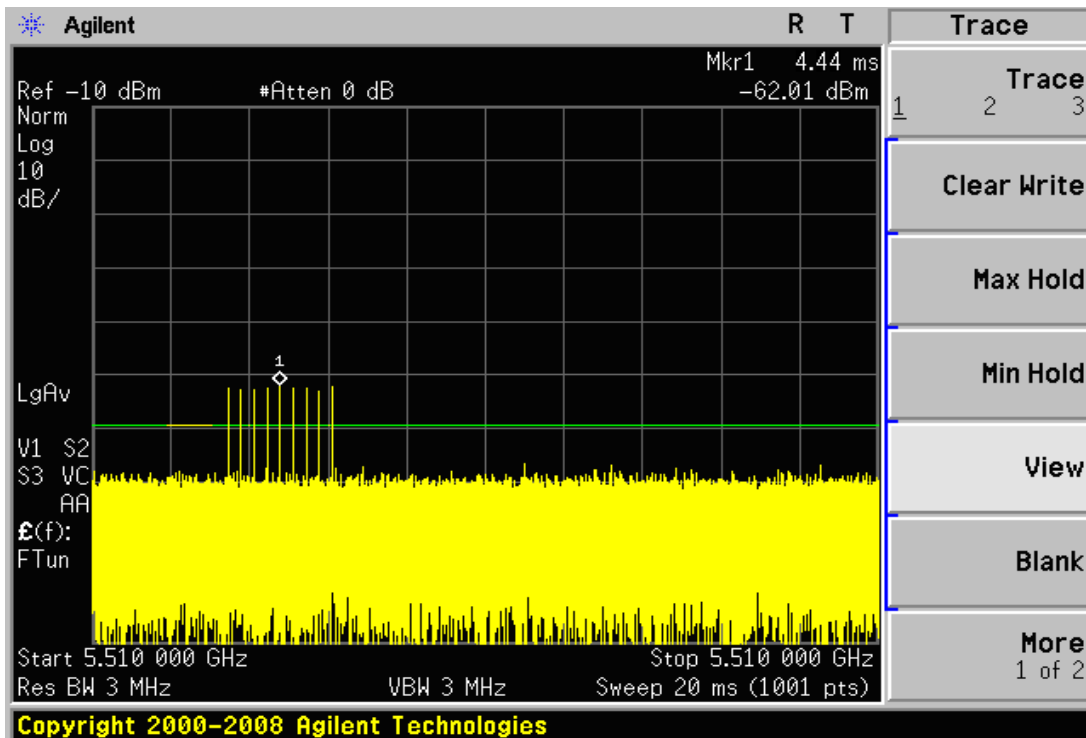



PLOT OF WLAN TRAFFIC FROM MASTER (5270MHz)

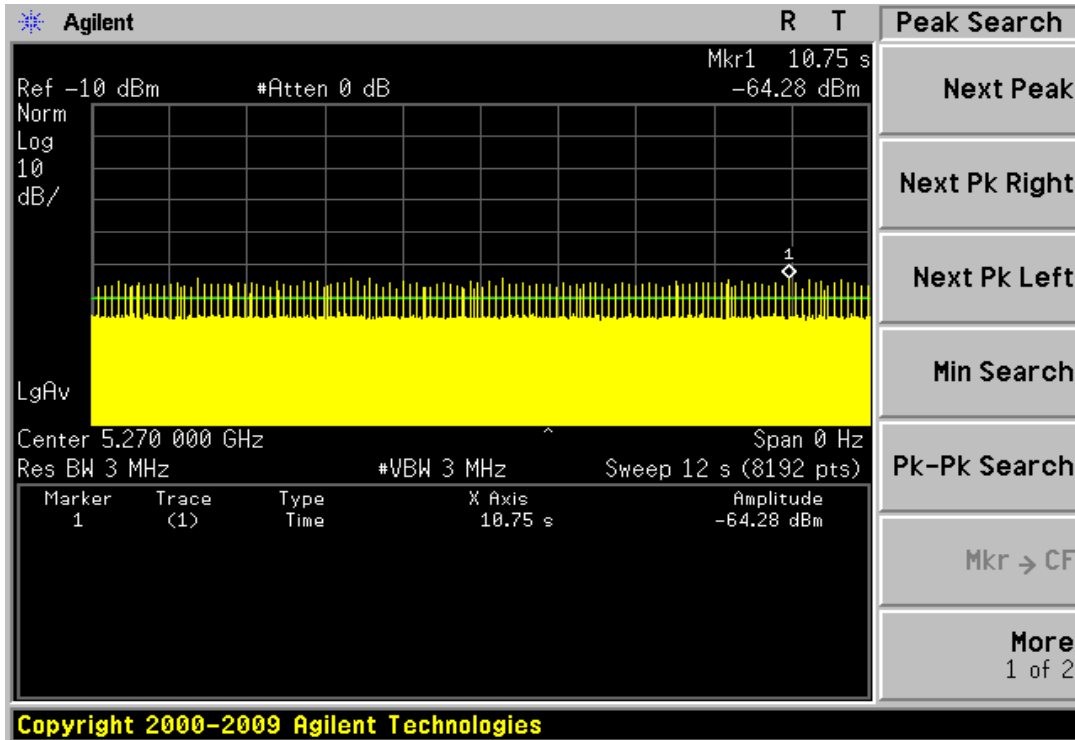

PLOT OF WLAN TRAFFIC FROM MASTER (5510MHz)

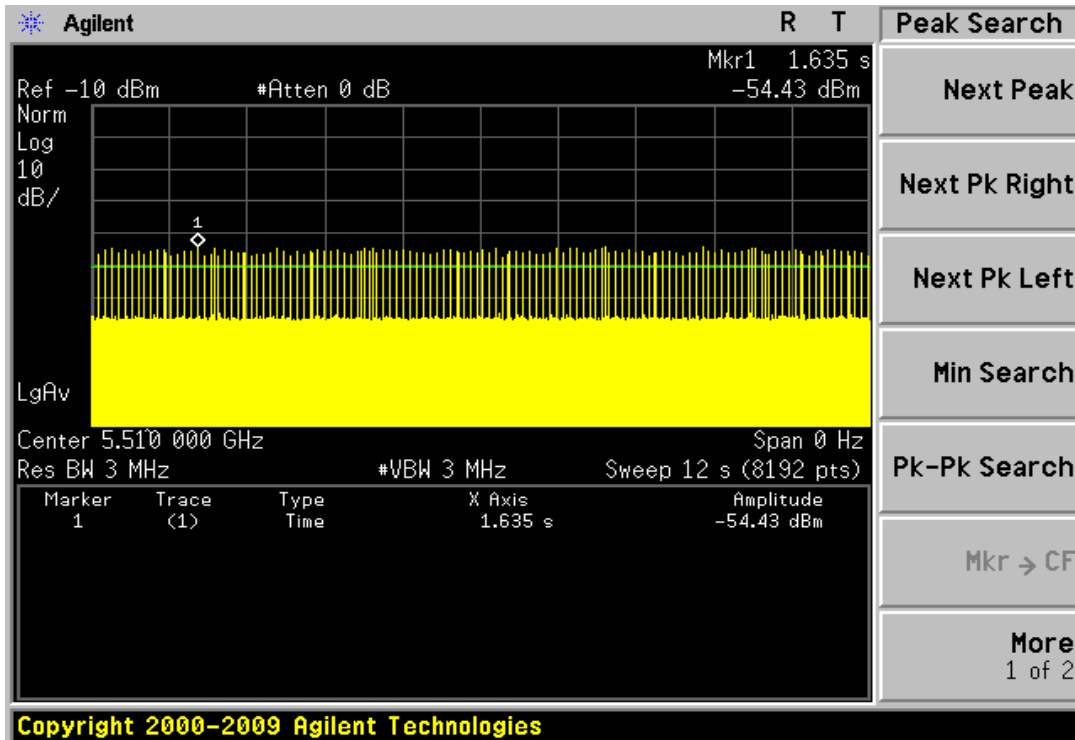



Without Data Traffic Plot (Noise plot)

5270MHz

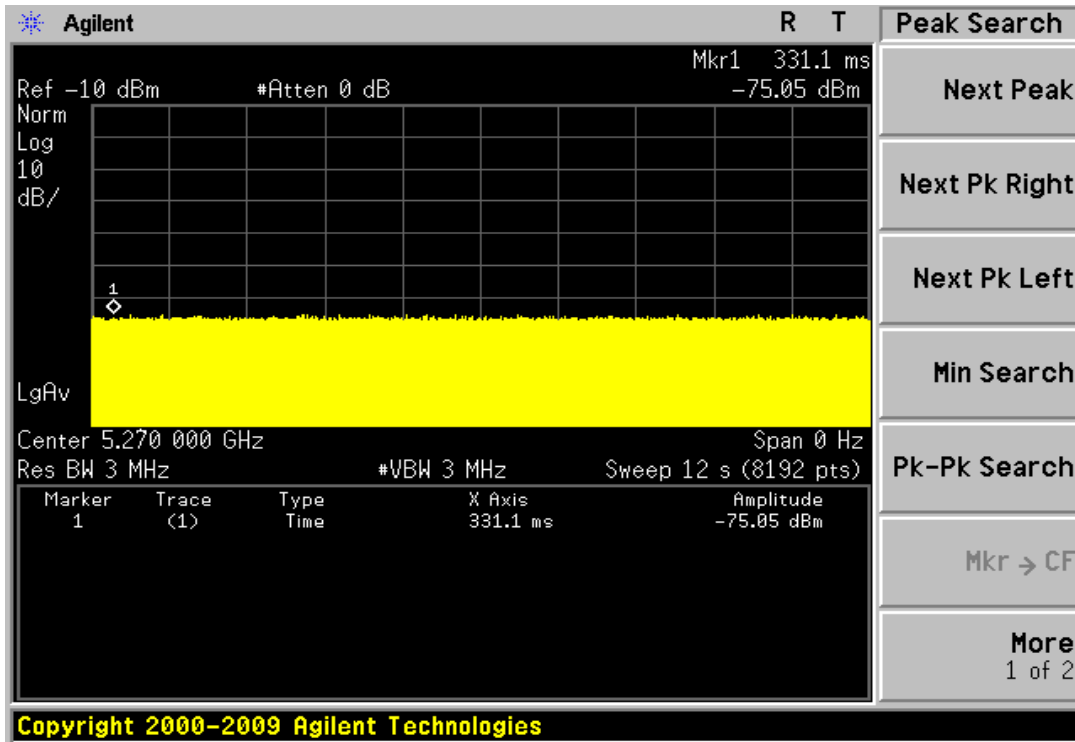

5510MHz

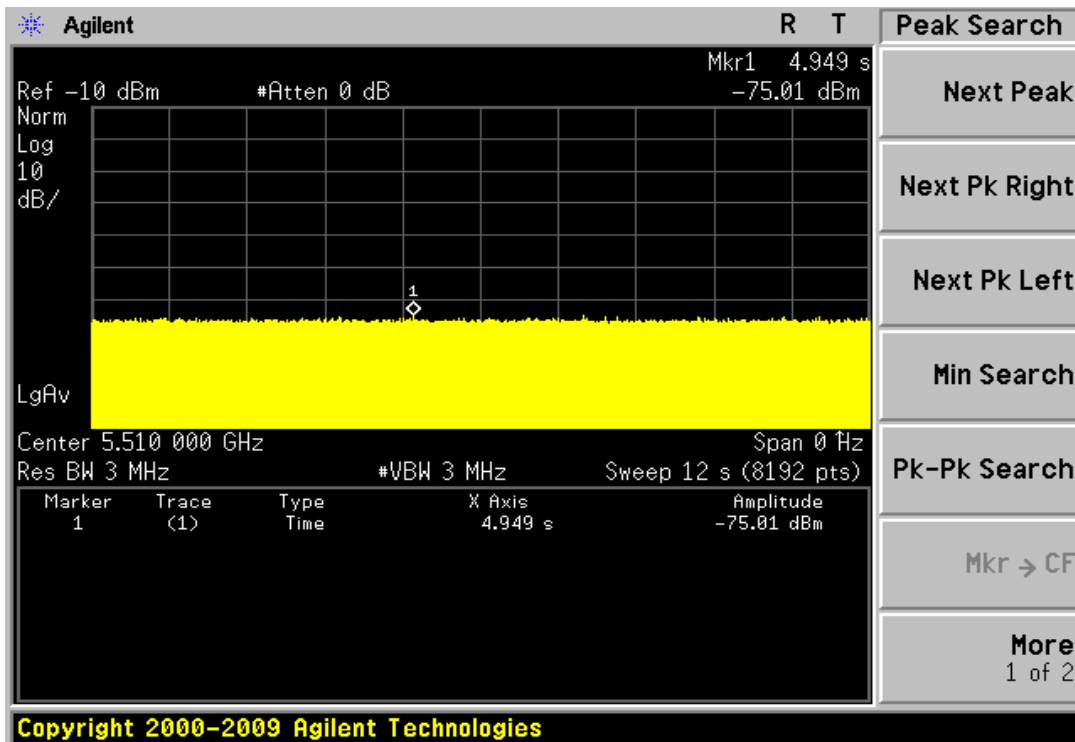



CHANNEL AVAILABILITY CHECK TIME

TEST PROCEDURE

1. Measurement the initial power-up time of EUT.
2. With link established on channel , apply a radar signal within 0~6 seconds after the initial power-up ; monitor the transmissions on channel from the spectrum analyzer.
- 3.Reboot EUT, with a link established on channel , apply radar signal within 54~60 seconds after the initial power-up period, and monitor the transmission on channel form the spectrum analyzer.

TEST CHANNEL AND METHOD

All tests were performed at a channel center frequency of 5510 MHz and5270MHz utilizing a Radiated test method.

EUT INITIAL POWER-UP CYCLE TIME

Frequency	EUT initial power-up cycle (sec)
5270 MHz	83.2
5510 MHz	82.4

CHANNEL AVAILABILITY CHECK TIME RESULT

If a radar signal is detected during the channel availability check then the PC controlling the EUT displays a message stating that radar was detected.

Timing of Radar Burst	Display on EUT / PC Control Computer	Spectrum Analyzer Display
No Radar Triggered	EUT Initiates Transmissions	Transmissions begin on channel after completion of the initial power-up cycle and the 60 second CAC
Within 0 to 6 second window	EUT indicates radar detected EUT does not display any radar parameter values	No transmissions on channel
Within 54 to 60 second window	EUT indicates radar detected EUT does not display any radar parameter values	No transmissions on channel



Please refer to the following plots.

Timing Plot Without Radar During CAC 5270MHz

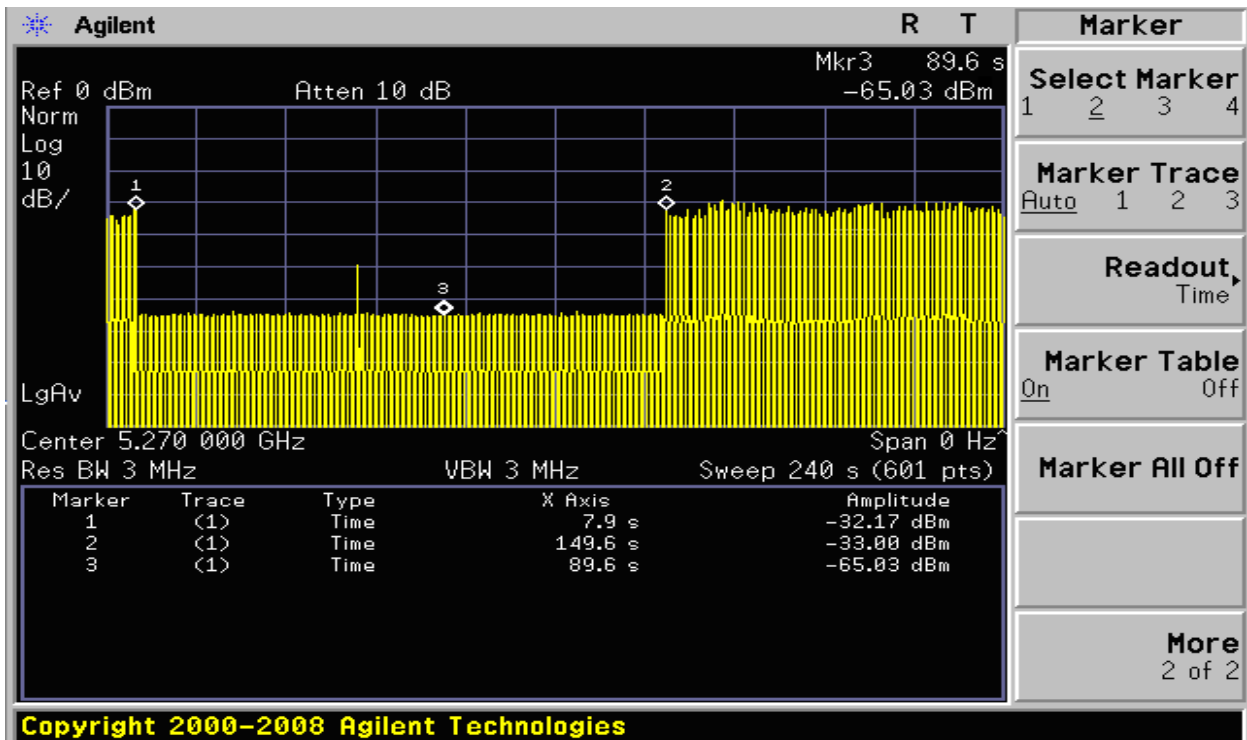

The initial power-up cycle requires $(149.6 - 60) = 89.6$ seconds



Timing Plot With Radar Near Beginning Of CAC

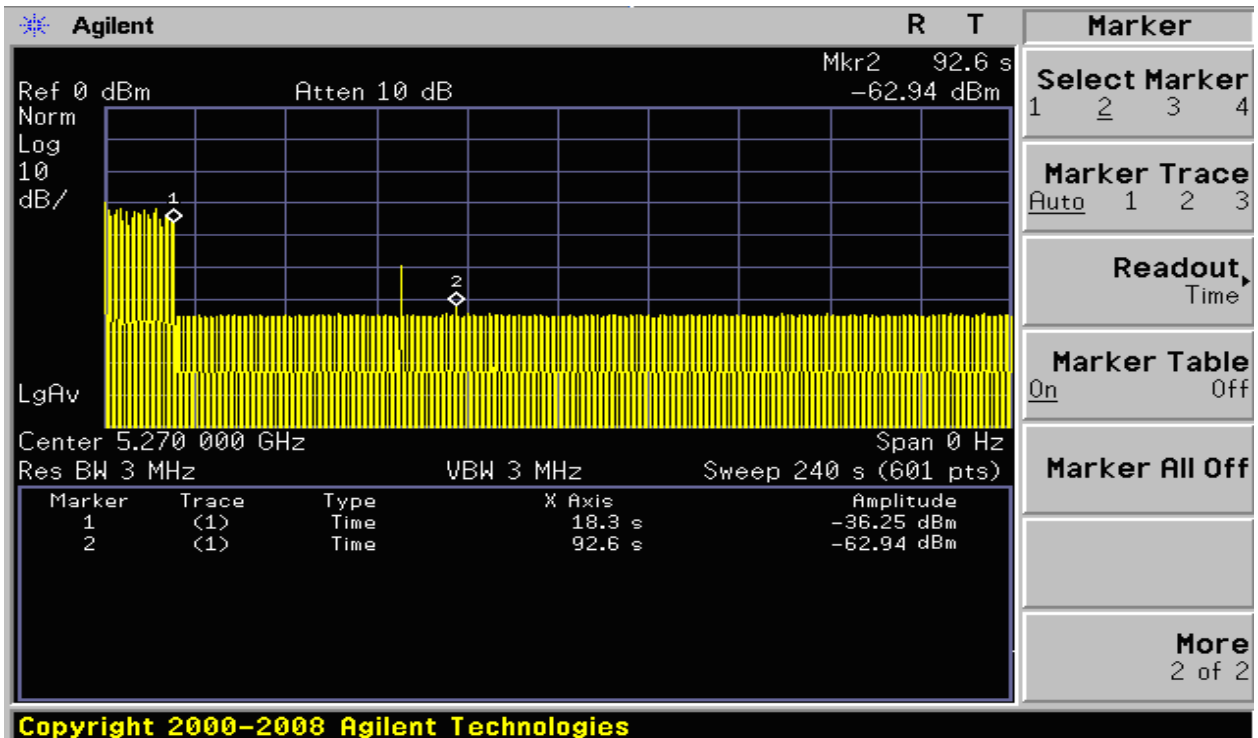

Timing Plot With Radar Near End Of CAC

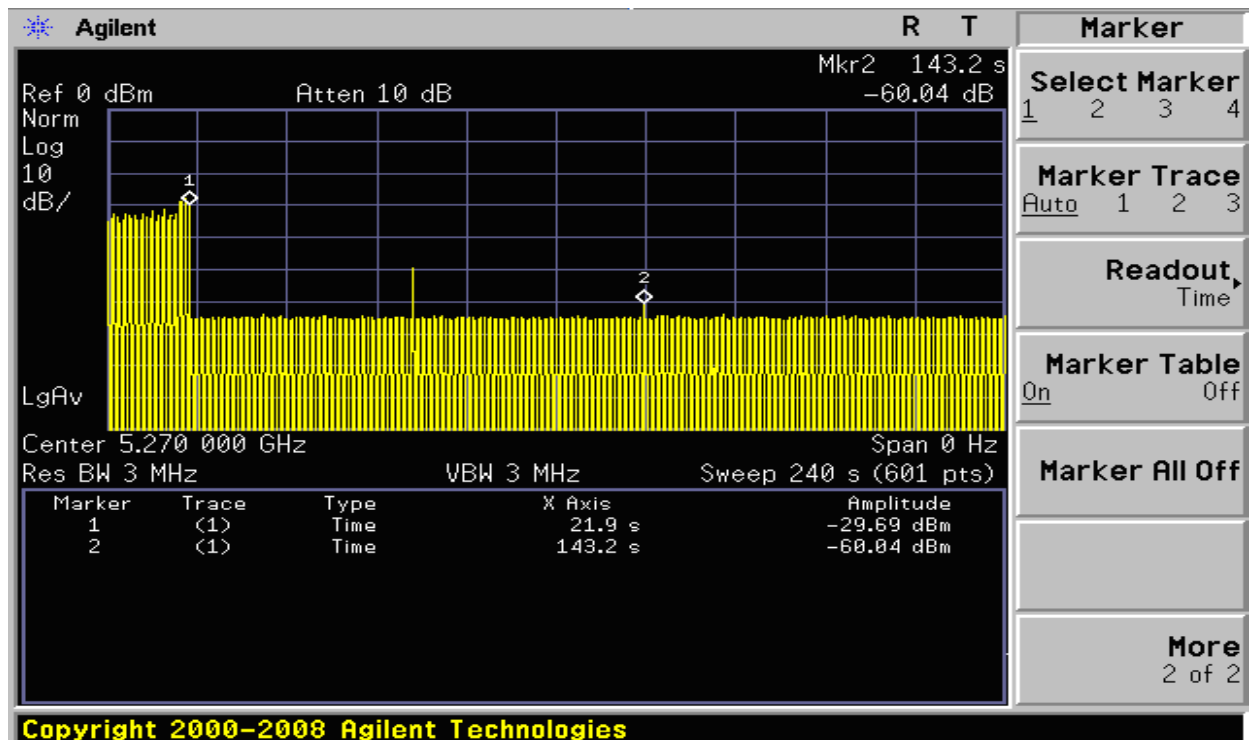



Timing Plot Without Radar During CAC 5510MHz

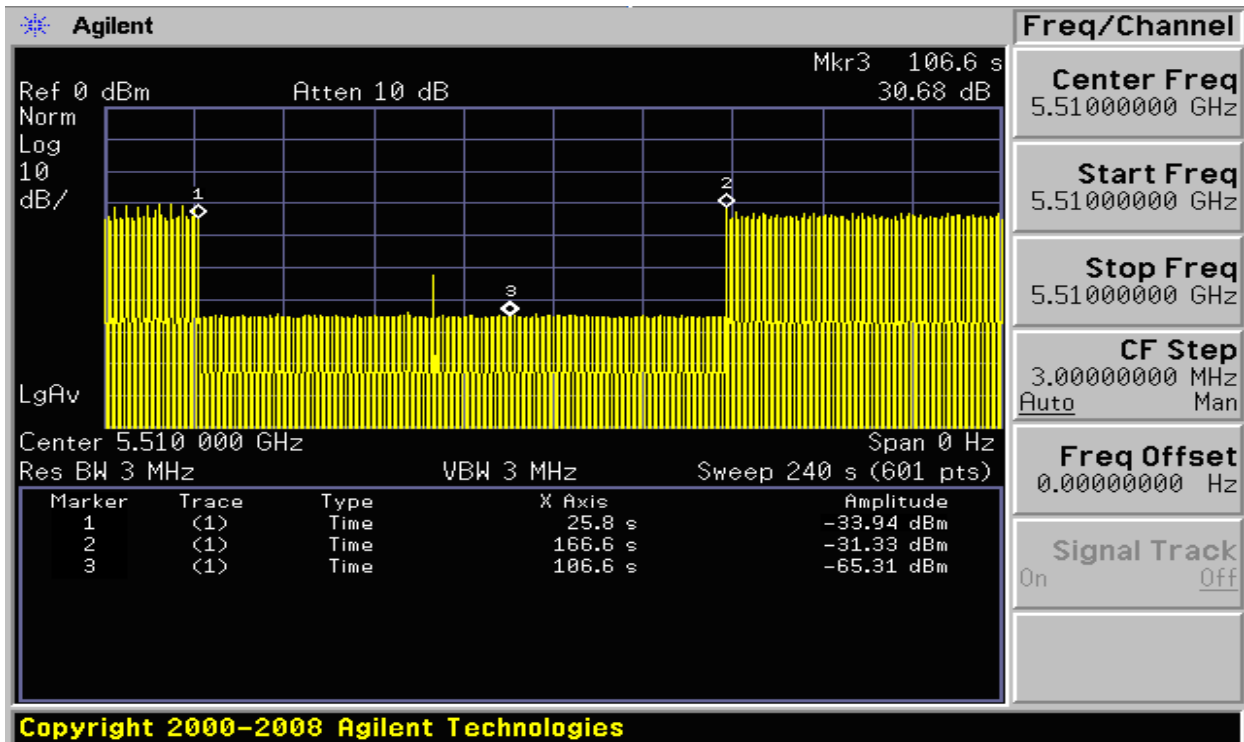

The initial power-up cycle requires $(166.6 - 60) = 106.6$ seconds



Timing Plot With Radar Near Beginning Of CAC

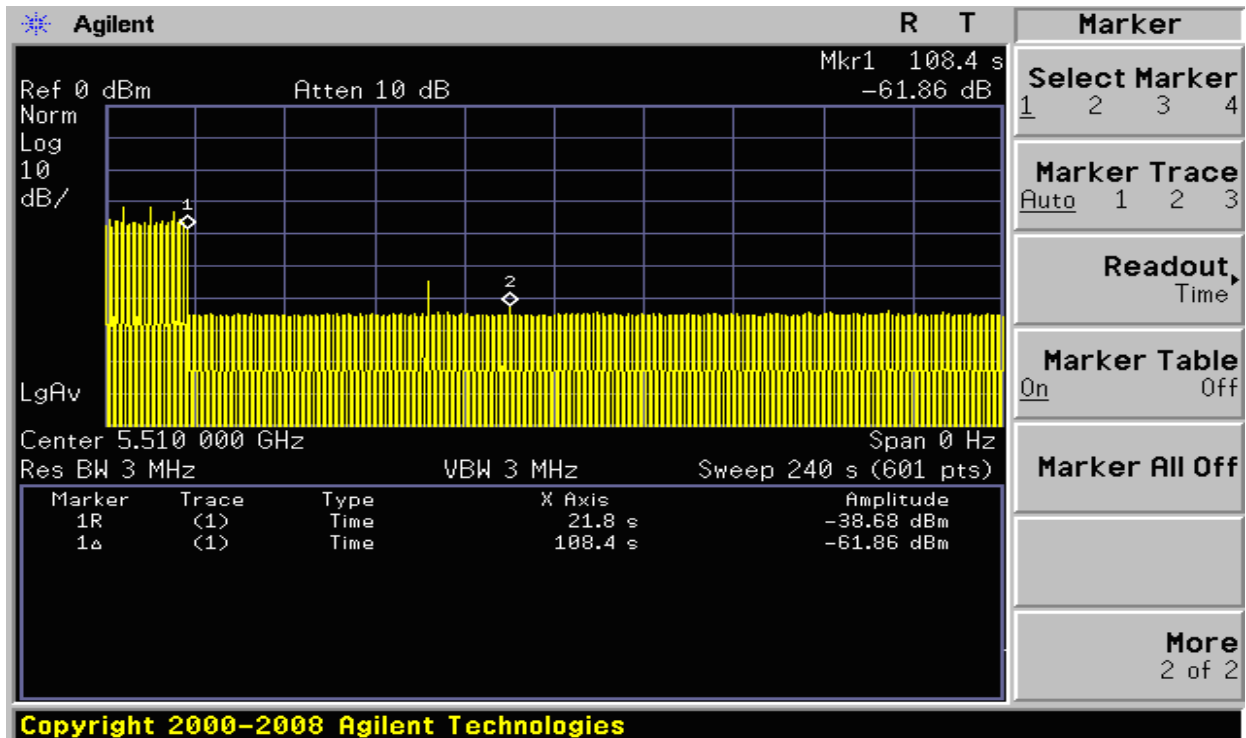

Timing Plot With Radar Near End Of CAC

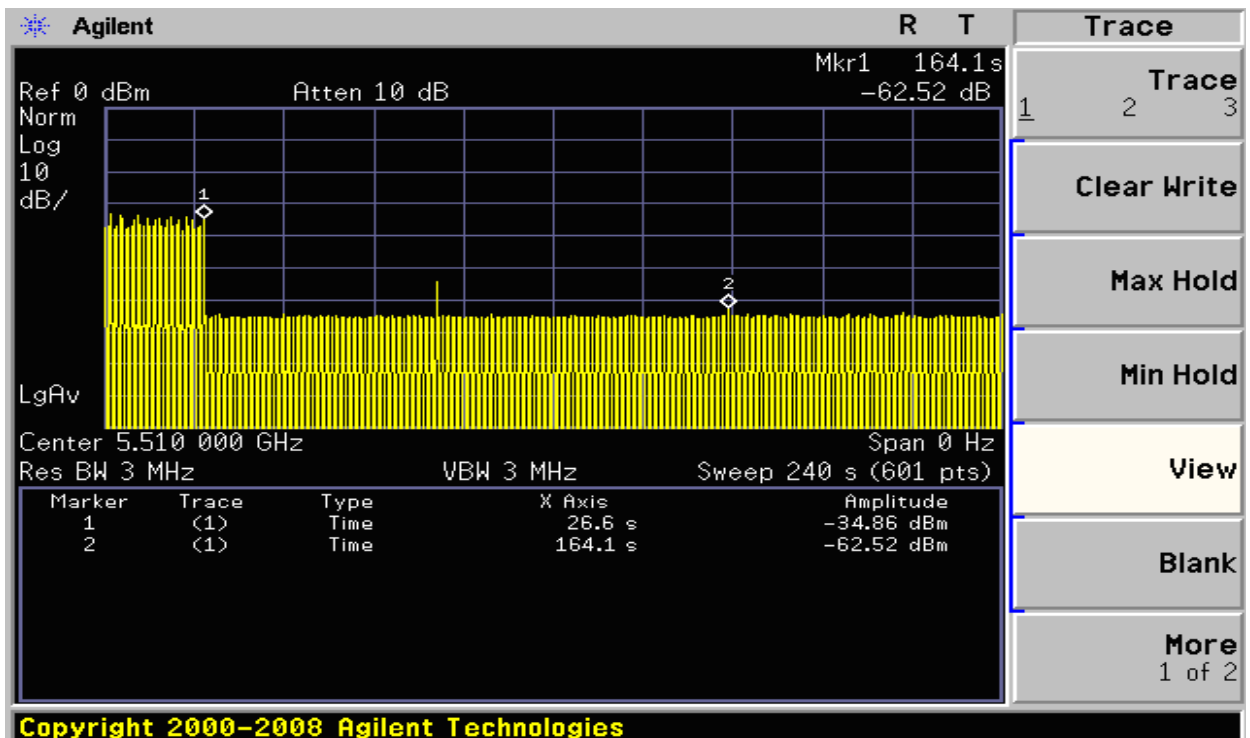



CHANNEL MOVE TIME AND CHANNEL CLOSING TRANSMISSION TIME

TEST PROCEDURE

Perform one of the type1 to type 4 short pulse radar waveform, BACL use type 1 radar signal, repeat using along pulse radar type5 waveform.

The aggregate channel closing transmission time is calculated as follows:

Aggregate Transmission Time = N * Dwell Time

N is the number of spectrum analyzer bins showing a device transmission

Dwell Time is the dwell time per bin (i.e. Dwell Time = S/B, S is the sweep time and B is the number of bin, i.e.8192)

TEST RESULT:

Frequency (MHz)	Bandwidth (MHz)	Radar Type	Results
5280	20	Type 1	pass
		Type 5	
5500	20	Type 1	pass
		Type 5	
5270	40	Type 1	pass
		Type 5	
5510	40	Type 1	pass
		Type 5	

Please refer to the following tables and plots.



Type 1 Channel Move Time Results(20MHz) (5280MHz)

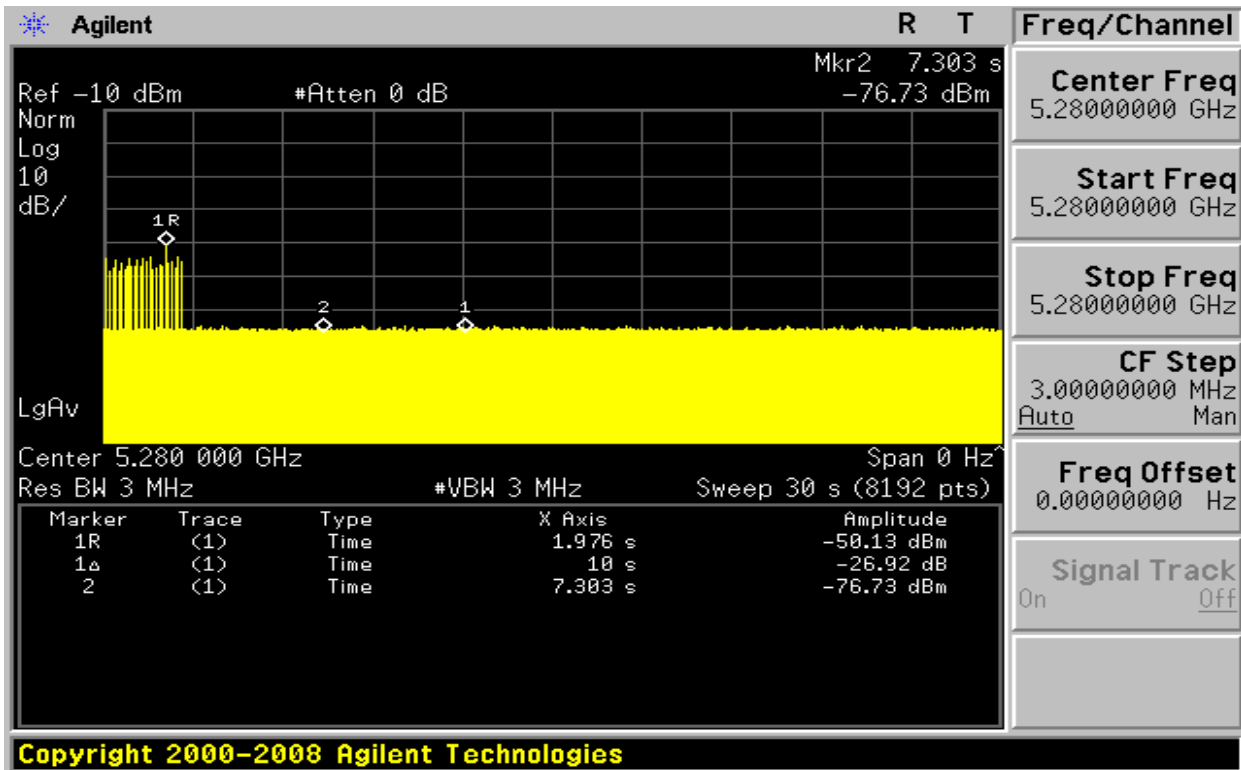

Type 5 Channel Move Time Results(20MHz) (5280MHz)

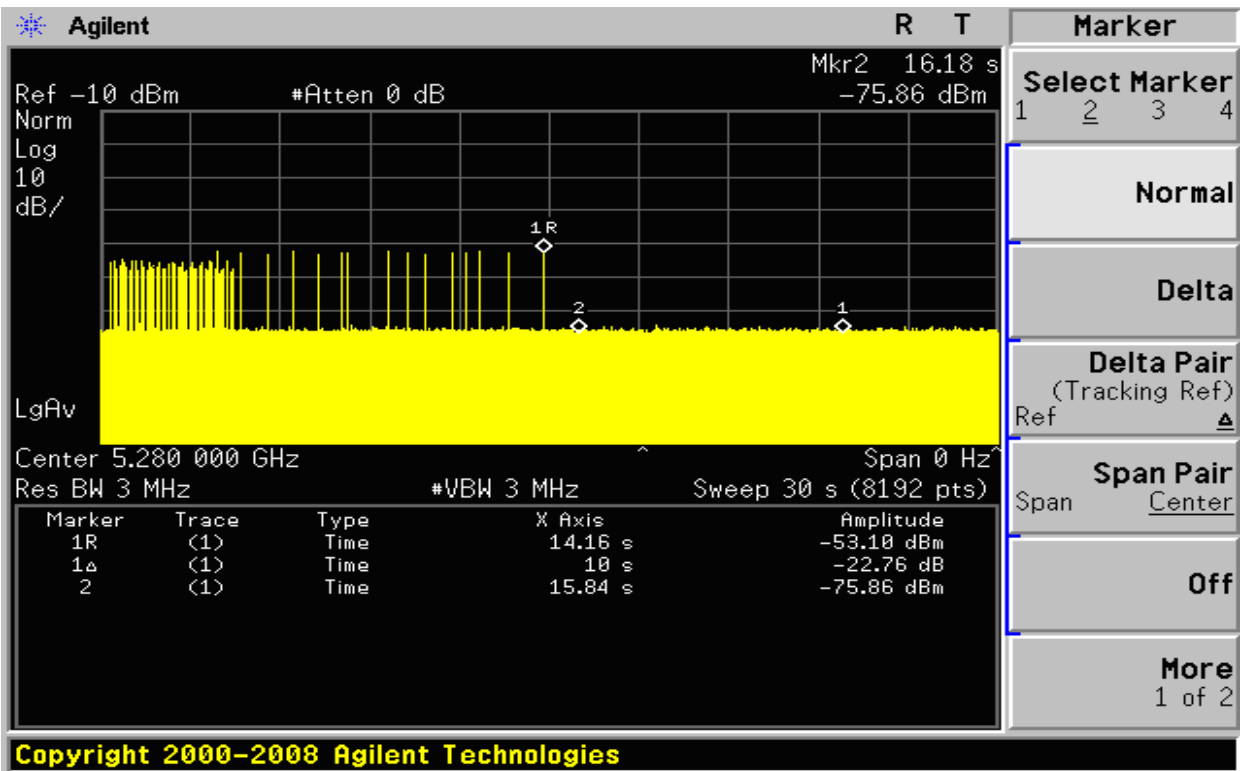



Type 1 Channel Move Time Results(20MHz) (5500MHz)

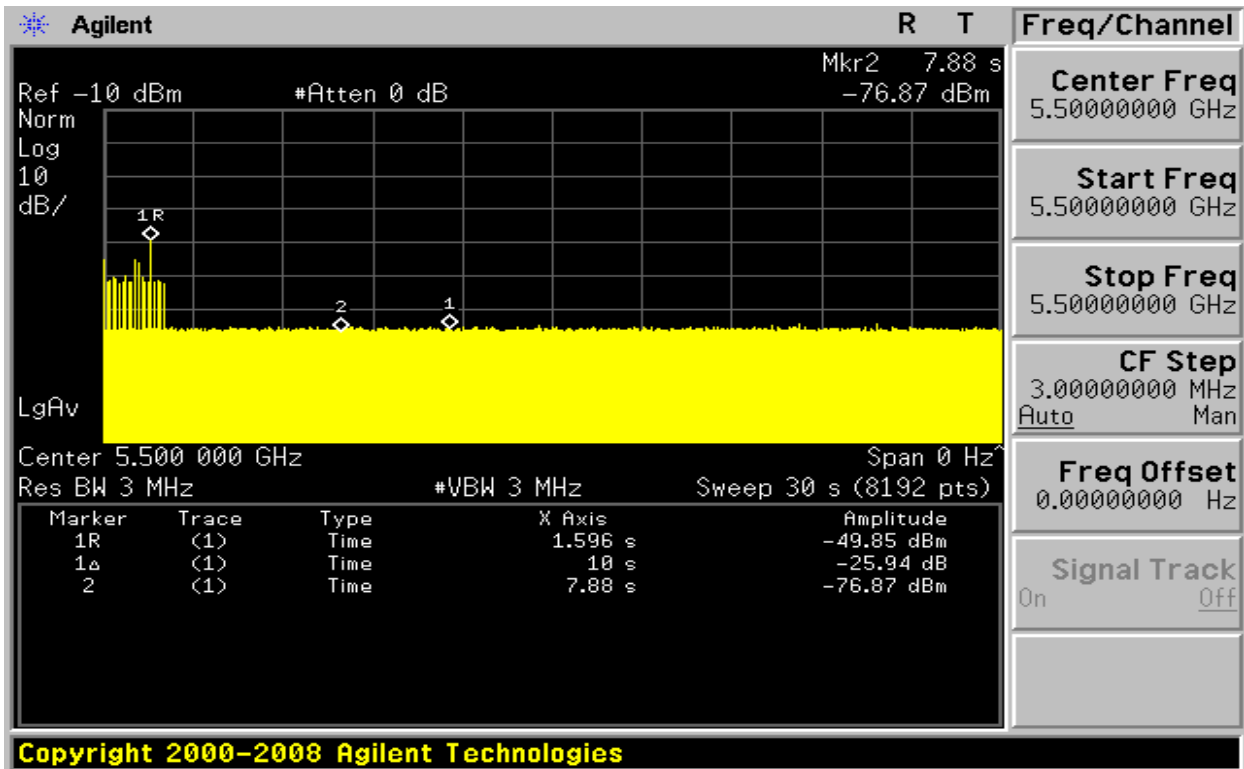

Type 5 Channel Move Time Results(20MHz) (5500MHz)

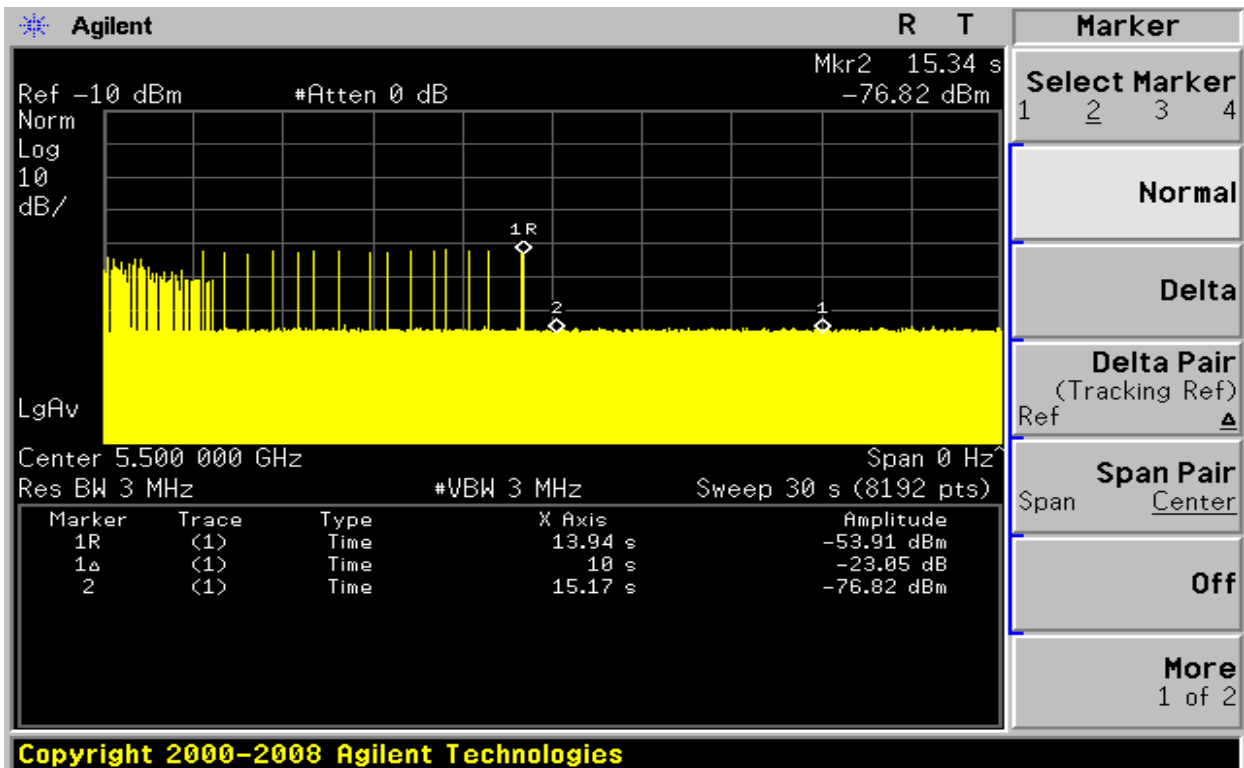



Compliance Certification Services Inc.

Report No: C131118R01-RPB

FCC ID: WBV-HIVEAP1X1

Date of Issue :Nov 19, 2013

IC: 7774A-HIVEAP1X1

Type 1 Channel Move Time Results(40MHz)(5270MHz)

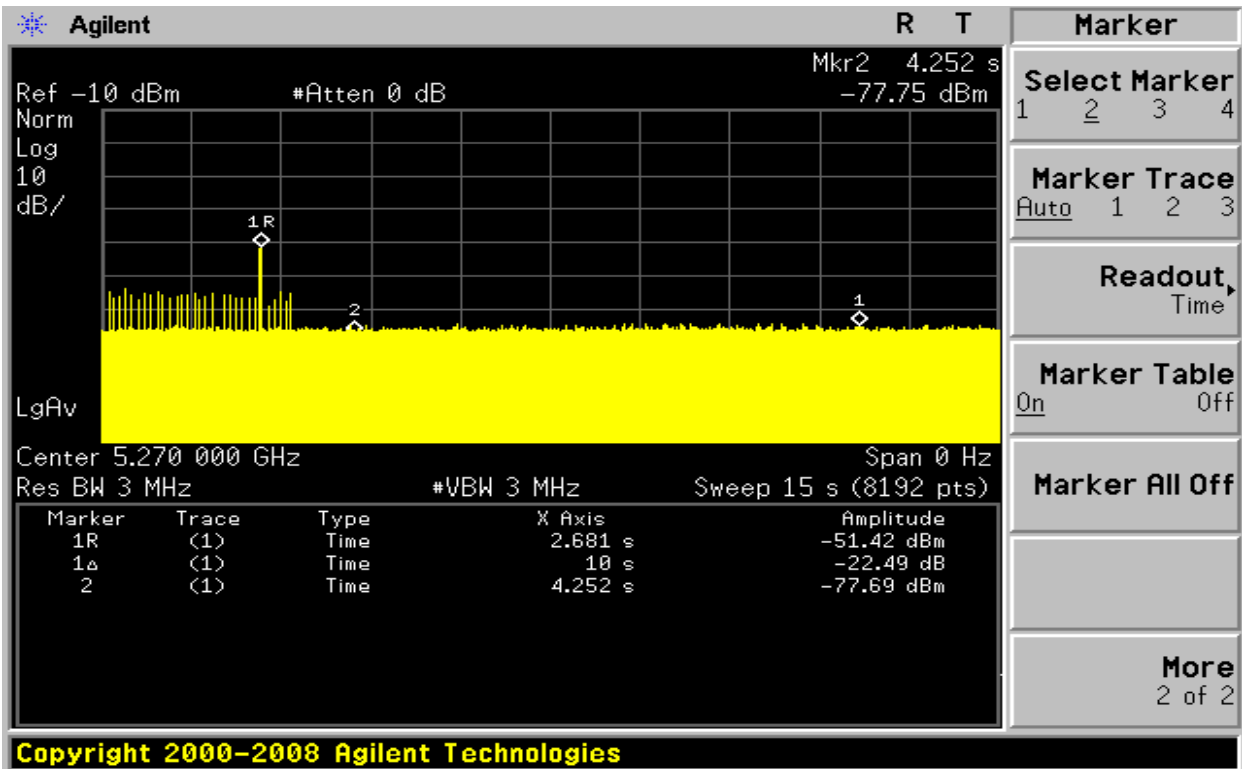

Type 5 Channel Move Time Results(40MHz)(5270MHz)

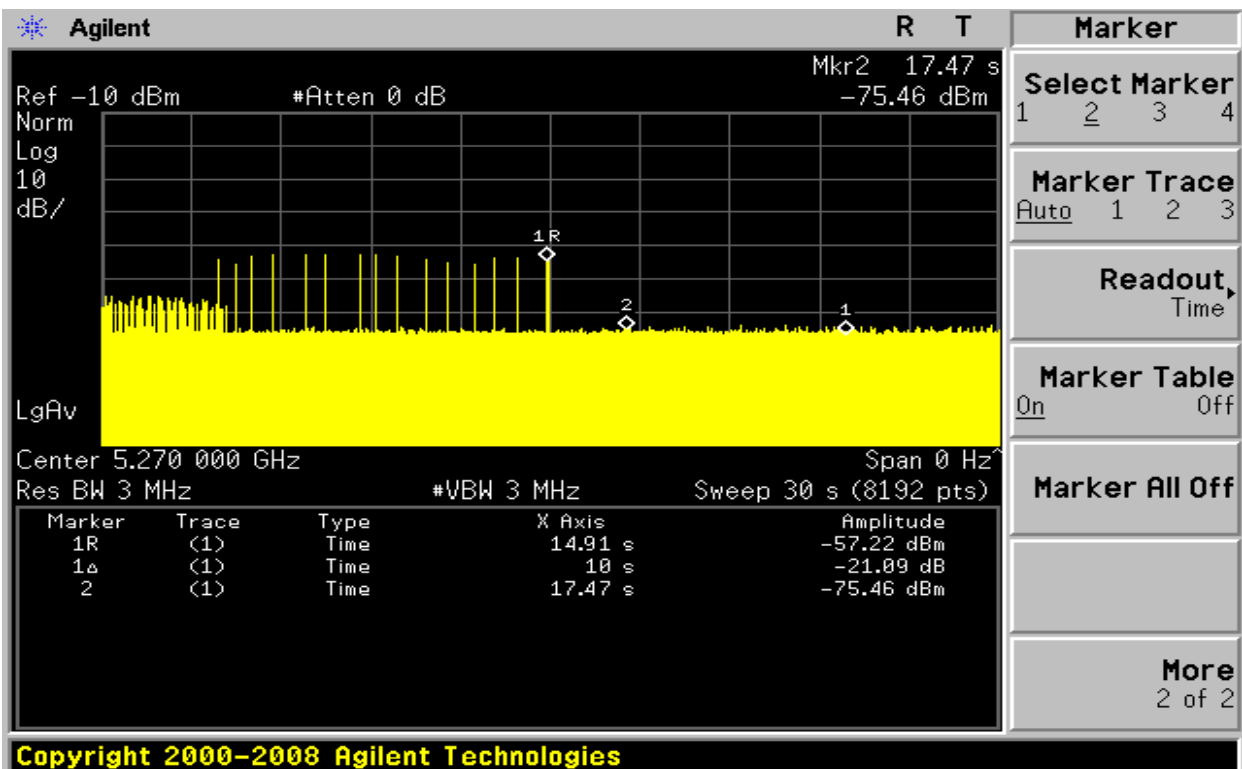



Compliance Certification Services Inc.

Report No: C131118R01-RPB

FCC ID: WBV-HIVEAP1X1

Date of Issue :Nov 19, 2013

IC: 7774A-HIVEAP1X1

Type 1 Channel Move Time Results(40MHz)(5510MHz)

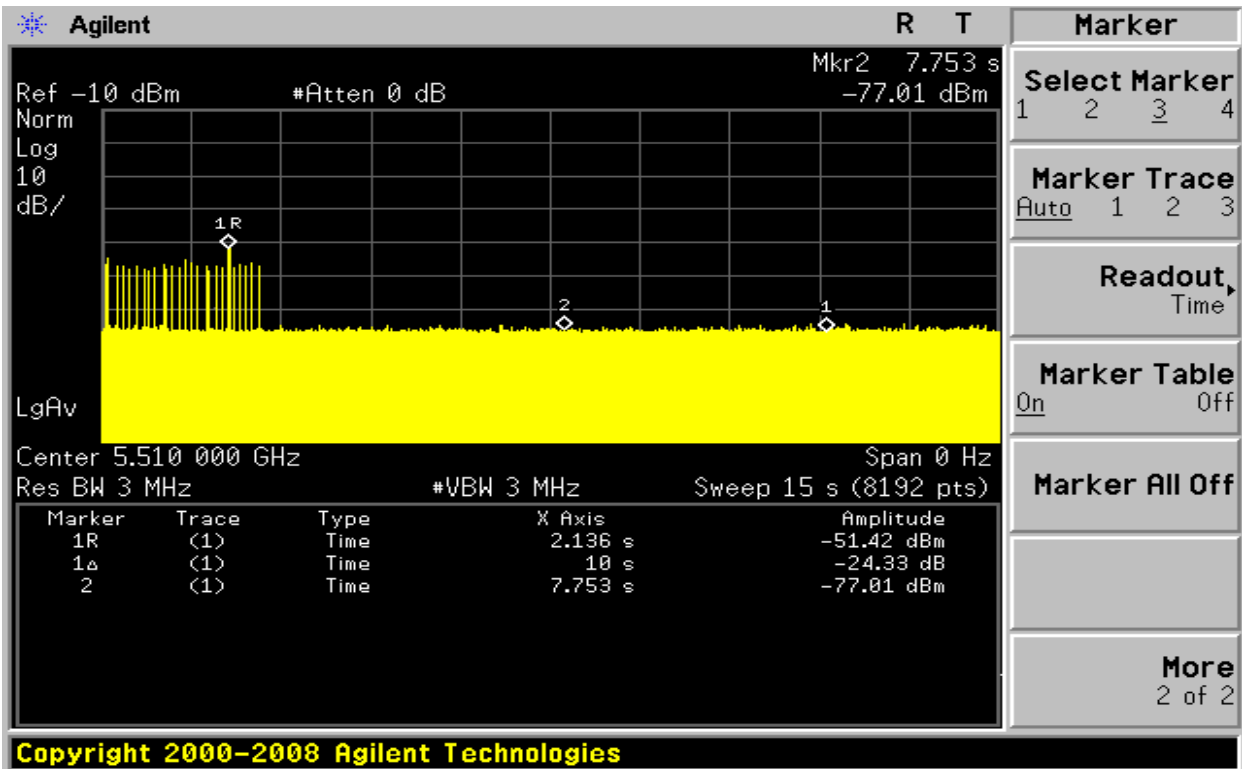

Type 5 Channel Move Time Results(40MHz)(5510MHz)

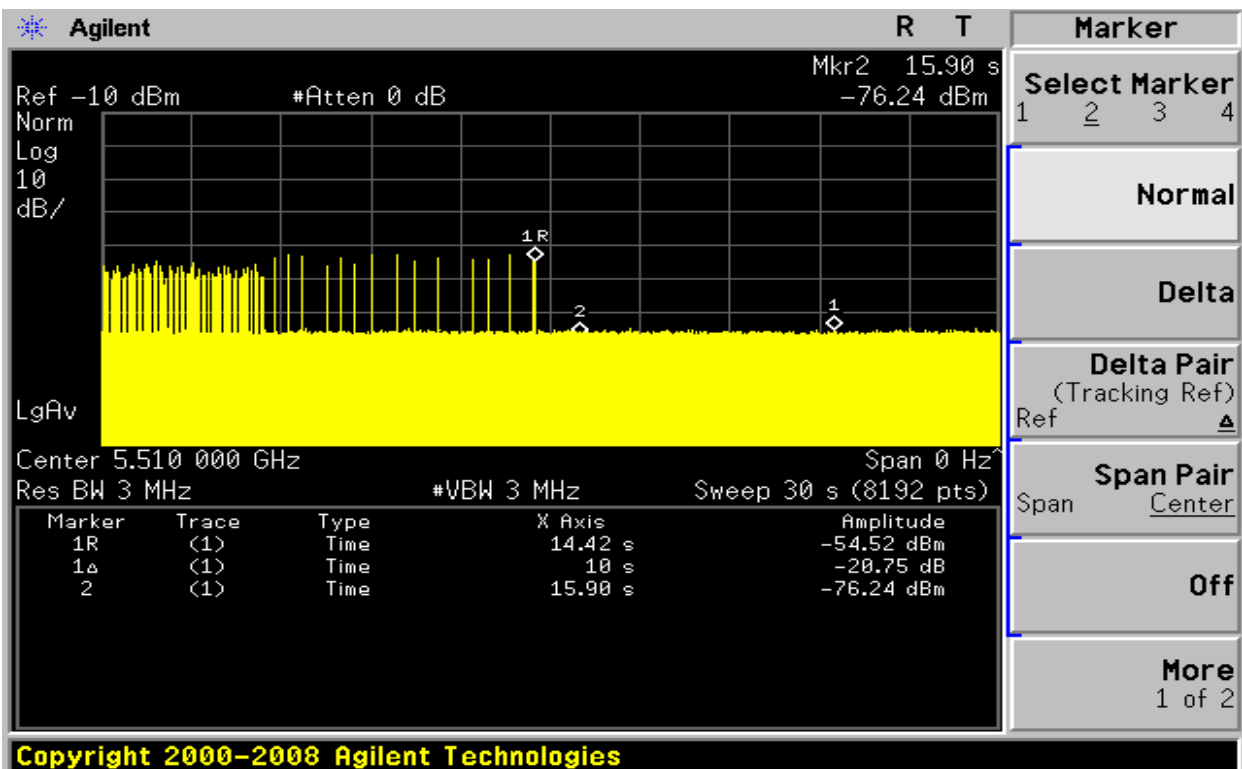



Type 1 Channel Closing Transmission Time Results (20 MHz)

5280MHz

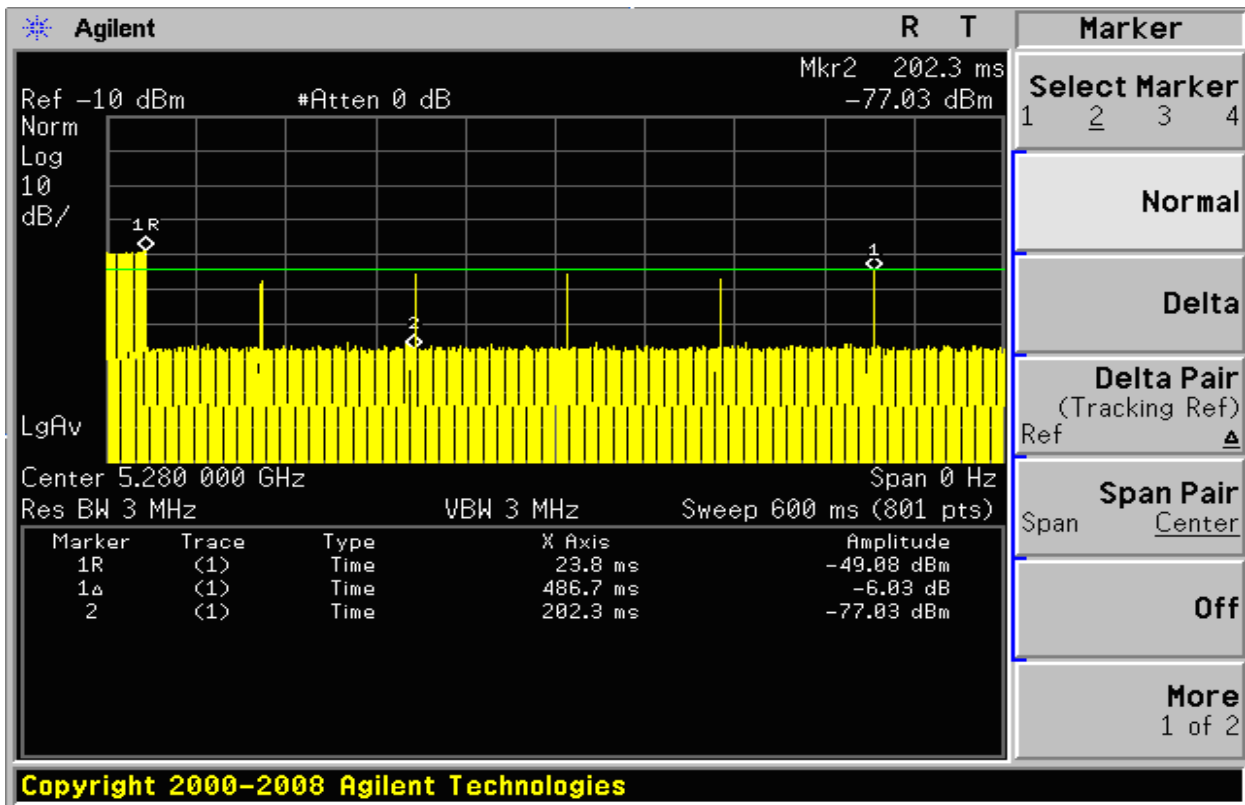

NOTE:

Dwell is the dwell time per spectrum analyzer sampling bin.

S is the sweep time

B is the number of spectrum analyzer sampling bins

C is the intermittent control signals of Channel Closing Transmission Time

N is the number of spectrum analyzer sampling bins (intermittent control signals)

showing a U-NII

transmission

$$\text{Dwell} = S (600) / B(801)$$

$$C = N(5) \times \text{Dwell}$$

$$C = 5 \times 0.749 = 3.745 \text{ ms}$$



Type 1 Channel Closing Transmission Time Results (20 MHz)

5500MHz

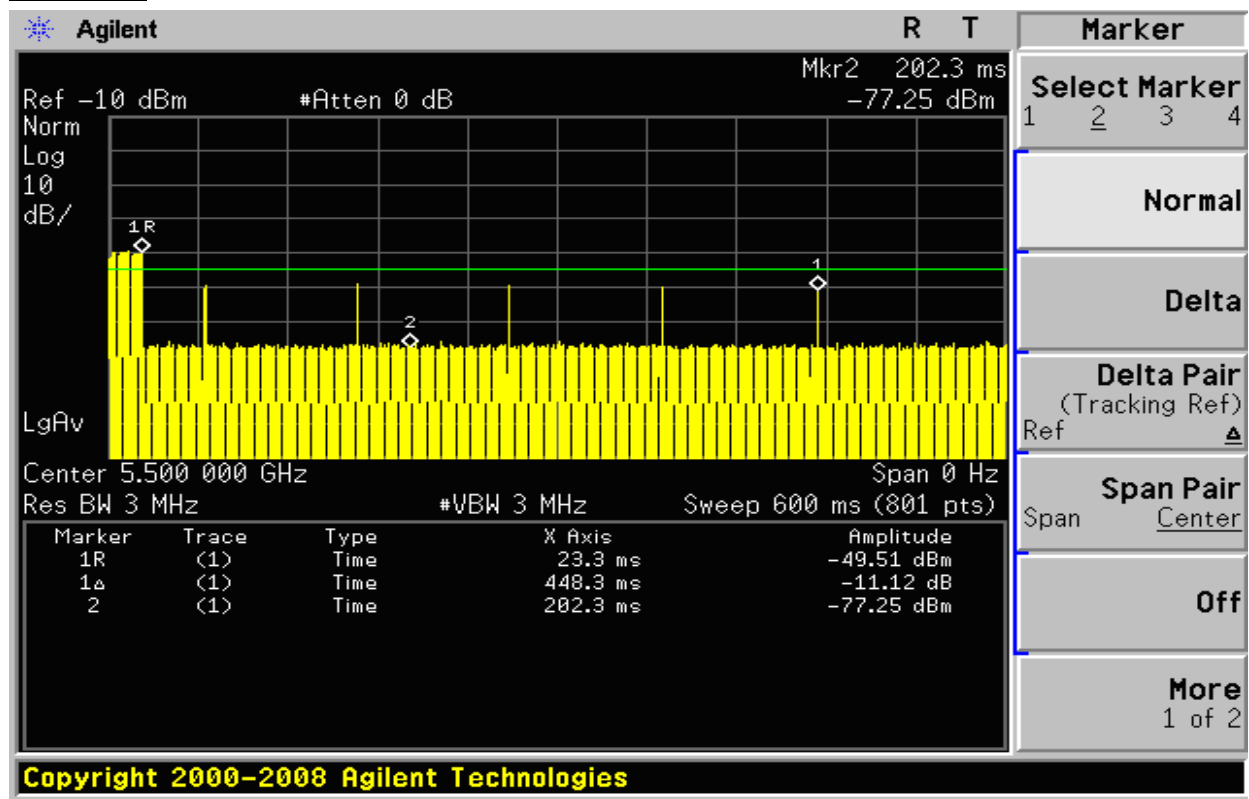

NOTE:

Dwell is the dwell time per spectrum analyzer sampling bin.

S is the sweep time

B is the number of spectrum analyzer sampling bins

C is the intermittent control signals of Channel Closing Transmission Time

N is the number of spectrum analyzer sampling bins (intermittent control signals)

showing a U-NII

transmission

$$\text{Dwell} = S (600) / B(801)$$

$$C = N(4) \times \text{Dwell}$$

$$C = 4 \times 0.749 = 2.996 \text{ ms}$$



Type 1 Channel Closing Transmission Time Results (40 MHz)

5270MHz

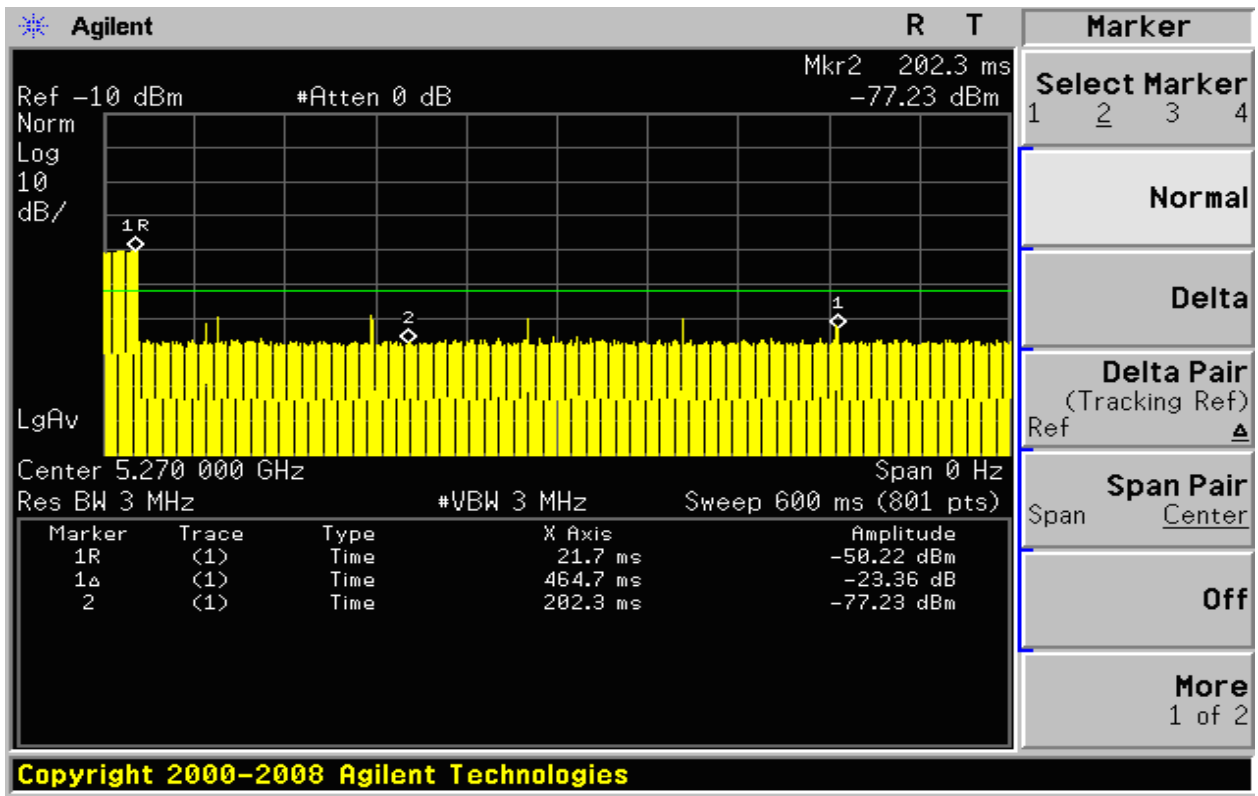

NOTE:

Dwell is the dwell time per spectrum analyzer sampling bin.

S is the sweep time

B is the number of spectrum analyzer sampling bins

C is the intermittent control signals of Channel Closing Transmission Time

N is the number of spectrum analyzer sampling bins (intermittent control signals)

showing a U-NII

transmission

$$\text{Dwell} = S (600) / B(801)$$

$$C = N(4) \times \text{Dwell}$$

$$C = 4 \times 0.749 = 2.996 \text{ ms}$$



Type 1 Channel Closing Transmission Time Results (40 MHz)

5510MHz

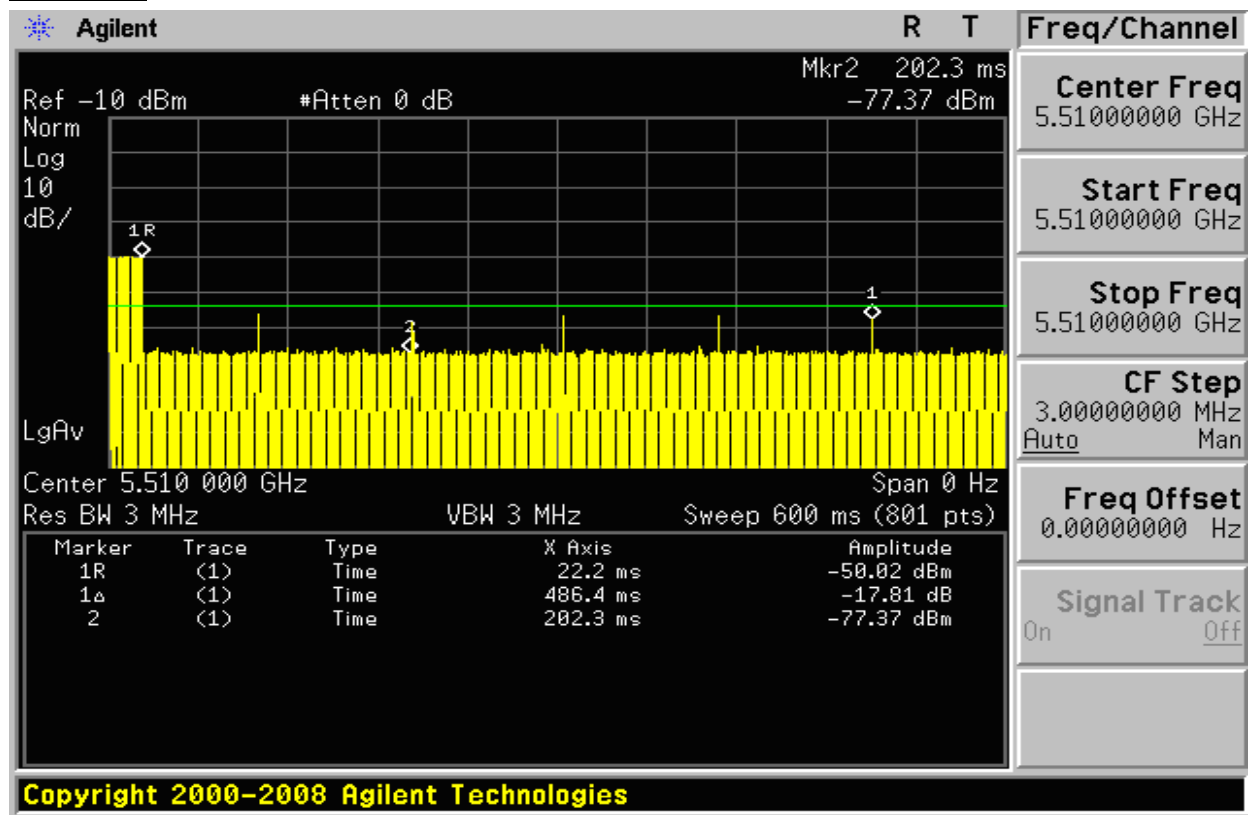

NOTE:

Dwell is the dwell time per spectrum analyzer sampling bin.

S is the sweep time

B is the number of spectrum analyzer sampling bins

C is the intermittent control signals of Channel Closing Transmission Time

N is the number of spectrum analyzer sampling bins (intermittent control signals)

showing a U-NII

transmission

$$\text{Dwell} = S (600) / B(801)$$

$$C = N(5) \times \text{Dwell}$$

$$C = 5 \times 0.749 = 3.745 \text{ ms}$$



Type 5 Channel Closing Transmission Time Results (20 MHz)

5280MHz

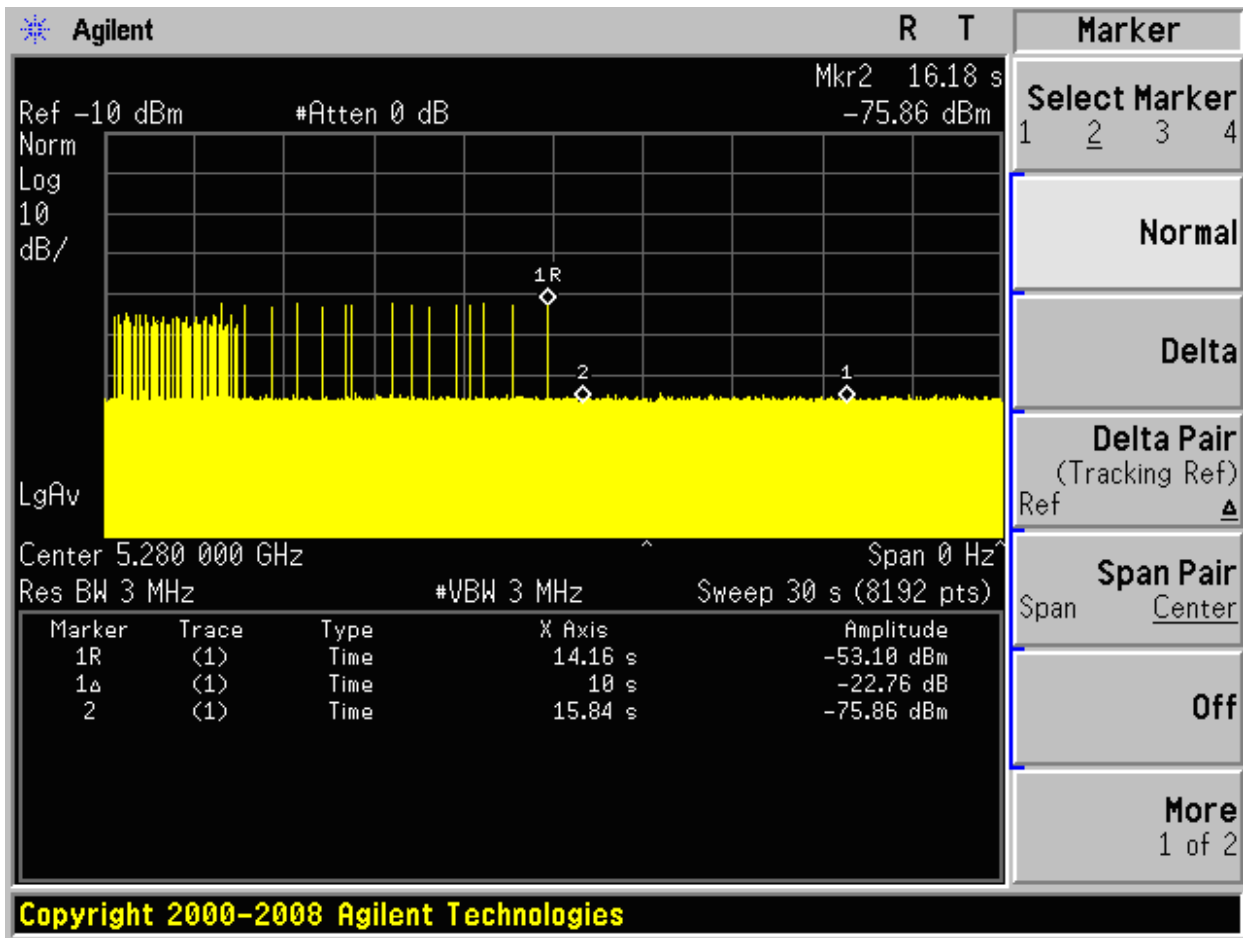

NOTE:

Dwell is the dwell time per spectrum analyzer sampling bin.

S is the sweep time

B is the number of spectrum analyzer sampling bins

C is the intermittent control signals of Channel Closing Transmission Time

N is the number of spectrum analyzer sampling bins (intermittent control signals) showing a U-NII transmission

$$\text{Dwell} = S (30000) / B(8192)$$

$$C = N(0) \times \text{Dwell}$$

$$C = 0 \times 3.662 = 0 \text{ ms}$$



Type 5 Channel Closing Transmission Time Results (20 MHz)

5500MHz

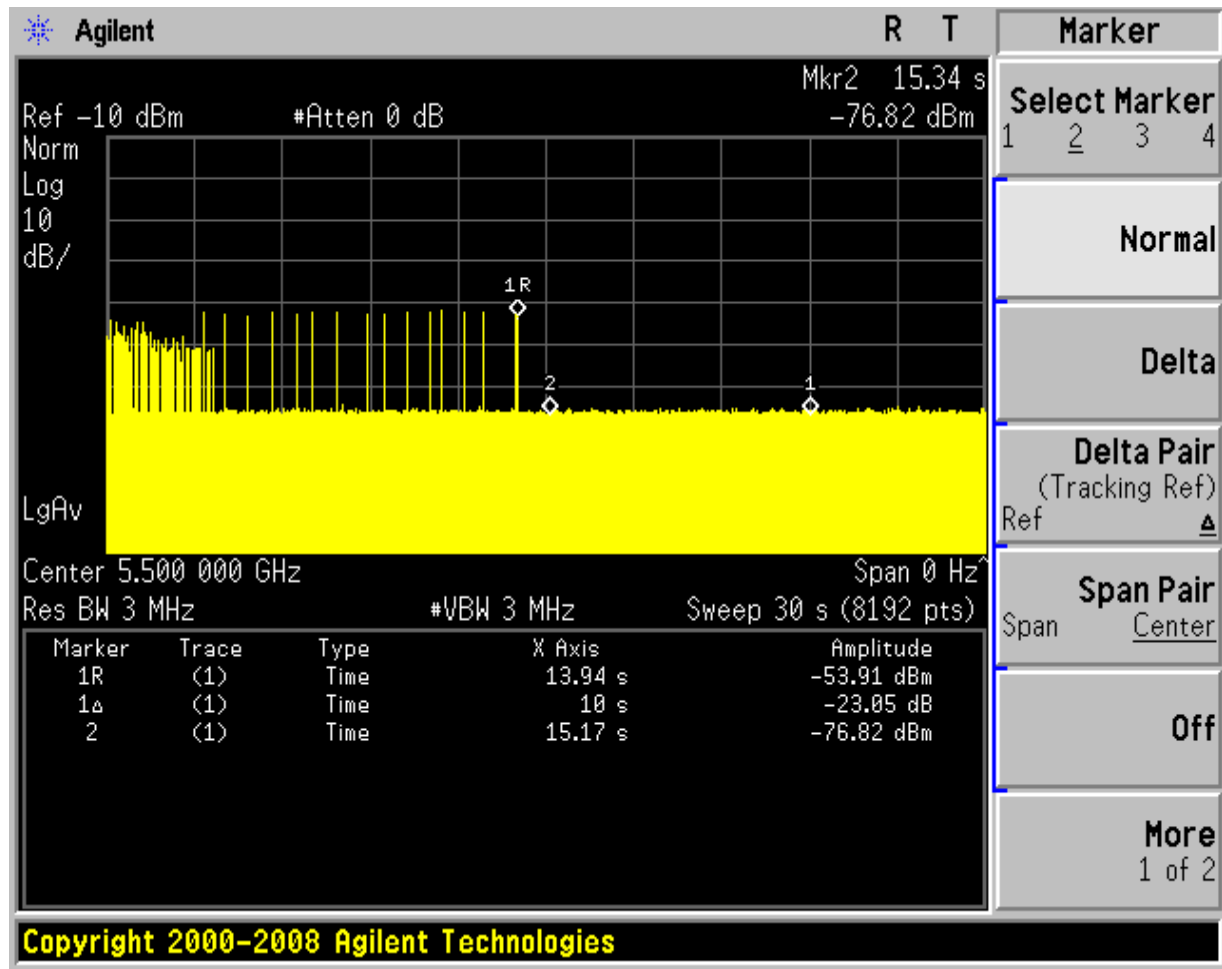

NOTE:

Dwell is the dwell time per spectrum analyzer sampling bin.

S is the sweep time

B is the number of spectrum analyzer sampling bins

C is the intermittent control signals of Channel Closing Transmission Time

N is the number of spectrum analyzer sampling bins (intermittent control signals) showing a U-NII transmission

$$\text{Dwell} = S (30000) / B(8192)$$

$$C = N(0) \times \text{Dwell}$$

$$C = 0 \times 3.662 = 0 \text{ ms}$$



Type 5 Channel Closing Transmission Time Results (40 MHz)

5270MHz

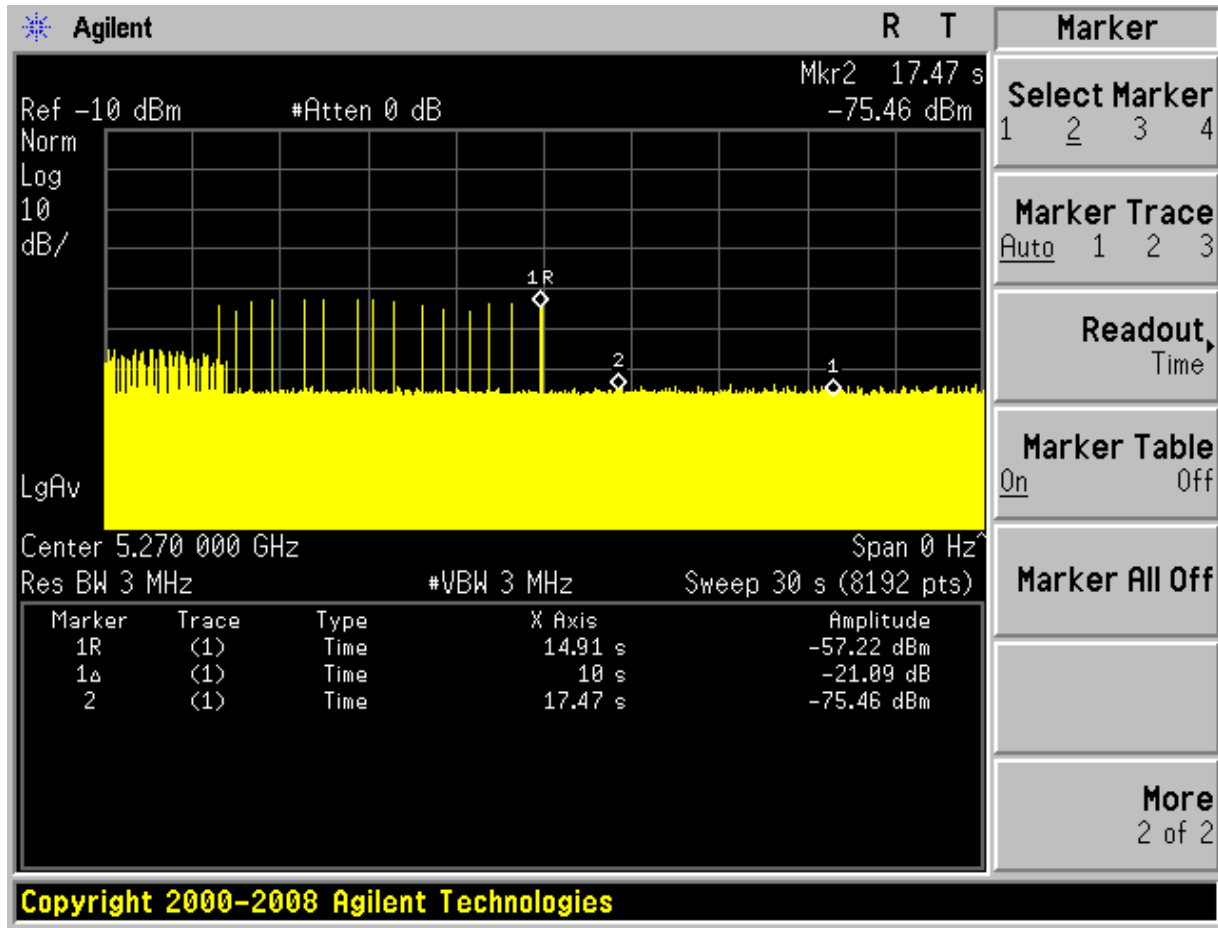

NOTE:

Dwell is the dwell time per spectrum analyzer sampling bin.

S is the sweep time

B is the number of spectrum analyzer sampling bins

C is the intermittent control signals of Channel Closing Transmission Time

N is the number of spectrum analyzer sampling bins (intermittent control signals) showing a U-NII transmission

transmission

$$\text{Dwell} = S (30000) / B(8192)$$

$$C = N(0) \times \text{Dwell}$$

$$C = 0 \times 3.662 = 0 \text{ ms}$$



Type 5 Channel Closing Transmission Time Results (40 MHz)

5510MHz

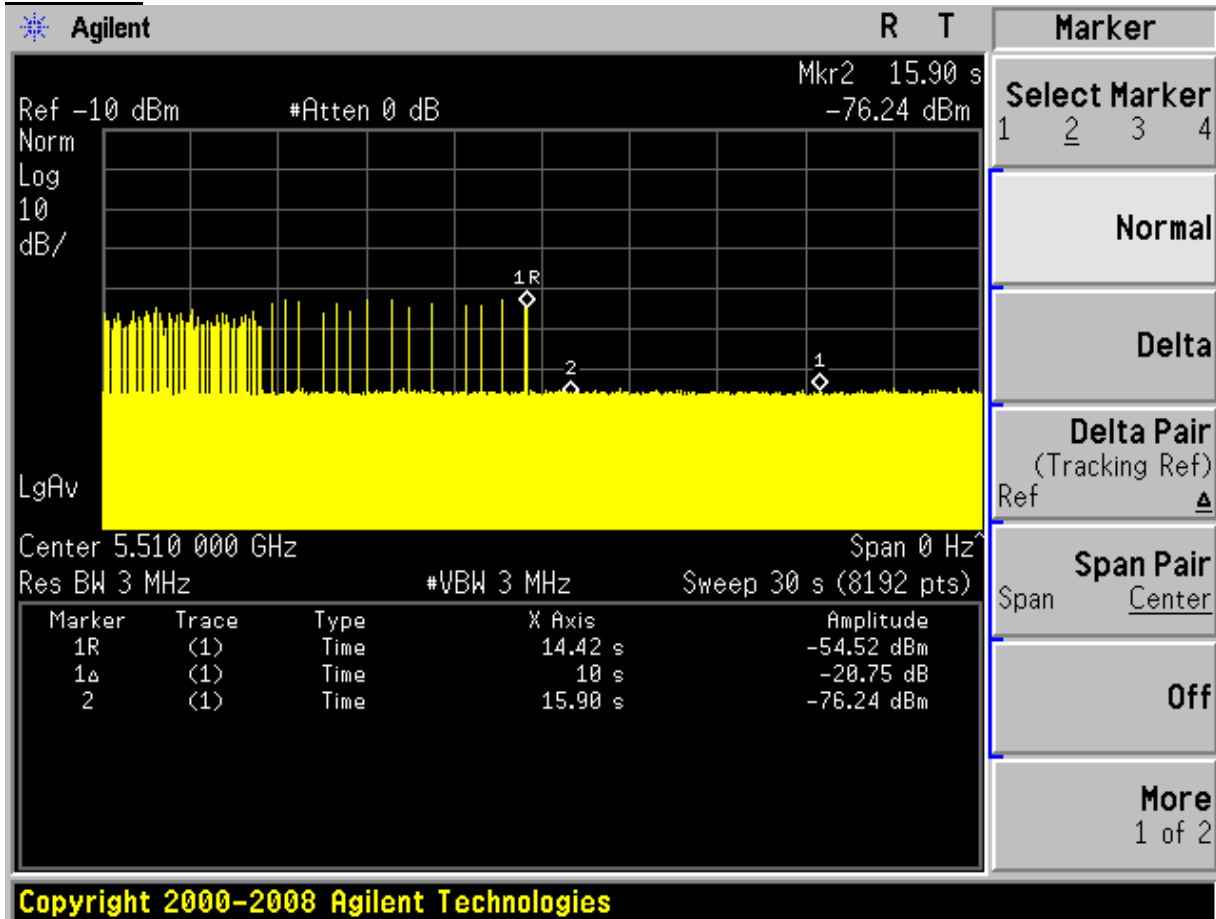

NOTE:

Dwell is the dwell time per spectrum analyzer sampling bin.

S is the sweep time

B is the number of spectrum analyzer sampling bins

C is the intermittent control signals of Channel Closing Transmission Time

N is the number of spectrum analyzer sampling bins (intermittent control signals) showing a U-NII transmission

transmission

$$\text{Dwell} = S (30000) / B(8192)$$

$$C = N(0) \times \text{Dwell}$$

$$C = 0 \times 3.662 = 0 \text{ ms}$$



Closing Transmission Time Results

Frequency (MHz)	Bandwidth (MHz)	Radar Type	Test Results	Limit	Results
5280	20	Type 5	0	60ms	Compliance
		Type 1	3.745	60ms	Compliance
5500	20	Type 5	0	60ms	Compliance
		Type 1	2.996	60ms	Compliance
5270	40	Type 5	0	60ms	Compliance
		Type 1	2.996	60ms	Compliance
5510	40	Type 5	0	60ms	Compliance
		Type 1	3.745	60ms	Compliance



NON-OCCUPANCY PERIOD

TEST PROCEDURE

Measure the EUT for more than 30 minutes following the channel close/move time to verify that the EUT does not resume transmission on this channel. Provide on plot to demonstrate on the channel for the non-occupancy period (30 minutes observation time)

TEST RESULTS

Frequency (MHz)	Bandwidth (MHz)	Spectrum Analyzer Display
5270	40	No transmission within 30 minutes
5510	40	No transmission within 30 minutes

Radar Type 1 Non-Occupancy Period Test Results

No non-compliance noted: No EUT transmissions were observed on the test channel during the 30 minute observation time.

5270MHz

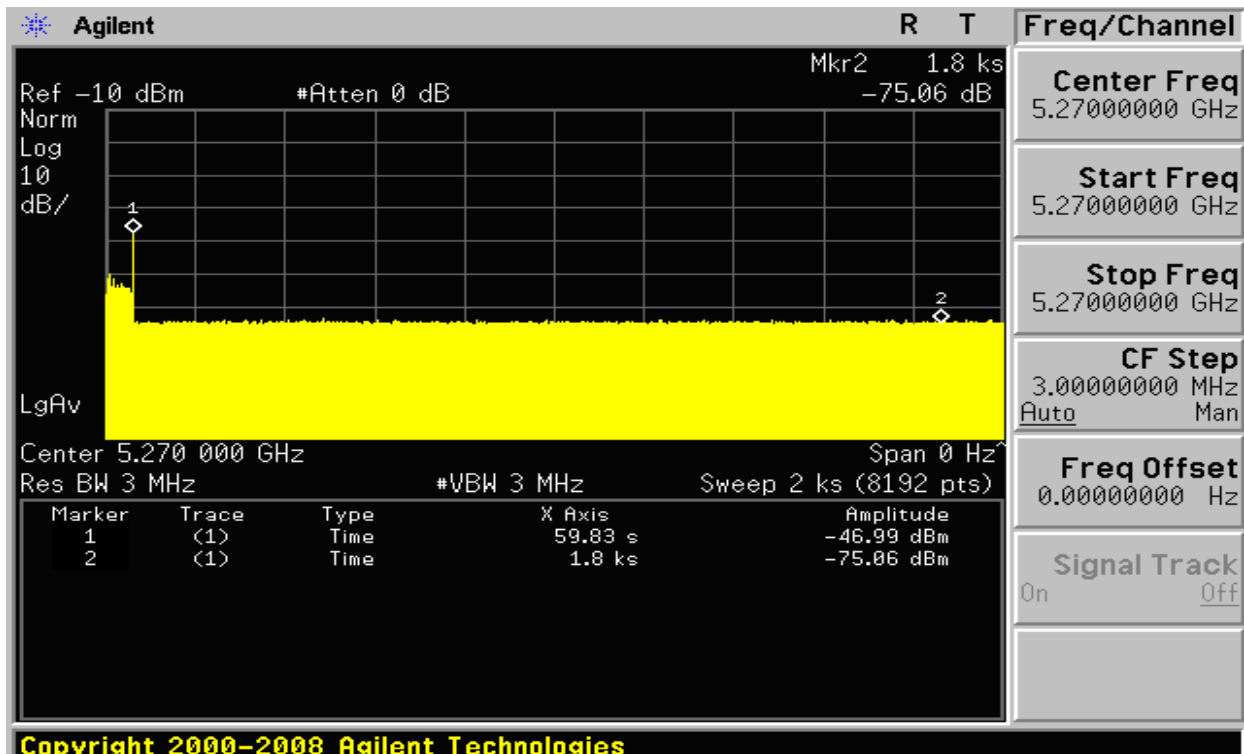



Compliance Certification Services Inc.

Report No: C131118R01-RPB

FCC ID: WBV-HIVEAP1X1

Date of Issue :Nov 19, 2013

IC: 7774A-HIVEAP1X1

5510MHz

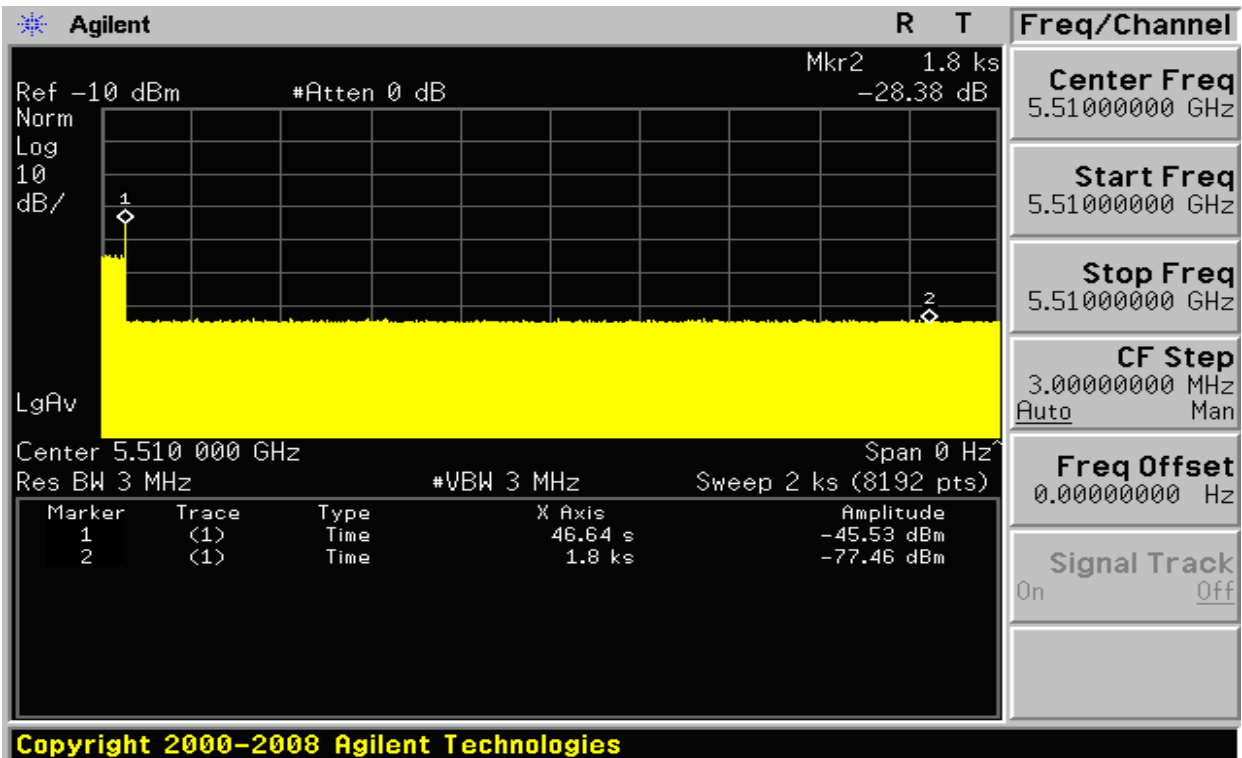



DETECTION BANDWIDTH

TEST PROCEDURE

Performed with any one of the short pulse radar waveforms (type 1, 2, 3 or 4)

Start with radar generator frequency set to the center of the channel (Fc)

Perform at least 10 trials and confirm at least 90% detected

Increment radar generator frequency by 1 MHz and repeat

Perform at least 10 trials and confirm at least 90% detected

Continue incrementing the radar frequency until detection rate falls below 90%

Starting at Fc - 1 MHz, repeat the process, this time decrementing the radar frequency by 1 MHz

FL is the lowest frequency at which detection was 80% or better

FH is the highest frequency at which detection was 80% or better

UNII Detection Bandwidth = FH - FL

Result

Frequency (MHz)	Detection Bandwidth (MHz)	FL (MHz)	FH (MHz)	Minimum Limit	Results
5280	20	5270	5290	80%	pass
5500	20	5490	5510	80%	pass
5270	40	5250	5290	80%	pass
5510	40	5490	5530	80%	pass



Compliance Certification Services Inc.

Report No: C131118R01-RPB

FCC ID: WBV-HIVEAP1X1

Date of Issue :Nov 19, 2013

IC: 7774A-HIVEAP1X1

Test Result for UNII Detection Bandwidth

For 40MHz / 5270 MHz

EUT Frequency=5270MHz											
Radar Frequency (MHz)	DFS Detection Trials (1=Detection, 0= No Detection)										Detection Rate (%)
	<u>1</u>	<u>2</u>	<u>3</u>	<u>4</u>	<u>5</u>	<u>6</u>	<u>7</u>	<u>8</u>	<u>9</u>	<u>10</u>	
5249	1	1	1	1	0	1	1	1	1	1	90%
5250(FL)	1	1	1	1	1	1	1	1	1	1	100%
5251	1	1	1	1	1	1	1	1	1	1	100%
5252	1	1	1	1	1	1	1	1	1	1	100%
5253	1	1	1	1	1	1	1	1	1	1	100%
5254	1	1	1	1	1	1	1	1	1	1	100%
5255	1	1	1	1	1	1	1	1	1	1	100%
5256	1	1	1	1	1	1	1	1	1	1	100%
5257	1	1	1	1	1	1	1	1	1	1	100%
5258	1	1	1	1	1	1	1	1	1	1	100%
5259	1	1	1	1	1	1	1	1	1	1	100%
5260	1	1	1	1	1	1	1	1	1	1	100%
5261	1	1	1	1	1	1	1	1	1	1	100%
5262	1	1	1	1	1	1	1	1	1	1	100%
5263	1	1	1	1	1	1	1	1	1	1	100%
5264	1	1	1	1	1	1	1	1	1	1	100%
5265	1	1	1	1	1	1	1	1	1	1	100%
5266	1	1	1	1	1	1	1	1	1	1	100%
5267	1	1	1	1	1	1	1	1	1	1	100%
5268	1	1	1	1	1	1	1	1	1	1	100%



Compliance Certification Services Inc.

Report No: C131118R01-RPB

FCC ID: WBV-HIVEAP1X1

Date of Issue :Nov 19, 2013

IC: 7774A-HIVEAP1X1

5269	1	1	1	1	1	1	1	1	1	1	100%
5270(FC)	1	1	1	1	1	1	1	1	1	1	100%
5271	1	1	1	1	1	1	1	1	1	1	100%
5272	1	1	1	1	1	1	1	1	1	1	100%
5273	1	1	1	1	1	1	1	1	1	1	100%
5274	1	1	1	1	1	1	1	1	1	1	100%
5275	1	1	1	1	1	1	1	1	1	1	100%
5276	1	1	1	1	1	1	1	1	1	1	100%
5277	1	1	1	1	1	1	1	1	1	1	100%
5278	1	1	1	1	1	1	1	1	1	1	100%
5279	1	1	1	1	1	1	1	1	1	1	100%
5280	1	1	1	1	1	1	1	1	1	1	100%
5281	1	1	1	1	1	1	1	1	1	1	100%
5282	1	1	1	1	1	1	1	1	1	1	100%
5283	1	1	1	1	1	1	1	1	1	1	100%
5284	1	1	1	1	1	1	1	1	1	1	100%
5285	1	1	1	1	1	1	1	1	1	1	100%
5286	1	1	1	1	1	1	1	1	1	1	100%
5287	1	1	1	1	1	1	1	1	1	1	100%
5288	1	1	1	1	1	1	1	1	1	1	100%
5289	1	1	1	1	1	1	1	1	1	1	100%
5290(FH)	1	1	1	1	1	1	1	1	1	1	100%
5291	1	1	1	1	0	1	1	1	1	1	90%
Detection Bandwidth = FH-FL = 5290MHz-5250MHz = 40MHz											
EUT 99% Bandwidth = 36MHz (see note)											
UNII Detection Bandwidth Min. Limit (MHz): 40MHz x 80% = 32MHz											



Compliance Certification Services Inc.

Report No: C131118R01-RPB

FCC ID: WBV-HIVEAP1X1

Date of Issue :Nov 19, 2013

IC: 7774A-HIVEAP1X1

Note: All UNII channels for this device have identical Channel bandwidths. Therefore, all DFS

testing was done at 5270 MHz. The 99% channel bandwidth is 36MHz. (See the 99% BW section of the RF report for further measurement details).

Agilent

R T

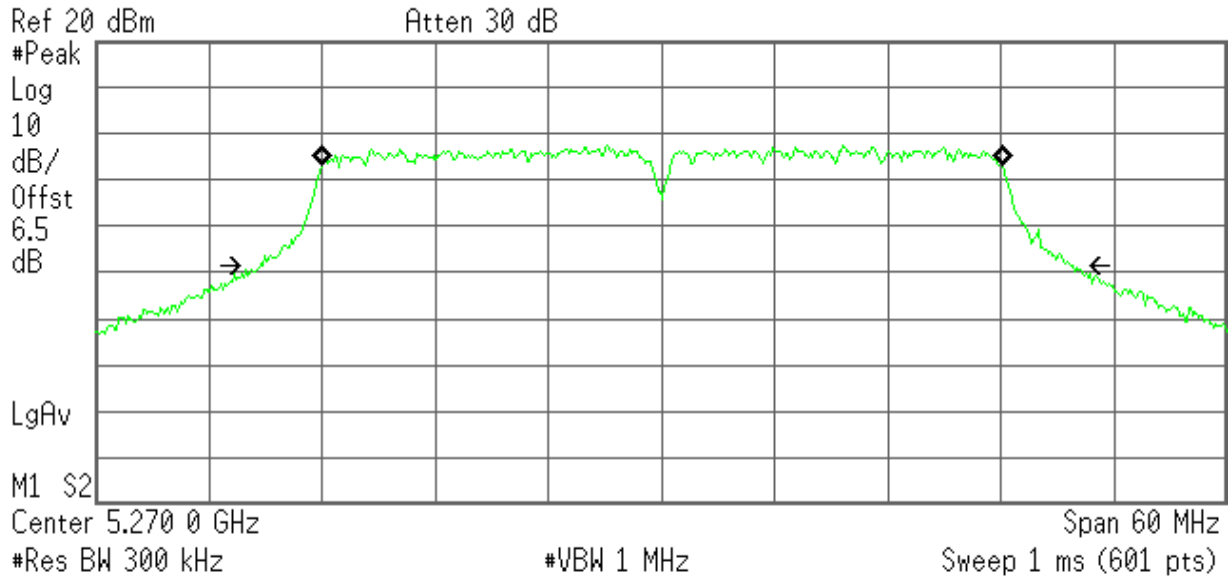

Occupied Bandwidth
36.1379 MHz

Occ BW % Pwr 99.00 %
x dB -26.00 dB

Transmit Freq Error 44.545 kHz
x dB Bandwidth 42.931 MHz



Compliance Certification Services Inc.

Report No: C131118R01-RPB

FCC ID: WBV-HIVEAP1X1

Date of Issue :Nov 19, 2013

IC: 7774A-HIVEAP1X1

Test Result for UNII Detection Bandwidth

For 40MHz / 5510 MHz

EUT Frequency=5510MHz											
Radar Frequency (MHz)	DFS Detection Trials (1=Detection, 0= No Detection)										Detection Rate (%)
	<u>1</u>	<u>2</u>	<u>3</u>	<u>4</u>	<u>5</u>	<u>6</u>	<u>7</u>	<u>8</u>	<u>9</u>	<u>10</u>	
5489	1	1	1	1	0	1	1	1	1	1	90%
5490(FL)	1	1	1	1	1	1	1	1	1	1	100%
5491	1	1	1	1	1	1	1	1	1	1	100%
5492	1	1	1	1	1	1	1	1	1	1	100%
5493	1	1	1	1	1	1	1	1	1	1	100%
5494	1	1	1	1	1	1	1	1	1	1	100%
5495	1	1	1	1	1	1	1	1	1	1	100%
5496	1	1	1	1	1	1	1	1	1	1	100%
5497	1	1	1	1	1	1	1	1	1	1	100%
5498	1	1	1	1	1	1	1	1	1	1	100%
5499	1	1	1	1	1	1	1	1	1	1	100%
5500	1	1	1	1	1	1	1	1	1	1	100%
5501	1	1	1	1	1	1	1	1	1	1	100%
5502	1	1	1	1	1	1	1	1	1	1	100%
5503	1	1	1	1	1	1	1	1	1	1	100%
5504	1	1	1	1	1	1	1	1	1	1	100%
5505	1	1	1	1	1	1	1	1	1	1	100%
5506	1	1	1	1	1	1	1	1	1	1	100%
5507	1	1	1	1	1	1	1	1	1	1	100%
5508	1	1	1	1	1	1	1	1	1	1	100%



Compliance Certification Services Inc.

Report No: C131118R01-RPB

FCC ID: WBV-HIVEAP1X1

Date of Issue :Nov 19, 2013

IC: 7774A-HIVEAP1X1

5509	1	1	1	1	1	1	1	1	1	1	100%
5510(FC)	1	1	1	1	1	1	1	1	1	1	100%
5511	1	1	1	1	1	1	1	1	1	1	100%
5512	1	1	1	1	1	1	1	1	1	1	100%
5513	1	1	1	1	1	1	1	1	1	1	100%
5514	1	1	1	1	1	1	1	1	1	1	100%
5515	1	1	1	1	1	1	1	1	1	1	100%
5516	1	1	1	1	1	1	1	1	1	1	100%
5517	1	1	1	1	1	1	1	1	1	1	100%
5518	1	1	1	1	1	1	1	1	1	1	100%
5519	1	1	1	1	1	1	1	1	1	1	100%
5520	1	1	1	1	1	1	1	1	1	1	100%
5521	1	1	1	1	1	1	1	1	1	1	100%
5522	1	1	1	1	1	1	1	1	1	1	100%
5523	1	1	1	1	1	1	1	1	1	1	100%
5524	1	1	1	1	1	1	1	1	1	1	100%
5525	1	1	1	1	1	1	1	1	1	1	100%
5526	1	1	1	1	1	1	1	1	1	1	100%
5527	1	1	1	1	1	1	1	1	1	1	100%
5528	1	1	1	1	1	1	1	1	1	1	100%
5529	1	1	1	1	1	1	1	1	1	1	100%
5530(FH)	1	1	1	1	1	1	1	1	1	1	100%
5531	1	1	1	1	1	1	1	1	1	0	90%
Detection Bandwidth = FH-FL = 5530MHz-5490MHz = 40MHz											
EUT 99% Bandwidth = 36MHz (see note)											
UNII Detection Bandwidth Min. Limit (MHz): 40MHz x 80% = 32MHz											



Compliance Certification Services Inc.

Report No: C131118R01-RPB

FCC ID: WBV-HIVEAP1X1

Date of Issue :Nov 19, 2013

IC: 7774A-HIVEAP1X1

Note: All UNII channels for this device have identical Channel bandwidths. Therefore, all DFS

testing was done at 5270 MHz. The 99% channel bandwidth is 36MHz. (See the 99% BW section of the RF report for further measurement details).

Agilent

R T

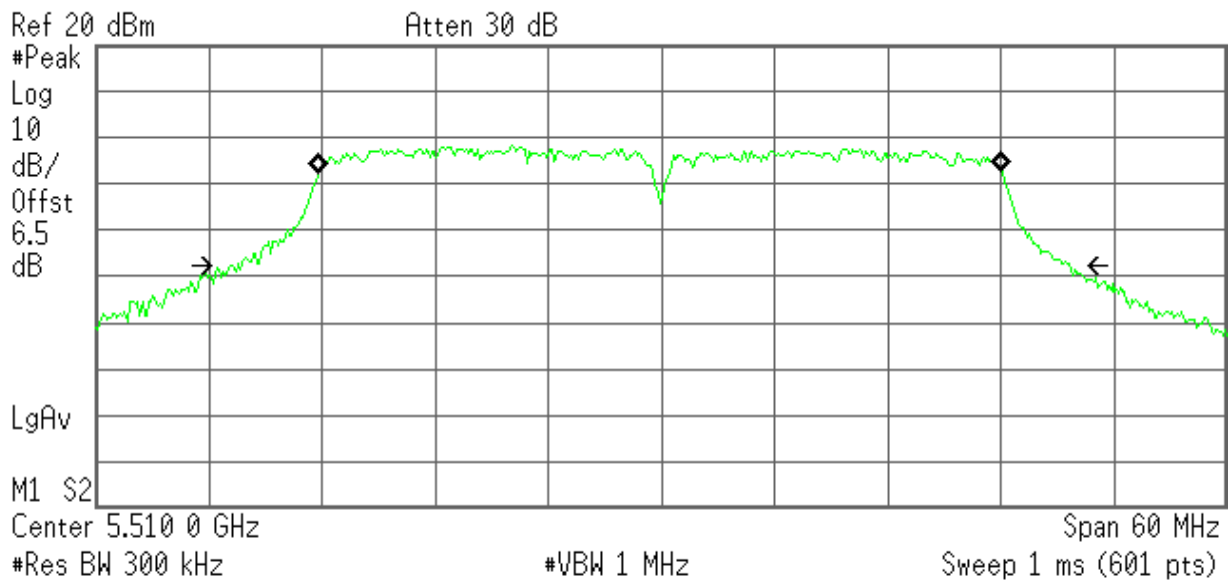

Occupied Bandwidth
36.2070 MHz

Occ BW % Pwr 99.00 %
x dB -26.00 dB

Transmit Freq Error -90.030 kHz
x dB Bandwidth 44.464 MHz



Compliance Certification Services Inc.

Report No: C131118R01-RPB

FCC ID: WBV-HIVEAP1X1

Date of Issue :Nov 19, 2013

IC: 7774A-HIVEAP1X1

Test Result for UNII Detection Bandwidth

For 20MHz / 5280 MHz

EUT Frequency=5280MHz											
Radar Frequency (MHz)	DFS Detection Trials (1=Detection, 0= No Detection)										Detection Rate (%)
	<u>1</u>	<u>2</u>	<u>3</u>	<u>4</u>	<u>5</u>	<u>6</u>	<u>7</u>	<u>8</u>	<u>9</u>	<u>10</u>	
5269	1	1	1	1	1	1	0	1	1	1	90%
5270(FL)	1	1	1	1	1	1	1	1	1	1	100%
5271	1	1	1	1	1	1	1	1	1	1	100%
5272	1	1	1	1	1	1	1	1	1	1	100%
5273	1	1	1	1	1	1	1	1	1	1	100%
5274	1	1	1	1	1	1	1	1	1	1	100%
5275	1	1	1	1	1	1	1	1	1	1	100%
5276	1	1	1	1	1	1	1	1	1	1	100%
5277	1	1	1	1	1	1	1	1	1	1	100%
5278	1	1	1	1	1	1	1	1	1	1	100%
5279	1	1	1	1	1	1	1	1	1	1	100%
5280(FC)	1	1	1	1	1	1	1	1	1	1	100%
5281	1	1	1	1	1	1	1	1	1	1	100%
5282	1	1	1	1	1	1	1	1	1	1	100%
5283	1	1	1	1	1	1	1	1	1	1	100%
5284	1	1	1	1	1	1	1	1	1	1	100%
5285	1	1	1	1	1	1	1	1	1	1	100%
5286	1	1	1	1	1	1	1	1	1	1	100%
5287	1	1	1	1	1	1	1	1	1	1	100%
5288	1	1	1	1	1	1	1	1	1	1	100%



Compliance Certification Services Inc.

Report No: C131118R01-RPB

FCC ID: WBV-HIVEAP1X1

Date of Issue :Nov 19, 2013

IC: 7774A-HIVEAP1X1

5289	1	1	1	1	1	1	1	1	1	1	100%
5290(FH)	1	1	1	1	1	1	1	1	1	1	100%
5291	0	1	1	1	1	1	1	1	1	1	90%
Detection Bandwidth = FH-FL = 5290MHz-5270MHz = 20MHz											
EUT 99% Bandwidth = 18MHz (see note)											
UNII Detection Bandwidth Min. Limit (MHz): 20MHz x 80% = 16MHz											

Note: All UNII channels for this device have identical Channel bandwidths. Therefore, all DFS

testing was done at 5270 MHz. The 99% channel bandwidth is 18MHz. (See the 99% BW section of the RF report for further measurement details).

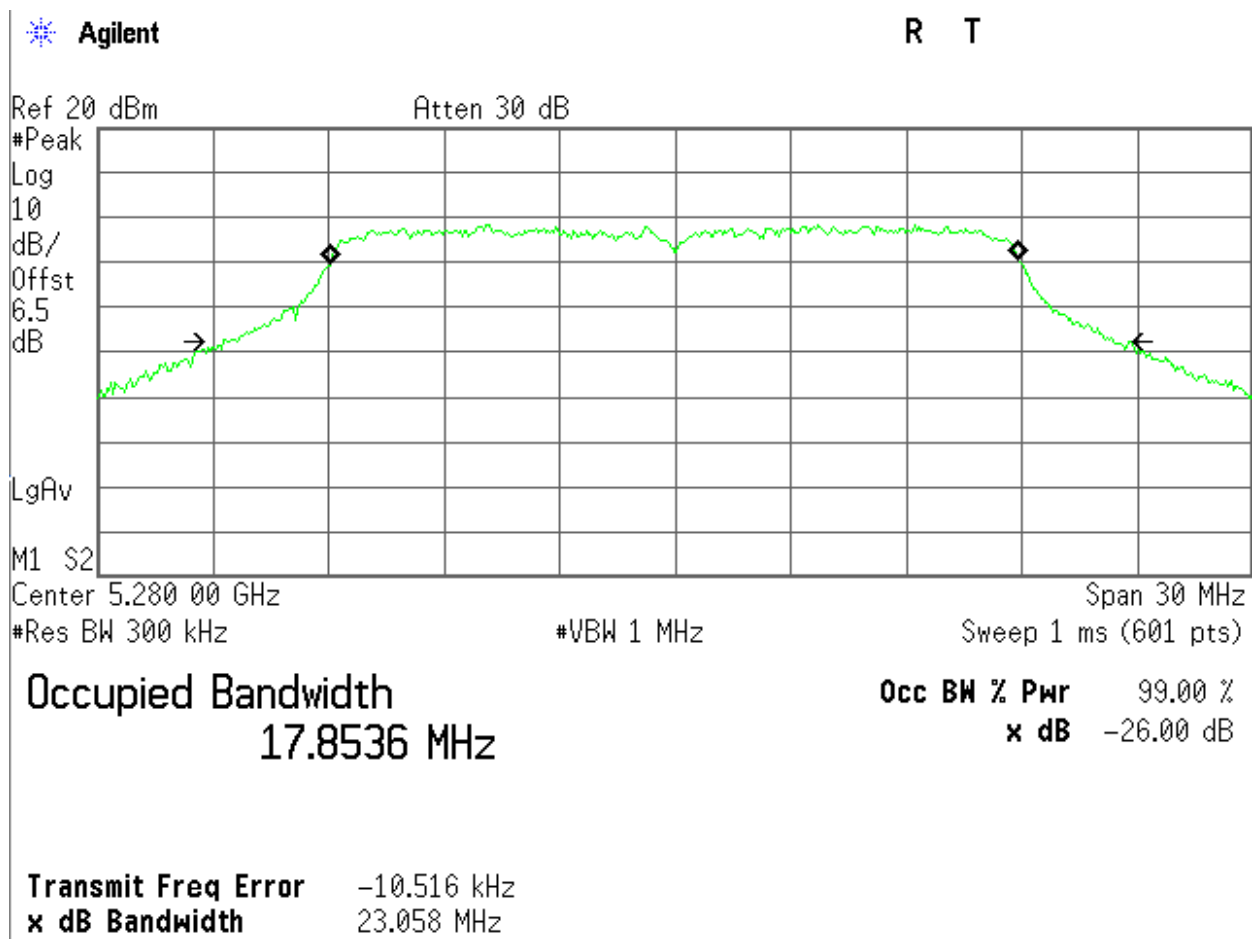



Compliance Certification Services Inc.

Report No: C131118R01-RPB

FCC ID: WBV-HIVEAP1X1

Date of Issue :Nov 19, 2013

IC: 7774A-HIVEAP1X1

Test Result for UNII Detection Bandwidth

For 20MHz / 5500 MHz

EUT Frequency=5500MHz											
Radar Frequency (MHz)	DFS Detection Trials (1=Detection, 0= No Detection)										Detection Rate (%)
	<u>1</u>	<u>2</u>	<u>3</u>	<u>4</u>	<u>5</u>	<u>6</u>	<u>7</u>	<u>8</u>	<u>9</u>	<u>10</u>	
5489	1	1	1	1	1	1	1	1	1	1	100%
5490(FL)	1	1	1	1	1	1	1	1	1	1	100%
5491	1	1	1	1	1	1	1	1	1	1	100%
5492	1	1	1	1	1	1	1	1	1	1	100%
5493	1	1	1	1	1	1	1	1	1	1	100%
5494	1	1	1	1	1	1	1	1	1	1	100%
5495	1	1	1	1	1	1	1	1	1	1	100%
5496	1	1	1	1	1	1	1	1	1	1	100%
5497	1	1	1	1	1	1	1	1	1	1	100%
5498	1	1	1	1	1	1	1	1	1	1	100%
5499	1	1	1	1	1	1	1	1	1	1	100%
5500(FC)	1	1	1	1	1	1	1	1	1	1	100%
5501	1	1	1	1	1	1	1	1	1	1	100%
5502	1	1	1	1	1	1	1	1	1	1	100%
5503	1	1	1	1	1	1	1	1	1	1	100%
5504	1	1	1	1	1	1	1	1	1	1	100%
5505	1	1	1	1	1	1	1	1	1	1	100%
5506	1	1	1	1	1	1	1	1	1	1	100%
5507	1	1	1	1	1	1	1	1	1	1	100%
5508	1	1	1	1	1	1	1	1	1	1	100%



Compliance Certification Services Inc.

Report No: C131118R01-RPB

FCC ID: WBV-HIVEAP1X1

Date of Issue :Nov 19, 2013

IC: 7774A-HIVEAP1X1

5509	1	1	1	1	1	1	1	1	1	1	100%
5510(FH)	1	1	1	1	1	1	1	1	1	1	100%
5511	1	1	1	1	1	1	1	1	1	0	90%
Detection Bandwidth = FH-FL = 5510MHz-5490MHz = 20MHz											
EUT 99% Bandwidth = 18MHz (see note)											
UNII Detection Bandwidth Min. Limit (MHz): 20MHz x 80% = 16MHz											

Note: All UNII channels for this device have identical Channel bandwidths. Therefore, all DFS

testing was done at 5270 MHz. The 99% channel bandwidth is 18MHz. (See the 99% BW section of the RF report for further measurement details).

Agilent

R T

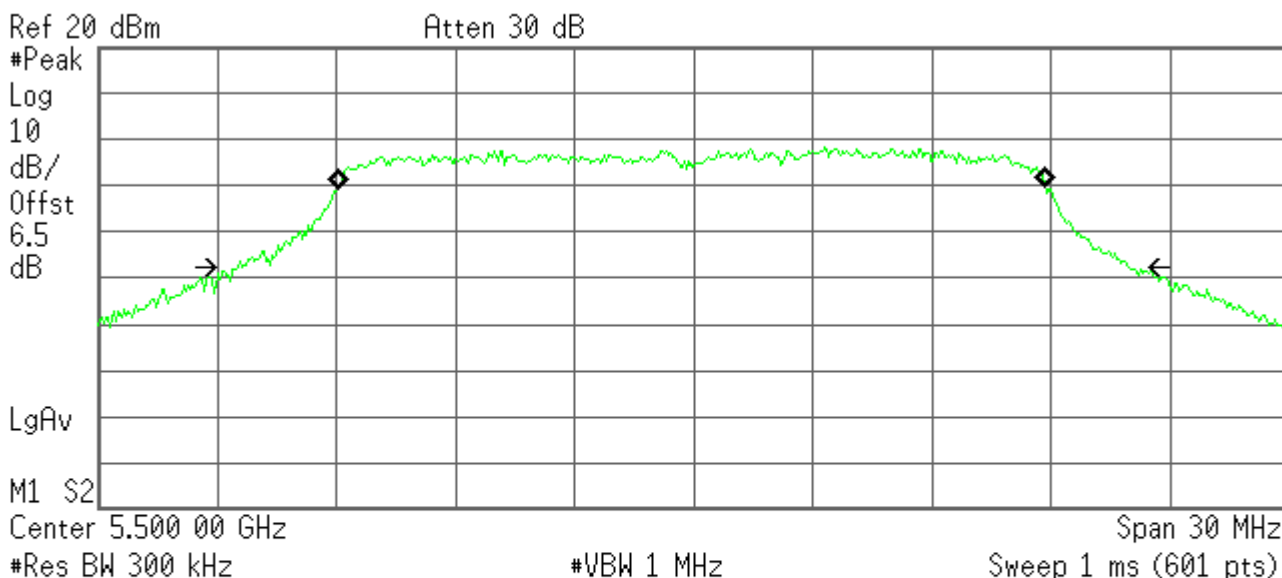

Occupied Bandwidth
17.7854 MHz

Occ BW % Pwr 99.00 %
x dB -26.00 dB

Transmit Freq Error -33.896 kHz
x dB Bandwidth 22.425 MHz



RADAR DETECTION

TEST PROCEDURE

Stream MPEG file from master to slave

Generate radar waveform

Record whether or not the waveform was detected

At least 30 trials are applied for each radar type

For radar types with randomized parameters, each trial uses a unique waveform

Perform with each of the radar types 1-6

Confirm that the detection rate for each radar type meets the minimum requirement

Type 1, 2, 3, 4: 60% each

Type 5: 80%

Type 6: 70%

Confirm that the mean of the rates for radar types 1 through 4 meets the requirement of 80%

Detection Ratio = (TotalWaveformDetections/TotalWaveformTrails)*100

Radar Type	Number of Trials	Detection (%)	Limit (%)	Pass / Fail
Short 1	30	100.00	60	Pass
Short 2	30	100.00	60	Pass
Short 3	30	90.00	60	Pass
Short 4	30	90.00	60	Pass
Aggregate of 1 to 4	30	95.00	80	Pass
Long 5	30	100.00	70	Pass
Hopping 6	30	100.00	80	Pass

Please refer to the following statistical tables:



Compliance Certification Services Inc.

Report No: C131118R01-RPB

FCC ID: WBV-HIVEAP1X1

Date of Issue :Nov 19, 2013

IC: 7774A-HIVEAP1X1

Radars Type 1 Statistical Performance Test Result For 40MHz

Trail #	Test Freq. (MHz)	Pulse Width (us)	PRI (us)	Pulses / Burst	1=Detection 0=No
1	5510	1	1428	18	1
2	5510	1	1428	18	1
3	5510	1	1428	18	1
4	5510	1	1428	18	1
5	5510	1	1428	18	1
6	5510	1	1428	18	1
7	5510	1	1428	18	1
8	5510	1	1428	18	1
9	5510	1	1428	18	1
10	5510	1	1428	18	1
11	5510	1	1428	18	1
12	5510	1	1428	18	1
13	5510	1	1428	18	1
14	5510	1	1428	18	1
15	5510	1	1428	18	1
16	5510	1	1428	18	1
17	5510	1	1428	18	1
18	5510	1	1428	18	1
19	5510	1	1428	18	1
20	5510	1	1428	18	1
21	5510	1	1428	18	1
22	5510	1	1428	18	1
23	5510	1	1428	18	1
24	5510	1	1428	18	1
25	5510	1	1428	18	1
26	5510	1	1428	18	1
27	5510	1	1428	18	1
28	5510	1	1428	18	1
29	5510	1	1428	18	1
30	5510	1	1428	18	1
Detection Percentage (%)					100%



Compliance Certification Services Inc.

Report No: C131118R01-RPB

FCC ID: WBV-HIVEAP1X1

Date of Issue :Nov 19, 2013

IC: 7774A-HIVEAP1X1

Radar Type 2 Statistical Performance Test Result For 40MHz

Trail #	Test Freq. (MHz)	Pulse Width (us)	PRI (us)	Pulses / Burst	1=Detection 0=No
1	5510	3.2	162	24	1
2	5510	2.4	174	26	1
3	5510	2.2	159	25	1
4	5510	3.9	221	28	1
5	5510	1.6	205	27	1
6	5510	2.8	168	24	1
7	5510	1.5	182	26	1
8	5510	3.3	153	27	1
9	5510	4.0	155	23	1
10	5510	2.7	216	28	1
11	5510	1.8	204	25	1
12	5510	2.4	151	26	1
13	5510	3.2	180	24	1
14	5510	3.6	228	25	1
15	5510	2.5	162	24	1
16	5510	2.4	171	28	1
17	5510	1.9	215	27	1
18	5510	3.1	222	25	1
19	5510	2.9	203	26	1
20	5510	2.7	208	24	1
21	5510	3.5	166	23	1
22	5510	3.6	174	28	1
23	5510	2.4	159	24	1
24	5510	3.6	183	26	1
25	5510	3.3	194	25	1
26	5510	4.2	204	24	1
27	5510	3.3	196	26	1
28	5510	2.1	211	28	1
29	5510	1.4	221	29	1
30	5510	2.5	208	25	1
Detection Percentage (%)					100%



Compliance Certification Services Inc.

Report No: C131118R01-RPB

FCC ID: WBV-HIVEAP1X1

Date of Issue :Nov 19, 2013

IC: 7774A-HIVEAP1X1

Radar Type 3 Statistical Performance Test Result For 40MHz

Trail #	Test Freq. (MHz)	Pulse Width (us)	PRI (us)	Pulses / Burst	1=Detection 0=No
1	5510	7.2	332	17	1
2	5510	8.3	414	18	1
3	5510	7.7	258	18	1
4	5510	6.5	394	17	1
5	5510	6.9	212	18	1
6	5510	9.2	369	17	1
7	5510	8.6	414	17	0
8	5510	9.1	456	18	1
9	5510	7.7	265	18	1
10	5510	6.5	228	16	1
11	5510	7.3	269	17	1
12	5510	8.1	347	16	1
13	5510	8.6	305	17	1
14	5510	9.4	364	16	1
15	5510	8.8	298	16	0
16	5510	7.9	235	17	1
17	5510	8.3	462	16	1
18	5510	7.5	425	16	1
19	5510	9.4	359	17	1
20	5510	9.8	330	16	1
21	5510	6.9	264	18	1
22	5510	7.4	414	18	1
23	5510	7.6	469	17	1
24	5510	8.3	388	16	1
25	5510	6.8	268	17	1
26	5510	7.6	306	18	1
27	5510	9.2	462	18	1
28	5510	9.4	402	16	1
29	5510	6.8	375	18	0
30	5510	7.4	298	17	1
Detection Percentage (%)					90%



Compliance Certification Services Inc.

Report No: C131118R01-RPB

FCC ID: WBV-HIVEAP1X1

Date of Issue :Nov 19, 2013

IC: 7774A-HIVEAP1X1

Radar Type 4 Statistical Performance Test Result For 40MHz

Trail #	Test Freq. (MHz)	Pulse Width (us)	PRI (us)	Pulses / Burst	1=Detection 0=No
1	5510	12.5	262	16	1
2	5510	14.6	341	13	1
3	5510	18.2	339	14	0
4	5510	16.3	416	15	1
5	5510	14.9	339	15	1
6	5510	17.2	348	16	0
7	5510	15.4	426	12	1
8	5510	15.3	402	15	1
9	5510	17.3	314	12	1
10	5510	16.8	295	16	1
11	5510	15.2	250	16	1
12	5510	16.2	226	15	1
13	5510	18.3	316	14	1
14	5510	18.5	328	13	1
15	5510	17.6	406	14	1
16	5510	13.4	334	14	1
17	5510	14.3	351	16	1
18	5510	16.5	298	16	1
19	5510	18.1	275	15	1
20	5510	16.7	462	13	1
21	5510	15.9	427	15	1
22	5510	13.8	433	16	1
23	5510	14.4	315	12	1
24	5510	19.1	278	16	1
25	5510	13.6	305	14	1
26	5510	15.5	264	16	1
27	5510	15.3	291	12	1
28	5510	16.7	405	13	0
29	5510	13.9	339	12	1
30	5510	12.8	416	14	1
Detection Percentage (%)					90%



Compliance Certification Services Inc.

Report No: C131118R01-RPB

FCC ID: WBV-HIVEAP1X1

Date of Issue :Nov 19, 2013

IC: 7774A-HIVEAP1X1

Total Type 1~4 Radar Statistical Performance

Radar Type #	Detection Percentage (%)
1	100.00
2	100.00
3	90.00
4	90.00
Total 1~4	95.00

Radar Type5 Statistical Performance Test Result For 40MHz

Trail #	1=Detection 0=No	Trail #	1=Detection 0=No	Trail #	1=Detection 0=No
1	1	11	1	21	1
2	1	12	1	22	1
3	1	13	1	23	1
4	1	14	1	24	1
5	1	15	1	25	1
6	1	16	1	26	1
7	1	17	1	27	1
8	1	18	1	28	1
9	1	19	1	29	1
10	1	20	1	30	1
Detection Percentage (%)					100%



Compliance Certification Services Inc.

Report No: C131118R01-RPB

FCC ID: WBV-HIVEAP1X1

Date of Issue :Nov 19, 2013

IC: 7774A-HIVEAP1X1

Radar Type 6 Statistical Performance For 40MHz

Trail #	Test Freq. (MHz)	Pulse Width (us)	PRI (us)	Pulses / Burst	1=Detection 0=No
1	5510	9	1	333	1
2	5510	9	1	333	1
3	5510	9	1	333	1
4	5510	9	1	333	1
5	5510	9	1	333	1
6	5510	9	1	333	1
7	5510	9	1	333	1
8	5510	9	1	333	1
9	5510	9	1	333	1
10	5510	9	1	333	1
11	5510	9	1	333	1
12	5510	9	1	333	1
13	5510	9	1	333	1
14	5510	9	1	333	1
15	5510	9	1	333	1
16	5510	9	1	333	1
17	5510	9	1	333	1
18	5510	9	1	333	1
19	5510	9	1	333	1
20	5510	9	1	333	1
21	5510	9	1	333	1
22	5510	9	1	333	1
23	5510	9	1	333	1
24	5510	9	1	333	1
25	5510	9	1	333	1
26	5510	9	1	333	1
27	5510	9	1	333	1
28	5510	9	1	333	1
29	5510	9	1	333	1
30	5510	9	1	333	1
Detection Percentage (%)					100%



APPENDIX 1 - PHOTOGRAPHS OF EUT SETUP

