



A D T

FCC TEST REPORT (15.247)

REPORT NO.: RF110816C05

MODEL NO.: HiveAP 170

FCC ID: WBV-HIVEAP170

RECEIVED: Aug. 16, 2011

TESTED: Aug. 23 ~ 31, 2011

ISSUED: Sep. 7, 2011

APPLICANT: Aerohive Networks Inc.

ADDRESS: 330 Gibraltar Drive Sunnyvale, CA 94089 United States

ISSUED BY: Bureau Veritas Consumer Products Services (H.K.) Ltd., Taoyuan Branch

LAB LOCATION: No. 47, 14th Ling, Chia Pau Vil., Lin Kou Dist., New Taipei City 244, Taiwan

This test report consists of 153 pages in total. It may be duplicated completely for legal use with the approval of the applicant. It should not be reproduced except in full, without the written approval of our laboratory. The client should not use it to claim product endorsement by TAF or any government agencies. The test results in the report only apply to the tested sample.





A D T

TABLE OF CONTENTS

RELEASE CONTROL RECORD.....	5
1. CERTIFICATION	6
2. SUMMARY OF TEST RESULTS.....	7
2.1 MEASUREMENT UNCERTAINTY	7
3. GENERAL INFORMATION	8
3.1 GENERAL DESCRIPTION OF EUT.....	8
3.2 DESCRIPTION OF TEST MODES.....	10
3.2.1 CONFIGURATION OF SYSTEM UNDER TEST	12
3.2.2 TEST MODE APPLICABILITY AND TESTED CHANNEL DETAIL	13
3.3 GENERAL DESCRIPTION OF APPLIED STANDARDS	17
3.4 DESCRIPTION OF SUPPORT UNITS.....	17
4. TEST TYPES AND RESULTS (FOR 2.4GHz BAND).....	18
4.1 CONDUCTED EMISSION MEASUREMENT	18
4.1.1 LIMITS OF CONDUCTED EMISSION MEASUREMENT.....	18
4.1.2 TEST INSTRUMENTS	18
4.1.3 TEST PROCEDURES.....	19
4.1.4 DEVIATION FROM TEST STANDARD	19
4.1.5 TEST SETUP	20
4.1.6 EUT OPERATING CONDITIONS.....	20
4.1.7 TEST RESULTS.....	21
4.2 RADIATED EMISSION MEASUREMENT	23
4.2.1 LIMITS OF RADIATED EMISSION MEASUREMENT.....	23
4.2.2 TEST INSTRUMENTS	24
4.2.3 TEST PROCEDURES.....	25
4.2.4 DEVIATION FROM TEST STANDARD	25
4.2.5 TEST SETUP	26
4.2.6 EUT OPERATING CONDITIONS.....	26
4.2.7 TEST RESULTS.....	27
4.3 6DB BANDWIDTH MEASUREMENT	40
4.3.1 LIMITS OF 6DB BANDWIDTH MEASUREMENT	40
4.3.2 TEST INSTRUMENTS	40
4.3.3 TEST PROCEDURE	40
4.3.4 DEVIATION FROM TEST STANDARD	40
4.3.5 TEST SETUP	41
4.3.6 EUT OPERATING CONDITIONS.....	41
4.3.7 TEST RESULTS.....	42
4.4 MAXIMUM OUTPUT POWER.....	46
4.4.1 LIMITS OF MAXIMUM OUTPUT POWER MEASUREMENT.....	46
4.4.2 INSTRUMENTS	46
4.4.3 TEST PROCEDURES.....	46
4.4.4 DEVIATION FROM TEST STANDARD	47
4.4.5 TEST SETUP	47



4.4.6	EUT OPERATING CONDITIONS	47
4.4.7	TEST RESULTS	48
4.5	POWER SPECTRAL DENSITY MEASUREMENT	49
4.5.1	LIMITS OF POWER SPECTRAL DENSITY MEASUREMENT	49
4.5.2	TEST INSTRUMENTS	49
4.5.3	TEST PROCEDURE	49
4.5.4	DEVIATION FROM TEST STANDARD	50
4.5.5	TEST SETUP	50
4.5.6	EUT OPERATING CONDITION	50
4.5.7	TEST RESULTS	51
4.6	BAND EDGES MEASUREMENT	55
4.6.1	LIMITS OF BAND EDGES MEASUREMENT	55
4.6.2	TEST INSTRUMENTS	55
4.6.3	TEST PROCEDURE	56
4.6.4	DEVIATION FROM TEST STANDARD	56
4.6.5	EUT OPERATING CONDITION	56
4.6.6	TEST RESULTS	57
5.	TEST TYPES AND RESULTS (FOR 5.0GHz BAND)	93
5.1	CONDUCTED EMISSION MEASUREMENT	93
5.1.1	LIMITS OF CONDUCTED EMISSION MEASUREMENT	93
5.1.2	TEST INSTRUMENTS	93
5.1.3	TEST PROCEDURES	94
5.1.4	DEVIATION FROM TEST STANDARD	94
5.1.5	TEST SETUP	95
5.1.6	EUT OPERATING CONDITIONS	95
5.1.7	TEST RESULTS	96
5.2	RADIATED EMISSION MEASUREMENT	98
5.2.1	LIMITS OF RADIATED EMISSION MEASUREMENT	98
5.2.2	TEST INSTRUMENTS	99
5.2.3	TEST PROCEDURES	100
5.2.4	DEVIATION FROM TEST STANDARD	100
5.2.5	TEST SETUP	101
5.2.6	EUT OPERATING CONDITIONS	101
5.2.7	TEST RESULTS	102
5.3	6dB BANDWIDTH MEASUREMENT	111
5.3.1	LIMITS OF 6dB BANDWIDTH MEASUREMENT	111
5.3.2	TEST INSTRUMENTS	111
5.3.3	TEST PROCEDURE	111
5.3.4	DEVIATION FROM TEST STANDARD	112
5.3.5	TEST SETUP	112
5.3.6	EUT OPERATING CONDITIONS	112
5.3.7	TEST RESULTS	113
5.4	MAXIMUM OUTPUT POWER	116
5.4.1	LIMITS OF MAXIMUM OUTPUT POWER MEASUREMENT	116
5.4.2	INSTRUMENTS	116
5.4.3	TEST PROCEDURES	116



A D T

5.4.4	DEVIATION FROM TEST STANDARD	117
5.4.5	TEST SETUP	117
5.4.6	EUT OPERATING CONDITIONS	117
5.4.7	TEST RESULTS	118
5.5	POWER SPECTRAL DENSITY MEASUREMENT	119
5.5.1	LIMITS OF POWER SPECTRAL DENSITY MEASUREMENT	119
5.5.2	TEST INSTRUMENTS	119
5.5.3	TEST PROCEDURE	119
5.5.4	DEVIATION FROM TEST STANDARD	120
5.5.5	TEST SETUP	120
5.5.6	EUT OPERATING CONDITION	120
5.5.7	TEST RESULTS	121
5.6	BAND EDGES MEASUREMENT	124
5.6.1	LIMITS OF BAND EDGES MEASUREMENT	124
5.6.2	TEST INSTRUMENTS	124
5.6.3	TEST PROCEDURE	125
5.6.4	DEVIATION FROM TEST STANDARD	125
5.6.5	EUT OPERATING CONDITION	126
5.6.6	TEST RESULTS	126
6.	PHOTOGRAPHS OF THE TEST CONFIGURATION	151
7.	INFORMATION ON THE TESTING LABORATORIES	152
8.	APPENDIX A - MODIFICATIONS RECORDERS FOR ENGINEERING CHANGES TO THE EUT BY THE LAB	153



A D T

RELEASE CONTROL RECORD

ISSUE NO.	REASON FOR CHANGE	DATE ISSUED
RF110816C05	Original release	Sep. 7, 2011



A D T

1. CERTIFICATION

PRODUCT: Wireless Access Points
BRAND NAME: Aerohive
MODEL NO.: HiveAP 170
APPLICANT: Aerohive Networks Inc.
TEST SAMPLE: ENGINEERING SAMPLE
TESTED: Aug. 23 ~ 31, 2011
STANDARDS: FCC Part 15, Subpart C (Section 15.247)
ANSI C63.4-2003
ANSI C63.10-2009

The above equipment has been tested by **Bureau Veritas Consumer Products Services (H.K.) Ltd., Taoyuan Branch**, and found compliance with the requirement of the above standards. The test record, data evaluation & Equipment Under Test (EUT) configurations represented herein are true and accurate accounts of the measurements of the sample's EMC characteristics under the conditions specified in this report.

PREPARED BY : Annie Chang , DATE: Sep. 7, 2011
(Annie Chang / Senior Specialist)

APPROVED BY : Ken Liu , DATE: Sep. 7, 2011
(Ken Liu / Manager)



A D T

2. SUMMARY OF TEST RESULTS

The EUT has been tested according to the following specifications:

APPLIED STANDARD: FCC PART 15, SUBPART C (SECTION 15.247)			
STANDARD SECTION	TEST TYPE AND LIMIT	RESULT	REMARK
15.207	AC Power Conducted Emission	PASS	Meet the requirement of limit. Minimum passing margin is -0.03dB at 0.677MHz
15.247(a)(2)	Spectrum Bandwidth of a Direct Sequence Spread Spectrum System Limit: min. 500kHz	PASS	Meet the requirement of limit.
15.247(b)	Maximum Peak Output Power Limit: max. 30dBm	PASS	Meet the requirement of limit.
15.247(d)	Radiated Emissions Limit: Table 15.209	PASS	Meet the requirement of limit. Minimum passing margin is -0.6dB at 531.95 & 2483.50MHz
15.247(e)	Power Spectral Density Limit: max. 8dBm	PASS	Meet the requirement of limit.
15.247(d)	Band Edge Measurement Limit: 20dB less than the peak value of fundamental frequency	PASS	Meet the requirement of limit.
15.203	Antenna Requirement	PASS	Antenna connector is N-Type and is installed by Professional trained personal.

2.1 MEASUREMENT UNCERTAINTY

Where relevant, the following measurement uncertainty levels have been estimated for tests performed on the EUT as specified in CISPR 16-4-2:

This uncertainty represents an expanded uncertainty expressed at approximately the 95% confidence level using a coverage factor of $k = 2$.

MEASUREMENT	FREQUENCY	UNCERTAINTY
Conducted emissions	150kHz~30MHz	2.41 dB
Radiated emissions	30MHz ~ 1GHz	3.87 dB
	Above 1GHz	3.36 dB



A D T

3. GENERAL INFORMATION

3.1 GENERAL DESCRIPTION OF EUT

PRODUCT	Wireless Access Points
MODEL NO.	HiveAP 170
FCC ID	WBV-HIVEAP170
NOMINAL VOLTAGE	48Vdc
MODULATION TYPE	CCK, DQPSK, DBPSK for DSSS 64QAM, 16QAM, QPSK, BPSK for OFDM
MODULATION TECHNOLOGY	DSSS, OFDM
TRANSFER RATE	802.11b: 11.0/ 5.5/ 2.0/ 1.0Mbps 802.11g: 54.0/ 48.0/ 36.0/ 24.0/ 18.0/ 12.0/ 9.0/ 6.0Mbps 802.11a: 54.0/ 48.0/ 36.0/ 24.0/ 18.0/ 12.0/ 9.0/ 6.0Mbps 802.11n: up to 300.0Mbps
OPERATING FREQUENCY	2.4GHz: 2412.0 ~ 2462.0MHz 5.0GHz: 5745.0 ~ 5825.0MHz
NUMBER OF CHANNEL	2.4GHz: 11 for 802.11b, 802.11g, 802.11n (20MHz) 7 for 802.11n (40MHz) 5.0GHz: 5 for 802.11a, 802.11n (20MHz) 2 for 802.11n (40MHz)
OUTPUT POWER	719.0mW for 2412.0 ~ 2462.0MHz 779.9mW for 5745.0 ~ 5825.0MHz
ANTENNA TYPE	Dipole antenna with 5dBi gain
ANTENNA CONNECTER	N-Type connector
DATA CABLE	NA
I/O PORTS	Refer to User's manual
ACCESSORY DEVICES	NA

NOTE:

1. The EUT is a Wireless Access Points. The functions of EUT listed as below:

FUNCTION	TEST STANDARD	REFERENCE REPORT
WLAN 802.11b/g/n	FCC Part 15, Subpart C (Section 15.247)	RF110816C05
WLAN 802.11a/n (5745~5825 MHz)		
WLAN 802.11a/n (5180~ 5240MHz)	FCC Part 15, Subpart E (Section 15.407)	RF110816C05-1

2. The frequency bands used in this EUT are listed as follows:

Frequency Band (MHz)	2412~2462	5180~5240	5745~5825
802.11b	√		
802.11g	√		
802.11a		√	√
802.11n (20MHz)	√	√	√
802.11n (40MHz)	√	√	√

3. The EUT incorporates a MIMO function. Physically, the EUT provides two completed transmitters and two receivers.

MODULATION MODE	TX FUNCTION
802.11b	2TX
802.11g	2TX
802.11a	2TX
802.11n (20MHz)	2TX
802.11n (40MHz)	2TX

4. The EUT uses following POE:

POE	
BRAND	N/A
MODEL	N/A
OUTPUT POWER	48Vdc
POE's Adapter	
BRAND	MW
MODEL	ES18U48-480
INPUT POWER	100-240Vac, 50/60Hz, 0.5A
OUTPUT POWER	48Vdc, 0.375A, 18W
POEWR LINE	1.8 m non-shielded cable with one core

**POE & POE's adapter were for the optional accessories

5. The above EUT information was declared by manufacturer and for more detailed features description, please refer to the manufacturer's specifications or user's manual.



3.2 DESCRIPTION OF TEST MODES

FOR 2.4GHz:

11 channels are provided for 802.11b, 802.11g and 802.11n (20MHz):

CHANNEL	FREQUENCY	CHANNEL	FREQUENCY
1	2412MHz	7	2442MHz
2	2417MHz	8	2447MHz
3	2422MHz	9	2452MHz
4	2427MHz	10	2457MHz
5	2432MHz	11	2462MHz
6	2437MHz		

7 channels are provided for 802.11n (40MHz):

CHANNEL	FREQUENCY	CHANNEL	FREQUENCY
1	2422MHz	5	2442MHz
2	2427MHz	6	2447MHz
3	2432MHz	7	2452MHz
4	2437MHz		

FOR 5.0GHz (5745 ~ 5825MHz):

5 channels are provided for 802.11a and 802.11n (20MHz):

CHANNEL	FREQUENCY	CHANNEL	FREQUENCY
149	5745MHz	161	5805MHz
153	5765MHz	165	5825MHz
157	5785MHz		

2 channels are provided for 802.11n (40MHz):

CHANNEL	FREQUENCY	CHANNEL	FREQUENCY
151	5755MHz	159	5795MHz



Power Setting for 802.11b, 802.11g, 802.11n (20MHz), 802.11n (40MHz):

CHANNEL	POWER SETTING		
	802.11b	802.11g	802.11n (20MHz)
1	14.0	15.0	15.0
6	14.0	17.0	16.5
11	12.0	14.0	15.0

CHANNEL	POWER SETTING
	802.11n (40MHz)
1	11.5
4	17.0
7	12.0

Power Setting for 802.11a, 802.11n (20MHz), 802.11n (40MHz):

CHANNEL	POWER SETTING	
	802.11a	802.11n (20MHz)
149	20.0	20.0
157	18.5	20.0
165	18.0	20.0

CHANNEL	POWER SETTING
	802.11n (40MHz)
151	20.0
159	20.0

3.2.1 CONFIGURATION OF SYSTEM UNDER TEST

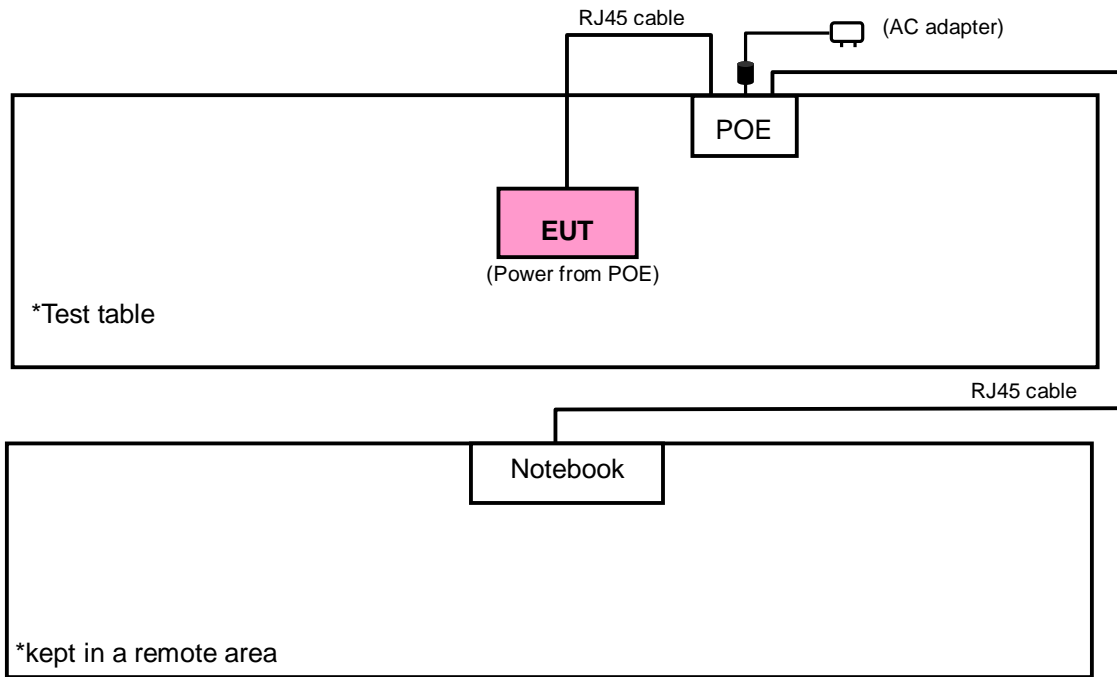



3.2.2 TEST MODE APPLICABILITY AND TESTED CHANNEL DETAIL

FOR 2.412 ~ 2.462GHz:

EUT CONFIGURE MODE	APPLICABLE TO				DESCRIPTION
	RE ³ 1G	RE<1G	PLC	APCM	
-	√	√	√	√	-

Where **RE³1G**: Radiated Emission above 1GHz **RE<1G**: Radiated Emission below 1GHz
PLC: Power Line Conducted Emission **APCM**: Antenna Port Conducted Measurement

RADIATED EMISSION TEST (ABOVE 1GHz):

- Pre-Scan has been conducted to determine the worst-case mode from all possible combinations between available modulations, data rates, XYZ Axis and antenna ports (if EUT with antenna diversity architecture).
- Following channel(s) was (were) selected for the final test as listed below.

MODE	AVAILABLE CHANNEL	TESTED CHANNEL	MODULATION TECHNOLOGY	MODULATION TYPE	DATA RATE (Mbps)	AXIS
802.11b	1 to 11	1, 6, 11	DSSS	DBPSK	1.0	X
802.11g	1 to 11	1, 6, 11	OFDM	BPSK	6.0	X
802.11n (20MHz)	1 to 11	1, 6, 11	OFDM	BPSK	13.0	X
802.11n (40MHz)	1 to 7	1, 4, 7	OFDM	BPSK	27.0	X

RADIATED EMISSION TEST (BELOW 1GHz):

- Pre-Scan has been conducted to determine the worst-case mode from all possible combinations between available modulations, data rates, XYZ Axis and antenna ports (if EUT with antenna diversity architecture).
- Following channel(s) was (were) selected for the final test as listed below.

MODE	AVAILABLE CHANNEL	TESTED CHANNEL	MODULATION TECHNOLOGY	MODULATION TYPE	DATA RATE (Mbps)	AXIS
802.11n (20MHz)	1 to 11	11	OFDM	BPSK	13.0	X

POWER LINE CONDUCTED EMISSION TEST:

- Pre-Scan has been conducted to determine the worst-case mode from all possible combinations between available modulations, data rates and antenna ports (if EUT with antenna diversity architecture).
- Following channel(s) was (were) selected for the final test as listed below.

MODE	AVAILABLE CHANNEL	TESTED CHANNEL	MODULATION TECHNOLOGY	MODULATION TYPE	DATA RATE (Mbps)
802.11n (20MHz)	1 to 11	11	OFDM	BPSK	13.0

**BANDEDGE MEASUREMENT:**

- Pre-Scan has been conducted to determine the worst-case mode from all possible combinations between available modulations, data rates and antenna ports (if EUT with antenna diversity architecture).
- Following channel(s) was (were) selected for the final test as listed below.

MODE	AVAILABLE CHANNEL	TESTED CHANNEL	MODULATION TECHNOLOGY	MODULATION TYPE	DATA RATE (Mbps)
802.11b	1 to 11	1, 11	DSSS	DBPSK	1.0
802.11g	1 to 11	1, 11	OFDM	BPSK	6.0
802.11n (20MHz)	1 to 11	1, 11	OFDM	BPSK	13.0
802.11n (40MHz)	1 to 7	1, 7	OFDM	BPSK	27.0

ANTENNA PORT CONDUCTED MEASUREMENT:

- This item includes all test value of each mode, but only includes spectrum plot of worst value of each mode.
- Pre-Scan has been conducted to determine the worst-case mode from all possible combinations between available modulations, data rates and antenna ports (if EUT with antenna diversity architecture).
- Following channel(s) was (were) selected for the final test as listed below.

MODE	AVAILABLE CHANNEL	TESTED CHANNEL	MODULATION TECHNOLOGY	MODULATION TYPE	DATA RATE (Mbps)
802.11b	1 to 11	1, 6, 11	DSSS	DBPSK	1.0
802.11g	1 to 11	1, 6, 11	OFDM	BPSK	6.0
802.11n (20MHz)	1 to 11	1, 6, 11	OFDM	BPSK	13.0
802.11n (40MHz)	1 to 7	1, 4, 7	OFDM	BPSK	27.0

TEST CONDITION:

APPLICABLE TO	ENVIRONMENTAL CONDITIONS	INPUT POWER	TESTED BY
PLC	26deg. C, 75% RH	120Vac, 60Hz	Jun Wu
RE ³ 1G	26deg. C, 70% RH	120Vac, 60Hz	Nick Chen
RE <1G	26deg. C, 70% RH	120Vac, 60Hz	Nick Chen
APCM	25deg. C, 78% RH	120Vac, 60Hz	Jun Wu



A D T

FOR 5.745 ~ 5.825GHz:

EUT CONFIGURE MODE	APPLICABLE TO				DESCRIPTION
	RE [≥] 1G	RE<1G	PLC	APCM	
-	√	√	√	√	-

Where **RE[≥]1G**: Radiated Emission above 1GHz **RE<1G**: Radiated Emission below 1GHz
PLC: Power Line Conducted Emission **APCM**: Antenna Port Conducted Measurement

RADIATED EMISSION TEST (ABOVE 1GHz):

- Pre-Scan has been conducted to determine the worst-case mode from all possible combinations between available modulations, data rates, XYZ Axis and antenna ports (if EUT with antenna diversity architecture).
- Following channel(s) was (were) selected for the final test as listed below.

MODE	AVAILABLE CHANNEL	TESTED CHANNEL	MODULATION TECHNOLOGY	MODULATION TYPE	DATA RATE (Mbps)	AXIS
802.11a	149 to 165	149, 157, 165	OFDM	BPSK	6.0	X
802.11n (20MHz)	149 to 165	149, 157, 165	OFDM	BPSK	13.0	X
802.11n (40MHz)	151 to 159	151, 159	OFDM	BPSK	27.0	X

RADIATED EMISSION TEST (BELOW 1GHz):

- Pre-Scan has been conducted to determine the worst-case mode from all possible combinations between available modulations, data rates, XYZ Axis and antenna ports (if EUT with antenna diversity architecture).
- Following channel(s) was (were) selected for the final test as listed below.

MODE	AVAILABLE CHANNEL	TESTED CHANNEL	MODULATION TECHNOLOGY	MODULATION TYPE	DATA RATE (Mbps)	AXIS
802.11a	149 to 165	149	OFDM	BPSK	6.0	X

POWER LINE CONDUCTED EMISSION TEST:

- Pre-Scan has been conducted to determine the worst-case mode from all possible combinations between available modulations, data rates and antenna ports (if EUT with antenna diversity architecture).
- Following channel(s) was (were) selected for the final test as listed below.

MODE	AVAILABLE CHANNEL	TESTED CHANNEL	MODULATION TECHNOLOGY	MODULATION TYPE	DATA RATE (Mbps)
802.11a	149 to 165	149	OFDM	BPSK	6.0



BANDEDGE MEASUREMENT:

- Pre-Scan has been conducted to determine the worst-case mode from all possible combinations between available modulations, data rates and antenna ports (if EUT with antenna diversity architecture).
- Following channel(s) was (were) selected for the final test as listed below.

MODE	AVAILABLE CHANNEL	TESTED CHANNEL	MODULATION TECHNOLOGY	MODULATION TYPE	DATA RATE (Mbps)
802.11a	149 to 165	149, 165	OFDM	BPSK	6.0
802.11n (20MHz)	149 to 165	149, 165	OFDM	BPSK	13.0
802.11n (40MHz)	151 to 159	151, 159	OFDM	BPSK	27.0

ANTENNA PORT CONDUCTED MEASUREMENT:

- This item includes all test value of each mode, but only includes spectrum plot of worst value of each mode.
- Pre-Scan has been conducted to determine the worst-case mode from all possible combinations between available modulations, data rates and antenna ports (if EUT with antenna diversity architecture).
- Following channel(s) was (were) selected for the final test as listed below.

MODE	AVAILABLE CHANNEL	TESTED CHANNEL	MODULATION TECHNOLOGY	MODULATION TYPE	DATA RATE (Mbps)
802.11a	149 to 165	149, 157, 165	OFDM	BPSK	6.0
802.11n (20MHz)	149 to 165	149, 157, 165	OFDM	BPSK	13.0
802.11n (40MHz)	151 to 159	151, 159	OFDM	BPSK	27.0

TEST CONDITION:

APPLICABLE TO	ENVIRONMENTAL CONDITIONS	INPUT POWER	TESTED BY
PLC	26deg. C, 75% RH	120Vac, 60Hz	Jun Wu
RE ³ 1G	26deg. C, 70% RH	120Vac, 60Hz	Nick Chen
RE <1G	26deg. C, 70% RH	120Vac, 60Hz	Nick Chen
APCM	25deg. C, 78% RH	120Vac, 60Hz	Chad Lee



A D T

3.3 GENERAL DESCRIPTION OF APPLIED STANDARDS

The EUT is a RF Product. According to the specifications of the manufacturer, it must comply with the requirements of the following standards:

FCC Part 15, Subpart C (15.247)

ANSI C63.4-2003

ANSI C63.10-2009

All test items have been performed and recorded as per the above standards.

3.4 DESCRIPTION OF SUPPORT UNITS

The EUT has been tested as an independent unit together with other necessary accessories or support units. The following support units or accessories were used to form a representative test configuration during the tests.

NO.	PRODUCT	BRAND	MODEL NO.	SERIAL NO.	FCC ID
1	NOTEBOOK COMPUTER	DELL	PP05L	19227741184	FCC DoC Approved
2	POE	NA	NA	NA	NA
3	ADAPTER	MW	ES18U48-480	NA	NA

NO.	SIGNAL CABLE DESCRIPTION OF THE ABOVE SUPPORT UNITS
1	N/A
2	10m RJ45 UTP cable, 1.8m RJ 45 UTP cable.
3	Input Power: 100-240Vac, 50/60Hz, 0.5A Output Power: 48Vdc, 0.375A, 18W

NOTE:

1. All power cords of the above support units are non shielded (1.8m).
2. Item 1 acted as a communication partner to transfer data.
3. Item 2-3 were provided by client.



A D T

4. TEST TYPES AND RESULTS (FOR 2.4GHz BAND)

4.1 CONDUCTED EMISSION MEASUREMENT

4.1.1 LIMITS OF CONDUCTED EMISSION MEASUREMENT

FREQUENCY OF EMISSION (MHz)	CONDUCTED LIMIT (dB μ V)	
	Quasi-peak	Average
0.15 ~ 0.5	66 to 56	56 to 46
0.5 ~ 5	56	46
5 ~ 30	60	50

- NOTE:** 1. The lower limit shall apply at the transition frequencies.
2. The limit decreases in line with the logarithm of the frequency in the range of 0.15 to 0.50MHz.
3. All emanations from a class A/B digital device or system, including any network of conductors and apparatus connected thereto, shall not exceed the level of field strengths specified above.

4.1.2 TEST INSTRUMENTS

DESCRIPTION & MANUFACTURER	MODEL NO.	SERIAL NO.	CALIBRATED DATE	CALIBRATED UNTIL
ROHDE & SCHWARZ Test Receiver	ESCS 30	100276	Dec. 31, 2010	Dec. 30, 2011
ROHDE & SCHWARZ Artificial Mains Network (for EUT)	ESH3-Z5	100219	Nov. 24, 2010	Nov. 23, 2011
LISN With Adapter (for EUT)	AD10	C10Ada-001	Nov. 24, 2010	Nov. 23, 2011
ROHDE & SCHWARZ Artificial Mains Network (for peripherals)	ESH3-Z5	100218	Nov. 24, 2010	Nov. 23, 2011
Software	ADT_Cond_V7.3.7	NA	NA	NA
Software	ADT_ISN_V7.3.7	NA	NA	NA
RF cable (JYEBAO)	5D-FB	Cable-C10.01	Feb. 22, 2011	Feb. 21, 2012
SUHNER Terminator (For ROHDE & SCHWARZ LISN)	65BNC-5001	E1-010773	Feb. 26, 2011	Feb. 25, 2012

- NOTE:** 1. The calibration interval of the above test instruments is 12 months and the calibrations are traceable to NML/ROC and NIST/USA.
2. The test was performed in Shielded Room No. 10.
3. The VCCI Site Registration No. C-1852.



A D T

4.1.3 TEST PROCEDURES

- a. The EUT was placed 0.4 meters from the conducting wall of the shielded room with EUT being connected to the power mains through a line impedance stabilization network (LISN). Other support units were connected to the power mains through another LISN. The two LISNs provide 50 ohm/ 50uH of coupling impedance for the measuring instrument.
- b. Both lines of the power mains connected to the EUT were checked for maximum conducted interference.
- c. The frequency range from 150kHz to 30MHz was searched. Emission levels under (Limit - 20dB) was not recorded.

NOTE: All modes of operation were investigated and the worst-case emissions are reported.

4.1.4 DEVIATION FROM TEST STANDARD

No deviation

4.1.5 TEST SETUP

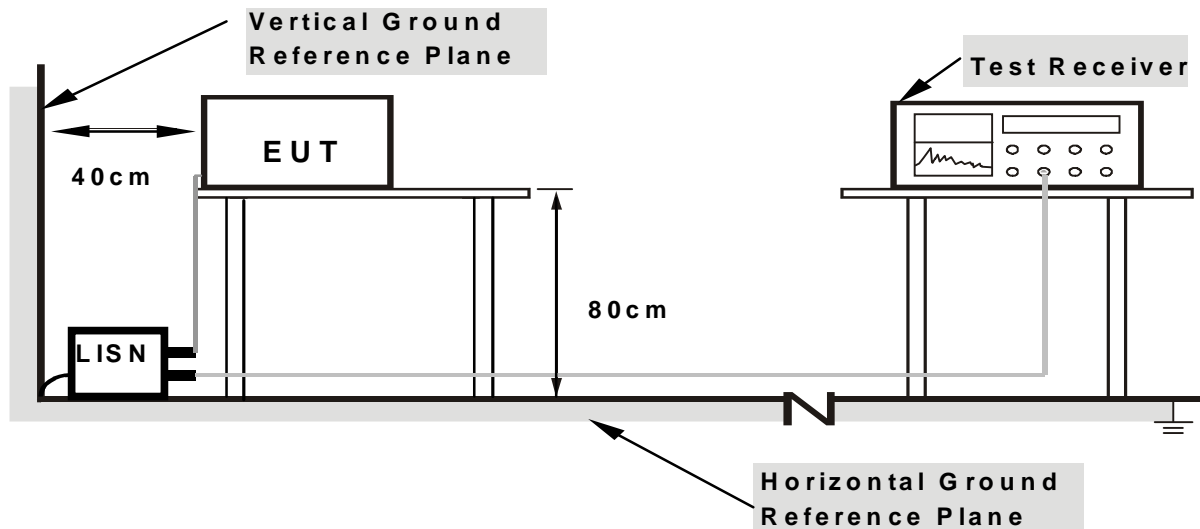

- Note:**
1. Support units were connected to second LISN.
 2. Both of LISNs (AMN) are 80 cm from EUT and at least 80 cm from other units and other metal planes support units.

For the actual test configuration, please refer to the attached file (Test Setup Photo).

4.1.6 EUT OPERATING CONDITIONS

- a. Turn on the power of all equipment.
- b. EUT ran a test program (provided by manufacture) to enable it under transmitting condition at specific channel continuously.



A D T

4.1.7 TEST RESULTS

CONDUCTED WORST-CASE DATA : 802.11n (20MHz)

6dB BANDWIDTH	9kHz	PHASE	Line 1
CHANNEL	Channel 11		

No	Freq. [MHz]	Corr. Factor (dB)	Reading Value		Emission Level		Limit		Margin	
			[dB (uV)]		[dB (uV)]		[dB (uV)]		(dB)	
			Q.P.	AV.	Q.P.	AV.	Q.P.	AV.	Q.P.	AV.
1	0.255	0.19	53.46	51.24	53.65	51.43	61.58	51.58	-7.93	-0.15
2	0.423	0.24	49.95	44.42	50.19	44.66	57.40	47.40	-7.21	-2.74
3	0.685	0.25	52.11	44.28	52.36	44.53	56.00	46.00	-3.64	-1.47
4	0.857	0.26	50.55	40.97	50.81	41.23	56.00	46.00	-5.19	-4.77
5	8.148	0.68	40.04	-	40.72	-	60.00	50.00	-19.28	-
6	23.727	1.45	42.83	-	44.28	-	60.00	50.00	-15.72	-

- REMARKS:**
1. Q.P. and AV. are abbreviations of quasi-peak and average individually.
 2. "-": The Quasi-peak reading value also meets average limit and measurement with the average detector is unnecessary.
 3. The emission levels of other frequencies were very low against the limit.
 4. Margin value = Emission level - Limit value
 5. Correction factor = Insertion loss + Cable loss
 6. Emission Level = Correction Factor + Reading Value.

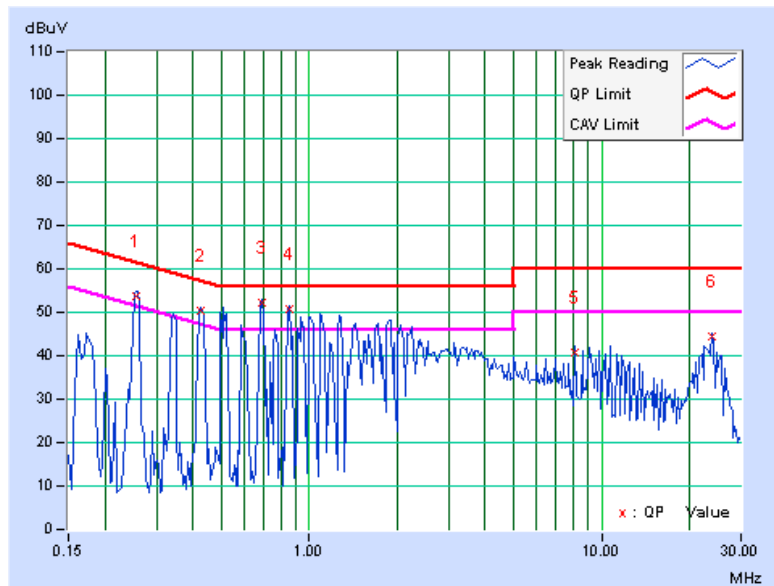



A D T

6dB BANDWIDTH	9kHz	PHASE	Line 2
CHANNEL	Channel 11		

No	Freq. [MHz]	Corr. Factor (dB)	Reading Value		Emission Level		Limit		Margin	
			[dB (uV)]		[dB (uV)]		[dB (uV)]		(dB)	
			Q.P.	AV.	Q.P.	AV.	Q.P.	AV.	Q.P.	AV.
1	0.254	0.20	53.00	51.09	53.20	51.29	61.62	51.62	-8.42	-0.33
2	0.427	0.25	49.72	45.07	49.97	45.32	57.30	47.30	-7.33	-1.98
3	0.689	0.26	51.87	42.20	52.13	42.46	56.00	46.00	-3.87	-3.54
4	1.032	0.28	46.29	35.05	46.57	35.33	56.00	46.00	-9.43	-10.67
5	9.582	0.65	35.50	-	36.15	-	60.00	50.00	-23.85	-
6	23.723	1.06	41.37	-	42.43	-	60.00	50.00	-17.57	-

- REMARKS:**
1. Q.P. and AV. are abbreviations of quasi-peak and average individually.
 2. "-": The Quasi-peak reading value also meets average limit and measurement with the average detector is unnecessary.
 3. The emission levels of other frequencies were very low against the limit.
 4. Margin value = Emission level - Limit value
 5. Correction factor = Insertion loss + Cable loss
 6. Emission Level = Correction Factor + Reading Value.

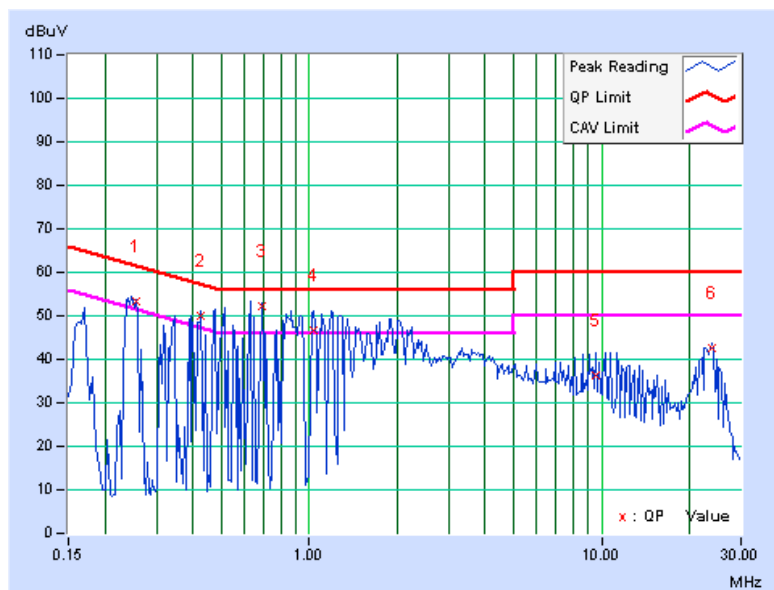



4.2 RADIATED EMISSION MEASUREMENT

4.2.1 LIMITS OF RADIATED EMISSION MEASUREMENT

Emissions radiated outside of the specified bands, shall be according to the general radiated limits in 15.209 as following:

FREQUENCIES (MHz)	FIELD STRENGTH (microvolts/meter)	MEASUREMENT DISTANCE (meters)
0.009 ~ 0.490	2400/F(kHz)	300
0.490 ~ 1.705	24000/F(kHz)	30
1.705 ~ 30.0	30	30
30 ~ 88	100	3
88 ~ 216	150	3
216 ~ 960	200	3
Above 960	500	3

NOTE:

1. The lower limit shall apply at the transition frequencies.
2. Emission level (dBuV/m) = 20 log Emission level (uV/m).
3. As shown in 15.35(b), for frequencies above 1000MHz, the field strength limits are based on average detector, however, the peak field strength of any emission shall not exceed the maximum permitted average limits, specified above by more than 20dB under any condition of modulation.



A D T

4.2.2 TEST INSTRUMENTS

DESCRIPTION & MANUFACTURER	MODEL NO.	SERIAL NO.	CALIBRATED DATE	CALIBRATED UNTIL
HP Preamplifier	8447D	2432A03504	Mar. 04, 2011	Mar. 03, 2012
HP Preamplifier	8449B	3008A01924	Mar. 04, 2011	Mar. 03, 2012
HP Preamplifier	8449B	3008A01292	Mar. 04, 2011	Mar. 03, 2012
Agilent Spectrum Analyzer	E4446A	MY46180403	Jun. 22, 2011	Jun. 21, 2012
ROHDE & SCHWARZ TEST RECEIVER	ESCS30	838251/021	Oct. 01, 2010	Sep. 30, 2011
Schwarzbeck Antenna	VULB 9168	137	Apr. 12, 2011	Apr. 11, 2012
Schwarzbeck Antenna	VHBA 9123	480	May 06, 2011	May 05, 2012
ADT. Turn Table	TT100	0306	NA	NA
ADT. Tower	AT100	0306	NA	NA
Software	ADT_Radiated_V 7.6.15.9.2	NA	NA	NA
SUHNER RF cable	SF102	CABLE-CH6	Aug. 19, 2011	Aug. 18, 2012
EMCO Horn Antenna	3115	6714	Oct. 26, 2010	Oct. 25, 2011
EMCO Horn Antenna	3115	9312-4192	Apr. 22, 2011	Apr. 21, 2012
Highpass filter Wainwright Instruments	WHK 3.1/18G-10SS	SN 8	NA	NA

- NOTE:** 1. The calibration interval of the above test instruments is 12/24 months. And the calibrations are traceable to NML/ROC and NIST/USA.
2. The horn antenna and HP preamplifier (model: 8449B) are used only for the measurement of emission frequency above 1GHz if tested.
3. The test was performed in Chamber No. 6.
4. The Industry Canada Reference No. IC 7450E-6.
5. The FCC Site Registration No. is 447212.



A D T

4.2.3 TEST PROCEDURES

- a. The EUT was placed on the top of a rotating table 0.8 meters above the ground at a 3 meters semi-anechoic chamber. The table was rotated 360 degrees to determine the position of the highest radiation.
- b. The EUT was set 3 meters away from the interference-receiving antenna, which was mounted on the top of a variable-height antenna tower.
- c. The height of antenna is varied from one meter to four meters above the ground to determine the maximum value of the field strength. Both horizontal and vertical polarizations of the antenna are set to make the measurement.
- d. For each suspected emission, the EUT was arranged to its worst case and then the antenna was tuned to heights from 1 meter to 4 meters and the rotatable table was turned from 0 degrees to 360 degrees to find the maximum reading.
- e. The test-receiver system was set to Peak Detect Function and Specified Bandwidth with Maximum Hold Mode.
- f. If the emission level of the EUT in peak mode was lower than the limit specified, then testing could be stopped and the peak values of the EUT would be reported. Otherwise the emissions would be re-tested one by one using peak, quasi-peak or average method as specified and then reported in a data sheet.

NOTE:

1. The resolution bandwidth and video bandwidth of test receiver/spectrum analyzer is 120kHz for Quasi-peak detection at frequency below 1GHz.
2. The resolution bandwidth of test receiver/spectrum analyzer is 1MHz and video bandwidth is 3MHz for Peak detection at frequency above 1GHz.
3. The resolution bandwidth of test receiver/spectrum analyzer is 1MHz and the video bandwidth is 10Hz for Average detection (AV) at frequency above 1GHz.
4. All modes of operation were investigated and the worst-case emissions are reported.

4.2.4 DEVIATION FROM TEST STANDARD

No deviation

4.2.5 TEST SETUP

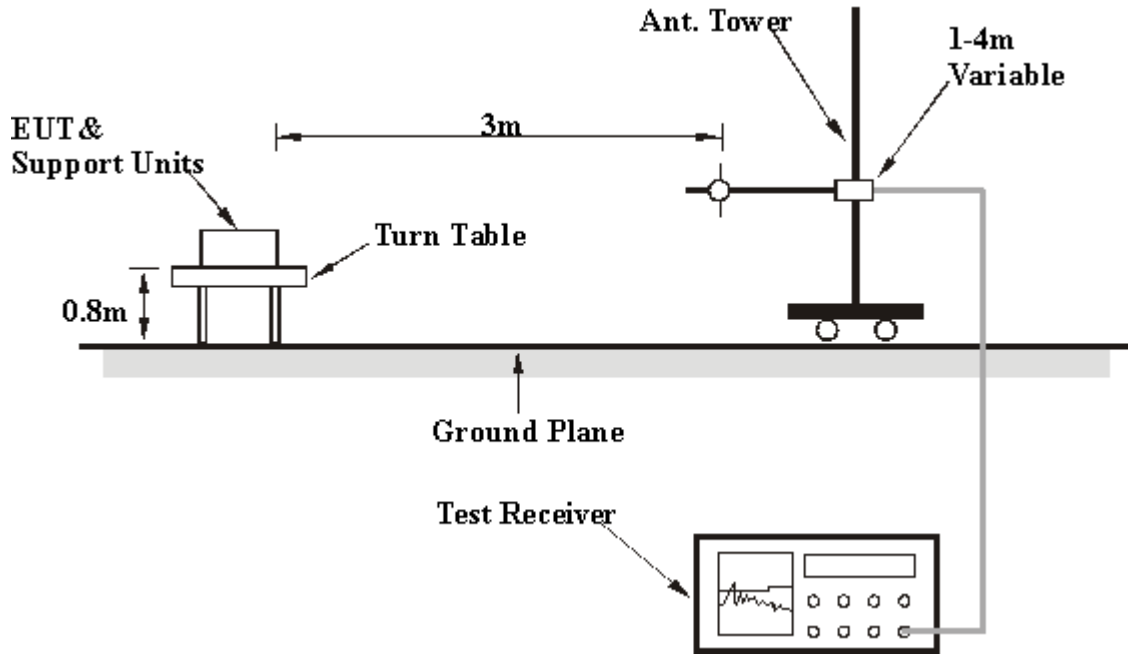

For the actual test configuration, please refer to the attached file (Test Setup Photo).

4.2.6 EUT OPERATING CONDITIONS

Same as item 4.1.6.



A D T

4.2.7 TEST RESULTS

802.11b

EUT TEST CONDITION		MEASUREMENT DETAIL	
CHANNEL	Channel 1	FREQUENCY RANGE	1 ~ 25GHz
INPUT POWER	120Vac, 60Hz	DETECTOR FUNCTION	Peak (PK) Average (AV)
ENVIRONMENTAL CONDITIONS	26deg. C, 70% RH	TESTED BY	Nick Chen

ANTENNA POLARITY & TEST DISTANCE: HORIZONTAL AT 3 M								
NO.	FREQ. (MHz)	EMISSION LEVEL (dBuV/m)	LIMIT (dBuV/m)	MARGIN (dB)	ANTENNA HEIGHT (m)	TABLE ANGLE (Degree)	RAW VALUE (dBuV)	CORRECTION FACTOR (dB/m)
1	2390.00	59.1 PK	74.0	-14.9	1.00 H	258	26.95	32.15
2	2390.00	48.6 AV	54.0	-5.4	1.00 H	258	16.44	32.15
3	*2412.00	108.9 PK			1.00 H	258	76.69	32.24
4	*2412.00	103.8 AV			1.00 H	258	71.59	32.24
5	4824.00	54.8 PK	74.0	-19.3	1.36 H	207	16.09	38.66
6	4824.00	52.6 AV	54.0	-1.4	1.36 H	207	13.91	38.66
7	#9648.00	60.1 PK	88.9	-28.8	1.23 H	168	11.82	48.27
8	#9648.00	53.8 AV	83.8	-30.0	1.23 H	168	5.55	48.27
ANTENNA POLARITY & TEST DISTANCE: VERTICAL AT 3 M								
NO.	FREQ. (MHz)	EMISSION LEVEL (dBuV/m)	LIMIT (dBuV/m)	MARGIN (dB)	ANTENNA HEIGHT (m)	TABLE ANGLE (Degree)	RAW VALUE (dBuV)	CORRECTION FACTOR (dB/m)
1	2390.00	57.3 PK	74.0	-16.7	1.34 V	5	25.15	32.15
2	2390.00	47.6 AV	54.0	-6.4	1.34 V	5	15.49	32.15
3	*2412.00	106.0 PK			1.34 V	5	73.76	32.24
4	*2412.00	101.7 AV			1.34 V	5	69.49	32.24
5	4824.00	53.0 PK	74.0	-21.0	1.28 V	164	14.36	38.66
6	4824.00	49.6 AV	54.0	-4.4	1.28 V	164	10.97	38.66
7	#9648.00	60.2 PK	86.0	-25.8	1.58 V	173	11.92	48.27
8	#9648.00	53.3 AV	81.7	-28.4	1.58 V	173	5.02	48.27

- REMARKS:**
1. Emission level (dBuV/m) = Raw Value (dBuV) + Correction Factor (dB/m).
 2. Correction Factor (dB/m) = Antenna Factor (dB/m) + Cable Factor (dB).
 3. The other emission levels were very low against the limit.
 4. Margin value = Emission level – Limit value.
 5. “ * “: Fundamental frequency.
 6. “#”:The radiated frequency is out the restricted band.



A D T

EUT TEST CONDITION		MEASUREMENT DETAIL	
CHANNEL	Channel 6	FREQUENCY RANGE	1 ~ 25GHz
INPUT POWER	120Vac, 60Hz	DETECTOR FUNCTION	Peak (PK) Average (AV)
ENVIRONMENTAL CONDITIONS	26deg. C, 70% RH	TESTED BY	Nick Chen

ANTENNA POLARITY & TEST DISTANCE: HORIZONTAL AT 3 M								
NO.	FREQ. (MHz)	EMISSION LEVEL (dBuV/m)	LIMIT (dBuV/m)	MARGIN (dB)	ANTENNA HEIGHT (m)	TABLE ANGLE (Degree)	RAW VALUE (dBuV)	CORRECTION FACTOR (dB/m)
1	*2437.00	109.2 PK			1.00 H	254	76.86	32.33
2	*2437.00	105.7 AV			1.00 H	254	73.34	32.33
3	4874.00	54.6 PK	74.0	-19.5	1.43 H	207	15.77	38.78
4	4874.00	51.3 AV	54.0	-2.7	1.43 H	207	12.53	38.78
5	#9748.00	61.1 PK	89.2	-28.1	1.24 H	167	12.70	48.42
6	#9748.00	53.8 AV	85.7	-31.9	1.24 H	167	5.34	48.42
ANTENNA POLARITY & TEST DISTANCE: VERTICAL AT 3 M								
NO.	FREQ. (MHz)	EMISSION LEVEL (dBuV/m)	LIMIT (dBuV/m)	MARGIN (dB)	ANTENNA HEIGHT (m)	TABLE ANGLE (Degree)	RAW VALUE (dBuV)	CORRECTION FACTOR (dB/m)
1	*2437.00	107.0 PK			1.03 V	4	74.66	32.33
2	*2437.00	103.5 AV			1.03 V	4	71.14	32.33
3	4874.00	52.7 PK	74.0	-21.3	1.27 V	177	13.92	38.78
4	4874.00	46.5 AV	54.0	-7.5	1.27 V	177	7.72	38.78
5	#9748.00	59.7 PK	87.0	-27.3	1.52 V	169	11.30	48.42
6	#9748.00	53.4 AV	83.5	-30.1	1.52 V	169	5.00	48.42

- REMARKS:**
1. Emission level (dBuV/m) = Raw Value (dBuV) + Correction Factor (dB/m).
 2. Correction Factor (dB/m) = Antenna Factor (dB/m) + Cable Factor (dB).
 3. The other emission levels were very low against the limit.
 4. Margin value = Emission level – Limit value.
 5. “ * “: Fundamental frequency.
 6. "#":The radiated frequency is out the restricted band.



A D T

EUT TEST CONDITION		MEASUREMENT DETAIL	
CHANNEL	Channel 11	FREQUENCY RANGE	1 ~ 25GHz
INPUT POWER	120Vac, 60Hz	DETECTOR FUNCTION	Peak (PK) Average (AV)
ENVIRONMENTAL CONDITIONS	26deg. C, 70% RH	TESTED BY	Nick Chen

ANTENNA POLARITY & TEST DISTANCE: HORIZONTAL AT 3 M								
NO.	FREQ. (MHz)	EMISSION LEVEL (dBuV/m)	LIMIT (dBuV/m)	MARGIN (dB)	ANTENNA HEIGHT (m)	TABLE ANGLE (Degree)	RAW VALUE (dBuV)	CORRECTION FACTOR (dB/m)
1	*2462.00	106.3 PK			1.00 H	257	73.90	32.43
2	*2462.00	103.8 AV			1.00 H	257	71.33	32.43
3	2483.50	59.7 PK	74.0	-14.3	1.00 H	257	27.23	32.51
4	2483.50	46.9 AV	54.0	-7.1	1.00 H	257	14.37	32.51
5	4924.00	51.9 PK	74.0	-22.1	1.38 H	207	12.97	38.90
6	4924.00	47.7 AV	54.0	-6.3	1.38 H	207	8.83	38.90
7	#9848.00	59.9 PK	86.3	-26.4	1.18 H	167	11.41	48.51
8	#9848.00	53.9 AV	83.8	-29.9	1.18 H	167	5.34	48.51
ANTENNA POLARITY & TEST DISTANCE: VERTICAL AT 3 M								
NO.	FREQ. (MHz)	EMISSION LEVEL (dBuV/m)	LIMIT (dBuV/m)	MARGIN (dB)	ANTENNA HEIGHT (m)	TABLE ANGLE (Degree)	RAW VALUE (dBuV)	CORRECTION FACTOR (dB/m)
1	*2462.00	104.3 PK			1.28 V	5	71.87	32.43
2	*2462.00	101.2 AV			1.28 V	5	68.79	32.43
3	2483.50	58.1 PK	74.0	-15.9	1.28 V	5	25.59	32.51
4	2483.50	45.4 AV	54.0	-8.7	1.28 V	5	12.84	32.51
5	4924.00	50.4 PK	74.0	-23.6	1.27 V	177	11.46	38.90
6	4924.00	43.4 AV	54.0	-10.6	1.27 V	177	4.47	38.90
7	#9848.00	59.7 PK	84.3	-24.6	1.60 V	172	11.19	48.51
8	#9848.00	51.3 AV	81.2	-30.0	1.60 V	172	2.74	48.51

- REMARKS:**
1. Emission level (dBuV/m) = Raw Value (dBuV) + Correction Factor (dB/m).
 2. Correction Factor (dB/m) = Antenna Factor (dB/m) + Cable Factor (dB).
 3. The other emission levels were very low against the limit.
 4. Margin value = Emission level – Limit value.
 5. “ * “: Fundamental frequency.
 6. “#”:The radiated frequency is out the restricted band.



A D T

802.11g

EUT TEST CONDITION		MEASUREMENT DETAIL	
CHANNEL	Channel 1	FREQUENCY RANGE	1 ~ 25GHz
INPUT POWER	120Vac, 60Hz	DETECTOR FUNCTION	Peak (PK) Average (AV)
ENVIRONMENTAL CONDITIONS	26deg. C, 70% RH	TESTED BY	Nick Chen

ANTENNA POLARITY & TEST DISTANCE: HORIZONTAL AT 3 M								
NO.	FREQ. (MHz)	EMISSION LEVEL (dBuV/m)	LIMIT (dBuV/m)	MARGIN (dB)	ANTENNA HEIGHT (m)	TABLE ANGLE (Degree)	RAW VALUE (dBuV)	CORRECTION FACTOR (dB/m)
1	2390.00	69.3 PK	74.0	-4.7	1.00 H	255	37.16	32.15
2	2390.00	52.6 AV	54.0	-1.4	1.00 H	255	20.46	32.15
3	*2412.00	114.2 PK			1.00 H	255	81.99	32.24
4	*2412.00	103.0 AV			1.00 H	255	70.80	32.24
5	4824.00	53.2 PK	74.0	-20.8	1.45 H	131	14.53	38.66
6	4824.00	39.3 AV	54.0	-14.7	1.45 H	131	0.64	38.66
7	#9648.00	59.5 PK	94.2	-34.7	1.44 H	167	11.25	48.27
8	#9648.00	44.8 AV	83.0	-38.2	1.44 H	167	-3.45	48.27
ANTENNA POLARITY & TEST DISTANCE: VERTICAL AT 3 M								
NO.	FREQ. (MHz)	EMISSION LEVEL (dBuV/m)	LIMIT (dBuV/m)	MARGIN (dB)	ANTENNA HEIGHT (m)	TABLE ANGLE (Degree)	RAW VALUE (dBuV)	CORRECTION FACTOR (dB/m)
1	2390.00	66.3 PK	74.0	-7.7	1.06 V	10	34.15	32.15
2	2390.00	49.9 AV	54.0	-4.1	1.06 V	10	17.75	32.15
3	*2412.00	110.3 PK			1.06 V	10	78.01	32.24
4	*2412.00	99.7 AV			1.06 V	10	67.44	32.24
5	4824.00	51.8 PK	74.0	-22.2	1.10 V	188	13.14	38.66
6	4824.00	38.8 AV	54.0	-15.3	1.10 V	188	0.09	38.66
7	#9648.00	58.4 PK	90.3	-31.8	1.50 V	182	10.14	48.27
8	#9648.00	44.7 AV	79.7	-35.0	1.50 V	182	-3.57	48.27

- REMARKS:**
1. Emission level (dBuV/m) = Raw Value (dBuV) + Correction Factor (dB/m).
 2. Correction Factor (dB/m) = Antenna Factor (dB/m) + Cable Factor (dB).
 3. The other emission levels were very low against the limit.
 4. Margin value = Emission level – Limit value.
 5. “ * “: Fundamental frequency.
 6. “#”:The radiated frequency is out the restricted band.



A D T

EUT TEST CONDITION		MEASUREMENT DETAIL	
CHANNEL	Channel 6	FREQUENCY RANGE	1 ~ 25GHz
INPUT POWER	120Vac, 60Hz	DETECTOR FUNCTION	Peak (PK) Average (AV)
ENVIRONMENTAL CONDITIONS	26deg. C, 70% RH	TESTED BY	Nick Chen

ANTENNA POLARITY & TEST DISTANCE: HORIZONTAL AT 3 M								
NO.	FREQ. (MHz)	EMISSION LEVEL (dBuV/m)	LIMIT (dBuV/m)	MARGIN (dB)	ANTENNA HEIGHT (m)	TABLE ANGLE (Degree)	RAW VALUE (dBuV)	CORRECTION FACTOR (dB/m)
1	*2437.00	116.7 PK			1.00 H	250	84.39	32.33
2	*2437.00	106.5 AV			1.00 H	250	74.14	32.33
3	4874.00	56.6 PK	74.0	-17.4	1.50 H	137	17.86	38.78
4	4874.00	44.0 AV	54.0	-10.1	1.50 H	137	5.17	38.78
5	#9748.00	62.0 PK	96.7	-34.7	1.20 H	162	13.58	48.42
6	#9748.00	49.2 AV	86.5	-37.3	1.20 H	162	0.75	48.42
ANTENNA POLARITY & TEST DISTANCE: VERTICAL AT 3 M								
NO.	FREQ. (MHz)	EMISSION LEVEL (dBuV/m)	LIMIT (dBuV/m)	MARGIN (dB)	ANTENNA HEIGHT (m)	TABLE ANGLE (Degree)	RAW VALUE (dBuV)	CORRECTION FACTOR (dB/m)
1	*2437.00	114.7 PK			1.00 V	15	82.37	32.33
2	*2437.00	104.8 AV			1.00 V	15	72.49	32.33
3	4874.00	54.0 PK	74.0	-20.0	1.39 V	183	15.26	38.78
4	4874.00	40.4 AV	54.0	-13.6	1.39 V	183	1.61	38.78
5	#9748.00	60.5 PK	94.7	-34.2	1.52 V	178	12.06	48.42
6	#9748.00	46.1 AV	84.8	-38.8	1.52 V	178	-2.36	48.42

- REMARKS:**
1. Emission level (dBuV/m) = Raw Value (dBuV) + Correction Factor (dB/m).
 2. Correction Factor (dB/m) = Antenna Factor (dB/m) + Cable Factor (dB).
 3. The other emission levels were very low against the limit.
 4. Margin value = Emission level – Limit value.
 5. “ * “: Fundamental frequency.
 6. "#":The radiated frequency is out the restricted band.



A D T

EUT TEST CONDITION		MEASUREMENT DETAIL	
CHANNEL	Channel 11	FREQUENCY RANGE	1 ~ 25GHz
INPUT POWER	120Vac, 60Hz	DETECTOR FUNCTION	Peak (PK) Average (AV)
ENVIRONMENTAL CONDITIONS	26deg. C, 70% RH	TESTED BY	Nick Chen

ANTENNA POLARITY & TEST DISTANCE: HORIZONTAL AT 3 M								
NO.	FREQ. (MHz)	EMISSION LEVEL (dBuV/m)	LIMIT (dBuV/m)	MARGIN (dB)	ANTENNA HEIGHT (m)	TABLE ANGLE (Degree)	RAW VALUE (dBuV)	CORRECTION FACTOR (dB/m)
1	*2462.00	113.6 PK			1.00 H	253	81.20	32.43
2	*2462.00	102.6 AV			1.00 H	253	70.21	32.43
3	2483.50	69.3 PK	74.0	-4.7	1.00 H	253	36.80	32.51
4	2483.50	52.1 AV	54.0	-1.9	1.00 H	253	19.58	32.51
5	4924.00	52.8 PK	74.0	-21.2	1.49 H	132	13.86	38.90
6	4924.00	38.7 AV	54.0	-15.3	1.49 H	132	-0.20	38.90
7	#9848.00	60.2 PK	93.6	-33.4	1.21 H	156	11.71	48.51
8	#9848.00	45.8 AV	82.6	-36.9	1.21 H	156	-2.73	48.51
ANTENNA POLARITY & TEST DISTANCE: VERTICAL AT 3 M								
NO.	FREQ. (MHz)	EMISSION LEVEL (dBuV/m)	LIMIT (dBuV/m)	MARGIN (dB)	ANTENNA HEIGHT (m)	TABLE ANGLE (Degree)	RAW VALUE (dBuV)	CORRECTION FACTOR (dB/m)
1	*2462.00	109.4 PK			1.03 V	7	76.95	32.43
2	*2462.00	99.6 AV			1.03 V	7	67.21	32.43
3	2483.50	66.4 PK	74.0	-7.7	1.03 V	7	33.84	32.51
4	2483.50	50.4 AV	54.0	-3.7	1.03 V	7	17.84	32.51
5	4924.00	47.1 PK	74.0	-26.9	1.08 V	206	8.23	38.90
6	4924.00	35.2 AV	54.0	-18.8	1.08 V	206	-3.71	38.90
7	#9848.00	59.7 PK	89.4	-29.7	1.56 V	171	11.16	48.51
8	#9848.00	45.6 AV	79.6	-34.0	1.56 V	171	-2.88	48.51

- REMARKS:**
1. Emission level (dBuV/m) = Raw Value (dBuV) + Correction Factor (dB/m).
 2. Correction Factor (dB/m) = Antenna Factor (dB/m) + Cable Factor (dB).
 3. The other emission levels were very low against the limit.
 4. Margin value = Emission level – Limit value.
 5. “ * “: Fundamental frequency.
 6. "#":The radiated frequency is out the restricted band.



A D T

802.11n (20MHz)

EUT TEST CONDITION		MEASUREMENT DETAIL	
CHANNEL	Channel 1	FREQUENCY RANGE	1 ~ 25GHz
INPUT POWER	120Vac, 60Hz	DETECTOR FUNCTION	Peak (PK) Average (AV)
ENVIRONMENTAL CONDITIONS	26deg. C, 70% RH	TESTED BY	Nick Chen

ANTENNA POLARITY & TEST DISTANCE: HORIZONTAL AT 3 M								
NO.	FREQ. (MHz)	EMISSION LEVEL (dBuV/m)	LIMIT (dBuV/m)	MARGIN (dB)	ANTENNA HEIGHT (m)	TABLE ANGLE (Degree)	RAW VALUE (dBuV)	CORRECTION FACTOR (dB/m)
1	2390.00	72.2 PK	74.0	-1.8	1.00 H	254	40.02	32.15
2	2390.00	52.7 AV	54.0	-1.3	1.00 H	254	20.55	32.15
3	*2412.00	113.3 PK			1.00 H	254	81.05	32.24
4	*2412.00	103.0 AV			1.00 H	254	70.76	32.24
5	4824.00	53.8 PK	74.0	-20.2	1.38 H	205	15.12	38.66
6	4824.00	40.9 AV	54.0	-13.1	1.38 H	205	2.22	38.66
ANTENNA POLARITY & TEST DISTANCE: VERTICAL AT 3 M								
NO.	FREQ. (MHz)	EMISSION LEVEL (dBuV/m)	LIMIT (dBuV/m)	MARGIN (dB)	ANTENNA HEIGHT (m)	TABLE ANGLE (Degree)	RAW VALUE (dBuV)	CORRECTION FACTOR (dB/m)
1	2390.00	67.3 PK	74.0	-6.7	1.01 V	6	35.11	32.15
2	2390.00	51.6 AV	54.0	-2.4	1.01 V	6	19.47	32.15
3	*2412.00	109.0 PK			1.01 V	6	76.74	32.24
4	*2412.00	99.1 AV			1.01 V	6	66.81	32.24
5	4824.00	52.0 PK	74.0	-22.0	1.26 V	167	13.31	38.66
6	4824.00	38.1 AV	54.0	-15.9	1.26 V	167	-0.58	38.66

- REMARKS:**
1. Emission level (dBuV/m) = Raw Value (dBuV) + Correction Factor (dB/m).
 2. Correction Factor (dB/m) = Antenna Factor (dB/m) + Cable Factor (dB).
 3. The other emission levels were very low against the limit.
 4. Margin value = Emission level – Limit value.
 5. “ * “: Fundamental frequency.



A D T

EUT TEST CONDITION		MEASUREMENT DETAIL	
CHANNEL	Channel 6	FREQUENCY RANGE	1 ~ 25GHz
INPUT POWER	120Vac, 60Hz	DETECTOR FUNCTION	Peak (PK) Average (AV)
ENVIRONMENTAL CONDITIONS	26deg. C, 70% RH	TESTED BY	Nick Chen

ANTENNA POLARITY & TEST DISTANCE: HORIZONTAL AT 3 M								
NO.	FREQ. (MHz)	EMISSION LEVEL (dBuV/m)	LIMIT (dBuV/m)	MARGIN (dB)	ANTENNA HEIGHT (m)	TABLE ANGLE (Degree)	RAW VALUE (dBuV)	CORRECTION FACTOR (dB/m)
1	*2437.00	115.0 PK			1.00 H	251	82.67	32.33
2	*2437.00	104.9 AV			1.00 H	251	72.57	32.33
3	4874.00	57.5 PK	74.0	-16.5	1.41 H	207	18.69	38.78
4	4874.00	44.2 AV	54.0	-9.8	1.41 H	207	5.43	38.78
ANTENNA POLARITY & TEST DISTANCE: VERTICAL AT 3 M								
NO.	FREQ. (MHz)	EMISSION LEVEL (dBuV/m)	LIMIT (dBuV/m)	MARGIN (dB)	ANTENNA HEIGHT (m)	TABLE ANGLE (Degree)	RAW VALUE (dBuV)	CORRECTION FACTOR (dB/m)
1	*2437.00	112.4 PK			1.00 V	0	80.06	32.33
2	*2437.00	102.2 AV			1.00 V	0	69.86	32.33
3	4874.00	52.3 PK	74.0	-21.7	1.14 V	166	13.51	38.78
4	4874.00	39.6 AV	54.0	-14.4	1.14 V	166	0.79	38.78

- REMARKS:**
1. Emission level (dBuV/m) = Raw Value (dBuV) + Correction Factor (dB/m).
 2. Correction Factor (dB/m) = Antenna Factor (dB/m) + Cable Factor (dB).
 3. The other emission levels were very low against the limit.
 4. Margin value = Emission level – Limit value.
 5. “ * “: Fundamental frequency.



A D T

EUT TEST CONDITION		MEASUREMENT DETAIL	
CHANNEL	Channel 11	FREQUENCY RANGE	1 ~ 25GHz
INPUT POWER	120Vac, 60Hz	DETECTOR FUNCTION	Peak (PK) Average (AV)
ENVIRONMENTAL CONDITIONS	26deg. C, 70% RH	TESTED BY	Nick Chen

ANTENNA POLARITY & TEST DISTANCE: HORIZONTAL AT 3 M								
NO.	FREQ. (MHz)	EMISSION LEVEL (dBuV/m)	LIMIT (dBuV/m)	MARGIN (dB)	ANTENNA HEIGHT (m)	TABLE ANGLE (Degree)	RAW VALUE (dBuV)	CORRECTION FACTOR (dB/m)
1	*2462.00	113.0 PK			1.00 H	253	80.57	32.43
2	*2462.00	102.4 AV			1.00 H	253	69.99	32.43
3	2483.50	72.3 PK	74.0	-1.7	1.00 H	253	39.79	32.51
4	2483.50	52.8 AV	54.0	-1.2	1.00 H	253	20.26	32.51
5	4924.00	53.9 PK	74.0	-20.1	1.47 H	207	15.03	38.90
6	4924.00	40.0 AV	54.0	-14.0	1.47 H	207	1.10	38.90
ANTENNA POLARITY & TEST DISTANCE: VERTICAL AT 3 M								
NO.	FREQ. (MHz)	EMISSION LEVEL (dBuV/m)	LIMIT (dBuV/m)	MARGIN (dB)	ANTENNA HEIGHT (m)	TABLE ANGLE (Degree)	RAW VALUE (dBuV)	CORRECTION FACTOR (dB/m)
1	*2462.00	111.4 PK			1.00 V	1	78.98	32.43
2	*2462.00	101.9 AV			1.00 V	1	69.46	32.43
3	2483.50	70.0 PK	74.0	-4.0	1.00 V	1	37.53	32.51
4	2483.50	52.0 AV	54.0	-2.0	1.00 V	1	19.52	32.51
5	4924.00	49.4 PK	74.0	-24.6	1.38 V	172	10.49	38.90
6	4924.00	35.1 AV	54.0	-18.9	1.38 V	172	-3.83	38.90

- REMARKS:**
1. Emission level (dBuV/m) = Raw Value (dBuV) + Correction Factor (dB/m).
 2. Correction Factor (dB/m) = Antenna Factor (dB/m) + Cable Factor (dB).
 3. The other emission levels were very low against the limit.
 4. Margin value = Emission level – Limit value.
 5. “ * “: Fundamental frequency.



A D T

802.11n (40MHz)

EUT TEST CONDITION		MEASUREMENT DETAIL	
CHANNEL	Channel 1	FREQUENCY RANGE	1 ~ 25GHz
INPUT POWER	120Vac, 60Hz	DETECTOR FUNCTION	Peak (PK) Average (AV)
ENVIRONMENTAL CONDITIONS	26deg. C, 70% RH	TESTED BY	Nick Chen

ANTENNA POLARITY & TEST DISTANCE: HORIZONTAL AT 3 M								
NO.	FREQ. (MHz)	EMISSION LEVEL (dBuV/m)	LIMIT (dBuV/m)	MARGIN (dB)	ANTENNA HEIGHT (m)	TABLE ANGLE (Degree)	RAW VALUE (dBuV)	CORRECTION FACTOR (dB/m)
1	2390.00	67.0 PK	74.0	-7.0	1.22 H	255	34.86	32.15
2	2390.00	52.7 AV	54.0	-1.3	1.22 H	255	20.59	32.15
3	*2422.00	106.0 PK			1.22 H	255	73.74	32.27
4	*2422.00	94.0 AV			1.22 H	255	61.68	32.27
5	4844.00	47.8 PK	74.0	-26.2	1.21 H	284	9.10	38.71
6	4844.00	33.6 AV	54.0	-20.4	1.21 H	284	-5.13	38.71
ANTENNA POLARITY & TEST DISTANCE: VERTICAL AT 3 M								
NO.	FREQ. (MHz)	EMISSION LEVEL (dBuV/m)	LIMIT (dBuV/m)	MARGIN (dB)	ANTENNA HEIGHT (m)	TABLE ANGLE (Degree)	RAW VALUE (dBuV)	CORRECTION FACTOR (dB/m)
1	2390.00	64.1 PK	74.0	-10.0	1.04 V	4	31.90	32.15
2	2390.00	50.5 AV	54.0	-3.5	1.04 V	4	18.38	32.15
3	*2422.00	102.5 PK			1.04 V	4	70.20	32.27
4	*2422.00	91.2 AV			1.04 V	4	58.93	32.27
5	4844.00	47.4 PK	74.0	-26.6	1.24 V	186	8.70	38.71
6	4844.00	34.2 AV	54.0	-19.8	1.24 V	186	-4.55	38.71

- REMARKS:**
1. Emission level (dBuV/m) = Raw Value (dBuV) + Correction Factor (dB/m).
 2. Correction Factor (dB/m) = Antenna Factor (dB/m) + Cable Factor (dB).
 3. The other emission levels were very low against the limit.
 4. Margin value = Emission level – Limit value.
 5. “ * “: Fundamental frequency.



A D T

EUT TEST CONDITION		MEASUREMENT DETAIL	
CHANNEL	Channel 4	FREQUENCY RANGE	1 ~ 25GHz
INPUT POWER	120Vac, 60Hz	DETECTOR FUNCTION	Peak (PK) Average (AV)
ENVIRONMENTAL CONDITIONS	26deg. C, 70% RH	TESTED BY	Nick Chen

ANTENNA POLARITY & TEST DISTANCE: HORIZONTAL AT 3 M								
NO.	FREQ. (MHz)	EMISSION LEVEL (dBuV/m)	LIMIT (dBuV/m)	MARGIN (dB)	ANTENNA HEIGHT (m)	TABLE ANGLE (Degree)	RAW VALUE (dBuV)	CORRECTION FACTOR (dB/m)
1	*2437.00	111.8 PK			1.00 H	253	79.42	32.33
2	*2437.00	99.9 AV			1.00 H	253	67.55	32.33
3	4874.00	52.4 PK	74.0	-21.6	1.44 H	213	13.66	38.78
4	4874.00	38.2 AV	54.0	-15.8	1.44 H	213	-0.59	38.78
ANTENNA POLARITY & TEST DISTANCE: VERTICAL AT 3 M								
NO.	FREQ. (MHz)	EMISSION LEVEL (dBuV/m)	LIMIT (dBuV/m)	MARGIN (dB)	ANTENNA HEIGHT (m)	TABLE ANGLE (Degree)	RAW VALUE (dBuV)	CORRECTION FACTOR (dB/m)
1	*2437.00	109.1 PK			1.00 V	9	76.74	32.33
2	*2437.00	95.8 AV			1.00 V	9	63.47	32.33
3	4874.00	50.0 PK	74.0	-24.1	1.00 V	189	11.17	38.78
4	4874.00	38.0 AV	54.0	-16.0	1.00 V	189	-0.79	38.78

- REMARKS:**
1. Emission level (dBuV/m) = Raw Value (dBuV) + Correction Factor (dB/m).
 2. Correction Factor (dB/m) = Antenna Factor (dB/m) + Cable Factor (dB).
 3. The other emission levels were very low against the limit.
 4. Margin value = Emission level – Limit value.
 5. “ * “: Fundamental frequency.



A D T

EUT TEST CONDITION		MEASUREMENT DETAIL	
CHANNEL	Channel 7	FREQUENCY RANGE	1 ~ 25GHz
INPUT POWER	120Vac, 60Hz	DETECTOR FUNCTION	Peak (PK) Average (AV)
ENVIRONMENTAL CONDITIONS	26deg. C, 70% RH	TESTED BY	Nick Chen

ANTENNA POLARITY & TEST DISTANCE: HORIZONTAL AT 3 M								
NO.	FREQ. (MHz)	EMISSION LEVEL (dBuV/m)	LIMIT (dBuV/m)	MARGIN (dB)	ANTENNA HEIGHT (m)	TABLE ANGLE (Degree)	RAW VALUE (dBuV)	CORRECTION FACTOR (dB/m)
1	*2452.00	104.5 PK			1.00 H	254	72.12	32.39
2	*2452.00	92.7 AV			1.00 H	254	60.33	32.39
3	2483.50	68.8 PK	74.0	-5.2	1.00 H	254	36.26	32.51
4	2483.50	53.4 AV	54.0	-0.6	1.00 H	254	20.86	32.51
5	4904.00	48.2 PK	74.0	-25.8	1.18 H	254	9.36	38.86
6	4904.00	34.4 AV	54.0	-19.6	1.18 H	254	-4.48	38.86
ANTENNA POLARITY & TEST DISTANCE: VERTICAL AT 3 M								
NO.	FREQ. (MHz)	EMISSION LEVEL (dBuV/m)	LIMIT (dBuV/m)	MARGIN (dB)	ANTENNA HEIGHT (m)	TABLE ANGLE (Degree)	RAW VALUE (dBuV)	CORRECTION FACTOR (dB/m)
1	*2452.00	103.2 PK			1.03 V	1	70.78	32.39
2	*2452.00	91.3 AV			1.03 V	1	58.90	32.39
3	2483.50	68.0 PK	74.0	-6.1	1.03 V	1	35.44	32.51
4	2483.50	52.2 AV	54.0	-1.8	1.03 V	1	19.66	32.51
5	4904.00	47.7 PK	74.0	-26.3	1.08 V	251	8.80	38.86
6	4904.00	33.7 AV	54.0	-20.3	1.08 V	251	-5.18	38.86

- REMARKS:**
1. Emission level (dBuV/m) = Raw Value (dBuV) + Correction Factor (dB/m).
 2. Correction Factor (dB/m) = Antenna Factor (dB/m) + Cable Factor (dB).
 3. The other emission levels were very low against the limit.
 4. Margin value = Emission level – Limit value.
 5. “ * “: Fundamental frequency.



A D T

BELOW 1GHz WORST-CASE DATA : 802.11n (20MHz)

EUT TEST CONDITION		MEASUREMENT DETAIL	
CHANNEL	Channel 11	FREQUENCY RANGE	Below 1000MHz
INPUT POWER	120Vac, 60Hz	DETECTOR FUNCTION	Quasi-Peak
ENVIRONMENTAL CONDITIONS	26deg. C, 70% RH	TESTED BY	Nick Chen

ANTENNA POLARITY & TEST DISTANCE: HORIZONTAL AT 3 M								
NO.	FREQ. (MHz)	EMISSION LEVEL (dBuV/m)	LIMIT (dBuV/m)	MARGIN (dB)	ANTENNA HEIGHT (m)	TABLE ANGLE (Degree)	RAW VALUE (dBuV)	CORRECTION FACTOR (dB/m)
1	199.47	28.4 QP	43.5	-15.1	1.07 H	49	17.03	11.39
2	373.78	39.5 QP	46.0	-6.5	1.22 H	310	21.62	17.90
3	399.60	33.6 QP	46.0	-12.4	1.03 H	301	14.97	18.63
4	531.95	43.6 QP	46.0	-2.4	1.50 H	241	21.68	21.93
5	665.91	34.1 QP	46.0	-12.0	1.53 H	226	10.12	23.93
6	678.82	31.1 QP	46.0	-14.9	1.22 H	226	7.02	24.04
7	866.04	34.3 QP	46.0	-11.8	1.50 H	241	6.84	27.41

ANTENNA POLARITY & TEST DISTANCE: VERTICAL AT 3 M								
NO.	FREQ. (MHz)	EMISSION LEVEL (dBuV/m)	LIMIT (dBuV/m)	MARGIN (dB)	ANTENNA HEIGHT (m)	TABLE ANGLE (Degree)	RAW VALUE (dBuV)	CORRECTION FACTOR (dB/m)
1	33.23	30.0 QP	40.0	-10.0	1.08 V	1	17.51	12.49
2	104.24	29.0 QP	43.5	-14.5	1.13 V	10	18.95	10.07
3	373.78	28.0 QP	46.0	-18.0	1.32 V	46	10.07	17.90
4	531.95	44.6 QP	46.0	-1.4	1.07 V	268	22.63	21.93
5	754.68	31.6 QP	46.0	-14.4	1.12 V	10	6.03	25.53
6	866.04	32.1 QP	46.0	-13.9	1.32 V	181	4.71	27.41

- REMARKS:**
1. Emission level (dBuV/m) = Raw Value (dBuV) + Correction Factor (dB/m).
 2. Correction Factor (dB/m) = Antenna Factor (dB/m) + Cable Factor (dB).
 3. The other emission levels were very low against the limit.
 4. Margin value = Emission level – Limit value.



A D T

4.3 6dB BANDWIDTH MEASUREMENT

4.3.1 LIMITS OF 6dB BANDWIDTH MEASUREMENT

The minimum of 6dB Bandwidth Measurement is 0.5 MHz.

4.3.2 TEST INSTRUMENTS

DESCRIPTION & MANUFACTURER	MODEL NO.	SERIAL NO.	DATE OF CALIBRATION	DUE DATE OF CALIBRATION
SPECTRUM ANALYZER	FSP 40	100036	Apr. 29, 2011	Apr. 28, 2012

NOTE: The calibration interval of the above test instruments is 12 months and the calibrations are traceable to NML/ROC and NIST/USA.

4.3.3 TEST PROCEDURE

The transmitter output was connected to the spectrum analyzer through an attenuator. The bandwidth of the fundamental frequency was measured by spectrum analyzer with 100kHz RBW and 300kHz VBW. The 6dB bandwidth is defined as the total spectrum the power of which is higher than peak power minus 6dB.

4.3.4 DEVIATION FROM TEST STANDARD

No deviation

4.3.5 TEST SETUP

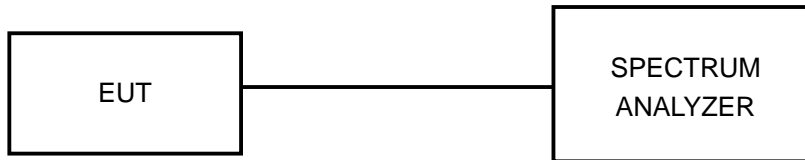

4.3.6 EUT OPERATING CONDITIONS

The software provided by client to enable the EUT under transmission condition continuously at lowest, middle and highest channel frequencies individually.



A D T

4.3.7 TEST RESULTS

802.11b

CHANNEL	CHANNEL FREQUENCY (MHz)	6dB BANDWIDTH (MHz)		MINIMUM LIMIT (MHz)	PASS / FAIL
		CHAIN 0	CHAIN 1		
1	2412	11.60	12.55	0.5	PASS
6	2437	12.06	12.53	0.5	PASS
11	2462	12.56	12.09	0.5	PASS

FOR CHAIN 0: CH 11

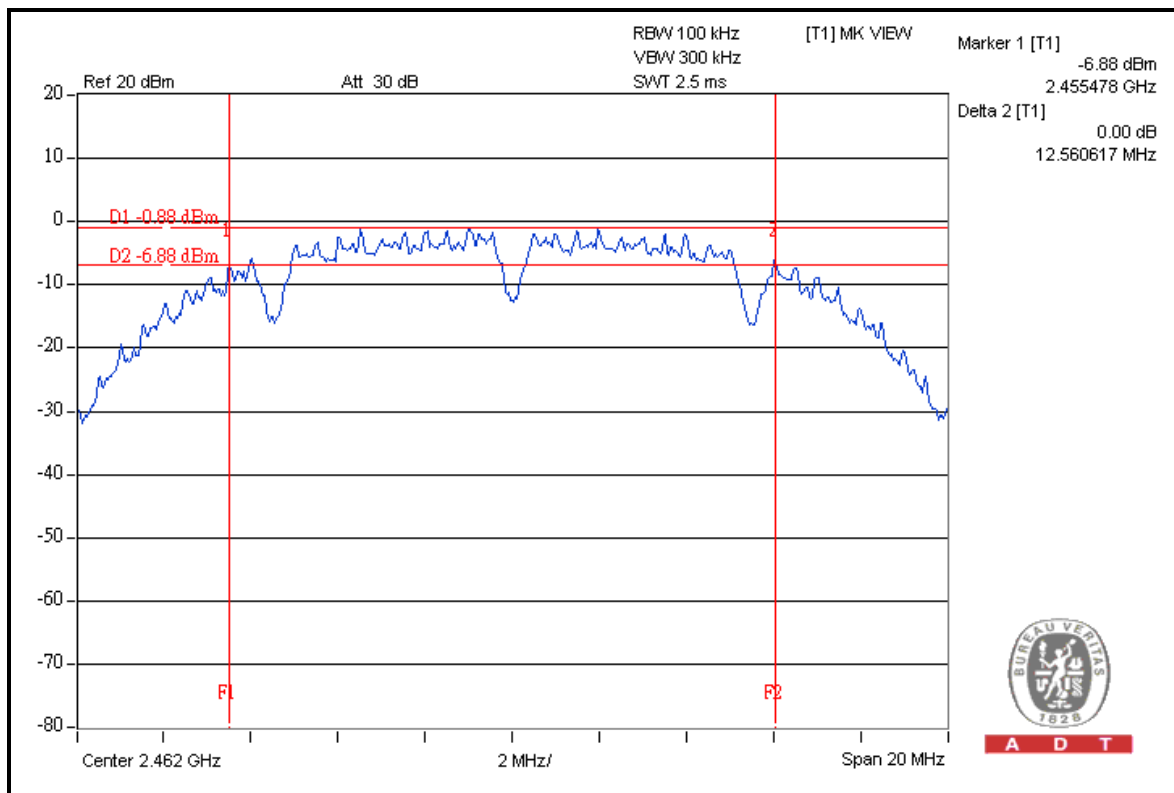



A D T

802.11g

CHANNEL	CHANNEL FREQUENCY (MHz)	6dB BANDWIDTH (MHz)		MINIMUM LIMIT (MHz)	PASS / FAIL
		CHAIN 0	CHAIN 1		
1	2412	16.41	16.39	0.5	PASS
6	2437	16.48	16.41	0.5	PASS
11	2462	16.52	16.47	0.5	PASS

FOR CHAIN 0: CH 11

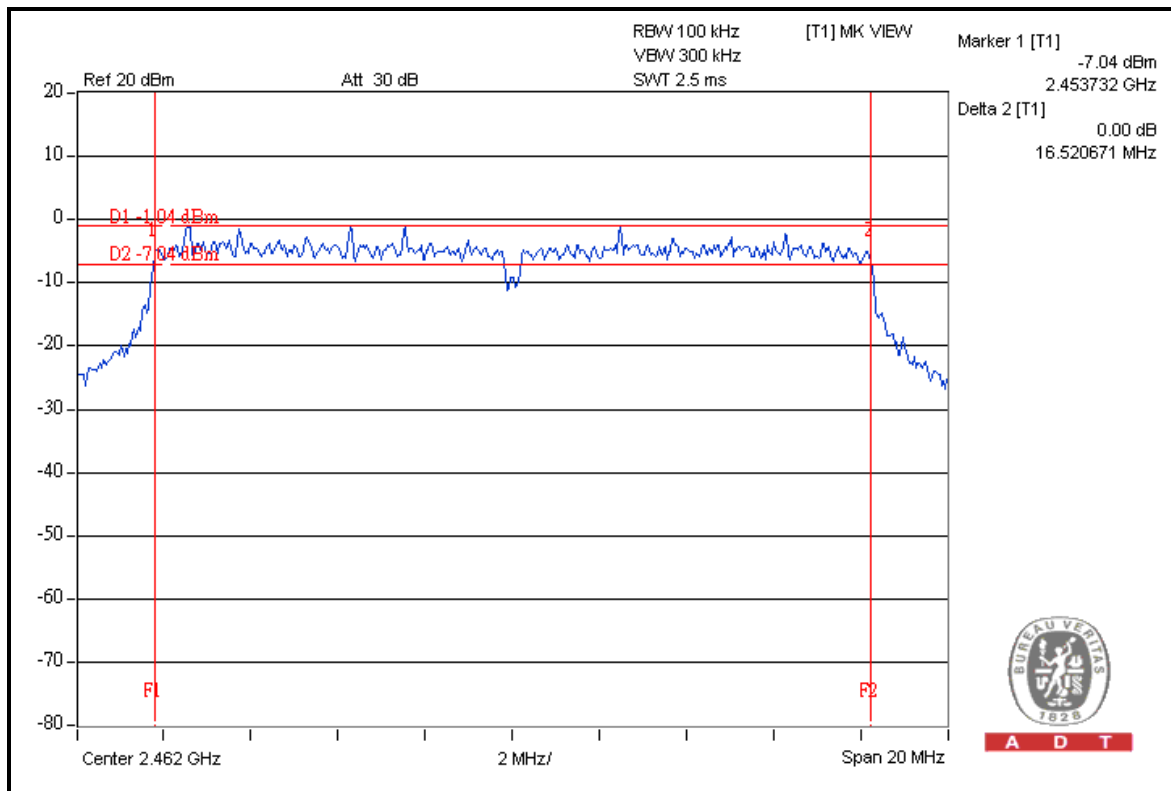



A D T

802.11n (20MHz)

CHANNEL	CHANNEL FREQUENCY (MHz)	6dB BANDWIDTH (MHz)		MINIMUM LIMIT (MHz)	PASS / FAIL
		CHAIN 0	CHAIN 1		
1	2412	17.69	17.66	0.5	PASS
6	2437	17.68	17.63	0.5	PASS
11	2462	17.64	17.68	0.5	PASS

FOR CHAIN 0: CH 1

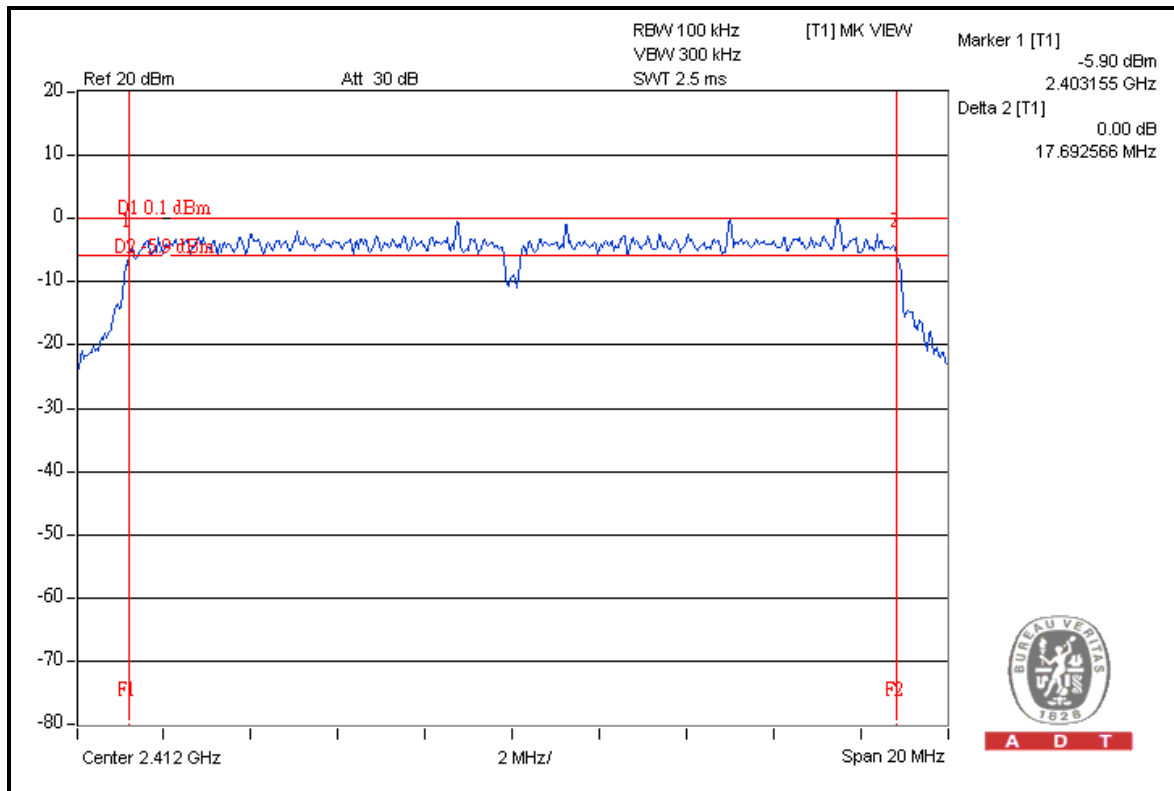



A D T

802.11n (40MHz)

CHANNEL	CHANNEL FREQUENCY (MHz)	6dB BANDWIDTH (MHz)		MINIMUM LIMIT (MHz)	PASS / FAIL
		CHAIN 0	CHAIN 1		
1	2422	36.37	36.16	0.5	PASS
4	2437	36.13	36.43	0.5	PASS
7	2452	36.43	36.50	0.5	PASS

FOR CHAIN 1: CH 7

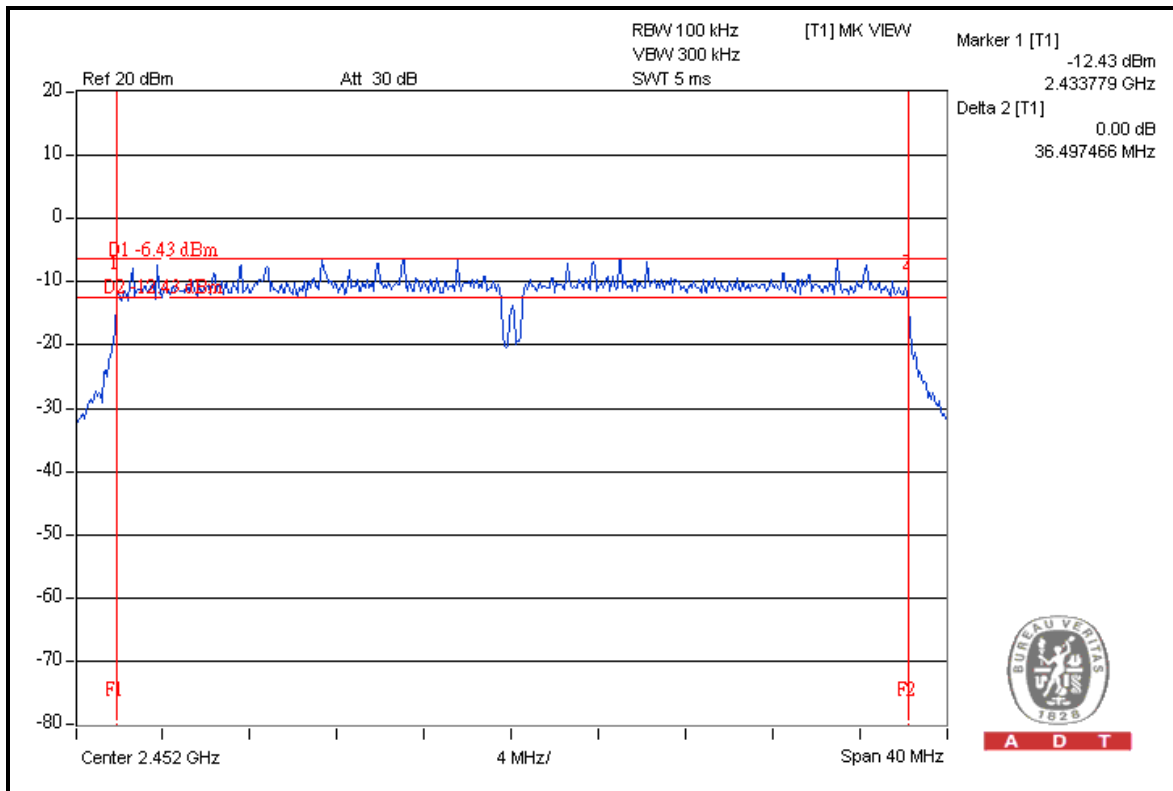



A D T

4.4 MAXIMUM OUTPUT POWER

4.4.1 LIMITS OF MAXIMUM OUTPUT POWER MEASUREMENT

The Maximum Output Power Measurement is 30dBm.

4.4.2 INSTRUMENTS

DESCRIPTION & MANUFACTURER	MODEL NO.	SERIAL NO.	DATE OF CALIBRATION	DUE DATE OF CALIBRATION
Anritsu Power Sensor	MA2411B	0738404	Apr. 26, 2011	Apr. 25, 2012
Anritsu Power Meter	ML2495A	0842014	Apr. 26, 2011	Apr. 25, 2012

Note:

1. The calibration interval of the above test instruments is 12 months and the calibrations are traceable to NML/ROC and NIST/USA.
2. Measurement Bandwidth of ML2495A is 65MHz greater than 6dB bandwidth of emission.

4.4.3 TEST PROCEDURES

A power sensor was used on the output port of the EUT. A power meter was used to read the response of the power sensor. Record the power level.

4.4.4 DEVIATION FROM TEST STANDARD

No deviation

4.4.5 TEST SETUP

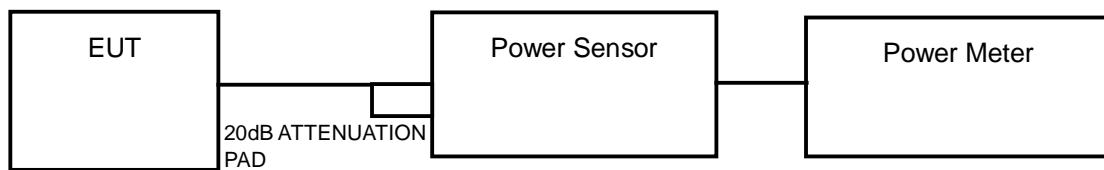

4.4.6 EUT OPERATING CONDITIONS

Same as Item 4.3.6

4.4.7 TEST RESULTS

802.11b

CHAN.	CHAN. FREQ. (MHz)	POWER OUTPUT (dBm)		TOTAL POWER (mW)	TOTAL POWER (dBm)	POWER LIMIT (dBm)	PASS / FAIL
		CHAIN 0	CHAIN 1				
1	2412	16.0	15.5	75.3	18.8	28	PASS
6	2437	15.5	16.0	75.3	18.8	28	PASS
11	2462	13.6	13.2	43.8	16.4	28	PASS

NOTE: Directional gain = $5\text{dBi} + 10\log(2) = 8\text{dBi} > 6\text{dBi}$, so the conducted power limit shall be reduced to $30 - (8 - 6) = 28\text{dBm}$.

802.11g

CHAN.	CHAN. FREQ. (MHz)	POWER OUTPUT (dBm)		TOTAL POWER (mW)	TOTAL POWER (dBm)	POWER LIMIT (dBm)	PASS / FAIL
		CHAIN 0	CHAIN 1				
1	2412	23.1	22.7	390.4	25.9	28	PASS
6	2437	25.1	24.8	625.6	27.9	28	PASS
11	2462	22.1	22.1	324.4	25.1	28	PASS

NOTE: Directional gain = $5\text{dBi} + 10\log(2) = 8\text{dBi} > 6\text{dBi}$, so the conducted power limit shall be reduced to $30 - (8 - 6) = 28\text{dBm}$.

802.11n (20MHz)

CHAN.	CHAN. FREQ. (MHz)	POWER OUTPUT (dBm)		TOTAL POWER (mW)	TOTAL POWER (dBm)	POWER LIMIT (dBm)	PASS / FAIL
		CHAIN 0	CHAIN 1				
1	2412	23.2	22.9	403.9	26.1	30	PASS
6	2437	24.5	24.5	563.7	27.5	30	PASS
11	2462	23.3	23.2	422.7	26.3	30	PASS

802.11n (40MHz)

CHAN.	CHAN. FREQ. (MHz)	POWER OUTPUT (dBm)		TOTAL POWER (mW)	TOTAL POWER (dBm)	POWER LIMIT (dBm)	PASS / FAIL
		CHAIN 0	CHAIN 1				
1	2422	20.3	19.8	202.7	23.1	30	PASS
4	2437	25.8	25.3	719.0	28.6	30	PASS
7	2452	20.8	20.2	224.9	23.5	30	PASS



A D T

4.5 POWER SPECTRAL DENSITY MEASUREMENT

4.5.1 LIMITS OF POWER SPECTRAL DENSITY MEASUREMENT

The Maximum of Power Spectral Density Measurement is 8dBm.

4.5.2 TEST INSTRUMENTS

DESCRIPTION & MANUFACTURER	MODEL NO.	SERIAL NO.	DATE OF CALIBRATION	DUE DATE OF CALIBRATION
SPECTRUM ANALYZER	FSP 40	100036	Apr. 29, 2011	Apr. 28, 2012

NOTE: The calibration interval of the above test instruments is 12 months and the calibrations are traceable to NML/ROC and NIST/USA.

4.5.3 TEST PROCEDURE

The transmitter output was connected to the spectrum analyzer through an attenuator, the bandwidth of the fundamental frequency was measured with the spectrum analyzer using 3kHz RBW and 30kHz VBW, set sweep time = span/3kHz. The power spectral density was measured and recorded.

The sweep time is allowed to be longer than span/3kHz for a full response of the mixer in the spectrum analyzer.

Follow method 2 of KDB 662911 D01 Multiple Transmitter Output v01 to calculate total power density of 2 TX port.



A D T

4.5.4 DEVIATION FROM TEST STANDARD

No deviation

4.5.5 TEST SETUP

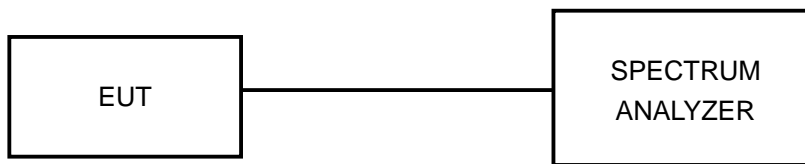

4.5.6 EUT OPERATING CONDITION

Same as Item 4.3.6



A D T

4.5.7 TEST RESULTS

802.11b

CHAIN	CHAN.	CHAN. FREQ. (MHz)	RF POWER LEVEL IN 3kHz BW (dBm)		TOTAL POWER DENSITY (dBm)	MAX. LIMIT (dBm)	PASS / FAIL
			MEASURED	10 log (N=2) dB			
0	1	2412	-12.0	3.01	-9.0	6	PASS
	6	2437	-13.7	3.01	-10.7	6	PASS
	11	2462	-13.8	3.01	-10.8	6	PASS
1	1	2412	-12.9	3.01	-9.9	6	PASS
	6	2437	-13.1	3.01	-10.1	6	PASS
	11	2462	-16.1	3.01	-13.1	6	PASS

NOTE: Directional gain = $5\text{dBi} + 10\log(2) = 8\text{dBi} > 6\text{dBi}$, so the power density limit shall be reduced to $8 - (8 - 6) = 6\text{dBm}$.

FOR CHAIN 0: CH 1

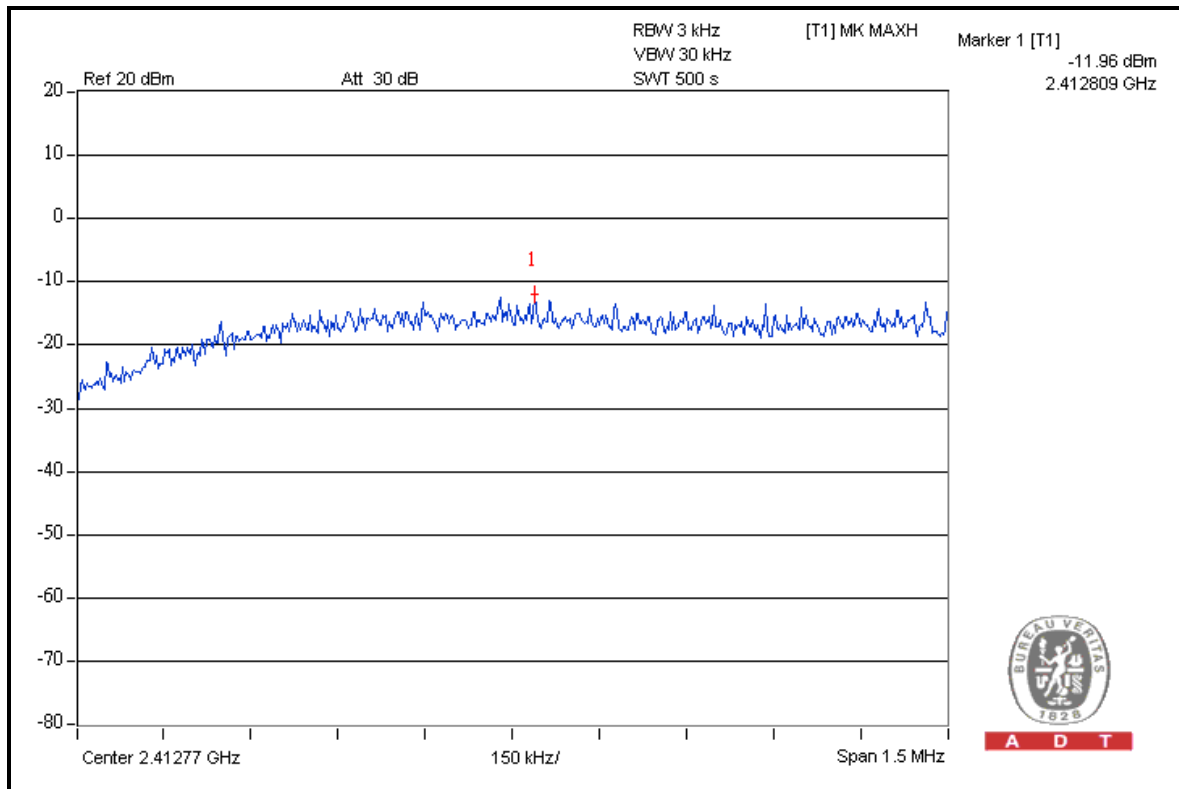



A D T

802.11g

CHAIN	CHAN.	CHAN. FREQ. (MHz)	RF POWER LEVEL IN 3kHz BW (dBm)		TOTAL POWER DENSITY (dBm)	MAX. LIMIT (dBm)	PASS / FAIL
			MEASURED	10 log (N=2) dB			
0	1	2412	-14.0	3.01	-11.0	6	PASS
	6	2437	-11.0	3.01	-8.0	6	PASS
	11	2462	-13.1	3.01	-10.1	6	PASS
1	1	2412	-10.9	3.01	-7.9	6	PASS
	6	2437	-10.9	3.01	-7.9	6	PASS
	11	2462	-8.3	3.01	-5.3	6	PASS

NOTE: Directional gain =5dBi + 10log(2)=8dBi > 6dBi , so the power density limit shall be reduced to 8-(8-6)=6dBm.

FOR CHAIN 1: CH 11

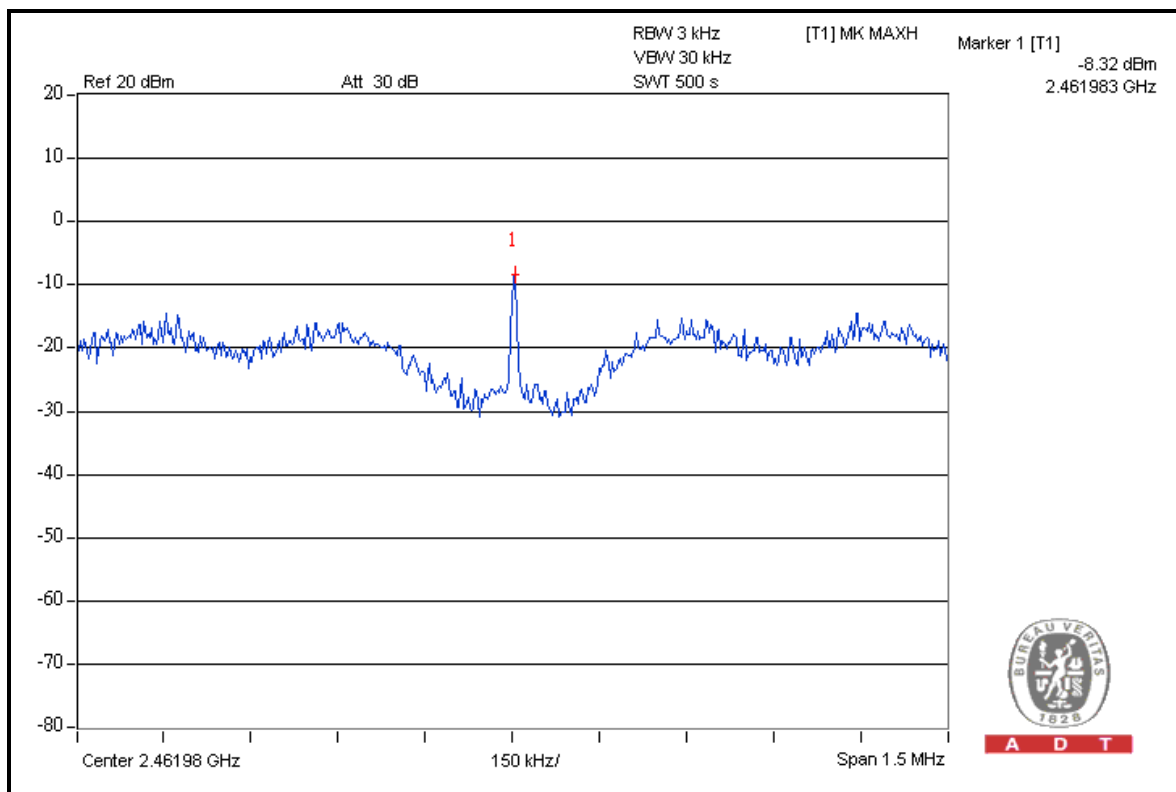

A D T



A D T

802.11n (20MHz)

CHAIN	CHAN.	CHAN. FREQ. (MHz)	RF POWER LEVEL IN 3kHz BW (dBm)		TOTAL POWER DENSITY (dBm)	MAX. LIMIT (dBm)	PASS / FAIL
			MEASURED	10 log (N=2) dB			
0	1	2412	-14.1	3.01	-11.1	8	PASS
	6	2437	-12.1	3.01	-9.1	8	PASS
	11	2462	-13.3	3.01	-10.3	8	PASS
1	1	2412	-9.1	3.01	-6.1	8	PASS
	6	2437	-8.1	3.01	-5.1	8	PASS
	11	2462	-8.1	3.01	-5.1	8	PASS

FOR CHAIN 1: CH 11

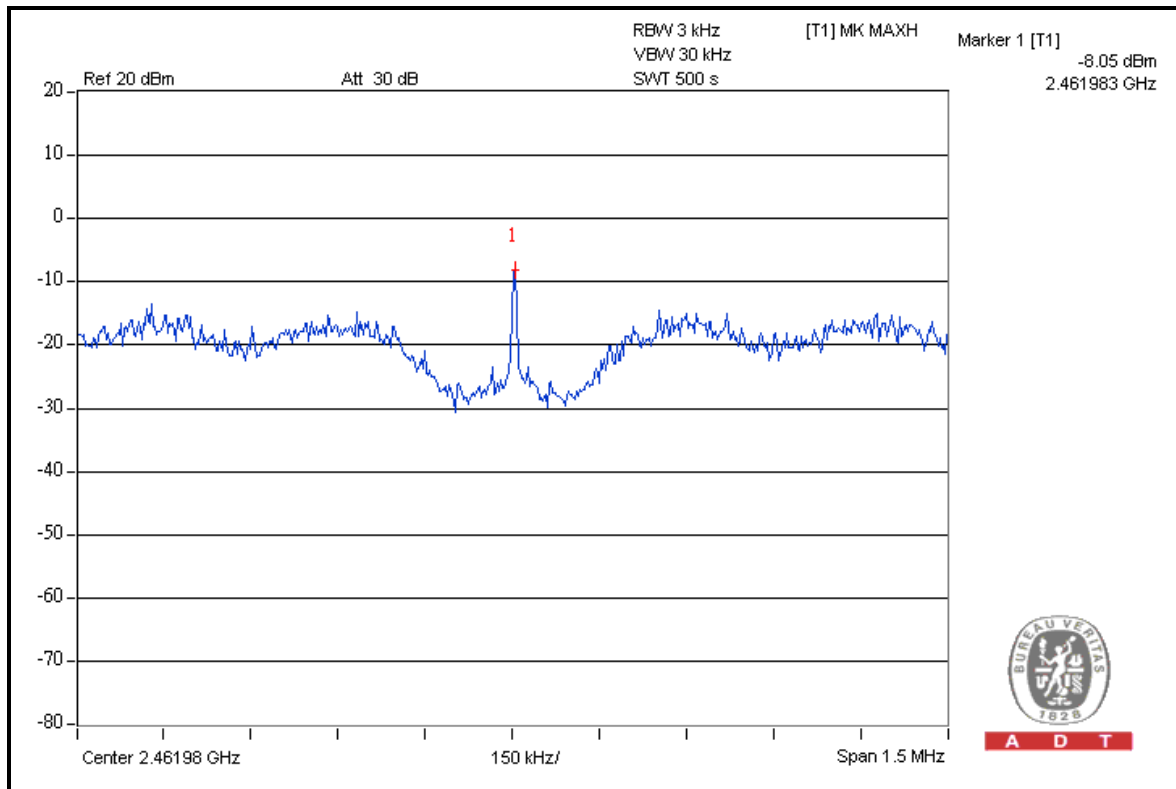

A D T



A D T

4.6 BAND EDGES MEASUREMENT

4.6.1 LIMITS OF BAND EDGES MEASUREMENT

Below -20dB of the highest emission level of operating band (in 100kHz Resolution Bandwidth).

4.6.2 TEST INSTRUMENTS

DESCRIPTION & MANUFACTURER	MODEL NO.	SERIAL NO.	DATE OF CALIBRATION	CALIBRATED UNTIL
FOR CONDUCTED MEASUREMENT:				
SPECTRUM ANALYZER	FSP 40	100036	Apr. 29, 2011	Apr. 28, 2012
FOR RADIATED MEASUREMENT:				
HP Preamplifier	8447D	2432A03504	Mar. 04, 2011	Mar. 03, 2012
HP Preamplifier	8449B	3008A01924	Mar. 04, 2011	Mar. 03, 2012
HP Preamplifier	8449B	3008A01292	Mar. 04, 2011	Mar. 03, 2012
Agilent Spectrum Analyzer	E4446A	MY46180403	Jun. 22, 2011	Jun. 21, 2012
ROHDE & SCHWARZ TEST RECEIVER	ESCS30	838251/021	Oct. 01, 2010	Sep. 30, 2011
Schwarzbeck Antenna	VULB 9168	137	Apr. 12, 2011	Apr. 11, 2012
Schwarzbeck Antenna	VHBA 9123	480	May 06, 2011	May 05, 2012
ADT. Turn Table	TT100	0306	NA	NA
ADT. Tower	AT100	0306	NA	NA
Software	ADT_Radiated_V7.6.15.9.2	NA	NA	NA
SUHNER RF cable	SF102	CABLE-CH6	Aug. 19, 2011	Aug. 18, 2012
EMCO Horn Antenna	3115	6714	Oct. 26, 2010	Oct. 25, 2011
EMCO Horn Antenna	3115	9312-4192	Apr. 22, 2011	Apr. 21, 2012
Highpass filter Wainwright Instruments	WHK 3.1/18G-10SS	SN 8	NA	NA

NOTE: The calibration interval of the above test instruments is 12/24 months. And the calibrations are traceable to NML/ROC and NIST/USA.



4.6.3 TEST PROCEDURE

FOR CONDUCTED MEASUREMENT:

The transmitter output was connected to the spectrum analyzer via a low loss cable. Set both RBW and VBW of spectrum analyzer to 100kHz and 300kHz with suitable frequency span including 100MHz bandwidth from band edge. The band edges was measured and recorded.

The spectrum plots (Peak RBW =100kHz, VBW = 300kHz; Average RBW = 1MHz, VBW = 10Hz) are attached on the following pages.

FOR RADIATED MEASUREMENT:

- a. The EUT was placed on the top of a rotating table 0.8 meters above the ground at a 3 meter semi-anechoic chamber. The table was rotated 360 degrees to determine the position of the highest radiation.
- b. The EUT was set 3 meters away from the interference-receiving antenna, which was mounted on the top of a variable-height antenna tower.
- c. The height of antenna is varied from one meter to four meters above the ground to determine the maximum value of the field strength. Both horizontal and vertical polarizations of the antenna are set to make the measurement.
- d. For each suspected emission, the EUT was arranged to its worst case and then the antenna was tuned to heights from 1 meter to 4 meters and the rotatable table was turned from 0 degrees to 360 degrees to find the maximum reading.
- e. Set both RBW and VBW of spectrum analyzer to 100kHz and 300kHz with suitable frequency span including 100MHz bandwidth from band edge. The band edges was measured and recorded.

The spectrum plots (Peak RBW =100kHz, VBW = 300kHz; Average RBW = 1MHz, VBW = 10Hz) are attached on the following pages.

NOTE: The resolution bandwidth of test receiver/spectrum analyzer is 1MHz and the video bandwidth is 10Hz for Average detection (AV) at frequency above 1GHz.

4.6.4 DEVIATION FROM TEST STANDARD

No deviation

4.6.5 EUT OPERATING CONDITION

Same as Item 4.3.6



4.6.6 TEST RESULTS

The spectrum plots are attached on the following pages. D1 line indicates the highest level, and D2 line indicates the 20dB offset below D1. It shows compliance with the requirement in part 15.247(d).

802.11b

RESTRICT BAND (2310 ~ 2390 MHz)

FREQUENCY (MHz)	FUNDAMENTAL EMISSION (dBuV/m)	DELTA (dB)	MAXIMUM FIELD STRENGTH IN RESTRICT BAND (dBuV/m)	LIMIT (dBuV/m)
2412.00 (PK)	108.9	52.2	56.7	74.0
2412.00 (AV)	103.8	59.7	44.1	54.0

RESTRICT BAND (2483.5 ~ 2500 MHz)

FREQUENCY (MHz)	FUNDAMENTAL EMISSION (dBuV/m)	DELTA (dB)	MAXIMUM FIELD STRENGTH IN RESTRICT BAND (dBuV/m)	LIMIT (dBuV/m)
2462.00 (PK)	106.3	48.8	57.5	74.0
2462.00 (AV)	103.8	59.9	43.9	54.0

NOTE:

1. Delta = Amplitude between the peak of the fundamental and the peak of the band edge emission. Please check following 2 pages.
2. Maximum field strength in restrict band = Fundamental emission – Delta.



A D T

FOR RADIATED MEASURED (TWO CHAINS ON)

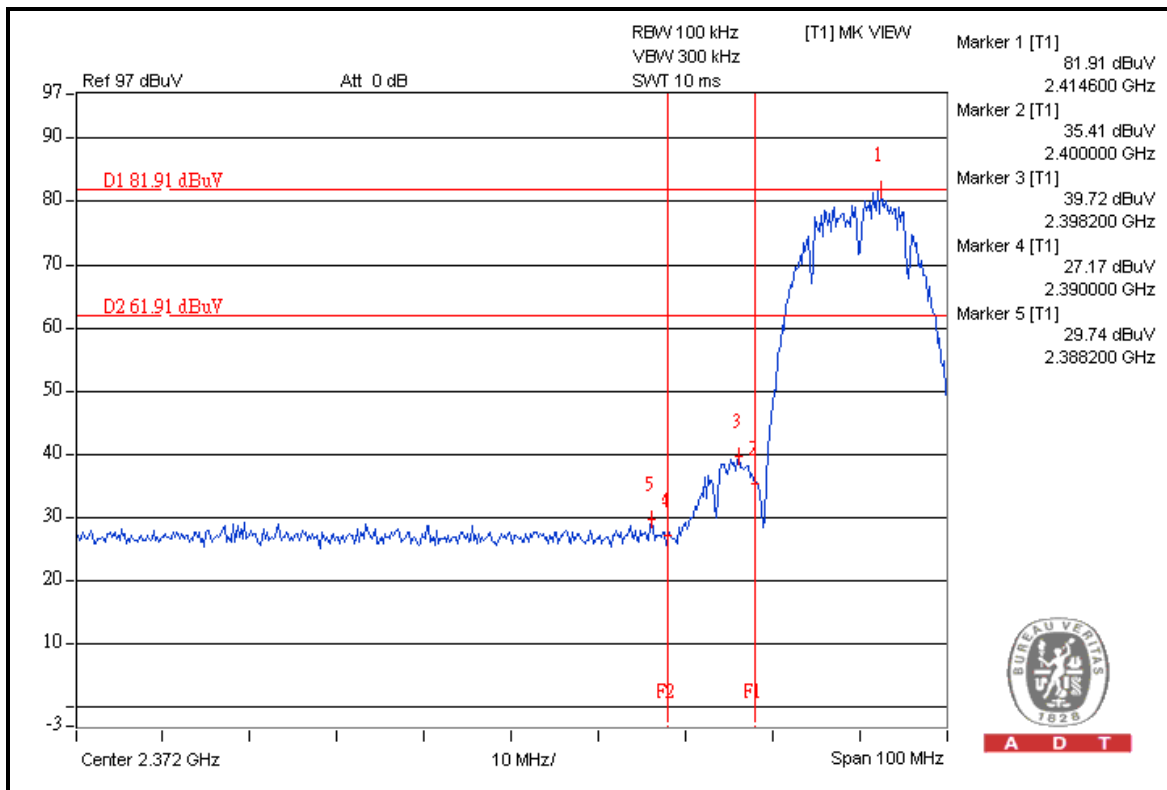

A D T

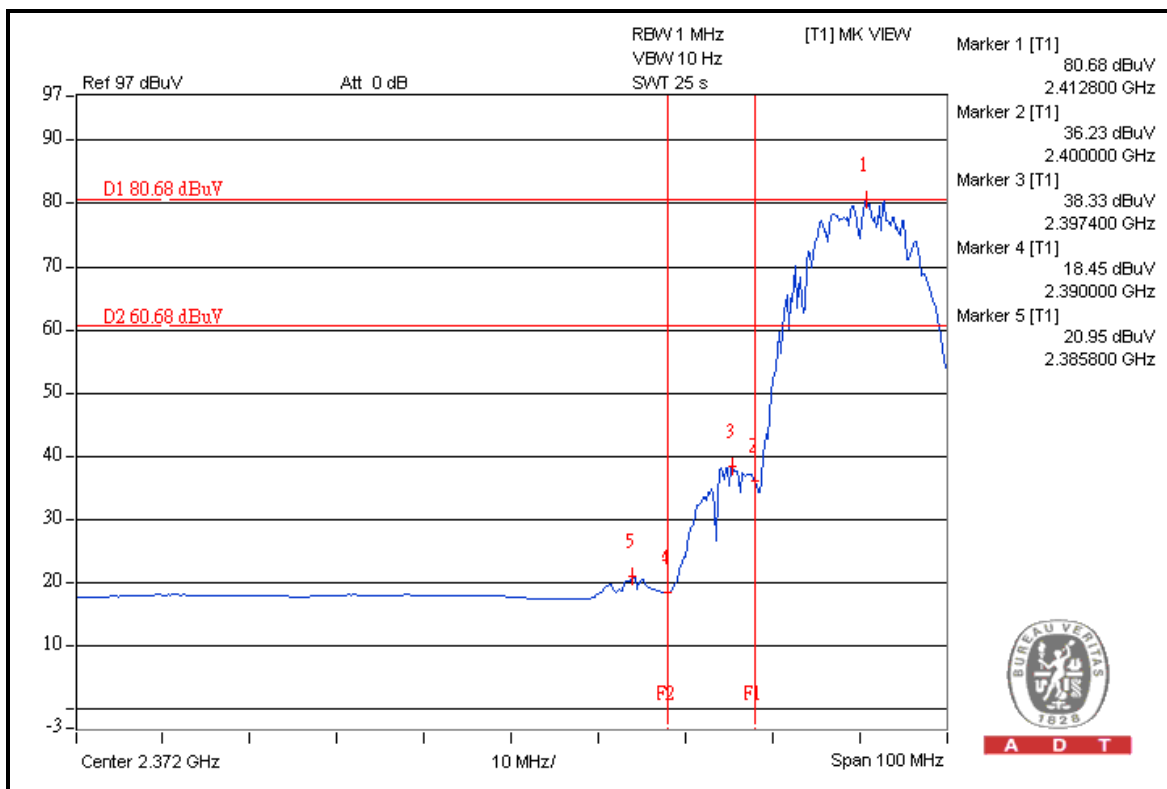

A D T



A D T

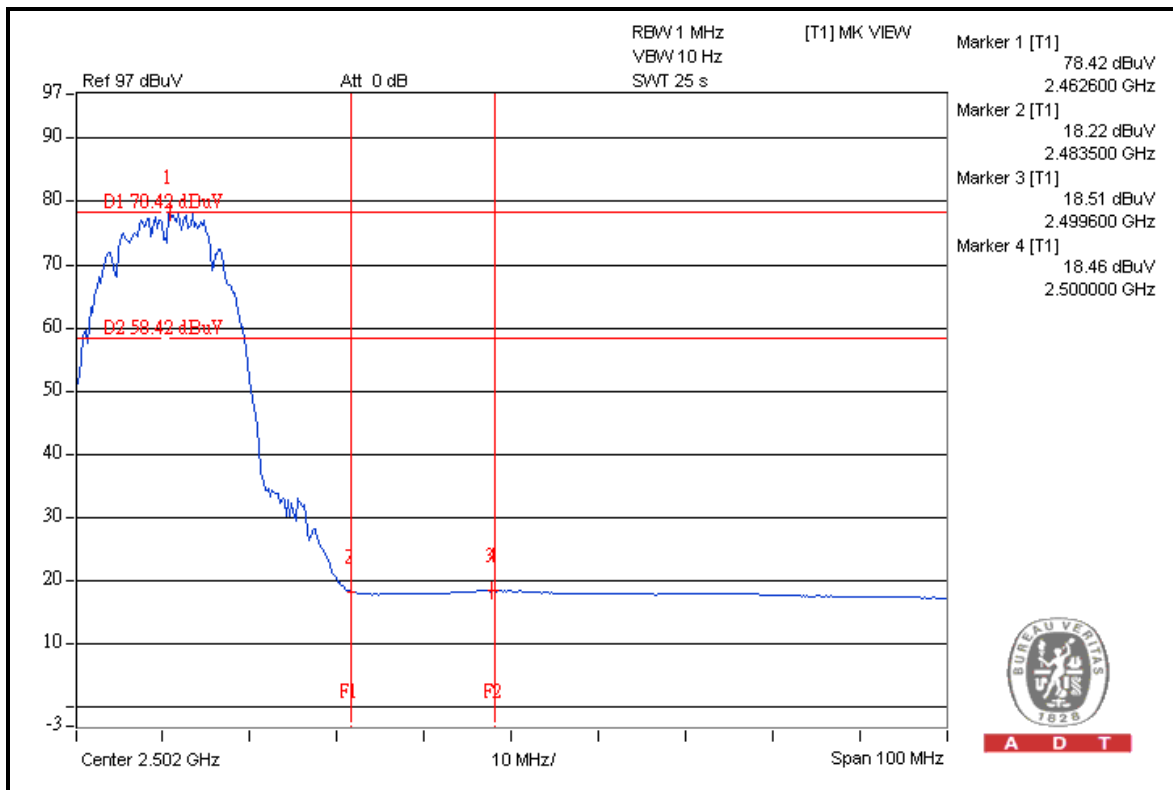
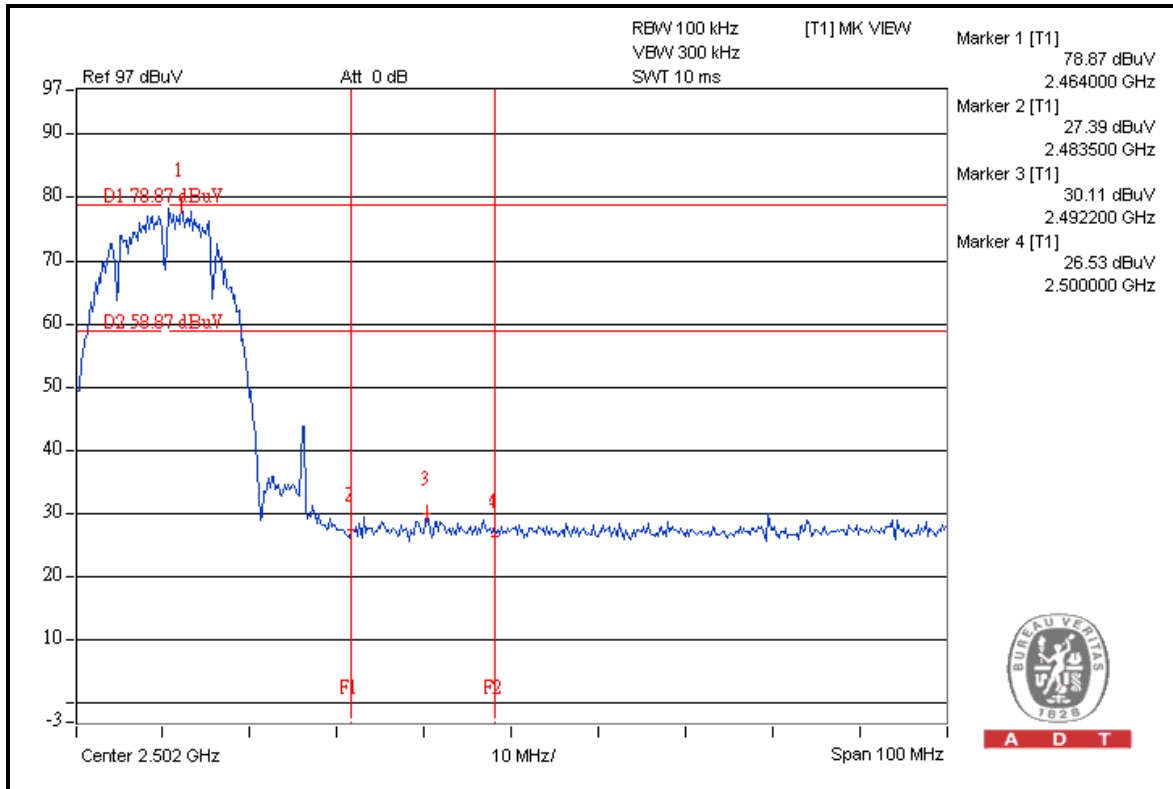



A D T

FOR CONDUCTED MEASURED CHAIN 0

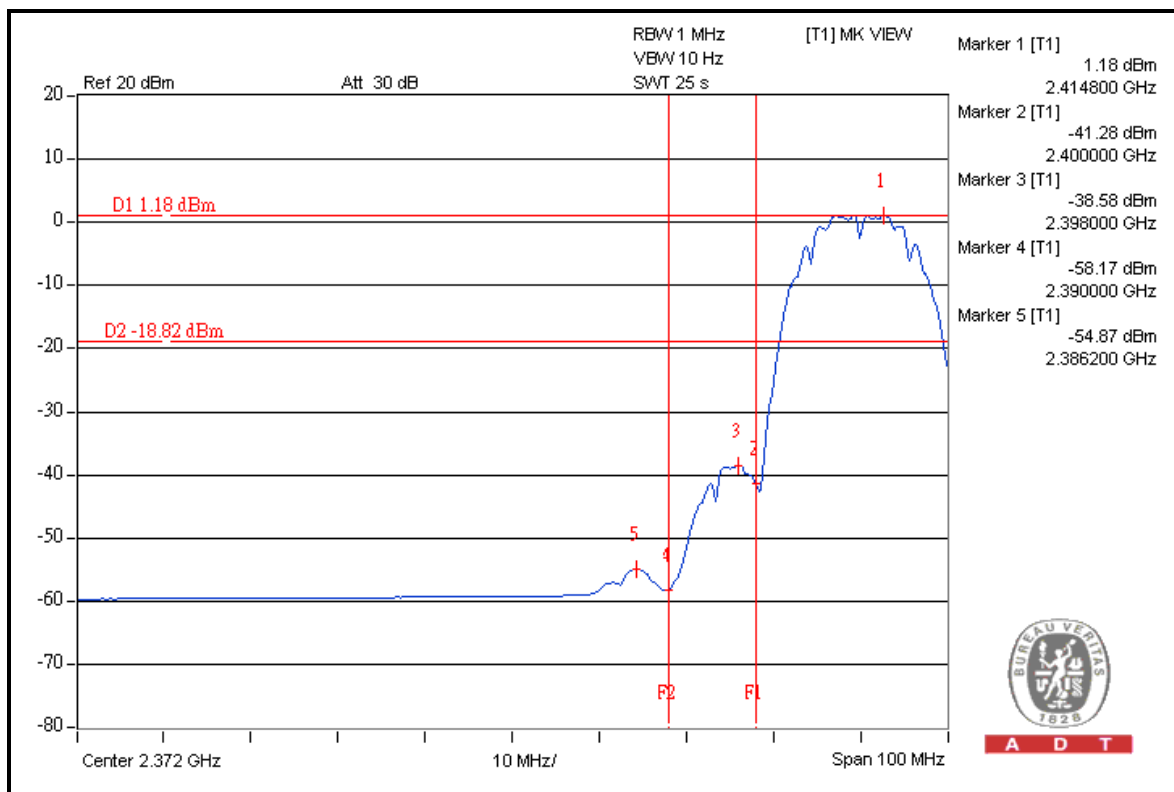
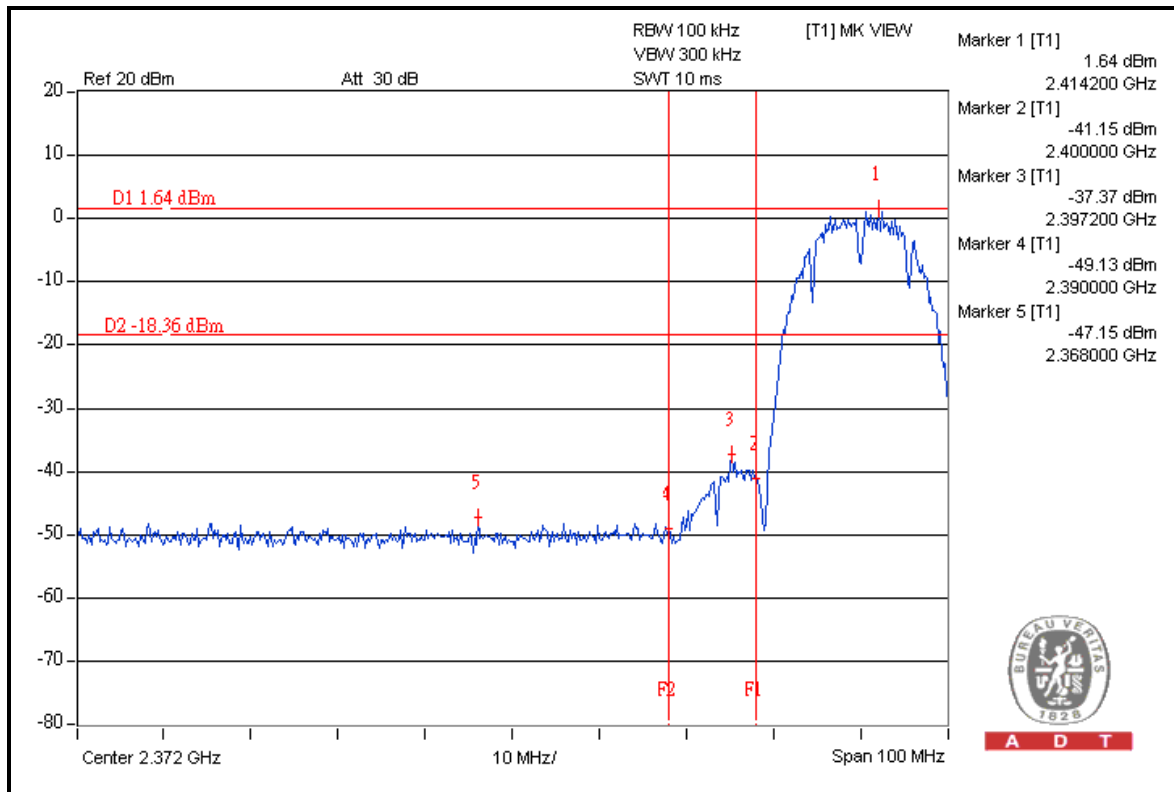



A D T

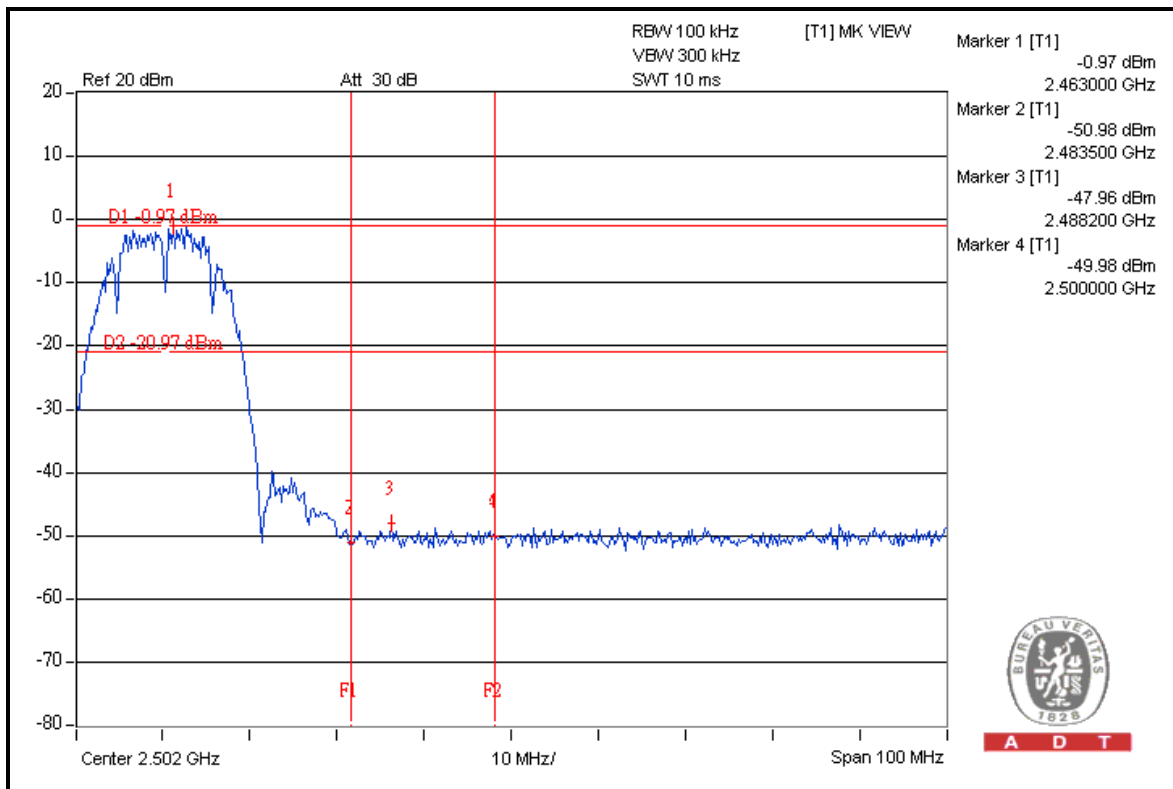
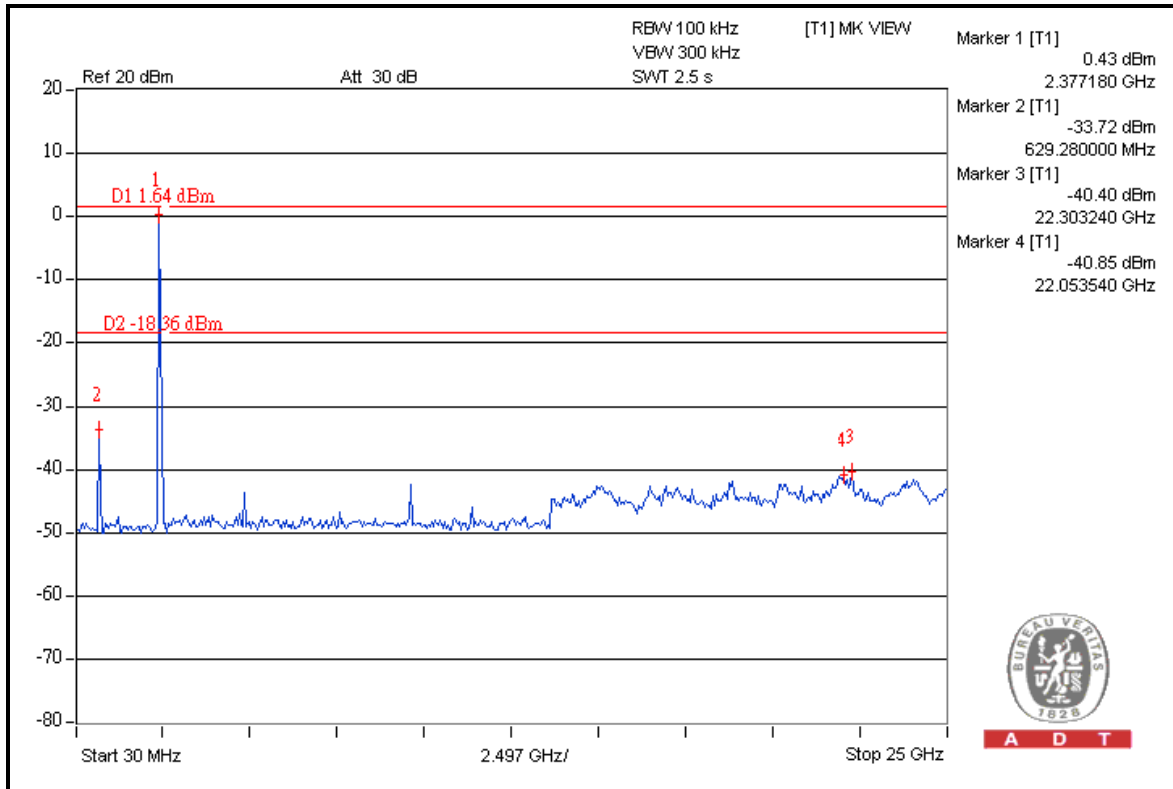



A D T

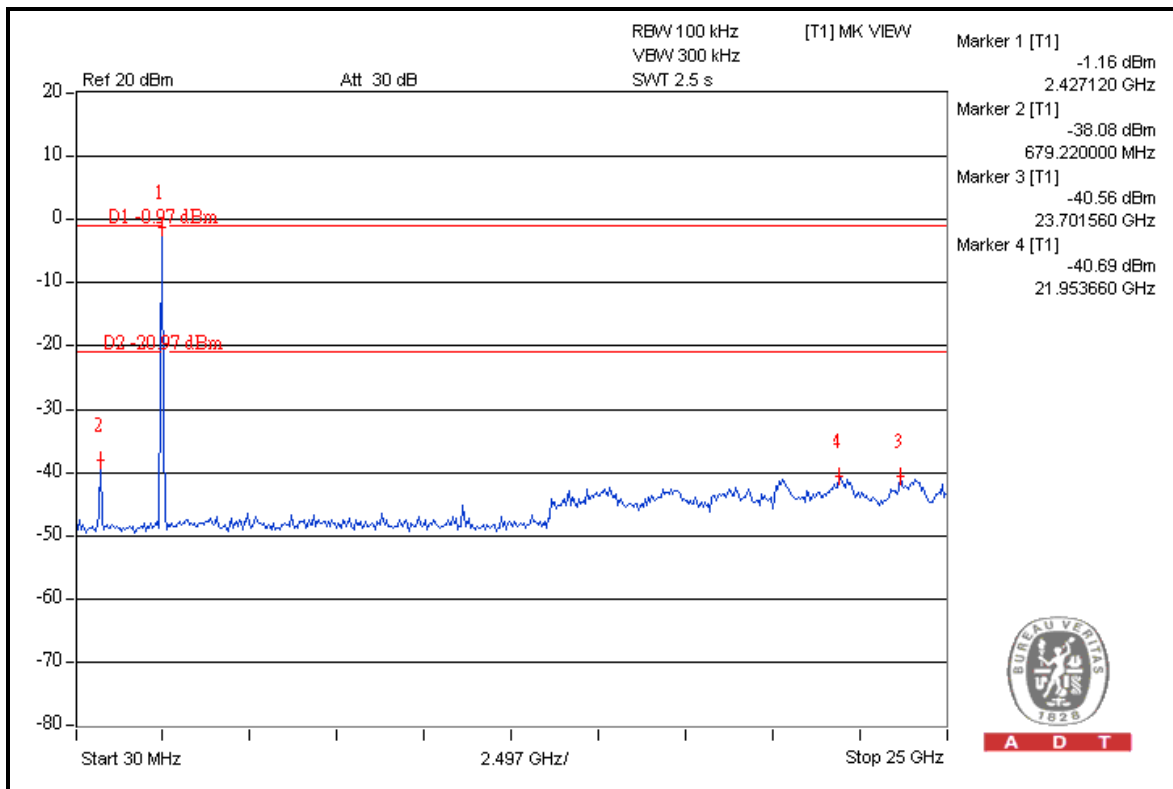
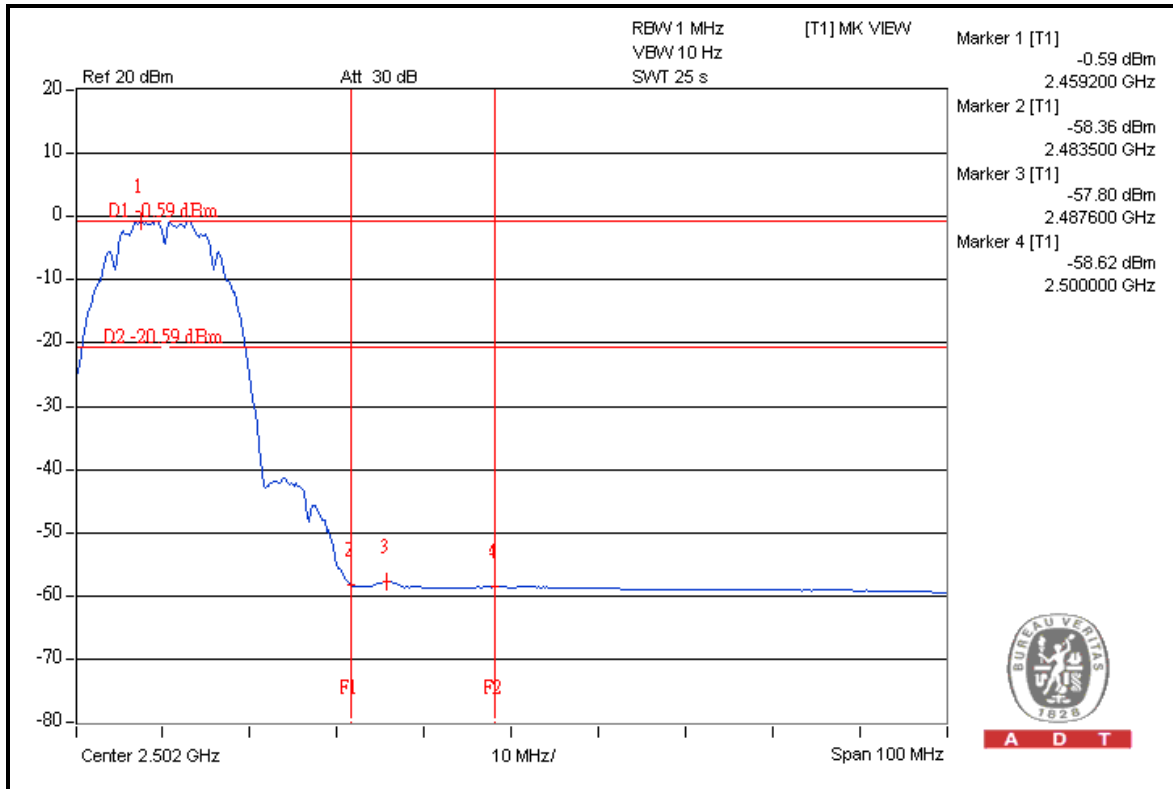



A D T

CHAIN 1

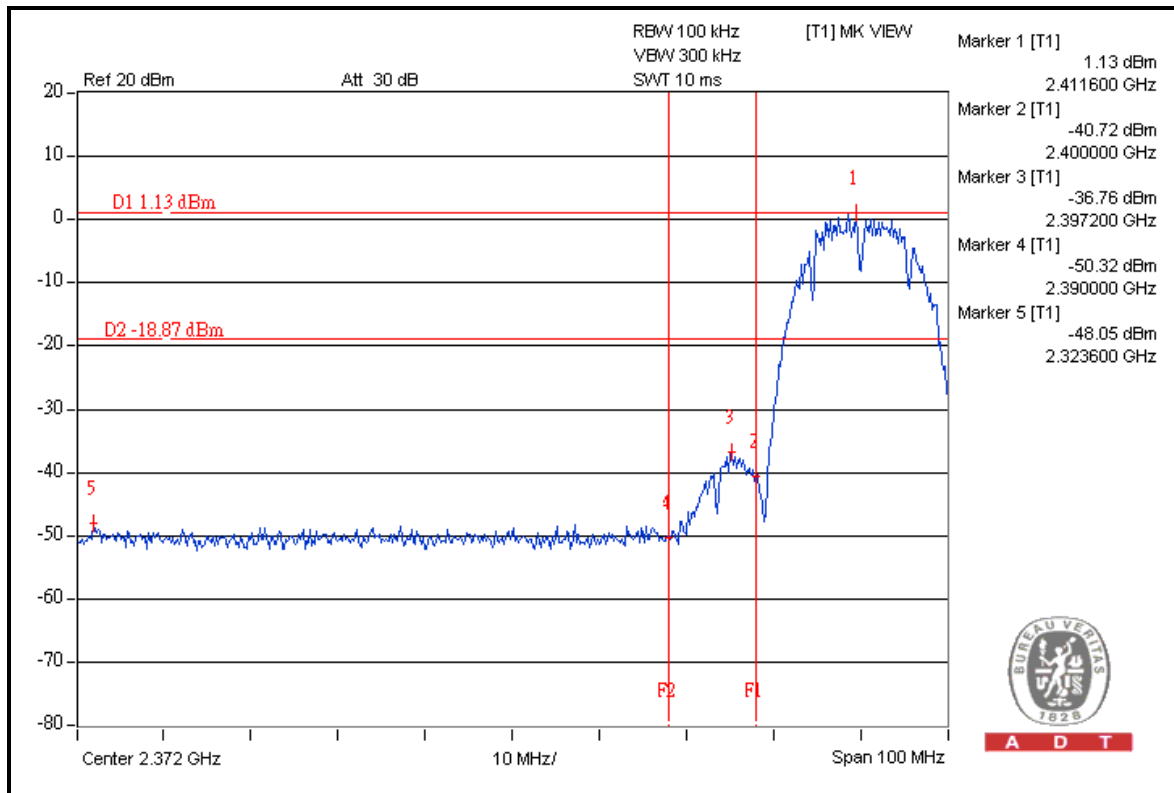

A D T

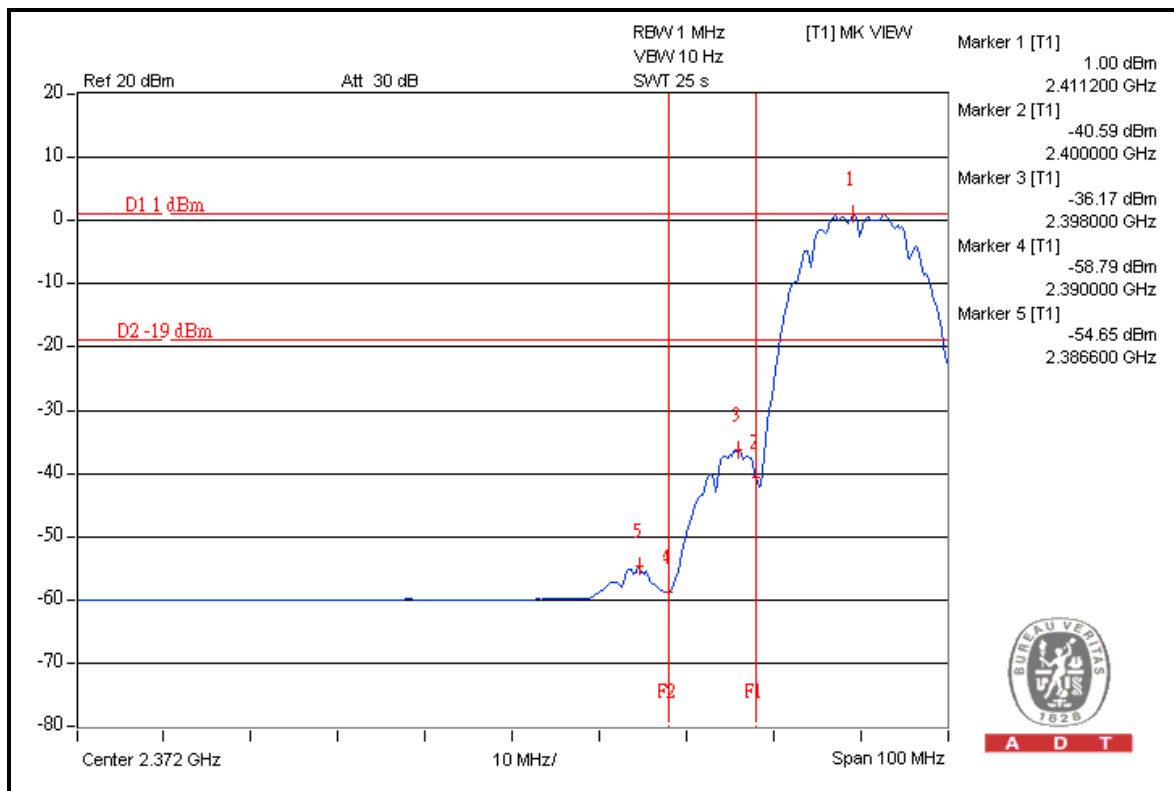

A D T



A D T

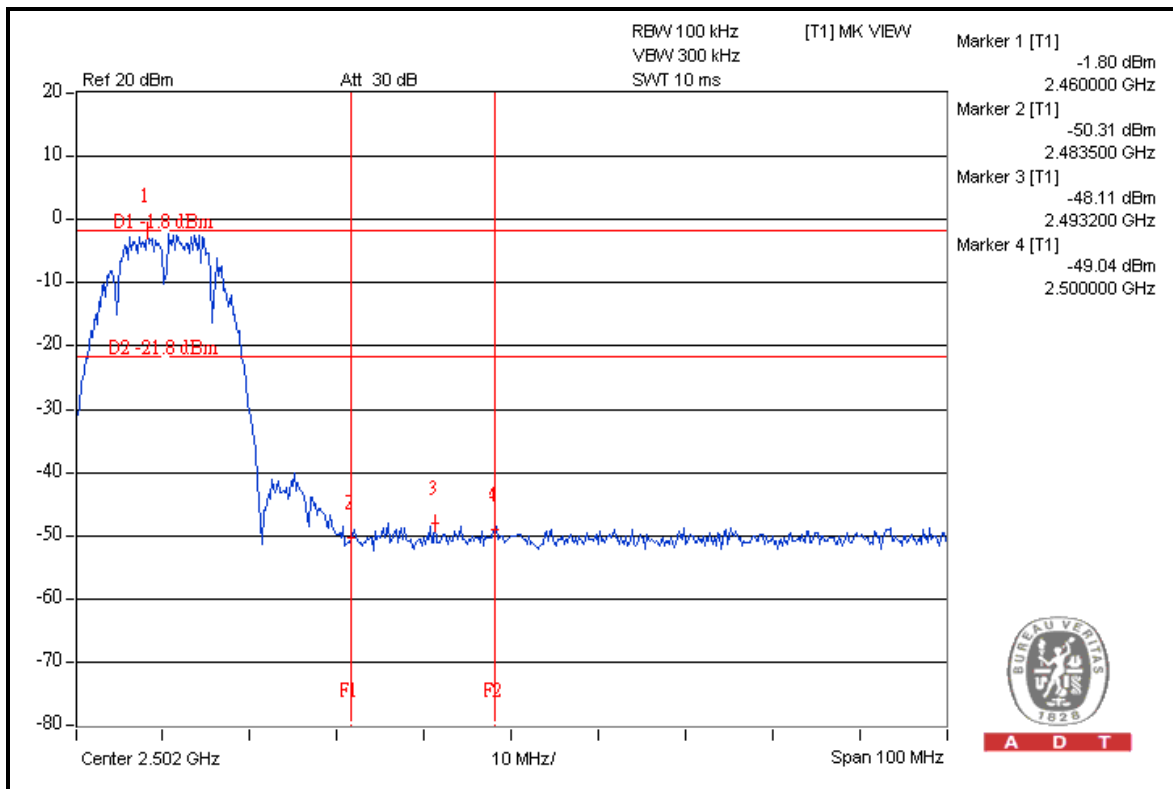
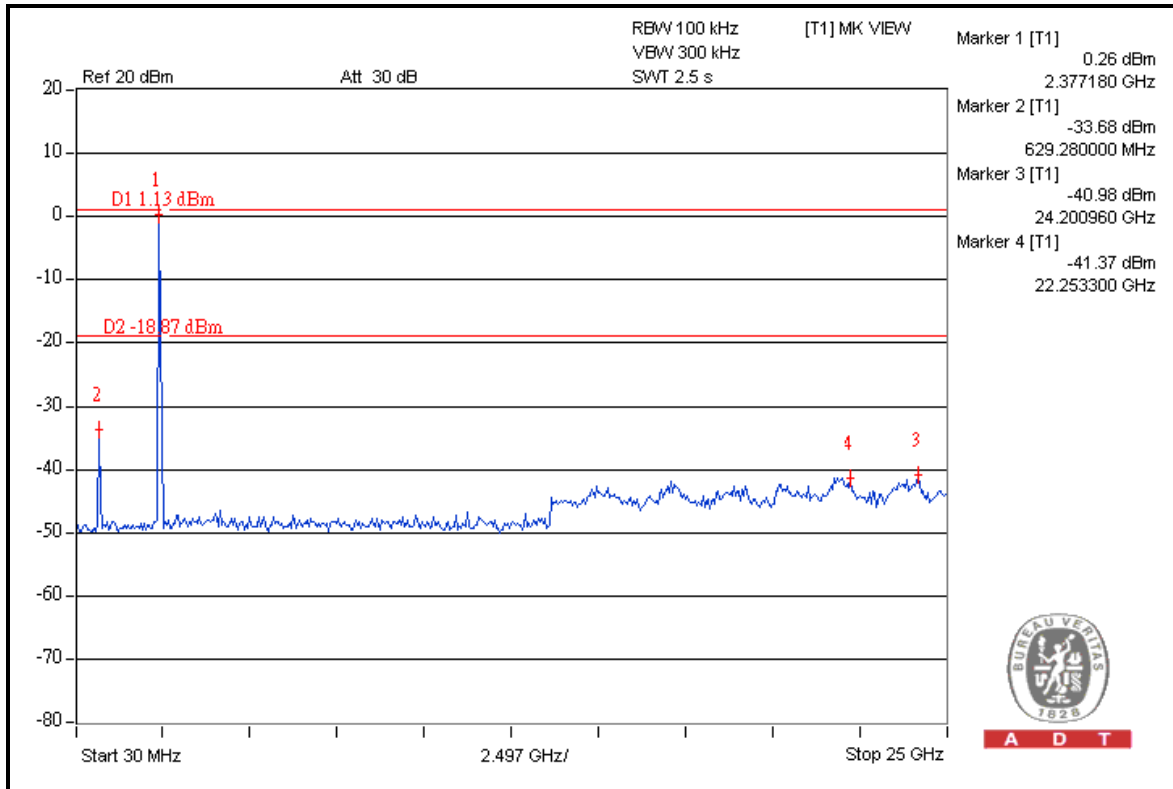



A D T

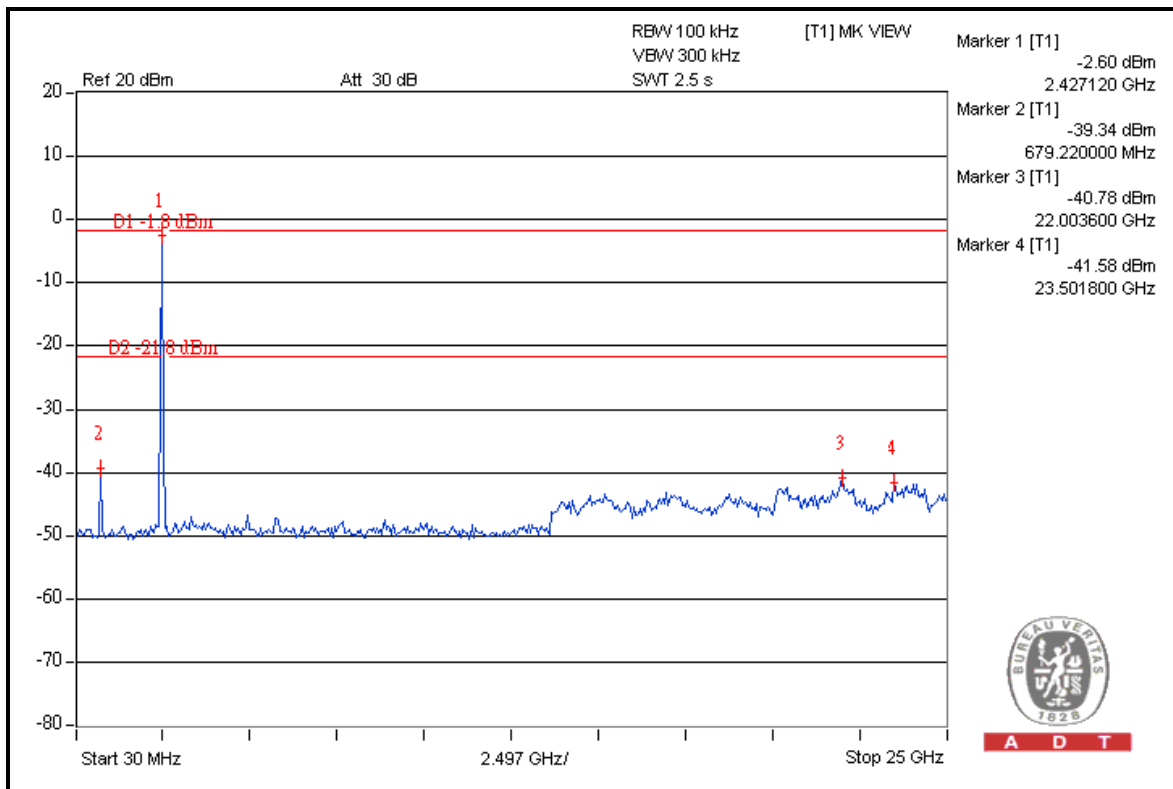
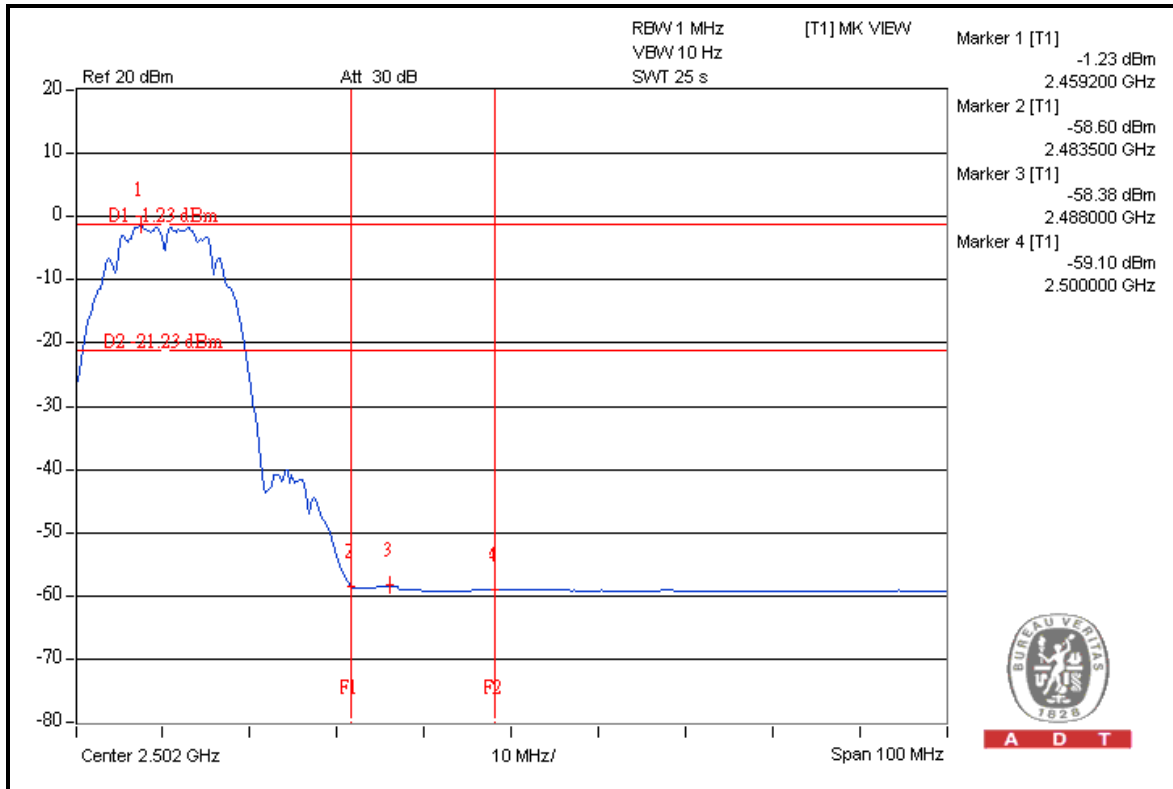



A D T

802.11g

RESTRICT BAND (2310 ~ 2390 MHz)

FREQUENCY (MHz)	FUNDAMENTAL EMISSION (dBuV/m)	DELTA (dB)	MAXIMUM FIELD STRENGTH IN RESTRICT BAND (dBuV/m)	LIMIT (dBuV/m)
2412.00 (PK)	114.2	47.0	67.2	74.0
2412.00 (AV)	103.0	52.1	50.9	54.0

RESTRICT BAND (2483.5 ~ 2500 MHz)

FREQUENCY (MHz)	FUNDAMENTAL EMISSION (dBuV/m)	DELTA (dB)	MAXIMUM FIELD STRENGTH IN RESTRICT BAND (dBuV/m)	LIMIT (dBuV/m)
2462.00 (PK)	113.6	46.9	66.7	74.0
2462.00 (AV)	102.6	53.0	49.6	54.0

NOTE:

1. Delta = Amplitude between the peak of the fundamental and the peak of the band edge emission. Please check following 2 pages.
2. Maximum field strength in restrict band = Fundamental emission – Delta.



A D T

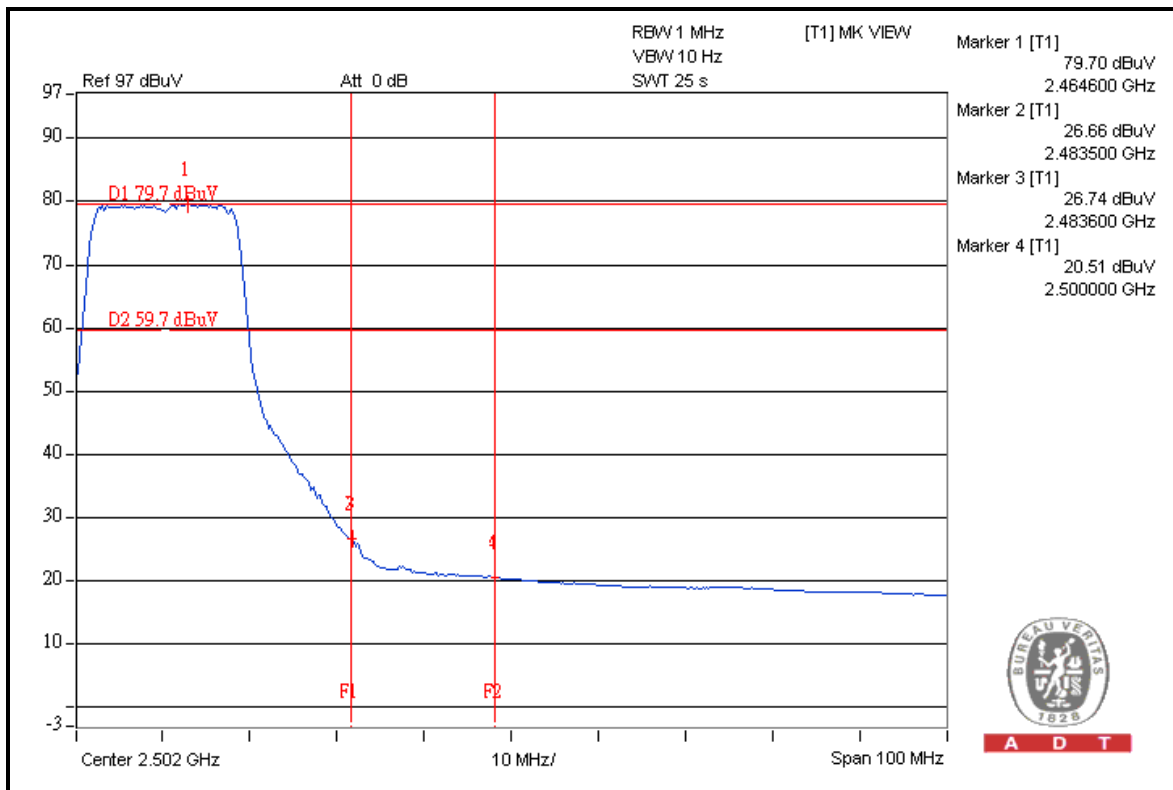
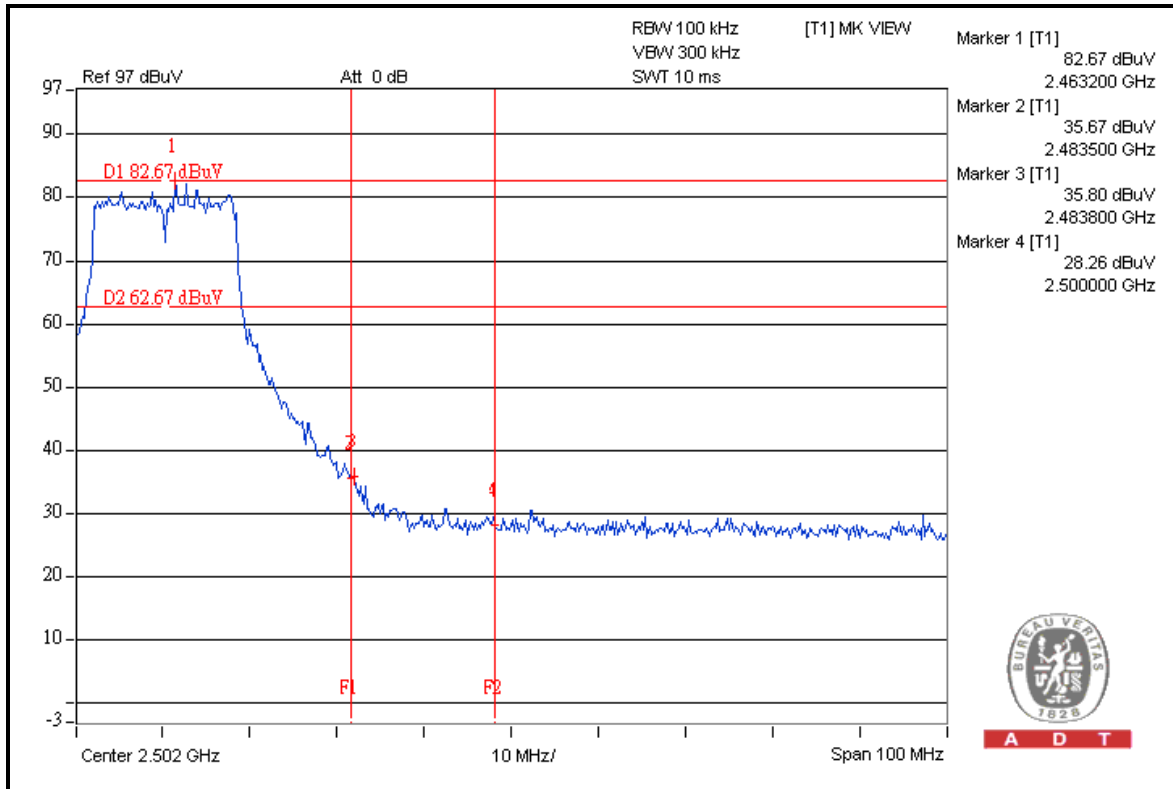



A D T

FOR CONDUCTED MEASURED CHAIN 0

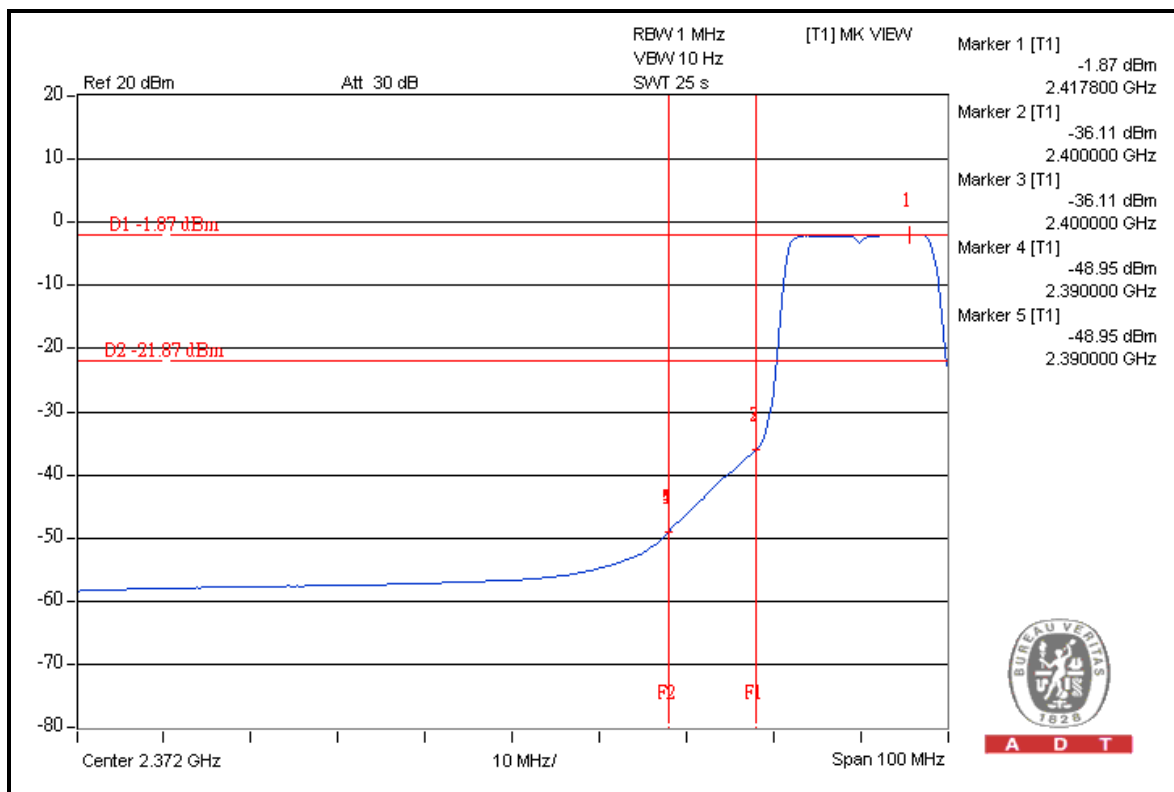
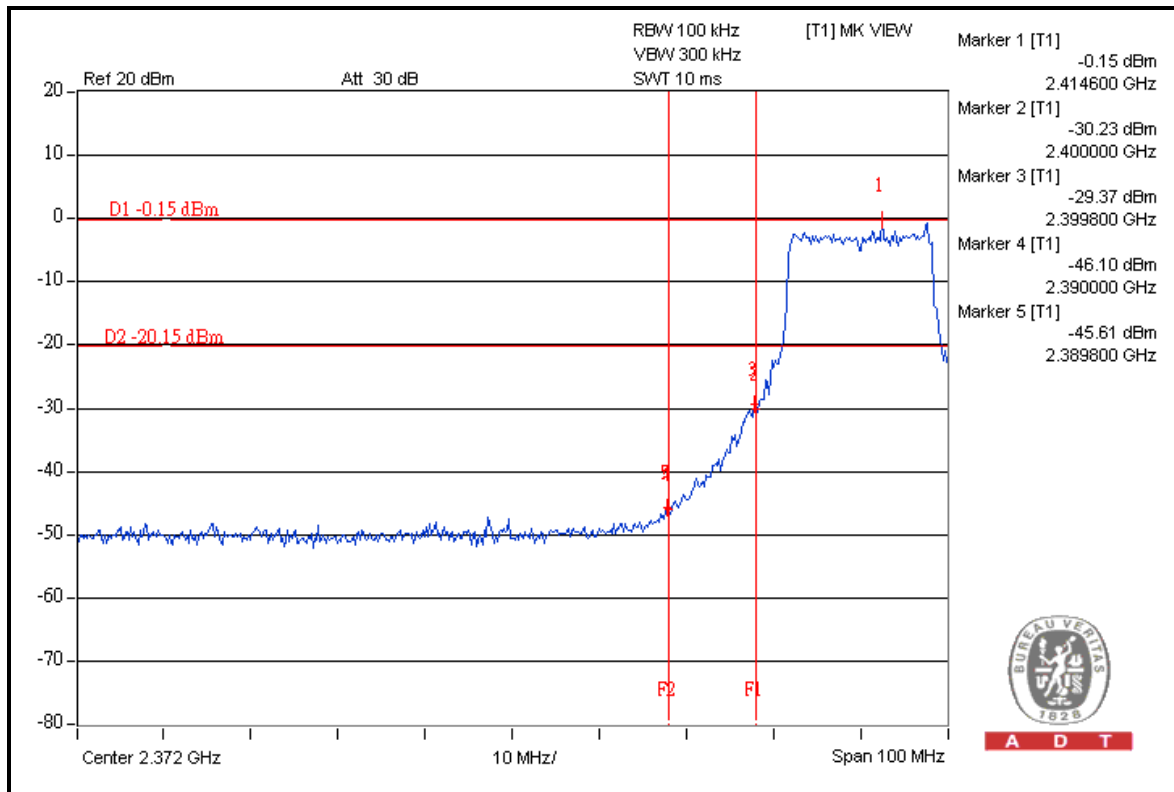



A D T

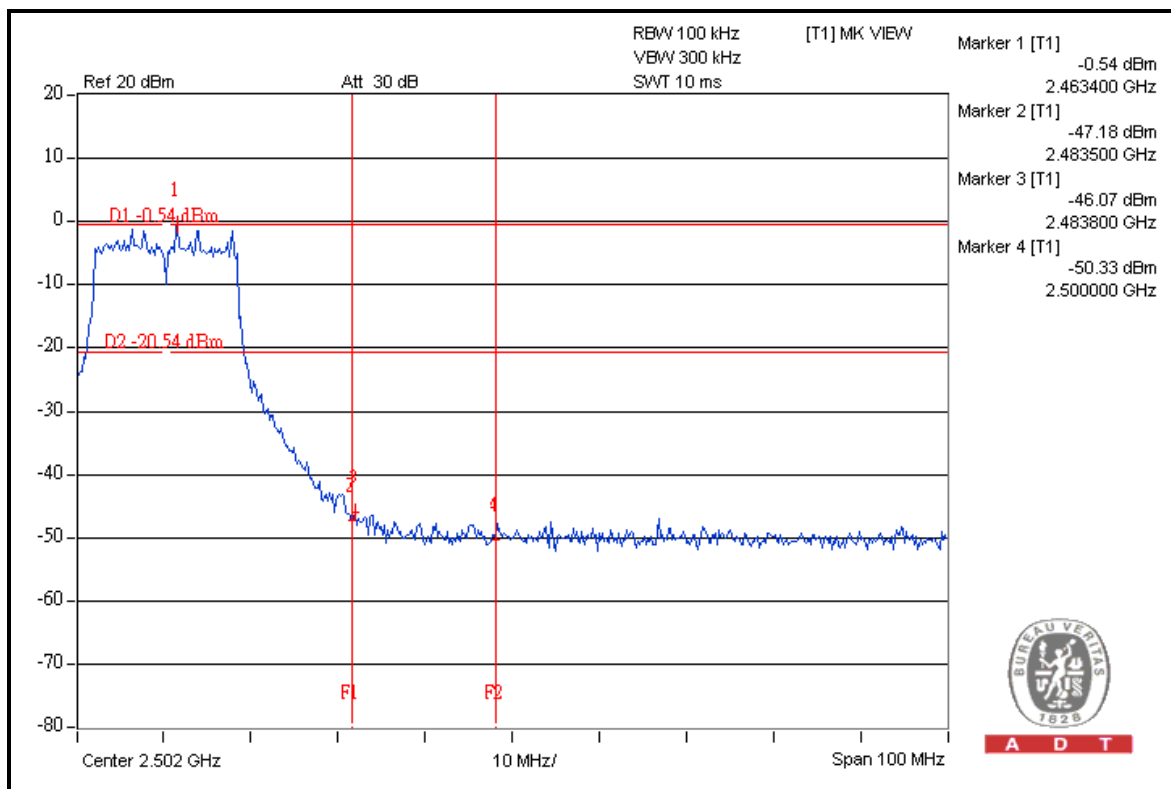
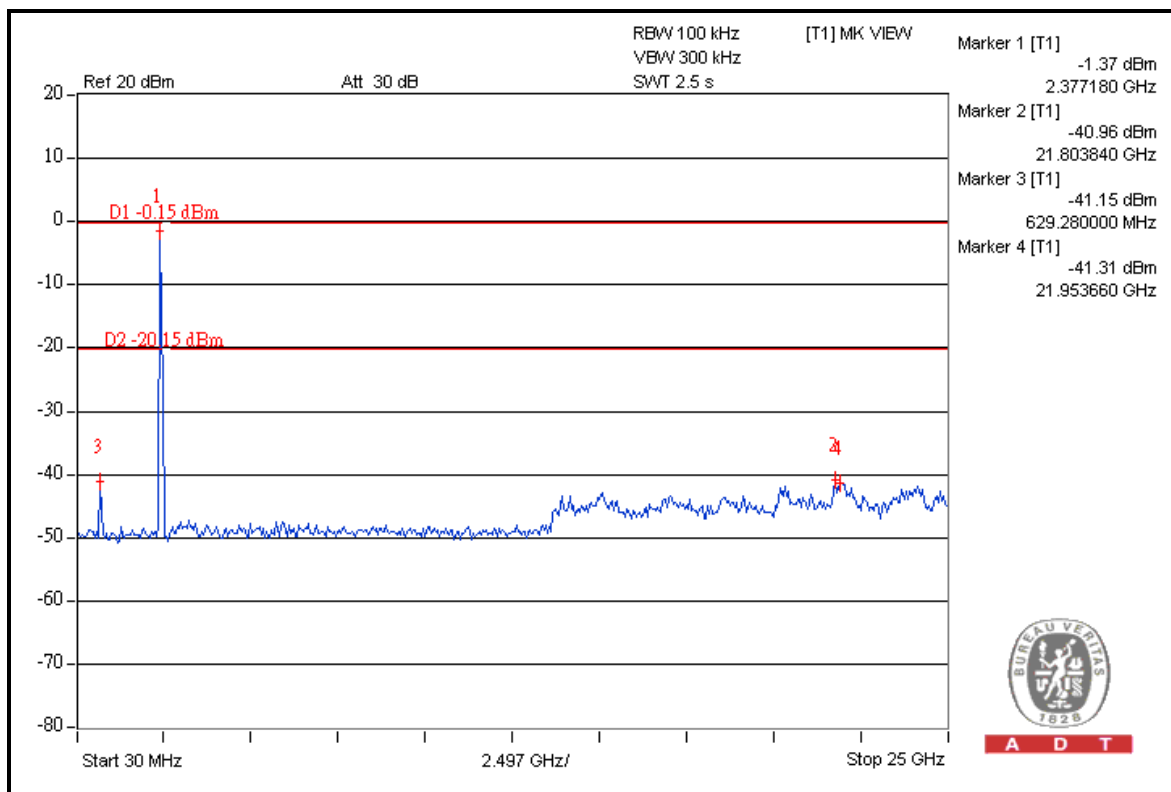



A D T

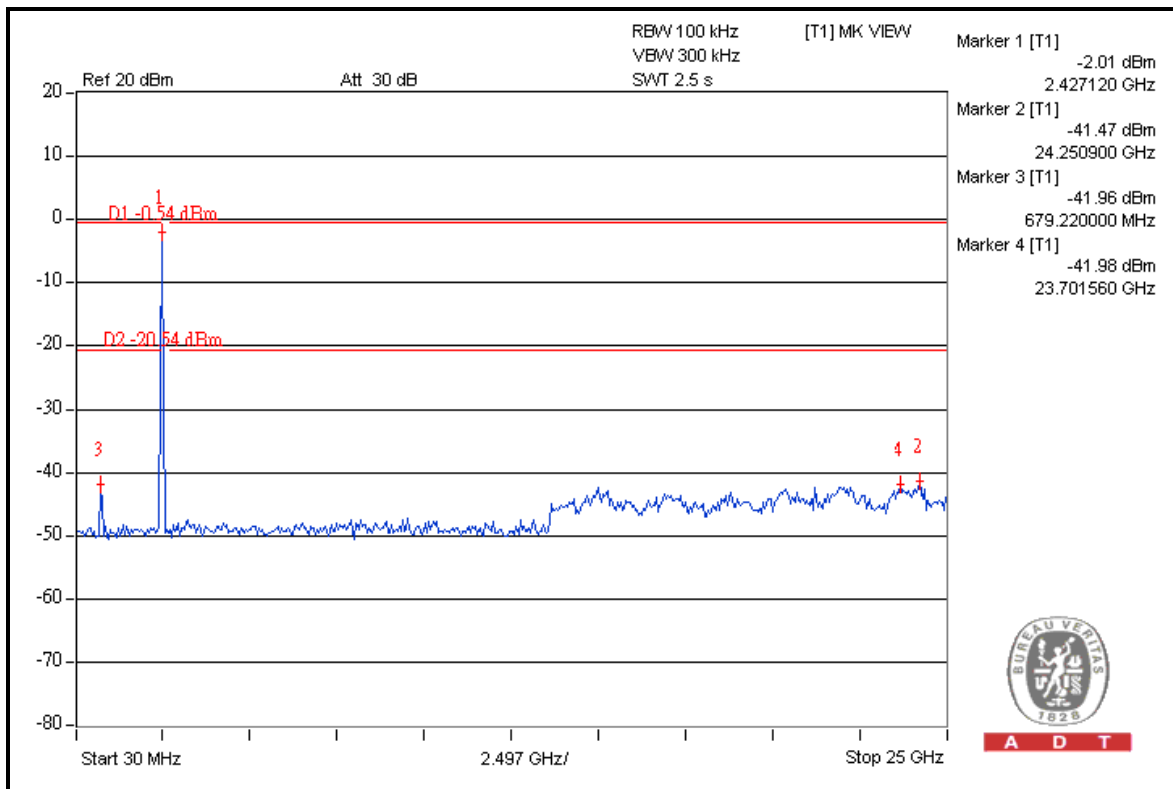
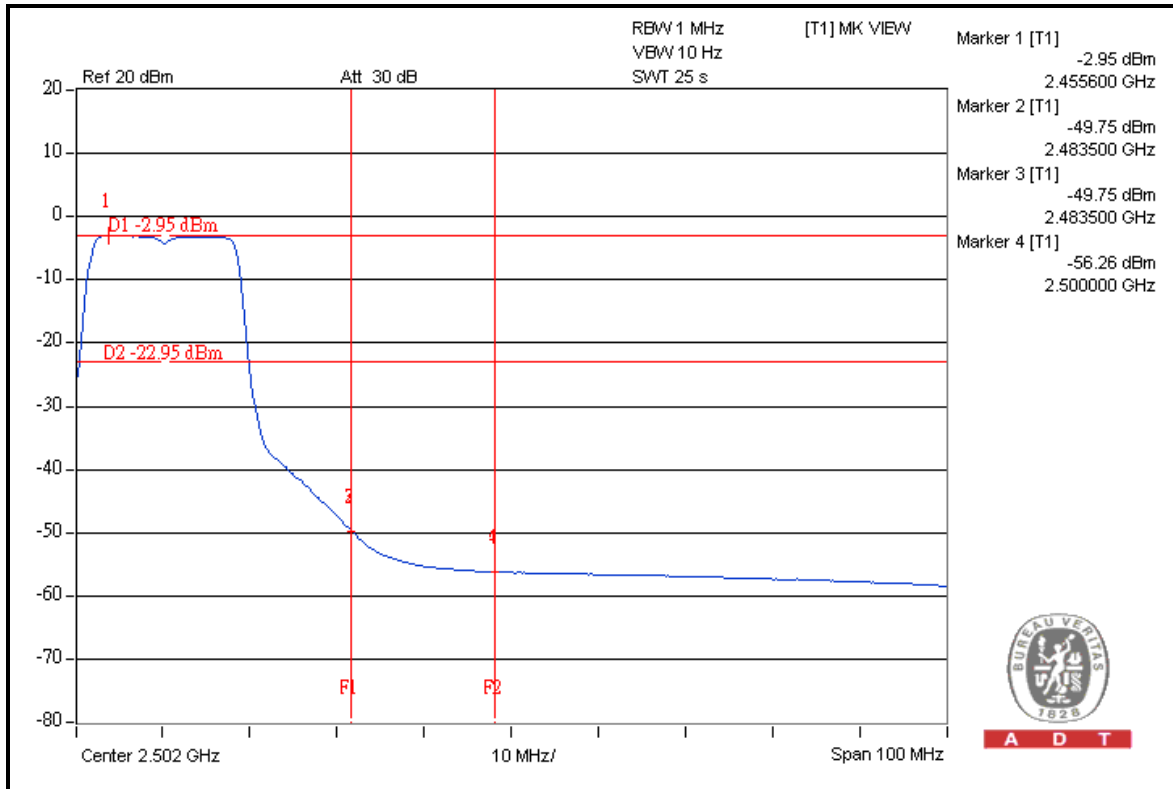



A D T

CHAIN 1

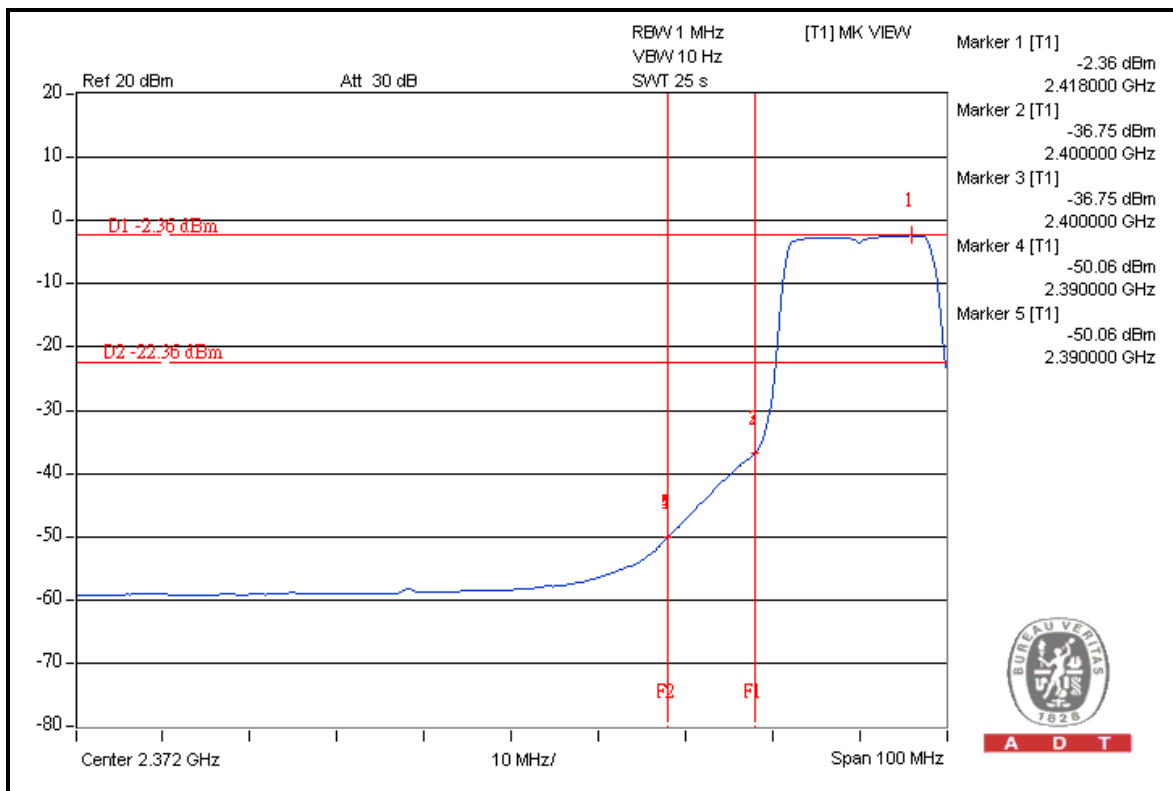
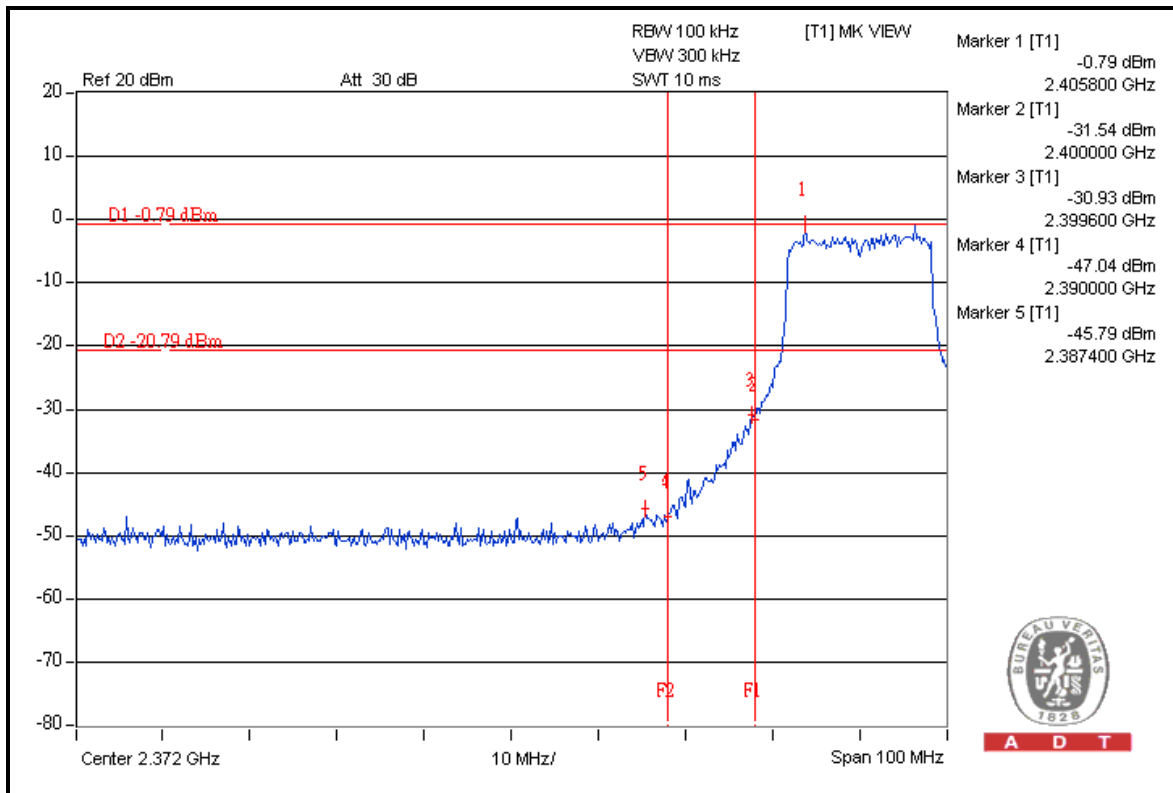



A D T

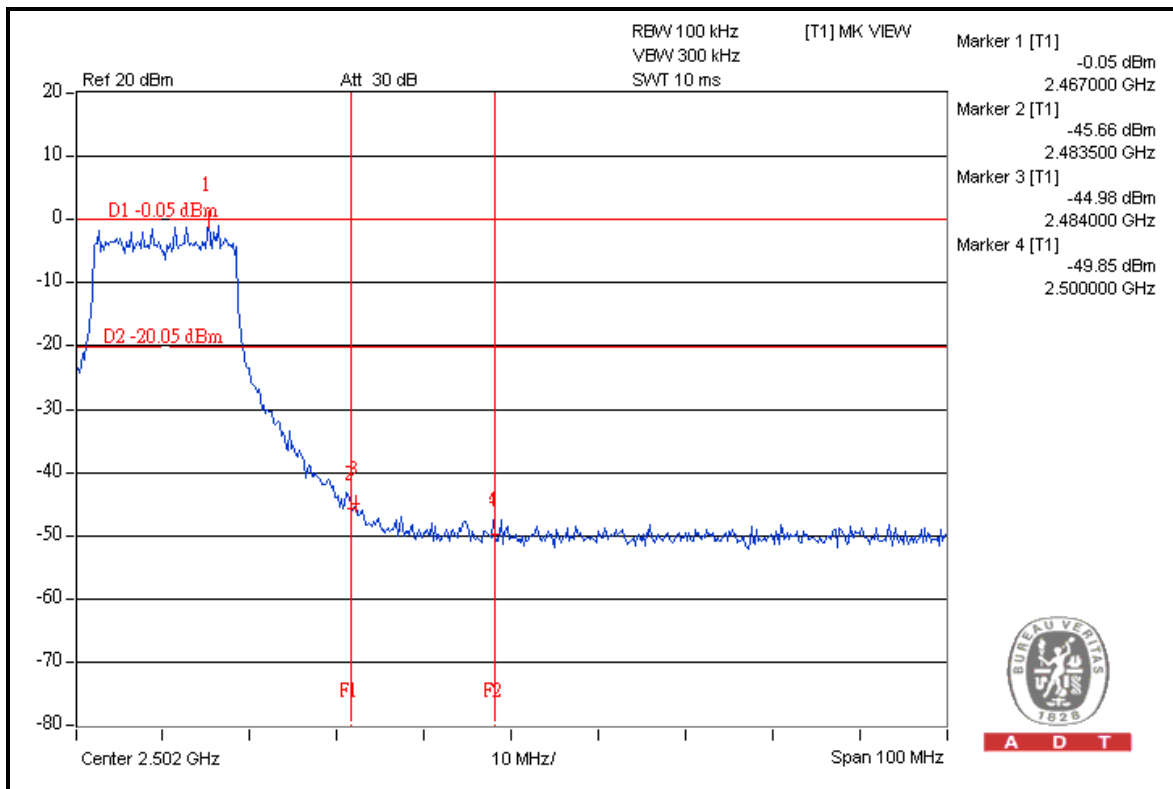
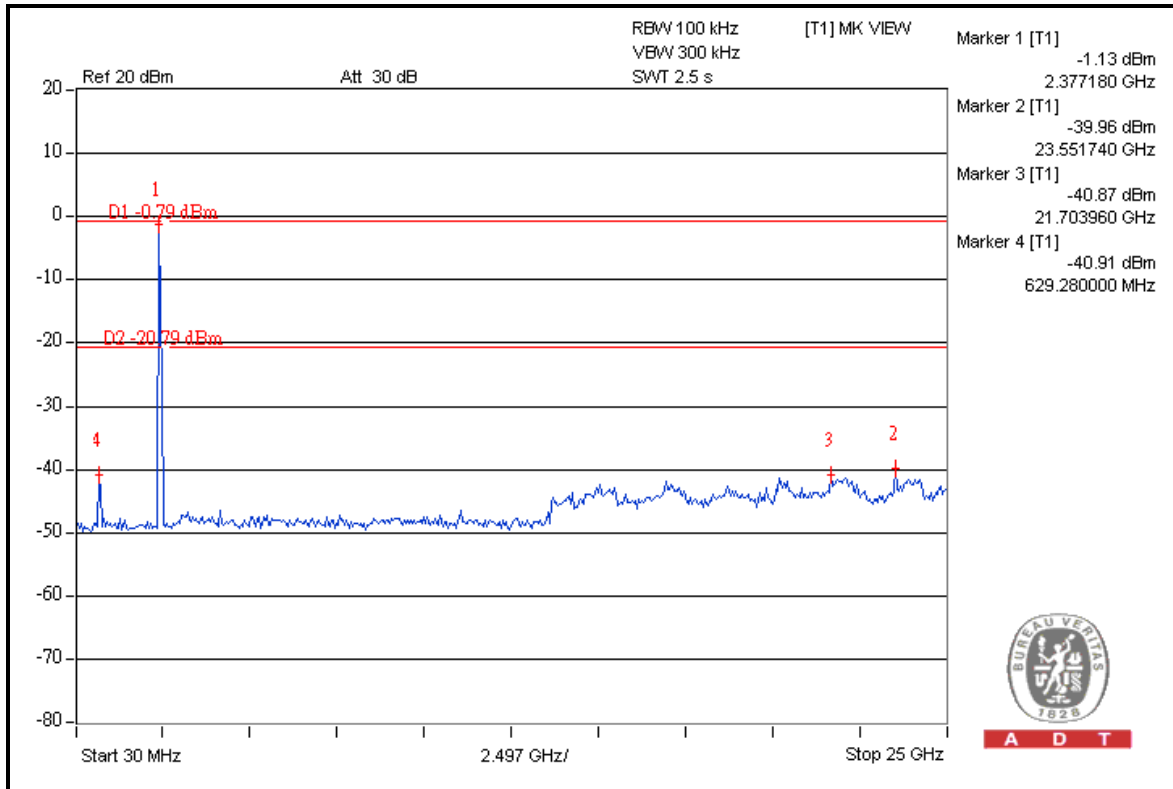



A D T

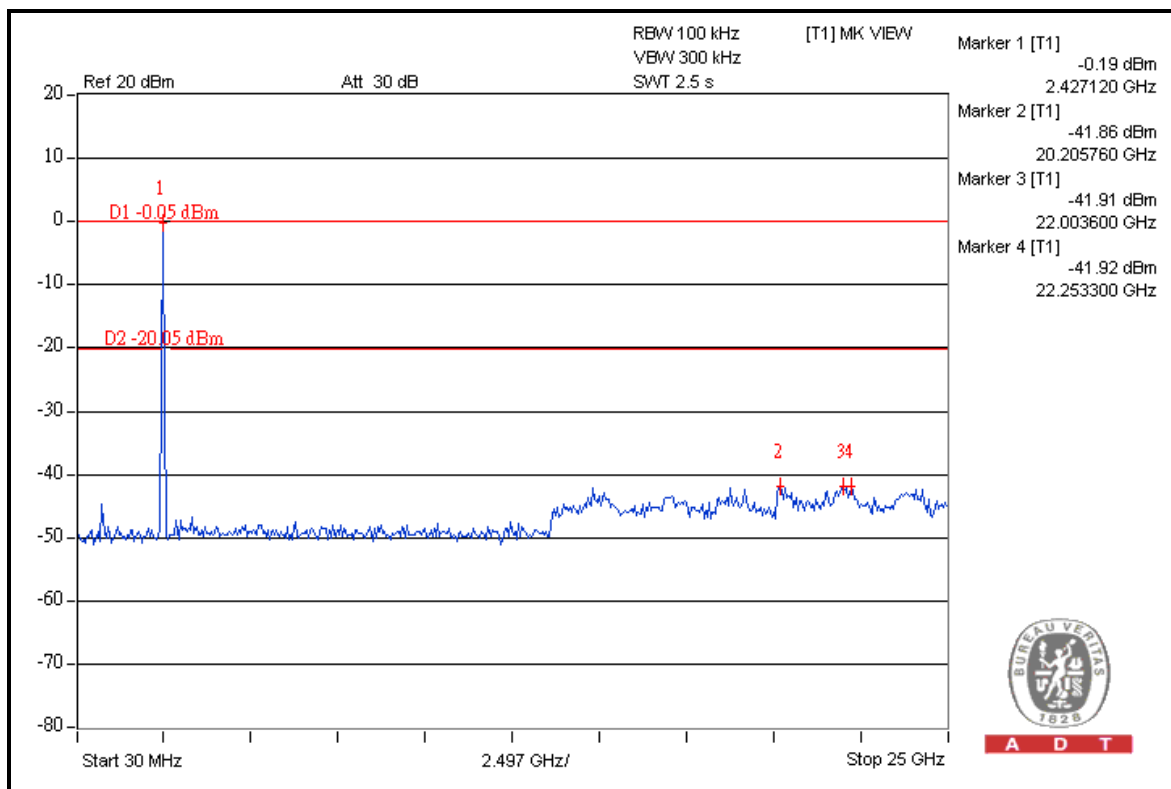
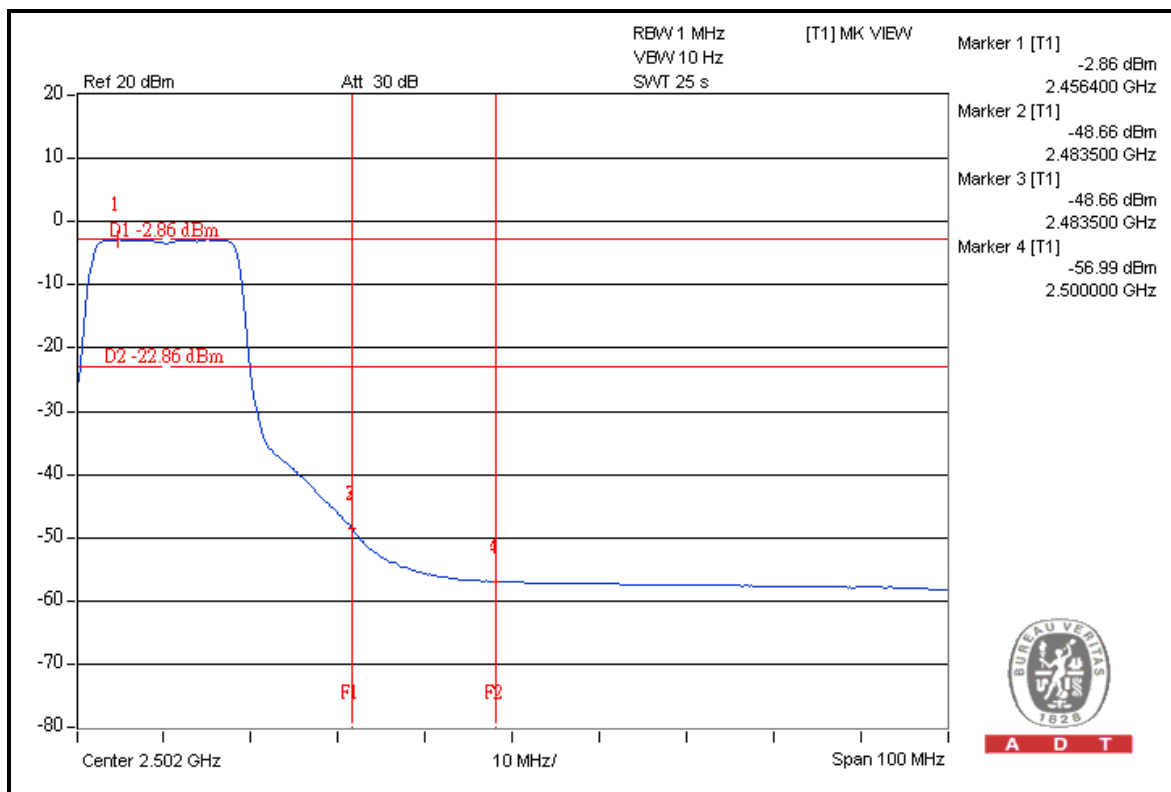



A D T

802.11n (20MHz)

RESTRICT BAND (2310 ~ 2390 MHz)

FREQUENCY (MHz)	FUNDAMENTAL EMISSION (dBuV/m)	DELTA (dB)	MAXIMUM FIELD STRENGTH IN RESTRICT BAND (dBuV/m)	LIMIT (dBuV/m)
2412.00 (PK)	113.3	44.7	68.6	74.0
2412.00 (AV)	103.0	51.3	51.7	54.0

RESTRICT BAND (2483.5 ~ 2500 MHz)

FREQUENCY (MHz)	FUNDAMENTAL EMISSION (dBuV/m)	DELTA (dB)	MAXIMUM FIELD STRENGTH IN RESTRICT BAND (dBuV/m)	LIMIT (dBuV/m)
2462.00 (PK)	113.0	44.7	68.3	74.0
2462.00 (AV)	102.4	53.9	48.5	54.0

NOTE:

1. Delta = Amplitude between the peak of the fundamental and the peak of the band edge emission. Please check following 2 pages.
2. Maximum field strength in restrict band = Fundamental emission – Delta.



A D T

FOR RADIATED MEASURED (TWO CHAINS ON)

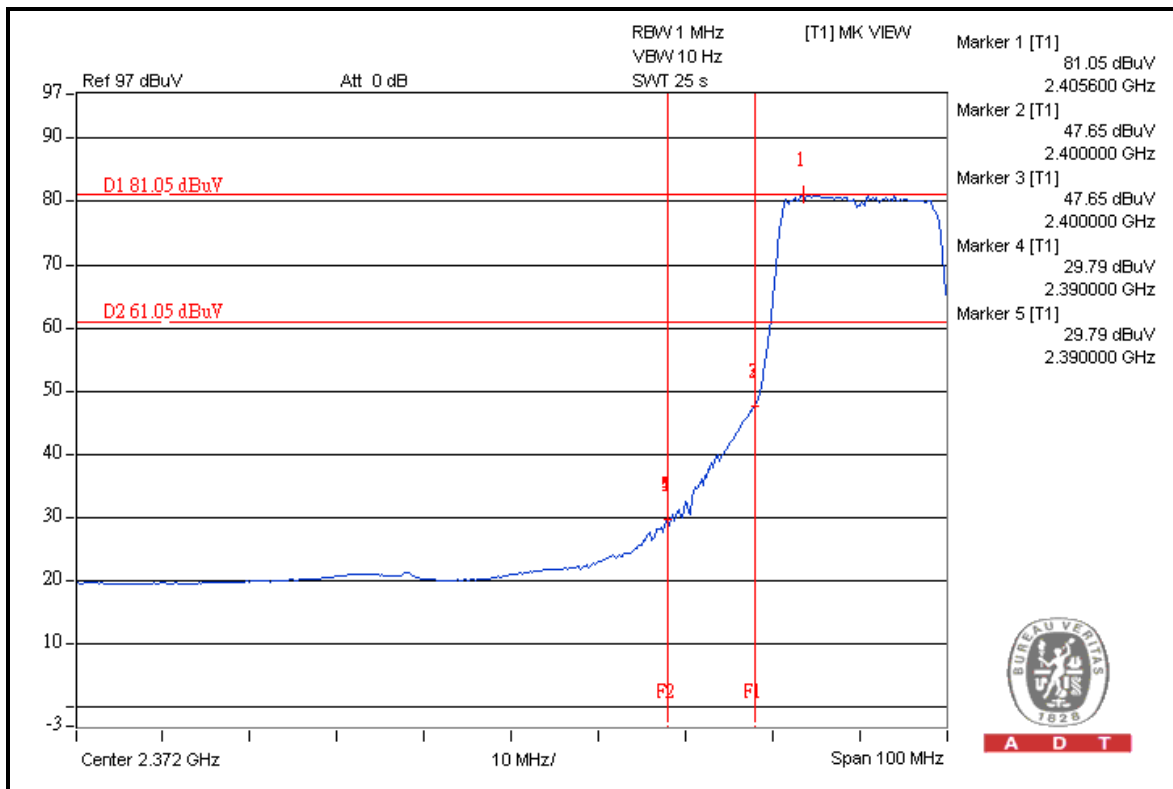
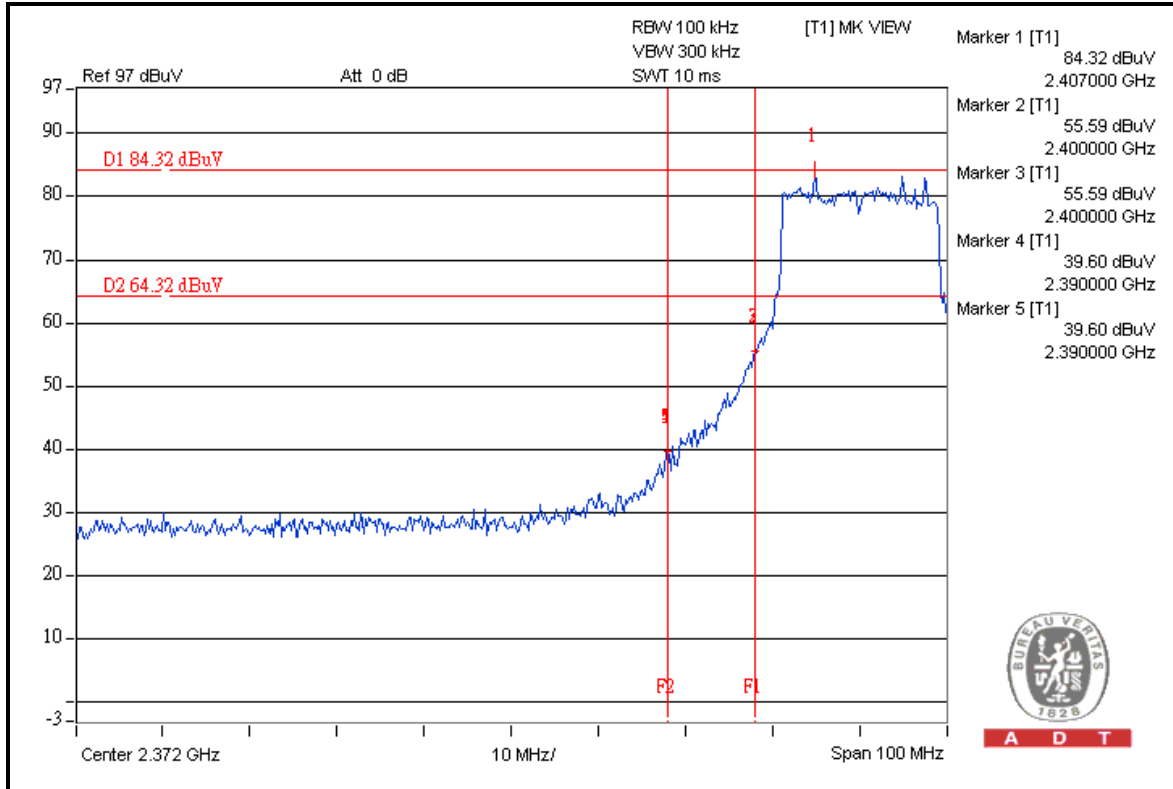



A D T

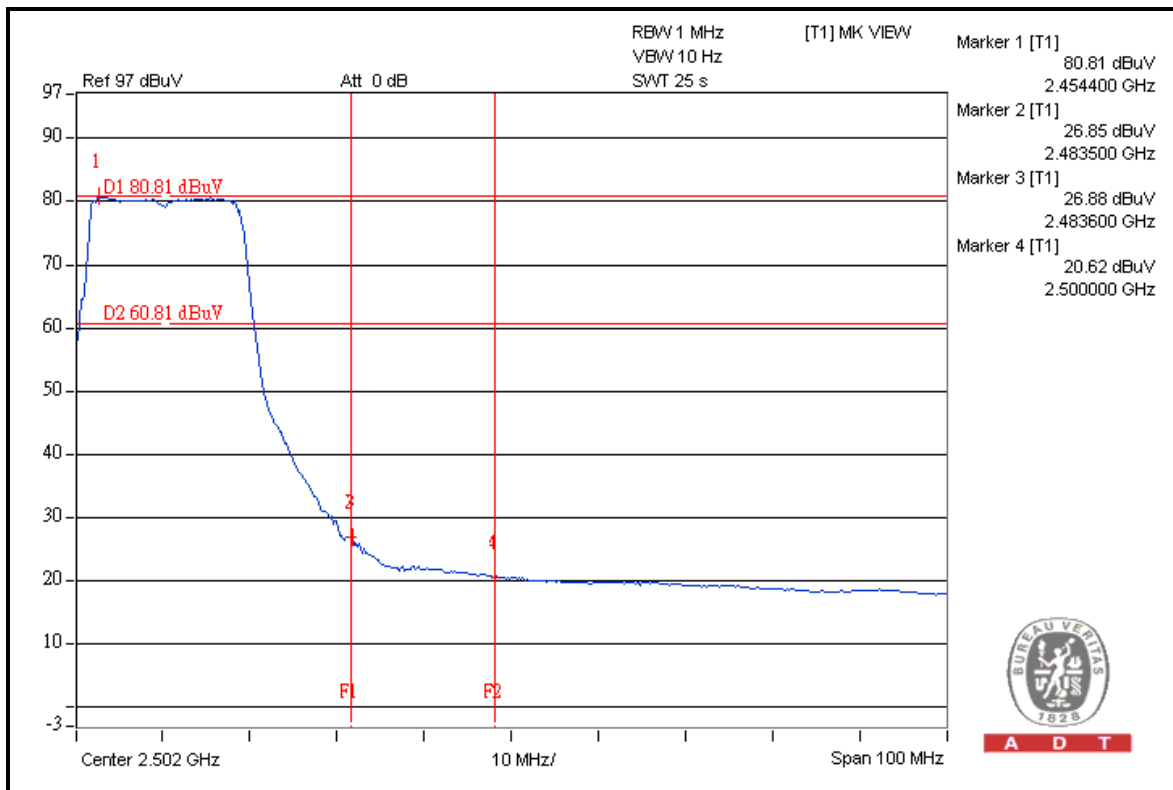
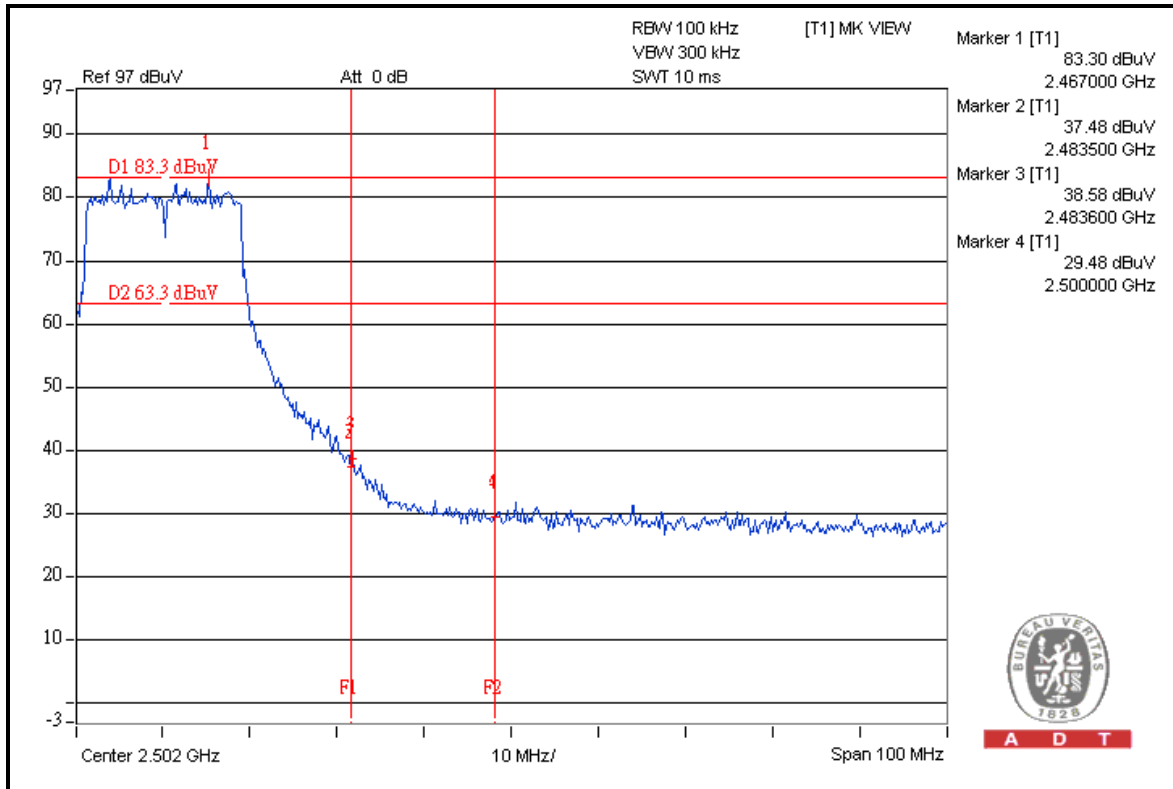



A D T

FOR CONDUCTED MEASURED CHAIN 0

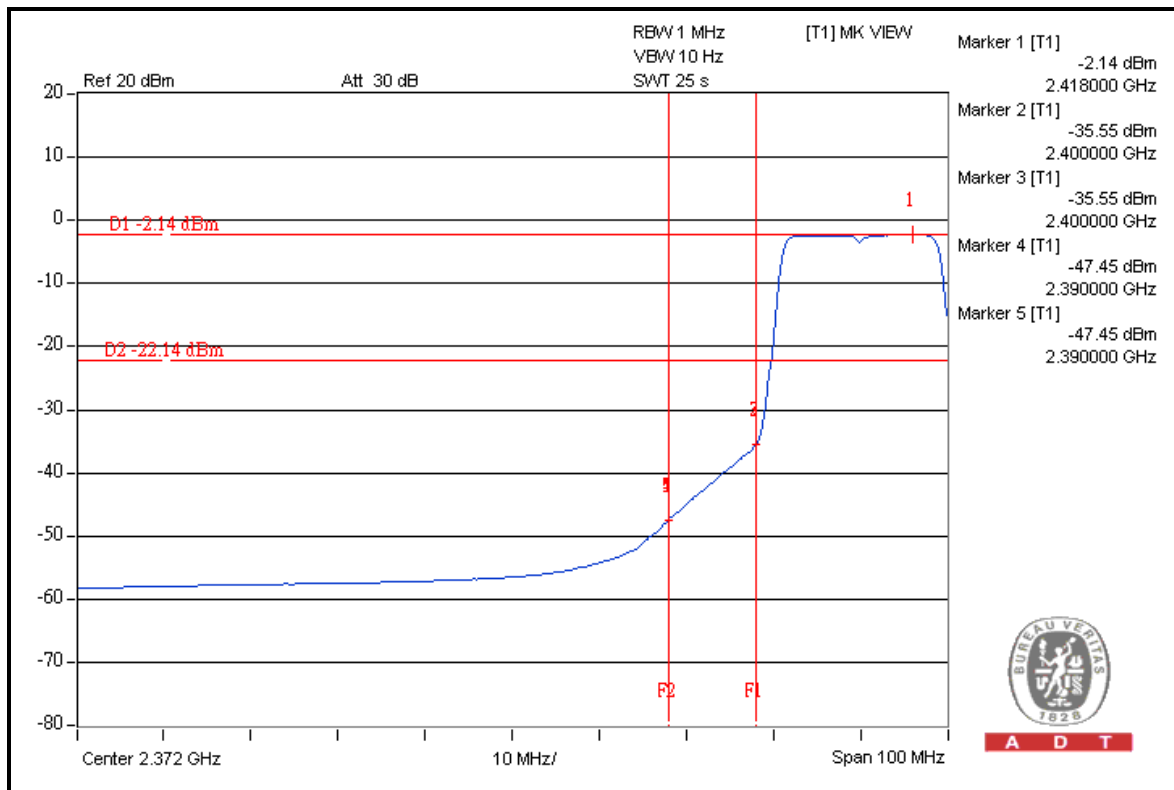
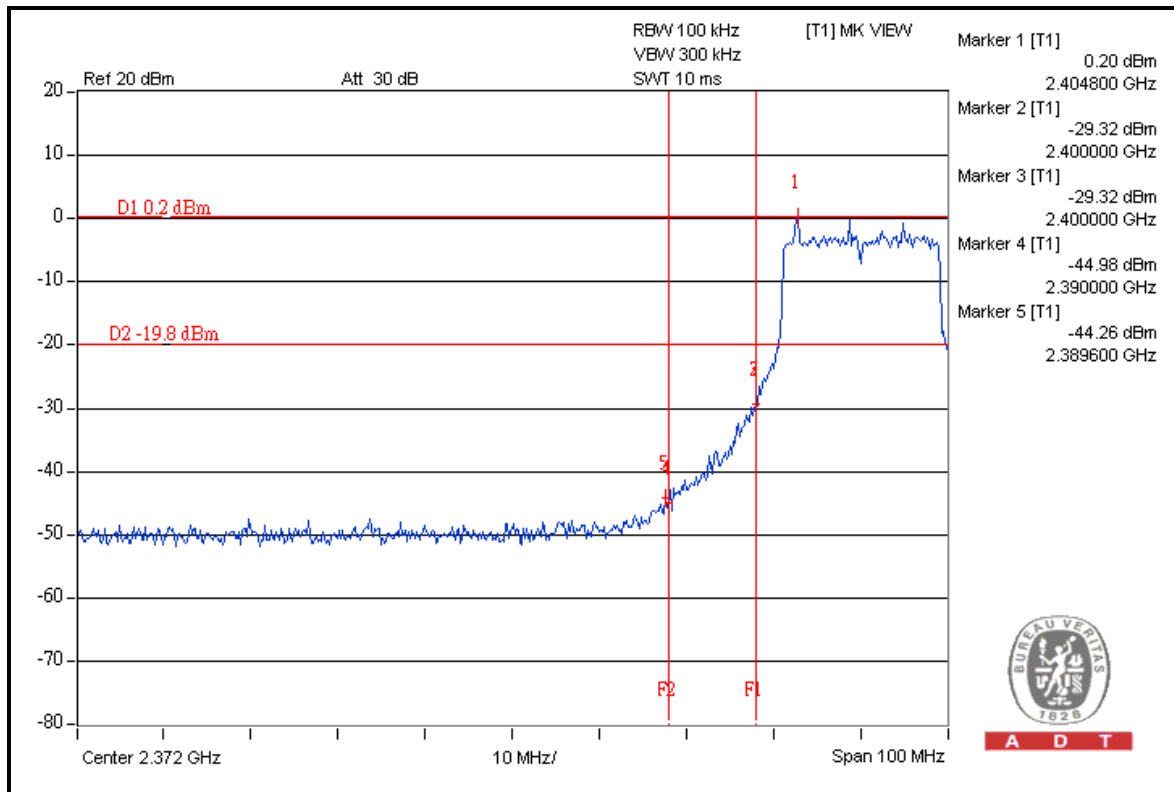



A D T

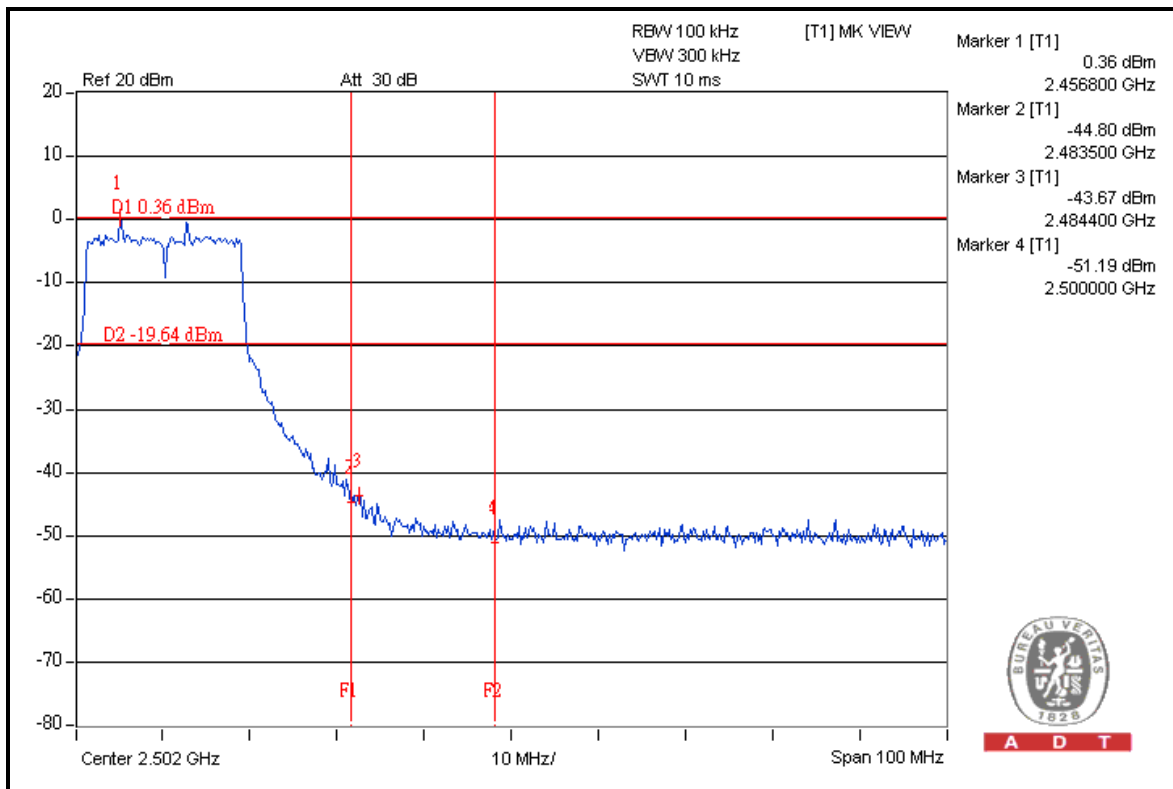
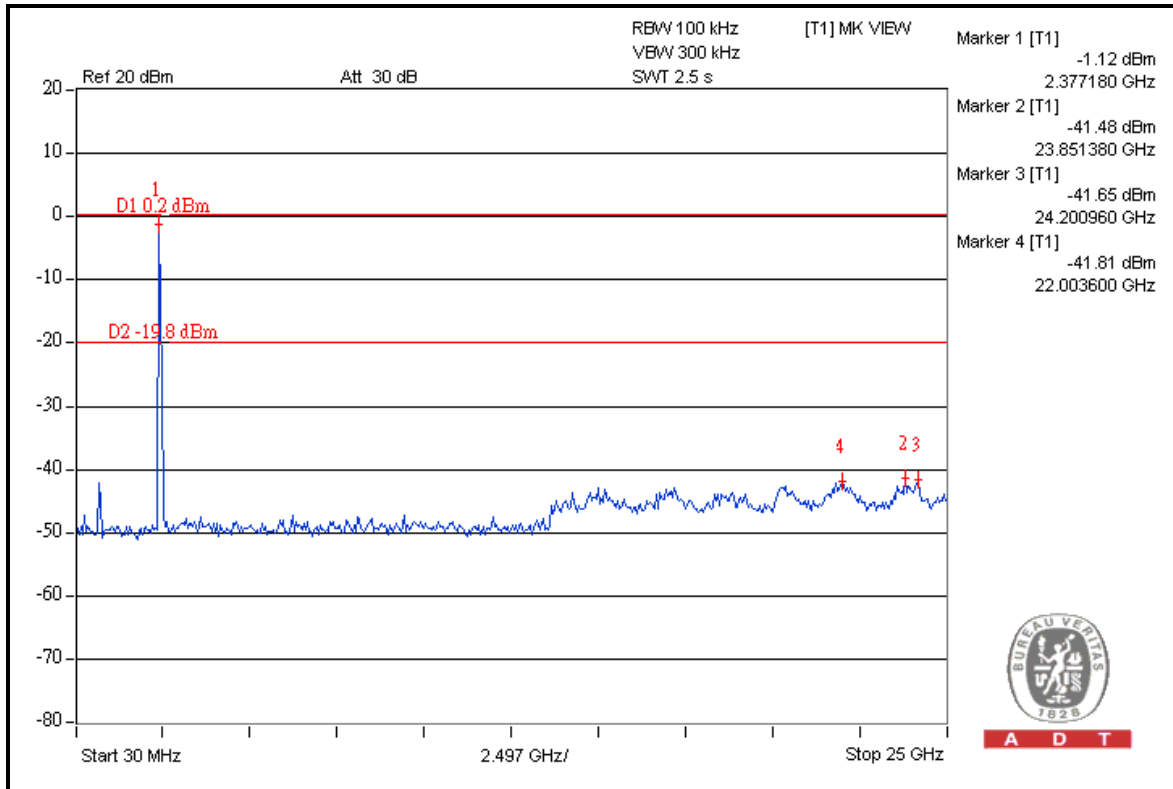



A D T

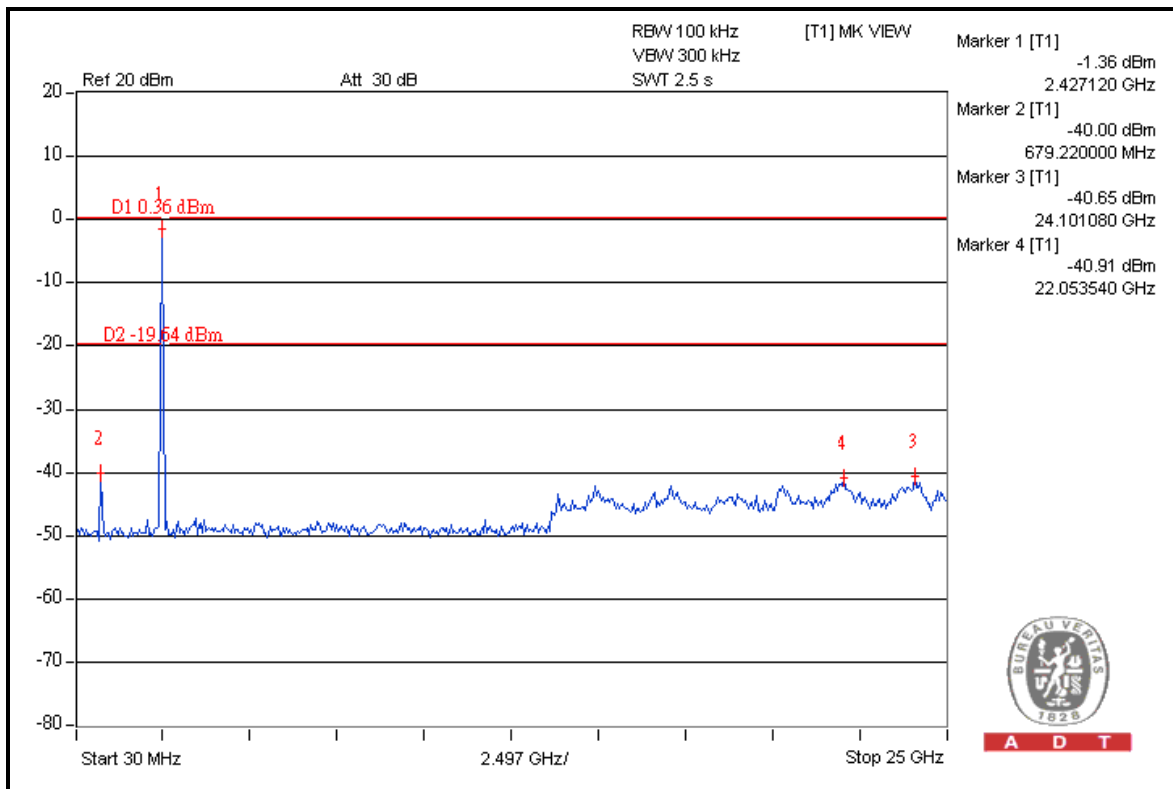
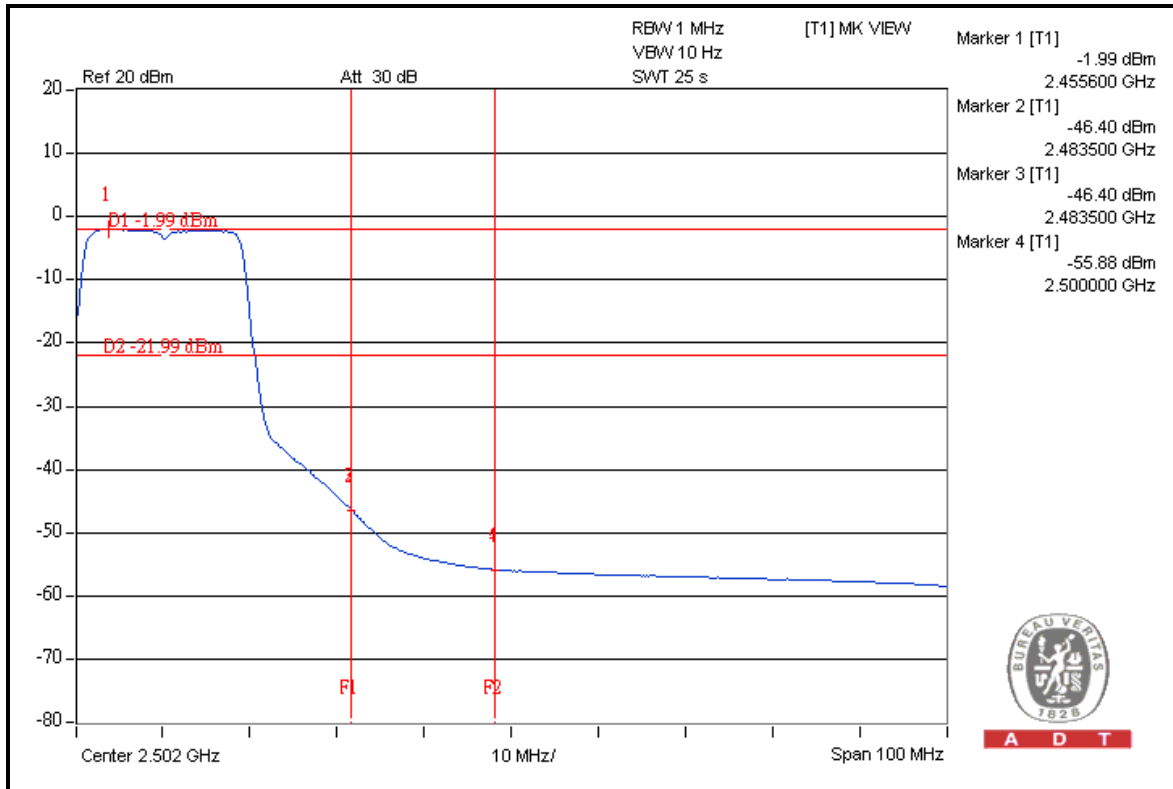



A D T

CHAIN 1

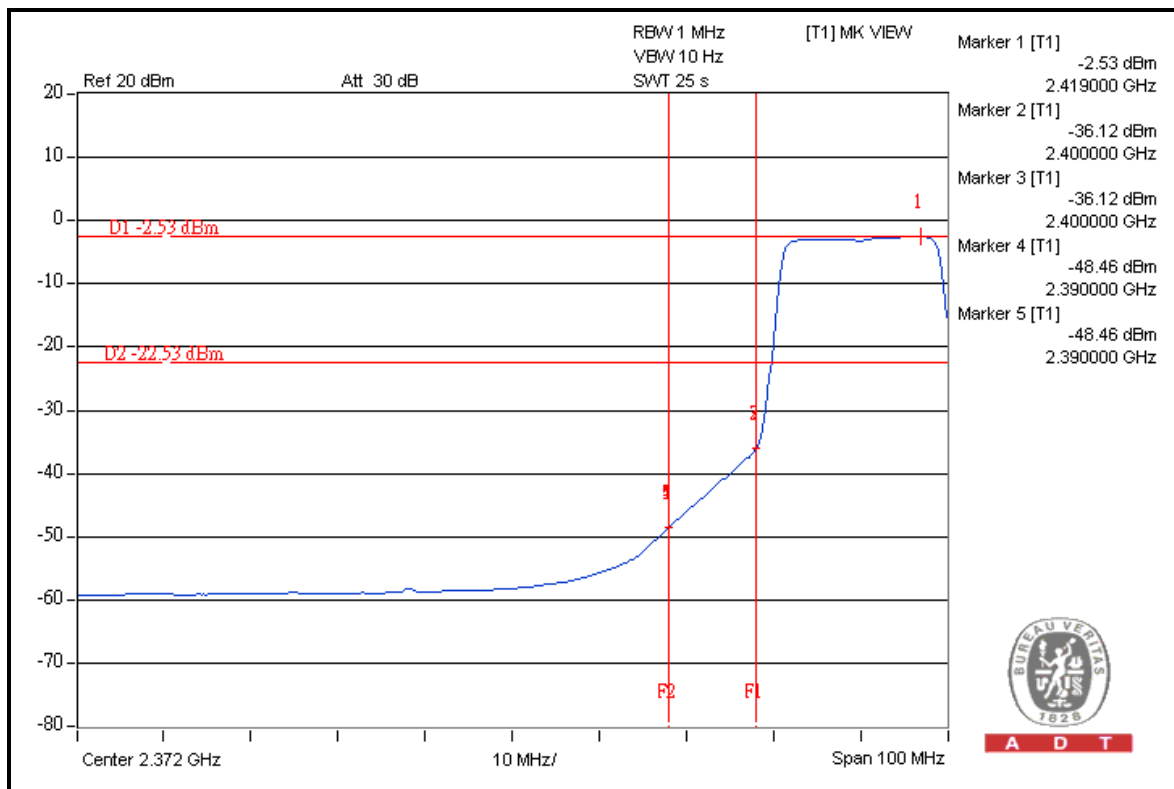
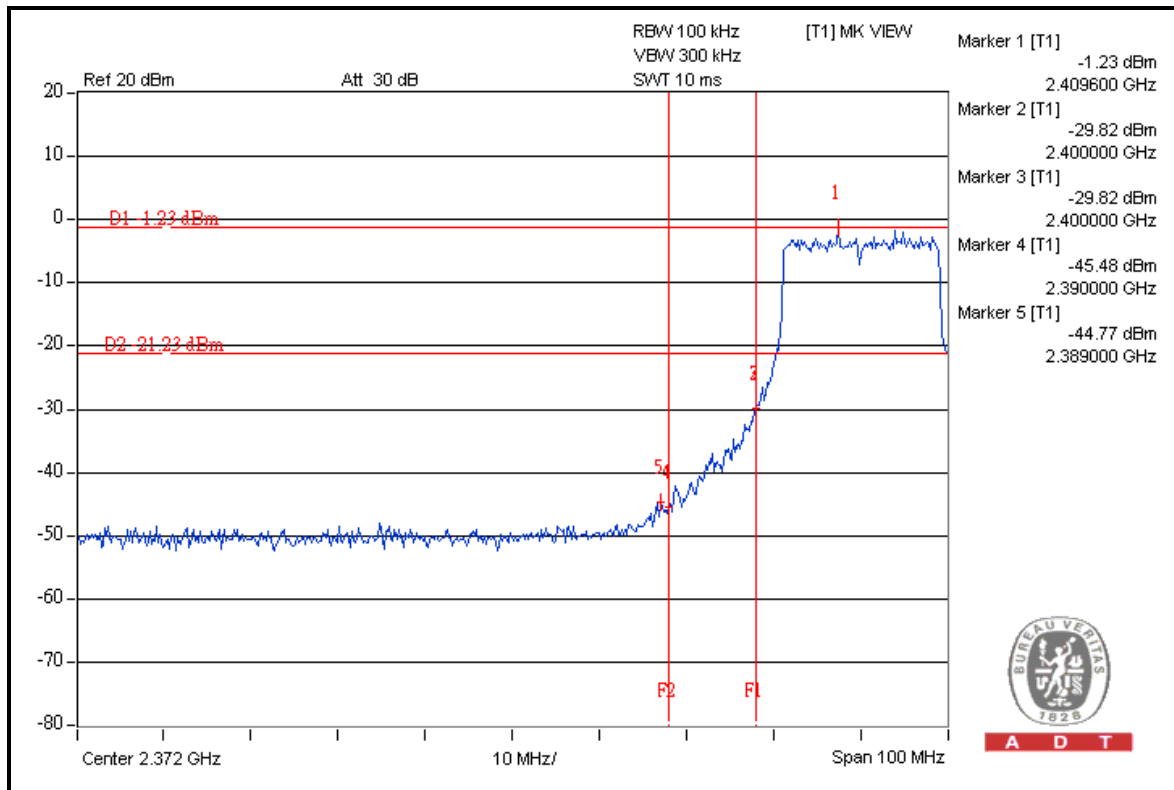



A D T

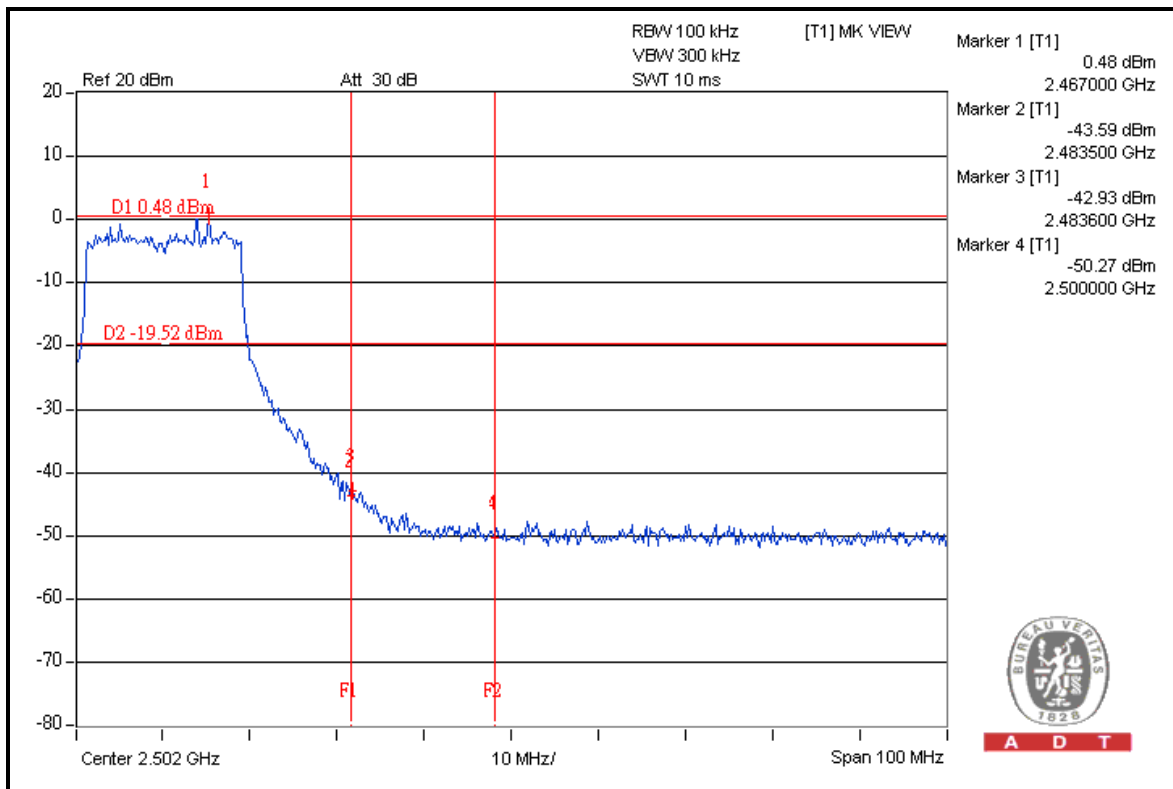
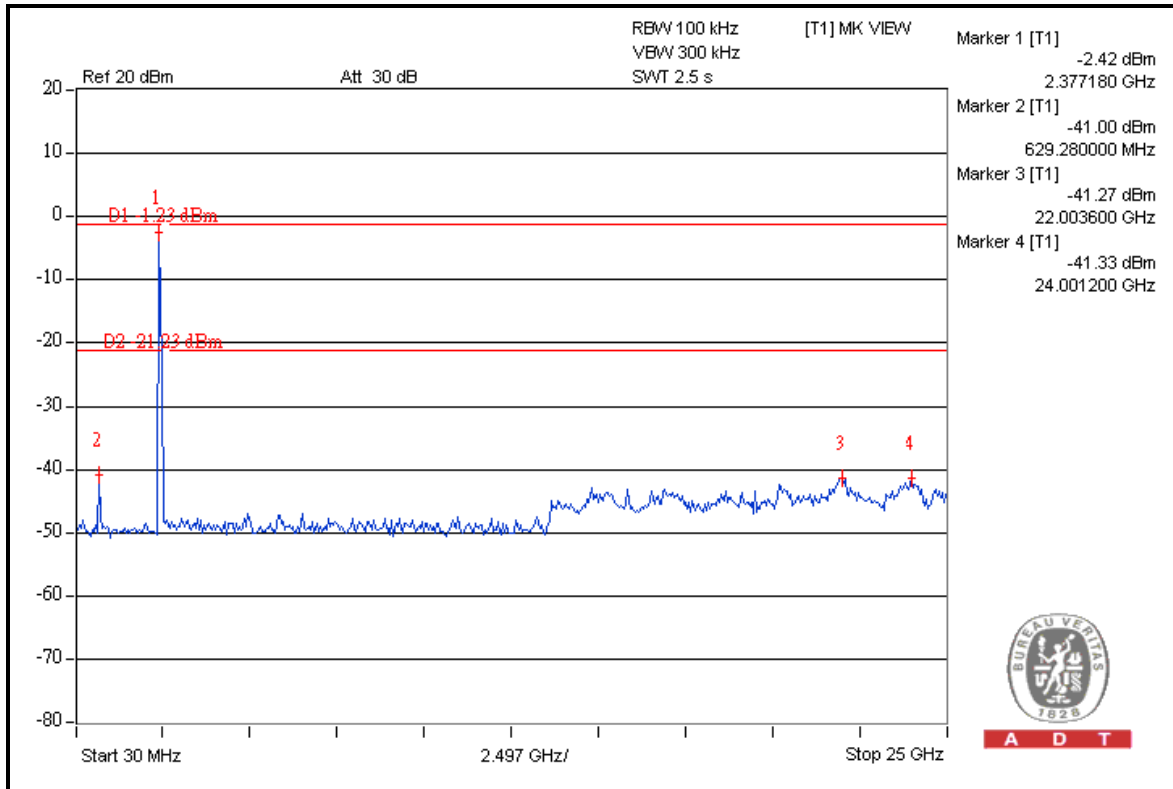



A D T

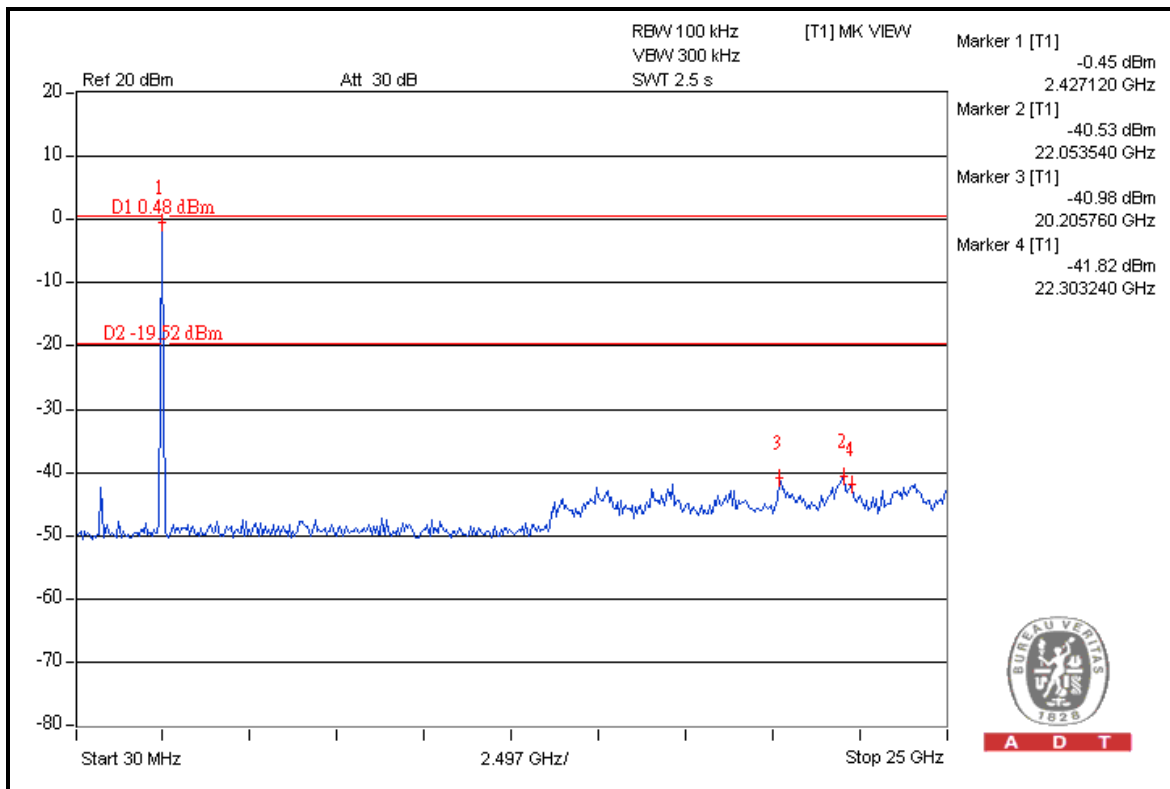
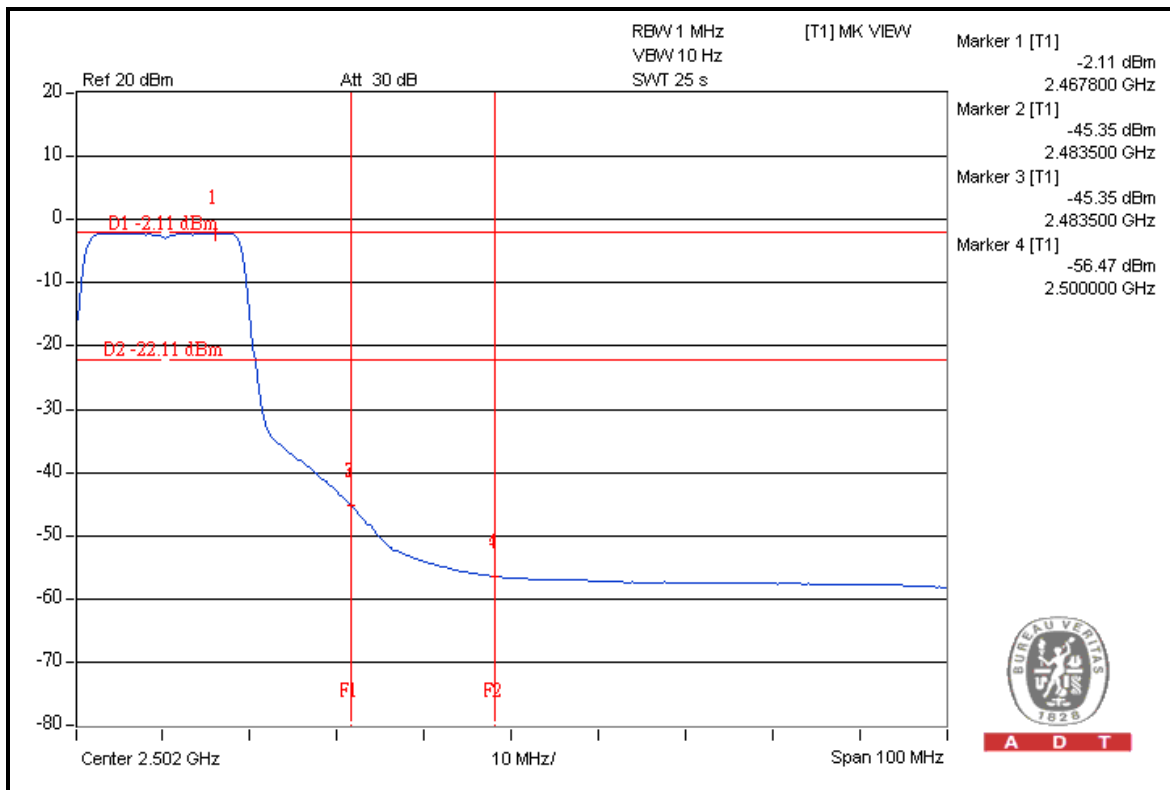



A D T

802.11n (40MHz)

RESTRICT BAND (2310 ~ 2390 MHz)

FREQUENCY (MHz)	FUNDAMENTAL EMISSION (dBuV/m)	DELTA (dB)	MAXIMUM FIELD STRENGTH IN RESTRICT BAND (dBuV/m)	LIMIT (dBuV/m)
2422.00 (PK)	106.0	39.2	66.8	74.0
2422.00 (AV)	94.0	43.6	50.4	54.0

RESTRICT BAND (2483.5 ~ 2500 MHz)

FREQUENCY (MHz)	FUNDAMENTAL EMISSION (dBuV/m)	DELTA (dB)	MAXIMUM FIELD STRENGTH IN RESTRICT BAND (dBuV/m)	LIMIT (dBuV/m)
2452.00 (PK)	104.5	39.0	65.5	74.0
2452.00 (AV)	92.7	47.9	44.8	54.0

NOTE:

1. Delta = Amplitude between the peak of the fundamental and the peak of the band edge emission. Please check following 2 pages.
2. Maximum field strength in restrict band = Fundamental emission – Delta.



A D T

FOR RADIATED MEASURED (TWO CHAINS ON)

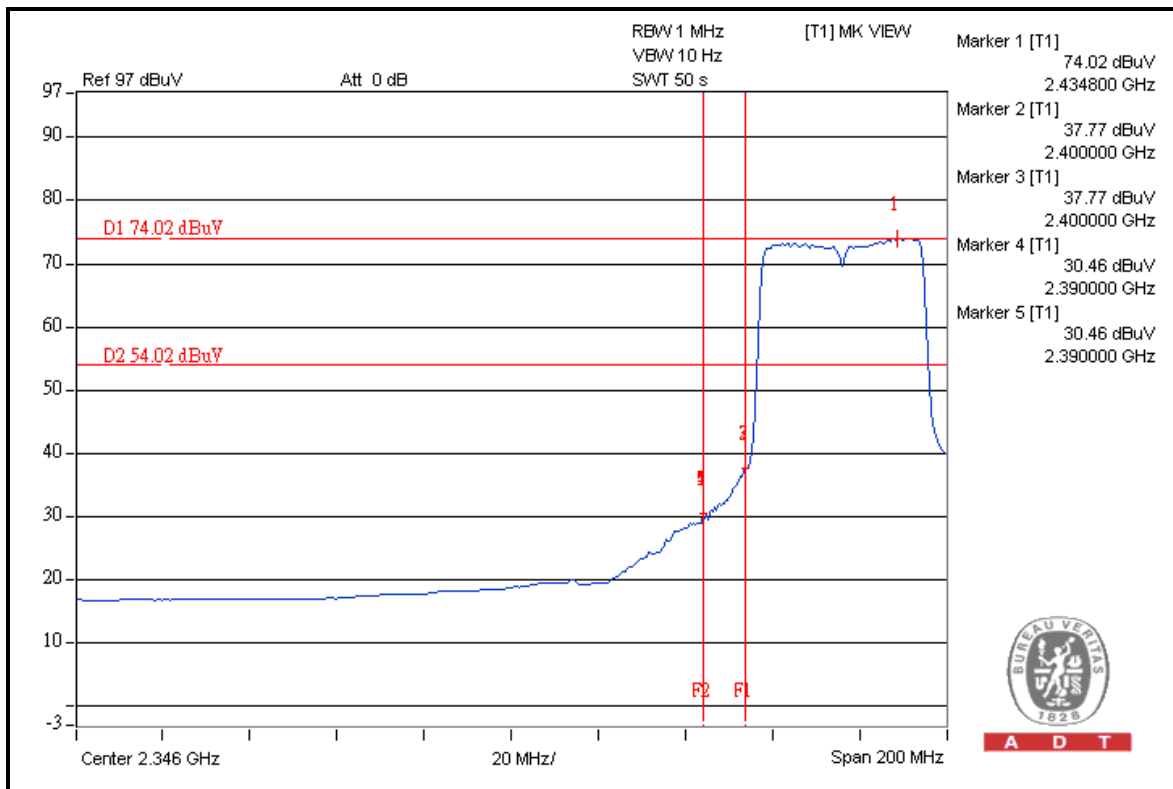
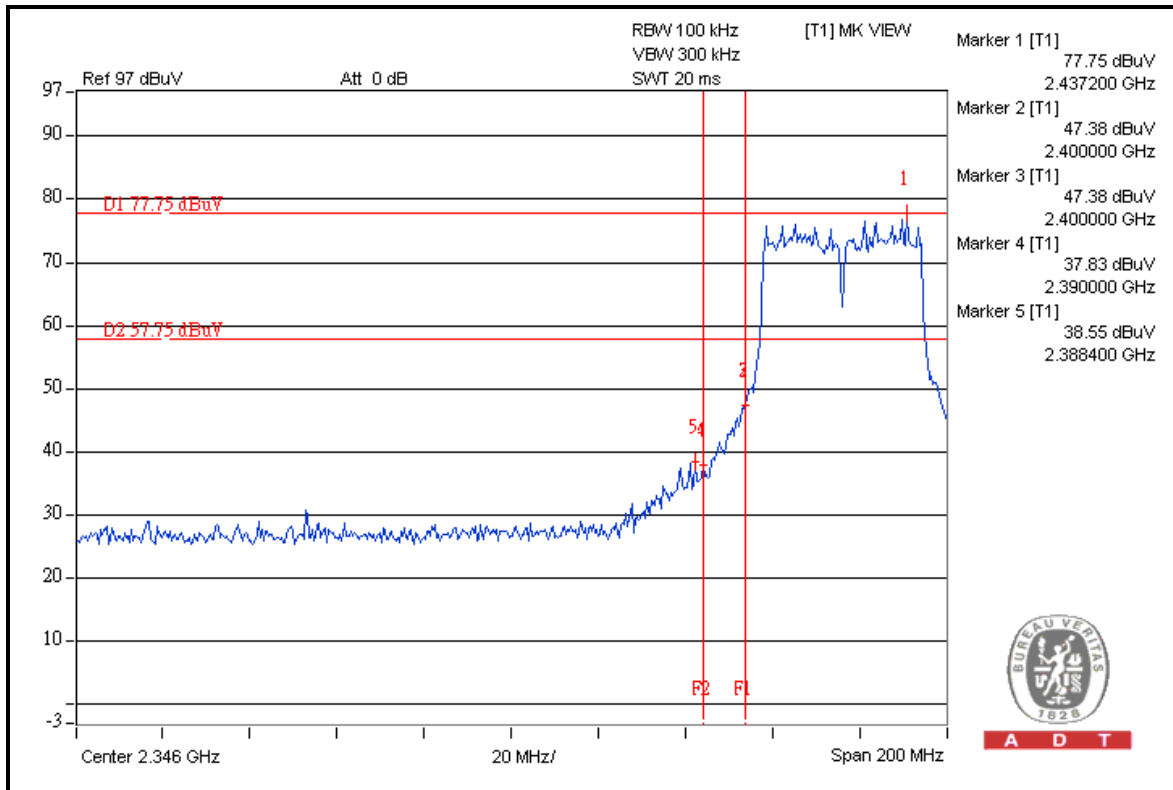



A D T

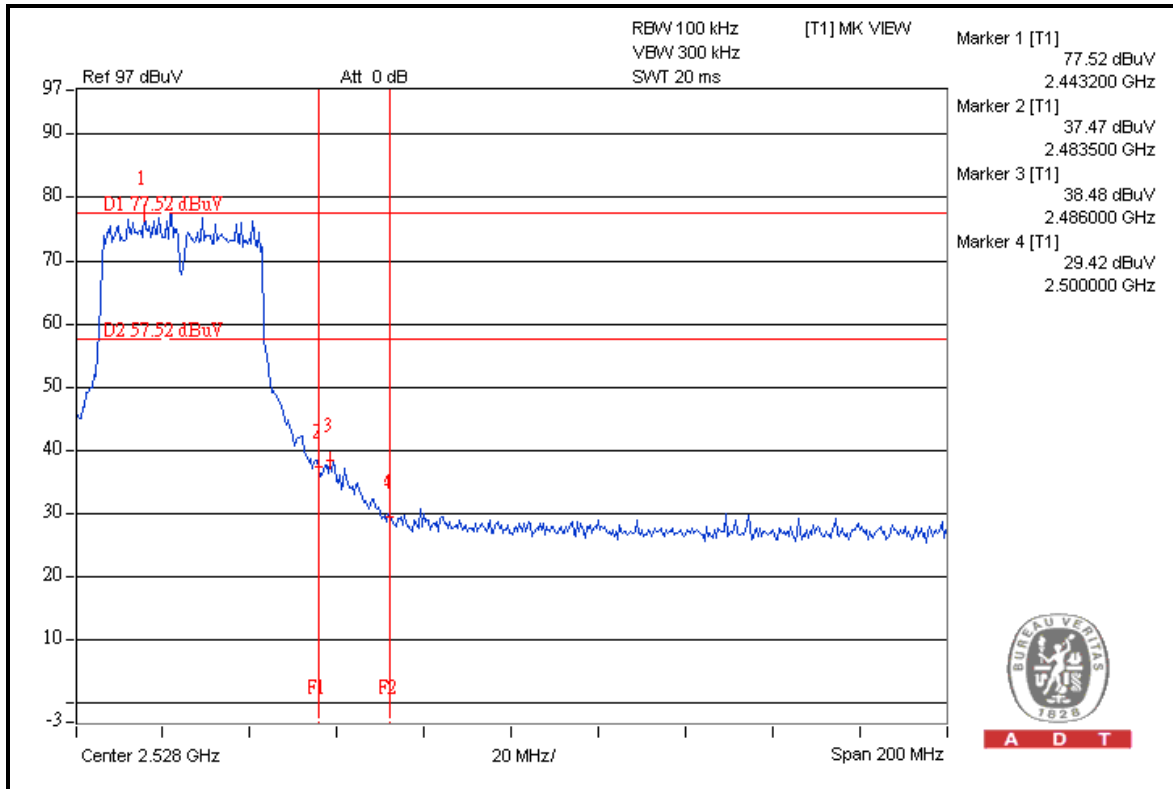

A D T

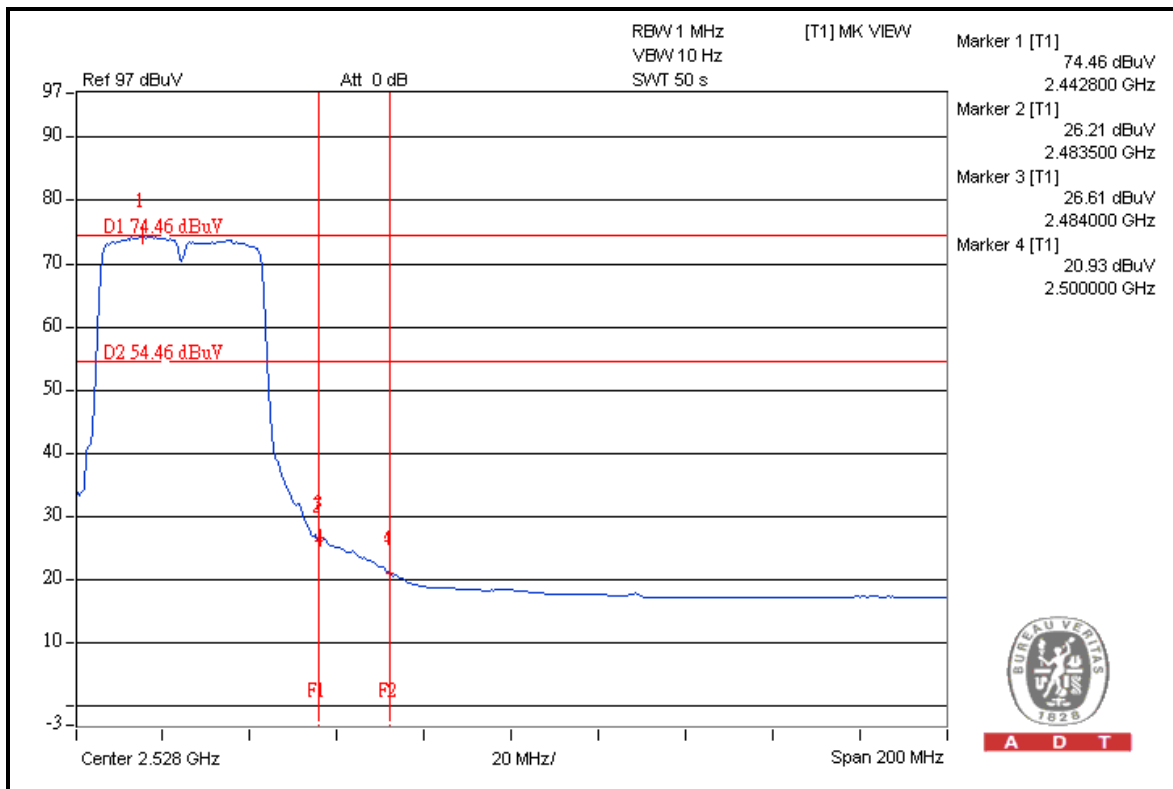

A D T



A D T

FOR CONDUCTED MEASURED

CHAIN 0

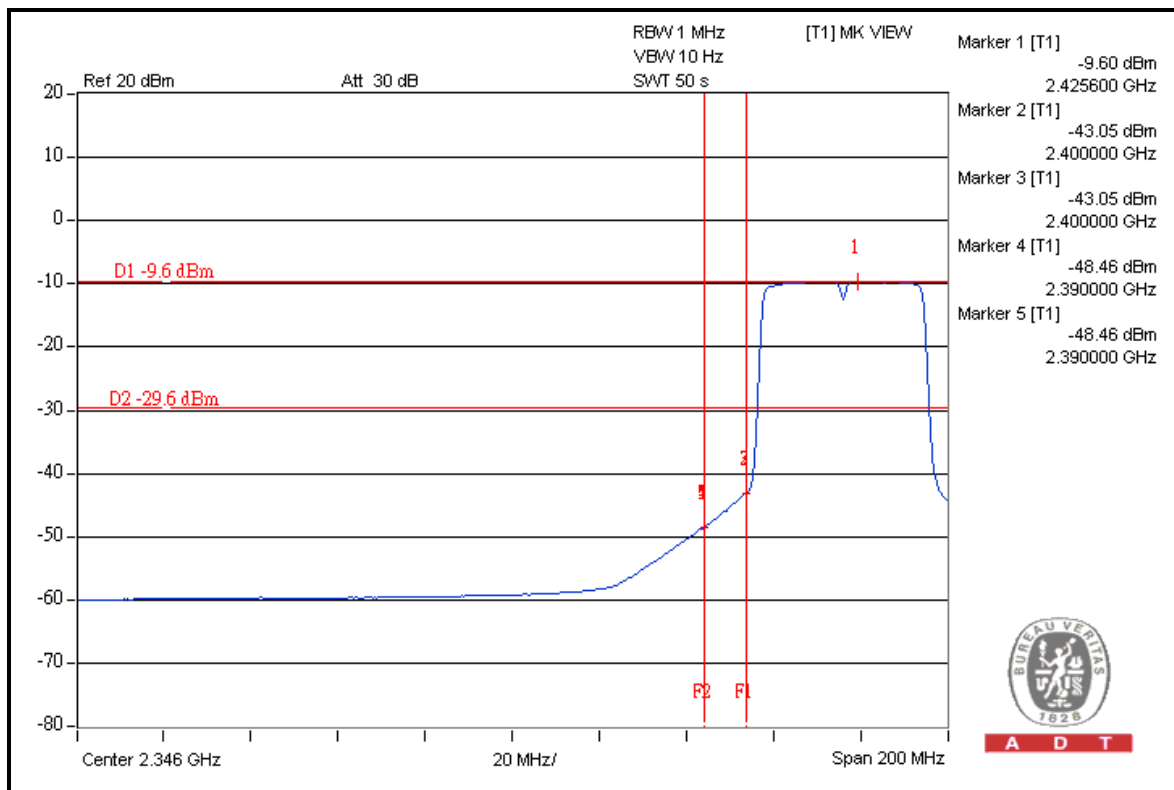
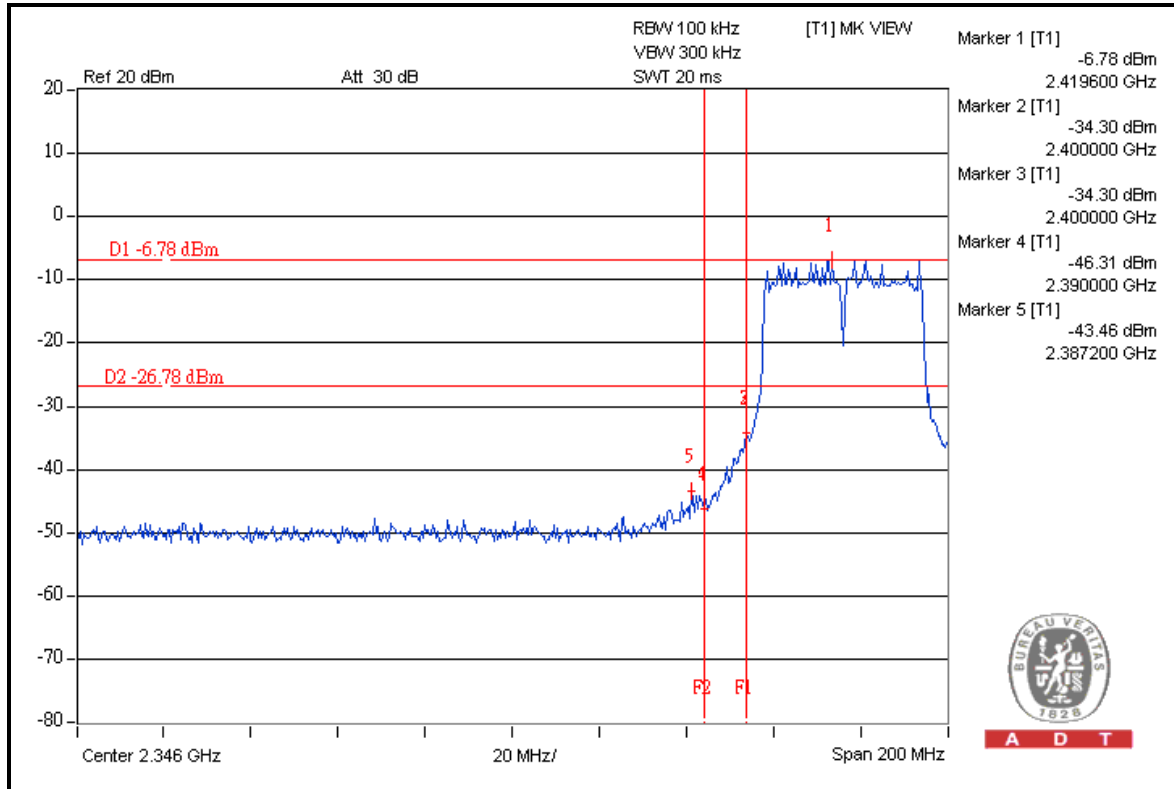



A D T

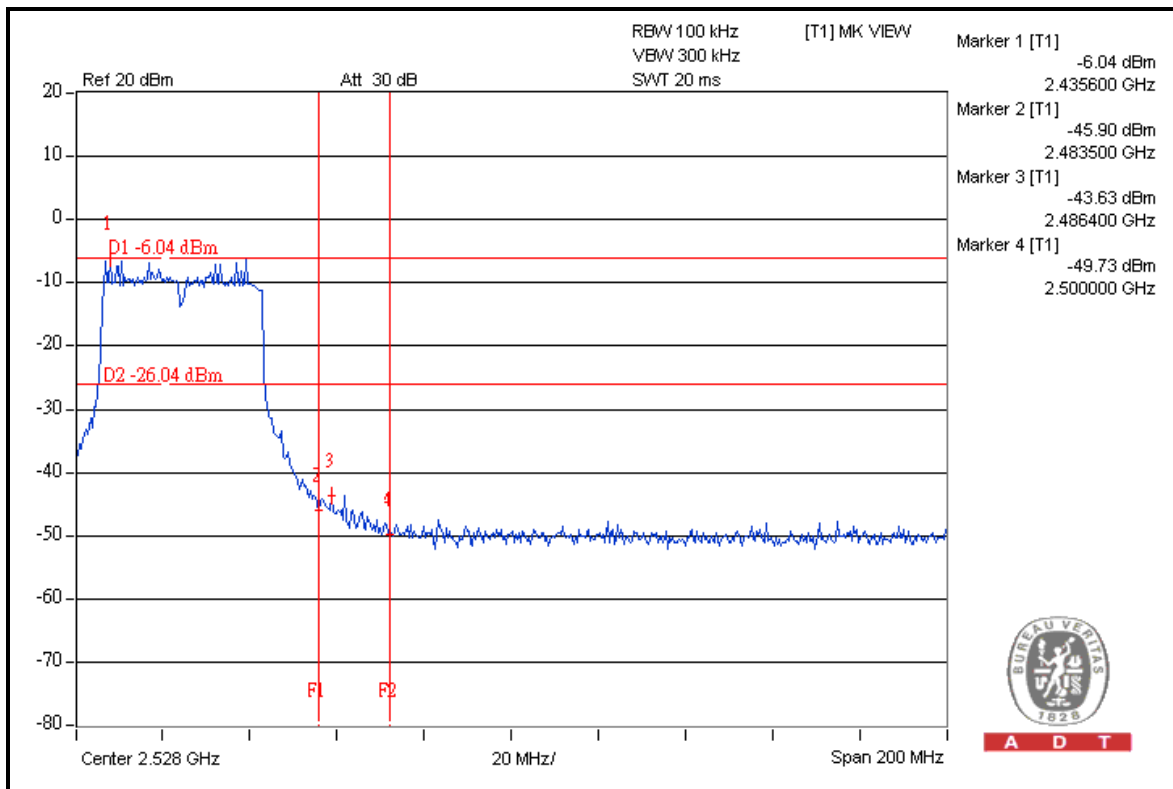
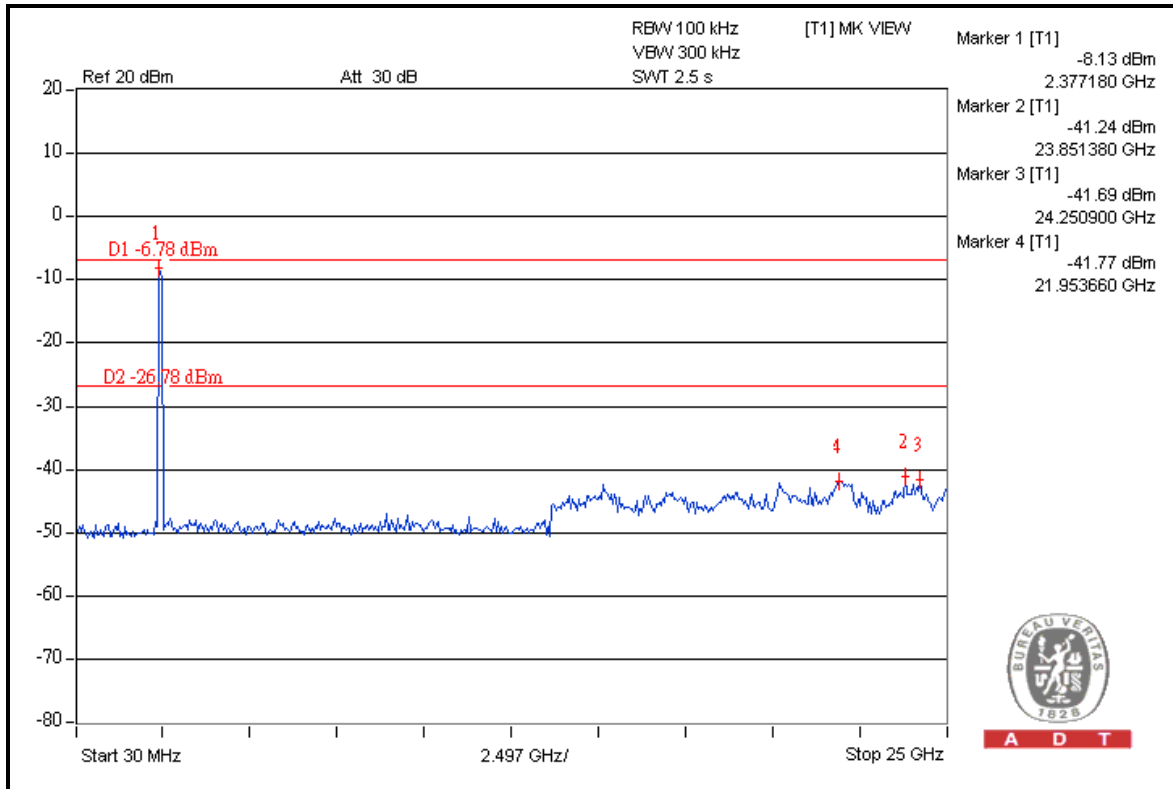



A D T

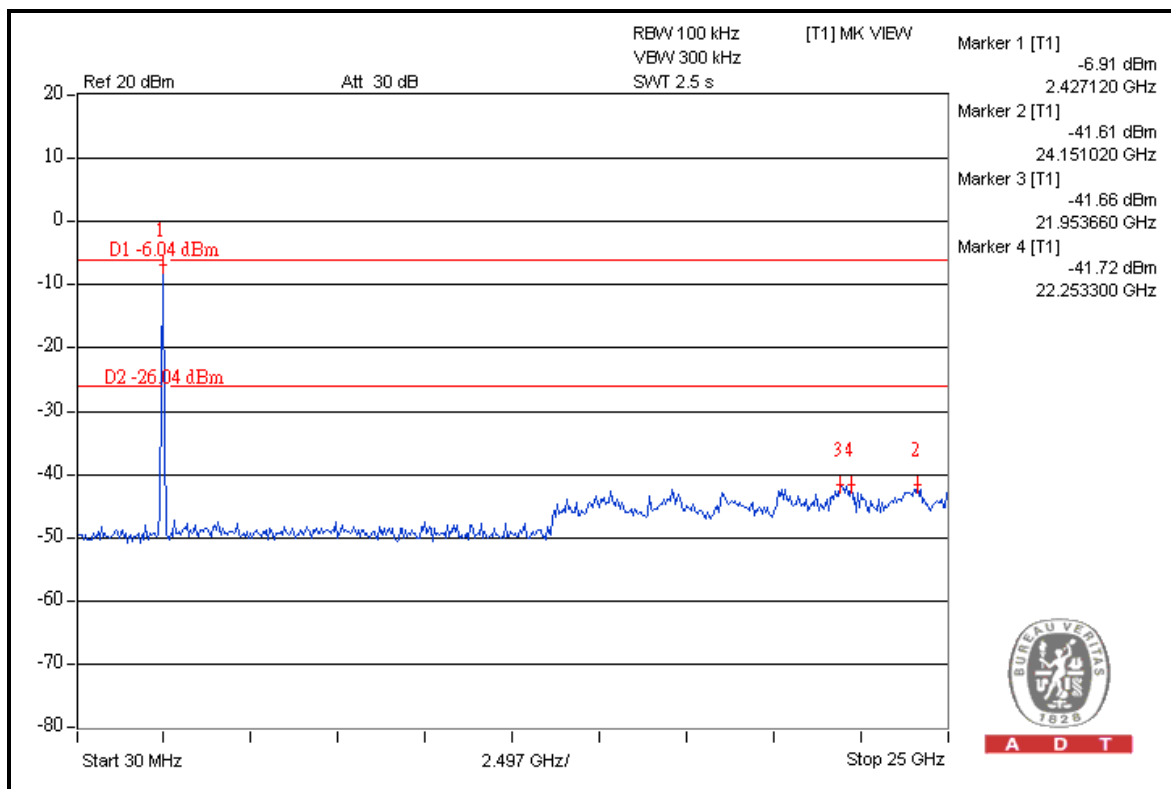
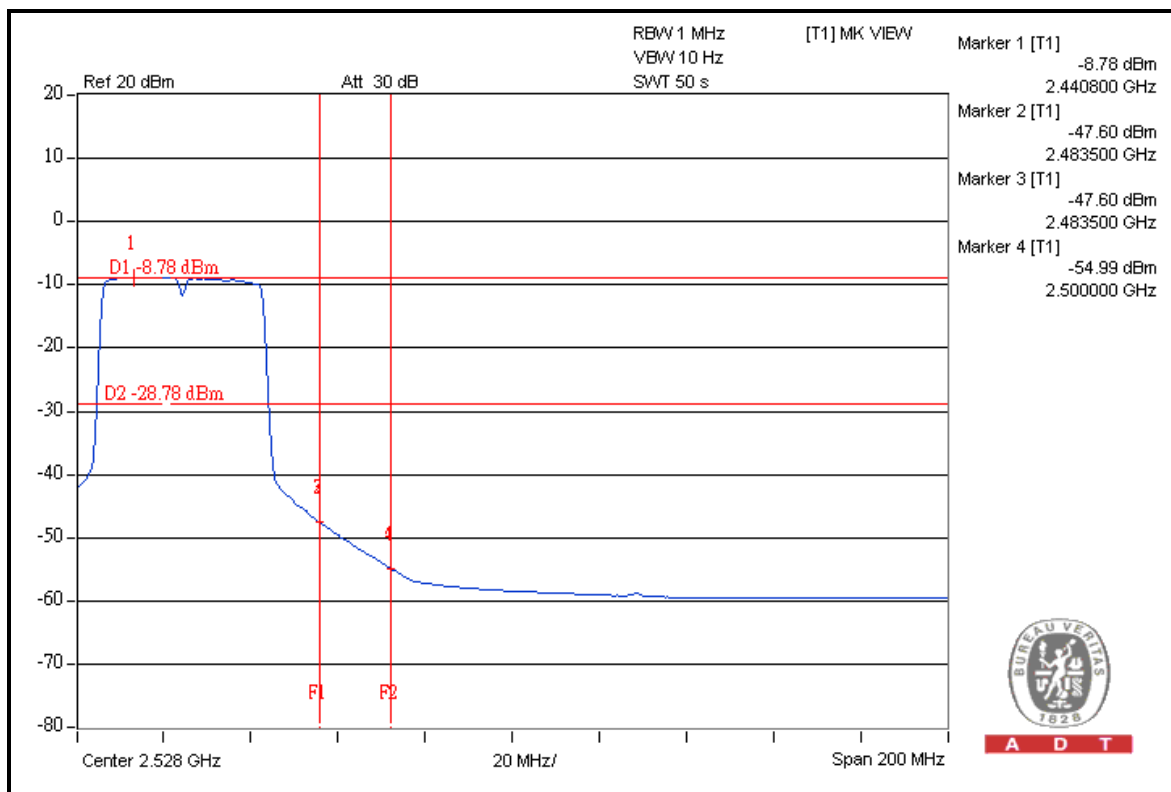



A D T

CHAIN 1

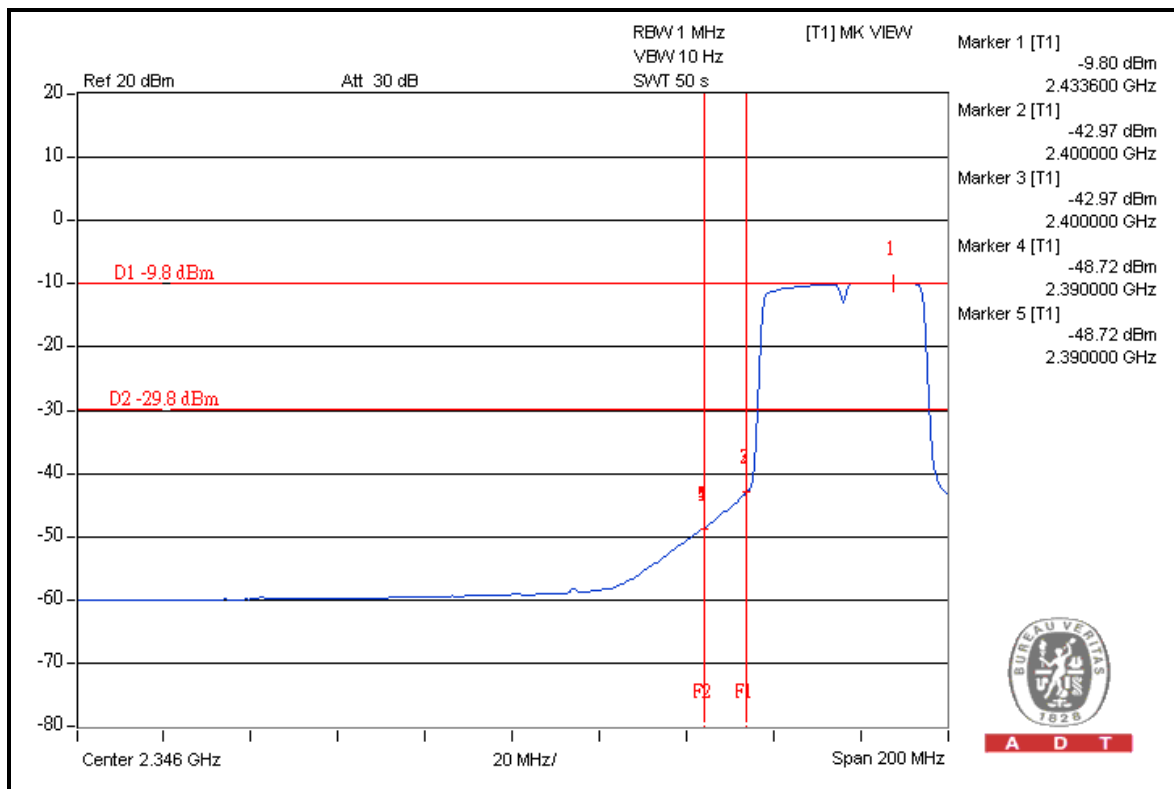
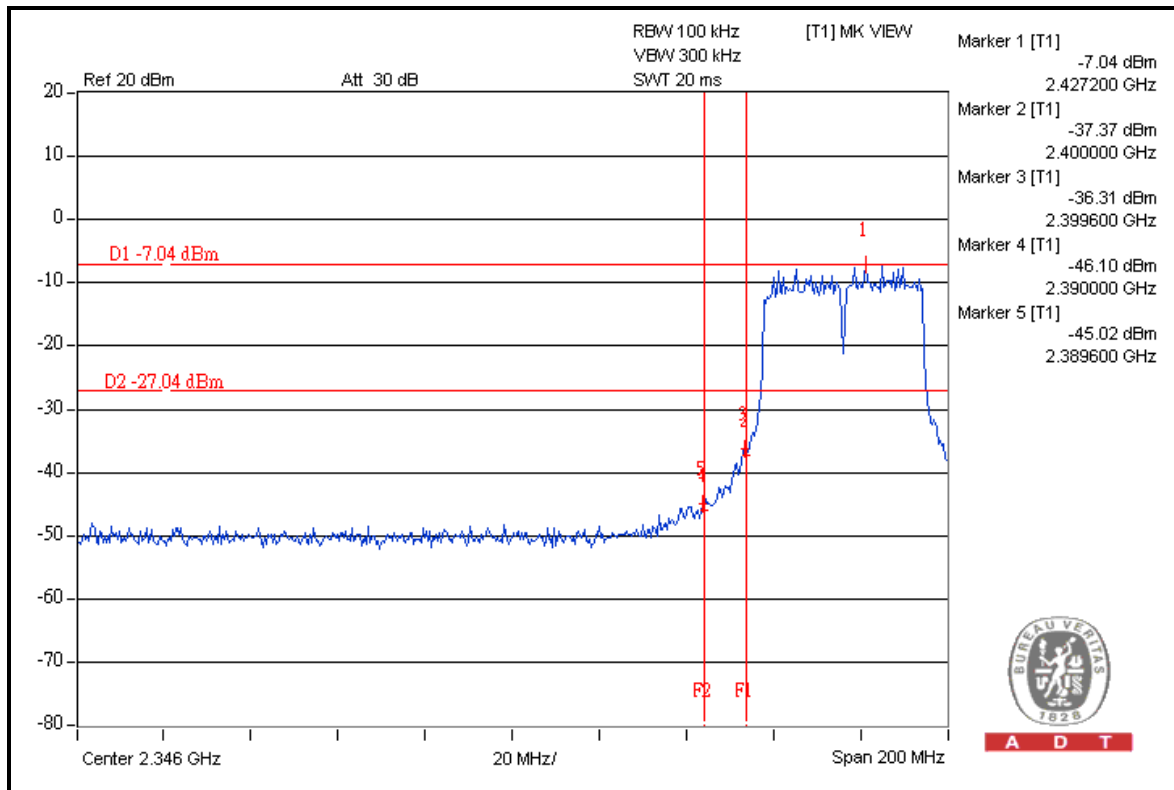



A D T

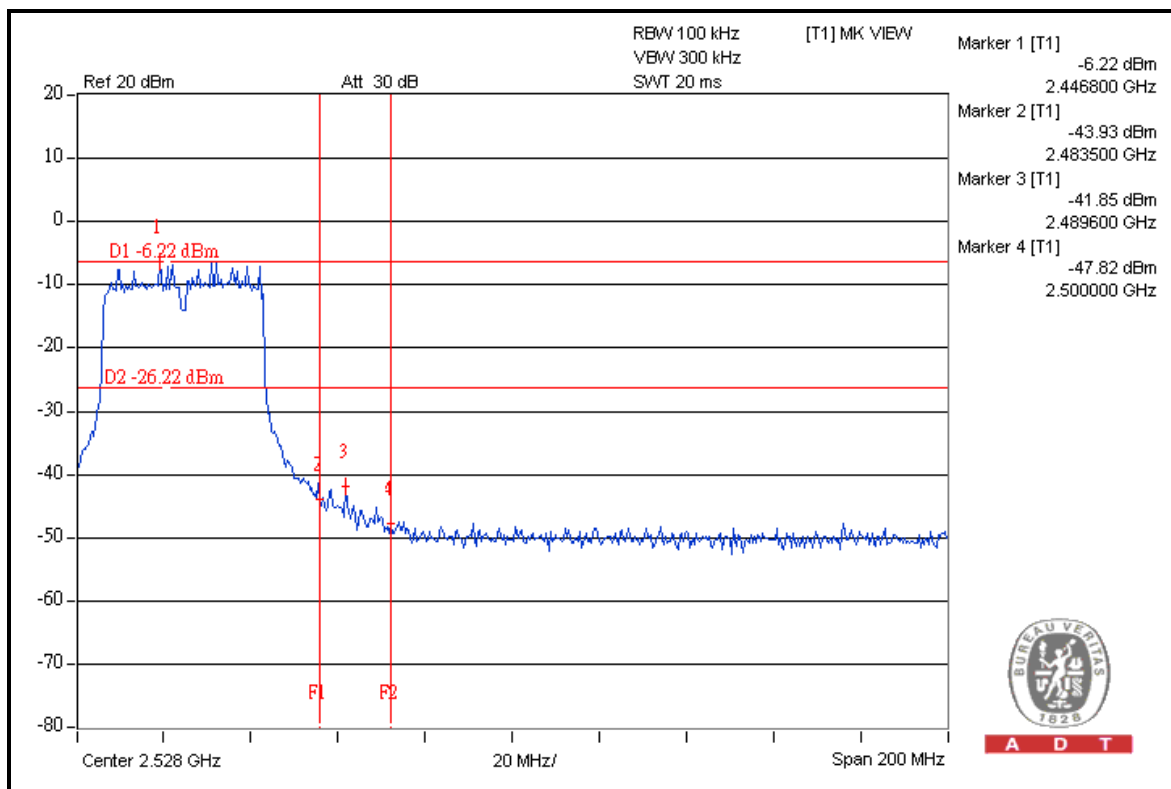
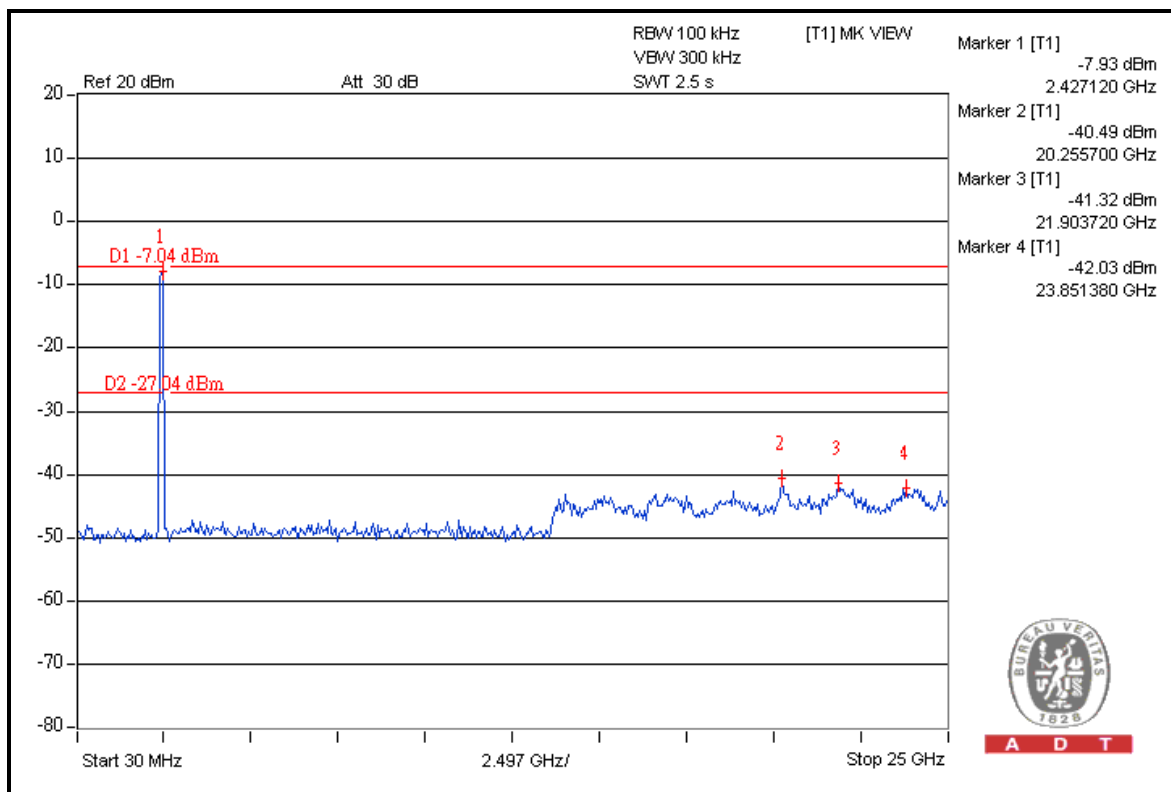



A D T

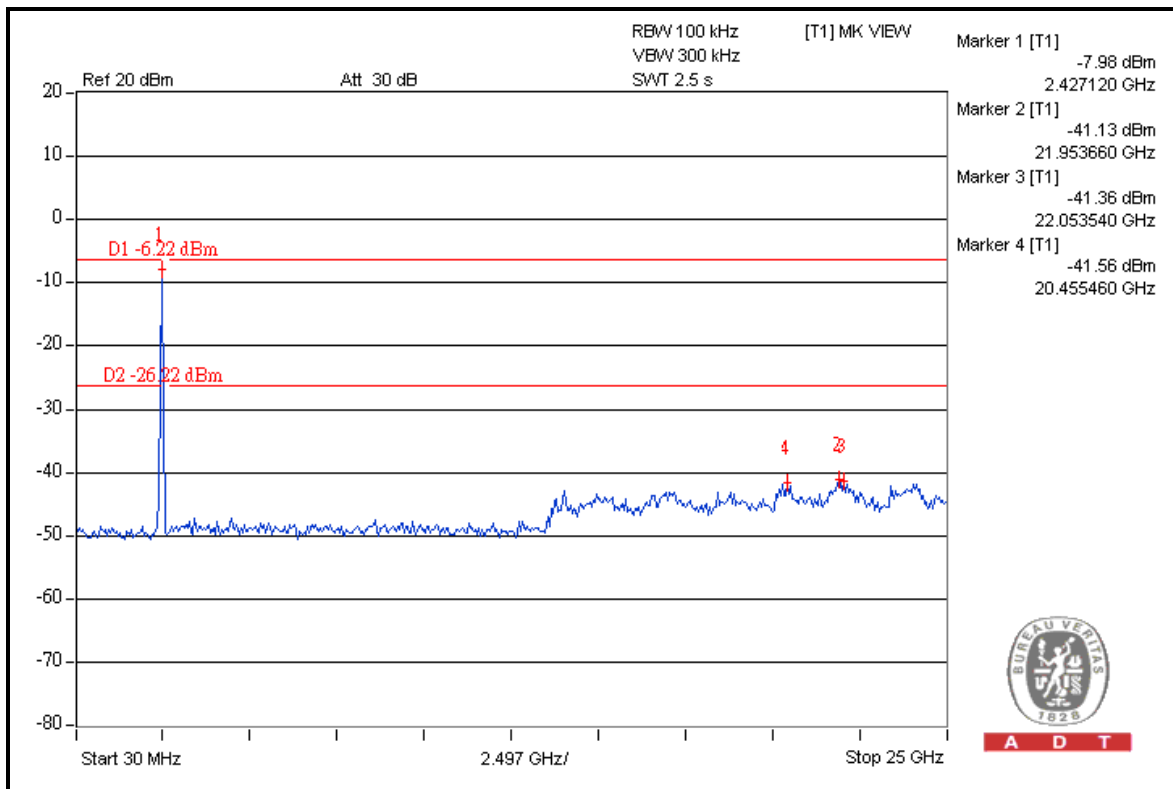
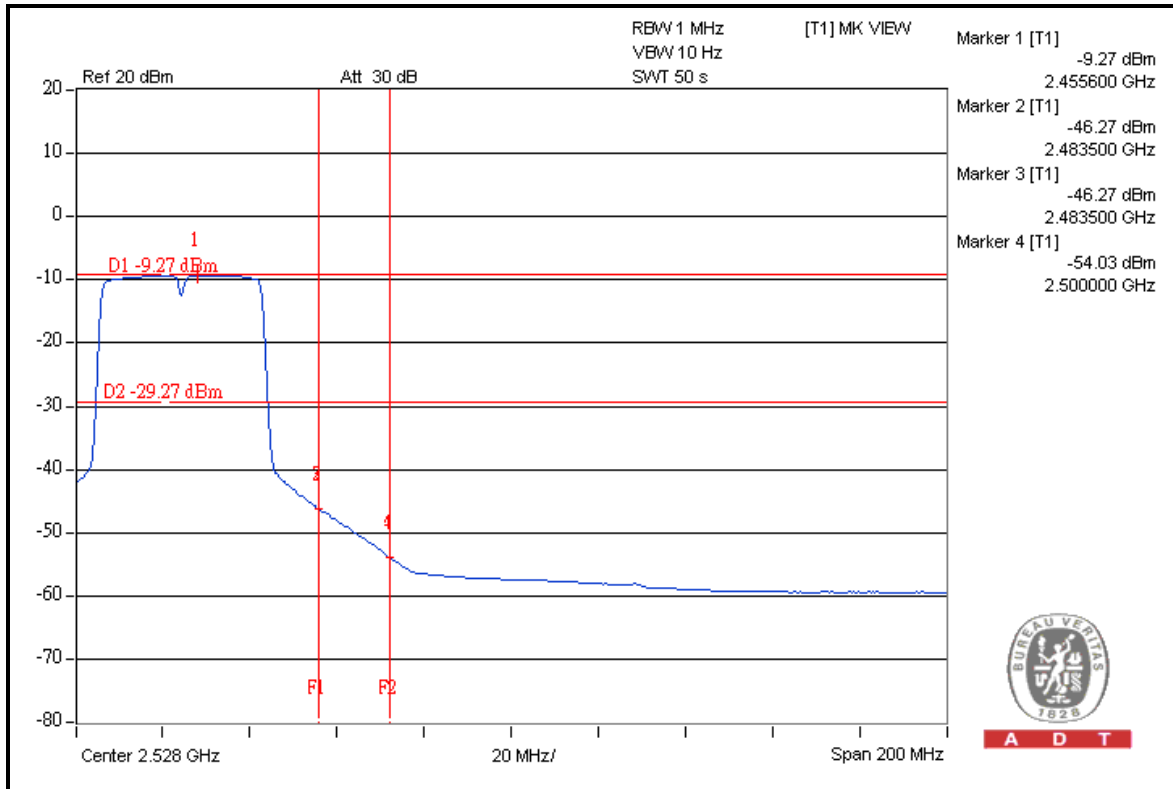



A D T

5. TEST TYPES AND RESULTS (FOR 5.0GHz BAND)

5.1 CONDUCTED EMISSION MEASUREMENT

5.1.1 LIMITS OF CONDUCTED EMISSION MEASUREMENT

FREQUENCY OF EMISSION (MHz)	CONDUCTED LIMIT (dBµV)	
	Quasi-peak	Average
0.15 ~ 0.5	66 to 56	56 to 46
0.5 ~ 5	56	46
5 ~ 30	60	50

- NOTE:** 1. The lower limit shall apply at the transition frequencies.
2. The limit decreases in line with the logarithm of the frequency in the range of 0.15 to 0.50MHz.
3. All emanations from a class A/B digital device or system, including any network of conductors and apparatus connected thereto, shall not exceed the level of field strengths specified above.

5.1.2 TEST INSTRUMENTS

DESCRIPTION & MANUFACTURER	MODEL NO.	SERIAL NO.	CALIBRATED DATE	CALIBRATED UNTIL
ROHDE & SCHWARZ Test Receiver	ESCS 30	100276	Dec. 31, 2010	Dec. 30, 2011
ROHDE & SCHWARZ Artificial Mains Network (for EUT)	ESH3-Z5	100219	Nov. 24, 2010	Nov. 23, 2011
LISN With Adapter (for EUT)	AD10	C10Ada-001	Nov. 24, 2010	Nov. 23, 2011
ROHDE & SCHWARZ Artificial Mains Network (for peripherals)	ESH3-Z5	100218	Nov. 24, 2010	Nov. 23, 2011
Software	ADT_Cond_V7.3.7	NA	NA	NA
Software	ADT_ISN_V7.3.7	NA	NA	NA
RF cable (JYEBAO)	5D-FB	Cable-C10.01	Feb. 22, 2011	Feb. 21, 2012
SUHNTER Terminator (For ROHDE & SCHWARZ LISN)	65BNC-5001	E1-010773	Feb. 26, 2011	Feb. 25, 2012

- NOTE:** 1. The calibration interval of the above test instruments is 12 months and the calibrations are traceable to NML/ROC and NIST/USA.
2. The test was performed in Shielded Room No. 10.
3. The VCCI Site Registration No. C-1852.



A D T

5.1.3 TEST PROCEDURES

- d. The EUT was placed 0.4 meters from the conducting wall of the shielded room with EUT being connected to the power mains through a line impedance stabilization network (LISN). Other support units were connected to the power mains through another LISN. The two LISNs provide 50 ohm/ 50uH of coupling impedance for the measuring instrument.
- e. Both lines of the power mains connected to the EUT were checked for maximum conducted interference.
- f. The frequency range from 150kHz to 30MHz was searched. Emission levels under (Limit - 20dB) was not recorded.

NOTE: All modes of operation were investigated and the worst-case emissions are reported.

5.1.4 DEVIATION FROM TEST STANDARD

No deviation

5.1.5 TEST SETUP

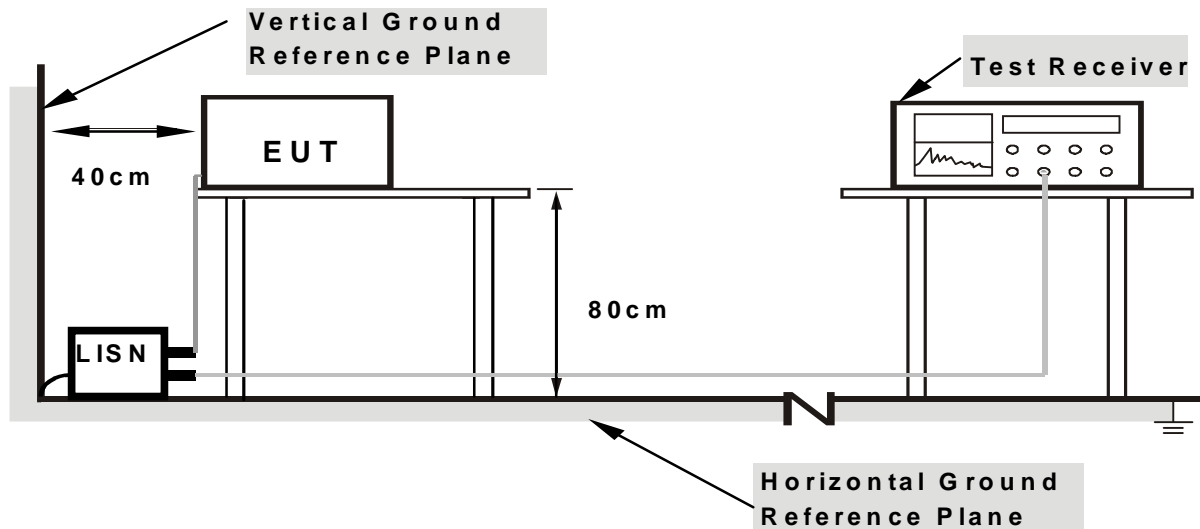

- Note:** 1. Support units were connected to second LISN.
2. Both of LISNs (AMN) are 80 cm from EUT and at least 80 cm from other units and other metal planes support units.

For the actual test configuration, please refer to the attached file (Test Setup Photo).

5.1.6 EUT OPERATING CONDITIONS

Same as item 4.1.6.

5.1.7 TEST RESULTS

CONDUCTED WORST-CASE DATA : 802.11a

6dB BANDWIDTH	9kHz	PHASE	Line 1
CHANNEL	Channel 149		

No	Freq. [MHz]	Corr. Factor (dB)	Reading Value		Emission Level		Limit		Margin	
			[dB (uV)]		[dB (uV)]		[dB (uV)]		(dB)	
			Q.P.	AV.	Q.P.	AV.	Q.P.	AV.	Q.P.	AV.
1	0.252	0.19	56.15	50.83	56.34	51.02	61.71	51.71	-5.37	-0.69
2	0.420	0.24	52.53	46.25	52.77	46.49	57.46	47.46	-4.69	-0.97
3	0.513	0.25	53.48	45.59	53.73	45.84	56.00	46.00	-2.27	-0.16
4	0.677	0.25	54.18	45.72	54.43	45.97	56.00	46.00	-1.57	-0.03
5	8.152	0.68	34.55	-	35.23	-	60.00	50.00	-24.77	-
6	25.414	1.50	40.56	-	42.06	-	60.00	50.00	-17.94	-

- REMARKS:**
1. Q.P. and AV. are abbreviations of quasi-peak and average individually.
 2. "-": The Quasi-peak reading value also meets average limit and measurement with the average detector is unnecessary.
 3. The emission levels of other frequencies were very low against the limit.
 4. Margin value = Emission level - Limit value
 5. Correction factor = Insertion loss + Cable loss
 6. Emission Level = Correction Factor + Reading Value.

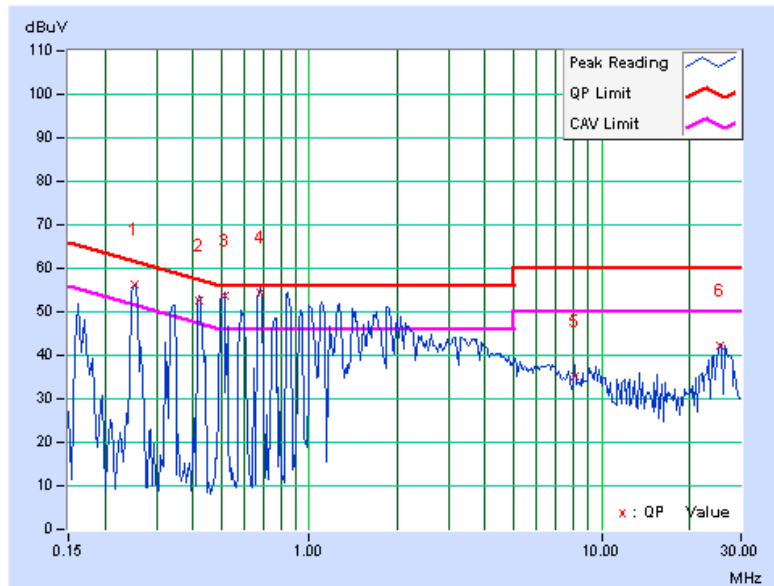



A D T

6dB BANDWIDTH	9kHz	PHASE	Line 2
CHANNEL	Channel 149		

No	Freq. [MHz]	Corr. Factor (dB)	Reading Value		Emission Level		Limit		Margin	
			[dB (uV)]		[dB (uV)]		[dB (uV)]		(dB)	
			Q.P.	AV.	Q.P.	AV.	Q.P.	AV.	Q.P.	AV.
1	0.255	0.20	55.40	50.67	55.60	50.87	61.58	51.58	-5.98	-0.71
2	0.423	0.25	51.77	46.52	52.02	46.77	57.38	47.38	-5.36	-0.61
3	0.513	0.26	53.95	44.74	54.21	45.00	56.00	46.00	-1.79	-1.00
4	0.681	0.26	53.82	45.41	54.08	45.67	56.00	46.00	-1.92	-0.33
5	9.109	0.63	34.64	-	35.27	-	60.00	50.00	-24.73	-
6	24.215	1.06	42.23	-	43.29	-	60.00	50.00	-16.71	-

- REMARKS:**
1. Q.P. and AV. are abbreviations of quasi-peak and average individually.
 2. "-": The Quasi-peak reading value also meets average limit and measurement with the average detector is unnecessary.
 3. The emission levels of other frequencies were very low against the limit.
 4. Margin value = Emission level - Limit value
 5. Correction factor = Insertion loss + Cable loss
 6. Emission Level = Correction Factor + Reading Value.

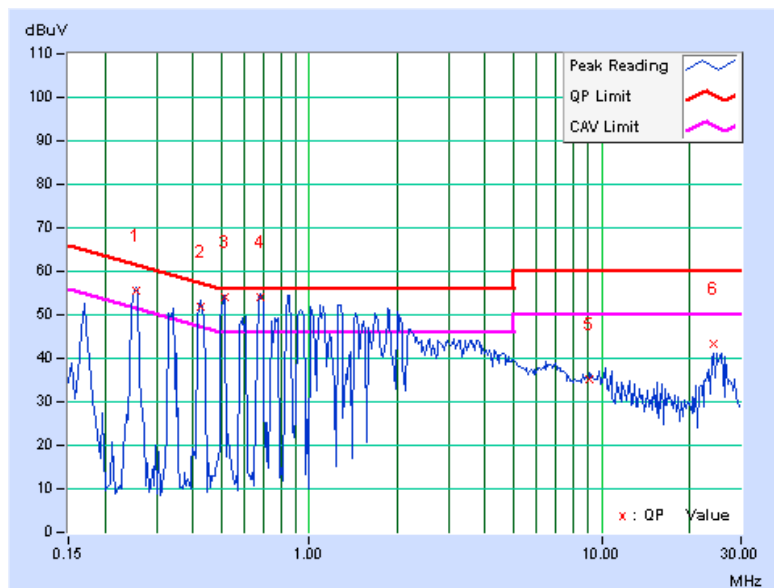



5.2 RADIATED EMISSION MEASUREMENT

5.2.1 LIMITS OF RADIATED EMISSION MEASUREMENT

Emissions radiated outside of the specified bands, shall be according to the general radiated limits in 15.209 as following:

FREQUENCIES (MHz)	FIELD STRENGTH (microvolts/meter)	MEASUREMENT DISTANCE (meters)
0.009 ~ 0.490	2400/F(kHz)	300
0.490 ~ 1.705	24000/F(kHz)	30
1.705 ~ 30.0	30	30
30 ~ 88	100	3
88 ~ 216	150	3
216 ~ 960	200	3
Above 960	500	3

NOTE:

1. The lower limit shall apply at the transition frequencies.
2. Emission level (dBuV/m) = 20 log Emission level (uV/m).
3. As shown in 15.35(b), for frequencies above 1000MHz, the field strength limits are based on average detector, however, the peak field strength of any emission shall not exceed the maximum permitted average limits, specified above by more than 20dB under any condition of modulation.



A D T

5.2.2 TEST INSTRUMENTS

DESCRIPTION & MANUFACTURER	MODEL NO.	SERIAL NO.	CALIBRATED DATE	CALIBRATED UNTIL
HP Preamplifier	8447D	2432A03504	Mar. 04, 2011	Mar. 03, 2012
HP Preamplifier	8449B	3008A01924	Mar. 04, 2011	Mar. 03, 2012
HP Preamplifier	8449B	3008A01292	Mar. 04, 2011	Mar. 03, 2012
Agilent Spectrum Analyzer	E4446A	MY46180403	Jun. 22, 2011	Jun. 21, 2012
ROHDE & SCHWARZ TEST RECEIVER	ESCS30	838251/021	Oct. 01, 2010	Sep. 30, 2011
Schwarzbeck Antenna	VULB 9168	137	Apr. 12, 2011	Apr. 11, 2012
Schwarzbeck Antenna	VHBA 9123	480	May 06, 2011	May 05, 2012
ADT. Turn Table	TT100	0306	NA	NA
ADT. Tower	AT100	0306	NA	NA
Software	ADT_Radiated_V 7.6.15.9.2	NA	NA	NA
SUHNER RF cable	SF102	CABLE-CH6	Aug. 19, 2011	Aug. 18, 2012
EMCO Horn Antenna	3115	6714	Oct. 26, 2010	Oct. 25, 2011
EMCO Horn Antenna	3115	9312-4192	Apr. 22, 2011	Apr. 21, 2012
Highpass filter Wainwright Instruments	WHK 3.1/18G-10SS	SN 8	NA	NA

- NOTE:** 1. The calibration interval of the above test instruments is 12/24 months. And the calibrations are traceable to NML/ROC and NIST/USA.
2. The horn antenna and HP preamplifier (model: 8449B) are used only for the measurement of emission frequency above 1GHz if tested.
3. The test was performed in Chamber No. 6.
4. The Industry Canada Reference No. IC 7450E-6.
5. The FCC Site Registration No. is 447212.



A D T

5.2.3 TEST PROCEDURES

- a. The EUT was placed on the top of a rotating table 0.8 meters above the ground at a 3 meters semi-anechoic chamber. The table was rotated 360 degrees to determine the position of the highest radiation.
- b. The EUT was set 3 meters away from the interference-receiving antenna, which was mounted on the top of a variable-height antenna tower.
- c. The antenna is a broadband antenna, and its height is varied from one meter to four meters above the ground to determine the maximum value of the field strength. Both horizontal and vertical polarizations of the antenna are set to make the measurement.
- d. For each suspected emission, the EUT was arranged to its worst case and then the antenna was tuned to heights from 1 meter to 4 meters and the rotatable table was turned from 0 degrees to 360 degrees to find the maximum reading.
- e. The test-receiver system was set to Peak Detect Function and Specified Bandwidth with Maximum Hold Mode.
- f. If the emission level of the EUT in peak mode was lower than the limit specified, then testing could be stopped and the peak values of the EUT would be reported. Otherwise the emissions would be re-tested one by one using peak, quasi-peak or average method as specified and then reported in a data sheet.

NOTE:

1. The resolution bandwidth and video bandwidth of test receiver/spectrum analyzer is 120kHz for Quasi-peak detection at frequency below 1GHz.
2. The resolution bandwidth of test receiver/spectrum analyzer is 100kHz and video bandwidth is 300kHz for Peak detection at frequency above 1GHz.
3. The resolution bandwidth of test receiver/spectrum analyzer is 1MHz and the video bandwidth is 10Hz for Average detection (AV) at frequency above 1GHz.
4. All modes of operation were investigated and the worst-case emissions are reported.

5.2.4 DEVIATION FROM TEST STANDARD

No deviation

5.2.5 TEST SETUP

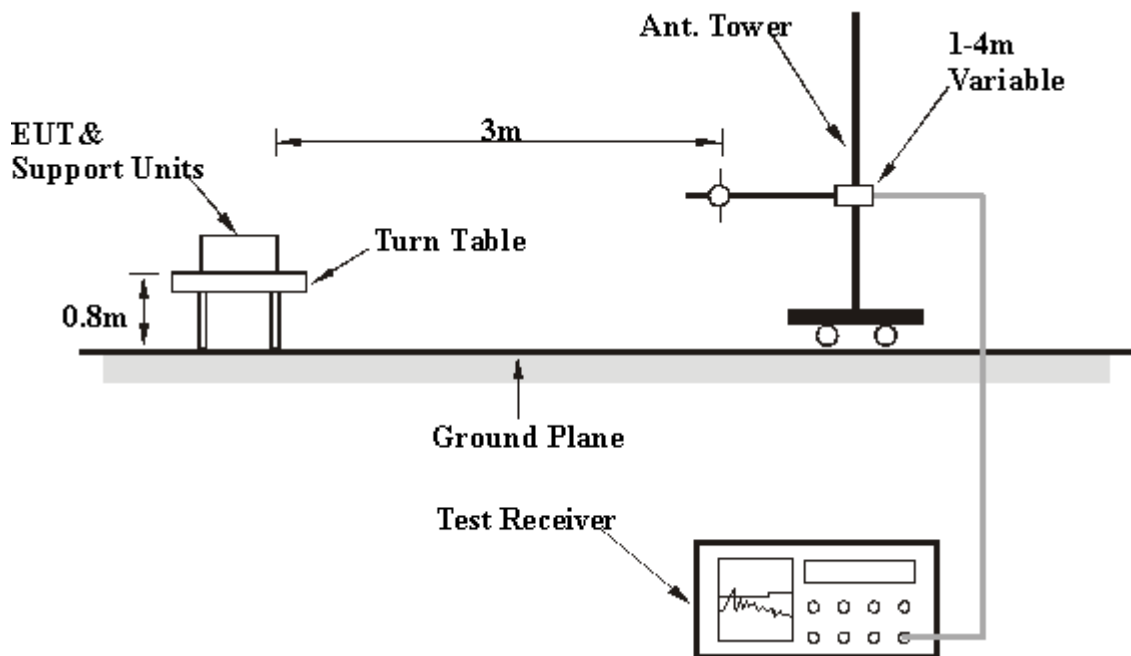

For the actual test configuration, please refer to the attached file (Test Setup Photo).

5.2.6 EUT OPERATING CONDITIONS

Same as 4.1.6



5.2.7 TEST RESULTS

802.11a

EUT TEST CONDITION		MEASUREMENT DETAIL	
CHANNEL	Channel 149	FREQUENCY RANGE	1 ~ 40GHz
INPUT POWER	120Vac, 60Hz	DETECTOR FUNCTION	Peak (PK) Average (AV)
ENVIRONMENTAL CONDITIONS	26deg. C, 70% RH	TESTED BY	Nick Chen

ANTENNA POLARITY & TEST DISTANCE: HORIZONTAL AT 3 M								
NO.	FREQ. (MHz)	EMISSION LEVEL (dBuV/m)	LIMIT (dBuV/m)	MARGIN (dB)	ANTENNA HEIGHT (m)	TABLE ANGLE (Degree)	RAW VALUE (dBuV)	CORRECTION FACTOR (dB/m)
1	#5725.00	86.6 PK	96.7	-10.0	1.45 H	273	46.43	40.21
2	#5725.00	64.1 AV	86.7	-22.7	1.45 H	273	23.85	40.21
3	*5745.00	116.7 PK			1.45 H	273	76.44	40.23
4	*5745.00	106.7 AV			1.45 H	273	66.51	40.23
5	11490.00	58.8 PK	74.0	-15.2	1.32 H	266	8.58	50.24
6	11490.00	45.0 AV	54.0	-9.0	1.32 H	266	-5.24	50.24
ANTENNA POLARITY & TEST DISTANCE: VERTICAL AT 3 M								
NO.	FREQ. (MHz)	EMISSION LEVEL (dBuV/m)	LIMIT (dBuV/m)	MARGIN (dB)	ANTENNA HEIGHT (m)	TABLE ANGLE (Degree)	RAW VALUE (dBuV)	CORRECTION FACTOR (dB/m)
1	#5725.00	62.4 PK	81.1	-18.7	1.10 V	179	22.19	40.21
2	#5725.00	42.6 AV	71.4	-28.7	1.10 V	179	2.42	40.21
3	*5745.00	101.1 PK			1.10 V	179	60.83	40.23
4	*5745.00	91.4 AV			1.10 V	179	51.14	40.23
5	11490.00	59.1 PK	74.0	-14.9	1.05 V	24	8.87	50.24
6	11490.00	44.9 AV	54.0	-9.1	1.05 V	24	-5.33	50.24

- REMARKS:**
1. Emission level (dBuV/m) = Raw Value (dBuV) + Correction Factor (dB/m).
 2. Correction Factor (dB/m) = Antenna Factor (dB/m) + Cable Factor (dB).
 3. The other emission levels were very low against the limit.
 4. Margin value = Emission level – Limit value.
 5. “ * “: Fundamental frequency.
 6. The limit value is defined as per 15.247.
 7. "#":The radiated frequency is out the restricted band.



A D T

EUT TEST CONDITION		MEASUREMENT DETAIL	
CHANNEL	Channel 157	FREQUENCY RANGE	1 ~ 40GHz
INPUT POWER	120Vac, 60Hz	DETECTOR FUNCTION	Peak (PK) Average (AV)
ENVIRONMENTAL CONDITIONS	26deg. C, 70% RH	TESTED BY	Nick Chen

ANTENNA POLARITY & TEST DISTANCE: HORIZONTAL AT 3 M								
NO.	FREQ. (MHz)	EMISSION LEVEL (dBuV/m)	LIMIT (dBuV/m)	MARGIN (dB)	ANTENNA HEIGHT (m)	TABLE ANGLE (Degree)	RAW VALUE (dBuV)	CORRECTION FACTOR (dB/m)
1	*5785.00	116.1 PK			1.48 H	282	75.78	40.29
2	*5785.00	106.8 AV			1.48 H	282	66.55	40.29
3	11570.00	58.9 PK	74.0	-15.1	1.25 H	251	8.73	50.20
4	11570.00	45.1 AV	54.0	-8.9	1.25 H	251	-5.08	50.20
ANTENNA POLARITY & TEST DISTANCE: VERTICAL AT 3 M								
NO.	FREQ. (MHz)	EMISSION LEVEL (dBuV/m)	LIMIT (dBuV/m)	MARGIN (dB)	ANTENNA HEIGHT (m)	TABLE ANGLE (Degree)	RAW VALUE (dBuV)	CORRECTION FACTOR (dB/m)
1	*5785.00	99.7 PK			1.00 V	194	59.44	40.29
2	*5785.00	88.7 AV			1.00 V	194	48.44	40.29
3	11570.00	59.4 PK	74.0	-14.6	1.15 V	154	9.16	50.20
4	11570.00	45.2 AV	54.0	-8.8	1.15 V	154	-5.03	50.20

- REMARKS:**
1. Emission level (dBuV/m) = Raw Value (dBuV) + Correction Factor (dB/m).
 2. Correction Factor (dB/m) = Antenna Factor (dB/m) + Cable Factor (dB).
 3. The other emission levels were very low against the limit.
 4. Margin value = Emission level – Limit value.
 5. “ * “: Fundamental frequency.
 6. The limit value is defined as per 15.247.



A D T

EUT TEST CONDITION		MEASUREMENT DETAIL	
CHANNEL	Channel 165	FREQUENCY RANGE	1 ~ 40GHz
INPUT POWER	120Vac, 60Hz	DETECTOR FUNCTION	Peak (PK) Average (AV)
ENVIRONMENTAL CONDITIONS	26deg. C, 70% RH	TESTED BY	Nick Chen

ANTENNA POLARITY & TEST DISTANCE: HORIZONTAL AT 3 M								
NO.	FREQ. (MHz)	EMISSION LEVEL (dBuV/m)	LIMIT (dBuV/m)	MARGIN (dB)	ANTENNA HEIGHT (m)	TABLE ANGLE (Degree)	RAW VALUE (dBuV)	CORRECTION FACTOR (dB/m)
1	*5825.00	117.3 PK			1.52 H	291	76.99	40.34
2	*5825.00	107.6 AV			1.52 H	291	67.24	40.34
3	#5850.00	78.2 PK	97.3	-19.1	1.52 H	291	37.81	40.38
4	#5850.00	57.9 AV	87.6	-29.6	1.52 H	291	17.56	40.38
5	11650.00	58.8 PK	74.0	-15.2	1.09 H	195	8.70	50.13
6	11650.00	44.9 AV	54.0	-9.1	1.09 H	195	-5.27	50.13
ANTENNA POLARITY & TEST DISTANCE: VERTICAL AT 3 M								
NO.	FREQ. (MHz)	EMISSION LEVEL (dBuV/m)	LIMIT (dBuV/m)	MARGIN (dB)	ANTENNA HEIGHT (m)	TABLE ANGLE (Degree)	RAW VALUE (dBuV)	CORRECTION FACTOR (dB/m)
1	*5825.00	100.9 PK			1.00 V	342	60.53	40.34
2	*5825.00	90.8 AV			1.00 V	342	50.46	40.34
3	#5850.00	58.1 PK	80.9	-22.8	1.00 V	342	17.69	40.38
4	#5850.00	41.8 AV	70.8	-29.0	1.00 V	342	1.41	40.38
5	11650.00	58.4 PK	74.0	-15.6	1.15 V	129	8.26	50.13
6	11650.00	45.1 AV	54.0	-8.9	1.15 V	129	-5.04	50.13

- REMARKS:**
1. Emission level (dBuV/m) = Raw Value (dBuV) + Correction Factor (dB/m).
 2. Correction Factor (dB/m) = Antenna Factor (dB/m) + Cable Factor (dB).
 3. The other emission levels were very low against the limit.
 4. Margin value = Emission level – Limit value.
 5. “ * “: Fundamental frequency.
 6. The limit value is defined as per 15.247.
 7. "#":The radiated frequency is out the restricted band.



A D T

802.11n (20MHz)

EUT TEST CONDITION		MEASUREMENT DETAIL	
CHANNEL	Channel 149	FREQUENCY RANGE	1 ~ 40GHz
INPUT POWER	120Vac, 60Hz	DETECTOR FUNCTION	Peak (PK) Average (AV)
ENVIRONMENTAL CONDITIONS	26deg. C, 70% RH	TESTED BY	Nick Chen

ANTENNA POLARITY & TEST DISTANCE: HORIZONTAL AT 3 M								
NO.	FREQ. (MHz)	EMISSION LEVEL (dBuV/m)	LIMIT (dBuV/m)	MARGIN (dB)	ANTENNA HEIGHT (m)	TABLE ANGLE (Degree)	RAW VALUE (dBuV)	CORRECTION FACTOR (dB/m)
1	#5725.00	84.7 PK	96.4	-11.7	1.56 H	278	44.47	40.21
2	#5725.00	65.5 AV	87.8	-22.3	1.56 H	278	25.32	40.21
3	*5745.00	116.4 PK			1.56 H	278	76.19	40.23
4	*5745.00	107.8 AV			1.56 H	278	67.55	40.23
5	11490.00	59.1 PK	74.0	-15.0	1.22 H	251	8.81	50.24
6	11490.00	45.1 AV	54.0	-8.9	1.22 H	251	-5.13	50.24

ANTENNA POLARITY & TEST DISTANCE: VERTICAL AT 3 M								
NO.	FREQ. (MHz)	EMISSION LEVEL (dBuV/m)	LIMIT (dBuV/m)	MARGIN (dB)	ANTENNA HEIGHT (m)	TABLE ANGLE (Degree)	RAW VALUE (dBuV)	CORRECTION FACTOR (dB/m)
1	#5725.00	70.3 PK	83.3	-13.0	1.10 V	251	30.04	40.21
2	#5725.00	51.9 AV	71.3	-19.4	1.10 V	251	11.73	40.21
3	*5745.00	103.3 PK			1.10 V	251	63.04	40.23
4	*5745.00	91.3 AV			1.10 V	251	51.11	40.23
5	11490.00	59.3 PK	74.0	-14.7	1.03 V	15	9.05	50.24
6	11490.00	45.1 AV	54.0	-8.9	1.03 V	15	-5.13	50.24

- REMARKS:**
1. Emission level (dBuV/m) = Raw Value (dBuV) + Correction Factor (dB/m).
 2. Correction Factor (dB/m) = Antenna Factor (dB/m) + Cable Factor (dB).
 3. The other emission levels were very low against the limit.
 4. Margin value = Emission level – Limit value.
 5. “ * “: Fundamental frequency.
 6. The limit value is defined as per 15.247.
 7. "#":The radiated frequency is out the restricted band.



A D T

EUT TEST CONDITION		MEASUREMENT DETAIL	
CHANNEL	Channel 157	FREQUENCY RANGE	1 ~ 40GHz
INPUT POWER	120Vac, 60Hz	DETECTOR FUNCTION	Peak (PK) Average (AV)
ENVIRONMENTAL CONDITIONS	26deg. C, 70% RH	TESTED BY	Nick Chen

ANTENNA POLARITY & TEST DISTANCE: HORIZONTAL AT 3 M								
NO.	FREQ. (MHz)	EMISSION LEVEL (dBuV/m)	LIMIT (dBuV/m)	MARGIN (dB)	ANTENNA HEIGHT (m)	TABLE ANGLE (Degree)	RAW VALUE (dBuV)	CORRECTION FACTOR (dB/m)
1	*5785.00	114.6 PK			1.50 H	264	74.33	40.29
2	*5785.00	102.7 AV			1.50 H	264	62.45	40.29
3	11570.00	59.0 PK	74.0	-15.0	1.33 H	254	8.77	50.20
4	11570.00	45.1 AV	54.0	-8.9	1.33 H	254	-5.09	50.20
ANTENNA POLARITY & TEST DISTANCE: VERTICAL AT 3 M								
NO.	FREQ. (MHz)	EMISSION LEVEL (dBuV/m)	LIMIT (dBuV/m)	MARGIN (dB)	ANTENNA HEIGHT (m)	TABLE ANGLE (Degree)	RAW VALUE (dBuV)	CORRECTION FACTOR (dB/m)
1	*5785.00	101.0 PK			1.01 V	339	60.67	40.29
2	*5785.00	81.2 AV			1.01 V	339	40.87	40.29
3	11570.00	59.2 PK	74.0	-14.8	1.07 V	39	9.01	50.20
4	11570.00	45.2 AV	54.0	-8.8	1.07 V	39	-4.99	50.20

- REMARKS:**
1. Emission level (dBuV/m) = Raw Value (dBuV) + Correction Factor (dB/m).
 2. Correction Factor (dB/m) = Antenna Factor (dB/m) + Cable Factor (dB).
 3. The other emission levels were very low against the limit.
 4. Margin value = Emission level – Limit value.
 5. “ * “: Fundamental frequency.
 6. The limit value is defined as per 15.247.



A D T

EUT TEST CONDITION		MEASUREMENT DETAIL	
CHANNEL	Channel 165	FREQUENCY RANGE	1 ~ 40GHz
INPUT POWER	120Vac, 60Hz	DETECTOR FUNCTION	Peak (PK) Average (AV)
ENVIRONMENTAL CONDITIONS	26deg. C, 70% RH	TESTED BY	Nick Chen

ANTENNA POLARITY & TEST DISTANCE: HORIZONTAL AT 3 M								
NO.	FREQ. (MHz)	EMISSION LEVEL (dBuV/m)	LIMIT (dBuV/m)	MARGIN (dB)	ANTENNA HEIGHT (m)	TABLE ANGLE (Degree)	RAW VALUE (dBuV)	CORRECTION FACTOR (dB/m)
1	*5825.00	113.8 PK			1.47 H	260	73.49	40.34
2	*5825.00	101.9 AV			1.47 H	260	61.60	40.34
3	#5850.00	73.7 PK	93.8	-20.1	1.47 H	260	33.34	40.38
4	#5850.00	54.6 AV	81.9	-27.4	1.47 H	260	14.18	40.38
5	11650.00	58.7 PK	74.0	-15.3	1.36 H	251	8.55	50.13
6	11650.00	44.9 AV	54.0	-9.1	1.36 H	251	-5.27	50.13
ANTENNA POLARITY & TEST DISTANCE: VERTICAL AT 3 M								
NO.	FREQ. (MHz)	EMISSION LEVEL (dBuV/m)	LIMIT (dBuV/m)	MARGIN (dB)	ANTENNA HEIGHT (m)	TABLE ANGLE (Degree)	RAW VALUE (dBuV)	CORRECTION FACTOR (dB/m)
1	*5825.00	101.3 PK			1.00 V	340	60.96	40.34
2	*5825.00	87.8 AV			1.00 V	340	47.50	40.34
3	#5850.00	59.5 PK	81.3	-21.9	1.00 V	340	19.07	40.38
4	#5850.00	42.9 AV	67.8	-25.0	1.00 V	340	2.48	40.38
5	11650.00	58.4 PK	74.0	-15.6	1.08 V	139	8.26	50.13
6	11650.00	44.5 AV	54.0	-9.5	1.08 V	139	-5.65	50.13

- REMARKS:**
1. Emission level (dBuV/m) = Raw Value (dBuV) + Correction Factor (dB/m).
 2. Correction Factor (dB/m) = Antenna Factor (dB/m) + Cable Factor (dB).
 3. The other emission levels were very low against the limit.
 4. Margin value = Emission level – Limit value.
 5. “ * “: Fundamental frequency.
 6. The limit value is defined as per 15.247.
 7. "#":The radiated frequency is out the restricted band.



A D T

802.11n (40MHz)

EUT TEST CONDITION		MEASUREMENT DETAIL	
CHANNEL	Channel 151	FREQUENCY RANGE	1 ~ 40GHz
INPUT POWER	120Vac, 60Hz	DETECTOR FUNCTION	Peak (PK) Average (AV)
ENVIRONMENTAL CONDITIONS	26deg. C, 70% RH	TESTED BY	Nick Chen

ANTENNA POLARITY & TEST DISTANCE: HORIZONTAL AT 3 M								
NO.	FREQ. (MHz)	EMISSION LEVEL (dBuV/m)	LIMIT (dBuV/m)	MARGIN (dB)	ANTENNA HEIGHT (m)	TABLE ANGLE (Degree)	RAW VALUE (dBuV)	CORRECTION FACTOR (dB/m)
1	#5725.00	88.1 PK	94.8	-6.7	1.44 H	278	47.85	40.21
2	#5725.00	71.0 AV	82.7	-11.8	1.44 H	278	30.78	40.21
3	*5755.00	114.8 PK			1.44 H	278	74.51	40.25
4	*5755.00	102.7 AV			1.44 H	278	62.49	40.25
5	11510.00	58.3 PK	74.0	-15.7	1.15 H	254	8.10	50.23
6	11510.00	45.4 AV	54.0	-8.6	1.15 H	254	-4.86	50.23

ANTENNA POLARITY & TEST DISTANCE: VERTICAL AT 3 M								
NO.	FREQ. (MHz)	EMISSION LEVEL (dBuV/m)	LIMIT (dBuV/m)	MARGIN (dB)	ANTENNA HEIGHT (m)	TABLE ANGLE (Degree)	RAW VALUE (dBuV)	CORRECTION FACTOR (dB/m)
1	#5725.00	68.2 PK	79.9	-11.7	1.09 V	249	28.00	40.21
2	#5725.00	55.2 AV	67.3	-12.1	1.09 V	249	14.94	40.21
3	*5755.00	99.9 PK			1.09 V	249	59.68	40.25
4	*5755.00	87.3 AV			1.09 V	249	47.02	40.25
5	11510.00	57.1 PK	74.0	-16.9	1.00 V	39	6.83	50.23
6	11510.00	44.5 AV	54.0	-9.5	1.00 V	39	-5.69	50.23

- REMARKS:**
1. Emission level (dBuV/m) = Raw Value (dBuV) + Correction Factor (dB/m).
 2. Correction Factor (dB/m) = Antenna Factor (dB/m) + Cable Factor (dB).
 3. The other emission levels were very low against the limit.
 4. Margin value = Emission level – Limit value.
 5. “ * “: Fundamental frequency.
 6. The limit value is defined as per 15.247.
 7. "#":The radiated frequency is out the restricted band.



A D T

EUT TEST CONDITION		MEASUREMENT DETAIL	
CHANNEL	Channel 159	FREQUENCY RANGE	1 ~ 40GHz
INPUT POWER	120Vac, 60Hz	DETECTOR FUNCTION	Peak (PK) Average (AV)
ENVIRONMENTAL CONDITIONS	26deg. C, 70% RH	TESTED BY	Nick Chen

ANTENNA POLARITY & TEST DISTANCE: HORIZONTAL AT 3 M								
NO.	FREQ. (MHz)	EMISSION LEVEL (dBuV/m)	LIMIT (dBuV/m)	MARGIN (dB)	ANTENNA HEIGHT (m)	TABLE ANGLE (Degree)	RAW VALUE (dBuV)	CORRECTION FACTOR (dB/m)
1	*5795.00	115.8 PK			1.54 H	283	75.52	40.30
2	*5795.00	103.8 AV			1.54 H	283	63.47	40.30
3	#5850.00	69.6 PK	95.8	-26.2	1.54 H	283	29.22	40.38
4	#5850.00	53.6 AV	83.8	-30.1	1.54 H	283	13.25	40.38
5	11590.00	58.6 PK	74.0	-15.5	1.28 H	243	8.36	50.19
6	11590.00	45.3 AV	54.0	-8.7	1.28 H	243	-4.92	50.19
ANTENNA POLARITY & TEST DISTANCE: VERTICAL AT 3 M								
NO.	FREQ. (MHz)	EMISSION LEVEL (dBuV/m)	LIMIT (dBuV/m)	MARGIN (dB)	ANTENNA HEIGHT (m)	TABLE ANGLE (Degree)	RAW VALUE (dBuV)	CORRECTION FACTOR (dB/m)
1	*5795.00	99.6 PK			1.13 V	342	59.28	40.30
2	*5795.00	87.6 AV			1.13 V	342	47.28	40.30
3	#5850.00	52.9 PK	79.6	-26.7	1.13 V	342	12.51	40.38
4	#5850.00	39.2 AV	67.6	-28.4	1.13 V	342	-1.17	40.38
5	11590.00	57.0 PK	74.0	-17.0	1.03 V	54	6.84	50.19
6	11590.00	44.8 AV	54.0	-9.2	1.03 V	54	-5.38	50.19

- REMARKS:**
1. Emission level (dBuV/m) = Raw Value (dBuV) + Correction Factor (dB/m).
 2. Correction Factor (dB/m) = Antenna Factor (dB/m) + Cable Factor (dB).
 3. The other emission levels were very low against the limit.
 4. Margin value = Emission level – Limit value.
 5. “ * “: Fundamental frequency.
 6. The limit value is defined as per 15.247.
 7. "#":The radiated frequency is out the restricted band.



A D T

BELOW 1GHz WORST-CASE DATA : 802.11a

EUT TEST CONDITION		MEASUREMENT DETAIL	
CHANNEL	Channel 149	FREQUENCY RANGE	Below 1000MHz
INPUT POWER	120Vac, 60Hz	DETECTOR FUNCTION	Quasi-Peak
ENVIRONMENTAL CONDITIONS	26deg. C, 70% RH	TESTED BY	Nick Chen

ANTENNA POLARITY & TEST DISTANCE: HORIZONTAL AT 3 M								
NO.	FREQ. (MHz)	EMISSION LEVEL (dBuV/m)	LIMIT (dBuV/m)	MARGIN (dB)	ANTENNA HEIGHT (m)	TABLE ANGLE (Degree)	RAW VALUE (dBuV)	CORRECTION FACTOR (dB/m)
1	373.78	39.4 QP	46.0	-6.6	1.07 H	304	21.53	17.90
2	399.60	33.1 QP	46.0	-12.9	1.13 H	292	14.43	18.63
3	531.95	45.4 QP	46.0	-0.6	1.28 H	241	23.45	21.93
4	573.91	30.2 QP	46.0	-15.8	1.33 H	223	7.37	22.87
5	665.91	33.5 QP	46.0	-12.5	1.34 H	241	9.56	23.93
6	678.82	31.4 QP	46.0	-14.6	1.11 H	238	7.39	24.04
7	866.04	34.3 QP	46.0	-11.7	1.27 H	241	6.91	27.41
ANTENNA POLARITY & TEST DISTANCE: VERTICAL AT 3 M								
NO.	FREQ. (MHz)	EMISSION LEVEL (dBuV/m)	LIMIT (dBuV/m)	MARGIN (dB)	ANTENNA HEIGHT (m)	TABLE ANGLE (Degree)	RAW VALUE (dBuV)	CORRECTION FACTOR (dB/m)
1	30.00	28.9 QP	40.0	-11.2	1.03 V	124	16.78	12.07
2	373.78	28.4 QP	46.0	-17.6	1.11 V	52	10.49	17.90
3	499.67	26.4 QP	46.0	-19.6	1.27 V	274	5.25	21.18
4	531.95	43.9 QP	46.0	-2.1	1.28 V	268	22.00	21.93
5	665.91	28.0 QP	46.0	-18.0	1.22 V	160	4.09	23.93
6	866.04	30.7 QP	46.0	-15.3	1.24 V	178	3.26	27.41

- REMARKS:**
1. Emission level (dBuV/m) = Raw Value (dBuV) + Correction Factor (dB/m).
 2. Correction Factor (dB/m) = Antenna Factor (dB/m) + Cable Factor (dB).
 3. The other emission levels were very low against the limit.
 4. Margin value = Emission level – Limit value.



A D T

5.3 6dB BANDWIDTH MEASUREMENT

5.3.1 LIMITS OF 6dB BANDWIDTH MEASUREMENT

The minimum of 6dB Bandwidth Measurement is 0.5MHz.

5.3.2 TEST INSTRUMENTS

DESCRIPTION & MANUFACTURER	MODEL NO.	SERIAL NO.	DATE OF CALIBRATION	DUE DATE OF CALIBRATION
SPECTRUM ANALYZER	FSP 40	100036	Apr. 29, 2011	Apr. 28, 2012

NOTE: The calibration interval of the above test instruments is 12 months and the calibrations are traceable to NML/ROC and NIST/USA.

5.3.3 TEST PROCEDURE

The transmitter output was connected to the spectrum analyzer through an attenuator. The bandwidth of the fundamental frequency was measured by spectrum analyzer with 100kHz RBW and 300kHz VBW. The 6dB bandwidth is defined as the total spectrum the power of which is higher than peak power minus 6dB.

5.3.4 DEVIATION FROM TEST STANDARD

No deviation

5.3.5 TEST SETUP

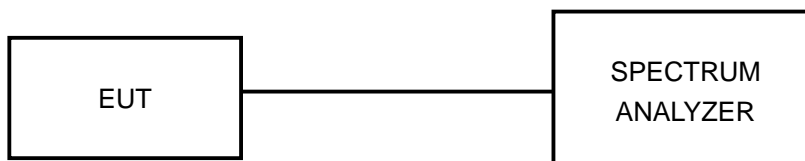

5.3.6 EUT OPERATING CONDITIONS

The software provided by client to enable the EUT under transmission condition continuously at lowest, middle and highest channel frequencies individually.



A D T

5.3.7 TEST RESULTS

802.11a

CHANNEL	CHANNEL FREQUENCY (MHz)	6dB BANDWIDTH (MHz)		MINIMUM LIMIT (MHz)	PASS / FAIL
		CHAIN 0	CHAIN 1		
149	5745	16.41	16.39	0.5	PASS
157	5785	16.42	16.43	0.5	PASS
165	5825	16.41	16.42	0.5	PASS

FOR CHAIN 1: CH 157

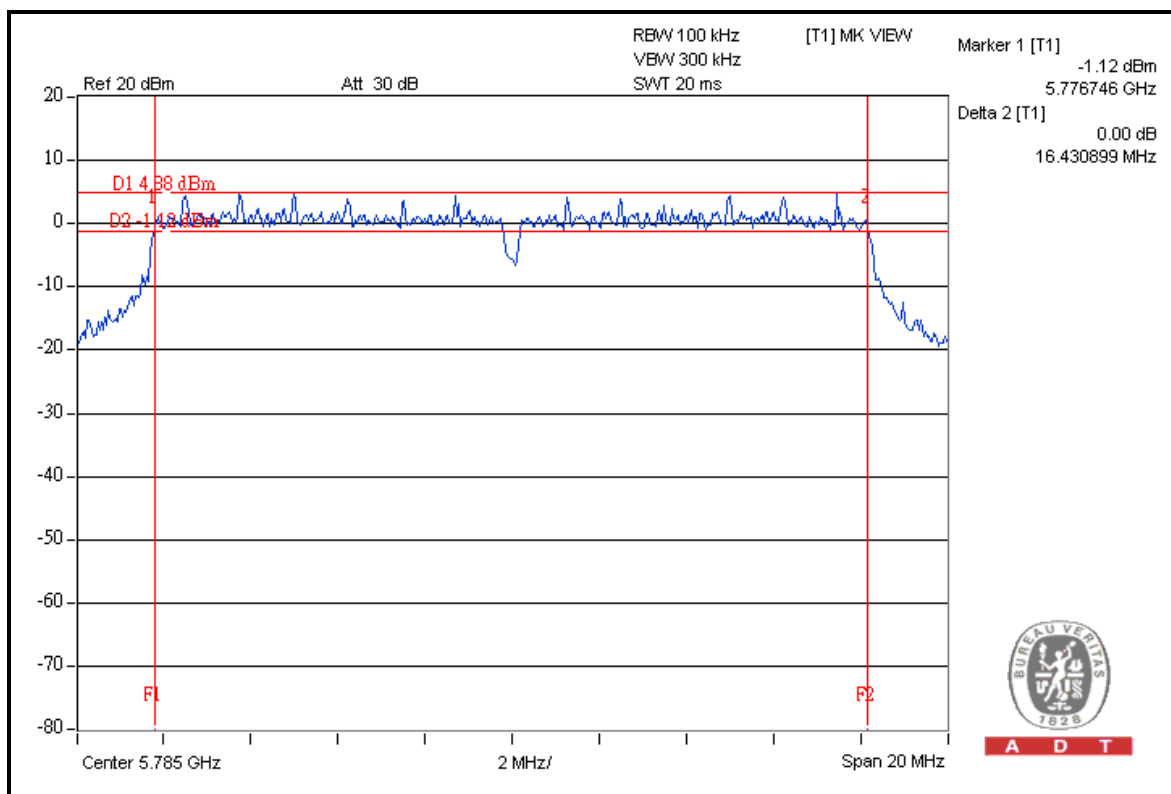



A D T

802.11n (20MHz)

CHANNEL	CHANNEL FREQUENCY (MHz)	6dB BANDWIDTH (MHz)		MINIMUM LIMIT (MHz)	PASS / FAIL
		CHAIN 0	CHAIN 1		
149	5745	17.66	17.68	0.5	PASS
157	5785	17.65	17.65	0.5	PASS
165	5825	17.65	17.65	0.5	PASS

FOR CHAIN 1: CH 149

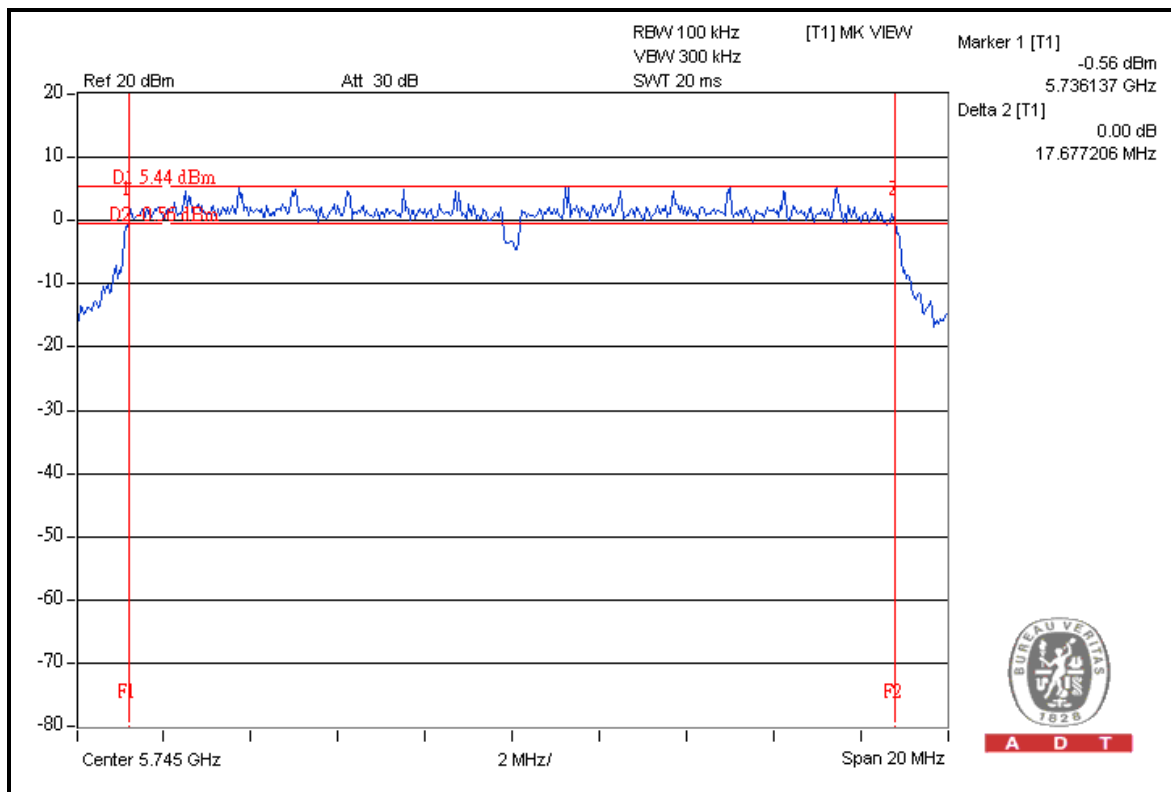



A D T

802.11n (40MHz)

CHANNEL	CHANNEL FREQUENCY (MHz)	6dB BANDWIDTH (MHz)		MINIMUM LIMIT (MHz)	PASS / FAIL
		CHAIN 0	CHAIN 1		
151	5755	36.19	36.46	0.5	PASS
159	5795	36.49	36.46	0.5	PASS

FOR CHAIN 0: CH 159

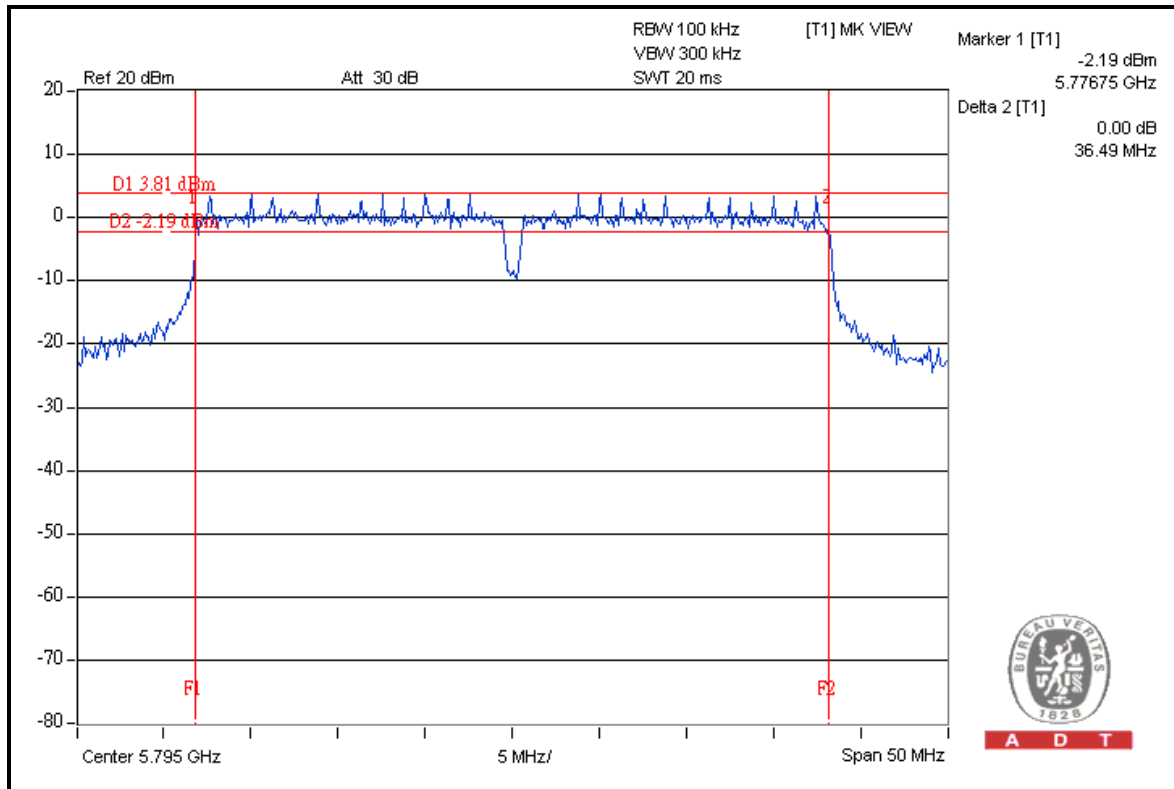

A D T



A D T

5.4 MAXIMUM OUTPUT POWER

5.4.1 LIMITS OF MAXIMUM OUTPUT POWER MEASUREMENT

The Maximum Peak Output Power Measurement is 30dBm.

5.4.2 INSTRUMENTS

DESCRIPTION & MANUFACTURER	MODEL NO.	SERIAL NO.	DATE OF CALIBRATION	DUE DATE OF CALIBRATION
Anritsu Power Sensor	MA2411B	0738404	Apr. 26, 2011	Apr. 25, 2012
Anritsu Power Meter	ML2495A	0842014	Apr. 26, 2011	Apr. 25, 2012

Note:

1. The calibration interval of the above test instruments is 12 months and the calibrations are traceable to NML/ROC and NIST/USA.
2. Measurement Bandwidth of ML2495A is 65MHz greater than 6dB bandwidth of emission.

5.4.3 TEST PROCEDURES

A power sensor was used on the output port of the EUT. A power meter was used to read the response of the power sensor. Record the power level.

5.4.4 DEVIATION FROM TEST STANDARD

No deviation

5.4.5 TEST SETUP

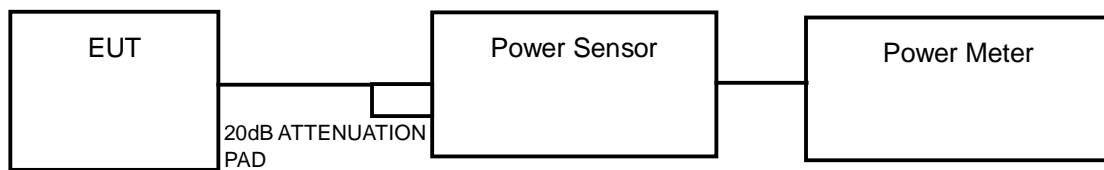

5.4.6 EUT OPERATING CONDITIONS

Same as Item 5.3.6



5.4.7 TEST RESULTS

802.11a

CHAN.	CHAN. FREQ. (MHz)	POWER OUTPUT (dBm)		TOTAL POWER (mW)	TOTAL POWER (dBm)	POWER LIMIT (dBm)	PASS / FAIL
		CHAIN 0	CHAIN 1				
149	5745	24.9	25.0	611.9	27.9	28	PASS
157	5785	25.2	24.7	611.9	27.9	28	PASS
165	5825	25.5	24.1	611.9	27.9	28	PASS

NOTE: Directional gain = 5dBi + 10log(2)=8dBi > 6dBi , so the conducted power limit shall be reduced to 30-(8-6)=28dBm.

802.11n (20MHz)

CHAN.	CHAN. FREQ. (MHz)	POWER OUTPUT (dBm)		TOTAL POWER (mW)	TOTAL POWER (dBm)	POWER LIMIT (dBm)	PASS / FAIL
		CHAIN 0	CHAIN 1				
149	5745	26.4	25.0	752.7	28.8	30	PASS
157	5785	25.7	25.2	702.7	28.5	30	PASS
165	5825	25.0	25.0	632.5	28.0	30	PASS

802.11n (40MHz)

CHAN.	CHAN. FREQ. (MHz)	POWER OUTPUT (dBm)		TOTAL POWER (mW)	TOTAL POWER (dBm)	POWER LIMIT (dBm)	PASS / FAIL
		CHAIN 0	CHAIN 1				
151	5755	25.2	25.4	677.9	28.3	30	PASS
159	5795	26.2	25.6	779.9	28.9	30	PASS



5.5 POWER SPECTRAL DENSITY MEASUREMENT

5.5.1 LIMITS OF POWER SPECTRAL DENSITY MEASUREMENT

The Maximum of Power Spectral Density Measurement is 8dBm.

5.5.2 TEST INSTRUMENTS

DESCRIPTION & MANUFACTURER	MODEL NO.	SERIAL NO.	DATE OF CALIBRATION	DUE DATE OF CALIBRATION
SPECTRUM ANALYZER	FSP 40	100036	Apr. 29, 2011	Apr. 28, 2012

NOTE: The calibration interval of the above test instruments is 12 months and the calibrations are traceable to NML/ROC and NIST/USA.

5.5.3 TEST PROCEDURE

The transmitter output was connected to the spectrum analyzer through an attenuator, the bandwidth of the fundamental frequency was measured with the spectrum analyzer using 3kHz RBW and 30kHz VBW, set sweep time = span/3kHz. The power spectral density was measured and recorded.

The sweep time is allowed to be longer than span/3kHz for a full response of the mixer in the spectrum analyzer.

Follow method 2 of KDB 662911 D01 Multiple Transmitter Output v01 to calculate total power density of 2 TX port.



A D T

5.5.4 DEVIATION FROM TEST STANDARD

No deviation

5.5.5 TEST SETUP

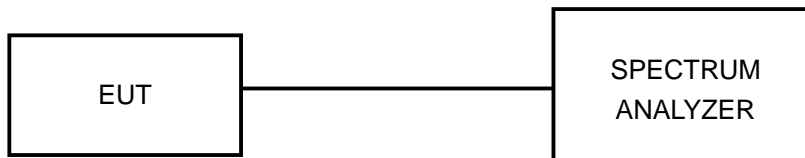

5.5.6 EUT OPERATING CONDITION

Same as Item 5.3.6



A D T

5.5.7 TEST RESULTS

802.11a

CHAIN	CHAN.	CHAN. FREQ. (MHz)	RF POWER LEVEL IN 3kHz BW (dBm)		TOTAL POWER DENSITY (dBm)	MAX. LIMIT (dBm)	PASS / FAIL
			MEASURED	10 log (N=2) dB			
0	149	5745	-8.7	3.01	-5.7	6	PASS
	157	5785	-10.2	3.01	-7.2	6	PASS
	165	5825	-9.7	3.01	-6.7	6	PASS
1	149	5745	-8.6	3.01	-5.6	6	PASS
	157	5785	-9.8	3.01	-6.8	6	PASS
	165	5825	-10.3	3.01	-7.3	6	PASS

NOTE: Directional gain = 5dBi + 10log(2)=8dBi > 6dBi , so the power density limit shall be reduced to 8-(8-6)=6dBm.

FOR CHAIN 1: CH 149

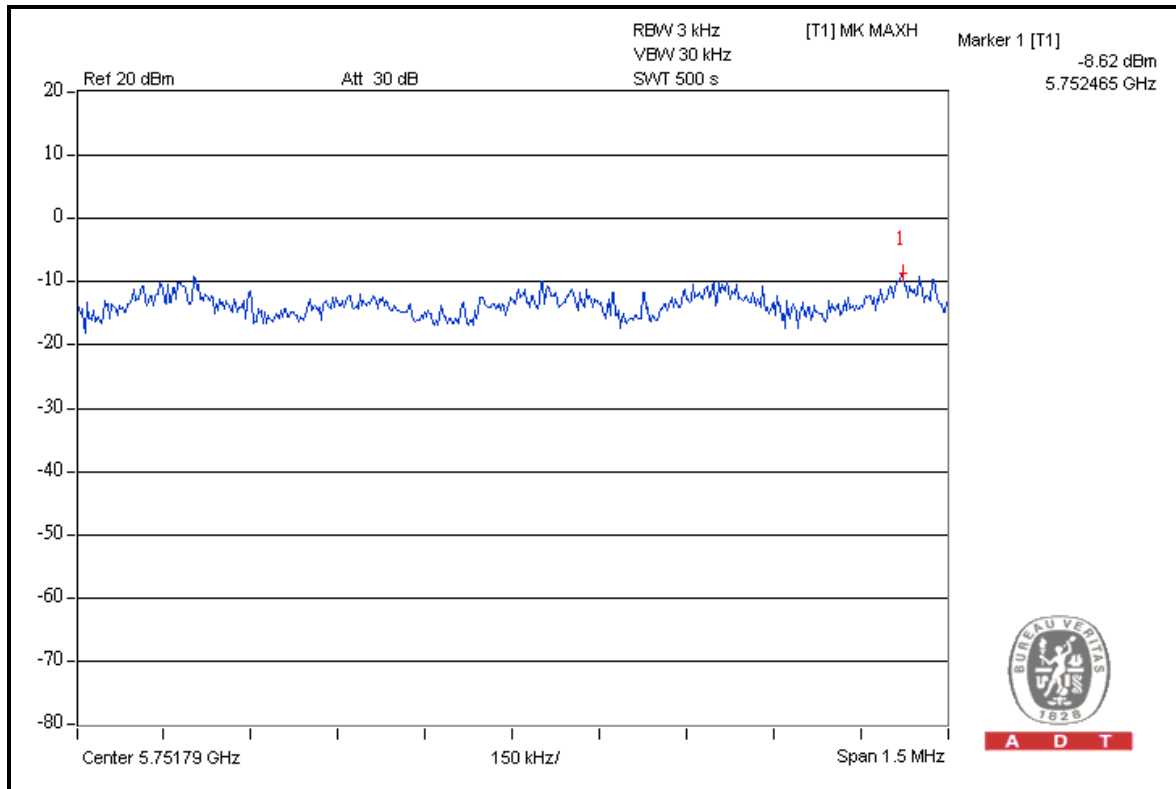

A D T



A D T

802.11n (20MHz)

CHAIN	CHAN.	CHAN. FREQ. (MHz)	RF POWER LEVEL IN 3kHz BW (dBm)		TOTAL POWER DENSITY (dBm)	MAX. LIMIT (dBm)	PASS / FAIL
			MEASURED	10 log (N=2) dB			
0	149	5745	-9.0	3.01	-6.0	8	PASS
	157	5785	-7.7	3.01	-4.7	8	PASS
	165	5825	-8.3	3.01	-5.3	8	PASS
1	149	5745	-9.2	3.01	-6.2	8	PASS
	157	5785	-8.5	3.01	-5.5	8	PASS
	165	5825	-9.1	3.01	-6.1	8	PASS

FOR CHAIN 0: CH 157

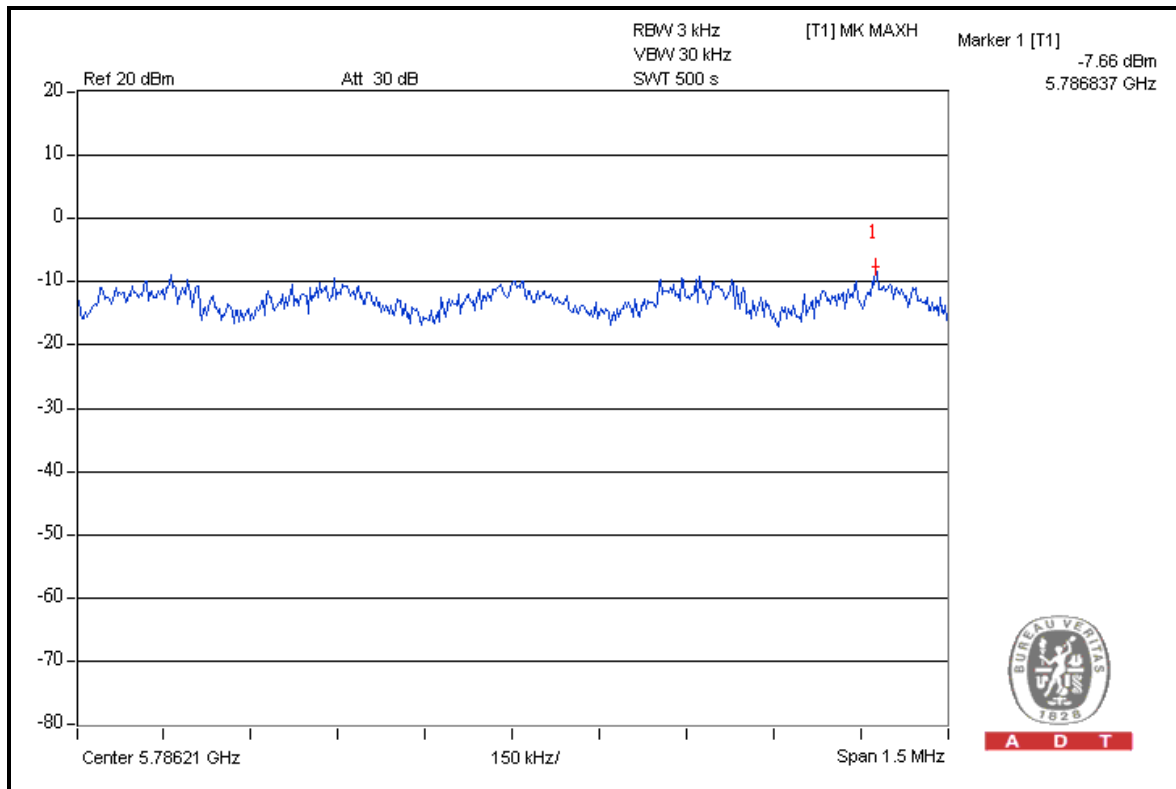



A D T

802.11n (40MHz)

CHAIN	CHAN.	CHAN. FREQ. (MHz)	RF POWER LEVEL IN 3kHz BW (dBm)		TOTAL POWER DENSITY (dBm)	MAX. LIMIT (dBm)	PASS / FAIL
			MEASURED	10 log (N=2) dB			
0	151	5755	-5.7	3.01	-2.7	8	PASS
	159	5795	-10.6	3.01	-7.6	8	PASS
1	151	5755	-4.5	3.01	-1.5	8	PASS
	159	5795	-2.5	3.01	0.5	8	PASS

FOR CHAIN 1: CH 159

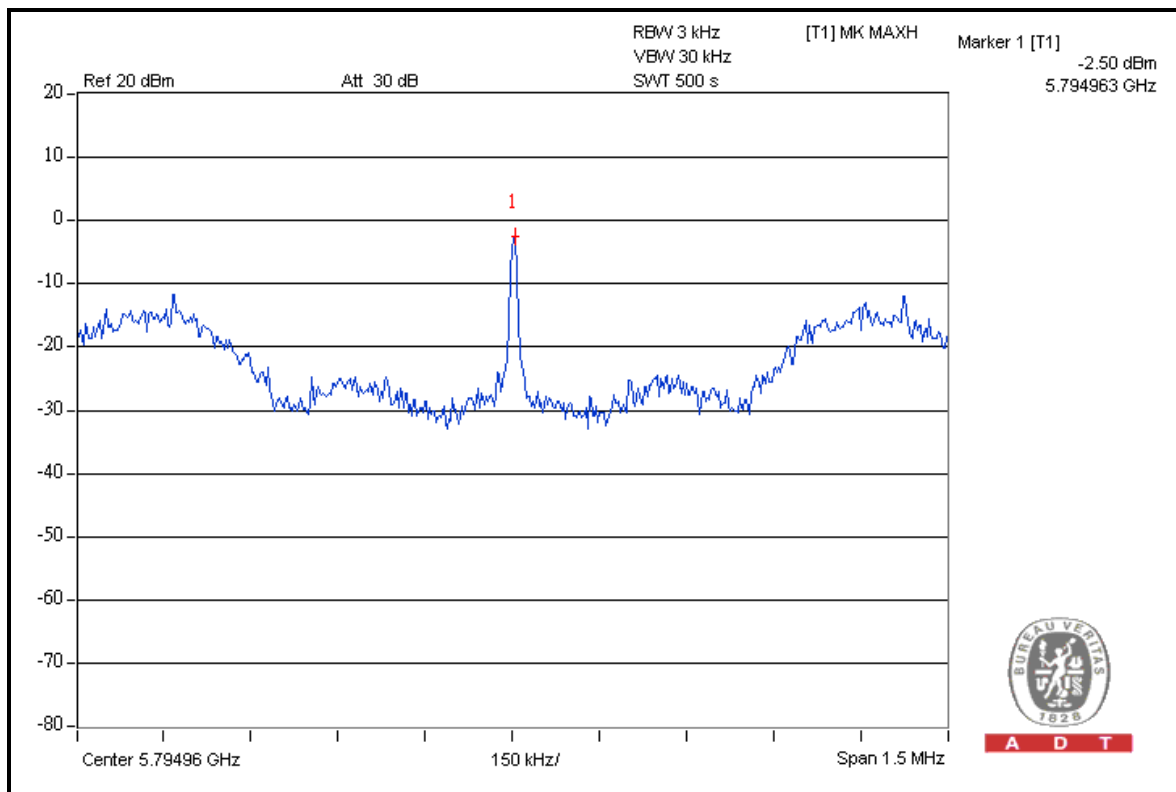



A D T

5.6 BAND EDGES MEASUREMENT

5.6.1 LIMITS OF BAND EDGES MEASUREMENT

Below -20dB of the highest emission level of operating band (in 100kHz Resolution Bandwidth).

5.6.2 TEST INSTRUMENTS

DESCRIPTION & MANUFACTURER	MODEL NO.	SERIAL NO.	DATE OF CALIBRATION	CALIBRATED UNTIL
FOR CONDUCTED MEASUREMENT:				
SPECTRUM ANALYZER	FSP 40	100036	Apr. 29, 2011	Apr. 28, 2012
FOR RADIATED MEASUREMENT:				
HP Preamplifier	8447D	2432A03504	Mar. 04, 2011	Mar. 03, 2012
HP Preamplifier	8449B	3008A01924	Mar. 04, 2011	Mar. 03, 2012
HP Preamplifier	8449B	3008A01292	Mar. 04, 2011	Mar. 03, 2012
Agilent Spectrum Analyzer	E4446A	MY46180403	Jun. 22, 2011	Jun. 21, 2012
ROHDE & SCHWARZ TEST RECEIVER	ESCS30	838251/021	Oct. 01, 2010	Sep. 30, 2011
Schwarzbeck Antenna	VULB 9168	137	Apr. 12, 2011	Apr. 11, 2012
Schwarzbeck Antenna	VHBA 9123	480	May 06, 2011	May 05, 2012
ADT. Turn Table	TT100	0306	NA	NA
ADT. Tower	AT100	0306	NA	NA
Software	ADT_Radiated_V7.6.15.9.2	NA	NA	NA
SUHNER RF cable	SF102	CABLE-CH6	Aug. 19, 2011	Aug. 18, 2012
EMCO Horn Antenna	3115	6714	Oct. 26, 2010	Oct. 25, 2011
EMCO Horn Antenna	3115	9312-4192	Apr. 22, 2011	Apr. 21, 2012
Highpass filter Wainwright Instruments	WHK 3.1/18G-10SS	SN 8	NA	NA

NOTE: The calibration interval of the above test instruments is 12/24 months. And the calibrations are traceable to NML/ROC and NIST/USA.



A D T

5.6.3 TEST PROCEDURE

FOR CONDUCTED MEASUREMENT:

The transmitter output was connected to the spectrum analyzer via a low loss cable. Set both RBW and VBW of spectrum analyzer to 100kHz and 300kHz with suitable frequency span including 100MHz bandwidth from band edge. The band edges was measured and recorded.

The spectrum plots (Peak RBW =100kHz, VBW = 300kHz; Average RBW = 1MHz, VBW = 10Hz) are attached on the following pages.

FOR RADIATED MEASUREMENT:

- a. The EUT was placed on the top of a rotating table 0.8 meters above the ground at a 3 meter semi-anechoic chamber. The table was rotated 360 degrees to determine the position of the highest radiation.
- b. The EUT was set 3 meters away from the interference-receiving antenna, which was mounted on the top of a variable-height antenna tower.
- c. The height of antenna is varied from one meter to four meters above the ground to determine the maximum value of the field strength. Both horizontal and vertical polarizations of the antenna are set to make the measurement.
- d. For each suspected emission, the EUT was arranged to its worst case and then the antenna was tuned to heights from 1 meter to 4 meters and the rotatable table was turned from 0 degrees to 360 degrees to find the maximum reading.
- e. Set both RBW and VBW of spectrum analyzer to 100kHz and 300kHz with suitable frequency span including 100MHz bandwidth from band edge. The band edges was measured and recorded.

The spectrum plots (Peak RBW =100kHz, VBW = 300kHz; Average RBW = 1MHz, VBW = 10Hz) are attached on the following pages.

NOTE: The resolution bandwidth of test receiver/spectrum analyzer is 1MHz and the video bandwidth is 10Hz for Average detection (AV) at frequency above 1GHz.

5.6.4 DEVIATION FROM TEST STANDARD

No deviation



A D T

5.6.5 EUT OPERATING CONDITION

Same as Item 5.3.6

5.6.6 TEST RESULTS

The spectrum plots are attached on the following pages. D1 line indicates the highest level, D2 line indicates the 20dB offset below D1. It shows compliance with the requirement in part 15.247(d).



A D T

802.11a

FOR RADIATED MEASURED (TWO CHAINS ON)

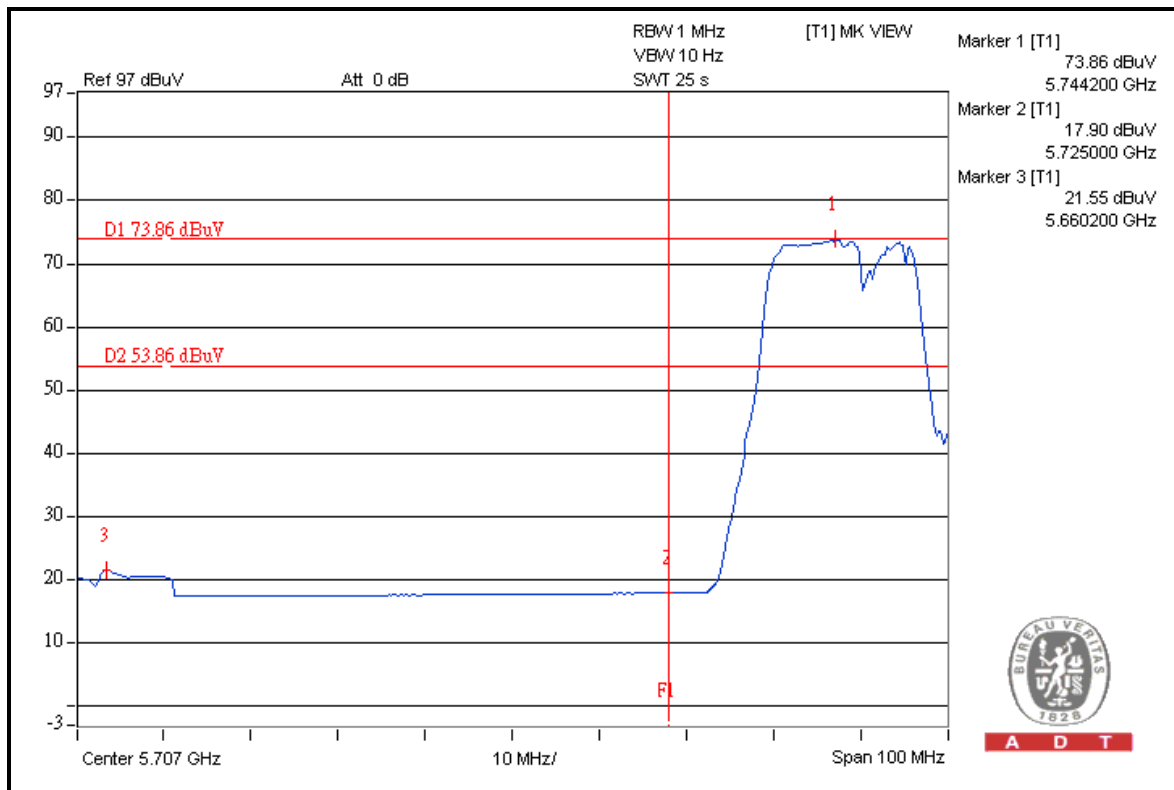
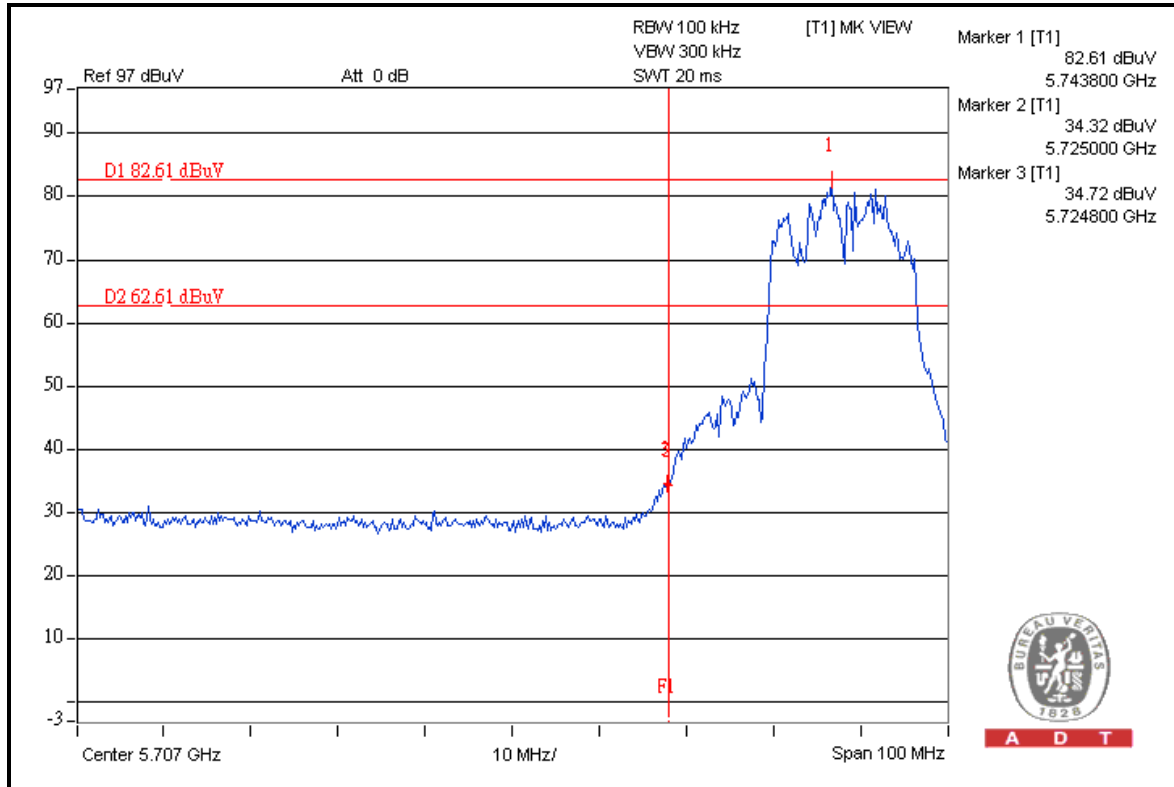



A D T

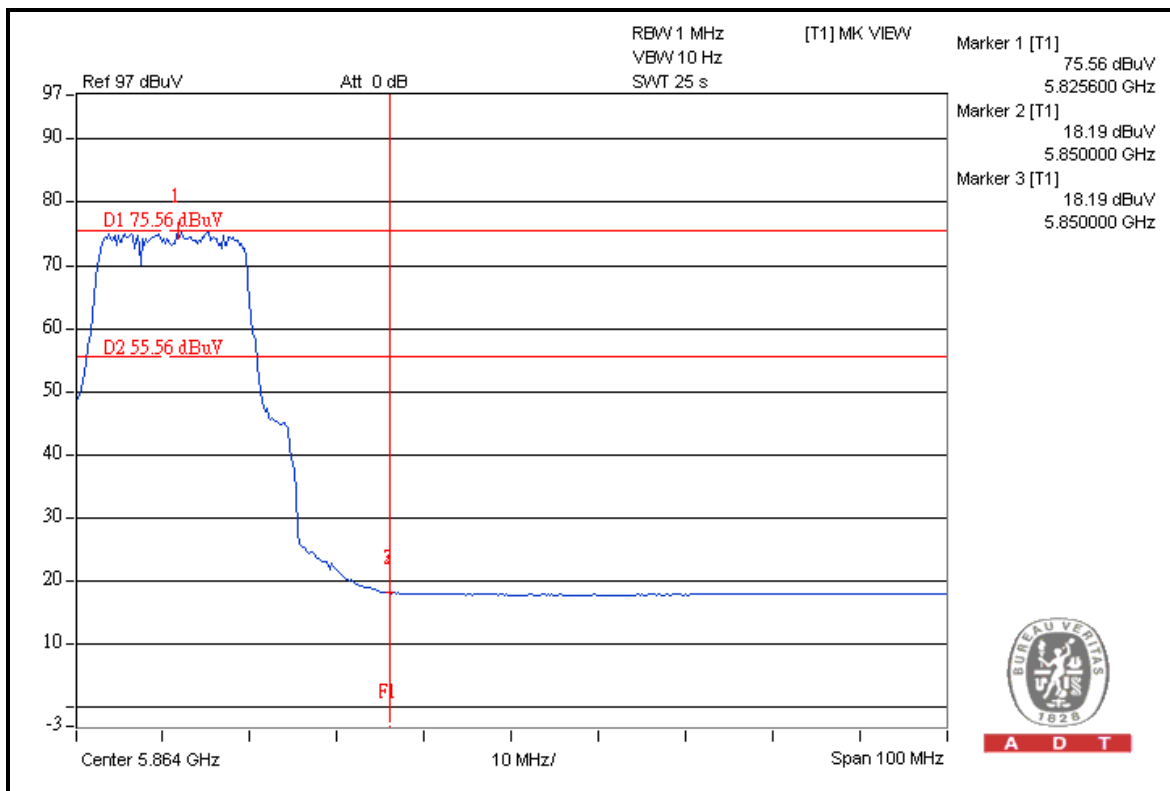
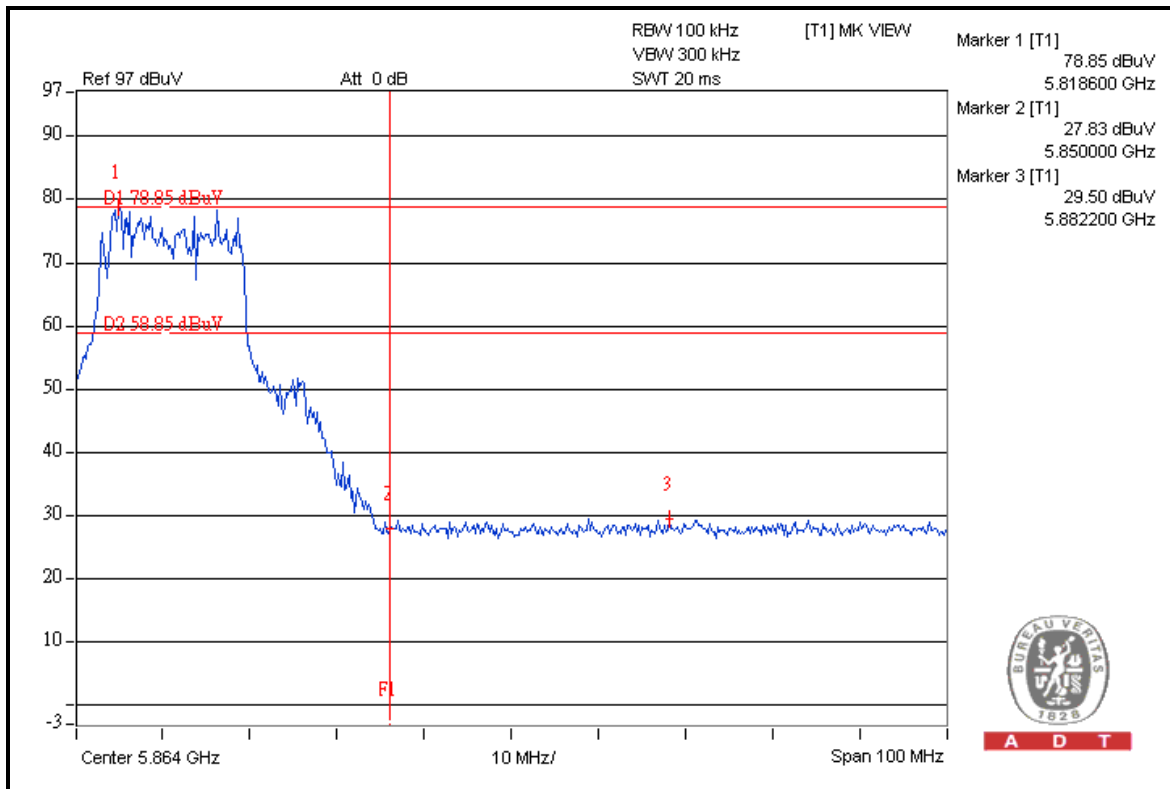



A D T

FOR CONDUCTED MEASURED

CHAIN 0

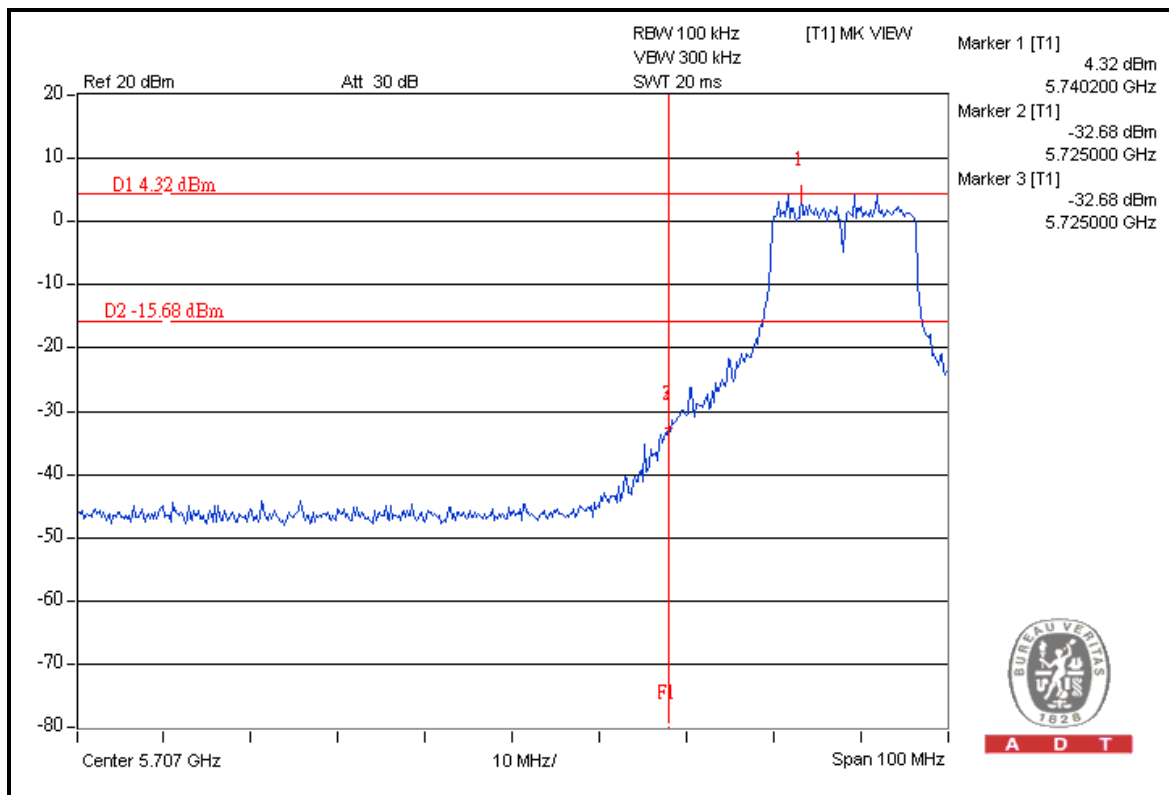

A D T

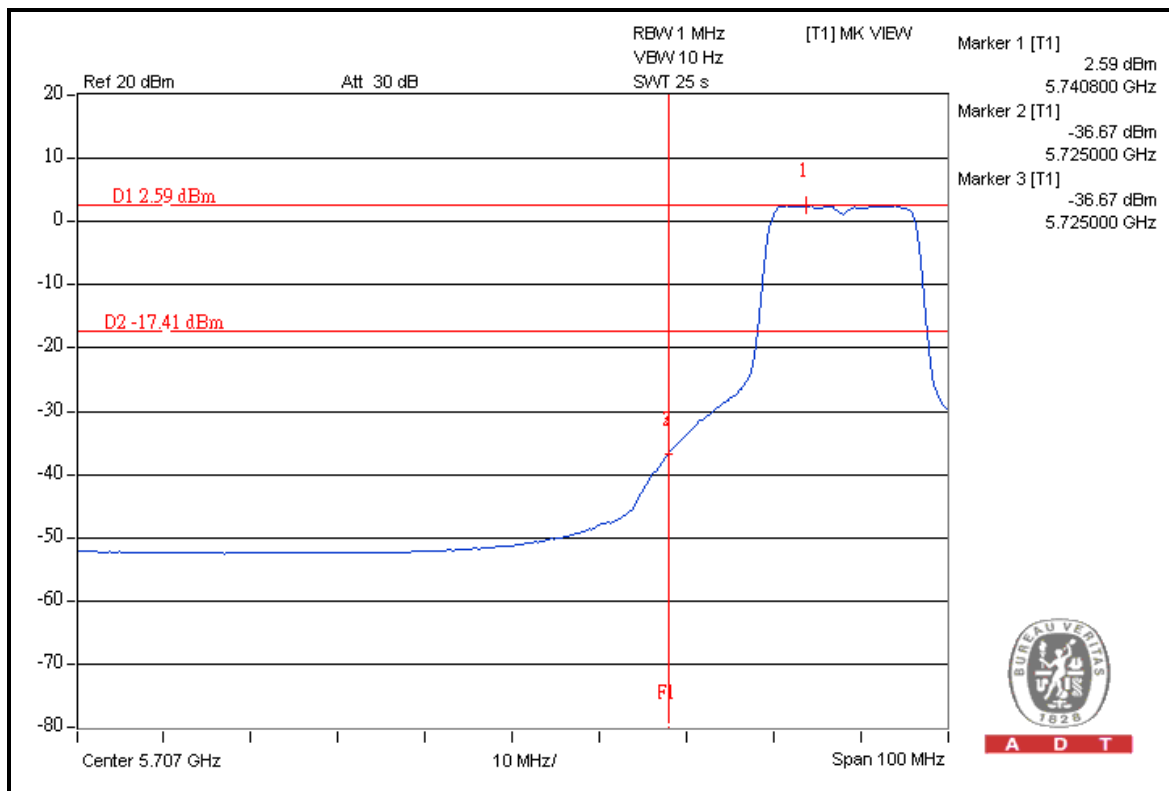

A D T



A D T

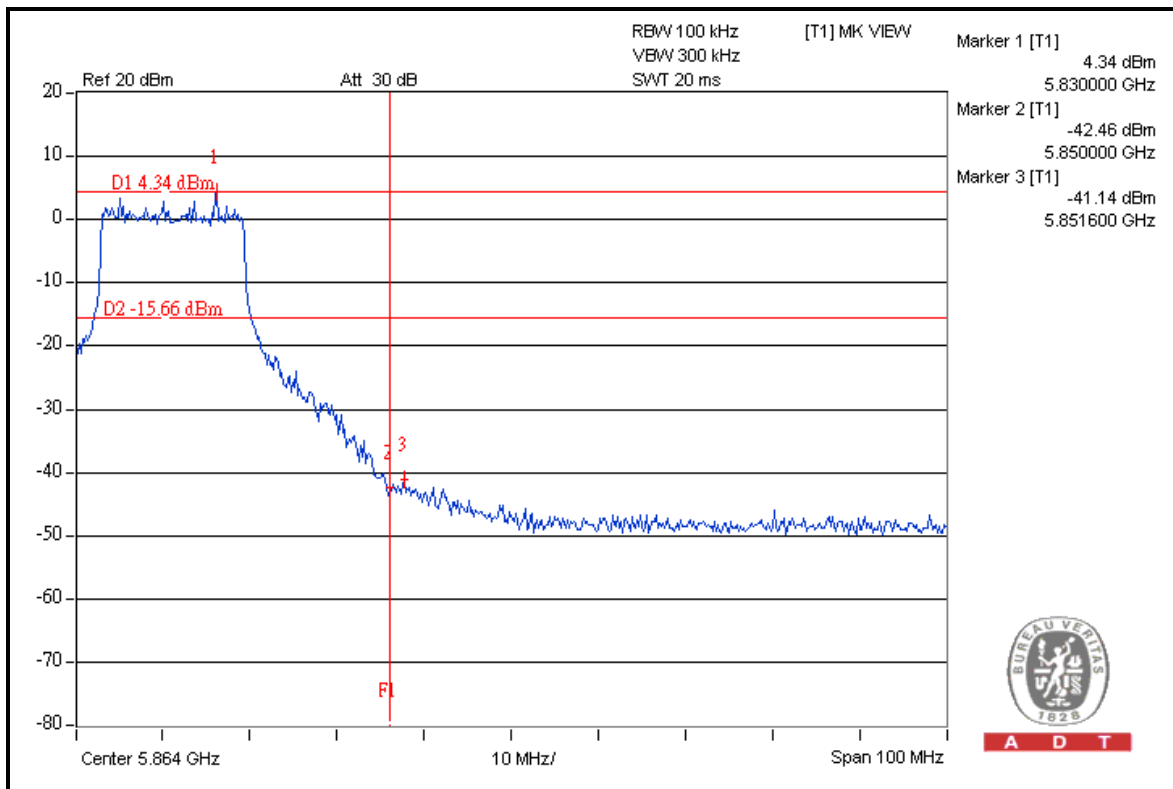
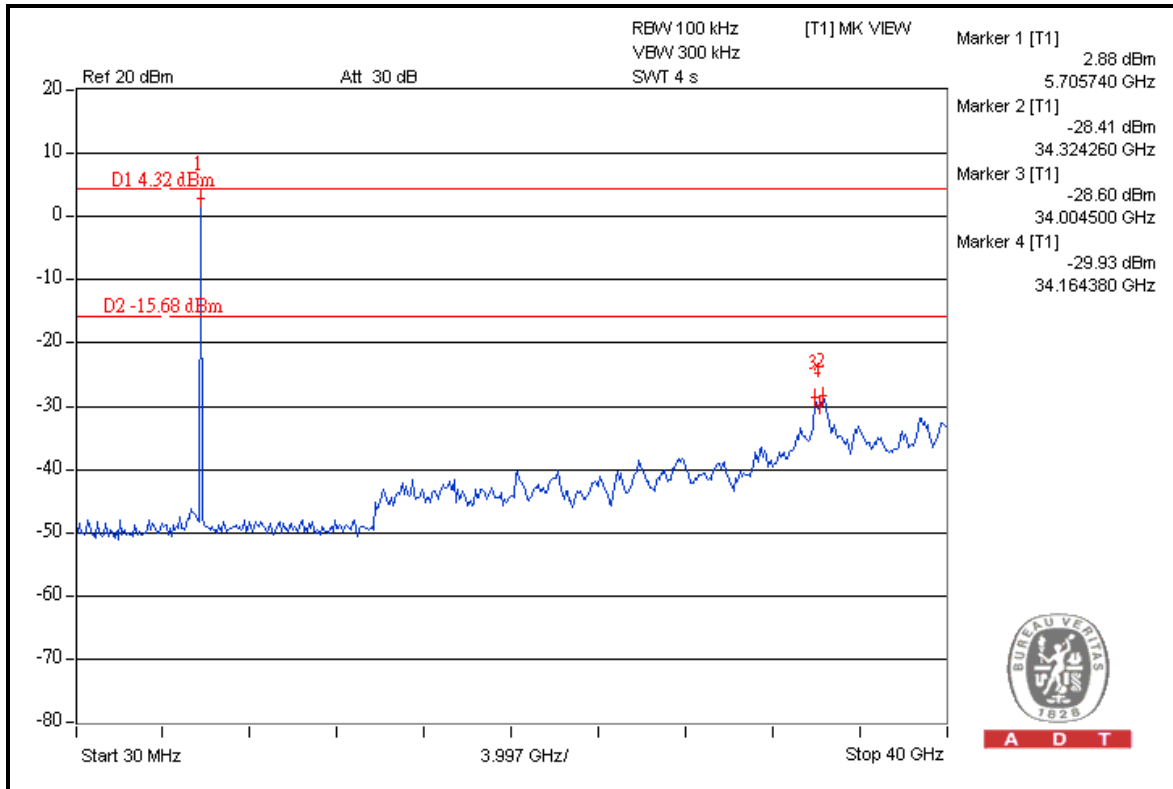



A D T

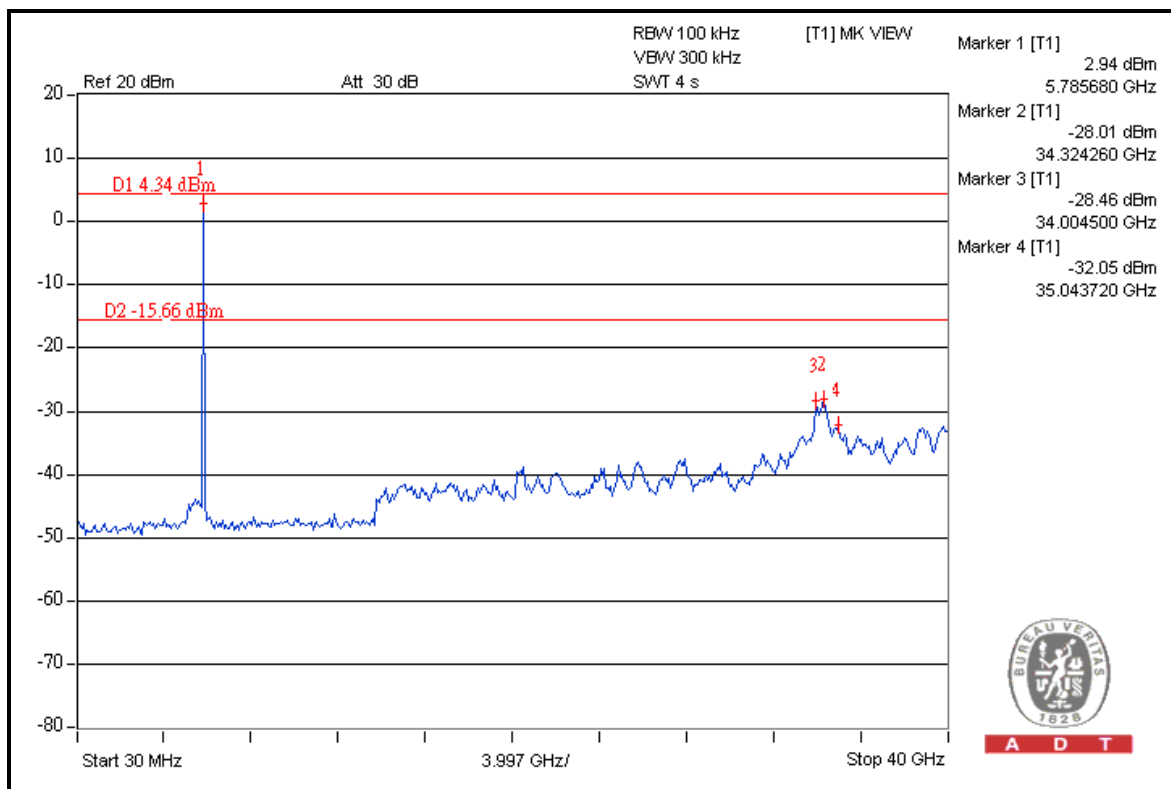
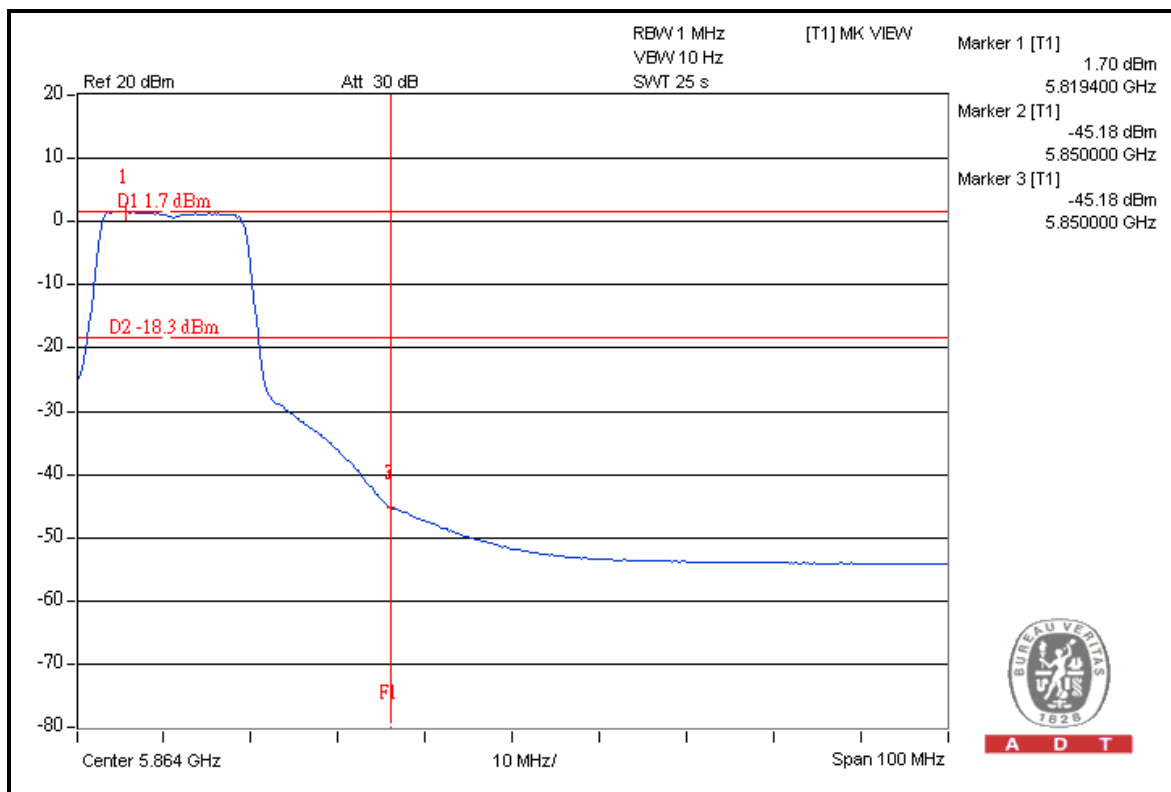



A D T

CHAIN 1

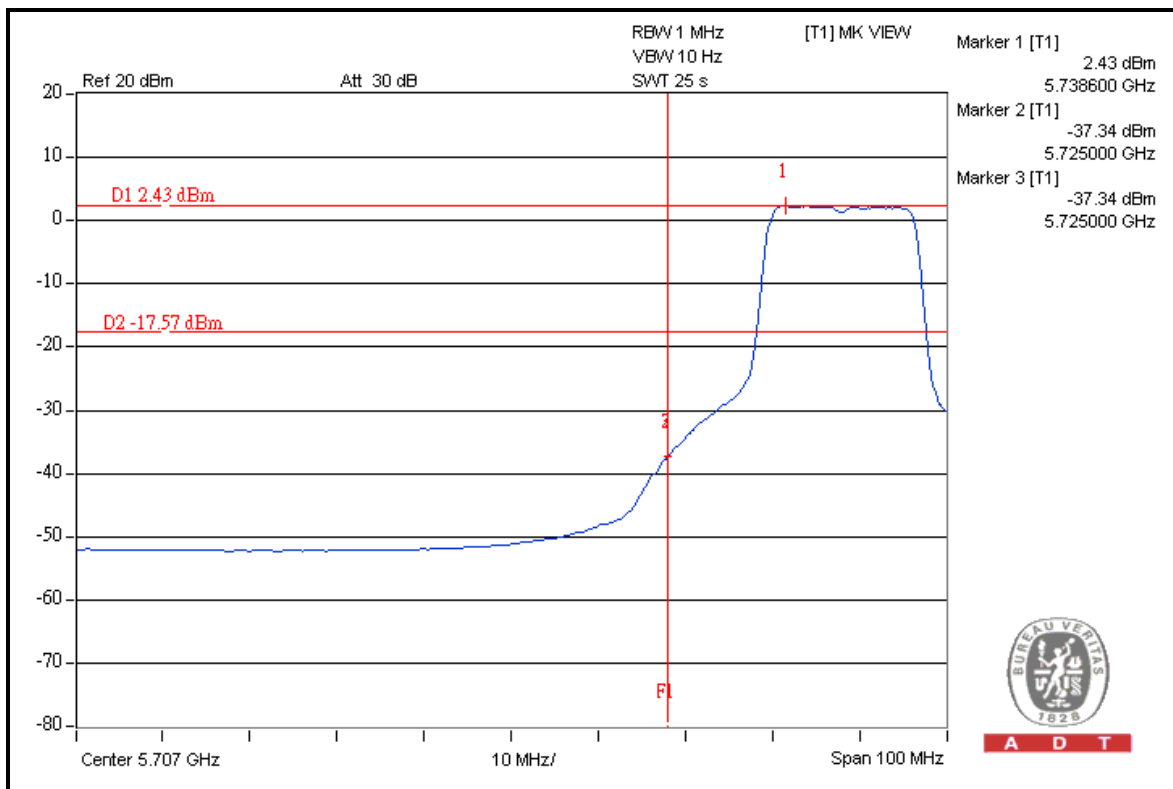
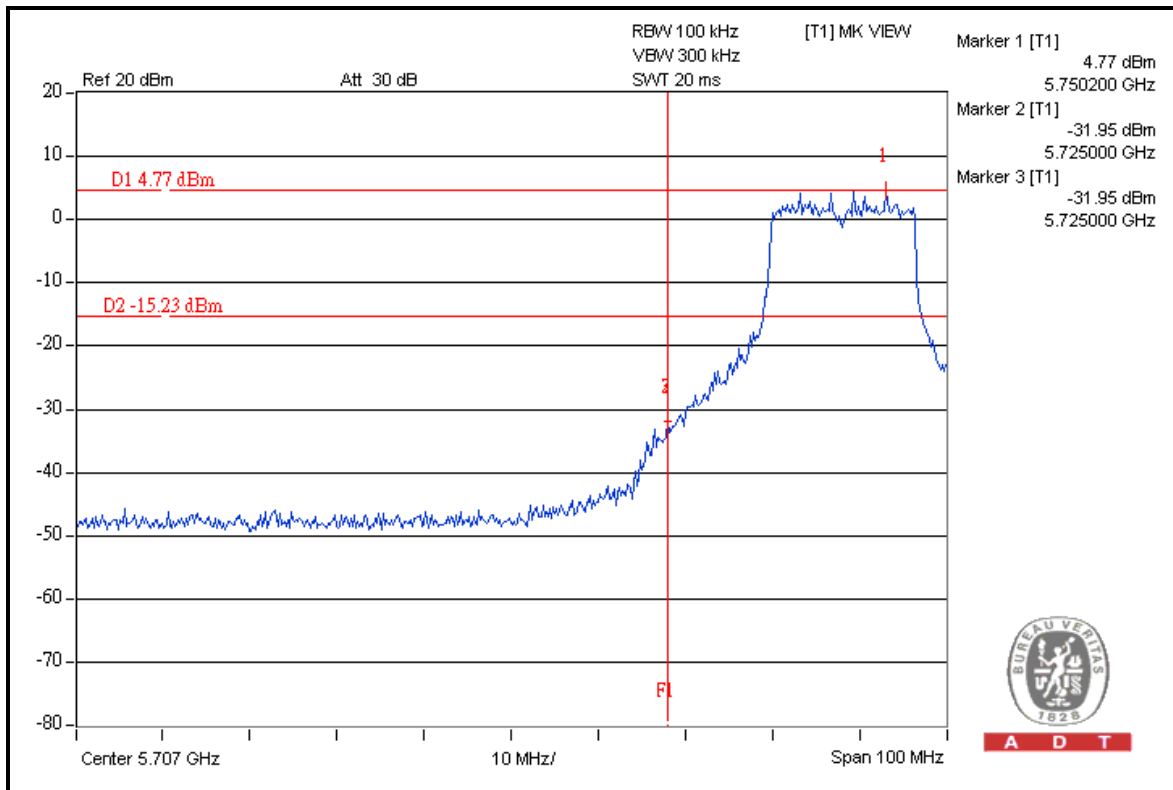



A D T

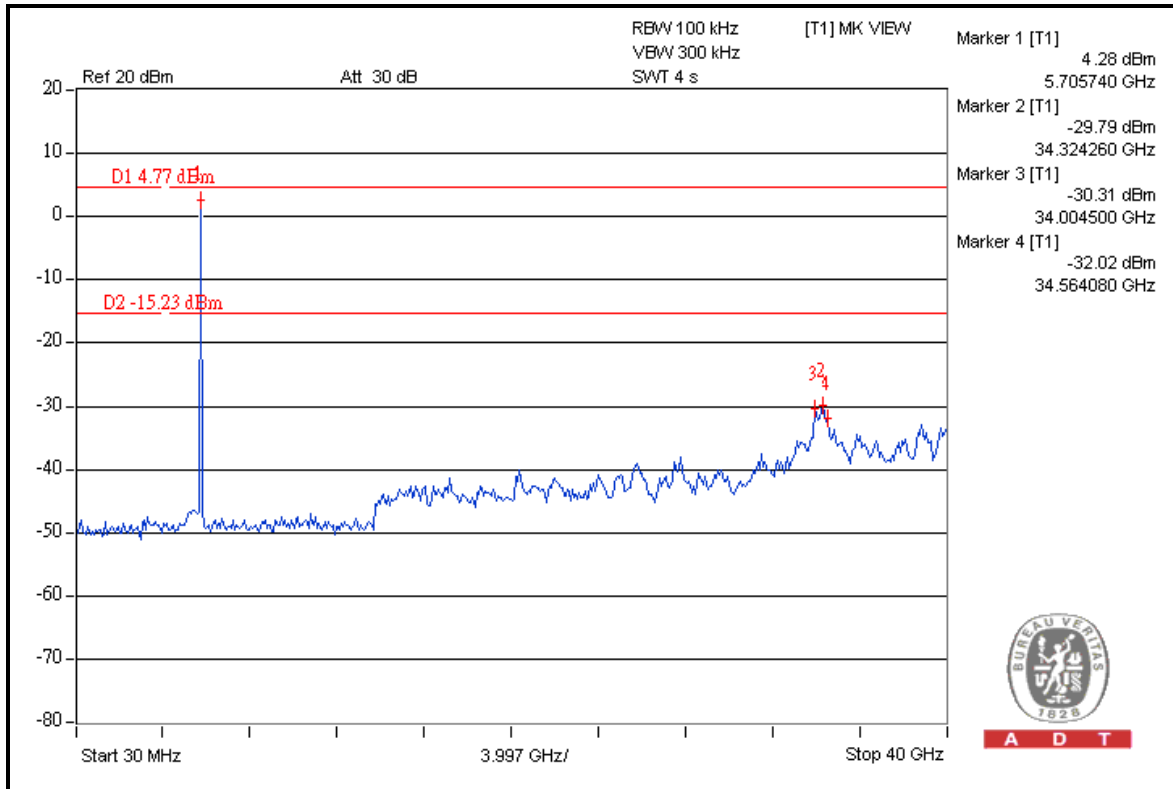

A D T

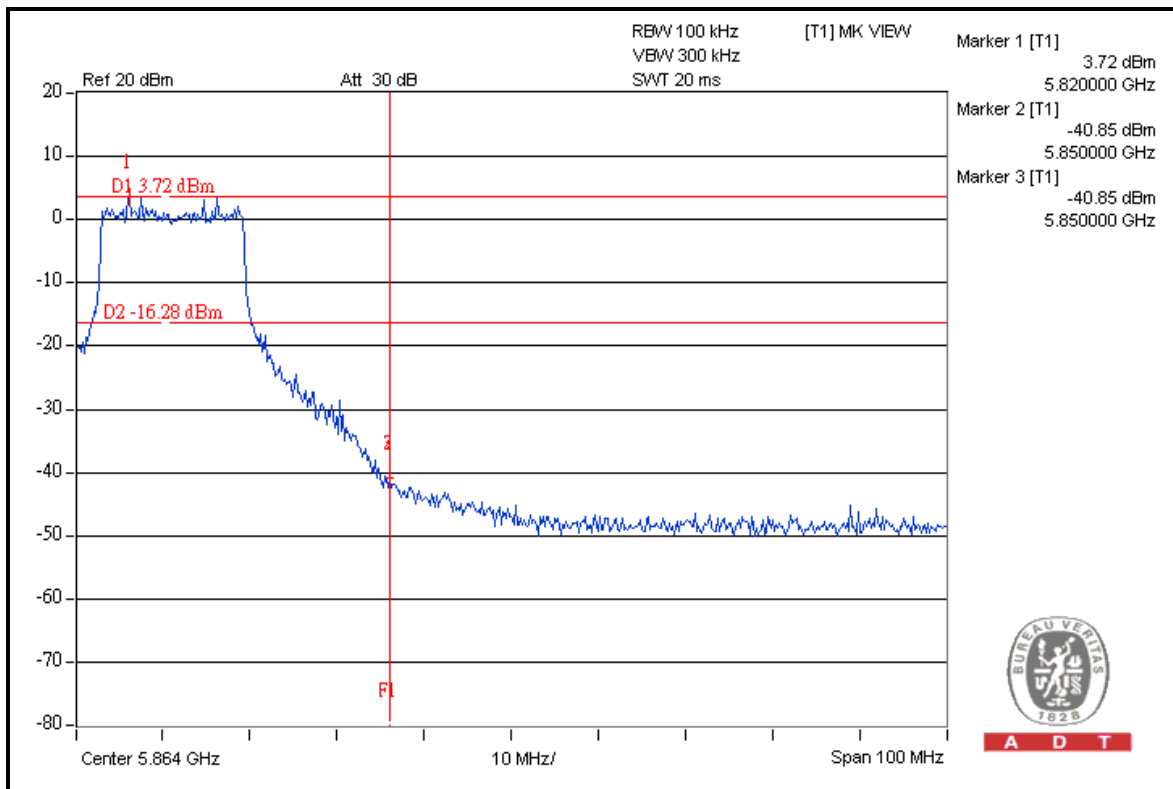

A D T



A D T

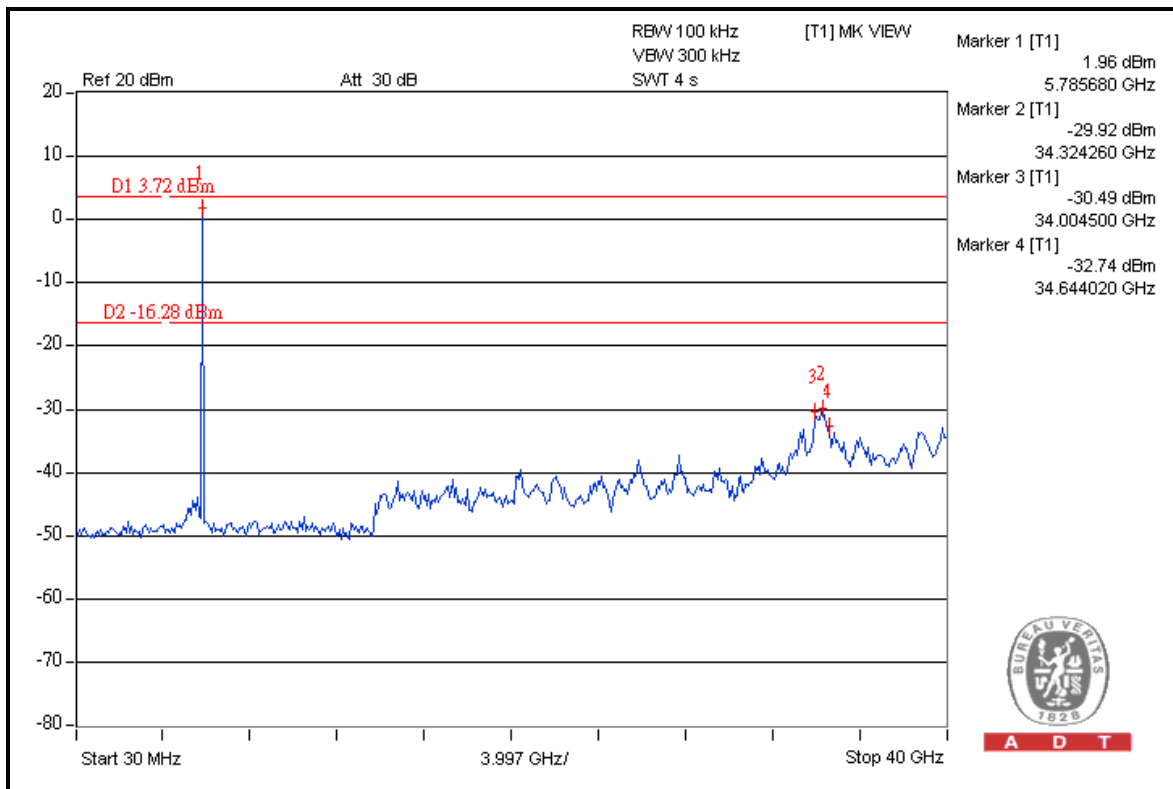
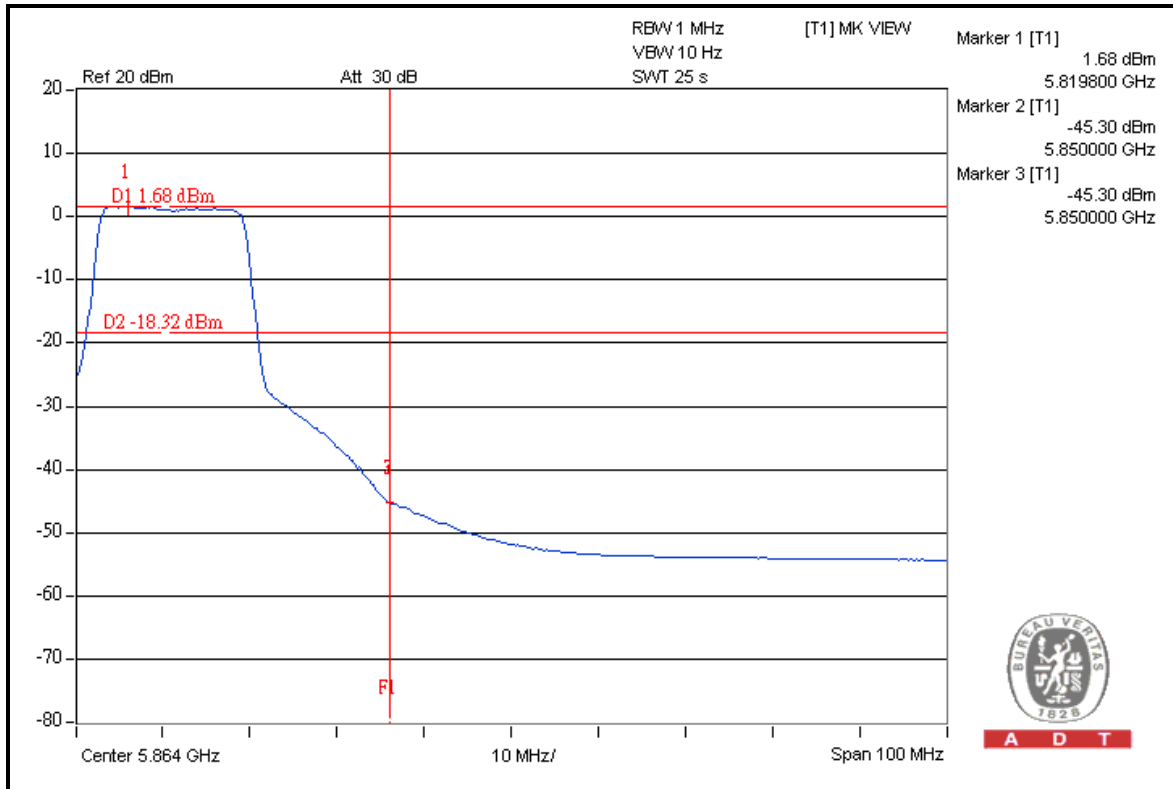



A D T

802.11n (20MHz)

FOR RADIATED MEASURED (TWO CHAINS ON)

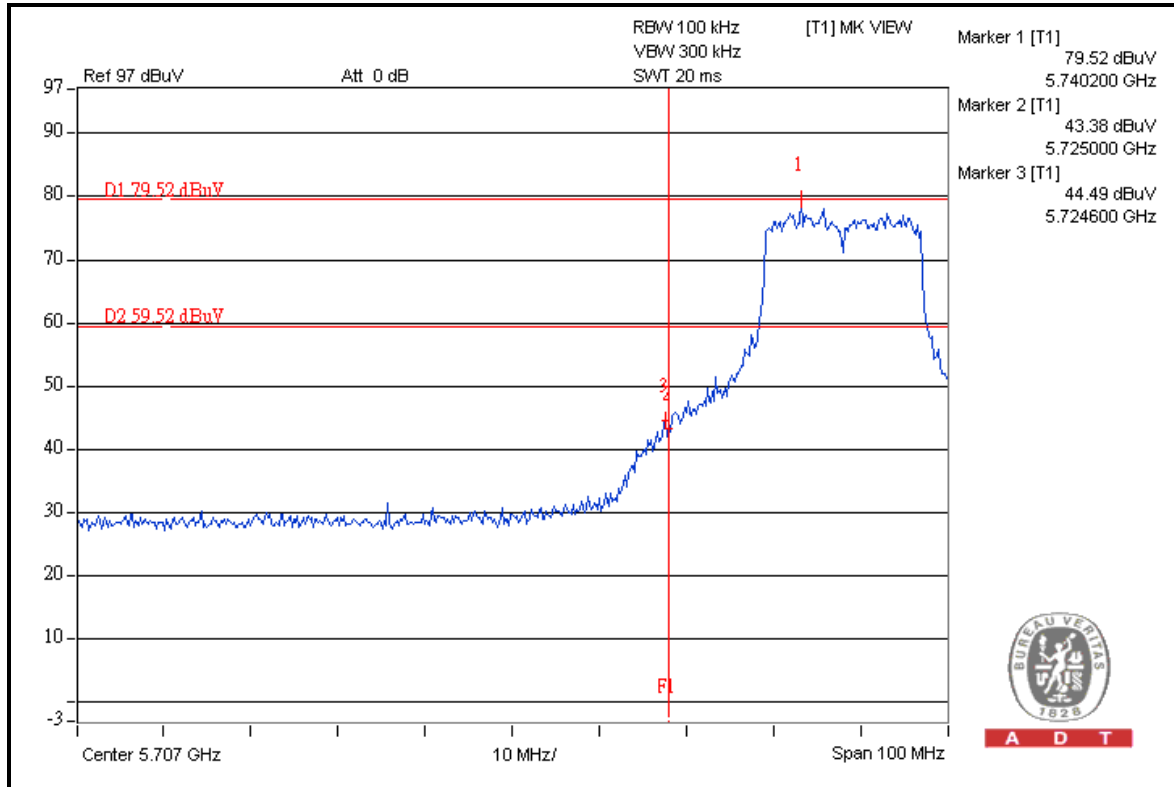

A D T

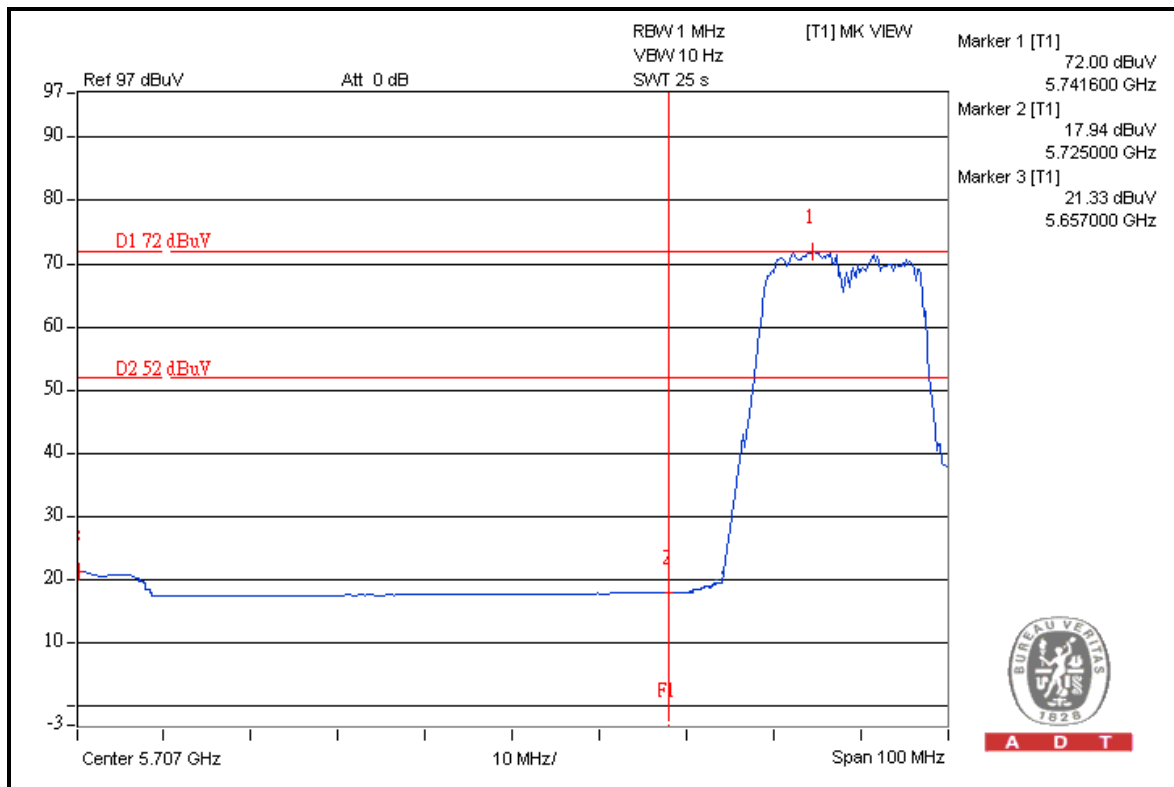

A D T



A D T

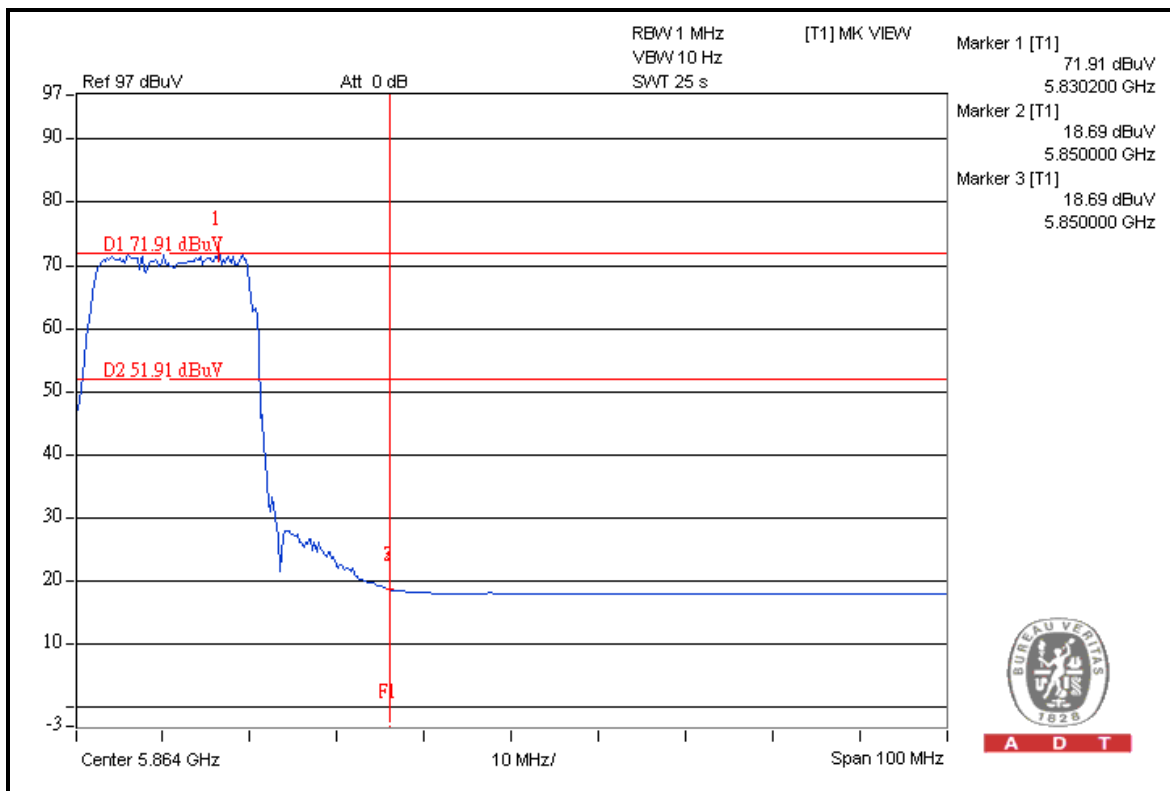
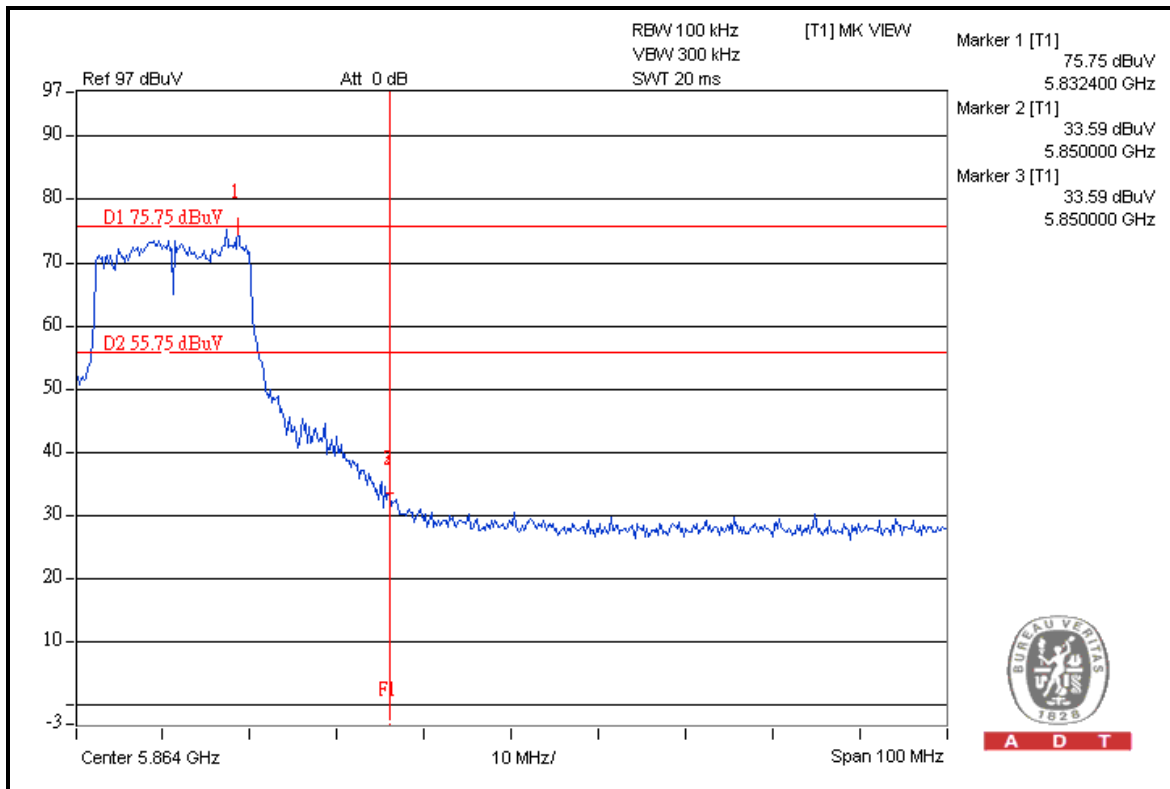



A D T

FOR CONDUCTED MEASURED

CHAIN 0

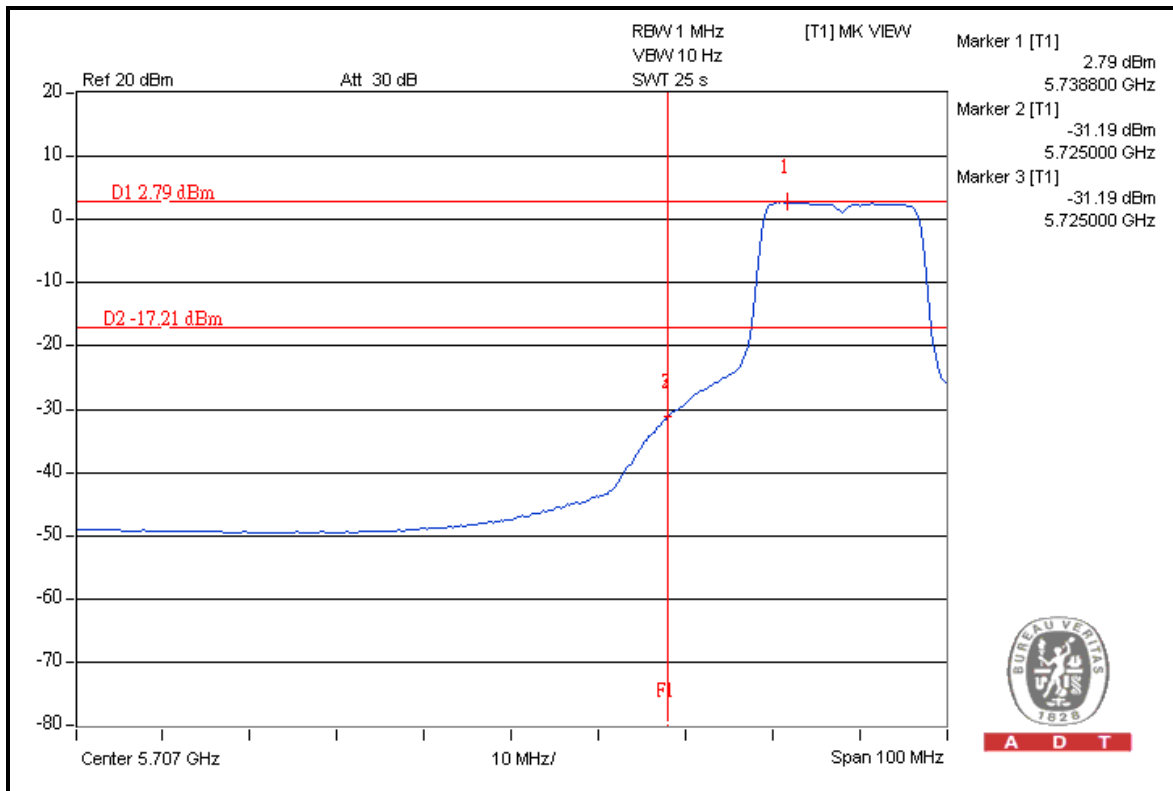
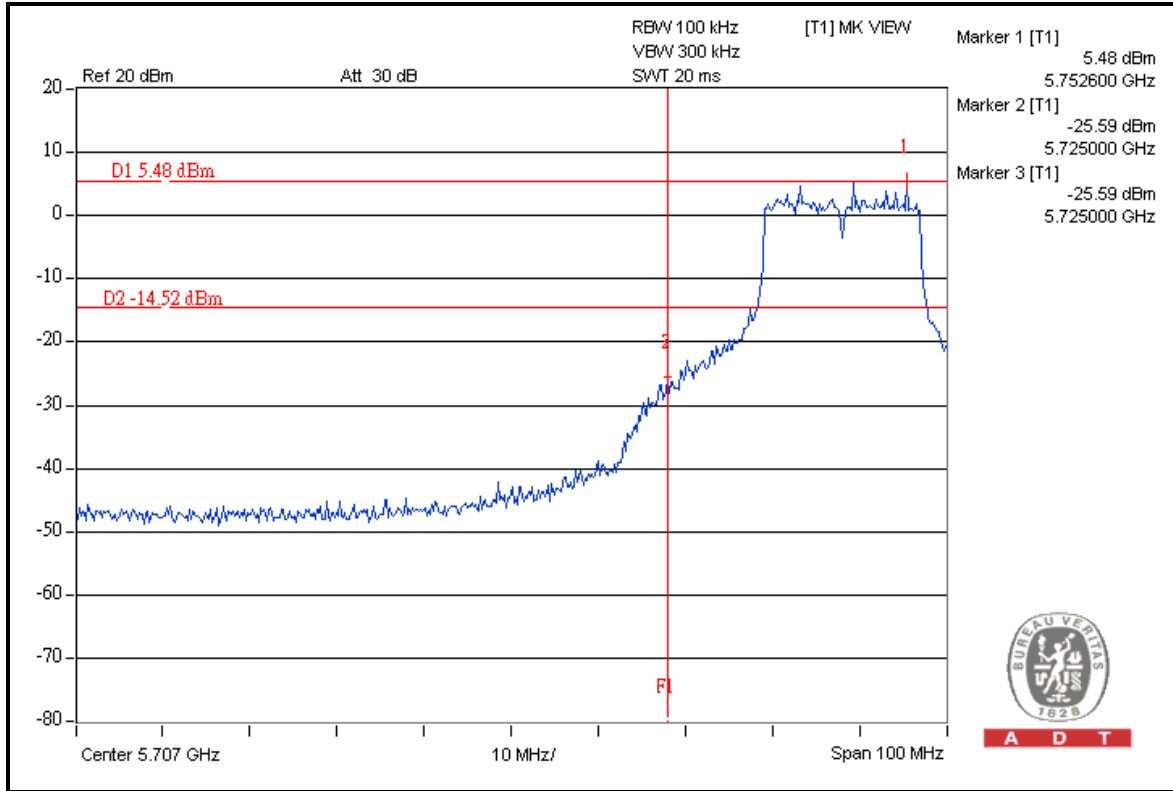



A D T

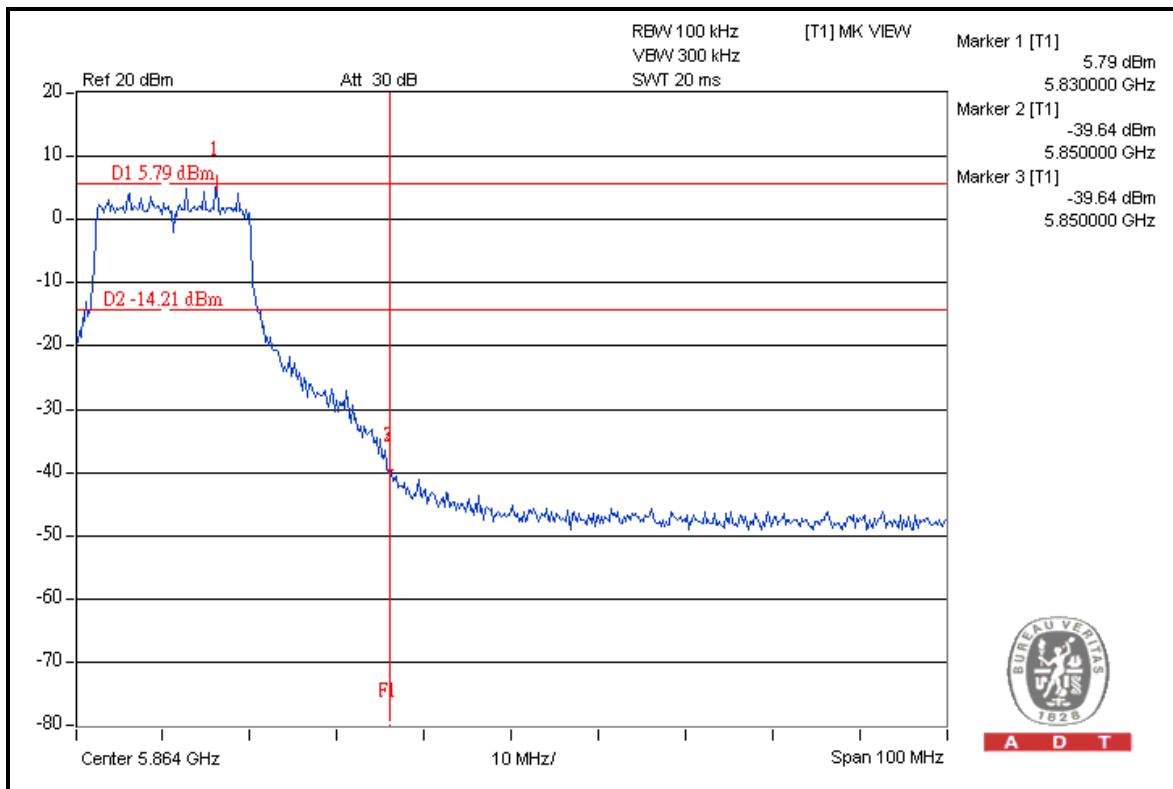
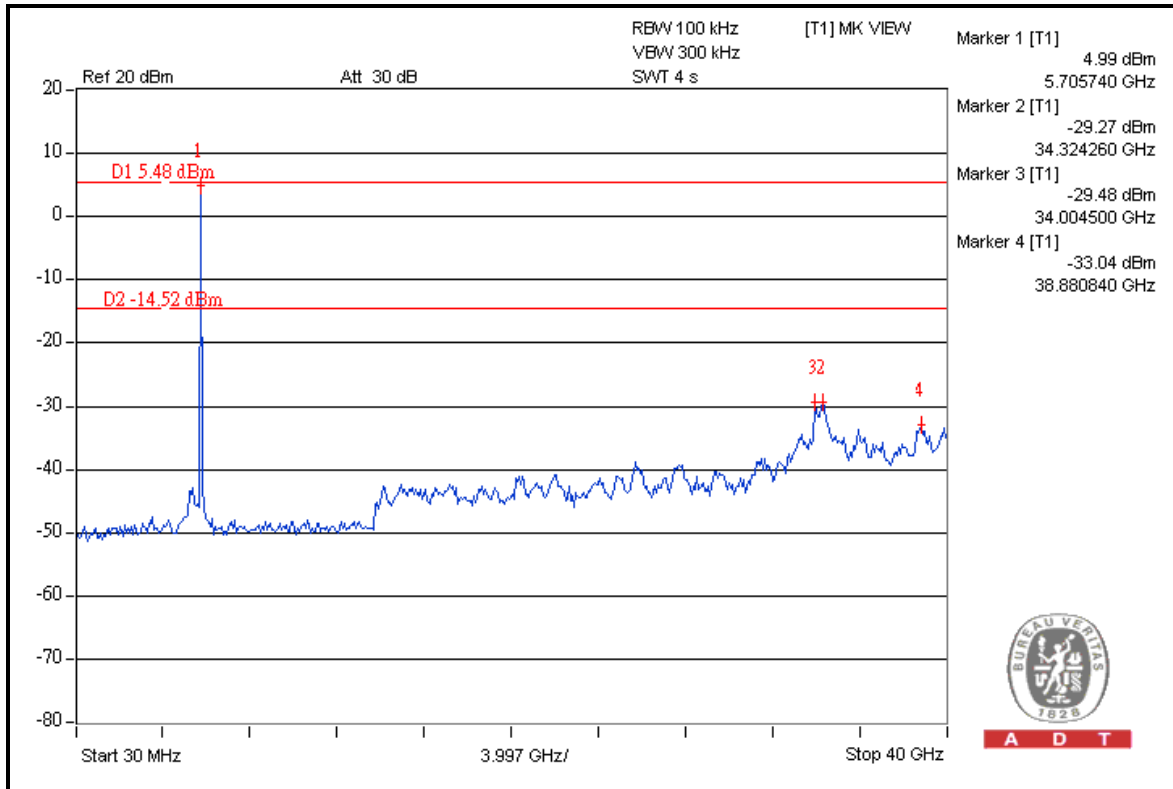



A D T

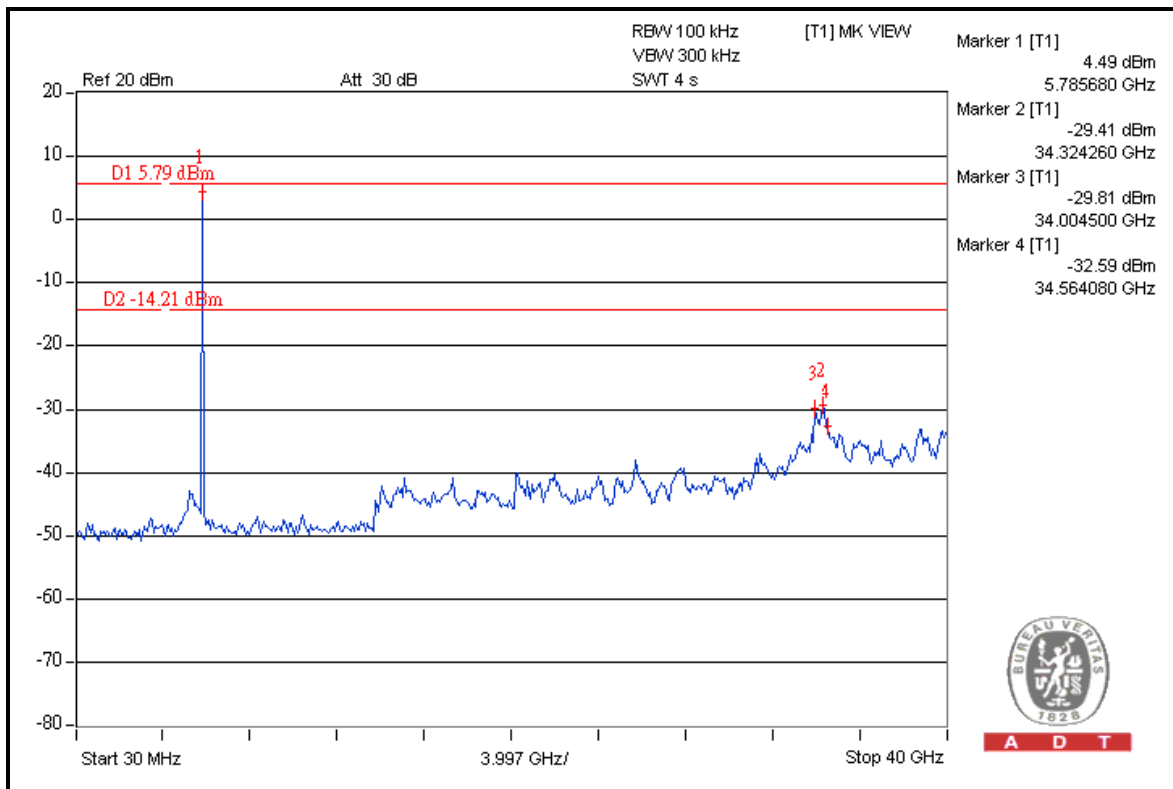
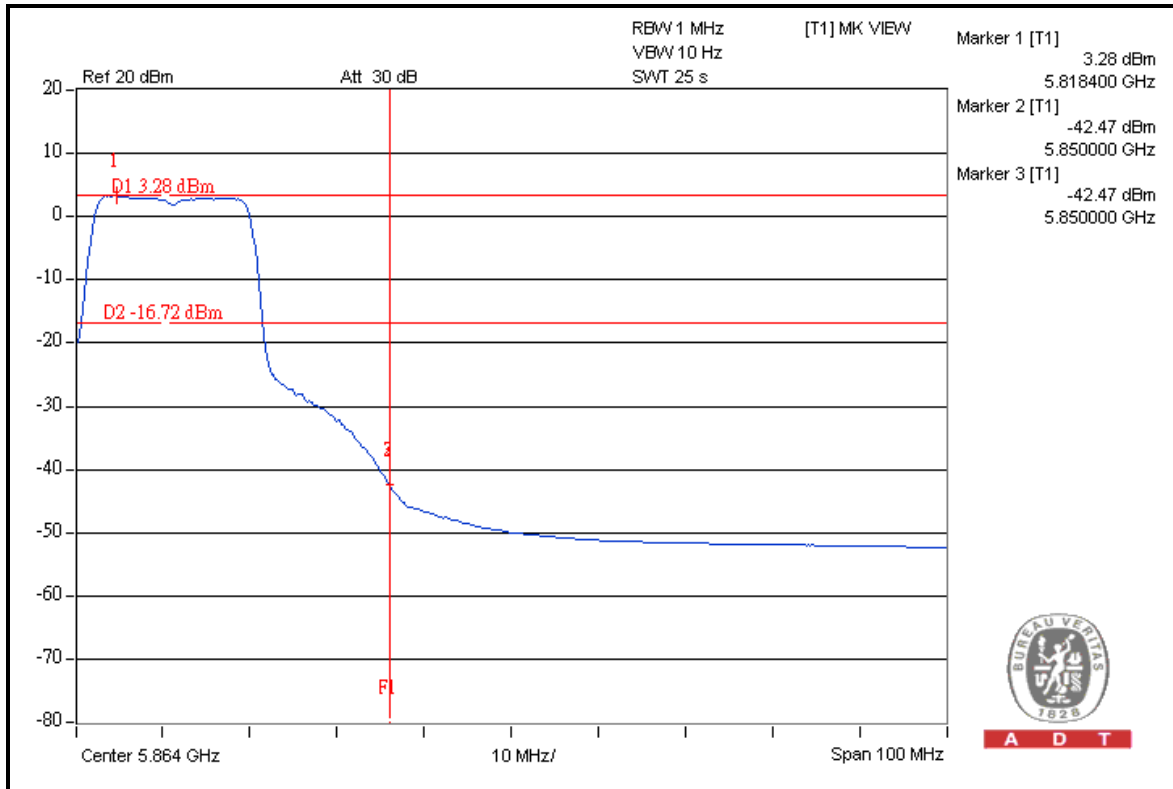



A D T

CHAIN 1

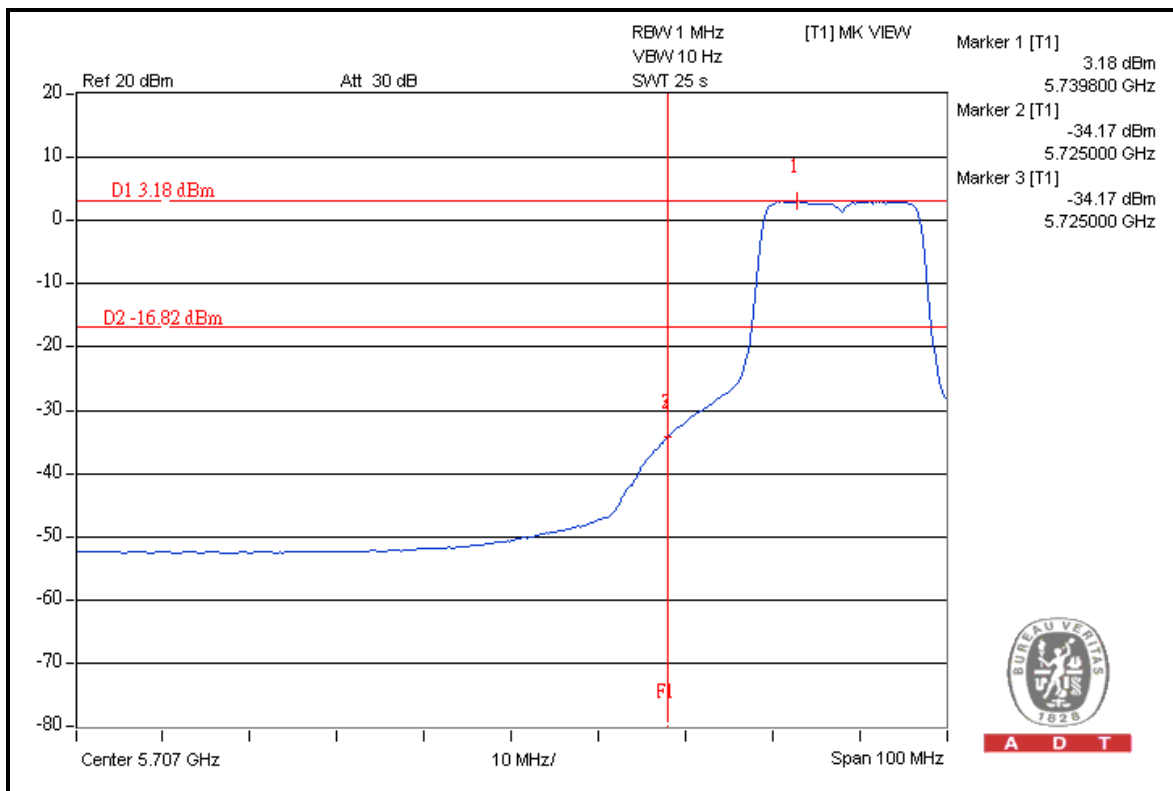
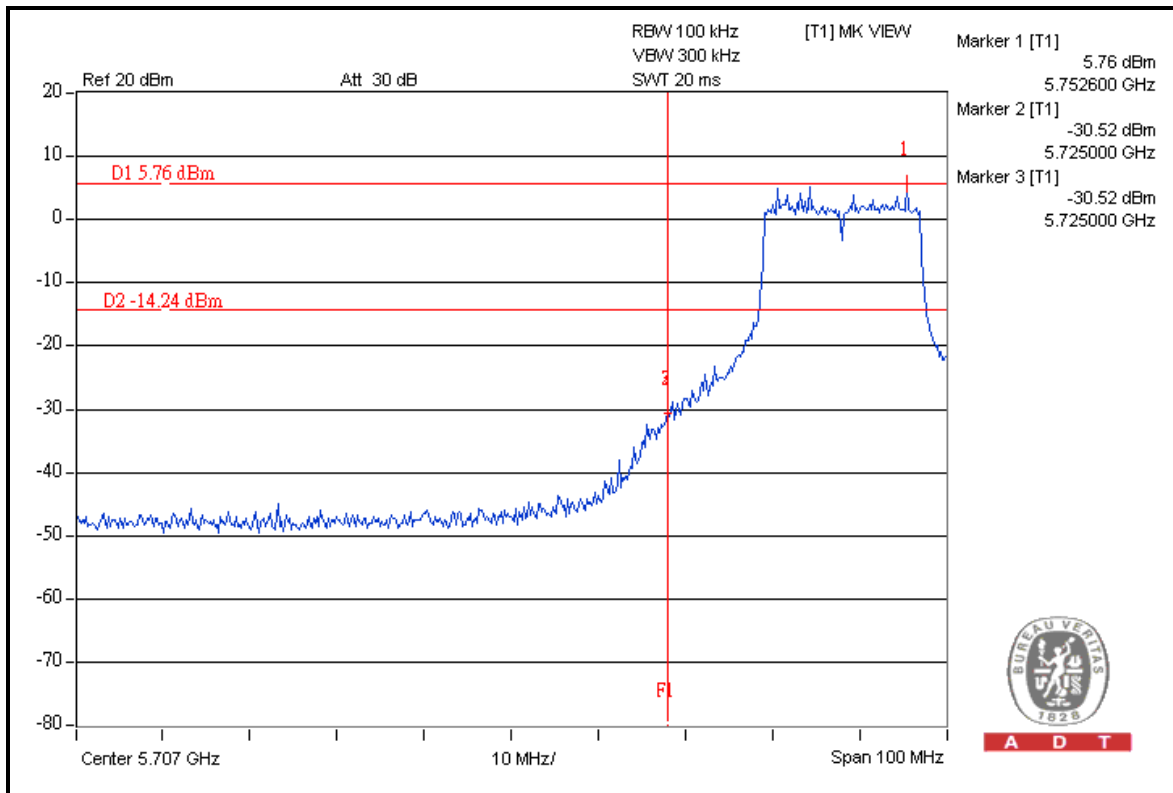



A D T

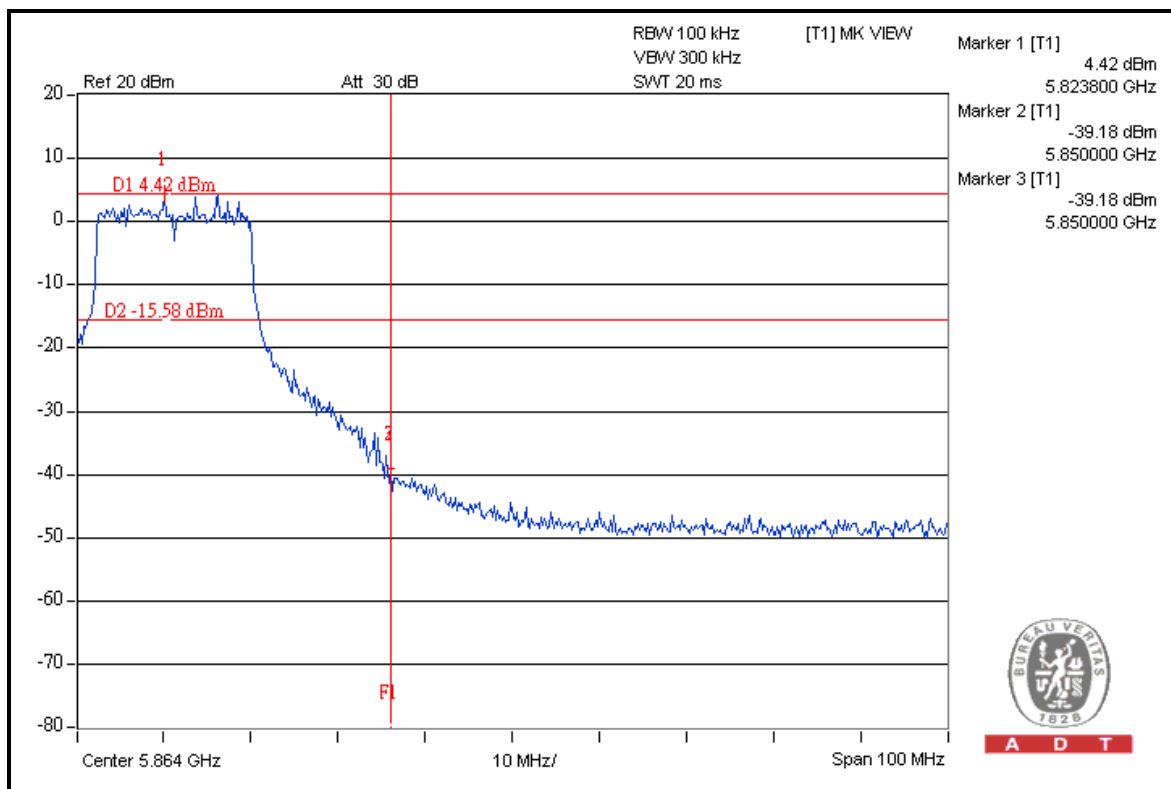
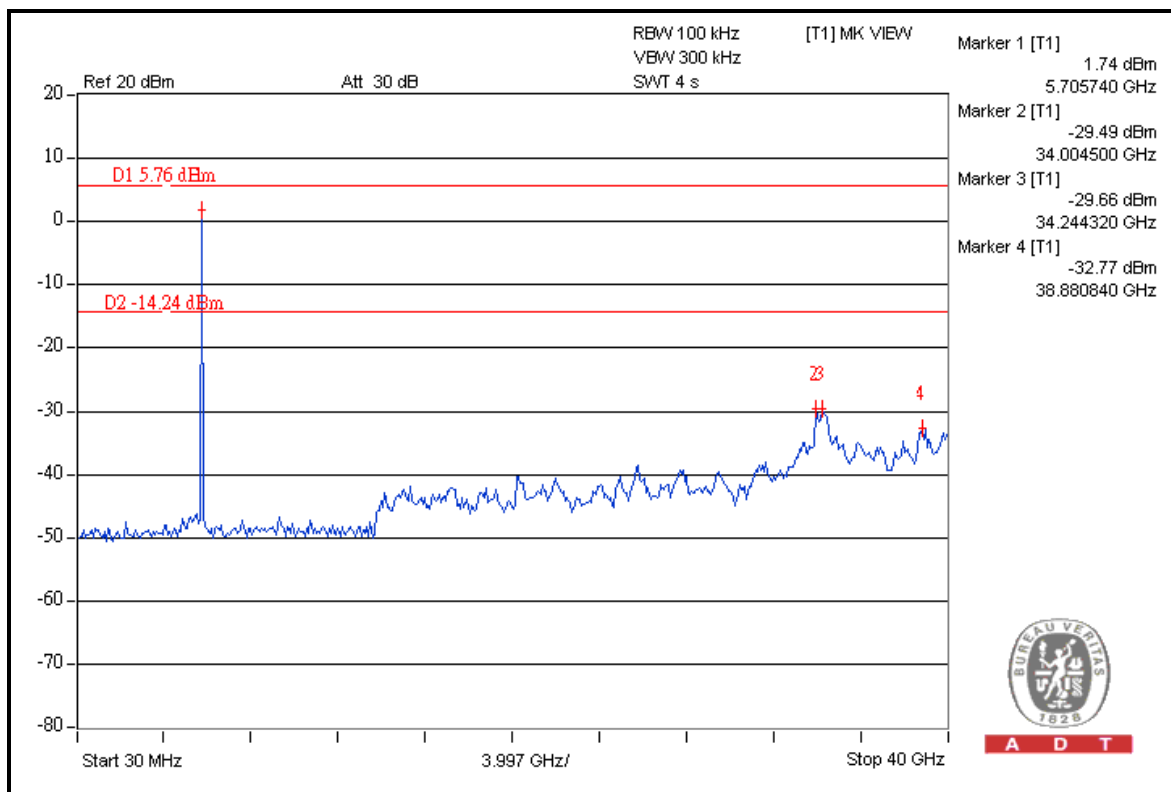



A D T

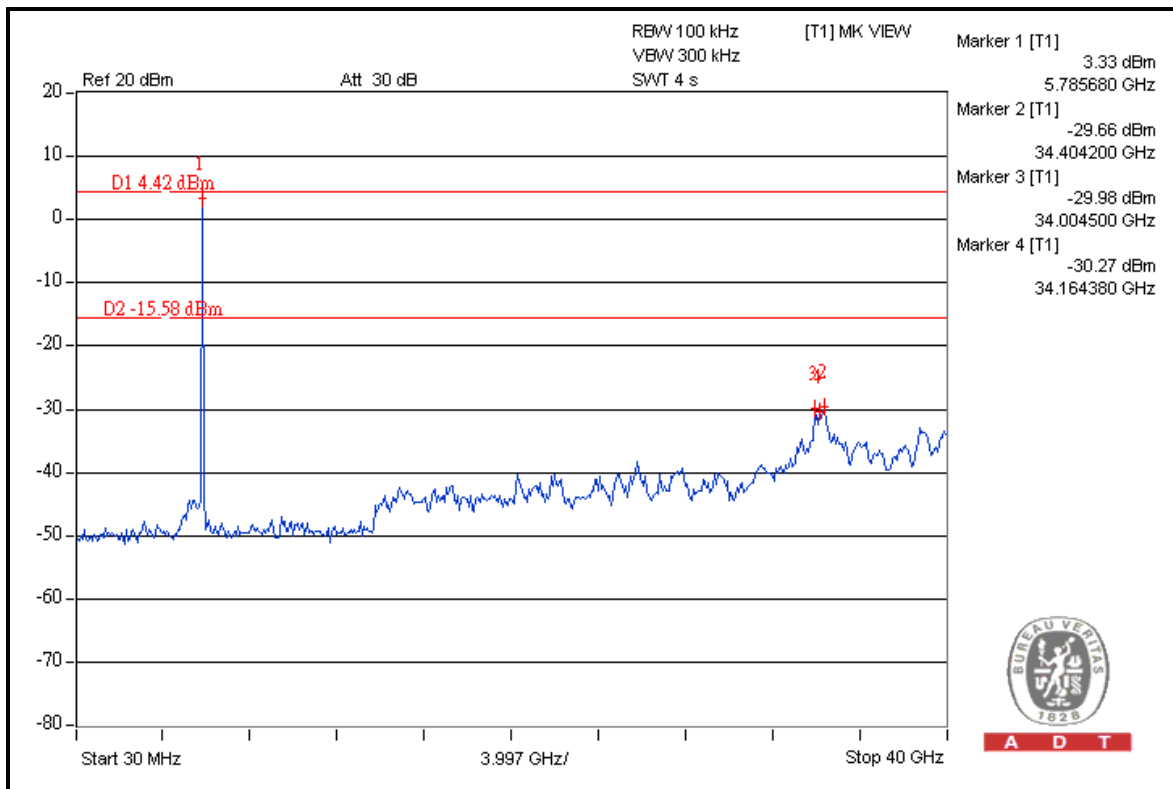
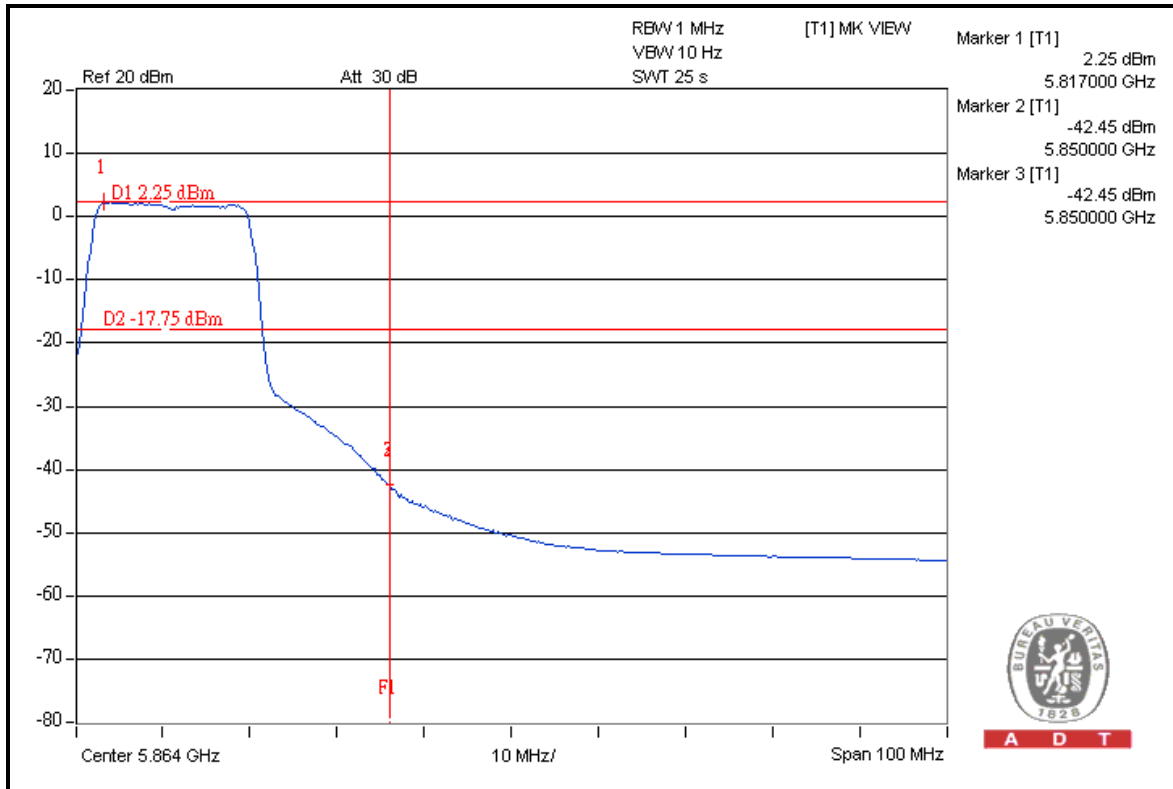



A D T

802.11n (40MHz)

FOR RADIATED MEASURED (TWO CHAINS ON)

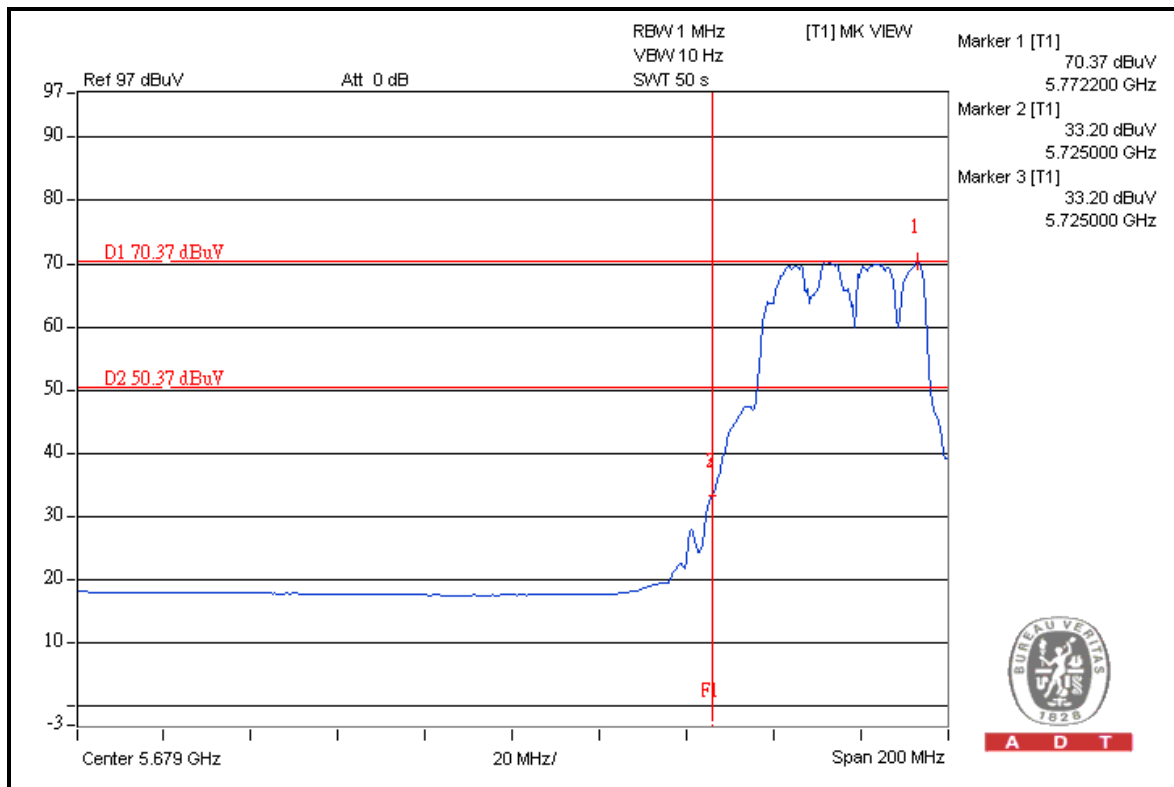
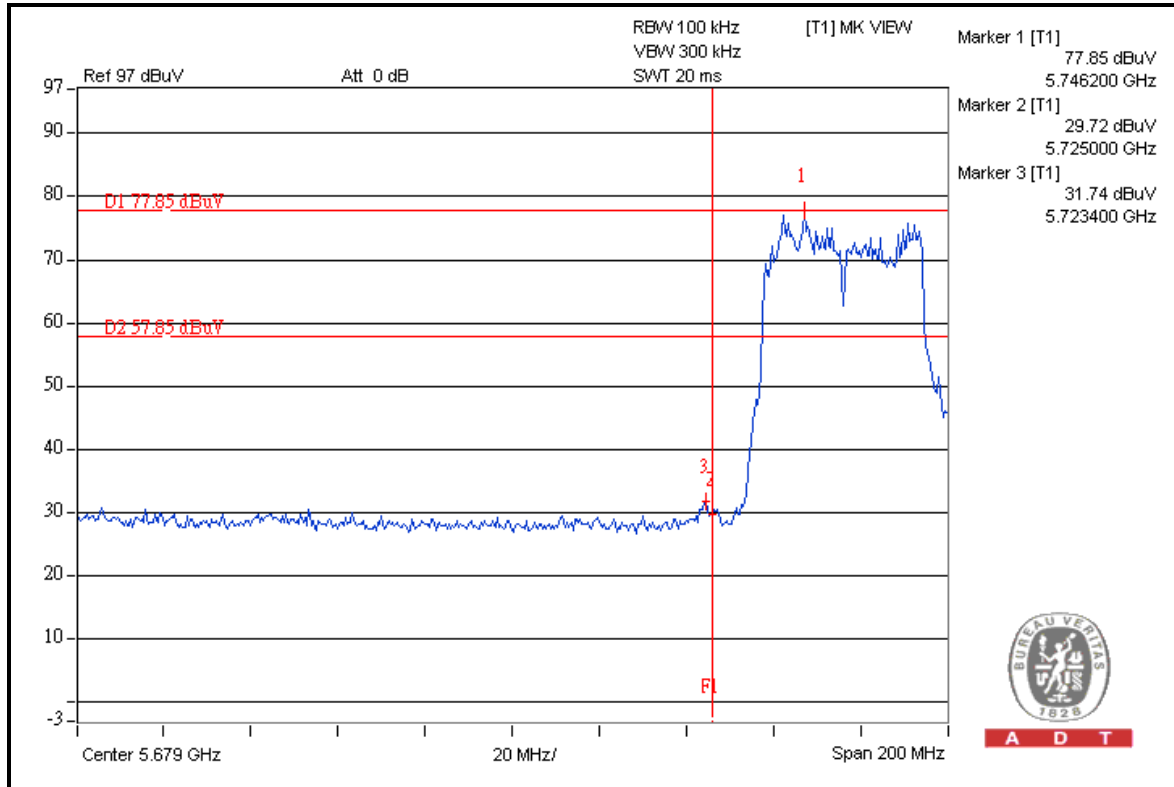



A D T

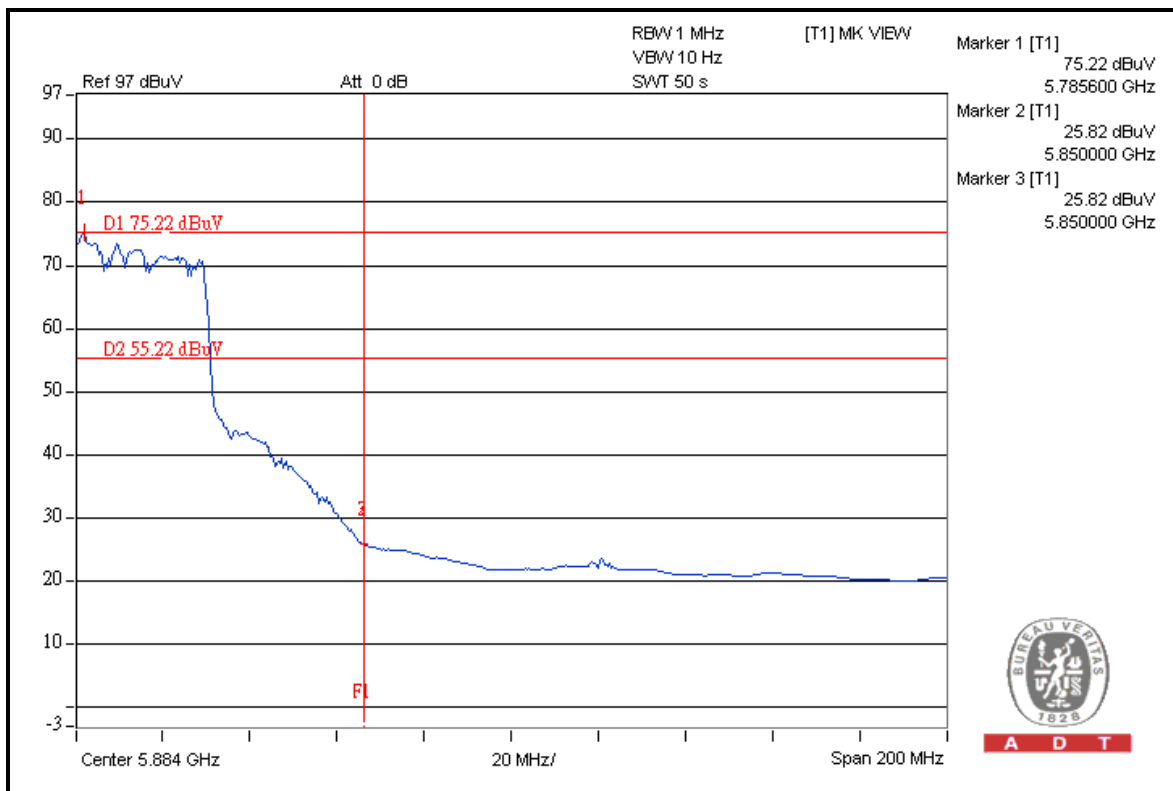
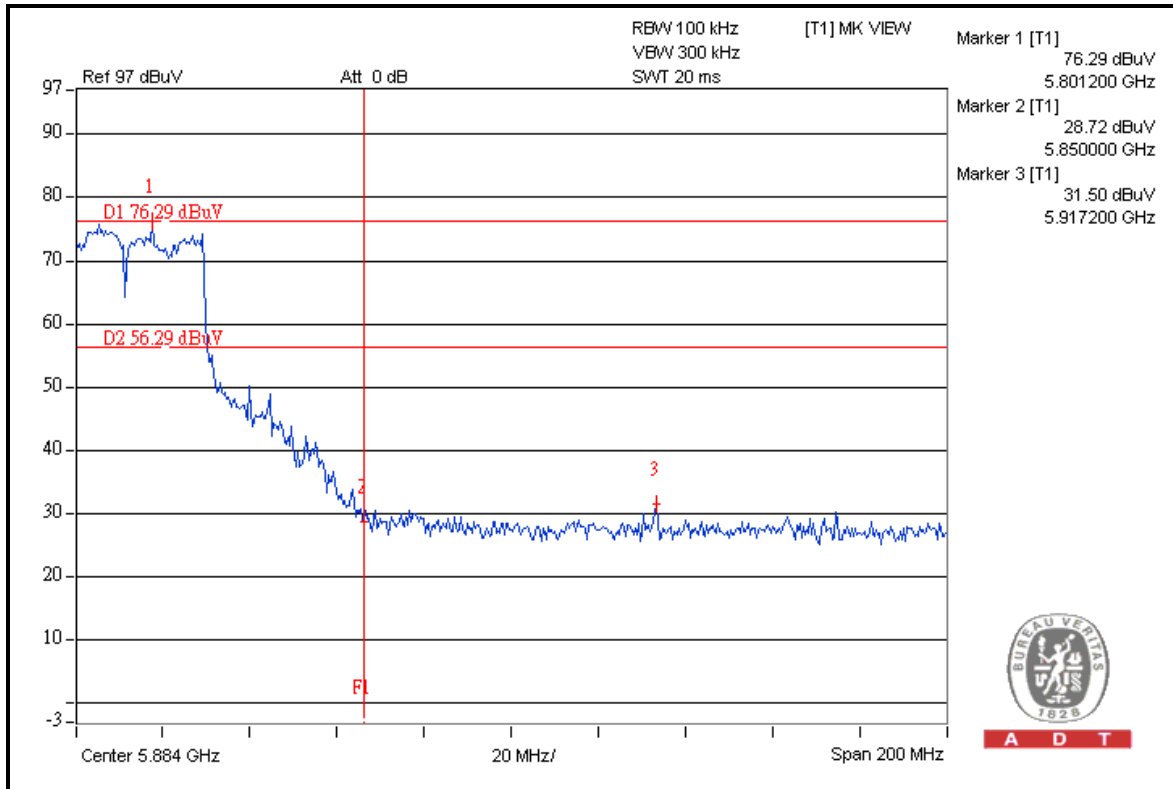



A D T

FOR CONDUCTED MEASURED

CHAIN 0

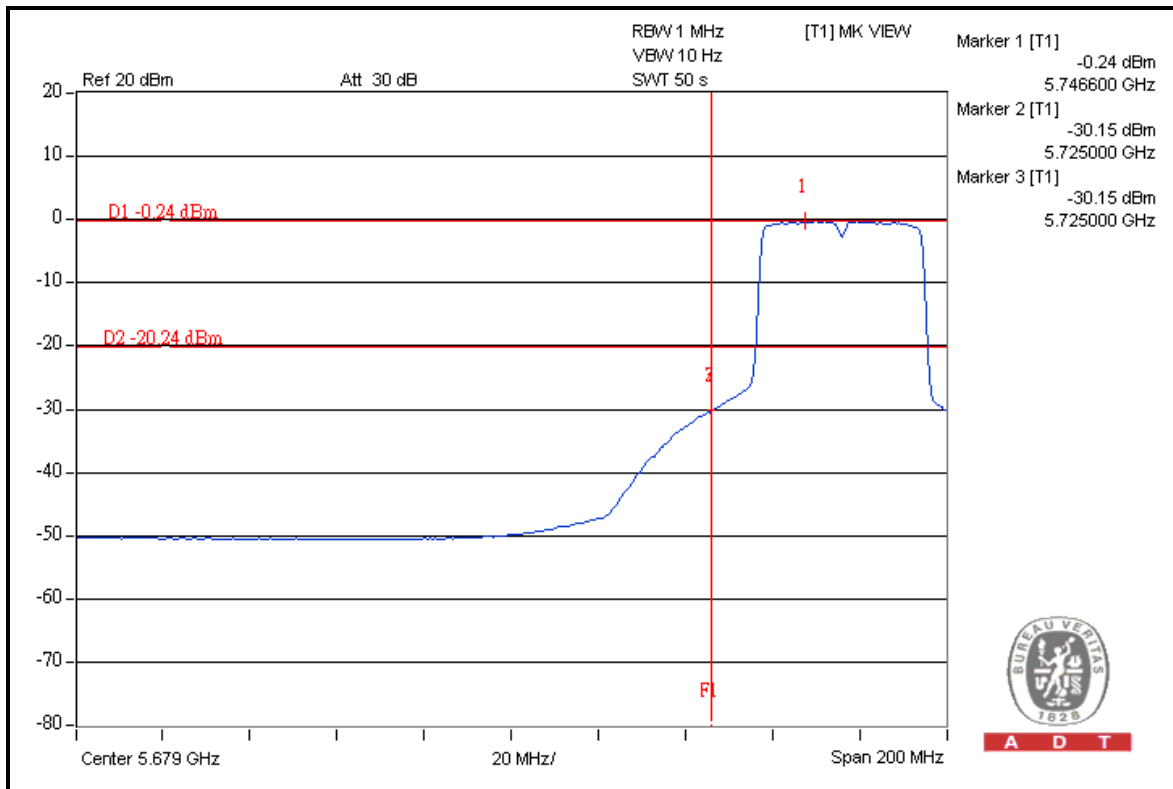
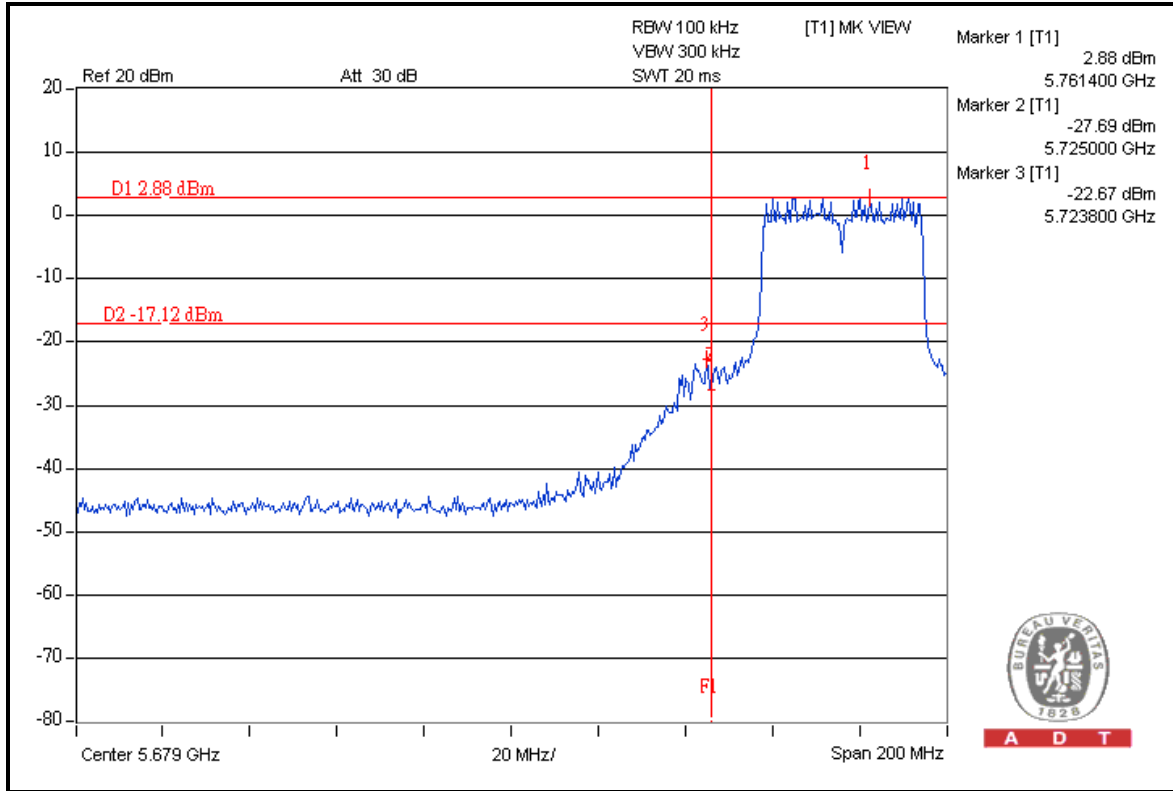



A D T

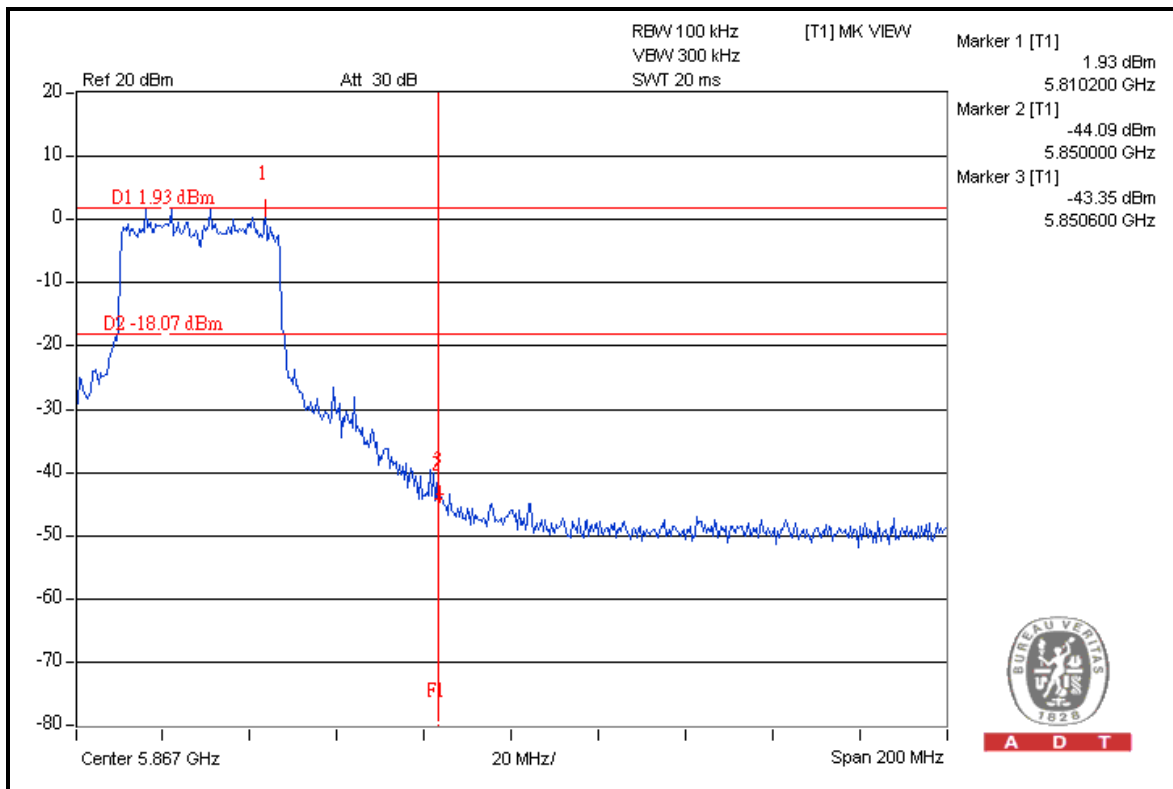
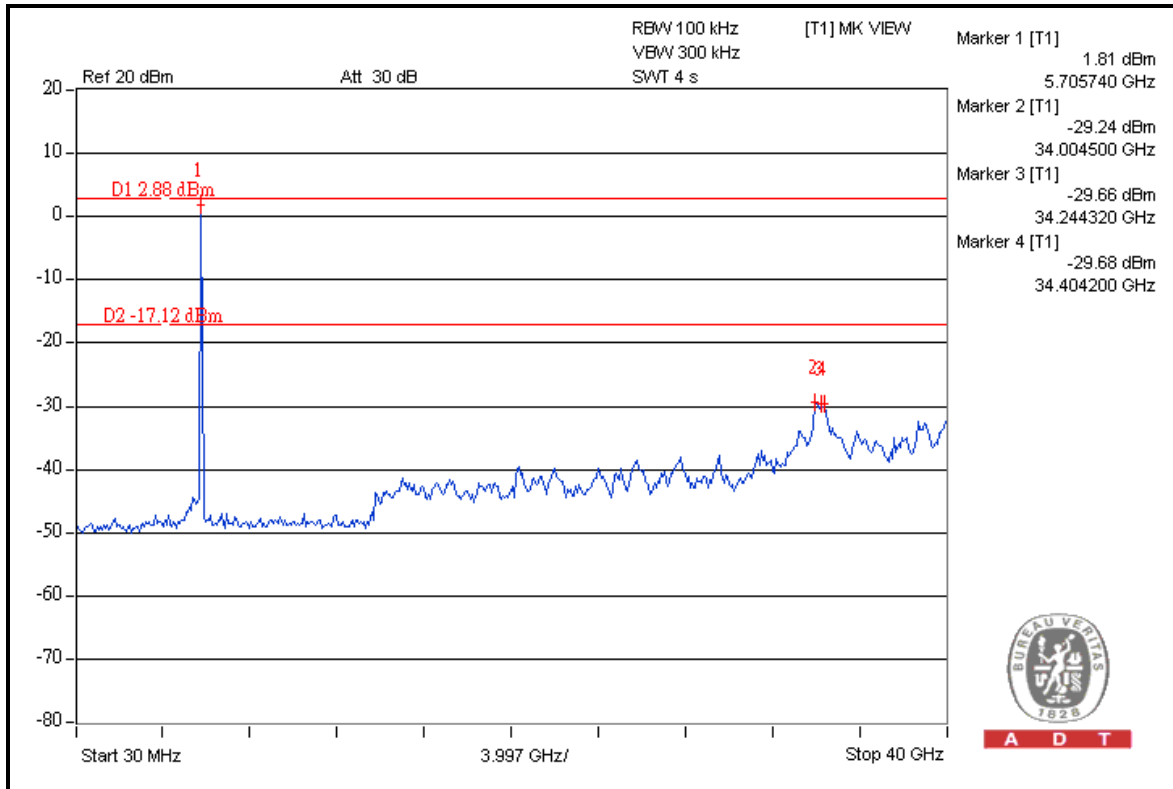



A D T

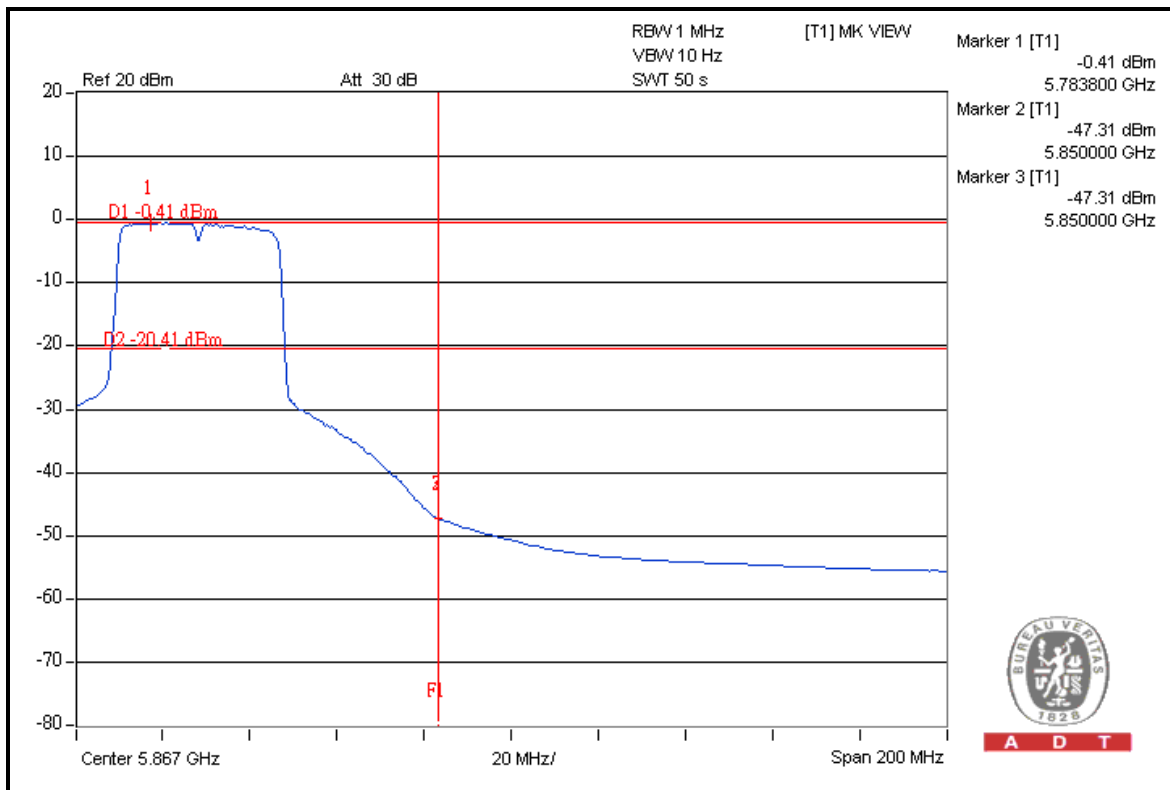

A D T

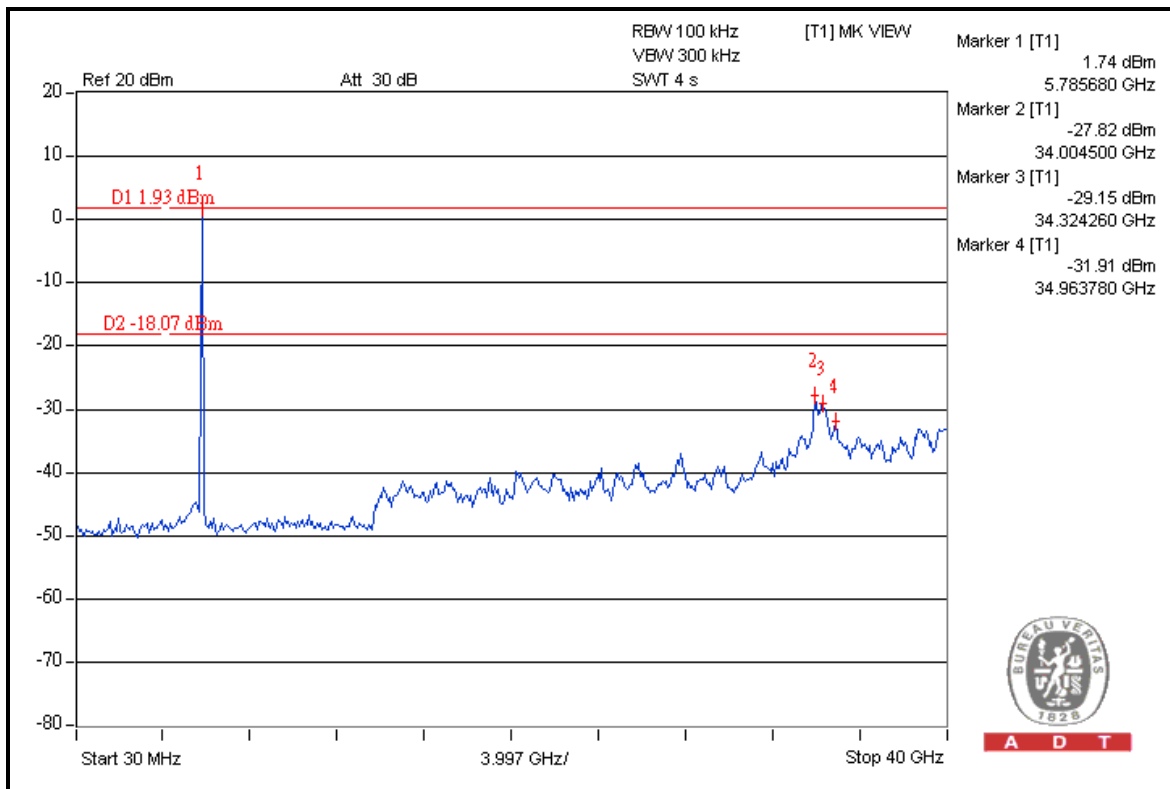

A D T



A D T

CHAIN 1

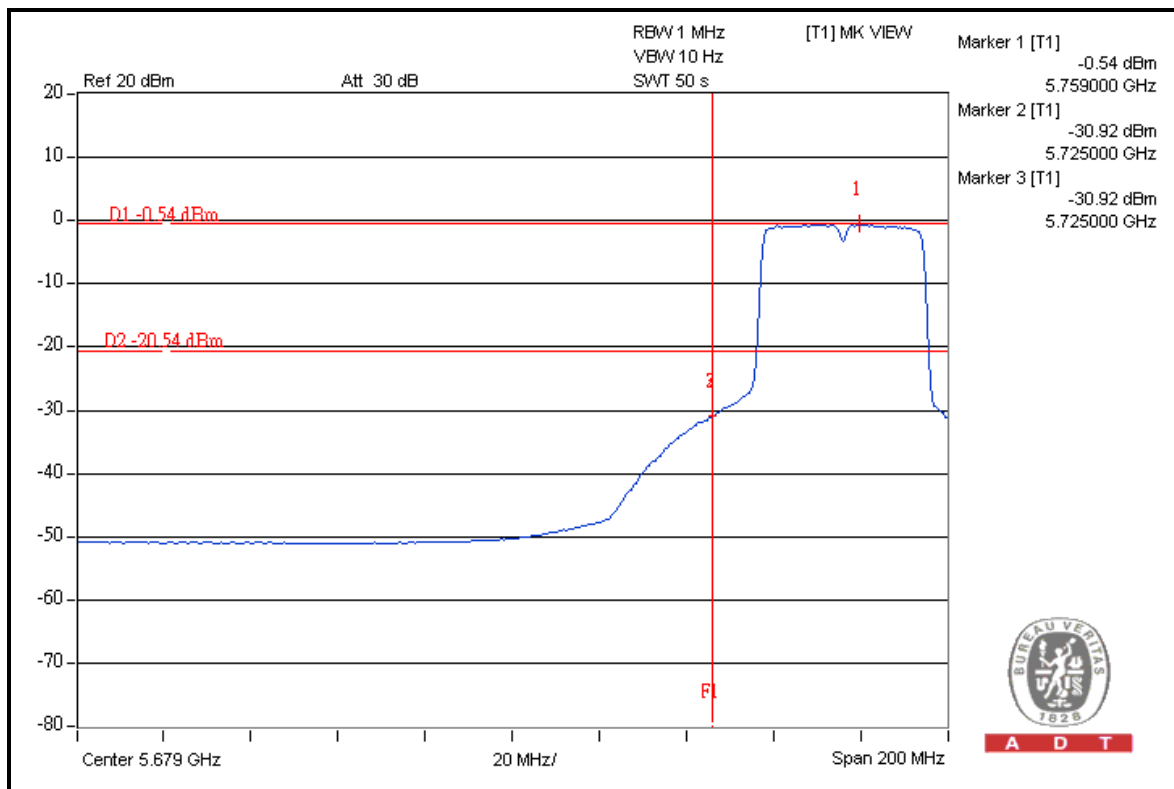
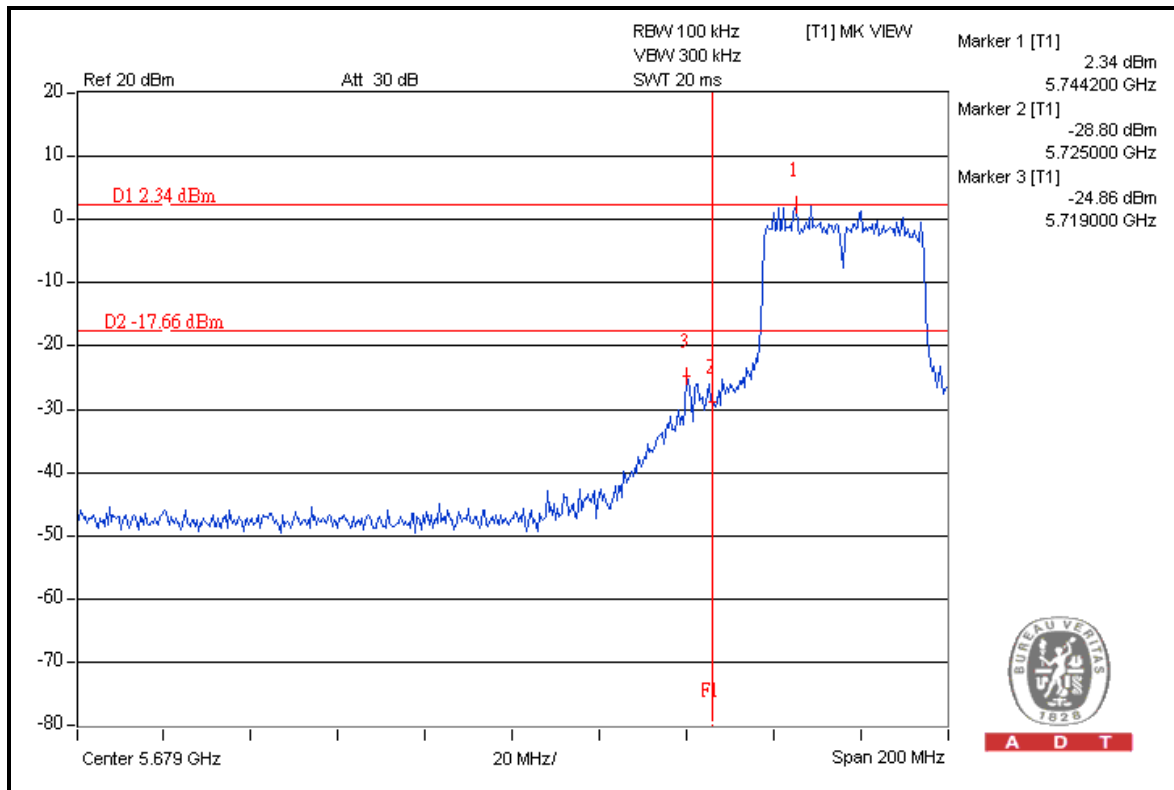



A D T

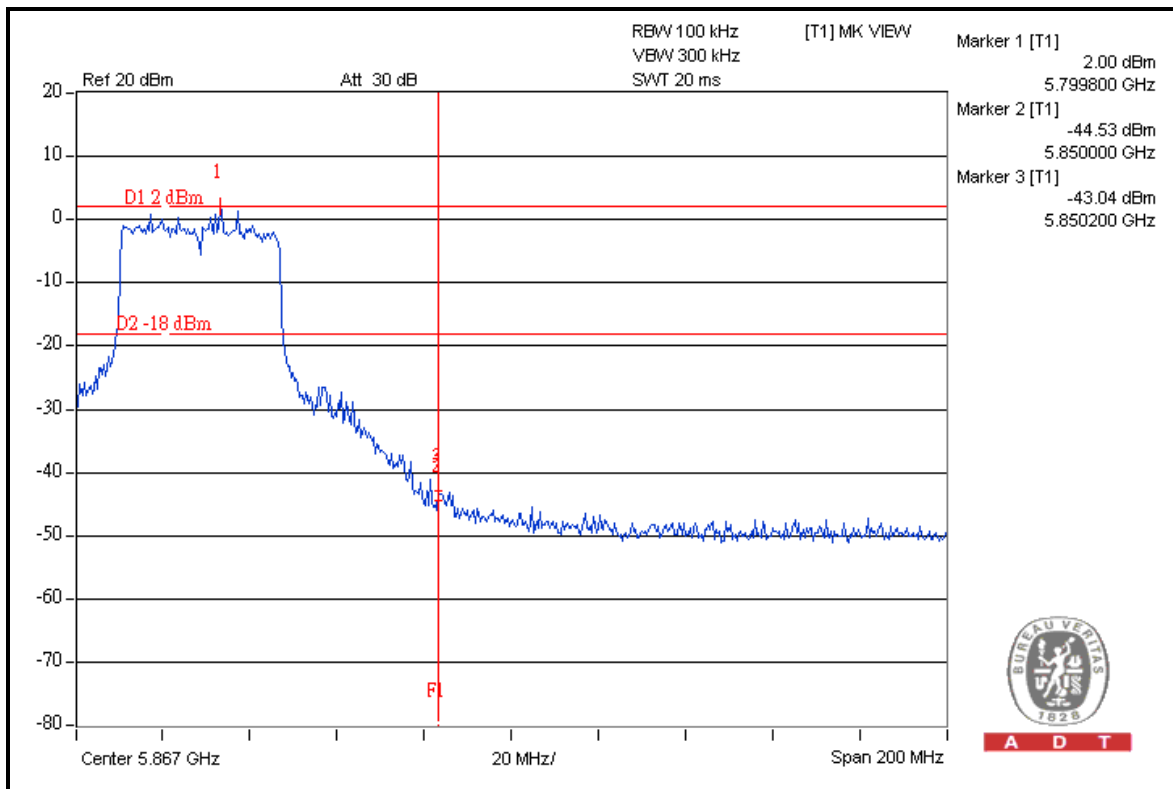
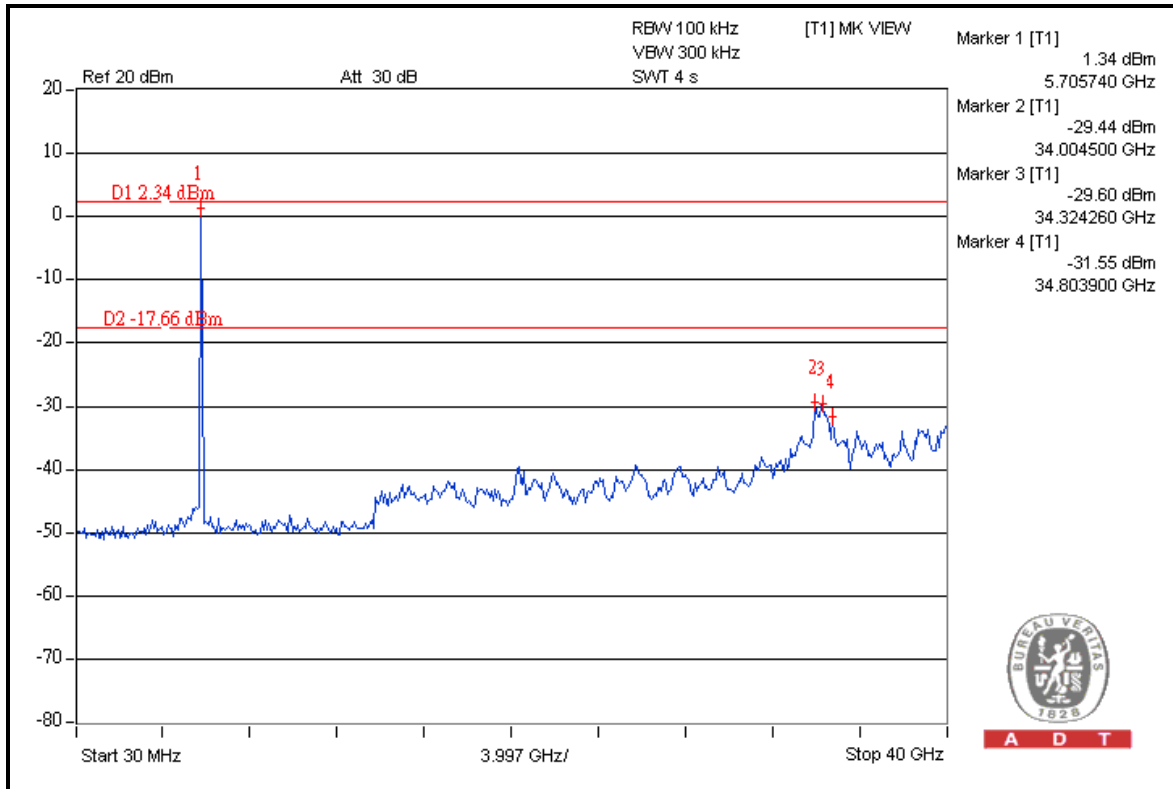



A D T

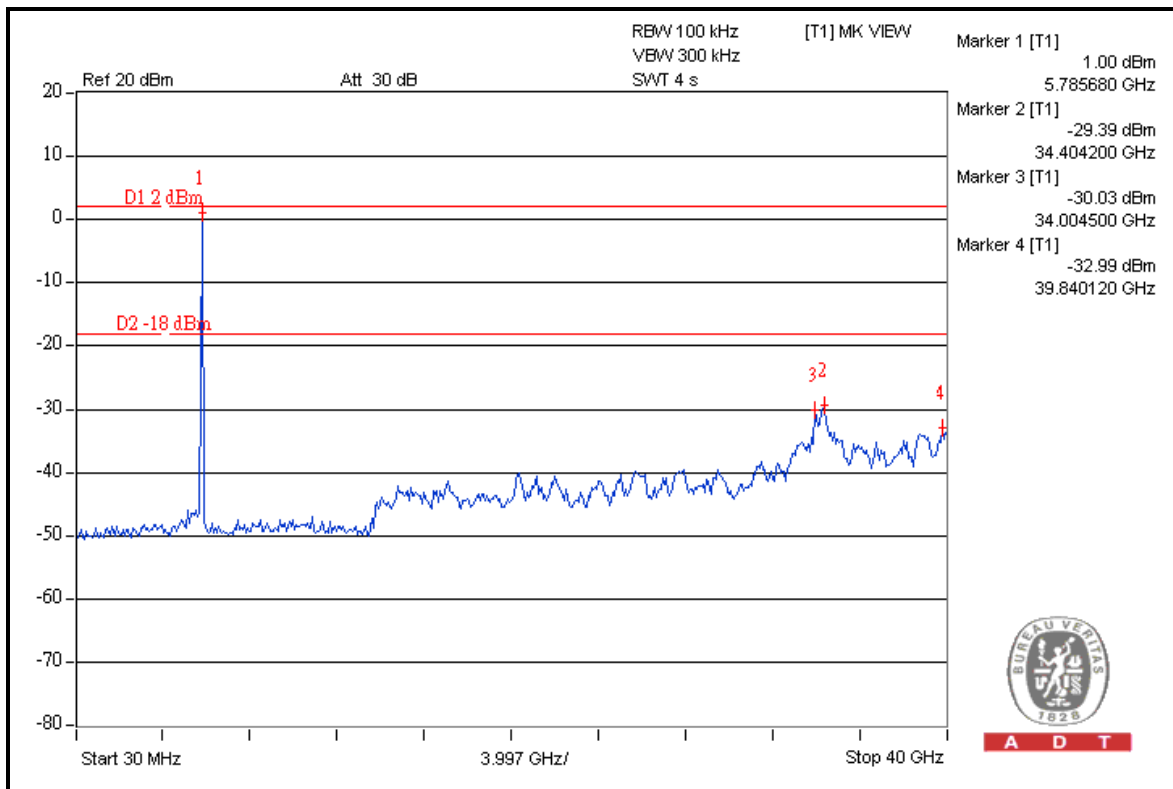
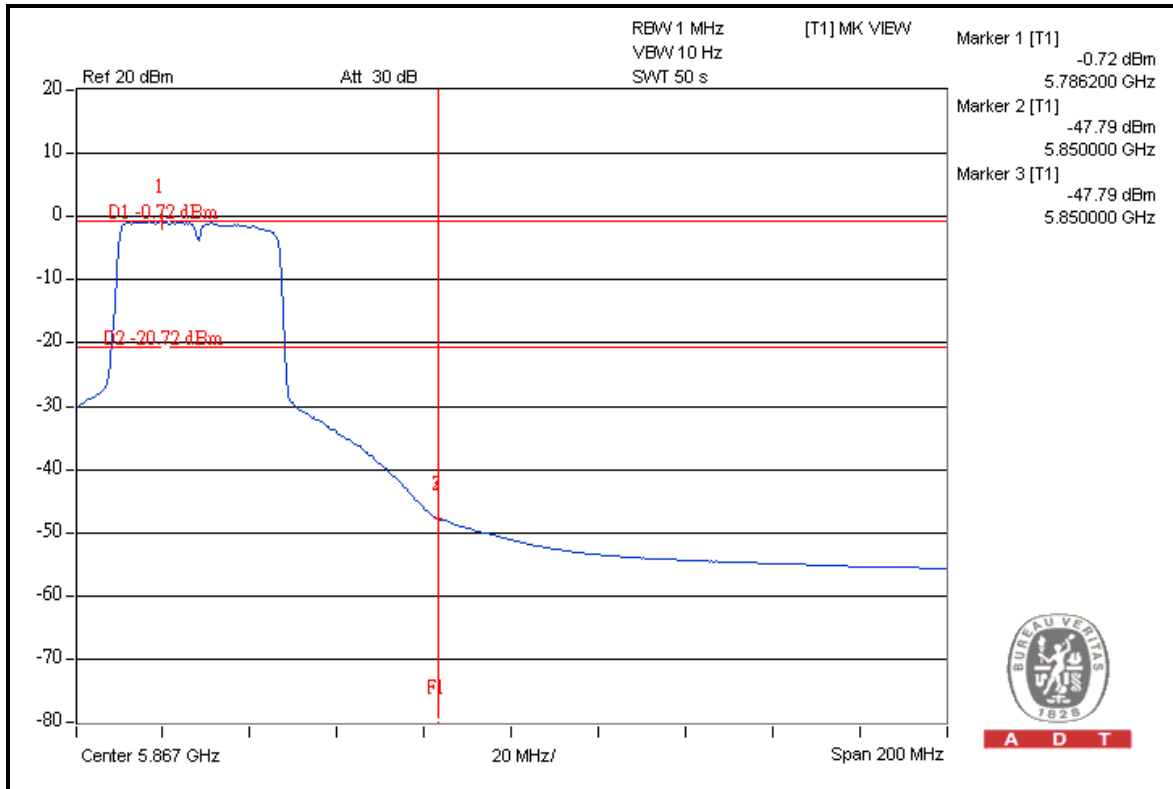



A D T

6. PHOTOGRAPHS OF THE TEST CONFIGURATION

Please refer to the attached file (Test Setup Photo).



A D T

7. INFORMATION ON THE TESTING LABORATORIES

We, Bureau Veritas Consumer Products Services (H.K.) Ltd., Taoyuan Branch, were founded in 1988 to provide our best service in EMC, Radio, Telecom and Safety consultation. Our laboratories are accredited and approved according to ISO/IEC 17025.

Copies of accreditation certificates of our laboratories obtained from approval agencies can be downloaded from our web site:

www.adt.com.tw/index.5/phtml. If you have any comments, please feel free to contact us at the following:

Linko EMC/RF Lab:

Tel: 886-2-26052180

Fax: 886-2-26051924

Hsin Chu EMC/RF Lab:

Tel: 886-3-5935343

Fax: 886-3-5935342

Hwa Ya EMC/RF/Safety Telecom Lab:

Tel: 886-3-3183232

Fax: 886-3-3185050

Email: service.adt@tw.bureauveritas.com

Web Site: www.adt.com.tw

The address and road map of all our labs can be found in our web site also.



A D T

8. APPENDIX A - MODIFICATIONS RECORDERS FOR ENGINEERING CHANGES TO THE EUT BY THE LAB

No any modifications are made to the EUT by the lab during the test.

---END---