



Test Report

FCC Part15 Subpart C & RSS-247 Issue 2

Product Name : Wireless Access point
Model No. : ATOM-AP30
FCC ID : WBV-ATOM-AP30
IC : 7774A-AP30

Applicant : Aerohive Networks, Inc
Address : Aerohive Networks 1011 McCarthy Boulevard
Milpitas, CA 95035 United States

Date of Receipt : Dec. 20, 2017
Test Date : Dec. 21, 2017~ Jan. 20, 2018
Issued Date : Mar. 31, 2018
Report No. : 17C2130R-RF-US-P06V02
Report Version : V 1.2

The test results relate only to the samples tested.

The test results shown in the test report are traceable to the national/international standard through the calibration of the equipment and evaluated measurement uncertainty herein.

This report must not be used to claim product endorsement by TAF, A2LA or any agency of the government.

The test report shall not be reproduced without the written approval of DEKRA Testing & Certification (Suzhou) Co., Ltd.

Test Report Certification

Issued Date : Mar. 31, 2018
Report No. : 17C2130R-RF-US-P06V02



Product Name : Wireless Access point
 Applicant : Aerohive Networks, Inc
 Address : Aerohive Networks1011 McCarthy Boulevard
 Milpitas, CA 95035 United States
 Manufacturer : Aerohive Networks, Inc
 Address : Aerohive Networks1011 McCarthy Boulevard
 Milpitas, CA 95035 United States
 Model No. : ATOM-AP30
 FCC ID : WBV-ATOM-AP30
 IC : 7774A-AP30
 EUT Voltage : DC 5V/2A, 10W
 Test Voltage : AC 120V/60Hz
 Applicable Standard : FCC CFR Title 47 Part 15 Subpart C
 ANSI C63.10:2013;
 KDB 558074 D01v04
 RSS-Gen Issue 4 / RSS-247 Issue 2
 Test Result : Complied
 Performed Location : DEKRA Testing & Certification (Suzhou) Co., Ltd.
 No.99 Hongye Rd., Suzhou Industrial Park, Suzhou, 215006,
 Jiangsu, China
 TEL: +86-512-6251-5088 / FAX: +86-512-6251-5098
 FCC Designation Number: CN1199; ISED Lab Code: 4075B

Documented By : Kitty Li
 (Project Assistant: Kitty Li)

Reviewed By : Frank He
 (Senior Engineer: Frank He)

Approved By : Harry Zhao
 (Engineering Manager: Harry Zhao)

TABLE OF CONTENTS

Description	Page
1. General Information.....	6
1.1. EUT Description.....	6
1.2. Working Frequency of Each Channel:.....	7
1.3. Antenna information.....	7
1.4. Mode of Operation.....	8
1.5. Tested System Details.....	8
1.6. Configuration of Tested System.....	9
1.7. EUT Exercise Software.....	10
2. Technical Test.....	11
2.1. Summary of Test Result.....	11
2.2. Test Frequency configuration:.....	13
2.3. Test Environment.....	14
2.4. Measurement Uncertainty.....	14
3. AC Power Line Conducted Emission.....	15
3.1. Test Equipment.....	15
3.2. Test Setup.....	15
3.3. Limit.....	16
3.4. Test Procedure.....	16
3.5. Test Result.....	17
4. Emissions in restricted frequency bands.....	17
4.1. Test Equipment.....	19
4.2. Test Setup.....	20
4.3. Limit.....	21
4.4. Test Procedure.....	24
4.5. EUT test Axis definition.....	25
4.6. Test Result.....	26
5. Emissions in non-restricted frequency bands.....	37
5.1. Test Equipment.....	37
5.2. Test Setup.....	37
5.3. Limit.....	38
5.4. Test Procedure.....	39
5.5. EUT test Axis definition.....	40
5.6. Test Result.....	41
6. Radiated Emission Band Edge.....	42
6.1. Test Equipment.....	42
6.2. Test Setup.....	43
6.3. Limit.....	43

- 6.4. Test Procedure..... 44
- 6.5. EUT test definition..... 45
- 6.6. Duty Cycle..... 46
- 6.7. Test Result..... 47
- 7. Occupied Bandwidth..... 55
- 7.1. Test Equipment..... 55
- 7.2. Test Setup..... 55
- 7.3. Limit..... 56
- 7.4. Test Procedure..... 56
- 7.5. EUT test definition..... 57
- 7.6. Test Result..... 58
- 8. Fundamental emission output power..... 59
- 8.1. Test Equipment..... 59
- 8.2. Test Setup..... 59
- 8.3. Limit..... 60
- 8.4. Test Procedure..... 61
- 8.5. EUT test definition..... 62
- 8.6. Test Result..... 63
- 9. Power Spectral Density..... 64
- 9.1. Test Equipment..... 64
- 9.2. Test Setup..... 64
- 9.3. Limit..... 64
- 9.4. Test Procedure..... 65
- 9.5. EUT test definition..... 66
- 9.6. Test Result..... 67

History of This Test Report

REPORT NO.	VERSION	DESCRIPTION	ISSUED DATE
17C2130R-RF-US-P06V02	V1.0	Initial Issued Report	Mar. 23, 2018
17C2130R-RF-US-P06V02	V1.1	Modified IC ID	Mar. 28, 2018
17C2130R-RF-US-P06V02	V1.2	(1) Update the Cal. Data. (2) Page 35-36,add Simultaneous transmission data.	Mar. 31, 2018

1. General Information

1.1. EUT Description

Product Name	Wireless Access point
Model No.	ATOM-AP30
EUT Voltage	DC 5V/2A, 10W
Test Voltage	AC 120V/60Hz
Bluetooth Specification	V4.2
Frequency Range	2402- 2480 MHz
Channel Number	V4.2: 40
Channel Separation	V4.2: 2MHz
Type of Modulation	V4.2: GFSK
Data Rate	V4.2: 1Mbps(GFSK)
Antenna Type	Reference to Antenna List
Peak Antenna Gain	Reference to Antenna List

1.2. Working Frequency of Each Channel:

Bluetooth Working Frequency of Each Channel: (For V4.2)							
Channel	Frequency	Channel	Frequency	Channel	Frequency	Channel	Frequency
00	2402 MHz	01	2404 MHz	02	2406 MHz	03	2408 MHz
04	2410 MHz	05	2412 MHz	06	2414 MHz	07	2416 MHz
08	2418 MHz	09	2420 MHz	10	2422 MHz	11	2424 MHz
12	2426 MHz	13	2428 MHz	14	2430 MHz	15	2432 MHz
16	2434 MHz	17	2436 MHz	18	2438 MHz	19	2440 MHz
20	2442 MHz	21	2444 MHz	22	2446 MHz	23	2448 MHz
24	2450 MHz	25	2452 MHz	26	2454 MHz	27	2456 MHz
28	2458 MHz	29	2460 MHz	30	2462 MHz	31	2464 MHz
32	2466 MHz	33	2468 MHz	34	2470 MHz	35	2472 MHz
36	2474 MHz	37	2476 MHz	38	2478 MHz	39	2480 MHz

1.3. Antenna information

Model No.	N/A					
Antenna manufacturer	PEGATRON					
Antenna Delivery	<input checked="" type="checkbox"/>	1*TX+1*RX	<input type="checkbox"/>	2*TX+2*RX	<input type="checkbox"/>	3*TX+3*RX
Antenna technology	<input checked="" type="checkbox"/>	SISO				
	<input type="checkbox"/>	MIMO	<input type="checkbox"/>	Basic		
			<input type="checkbox"/>	CDD		
			<input type="checkbox"/>	Sectorized		
			<input type="checkbox"/>	Beam-forming		
Antenna Type	<input type="checkbox"/>	External	<input type="checkbox"/>	Dipole		
			<input type="checkbox"/>	Sectorized		
	<input checked="" type="checkbox"/>	Internal	<input checked="" type="checkbox"/>	PIFA		
			<input type="checkbox"/>	PCB		
			<input type="checkbox"/>	Ceramic Chip Antenna		
			<input type="checkbox"/>	Monopole Antenna		
	Ant Gain (dBi)	1.8dBi				

1.4. Mode of Operation

Test Mode
Mode 1: Transmit-1Mbps(GFSK_BLE)

1.5. Tested System Details

The types for all equipment, plus descriptions of all cables used in the tested system (including inserted cards) are:

No.	Product	Manufacturer	Model No.	Serial No.	Power Cord
1	Notebook	Think Pad	2526	LV-A3285	Power by adapter
A	LAN Cable	N/A	N/A	N/A	Shield, 0.75m
B	LAN Cable	N/A	N/A	N/A	Shield, 10m

1.6. Configuration of Tested System

Test setup Diagram- AC Line Conducted Emission Test

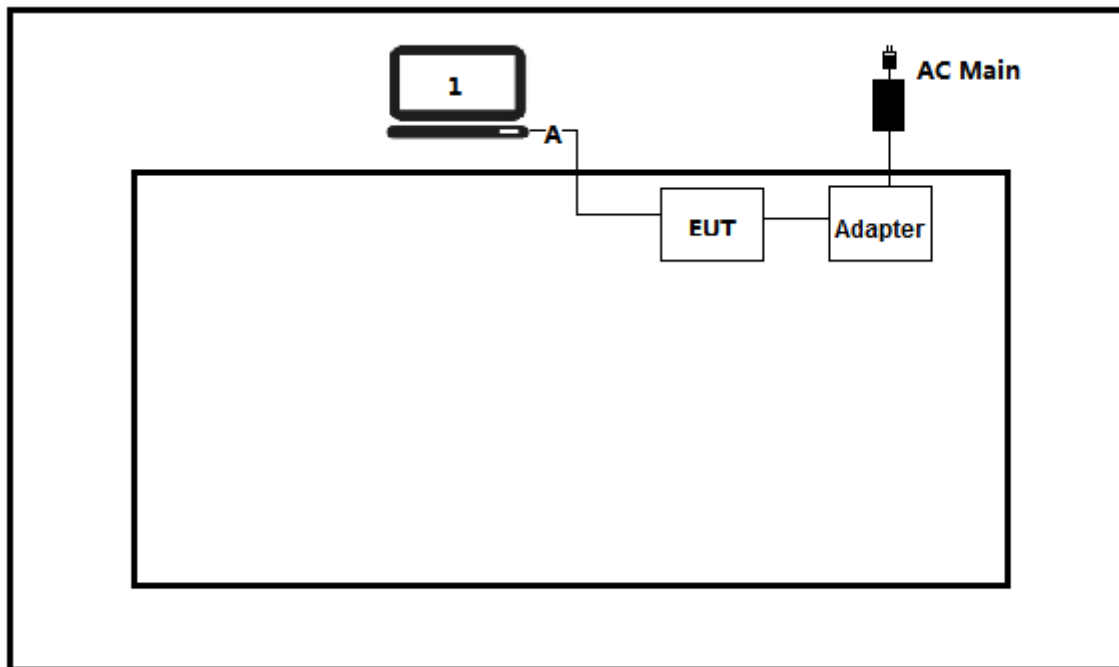

Test setup Diagram- Radiated Emission

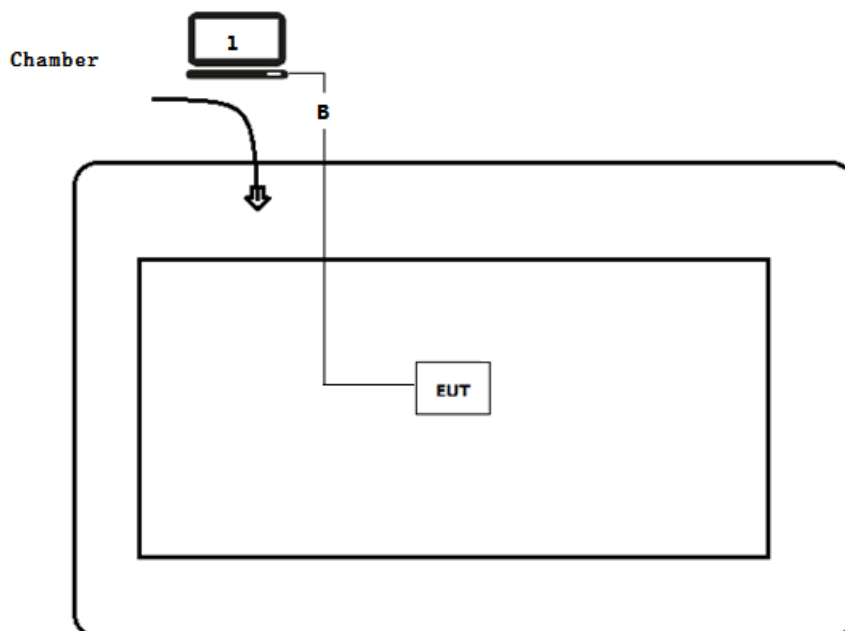

1.7. EUT Exercise Software

1	Setup the EUT and simulators as shown on above.
2	Turn on the power of all equipment.
3	Run RF software [Mtool], and set the test mode and channel, then press OK to start to continue transmit.

2. Technical Test

2.1. Summary of Test Result

For FCC

Performed Test Item	Normative References	Limit	Result
AC Power Line Conducted Emission	FCC CFR Title 47 Part 15 Subpart C: 2015 Section 15.207	FCC 15.207	PASS
Emissions in restricted frequency bands	FCC CFR Title 47 Part 15 Subpart C: 2015 Section 15.209	FCC 15.209	PASS
Emissions in non-restricted frequency bands	FCC CFR Title 47 Part 15 Subpart C: 2015 Section 15.247(d)	$\geq 20\text{dBc}$	PASS
Radiated Emission Band Edge	FCC CFR Title 47 Part 15 Subpart C: 2015 15.247(d)	FCC 15.209	PASS
Occupied Bandwidth	FCC CFR Title 47 Part 15 Subpart C: 2015 Section 15.247(a)(2)	$\geq 500\text{kHz}$	PASS
Fundamental emission output power	FCC CFR Title 47 Part 15 Subpart C: 2015 Section 15.247(b)(3)	$\leq 30\text{dBm}$	PASS
Power Spectral Density	FCC CFR Title 47 Part 15 Subpart C: 2015 Section 15.247(e)	$\leq 8\text{dBm}/3\text{kHz}$	PASS
Antenna Requirement	FCC CFR Title 47 Part 15 Subpart C: 2015 Section 15.203	FCC 15.203	PASS

For ISED

Performed Test Item	Normative References	Limit	Result
AC Power Line Conducted Emission	RSS-Gen Issue 4 Section 8.8	RSS-Gen	PASS
Emissions in restricted frequency bands	RSS-Gen Issue 4 Section 8.9	RSS-Gen	PASS
Emissions in non-restricted frequency bands	RSS-247 Issue 2 Section A5.5	$\geq 20\text{dBc}$	PASS
Radiated Emission Band Edge	RSS-247 Issue 2 Section A5.5	RSS-247	PASS
Occupied Bandwidth	RSS-Gen Issue 4 Section 6.6 RSS-247 Issue 2 Section A5.2(1)	$\geq 500\text{kHz}$	PASS
Fundamental emission output power	RSS-247 Issue 2 Section A5.4(4)	$\leq 30\text{dBm}$	PASS
Power Spectral Density	RSS-247 Issue 2 Section A5.2(2)	$\leq 8\text{dBm}/3\text{kHz}$	PASS
Antenna Requirement	RSS-Gen Issue 4 Section 8.3	RSS-Gen Issue 4	PASS

2.2. Test Frequency configuration:

Modulation Mode	Channel	Frequency	Channel	Frequency	Channel	Frequency
BLE	00	2402 MHz	19	2440 MHz	39	2480MHz

2.3. Test Environment

Items	Required (IEC 68-1)	Actual
Temperature (°C)	15-35	21
Humidity (%RH)	25-75	50
Barometric pressure (mbar)	860-1060	950-1000

2.4. Measurement Uncertainty

Test Items	Uncertainty
AC Power Line Conducted Emission	$\pm 2.02\text{dB}$
Radiated Emission	Below 1GHz $\pm 3.8\text{ dB}$
	Above 1GHz $\pm 3.9\text{ dB}$
RF Antenna Port Conducted Emission	$\pm 1.27\text{dB}$
Radiated Emission Band Edge	$\pm 3.9\text{dB}$
Occupied Bandwidth	$\pm 1\text{kHz}$
Power Spectral Density	$\pm 1.27\text{dB}$

3. AC Power Line Conducted Emission

3.1. Test Equipment

AC Power Line Conducted Emission / TR-1					
Instrument	Manufacturer	Type No.	Serial No.	Cal. Date	Cal. Due Date
EMI Test Receiver	R&S	ESCI	100906	2017.03.05	2018.03.04
Two-Line V-Network	R&S	ENV 216	101189	2017.07.16	2018.07.15
Two-Line V-Network	R&S	ENV 216	101044	2017.09.16	2018.09.15
50ohm Coaxial Switch	Anritsu	MP59B	6200464462	N/A	N/A
50ohm Termination	SHX	TF2	07081402	2017.09.16	2018.09.15
Temperature/Humidity Meter	Zhichen	ZC1-2	TR1-TH	2018.01.04	2019.01.03

Note: All equipment are calibrated with traceable calibrations. Each calibration is traceable to the national or international standards.

3.2. Test Setup

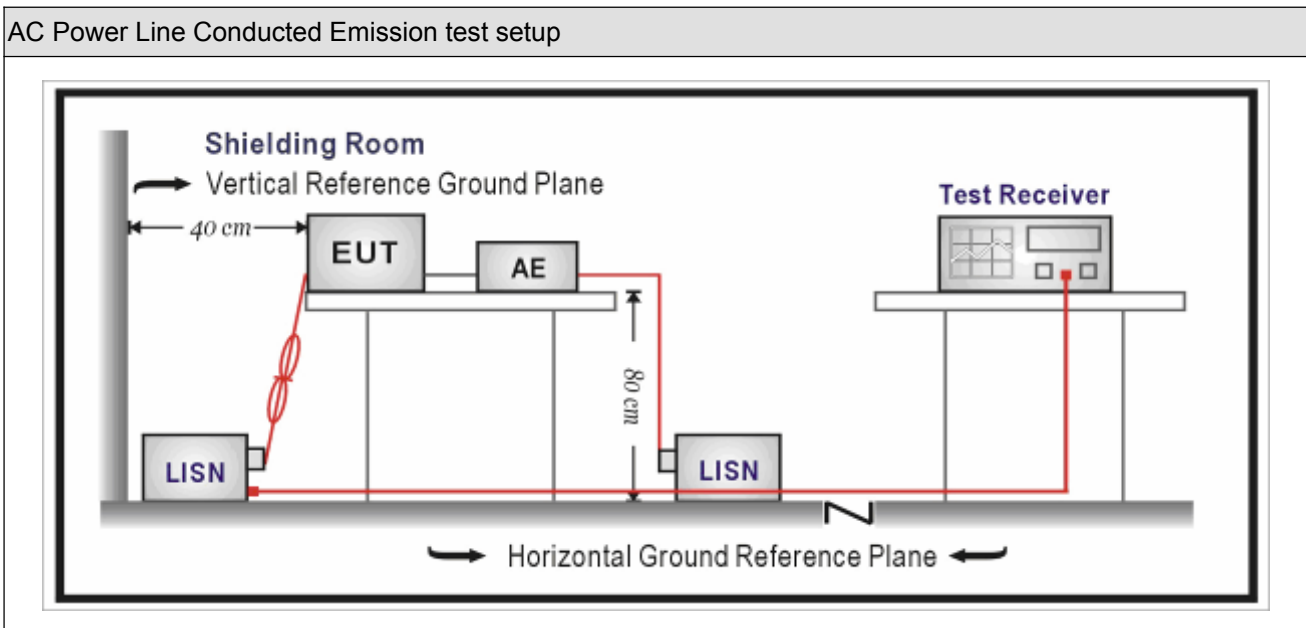

3.3. Limit

Frequency of Emission (MHz)	Conducted Limit	
	Quasi-peak (dB μ V)	Average (dB μ V)
0.15-0.5	66 to 56	56 to 46
0.5-5	56	46
5-30	60	50

Note 1: The lower limit shall apply at the transition frequencies.
 Note 2: The limit decreases linearly with the logarithm of the frequency in the range 0.15 MHz to 0.5 MHz.

3.4. Test Procedure

Test Method			
	References Rule	Chapter	Item
<input checked="" type="checkbox"/>	ANSI C63.10-2013	6.2	Standard test method for ac power-line conducted emissions from unlicensed wireless devices

3.5. Test Result

Engineer: Aaron	
Site: TR1	Time: 2017/12/26
Limit: FCC_Part15.107_CE_AC Power_ClassB	Margin: 0
Probe: ENV216_101190(0.009-30MHz)	Polarity: Line
EUT: Wireless Access point	Power: AC 120V/60Hz
Note: Mode 1:Transmit at 2402MHz by BLE	

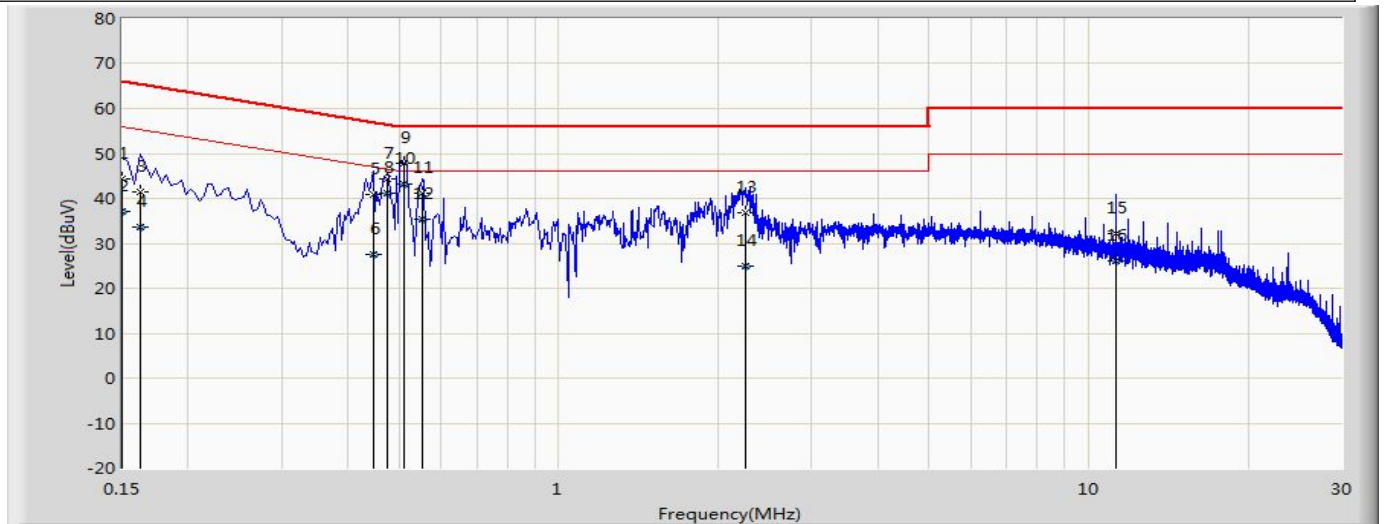

No	Mark	Frequency (MHz)	Measure Level (dBuV)	Reading Level (dBuV)	Over Limit (dB)	Limit (dBuV)	Probe (dB)	Cable (dB)	Amp (dB)	Type
1		0.150	44.485	34.850	-21.515	66.000	9.610	0.025	0.000	QP
2		0.150	36.969	27.334	-19.031	56.000	9.610	0.025	0.000	AV
3		0.162	41.594	31.961	-23.767	65.361	9.607	0.026	0.000	QP
4		0.162	33.553	23.919	-21.808	55.361	9.607	0.026	0.000	AV
5		0.446	40.883	31.243	-16.066	56.949	9.600	0.041	0.000	QP
6		0.446	27.423	17.782	-19.527	46.949	9.600	0.041	0.000	AV
7		0.474	44.292	34.651	-12.152	56.444	9.600	0.041	0.000	QP
8		0.474	41.155	31.514	-5.289	46.444	9.600	0.041	0.000	AV
9		0.510	47.826	38.226	-8.174	56.000	9.600	0.000	0.000	QP
10	*	0.510	43.132	33.532	-2.868	46.000	9.600	0.000	0.000	AV
11		0.554	41.168	31.524	-14.832	56.000	9.600	0.045	0.000	QP
12		0.554	35.399	25.754	-10.601	46.000	9.600	0.045	0.000	AV
13		2.254	36.668	26.960	-19.332	56.000	9.614	0.094	0.000	QP
14		2.254	24.948	15.241	-21.052	46.000	9.614	0.094	0.000	AV
15		11.250	32.184	22.167	-27.816	60.000	9.803	0.214	0.000	QP
16		11.250	26.094	16.077	-23.906	50.000	9.803	0.214	0.000	AV

Note: 1. " * ", means this data is the worst emission level.

2. Measurement Level = Reading Level + Factor(Probe+Cable-Amp).

Engineer: Aaron	
Site: TR1	Time: 2017/12/26
Limit: FCC_Part15.107_CE_AC Power_ClassB	Margin: 0
Probe: ENV216_101190(0.009-30MHz)	Polarity: Neutral
EUT: Wireless Access point	Power: AC 120V/60Hz
Note: Mode 1:Transmit at 2402MHz by BLE	

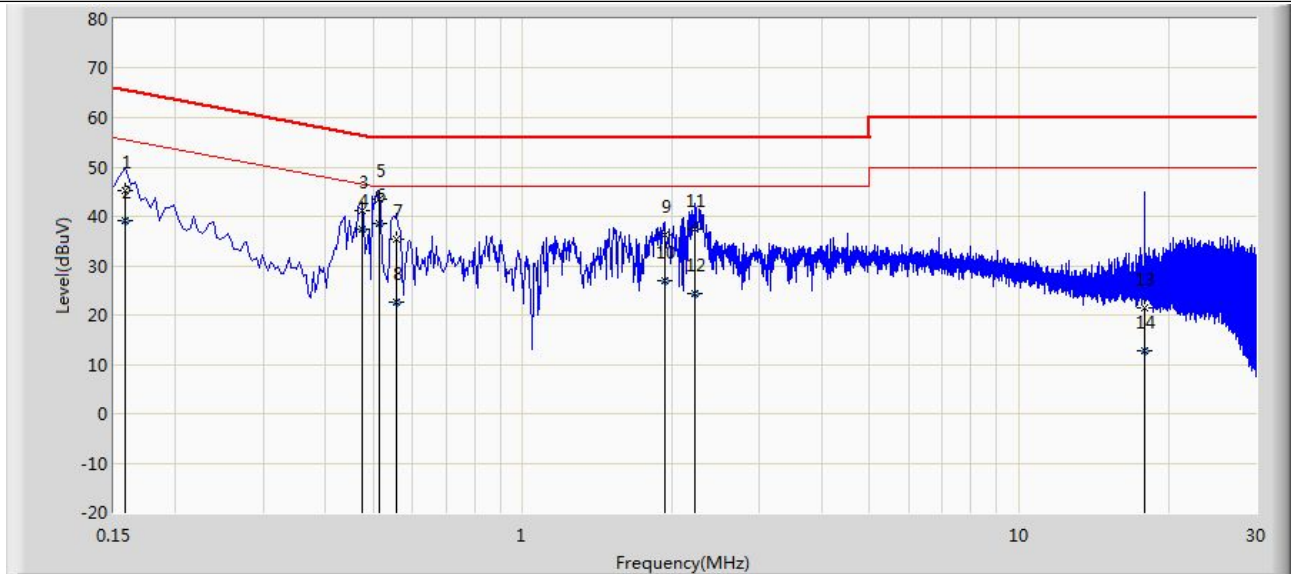

No	Mark	Frequency (MHz)	Measure Level (dBuV)	Reading Level (dBuV)	Over Limit (dB)	Limit (dBuV)	Probe (dB)	Cable (dB)	Amp (dB)	Type
1		0.158	45.075	35.457	-20.493	65.568	9.592	0.026	0.000	QP
2		0.158	39.117	29.499	-16.452	55.568	9.592	0.026	0.000	AV
3		0.474	41.116	31.484	-15.328	56.444	9.590	0.041	0.000	QP
4		0.474	37.369	27.737	-9.075	46.444	9.590	0.041	0.000	AV
5		0.514	43.535	33.901	-12.465	56.000	9.590	0.043	0.000	QP
6	*	0.514	38.546	28.913	-7.454	46.000	9.590	0.043	0.000	AV
7		0.558	35.427	25.793	-20.573	56.000	9.590	0.045	0.000	QP
8		0.558	22.687	13.052	-23.313	46.000	9.590	0.045	0.000	AV
9		1.930	36.090	26.396	-19.910	56.000	9.609	0.086	0.000	QP
10		1.930	27.001	17.306	-18.999	46.000	9.609	0.086	0.000	AV
11		2.222	37.396	27.690	-18.604	56.000	9.613	0.093	0.000	QP
12		2.222	24.356	14.650	-21.644	46.000	9.613	0.093	0.000	AV
13		17.906	21.473	11.113	-38.527	60.000	10.088	0.272	0.000	QP
14		17.906	12.729	2.369	-37.271	50.000	10.088	0.272	0.000	AV

Note:

- "*", means this data is the worst emission level.
- Measurement Level = Reading Level + Factor(Probe+Cable-Amp).

4. Emissions in restricted frequency bands

4.1. Test Equipment

Radiated Emission(Below 1GHz) / AC-2					
Instrument	Manufacturer	Type No.	Serial No.	Cal. Date	Cal. Due Date
EMI Test Receiver	R&S	ESCI	100573	2017.03.29	2018.03.28
Loop Antenna	R&S	HFH2-Z2	833799/003	2017.11.16	2018.11.15
Bilog Antenna	Teseq GmbH	CBL6112D	27611	2017.10.16	2018.10.15
Coaxial Cable	Huber+Suhner	SUCOFLEX 106	AC2-C	2017.03.02	2018.03.01
Temperature/Humidity Meter	Zhichen	ZC1-2	AC2-TH	2018.01.03	2019.01.02

Note: All equipment are calibrated with traceable calibrations. Each calibration is traceable to the national or international standards.

Radiated Emission(Above 1GHz) / AC-5					
Instrument	Manufacturer	Type No.	Serial No.	Cal. Date	Cal. Due Date
Spectrum Analyzer	Agilent	E4446A	MY45300103	2018.01.04	2019.01.03
Preamplifier	Miteq	NSP1800-25	1364185	2017.05.06	2018.05.05
Preamplifier	QuieTek	AP-040G	CHM-0906001	2017.05.06	2018.05.05
DRG Horn	ETS-Lindgren	3117	00123988	2018.01.22	2019.01.21
Broad-Band Horn Antenna	Schwarzbeck	BBHA9170	294	2017.11.25	2018.11.24
Coaxial Cable	Huber+Suhner	SUCOFLEX 106	AC5-C1	2017.03.02	2018.03.01
Coaxial Cable	Huber+Suhner	SUCOFLEX 106	AC5-C2	2017.03.02	2018.03.01
Coaxial Cable	Huber+Suhner	SUCOFLEX 102	AC5-C3	2017.03.02	2018.03.01
EMI Receiver	Agilent	N9038A	MY51210196	2017.06.10	2018.06.09
Temperature/Humidity Meter	Zhichen	ZC1-2	AC5-TH	2018.01.04	2019.01.03

Note: All equipment are calibrated with traceable calibrations. Each calibration is traceable to the national or international standards.

4.2. Test Setup

Below 30MHz Test Setup:

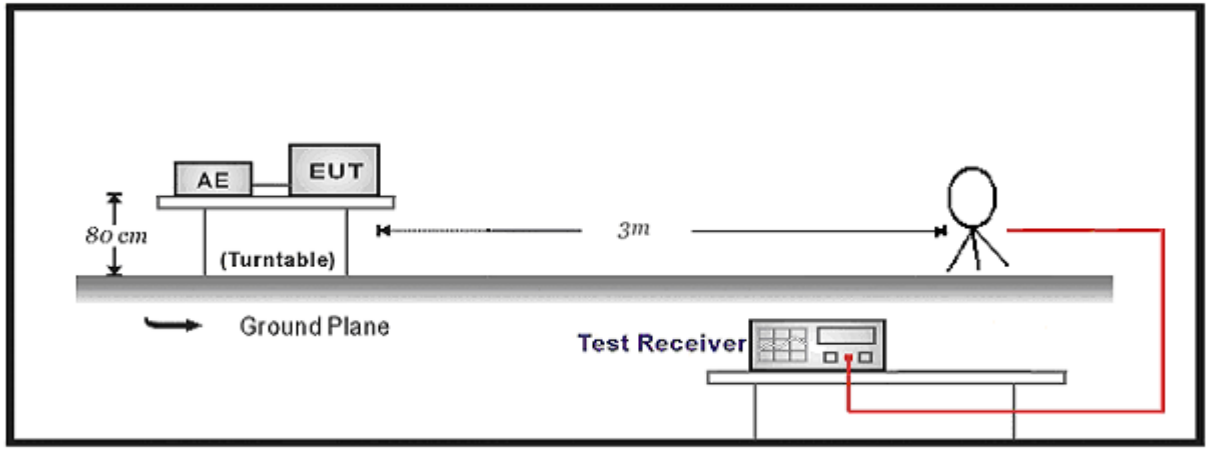

30MHz-1GHz Test Setup:

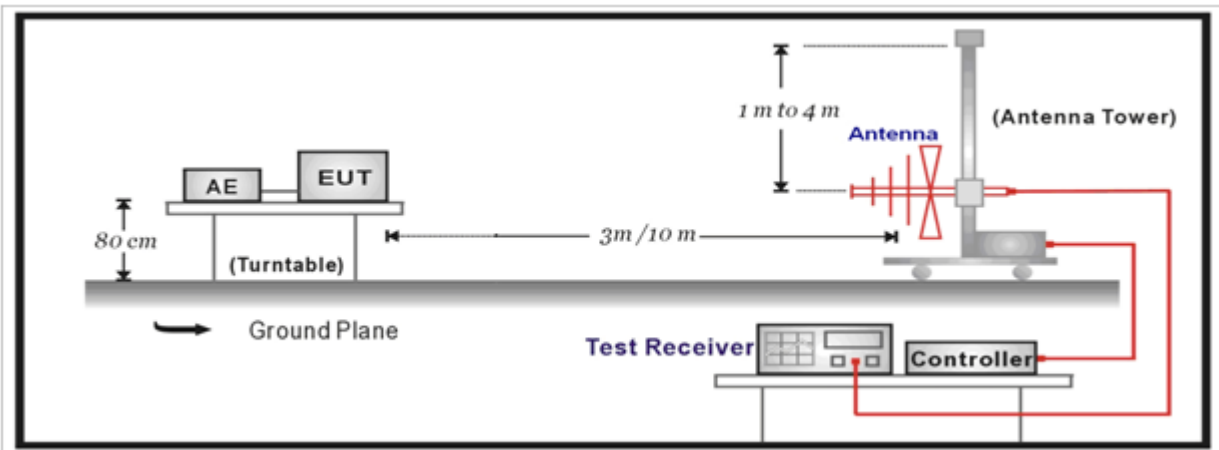

Above 1GHz Test Setup:

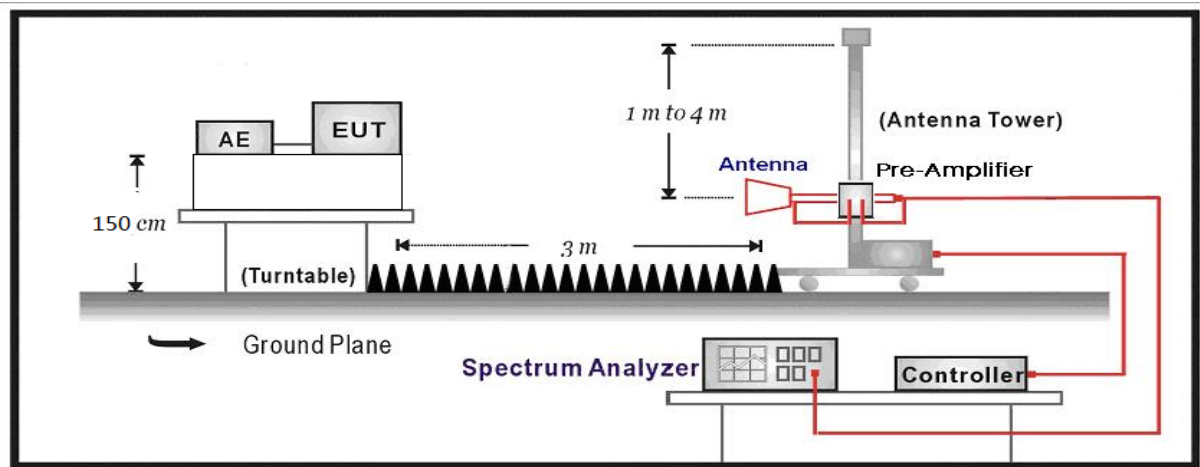

4.3. Limit

For FCC

Restricted Bands of operation			
Frequency (MHz)	Frequency (MHz)	Frequency (MHz)	Frequency (GHz)
0.090 – 0.110	16.42 – 16.423	399.9 – 410	4.5 – 5.15
0.495 – 0.505	16.69475 – 16.69525	608 – 614	5.35 – 5.46
2.1735 – 2.1905	16.80425 – 16.80475	960 – 1240	7.25 – 7.75
4.125 – 4.128	25.5 – 25.67	1300 – 1427	8.025 – 8.5
4.17725 – 4.17775	37.5 – 38.25	1435 – 1626.5	9.0 – 9.2
4.20725 – 4.20775	73 – 74.6	1645.5 – 1646.5	9.3 – 9.5
6.215 – 6.218	74.8 – 75.2	1660 – 1710	10.6 – 12.7
6.26775 – 6.26825	108 – 121.94	1718.8 – 1722.2	13.25 – 13.4
6.31175 – 6.31225	123 – 138	2200 – 2300	14.47 – 14.5
8.291 – 8.294	149.9 – 150.05	2310 – 2390	15.35 – 16.2
8.362 – 8.366	156.52475 – 156.52525	2483.5 – 2500	17.7 – 21.4
8.37625 – 8.38675	156.7 – 156.9	2690 – 2900	22.01 – 23.12
8.81425 – 8.81475	162.0125 – 167.17	3260 – 3267	23.6 – 24.0
12.29 – 12.293	167.72 – 173.2	3332 – 3339	31.2 – 31.8
12.51975 – 12.52025	240 – 285	3345.8 – 3358	36.43 – 36.5
12.57675 – 12.57725	322 – 335.4	3600 – 4400	
13.36 – 13.41			

For IC:

Restricted Bands of operation			
Frequency (MHz)	Frequency (MHz)	Frequency (MHz)	Frequency (GHz)
0.090-0.110	13.36-13.41	1645.5-1646.5	9.0-9.2
2.1735-2.1905	16.42-16.423	1660-1710	9.3-9.5
3.020-3.026	16.69475-16.69525	1718.8-1722.2	10.6-12.7
4.125-4.128	16.80425-16.80475	2200-2300	13.25-13.4
4.17725-4.17775	25.5-25.67	2310-2390	14.47-14.5
4.20725-4.20775	37.5-38.25	2655-2900	15.35-16.2
5.677-5.683	73-74.6	3260-3267	17.7-21.4
6.215-6.218	74.8-75.2	3332-3339	22.01-23.12
6.26775-6.26825	108-138	3345.8-3358	23.6-24.0
6.31175-6.31225	156.52475-156.52525	3500-4400	31.2-31.8
8.291-8.294	156.7-156.9	4500-5150	36.43-36.5
8.362-8.366	240-285	5350-5460	Above 38.6
8.37625-8.38675	322-335.4	7250-7750	
8.41425-8.41475	399.9-410	8025-8500	
12.29-12.293	608-614		
12.51975-12.52025	960-1427		
12.57675-12.57725	1435-1626.5		

Restricted Band Emissions Limit			
Frequency (MHz)	Field strength (μ V/m)	Field strength (dB μ V/m)	Measurement distance (m)
0.009 - 0.49	2400/F(kHz)	48.5 – 13.8	300 _(Note 1)
0.49 - 1.705	24000/F(kHz)	33.8 - 23	30 _(Note 1)
1.705 - 30	30	29.5	30 _(Note 1)
30 - 88	100	40	3 _(Note 2)
88 - 216	150	43.5	3 _(Note 2)
216 - 960	200	46	3 _(Note 2)
Above 960	500	54	3 _(Note 2)



Note 1: At frequencies below 30 MHz, measurements may be performed at a distance closer than that specified in the regulations; however, an attempt should be made to avoid making measurements in the near field. Pending the development of an appropriate measurement procedure for measurements performed below 30 MHz, when performing measurements at a closer distance than specified, the results shall be extrapolated to the specified distance by either making measurements at a minimum of two distances on at least one radial to determine the proper extrapolation factor or by using the square of an inverse linear distance extrapolation factor (40 dB/decade).

Note 2: At frequencies at or above 30 MHz, measurements may be performed at a distance other than what is specified provided: measurements are not made in the near field except where it can be shown that near field measurements are appropriate due to the characteristics of the device; and it can be demonstrated that the signal levels needed to be measured at the distance employed can be detected by the measurement equipment. Measurements shall not be performed at a distance greater than 30 meters unless it can be further demonstrated that measurements at a distance of 30 meters or less are impractical. When performing measurements at a distance other than that specified, the results shall be extrapolated to the specified distance using an extrapolation factor of 20 dB/decade (inverse linear-distance for field strength measurements; inverse-linear-distance-squared for power density measurements).

4.4. Test Procedure

Test Method				
	References	Rule	Chapter	Description
<input type="checkbox"/>		ANSI C63.10	11.11	Emissions in non-restricted frequency bands
	<input type="checkbox"/>	ANSI C63.10	11.11.2	Reference level measurement
	<input type="checkbox"/>	ANSI C63.10	11.11.3	Emission level measurement
<input checked="" type="checkbox"/>		ANSI C63.10	11.12	Emissions in restricted frequency bands
	<input checked="" type="checkbox"/>	ANSI C63.10	11.12.1	Radiated emission measurements
	<input checked="" type="checkbox"/>	ANSI C63.10	11.12.2.7	Radiated spurious emission test
	<input checked="" type="checkbox"/>	ANSI C63.10	6.4	Radiated emissions from unlicensed wireless devices below 30 MHz
	<input checked="" type="checkbox"/>	ANSI C63.10	6.5	Radiated emissions from unlicensed wireless devices in the frequency range of 30 MHz to 1000 MHz
	<input checked="" type="checkbox"/>	ANSI C63.10	6.6	Radiated emissions from unlicensed wireless devices above 1 GHz
	<input type="checkbox"/>	ANSI C63.10	11.12.2.3	Quasi-peak measurement procedure
	<input checked="" type="checkbox"/>	ANSI C63.10	11.12.2.4	Peak power measurement procedure
	<input checked="" type="checkbox"/>	ANSI C63.10	11.12.2.5	Average power measurement procedures
		<input type="checkbox"/>	ANSI C63.10	11.12.2.5.1 Trace averaging with continuous EUT transmission at full power
		<input type="checkbox"/>	ANSI C63.10	11.12.2.5.2 Trace averaging across ON and OFF times of the EUT transmissions followed by duty cycle correction
		<input checked="" type="checkbox"/>	ANSI C63.10	11.12.2.5.3 Reduced VBW averaging across ON and OFF times of the EUT transmissions with max hold

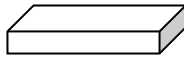
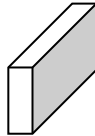
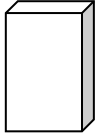
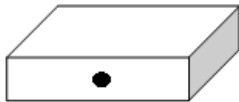
4.5. EUT test Axis definition

Item	Emissions in restricted frequency bands			
Device Category	<input type="checkbox"/>	Fixed point-to-point		
	<input type="checkbox"/>	Emit multiple directional beams, simultaneously or sequentially		
	<input checked="" type="checkbox"/>	Other cases		
Test mode	Mode 1			
Test method	<input checked="" type="checkbox"/>	Radiated		
		X Axis	Y Axis	Z Axis
				
		Worst Axis <input checked="" type="checkbox"/>	Worst Axis <input type="checkbox"/>	Worst Axis <input type="checkbox"/>
	<input type="checkbox"/>	Conducted		
	<input type="checkbox"/>	Chain 1		
				
	<input type="checkbox"/>	Chain 1	Chain 2	
				
	<input type="checkbox"/>	Chain 1	Chain 2	Chain 3
				

4.6. Test Result

Engineer: Eric	
Site: AC5	Time: 2018/01/04 - 21:14
Limit: FCC_Part15.209_RE(3m)	Margin: 0
Probe: Horn_3117_00167055(1-18GHz)	Polarity: Horizontal
EUT: Wireless Access point	Power: AC 120V/60Hz
Note: Mode 1:Transmit at 2402MHz by BLE	

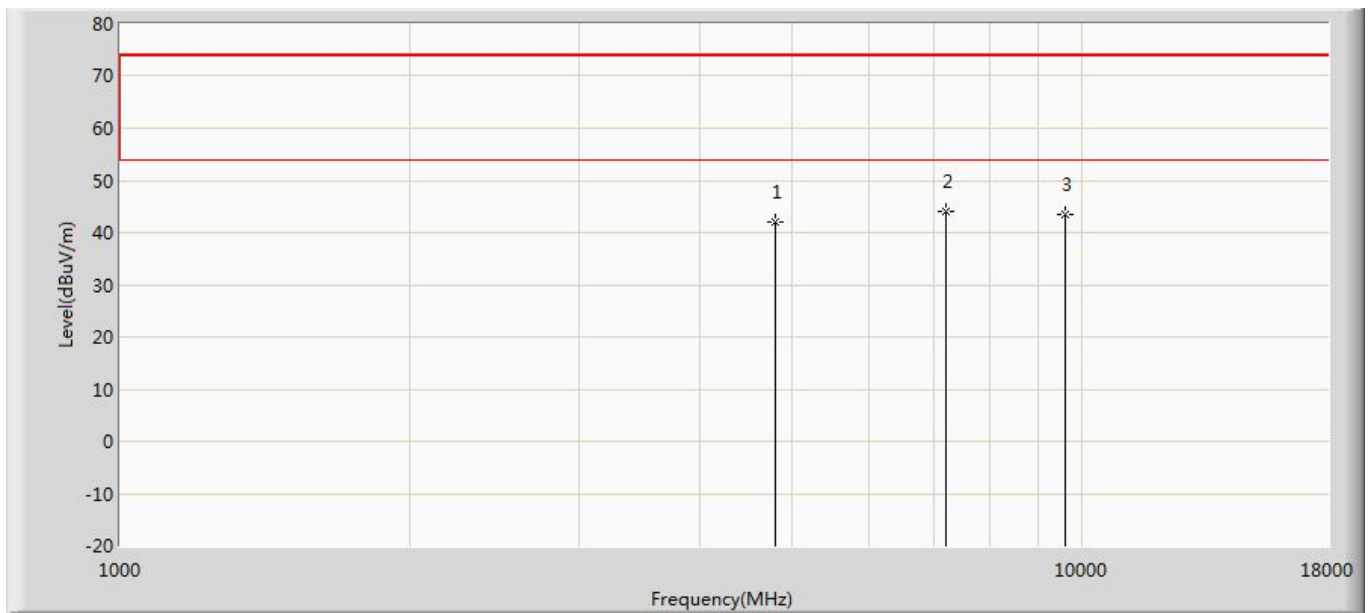

No	Mark	Frequency (MHz)	Measure Level (dBuV/m)	Reading Level (dBuV)	Over Limit (dB)	Limit (dBuV/m)	Factor (dB)	Type
1		4804.000	42.113	42.632	-31.887	74.000	-0.519	PK
2	*	7206.000	43.970	39.954	-30.030	74.000	4.016	PK
3		9608.000	43.540	37.722	-30.460	74.000	5.817	PK

Engineer: Eric	
Site: AC5	Time: 2018/01/04 - 21:14
Limit: FCC_Part15.209_RE(3m)	Margin: 0
Probe: Horn_3117_00167055(1-18GHz)	Polarity: Vertical
EUT: Wireless Access point	Power: AC 120V/60Hz
Note: Mode 1:Transmit at 2402MHz by BLE	

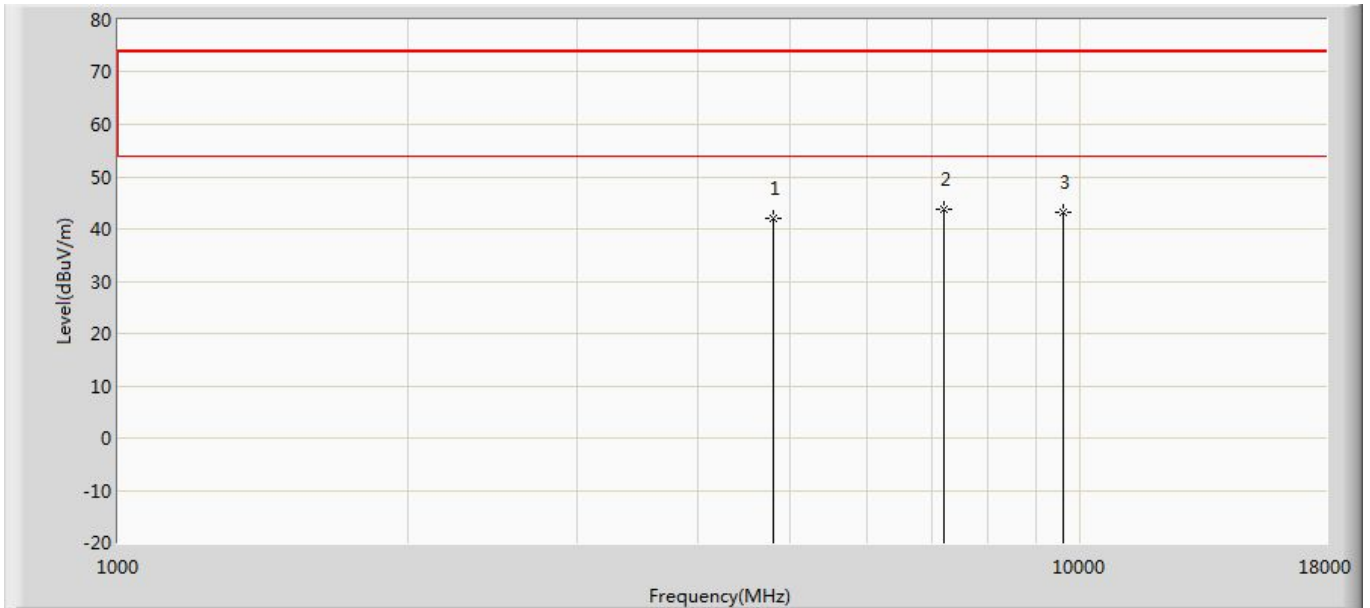

No	Mark	Frequency (MHz)	Measure Level (dBuV/m)	Reading Level (dBuV)	Over Limit (dB)	Limit (dBuV/m)	Factor (dB)	Type
1		4804.000	41.926	42.445	-32.074	74.000	-0.519	PK
2	*	7206.000	43.765	39.749	-30.235	74.000	4.016	PK
3		9608.000	43.238	37.420	-30.762	74.000	5.817	PK

Engineer: Eric	
Site: AC5	Time: 2018/01/04 - 21:15
Limit: FCC_Part15.209_RE(3m)	Margin: 0
Probe: Horn_3117_00167055(1-18GHz)	Polarity: Horizontal
EUT: Wireless Access point	Power: AC 120V/60Hz
Note: Mode 1:Transmit at 2441MHz by BLE	

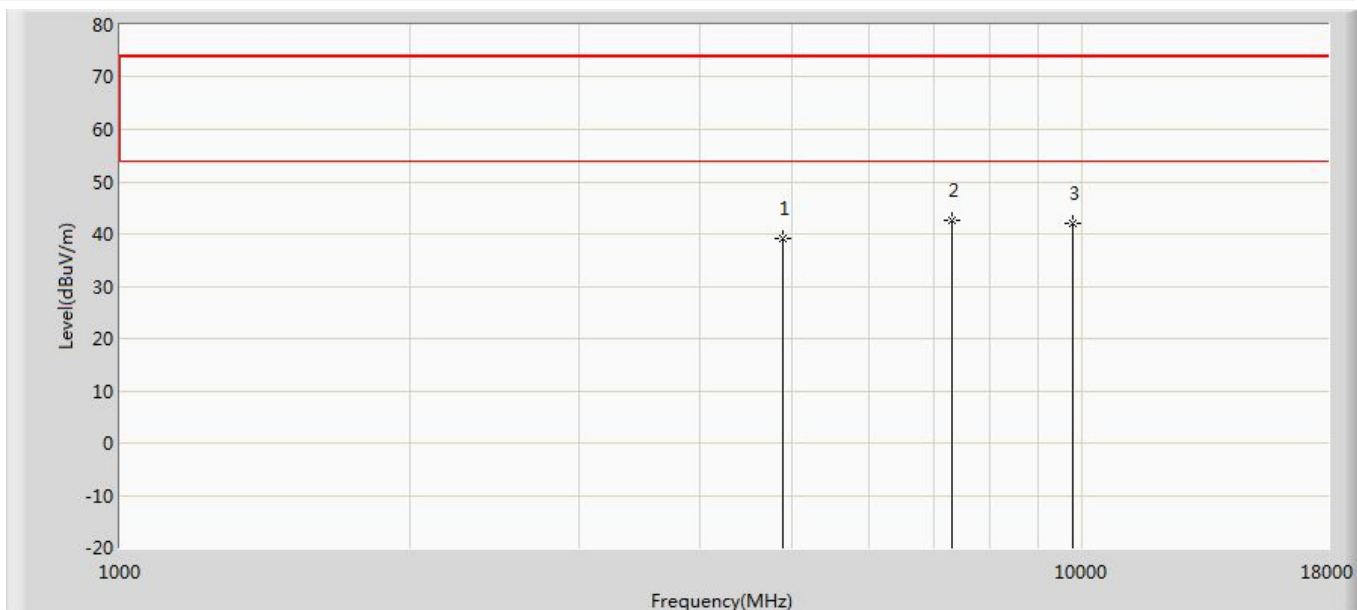

No	Mark	Frequency (MHz)	Measure Level (dBuV/m)	Reading Level (dBuV)	Over Limit (dB)	Limit (dBuV/m)	Factor (dB)	Type
1		4880.000	39.136	39.615	-34.864	74.000	-0.478	PK
2	*	7320.000	42.505	38.591	-31.495	74.000	3.914	PK
3		9760.000	41.939	37.163	-32.061	74.000	4.776	PK

Engineer: Eric	
Site: AC5	Time: 2018/01/04 - 21:15
Limit: FCC_Part15.209_RE(3m)	Margin: 0
Probe: Horn_3117_00167055(1-18GHz)	Polarity: Vertical
EUT: Wireless Access point	Power: AC 120V/60Hz
Note: Mode 1:Transmit at 2440MHz by BLE	

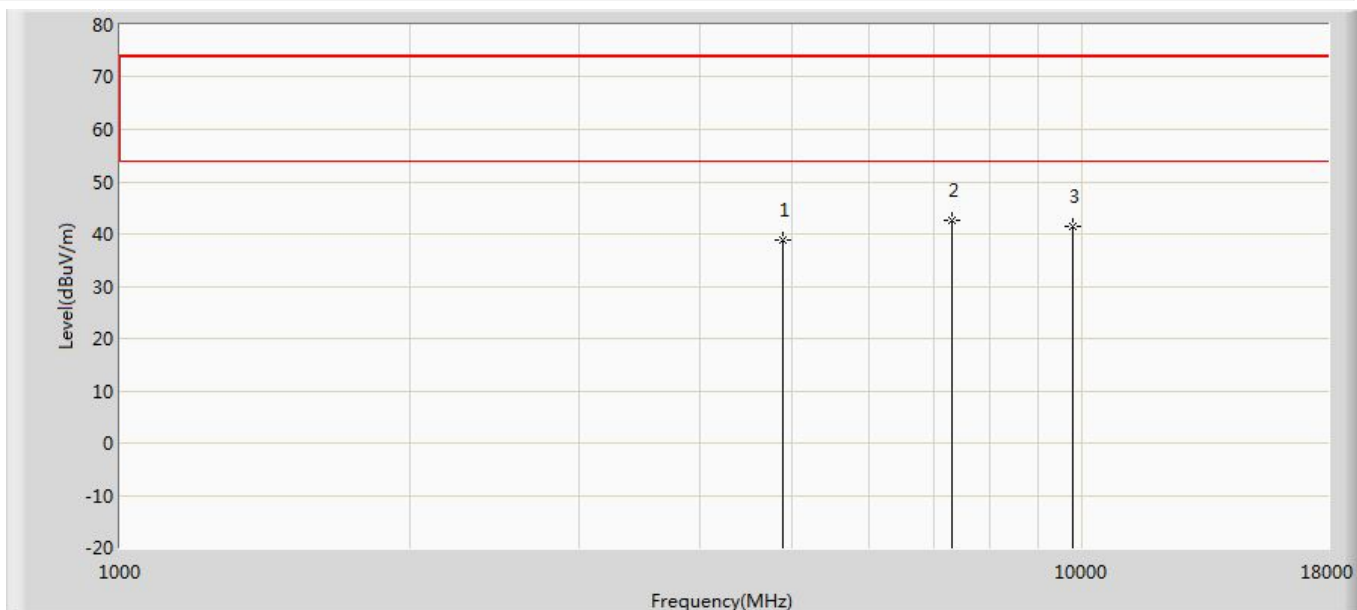

No	Mark	Frequency (MHz)	Measure Level (dBuV/m)	Reading Level (dBuV)	Over Limit (dB)	Limit (dBuV/m)	Factor (dB)	Type
1		4880.000	38.969	39.448	-35.031	74.000	-0.478	PK
2	*	7320.000	42.585	38.671	-31.415	74.000	3.914	PK
3		9760.000	41.575	36.799	-32.425	74.000	4.776	PK

Engineer: Eric	
Site: AC5	Time: 2018/01/04 - 21:15
Limit: FCC_Part15.209_RE(3m)	Margin: 0
Probe: Horn_3117_00167055(1-18GHz)	Polarity: Horizontal
EUT: Wireless Access point	Power: AC 120V/60Hz
Note: Mode 1:Transmit at 2480MHz by BLE	

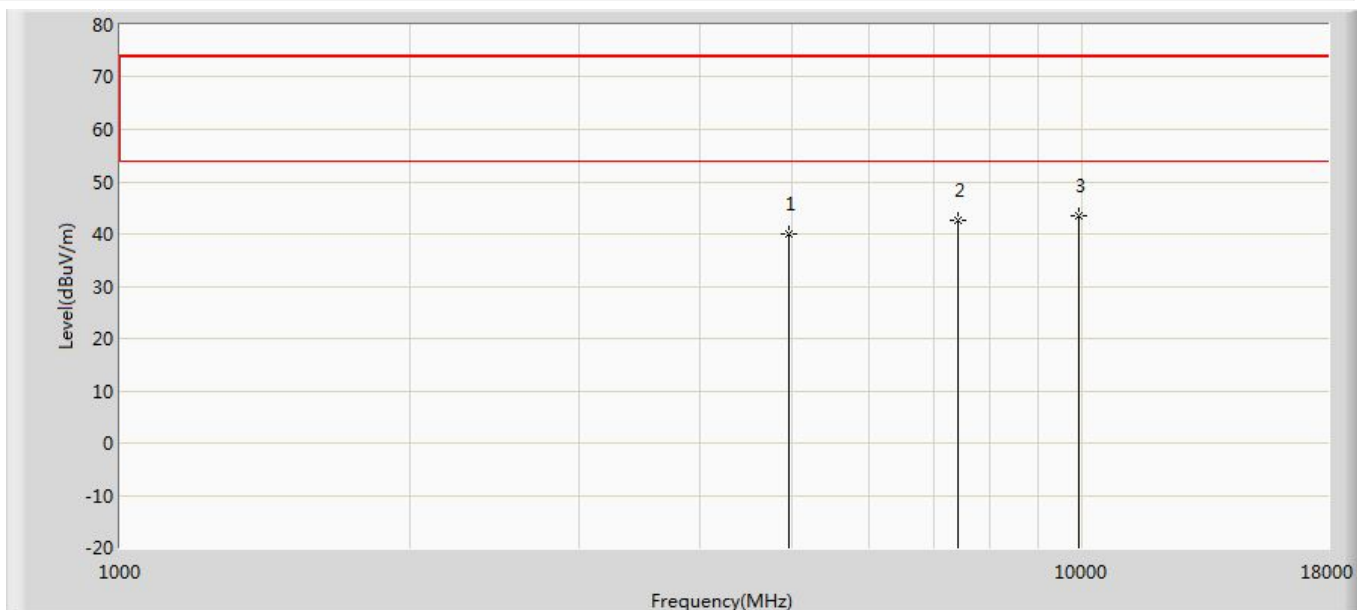

No	Mark	Frequency (MHz)	Measure Level (dBuV/m)	Reading Level (dBuV)	Over Limit (dB)	Limit (dBuV/m)	Factor (dB)	Type
1		4960.000	39.945	40.822	-34.055	74.000	-0.877	PK
2		7440.000	42.547	38.908	-31.453	74.000	3.638	PK
3	*	9920.000	43.334	37.368	-30.666	74.000	5.966	PK

Engineer: Eric	
Site: AC5	Time: 2018/01/04 - 21:15
Limit: FCC_Part15.209_RE(3m)	Margin: 0
Probe: Horn_3117_00167055(1-18GHz)	Polarity: Vertical
EUT: Wireless Access point	Power: AC 120V/60Hz
Note: Mode 1:Transmit at 2480MHz by BLE	

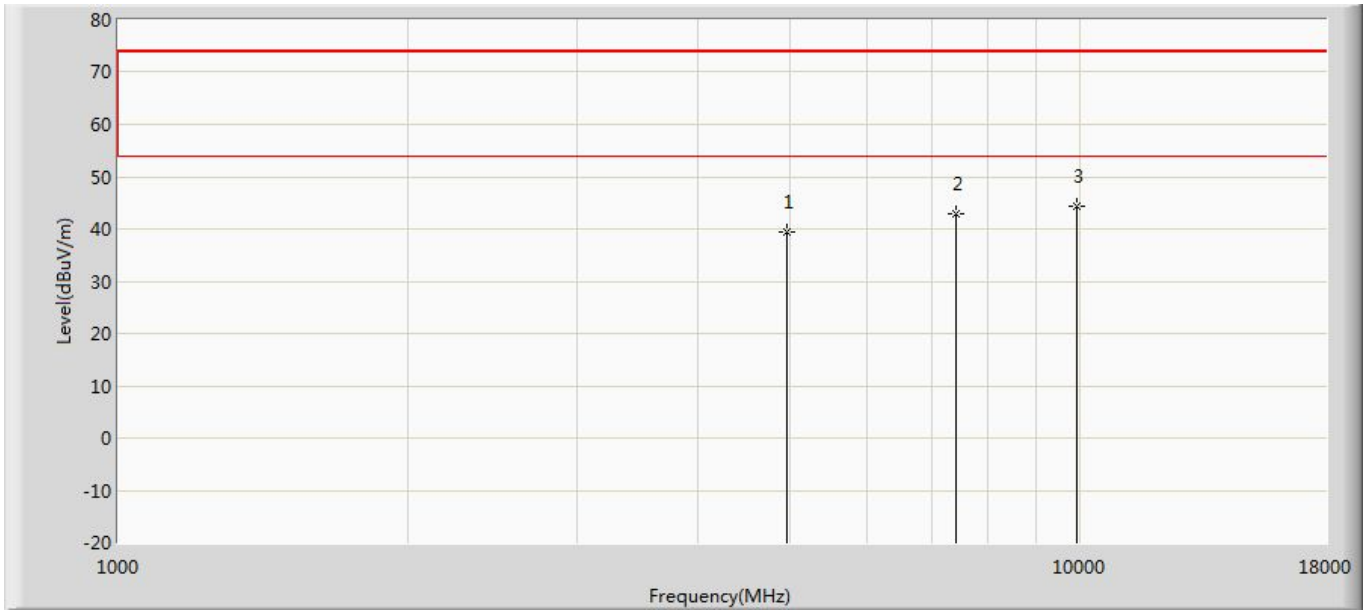

No	Mark	Frequency (MHz)	Measure Level (dBuV/m)	Reading Level (dBuV)	Over Limit (dB)	Limit (dBuV/m)	Factor (dB)	Type
1		4960.000	39.473	40.350	-34.527	74.000	-0.877	PK
2		7440.000	42.791	39.152	-31.209	74.000	3.638	PK
3	*	9920.000	44.395	38.429	-29.605	74.000	5.966	PK

Engineer: Eric	
Site: AC5	Time: 2018/01/04 - 21:15
Limit: FCC_Part15.209_RE(3m)	Margin: 0
Probe: Horn_3117_00167055(1-18GHz)	Polarity: Vertical
EUT: Wireless Access point	Power: AC 120V/60Hz
Note: Mode 1:Transmit at 2480MHz by BLE	

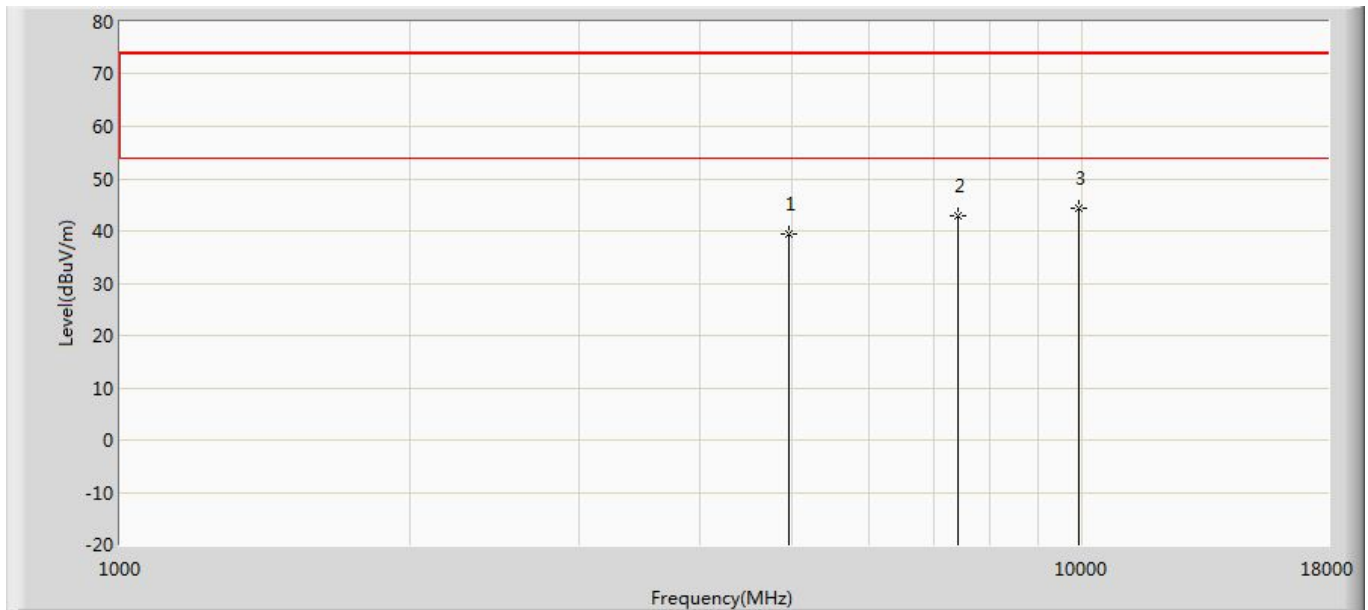

No	Mark	Frequency (MHz)	Measure Level (dBuV/m)	Reading Level (dBuV)	Over Limit (dB)	Limit (dBuV/m)	Factor (dB)	Type
1		4960.000	39.473	40.350	-34.527	74.000	-0.877	PK
2		7440.000	42.791	39.152	-31.209	74.000	3.638	PK
3	*	9920.000	44.395	38.429	-29.605	74.000	5.966	PK

Note: 1. Measure Level = Reading Level + Factor.

Note: 2. The test frequency range, 9kHz~30MHz, 18GHz~25GHz, both of the worst case are at least 6dB below the limits, therefore no data appear in the report.

Note: 3. This limit applies for using average detector, if the test result on peak is lower than average limit, then average measurement needn't be performed.

The worst case of Radiated Emission below 1GHz:

Engineer: CptJack	
Site: AC2	Time: 2017/12/05
Limit: FCC_Part15.109_RE(3m)_ClassB	Margin: 0
Probe: AC2_3M(30-1000M)	Polarity: Horizontal
EUT: Wireless Access point	Power: AC 120V/60Hz
Note: Mode 1:Transmit at channel 2402MHz by BLE	

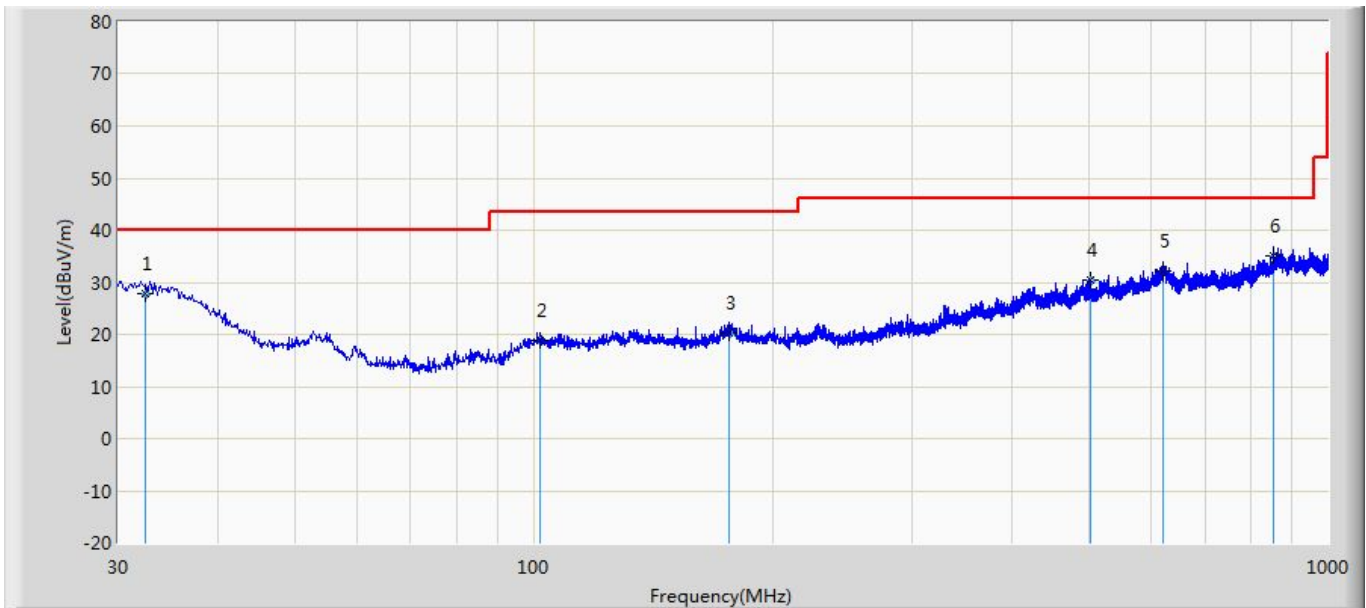

No	Mark	Frequency (MHz)	Measure Level (dBuV/m)	Reading Level (dBuV)	Over Limit (dB)	Limit (dBuV/m)	Probe (dB/m)	Cable (dB)	Amp (dB)	Ant Pos (cm)	Table Pos (deg)	Type
1		32.472	27.877	0.500	-12.123	40.000	20.731	6.645	0.000	100	355	QP
2		101.842	18.739	1.600	-24.761	43.500	10.252	6.886	0.000	200	66	QP
3		175.885	20.284	3.100	-23.216	43.500	9.896	7.289	0.000	187	360	QP
4		501.621	30.568	3.000	-15.432	46.000	19.522	8.046	0.000	100	5	QP
5		621.034	32.033	1.200	-13.967	46.000	22.273	8.560	0.000	200	149	QP
6	*	854.610	34.950	2.600	-11.050	46.000	23.210	9.140	0.000	100	124	QP

Note:

1. " * ", means this data is the worst emission level.
2. Measurement Level = Reading Level + Factor(Probe+Cable-Amp).

Engineer: CptJack	
Site: AC2	Time: 2017/12/05
Limit: FCC_Part15.109_RE(3m)_ClassB	Margin: 0
Probe: AC2_3M(30-1000M)	Polarity: Vertical
EUT: Wireless Access point	Power: AC 120V/60Hz
Note: Mode 1:Transmit at channel 2402MHz by BLE	

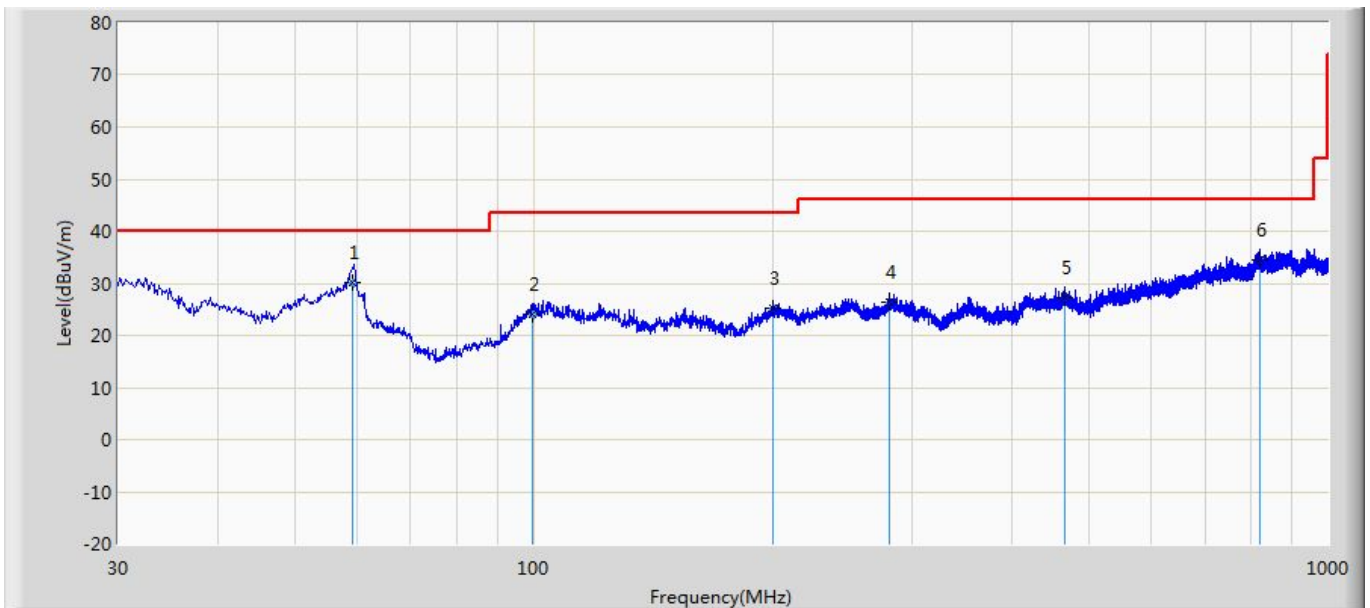

No	Mark	Frequency (MHz)	Measure Level (dBuV/m)	Reading Level (dBuV)	Over Limit (dB)	Limit (dBuV/m)	Probe (dB/m)	Cable (dB)	Amp (dB)	Ant Pos (cm)	Table Pos (deg)	Type
1	*	59.154	30.152	13.600	-9.848	40.000	9.848	6.704	0.000	100	59	QP
2		99.719	23.958	2.056	-19.542	43.500	15.036	6.867	0.000	200	204	QP
3		200.114	25.294	1.724	-18.206	43.500	16.229	7.342	0.000	100	195	QP
4		280.987	26.247	1.158	-19.753	46.000	17.489	7.601	0.000	200	354	QP
5		466.621	27.342	0.600	-18.658	46.000	18.733	8.009	0.000	100	113	QP
6		822.732	34.529	1.743	-11.471	46.000	23.722	9.064	0.000	100	251	QP

Note:

- " * ", means this data is the worst emission level.
- Measurement Level = Reading Level + Factor(Probe+Cable-Amp).

The worst case of Simultaneous transmission:

Engineer: Eric	
Site: AC5	Time: 2018/01/04 - 14:09
Limit: FCC_Part15.209_RE(3m)	Margin: 0
Probe: Horn_3117_00167055(1-18GHz)	Polarity: Horizontal
EUT: Wireless Access point	Power: AC 120V/60Hz
Note: Simultaneous transmission with WIFI(2.4G+5G)+BT	

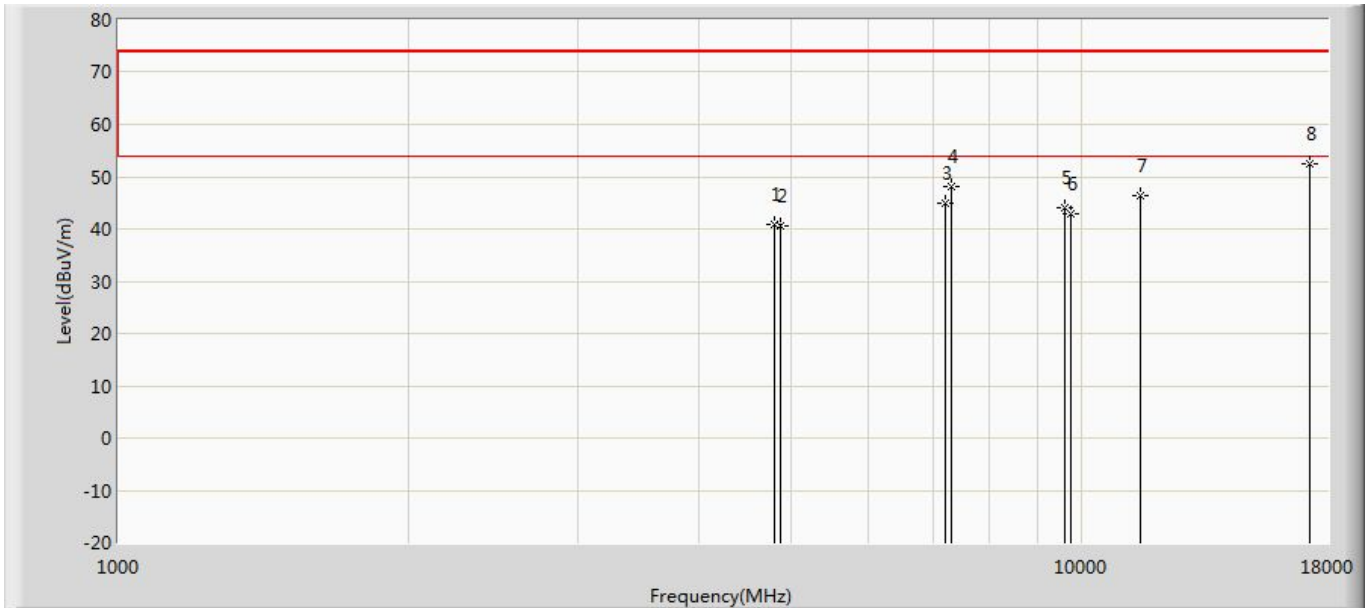

No	Mark	Frequency (MHz)	Measure Level (dBuV/m)	Reading Level (dBuV)	Over Limit (dB)	Limit (dBuV/m)	Factor (dB)	Type
1		4804.000	41.001	41.520	-32.999	74.000	-0.519	PK
2		4874.000	40.691	41.133	-33.309	74.000	-0.442	PK
3		7206.000	44.986	40.970	-29.014	74.000	4.016	PK
4		7315.000	48.078	44.187	-25.922	74.000	3.891	PK
5		9608.000	43.940	38.122	-30.060	74.000	5.817	PK
6		9748.000	42.862	37.861	-31.138	74.000	5.002	PK
7		11490.000	46.293	36.567	-27.707	74.000	9.726	PK
8	*	17235.000	52.597	34.178	-21.403	74.000	18.419	PK

Engineer: Eric	
Site: AC5	Time: 2018/01/04 - 14:09
Limit: FCC_Part15.209_RE(3m)	Margin: 0
Probe: Horn_3117_00167055(1-18GHz)	Polarity: Vertical
EUT: Wireless Access point	Power: AC 120V/60Hz
Note: Simultaneous transmission with WIFI(2.4G+5G)+BT	

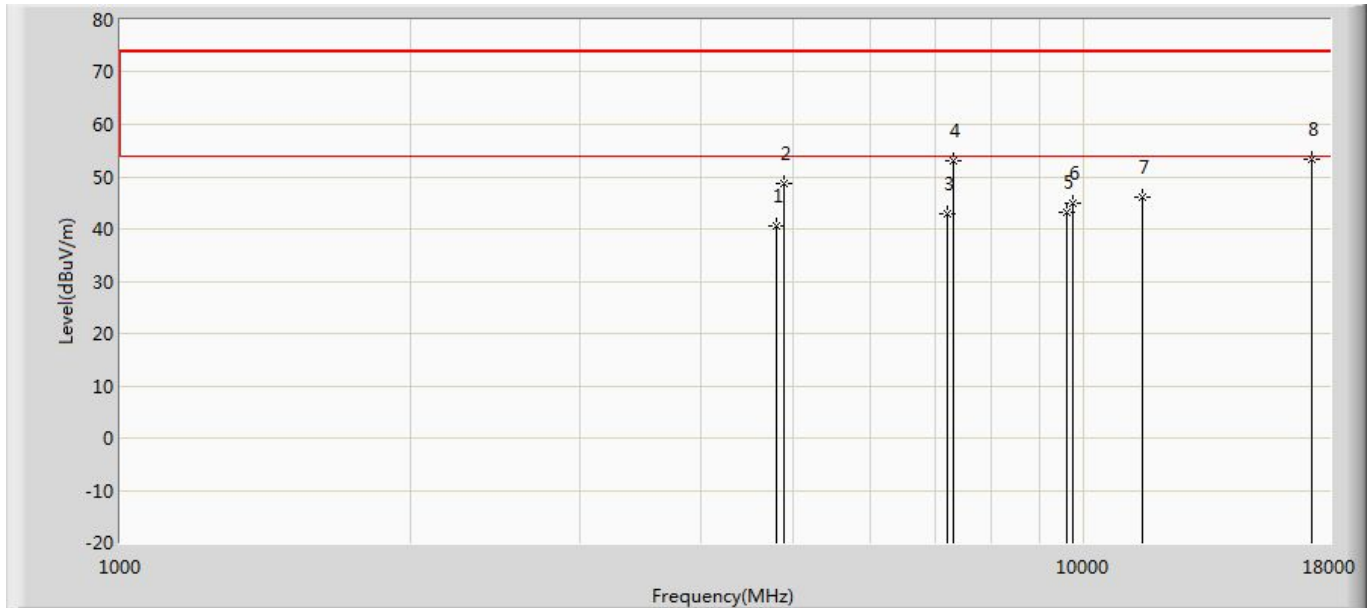

No	Mark	Frequency (MHz)	Measure Level (dBuV/m)	Reading Level (dBuV)	Over Limit (dB)	Limit (dBuV/m)	Factor (dB)	Type
1		4804.000	40.501	41.020	-33.499	74.000	-0.519	PK
2		4876.000	48.570	48.980	-25.430	74.000	-0.410	PK
3		7206.000	42.896	38.880	-31.104	74.000	4.016	PK
4		7315.000	53.001	49.110	-20.999	74.000	3.891	PK
5		9608.000	43.328	37.510	-30.672	74.000	5.817	PK
6		9748.000	45.061	40.060	-28.939	74.000	5.002	PK
7		11490.000	46.096	36.370	-27.904	74.000	9.726	PK
8	*	17235.000	53.245	34.826	-20.755	74.000	18.419	PK

5. Emissions in non-restricted frequency bands

5.1. Test Equipment

Emissions in non-restricted frequency bands / TR-8					
Instrument	Manufacturer	Type No.	Serial No.	Cal. Date	Cal. Due Date
Spectrum Analyzer	Agilent	N9010A	MY48030494	2017.02.04	2018.02.03
EXA Spectrum Analyzer	Keysight	N9010A	MY55370495	2017.04.09	2018.04.08
MXA Signal Analyzer	Keysight	N9020A	MY56060147	2017.04.09	2018.04.08
Temperature/Humidity Meter	zhichen	ZC1-2	TR8-TH	2017.04.10	2018.04.09

Note: All equipment are calibrated with traceable calibrations. Each calibration is traceable to the national or international standards.

5.2. Test Setup

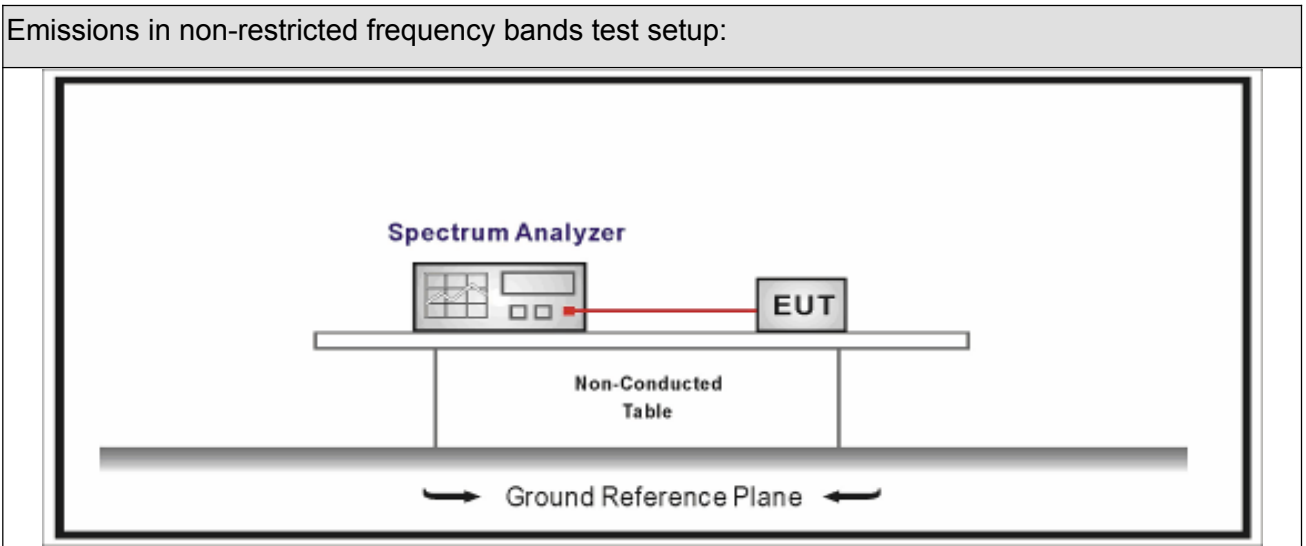





5.3. Limit

Un-Restricted Band Emissions Limit	
RF Output power (Detection methods)	Limit(dB)
RF Output power(Average detector)	30c(Note1)
RF Output power(PK detector)	20c(Note2)
<p>Note 1: If maximum conducted (average) output power was used to demonstrate compliance as described in 9.2, then the peak power in any 100 kHz bandwidth outside of the authorized frequency band shall be attenuated by at least 30 dB relative to the maximum in-band peak PSD level in 100 kHz (i.e., 30 dBc).</p> <p>Note 2: If the maximum peak conducted output power procedure was used, then the peak output power measured in any 100 kHz bandwidth outside of the authorized frequency band shall be attenuated by at least 20 dB relative to the maximum in-band peak PSD level in 100 kHz (i.e., 20 dBc).</p>	

5.4. Test Procedure

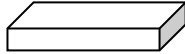
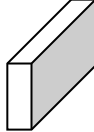
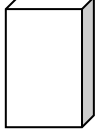
Test Method			
	References Rule	Chapter	Description
<input checked="" type="checkbox"/>	ANSI C63.10	11.11	Emissions in non-restricted frequency bands
	<input checked="" type="checkbox"/> ANSI C63.10	11.11.2	Reference level measurement
	<input checked="" type="checkbox"/> ANSI C63.10	11.11.3	Emission level measurement
<input type="checkbox"/>	ANSI C63.10	11.12	Emissions in restricted frequency bands
	<input type="checkbox"/> ANSI C63.10	11.12.1	Radiated emission measurements
	<input type="checkbox"/> ANSI C63.10	11.12.2.7	Radiated spurious emission test
<input type="checkbox"/>	ANSI C63.10	6.4	Radiated emissions from unlicensed wireless devices below 30 MHz
<input type="checkbox"/>	ANSI C63.10	6.5	Radiated emissions from unlicensed wireless devices in the frequency range of 30 MHz to 1000 MHz
<input type="checkbox"/>	ANSI C63.10	6.6	Radiated emissions from unlicensed wireless devices above 1 GHz
	<input checked="" type="checkbox"/> ANSI C63.10	11.12.2	Antenna-port conducted measurements
	<input type="checkbox"/> ANSI C63.10	11.12.2.3	Quasi-peak measurement procedure
	<input checked="" type="checkbox"/> ANSI C63.10	11.12.2.4	Peak power measurement procedure
	<input type="checkbox"/> ANSI C63.10	11.12.2.5	Average power measurement procedures
	<input type="checkbox"/> ANSI C63.10	11.12.2.5.1	Trace averaging with continuous EUT transmission at full power
	<input type="checkbox"/> ANSI C63.10	11.12.2.5.2	Trace averaging across ON and OFF times of the EUT transmissions followed by duty cycle correction
	<input type="checkbox"/> ANSI C63.10	11.12.2.5.3	Reduced VBW averaging across ON and OFF times of the EUT transmissions with max hold

5.5. EUT test Axis definition

Item	Emissions in non-restricted frequency bands			
Device Category	<input type="checkbox"/>	Fixed point-to-point		
	<input type="checkbox"/>	Emit multiple directional beams, simultaneously or sequentially		
	<input checked="" type="checkbox"/>	Other cases		
Test mode	Mode 1			
Test method	<input type="checkbox"/>	Radiated		
		X Axis	Y Axis	Z Axis
				
		Worst Axis <input type="checkbox"/>	Worst Axis <input type="checkbox"/>	Worst Axis <input type="checkbox"/>
	<input checked="" type="checkbox"/>	Conducted		
	<input checked="" type="checkbox"/>	Chain 1		
				
	<input type="checkbox"/>	Chain 1	Chain 2	
				
	<input type="checkbox"/>	Chain 1	Chain 2	Chain 3
				

5.6. Test Result

Product Name	: Wireless Access point	Power	: AC 120V/60Hz
Test Mode	: Mode 1	Test Site	: TR-8
Test Date	: 2018.01.06	Test Engineer	: Eric

Mode	Channel	Test Frequency (MHz)	In-Band PSD[a] (dBm/100kHz)	Frequency (MHz)	Out-Band PSD[b] (dBm/100kHz)	[a]-[b] (dB)	Limit (dB)	Result
1	00	2402	3.448	2400.00	-53.031	56.479	>20	Pass
1	39	2480	3.945	2500.00	-59.422	63.367	>20	Pass

Note: The worst case of Emissions in non-restricted frequency bands as below:

Mode 1 CH00 (2402MHz)

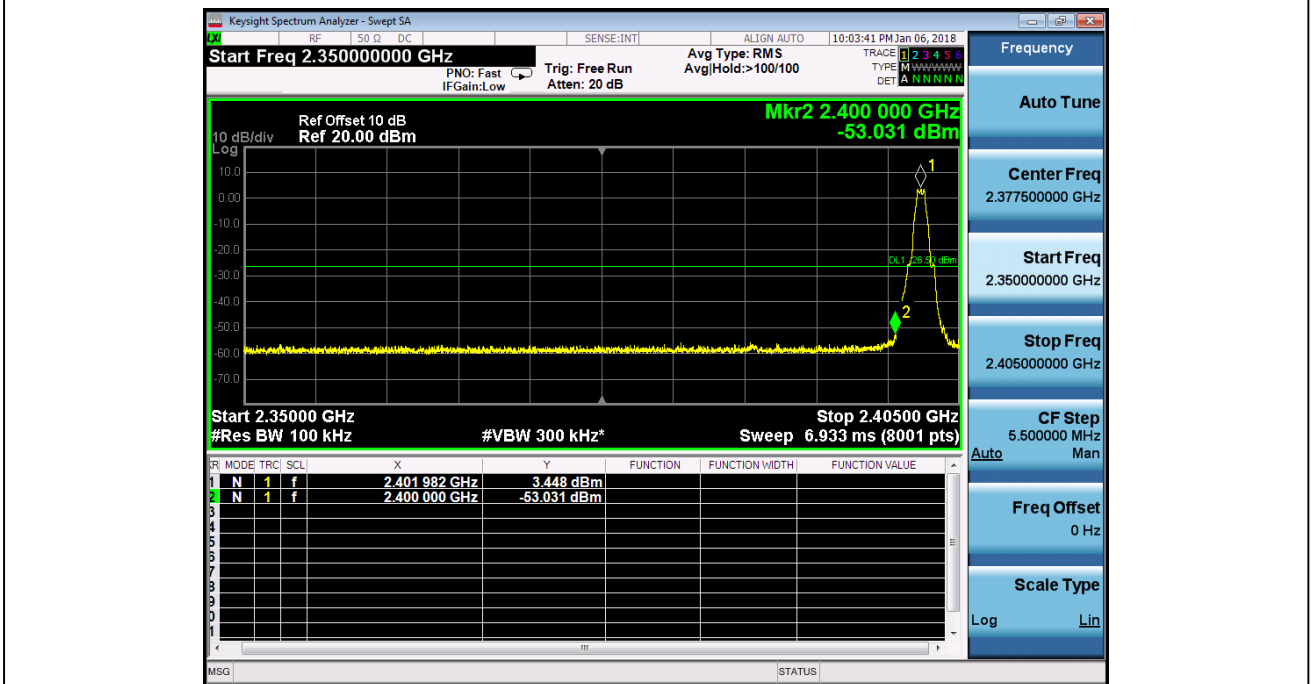

6. Radiated Emission Band Edge

6.1. Test Equipment

Radiated Emission(Above 1GHz) / AC-5					
Instrument	Manufacturer	Type No.	Serial No.	Cal. Date	Cal. Due Date
EMI Receiver	Agilent	N9038A	MY51210196	2017.07.16	2018.07.15
Pre-Amplifier	Miteq	NSP1800-25	1364185	2017.05.03	2018.05.02
DRG Horn Antenna	ETS-Lindgren	3117	00167055	2017.07.12	2018.07.11
Broad-Band Horn Antenna	Schwarzbeck	BBHA9170	294	2017.09.18	2018.09.17
Coaxial Cable	Huber+Suhner	SUCOFLEX 106	AC5-C1	2017.02.28	2018.02.27
Coaxial Cable	Huber+Suhner	SUCOFLEX 106	AC5-C2	2017.02.28	2018.02.27
Temperature/Humidity Meter	Zhichen	ZC1-2	AC5-TH	2018.01.05	2019.01.04

6.2. Test Setup

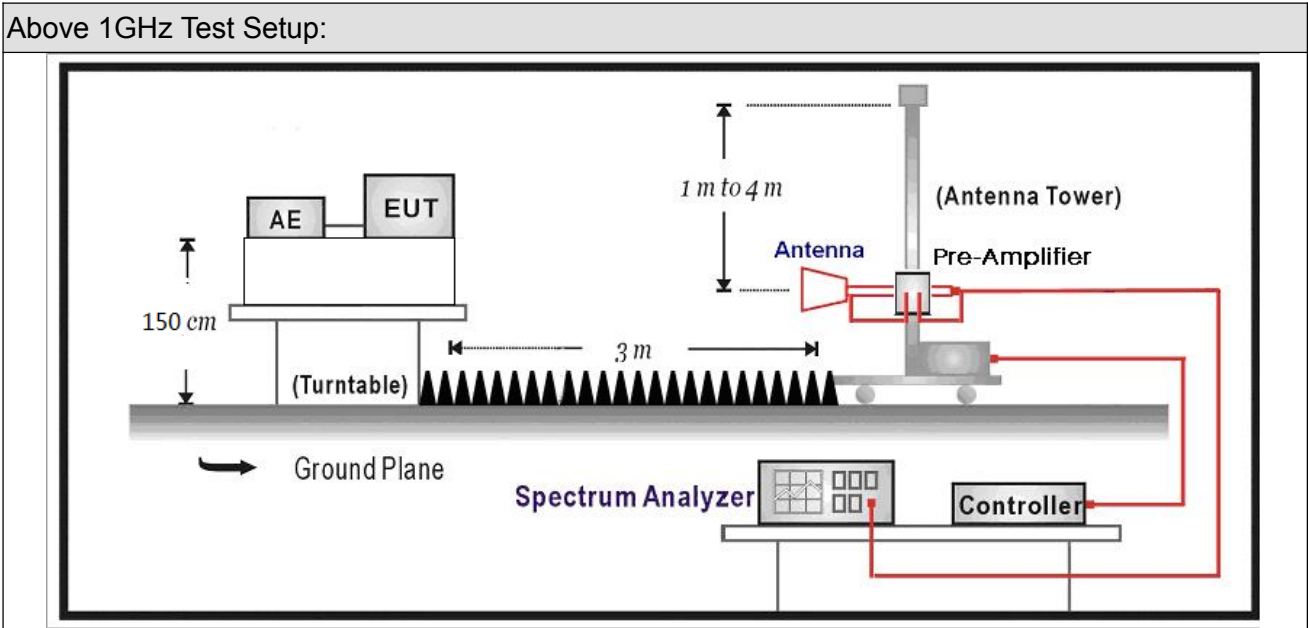

6.3. Limit





Band edge Limit				
Frequency bands (MHz)	Detector	Limit (dB μ V/m)	RBW (MHz)	Distance (m)
2310-2390	PK	74	1	3
2483.5-2500	AV	54	1	3

Note: The field strength of emissions appearing within these frequency bands shall not exceed the limits

6.4. Test Procedure

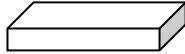
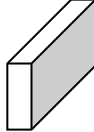
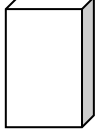
Test Method			
	References Rule	Chapter	Description
<input checked="" type="checkbox"/>	ANSI C63.10	6.10	Band-edge testing
	<input checked="" type="checkbox"/> ANSI C63.10	6.10.5	Restricted-band band-edge measurements
	<input type="checkbox"/> ANSI C63.10	6.10.6	Marker-delta method
<input checked="" type="checkbox"/>	ANSI C63.10	11.12	Emissions in restricted frequency bands
	<input checked="" type="checkbox"/> ANSI C63.10	11.12.1	Radiated emission measurements
	<input checked="" type="checkbox"/> ANSI C63.10	11.12.2.7	Radiated spurious emission test
<input type="checkbox"/>	ANSI C63.10	6.4	Radiated emissions from unlicensed wireless devices below 30 MHz
<input type="checkbox"/>	ANSI C63.10	6.5	Radiated emissions from unlicensed wireless devices in the frequency range of 30 MHz to 1000 MHz
<input checked="" type="checkbox"/>	ANSI C63.10	6.6	Radiated emissions from unlicensed wireless devices above 1 GHz
	<input type="checkbox"/> ANSI C63.10	11.12.2.3	Quasi-peak measurement procedure
	<input checked="" type="checkbox"/> ANSI C63.10	11.12.2.4	Peak power measurement procedure
	<input checked="" type="checkbox"/> ANSI C63.10	11.12.2.5	Average power measurement procedures
	<input type="checkbox"/> ANSI C63.10	11.12.2.5.1	Trace averaging with continuous EUT transmission at full power
	<input type="checkbox"/> ANSI C63.10	11.12.2.5.2	Trace averaging across ON and OFF times of the EUT transmissions followed by duty cycle correction
	<input checked="" type="checkbox"/> ANSI C63.10	11.12.2.5.3	Reduced VBW averaging across ON and OFF times of the EUT transmissions with max hold

6.5. EUT test definition

Item	Radiated Emission Band Edge			
Device Category	<input type="checkbox"/>	Fixed point-to-point		
	<input type="checkbox"/>	Emit multiple directional beams, simultaneously or sequentially		
	<input checked="" type="checkbox"/>	Other cases		
Test mode	Mode 1			
Test method	<input checked="" type="checkbox"/>	Radiated		
		X Axis	Y Axis	Z Axis
				
		Worst Axis <input checked="" type="checkbox"/>	Worst Axis <input type="checkbox"/>	Worst Axis <input type="checkbox"/>
	<input type="checkbox"/>	Conducted		
	<input type="checkbox"/>	Chain 1		
				
	<input type="checkbox"/>	Chain 1	Chain 2	
				
	<input type="checkbox"/>	Chain 1	Chain 2	Chain 3
				

6.6. Duty Cycle

Test Mode	Tx On (ms)	Tx Off (ms)	Reduced VBW (kHz)	Tx On + Tx Off (ms)	Duty Cycle
BLE	0.389	0.236	2.7kHz	0.625	62.24%

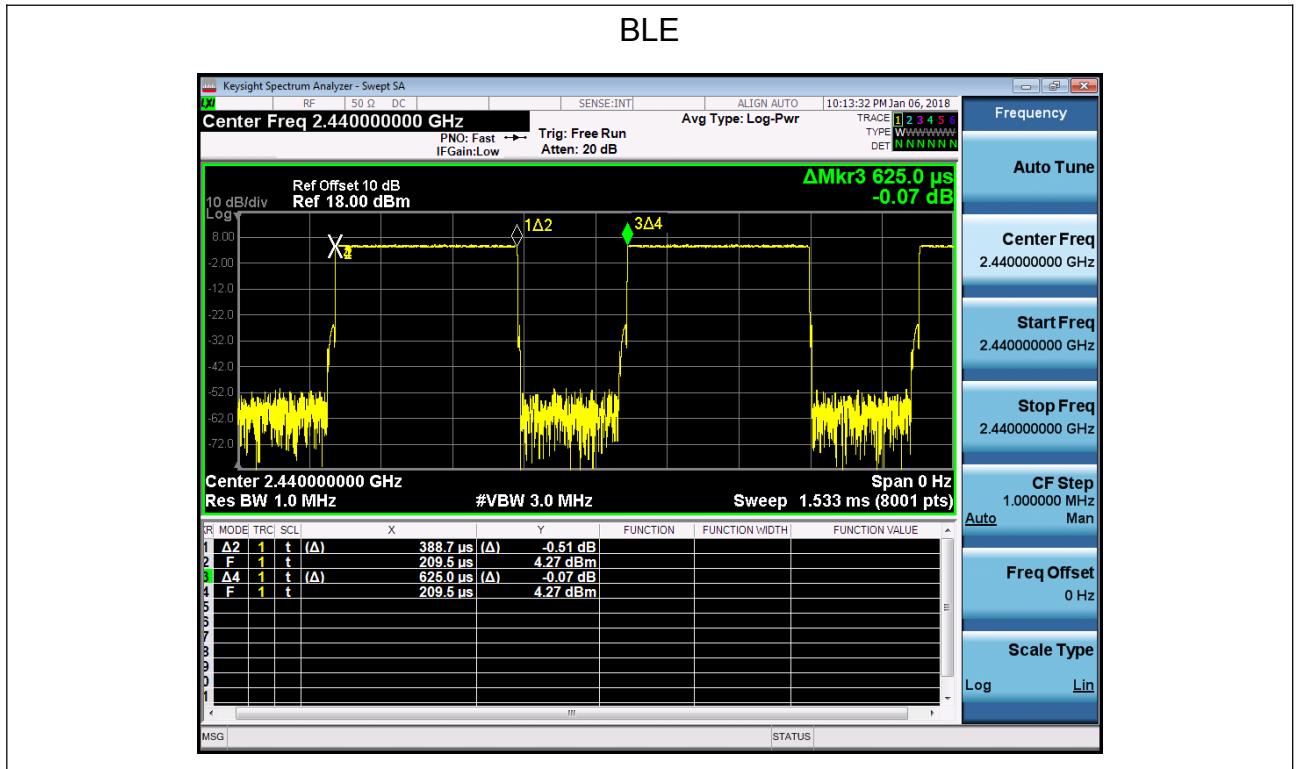

6.7 Test Result

Engineer: Eric	
Site: AC5	Time: 2018/01/04 - 20:05
Limit: FCC_Part15.209_RE(3m)	Margin: 0
Probe: Horn_3117_00167055(1-18GHz)	Polarity: Horizontal
EUT: Wireless Access point	Power: AC 120V/60Hz
Note: Mode 1:Transmit at 2402MHz by BLE	

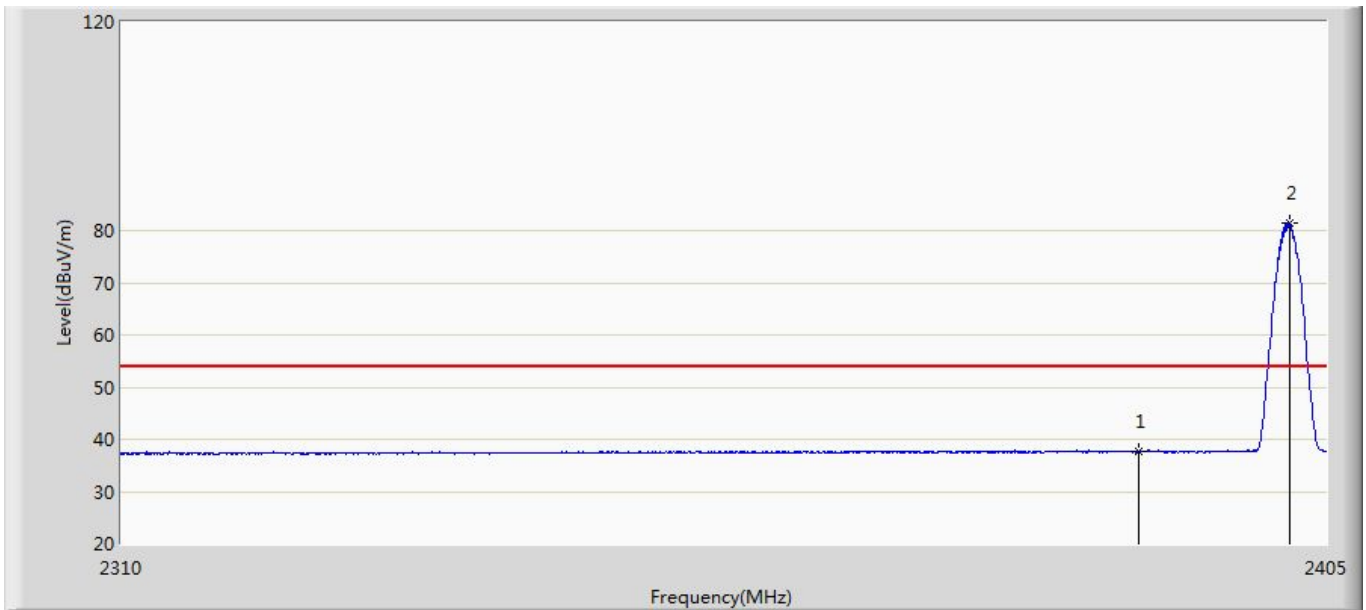

No	Mark	Frequency (MHz)	Measure Level (dBuV/m)	Reading Level (dBuV)	Over Limit (dB)	Limit (dBuV/m)	Factor (dB)	Type
1		2390.000	37.642	1.960	-16.358	54.000	35.682	AV
2	*	2402.103	81.416	45.703	N/A	N/A	35.713	AV

Engineer: Eric	
Site: AC5	Time: 2018/01/04 - 20:09
Limit: FCC_Part15.209_RE(3m)	Margin: 0
Probe: Horn_3117_00167055(1-18GHz)	Polarity: Horizontal
EUT: Wireless Access point	Power: AC 120V/60Hz
Note: Mode 1:Transmit at 2402MHz by BLE	

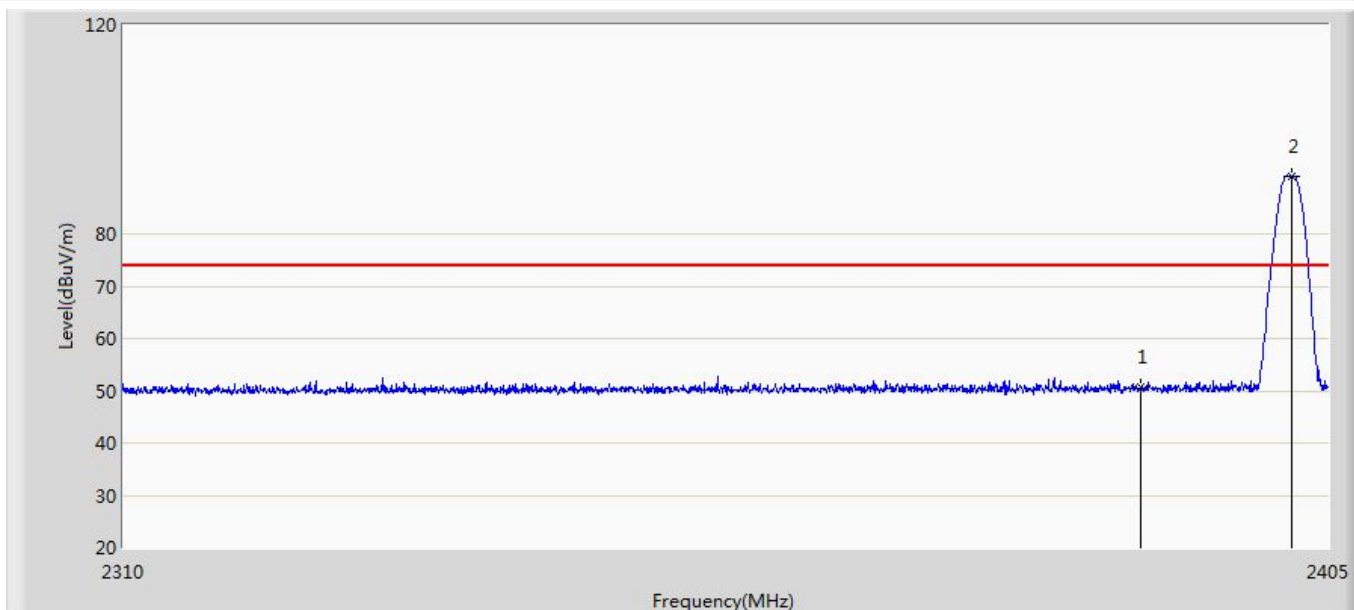

No	Mark	Frequency (MHz)	Measure Level (dBuV/m)	Reading Level (dBuV)	Over Limit (dB)	Limit (dBuV/m)	Factor (dB)	Type
1		2390.000	50.607	14.925	-23.393	74.000	35.682	PK
2	*	2402.055	91.095	55.382	N/A	N/A	35.712	PK

Engineer: Eric	
Site: AC5	Time: 2018/01/04 - 20:11
Limit: FCC_Part15.209_RE(3m)	Margin: 0
Probe: Horn_3117_00167055(1-18GHz)	Polarity: Vertical
EUT: Wireless Access point	Power: AC 120V/60Hz
Note: Mode 1:Transmit at 2402MHz by BLE	

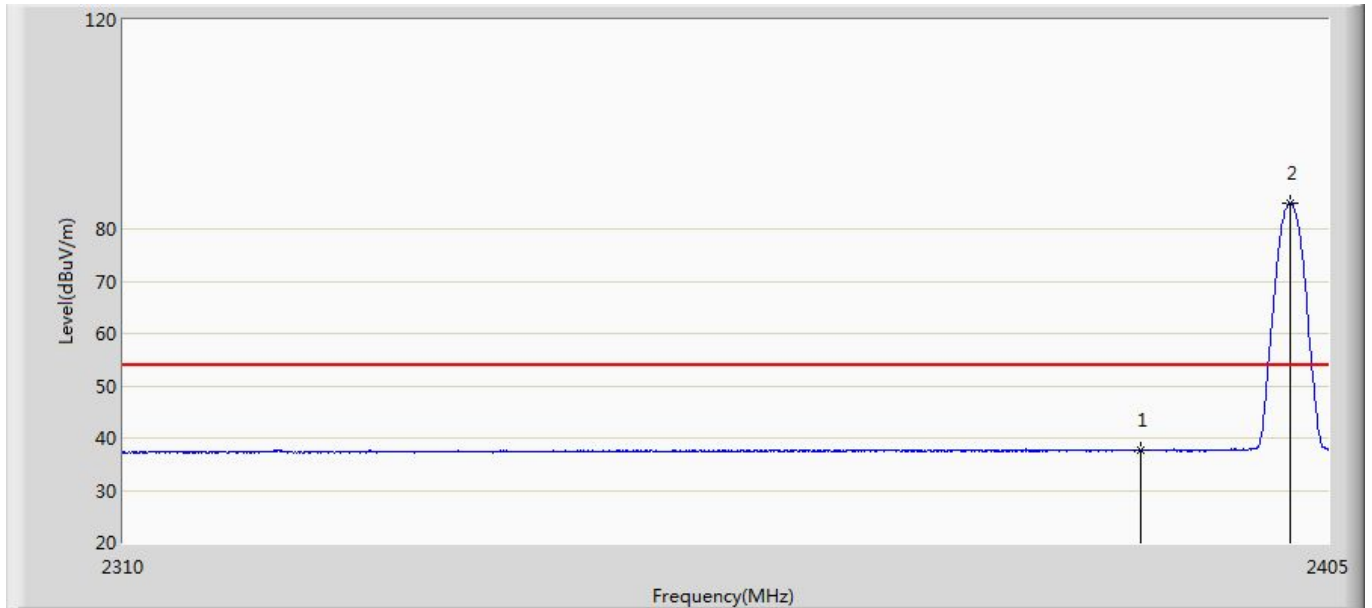

No	Mark	Frequency (MHz)	Measure Level (dBuV/m)	Reading Level (dBuV)	Over Limit (dB)	Limit (dBuV/m)	Factor (dB)	Type
1		2390.000	37.676	1.994	-16.324	54.000	35.682	AV
2	*	2402.008	85.072	49.359	N/A	N/A	35.712	AV

Engineer: Eric	
Site: AC5	Time: 2018/01/04 - 20:12
Limit: FCC_Part15.209_RE(3m)	Margin: 0
Probe: Horn_3117_00167055(1-18GHz)	Polarity: Vertical
EUT: Wireless Access point	Power: AC 120V/60Hz
Note: Mode 1:Transmit at 2402MHz by BLE	

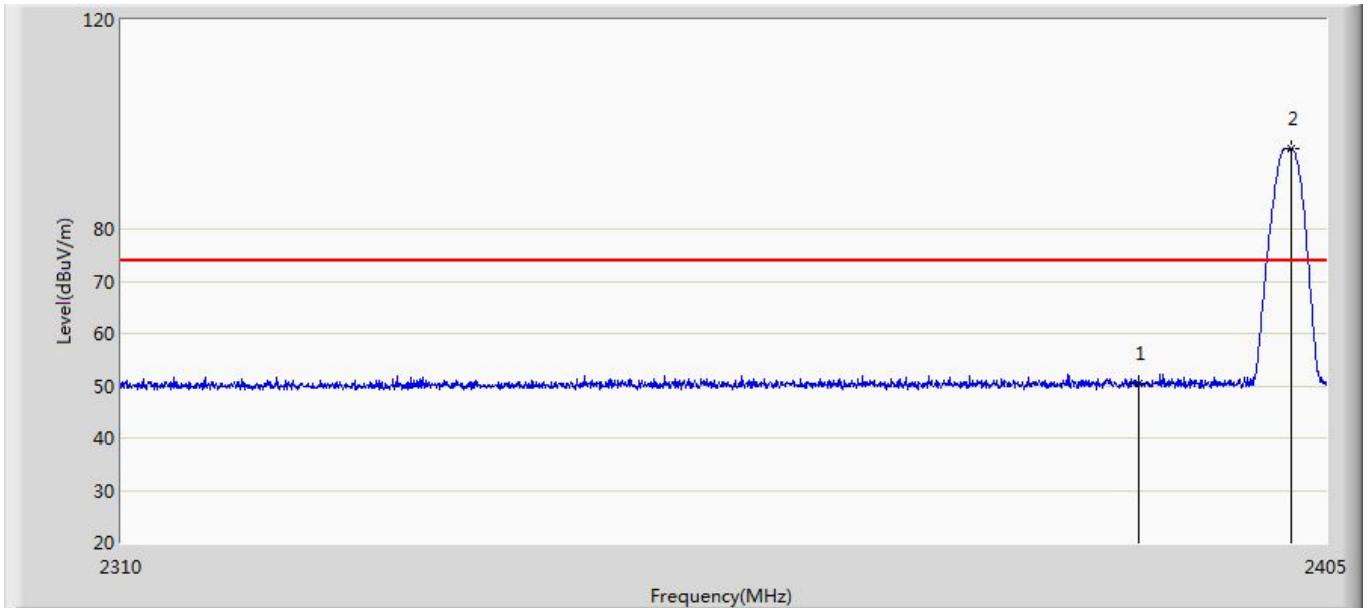

No	Mark	Frequency (MHz)	Measure Level (dBuV/m)	Reading Level (dBuV)	Over Limit (dB)	Limit (dBuV/m)	Factor (dB)	Type
1		2390.000	50.499	14.817	-23.501	74.000	35.682	PK
2	*	2402.150	95.345	59.632	N/A	N/A	35.713	PK

Engineer: Eric	
Site: AC5	Time: 2018/01/04 - 20:14
Limit: FCC_Part15.209_RE(3m)	Margin: 0
Probe: Horn_3117_00167055(1-18GHz)	Polarity: Horizontal
EUT: Wireless Access point	Power: AC 120V/60Hz
Note: Mode 1:Transmit at 2480MHz by BLE	

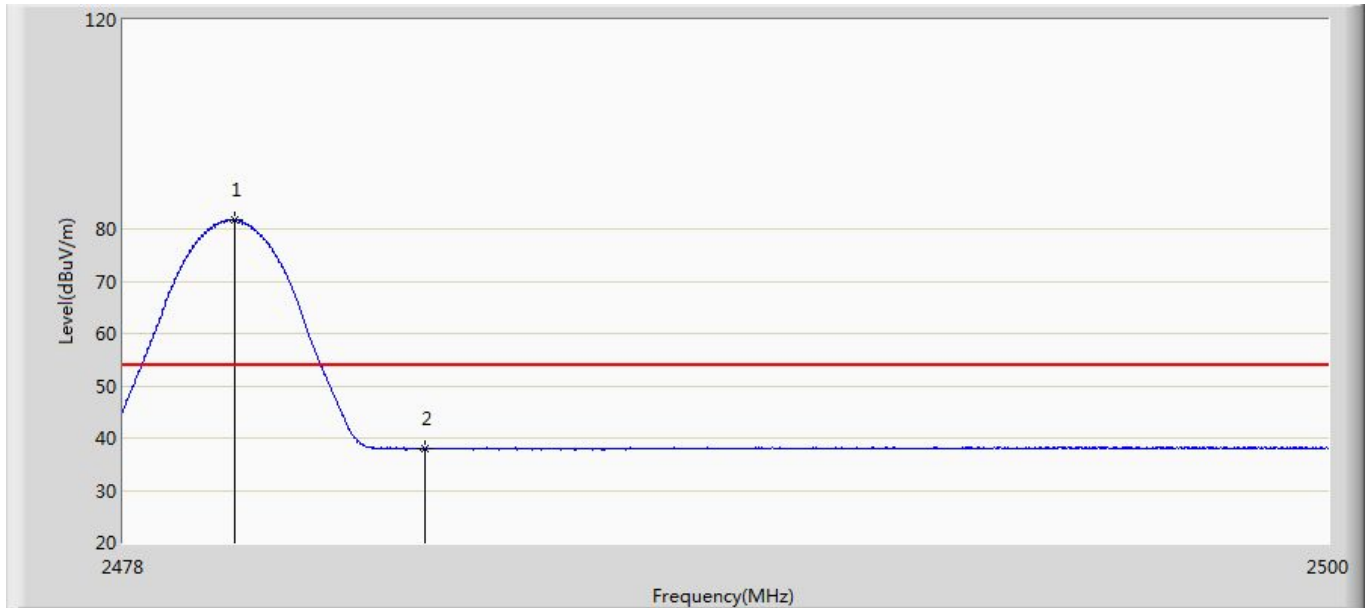

No	Mark	Frequency (MHz)	Measure Level (dBuV/m)	Reading Level (dBuV)	Over Limit (dB)	Limit (dBuV/m)	Factor (dB)	Type
1	*	2480.024	81.751	45.884	N/A	N/A	35.866	AV
2		2483.500	37.907	2.015	-16.093	54.000	35.891	AV

Engineer: Eric	
Site: AC5	Time: 2018/01/04 - 20:25
Limit: FCC_Part15.209_RE(3m)	Margin: 0
Probe: Horn_3117_00167055(1-18GHz)	Polarity: Horizontal
EUT: Wireless Access point	Power: AC 120V/60Hz
Note: Mode 1:Transmit at 2480MHz by BLE	

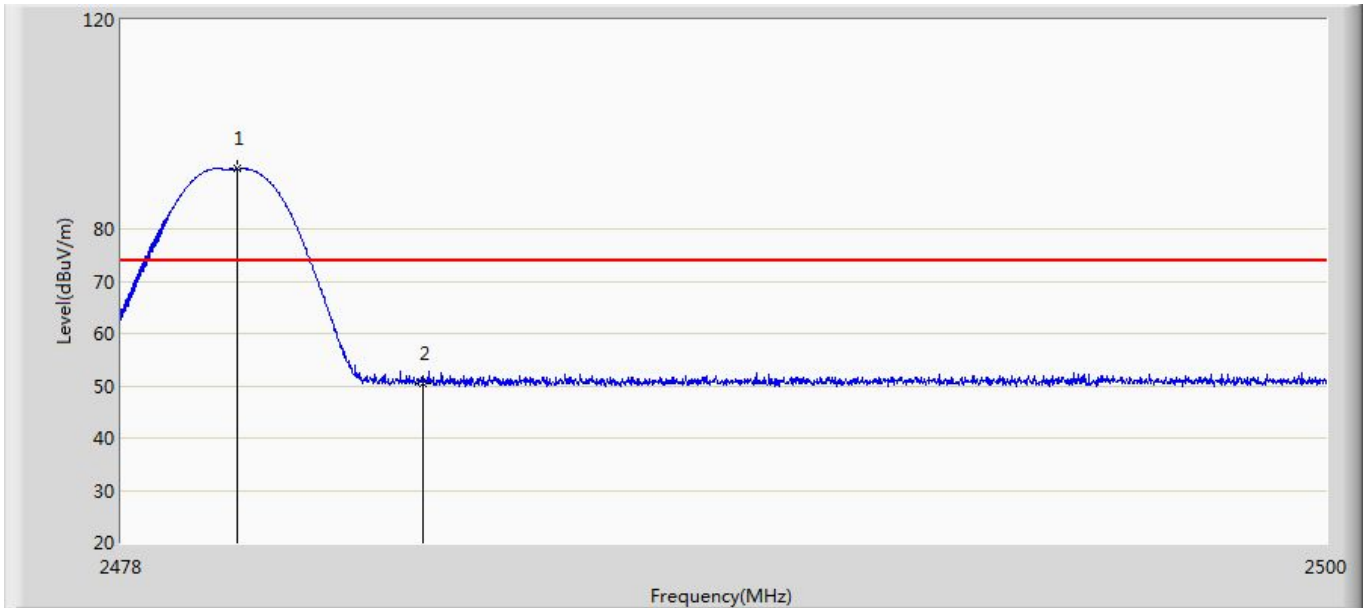

No	Mark	Frequency (MHz)	Measure Level (dBuV/m)	Reading Level (dBuV)	Over Limit (dB)	Limit (dBuV/m)	Factor (dB)	Type
1	*	2480.112	91.454	55.587	N/A	N/A	35.867	PK
2		2483.500	50.498	14.606	-23.502	74.000	35.891	PK

Engineer: Eric	
Site: AC5	Time: 2018/01/04 - 20:27
Limit: FCC_Part15.209_RE(3m)	Margin: 0
Probe: Horn_3117_00167055(1-18GHz)	Polarity: Vertical
EUT: Wireless Access point	Power: AC 120V/60Hz
Note: Mode 1:Transmit at 2480MHz by BLE	

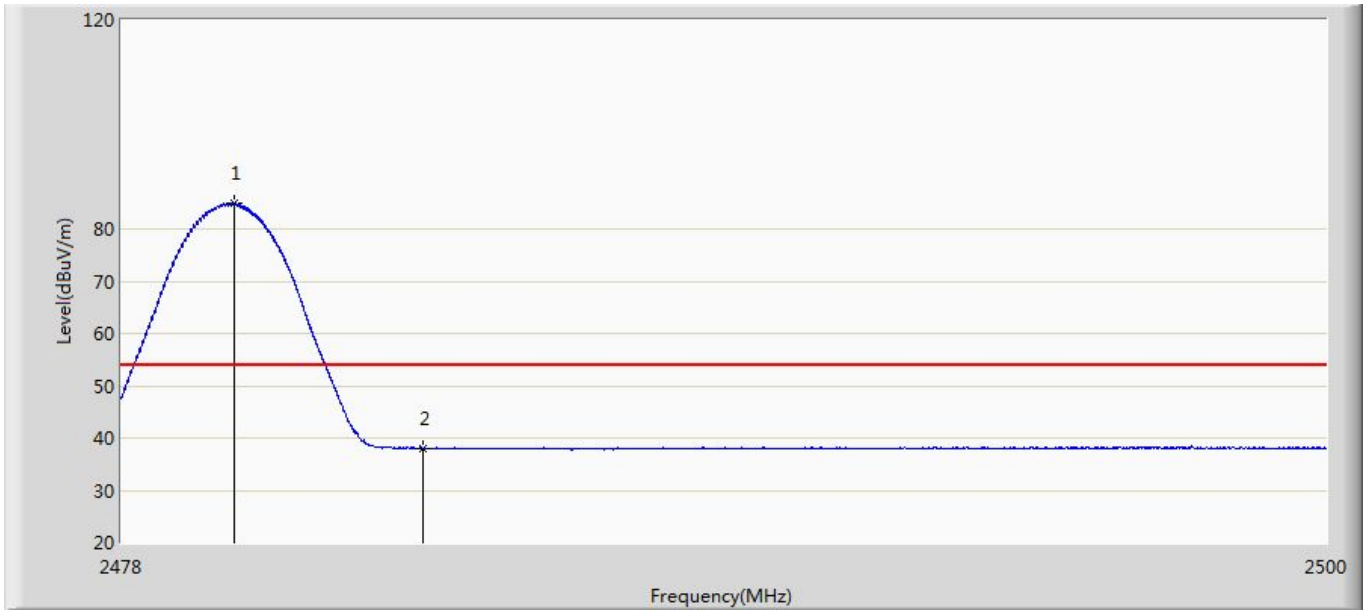

No	Mark	Frequency (MHz)	Measure Level (dBuV/m)	Reading Level (dBuV)	Over Limit (dB)	Limit (dBuV/m)	Factor (dB)	Type
1	*	2480.046	84.893	49.026	N/A	N/A	35.866	AV
2		2483.500	38.000	2.108	-16.000	54.000	35.891	AV

Engineer: Eric	
Site: AC5	Time: 2018/01/04 - 20:30
Limit: FCC_Part15.209_RE(3m)	Margin: 0
Probe: Horn_3117_00167055(1-18GHz)	Polarity: Vertical
EUT: Wireless Access point	Power: AC 120V/60Hz
Note: Mode 1:Transmit at 2480MHz by BLE	

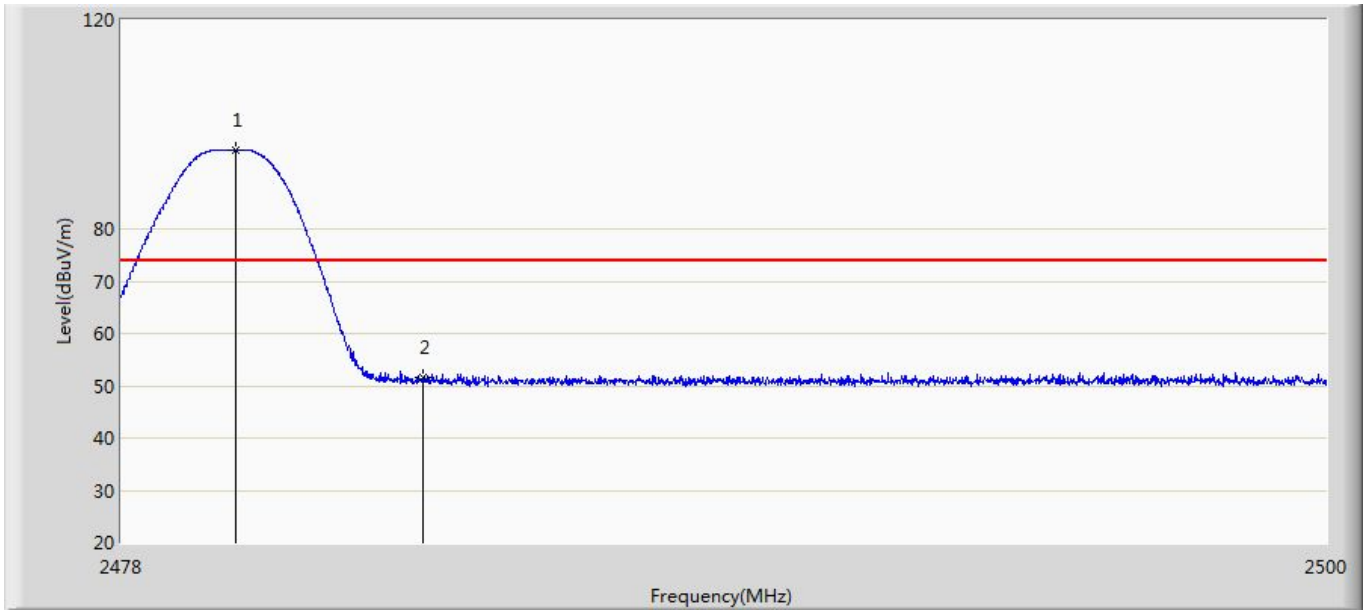

No	Mark	Frequency (MHz)	Measure Level (dBuV/m)	Reading Level (dBuV)	Over Limit (dB)	Limit (dBuV/m)	Factor (dB)	Type
1	*	2480.079	95.030	59.163	N/A	N/A	35.867	PK
2		2483.500	51.677	15.785	-22.323	74.000	35.891	PK

7. Occupied Bandwidth

7.1. Test Equipment

Occupied Bandwidth / TR-8					
Instrument	Manufacturer	Type No.	Serial No.	Cal. Date	Cal. Due Date
Spectrum Analyzer	Agilent	N9010A	MY48030494	2017.02.04	2018.02.03
EXA Spectrum Analyzer	Keysight	N9010A	MY55370495	2017.04.09	2018.04.08
MXA Signal Analyzer	Keysight	N9020A	MY56060147	2017.04.09	2018.04.08
Temperature/Humidity Meter	zhichen	ZC1-2	TR8-TH	2017.04.10	2018.04.09

Note: All equipment are calibrated with traceable calibrations. Each calibration is traceable to the national or international standards.

7.2. Test Setup

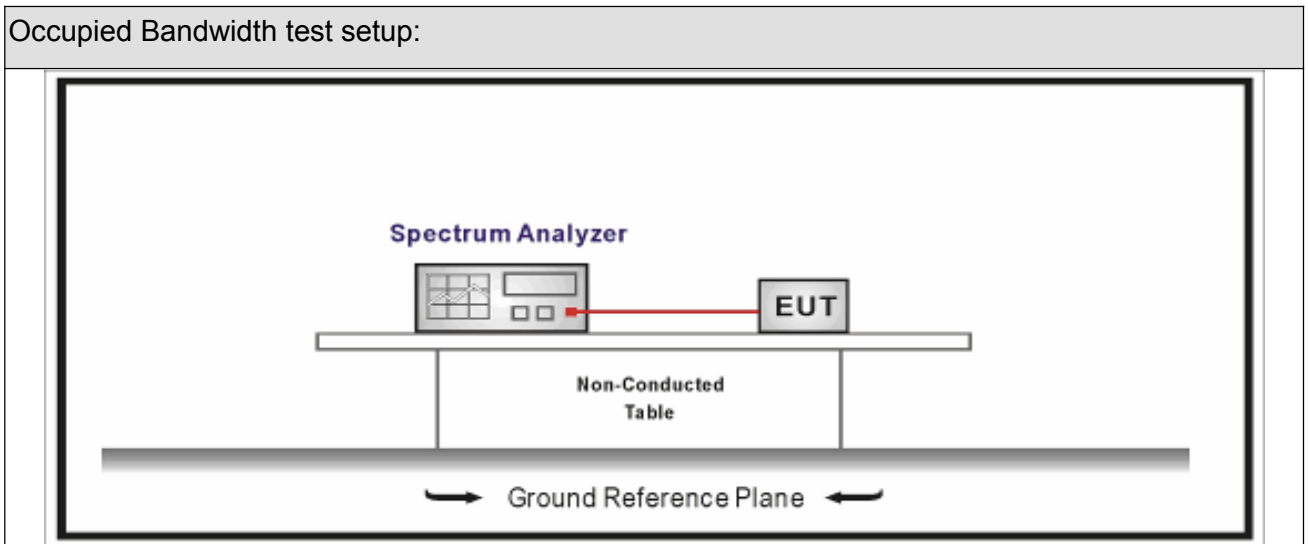





7.3. Limit

Occupied Bandwidth
Systems using digital modulation techniques operate in the 2400-2483.5 MHz .The minimum 6 dB bandwidth shall be at least 500 kHz

7.4. Test Procedure

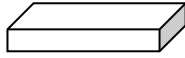
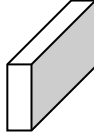
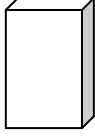
Test Method			
	Reference Rule	Chapter	Description
<input checked="" type="checkbox"/>	ANSI C63.10	11.8	DTS bandwidth
<input type="checkbox"/>	ANSI C63.10	11.8.1	Option 1
<input checked="" type="checkbox"/>	ANSI C63.10	11.8.2	Option 2

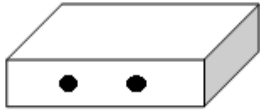
7.5. EUT test definition

Item	Occupied Bandwidth			
Device Category	<input type="checkbox"/>	Fixed point-to-point		
	<input type="checkbox"/>	Emit multiple directional beams, simultaneously or sequentially		
	<input checked="" type="checkbox"/>	Other cases		
Test mode	Mode 1			
Test method	<input type="checkbox"/>	Radiated		
		X Axis	Y Axis	Z Axis
				
		Worst Axis <input type="checkbox"/>	Worst Axis <input type="checkbox"/>	Worst Axis <input type="checkbox"/>
	<input checked="" type="checkbox"/>	Conducted		
	<input checked="" type="checkbox"/>	Chain 1		
				
	<input type="checkbox"/>	Chain 1	Chain 2	
				
	<input type="checkbox"/>	Chain 1	Chain 2	Chain 3
				

7.6. Test Result

Product Name	: Wireless Access point	Power	: AC 120V/60Hz
Test Mode	: Mode 1	Test Site	: TR-8
Test Date	: 2018.01.06	Test Engineer	: Eric

Mode	CH.	Test Freq. (MHz)	99% Occupied Bandwidth (kHz)	6dB Occupied Bandwidth (kHz)	Limit (kHz)	Result
1	00	2402	1106.3	687.4	>500	Pass
1	19	2440	1108.8	655.6	>500	Pass
1	39	2480	1096.8	665.2	>500	Pass

Note : The worst case of Occupied Bandwidth as below:

Mode 1 CH19 (2440MHz)



8. Fundamental emission output power

8.1. Test Equipment

Fundamental emission output power/ TR-8					
Instrument	Manufacturer	Type No.	Serial No.	Cal. Date	Cal. Due Date
Spectrum Analyzer	Agilent	E4446A	MY45300103	2018.01.04	2019.01.03
Spectrum Analyzer	Agilent	N9010A	MY48030494	2018.01.04	2019.01.03
Wideband Peak Power Meter	Anritsu	ML2495A	0905006	2017.10.14	2018.10.13
Power Sensor	Anritsu	MA2411B	0846014	2017.10.14	2018.10.13
Temperature/Humidity Meter	zhicheng	ZC1-2	TR8-TH	2017.04.10	2018.04.09

Note: All equipment are calibrated with traceable calibrations. Each calibration is traceable to the national or international standards.

8.2. Test Setup

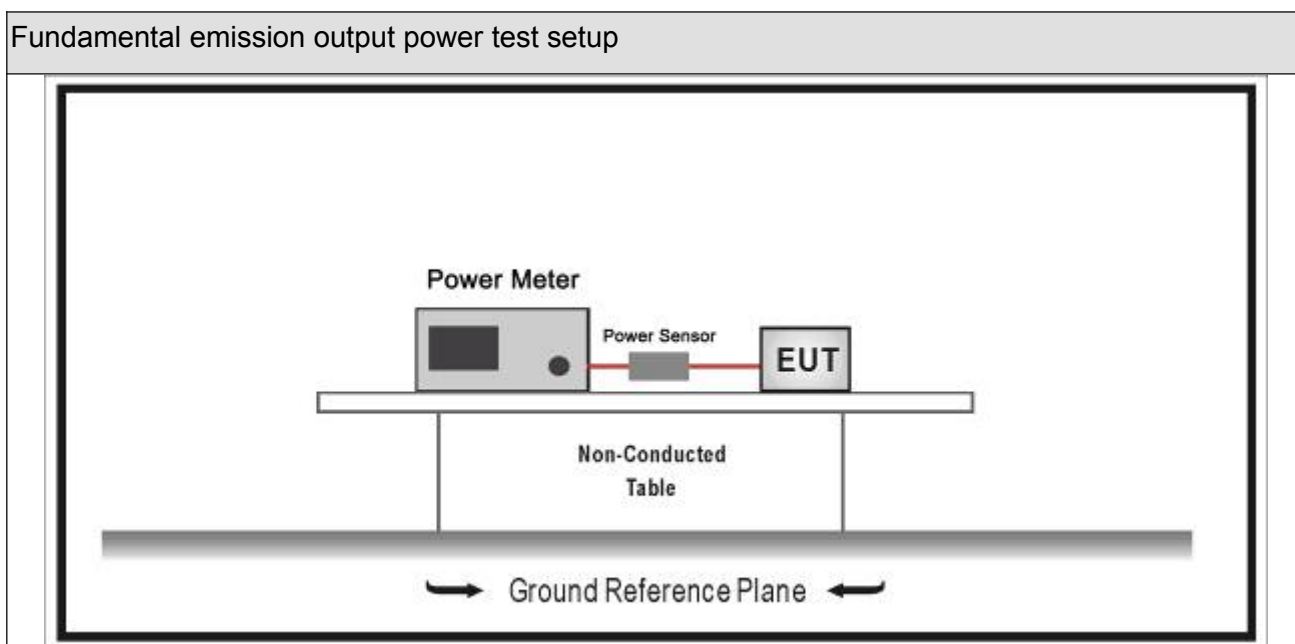



8.3. Limit

Fundamental emission output power Limit		
<input checked="" type="checkbox"/>	$G_{TX} < 6\text{dBi}$	$P_{out} \leq 30\text{dBm}$
<input type="checkbox"/>	$G_{TX} > 6\text{dBi}$	
<input type="checkbox"/>	Non-Fix point-point	$P_{out} \leq 30 - (G_{TX} - 6)$
<input type="checkbox"/>	Fix point-point	$P_{out} \leq 30 - [(G_{TX} - 6)]/3$
<input type="checkbox"/>	Point-to-multipoint	$P_{out} \leq 30 - (G_{TX} - 6)$
<input type="checkbox"/>	Overlap Beams	$P_{out} \leq 30 - [(G_{TX} - 6)]/3$
<input type="checkbox"/>	Aggregate power transmitted simultaneously on all beams	$P_{out} \leq 30 - [(G_{TX} - 6)]/3$
<input type="checkbox"/>	single directional beam	$P_{out} \leq 30 - [(G_{TX} - 6)]/3 + 8\text{dB}$
<p>Note 1 : G_{TX} directional gain of transmitting antennas.</p> <p>Note 2 : P_{out} is maximum peak conducted output power .</p>		

8.4. Test Procedure

Fundamental emission output power Test Method					
	References Rule		Chapter	Description	
<input checked="" type="checkbox"/>	ANSI C63.10		11.9	Fundamental emission output power	
	<input checked="" type="checkbox"/>	ANSI C63.10		11.9.1	Maximum peak conducted output power
	<input type="checkbox"/>	ANSI C63.10	11.9.1.1	RBW \geq DTS bandwidth	
	<input type="checkbox"/>	ANSI C63.10	11.9.1.2	Integrated band power method	
	<input checked="" type="checkbox"/>	ANSI C63.10	11.9.1.3	PKPM1 Peak power meter method	
	<input type="checkbox"/>	ANSI C63.10		11.9.2	Maximum conducted (average) output power
	<input type="checkbox"/>	ANSI C63.10		11.9.2.2	Measurement using a spectrum analyzer (SA)
	<input type="checkbox"/>	ANSI C63.10	11.9.2.2.2	Method AVGSA-1(Duty cycle \geq 98%)	
	<input type="checkbox"/>	ANSI C63.10	11.9.2.2.3	Method AVGSA-1A(Duty cycle \geq 98%)	
	<input type="checkbox"/>	ANSI C63.10	11.9.2.2.4	Method AVGSA-2(Duty cycle \leq 98%)	
	<input type="checkbox"/>	ANSI C63.10	11.9.2.2.5	Method AVGSA-2A(Duty cycle \leq 98%)	
	<input type="checkbox"/>	ANSI C63.10	11.9.2.2.4	Method AVGSA-3	
	<input type="checkbox"/>	ANSI C63.10	11.9.2.2.5	Method AVGSA-3A	
	<input type="checkbox"/>	ANSI C63.10		11.9.2.3	Measurement using a power meter (PM)
	<input type="checkbox"/>	ANSI C63.10	11.9.2.3.1	Method AVGPM	
<input type="checkbox"/>	ANSI C63.10	11.9.2.3.2	Method AVGPM-G		

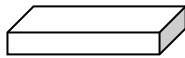
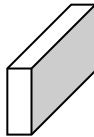
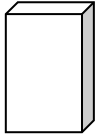
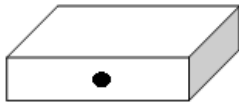
8.5. EUT test definition

Item	Fundamental emission output power			
Device Category	<input type="checkbox"/>	Fixed point-to-point		
	<input type="checkbox"/>	Emit multiple directional beams, simultaneously or sequentially		
	<input checked="" type="checkbox"/>	Other cases		
Test mode	Mode 1			
Test method	<input type="checkbox"/>	Radiated		
		X Axis	Y Axis	Z Axis
				
		Worst Axis <input type="checkbox"/>	Worst Axis <input type="checkbox"/>	Worst Axis <input type="checkbox"/>
	<input checked="" type="checkbox"/>	Conducted		
	<input checked="" type="checkbox"/>	Chain 1		
				
	<input type="checkbox"/>	Chain 1	Chain 2	
				
	<input type="checkbox"/>	Chain 1	Chain 2	Chain 3
				

8.6. Test Result

Product Name	: Wireless Access point	Power	: AC 120V/60Hz
Test Mode	: Mode 1	Test Site	: TR-8
Test Date	: 2018.01.06	Test Engineer	: Eric

Mode	Channel	Test Frequency (MHz)	Measurement Power Output (dBm)	Limit (dBm)	Result
1	00	2402	4.20	30	Pass
1	19	2440	4.73	30	Pass
1	39	2480	5.17	30	Pass

9. Power Spectral Density

9.1. Test Equipment

Power Spectral Density / TR-8					
Instrument	Manufacturer	Type No.	Serial No.	Cal. Date	Cal. Due Date
Spectrum Analyzer	Agilent	N9010A	MY48030494	2017.02.04	2018.02.03
EXA Spectrum Analyzer	Keysight	N9010A	MY55370495	2017.04.09	2018.04.08
MXA Signal Analyzer	Keysight	N9020A	MY56060147	2017.04.09	2018.04.08
Temperature/Humidity Meter	zhichen	ZC1-2	TR8-TH	2017.04.10	2018.04.09

Note: All equipment are calibrated with traceable calibrations. Each calibration is traceable to the national or international standards.

9.2. Test Setup

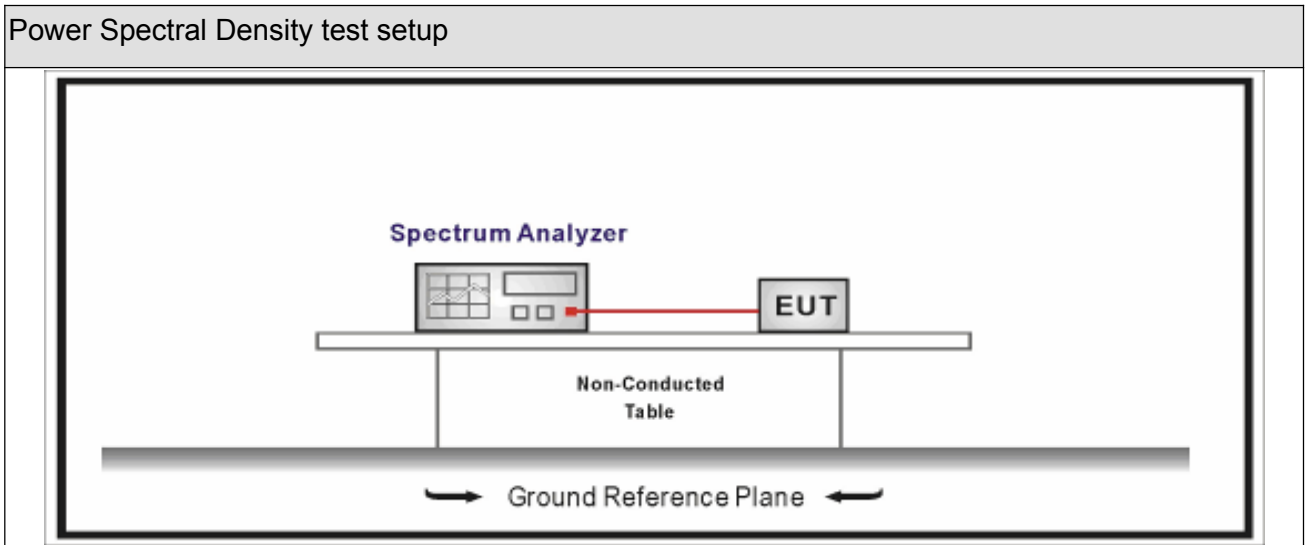

9.3. Limit



Power Spectral Density Limit

Power Spectral Density $\leq 8\text{dBm}/3\text{kHz}$

9.4. Test Procedure

Power Spectral Density Test Method			
	References Rule	Chapter	Description
<input checked="" type="checkbox"/>	ANSI C63.10	11.10	Maximum power spectral density level in the fundamental emission
<input checked="" type="checkbox"/>	ANSI C63.10	11.10.2	Method PKPSD (peak PSD)
<input type="checkbox"/>	ANSI C63.10	11.10.3	Method AVGPSD-1(Duty cycle \geq 98%)
<input type="checkbox"/>	ANSI C63.10	11.10.4	Method AVGPSD-1A(Duty cycle \geq 98%)
<input type="checkbox"/>	ANSI C63.10	11.10.5	Method AVGPSD-2(Duty cycle $<$ 98%)
<input type="checkbox"/>	ANSI C63.10	11.10.6	Method AVGPSD-2A(Duty cycle $<$ 98%)
<input type="checkbox"/>	ANSI C63.10	11.10.7	Method AVGPSD-3
<input type="checkbox"/>	ANSI C63.10	11.10.8	Method AVGPSD-3A

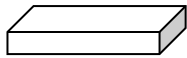
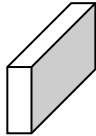
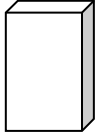
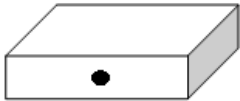
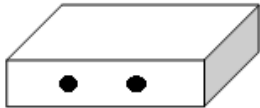
9.5. EUT test definition

Item	Power Spectral Density Test Method			
Device Category	<input type="checkbox"/>	Fixed point-to-point		
	<input type="checkbox"/>	Emit multiple directional beams, simultaneously or sequentially		
	<input checked="" type="checkbox"/>	Other cases		
Test mode	Mode 1			
Test method	<input type="checkbox"/>	Radiated		
		X Axis	Y Axis	Z Axis
				
		Worst Axis <input type="checkbox"/>	Worst Axis <input type="checkbox"/>	Worst Axis <input type="checkbox"/>
	<input checked="" type="checkbox"/>	Conducted		
	<input checked="" type="checkbox"/>	Chain 1		
				
	<input type="checkbox"/>	Chain 1	Chain 2	
				
	<input type="checkbox"/>	Chain 1	Chain 2	Chain 3
				

9.6. Test Result

Product Name	: Wireless Access point	Power	: AC 120V/60Hz
Test Mode	: Mode 1	Test Site	: TR-8
Test Date	: 2018.01.06	Test Engineer	: Eric

Mode	Channel	Test Frequency (MHz)	Measurement PSD (dBm/3kHz)	Total PSD (dBm/3kHz)	Limit (dBm/3kHz)	Result
1	00	2402	-14.083	-14.083	8	Pass
1	19	2440	-13.529	-13.529	8	Pass
1	39	2480	-13.362	-13.362	8	Pass

Note : The worst case of Power Spectral Density as below:

Mode 1 CH39(2480MHz)



10. Antenna Requirement

10.1. Limit

Antenna Requirement Limit
<p>An intentional radiator shall be designed to ensure that no antenna other than that furnished by the responsible party shall be used with the device. The use of a permanently attached antenna or of an antenna that uses a unique coupling to the intentional radiator shall be considered sufficient to comply with the provisions of this section. The manufacturer may design the unit so that a broken antenna can be replaced by the user, but the use of a standard antenna jack or electrical connector is prohibited. This requirement does not apply to carrier current devices or to devices operated under the provisions of §15.211, §15.213, §15.217, §15.219, or §15.221. Further, this requirement does not apply to intentional radiators that must be professionally installed, such as perimeter protection systems and some field disturbance sensors, or to other intentional radiators which, in accordance with §15.31(d), must be measured at the installation site. However, the installer shall be responsible for ensuring that the proper antenna is employed so that the limits in this part are not exceeded.</p>

10.2. Antenna Connector Construction

Antenna Connector Construction	
<input checked="" type="checkbox"/>	The use of a permanently attached antenna
<input type="checkbox"/>	The antenna use of a unique coupling to the intentional radiator
<input type="checkbox"/>	The use of a nonstandard antenna jack or electrical connector
Please refer to the attached document "Internal Photograph" to show the antenna connector.	

_____ The End _____