

DFS Test Report

Report No.: RF160407E10A-1

FCC ID: WBV-AP550

Test Model: AP550

Received Date: Apr. 08, 2016

Test Date: Sep. 05 to 12, 2016

Issued Date: Oct. 12, 2016

Applicant: Aerohive Networks Inc.

Address: 1011 McCarthy Blvd, Milpitas, CA 95035, USA

Issued By: Bureau Veritas Consumer Products Services (H.K.) Ltd., Taoyuan Branch
Hsin Chu Laboratory

Lab Address: E-2, No.1, Li Hsin 1st Road, Hsinchu Science Park, Hsinchu City 300,
Taiwan R.O.C.



This report is for your exclusive use. Any copying or replication of this report to or for any other person or entity, or use of our name or trademark, is permitted only with our prior written permission. This report sets forth our findings solely with respect to the test samples identified herein. The results set forth in this report are not indicative or representative of the quality or characteristics of the lot from which a test sample was taken or any similar or identical product unless specifically and expressly noted. Our report includes all of the tests requested by you and the results thereof based upon the information that you provided to us. You have 60 days from date of issuance of this report to notify us of any material error or omission caused by our negligence, provided, however, that such notice shall be in writing and shall specifically address the issue you wish to raise. A failure to raise such issue within the prescribed time shall constitute your unqualified acceptance of the completeness of this report, the tests conducted and the correctness of the report contents. Unless specific mention, the uncertainty of measurement has been explicitly taken into account to declare the compliance or non-compliance to the specification. The report must not be used by the client to claim product certification, approval, or endorsement by TAF or any government agencies.

Table of Contents

Release Control Record	3
1 Certificate of Conformity	4
2 EUT Information	5
2.1 Operating Frequency Bands and Mode of EUT	5
2.2 EUT Software and Firmware Version	5
2.3 Description of Available Antennas to the EUT	6
2.4 EUT Maximum and Minimum Conducted Power	7
2.5 EUT Maximum and Minimum EIRP Power	15
2.6 Transmit Power Control (TPc).....	23
2.7 Statement of Manufacturer	23
3. U-NII DFS Rule Requirements	24
3.1 Working Modes and Required Test Items	24
3.2 Test Limits and Radar Signal Parameters	25
4. Test & Support Equipment List	28
4.1 Test Instruments	28
4.2 Description of Support Units	28
5. Test Procedure	29
5.1 DFS Measurement System	29
5.2 Calibration of DFS Detection Threshold Level	30
5.3 Deviation from Test Standard	30
5.4 Radiated Test Setup Configuration	31
6. Test Results	32
6.1 Summary of Test Results	32
6.2 Test Results	33
6.2.1 Test Mode: Device Operating In Master Mode	33
6.2.2 U-NII Detection Bandwidth	38
6.2.3 Channel Availability Check Time	52
6.2.4 Channel Closing Transmission and Channel Move Time.....	56
6.2.5 Non- Occupancy Period	121
7. Information on the Testing Laboratories	124
8. APPENDIX-A	125

Release Control Record

Issue No.	Description	Date Issued
RF160407E10A-1	Original release.	Oct. 12, 2016

1 Certificate of Conformity

Product: Access Point

Brand: Aerohive

Test Model: AP550

Sample Status: ENGINEERING SAMPLE

Applicant: Aerohive Networks Inc.

Test Date: Sep. 05 to 12 ,2016

Standards: FCC Part 15, Subpart E (Section 15.407)

KDB 905462 D02 UNII DFS Compliance Procedures New Rules v02

The above equipment has been tested by **Bureau Veritas Consumer Products Services (H.K.) Ltd., Taoyuan Branch**, and found compliance with the requirement of the above standards. The test record, data evaluation & Equipment Under Test (EUT) configurations represented herein are true and accurate accounts of the measurements of the sample's EMC characteristics under the conditions specified in this report.

Prepared by : Midoli Peng , **Date:** Oct. 12, 2016
Midoli Peng / Specialist

Approved by : May Chen , **Date:** Oct. 12, 2016
May Chen / Manager

2 EUT Information

2.1 Operating Frequency Bands and Mode of EUT

Table 1: Operating Frequency Bands and Mode of EUT

Operational Mode	Operating Frequency Range	
	5250~5350MHz	5470~5725MHz
Master	✓	✓

2.2 EUT Software and Firmware Version

Table 2: The EUT Software/Firmware Version

No.	Product	Model No.	Software/Firmware Version
Radio1	Access Point	AP550	9.10 RC178.40 wl0: Jul 26 2016 15:18:13 version 10.10.69.74_e5.0.9.1 (r629731 WLTEST)
Radio2	Access Point	AP550	9.10 RC178.40 wl1: Jul 26 2016 15:18:13 version 10.10.69.74_e5.0.9.1 (r629731 WLTEST)

2.3 Description of Available Antennas to the EUT

Table 3: Antenna List

Radio	Ant. No.	Chain No.	Antenna Gain(dBi) (Including cable loss)	Frequency range	Antenna Type	Connector Type	Cable Loss(dB)	Cable Length	
1	Ant. 1	Chain 0	4.00	2.4~2.4835GHz	PIFA	i-pex	0.39	95	
			5.84	5.15~5.25GHz					
			5.92	5.25~5.35GHz					
			5.29	5.47~5.725GHz					
1	Ant. 2	Chain 1	5.78	5.725~5.85GHz	PIFA	i-pex	0.41	100	
			3.41	2.4~2.4835GHz					
			5.88	5.15~5.25GHz					
			5.36	5.25~5.35GHz					
1	Ant. 3	Chain 2	5.84	5.47~5.725GHz	PIFA	i-pex	0.65	160	
			5.72	5.725~5.85GHz					
			3.77	2.4~2.4835GHz					
			5.64	5.15~5.25GHz					
1	Ant. 4	Chain 3	5.49	5.25~5.35GHz	PIFA	i-pex	0.83	203	
			5.31	5.47~5.725GHz					
			5.75	5.725~5.85GHz					
			3.94	2.4~2.4835GHz					
2	Ant. 5	Chain 0	5.39	5.15~5.25GHz	PIFA	i-pex	0.4	98	
			5.91	5.25~5.35GHz					
			5.67	5.47~5.725GHz					
			5.92	5.725~5.85GHz					
	2	Ant. 6	Chain 1	5.11	5.15~5.25GHz	PIFA	i-pex	0.32	78
				5.50	5.25~5.35GHz				
				5.08	5.47~5.725GHz				
				5.40	5.725~5.85GHz				
2	Ant. 7	Chain 2	5.55	5.15~5.25GHz	PIFA	i-pex	0.6	148	
			5.02	5.25~5.35GHz					
			5.30	5.47~5.725GHz					
			5.94	5.725~5.85GHz					
2	Ant. 8	Chain 3	5.62	5.15~5.25GHz	PIFA	i-pex	0.87	213	
			5.78	5.25~5.35GHz					
			5.67	5.47~5.725GHz					
			5.64	5.725~5.85GHz					
2	Ant. 10	Chain 0	5.23	5.15~5.25GHz	Dipole	i-pex	0.23	57	
			5.69	5.25~5.35GHz					
			5.75	5.47~5.725GHz					
			5.73	5.725~5.85GHz					
2	Ant. 11	Chain 1	4.70	5.15~5.25GHz	Dipole	i-pex	0.44	107	
			5.31	5.25~5.35GHz					
			5.68	5.47~5.725GHz					
			4.74	5.725~5.85GHz					
2	Ant. 12	Chain 2	5.15	5.15~5.25GHz	Dipole	i-pex	0.68	167	
			5.25	5.25~5.35GHz					
			4.50	5.47~5.725GHz					
			5.20	5.725~5.85GHz					
2	Ant. 13	Chain 3	4.53	5.15~5.25GHz	Dipole	i-pex	0.93	227	
			4.55	5.25~5.35GHz					
			4.42	5.47~5.725GHz					
			5.21	5.725~5.85GHz					
3	Ant. 9	Chain 0	4.87	5.15~5.25GHz	Dipole	i-pex	0.36	148	
			4.69	5.25~5.35GHz					
			4.95	5.47~5.725GHz					
			4.41	5.725~5.85GHz					

2.4 EUT Maximum and Minimum Conducted Power

Table 4: The Measured Conducted Output Power

Radio1

802.11a

2Tx CDD Mode

Frequency Band (MHz)	MAX. Power		MIN. Power	
	Output Power(dBm)	Output Power(mW)	Output Power(dBm)	Output Power(mW)
5250~5350	21.06	127.712	15.06	32.063
5470~5725	21.2	131.726	15.2	33.113

802.11ac (VHT20)

2Tx CDD Mode

Frequency Band (MHz)	MAX. Power		MIN. Power	
	Output Power(dBm)	Output Power(mW)	Output Power(dBm)	Output Power(mW)
5250~5350	21.06	127.712	15.06	32.063
5470~5725	21.22	132.544	15.22	33.266

2Tx Beamforming Mode MCS0NSS1

Frequency Band (MHz)	MAX. Power		MIN. Power	
	Output Power(dBm)	Output Power(mW)	Output Power(dBm)	Output Power(mW)
5250~5350	21.06	127.712	15.06	32.063
5470~5725	21.22	132.544	15.22	33.266

802.11ac (VHT40)
2Tx CDD Mode

Frequency Band (MHz)	MAX. Power		MIN. Power	
	Output Power(dBm)	Output Power(mW)	Output Power(dBm)	Output Power(mW)
5250~5350	23.35	216.399	17.35	54.325
5470~5725	23.2	208.999	17.2	54.481

2Tx Beamforming Mode MCS0NSS1

Frequency Band (MHz)	MAX. Power		MIN. Power	
	Output Power(dBm)	Output Power(mW)	Output Power(dBm)	Output Power(mW)
5250~5350	21.01	126.317	15.01	31.696
5470~5725	21.19	131.581	15.19	33.037

802.11ac (VHT80)
2Tx CDD Mode

Frequency Band (MHz)	MAX. Power		MIN. Power	
	Output Power(dBm)	Output Power(mW)	Output Power(dBm)	Output Power(mW)
5250~5350	15.09	32.302	9.09	8.11
5470~5725	21.32	135.571	15.32	34.041

2Tx Beamforming Mode MCS0NSS1

Frequency Band (MHz)	MAX. Power		MIN. Power	
	Output Power(dBm)	Output Power(mW)	Output Power(dBm)	Output Power(mW)
5250~5350	15.09	32.302	9.09	8.11
5470~5725	21.12	129.437	15.12	32.509

802.11a
4Tx CDD Mode

Frequency Band (MHz)	MAX. Power		MIN. Power	
	Output Power(dBm)	Output Power(mW)	Output Power(dBm)	Output Power(mW)
5250~5350	18.27	67.172	12.27	16.866
5470~5725	18.4	69.196	12.4	17.378

802.11ac (VHT20)
4Tx CDD Mode

Frequency Band (MHz)	MAX. Power		MIN. Power	
	Output Power(dBm)	Output Power(mW)	Output Power(dBm)	Output Power(mW)
5250~5350	18.13	64.955	12.13	16.331
5470~5725	18.34	68.271	12.34	17.14

4Tx Beamforming Mode MCS0NSS1

Frequency Band (MHz)	MAX. Power		MIN. Power	
	Output Power(dBm)	Output Power(mW)	Output Power(dBm)	Output Power(mW)
5250~5350	18.13	64.955	12.13	16.331
5470~5725	18.34	68.271	12.34	17.14

802.11ac (VHT40)
4Tx CDD Mode

Frequency Band (MHz)	MAX. Power		MIN. Power	
	Output Power(dBm)	Output Power(mW)	Output Power(dBm)	Output Power(mW)
5250~5350	21.08	128.338	15.08	32.211
5470~5725	21.36	136.858	15.36	34.356

4Tx Beamforming Mode MCS0NSS1

Frequency Band (MHz)	MAX. Power		MIN. Power	
	Output Power(dBm)	Output Power(mW)	Output Power(dBm)	Output Power(mW)
5250~5350	18.29	67.494	12.29	16.943
5470~5725	18.4	69.149	12.4	17.378

802.11ac (VHT80)
4Tx CDD Mode

Frequency Band (MHz)	MAX. Power		MIN. Power	
	Output Power(dBm)	Output Power(mW)	Output Power(dBm)	Output Power(mW)
5250~5350	15.8	38.018	9.8	9.55
5470~5725	23.21	209.472	17.21	52.602

4Tx Beamforming Mode MCS0NSS1

Frequency Band (MHz)	MAX. Power		MIN. Power	
	Output Power(dBm)	Output Power(mW)	Output Power(dBm)	Output Power(mW)
5250~5350	15.8	38.018	9.8	9.55
5470~5725	18.4	69.211	12.4	17.378

Radio2
802.11a
2Tx CDD Mode

Frequency Band (MHz)	MAX. Power		MIN. Power	
	Output Power(dBm)	Output Power(mW)	Output Power(dBm)	Output Power(mW)
5250~5350	21.16	130.491	15.16	32.81
5470~5725	21.15	130.197	15.15	32.734

802.11ac (VHT20)
2Tx CDD Mode

Frequency Band (MHz)	MAX. Power		MIN. Power	
	Output Power(dBm)	Output Power(mW)	Output Power(dBm)	Output Power(mW)
5250~5350	21.24	133.114	15.24	33.42
5470~5725	21.14	129.959	15.14	32.659

2Tx Beamforming Mode MCS0NSS1

Frequency Band (MHz)	MAX. Power		MIN. Power	
	Output Power(dBm)	Output Power(mW)	Output Power(dBm)	Output Power(mW)
5250~5350	21.24	133.114	15.24	33.42
5470~5725	21.14	129.959	15.14	32.659

802.11ac (VHT40)
2Tx CDD Mode

Frequency Band (MHz)	MAX. Power		MIN. Power	
	Output Power(dBm)	Output Power(mW)	Output Power(dBm)	Output Power(mW)
5250~5350	23.13	205.746	17.13	51.642
5470~5725	23.73	235.989	17.73	59.293

2Tx Beamforming Mode MCS0NSS1

Frequency Band (MHz)	MAX. Power		MIN. Power	
	Output Power(dBm)	Output Power(mW)	Output Power(dBm)	Output Power(mW)
5250~5350	21.16	130.544	15.16	32.81
5470~5725	21.11	129.253	15.11	32.434

802.11ac (VHT80)
2Tx CDD Mode

Frequency Band (MHz)	MAX. Power		MIN. Power	
	Output Power(dBm)	Output Power(mW)	Output Power(dBm)	Output Power(mW)
5250~5350	14.27	26.757	8.27	6.714
5470~5725	21.35	136.466	15.35	34.277

2Tx Beamforming Mode MCS0NSS1

Frequency Band (MHz)	MAX. Power		MIN. Power	
	Output Power(dBm)	Output Power(mW)	Output Power(dBm)	Output Power(mW)
5250~5350	14.27	26.757	8.27	6.714
5470~5725	21.05	127.242	15.05	31.989

802.11a
4Tx CDD Mode

Frequency Band (MHz)	MAX. Power		MIN. Power	
	Output Power(dBm)	Output Power(mW)	Output Power(dBm)	Output Power(mW)
5250~5350	18.15	65.301	12.15	16.406
5470~5725	18.36	68.555	12.36	17.219

802.11ac (VHT20)
4Tx CDD Mode

Frequency Band (MHz)	MAX. Power		MIN. Power	
	Output Power(dBm)	Output Power(mW)	Output Power(dBm)	Output Power(mW)
5250~5350	18.24	66.75	12.24	16.749
5470~5725	18.36	68.515	12.36	17.219

4Tx Beamforming Mode MCS0NSS1

Frequency Band (MHz)	MAX. Power		MIN. Power	
	Output Power(dBm)	Output Power(mW)	Output Power(dBm)	Output Power(mW)
5250~5350	18.24	66.75	12.24	16.749
5470~5725	18.36	68.515	12.36	17.219

802.11ac (VHT40)
4Tx CDD Mode

Frequency Band (MHz)	MAX. Power		MIN. Power	
	Output Power(dBm)	Output Power(mW)	Output Power(dBm)	Output Power(mW)
5250~5350	21.38	137.271	15.38	34.514
5470~5725	21.23	132.679	15.23	33.343

4Tx Beamforming Mode MCS0NSS1

Frequency Band (MHz)	MAX. Power		MIN. Power	
	Output Power(dBm)	Output Power(mW)	Output Power(dBm)	Output Power(mW)
5250~5350	18.03	63.472	12.03	15.959
5470~5725	18.08	64.21	12.08	16.144

802.11ac (VHT80)
4Tx CDD Mode

Frequency Band (MHz)	MAX. Power		MIN. Power	
	Output Power(dBm)	Output Power(mW)	Output Power(dBm)	Output Power(mW)
5250~5350	17.38	54.745	11.38	13.74
5470~5725	23.93	246.926	17.93	62.087

4Tx Beamforming Mode MCS0NSS1

Frequency Band (MHz)	MAX. Power		MIN. Power	
	Output Power(dBm)	Output Power(mW)	Output Power(dBm)	Output Power(mW)
5250~5350	17.38	54.745	11.38	13.74
5470~5725	18.05	63.828	12.05	16.032

2.5 EUT Maximum and Minimum EIRP Power

Table 5: The EIRP Output Power List

Radio1

802.11a

2Tx CDD Mode

Frequency Band (MHz)	MAX. Power		MIN. Power	
	Output Power(dBm)	Output Power(mW)	Output Power(dBm)	Output Power(mW)
5250~5350	26.98	499.151	20.98	125.314
5470~5725	27.04	505.442	21.04	127.057

802.11ac (VHT20)

2Tx CDD Mode

Frequency Band (MHz)	MAX. Power		MIN. Power	
	Output Power(dBm)	Output Power(mW)	Output Power(dBm)	Output Power(mW)
5250~5350	26.98	499.151	20.98	125.314
5470~5725	27.06	508.581	21.06	127.644

2Tx Beamforming Mode MCS0NSS1

Frequency Band (MHz)	MAX. Power		MIN. Power	
	Output Power(dBm)	Output Power(mW)	Output Power(dBm)	Output Power(mW)
5250~5350	29.99	998.233	23.99	250.611
5470~5725	29.99	998.528	23.99	250.611

802.11ac (VHT40)
2Tx CDD Mode

Frequency Band (MHz)	MAX. Power		MIN. Power	
	Output Power(dBm)	Output Power(mW)	Output Power(dBm)	Output Power(mW)
5250~5350	29.27	845.776	23.27	212.324
5470~5725	29.04	801.944	23.04	201.372

2Tx Beamforming Mode MCS0NSS1

Frequency Band (MHz)	MAX. Power		MIN. Power	
	Output Power(dBm)	Output Power(mW)	Output Power(dBm)	Output Power(mW)
5250~5350	29.94	987.329	23.94	247.742
5470~5725	29.96	991.273	23.96	248.886

802.11ac (VHT80)
2Tx CDD Mode

Frequency Band (MHz)	MAX. Power		MIN. Power	
	Output Power(dBm)	Output Power(mW)	Output Power(dBm)	Output Power(mW)
5250~5350	21.01	126.249	15.01	31.696
5470~5725	27.16	520.196	21.16	130.617

2Tx Beamforming Mode MCS0NSS1

Frequency Band (MHz)	MAX. Power		MIN. Power	
	Output Power(dBm)	Output Power(mW)	Output Power(dBm)	Output Power(mW)
5250~5350	24.02	252.481	18.02	63.387
5470~5725	29.89	975.121	23.89	244.906

802.11a
4Tx CDD Mode

Frequency Band (MHz)	MAX. Power		MIN. Power	
	Output Power(dBm)	Output Power(mW)	Output Power(dBm)	Output Power(mW)
5250~5350	24.19	262.536	18.19	65.917
5470~5725	24.24	265.51	18.24	66.681

802.11ac (VHT20)
4Tx CDD Mode

Frequency Band (MHz)	MAX. Power		MIN. Power	
	Output Power(dBm)	Output Power(mW)	Output Power(dBm)	Output Power(mW)
5250~5350	24.05	253.871	18.05	63.826
5470~5725	24.18	261.961	18.18	65.766

4Tx Beamforming Mode MCS0NSS1

Frequency Band (MHz)	MAX. Power		MIN. Power	
	Output Power(dBm)	Output Power(mW)	Output Power(dBm)	Output Power(mW)
5250~5350	29.82	958.545	23.82	240.991
5470~5725	29.89	975.52	23.89	244.906

802.11ac (VHT40)
4Tx CDD Mode

Frequency Band (MHz)	MAX. Power		MIN. Power	
	Output Power(dBm)	Output Power(mW)	Output Power(dBm)	Output Power(mW)
5250~5350	27	501.597	21	125.893
5470~5725	27.2	525.134	21.2	131.826

4Tx Beamforming Mode MCS0NSS1

Frequency Band (MHz)	MAX. Power		MIN. Power	
	Output Power(dBm)	Output Power(mW)	Output Power(dBm)	Output Power(mW)
5250~5350	29.98	996.013	23.98	250.035
5470~5725	29.95	988.066	23.95	248.313

802.11ac (VHT80)
4Tx CDD Mode

Frequency Band (MHz)	MAX. Power		MIN. Power	
	Output Power(dBm)	Output Power(mW)	Output Power(dBm)	Output Power(mW)
5250~5350	21.72	148.59	15.72	37.325
5470~5725	29.05	803.759	23.05	201.837

4Tx Beamforming Mode MCS0NSS1

Frequency Band (MHz)	MAX. Power		MIN. Power	
	Output Power(dBm)	Output Power(mW)	Output Power(dBm)	Output Power(mW)
5250~5350	27.49	561.034	21.49	140.929
5470~5725	29.95	988.952	23.95	248.313

Radio2
802.11a
2Tx CDD Mode

Frequency Band (MHz)	MAX. Power		MIN. Power	
	Output Power(dBm)	Output Power(mW)	Output Power(dBm)	Output Power(mW)
5250~5350	26.94	493.834	20.94	124.165
5470~5725	26.9	489.329	20.9	123.027

802.11ac (VHT20)
2Tx CDD Mode

Frequency Band (MHz)	MAX. Power		MIN. Power	
	Output Power(dBm)	Output Power(mW)	Output Power(dBm)	Output Power(mW)
5250~5350	27.02	503.76	21.02	126.474
5470~5725	26.89	488.435	20.89	122.744

2Tx Beamforming Mode MCS0NSS1

Frequency Band (MHz)	MAX. Power		MIN. Power	
	Output Power(dBm)	Output Power(mW)	Output Power(dBm)	Output Power(mW)
5250~5350	29.99	998.214	23.99	250.611
5470~5725	29.86	967.846	23.86	243.220

802.11ac (VHT40)
2Tx CDD Mode

Frequency Band (MHz)	MAX. Power		MIN. Power	
	Output Power(dBm)	Output Power(mW)	Output Power(dBm)	Output Power(mW)
5250~5350	28.91	778.63	22.94	196.789
5470~5725	29.48	886.935	23.48	222.844

2Tx Beamforming Mode MCS0NSS1

Frequency Band (MHz)	MAX. Power		MIN. Power	
	Output Power(dBm)	Output Power(mW)	Output Power(dBm)	Output Power(mW)
5250~5350	29.91	978.942	23.91	246.037
5470~5725	29.83	962.588	23.83	241.546

802.11ac (VHT80)
2Tx CDD Mode

Frequency Band (MHz)	MAX. Power		MIN. Power	
	Output Power(dBm)	Output Power(mW)	Output Power(dBm)	Output Power(mW)
5250~5350	20.05	101.26	14.05	25.41
5470~5725	27.1	512.89	21.1	128.825

2Tx Beamforming Mode MCS0NSS1

Frequency Band (MHz)	MAX. Power		MIN. Power	
	Output Power(dBm)	Output Power(mW)	Output Power(dBm)	Output Power(mW)
5250~5350	23.02	200.649	17.02	50.35
5470~5725	29.77	947.612	23.77	238.232

802.11a
4Tx CDD Mode

Frequency Band (MHz)	MAX. Power		MIN. Power	
	Output Power(dBm)	Output Power(mW)	Output Power(dBm)	Output Power(mW)
5250~5350	23.93	247.127	17.93	62.087
5470~5725	24.11	257.655	18.11	64.714

802.11ac (VHT20)
4Tx CDD Mode

Frequency Band (MHz)	MAX. Power		MIN. Power	
	Output Power(dBm)	Output Power(mW)	Output Power(dBm)	Output Power(mW)
5250~5350	24.02	252.61	18.02	63.387
5470~5725	24.11	257.505	18.11	64.714

4Tx Beamforming Mode MCS0NSS1

Frequency Band (MHz)	MAX. Power		MIN. Power	
	Output Power(dBm)	Output Power(mW)	Output Power(dBm)	Output Power(mW)
5250~5350	29.82	960.398	23.82	240.991
5470~5725	29.98	994.914	23.98	250.035

802.11ac (VHT40)
4Tx CDD Mode

Frequency Band (MHz)	MAX. Power		MIN. Power	
	Output Power(dBm)	Output Power(mW)	Output Power(dBm)	Output Power(mW)
5250~5350	27.16	519.492	21.16	130.617
5470~5725	26.98	498.657	20.98	125.314

4Tx Beamforming Mode MCS0NSS1

Frequency Band (MHz)	MAX. Power		MIN. Power	
	Output Power(dBm)	Output Power(mW)	Output Power(dBm)	Output Power(mW)
5250~5350	29.61	913.234	23.61	229.615
5470~5725	29.7	932.401	23.7	234.423

802.11ac (VHT80)
4Tx CDD Mode

Frequency Band (MHz)	MAX. Power		MIN. Power	
	Output Power(dBm)	Output Power(mW)	Output Power(dBm)	Output Power(mW)
5250~5350	23.16	207.178	17.16	52
5470~5725	29.68	928.04	23.68	233.346

4Tx Beamforming Mode MCS0NSS1

Frequency Band (MHz)	MAX. Power		MIN. Power	
	Output Power(dBm)	Output Power(mW)	Output Power(dBm)	Output Power(mW)
5250~5350	28.96	787.67	22.96	197.697
5470~5725	29.67	926.854	23.67	232.809

2.6 Transmit Power Control (TPC)

U-NII devices operating in the 5.25-5.35 GHz band and the 5.47-5.725 GHz band shall employ a TPC mechanism. The U-NII device is required to have the capability to operate at least 6 dB below the mean EIRP value of 30 dBm. A TPC mechanism is not required for systems with an e.i.r.p. of less than 500 mW.

Radio1

Maximum EIRP of this device is **998.528** mW which more than 500mW, therefore it's require TPC function.

The UUT can adjust a transmitter's output power based on the signal level present at the receiver. TPC is auto controlled by software

Radio2

Maximum EIRP of this device is **998.214** mW which more than 500mW, therefore it's require TPC function.

The UUT can adjust a transmitter's output power based on the signal level present at the receiver. TPC is auto controlled by software

2.7 Statement of Manufacturer

Manufacturer statement confirming that information regarding the parameters of the detected Radar Waveforms is not available to the end user.

3. U-NII DFS Rule Requirements

3.1 Working Modes and Required Test Items

The manufacturer shall state whether the UUT is capable of operating as a Master and/or a Client. If the UUT is capable of operating in more than one operating mode then each operating mode shall be tested separately. See tables 6 and 7 for the applicability of DFS requirements for each of the operational modes.

Table 6: Applicability of DFS Requirements Prior To Use a Channel

Requirement	Operational Mode		
	Master	Client without radar detection	Client with radar detection
Non-Occupancy Period	✓	✓ _{note}	✓
DFS Detection Threshold	✓	Not required	✓
Channel Availability Check Time	✓	Not required	Not required
U-NII Detection Bandwidth	✓	Not required	✓

Note: Regarding KDB 905462 D03 Client Without DFS New Rules v01r01 section (b)(5/6), If the client moves with the master, the device is considered compliant if nothing appears in the client non-occupancy period test. For devices that shut down (rather than moving channels), no beacons should appear. An analyzer plot that contains a single 30-minute sweep on the original channel

Table 7: Applicability of DFS Requirements During Normal Operation.

Requirement	Operational Mode	
	Master or Client with radar detection	Client without radar detection
DFS Detection Threshold	✓	Not required
Channel Closing Transmission Time	✓	✓
Channel Move Time	✓	✓
U-NII Detection Bandwidth	✓	Not required

Additional requirements for devices with multiple bandwidth modes	Master or Client with radar detection	Client without radar detection
U-NII Detection Bandwidth and Statistical Performance Check	All BW modes must be tested	Not required
Channel Move Time and Channel Closing Transmission Time	Test using widest BW mode available	Test using the widest BW mode available for the link
All other tests	Any single BW mode	Not required

Note: Frequencies selected for statistical performance check (Section 7.8.4) should include several frequencies within the radar detection bandwidth and frequencies near the edge of the radar detection bandwidth. For 802.11 devices it is suggested to select frequencies in each of the bonded 20 MHz channels and the channel center frequency.

3.2 Test Limits and Radar Signal Parameters

Detection Threshold Values

Table 8: DFS Detection Thresholds for Master Devices and Client Devices With Radar Detection

Maximum Transmit Power	Value (See Notes 1, 2, and 3)
EIRP \geq 200 milliwatt	-64 dBm
EIRP < 200 milliwatt and power spectral density < 10 dBm/MHz	-62 dBm
EIRP < 200 milliwatt that do not meet the power spectral density requirement	-64 dBm

Note 1: This is the level at the input of the receiver assuming a 0 dBi receive antenna.
 Note 2: Throughout these test procedures an additional 1 dB has been added to the amplitude of the test transmission waveforms to account for variations in measurement equipment. This will ensure that the test signal is at or above the detection threshold level to trigger a DFS response.
 Note3: EIRP is based on the highest antenna gain. For MIMO devices refer to KDB Publication 662911 D01.

Table 9: DFS Response Requirement Values

Parameter	Value
Non-occupancy period	Minimum 30 minutes
Channel Availability Check Time	60 seconds
Channel Move Time	10 seconds See Note 1.
Channel Closing Transmission Time	200 milliseconds + an aggregate of 60 milliseconds over remaining 10 second period. See Notes 1 and 2.
U-NII Detection Bandwidth	Minimum 100% of the U-NII 99% transmission power bandwidth. See Note 3

Note 1: Channel Move Time and the Channel Closing Transmission Time should be performed with Radar Type 0. The measurement timing begins at the end of the Radar Type 0 burst.
 Note 2: The Channel Closing Transmission Time is comprised of 200 milliseconds starting at the beginning of the Channel Move Time plus any additional intermittent control signals required to facilitate a Channel move (an aggregate of 60 milliseconds) during the remainder of the 10 second period. The aggregate duration of control signals will not count quiet periods in between transmissions.
 Note 3: During the U-NII Detection Bandwidth detection test, radar type 0 should be used. For each frequency step the minimum percentage of detection is 90 percent. Measurements are performed with no data traffic.

Parameters of DFS Test Signals

Step intervals of 0.1 microsecond for Pulse Width, 1 microsecond for PRI, 1 MHz for chirp width and 1 for the number of pulses will be utilized for the random determination of specific test waveforms.

Table 10: Short Pulse Radar Test Waveforms

Radar Type	Pulse Width (μsec)	PRI (μsec)	Number of Pulses	Minimum Percentage of Successful Detection	Minimum Number of Trials
0	1	1428	18	See Note 1	See Note 1
1	1	Test A: 15 unique PRI values randomly selected from the list of 23 PRI values in Table 5a	$\text{Roundup} \left\{ \left(\frac{1}{360} \right) \cdot \left(\frac{19 \cdot 10^6}{\text{PRI}_{\text{min spec}}} \right) \right\}$	60%	30
		Test B: 15 unique PRI values randomly selected within the range of 518-3066μ sec, with a minimum increment of 1μ sec, excluding PRI values selected in Test A			
2	1-5	150-230	23-29	60%	30
3	6-10	200-500	16-18	60%	30
4	11-20	200-500	12-16	60%	30
Aggregate (Radar Types 1-4)				80%	120
Note 1: Short Pulse Radar Type 0 should be used for the detection bandwidth test, channel move time, and channel closing time tests.					

Table 11: Long Pulse Radar Test Waveform

Radar Type	Pulse Width (µsec)	Chirp Width (MHz)	PRI (µsec)	Number Of Pulses Per Burst	Number Of Bursts	Minimum Percentage Of Successful Detection	Minimum Number Of Trials
5	50-100	5-20	1000-2000	1-3	8-20	80%	30

Three subsets of trials will be performed with a minimum of ten trials per subset. The subset of trials differ in where the Long Pulse Type 5 Signal is tuned in frequency.

- a) the Channel center frequency
- b) tuned frequencies such that 90% of the Long Pulse Type 5 frequency modulation is within the low edge of the UUT Occupied Bandwidth
- c) tuned frequencies such that 90% of the Long Pulse Type 5 frequency modulation is within the high edge of the UUT Occupied Bandwidth

It include 10 trails for every subset, the formula as below,

For subset case 1: the center frequency of the signal generator will remain fixed at the center of the UUT Channel.

For subset case 2: to retain 90% frequency overlap between the radar signal and the UUT Occupied Bandwidth, the center frequency of the signal generator will vary for each of the ten trials in subset case 2. The center frequency of the signal generator for each trial is calculated by:

$$FL+(0.4*Chirp\ Width\ [in\ MHz])$$

For subset case 3: to retain 90% frequency overlap between the radar signal and the UUT Occupied Bandwidth, the center frequency of the signal generator will vary for each of the ten trials in subset case 3. The center frequency of the signal generator for each trial is calculated by:

$$FH-(0.4*Chirp\ Width\ [in\ MHz])$$

Table 12: Frequency Hopping Radar Test Waveform

Radar Type	Pulse Width (µsec)	PRI (µsec)	Pulses per Hop	Hopping Rate (kHz)	Hopping Sequence Length (msec)	Minimum Percentage Of Successful Detection	Minimum Number Of Trials
6	1	333	9	0.333	300	70%	30

4. Test & Support Equipment List

4.1 Test Instruments

Table 13: Test Instruments List

Description & Manufacturer	Model No.	Serial No	Date Of Calibration	Due Date Of Calibration
Spectrum Analyzer R&S	FSP40	100060	May 11, 2016	May 10, 2017
Vector Signal Generator Agilent	N5182B	MY53051263	Sep. 05, 2016	Sep. 04, 2017
Horn_Antenna EMCO	1018G	0001	Jan. 08, 2016	Jan. 07, 2017
DFS Switch Box	PS-X10-100	PS-X10-100_01	Sep. 23, 2015	Sep. 22, 2016

4.2 Description of Support Units

Table 14: Support Unit Information.

No.	Product	Brand	Model No.	FCC ID	Spec
1	Wireless LAN Unit	NEC	NP05LM	RRK-NECNP05LM	

NOTE: This device was functioned as a Master Slave device during the DFS test.

Table 15: Software/Firmware Information.

No.	Product	Model No.	Software/Firmware Version
1	Wireless LAN Unit	NP05LM	Driver Version: 06/18/2014, 1026.12.606.2014

5. Test Procedure

5.1 DFS Measurement System

A complete DFS Measurement System consists of two subsystems: (1) the Radar Signal Generating system and (2) the Traffic Monitoring system. The control PC is necessary for generating the Radar waveforms in Table 10, 11 and 12. The traffic monitoring subsystem is specified to the type of unit under test (UUT).

Radiated Setup Configuration of DFS Measurement System

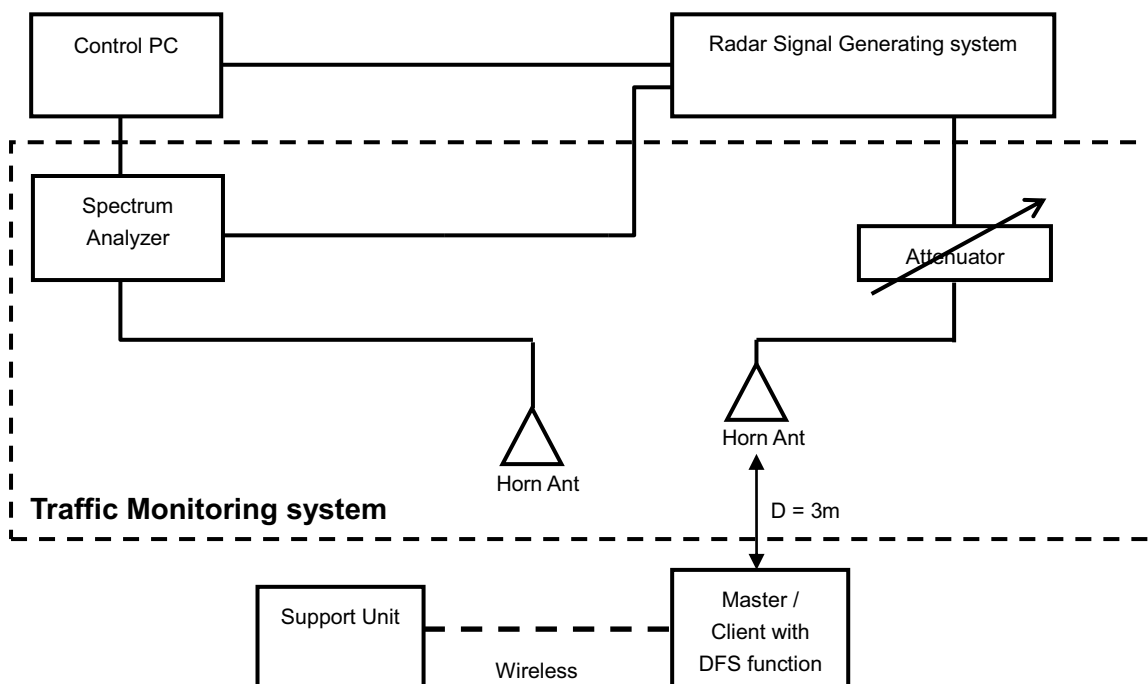

Channel Loading

System testing will be performed with channel-loading using means appropriate to the data types that are used by the unlicensed device. The following requirements apply:

a)	The data file must be of a type that is typical for the device (i.e., MPEG-2, MPEG-4, WAV, MP3, MP4, AVI, etc.) and must generally be transmitting in a streaming mode.	
b)	Software to ping the client is permitted to simulate data transfer but must have random ping intervals.	
c)	Timing plots are required with calculations demonstrating a minimum channel loading of approximately 17% or greater.	✓
d)	Unicast or Multicast protocols are preferable but other protocols may be used. The appropriate protocol used must be described in the test procedures.	

5.2 Calibration of DFS Detection Threshold Level

The measured channel is 5500MHz and 5510MHz and 5530MHz. The radar signal was the same as transmitted channels, and injected into the antenna of AP (master) or Client Device with Radar Detection, measured the channel closing transmission time and channel move time.

Radiated setup configuration of Calibration of DFS Detection Threshold Level

The calibrated conducted detection threshold level is set to -64dBm. The tested level is lower than required level hence it provides margin to the limit.

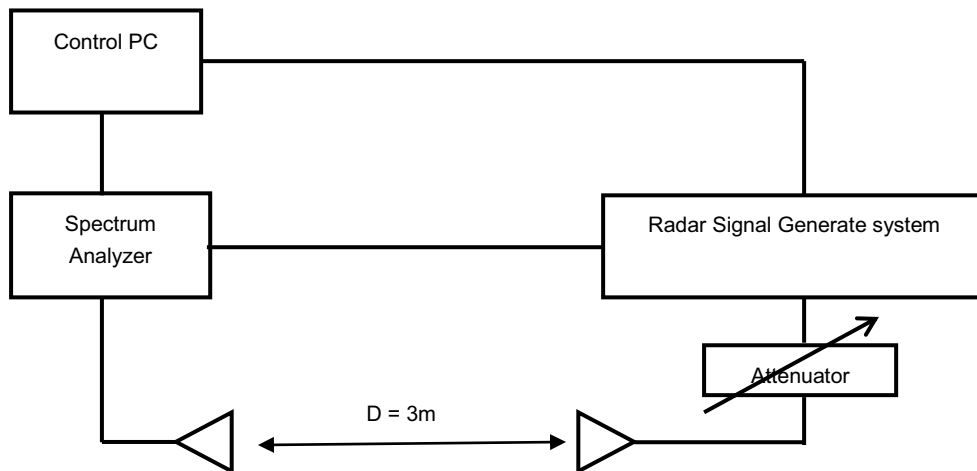

5.3 Deviation from Test Standard

No deviation.

5.4 Radiated Test Setup Configuration

Master mode

The EUT is a U-NII Device operating in Master mode. The radar test signals are injected into the Master Device.

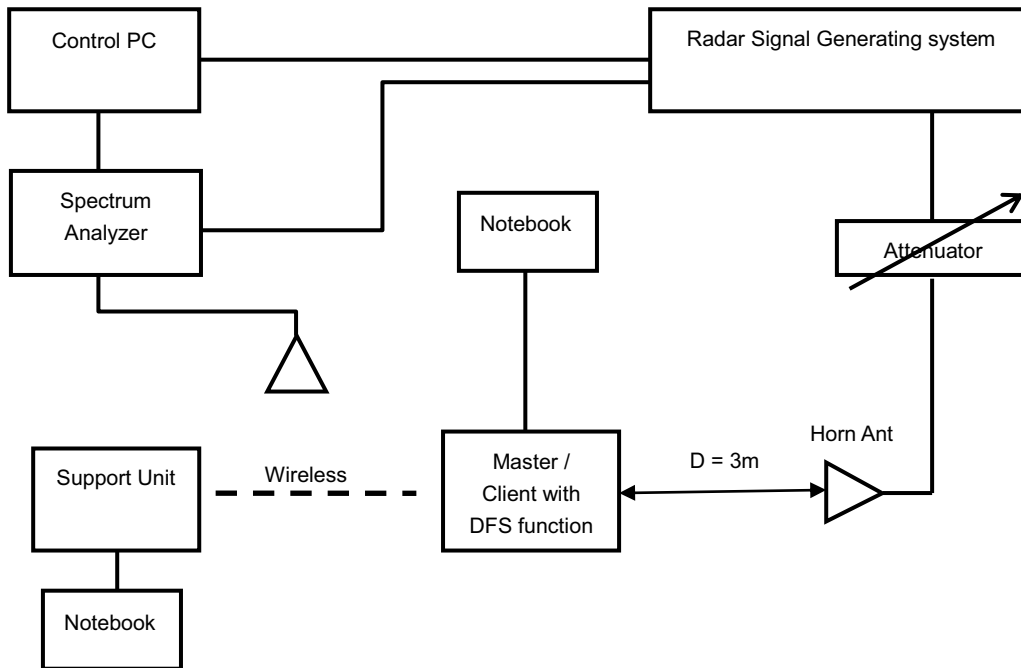

Note: The UUT main beam of the antenna is directly toward the radar emitter during testing.

6. Test Results

6.1 Summary of Test Results

Clause	Test Parameter	Remarks	Pass/Fail
15.407	DFS Detection Threshold	Applicable	Pass
15.407	Channel Availability Check Time	Applicable	Pass
15.407	Channel Move Time	Applicable	Pass
15.407	Channel Closing Transmission Time	Applicable	Pass
15.407	Non- Occupancy Period	Applicable	Pass
15.407	U-NII Detection Bandwidth	Applicable	Pass

6.2 Test Results

6.2.1 Test Mode: Device Operating In Master Mode.

The radar test waveforms are injected into the Master.
This test was investigated for different bandwidth (20MHz · 40MHz and 80MHz).
The following plots was done on 80MHz as a representative

DFS Detection Threshold

For detection threshold level of -64dBm, the tested level is lower than required level for 1dB, hence it provides margin to the limit.

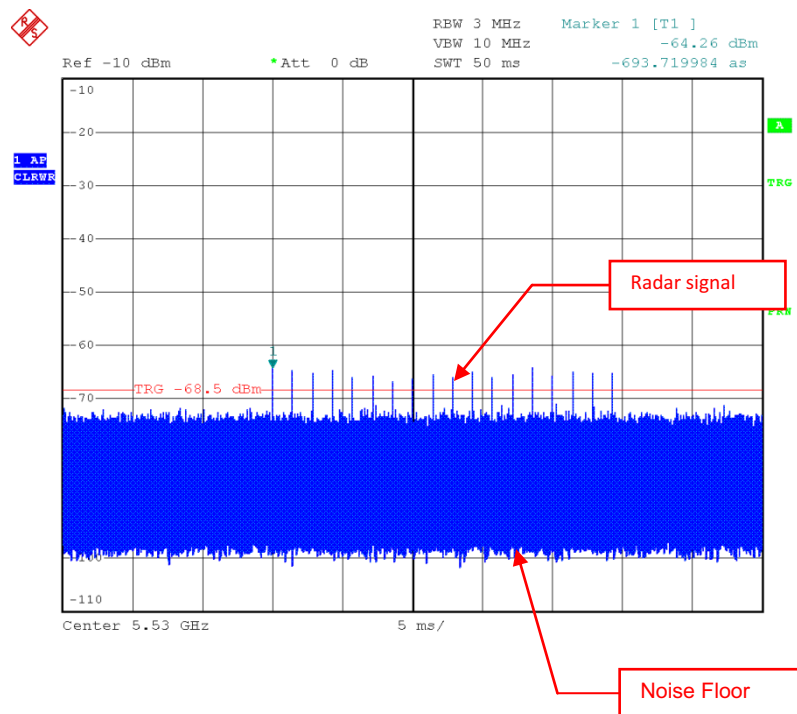

Radar Signal 0

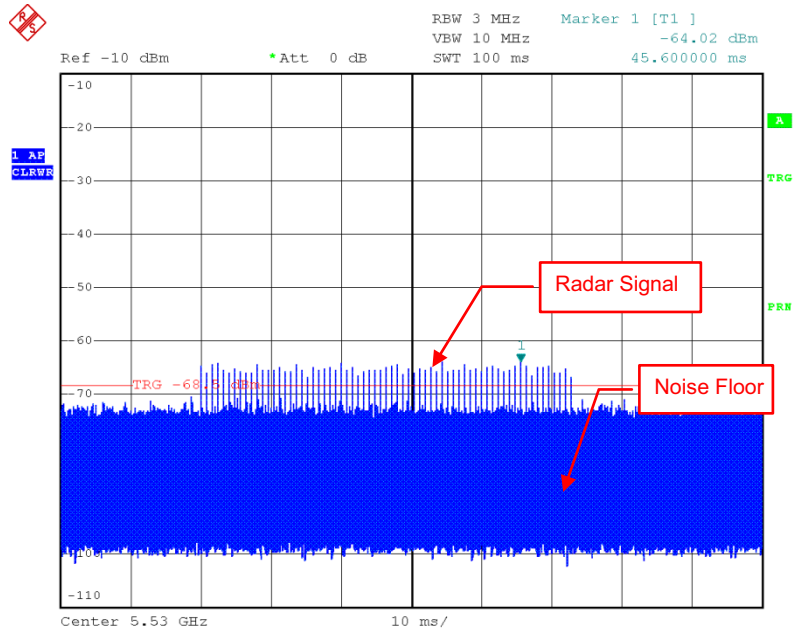

Radar Signal 1 (Test A)

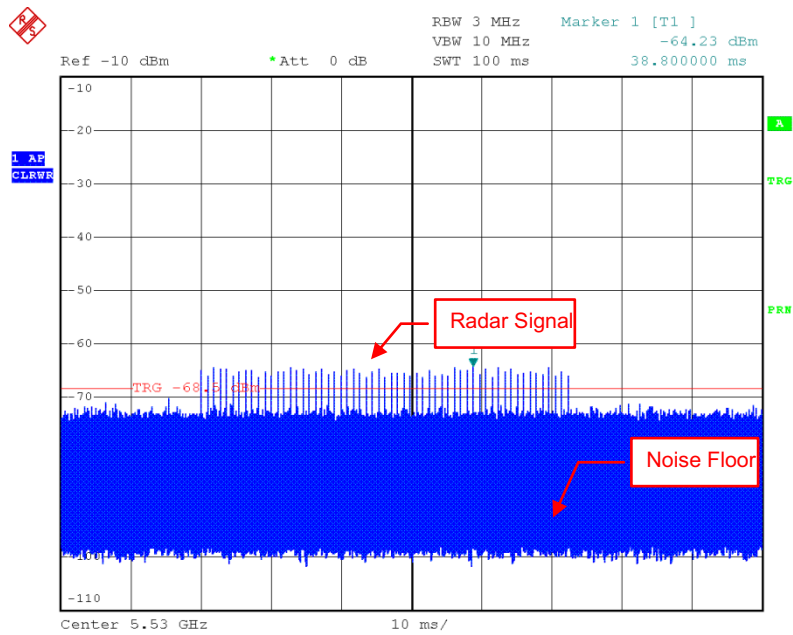

Radar Signal 1 (Test B)

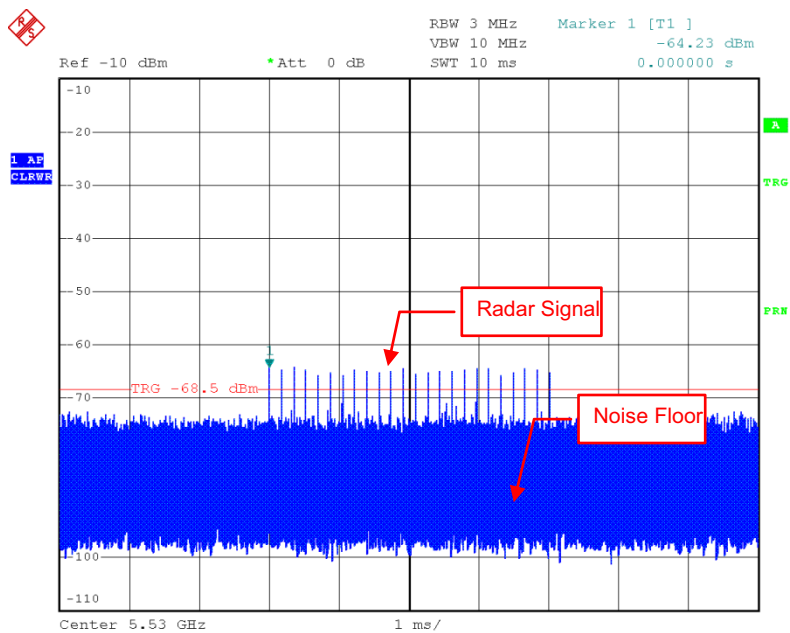

Radar Signal 2

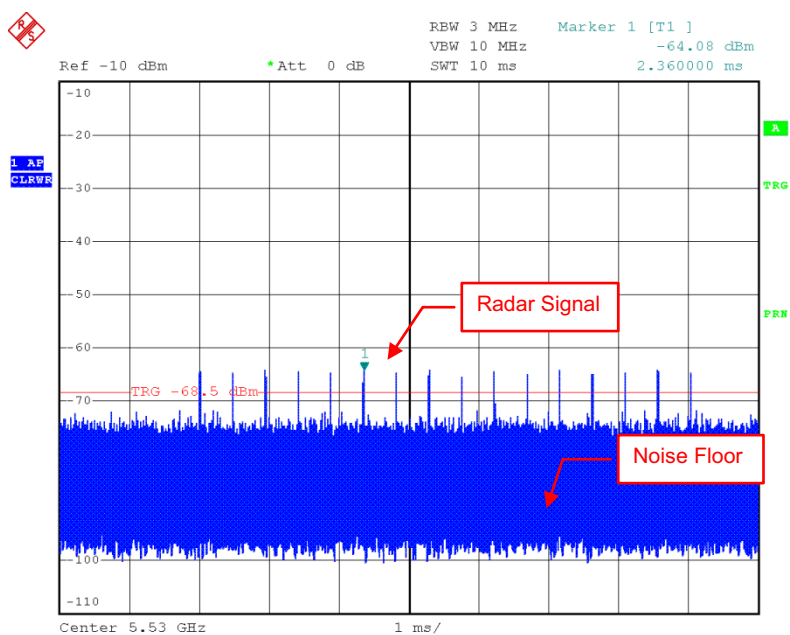

Radar Signal 3

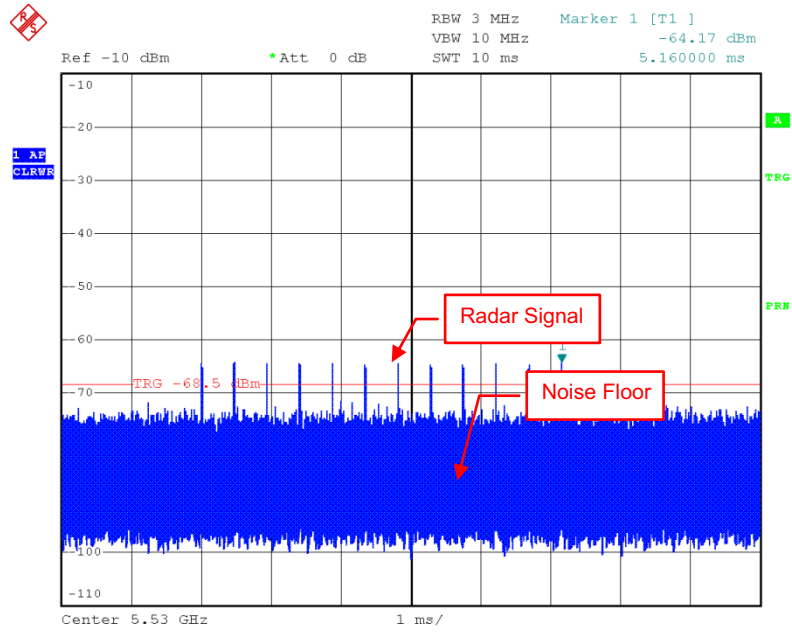

Single Burst of Radar Signal 4

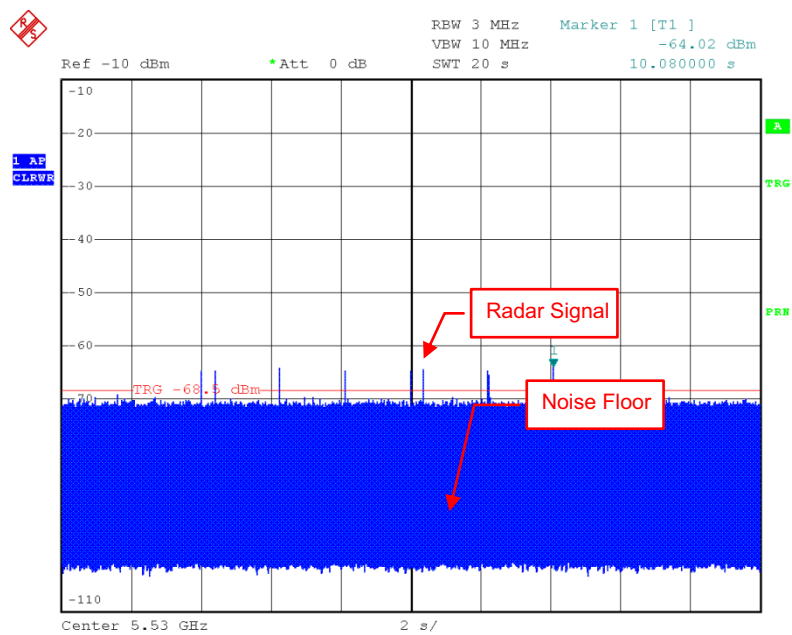

Radar Signal 5

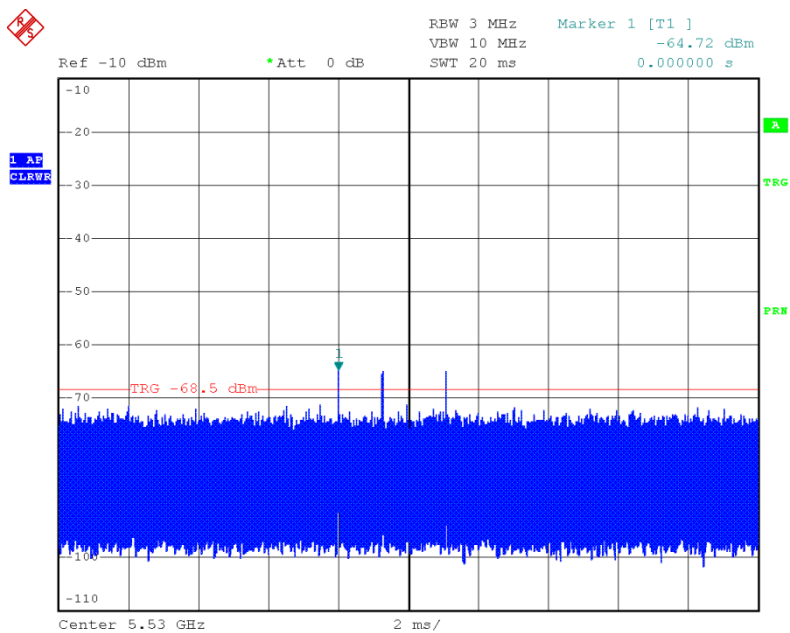

Single Burst of Radar Signal 5

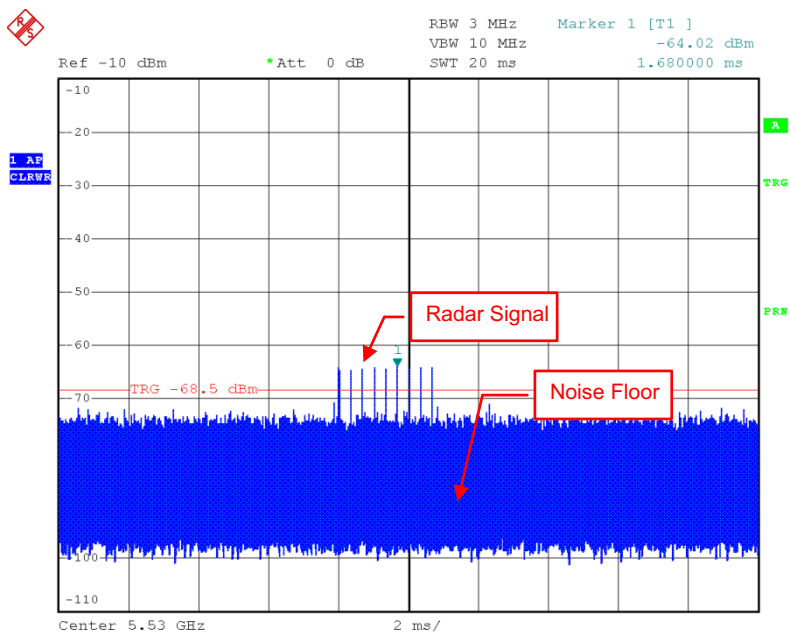

Radar Signal 6

6.2.2 U-NII Detection Bandwidth

Radio1

802.11ac (VHT20)



*RBW 300 kHz Marker 1 [T1]
 *VBW 1 MHz -36.89 dBm
 Ref -10 dBm *Att 0 dB SWT 40 ms 5.507087500 GHz

1 PK
 MAXH

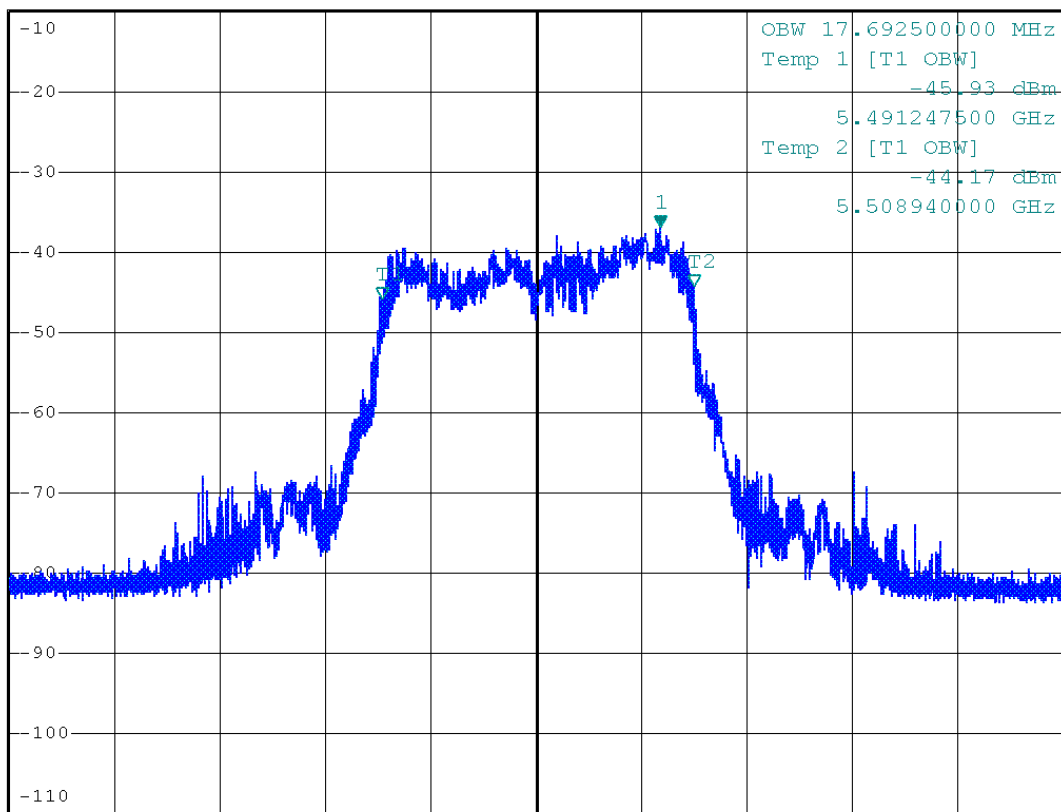

Center 5.5 GHz 6 MHz/ Span 60 MHz

U-NII 99% Channel bandwidth

802.11ac (VHT40)



*RBW 1 MHz Marker 1 [T1]
 *VBW 3 MHz -32.52 dBm
 Ref -10 dBm 5.506050000 GHz
 *Att 0 dB SWT 40 ms

1 PK
MAXH

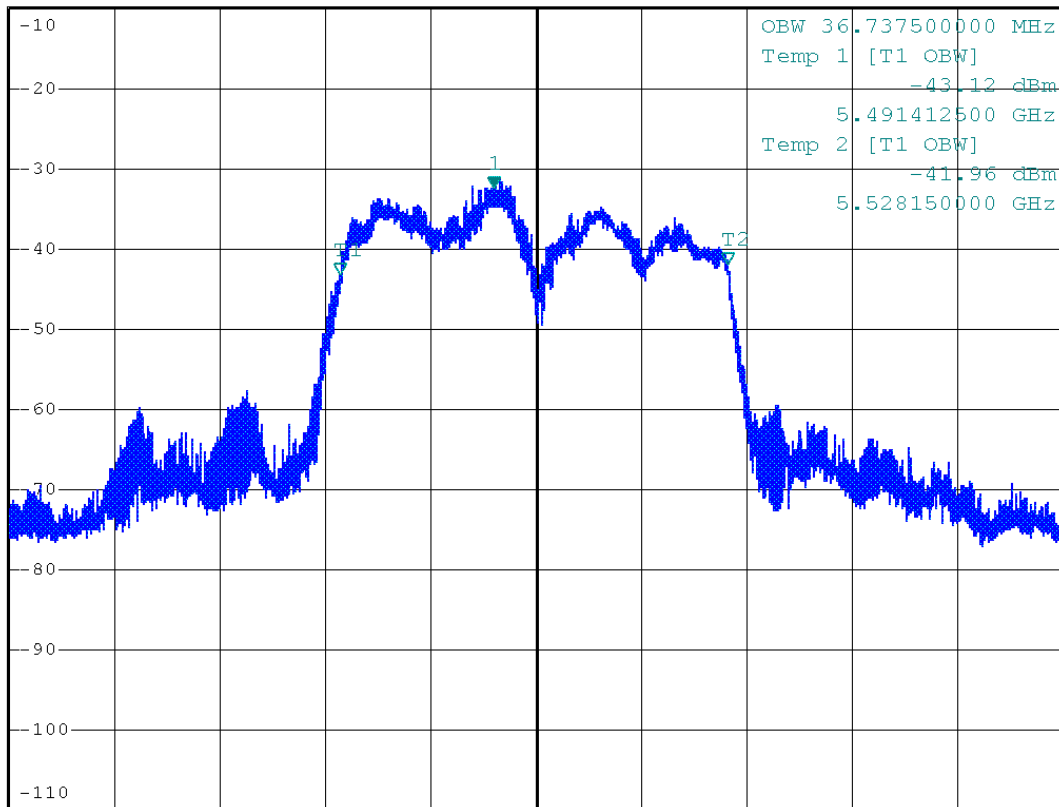

Center 5.51 GHz 10 MHz/ Span 100 MHz

U-NII 99% Channel bandwidth

802.11ac (VHT80)



*RBW 1 MHz Marker 1 [T1]
 *VBW 3 MHz -31.34 dBm
 Ref -10 dBm *Att 0 dB SWT 40 ms 5.506820000 GHz

1 PK
 MAXH

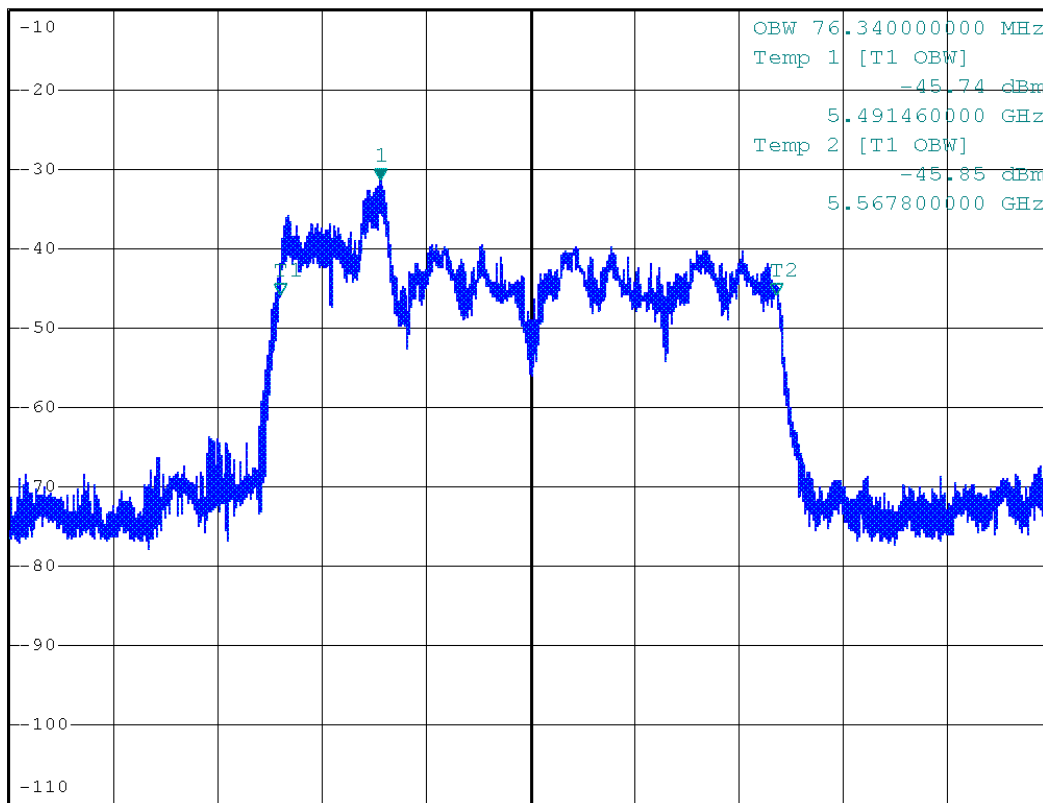

Center 5.53 GHz 16 MHz/ Span 160 MHz

U-NII 99% Channel bandwidth

Detection Bandwidth Test - 802.11ac (VHT20)

Radar Type 0

EUT Frequency: 5500MHz

EUT 99% Power bandwidth: 17.6925MHz

Detection bandwidth limit (100% of EUT 99% Power bandwidth): 17.6925MHz

Detection bandwidth (5509(FH) – 5491(FL)) : 18MHz

Test Result : PASS

Radar Frequency (Hz)	Trial Number / Detection										Detection Rate (%)
	1	2	3	4	5	6	7	8	9	10	
5.491G(FL)	Yes	No	Yes	Yes	Yes	Yes	Yes	Yes	Yes	Yes	90
5.492G	Yes	Yes	Yes	Yes	Yes	Yes	Yes	Yes	Yes	Yes	100
5.493G	Yes	Yes	Yes	Yes	Yes	Yes	Yes	Yes	Yes	Yes	100
5.494G	Yes	Yes	Yes	Yes	Yes	Yes	Yes	Yes	Yes	Yes	100
5.495G	Yes	Yes	Yes	Yes	Yes	Yes	Yes	Yes	Yes	Yes	100
5.496G	Yes	Yes	Yes	Yes	Yes	Yes	Yes	Yes	Yes	Yes	100
5.497G	Yes	Yes	Yes	Yes	Yes	Yes	Yes	Yes	Yes	Yes	100
5.498G	Yes	Yes	Yes	Yes	Yes	Yes	Yes	Yes	Yes	Yes	100
5.499G	Yes	Yes	Yes	Yes	Yes	Yes	Yes	Yes	Yes	Yes	100
5.500G	Yes	Yes	Yes	Yes	Yes	Yes	Yes	Yes	Yes	Yes	100
5.501G	Yes	Yes	Yes	Yes	Yes	Yes	Yes	Yes	Yes	Yes	100
5.502G	Yes	Yes	Yes	Yes	Yes	Yes	Yes	Yes	Yes	Yes	100
5.503G	Yes	Yes	Yes	Yes	Yes	Yes	Yes	Yes	Yes	Yes	100
5.504G	Yes	Yes	Yes	Yes	Yes	Yes	Yes	Yes	Yes	Yes	100
5.505G	Yes	Yes	Yes	Yes	Yes	Yes	Yes	Yes	Yes	Yes	100
5.506G	Yes	Yes	Yes	Yes	Yes	Yes	Yes	Yes	Yes	Yes	100
5.507G	No	Yes	Yes	Yes	Yes	Yes	Yes	Yes	Yes	Yes	90
5.508G	Yes	Yes	Yes	Yes	Yes	Yes	Yes	Yes	Yes	Yes	100
5.509G(FH)	Yes	No	Yes	Yes	Yes	Yes	Yes	Yes	Yes	Yes	90

Detection Bandwidth Test - 802.11ac (VHT40)

Radar Type 0

EUT Frequency: 5510MHz

EUT 99% Power bandwidth: 36.7375MHz

Detection bandwidth limit (100% of EUT 99% Power bandwidth): 36.7375MHz

Detection bandwidth (5529(FH) – 5491(FL)) : 38MHz

Test Result : PASS

Radar Frequency (Hz)	Trial Number / Detection										Detection Rate (%)
	1	2	3	4	5	6	7	8	9	10	
5.491G(FL)	Yes	No	Yes	Yes	Yes	Yes	Yes	Yes	Yes	Yes	90
5.492G	Yes	Yes	Yes	Yes	Yes	Yes	Yes	Yes	Yes	Yes	100
5.493G	Yes	Yes	Yes	Yes	Yes	Yes	Yes	Yes	Yes	Yes	100
5.494G	Yes	Yes	Yes	Yes	Yes	Yes	Yes	Yes	Yes	Yes	100
5.495G	Yes	Yes	Yes	Yes	Yes	Yes	Yes	Yes	Yes	Yes	100
5.496G	Yes	Yes	Yes	Yes	Yes	Yes	Yes	Yes	Yes	Yes	100
5.497G	Yes	Yes	Yes	Yes	Yes	Yes	Yes	Yes	Yes	Yes	100
5.498G	Yes	Yes	Yes	Yes	Yes	Yes	Yes	Yes	Yes	Yes	100
5.499G	Yes	Yes	Yes	Yes	Yes	Yes	Yes	Yes	Yes	Yes	100
5.500G	Yes	Yes	Yes	Yes	Yes	Yes	Yes	Yes	Yes	Yes	100
5.501G	Yes	Yes	Yes	Yes	Yes	Yes	Yes	Yes	Yes	Yes	100
5.502G	Yes	Yes	Yes	Yes	Yes	Yes	Yes	Yes	Yes	Yes	100
5.503G	Yes	Yes	Yes	Yes	Yes	Yes	Yes	Yes	Yes	Yes	100
5.504G	Yes	Yes	Yes	Yes	Yes	Yes	Yes	Yes	Yes	Yes	100
5.505G	Yes	Yes	Yes	Yes	Yes	Yes	Yes	Yes	Yes	Yes	100
5.506G	Yes	Yes	Yes	Yes	Yes	Yes	Yes	Yes	Yes	Yes	100
5.507G	Yes	Yes	Yes	Yes	Yes	Yes	Yes	Yes	Yes	Yes	100
5.508G	Yes	Yes	Yes	Yes	Yes	Yes	Yes	Yes	Yes	Yes	100
5.509G	Yes	Yes	Yes	Yes	Yes	Yes	Yes	Yes	Yes	Yes	100
5.510G	Yes	Yes	Yes	Yes	Yes	Yes	Yes	Yes	Yes	Yes	100
5.511G	Yes	Yes	Yes	Yes	Yes	Yes	Yes	Yes	Yes	Yes	100
5.512G	Yes	Yes	Yes	Yes	Yes	Yes	Yes	Yes	Yes	Yes	100
5.513G	Yes	Yes	Yes	Yes	Yes	Yes	Yes	Yes	Yes	Yes	100
5.514G	Yes	Yes	Yes	Yes	Yes	Yes	Yes	Yes	Yes	Yes	100
5.515G	Yes	Yes	Yes	Yes	Yes	Yes	Yes	Yes	Yes	Yes	100
5.516G	Yes	Yes	Yes	Yes	Yes	Yes	Yes	Yes	Yes	Yes	100
5.517G	Yes	Yes	Yes	Yes	Yes	Yes	Yes	Yes	Yes	Yes	100
5.518G	Yes	Yes	Yes	Yes	Yes	Yes	Yes	Yes	Yes	Yes	100
5.519G	Yes	Yes	Yes	Yes	Yes	Yes	Yes	Yes	Yes	Yes	100
5.520G	Yes	Yes	Yes	Yes	Yes	Yes	Yes	Yes	Yes	Yes	100
5.521G	Yes	Yes	Yes	Yes	Yes	Yes	Yes	Yes	Yes	Yes	100
5.522G	Yes	Yes	Yes	Yes	Yes	Yes	Yes	Yes	Yes	Yes	100
5.523G	Yes	Yes	Yes	Yes	Yes	Yes	Yes	Yes	Yes	Yes	100
5.524G	Yes	Yes	Yes	Yes	Yes	Yes	Yes	Yes	Yes	Yes	100
5.525G	Yes	Yes	Yes	Yes	Yes	Yes	Yes	Yes	Yes	Yes	100
5.526G	Yes	Yes	Yes	Yes	Yes	Yes	Yes	Yes	Yes	Yes	100
5.527G	Yes	Yes	Yes	Yes	Yes	Yes	Yes	Yes	Yes	Yes	100
5.528G	Yes	Yes	No	Yes	Yes	Yes	Yes	Yes	Yes	Yes	90
5.529G(FH)	Yes	Yes	Yes	Yes	Yes	Yes	Yes	Yes	No	Yes	90

Detection Bandwidth Test - 802.11ac (VHT80)

Radar Type 0

EUT Frequency: 5530MHz

EUT 99% Power bandwidth: 76.34MHz

Detection bandwidth limit (100% of EUT 99% Power bandwidth): 76.34MHz

Detection bandwidth (5569(FH) – 5491(FL)) : 78MHz

Test Result : PASS

Radar Frequency (Hz)	Trial Number / Detection										Detection Rate (%)
	1	2	3	4	5	6	7	8	9	10	
5491G(FL)	Yes	No	Yes	Yes	Yes	Yes	Yes	Yes	Yes	Yes	90
5.492G	Yes	No	Yes	Yes	Yes	Yes	Yes	Yes	Yes	Yes	90
5.493G	Yes	Yes	Yes	Yes	Yes	Yes	Yes	Yes	Yes	Yes	100
5.494G	Yes	Yes	Yes	Yes	Yes	Yes	Yes	Yes	Yes	Yes	100
5.495G	Yes	Yes	Yes	Yes	Yes	Yes	Yes	Yes	Yes	Yes	100
5.496G	Yes	Yes	Yes	Yes	Yes	Yes	Yes	Yes	Yes	Yes	100
5.497G	Yes	Yes	Yes	Yes	Yes	Yes	Yes	Yes	Yes	Yes	100
5.498G	Yes	Yes	Yes	Yes	Yes	Yes	Yes	Yes	Yes	Yes	100
5.499G	Yes	Yes	Yes	Yes	Yes	Yes	Yes	Yes	Yes	Yes	100
5.500G	Yes	Yes	Yes	Yes	Yes	Yes	Yes	Yes	Yes	Yes	100
5.501G	Yes	Yes	Yes	Yes	Yes	Yes	Yes	Yes	Yes	Yes	100
5.502G	Yes	Yes	Yes	Yes	Yes	Yes	Yes	Yes	Yes	Yes	100
5.503G	Yes	Yes	Yes	Yes	Yes	Yes	Yes	Yes	Yes	Yes	100
5.504G	Yes	Yes	Yes	Yes	Yes	Yes	Yes	Yes	Yes	Yes	100
5.505G	Yes	Yes	Yes	Yes	Yes	Yes	Yes	Yes	Yes	Yes	100
5.506G	Yes	Yes	Yes	Yes	Yes	Yes	Yes	Yes	Yes	Yes	100
5.507G	Yes	Yes	Yes	Yes	Yes	Yes	Yes	Yes	Yes	Yes	100
5.508G	Yes	Yes	Yes	Yes	Yes	Yes	Yes	Yes	Yes	Yes	100
5.509G	Yes	Yes	Yes	Yes	Yes	Yes	Yes	Yes	Yes	Yes	100
5.510G	Yes	Yes	Yes	Yes	Yes	Yes	Yes	Yes	Yes	Yes	100
5.511G	Yes	Yes	Yes	Yes	Yes	Yes	Yes	Yes	Yes	Yes	100
5.512G	Yes	Yes	Yes	Yes	Yes	Yes	Yes	Yes	Yes	Yes	100
5.513G	Yes	Yes	Yes	Yes	Yes	Yes	Yes	Yes	Yes	Yes	100
5.514G	Yes	Yes	Yes	Yes	Yes	Yes	Yes	Yes	Yes	Yes	100
5.515G	Yes	Yes	Yes	Yes	Yes	Yes	Yes	Yes	Yes	Yes	100
5.516G	Yes	Yes	Yes	Yes	Yes	Yes	Yes	Yes	Yes	Yes	100
5.517G	Yes	Yes	Yes	Yes	Yes	Yes	Yes	Yes	Yes	Yes	100
5.518G	Yes	Yes	Yes	Yes	Yes	Yes	Yes	Yes	Yes	Yes	100
5.519G	Yes	Yes	Yes	Yes	Yes	Yes	Yes	Yes	Yes	Yes	100
5.520G	Yes	Yes	Yes	Yes	Yes	Yes	Yes	Yes	Yes	Yes	100
5.521G	Yes	Yes	Yes	Yes	Yes	Yes	Yes	Yes	Yes	Yes	100
5.522G	Yes	Yes	Yes	Yes	Yes	Yes	Yes	Yes	Yes	Yes	100
5.523G	Yes	Yes	Yes	Yes	Yes	Yes	Yes	Yes	Yes	Yes	100
5.524G	Yes	Yes	Yes	Yes	Yes	Yes	Yes	Yes	Yes	Yes	100
5.525G	Yes	Yes	Yes	Yes	Yes	Yes	Yes	Yes	Yes	Yes	100
5.526G	Yes	Yes	Yes	Yes	Yes	Yes	Yes	Yes	Yes	Yes	100
5.527G	Yes	Yes	Yes	Yes	Yes	Yes	Yes	Yes	Yes	Yes	100
5.528G	Yes	Yes	Yes	Yes	Yes	Yes	Yes	Yes	Yes	Yes	100
5.529G	Yes	Yes	Yes	Yes	Yes	Yes	Yes	Yes	Yes	Yes	100
5.530G	Yes	Yes	Yes	Yes	Yes	Yes	Yes	Yes	Yes	Yes	100

5.531G	Yes	Yes	Yes	Yes	Yes	Yes	Yes	Yes	Yes	Yes	100
5.532G	Yes	Yes	Yes	Yes	Yes	Yes	Yes	Yes	Yes	Yes	100
5.533G	Yes	Yes	Yes	Yes	Yes	Yes	Yes	Yes	Yes	Yes	100
5.534G	Yes	Yes	Yes	Yes	Yes	Yes	Yes	Yes	Yes	Yes	100
5.535G	Yes	Yes	Yes	Yes	Yes	Yes	Yes	Yes	Yes	Yes	100
5.536G	Yes	Yes	Yes	Yes	Yes	Yes	Yes	Yes	Yes	Yes	100
5.537G	Yes	Yes	Yes	Yes	Yes	Yes	Yes	Yes	Yes	Yes	100
5.538G	Yes	Yes	Yes	Yes	Yes	Yes	Yes	Yes	Yes	Yes	100
5.539G	Yes	Yes	Yes	Yes	Yes	Yes	Yes	Yes	Yes	Yes	100
5.540G	Yes	Yes	Yes	Yes	Yes	Yes	Yes	Yes	Yes	Yes	100
5.541G	Yes	Yes	Yes	Yes	Yes	Yes	Yes	Yes	Yes	Yes	100
5.542G	Yes	Yes	Yes	Yes	Yes	Yes	Yes	Yes	Yes	Yes	100
5.543G	Yes	Yes	Yes	Yes	Yes	Yes	Yes	Yes	Yes	Yes	100
5.544G	Yes	Yes	Yes	Yes	Yes	Yes	Yes	Yes	Yes	Yes	100
5.545G	Yes	Yes	Yes	Yes	Yes	Yes	Yes	Yes	Yes	Yes	100
5.546G	Yes	Yes	Yes	Yes	Yes	Yes	Yes	Yes	Yes	Yes	100
5.547G	Yes	Yes	Yes	Yes	Yes	Yes	Yes	Yes	Yes	Yes	100
5.548G	Yes	Yes	Yes	Yes	Yes	Yes	Yes	Yes	Yes	Yes	100
5.549G	Yes	Yes	Yes	Yes	Yes	Yes	Yes	Yes	Yes	Yes	100
5.550G	Yes	Yes	Yes	Yes	Yes	Yes	Yes	Yes	Yes	Yes	100
5.551G	Yes	Yes	Yes	Yes	Yes	Yes	Yes	Yes	Yes	Yes	100
5.552G	Yes	Yes	Yes	Yes	Yes	Yes	Yes	Yes	Yes	Yes	100
5.553G	Yes	Yes	Yes	Yes	Yes	Yes	Yes	Yes	Yes	Yes	100
5.554G	Yes	Yes	Yes	Yes	Yes	Yes	Yes	Yes	Yes	Yes	100
5.555G	Yes	Yes	Yes	Yes	Yes	Yes	Yes	Yes	Yes	Yes	100
5.556G	Yes	Yes	Yes	Yes	Yes	Yes	Yes	Yes	Yes	Yes	100
5.557G	Yes	Yes	Yes	Yes	Yes	Yes	Yes	Yes	Yes	Yes	100
5.558G	Yes	Yes	Yes	Yes	Yes	Yes	Yes	Yes	Yes	Yes	100
5.559G	Yes	Yes	Yes	Yes	Yes	Yes	Yes	Yes	Yes	Yes	100
5.560G	Yes	Yes	Yes	Yes	Yes	Yes	Yes	Yes	Yes	Yes	100
5.561G	Yes	Yes	Yes	Yes	Yes	Yes	Yes	Yes	Yes	Yes	100
5.562G	Yes	Yes	Yes	Yes	Yes	Yes	Yes	Yes	Yes	Yes	100
5.563G	Yes	Yes	Yes	Yes	Yes	Yes	Yes	Yes	Yes	Yes	100
5.564G	Yes	Yes	Yes	Yes	Yes	Yes	Yes	Yes	Yes	Yes	100
5.565G	Yes	Yes	Yes	Yes	Yes	Yes	Yes	Yes	Yes	Yes	100
5.566G	Yes	Yes	Yes	Yes	Yes	Yes	Yes	Yes	Yes	Yes	100
5.567G	Yes	Yes	Yes	Yes	Yes	Yes	Yes	Yes	Yes	Yes	100
5.568G	Yes	Yes	Yes	Yes	Yes	Yes	Yes	Yes	Yes	Yes	100
5.569G(FH)	Yes	Yes	Yes	Yes	Yes	Yes	Yes	Yes	Yes	Yes	100

Radio2
802.11ac (VHT20)



*RBW 300 kHz Marker 1 [T1]
 *VBW 1 MHz -35.39 dBm
 Ref -10 dBm *Att 0 dB SWT 40 ms 5.508190000 GHz

1 PK
MAXH

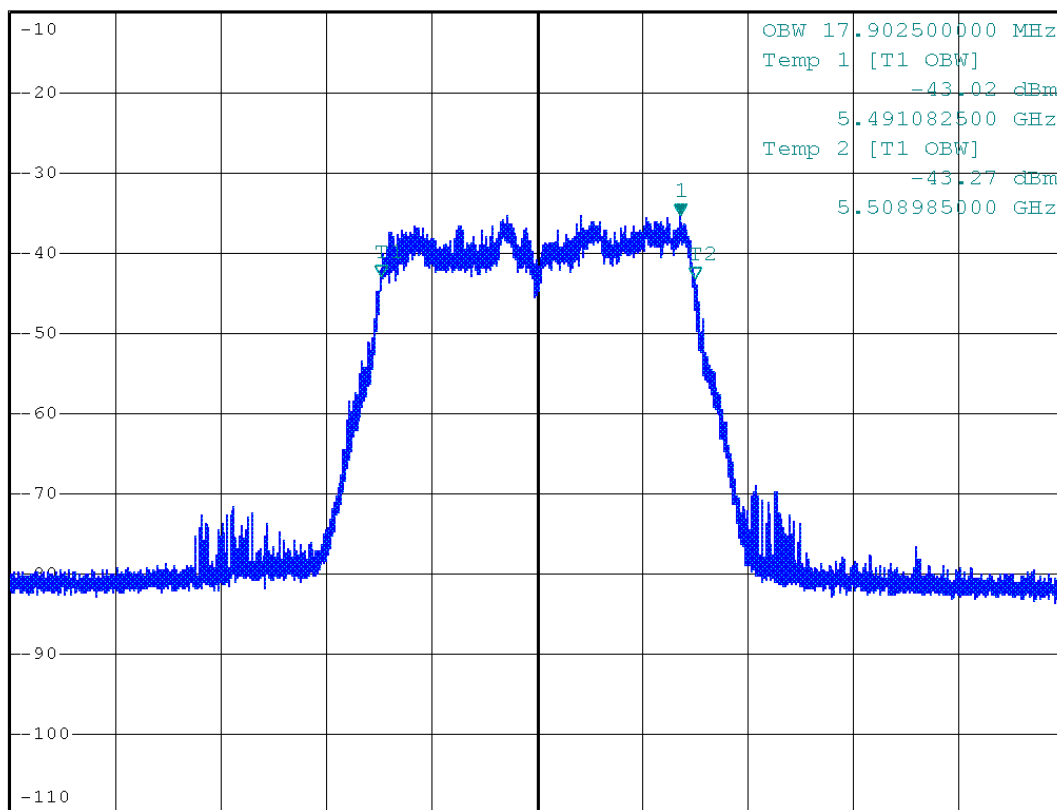

Center 5.5 GHz 6 MHz/ Span 60 MHz

U-NII 99% Channel bandwidth

802.11ac (VHT40)



*RBW 1 MHz Marker 1 [T1]
 *VBW 3 MHz -30.90 dBm
 SWT 40 ms 5.506225000 GHz

Ref -10 dBm

*Att 0 dB

1 PK
 MAXH

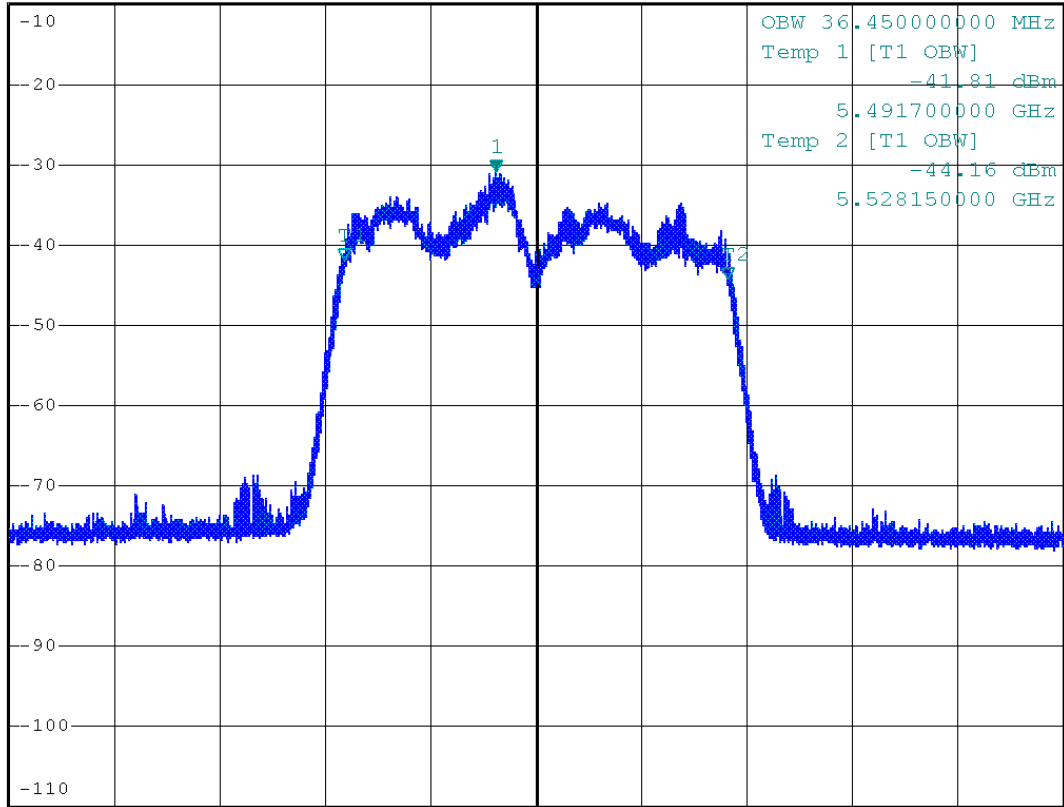

Center 5.51 GHz

10 MHz/

Span 100 MHz

U-NII 99% Channel bandwidth

802.11ac (VHT80)



*RBW 1 MHz Marker 1 [T1]
 *VBW 3 MHz -29.58 dBm
 Ref -10 dBm *Att 0 dB SWT 40 ms 5.507200000 GHz

1 PK
 MAXH

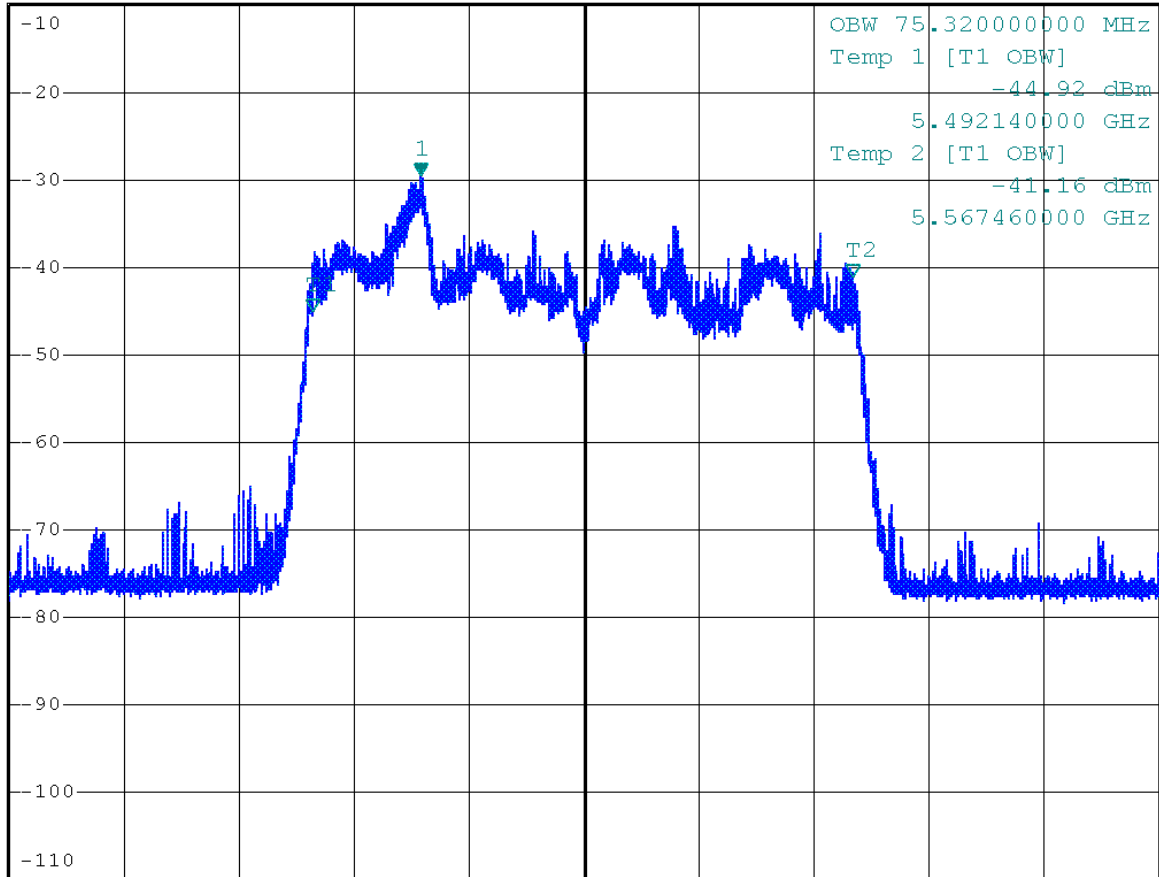

Center 5.53 GHz 16 MHz/ Span 160 MHz

U-NII 99% Channel bandwidth

Detection Bandwidth Test - 802.11ac (VHT20)											
Radar Type 0											
EUT Frequency: 5500MHz											
EUT 99% Power bandwidth: 17.9025MHz											
Detection bandwidth limit (100% of EUT 99% Power bandwidth): 17.9025MHz											
Detection bandwidth (5509(FH) – 5491(FL)) : 18MHz											
Test Result : PASS											
Radar Frequency (Hz)	Trial Number / Detection										Detection Rate (%)
	1	2	3	4	5	6	7	8	9	10	
5.491G(FL)	Yes	No	Yes	Yes	Yes	Yes	Yes	Yes	Yes	Yes	90
5.492G	Yes	Yes	Yes	Yes	Yes	Yes	Yes	Yes	Yes	Yes	100
5.493G	Yes	Yes	Yes	Yes	Yes	Yes	Yes	Yes	Yes	Yes	100
5.494G	Yes	Yes	Yes	Yes	Yes	Yes	Yes	Yes	Yes	Yes	100
5.495G	Yes	Yes	Yes	Yes	Yes	Yes	Yes	Yes	Yes	Yes	100
5.496G	Yes	Yes	Yes	Yes	Yes	Yes	Yes	Yes	Yes	Yes	100
5.497G	Yes	Yes	Yes	Yes	Yes	Yes	Yes	Yes	Yes	Yes	100
5.498G	Yes	Yes	Yes	Yes	Yes	Yes	Yes	Yes	Yes	Yes	100
5.499G	Yes	Yes	Yes	Yes	Yes	Yes	Yes	Yes	Yes	Yes	100
5.500G	Yes	Yes	Yes	Yes	Yes	Yes	Yes	Yes	Yes	Yes	100
5.501G	Yes	Yes	Yes	Yes	Yes	Yes	Yes	Yes	Yes	Yes	100
5.502G	Yes	Yes	Yes	Yes	Yes	Yes	Yes	Yes	Yes	Yes	100
5.503G	Yes	Yes	Yes	Yes	Yes	Yes	Yes	Yes	Yes	Yes	100
5.504G	Yes	Yes	Yes	Yes	Yes	Yes	Yes	Yes	Yes	Yes	100
5.505G	Yes	Yes	Yes	Yes	Yes	Yes	Yes	Yes	Yes	Yes	100
5.506G	Yes	Yes	Yes	Yes	Yes	Yes	Yes	Yes	Yes	Yes	100
5.507G	No	Yes	Yes	Yes	Yes	Yes	Yes	Yes	Yes	Yes	90
5.508G	Yes	Yes	Yes	Yes	Yes	Yes	Yes	Yes	Yes	Yes	100
5.509G(FH)	Yes	No	Yes	Yes	Yes	Yes	Yes	Yes	Yes	Yes	90

Detection Bandwidth Test - 802.11ac (VHT40)											
Radar Type 0											
EUT Frequency: 5510MHz											
EUT 99% Power bandwidth: 36.45MHz											
Detection bandwidth limit (100% of EUT 99% Power bandwidth): 36.45MHz											
Detection bandwidth (5529(FH) – 5491(FL)) : 38MHz											
Test Result : PASS											
Radar Frequency (Hz)	Trial Number / Detection										Detection Rate (%)
	1	2	3	4	5	6	7	8	9	10	
5.491G(FL)	Yes	No	Yes	Yes	Yes	Yes	Yes	Yes	Yes	Yes	90
5.492G	Yes	Yes	Yes	Yes	Yes	Yes	Yes	Yes	Yes	Yes	100
5.493G	Yes	Yes	Yes	Yes	Yes	Yes	Yes	Yes	Yes	Yes	100
5.494G	Yes	Yes	Yes	Yes	Yes	Yes	Yes	Yes	Yes	Yes	100
5.495G	Yes	Yes	Yes	Yes	Yes	Yes	Yes	Yes	Yes	Yes	100
5.496G	Yes	Yes	Yes	Yes	Yes	Yes	Yes	Yes	Yes	Yes	100
5.497G	Yes	Yes	Yes	Yes	Yes	Yes	Yes	Yes	Yes	Yes	100
5.498G	Yes	Yes	Yes	Yes	Yes	Yes	Yes	Yes	Yes	Yes	100
5.499G	Yes	Yes	Yes	Yes	Yes	Yes	Yes	Yes	Yes	Yes	100
5.500G	Yes	Yes	Yes	Yes	Yes	Yes	Yes	Yes	Yes	Yes	100
5.501G	Yes	Yes	Yes	Yes	Yes	Yes	Yes	Yes	Yes	Yes	100
5.502G	Yes	Yes	Yes	Yes	Yes	Yes	Yes	Yes	Yes	Yes	100
5.503G	Yes	Yes	Yes	Yes	Yes	Yes	Yes	Yes	Yes	Yes	100
5.504G	Yes	Yes	Yes	Yes	Yes	Yes	Yes	Yes	Yes	Yes	100
5.505G	Yes	Yes	Yes	Yes	Yes	Yes	Yes	Yes	Yes	Yes	100
5.506G	Yes	Yes	Yes	Yes	Yes	Yes	Yes	Yes	Yes	Yes	100
5.507G	Yes	Yes	Yes	Yes	Yes	Yes	Yes	Yes	Yes	Yes	100
5.508G	Yes	Yes	Yes	Yes	Yes	Yes	Yes	Yes	Yes	Yes	100
5.509G	Yes	Yes	Yes	Yes	Yes	Yes	Yes	Yes	Yes	Yes	100
5.510G	Yes	Yes	Yes	Yes	Yes	Yes	Yes	Yes	Yes	Yes	100
5.511G	Yes	Yes	Yes	Yes	Yes	Yes	Yes	Yes	Yes	Yes	100
5.512G	Yes	Yes	Yes	Yes	Yes	Yes	Yes	Yes	Yes	Yes	100
5.513G	Yes	Yes	Yes	Yes	Yes	Yes	Yes	Yes	Yes	Yes	100
5.514G	Yes	Yes	Yes	Yes	Yes	Yes	Yes	Yes	Yes	Yes	100
5.515G	Yes	Yes	Yes	Yes	Yes	Yes	Yes	Yes	Yes	Yes	100
5.516G	Yes	Yes	Yes	Yes	Yes	Yes	Yes	Yes	Yes	Yes	100
5.517G	Yes	Yes	Yes	Yes	Yes	Yes	Yes	Yes	Yes	Yes	100
5.518G	Yes	Yes	Yes	Yes	Yes	Yes	Yes	Yes	Yes	Yes	100
5.519G	Yes	Yes	Yes	Yes	Yes	Yes	Yes	Yes	Yes	Yes	100
5.520G	Yes	Yes	Yes	Yes	Yes	Yes	Yes	Yes	Yes	Yes	100
5.521G	Yes	Yes	Yes	Yes	Yes	Yes	Yes	Yes	Yes	Yes	100
5.522G	Yes	Yes	Yes	Yes	Yes	Yes	Yes	Yes	Yes	Yes	100
5.523G	Yes	Yes	Yes	Yes	Yes	Yes	Yes	Yes	Yes	Yes	100
5.524G	Yes	Yes	Yes	Yes	Yes	Yes	Yes	Yes	Yes	Yes	100
5.525G	Yes	Yes	Yes	Yes	Yes	Yes	Yes	Yes	Yes	Yes	100
5.526G	Yes	Yes	Yes	Yes	Yes	Yes	Yes	Yes	Yes	Yes	100
5.527G	Yes	Yes	Yes	Yes	Yes	Yes	Yes	Yes	Yes	Yes	100
5.528G	Yes	Yes	No	Yes	Yes	Yes	Yes	Yes	Yes	Yes	90
5.529G(FH)	Yes	Yes	Yes	Yes	Yes	Yes	Yes	Yes	No	Yes	90

Detection Bandwidth Test - 802.11ac (VHT80)											
Radar Type 0											
EUT Frequency: 5530MHz											
EUT 99% Power bandwidth: 75.32MHz											
Detection bandwidth limit (100% of EUT 99% Power bandwidth): 75.32MHz											
Detection bandwidth (5568(FH) – 5492(FL)) : 76MHz											
Test Result : PASS											
Radar Frequency (Hz)	Trial Number / Detection										Detection Rate (%)
	1	2	3	4	5	6	7	8	9	10	
5.492G(FL)	Yes	No	Yes	Yes	Yes	Yes	Yes	Yes	Yes	Yes	90
5.493G	Yes	Yes	Yes	Yes	Yes	Yes	Yes	Yes	Yes	Yes	100
5.494G	Yes	Yes	Yes	Yes	Yes	Yes	Yes	Yes	Yes	Yes	100
5.495G	Yes	Yes	Yes	Yes	Yes	Yes	Yes	Yes	Yes	Yes	100
5.496G	Yes	Yes	Yes	Yes	Yes	Yes	Yes	Yes	Yes	Yes	100
5.497G	Yes	Yes	Yes	Yes	Yes	Yes	Yes	Yes	Yes	Yes	100
5.498G	Yes	Yes	Yes	Yes	Yes	Yes	Yes	Yes	Yes	Yes	100
5.499G	Yes	Yes	Yes	Yes	Yes	Yes	Yes	Yes	Yes	Yes	100
5.500G	Yes	Yes	Yes	Yes	Yes	Yes	Yes	Yes	Yes	Yes	100
5.501G	Yes	Yes	Yes	Yes	Yes	Yes	Yes	Yes	Yes	Yes	100
5.502G	Yes	Yes	Yes	Yes	Yes	Yes	Yes	Yes	Yes	Yes	100
5.503G	Yes	Yes	Yes	Yes	Yes	Yes	Yes	Yes	Yes	Yes	100
5.504G	Yes	Yes	Yes	Yes	Yes	Yes	Yes	Yes	Yes	Yes	100
5.505G	Yes	Yes	Yes	Yes	Yes	Yes	Yes	Yes	Yes	Yes	100
5.506G	Yes	Yes	Yes	Yes	Yes	Yes	Yes	Yes	Yes	Yes	100
5.507G	Yes	Yes	Yes	Yes	Yes	Yes	Yes	Yes	Yes	Yes	100
5.508G	Yes	Yes	Yes	Yes	Yes	Yes	Yes	Yes	Yes	Yes	100
5.509G	Yes	Yes	Yes	Yes	Yes	Yes	Yes	Yes	Yes	Yes	100
5.510G	Yes	Yes	Yes	Yes	Yes	Yes	Yes	Yes	Yes	Yes	100
5.511G	Yes	Yes	Yes	Yes	Yes	Yes	Yes	Yes	Yes	Yes	100
5.512G	Yes	Yes	Yes	Yes	Yes	Yes	Yes	Yes	Yes	Yes	100
5.513G	Yes	Yes	Yes	Yes	Yes	Yes	Yes	Yes	Yes	Yes	100
5.514G	Yes	Yes	Yes	Yes	Yes	Yes	Yes	Yes	Yes	Yes	100
5.515G	Yes	Yes	Yes	Yes	Yes	Yes	Yes	Yes	Yes	Yes	100
5.516G	Yes	Yes	Yes	Yes	Yes	Yes	Yes	Yes	Yes	Yes	100
5.517G	Yes	Yes	Yes	Yes	Yes	Yes	Yes	Yes	Yes	Yes	100
5.518G	Yes	Yes	Yes	Yes	Yes	Yes	Yes	Yes	Yes	Yes	100
5.519G	Yes	Yes	Yes	Yes	Yes	Yes	Yes	Yes	Yes	Yes	100
5.520G	Yes	Yes	Yes	Yes	Yes	Yes	Yes	Yes	Yes	Yes	100
5.521G	Yes	Yes	Yes	Yes	Yes	Yes	Yes	Yes	Yes	Yes	100
5.522G	Yes	Yes	Yes	Yes	Yes	Yes	Yes	Yes	Yes	Yes	100
5.523G	Yes	Yes	Yes	Yes	Yes	Yes	Yes	Yes	Yes	Yes	100
5.524G	Yes	Yes	Yes	Yes	Yes	Yes	Yes	Yes	Yes	Yes	100
5.525G	Yes	Yes	Yes	Yes	Yes	Yes	Yes	Yes	Yes	Yes	100
5.526G	Yes	Yes	Yes	Yes	Yes	Yes	Yes	Yes	Yes	Yes	100
5.527G	Yes	Yes	Yes	Yes	Yes	Yes	Yes	Yes	Yes	Yes	100
5.528G	Yes	Yes	Yes	Yes	Yes	Yes	Yes	Yes	Yes	Yes	100
5.529G	Yes	Yes	Yes	Yes	Yes	Yes	Yes	Yes	Yes	Yes	100
5.530G	Yes	Yes	Yes	Yes	Yes	Yes	Yes	Yes	Yes	Yes	100
5.531G	Yes	Yes	Yes	Yes	Yes	Yes	Yes	Yes	Yes	Yes	100
5.532G	Yes	Yes	Yes	Yes	Yes	Yes	Yes	Yes	Yes	Yes	100
5.533G	Yes	Yes	Yes	Yes	Yes	Yes	Yes	Yes	Yes	Yes	100
5.534G	Yes	Yes	Yes	Yes	Yes	Yes	Yes	Yes	Yes	Yes	100
5.535G	Yes	Yes	Yes	Yes	Yes	Yes	Yes	Yes	Yes	Yes	100
5.536G	Yes	Yes	Yes	Yes	Yes	Yes	Yes	Yes	Yes	Yes	100

5.537G	Yes	Yes	Yes	Yes	Yes	Yes	Yes	Yes	Yes	Yes	100
5.538G	Yes	Yes	Yes	Yes	Yes	Yes	Yes	Yes	Yes	Yes	100
5.539G	Yes	Yes	Yes	Yes	Yes	Yes	Yes	Yes	Yes	Yes	100
5.540G	Yes	Yes	Yes	Yes	Yes	Yes	Yes	Yes	Yes	Yes	100
5.541G	Yes	Yes	Yes	Yes	Yes	Yes	Yes	Yes	Yes	Yes	100
5.542G	Yes	Yes	Yes	Yes	Yes	Yes	Yes	Yes	Yes	Yes	100
5.543G	Yes	Yes	Yes	Yes	Yes	Yes	Yes	Yes	Yes	Yes	100
5.544G	Yes	Yes	Yes	Yes	Yes	Yes	Yes	Yes	Yes	Yes	100
5.545G	Yes	Yes	Yes	Yes	Yes	Yes	Yes	Yes	Yes	Yes	100
5.546G	Yes	Yes	Yes	Yes	Yes	Yes	Yes	Yes	Yes	Yes	100
5.547G	Yes	Yes	Yes	Yes	Yes	Yes	Yes	Yes	Yes	Yes	100
5.548G	Yes	Yes	Yes	Yes	Yes	Yes	Yes	Yes	Yes	Yes	100
5.549G	Yes	Yes	Yes	Yes	Yes	Yes	Yes	Yes	Yes	Yes	100
5.550G	Yes	Yes	Yes	Yes	Yes	Yes	Yes	Yes	Yes	Yes	100
5.551G	Yes	Yes	Yes	Yes	Yes	Yes	Yes	Yes	Yes	Yes	100
5.552G	Yes	Yes	Yes	Yes	Yes	Yes	Yes	Yes	Yes	Yes	100
5.553G	Yes	Yes	Yes	Yes	Yes	Yes	Yes	Yes	Yes	Yes	100
5.554G	Yes	Yes	Yes	Yes	Yes	Yes	Yes	Yes	Yes	Yes	100
5.555G	Yes	Yes	Yes	Yes	Yes	Yes	Yes	Yes	Yes	Yes	100
5.556G	Yes	Yes	Yes	Yes	Yes	Yes	Yes	Yes	Yes	Yes	100
5.557G	Yes	Yes	Yes	Yes	Yes	Yes	Yes	Yes	Yes	Yes	100
5.558G	Yes	Yes	Yes	Yes	Yes	Yes	Yes	Yes	Yes	Yes	100
5.559G	Yes	Yes	Yes	Yes	Yes	Yes	Yes	Yes	Yes	Yes	100
5.560G	Yes	Yes	Yes	Yes	Yes	Yes	Yes	Yes	Yes	Yes	100
5.561G	Yes	Yes	Yes	Yes	Yes	Yes	Yes	Yes	Yes	Yes	100
5.562G	Yes	Yes	Yes	Yes	Yes	Yes	Yes	Yes	Yes	Yes	100
5.563G	Yes	Yes	Yes	Yes	Yes	Yes	Yes	Yes	Yes	Yes	100
5.564G	Yes	Yes	Yes	Yes	Yes	Yes	Yes	Yes	Yes	Yes	100
5.565G	Yes	Yes	Yes	Yes	Yes	Yes	Yes	Yes	Yes	Yes	100
5.566G	Yes	Yes	Yes	Yes	Yes	Yes	Yes	Yes	Yes	Yes	100
5.567G	Yes	Yes	Yes	Yes	Yes	Yes	Yes	Yes	Yes	Yes	100
5.568G(FH)	Yes	Yes	Yes	Yes	Yes	Yes	Yes	Yes	Yes	Yes	100

6.2.3 Channel Availability Check Time

If the EUT successfully detected the radar burst, it should be observed as the EUT has no transmissions occurred until the EUT starts transmitting on another channel.

Timing of Radar Signal	Observation	
	EUT	Spectrum Analyzer
Within 1 to 6 second	Detected	No transmissions
Within 54 to 60 second	Detected	No transmissions

Initial Channel Availability Check Time

Radio1

Channel Availability Check @CH106-5530MHz

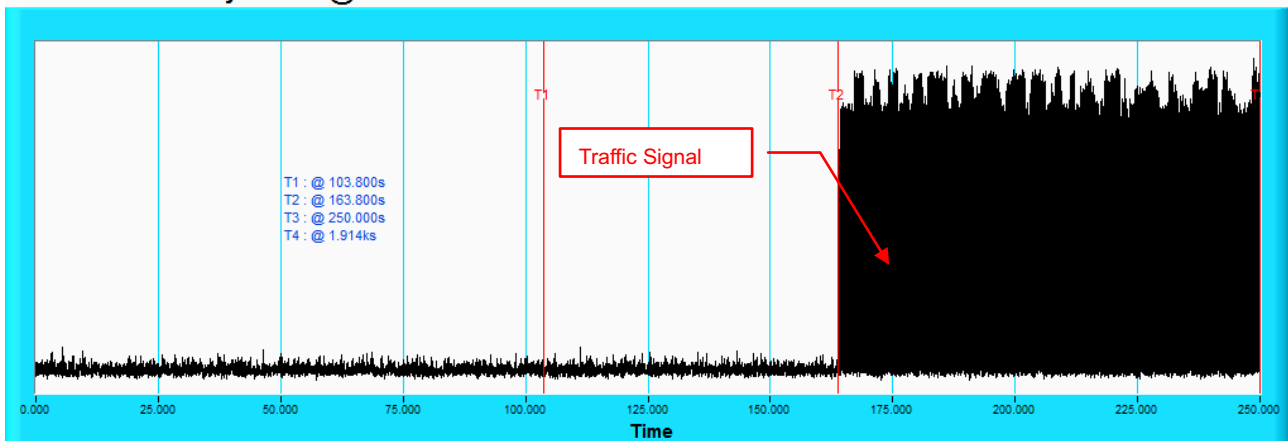

NOTE: T1 denotes the end of power-up time period is 103.8th second. T2 denotes the end of Channel Availability Check time is 163.8th second. Channel Availability Check time is equal to (T2 – T1) 60 seconds.

Radar Burst at the Beginning of the Channel Availability Check Time

Channel Availability Check @CH106-5530MHz

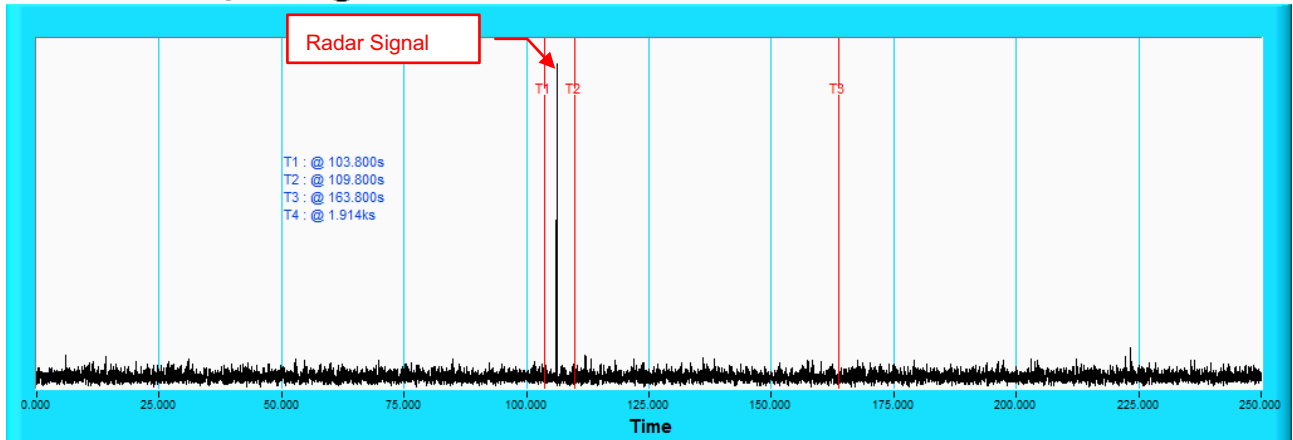

NOTE: T1 denotes the end of power up time period is 103.8th second. T2 denotes 109.8th second and the radar burst was commenced within a 6 second window starting from the end of power-up sequence. T3 denotes the 163.8th second.

Radar Burst at the End of the Channel Availability Check Time

Channel Availability Check @CH106-5530MHz

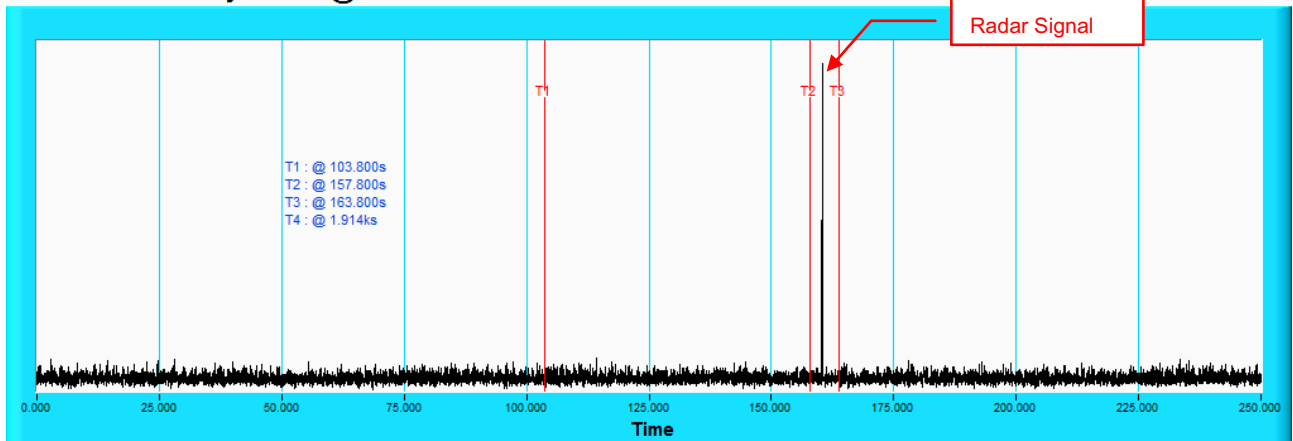

NOTE: T1 denotes the end of power up time period is 103.8th second. T2 denotes 157.8th second and the radar burst was commenced within 157.8th second to 163.8th second window starting from the end of power-up sequence. T3 denotes the 163.8th second.

Radio2

Channel Availability Check @CH106-5530MHz

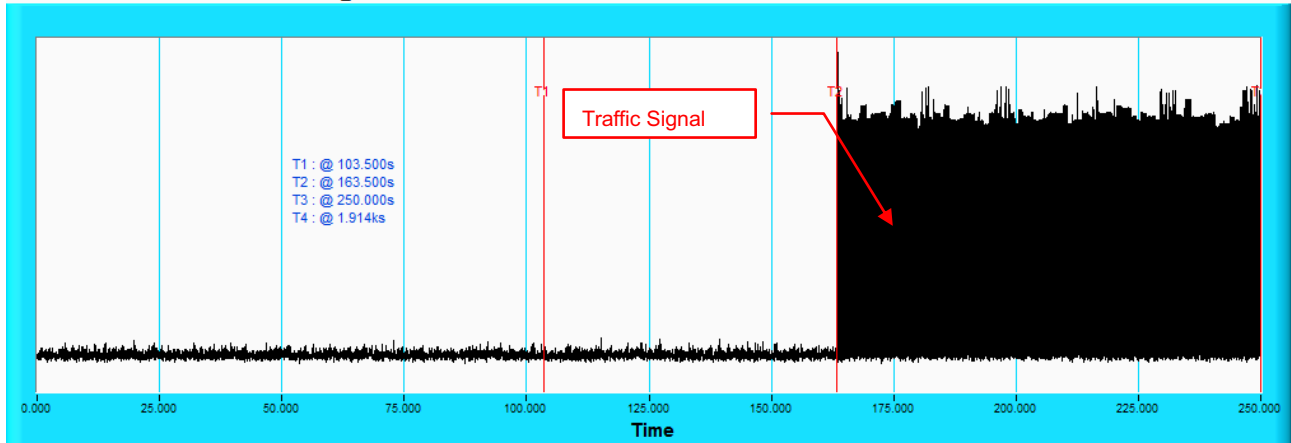

NOTE: T1 denotes the end of power-up time period is 103.5th second. T2 denotes the end of Channel Availability Check time is 163.5th second. Channel Availability Check time is equal to (T2 – T1) 60 seconds.

Radar Burst at the Beginning of the Channel Availability Check Time

Channel Availability Check @CH106-5530MHz

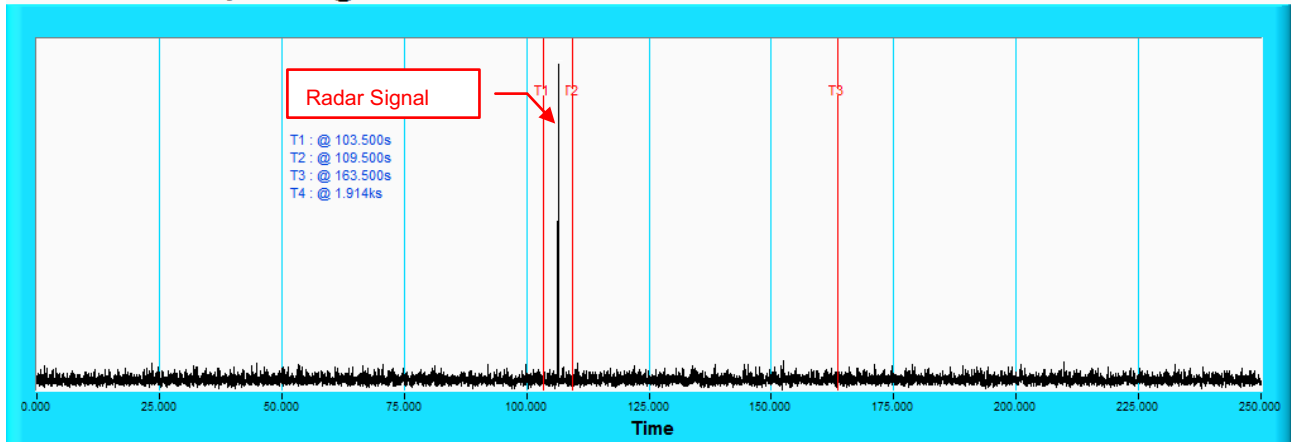

NOTE: T1 denotes the end of power up time period is 103.5th second. T2 denotes 109.5th second and the radar burst was commenced within a 6 second window starting from the end of power-up sequence. T3 denotes the 163.5th second.

Radar Burst at the End of the Channel Availability Check Time

Channel Availability Check @CH106-5530MHz

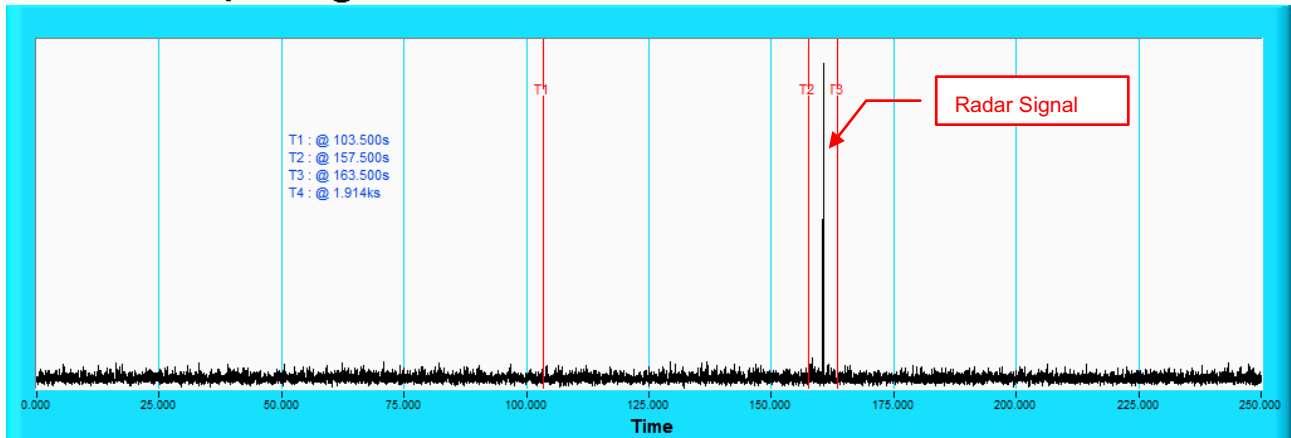

NOTE: T1 denotes the end of power up time period is 103.5th second. T2 denotes 157.5th second and the radar burst was commenced within 157.5th second to 163.5th second window starting from the end of power-up sequence. T3 denotes the 163.5th second.

6.2.4 Channel Closing Transmission and Channel Move Time

Wireless Traffic Loading 802.11ac (VHT20) Duty Cycle

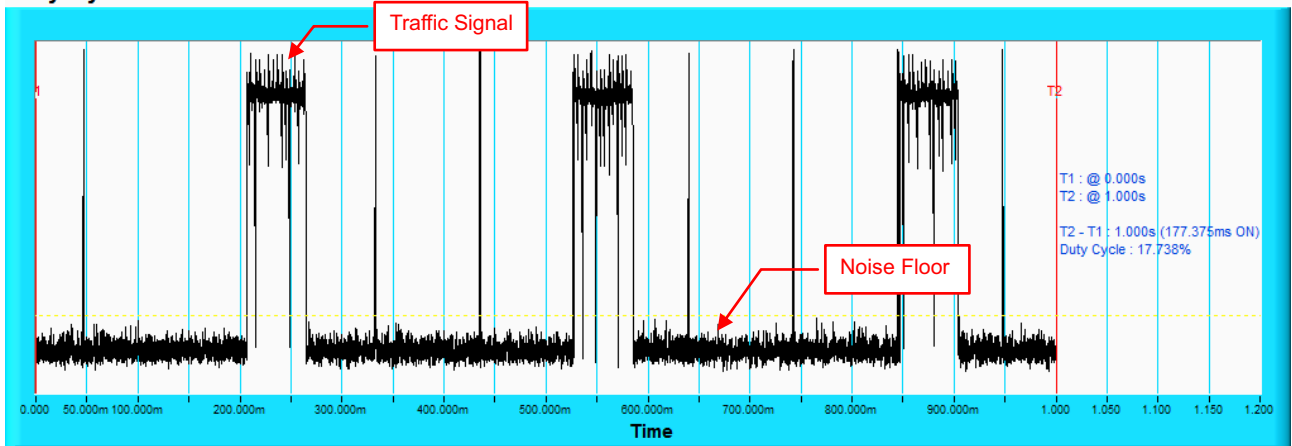

802.11ac (VHT40) Duty Cycle

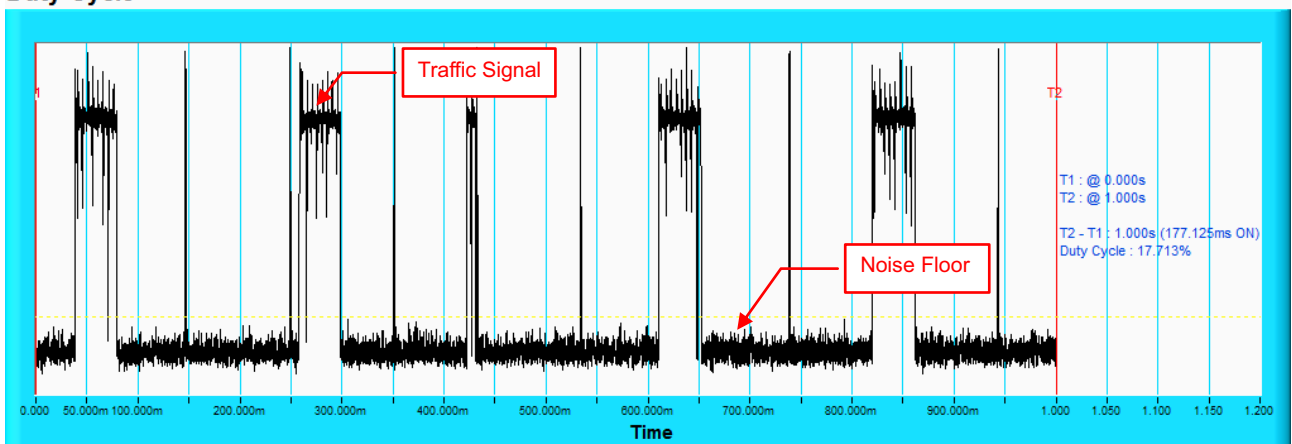

802.11ac (VHT80) Duty Cycle

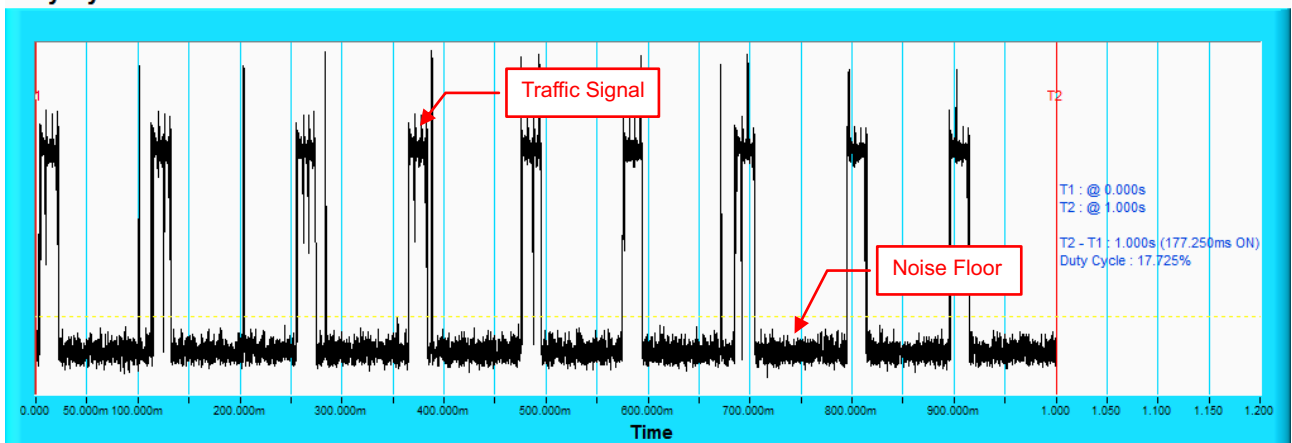

**Radio1
802.11ac (VHT20)**

Table 1: Short Pulse Radar Test Waveforms.

Radar Type	Pulse Width (µsec)	PRI (µsec)	Number of Pulses	Number of Trials(Times)	Percentage of Successful Detection (%)
1	Test A: 15 unique PRI values randomly selected from the list of 23 PRI values in Table 5a ----- Test B: 15 unique PRI values randomly selected within the range of 518-3066 µ sec, with a minimum increment of 1 µ sec, excluding PRI values selected in Test A	$\text{Roundup} \left\{ \begin{array}{l} \left(\frac{1}{360} \right) \cdot \\ \left(\frac{19 \cdot 10^6}{\text{PRI}_{\mu \text{ sec}}} \right) \end{array} \right\}$	18	30	90
2	1-5	150-230	23-29	30	93.3
3	6-10	200-500	16-18	30	90
4	11-20	200-500	12-16	30	86.7
Aggregate (Radar Types 1-4)				120	90

Table 2: Long Pulse Radar Test Waveform

Radar Type	Pulse Width (µsec)	Chirp Width (MHz)	PRI (µsec)	Number of Pulses per Burst	Number of Bursts	Number of Trials(Times)	Percentage of Successful Detection (%)
5	50-100	5-20	1000-2000	1-3	8-20	30	86.7

Table 3: Frequency Hopping Radar Test Waveform

Radar Type	Pulse Width (μsec)	PRI (μsec)	Pulses per Hop	Hopping Rate (kHz)	Hopping Sequence Length (msec)	Number of Trials(Times)	Percentage of Successful Detection (%)
6	1	333	9	0.333	300	30	90

802.11ac (VHT40)

Table 1: Short Pulse Radar Test Waveforms.

Radar Type	Pulse Width (µsec)	PRI (µsec)	Number of Pulses	Number of Trials(Times)	Percentage of Successful Detection (%)
1	Test A: 15 unique PRI values randomly selected from the list of 23 PRI values in Table 5a ----- Test B: 15 unique PRI values randomly selected within the range of 518-3066 µ sec, with a minimum increment of 1 µ sec, excluding PRI values selected in Test A	$\left. \begin{array}{l} \frac{1}{360} \\ 19 \cdot 10^6 \\ \text{PRI}_{\mu \text{ sec}} \end{array} \right\} \text{Roundup}$	18	30	93.3
2	1-5	150-230	23-29	30	90
3	6-10	200-500	16-18	30	90
4	11-20	200-500	12-16	30	86.7
Aggregate (Radar Types 1-4)				120	90

Table 2: Long Pulse Radar Test Waveform

Radar Type	Pulse Width (µsec)	Chirp Width (MHz)	PRI (µsec)	Number of Pulses per Burst	Number of Bursts	Number of Trials(Times)	Percentage of Successful Detection (%)
5	50-100	5-20	1000-2000	1-3	8-20	30	90

Table 3: Frequency Hopping Radar Test Waveform

Radar Type	Pulse Width (μsec)	PRI (μsec)	Pulses per Hop	Hopping Rate (kHz)	Hopping Sequence Length (msec)	Number of Trials(Times)	Percentage of Successful Detection (%)
6	1	333	9	0.333	300	30	90

802.11ac (VHT80)

Table 1: Short Pulse Radar Test Waveforms.

Radar Type	Pulse Width (µsec)	PRI (µsec)	Number of Pulses	Number of Trials(Times)	Percentage of Successful Detection (%)
1	Test A: 15 unique PRI values randomly selected from the list of 23 PRI values in Table 5a ----- Test B: 15 unique PRI values randomly selected within the range of 518-3066 µ sec, with a minimum increment of 1 µ sec, excluding PRI values selected in Test A	$\text{Roundup} \left\{ \begin{array}{l} \left(\frac{1}{360} \right) \cdot \\ \left(\frac{19 \cdot 10^6}{\text{PRI}_{\mu \text{ sec}}} \right) \end{array} \right\}$	18	30	90
2	1-5	150-230	23-29	30	86.7
3	6-10	200-500	16-18	30	90
4	11-20	200-500	12-16	30	86.7
Aggregate (Radar Types 1-4)				120	88.3

Table 2: Long Pulse Radar Test Waveform

Radar Type	Pulse Width (µsec)	Chirp Width (MHz)	PRI (µsec)	Number of Pulses per Burst	Number of Bursts	Number of Trials(Times)	Percentage of Successful Detection (%)
5	50-100	5-20	1000-2000	1-3	8-20	30	86.7

Table 3: Frequency Hopping Radar Test Waveform

Radar Type	Pulse Width (μsec)	PRI (μsec)	Pulses per Hop	Hopping Rate (kHz)	Hopping Sequence Length (msec)	Number of Trials(Times)	Percentage of Successful Detection (%)
6	1	333	9	0.333	300	30	90

Radio2
802.11ac (VHT20)

Table 1: Short Pulse Radar Test Waveforms.

Radar Type	Pulse Width (µsec)	PRI (µsec)	Number of Pulses	Number of Trials(Times)	Percentage of Successful Detection (%)
1	<p>Test A: 15 unique PRI values randomly selected from the list of 23 PRI values in Table 5a</p> <p>-----</p> <p>Test B: 15 unique PRI values randomly selected within the range of 518-3066 µ sec, with a minimum increment of 1 µ sec, excluding PRI values selected in Test A</p>	$\text{Roundup} \left\{ \begin{array}{l} \left(\frac{1}{360} \right) \cdot \\ \left(\frac{19 \cdot 10^6}{\text{PRI}_{\mu \text{ sec}}} \right) \end{array} \right\}$	18	30	90
2	1-5	150-230	23-29	30	90
3	6-10	200-500	16-18	30	83.3
4	11-20	200-500	12-16	30	86.7
Aggregate (Radar Types 1-4)				120	87.5

Table 2: Long Pulse Radar Test Waveform

Radar Type	Pulse Width (µsec)	Chirp Width (MHz)	PRI (µsec)	Number of Pulses per Burst	Number of Bursts	Number of Trials(Times)	Percentage of Successful Detection (%)
5	50-100	5-20	1000-2000	1-3	8-20	30	90

Table 3: Frequency Hopping Radar Test Waveform

Radar Type	Pulse Width (μsec)	PRI (μsec)	Pulses per Hop	Hopping Rate (kHz)	Hopping Sequence Length (msec)	Number of Trials(Times)	Percentage of Successful Detection (%)
6	1	333	9	0.333	300	30	93.3

802.11ac (VHT40)

Table 1: Short Pulse Radar Test Waveforms.

Radar Type	Pulse Width (µsec)	PRI (µsec)	Number of Pulses	Number of Trials(Times)	Percentage of Successful Detection (%)
1	<p>Test A: 15 unique PRI values randomly selected from the list of 23 PRI values in Table 5a</p> <p>-----</p> <p>Test B: 15 unique PRI values randomly selected within the range of 518-3066 µ sec, with a minimum increment of 1 µ sec, excluding PRI values selected in Test A</p>	$\left. \begin{array}{l} \frac{1}{360} \\ \text{Roundup} \\ \frac{19 \cdot 10^6}{\text{PRI}_{\mu \text{ sec}}} \end{array} \right\}$	18	30	90
2	1-5	150-230	23-29	30	86.7
3	6-10	200-500	16-18	30	86.7
4	11-20	200-500	12-16	30	90
Aggregate (Radar Types 1-4)				120	88.3

Table 2: Long Pulse Radar Test Waveform

Radar Type	Pulse Width (µsec)	Chirp Width (MHz)	PRI (µsec)	Number of Pulses per Burst	Number of Bursts	Number of Trials(Times)	Percentage of Successful Detection (%)
5	50-100	5-20	1000-2000	1-3	8-20	30	93.3

Table 3: Frequency Hopping Radar Test Waveform

Radar Type	Pulse Width (μsec)	PRI (μsec)	Pulses per Hop	Hopping Rate (kHz)	Hopping Sequence Length (msec)	Number of Trials(Times)	Percentage of Successful Detection (%)
6	1	333	9	0.333	300	30	90

802.11ac (VHT80)

Table 1: Short Pulse Radar Test Waveforms.

Radar Type	Pulse Width (µsec)	PRI (µsec)	Number of Pulses	Number of Trials(Times)	Percentage of Successful Detection (%)
1	Test A: 15 unique PRI values randomly selected from the list of 23 PRI values in Table 5a ----- Test B: 15 unique PRI values randomly selected within the range of 518-3066 µ sec, with a minimum increment of 1 µ sec, excluding PRI values selected in Test A	$\text{Roundup} \left\{ \begin{array}{l} \left(\frac{1}{360} \right) \cdot \\ \left(\frac{19 \cdot 10^6}{\text{PRI}_{\mu \text{ sec}}} \right) \end{array} \right\}$	18	30	90
2	1-5	150-230	23-29	30	90
3	6-10	200-500	16-18	30	86.7
4	11-20	200-500	12-16	30	76.7
Aggregate (Radar Types 1-4)				120	85.8

Table 2: Long Pulse Radar Test Waveform

Radar Type	Pulse Width (µsec)	Chirp Width (MHz)	PRI (µsec)	Number of Pulses per Burst	Number of Bursts	Number of Trials(Times)	Percentage of Successful Detection (%)
5	50-100	5-20	1000-2000	1-3	8-20	30	90

Table 3: Frequency Hopping Radar Test Waveform

Radar Type	Pulse Width (μsec)	PRI (μsec)	Pulses per Hop	Hopping Rate (kHz)	Hopping Sequence Length (msec)	Number of Trials(Times)	Percentage of Successful Detection (%)
6	1	333	9	0.333	300	30	90

Radio1
 Radar signal 0
 802.11ac (VHT80)
 Channel Closing Transmission Time & Channel Move Time @CH106-5530MHz

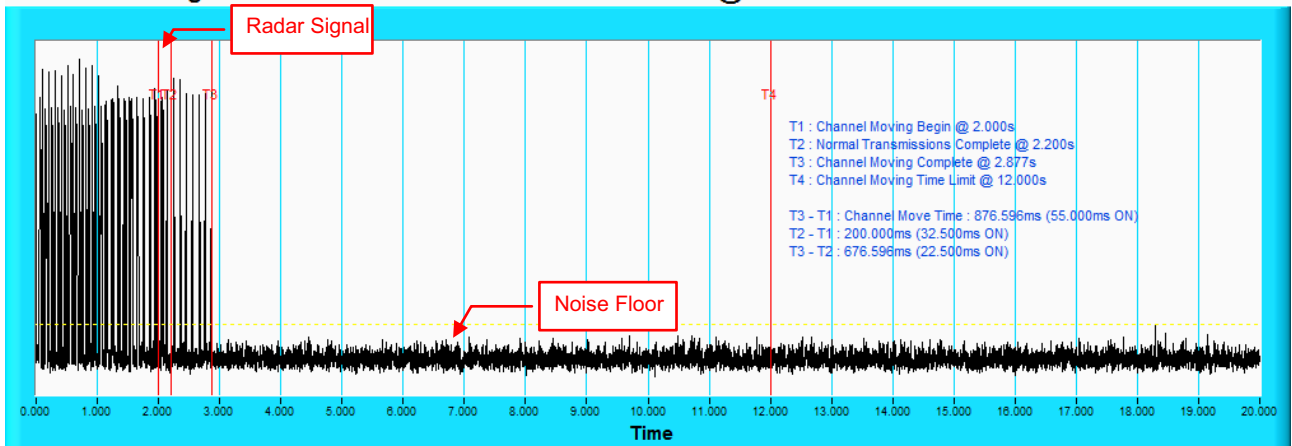

NOTE: T1 denotes the start of Channel Move Time upon the end of the last Radar burst. T2 denotes the data transmission time of 200ms from T1. T3 denotes the end of Channel Move Time. T4 denotes the 10 second from T1 to observe the aggregate duration of transmissions.

Channel Closing Transmission Time & Channel Move Time @CH106-5530MHz

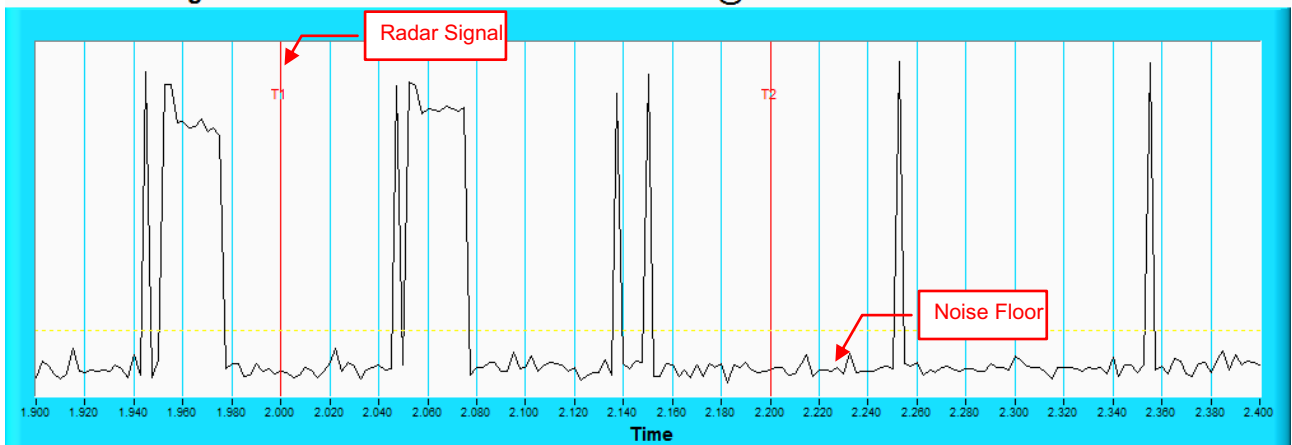

NOTE: Zoom in of the first 500ms after radar signal applied.

**Radar signal 1
802.11ac (VHT80)**

Channel Closing Transmission Time & Channel Move Time @CH106-5530MHz

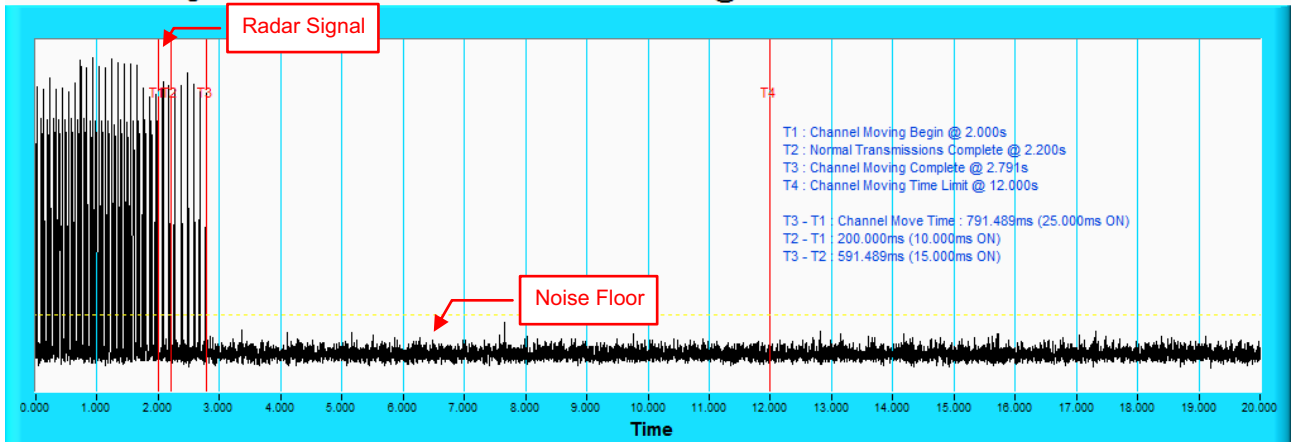

NOTE: T1 denotes the start of Channel Move Time upon the end of the last Radar burst. T2 denotes the data transmission time of 200ms from T1. T3 denotes the end of Channel Move Time. T4 denotes the 10 second from T1 to observe the aggregate duration of transmissions.

Channel Closing Transmission Time & Channel Move Time @CH106-5530MHz

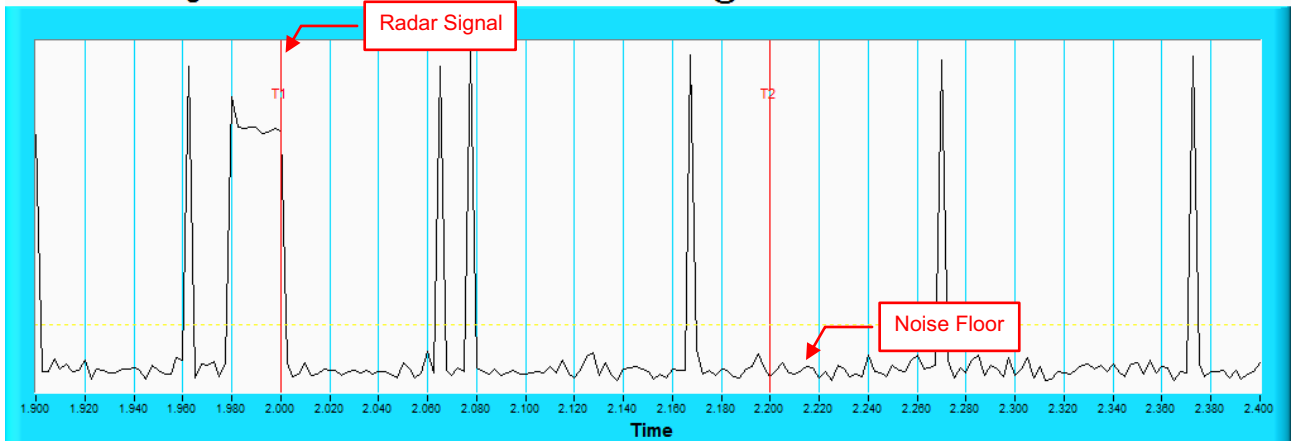

NOTE: Zoom in of the first 500ms after radar signal applied.

**Radar signal 2
802.11ac (VHT80)**

Channel Closing Transmission Time & Channel Move Time @CH106-5530MHz

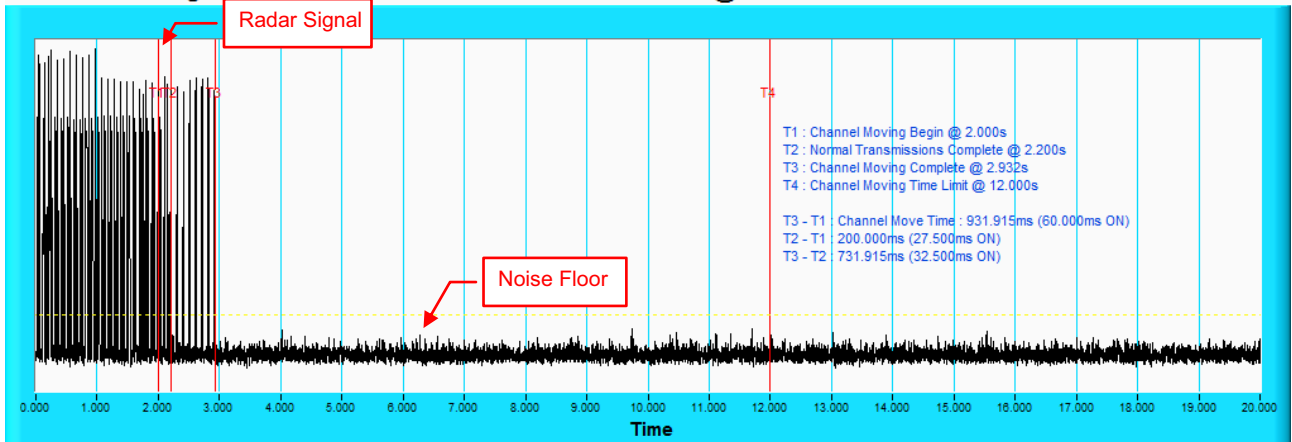

NOTE: T1 denotes the start of Channel Move Time upon the end of the last Radar burst. T2 denotes the data transmission time of 200ms from T1. T3 denotes the end of Channel Move Time. T4 denotes the 10 second from T1 to observe the aggregate duration of transmissions.

Channel Closing Transmission Time & Channel Move Time @CH106-5530MHz

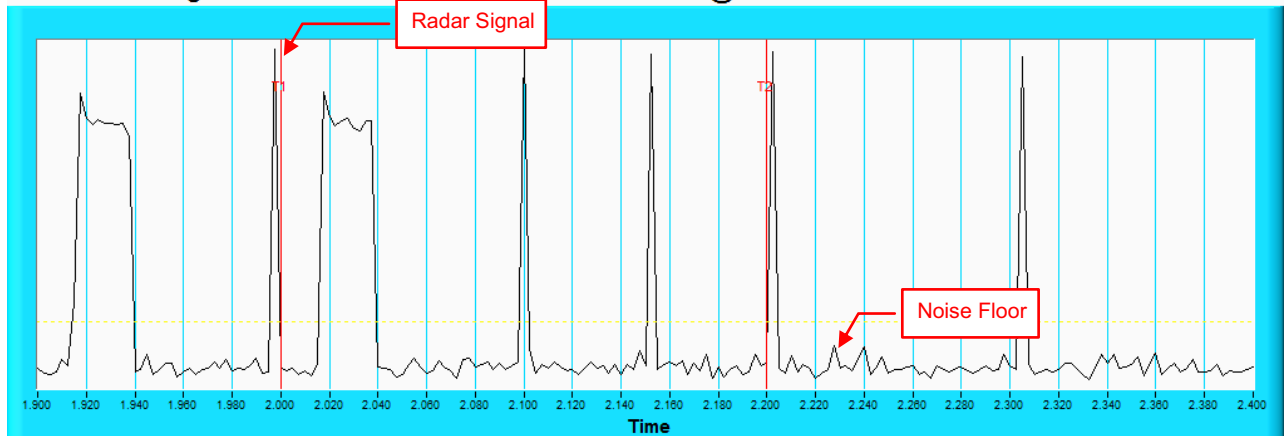

NOTE: Zoom in of the first 500ms after radar signal applied.

Radar signal 3
802.11ac (VHT80)
Channel Closing Transmission Time & Channel Move Time @CH106-5530MHz

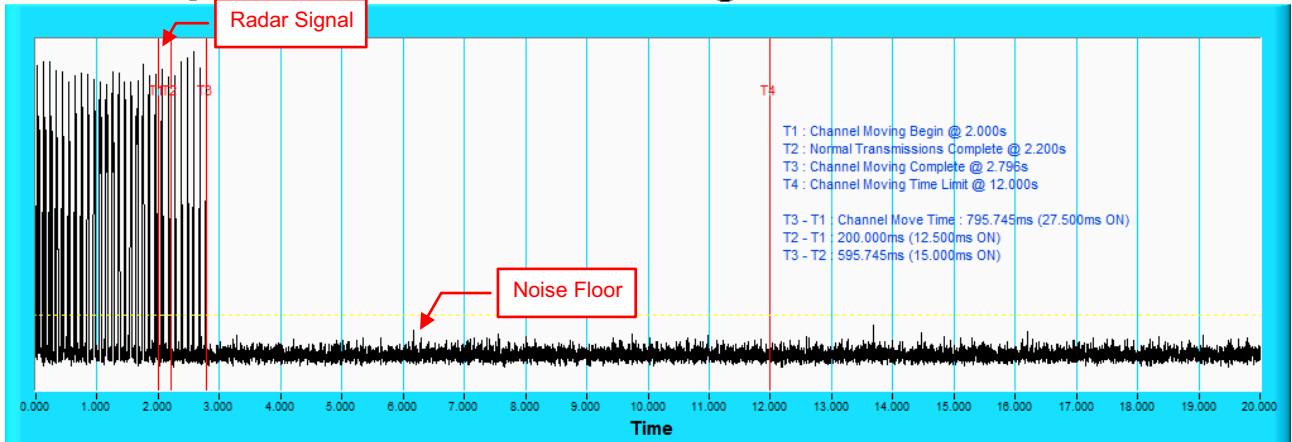

NOTE: T1 denotes the start of Channel Move Time upon the end of the last Radar burst. T2 denotes the data transmission time of 200ms from T1. T3 denotes the end of Channel Move Time. T4 denotes the 10 second from T1 to observe the aggregate duration of transmissions.

Channel Closing Transmission Time & Channel Move Time @CH106-5530MHz

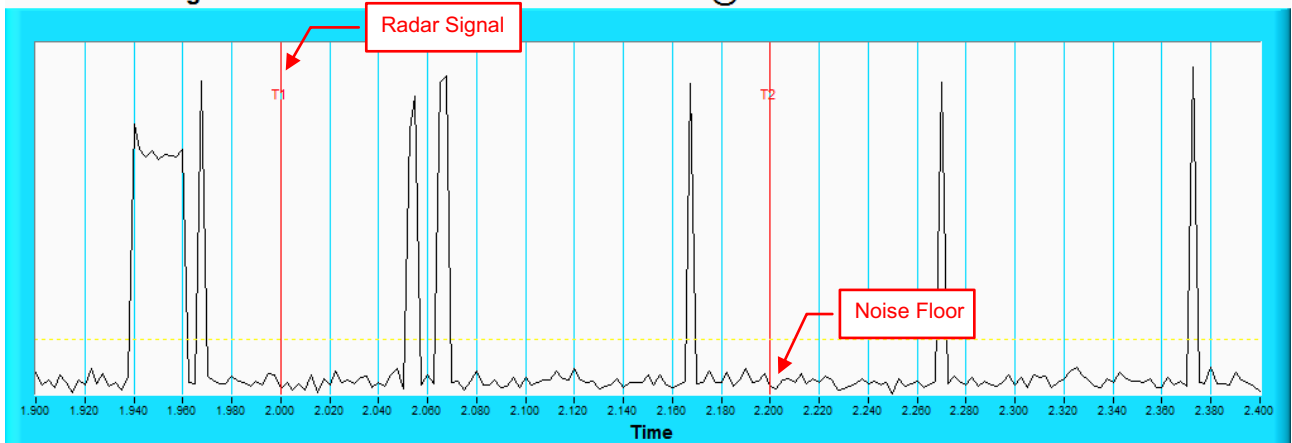

NOTE: Zoom in of the first 500ms after radar signal applied.

**Radar signal 4
802.11ac (VHT80)**

Channel Closing Transmission Time & Channel Move Time @CH106-5530MHz

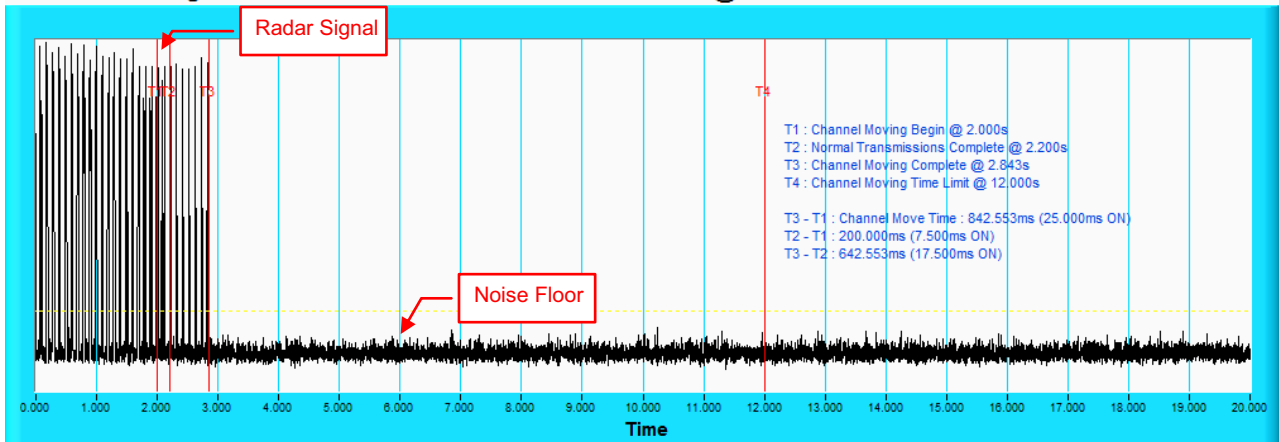

NOTE: T1 denotes the start of Channel Move Time upon the end of the last Radar burst. T2 denotes the data transmission time of 200ms from T1. T3 denotes the end of Channel Move Time. T4 denotes the 10 second from T1 to observe the aggregate duration of transmissions.

Channel Closing Transmission Time & Channel Move Time @CH106-5530MHz

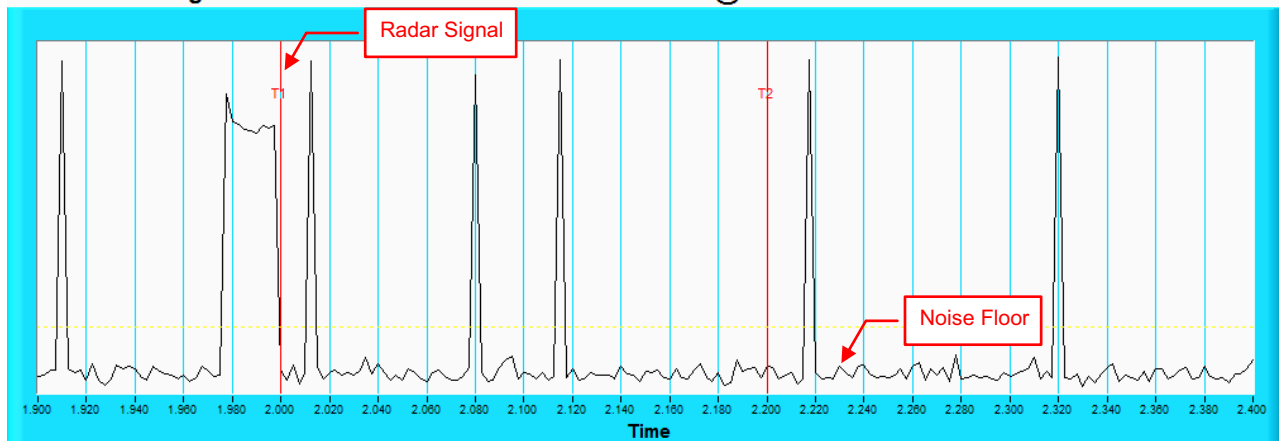

NOTE: Zoom in of the first 500ms after radar signal applied.

Radio2
Radar signal 0

802.11ac (VHT80)

Channel Closing Transmission Time & Channel Move Time @CH106-5530MHz

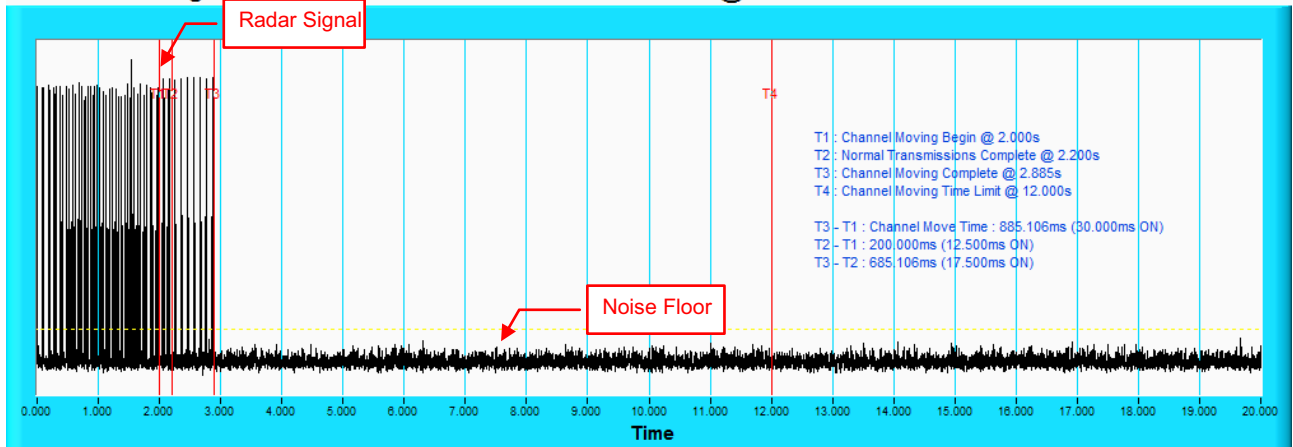

NOTE: T1 denotes the start of Channel Move Time upon the end of the last Radar burst. T2 denotes the data transmission time of 200ms from T1. T3 denotes the end of Channel Move Time. T4 denotes the 10 second from T1 to observe the aggregate duration of transmissions.

Channel Closing Transmission Time & Channel Move Time @CH106-5530MHz

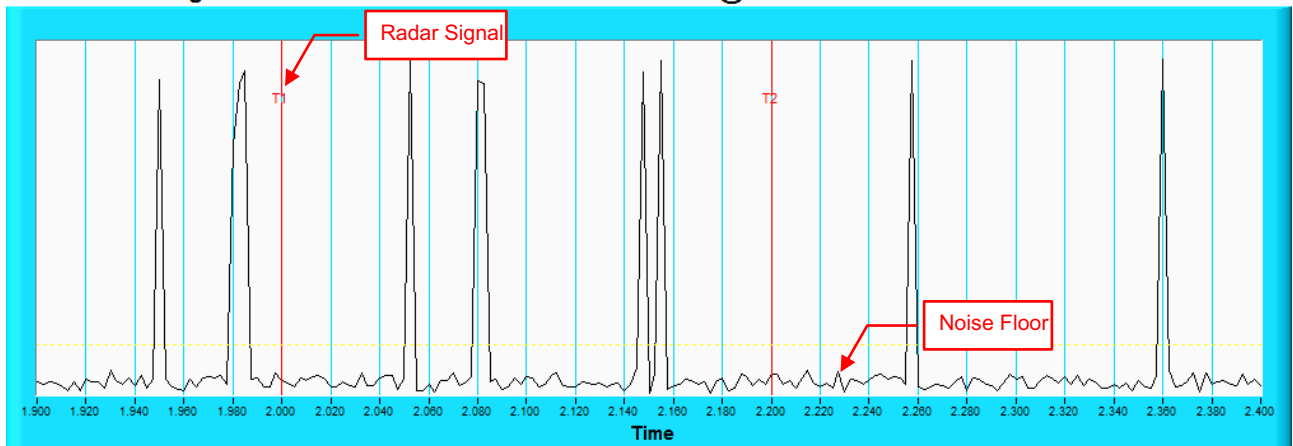

NOTE: Zoom in of the first 500ms after radar signal applied.

Radar signal 1

802.11ac (VHT80)

Channel Closing Transmission Time & Channel Move Time @CH106-5530MHz

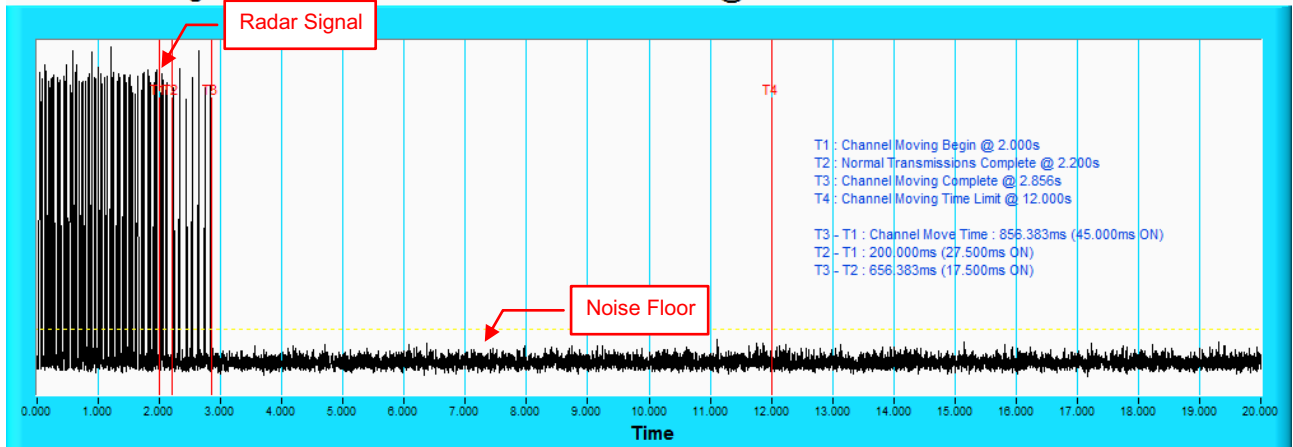

NOTE: T1 denotes the start of Channel Move Time upon the end of the last Radar burst. T2 denotes the data transmission time of 200ms from T1. T3 denotes the end of Channel Move Time. T4 denotes the 10 second from T1 to observe the aggregate duration of transmissions.

Channel Closing Transmission Time & Channel Move Time @CH106-5530MHz

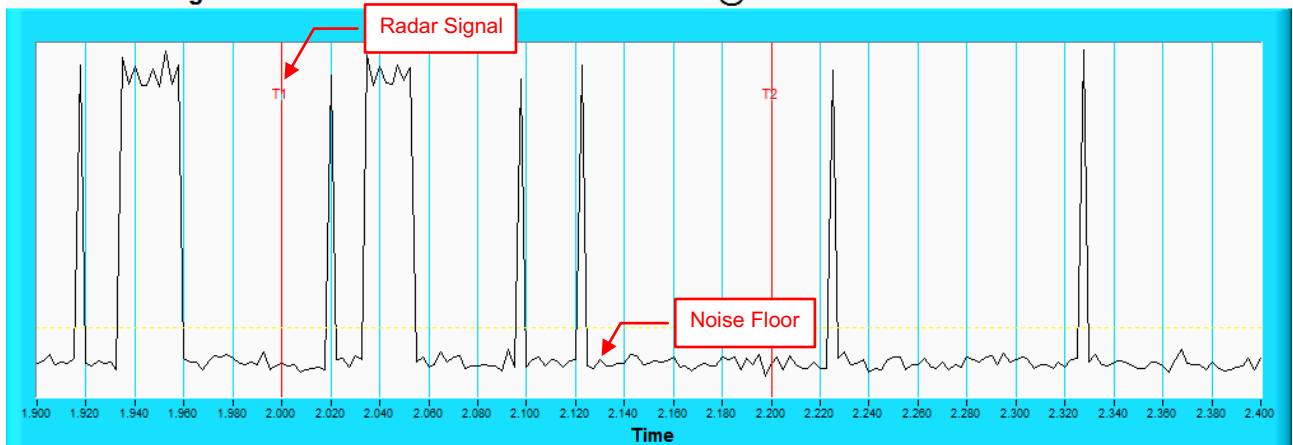

NOTE: Zoom in of the first 500ms after radar signal applied.

Radar signal 2

802.11ac (VHT80)

Channel Closing Transmission Time & Channel Move Time @CH106-5530MHz

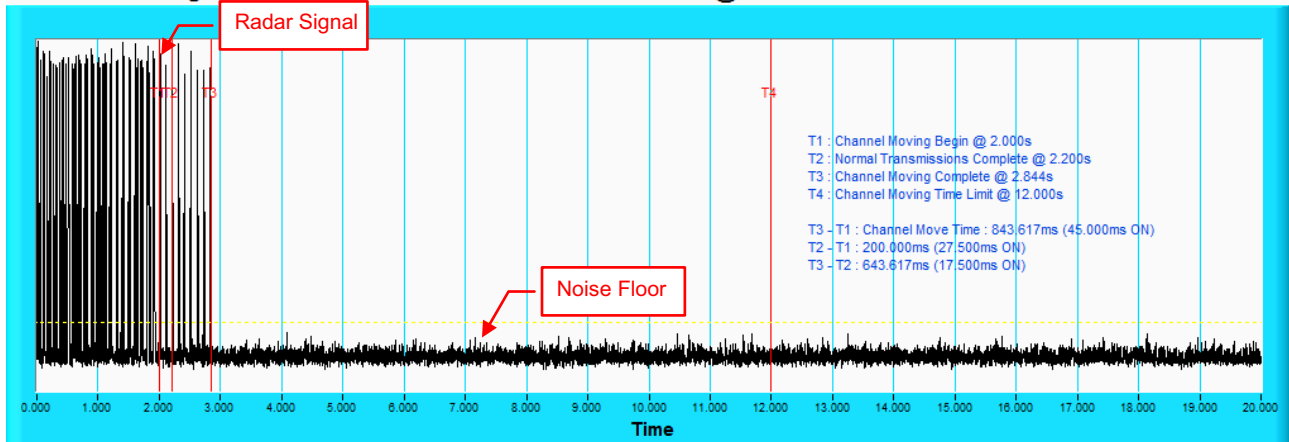

NOTE: T1 denotes the start of Channel Move Time upon the end of the last Radar burst. T2 denotes the data transmission time of 200ms from T1. T3 denotes the end of Channel Move Time. T4 denotes the 10 second from T1 to observe the aggregate duration of transmissions.

Channel Closing Transmission Time & Channel Move Time @CH106-5530MHz

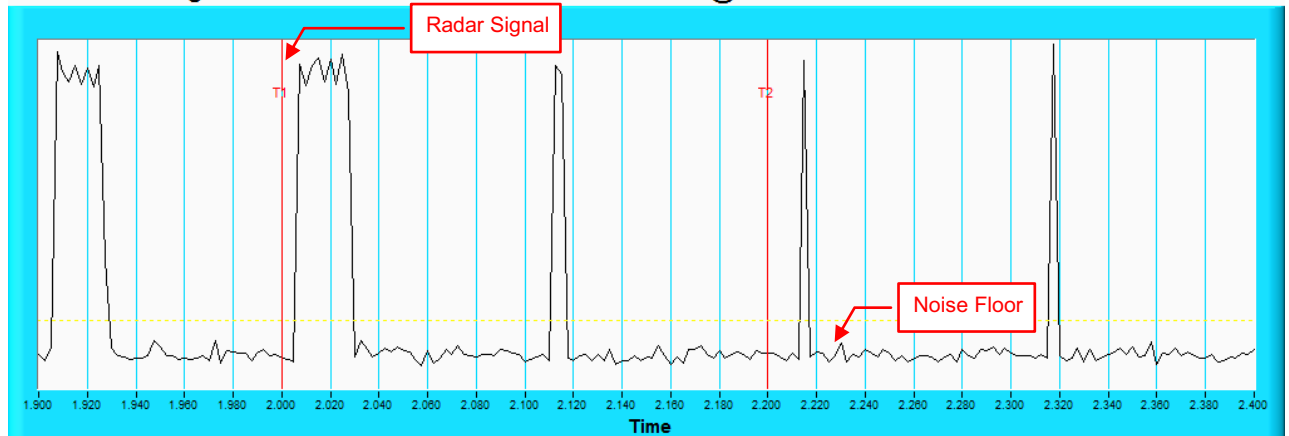

NOTE: Zoom in of the first 500ms after radar signal applied.

Radar signal 3

802.11ac (VHT80)

Channel Closing Transmission Time & Channel Move Time @CH106-5530MHz

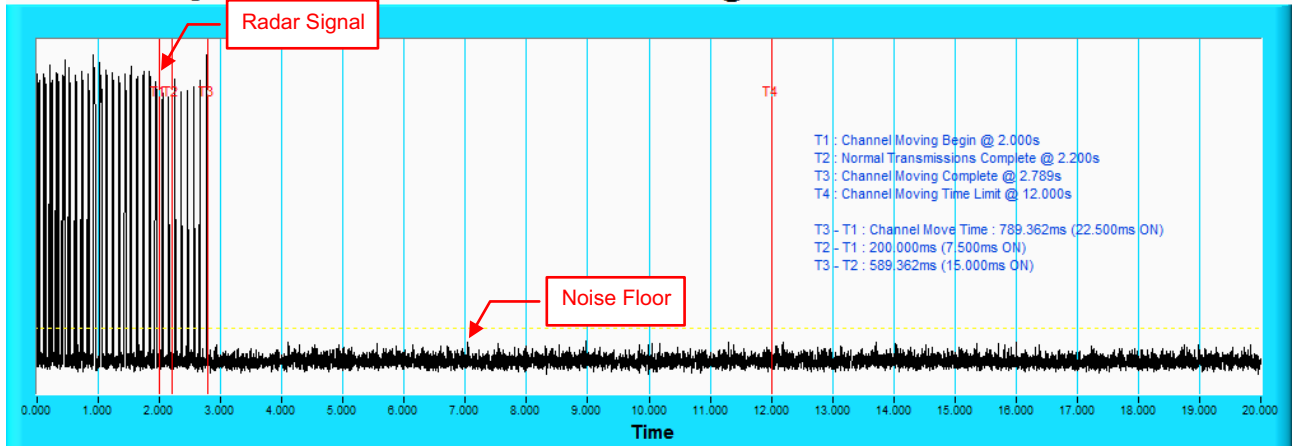

NOTE: T1 denotes the start of Channel Move Time upon the end of the last Radar burst. T2 denotes the data transmission time of 200ms from T1. T3 denotes the end of Channel Move Time. T4 denotes the 10 second from T1 to observe the aggregate duration of transmissions.

Channel Closing Transmission Time & Channel Move Time @CH106-5530MHz

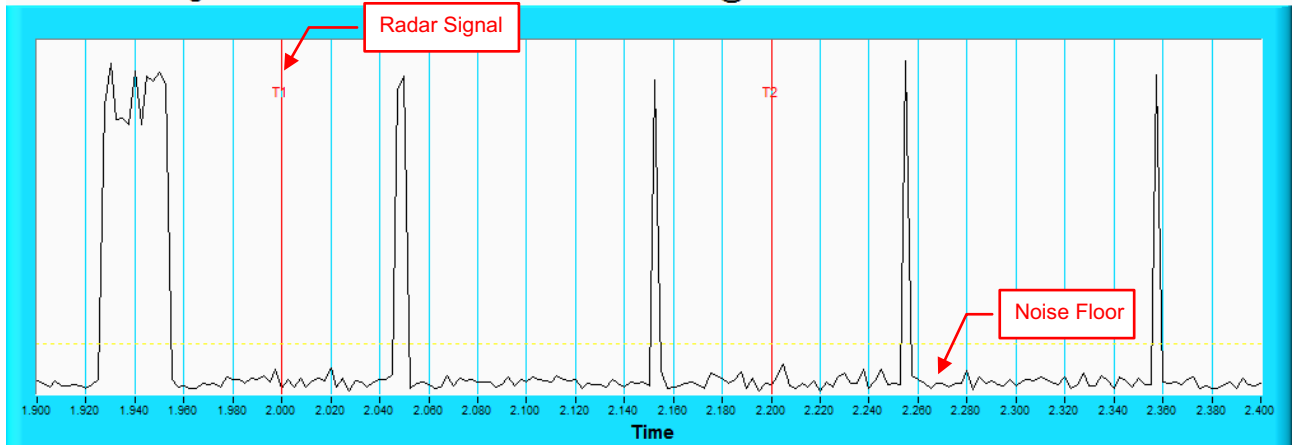

NOTE: Zoom in of the first 500ms after radar signal applied.

Radar signal 4

802.11ac (VHT80)

Channel Closing Transmission Time & Channel Move Time @CH106-5530MHz

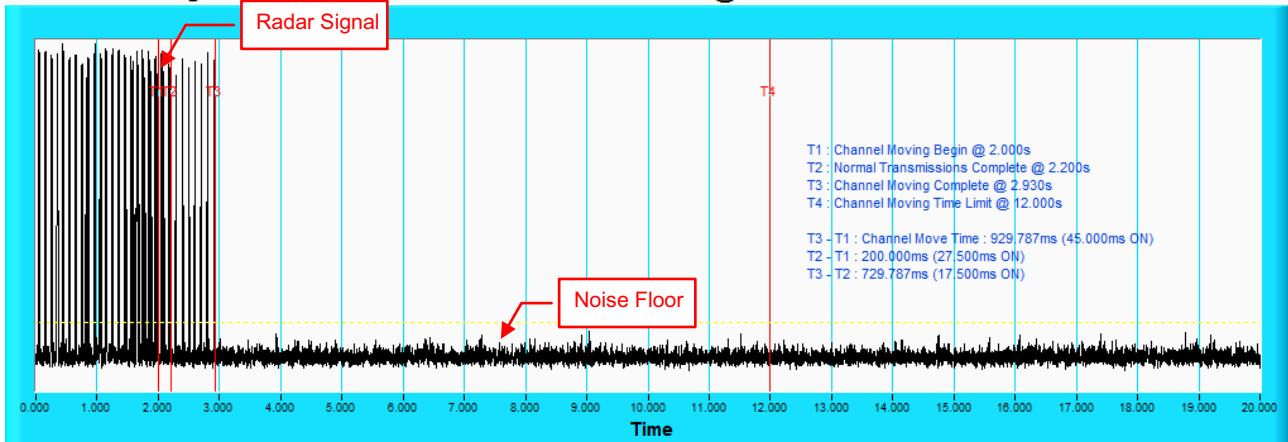

NOTE: T1 denotes the start of Channel Move Time upon the end of the last Radar burst. T2 denotes the data transmission time of 200ms from T1. T3 denotes the end of Channel Move Time. T4 denotes the 10 second from T1 to observe the aggregate duration of transmissions.

Channel Closing Transmission Time & Channel Move Time @CH106-5530MHz

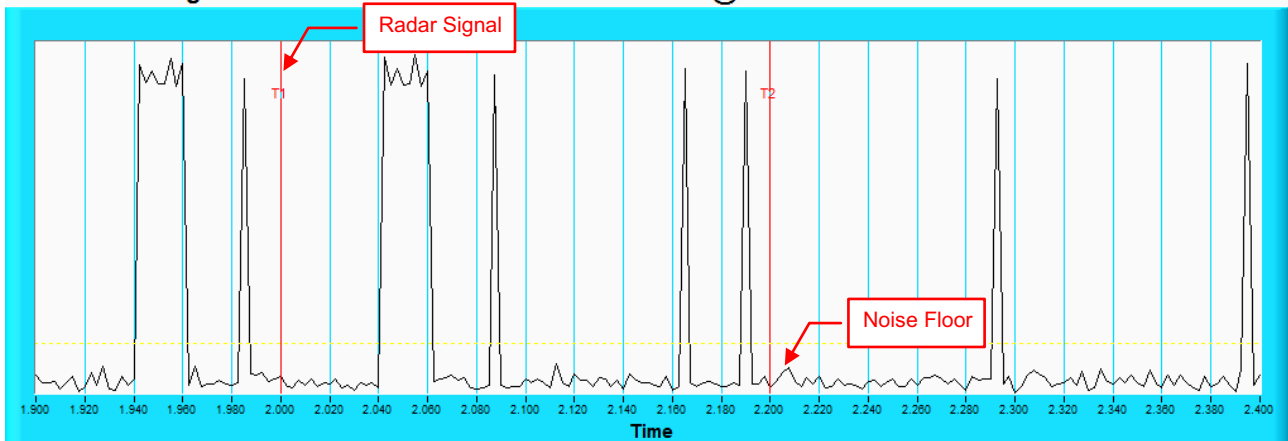

NOTE: Zoom in of the first 500ms after radar signal applied.

Radio1
802.11ac (VHT20)
Type 1 Radar Statistical Performances

Trial #	Test Frequency (MHz)	Pulse Repetition Frequency Number (1 to 23)	Pulse Repetition Frequency (Pulse per seconds)	Pulses per Burst	Pulse Repetition Interval (microseconds)	Detection
1	5500	5	1672	89	598	Yes
2	5493	21	1089	58	918	Yes
3	5502	14	1285	68	778	Yes
4	5508	23	326.2	18	3066	Yes
5	5501	10	1433	76	698	No
6	5493	13	1319	70	758	Yes
7	5496	16	1223	65	818	Yes
8	5502	15	1253	67	798	Yes
9	5493	11	1393	74	718	Yes
10	5501	3	1792	95	558	Yes
11	5497	22	1066	57	938	Yes
12	5505	7	1567	83	638	Yes
13	5506	17	1193	63	838	Yes
14	5499	18	1166	62	858	Yes
15	5498	9	1475	78	678	Yes
16	5506		1524	81	656	Yes
17	5494		749.6	40	1334	Yes
18	5499		1812	96	552	Yes
19	5499		660.5	35	1514	Yes
20	5500		364.2	20	2746	Yes
21	5505		960.6	51	1041	No
22	5504		344.1	19	2906	Yes
23	5505		421.2	23	2374	Yes
24	5506		751.3	40	1331	No
25	5505		513.3	28	1948	Yes
26	5500		1027	55	974	Yes
27	5503		409.3	22	2443	Yes
28	5492		557.4	30	1794	Yes
29	5501		874.1	47	1144	Yes
30	5501		473.5	25	2112	Yes

Detection Rate: 90 %

802.11ac (VHT20)

Type 2 Radar Statistical Performances					
Trial #	Test Frequency (MHz)	Pulses per Burst	Pulse Width(us)	PRI(us)	Detection
1	5500	28	4.2	228	Yes
2	5508	24	1.6	202	No
3	5495	24	1.9	193	Yes
4	5492	29	4.6	189	Yes
5	5493	26	3	167	Yes
6	5506	25	2.6	180	Yes
7	5499	23	1.4	165	Yes
8	5500	29	5	190	Yes
9	5507	23	1.2	168	Yes
10	5492	26	3	224	Yes
11	5494	27	3.9	187	No
12	5508	29	5	171	Yes
13	5505	28	4.3	223	Yes
14	5495	26	2.9	216	Yes
15	5503	26	2.9	219	Yes
16	5499	27	3.6	169	Yes
17	5491	25	2.5	199	Yes
18	5496	26	3	151	Yes
19	5504	25	2.4	198	Yes
20	5498	29	5	207	Yes
21	5508	23	1.5	162	Yes
22	5497	29	5	161	Yes
23	5498	24	1.8	194	Yes
24	5496	28	4.1	178	Yes
25	5497	24	1.6	170	Yes
26	5509	27	3.4	195	Yes
27	5501	25	2.7	212	Yes
28	5497	24	1.7	196	Yes
29	5506	26	2.8	217	Yes
30	5502	24	1.8	183	Yes
					Detection Rate: 93.3 %

802.11ac (VHT20)
Type 3 Radar Statistical Performances

Trial #	Test Frequency (MHz)	Pulses per Burst	Pulse Width(us)	PRI(us)	Detection
1	5500	18	9.2	258	Yes
2	5502	16	6.6	493	Yes
3	5503	16	6.9	359	Yes
4	5500	18	9.6	397	Yes
5	5492	17	8	355	Yes
6	5502	17	7.6	428	Yes
7	5505	16	6.4	271	Yes
8	5504	18	10	371	Yes
9	5499	16	6.2	430	Yes
10	5497	17	8	272	Yes
11	5504	18	8.9	202	Yes
12	5506	18	10	264	Yes
13	5496	18	9.3	207	Yes
14	5502	17	7.9	456	Yes
15	5502	17	7.9	291	Yes
16	5506	17	8.6	411	Yes
17	5499	17	7.5	368	Yes
18	5492	17	8	241	Yes
19	5507	17	7.4	467	Yes
20	5496	18	10	339	Yes
21	5503	16	6.5	500	No
22	5504	18	10	358	Yes
23	5498	16	6.8	251	No
24	5499	18	9.1	230	Yes
25	5503	16	6.6	285	Yes
26	5498	17	8.4	426	No
27	5508	17	7.7	350	Yes
28	5491	16	6.7	434	Yes
29	5495	17	7.8	491	Yes
30	5494	16	6.8	438	Yes

Detection Rate: 90 %

802.11ac (VHT20)
Type 4 Radar Statistical Performances

Trial #	Test Frequency (MHz)	Pulses per Burst	Pulse Width(us)	PRI(us)	Detection
1	5500	15	18.1	258	Yes
2	5501	12	12.3	493	Yes
3	5507	13	13.2	359	Yes
4	5500	16	19.1	397	Yes
5	5506	14	15.4	355	Yes
6	5498	14	14.6	428	Yes
7	5505	12	11.9	271	Yes
8	5502	16	19.9	371	No
9	5499	12	11.6	430	Yes
10	5507	14	15.4	272	Yes
11	5505	15	17.4	202	Yes
12	5508	16	19.9	264	Yes
13	5503	16	18.4	207	Yes
14	5496	14	15.3	456	Yes
15	5494	14	15.3	291	Yes
16	5505	15	16.8	411	No
17	5495	13	14.3	368	Yes
18	5495	14	15.5	241	Yes
19	5493	13	14.2	467	No
20	5497	16	20	339	Yes
21	5496	12	12.2	500	Yes
22	5503	16	19.9	358	Yes
23	5497	13	12.9	251	No
24	5509	15	17.9	230	Yes
25	5501	12	12.3	285	Yes
26	5502	15	16.5	426	Yes
27	5506	14	14.8	350	Yes
28	5507	12	12.6	434	Yes
29	5503	14	15.1	491	Yes
30	5506	13	12.9	438	Yes

Detection Rate: 86.7 %

802.11ac (VHT20)
Type 5 Radar Statistical Performances

Trial #	Minimum Chirp Width(MHz)	Chirp Center Frequency(MHz)	Test Signal Name	Detection
1	17	5500	LP_Signal_01	Yes
2	7	5500	LP_Signal_02	Yes
3	8	5500	LP_Signal_03	Yes
4	19	5500	LP_Signal_04	Yes
5	12	5500	LP_Signal_05	Yes
6	11	5500	LP_Signal_06	Yes
7	6	5500	LP_Signal_07	Yes
8	20	5500	LP_Signal_08	Yes
9	6	5500	LP_Signal_09	No
10	12	5500	LP_Signal_10	Yes
11	16	5497	LP_Signal_11	No
12	20	5499	LP_Signal_12	Yes
13	18	5498	LP_Signal_13	Yes
14	12	5496	LP_Signal_14	Yes
15	12	5496	LP_Signal_15	Yes
16	15	5497	LP_Signal_16	Yes
17	10	5495	LP_Signal_17	Yes
18	12	5496	LP_Signal_18	Yes
19	10	5495	LP_Signal_19	Yes
20	20	5499	LP_Signal_20	Yes
21	7	5506	LP_Signal_21	No
22	20	5501	LP_Signal_22	No
23	8	5506	LP_Signal_23	Yes
24	17	5502	LP_Signal_24	Yes
25	7	5506	LP_Signal_25	Yes
26	14	5503	LP_Signal_26	Yes
27	11	5505	LP_Signal_27	Yes
28	7	5506	LP_Signal_28	Yes
29	12	5504	LP_Signal_29	Yes
30	8	5506	LP_Signal_30	Yes

Detection Rate: 86.7 %

The Long Pulse Radar pattern shown in Appendix A.1

802.11ac (VHT20)

Type 6 Radar Statistical Performances				
Trial #	Pulses per Burst	Pulse Width(us)	PRI(us)	Detection
1	9	1	333.3	No
2	9	1	333.3	Yes
3	9	1	333.3	Yes
4	9	1	333.3	Yes
5	9	1	333.3	Yes
6	9	1	333.3	Yes
7	9	1	333.3	Yes
8	9	1	333.3	Yes
9	9	1	333.3	Yes
10	9	1	333.3	No
11	9	1	333.3	Yes
12	9	1	333.3	Yes
13	9	1	333.3	Yes
14	9	1	333.3	Yes
15	9	1	333.3	Yes
16	9	1	333.3	Yes
17	9	1	333.3	Yes
18	9	1	333.3	Yes
19	9	1	333.3	Yes
20	9	1	333.3	Yes
21	9	1	333.3	Yes
22	9	1	333.3	No
23	9	1	333.3	Yes
24	9	1	333.3	Yes
25	9	1	333.3	Yes
26	9	1	333.3	Yes
27	9	1	333.3	Yes
28	9	1	333.3	Yes
29	9	1	333.3	Yes
30	9	1	333.3	Yes

Detection Rate: 90 %

802.11ac (VHT20)

Type 6 Radar Statistical Performances		
Trial #	Hopping Frequency Sequence Name	Detection
1	HOP_FREQ_SEQ_01	No
2	HOP_FREQ_SEQ_02	Yes
3	HOP_FREQ_SEQ_03	Yes
4	HOP_FREQ_SEQ_04	Yes
5	HOP_FREQ_SEQ_05	Yes
6	HOP_FREQ_SEQ_06	Yes
7	HOP_FREQ_SEQ_07	Yes
8	HOP_FREQ_SEQ_08	Yes
9	HOP_FREQ_SEQ_09	Yes
10	HOP_FREQ_SEQ_10	No
11	HOP_FREQ_SEQ_11	Yes
12	HOP_FREQ_SEQ_12	Yes
13	HOP_FREQ_SEQ_13	Yes
14	HOP_FREQ_SEQ_14	Yes
15	HOP_FREQ_SEQ_15	Yes
16	HOP_FREQ_SEQ_16	Yes
17	HOP_FREQ_SEQ_17	Yes
18	HOP_FREQ_SEQ_18	Yes
19	HOP_FREQ_SEQ_19	Yes
20	HOP_FREQ_SEQ_20	Yes
21	HOP_FREQ_SEQ_21	Yes
22	HOP_FREQ_SEQ_22	No
23	HOP_FREQ_SEQ_23	Yes
24	HOP_FREQ_SEQ_24	Yes
25	HOP_FREQ_SEQ_25	Yes
26	HOP_FREQ_SEQ_26	Yes
27	HOP_FREQ_SEQ_27	Yes
28	HOP_FREQ_SEQ_28	Yes
29	HOP_FREQ_SEQ_29	Yes
30	HOP_FREQ_SEQ_30	Yes
		Detection Rate: 90 %

The Frequency Hopping Radar pattern shown in Appendix A.2



802.11ac (VHT40)

Type 1 Radar Statistical Performances

Trial #	Test Frequency (MHz)	Pulse Repetition Frequency Number (1 to 23)	Pulse Repetition Frequency (Pulse per seconds)	Pulses per Burst	Pulse Repetition Interval (microseconds)	Detection
1	5510	5	1672	89	598	Yes
2	5520	21	1089	58	918	Yes
3	5500	14	1285	68	778	Yes
4	5500	23	326.2	18	3066	Yes
5	5525	10	1433	76	698	Yes
6	5506	13	1319	70	758	Yes
7	5501	16	1223	65	818	Yes
8	5528	15	1253	67	798	Yes
9	5513	11	1393	74	718	Yes
10	5519	3	1792	95	558	Yes
11	5495	22	1066	57	938	Yes
12	5525	7	1567	83	638	Yes
13	5525	17	1193	63	838	Yes
14	5503	18	1166	62	858	No
15	5502	9	1475	78	678	Yes
16	5498		1524	81	656	Yes
17	5516		749.6	40	1334	Yes
18	5493		1812	96	552	Yes
19	5517		660.5	35	1514	Yes
20	5498		364.2	20	2746	Yes
21	5495		960.6	51	1041	No
22	5495		344.1	19	2906	Yes
23	5523		421.2	23	2374	Yes
24	5499		751.3	40	1331	Yes
25	5525		513.3	28	1948	Yes
26	5518		1027	55	974	Yes
27	5507		409.3	22	2443	Yes
28	5510		557.4	30	1794	Yes
29	5527		874.1	47	1144	Yes
30	5502		473.5	25	2112	Yes

Detection Rate: 93.3 %

802.11ac (VHT40)

Type 2 Radar Statistical Performances					
Trial #	Test Frequency (MHz)	Pulses per Burst	Pulse Width(us)	PRI(us)	Detection
1	5510	28	4.2	228	Yes
2	5520	24	1.6	202	Yes
3	5500	24	1.9	193	Yes
4	5497	29	4.6	189	Yes
5	5510	26	3	167	Yes
6	5520	25	2.6	180	Yes
7	5500	23	1.4	165	Yes
8	5493	29	5	190	Yes
9	5528	23	1.2	168	No
10	5492	26	3	224	No
11	5493	27	3.9	187	Yes
12	5492	29	5	171	Yes
13	5512	28	4.3	223	Yes
14	5519	26	2.9	216	Yes
15	5493	26	2.9	219	Yes
16	5499	27	3.6	169	Yes
17	5493	25	2.5	199	Yes
18	5518	26	3	151	Yes
19	5508	25	2.4	198	Yes
20	5517	29	5	207	No
21	5522	23	1.5	162	Yes
22	5508	29	5	161	Yes
23	5494	24	1.8	194	Yes
24	5496	28	4.1	178	Yes
25	5523	24	1.6	170	Yes
26	5496	27	3.4	195	Yes
27	5523	25	2.7	212	Yes
28	5520	24	1.7	196	Yes
29	5494	26	2.8	217	Yes
30	5504	24	1.8	183	Yes

Detection Rate: 90 %

802.11ac (VHT40)

Type 3 Radar Statistical Performances					
Trial #	Test Frequency (MHz)	Pulses per Burst	Pulse Width(us)	PRI(us)	Detection
1	5510	18	9.2	258	Yes
2	5520	16	6.6	493	Yes
3	5500	16	6.9	359	Yes
4	5528	18	9.6	397	Yes
5	5494	17	8	355	Yes
6	5504	17	7.6	428	Yes
7	5493	16	6.4	271	No
8	5528	18	10	371	Yes
9	5509	16	6.2	430	Yes
10	5509	17	8	272	Yes
11	5514	18	8.9	202	Yes
12	5505	18	10	264	Yes
13	5501	18	9.3	207	Yes
14	5507	17	7.9	456	No
15	5498	17	7.9	291	Yes
16	5515	17	8.6	411	Yes
17	5502	17	7.5	368	Yes
18	5511	17	8	241	Yes
19	5500	17	7.4	467	Yes
20	5497	18	10	339	Yes
21	5524	16	6.5	500	Yes
22	5498	18	10	358	Yes
23	5501	16	6.8	251	Yes
24	5519	18	9.1	230	Yes
25	5515	16	6.6	285	Yes
26	5495	17	8.4	426	Yes
27	5492	17	7.7	350	Yes
28	5498	16	6.7	434	Yes
29	5493	17	7.8	491	Yes
30	5497	16	6.8	438	No

Detection Rate: 90 %

802.11ac (VHT40)

Type 4 Radar Statistical Performances					
Trial #	Test Frequency (MHz)	Pulses per Burst	Pulse Width(us)	PRI(us)	Detection
1	5510	15	18.1	258	Yes
2	5520	12	12.3	493	Yes
3	5500	13	13.2	359	Yes
4	5499	16	19.1	397	Yes
5	5511	14	15.4	355	Yes
6	5504	14	14.6	428	No
7	5499	12	11.9	271	Yes
8	5522	16	19.9	371	Yes
9	5528	12	11.6	430	Yes
10	5512	14	15.4	272	No
11	5512	15	17.4	202	Yes
12	5503	16	19.9	264	No
13	5512	16	18.4	207	Yes
14	5494	14	15.3	456	Yes
15	5502	14	15.3	291	Yes
16	5501	15	16.8	411	Yes
17	5521	13	14.3	368	Yes
18	5502	14	15.5	241	Yes
19	5509	13	14.2	467	Yes
20	5520	16	20	339	Yes
21	5502	12	12.2	500	Yes
22	5496	16	19.9	358	Yes
23	5517	13	12.9	251	Yes
24	5492	15	17.9	230	Yes
25	5500	12	12.3	285	Yes
26	5495	15	16.5	426	Yes
27	5511	14	14.8	350	Yes
28	5515	12	12.6	434	Yes
29	5502	14	15.1	491	Yes
30	5503	13	12.9	438	No

Detection Rate: 86.7 %

802.11ac (VHT40)
Type 5 Radar Statistical Performances

Trial #	Minimum Chirp Width(MHz)	Chirp Center Frequency(MHz)	Test Signal Name	Detection
1	17	5510	LP_Signal_01	Yes
2	7	5510	LP_Signal_02	No
3	8	5510	LP_Signal_03	Yes
4	19	5510	LP_Signal_04	Yes
5	12	5510	LP_Signal_05	Yes
6	11	5510	LP_Signal_06	Yes
7	6	5510	LP_Signal_07	Yes
8	20	5510	LP_Signal_08	Yes
9	6	5510	LP_Signal_09	Yes
10	12	5510	LP_Signal_10	Yes
11	16	5497	LP_Signal_11	Yes
12	20	5499	LP_Signal_12	Yes
13	18	5498	LP_Signal_13	Yes
14	12	5496	LP_Signal_14	Yes
15	12	5496	LP_Signal_15	Yes
16	15	5497	LP_Signal_16	Yes
17	10	5495	LP_Signal_17	Yes
18	12	5496	LP_Signal_18	No
19	10	5495	LP_Signal_19	Yes
20	20	5499	LP_Signal_20	Yes
21	7	5526	LP_Signal_21	Yes
22	20	5521	LP_Signal_22	No
23	8	5526	LP_Signal_23	Yes
24	17	5522	LP_Signal_24	Yes
25	7	5526	LP_Signal_25	Yes
26	14	5523	LP_Signal_26	Yes
27	11	5525	LP_Signal_27	Yes
28	7	5526	LP_Signal_28	Yes
29	12	5524	LP_Signal_29	Yes
30	8	5526	LP_Signal_30	Yes

Detection Rate: 90 %

The Long Pulse Radar pattern shown in Appendix A.1

802.11ac (VHT40)

Type 6 Radar Statistical Performances				
Trial #	Pulses per Burst	Pulse Width(us)	PRI(us)	Detection
1	9	1	333.3	Yes
2	9	1	333.3	Yes
3	9	1	333.3	No
4	9	1	333.3	Yes
5	9	1	333.3	Yes
6	9	1	333.3	Yes
7	9	1	333.3	Yes
8	9	1	333.3	No
9	9	1	333.3	Yes
10	9	1	333.3	Yes
11	9	1	333.3	Yes
12	9	1	333.3	Yes
13	9	1	333.3	No
14	9	1	333.3	Yes
15	9	1	333.3	Yes
16	9	1	333.3	Yes
17	9	1	333.3	Yes
18	9	1	333.3	Yes
19	9	1	333.3	Yes
20	9	1	333.3	Yes
21	9	1	333.3	Yes
22	9	1	333.3	Yes
23	9	1	333.3	Yes
24	9	1	333.3	Yes
25	9	1	333.3	Yes
26	9	1	333.3	Yes
27	9	1	333.3	Yes
28	9	1	333.3	Yes
29	9	1	333.3	Yes
30	9	1	333.3	Yes
				Detection Rate: 90 %

802.11ac (VHT40)

Type 6 Radar Statistical Performances		
Trial #	Hopping Frequency Sequence Name	Detection
1	HOP_FREQ_SEQ_01	Yes
2	HOP_FREQ_SEQ_02	Yes
3	HOP_FREQ_SEQ_03	No
4	HOP_FREQ_SEQ_04	Yes
5	HOP_FREQ_SEQ_05	Yes
6	HOP_FREQ_SEQ_06	Yes
7	HOP_FREQ_SEQ_07	Yes
8	HOP_FREQ_SEQ_08	No
9	HOP_FREQ_SEQ_09	Yes
10	HOP_FREQ_SEQ_10	Yes
11	HOP_FREQ_SEQ_11	Yes
12	HOP_FREQ_SEQ_12	Yes
13	HOP_FREQ_SEQ_13	No
14	HOP_FREQ_SEQ_14	Yes
15	HOP_FREQ_SEQ_15	Yes
16	HOP_FREQ_SEQ_16	Yes
17	HOP_FREQ_SEQ_17	Yes
18	HOP_FREQ_SEQ_18	Yes
19	HOP_FREQ_SEQ_19	Yes
20	HOP_FREQ_SEQ_20	Yes
21	HOP_FREQ_SEQ_21	Yes
22	HOP_FREQ_SEQ_22	Yes
23	HOP_FREQ_SEQ_23	Yes
24	HOP_FREQ_SEQ_24	Yes
25	HOP_FREQ_SEQ_25	Yes
26	HOP_FREQ_SEQ_26	Yes
27	HOP_FREQ_SEQ_27	Yes
28	HOP_FREQ_SEQ_28	Yes
29	HOP_FREQ_SEQ_29	Yes
30	HOP_FREQ_SEQ_30	Yes
		Detection Rate: 90 %

The Frequency Hopping Radar pattern shown in Appendix A.2

802.11ac (VHT80)

Type 1 Radar Statistical Performances						
Trial #	Test Frequency (MHz)	Pulse Repetition Frequency Number (1 to 23)	Pulse Repetition Frequency (Pulse per seconds)	Pulses per Burst	Pulse Repetition Interval (microseconds)	Detection
1	5530	5	1672	89	598	Yes
2	5540	21	1089	58	918	Yes
3	5560	14	1285	68	778	Yes
4	5520	23	326.2	18	3066	Yes
5	5500	10	1433	76	698	Yes
6	5541	13	1319	70	758	Yes
7	5540	16	1223	65	818	No
8	5526	15	1253	67	798	Yes
9	5559	11	1393	74	718	Yes
10	5537	3	1792	95	558	Yes
11	5539	22	1066	57	938	Yes
12	5494	7	1567	83	638	Yes
13	5503	17	1193	63	838	No
14	5529	18	1166	62	858	Yes
15	5543	9	1475	78	678	Yes
16	5554		1524	81	656	Yes
17	5537		749.6	40	1334	Yes
18	5563		1812	96	552	No
19	5548		660.5	35	1514	Yes
20	5531		364.2	20	2746	Yes
21	5496		960.6	51	1041	Yes
22	5534		344.1	19	2906	Yes
23	5524		421.2	23	2374	Yes
24	5496		751.3	40	1331	Yes
25	5558		513.3	28	1948	Yes
26	5542		1027	55	974	Yes
27	5512		409.3	22	2443	Yes
28	5560		557.4	30	1794	Yes
29	5522		874.1	47	1144	Yes
30	5565		473.5	25	2112	Yes
Detection Rate: 90 %						

802.11ac (VHT80)
Type 2 Radar Statistical Performances

Trial #	Test Frequency (MHz)	Pulses per Burst	Pulse Width(us)	PRI(us)	Detection
1	5530	28	4.2	228	Yes
2	5540	24	1.6	202	Yes
3	5560	24	1.9	193	Yes
4	5520	29	4.6	189	No
5	5500	26	3	167	Yes
6	5512	25	2.6	180	Yes
7	5560	23	1.4	165	Yes
8	5499	29	5	190	Yes
9	5548	23	1.2	168	Yes
10	5541	26	3	224	Yes
11	5500	27	3.9	187	Yes
12	5510	29	5	171	No
13	5567	28	4.3	223	Yes
14	5528	26	2.9	216	Yes
15	5550	26	2.9	219	Yes
16	5523	27	3.6	169	Yes
17	5507	25	2.5	199	Yes
18	5524	26	3	151	Yes
19	5535	25	2.4	198	Yes
20	5561	29	5	207	Yes
21	5504	23	1.5	162	Yes
22	5499	29	5	161	No
23	5509	24	1.8	194	Yes
24	5546	28	4.1	178	Yes
25	5558	24	1.6	170	Yes
26	5548	27	3.4	195	Yes
27	5566	25	2.7	212	Yes
28	5522	24	1.7	196	Yes
29	5516	26	2.8	217	No
30	5531	24	1.8	183	Yes

Detection Rate: 86.7 %

802.11ac (VHT80)
Type 3 Radar Statistical Performances

Trial #	Test Frequency (MHz)	Pulses per Burst	Pulse Width(us)	PRI(us)	Detection
1	5530	18	9.2	258	Yes
2	5540	16	6.6	493	Yes
3	5560	16	6.9	359	Yes
4	5520	18	9.6	397	No
5	5500	17	8	355	Yes
6	5510	17	7.6	428	Yes
7	5536	16	6.4	271	Yes
8	5536	18	10	371	Yes
9	5549	16	6.2	430	No
10	5557	17	8	272	Yes
11	5513	18	8.9	202	Yes
12	5533	18	10	264	No
13	5494	18	9.3	207	Yes
14	5543	17	7.9	456	Yes
15	5541	17	7.9	291	Yes
16	5551	17	8.6	411	Yes
17	5555	17	7.5	368	Yes
18	5517	17	8	241	Yes
19	5498	17	7.4	467	Yes
20	5565	18	10	339	Yes
21	5526	16	6.5	500	Yes
22	5516	18	10	358	Yes
23	5555	16	6.8	251	Yes
24	5559	18	9.1	230	Yes
25	5510	16	6.6	285	Yes
26	5551	17	8.4	426	Yes
27	5546	17	7.7	350	Yes
28	5528	16	6.7	434	Yes
29	5508	17	7.8	491	Yes
30	5533	16	6.8	438	Yes

Detection Rate: 90 %

802.11ac (VHT80)
Type 4 Radar Statistical Performances

Trial #	Test Frequency (MHz)	Pulses per Burst	Pulse Width(us)	PRI(us)	Detection
1	5530	15	18.1	258	Yes
2	5540	12	12.3	493	No
3	5560	13	13.2	359	Yes
4	5520	16	19.1	397	Yes
5	5500	14	15.4	355	Yes
6	5505	14	14.6	428	Yes
7	5537	12	11.9	271	No
8	5512	16	19.9	371	Yes
9	5526	12	11.6	430	Yes
10	5564	14	15.4	272	Yes
11	5496	15	17.4	202	Yes
12	5496	16	19.9	264	No
13	5508	16	18.4	207	Yes
14	5549	14	15.3	456	Yes
15	5550	14	15.3	291	Yes
16	5530	15	16.8	411	No
17	5543	13	14.3	368	Yes
18	5544	14	15.5	241	Yes
19	5502	13	14.2	467	Yes
20	5554	16	20	339	Yes
21	5512	12	12.2	500	Yes
22	5505	16	19.9	358	Yes
23	5553	13	12.9	251	Yes
24	5499	15	17.9	230	Yes
25	5552	12	12.3	285	Yes
26	5507	15	16.5	426	Yes
27	5560	14	14.8	350	Yes
28	5519	12	12.6	434	Yes
29	5495	14	15.1	491	Yes
30	5566	13	12.9	438	Yes

Detection Rate: 86.7 %

802.11ac (VHT80)
Type 5 Radar Statistical Performances

Trial #	Minimum Chirp Width(MHz)	Chirp Center Frequency(MHz)	Test Signal Name	Detection
1	17	5530	LP_Signal_01	Yes
2	7	5530	LP_Signal_02	Yes
3	8	5530	LP_Signal_03	Yes
4	19	5530	LP_Signal_04	Yes
5	12	5530	LP_Signal_05	Yes
6	11	5530	LP_Signal_06	Yes
7	6	5530	LP_Signal_07	Yes
8	20	5530	LP_Signal_08	Yes
9	6	5530	LP_Signal_09	Yes
10	12	5530	LP_Signal_10	Yes
11	16	5497	LP_Signal_11	Yes
12	20	5499	LP_Signal_12	Yes
13	18	5498	LP_Signal_13	No
14	12	5496	LP_Signal_14	Yes
15	12	5496	LP_Signal_15	No
16	15	5497	LP_Signal_16	No
17	10	5495	LP_Signal_17	Yes
18	12	5496	LP_Signal_18	Yes
19	10	5495	LP_Signal_19	Yes
20	20	5499	LP_Signal_20	Yes
21	7	5566	LP_Signal_21	Yes
22	20	5561	LP_Signal_22	Yes
23	8	5566	LP_Signal_23	Yes
24	17	5562	LP_Signal_24	No
25	7	5566	LP_Signal_25	Yes
26	14	5563	LP_Signal_26	Yes
27	11	5565	LP_Signal_27	Yes
28	7	5566	LP_Signal_28	Yes
29	12	5564	LP_Signal_29	Yes
30	8	5566	LP_Signal_30	Yes

Detection Rate: 86.7 %

The Long Pulse Radar pattern shown in Appendix A.1

802.11ac (VHT80)

Type 6 Radar Statistical Performances				
Trial #	Pulses per Burst	Pulse Width(us)	PRI(us)	Detection
1	9	1	333.3	Yes
2	9	1	333.3	Yes
3	9	1	333.3	Yes
4	9	1	333.3	Yes
5	9	1	333.3	Yes
6	9	1	333.3	Yes
7	9	1	333.3	Yes
8	9	1	333.3	Yes
9	9	1	333.3	Yes
10	9	1	333.3	Yes
11	9	1	333.3	Yes
12	9	1	333.3	Yes
13	9	1	333.3	Yes
14	9	1	333.3	Yes
15	9	1	333.3	Yes
16	9	1	333.3	Yes
17	9	1	333.3	No
18	9	1	333.3	Yes
19	9	1	333.3	Yes
20	9	1	333.3	Yes
21	9	1	333.3	Yes
22	9	1	333.3	No
23	9	1	333.3	Yes
24	9	1	333.3	Yes
25	9	1	333.3	Yes
26	9	1	333.3	Yes
27	9	1	333.3	Yes
28	9	1	333.3	Yes
29	9	1	333.3	No
30	9	1	333.3	Yes
				Detection Rate: 90 %

802.11ac (VHT80)
Type 6 Radar Statistical Performances

Trial #	Hopping Frequency Sequence Name	Detection
1	HOP_FREQ_SEQ_01	Yes
2	HOP_FREQ_SEQ_02	Yes
3	HOP_FREQ_SEQ_03	Yes
4	HOP_FREQ_SEQ_04	Yes
5	HOP_FREQ_SEQ_05	Yes
6	HOP_FREQ_SEQ_06	Yes
7	HOP_FREQ_SEQ_07	Yes
8	HOP_FREQ_SEQ_08	Yes
9	HOP_FREQ_SEQ_09	Yes
10	HOP_FREQ_SEQ_10	Yes
11	HOP_FREQ_SEQ_11	Yes
12	HOP_FREQ_SEQ_12	Yes
13	HOP_FREQ_SEQ_13	Yes
14	HOP_FREQ_SEQ_14	Yes
15	HOP_FREQ_SEQ_15	Yes
16	HOP_FREQ_SEQ_16	Yes
17	HOP_FREQ_SEQ_17	No
18	HOP_FREQ_SEQ_18	Yes
19	HOP_FREQ_SEQ_19	Yes
20	HOP_FREQ_SEQ_20	Yes
21	HOP_FREQ_SEQ_21	Yes
22	HOP_FREQ_SEQ_22	No
23	HOP_FREQ_SEQ_23	Yes
24	HOP_FREQ_SEQ_24	Yes
25	HOP_FREQ_SEQ_25	Yes
26	HOP_FREQ_SEQ_26	Yes
27	HOP_FREQ_SEQ_27	Yes
28	HOP_FREQ_SEQ_28	Yes
29	HOP_FREQ_SEQ_29	No
30	HOP_FREQ_SEQ_30	Yes
		Detection Rate: 90 %

The Frequency Hopping Radar pattern shown in Appendix A.2



Radio2
802.11ac (VHT20)

Type 1 Radar Statistical Performances

Trial #	Test Frequency (MHz)	Pulse Repetition Frequency Number (1 to 23)	Pulse Repetition Frequency (Pulse per seconds)	Pulses per Burst	Pulse Repetition Interval (microseconds)	Detection
1	5500	5	1672	89	598	Yes
2	5497	21	1089	58	918	Yes
3	5495	14	1285	68	778	Yes
4	5502	23	326.2	18	3066	Yes
5	5503	10	1433	76	698	Yes
6	5499	13	1319	70	758	Yes
7	5491	16	1223	65	818	Yes
8	5507	15	1253	67	798	Yes
9	5504	11	1393	74	718	Yes
10	5498	3	1792	95	558	No
11	5504	22	1066	57	938	Yes
12	5491	7	1567	83	638	Yes
13	5496	17	1193	63	838	Yes
14	5497	18	1166	62	858	Yes
15	5504	9	1475	78	678	Yes
16	5500		1524	81	656	Yes
17	5493		749.6	40	1334	Yes
18	5492		1812	96	552	No
19	5499		660.5	35	1514	Yes
20	5507		364.2	20	2746	Yes
21	5508		960.6	51	1041	Yes
22	5504		344.1	19	2906	Yes
23	5499		421.2	23	2374	Yes
24	5506		751.3	40	1331	Yes
25	5496		513.3	28	1948	Yes
26	5492		1027	55	974	Yes
27	5506		409.3	22	2443	No
28	5507		557.4	30	1794	Yes
29	5502		874.1	47	1144	Yes
30	5507		473.5	25	2112	Yes

Detection Rate: 90 %

802.11ac (VHT20)

Type 2 Radar Statistical Performances					
Trial #	Test Frequency (MHz)	Pulses per Burst	Pulse Width(us)	PRI(us)	Detection
1	5500	28	4.2	228	Yes
2	5497	24	1.6	202	Yes
3	5499	24	1.9	193	Yes
4	5507	29	4.6	189	Yes
5	5504	26	3	167	Yes
6	5497	25	2.6	180	Yes
7	5503	23	1.4	165	No
8	5500	29	5	190	Yes
9	5502	23	1.2	168	Yes
10	5499	26	3	224	Yes
11	5496	27	3.9	187	Yes
12	5504	29	5	171	Yes
13	5507	28	4.3	223	Yes
14	5508	26	2.9	216	Yes
15	5497	26	2.9	219	Yes
16	5492	27	3.6	169	Yes
17	5494	25	2.5	199	Yes
18	5493	26	3	151	Yes
19	5504	25	2.4	198	Yes
20	5505	29	5	207	Yes
21	5493	23	1.5	162	Yes
22	5494	29	5	161	No
23	5499	24	1.8	194	Yes
24	5508	28	4.1	178	Yes
25	5498	24	1.6	170	Yes
26	5494	27	3.4	195	No
27	5505	25	2.7	212	Yes
28	5493	24	1.7	196	Yes
29	5507	26	2.8	217	Yes
30	5498	24	1.8	183	Yes

Detection Rate: 90 %

802.11ac (VHT20)
Type 3 Radar Statistical Performances

Trial #	Test Frequency (MHz)	Pulses per Burst	Pulse Width(us)	PRI(us)	Detection
1	5500	18	9.2	258	Yes
2	5492	16	6.6	493	Yes
3	5502	16	6.9	359	No
4	5502	18	9.6	397	Yes
5	5503	17	8	355	Yes
6	5504	17	7.6	428	Yes
7	5495	16	6.4	271	Yes
8	5508	18	10	371	Yes
9	5498	16	6.2	430	Yes
10	5505	17	8	272	No
11	5502	18	8.9	202	No
12	5496	18	10	264	Yes
13	5500	18	9.3	207	Yes
14	5503	17	7.9	456	Yes
15	5499	17	7.9	291	Yes
16	5496	17	8.6	411	Yes
17	5497	17	7.5	368	Yes
18	5491	17	8	241	Yes
19	5502	17	7.4	467	Yes
20	5508	18	10	339	Yes
21	5497	16	6.5	500	Yes
22	5497	18	10	358	Yes
23	5499	16	6.8	251	Yes
24	5498	18	9.1	230	Yes
25	5500	16	6.6	285	Yes
26	5500	17	8.4	426	No
27	5495	17	7.7	350	No
28	5499	16	6.7	434	Yes
29	5499	17	7.8	491	Yes
30	5496	16	6.8	438	Yes

Detection Rate: 83.3 %

802.11ac (VHT20)
Type 4 Radar Statistical Performances

Trial #	Test Frequency (MHz)	Pulses per Burst	Pulse Width(us)	PRI(us)	Detection
1	5500	15	18.1	258	Yes
2	5498	12	12.3	493	No
3	5493	13	13.2	359	Yes
4	5495	16	19.1	397	Yes
5	5506	14	15.4	355	Yes
6	5502	14	14.6	428	No
7	5507	12	11.9	271	Yes
8	5494	16	19.9	371	Yes
9	5499	12	11.6	430	Yes
10	5501	14	15.4	272	Yes
11	5502	15	17.4	202	Yes
12	5507	16	19.9	264	Yes
13	5494	16	18.4	207	Yes
14	5505	14	15.3	456	No
15	5507	14	15.3	291	Yes
16	5509	15	16.8	411	Yes
17	5506	13	14.3	368	No
18	5495	14	15.5	241	Yes
19	5501	13	14.2	467	Yes
20	5499	16	20	339	Yes
21	5499	12	12.2	500	Yes
22	5494	16	19.9	358	Yes
23	5492	13	12.9	251	Yes
24	5507	15	17.9	230	Yes
25	5504	12	12.3	285	Yes
26	5501	15	16.5	426	Yes
27	5507	14	14.8	350	Yes
28	5495	12	12.6	434	Yes
29	5507	14	15.1	491	Yes
30	5493	13	12.9	438	Yes

Detection Rate: 86.7 %

802.11ac (VHT20)
Type 5 Radar Statistical Performances

Trial #	Minimum Chirp Width(MHz)	Chirp Center Frequency(MHz)	Test Signal Name	Detection
1	17	5500	LP_Signal_01	Yes
2	7	5500	LP_Signal_02	Yes
3	8	5500	LP_Signal_03	Yes
4	19	5500	LP_Signal_04	No
5	12	5500	LP_Signal_05	Yes
6	11	5500	LP_Signal_06	No
7	6	5500	LP_Signal_07	Yes
8	20	5500	LP_Signal_08	Yes
9	6	5500	LP_Signal_09	Yes
10	12	5500	LP_Signal_10	Yes
11	16	5497	LP_Signal_11	Yes
12	20	5499	LP_Signal_12	Yes
13	18	5498	LP_Signal_13	Yes
14	12	5496	LP_Signal_14	Yes
15	12	5496	LP_Signal_15	Yes
16	15	5497	LP_Signal_16	Yes
17	10	5495	LP_Signal_17	Yes
18	12	5496	LP_Signal_18	Yes
19	10	5495	LP_Signal_19	Yes
20	20	5499	LP_Signal_20	Yes
21	7	5506	LP_Signal_21	Yes
22	20	5501	LP_Signal_22	Yes
23	8	5506	LP_Signal_23	No
24	17	5502	LP_Signal_24	Yes
25	7	5506	LP_Signal_25	Yes
26	14	5503	LP_Signal_26	Yes
27	11	5505	LP_Signal_27	Yes
28	7	5506	LP_Signal_28	Yes
29	12	5504	LP_Signal_29	Yes
30	8	5506	LP_Signal_30	Yes

Detection Rate: 90 %

The Long Pulse Radar pattern shown in Appendix A.1

802.11ac (VHT20)

Type 6 Radar Statistical Performances				
Trial #	Pulses per Burst	Pulse Width(us)	PRI(us)	Detection
1	9	1	333.3	Yes
2	9	1	333.3	Yes
3	9	1	333.3	Yes
4	9	1	333.3	Yes
5	9	1	333.3	Yes
6	9	1	333.3	Yes
7	9	1	333.3	Yes
8	9	1	333.3	Yes
9	9	1	333.3	Yes
10	9	1	333.3	Yes
11	9	1	333.3	Yes
12	9	1	333.3	Yes
13	9	1	333.3	Yes
14	9	1	333.3	Yes
15	9	1	333.3	Yes
16	9	1	333.3	Yes
17	9	1	333.3	Yes
18	9	1	333.3	Yes
19	9	1	333.3	No
20	9	1	333.3	Yes
21	9	1	333.3	Yes
22	9	1	333.3	Yes
23	9	1	333.3	Yes
24	9	1	333.3	No
25	9	1	333.3	Yes
26	9	1	333.3	Yes
27	9	1	333.3	Yes
28	9	1	333.3	Yes
29	9	1	333.3	Yes
30	9	1	333.3	Yes

Detection Rate: 93.3 %

802.11ac (VHT20)

Type 6 Radar Statistical Performances		
Trial #	Hopping Frequency Sequence Name	Detection
1	HOP_FREQ_SEQ_01	Yes
2	HOP_FREQ_SEQ_02	Yes
3	HOP_FREQ_SEQ_03	Yes
4	HOP_FREQ_SEQ_04	Yes
5	HOP_FREQ_SEQ_05	Yes
6	HOP_FREQ_SEQ_06	Yes
7	HOP_FREQ_SEQ_07	Yes
8	HOP_FREQ_SEQ_08	Yes
9	HOP_FREQ_SEQ_09	Yes
10	HOP_FREQ_SEQ_10	Yes
11	HOP_FREQ_SEQ_11	Yes
12	HOP_FREQ_SEQ_12	Yes
13	HOP_FREQ_SEQ_13	Yes
14	HOP_FREQ_SEQ_14	Yes
15	HOP_FREQ_SEQ_15	Yes
16	HOP_FREQ_SEQ_16	Yes
17	HOP_FREQ_SEQ_17	Yes
18	HOP_FREQ_SEQ_18	Yes
19	HOP_FREQ_SEQ_19	No
20	HOP_FREQ_SEQ_20	Yes
21	HOP_FREQ_SEQ_21	Yes
22	HOP_FREQ_SEQ_22	Yes
23	HOP_FREQ_SEQ_23	Yes
24	HOP_FREQ_SEQ_24	No
25	HOP_FREQ_SEQ_25	Yes
26	HOP_FREQ_SEQ_26	Yes
27	HOP_FREQ_SEQ_27	Yes
28	HOP_FREQ_SEQ_28	Yes
29	HOP_FREQ_SEQ_29	Yes
30	HOP_FREQ_SEQ_30	Yes
		Detection Rate: 93.3 %

The Frequency Hopping Radar pattern shown in Appendix A.2

802.11ac (VHT40)
Type 1 Radar Statistical Performances

Trial #	Test Frequency (MHz)	Pulse Repetition Frequency Number (1 to 23)	Pulse Repetition Frequency (Pulse per seconds)	Pulses per Burst	Pulse Repetition Interval (microseconds)	Detection
1	5510	5	1672	89	598	Yes
2	5520	21	1089	58	918	Yes
3	5500	14	1285	68	778	Yes
4	5492	23	326.2	18	3066	Yes
5	5492	10	1433	76	698	Yes
6	5524	13	1319	70	758	No
7	5524	16	1223	65	818	Yes
8	5497	15	1253	67	798	Yes
9	5497	11	1393	74	718	Yes
10	5504	3	1792	95	558	Yes
11	5498	22	1066	57	938	Yes
12	5525	7	1567	83	638	Yes
13	5493	17	1193	63	838	Yes
14	5492	18	1166	62	858	Yes
15	5511	9	1475	78	678	Yes
16	5498		1524	81	656	Yes
17	5517		749.6	40	1334	No
18	5501		1812	96	552	Yes
19	5492		660.5	35	1514	Yes
20	5511		364.2	20	2746	Yes
21	5505		960.6	51	1041	Yes
22	5508		344.1	19	2906	No
23	5501		421.2	23	2374	Yes
24	5518		751.3	40	1331	Yes
25	5507		513.3	28	1948	Yes
26	5505		1027	55	974	Yes
27	5503		409.3	22	2443	Yes
28	5517		557.4	30	1794	Yes
29	5502		874.1	47	1144	Yes
30	5510		473.5	25	2112	Yes

Detection Rate: 90 %

802.11ac (VHT40)

Type 2 Radar Statistical Performances					
Trial #	Test Frequency (MHz)	Pulses per Burst	Pulse Width(us)	PRI(us)	Detection
1	5510	28	4.2	228	Yes
2	5520	24	1.6	202	Yes
3	5500	24	1.9	193	Yes
4	5521	29	4.6	189	Yes
5	5521	26	3	167	Yes
6	5512	25	2.6	180	Yes
7	5495	23	1.4	165	Yes
8	5501	29	5	190	Yes
9	5516	23	1.2	168	Yes
10	5505	26	3	224	Yes
11	5526	27	3.9	187	Yes
12	5496	29	5	171	Yes
13	5512	28	4.3	223	No
14	5516	26	2.9	216	Yes
15	5500	26	2.9	219	Yes
16	5492	27	3.6	169	Yes
17	5523	25	2.5	199	Yes
18	5525	26	3	151	No
19	5503	25	2.4	198	Yes
20	5517	29	5	207	No
21	5511	23	1.5	162	Yes
22	5507	29	5	161	Yes
23	5514	24	1.8	194	Yes
24	5506	28	4.1	178	Yes
25	5500	24	1.6	170	Yes
26	5496	27	3.4	195	Yes
27	5509	25	2.7	212	No
28	5495	24	1.7	196	Yes
29	5519	26	2.8	217	Yes
30	5512	24	1.8	183	Yes

Detection Rate: 86.7 %

802.11ac (VHT40)

Type 3 Radar Statistical Performances					
Trial #	Test Frequency (MHz)	Pulses per Burst	Pulse Width(us)	PRI(us)	Detection
1	5510	18	9.2	258	Yes
2	5520	16	6.6	493	Yes
3	5500	16	6.9	359	Yes
4	5507	18	9.6	397	Yes
5	5522	17	8	355	Yes
6	5494	17	7.6	428	Yes
7	5509	16	6.4	271	Yes
8	5528	18	10	371	Yes
9	5496	16	6.2	430	No
10	5517	17	8	272	Yes
11	5493	18	8.9	202	Yes
12	5514	18	10	264	Yes
13	5505	18	9.3	207	Yes
14	5492	17	7.9	456	Yes
15	5525	17	7.9	291	Yes
16	5504	17	8.6	411	Yes
17	5518	17	7.5	368	Yes
18	5502	17	8	241	Yes
19	5513	17	7.4	467	Yes
20	5517	18	10	339	Yes
21	5507	16	6.5	500	No
22	5505	18	10	358	Yes
23	5525	16	6.8	251	No
24	5520	18	9.1	230	No
25	5503	16	6.6	285	Yes
26	5526	17	8.4	426	Yes
27	5507	17	7.7	350	Yes
28	5497	16	6.7	434	Yes
29	5497	17	7.8	491	Yes
30	5505	16	6.8	438	Yes

Detection Rate: 86.7 %

802.11ac (VHT40)

Type 4 Radar Statistical Performances					
Trial #	Test Frequency (MHz)	Pulses per Burst	Pulse Width(us)	PRI(us)	Detection
1	5510	15	18.1	258	Yes
2	5520	12	12.3	493	Yes
3	5500	13	13.2	359	Yes
4	5523	16	19.1	397	Yes
5	5520	14	15.4	355	Yes
6	5500	14	14.6	428	Yes
7	5518	12	11.9	271	Yes
8	5516	16	19.9	371	Yes
9	5506	12	11.6	430	Yes
10	5508	14	15.4	272	Yes
11	5500	15	17.4	202	Yes
12	5505	16	19.9	264	Yes
13	5497	16	18.4	207	Yes
14	5522	14	15.3	456	Yes
15	5523	14	15.3	291	Yes
16	5497	15	16.8	411	Yes
17	5517	13	14.3	368	Yes
18	5506	14	15.5	241	Yes
19	5511	13	14.2	467	No
20	5493	16	20	339	Yes
21	5508	12	12.2	500	Yes
22	5510	16	19.9	358	Yes
23	5505	13	12.9	251	No
24	5524	15	17.9	230	Yes
25	5503	12	12.3	285	Yes
26	5502	15	16.5	426	Yes
27	5513	14	14.8	350	Yes
28	5509	12	12.6	434	Yes
29	5503	14	15.1	491	Yes
30	5518	13	12.9	438	No

Detection Rate: 90 %

802.11ac (VHT40)
Type 5 Radar Statistical Performances

Trial #	Minimum Chirp Width(MHz)	Chirp Center Frequency(MHz)	Test Signal Name	Detection
1	17	5510	LP_Signal_01	No
2	7	5510	LP_Signal_02	Yes
3	8	5510	LP_Signal_03	Yes
4	19	5510	LP_Signal_04	Yes
5	12	5510	LP_Signal_05	Yes
6	11	5510	LP_Signal_06	Yes
7	6	5510	LP_Signal_07	Yes
8	20	5510	LP_Signal_08	Yes
9	6	5510	LP_Signal_09	Yes
10	12	5510	LP_Signal_10	Yes
11	16	5497	LP_Signal_11	Yes
12	20	5499	LP_Signal_12	Yes
13	18	5498	LP_Signal_13	Yes
14	12	5496	LP_Signal_14	Yes
15	12	5496	LP_Signal_15	Yes
16	15	5497	LP_Signal_16	Yes
17	10	5495	LP_Signal_17	Yes
18	12	5496	LP_Signal_18	Yes
19	10	5495	LP_Signal_19	Yes
20	20	5499	LP_Signal_20	Yes
21	7	5526	LP_Signal_21	Yes
22	20	5521	LP_Signal_22	No
23	8	5526	LP_Signal_23	Yes
24	17	5522	LP_Signal_24	Yes
25	7	5526	LP_Signal_25	Yes
26	14	5523	LP_Signal_26	Yes
27	11	5525	LP_Signal_27	Yes
28	7	5526	LP_Signal_28	Yes
29	12	5524	LP_Signal_29	Yes
30	8	5526	LP_Signal_30	Yes

Detection Rate: 93.3 %

The Long Pulse Radar pattern shown in Appendix A.1

802.11ac (VHT40)

Type 6 Radar Statistical Performances				
Trial #	Pulses per Burst	Pulse Width(us)	PRI(us)	Detection
1	9	1	333.3	Yes
2	9	1	333.3	Yes
3	9	1	333.3	Yes
4	9	1	333.3	Yes
5	9	1	333.3	Yes
6	9	1	333.3	Yes
7	9	1	333.3	Yes
8	9	1	333.3	Yes
9	9	1	333.3	Yes
10	9	1	333.3	Yes
11	9	1	333.3	Yes
12	9	1	333.3	Yes
13	9	1	333.3	No
14	9	1	333.3	Yes
15	9	1	333.3	Yes
16	9	1	333.3	Yes
17	9	1	333.3	No
18	9	1	333.3	Yes
19	9	1	333.3	Yes
20	9	1	333.3	Yes
21	9	1	333.3	Yes
22	9	1	333.3	Yes
23	9	1	333.3	Yes
24	9	1	333.3	No
25	9	1	333.3	Yes
26	9	1	333.3	Yes
27	9	1	333.3	Yes
28	9	1	333.3	Yes
29	9	1	333.3	Yes
30	9	1	333.3	Yes
				Detection Rate: 90 %

802.11ac (VHT40)

Type 6 Radar Statistical Performances		
Trial #	Hopping Frequency Sequence Name	Detection
1	HOP_FREQ_SEQ_01	Yes
2	HOP_FREQ_SEQ_02	Yes
3	HOP_FREQ_SEQ_03	Yes
4	HOP_FREQ_SEQ_04	Yes
5	HOP_FREQ_SEQ_05	Yes
6	HOP_FREQ_SEQ_06	Yes
7	HOP_FREQ_SEQ_07	Yes
8	HOP_FREQ_SEQ_08	Yes
9	HOP_FREQ_SEQ_09	Yes
10	HOP_FREQ_SEQ_10	Yes
11	HOP_FREQ_SEQ_11	Yes
12	HOP_FREQ_SEQ_12	Yes
13	HOP_FREQ_SEQ_13	No
14	HOP_FREQ_SEQ_14	Yes
15	HOP_FREQ_SEQ_15	Yes
16	HOP_FREQ_SEQ_16	Yes
17	HOP_FREQ_SEQ_17	No
18	HOP_FREQ_SEQ_18	Yes
19	HOP_FREQ_SEQ_19	Yes
20	HOP_FREQ_SEQ_20	Yes
21	HOP_FREQ_SEQ_21	Yes
22	HOP_FREQ_SEQ_22	Yes
23	HOP_FREQ_SEQ_23	Yes
24	HOP_FREQ_SEQ_24	No
25	HOP_FREQ_SEQ_25	Yes
26	HOP_FREQ_SEQ_26	Yes
27	HOP_FREQ_SEQ_27	Yes
28	HOP_FREQ_SEQ_28	Yes
29	HOP_FREQ_SEQ_29	Yes
30	HOP_FREQ_SEQ_30	Yes
		Detection Rate: 90 %

The Frequency Hopping Radar pattern shown in Appendix A.2

802.11ac (VHT80)
Type 1 Radar Statistical Performances

Trial #	Test Frequency (MHz)	Pulse Repetition Frequency Number (1 to 23)	Pulse Repetition Frequency (Pulse per seconds)	Pulses per Burst	Pulse Repetition Interval (microseconds)	Detection
1	5530	5	1672	89	598	Yes
2	5540	21	1089	58	918	Yes
3	5560	14	1285	68	778	Yes
4	5520	23	326.2	18	3066	Yes
5	5500	10	1433	76	698	Yes
6	5559	13	1319	70	758	Yes
7	5526	16	1223	65	818	Yes
8	5508	15	1253	67	798	Yes
9	5516	11	1393	74	718	Yes
10	5548	3	1792	95	558	Yes
11	5530	22	1066	57	938	Yes
12	5510	7	1567	83	638	Yes
13	5515	17	1193	63	838	No
14	5565	18	1166	62	858	Yes
15	5560	9	1475	78	678	No
16	5531		1524	81	656	Yes
17	5541		749.6	40	1334	Yes
18	5497		1812	96	552	Yes
19	5536		660.5	35	1514	Yes
20	5494		364.2	20	2746	Yes
21	5554		960.6	51	1041	Yes
22	5502		344.1	19	2906	Yes
23	5538		421.2	23	2374	No
24	5555		751.3	40	1331	Yes
25	5511		513.3	28	1948	Yes
26	5509		1027	55	974	Yes
27	5512		409.3	22	2443	Yes
28	5520		557.4	30	1794	Yes
29	5493		874.1	47	1144	Yes
30	5545		473.5	25	2112	Yes

Detection Rate: 90 %

802.11ac (VHT80)
Type 2 Radar Statistical Performances

Trial #	Test Frequency (MHz)	Pulses per Burst	Pulse Width(us)	PRI(us)	Detection
1	5530	28	4.2	228	Yes
2	5540	24	1.6	202	Yes
3	5560	24	1.9	193	Yes
4	5520	29	4.6	189	Yes
5	5500	26	3	167	Yes
6	5563	25	2.6	180	Yes
7	5548	23	1.4	165	Yes
8	5558	29	5	190	No
9	5524	23	1.2	168	Yes
10	5528	26	3	224	No
11	5552	27	3.9	187	Yes
12	5492	29	5	171	Yes
13	5553	28	4.3	223	No
14	5542	26	2.9	216	Yes
15	5507	26	2.9	219	Yes
16	5493	27	3.6	169	Yes
17	5550	25	2.5	199	Yes
18	5558	26	3	151	Yes
19	5547	25	2.4	198	Yes
20	5509	29	5	207	Yes
21	5526	23	1.5	162	Yes
22	5527	29	5	161	Yes
23	5546	24	1.8	194	Yes
24	5523	28	4.1	178	Yes
25	5497	24	1.6	170	Yes
26	5542	27	3.4	195	Yes
27	5561	25	2.7	212	Yes
28	5524	24	1.7	196	Yes
29	5495	26	2.8	217	Yes
30	5498	24	1.8	183	Yes

Detection Rate: 90 %

802.11ac (VHT80)
Type 3 Radar Statistical Performances

Trial #	Test Frequency (MHz)	Pulses per Burst	Pulse Width(us)	PRI(us)	Detection
1	5530	18	9.2	258	Yes
2	5540	16	6.6	493	Yes
3	5560	16	6.9	359	Yes
4	5520	18	9.6	397	Yes
5	5500	17	8	355	Yes
6	5520	17	7.6	428	Yes
7	5517	16	6.4	271	Yes
8	5562	18	10	371	Yes
9	5528	16	6.2	430	Yes
10	5514	17	8	272	Yes
11	5516	18	8.9	202	Yes
12	5526	18	10	264	No
13	5513	18	9.3	207	Yes
14	5563	17	7.9	456	Yes
15	5537	17	7.9	291	Yes
16	5518	17	8.6	411	No
17	5563	17	7.5	368	No
18	5543	17	8	241	Yes
19	5494	17	7.4	467	Yes
20	5514	18	10	339	No
21	5525	16	6.5	500	Yes
22	5535	18	10	358	Yes
23	5531	16	6.8	251	Yes
24	5554	18	9.1	230	Yes
25	5565	16	6.6	285	Yes
26	5535	17	8.4	426	Yes
27	5515	17	7.7	350	Yes
28	5500	16	6.7	434	Yes
29	5506	17	7.8	491	Yes
30	5513	16	6.8	438	Yes

Detection Rate: 86.7 %

802.11ac (VHT80)
Type 4 Radar Statistical Performances

Trial #	Test Frequency (MHz)	Pulses per Burst	Pulse Width(us)	PRI(us)	Detection
1	5530	15	18.1	258	Yes
2	5540	12	12.3	493	Yes
3	5560	13	13.2	359	Yes
4	5520	16	19.1	397	Yes
5	5500	14	15.4	355	No
6	5522	14	14.6	428	No
7	5501	12	11.9	271	Yes
8	5512	16	19.9	371	Yes
9	5502	12	11.6	430	Yes
10	5527	14	15.4	272	Yes
11	5525	15	17.4	202	Yes
12	5527	16	19.9	264	Yes
13	5547	16	18.4	207	Yes
14	5555	14	15.3	456	Yes
15	5493	14	15.3	291	No
16	5548	15	16.8	411	No
17	5526	13	14.3	368	Yes
18	5493	14	15.5	241	No
19	5502	13	14.2	467	Yes
20	5535	16	20	339	Yes
21	5541	12	12.2	500	Yes
22	5531	16	19.9	358	No
23	5536	13	12.9	251	Yes
24	5508	15	17.9	230	Yes
25	5535	12	12.3	285	Yes
26	5497	15	16.5	426	Yes
27	5509	14	14.8	350	Yes
28	5515	12	12.6	434	No
29	5519	14	15.1	491	Yes
30	5540	13	12.9	438	Yes

Detection Rate: 76.7 %

802.11ac (VHT80)
Type 5 Radar Statistical Performances

Trial #	Minimum Chirp Width(MHz)	Chirp Center Frequency(MHz)	Test Signal Name	Detection
1	17	5530	LP_Signal_01	Yes
2	7	5530	LP_Signal_02	Yes
3	8	5530	LP_Signal_03	No
4	19	5530	LP_Signal_04	Yes
5	12	5530	LP_Signal_05	Yes
6	11	5530	LP_Signal_06	Yes
7	6	5530	LP_Signal_07	Yes
8	20	5530	LP_Signal_08	Yes
9	6	5530	LP_Signal_09	Yes
10	12	5530	LP_Signal_10	Yes
11	16	5498	LP_Signal_11	Yes
12	20	5500	LP_Signal_12	Yes
13	18	5499	LP_Signal_13	Yes
14	12	5497	LP_Signal_14	Yes
15	12	5497	LP_Signal_15	Yes
16	15	5498	LP_Signal_16	Yes
17	10	5496	LP_Signal_17	Yes
18	12	5497	LP_Signal_18	Yes
19	10	5496	LP_Signal_19	Yes
20	20	5500	LP_Signal_20	Yes
21	7	5565	LP_Signal_21	Yes
22	20	5560	LP_Signal_22	No
23	8	5565	LP_Signal_23	Yes
24	17	5561	LP_Signal_24	Yes
25	7	5565	LP_Signal_25	Yes
26	14	5562	LP_Signal_26	No
27	11	5564	LP_Signal_27	Yes
28	7	5565	LP_Signal_28	Yes
29	12	5563	LP_Signal_29	Yes
30	8	5565	LP_Signal_30	Yes

Detection Rate: 90 %

The Long Pulse Radar pattern shown in Appendix A.1

802.11ac (VHT80)

Type 6 Radar Statistical Performances				
Trial #	Pulses per Burst	Pulse Width(us)	PRI(us)	Detection
1	9	1	333.3	Yes
2	9	1	333.3	Yes
3	9	1	333.3	No
4	9	1	333.3	No
5	9	1	333.3	Yes
6	9	1	333.3	Yes
7	9	1	333.3	Yes
8	9	1	333.3	Yes
9	9	1	333.3	Yes
10	9	1	333.3	Yes
11	9	1	333.3	Yes
12	9	1	333.3	Yes
13	9	1	333.3	Yes
14	9	1	333.3	Yes
15	9	1	333.3	Yes
16	9	1	333.3	Yes
17	9	1	333.3	Yes
18	9	1	333.3	Yes
19	9	1	333.3	Yes
20	9	1	333.3	No
21	9	1	333.3	Yes
22	9	1	333.3	Yes
23	9	1	333.3	Yes
24	9	1	333.3	Yes
25	9	1	333.3	Yes
26	9	1	333.3	Yes
27	9	1	333.3	Yes
28	9	1	333.3	Yes
29	9	1	333.3	Yes
30	9	1	333.3	Yes
				Detection Rate: 90 %

802.11ac (VHT80)

Type 6 Radar Statistical Performances		
Trial #	Hopping Frequency Sequence Name	Detection
1	HOP_FREQ_SEQ_01	Yes
2	HOP_FREQ_SEQ_02	Yes
3	HOP_FREQ_SEQ_03	No
4	HOP_FREQ_SEQ_04	No
5	HOP_FREQ_SEQ_05	Yes
6	HOP_FREQ_SEQ_06	Yes
7	HOP_FREQ_SEQ_07	Yes
8	HOP_FREQ_SEQ_08	Yes
9	HOP_FREQ_SEQ_09	Yes
10	HOP_FREQ_SEQ_10	Yes
11	HOP_FREQ_SEQ_11	Yes
12	HOP_FREQ_SEQ_12	Yes
13	HOP_FREQ_SEQ_13	Yes
14	HOP_FREQ_SEQ_14	Yes
15	HOP_FREQ_SEQ_15	Yes
16	HOP_FREQ_SEQ_16	Yes
17	HOP_FREQ_SEQ_17	Yes
18	HOP_FREQ_SEQ_18	Yes
19	HOP_FREQ_SEQ_19	Yes
20	HOP_FREQ_SEQ_20	No
21	HOP_FREQ_SEQ_21	Yes
22	HOP_FREQ_SEQ_22	Yes
23	HOP_FREQ_SEQ_23	Yes
24	HOP_FREQ_SEQ_24	Yes
25	HOP_FREQ_SEQ_25	Yes
26	HOP_FREQ_SEQ_26	Yes
27	HOP_FREQ_SEQ_27	Yes
28	HOP_FREQ_SEQ_28	Yes
29	HOP_FREQ_SEQ_29	Yes
30	HOP_FREQ_SEQ_30	Yes
		Detection Rate: 90 %

The Frequency Hopping Radar pattern shown in Appendix A.2

6.2.5 Non- Occupancy Period

1) Test results demonstrating an associated client link is established with the master on a test frequency.

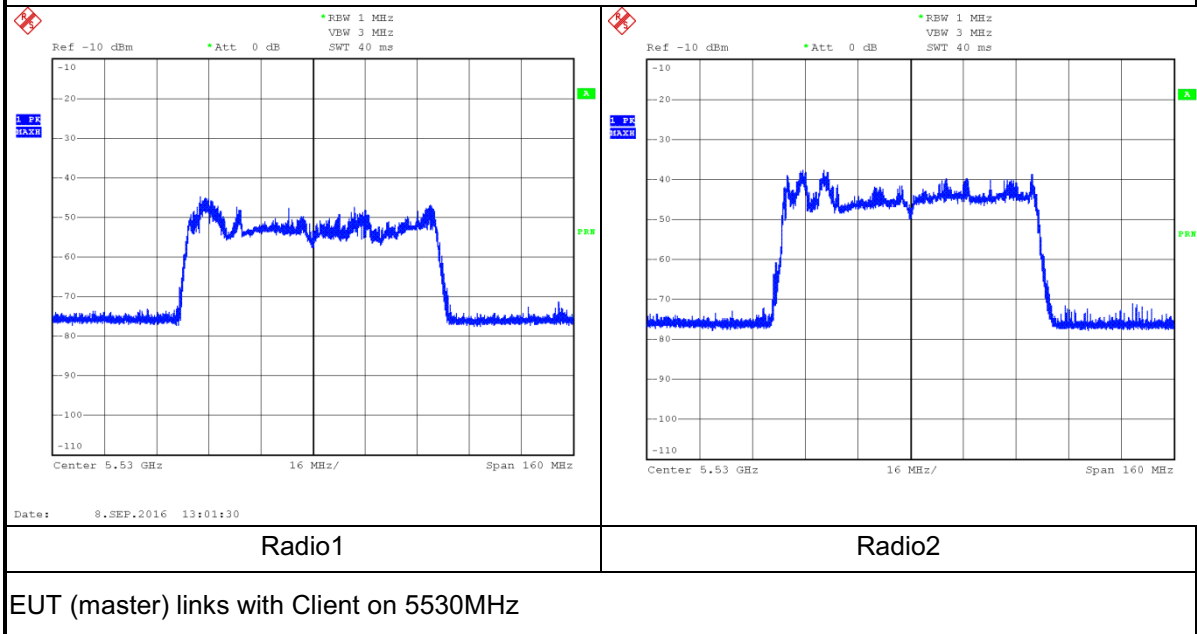

2) The master and DFS-certified client device are associated, and system testing will be performed with channel-loading for a non-occupancy period test.

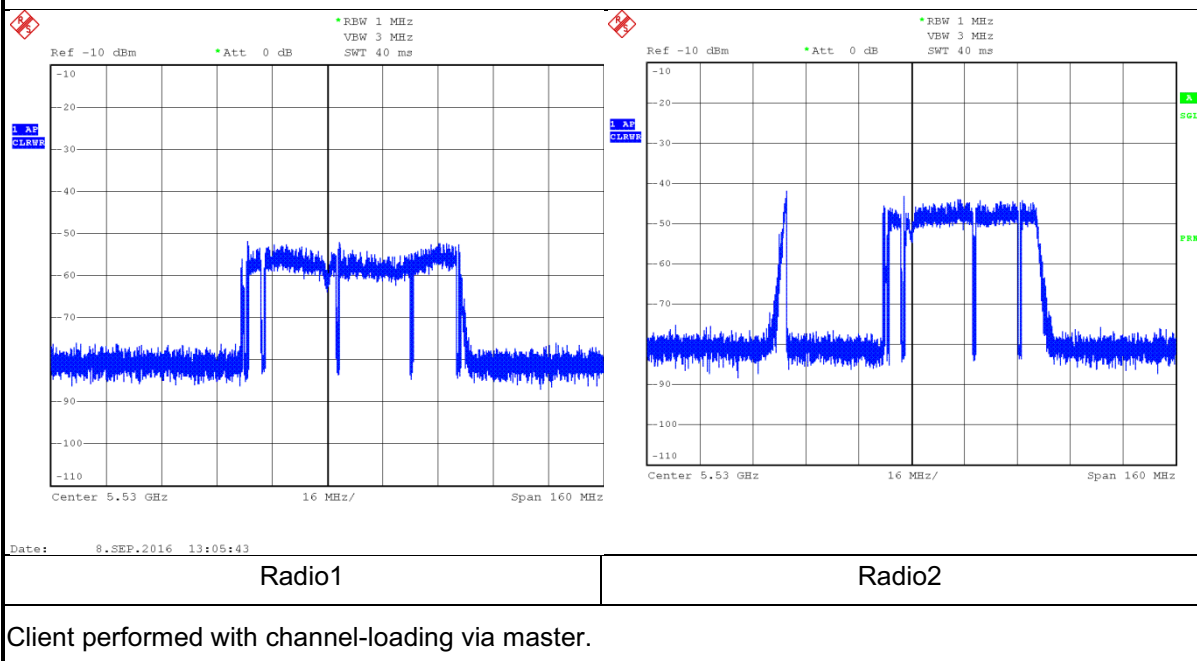

3). The device transmits one type of radar as specified in the DFS Order.

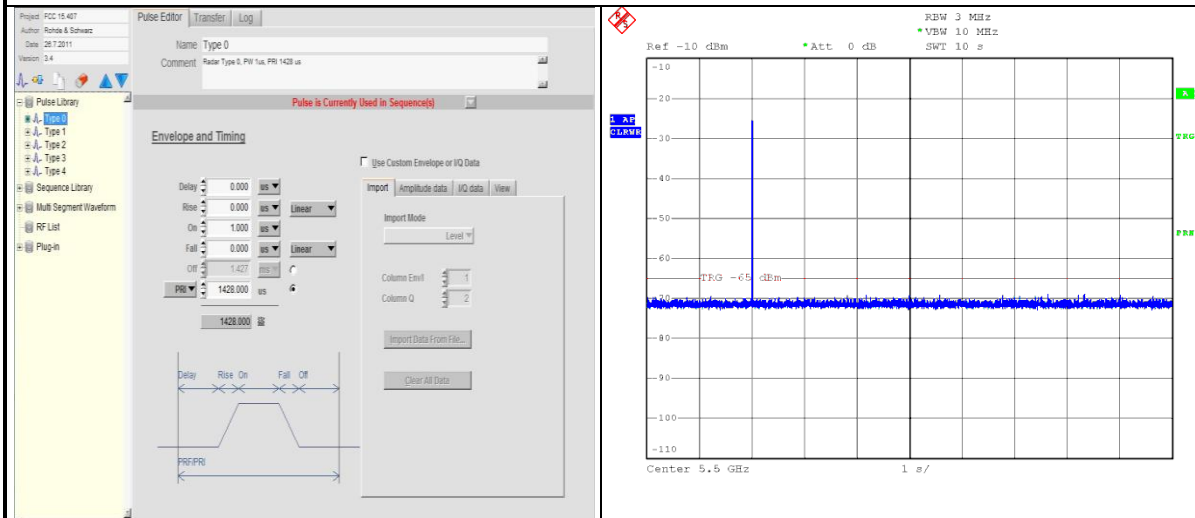

Radar 0 is used to test during DFS testing.

4) The test frequency has been monitored to ensure no transmission of any type has occurred for 30 minutes;

Note: If the client moves with the master, the device is considered compliant if nothing appears in the client non-occupancy period test. For devices that shut down (rather than moving channels), no beacons should appear;

5) An analyzer plot that contains a single 30-minute sweep on the original test frequency.

Radio1

Non - Occupancy Period @CH106-5530MHz

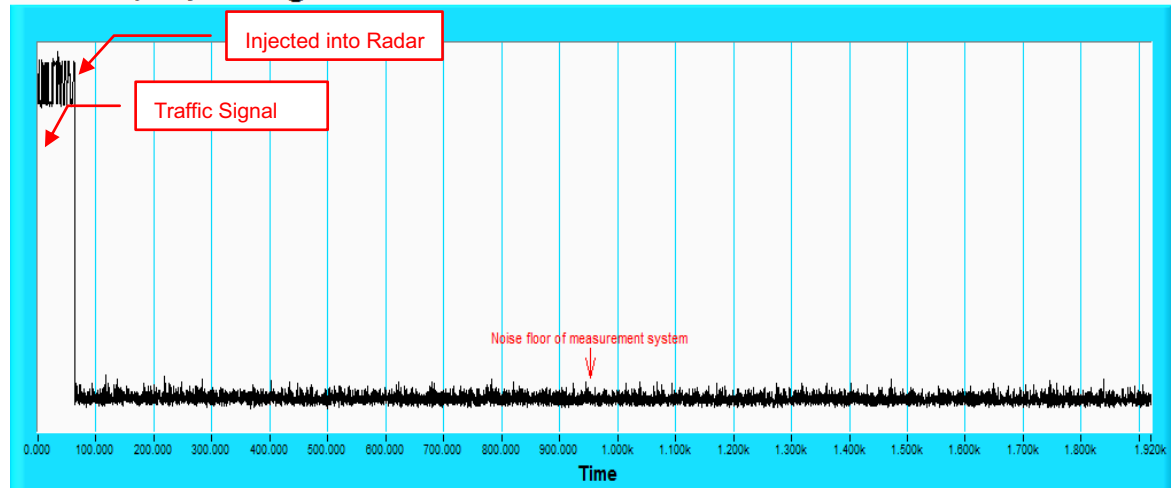

Radio2

Non - Occupancy Period @CH106-5530MHz

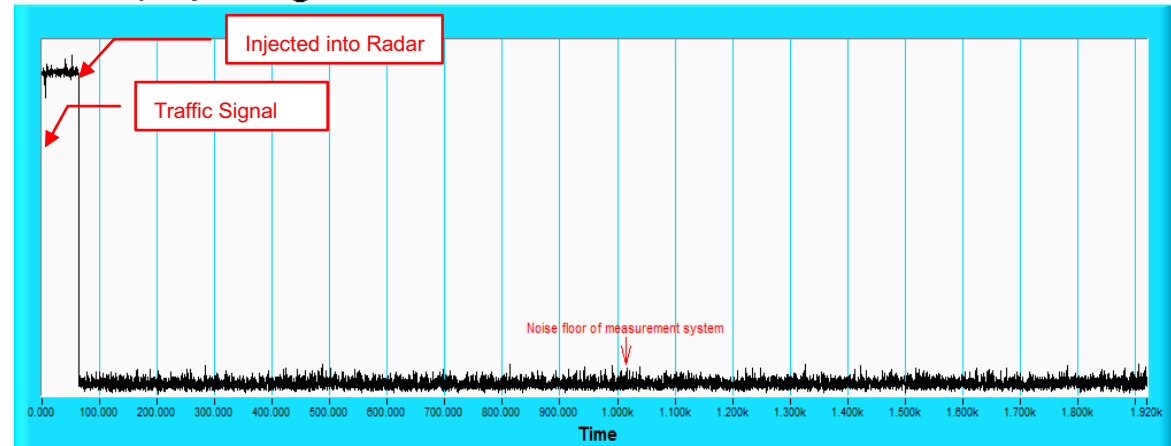

7. Information on the Testing Laboratories

We, Bureau Veritas Consumer Products Services (H.K.) Ltd., Taoyuan Branch, were founded in 1988 to provide our best service in EMC, Radio, Telecom and Safety consultation. Our laboratories are accredited and approved according to ISO/IEC 17025.

If you have any comments, please feel free to contact us at the following:

Linko EMC/RF Lab

Tel: 886-2-26052180

Fax: 886-2-26051924

Hsin Chu EMC/RF/Telecom Lab

Tel: 886-3-6668565

Fax: 886-3-6668323

Hwa Ya EMC/RF/Safety

Tel: 886-3-3183232

Fax: 886-3-3270892

Email: service.adt@tw.bureauveritas.com

Web Site: www.bureauveritas-adt.com

The address and road map of all our labs can be found in our web site also.

8. APPENDIX-A

RADAR TEST SIGNAL

A.1 The Long Pulse Radar Pattern

Long Pulse Radar Test Signal

Test Signal Name: LP_Signal_01

Number of Bursts in Trial: 13

Burst	Pulses per Burst	Chirp (MHz)	Pulse Width(us)	PRI-1 (us)	PRI-2 (us)	PRI-3 (us)
1	2	5	71.4	1802	1484	-
2	2	5	72.9	1618	1750	-
3	1	5	52.9	1654	-	-
4	2	5	74	1742	1659	-
5	1	5	63.4	1097	-	-
6	2	5	71.2	1072	1940	-
7	3	5	97	1824	1300	1658
8	3	5	97.9	1279	1115	1411
9	1	5	54.5	1974	-	-
10	2	5	79.6	1304	1378	-
11	3	5	96.2	1471	1233	1921
12	2	5	74.7	1177	1638	-
13	3	5	91	1668	1763	1077
14						
15						
16						
17						
18						
19						
20						

Long Pulse Radar Test Signal

Test Signal Name: LP_Signal_02

Number of Bursts in Trial: 13

Burst	Pulses per Burst	Chirp (MHz)	Pulse Width(us)	PRI-1 (us)	PRI-2 (us)	PRI-3 (us)
1	1	5	57.6	1988	-	-
2	1	5	64.1	1013	-	-
3	2	5	82.6	1611	1070	-
4	2	5	82.3	1991	1683	-
5	2	5	78.8	1702	1478	-
6	3	5	96.1	1813	1847	1995
7	3	5	90	1749	1346	1133
8	1	5	50.6	1710	-	-
9	1	5	52.8	1195	-	-
10	2	5	75.6	1861	1244	-
11	1	5	58.8	1218	-	-
12	2	5	79.1	1544	1775	-
13	1	5	65.7	1186	-	-
14						
15						
16						
17						
18						
19						
20						

Long Pulse Radar Test Signal

Test Signal Name: LP_Signal_03

Number of Bursts in Trial: 8

Burst	Pulses per Burst	Chirp (MHz)	Pulse Width(us)	PRI-1 (us)	PRI-2 (us)	PRI-3 (us)
1	3	5	83.6	1369	1139	1441
2	1	5	63.2	1909	-	-
3	1	5	51.6	1664	-	-
4	1	5	66.5	1883	-	-
5	2	5	75.5	1560	1335	-
6	3	5	91.2	1144	1617	1582
7	3	5	95.9	1111	1312	1329
8	1	5	60.7	1754	-	-
9						
10						
11						
12						
13						
14						
15						
16						
17						
18						
19						
20						

Long Pulse Radar Test Signal

Test Signal Name: LP_Signal_04

Number of Bursts in Trial: 14

Burst	Pulses per Burst	Chirp (MHz)	Pulse Width(us)	PRI-1 (us)	PRI-2 (us)	PRI-3 (us)
1	3	6	89.3	1564	1977	1832
2	1	6	57.6	1639	-	-
3	2	6	74.3	1600	1127	-
4	2	6	75.7	1631	1125	-
5	3	6	94.3	1353	1464	1984
6	1	6	53.3	1030	-	-
7	2	6	70.7	1677	1798	-
8	1	6	60.8	1836	-	-
9	1	6	63.4	1053	-	-
10	1	6	64.6	1899	-	-
11	2	6	82.6	1725	1082	-
12	3	6	86	1272	1821	1171
13	2	6	69.9	1833	1765	-
14	2	6	79.9	1102	1385	-
15						
16						
17						
18						
19						
20						

Long Pulse Radar Test Signal

Test Signal Name: LP_Signal_05

Number of Bursts in Trial: 11

Burst	Pulses per Burst	Chirp (MHz)	Pulse Width(us)	PRI-1 (us)	PRI-2 (us)	PRI-3 (us)
1	1	5	51.3	1017	-	-
2	2	5	70.5	1275	1651	-
3	2	5	72.8	1868	1107	-
4	3	5	88.8	1682	1496	1714
5	1	5	58	1389	-	-
6	1	5	66.1	1588	-	-
7	3	5	99.9	1242	1577	1063
8	2	5	68.6	1035	1311	-
9	3	5	97.3	1672	1578	1203
10	3	5	94.1	1660	1348	1783
11	3	5	94.9	1278	1058	1859
12						
13						
14						
15						
16						
17						
18						
19						
20						

Long Pulse Radar Test Signal

Test Signal Name: LP_Signal_06

Number of Bursts in Trial: 20

Burst	Pulses per Burst	Chirp (MHz)	Pulse Width(us)	PRI-1 (us)	PRI-2 (us)	PRI-3 (us)
1	3	6	97.8	1376	1735	1705
2	3	6	87.6	1264	1721	1020
3	3	6	83.7	1715	1246	1361
4	3	6	96.3	1078	1815	1116
5	3	6	88.1	1176	1997	1302
6	1	6	54.1	1375	-	-
7	1	6	54.9	1168	-	-
8	2	6	78.9	1467	1657	-
9	2	6	80.3	1148	1568	-
10	2	6	68.3	1963	1402	-
11	1	6	56.4	1848	-	-
12	1	6	58.2	1630	-	-
13	1	6	56.5	1105	-	-
14						
15						
16						
17						
18						
19						
20						

Long Pulse Radar Test Signal

Test Signal Name: LP_Signal_07

Number of Bursts in Trial: 20

Burst	Pulses per Burst	Chirp (MHz)	Pulse Width(us)	PRI-1 (us)	PRI-2 (us)	PRI-3 (us)
1	3	6	84.6	1756	1857	1741
2	3	6	92.7	1470	1236	1262
3	2	6	69.2	1733	1200	-
4	3	6	89.8	1793	1703	1923
5	3	6	89.4	1880	1676	1486
6	1	6	61	1462	-	-
7	2	6	76.2	1280	1918	-
8	3	6	93.1	1299	1661	1110
9	3	6	95.8	1846	1011	1964
10	1	6	53.6	1810	-	-
11	1	6	61.9	1435	-	-
12	2	6	81.1	1744	1864	-
13	3	6	93.7	1875	1392	1212
14	3	6	86.8	1644	1622	1863
15	2	6	83.2	1445	1797	-
16	2	6	79.7	1764	1674	-
17	1	6	60.8	1500	-	-
18	2	6	70.7	1901	1033	-
19	1	6	60.4	1751	-	-
20	2	6	80.2	1626	1730	-

Long Pulse Radar Test Signal

Test Signal Name: LP_Signal_08

Number of Bursts in Trial: 20

Burst	Pulses per Burst	Chirp (MHz)	Pulse Width(us)	PRI-1 (us)	PRI-2 (us)	PRI-3 (us)
1	2	6	80.9	1545	1603	-
2	3	6	96.5	1189	1449	1225
3	1	6	65.8	1925	-	-
4	3	6	87	1018	1049	1841
5	1	6	64.6	1048	-	-
6	2	6	75.3	1429	1368	-
7	1	6	60.4	1156	-	-
8	2	6	77.7	1681	1307	-
9	1	6	57.1	1625	-	-
10	3	6	89.7	1355	1088	1374
11	1	6	61.6	1537	-	-
12	3	6	94.9	1989	1865	1947
13	1	6	62.2	1234	-	-
14	1	6	66.2	1931	-	-
15	1	6	54.2	1062	-	-
16	1	6	65.4	1014	-	-
17	3	6	96.9	1572	1489	1042
18	1	6	60	1576	-	-
19	2	6	79.2	1757	1993	-
20	3	6	86.2	1237	1607	1060

Long Pulse Radar Test Signal

Test Signal Name: LP_Signal_09

Number of Bursts in Trial: 10

Burst	Pulses per Burst	Chirp (MHz)	Pulse Width(us)	PRI-1 (us)	PRI-2 (us)	PRI-3 (us)
1	2	5	67.9	1522	1835	-
2	1	5	51.7	1472	-	-
3	1	5	51.9	1917	-	-
4	3	5	83.9	1130	1323	1518
5	2	5	71.8	1284	1515	-
6	1	5	65.1	1068	-	-
7	3	5	94.4	1173	1019	1934
8	2	5	67.4	1624	1866	-
9	2	5	71.8	1209	1288	-
10	2	5	68.1	1963	1468	-
11						
12						
13						
14						
15						
16						
17						
18						
19						
20						

Long Pulse Radar Test Signal

Test Signal Name: LP_Signal_10

Number of Bursts in Trial: 15

Burst	Pulses per Burst	Chirp (MHz)	Pulse Width(us)	PRI-1 (us)	PRI-2 (us)	PRI-3 (us)
1	3	5	99.2	1814	1640	1794
2	2	5	69.4	1316	1641	-
3	3	5	97.7	1675	1548	1344
4	3	5	96.1	1075	1407	1413
5	2	5	78.1	1728	1052	-
6	2	5	75.7	1492	1162	-
7	3	5	88.1	1205	1529	1508
8	2	5	76.9	1584	1558	-
9	2	5	82.3	1616	1438	-
10	2	5	75.2	1074	1680	-
11	1	5	64	1566	-	-
12	1	5	50.5	1085	-	-
13	3	5	98.6	1123	1090	1509
14	3	5	85.9	1719	1845	1949
15	1	5	56.1	1726	-	-
16						
17						
18						
19						
20						

Long Pulse Radar Test Signal

Test Signal Name: LP_Signal_11

Number of Bursts in Trial: 19

Burst	Pulses per Burst	Chirp (MHz)	Pulse Width(us)	PRI-1 (us)	PRI-2 (us)	PRI-3 (us)
1	3	5	92.1	1098	1308	1459
2	2	5	67	1927	1877	-
3	2	5	68.8	1126	1468	-
4	2	5	77.5	1609	1286	-
5	2	5	82.5	1091	1083	-
6	2	5	67.8	1163	1523	-
7	2	5	82.9	1650	1843	-
8	1	5	50.8	1643	-	-
9	3	5	91.5	1405	1469	1739
10	2	5	74.2	1933	1366	-
11	1	5	62.3	1352	-	-
12	2	5	79.1	1944	1119	-
13	3	5	94.6	1034	1357	1554
14	2	5	81.9	1227	1839	-
15	1	5	65.2	1592	-	-
16	3	5	99.5	1418	1636	1533
17	2	5	80.9	1881	1786	-
18	3	5	93.1	1818	1998	1736
19	1	5	55.9	1936	-	-
20						

Long Pulse Radar Test Signal

Test Signal Name: LP_Signal_12

Number of Bursts in Trial: 14

Burst	Pulses per Burst	Chirp (MHz)	Pulse Width(us)	PRI-1 (us)	PRI-2 (us)	PRI-3 (us)
1	1	7	58	1004	-	-
2	2	7	70.3	1393	1504	-
3	1	7	63.9	1586	-	-
4	3	7	98.9	1822	1727	1986
5	3	7	84.2	1623	1382	1419
6	3	7	90.6	1096	1745	1987
7	1	7	66.1	1669	-	-
8	3	7	88.5	1820	1811	1590
9	1	7	64.5	1834	-	-
10	3	7	84.8	1036	1466	1027
11	1	7	65.1	1536	-	-
12	3	7	85.6	1620	1347	1397
13	2	7	69.3	1951	1772	-
14	1	7	65.8	1693	-	-
15						
16						
17						
18						
19						
20						

Long Pulse Radar Test Signal

Test Signal Name: LP_Signal_13

Number of Bursts in Trial: 13

Burst	Pulses per Burst	Chirp (MHz)	Pulse Width(us)	PRI-1 (us)	PRI-2 (us)	PRI-3 (us)
1	3	6	95.9	1905	1890	1037
2	3	6	91.9	1724	1615	1081
3	1	6	54.7	1912	-	-
4	3	6	96.3	1169	1073	1805
5	2	6	66.9	1482	1550	-
6	3	6	84.9	1356	1953	1450
7	1	6	53.9	1157	-	-
8	1	6	66.2	1720	-	-
9	2	6	68.6	1530	1093	-
10	1	6	56.2	1296	-	-
11	2	6	71.9	1159	1021	-
12	1	6	65.8	1955	-	-
13	3	6	96.6	1394	1431	1422
14						
15						
16						
17						
18						
19						
20						

Long Pulse Radar Test Signal

Test Signal Name: LP_Signal_14

Number of Bursts in Trial: 9

Burst	Pulses per Burst	Chirp (MHz)	Pulse Width(us)	PRI-1 (us)	PRI-2 (us)	PRI-3 (us)
1	1	7	57.5	1259	-	-
2	3	7	92.6	1516	1241	1129
3	2	7	77.9	1326	1684	-
4	3	7	85.9	1990	1968	1103
5	2	7	78.2	1614	1531	-
6	2	7	68.2	1332	1166	-
7	3	7	84.7	1985	1124	1502
8	3	7	86.9	1251	1118	1882
9	1	7	66.4	1959	-	-
10						
11						
12						
13						
14						
15						
16						
17						
18						
19						
20						

Long Pulse Radar Test Signal

Test Signal Name: LP_Signal_15

Number of Bursts in Trial: 11

Burst	Pulses per Burst	Chirp (MHz)	Pulse Width(us)	PRI-1 (us)	PRI-2 (us)	PRI-3 (us)
1	2	6	79.3	1439	1557	-
2	2	6	68.3	1809	1924	-
3	1	6	66	1291	-	-
4	2	6	76.3	1782	1475	-
5	3	6	88.6	1491	1887	1790
6	3	6	93	1408	1055	1206
7	1	6	63.2	1437	-	-
8	3	6	98.8	1926	1403	1399
9	3	6	90.1	1202	1517	1686
10	1	6	60.4	1220	-	-
11	1	6	53.1	1543	-	-
12						
13						
14						
15						
16						
17						
18						
19						
20						

Long Pulse Radar Test Signal

Test Signal Name: LP_Signal_16

Number of Bursts in Trial: 16

Burst	Pulses per Burst	Chirp (MHz)	Pulse Width(us)	PRI-1 (us)	PRI-2 (us)	PRI-3 (us)
1	1	5	64	1919	-	-
2	1	5	58.2	1321	-	-
3	1	5	51.9	1945	-	-
4	3	5	91.8	1287	1025	1428
5	1	5	51.6	1456	-	-
6	1	5	57.7	1904	-	-
7	2	5	76.9	1330	1002	-
8	2	5	68.3	1633	1406	-
9	3	5	94	1141	1801	1138
10	2	5	72.7	1261	1520	-
11	3	5	93.5	1185	1574	1354
12	3	5	97.5	1591	1112	1528
13	1	5	59	1172	-	-
14	2	5	82	1228	1196	-
15	2	5	78.1	1553	1506	-
16	2	5	76.7	1320	1143	-
17						
18						
19						
20						

Long Pulse Radar Test Signal

Test Signal Name: LP_Signal_17

Number of Bursts in Trial: 16

Burst	Pulses per Burst	Chirp (MHz)	Pulse Width(us)	PRI-1 (us)	PRI-2 (us)	PRI-3 (us)
1	3	6	88	1009	1911	1734
2	1	6	60	1444	-	-
3	1	6	63.6	1902	-	-
4	3	6	86.6	1916	1223	1488
5	1	6	61.6	1889	-	-
6	2	6	80	1573	1167	-
7	2	6	68.5	1938	1692	-
8	2	6	74.7	1265	1219	-
9	3	6	97.9	1587	1213	1637
10	1	6	52.5	1701	-	-
11	2	6	79.9	1454	1807	-
12	2	6	83.3	1930	1142	-
13	2	6	72.9	1606	1939	-
14	3	6	83.4	1778	1731	1314
15	3	6	94.8	1260	1067	1535
16	1	6	54.9	1440	-	-
17						
18						
19						
20						

Long Pulse Radar Test Signal

Test Signal Name: LP_Signal_18

Number of Bursts in Trial: 15

Burst	Pulses per Burst	Chirp (MHz)	Pulse Width(us)	PRI-1 (us)	PRI-2 (us)	PRI-3 (us)
1	1	7	56.6	1147	-	-
2	2	7	72.6	1152	1601	-
3	2	7	69.1	1571	1803	-
4	3	7	99.4	1350	1146	1760
5	3	7	90.7	1064	1309	1896
6	3	7	86.1	1983	1816	1855
7	3	7	84.2	1370	1823	1646
8	2	7	70.4	1635	1854	-
9	3	7	91.3	1334	1136	1341
10	1	7	66.3	1360	-	-
11	3	7	93	1271	1057	1929
12	3	7	93.7	1906	1497	1479
13	3	7	85.8	1546	1015	1718
14	2	7	70.8	1001	1005	-
15	1	7	57	1685	-	-
16						
17						
18						
19						
20						



Long Pulse Radar Test Signal

Test Signal Name: LP_Signal_19

Number of Bursts in Trial: 19

Burst	Pulses per Burst	Chirp (MHz)	Pulse Width(us)	PRI-1 (us)	PRI-2 (us)	PRI-3 (us)
1	3	8	94.3	1920	1954	1181
2	1	8	60.5	1922	-	-
3	1	8	66.2	1738	-	-
4	2	8	75.3	1595	1443	-
5	3	8	88.8	1777	1789	1150
6	2	8	76.4	1343	1420	-
7	2	8	73.9	1379	1982	-
8	3	8	91.5	1175	1221	1569
9	3	8	84	1238	1694	1306
10	3	8	89.7	1179	1628	1791
11	2	8	77.3	1967	1795	-
12	3	8	94	1696	1359	2000
13	3	8	99.2	1788	1596	1521
14	2	8	77.8	1086	1165	-
15	3	8	93.7	1753	1780	1192
16	3	8	95.5	1188	1853	1425
17	1	8	60.5	1434	-	-
18	2	8	77.9	1808	1698	-
19	3	8	88.5	1183	1773	1187
20						

Long Pulse Radar Test Signal

Test Signal Name: LP_Signal_20

Number of Bursts in Trial: 18

Burst	Pulses per Burst	Chirp (MHz)	Pulse Width(us)	PRI-1 (us)	PRI-2 (us)	PRI-3 (us)
1	3	5	90.8	1878	1465	1873
2	3	5	86.4	1648	1415	1135
3	1	5	62.9	1318	-	-
4	2	5	78.7	1282	1263	-
5	3	5	86.1	1273	1561	1501
6	1	5	51.8	1844	-	-
7	2	5	75.8	1442	1285	-
8	3	5	93.2	1541	1160	1383
9	3	5	95.3	1448	1642	1290
10	3	5	95.3	1678	1589	1526
11	3	5	87.1	1317	1723	1293
12	2	5	74.8	1240	1178	-
13	3	5	88.9	1806	1975	1935
14	2	5	77	1158	1932	-
15	3	5	95.6	1191	1512	1874
16	3	5	85.6	1830	1737	1089
17	2	5	72.8	1398	1761	-
18	1	5	56.6	1339	-	-
19						
20						

Long Pulse Radar Test Signal

Test Signal Name: LP_Signal_21

Number of Bursts in Trial: 8

Burst	Pulses per Burst	Chirp (MHz)	Pulse Width(us)	PRI-1 (us)	PRI-2 (us)	PRI-3 (us)
1	1	6	58.1	1451	-	-
2	1	6	56	1771	-	-
3	2	6	78.6	1534	1372	-
4	2	6	82.8	1511	1869	-
5	2	6	81.1	1532	1266	-
6	3	6	85.2	1758	1137	1663
7	1	6	59.6	1249	-	-
8	1	6	63.3	1613	-	-
9						
10						
11						
12						
13						
14						
15						
16						
17						
18						
19						
20						

Long Pulse Radar Test Signal

Test Signal Name: LP_Signal_22

Number of Bursts in Trial: 8

Burst	Pulses per Burst	Chirp (MHz)	Pulse Width(us)	PRI-1 (us)	PRI-2 (us)	PRI-3 (us)
1	3	10	92.2	1711	1066	1483
2	3	10	85.1	1120	1108	1400
3	3	10	92.7	1862	1155	1305
4	3	10	97.7	1980	1301	1446
5	2	10	70.9	1007	1095	-
6	2	10	82.4	1787	1632	-
7	1	10	65.8	1871	-	-
8	3	10	97.3	1324	1476	1872
9						
10						
11						
12						
13						
14						
15						
16						
17						
18						
19						
20						

Long Pulse Radar Test Signal

Test Signal Name: LP_Signal_23

Number of Bursts in Trial: 14

Burst	Pulses per Burst	Chirp (MHz)	Pulse Width(us)	PRI-1 (us)	PRI-2 (us)	PRI-3 (us)
1	2	9	80.1	1452	1746	-
2	2	9	70.6	1827	1474	-
3	2	9	81.4	1325	1539	-
4	2	9	81.8	1898	1900	-
5	2	9	80.1	1248	1524	-
6	2	9	73.4	1092	1255	-
7	1	9	62.9	1579	-	-
8	2	9	83.2	1276	1351	-
9	2	9	78.6	1575	1950	-
10	3	9	96.2	1784	1494	1003
11	3	9	96.9	1610	1367	1274
12	1	9	64.9	1915	-	-
13	3	9	88.4	1503	1876	1087
14	2	9	66.9	1207	1315	-
15						
16						
17						
18						
19						
20						

Long Pulse Radar Test Signal

Test Signal Name: LP_Signal_24

Number of Bursts in Trial: 10

Burst	Pulses per Burst	Chirp (MHz)	Pulse Width(us)	PRI-1 (us)	PRI-2 (us)	PRI-3 (us)
1	1	6	53.5	1670	-	-
2	3	6	92.2	1893	1908	1164
3	2	6	70.8	1193	1828	-
4	3	6	88.8	1514	1634	1313
5	1	6	52.4	1229	-	-
6	2	6	71.9	1969	1038	-
7	1	6	59.9	1952	-	-
8	1	6	57.9	1101	-	-
9	1	6	55.2	1022	-	-
10	2	6	77.7	1149	1006	-
11						
12						
13						
14						
15						
16						
17						
18						
19						
20						

Long Pulse Radar Test Signal

Test Signal Name: LP_Signal_25

Number of Bursts in Trial: 15

Burst	Pulses per Burst	Chirp (MHz)	Pulse Width(us)	PRI-1 (us)	PRI-2 (us)	PRI-3 (us)
1	2	5	69.1	1525	1197	-
2	2	5	72.7	1976	1838	-
3	1	5	59.7	1849	-	-
4	3	5	90.8	1080	1913	1767
5	1	5	50.5	1972	-	-
6	3	5	97.7	1310	1867	1427
7	2	5	74.4	1910	1819	-
8	1	5	54.6	1277	-	-
9	1	5	59	1481	-	-
10	3	5	91.6	1023	1024	1079
11	3	5	97	1410	1914	1480
12	2	5	75	1781	1886	-
13	1	5	54.2	1505	-	-
14	3	5	91.1	1008	1363	1298
15	2	5	76.6	1567	1948	-
16						
17						
18						
19						
20						

Long Pulse Radar Test Signal

Test Signal Name: LP_Signal_26

Number of Bursts in Trial: 12

Burst	Pulses per Burst	Chirp (MHz)	Pulse Width(us)	PRI-1 (us)	PRI-2 (us)	PRI-3 (us)
1	3	5	84.8	1556	1510	1182
2	3	5	93.1	1956	1458	1386
3	3	5	95.4	1388	1704	1826
4	1	5	54.2	1962	-	-
5	3	5	84.9	1812	1706	1362
6	3	5	88.3	1555	1031	1056
7	3	5	94.8	1852	1292	1652
8	2	5	74.9	1084	1752	-
9	2	5	75.3	1210	1328	-
10	2	5	81.5	1937	1349	-
11	1	5	50.4	1649	-	-
12	2	5	76.8	1338	1270	-
13						
14						
15						
16						
17						
18						
19						
20						

Long Pulse Radar Test Signal

Test Signal Name: LP_Signal_27

Number of Bursts in Trial: 16

Burst	Pulses per Burst	Chirp (MHz)	Pulse Width(us)	PRI-1 (us)	PRI-2 (us)	PRI-3 (us)
1	2	6	82.1	1076	1629	-
2	2	6	80	1230	1257	-
3	3	6	93.9	1994	1447	1690
4	3	6	87.4	1507	1645	1365
5	2	6	72.1	1768	1897	-
6	1	6	65.3	1747	-	-
7	1	6	53.7	1540	-	-
8	1	6	62.7	1423	-	-
9	1	6	57.4	1829	-	-
10	1	6	63.7	1113	-	-
11	2	6	72.2	1604	1122	-
12	2	6	82.7	1396	1860	-
13	2	6	81	1047	1232	-
14	2	6	71.8	1026	1785	-
15	3	6	92.3	1358	1695	1605
16	1	6	55.9	1417	-	-
17						
18						
19						
20						

Long Pulse Radar Test Signal

Test Signal Name: LP_Signal_28

Number of Bursts in Trial: 11

Burst	Pulses per Burst	Chirp (MHz)	Pulse Width(us)	PRI-1 (us)	PRI-2 (us)	PRI-3 (us)
1	3	6	96.9	1709	1687	1743
2	2	6	69.9	1252	1414	-
3	2	6	78.6	1647	1043	-
4	3	6	88	1180	1884	1283
5	2	6	79.8	1656	1061	-
6	1	6	62.2	1662	-	-
7	2	6	67.7	1224	1199	-
8	2	6	78.9	1655	1250	-
9	1	6	64.6	1214	-	-
10	1	6	53.7	1380	-	-
11	2	6	70.4	1401	1364	-
12						
13						
14						
15						
16						
17						
18						
19						
20						

Long Pulse Radar Test Signal

Test Signal Name: LP_Signal_29

Number of Bursts in Trial: 8

Burst	Pulses per Burst	Chirp (MHz)	Pulse Width(us)	PRI-1 (us)	PRI-2 (us)	PRI-3 (us)
1	3	5	89.4	1170	1109	1565
2	2	5	74.3	1243	1059	-
3	3	5	97.8	1697	1946	1712
4	3	5	84.5	1800	1688	1245
5	1	5	59.2	1689	-	-
6	1	5	50.1	1477	-	-
7	2	5	70.8	1840	1942	-
8	3	5	92.4	1174	1028	1094
9						
10						
11						
12						
13						
14						
15						
16						
17						
18						
19						

Long Pulse Radar Test Signal

Test Signal Name: LP_Signal_30

Number of Bursts in Trial: 12

Burst	Pulses per Burst	Chirp (MHz)	Pulse Width(us)	PRI-1 (us)	PRI-2 (us)	PRI-3 (us)
1	2	6	74.6	1792	1593	-
2	1	6	65.1	1117	-	-
3	1	6	54.2	1538	-	-
4	2	6	74.9	1716	1999	-
5	1	6	59.6	1627	-	-
6	1	6	50.5	1337	-	-
7	2	6	78.3	1239	1562	-
8	2	6	69.1	1903	1190	-
9	2	6	71	1965	1717	-
10	2	6	70.9	1226	1762	-
11	1	6	62.7	1345	-	-
12	2	6	73.2	1770	1493	-
13						
14						
15						
16						
17						
18						
19						
20						

A.2 The Frequency Hopping Radar pattern

Hopping Frequency Sequence Name: HOP_FREQ_SEQ_01					
Frequency (MHz)	0	1	2	3	4
0	5436	5618	5502	5507	5674
5	5429	5363	5362	5339	5615
10	5432	5291	5566	5689	5400
15	5658	5277	5656	5265	5588
20	5643	5342	5449	5558	5600
25	5557	5293	5478	5488	5560
30	5331	5350	5559	5604	5505
35	5251	5413	5292	5424	5703
40	5596	5433	5266	5273	5548
45	5437	5253	5447	5628	5286
50	5340	5690	5302	5441	5439
55	5421	5694	5417	5609	5576
60	5305	5351	5288	5354	5335
65	5620	5657	5686	5711	5663
70	5610	5297	5634	5510	5426
75	5357	5667	5370	5387	5281
80	5585	5524	5338	5385	5673
85	5464	5693	5455	5633	5712
90	5679	5269	5607	5651	5352
95	5358	5612	5289	5397	5402

Hopping Frequency Sequence Name: HOP_FREQ_SEQ_02					
Frequency (MHz)	0	1	2	3	4
0	5691	5382	5438	5668	5419
5	5471	5385	5437	5502	5347
10	5363	5555	5607	5409	5421
15	5649	5404	5284	5310	5305
20	5554	5508	5370	5441	5531
25	5488	5496	5582	5522	5602
30	5317	5307	5299	5281	5325
35	5390	5504	5563	5577	5714
40	5435	5613	5679	5513	5642
45	5587	5417	5336	5505	5681
50	5648	5594	5391	5256	5530
55	5262	5722	5387	5278	5614
60	5580	5705	5470	5296	5595
65	5655	5378	5443	5606	5625
70	5446	5413	5466	5717	5275
75	5711	5626	5339	5410	5424
80	5566	5301	5448	5641	5293
85	5573	5393	5367	5535	5515
90	5350	5633	5459	5467	5297
95	5279	5386	5715	5624	5403

Hopping Frequency Sequence Name: HOP_FREQ_SEQ_03

Frequency (MHz)	0	1	2	3	4
0	5471	5621	5374	5354	5261
5	5513	5310	5512	5568	5651
10	5672	5344	5648	5507	5442
15	5262	5434	5290	5355	5497
20	5562	5577	5408	5530	5504
25	5279	5699	5308	5556	5266
30	5681	5264	5514	5523	5432
35	5595	5359	5255	5628	5274
40	5696	5520	5278	5639	5516
45	5397	5419	5563	5259	5438
50	5470	5567	5307	5619	5463
55	5666	5575	5707	5502	5433
60	5551	5635	5338	5427	5481
65	5324	5644	5555	5661	5350
70	5691	5538	5703	5613	5687
75	5585	5686	5547	5553	5461
80	5422	5457	5636	5588	5367
85	5377	5478	5445	5545	5684
90	5610	5287	5462	5285	5323
95	5597	5258	5420	5467	5698

Hopping Frequency Sequence Name: HOP_FREQ_SEQ_04

Frequency (MHz)	0	1	2	3	4
0	5251	5385	5310	5515	5481
5	5555	5332	5587	5256	5383
10	5603	5705	5311	5702	5463
15	5350	5561	5393	5400	5689
20	5570	5268	5349	5522	5477
25	5642	5685	5427	5412	5590
30	5308	5696	5632	5682	5343
35	5571	5686	5252	5505	5542
40	5304	5458	5421	5636	5348
45	5280	5502	5524	5312	5325
50	5346	5358	5708	5286	5513
55	5288	5661	5692	5488	5283
60	5356	5404	5270	5370	5504
65	5697	5717	5397	5707	5616
70	5351	5663	5544	5655	5650
75	5613	5625	5330	5678	5321
80	5307	5316	5538	5637	5413
85	5638	5485	5627	5291	5357
90	5382	5437	5562	5451	5596
95	5473	5366	5395	5509	5464

Hopping Frequency Sequence Name: HOP_FREQ_SEQ_05

Frequency (MHz)	0	1	2	3	4
0	5506	5624	5721	5579	5323
5	5694	5257	5662	5419	5590
10	5437	5494	5352	5422	5484
15	5438	5688	5496	5348	5406
20	5578	5337	5290	5611	5547
25	5433	5537	5533	5516	5350
30	5556	5372	5456	5541	5710
35	5302	5523	5658	5553	5524
40	5387	5396	5661	5633	5277
45	5260	5585	5582	5365	5697
50	5444	5409	5584	5457	5379
55	5615	5407	5546	5520	5490
60	5703	5663	5705	5691	5668
65	5550	5636	5320	5512	5675
70	5304	5716	5639	5503	5527
75	5295	5659	5606	5485	5681
80	5459	5384	5648	5501	5378
85	5689	5631	5305	5317	5297
90	5294	5264	5454	5617	5435
95	5452	5469	5690	5507	5562

Hopping Frequency Sequence Name: HOP_FREQ_SEQ_06

Frequency (MHz)	0	1	2	3	4
0	5664	5388	5657	5265	5543
5	5261	5279	5262	5582	5419
10	5368	5283	5393	5617	5505
15	5526	5340	5599	5598	5489
20	5503	5328	5603	5520	5321
25	5486	5620	5658	5445	5513
30	5587	5705	5361	5277	5490
35	5319	5336	5467	5363	5567
40	5334	5426	5630	5584	5715
45	5668	5640	5418	5477	5476
50	5460	5508	5407	5304	5569
55	5597	5268	5367	5649	5655
60	5648	5495	5531	5259	5394
65	5499	5672	5530	5307	5478
70	5473	5719	5524	5615	5462
75	5496	5415	5327	5694	5377
80	5447	5301	5320	5572	5561
85	5449	5721	5643	5404	5482
90	5303	5488	5471	5392	5413
95	5602	5299	5454	5351	5675

Hopping Frequency Sequence Name: HOP_FREQ_SEQ_07

Frequency (MHz)	0	1	2	3	4
0	5444	5627	5593	5426	5385
5	5303	5679	5337	5648	5626
10	5299	5547	5434	5526	5517
15	5467	5702	5438	5412	5497
20	5572	5269	5692	5493	5587
25	5338	5464	5346	5531	5431
30	5470	5327	5382	5656	5416
35	5581	5590	5586	5381	5677
40	5650	5272	5666	5724	5513
45	5695	5276	5601	5374	5267
50	5352	5321	5511	5597	5608
55	5723	5280	5523	5312	5562
60	5345	5690	5454	5680	5448
65	5611	5362	5674	5281	5545
70	5344	5373	5591	5421	5465
75	5568	5514	5329	5496	5541
80	5510	5298	5515	5551	5414
85	5524	5641	5686	5652	5701
90	5647	5406	5265	5500	5585
95	5252	5387	5313	5675	5697

Hopping Frequency Sequence Name: HOP_FREQ_SEQ_08

Frequency (MHz)	0	1	2	3	4
0	5699	5391	5529	5587	5605
5	5442	5701	5412	5336	5358
10	5608	5475	5435	5547	5497
15	5708	5483	5604	5505	5263
20	5685	5684	5466	5665	5667
25	5450	5251	5573	5320	5427
30	5445	5631	5379	5555	5672
35	5264	5392	5516	5258	5334
40	5721	5675	5359	5659	5629
45	5703	5562	5686	5431	5570
50	5468	5477	5502	5381	5309
55	5432	5510	5635	5256	5280
60	5626	5418	5397	5647	5572
65	5469	5559	5714	5255	5347
70	5600	5470	5380	5337	5558
75	5549	5291	5439	5277	5670
80	5673	5710	5454	5584	5261
85	5554	5648	5425	5521	5299
90	5288	5609	5602	5307	5484
95	5285	5303	5317	5723	5444

Hopping Frequency Sequence Name: HOP_FREQ_SEQ_09

Frequency (MHz)	0	1	2	3	4
0	5479	5630	5465	5273	5447
5	5484	5626	5487	5499	5662
10	5539	5697	5516	5568	5693
15	5624	5336	5431	5321	5416
20	5429	5723	5298	5439	5363
25	5614	5395	5554	5285	5712
30	5684	5384	5660	5308	5674
35	5694	5288	5279	5417	5306
40	5452	5438	5623	5574	5718
45	5274	5655	5442	5717	5480
50	5419	5579	5673	5613	5397
55	5254	5514	5656	5692	5578
60	5658	5561	5675	5580	5563
65	5678	5669	5716	5346	5683
70	5404	5361	5265	5311	5449
75	5446	5339	5659	5530	5543
80	5533	5297	5258	5670	5430
85	5454	5547	5453	5519	5602
90	5719	5502	5418	5711	5548
95	5619	5362	5468	5649	5406

Hopping Frequency Sequence Name: HOP_FREQ_SEQ_10

Frequency (MHz)	0	1	2	3	4
0	5637	5394	5401	5434	5667
5	5526	5648	5562	5662	5470
10	5486	5557	5350	5589	5306
15	5276	5439	5476	5513	5424
20	5498	5664	5290	5412	5629
25	5466	5501	5658	5319	5279
30	5670	5341	5400	5397	5261
35	5379	5550	5570	5695	5291
40	5521	5464	5339	5715	5678
45	5538	5525	5300	5533	5358
50	5374	5552	5361	5369	5385
55	5310	5593	5365	5395	5504
60	5615	5442	5295	5622	5614
65	5631	5543	5383	5324	5450
70	5298	5422	5653	5323	5705
75	5511	5320	5314	5461	5321
80	5625	5357	5512	5607	5645
85	5387	5349	5539	5270	5430
90	5255	5636	5417	5549	5556
95	5628	5509	5352	5410	5672

Hopping Frequency Sequence Name: HOP_FREQ_SEQ_11

Frequency (MHz)	0	1	2	3	4
0	5417	5633	5337	5595	5509
5	5568	5670	5637	5253	5601
10	5304	5275	5598	5545	5610
15	5297	5403	5542	5521	5705
20	5432	5664	5605	5379	5385
25	5517	5415	5704	5287	5353
30	5321	5559	5298	5615	5709
35	5692	5400	5470	5443	5345
40	5609	5604	5402	5482	5712
45	5510	5518	5608	5261	5586
50	5571	5550	5715	5575	5278
55	5305	5460	5339	5500	5691
60	5600	5722	5530	5567	5702
65	5330	5561	5643	5719	5658
70	5446	5426	5346	5552	5310
75	5453	5622	5398	5257	5373
80	5492	5475	5570	5625	5481
85	5442	5260	5354	5265	5352
90	5607	5597	5262	5357	5527
95	5690	5364	5472	5533	5454

Hopping Frequency Sequence Name: HOP_FREQ_SEQ_12

Frequency (MHz)	0	1	2	3	4
0	5672	5397	5273	5659	5254
5	5707	5595	5712	5416	5430
10	5710	5539	5261	5265	5631
15	5385	5530	5645	5469	5422
20	5343	5258	5643	5371	5358
25	5308	5267	5432	5488	5387
30	5460	5448	5255	5483	5415
35	5658	5714	5498	5620	5444
40	5687	5340	5722	5331	5439
45	5691	5319	5639	5458	5585
50	5251	5291	5664	5576	5627
55	5648	5293	5690	5510	5571
60	5376	5695	5512	5534	5253
65	5507	5466	5668	5597	5656
70	5318	5624	5296	5553	5374
75	5494	5419	5473	5252	5685
80	5351	5692	5544	5661	5637
85	5260	5630	5457	5370	5557
90	5522	5533	5716	5572	5292
95	5527	5517	5352	5489	5618

Hopping Frequency Sequence Name: HOP_FREQ_SEQ_13

Frequency (MHz)	0	1	2	3	4
0	5452	5636	5684	5345	5571
5	5274	5617	5312	5579	5637
10	5544	5328	5302	5363	5652
15	5473	5560	5651	5514	5614
20	5351	5424	5584	5460	5331
25	5671	5594	5635	5592	5421
30	5502	5434	5687	5710	5581
35	5510	5534	5380	5392	5278
40	5487	5368	5478	5299	5377
45	5692	5723	5364	5427	5342
50	5399	5361	5722	5405	5707
55	5445	5505	5385	5457	5463
60	5554	5550	5667	5633	5488
65	5588	5318	5379	5556	5698
70	5253	5650	5586	5562	5454
75	5504	5320	5607	5381	5561
80	5357	5638	5610	5593	5552
85	5660	5612	5618	5280	5539
90	5275	5485	5309	5582	5598
95	5347	5371	5721	5568	5358

Hopping Frequency Sequence Name: HOP_FREQ_SEQ_14

Frequency (MHz)	0	1	2	3	4
0	5707	5400	5620	5506	5316
5	5542	5387	5267	5369	5475
10	5689	5343	5558	5673	5561
15	5687	5279	5559	5331	5359
20	5493	5525	5452	5304	5462
25	5543	5363	5696	5358	5544
30	5323	5644	5688	5409	5433
35	5720	5365	5306	5426	5448
40	5694	5691	5252	5325	5675
45	5458	5382	5338	5648	5610
50	5715	5603	5393	5464	5697
55	5418	5549	5579	5595	5526
60	5416	5634	5550	5499	5295
65	5380	5496	5490	5566	5669
70	5698	5480	5608	5390	5656
75	5547	5704	5609	5335	5706
80	5532	5281	5333	5388	5545
85	5670	5552	5541	5556	5269
90	5528	5663	5391	5575	5377
95	5714	5594	5326	5637	5582

Hopping Frequency Sequence Name: HOP_FREQ_SEQ_15

Frequency (MHz)	0	1	2	3	4
0	5390	5639	5556	5667	5633
5	5358	5564	5462	5333	5576
10	5406	5478	5384	5278	5694
15	5552	5339	5382	5604	5620
20	5270	5659	5466	5541	5277
25	5350	5395	5469	5325	5392
30	5586	5687	5601	5428	5561
35	5253	5456	5674	5579	5459
40	5533	5558	5629	5322	5438
45	5465	5396	5701	5400	5591
50	5304	5444	5553	5520	5362
55	5262	5310	5345	5387	5288
60	5715	5602	5303	5442	5691
65	5515	5608	5530	5275	5411
70	5559	5351	5680	5568	5276
75	5513	5443	5644	5709	5355
80	5555	5272	5391	5616	5461
85	5493	5617	5298	5542	5551
90	5721	5596	5703	5343	5692
95	5566	5618	5707	5452	5313

Hopping Frequency Sequence Name: HOP_FREQ_SEQ_16

Frequency (MHz)	0	1	2	3	4
0	5645	5500	5492	5353	5378
5	5497	5489	5537	5496	5405
10	5715	5267	5425	5473	5640
15	5466	5485	5552	5337	5278
20	5253	5504	5533	5250	5616
25	5344	5672	5526	5426	5673
30	5558	5546	5335	5548	5523
35	5547	5470	5257	5373	5372
40	5263	5567	5635	5319	5436
45	5321	5454	5279	5287	5467
50	5480	5495	5642	5721	5684
55	5450	5487	5542	5358	5320
60	5389	5434	5604	5514	5464
65	5644	5265	5545	5689	5631
70	5284	5720	5656	5527	5273
75	5374	5419	5494	5688	5553
80	5301	5418	5564	5444	5708
85	5579	5556	5361	5668	5412
90	5593	5707	5654	5658	5381
95	5457	5272	5647	5516	5686

Hopping Frequency Sequence Name: HOP_FREQ_SEQ_17

Frequency (MHz)	0	1	2	3	4
0	5425	5264	5428	5514	5695
5	5539	5511	5612	5659	5646
10	5531	5466	5668	5261	5253
15	5496	5588	5597	5529	5286
20	5419	5445	5622	5698	5504
25	5671	5400	5630	5460	5292
30	5562	5515	5487	5271	5565
35	5260	5266	5507	5287	5686
40	5346	5505	5316	5365	5301
45	5631	5415	5332	5552	5721
50	5656	5546	5256	5544	5628
55	5638	5441	5593	5361	5707
60	5449	5570	5334	5527	5431
65	5715	5413	5583	5572	5437
70	5492	5325	5420	5472	5632
75	5486	5620	5494	5465	5475
80	5566	5681	5481	5549	5284
85	5347	5647	5639	5273	5326
90	5660	5397	5692	5263	5349
95	5474	5327	5414	5568	5658

Hopping Frequency Sequence Name: HOP_FREQ_SEQ_18

Frequency (MHz)	0	1	2	3	4
0	5680	5503	5364	5675	5440
5	5581	5436	5687	5347	5344
10	5577	5320	5507	5291	5282
15	5341	5623	5594	5642	5721
20	5672	5585	5386	5614	5671
25	5392	5523	5603	5259	5494
30	5334	5548	5472	5501	5261
35	5566	5704	5351	5634	5660
40	5298	5622	5429	5346	5640
45	5410	5294	5281	5714	5473
50	5385	5439	5597	5357	5442
55	5367	5475	5254	5395	5308
60	5655	5678	5578	5260	5376
65	5670	5353	5377	5441	5362
70	5619	5307	5707	5295	5397
75	5406	5387	5321	5608	5445
80	5589	5456	5717	5676	5462
85	5629	5544	5449	5479	5489
90	5602	5368	5669	5673	5336
95	5611	5465	5666	5361	5491

Hopping Frequency Sequence Name: HOP_FREQ_SEQ_19

Frequency (MHz)	0	1	2	3	4
0	5363	5267	5300	5361	5282
5	5623	5458	5287	5510	5648
10	5411	5681	5645	5486	5303
15	5332	5275	5697	5687	5438
20	5680	5654	5424	5703	5644
25	5658	5472	5331	5528	5473
30	5437	5429	5716	5413	5289
35	5368	5442	5430	5338	5461
40	5512	5284	5308	5407	5601
45	5261	5322	5531	5704	5436
50	5665	5419	5349	5498	5474
55	5649	5707	5425	5321	5502
60	5323	5264	5311	5655	5614
65	5599	5573	5566	5392	5390
70	5487	5404	5259	5494	5718
75	5318	5446	5674	5250	5662
80	5560	5634	5627	5584	5334
85	5630	5672	5663	5405	5470
90	5508	5696	5685	5389	5525
95	5596	5292	5465	5720	5520

Hopping Frequency Sequence Name: HOP_FREQ_SEQ_20

Frequency (MHz)	0	1	2	3	4
0	5618	5506	5711	5425	5502
5	5287	5383	5362	5576	5380
10	5342	5470	5686	5681	5324
15	5420	5402	5325	5635	5630
20	5688	5345	5365	5695	5617
25	5546	5437	5564	5562	5515
30	5326	5386	5359	5662	5584
35	5410	5533	5701	5588	5601
40	5300	5692	5697	5548	5404
45	5530	5716	5405	5492	5394
50	5591	5349	5612	5699	5620
55	5391	5266	5303	5671	5361
60	5687	5334	5577	5366	5465
65	5260	5594	5279	5638	5378
70	5393	5494	5463	5363	5430
75	5282	5322	5418	5271	5499
80	5385	5292	5443	5491	5250
85	5270	5625	5277	5678	5357
90	5532	5320	5579	5622	5680
95	5408	5723	5417	5605	5639

Hopping Frequency Sequence Name: HOP_FREQ_SEQ_21

Frequency (MHz)	0	1	2	3	4
0	5398	5270	5647	5586	5344
5	5329	5405	5437	5264	5587
10	5273	5259	5252	5401	5345
15	5508	5529	5428	5680	5347
20	5599	5414	5306	5309	5590
25	5337	5640	5668	5596	5557
30	5312	5343	5574	5339	5307
35	5549	5624	5594	5266	5612
40	5614	5300	5635	5313	5362
45	5696	5488	5550	5447	5381
50	5603	5275	5709	5689	5685
55	5257	5403	5490	5494	5393
60	5377	5686	5641	5288	5684
65	5630	5656	5664	5710	5461
70	5493	5721	5439	5700	5302
75	5402	5368	5399	5426	5434
80	5280	5355	5440	5628	5372
85	5370	5632	5605	5352	5485
90	5634	5547	5591	5639	5578
95	5387	5595	5543	5629	5282

Hopping Frequency Sequence Name: HOP_FREQ_SEQ_22

Frequency (MHz)	0	1	2	3	4
0	5653	5509	5583	5272	5564
5	5371	5330	5512	5427	5416
10	5582	5523	5293	5499	5366
15	5596	5559	5531	5250	5539
20	5607	5580	5344	5301	5563
25	5700	5600	5368	5297	5630
30	5696	5676	5300	5314	5588
35	5602	5688	5715	5390	5419
40	5526	5550	5383	5573	5456
45	5398	5291	5571	5608	5500
50	5268	5479	5489	5326	5420
55	5532	5686	5593	5309	5465
60	5522	5542	5253	5570	5704
65	5258	5633	5666	5391	5556
70	5360	5404	5447	5496	5415
75	5659	5271	5511	5380	5678
80	5536	5713	5515	5437	5406
85	5648	5335	5586	5378	5650
90	5312	5668	5429	5656	5270
95	5476	5269	5698	5266	5277

Hopping Frequency Sequence Name: HOP_FREQ_SEQ_23

Frequency (MHz)	0	1	2	3	4
0	5433	5273	5519	5406	5413
5	5352	5587	5590	5623	5513
10	5312	5334	5694	5387	5686
15	5537	5673	5353	5615	5649
20	5285	5390	5536	5491	5452
25	5571	5401	5664	5263	5565
30	5257	5529	5265	5422	5428
35	5661	5669	5440	5389	5466
40	5511	5696	5492	5695	5559
45	5654	5569	5553	5533	5355
50	5665	5377	5509	5335	5476
55	5719	5640	5308	5506	5436
60	5651	5707	5402	5627	5301
65	5582	5605	5698	5351	5638
70	5596	5419	5391	5618	5715
75	5642	5557	5458	5455	5317
80	5578	5434	5601	5531	5368
85	5708	5659	5678	5637	5626
90	5370	5340	5318	5689	5657
95	5254	5374	5723	5326	5464

Hopping Frequency Sequence Name: HOP_FREQ_SEQ_24

Frequency (MHz)	0	1	2	3	4
0	5591	5512	5455	5594	5626
5	5552	5277	5662	5656	5355
10	5347	5673	5375	5414	5408
15	5675	5338	5640	5718	5545
20	5526	5340	5701	5382	5509
25	5379	5401	5299	5602	5698
30	5305	5551	5689	5647	5514
35	5620	5394	5519	5457	5451
40	5703	5646	5449	5461	5489
45	5527	5539	5359	5627	5606
50	5420	5706	5366	5428	5598
55	5536	5323	5335	5325	5407
60	5397	5618	5709	5453	5722
65	5513	5531	5641	5433	5441
70	5645	5516	5599	5268	5367
75	5577	5587	5287	5700	5439
80	5707	5667	5573	5469	5334
85	5321	5434	5685	5671	5376
90	5643	5399	5568	5505	5324
95	5639	5571	5346	5312	5712

Hopping Frequency Sequence Name: HOP_FREQ_SEQ_25

Frequency (MHz)	0	1	2	3	4
0	5371	5276	5391	5280	5468
5	5594	5299	5262	5344	5659
10	5278	5462	5416	5609	5429
15	5288	5465	5268	5534	5409
20	5264	5471	5482	5267	5253
25	5405	5706	5257	5444	5440
30	5646	5387	5666	5533	5610
35	5350	5500	5365	5542	5254
40	5290	5701	5486	5456	5519
45	5442	5685	5485	5479	5687
50	5359	5523	5548	5591	5619
55	5281	5434	5562	5563	5541
60	5376	5668	5714	5480	5580
65	5265	5513	5622	5717	5502
70	5699	5592	5721	5536	5556
75	5310	5368	5420	5484	5680
80	5354	5633	5704	5331	5613
85	5337	5624	5256	5568	5511
90	5642	5550	5388	5670	5427
95	5576	5453	5455	5329	5292

Hopping Frequency Sequence Name: HOP_FREQ_SEQ_26

Frequency (MHz)	0	1	2	3	4
0	5626	5515	5327	5441	5688
5	5636	5699	5337	5507	5391
10	5684	5251	5457	5329	5450
15	5376	5592	5371	5333	5454
20	5542	5575	5680	5463	5455
25	5533	5677	5608	5335	5291
30	5486	5426	5603	5602	5440
35	5638	5672	5701	5621	5275
40	5279	5381	5703	5369	5483
45	5288	5499	5525	5646	5615
50	5572	5361	5718	5530	5301
55	5657	5589	5711	5405	5306
60	5438	5252	5563	5605	5373
65	5537	5429	5616	5475	5425
70	5411	5488	5702	5344	5697
75	5495	5428	5430	5414	5401
80	5261	5315	5610	5322	5389
85	5328	5466	5694	5663	5476
90	5596	5323	5586	5360	5433
95	5713	5564	5346	5347	5303

Hopping Frequency Sequence Name: HOP_FREQ_SEQ_27

Frequency (MHz)	0	1	2	3	4
0	5406	5279	5263	5505	5530
5	5678	5721	5412	5670	5598
10	5518	5515	5595	5427	5471
15	5367	5622	5474	5281	5646
20	5453	5644	5621	5552	5428
25	5421	5529	5336	5439	5325
30	5528	5315	5560	5342	5592
35	5458	5317	5417	5290	5517
40	5641	5609	5480	5692	5479
45	5608	5704	5668	5362	5712
50	5419	5581	5487	5533	5424
55	5359	5496	5635	5698	5550
60	5302	5503	5657	5378	5652
65	5307	5675	5703	5483	5705
70	5673	5454	5397	5557	5382
75	5416	5425	5391	5486	5452
80	5715	5308	5380	5344	5647
85	5571	5525	5547	5576	5363
90	5402	5287	5538	5445	5500
95	5590	5476	5252	5446	5432

Hopping Frequency Sequence Name: HOP_FREQ_SEQ_28

Frequency (MHz)	0	1	2	3	4
0	5564	5518	5674	5666	5275
5	5342	5646	5487	5261	5427
10	5449	5304	5636	5622	5492
15	5455	5274	5480	5326	5363
20	5461	5335	5659	5544	5401
25	5687	5381	5539	5640	5359
30	5570	5679	5517	5460	5366
35	5656	5378	5505	5310	5581
40	5631	5600	5579	5374	5574
45	5621	5459	5691	5287	5721
50	5724	5491	5595	5632	5576
55	5681	5380	5612	5313	5686
60	5454	5669	5582	5495	5609
65	5426	5603	5561	5327	5591
70	5470	5506	5652	5557	5330
75	5649	5413	5269	5670	5668
80	5438	5647	5553	5515	5322
85	5723	5618	5722	5717	5475
90	5309	5601	5344	5604	5690
95	5445	5685	5457	5368	5436

Hopping Frequency Sequence Name: HOP_FREQ_SEQ_29

Frequency (MHz)	0	1	2	3	4
0	5344	5282	5610	5352	5592
5	5384	5668	5562	5424	5634
10	5380	5665	5677	5342	5513
15	5543	5401	5583	5371	5555
20	5469	5501	5600	5633	5374
25	5575	5330	5267	5269	5393
30	5709	5474	5675	5518	5476
35	5517	5596	5581	5356	5593
40	5470	5683	5614	5571	5453
45	5299	5723	5514	5367	5296
50	5504	5324	5325	5273	5378
55	5272	5537	5441	5252	5549
60	5287	5276	5627	5349	5362
65	5309	5724	5333	5366	5625
70	5372	5713	5315	5271	5445
75	5548	5428	5717	5697	5443
80	5618	5564	5680	5667	5652
85	5615	5262	5494	5512	5334
90	5306	5421	5305	5522	5620
95	5413	5619	5284	5552	5714

Hopping Frequency Sequence Name: HOP_FREQ_SEQ_30

Frequency (MHz)	0	1	2	3	4
0	5599	5521	5546	5513	5337
5	5426	5593	5637	5587	5366
10	5689	5454	5718	5537	5534
15	5631	5528	5686	5416	5272
20	5380	5570	5541	5625	5347
25	5657	5373	5427	5276	5554
30	5431	5415	5292	5296	5656
35	5687	5377	5509	5604	5309
40	5291	5455	5282	5568	5382
45	5322	5306	5352	5401	5472
50	5259	5279	5327	5646	5696
55	5591	5470	5514	5507	5437
60	5482	5273	5553	5592	5585
65	5700	5566	5559	5632	5490
70	5321	5529	5433	5601	5331
75	5338	5317	5325	5697	5658
80	5684	5406	5263	5694	5260
85	5503	5265	5384	5617	5606
90	5365	5622	5545	5552	5522
95	5511	5567	5336	5707	5663

--- END ---