

## FCC Test Report

**Report No.:** RF160407E10

**FCC ID:** WBV-AP550

**Test Model:** AP550

**Received Date:** Apr. 07, 2016

**Test Date:** May 30 ~ Jun. 17, 2016

**Issued Date:** Jun. 29, 2016

**Applicant:** Aerohive Networks Inc.

**Address:** 1011 McCarthy Blvd, Milpitas, CA 95035, USA

**Issued By:** Bureau Veritas Consumer Products Services (H.K.) Ltd., Taoyuan Branch

**Lab Address:** E-2, No.1, Li Hsin 1st Road, Hsinchu Science Park, Hsinchu City 300, Taiwan R.O.C.

**Test Location (1):** E-2, No.1, Li Hsin 1st Road, Hsinchu Science Park, Hsinchu City 300, Taiwan R.O.C.

**Test Location (2):** No. 49, Ln. 206, Wende Rd., Shangshan Tsuen, Chiung Lin Hsiang, Hsin Chu Hsien 307, Taiwan R.O.C.



This report is for your exclusive use. Any copying or replication of this report to or for any other person or entity, or use of our name or trademark, is permitted only with our prior written permission. This report sets forth our findings solely with respect to the test samples identified herein. The results set forth in this report are not indicative or representative of the quality or characteristics of the lot from which a test sample was taken or any similar or identical product unless specifically and expressly noted. Our report includes all of the tests requested by you and the results thereof based upon the information that you provided to us. You have 60 days from date of issuance of this report to notify us of any material error or omission caused by our negligence, provided, however, that such notice shall be in writing and shall specifically address the issue you wish to raise. A failure to raise such issue within the prescribed time shall constitute your unqualified acceptance of the completeness of this report, the tests conducted and the correctness of the report contents. Unless specific mention, the uncertainty of measurement has been explicitly taken into account to declare the compliance or non-compliance to the specification. This report should not be used by the client to claim product certification, approval, or endorsement by TAF or any government agencies.

## Table of Contents

<b>Release Control Record</b> .....	<b>4</b>
<b>1 Certificate of Conformity</b> .....	<b>5</b>
<b>2 Summary of Test Results</b> .....	<b>6</b>
2.1 Measurement Uncertainty.....	6
2.2 Modification Record.....	6
<b>3 General Information</b> .....	<b>7</b>
3.1 General Description of EUT.....	7
3.2 Description of Test Modes.....	10
3.2.1 Test Mode Applicability and Tested Channel Detail.....	11
3.3 Duty Cycle of Test Signal.....	13
3.4 Description of Support Units.....	14
3.4.1 Configuration of System under Test.....	15
3.5 General Description of Applied Standards.....	16
<b>4 Test Types and Results</b> .....	<b>17</b>
4.1 Radiated Emission and Bandedge Measurement.....	17
4.1.1 Limits of Radiated Emission and Bandedge Measurement.....	17
4.1.2 Test Instruments.....	18
4.1.3 Test Procedures.....	20
4.1.4 Deviation from Test Standard.....	20
4.1.5 Test Set Up.....	21
4.1.6 EUT Operating Conditions.....	21
4.1.7 Test Results.....	22
4.2 Conducted Emission Measurement.....	42
4.2.1 Limits of Conducted Emission Measurement.....	42
4.2.2 Test Instruments.....	42
4.2.3 Test Procedures.....	43
4.2.4 Deviation from Test Standard.....	43
4.2.5 Test Setup.....	43
4.2.6 EUT Operating Conditions.....	43
4.2.7 Test Results.....	44
4.3 6dB Bandwidth Measurement.....	48
4.3.1 Limits of 6dB Bandwidth Measurement.....	48
4.3.2 Test Setup.....	48
4.3.3 Test Instruments.....	48
4.3.4 Test Procedure.....	48
4.3.5 Deviation from Test Standard.....	48
4.3.6 EUT Operating Conditions.....	48
4.3.7 Test Result.....	49
4.4 Conducted Output Power Measurement.....	53
4.4.1 Limits of Conducted Output Power Measurement.....	53
4.4.2 Test Setup.....	53
4.4.3 Test Instruments.....	53
4.4.4 Test Procedures.....	53
4.4.5 Deviation from Test Standard.....	53
4.4.6 EUT Operating Conditions.....	53
4.4.7 Test Results.....	54
4.5 Power Spectral Density Measurement.....	57
4.5.1 Limits of Power Spectral Density Measurement.....	57
4.5.2 Test Setup.....	57
4.5.3 Test Instruments.....	57
4.5.4 Test Procedure.....	57
4.5.5 Deviation from Test Standard.....	58
4.5.6 EUT Operating Condition.....	58

4.5.7 Test Results .....	58
4.6 Conducted Out of Band Emission Measurement.....	65
4.6.1 Limits of Conducted Out of Band Emission Measurement .....	65
4.6.2 Test Setup.....	65
4.6.3 Test Instruments .....	65
4.6.4 Test Procedure .....	65
4.6.5 Deviation from Test Standard .....	66
4.6.6 EUT Operating Condition .....	66
4.6.7 Test Results .....	66
<b>5 Pictures of Test Arrangements.....</b>	<b>85</b>
<b>Appendix – Information on the Testing Laboratories .....</b>	<b>86</b>

### Release Control Record

Issue No.	Description	Date Issued
RF160407E10	Original release	Jun. 29, 2016

## 1 Certificate of Conformity

**Product:** Access Point

**Brand:** Aerohive

**Test Model:** AP550

**Sample Status:** Engineering sample

**Applicant:** Aerohive Networks Inc.

**Test Date:** May 30 ~ Jun. 17, 2016

**Standards:** 47 CFR FCC Part 15, Subpart C (Section 15.247)  
ANSI C63.10:2013

The above equipment has been tested by **Bureau Veritas Consumer Products Services (H.K.) Ltd., Taoyuan Branch**, and found compliance with the requirement of the above standards. The test record, data evaluation & Equipment Under Test (EUT) configurations represented herein are true and accurate accounts of the measurements of the sample's EMC characteristics under the conditions specified in this report.

**Prepared by :**  , **Date:** Jun. 29, 2016  
Ivy Lin / Specialist

**Approved by :**  , **Date:** Jun. 29, 2016  
May Chen / Manager

## 2 Summary of Test Results

47 CFR FCC Part 15, Subpart C (Section 15.247)			
FCC Clause	Test Item	Result	Remarks
15.207	AC Power Conducted Emission	Pass	Meet the requirement of limit. Minimum passing margin is -14.85dB at 19.66406MHz
15.205 / 15.209 / 15.247(d)	Radiated Emissions and Band Edge Measurement	Pass	Meet the requirement of limit. Minimum passing margin is -0.1dB at 2390.00, 2483.50MHz.
15.247(d)	Antenna Port Emission	Pass	Meet the requirement of limit.
15.247(a)(2)	6dB bandwidth	Pass	Meet the requirement of limit.
15.247(b)	Conducted power	Pass	Meet the requirement of limit.
15.247(e)	Power Spectral Density	Pass	Meet the requirement of limit.
15.203	Antenna Requirement	Pass	Antenna connector is IPEX not a standard connector.

### 3 General Information

#### 3.1 General Description of EUT

Product	Access Point
Brand	Aerohive
Test Model	AP550
Status of EUT	Engineering sample
Power Supply Rating	12Vdc from adapter 55Vdc from PoE
Modulation Type	CCK, DQPSK, DBPSK for DSSS 256QAM, 64QAM, 16QAM, QPSK, BPSK for OFDM
Modulation Technology	DSSS, OFDM
Transfer Rate	802.11b: 11.0/ 5.5/ 2.0/ 1.0Mbps 802.11g: 54.0/ 48.0/ 36.0/ 24.0/ 18.0/ 12.0/ 9.0/ 6.0Mbps 802.11n: up to 346.7Mbps with 256QAM
Operating Frequency	2412 ~ 2462MHz
Number of Channel	11 for 802.11b, 802.11g, 802.11n (HT20)/(VHT20)
Output Power	CDD Mode 2TX: 365.809mW 4TX: 623.136mW BF Mode 2TX: 362.808mW 4TX: 406.333mW
Antenna Type	Refer to Note
Antenna Connector	Refer to Note
Accessory Device	N/A
Data Cable Supplied	N/A

Note:

1. There are three radios for the EUT.

Radio	Function
Radio 1	WLAN 2.4G & 5G
Radio 2	WLAN 5G
Radio 3	BT EDR & BT LE

2. The EUT incorporates a MIMO function. Physically, the EUT provides 4 completed transmitters and 4 receivers.

Modulation Mode	TX Function	Beamforming
Radio 1		
802.11b	2TX/4TX	Not Support
802.11g	2TX/4TX	Not Support
802.11n (HT20)/(VHT20)	2TX/4TX	Support

3. The following antennas were provided to the EUT.

Radio	Ant. No.	Chain No.	Antenna Gain(dBi) (Including cable loss)	Frequency range	Antenna Type	Connector Type	*Cable Loss(dB)	*Cable Length	
1	Ant. 1	Chain 0	4.00	2.4~2.4835GHz	PIFA	i-pex	0.39	95	
			5.84	5.15~5.25GHz					
			5.92	5.25~5.35GHz					
			5.29	5.47~5.725GHz					
	Ant. 2	Chain 1	5.78	5.725~5.85GHz	PIFA	i-pex	0.41	100	
			3.41	2.4~2.4835GHz					
			5.88	5.15~5.25GHz					
			5.36	5.25~5.35GHz					
	Ant. 3	Chain 2	5.84	5.47~5.725GHz	PIFA	i-pex	0.65	160	
			5.72	5.725~5.85GHz					
			3.77	2.4~2.4835GHz					
			5.64	5.15~5.25GHz					
	Ant. 4	Chain 3	5.49	5.25~5.35GHz	PIFA	i-pex	0.83	203	
			5.31	5.47~5.725GHz					
			5.75	5.725~5.85GHz					
			5.92	5.725~5.85GHz					
2	Ant. 5	Chain 0	5.11	5.15~5.25GHz	PIFA	i-pex	0.4	98	
			5.50	5.25~5.35GHz					
			5.08	5.47~5.725GHz					
			5.40	5.725~5.85GHz					
		Ant. 6	Chain 1	5.55	5.15~5.25GHz	PIFA	i-pex	0.32	78
				5.02	5.25~5.35GHz				
				5.30	5.47~5.725GHz				
				5.94	5.725~5.85GHz				
		Ant. 7	Chain 2	5.62	5.15~5.25GHz	PIFA	i-pex	0.6	148
				5.78	5.25~5.35GHz				
				5.67	5.47~5.725GHz				
				5.64	5.725~5.85GHz				
		Ant. 8	Chain 3	5.23	5.15~5.25GHz	PIFA	i-pex	0.87	213
5.69				5.25~5.35GHz					
5.75				5.47~5.725GHz					
5.73				5.725~5.85GHz					
	Ant. 10	Chain 0	4.70	5.15~5.25GHz	Dipole	i-pex	0.23	57	
			5.31	5.25~5.35GHz					
			5.68	5.47~5.725GHz					
			4.74	5.725~5.85GHz					
	Ant. 11	Chain 1	5.15	5.15~5.25GHz	Dipole	i-pex	0.44	107	
			5.25	5.25~5.35GHz					
			4.50	5.47~5.725GHz					
			5.20	5.725~5.85GHz					
	Ant. 12	Chain 2	4.53	5.15~5.25GHz	Dipole	i-pex	0.68	167	
			4.55	5.25~5.35GHz					
			4.42	5.47~5.725GHz					
			5.21	5.725~5.85GHz					
	Ant. 13	Chain 3	4.87	5.15~5.25GHz	Dipole	i-pex	0.93	227	
			4.69	5.25~5.35GHz					
			4.95	5.47~5.725GHz					
			4.41	5.725~5.85GHz					
3	Ant. 9	Chain 0	5.83	2.4~2.4835GHz	Dipole	i-pex	0.36	148	

\* For 2TX: the worst antenna for each mode please refers to section 3.2.1.



4. The EUT uses following adapter & PoE. (Support unit only)

Adapter	
Brand	DVE
Model	DSA-36PFH-12FUS
Input Power	100-240Vac, 50/60Hz, 1A
Output Power	12.0Vdc / 3.0A
Power Line	1.5m DC cable without core attached on adapter

PoE	
Brand	PowerDsine
Model	PD-9001GR/AT/AC
Input Power	100-240Vac, 50/60Hz, 0.67A
Output Power	55Vdc / 0.6A

5. Spurious emission of the simultaneous operation (Radio 1, 2, & 3) has been evaluated and no non-compliance was found.

6. The power setting are list as below:

CDD Mode: 2TX			
	802.11b	802.11g	802.11n (VHT20)
CH01	84	72	69
CH06	88	95	95
CH11	83	72	65

CDD Mode: 4TX			
	802.11b	802.11g	802.11n (VHT20)
CH01	74	66	66
CH06	77	93	92
CH11	80	65	65

Beamforming Mode: 2TX	
	802.11n (VHT20)
CH01	69
CH06	95
CH11	65

Beamforming Mode: 4TX	
	802.11n (VHT20)
CH01	66
CH06	86
CH11	65

### 3.2 Description of Test Modes

#### For 2.4GHz:

11 channels are provided for 802.11b, 802.11g and 802.11n (HT20)/ (VHT20)

Channel	Frequency	Channel	Frequency
1	2412MHz	7	2442MHz
2	2417MHz	8	2447MHz
3	2422MHz	9	2452MHz
4	2427MHz	10	2457MHz
5	2432MHz	11	2462MHz
6	2437MHz		

### 3.2.1 Test Mode Applicability and Tested Channel Detail

EUT CONFIGURE MODE	APPLICABLE TO				DESCRIPTION
	RE $\geq$ 1G	RE $<$ 1G	PLC	APCM	
A	√	√	√	√	EUT with PoE mode
B	-	√	√	-	EUT with Adapter mode

Where **RE $\geq$ 1G**: Radiated Emission above 1GHz & Bandedge Measurement  
**RE $<$ 1G**: Radiated Emission below 1GHz  
**PLC**: Power Line Conducted Emission  
**APCM**: Antenna Port Conducted Measurement

**NOTE:**

- The EUT had been pre-tested on the positioned of each 2 axis. The worst case was following as below.
  - ◆ For the Radio 1 above 1GHz was found when positioned on X-plane.
  - ◆ For the Radio 1 below 1GHz was found when positioned on Y-plane.
- "-" means no effect.

**Radiated Emission Test (Above 1GHz):**

- Pre-Scan has been conducted to determine the worst-case mode from all possible combinations between available modulations, data rates and antenna ports (if EUT with antenna diversity architecture).
- Following channel(s) was (were) selected for the final test as listed below.

EUT CONFIGURE MODE	MODE	AVAILABLE CHANNEL	TESTED CHANNEL	MODULATION TECHNOLOGY	MODULATION TYPE	DATA RATE (Mbps)	Mode
A	802.11b	1 to 11	1, 6, 11	DSSS	DBPSK	1.0	CDD (Ant. 1, 4)
A	802.11g	1 to 11	1, 6, 11	OFDM	BPSK	6.0	
A	802.11n (VHT20)	1 to 11	1, 6, 11	OFDM	BPSK	6.5	
A	802.11b	1 to 11	1, 6, 11	DSSS	DBPSK	1.0	CDD (Ant. 1, 2, 3, 4)
A	802.11g	1 to 11	1, 6, 11	OFDM	BPSK	6.0	
A	802.11n (VHT20)	1 to 11	1, 6, 11	OFDM	BPSK	6.5	

**Radiated Emission Test (Below 1GHz):**

- Pre-Scan has been conducted to determine the worst-case mode from all possible combinations between available modulations, data rates and antenna ports (if EUT with antenna diversity architecture).
- Following channel(s) was (were) selected for the final test as listed below.

EUT CONFIGURE MODE	MODE	AVAILABLE CHANNEL	TESTED CHANNEL	MODULATION TECHNOLOGY	MODULATION TYPE	DATA RATE (Mbps)	Mode
A, B	802.11g	1 to 11	6	OFDM	BPSK	6.0	CDD (Ant. 1, 2, 3, 4)

**Power Line Conducted Emission Test:**

- Pre-Scan has been conducted to determine the worst-case mode from all possible combinations between available modulations, data rates and antenna ports (if EUT with antenna diversity architecture).
- Following channel(s) was (were) selected for the final test as listed below.

EUT CONFIGURE MODE	MODE	AVAILABLE CHANNEL	TESTED CHANNEL	MODULATION TECHNOLOGY	MODULATION TYPE	DATA RATE (Mbps)	Mode
A, B	802.11g	1 to 11	6	OFDM	BPSK	6.0	CDD (Ant. 1, 2, 3, 4)

**Antenna Port Conducted Measurement:**

- This item includes all test value of each mode, but only includes spectrum plot of worst value of each mode.
- Pre-Scan has been conducted to determine the worst-case mode from all possible combinations between available modulations, data rates and antenna ports (if EUT with antenna diversity architecture).
- Following channel(s) was (were) selected for the final test as listed below.

EUT CONFIGURE MODE	MODE	AVAILABLE CHANNEL	TESTED CHANNEL	MODULATION TECHNOLOGY	MODULATION TYPE	DATA RATE (Mbps)	Mode
A	802.11b	1 to 11	1, 6, 11	DSSS	DBPSK	1.0	CDD (Ant. 1, 2, 3, 4)
A	802.11g	1 to 11	1, 6, 11	OFDM	BPSK	6.0	
A	802.11n (VHT20)	1 to 11	1, 6, 11	OFDM	BPSK	6.5	
A	802.11n (VHT20) (Output Power only)	1 to 11	1, 6, 11	OFDM	BPSK	6.5	TxBF (Ant. 1, 2, 3, 4)
A	802.11b	1 to 11	1, 6, 11	DSSS	DBPSK	1.0	CDD (Ant. 1, 4)
A	802.11g	1 to 11	1, 6, 11	OFDM	BPSK	6.0	
A	802.11n (VHT20)	1 to 11	1, 6, 11	OFDM	BPSK	6.5	
A	802.11n (VHT20) (Output Power only)	1 to 11	1, 6, 11	OFDM	BPSK	6.5	TxBF (Ant. 1, 4)

**Test Condition:**

APPLICABLE TO	ENVIRONMENTAL CONDITIONS	INPUT POWER (SYSTEM)	TESTED BY
RE≥1G	21deg. C, 63%RH 25deg. C, 65%RH	120Vac, 60Hz	Tim Ho
RE<1G	25deg. C, 65%RH	120Vac, 60Hz	Tim Ho
PLC	24deg. C, 61%RH	120Vac, 60Hz	Jyun Chun Lin
APCM	25deg. C, 60%RH	120Vac, 60Hz	Gary Cheng

### 3.3 Duty Cycle of Test Signal

Duty cycle of test signal is > 98%, duty factor is not required

**802.11b:** Duty cycle = 100%

**802.11g:** Duty cycle =  $2.064/2.084 = 0.990$

**802.11n (VHT20):** Duty cycle =  $1.920/1.940 = 0.990$

#### 802.11b

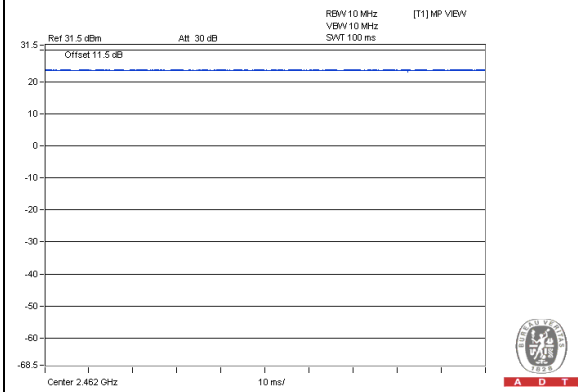

#### 802.11g

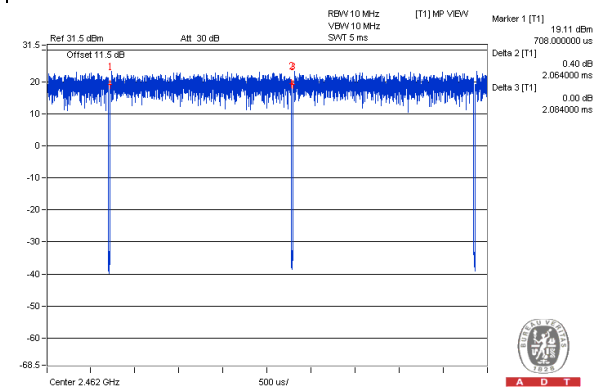

#### 802.11n (VHT20)

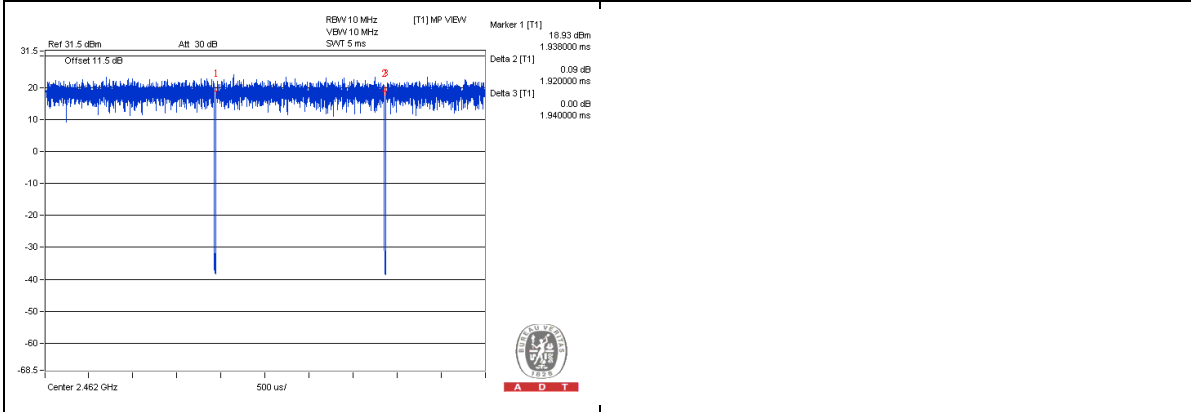

### 3.4 Description of Support Units

The EUT has been tested as an independent unit together with other necessary accessories or support units. The following support units or accessories were used to form a representative test configuration during the tests.

ID	Product	Brand	Model No.	Serial No.	FCC ID	Remarks
A.	Notebook	DELL	E5430	HYV4VY1	FCC DoC Approved	-
B.	iPod	Apple	MC749TA/A	CC4DMFJUDFDM	FCC DoC Approved	-
C.	HUB	ZyXEL	ES-116P	S060H02000215	FCC DoC Approved	-
D.	POE	PowerDsine	PD-9001GR/AT/AC	NA	NA	For test mode A
E.	Adapter	DVE	DSA-36PFH-12FUS	NA	NA	For test mode B

Note:

1. All power cords of the above support units are non-shielded (1.8m).
2. Items A and C acted as communication partners to transfer data.

ID	Descriptions	Qty.	Length (m)	Shielding (Yes/No)	Cores (Qty.)	Remarks
1.	USB cable	1	0.1	Y	0	-
2.	RJ45 cable	1	3	N	0	Cat5e For test mode A
3.	RJ45 cable	1	10	N	0	Cat5e
4.	RJ45 cable	1	10	N	0	Cat5e
5.	Console cable	1	1.5	N	0	-
6.	DC power cable	1	1.5	N	0	Attached on adapter For test mode B

### 3.4.1 Configuration of System under Test

Test Mode A

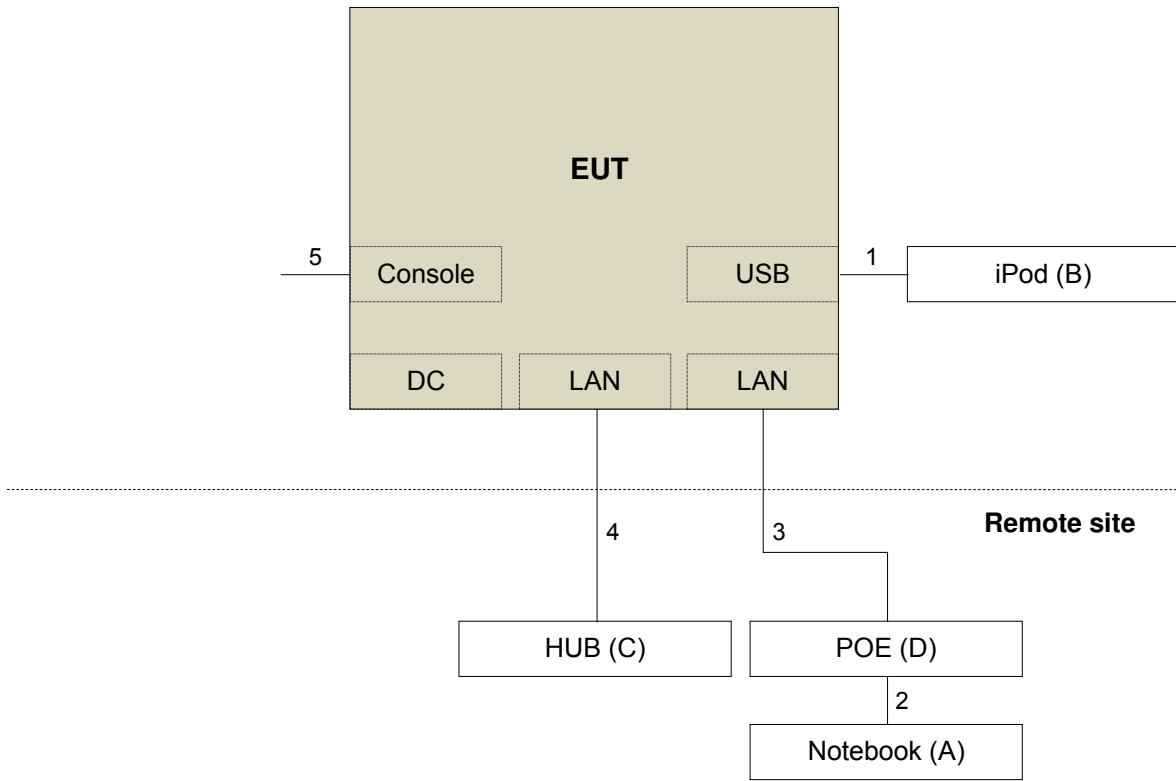

Test Mode B

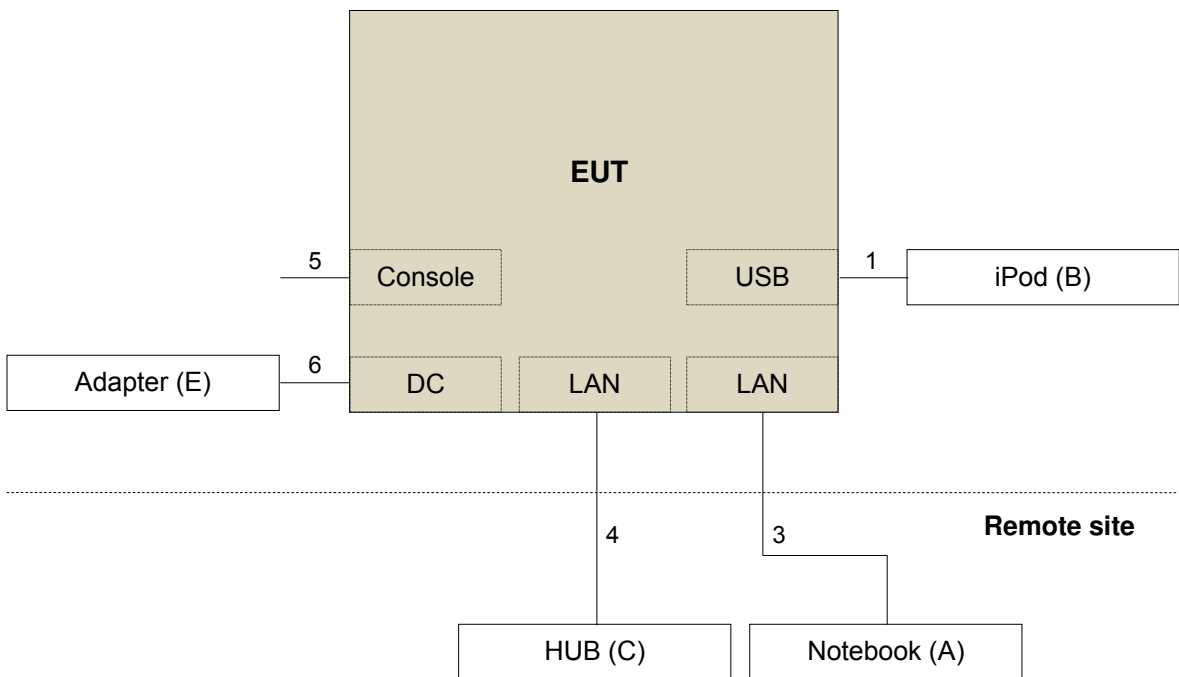

### 3.5 General Description of Applied Standards

The EUT is a RF Product. According to the specifications of the manufacturer, it must comply with the requirements of the following standards:

**FCC Part 15, Subpart C (15.247)**  
**558074 D01 DTS Meas Guidance v03r05**  
**662911 D01 Multiple Transmitter Output v02r01**  
ANSI C63.10-2013

All test items have been performed and recorded as per the above standards.



## 4 Test Types and Results

### 4.1 Radiated Emission and Bandedge Measurement

#### 4.1.1 Limits of Radiated Emission and Bandedge Measurement

Radiated emissions which fall in the restricted bands must comply with the radiated emission limits specified as below table. Other emissions shall be at least 30dB below the highest level of the desired power:

Frequencies (MHz)	Field Strength (microvolts/meter)	Measurement Distance (meters)
0.009 ~ 0.490	2400/F(kHz)	300
0.490 ~ 1.705	24000/F(kHz)	30
1.705 ~ 30.0	30	30
30 ~ 88	100	3
88 ~ 216	150	3
216 ~ 960	200	3
Above 960	500	3

**Note:**

1. The lower limit shall apply at the transition frequencies.
2. Emission level (dBuV/m) = 20 log Emission level (uV/m).
3. For frequencies above 1000MHz, the field strength limits are based on average detector, however, the peak field strength of any emission shall not exceed the maximum permitted average limits, specified above by more than 30dB under any condition of modulation.

#### 4.1.2 Test Instruments

Description & Manufacturer	Model No.	Serial No.	Cal. Date	Cal. Due
Test Receiver Agilent	N9038A	MY50010156	Aug. 12, 2015	Aug. 11, 2016
Pre-Amplifier(*) EMCI	EMC001340	980142	Jan. 20, 2016	Jan. 19, 2018
Loop Antenna(*) Electro-Metrics	EM-6879	264	Dec. 16, 2014	Dec. 15, 2016
RF Cable	NA	LOOPCAB-001 LOOPCAB-002	Jan. 18, 2016	Jan. 17, 2017
Pre-Amplifier Mini-Circuits	ZFL-1000VH2B	AMP-ZFL-05	May 07, 2016	May 06, 2017
Trilog Broadband Antenna SCHWARZBECK	VULB 9168	9168-156	Jan. 04, 2016	Jan. 03, 2017
RF Cable	8D	966-3-1 966-3-2 966-3-3	Apr. 02, 2016	Apr. 01, 2017
Horn_Antenna SCHWARZBECK	BBHA9120-D	9120D-406	Jan. 20, 2016	Jan. 19, 2017
Pre-Amplifier Agilent	8449B	3008A02465	Apr. 05, 2016	Apr. 04, 2017
RF Cable	EMC104-SM-SM-2000 EMC104-SM-SM-5000 EMC104-SM-SM-5000	150317 150321 150322	Mar. 30, 2016	Mar. 29, 2017
Spectrum Analyzer Keysight	N9030A	MY54490520	July 26, 2015	July 25, 2016
Pre-Amplifier EMCI	EMC184045	980143	Jan. 15, 2016	Jan. 14, 2017
Horn_Antenna SCHWARZBECK	BBHA 9170	BBHA9170608	Jan. 08, 2016	Jan. 07, 2017
RF Cable	SUCOFLEX 102	36432/2 36441/2	Jan. 16, 2016	Jan. 15, 2017
Software	ADT_Radiated_V8.7.0 7	NA	NA	NA
Antenna Tower & Turn Table Max-Full	MF-7802	MF780208406	NA	NA
Boresight Antenna Fixture	FBA-01	FBA-SIP01	NA	NA

Note:

1. The calibration interval of the above test instruments is 12 months and the calibrations are traceable to NML/ROC and NIST/USA.
2. The horn antenna, preamplifier (model: 8449B) are used only for the measurement of emission frequency above 1GHz if tested.
3. The test was performed in 966 Chamber No. 3.
4. The FCC Site Registration No. is 147459
5. The CANADA Site Registration No. is 20331-1
6. Tested Date: May 30 ~ Jun. 08, 2016

Description & Manufacturer	Model No.	Serial No.	Cal. Date	Cal. Due
Spectrum Analyzer R&S	FSP40	100060	May 11, 2016	May 10, 2017
Spectrum Analyzer Agilent	E4446A	MY48250253	Dec. 22, 2015	Dec. 21, 2016
Power meter Anritsu	ML2495A	1014008	May 5, 2016	May 4, 2017
Power sensor Anritsu	MA2411B	0917122	May 5, 2016	May 4, 2017
AC Power Source Extech Electronics	6205	1440452	NA	NA
Temperature & Humidity Chamber Giant Force	GTH-150-40-SP-AR	MAA0812-008	Jan. 15, 2016	Jan. 14, 2017
DC Power Supply Topward	6603D	795558	NA	NA
ESG Vector signal generator Agilent	E4438C	MY45094468/005 506 602 UK6 UNJ	Dec. 01, 2015	Nov. 30, 2016
Mech Switch Absorptive Mini-Circuits	MSP4TA-18+	0140	Mar. 19, 2016	Mar. 18, 2017
FXD ATTEN Mini-Circuits	BW-S3W2+	MN71981	Mar. 19, 2016	Mar. 18, 2017
Software	ADT_RF Test Software V6.6.5.3	NA	NA	NA

Note:

1. The test was performed in Oven room 2.
2. The calibration interval of the above test instruments is 12 months and the calibrations are traceable to NML/ROC and NIST/USA.
3. Tested Date: May 31, 2016

#### 4.1.3 Test Procedures

- a. The EUT was placed on the top of a rotating table 0.8 meters (for below 1GHz) / 1.5 meters (for above 1GHz) above the ground at 3 meter chamber room for test. The table was rotated 360 degrees to determine the position of the highest radiation.
- b. The EUT was set 3 meters away from the interference-receiving antenna, which was mounted on the top of a variable-height antenna tower.
- c. The height of antenna is varied from one meter to four meters above the ground to determine the maximum value of the field strength. Both horizontal and vertical polarizations of the antenna are set to make the measurement.
- d. For each suspected emission, the EUT was arranged to its worst case and then the antenna was tuned to heights from 1 meter to 4 meters and the rotatable table was turned from 0 degrees to 360 degrees to find the maximum reading.
- e. The test-receiver system was set to quasi-peak detect function and specified bandwidth with maximum hold mode when the test frequency is below 1 GHz.
- f. The test-receiver system was set to peak and average detect function and specified bandwidth with maximum hold mode when the test frequency is above 1 GHz. If the peak reading value also meets average limit, measurement with the average detector is unnecessary.

**Note:**

1. The resolution bandwidth and video bandwidth of test receiver/spectrum analyzer is 120kHz for Quasi-peak detection (QP) at frequency below 1GHz.
2. The resolution bandwidth of test receiver/spectrum analyzer is 1 MHz and the video bandwidth is 3 MHz for Peak detection (PK) at frequency above 1GHz.
3. The resolution bandwidth of test receiver/spectrum analyzer is 1MHz and the video bandwidth is 3MHz for RMS Average (Duty cycle < 98%) for Average detection (AV) at frequency above 1GHz, then the measurement results was added to a correction factor ( $10 \log(1/\text{duty cycle})$ ).
4. The resolution bandwidth of test receiver/spectrum analyzer is 1MHz and the video bandwidth is 10Hz (Duty cycle  $\geq 98\%$ ) for Average detection (AV) at frequency above 1GHz.
5. All modes of operation were investigated and the worst-case emissions are reported.

#### 4.1.4 Deviation from Test Standard

No deviation.

#### 4.1.5 Test Set Up

##### <Frequency Range below 1GHz>

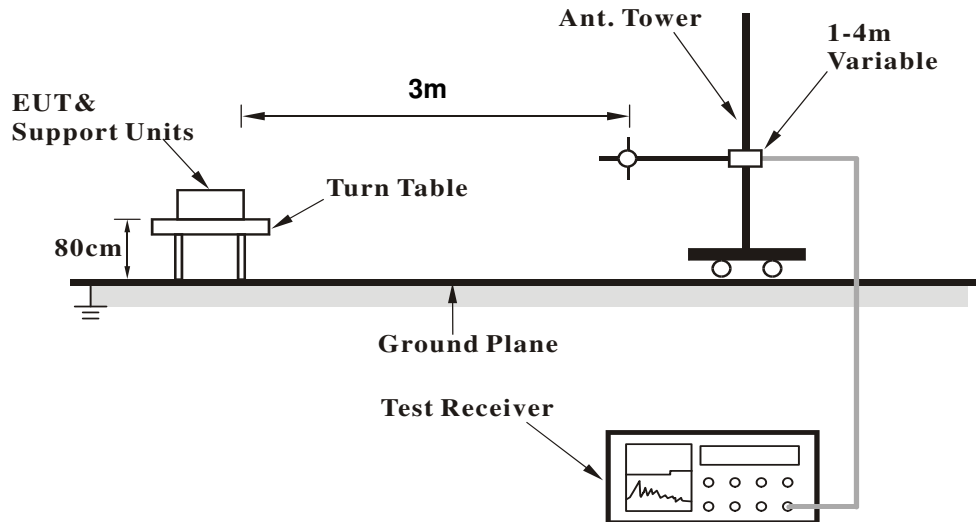

##### <Frequency Range above 1GHz>

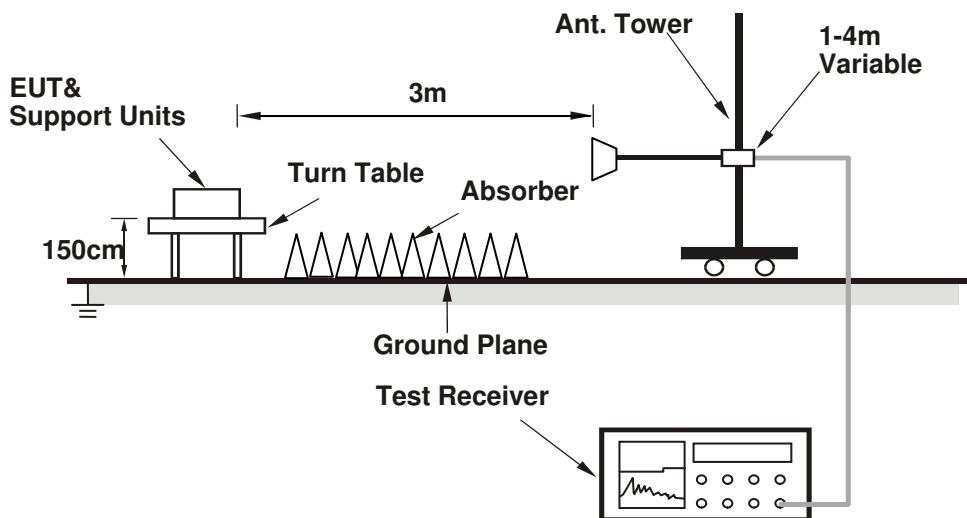

For the actual test configuration, please refer to the attached file (Test Setup Photo).

#### 4.1.6 EUT Operating Conditions

- Placed the EUT on the testing table.
- Prepared notebook to act as communication partner and placed it outside of testing area.
- The communication partner connected with EUT via a RJ45 cable and ran a test program (MTool\_REL\_2\_0\_3\_2) to enable EUT under transmission condition continuously at specific channel frequency.
- The communication partner sent data to EUT by command "PING".

#### 4.1.7 Test Results

CDD Mode

Above 1GHz data:

2TX

802.11b

CHANNEL	TX Channel 1	DETECTOR	Peak (PK)
FREQUENCY RANGE	1GHz ~ 25GHz	FUNCTION	Average (AV)

ANTENNA POLARITY & TEST DISTANCE: HORIZONTAL AT 3 M								
NO.	FREQ. (MHz)	EMISSION LEVEL (dBuV/m)	LIMIT (dBuV/m)	MARGIN (dB)	ANTENNA HEIGHT (m)	TABLE ANGLE (Degree)	RAW VALUE (dBuV)	CORRECTION FACTOR (dB/m)
1	2390.00	54.2 PK	74.0	-19.8	1.22 H	35	58.40	-4.20
2	2390.00	46.4 AV	54.0	-7.6	1.22 H	35	50.60	-4.20
3	*2412.00	106.9 PK			1.22 H	35	111.00	-4.10
4	*2412.00	104.4 AV			1.22 H	35	108.50	-4.10
5	4824.00	48.7 PK	74.0	-25.3	1.56 H	14	46.40	2.30
6	4824.00	43.8 AV	54.0	-10.2	1.56 H	14	41.50	2.30
ANTENNA POLARITY & TEST DISTANCE: VERTICAL AT 3 M								
NO.	FREQ. (MHz)	EMISSION LEVEL (dBuV/m)	LIMIT (dBuV/m)	MARGIN (dB)	ANTENNA HEIGHT (m)	TABLE ANGLE (Degree)	RAW VALUE (dBuV)	CORRECTION FACTOR (dB/m)
1	2390.00	59.0 PK	74.0	-15.0	1.48 V	273	63.20	-4.20
2	2390.00	51.3 AV	54.0	-2.7	1.48 V	273	55.50	-4.20
3	*2412.00	113.8 PK			1.48 V	273	117.90	-4.10
4	*2412.00	111.7 AV			1.48 V	273	115.80	-4.10
5	4824.00	55.1 PK	74.0	-18.9	2.44 V	307	52.80	2.30
6	4824.00	53.6 AV	54.0	-0.4	2.44 V	307	51.30	2.30

#### REMARKS:

1. Emission Level(dBuV/m) = Raw Value(dBuV) + Correction Factor(dB/m)
2. Correction Factor(dB/m) = Antenna Factor(dB/m) + Cable Factor(dB)
3. The other emission levels were very low against the limit.
4. Margin value = Emission Level – Limit value
5. " \* ": Fundamental frequency.

CHANNEL	TX Channel 6	DETECTOR FUNCTION	Peak (PK)
FREQUENCY RANGE	1GHz ~ 25GHz		Average (AV)

**ANTENNA POLARITY & TEST DISTANCE: HORIZONTAL AT 3 M**

NO.	FREQ. (MHz)	EMISSION LEVEL (dBuV/m)	LIMIT (dBuV/m)	MARGIN (dB)	ANTENNA HEIGHT (m)	TABLE ANGLE (Degree)	RAW VALUE (dBuV)	CORRECTION FACTOR (dB/m)
1	2390.00	48.1 PK	74.0	-25.9	1.20 H	21	52.30	-4.20
2	2390.00	33.2 AV	54.0	-20.8	1.20 H	21	37.40	-4.20
3	*2437.00	106.6 PK			1.20 H	21	110.60	-4.00
4	*2437.00	104.4 AV			1.20 H	21	108.40	-4.00
5	2483.50	58.4 PK	74.0	-15.6	1.20 H	21	62.40	-4.00
6	2483.50	38.7 AV	54.0	-15.3	1.20 H	21	42.70	-4.00
7	4874.00	49.2 PK	74.0	-24.8	1.48 H	38	46.70	2.50
8	4874.00	44.3 AV	54.0	-9.7	1.48 H	38	41.80	2.50
9	7311.00	43.1 PK	74.0	-30.9	2.25 H	127	34.20	8.90
10	7311.00	33.6 AV	54.0	-20.4	2.25 H	127	24.70	8.90

**ANTENNA POLARITY & TEST DISTANCE: VERTICAL AT 3 M**

NO.	FREQ. (MHz)	EMISSION LEVEL (dBuV/m)	LIMIT (dBuV/m)	MARGIN (dB)	ANTENNA HEIGHT (m)	TABLE ANGLE (Degree)	RAW VALUE (dBuV)	CORRECTION FACTOR (dB/m)
1	2390.00	49.4 PK	74.0	-24.6	2.57 V	145	53.60	-4.20
2	2390.00	37.9 AV	54.0	-16.1	2.57 V	145	42.10	-4.20
3	*2437.00	114.3 PK			2.57 V	145	118.30	-4.00
4	*2437.00	112.0 AV			2.57 V	145	116.00	-4.00
5	2483.50	53.0 PK	74.0	-21.0	2.57 V	145	57.00	-4.00
6	2483.50	39.7 AV	54.0	-14.3	2.57 V	145	43.70	-4.00
7	4874.00	54.9 PK	74.0	-19.1	2.50 V	36	52.40	2.50
8	4874.00	53.5 AV	54.0	-0.5	2.50 V	36	51.00	2.50
9	7311.00	48.7 PK	74.0	-25.3	3.12 V	70	39.80	8.90
10	7311.00	40.4 AV	54.0	-13.6	3.12 V	70	31.50	8.90

**REMARKS:**

1. Emission Level(dBuV/m) = Raw Value(dBuV) + Correction Factor(dB/m)
2. Correction Factor(dB/m) = Antenna Factor(dB/m) + Cable Factor(dB)
3. The other emission levels were very low against the limit.
4. Margin value = Emission Level – Limit value
5. " \* ": Fundamental frequency.

CHANNEL	TX Channel 11	DETECTOR FUNCTION	Peak (PK)
FREQUENCY RANGE	1GHz ~ 25GHz		Average (AV)

**ANTENNA POLARITY & TEST DISTANCE: HORIZONTAL AT 3 M**

NO.	FREQ. (MHz)	EMISSION LEVEL (dBuV/m)	LIMIT (dBuV/m)	MARGIN (dB)	ANTENNA HEIGHT (m)	TABLE ANGLE (Degree)	RAW VALUE (dBuV)	CORRECTION FACTOR (dB/m)
1	2362.70	46.3 PK	74.0	-27.7	1.17 H	33	50.70	-4.40
2	2362.70	40.9 AV	54.0	-13.1	1.17 H	33	45.30	-4.40
3	*2462.00	107.1 PK			1.17 H	33	111.20	-4.10
4	*2462.00	104.7 AV			1.17 H	33	108.80	-4.10
5	2483.50	55.5 PK	74.0	-18.5	1.17 H	33	59.50	-4.00
6	2483.50	47.0 AV	54.0	-7.0	1.17 H	33	51.00	-4.00
7	4924.00	44.8 PK	74.0	-29.2	1.51 H	25	42.30	2.50
8	4924.00	38.4 AV	54.0	-15.6	1.51 H	25	35.90	2.50
9	7386.00	43.2 PK	74.0	-30.8	2.30 H	132	33.90	9.30
10	7386.00	33.4 AV	54.0	-20.6	2.30 H	132	24.10	9.30

**ANTENNA POLARITY & TEST DISTANCE: VERTICAL AT 3 M**

NO.	FREQ. (MHz)	EMISSION LEVEL (dBuV/m)	LIMIT (dBuV/m)	MARGIN (dB)	ANTENNA HEIGHT (m)	TABLE ANGLE (Degree)	RAW VALUE (dBuV)	CORRECTION FACTOR (dB/m)
1	2362.70	53.8 PK	74.0	-20.2	3.21 V	344	58.20	-4.40
2	2362.70	48.5 AV	54.0	-5.5	3.21 V	344	52.90	-4.40
3	*2462.00	114.9 PK			3.30 V	342	119.00	-4.10
4	*2462.00	112.6 AV			3.30 V	342	116.70	-4.10
5	2483.50	62.3 PK	74.0	-11.7	3.30 V	342	66.30	-4.00
<b>6</b>	<b>2483.50</b>	<b>53.9 AV</b>	<b>54.0</b>	<b>-0.1</b>	<b>3.30 V</b>	<b>342</b>	<b>57.90</b>	<b>-4.00</b>
7	4924.00	48.7 PK	74.0	-25.3	2.69 V	311	46.20	2.50
8	4924.00	45.9 AV	54.0	-8.1	2.69 V	311	43.40	2.50
9	7386.00	42.5 PK	74.0	-31.5	2.83 V	44	33.20	9.30
10	7386.00	33.6 AV	54.0	-20.4	2.83 V	44	24.30	9.30

**REMARKS:**

1. Emission Level(dBuV/m) = Raw Value(dBuV) + Correction Factor(dB/m)
2. Correction Factor(dB/m) = Antenna Factor(dB/m) + Cable Factor(dB)
3. The other emission levels were very low against the limit.
4. Margin value = Emission Level – Limit value
5. " \* ": Fundamental frequency.



802.11g

CHANNEL	TX Channel 1	DETECTOR FUNCTION	Peak (PK)
FREQUENCY RANGE	1GHz ~ 25GHz		Average (AV)

**ANTENNA POLARITY & TEST DISTANCE: HORIZONTAL AT 3 M**

NO.	FREQ. (MHz)	EMISSION LEVEL (dBuV/m)	LIMIT (dBuV/m)	MARGIN (dB)	ANTENNA HEIGHT (m)	TABLE ANGLE (Degree)	RAW VALUE (dBuV)	CORRECTION FACTOR (dB/m)
1	2390.00	66.0 PK	74.0	-8.0	1.20 H	27	70.20	-4.20
2	2390.00	45.5 AV	54.0	-8.5	1.20 H	27	49.70	-4.20
3	*2412.00	104.8 PK			1.20 H	27	108.90	-4.10
4	*2412.00	94.7 AV			1.20 H	27	98.80	-4.10
5	4824.00	44.5 PK	74.0	-29.5	1.52 H	24	42.20	2.30
6	4824.00	38.2 AV	54.0	-15.8	1.52 H	24	35.90	2.30

NO.	FREQ. (MHz)	EMISSION LEVEL (dBuV/m)	LIMIT (dBuV/m)	MARGIN (dB)	ANTENNA HEIGHT (m)	TABLE ANGLE (Degree)	RAW VALUE (dBuV)	CORRECTION FACTOR (dB/m)
<b>1</b>	<b>2390.00</b>	<b>73.9 PK</b>	<b>74.0</b>	<b>-0.1</b>	<b>1.82 V</b>	<b>153</b>	<b>78.10</b>	<b>-4.20</b>
2	2390.00	53.5 AV	54.0	-0.5	1.82 V	153	57.70	-4.20
3	*2412.00	113.0 PK			1.82 V	153	117.10	-4.10
4	*2412.00	102.9 AV			1.82 V	153	107.00	-4.10
5	4824.00	45.0 PK	74.0	-29.0	2.67 V	318	42.70	2.30
6	4824.00	38.6 AV	54.0	-15.4	2.67 V	318	36.30	2.30

**REMARKS:**

1. Emission Level(dBuV/m) = Raw Value(dBuV) + Correction Factor(dB/m)
2. Correction Factor(dB/m) = Antenna Factor(dB/m) + Cable Factor(dB)
3. The other emission levels were very low against the limit.
4. Margin value = Emission Level – Limit value
5. " \* ": Fundamental frequency.

CHANNEL	TX Channel 6	DETECTOR FUNCTION	Peak (PK)
FREQUENCY RANGE	1GHz ~ 25GHz		Average (AV)

**ANTENNA POLARITY & TEST DISTANCE: HORIZONTAL AT 3 M**

NO.	FREQ. (MHz)	EMISSION LEVEL (dBuV/m)	LIMIT (dBuV/m)	MARGIN (dB)	ANTENNA HEIGHT (m)	TABLE ANGLE (Degree)	RAW VALUE (dBuV)	CORRECTION FACTOR (dB/m)
1	2390.00	59.3 PK	74.0	-14.7	1.22 H	35	63.50	-4.20
2	2390.00	40.0 AV	54.0	-14.0	1.22 H	35	44.20	-4.20
3	*2437.00	110.6 PK			1.22 H	35	114.60	-4.00
4	*2437.00	100.2 AV			1.22 H	35	104.20	-4.00
5	2483.50	60.7 PK	74.0	-13.3	1.22 H	35	64.70	-4.00
6	2483.50	41.8 AV	54.0	-12.2	1.22 H	35	45.80	-4.00
7	4874.00	44.8 PK	74.0	-29.2	1.47 H	40	42.30	2.50
8	4874.00	38.3 AV	54.0	-15.7	1.47 H	40	35.80	2.50
9	7311.00	43.1 PK	74.0	-30.9	2.29 H	132	34.20	8.90
10	7311.00	33.2 AV	54.0	-20.8	2.29 H	132	24.30	8.90

**ANTENNA POLARITY & TEST DISTANCE: VERTICAL AT 3 M**

NO.	FREQ. (MHz)	EMISSION LEVEL (dBuV/m)	LIMIT (dBuV/m)	MARGIN (dB)	ANTENNA HEIGHT (m)	TABLE ANGLE (Degree)	RAW VALUE (dBuV)	CORRECTION FACTOR (dB/m)
1	2390.00	67.4 PK	74.0	-6.6	2.34 V	106	71.60	-4.20
2	2390.00	48.3 AV	54.0	-5.7	2.34 V	106	52.50	-4.20
3	*2437.00	118.6 PK			2.34 V	160	122.60	-4.00
4	*2437.00	108.4 AV			2.34 V	160	112.40	-4.00
5	2483.50	68.9 PK	74.0	-5.1	2.34 V	160	72.90	-4.00
6	2483.50	50.1 AV	54.0	-3.9	2.34 V	160	54.10	-4.00
7	4874.00	45.0 PK	74.0	-29.0	2.67 V	320	42.50	2.50
8	4874.00	38.6 AV	54.0	-15.4	2.67 V	320	36.10	2.50
9	7311.00	43.6 PK	74.0	-30.4	2.86 V	46	34.70	8.90
10	7311.00	33.6 AV	54.0	-20.4	2.86 V	46	24.70	8.90

**REMARKS:**

1. Emission Level(dBuV/m) = Raw Value(dBuV) + Correction Factor(dB/m)
2. Correction Factor(dB/m) = Antenna Factor(dB/m) + Cable Factor(dB)
3. The other emission levels were very low against the limit.
4. Margin value = Emission Level – Limit value
5. " \* ": Fundamental frequency.

CHANNEL	TX Channel 11	DETECTOR FUNCTION	Peak (PK)
FREQUENCY RANGE	1GHz ~ 25GHz		Average (AV)

**ANTENNA POLARITY & TEST DISTANCE: HORIZONTAL AT 3 M**

NO.	FREQ. (MHz)	EMISSION LEVEL (dBuV/m)	LIMIT (dBuV/m)	MARGIN (dB)	ANTENNA HEIGHT (m)	TABLE ANGLE (Degree)	RAW VALUE (dBuV)	CORRECTION FACTOR (dB/m)
1	*2462.00	106.5 PK			1.14 H	21	110.60	-4.10
2	*2462.00	96.4 AV			1.14 H	21	100.50	-4.10
3	2483.50	63.9 PK	74.0	-10.1	1.14 H	21	67.90	-4.00
4	2483.50	46.2 AV	54.0	-7.8	1.14 H	21	50.20	-4.00
5	4924.00	45.5 PK	74.0	-28.5	1.49 H	29	43.00	2.50
6	4924.00	38.7 AV	54.0	-15.3	1.49 H	29	36.20	2.50
7	7386.00	43.2 PK	74.0	-30.8	2.28 H	128	33.90	9.30
8	7386.00	33.3 AV	54.0	-20.7	2.28 H	128	24.00	9.30

**ANTENNA POLARITY & TEST DISTANCE: VERTICAL AT 3 M**

NO.	FREQ. (MHz)	EMISSION LEVEL (dBuV/m)	LIMIT (dBuV/m)	MARGIN (dB)	ANTENNA HEIGHT (m)	TABLE ANGLE (Degree)	RAW VALUE (dBuV)	CORRECTION FACTOR (dB/m)
1	*2462.00	114.6 PK			2.21 V	154	118.70	-4.10
2	*2462.00	104.6 AV			2.21 V	154	108.70	-4.10
3	2483.50	71.6 PK	74.0	-2.4	2.21 V	154	75.60	-4.00
<b>4</b>	<b>2483.50</b>	<b>53.9 AV</b>	<b>54.0</b>	<b>-0.1</b>	<b>2.21 V</b>	<b>154</b>	<b>57.90</b>	<b>-4.00</b>
5	4924.00	44.9 PK	74.0	-29.1	2.73 V	327	42.40	2.50
6	4924.00	38.6 AV	54.0	-15.4	2.73 V	327	36.10	2.50
7	7386.00	43.0 PK	74.0	-31.0	2.85 V	42	33.70	9.30
8	7386.00	33.2 AV	54.0	-20.8	2.85 V	42	23.90	9.30

**REMARKS:**

1. Emission Level(dBuV/m) = Raw Value(dBuV) + Correction Factor(dB/m)
2. Correction Factor(dB/m) = Antenna Factor(dB/m) + Cable Factor(dB)
3. The other emission levels were very low against the limit.
4. Margin value = Emission Level – Limit value
5. " \* ": Fundamental frequency.

802.11n (VHT20)

CHANNEL	TX Channel 1	DETECTOR FUNCTION	Peak (PK)
FREQUENCY RANGE	1GHz ~ 25GHz		Average (AV)

ANTENNA POLARITY & TEST DISTANCE: HORIZONTAL AT 3 M

NO.	FREQ. (MHz)	EMISSION LEVEL (dBuV/m)	LIMIT (dBuV/m)	MARGIN (dB)	ANTENNA HEIGHT (m)	TABLE ANGLE (Degree)	RAW VALUE (dBuV)	CORRECTION FACTOR (dB/m)
1	2390.00	66.1 PK	74.0	-7.9	1.21 H	28	70.30	-4.20
2	2390.00	44.2 AV	54.0	-9.8	1.21 H	28	48.40	-4.20
3	*2412.00	104.3 PK			1.21 H	28	108.40	-4.10
4	*2412.00	94.0 AV			1.21 H	28	98.10	-4.10
5	4824.00	44.9 PK	74.0	-29.1	1.45 H	45	42.60	2.30
6	4824.00	38.3 AV	54.0	-15.7	1.45 H	45	36.00	2.30

ANTENNA POLARITY & TEST DISTANCE: VERTICAL AT 3 M

NO.	FREQ. (MHz)	EMISSION LEVEL (dBuV/m)	LIMIT (dBuV/m)	MARGIN (dB)	ANTENNA HEIGHT (m)	TABLE ANGLE (Degree)	RAW VALUE (dBuV)	CORRECTION FACTOR (dB/m)
1	2390.00	73.8 PK	74.0	-0.2	2.76 V	98	78.00	-4.20
2	2390.00	51.8 AV	54.0	-2.2	2.76 V	98	56.00	-4.20
3	*2412.00	112.3 PK			2.76 V	98	116.40	-4.10
4	*2412.00	101.9 AV			2.76 V	98	106.00	-4.10
5	4824.00	45.2 PK	74.0	-28.8	2.68 V	335	42.90	2.30
6	4824.00	38.5 AV	54.0	-15.5	2.68 V	335	36.20	2.30

**REMARKS:**

1. Emission Level(dBuV/m) = Raw Value(dBuV) + Correction Factor(dB/m)
2. Correction Factor(dB/m) = Antenna Factor(dB/m) + Cable Factor(dB)
3. The other emission levels were very low against the limit.
4. Margin value = Emission Level – Limit value
5. " \* ": Fundamental frequency.

CHANNEL	TX Channel 6	DETECTOR FUNCTION	Peak (PK)
FREQUENCY RANGE	1GHz ~ 25GHz		Average (AV)

**ANTENNA POLARITY & TEST DISTANCE: HORIZONTAL AT 3 M**

NO.	FREQ. (MHz)	EMISSION LEVEL (dBuV/m)	LIMIT (dBuV/m)	MARGIN (dB)	ANTENNA HEIGHT (m)	TABLE ANGLE (Degree)	RAW VALUE (dBuV)	CORRECTION FACTOR (dB/m)
1	2390.00	58.5 PK	74.0	-15.5	1.13 H	17	62.70	-4.20
2	2390.00	41.5 AV	54.0	-12.5	1.13 H	17	45.70	-4.20
3	*2437.00	110.7 PK			1.13 H	17	114.70	-4.00
4	*2437.00	100.3 AV			1.13 H	17	104.30	-4.00
5	2483.50	65.2 PK	74.0	-8.8	1.13 H	17	69.20	-4.00
6	2483.50	42.9 AV	54.0	-11.1	1.13 H	17	46.90	-4.00
7	4874.00	45.5 PK	74.0	-28.5	1.48 H	37	43.00	2.50
8	4874.00	38.8 AV	54.0	-15.2	1.48 H	37	36.30	2.50
9	7311.00	43.1 PK	74.0	-30.9	2.24 H	125	34.20	8.90
10	7311.00	33.4 AV	54.0	-20.6	2.24 H	125	24.50	8.90

**ANTENNA POLARITY & TEST DISTANCE: VERTICAL AT 3 M**

NO.	FREQ. (MHz)	EMISSION LEVEL (dBuV/m)	LIMIT (dBuV/m)	MARGIN (dB)	ANTENNA HEIGHT (m)	TABLE ANGLE (Degree)	RAW VALUE (dBuV)	CORRECTION FACTOR (dB/m)
1	2390.00	66.1 PK	74.0	-7.9	2.34 V	160	70.30	-4.20
2	2390.00	49.2 AV	54.0	-4.8	2.34 V	160	53.40	-4.20
3	*2437.00	118.4 PK			2.34 V	160	122.40	-4.00
4	*2437.00	107.9 AV			2.34 V	160	111.90	-4.00
5	2483.50	73.4 PK	74.0	-0.6	2.34 V	160	77.40	-4.00
6	2483.50	51.2 AV	54.0	-2.8	2.34 V	160	55.20	-4.00
7	4874.00	44.9 PK	74.0	-29.1	2.70 V	335	42.40	2.50
8	4874.00	38.4 AV	54.0	-15.6	2.70 V	335	35.90	2.50
9	7311.00	43.2 PK	74.0	-30.8	2.80 V	49	34.30	8.90
10	7311.00	33.2 AV	54.0	-20.8	2.80 V	49	24.30	8.90

**REMARKS:**

1. Emission Level(dBuV/m) = Raw Value(dBuV) + Correction Factor(dB/m)
2. Correction Factor(dB/m) = Antenna Factor(dB/m) + Cable Factor(dB)
3. The other emission levels were very low against the limit.
4. Margin value = Emission Level – Limit value
5. " \* ": Fundamental frequency.

CHANNEL	TX Channel 11	DETECTOR FUNCTION	Peak (PK)
FREQUENCY RANGE	1GHz ~ 25GHz		Average (AV)

**ANTENNA POLARITY & TEST DISTANCE: HORIZONTAL AT 3 M**

NO.	FREQ. (MHz)	EMISSION LEVEL (dBuV/m)	LIMIT (dBuV/m)	MARGIN (dB)	ANTENNA HEIGHT (m)	TABLE ANGLE (Degree)	RAW VALUE (dBuV)	CORRECTION FACTOR (dB/m)
1	*2462.00	105.5 PK			1.13 H	47	109.60	-4.10
2	*2462.00	94.5 AV			1.13 H	47	98.60	-4.10
3	2483.50	65.6 PK	74.0	-8.4	1.13 H	47	69.60	-4.00
4	2483.50	40.4 AV	54.0	-13.6	1.13 H	47	44.40	-4.00
5	4924.00	45.0 PK	74.0	-29.0	1.51 H	39	42.50	2.50
6	4924.00	38.6 AV	54.0	-15.4	1.51 H	39	36.10	2.50
7	7386.00	42.4 PK	74.0	-31.6	2.25 H	122	33.10	9.30
8	7386.00	32.8 AV	54.0	-21.2	2.25 H	122	23.50	9.30

**ANTENNA POLARITY & TEST DISTANCE: VERTICAL AT 3 M**

NO.	FREQ. (MHz)	EMISSION LEVEL (dBuV/m)	LIMIT (dBuV/m)	MARGIN (dB)	ANTENNA HEIGHT (m)	TABLE ANGLE (Degree)	RAW VALUE (dBuV)	CORRECTION FACTOR (dB/m)
1	*2462.00	113.3 PK			2.82 V	0	117.40	-4.10
2	*2462.00	102.5 AV			2.82 V	0	106.60	-4.10
3	2483.50	73.6 PK	74.0	-0.4	2.82 V	0	77.60	-4.00
4	2483.50	48.4 AV	54.0	-5.6	2.82 V	0	52.40	-4.00
5	4924.00	44.8 PK	74.0	-29.2	2.62 V	325	42.30	2.50
6	4924.00	38.5 AV	54.0	-15.5	2.62 V	325	36.00	2.50
7	7386.00	43.5 PK	74.0	-30.5	2.87 V	44	34.20	9.30
8	7386.00	33.7 AV	54.0	-20.3	2.87 V	44	24.40	9.30

**REMARKS:**

1. Emission Level(dBuV/m) = Raw Value(dBuV) + Correction Factor(dB/m)
2. Correction Factor(dB/m) = Antenna Factor(dB/m) + Cable Factor(dB)
3. The other emission levels were very low against the limit.
4. Margin value = Emission Level – Limit value
5. " \* ": Fundamental frequency.

CDD Mode

4TX

802.11b

CHANNEL	TX Channel 1	DETECTOR FUNCTION	Peak (PK)
FREQUENCY RANGE	1GHz ~ 25GHz		Average (AV)

ANTENNA POLARITY & TEST DISTANCE: HORIZONTAL AT 3 M

NO.	FREQ. (MHz)	EMISSION LEVEL (dBuV/m)	LIMIT (dBuV/m)	MARGIN (dB)	ANTENNA HEIGHT (m)	TABLE ANGLE (Degree)	RAW VALUE (dBuV)	CORRECTION FACTOR (dB/m)
1	2390.00	55.2 PK	74.0	-18.8	2.01 H	154	59.40	-4.20
2	2390.00	43.1 AV	54.0	-10.9	2.01 H	154	47.30	-4.20
3	*2412.00	113.1 PK			2.01 H	154	117.20	-4.10
4	*2412.00	110.7 AV			2.01 H	154	114.80	-4.10
5	4824.00	46.2 PK	74.0	-27.8	1.00 H	126	43.90	2.30
6	4824.00	40.4 AV	54.0	-13.6	1.00 H	126	38.10	2.30

ANTENNA POLARITY & TEST DISTANCE: VERTICAL AT 3 M

NO.	FREQ. (MHz)	EMISSION LEVEL (dBuV/m)	LIMIT (dBuV/m)	MARGIN (dB)	ANTENNA HEIGHT (m)	TABLE ANGLE (Degree)	RAW VALUE (dBuV)	CORRECTION FACTOR (dB/m)
1	2390.00	57.5 PK	74.0	-16.5	3.61 V	135	61.70	-4.20
2	2390.00	45.4 AV	54.0	-8.6	3.61 V	135	49.60	-4.20
3	*2412.00	116.1 PK			3.61 V	135	120.20	-4.10
4	*2412.00	113.8 AV			3.61 V	135	117.90	-4.10
5	4824.00	55.2 PK	74.0	-18.8	2.81 V	196	52.90	2.30
6	4824.00	53.4 AV	54.0	-0.6	2.81 V	196	51.10	2.30

REMARKS:

1. Emission Level(dBuV/m) = Raw Value(dBuV) + Correction Factor(dB/m)
2. Correction Factor(dB/m) = Antenna Factor(dB/m) + Cable Factor(dB)
3. The other emission levels were very low against the limit.
4. Margin value = Emission Level – Limit value
5. " \* ": Fundamental frequency.

CHANNEL	TX Channel 6	DETECTOR FUNCTION	Peak (PK)
FREQUENCY RANGE	1GHz ~ 25GHz		Average (AV)

**ANTENNA POLARITY & TEST DISTANCE: HORIZONTAL AT 3 M**

NO.	FREQ. (MHz)	EMISSION LEVEL (dBuV/m)	LIMIT (dBuV/m)	MARGIN (dB)	ANTENNA HEIGHT (m)	TABLE ANGLE (Degree)	RAW VALUE (dBuV)	CORRECTION FACTOR (dB/m)
1	2390.00	53.8 PK	74.0	-20.2	2.03 H	165	58.00	-4.20
2	2390.00	39.0 AV	54.0	-15.0	2.03 H	165	43.20	-4.20
3	*2437.00	112.3 PK			2.03 H	165	116.30	-4.00
4	*2437.00	110.2 AV			2.03 H	165	114.20	-4.00
5	2483.50	52.4 PK	74.0	-21.6	2.03 H	165	56.40	-4.00
6	2483.50	37.6 AV	54.0	-16.4	2.03 H	165	41.60	-4.00
7	4874.00	46.3 PK	74.0	-27.7	1.51 H	93	43.80	2.50
8	4874.00	40.5 AV	54.0	-13.5	1.51 H	93	38.00	2.50
9	7311.00	46.9 PK	74.0	-27.1	3.04 H	257	38.00	8.90
10	7311.00	36.3 AV	54.0	-17.7	3.04 H	257	27.40	8.90

**ANTENNA POLARITY & TEST DISTANCE: VERTICAL AT 3 M**

NO.	FREQ. (MHz)	EMISSION LEVEL (dBuV/m)	LIMIT (dBuV/m)	MARGIN (dB)	ANTENNA HEIGHT (m)	TABLE ANGLE (Degree)	RAW VALUE (dBuV)	CORRECTION FACTOR (dB/m)
1	2390.00	54.6 PK	74.0	-19.4	3.87 V	143	58.80	-4.20
2	2390.00	49.1 AV	54.0	-4.9	3.87 V	143	53.30	-4.20
3	*2437.00	116.5 PK			3.87 V	143	120.50	-4.00
4	*2437.00	114.2 AV			3.87 V	143	118.20	-4.00
5	2483.50	53.2 PK	74.0	-20.8	3.87 V	143	57.20	-4.00
6	2483.50	40.8 AV	54.0	-13.2	3.87 V	143	44.80	-4.00
7	4874.00	55.1 PK	74.0	-18.9	2.83 V	199	52.60	2.50
8	4874.00	53.1 AV	54.0	-0.9	2.83 V	199	50.60	2.50
9	7311.00	47.6 PK	74.0	-26.4	3.36 V	112	38.70	8.90
10	7311.00	36.6 AV	54.0	-17.4	3.36 V	112	27.70	8.90

**REMARKS:**

1. Emission Level(dBuV/m) = Raw Value(dBuV) + Correction Factor(dB/m)
2. Correction Factor(dB/m) = Antenna Factor(dB/m) + Cable Factor(dB)
3. The other emission levels were very low against the limit.
4. Margin value = Emission Level – Limit value
5. " \* ": Fundamental frequency.



CHANNEL	TX Channel 11	DETECTOR FUNCTION	Peak (PK)
FREQUENCY RANGE	1GHz ~ 25GHz		Average (AV)

**ANTENNA POLARITY & TEST DISTANCE: HORIZONTAL AT 3 M**

NO.	FREQ. (MHz)	EMISSION LEVEL (dBuV/m)	LIMIT (dBuV/m)	MARGIN (dB)	ANTENNA HEIGHT (m)	TABLE ANGLE (Degree)	RAW VALUE (dBuV)	CORRECTION FACTOR (dB/m)
1	*2462.00	112.9 PK			2.05 H	140	117.00	-4.10
2	*2462.00	110.7 AV			2.05 H	140	114.80	-4.10
3	2483.50	55.7 PK	74.0	-18.3	2.05 H	140	59.70	-4.00
4	2483.50	43.5 AV	54.0	-10.5	2.05 H	140	47.50	-4.00
5	4924.00	46.5 PK	74.0	-27.5	1.45 H	100	44.00	2.50
6	4924.00	40.7 AV	54.0	-13.3	1.45 H	100	38.20	2.50
7	7386.00	47.6 PK	74.0	-26.4	3.01 H	241	38.30	9.30
8	7386.00	36.8 AV	54.0	-17.2	3.01 H	241	27.50	9.30

**ANTENNA POLARITY & TEST DISTANCE: VERTICAL AT 3 M**

NO.	FREQ. (MHz)	EMISSION LEVEL (dBuV/m)	LIMIT (dBuV/m)	MARGIN (dB)	ANTENNA HEIGHT (m)	TABLE ANGLE (Degree)	RAW VALUE (dBuV)	CORRECTION FACTOR (dB/m)
1	2362.00	57.9 PK	74.0	-16.1	3.39 V	128	62.30	-4.40
2	2362.00	53.8 AV	54.0	-0.2	3.39 V	128	58.20	-4.40
3	*2462.00	117.3 PK			3.89 V	139	121.40	-4.10
4	*2462.00	114.9 AV			3.89 V	139	119.00	-4.10
5	2483.50	62.5 PK	74.0	-11.5	3.89 V	139	66.50	-4.00
6	2483.50	53.6 AV	54.0	-0.4	3.89 V	139	57.60	-4.00
7	4924.00	55.8 PK	74.0	-18.2	2.83 V	198	53.30	2.50
8	4924.00	53.7 AV	54.0	-0.3	2.83 V	198	51.20	2.50
9	7386.00	47.3 PK	74.0	-26.7	3.33 V	116	38.00	9.30
10	7386.00	36.3 AV	54.0	-17.7	3.33 V	116	27.00	9.30

**REMARKS:**

1. Emission Level(dBuV/m) = Raw Value(dBuV) + Correction Factor(dB/m)
2. Correction Factor(dB/m) = Antenna Factor(dB/m) + Cable Factor(dB)
3. The other emission levels were very low against the limit.
4. Margin value = Emission Level – Limit value
5. " \* ": Fundamental frequency.

802.11g

CHANNEL	TX Channel 1	DETECTOR FUNCTION	Peak (PK)
FREQUENCY RANGE	1GHz ~ 25GHz		Average (AV)

**ANTENNA POLARITY & TEST DISTANCE: HORIZONTAL AT 3 M**

NO.	FREQ. (MHz)	EMISSION LEVEL (dBuV/m)	LIMIT (dBuV/m)	MARGIN (dB)	ANTENNA HEIGHT (m)	TABLE ANGLE (Degree)	RAW VALUE (dBuV)	CORRECTION FACTOR (dB/m)
1	2390.00	71.9 PK	74.0	-2.1	1.99 H	133	76.10	-4.20
2	2390.00	51.6 AV	54.0	-2.4	1.99 H	133	55.80	-4.20
3	*2412.00	112.1 PK			1.99 H	133	116.20	-4.10
4	*2412.00	103.4 AV			1.99 H	133	107.50	-4.10
5	4824.00	48.7 PK	74.0	-25.3	1.41 H	93	46.40	2.30
6	4824.00	37.1 AV	54.0	-16.9	1.41 H	93	34.80	2.30

**ANTENNA POLARITY & TEST DISTANCE: VERTICAL AT 3 M**

NO.	FREQ. (MHz)	EMISSION LEVEL (dBuV/m)	LIMIT (dBuV/m)	MARGIN (dB)	ANTENNA HEIGHT (m)	TABLE ANGLE (Degree)	RAW VALUE (dBuV)	CORRECTION FACTOR (dB/m)
1	2390.00	73.7 PK	74.0	-0.3	3.47 V	140	77.90	-4.20
<b>2</b>	<b>2390.00</b>	<b>53.9 AV</b>	<b>54.0</b>	<b>-0.1</b>	<b>3.47 V</b>	<b>140</b>	<b>58.10</b>	<b>-4.20</b>
3	*2412.00	115.7 PK			3.47 V	140	119.80	-4.10
4	*2412.00	106.6 AV			3.47 V	140	110.70	-4.10
5	4824.00	55.3 PK	74.0	-18.7	2.76 V	199	53.00	2.30
6	4824.00	40.1 AV	54.0	-13.9	2.76 V	199	37.80	2.30

**REMARKS:**

1. Emission Level(dBuV/m) = Raw Value(dBuV) + Correction Factor(dB/m)
2. Correction Factor(dB/m) = Antenna Factor(dB/m) + Cable Factor(dB)
3. The other emission levels were very low against the limit.
4. Margin value = Emission Level – Limit value
5. " \* ": Fundamental frequency.

CHANNEL	TX Channel 6	DETECTOR FUNCTION	Peak (PK)
FREQUENCY RANGE	1GHz ~ 25GHz		Average (AV)

**ANTENNA POLARITY & TEST DISTANCE: HORIZONTAL AT 3 M**

NO.	FREQ. (MHz)	EMISSION LEVEL (dBuV/m)	LIMIT (dBuV/m)	MARGIN (dB)	ANTENNA HEIGHT (m)	TABLE ANGLE (Degree)	RAW VALUE (dBuV)	CORRECTION FACTOR (dB/m)
1	2390.00	63.1 PK	74.0	-10.9	1.95 H	110	67.30	-4.20
2	2390.00	46.2 AV	54.0	-7.8	1.95 H	110	50.40	-4.20
3	*2437.00	118.2 PK			1.95 H	110	122.20	-4.00
4	*2437.00	108.1 AV			1.95 H	110	112.10	-4.00
5	2483.50	59.7 PK	74.0	-14.3	1.95 H	110	63.70	-4.00
6	2483.50	42.4 AV	54.0	-11.6	1.95 H	110	46.40	-4.00
7	4874.00	48.9 PK	74.0	-25.1	1.42 H	106	46.40	2.50
8	4874.00	37.2 AV	54.0	-16.8	1.42 H	106	34.70	2.50
9	7311.00	48.0 PK	74.0	-26.0	3.04 H	250	39.10	8.90
10	7311.00	37.3 AV	54.0	-16.7	3.04 H	250	28.40	8.90

**ANTENNA POLARITY & TEST DISTANCE: VERTICAL AT 3 M**

NO.	FREQ. (MHz)	EMISSION LEVEL (dBuV/m)	LIMIT (dBuV/m)	MARGIN (dB)	ANTENNA HEIGHT (m)	TABLE ANGLE (Degree)	RAW VALUE (dBuV)	CORRECTION FACTOR (dB/m)
1	2390.00	70.0 PK	74.0	-4.0	3.13 V	135	74.20	-4.20
2	2390.00	53.5 AV	54.0	-0.5	3.13 V	135	57.70	-4.20
3	*2437.00	120.8 PK			3.13 V	135	124.80	-4.00
4	*2437.00	111.5 AV			3.13 V	135	115.50	-4.00
5	2483.50	66.3 PK	74.0	-7.7	3.13 V	135	70.30	-4.00
6	2483.50	49.4 AV	54.0	-4.6	3.13 V	135	53.40	-4.00
7	4874.00	62.0 PK	74.0	-12.0	2.72 V	198	59.50	2.50
8	4874.00	47.6 AV	54.0	-6.4	2.72 V	198	45.10	2.50
9	7311.00	47.4 PK	74.0	-26.6	3.42 V	123	38.50	8.90
10	7311.00	36.5 AV	54.0	-17.5	3.42 V	123	27.60	8.90

**REMARKS:**

1. Emission Level(dBuV/m) = Raw Value(dBuV) + Correction Factor(dB/m)
2. Correction Factor(dB/m) = Antenna Factor(dB/m) + Cable Factor(dB)
3. The other emission levels were very low against the limit.
4. Margin value = Emission Level – Limit value
5. " \* ": Fundamental frequency.

CHANNEL	TX Channel 11	DETECTOR FUNCTION	Peak (PK)
FREQUENCY RANGE	1GHz ~ 25GHz		Average (AV)

**ANTENNA POLARITY & TEST DISTANCE: HORIZONTAL AT 3 M**

NO.	FREQ. (MHz)	EMISSION LEVEL (dBuV/m)	LIMIT (dBuV/m)	MARGIN (dB)	ANTENNA HEIGHT (m)	TABLE ANGLE (Degree)	RAW VALUE (dBuV)	CORRECTION FACTOR (dB/m)
1	*2462.00	111.9 PK			1.95 H	119	116.00	-4.10
2	*2462.00	102.9 AV			1.95 H	119	107.00	-4.10
3	2483.50	72.0 PK	74.0	-2.0	1.95 H	119	76.00	-4.00
4	2483.50	52.0 AV	54.0	-2.0	1.95 H	119	56.00	-4.00
5	4924.00	48.7 PK	74.0	-25.3	1.41 H	110	46.20	2.50
6	4924.00	37.2 AV	54.0	-16.8	1.41 H	110	34.70	2.50
7	7386.00	47.2 PK	74.0	-26.8	3.00 H	226	37.90	9.30
8	7386.00	36.7 AV	54.0	-17.3	3.00 H	226	27.40	9.30

**ANTENNA POLARITY & TEST DISTANCE: VERTICAL AT 3 M**

NO.	FREQ. (MHz)	EMISSION LEVEL (dBuV/m)	LIMIT (dBuV/m)	MARGIN (dB)	ANTENNA HEIGHT (m)	TABLE ANGLE (Degree)	RAW VALUE (dBuV)	CORRECTION FACTOR (dB/m)
1	*2462.00	115.3 PK			2.94 V	131	119.40	-4.10
2	*2462.00	106.5 AV			2.94 V	131	110.60	-4.10
3	2483.50	73.6 PK	74.0	-0.4	2.81 V	131	77.60	-4.00
4	2483.50	53.1 AV	54.0	-0.9	2.81 V	131	57.10	-4.00
5	4924.00	54.9 PK	74.0	-19.1	2.77 V	197	52.40	2.50
6	4924.00	39.9 AV	54.0	-14.1	2.77 V	197	37.40	2.50
7	7386.00	47.6 PK	74.0	-26.4	3.41 V	113	38.30	9.30
8	7386.00	36.6 AV	54.0	-17.4	3.41 V	113	27.30	9.30

**REMARKS:**

1. Emission Level(dBuV/m) = Raw Value(dBuV) + Correction Factor(dB/m)
2. Correction Factor(dB/m) = Antenna Factor(dB/m) + Cable Factor(dB)
3. The other emission levels were very low against the limit.
4. Margin value = Emission Level – Limit value
5. " \* ": Fundamental frequency.

802.11n (VHT20)

CHANNEL	TX Channel 1	DETECTOR FUNCTION	Peak (PK)
FREQUENCY RANGE	1GHz ~ 25GHz		Average (AV)

ANTENNA POLARITY & TEST DISTANCE: HORIZONTAL AT 3 M

NO.	FREQ. (MHz)	EMISSION LEVEL (dBuV/m)	LIMIT (dBuV/m)	MARGIN (dB)	ANTENNA HEIGHT (m)	TABLE ANGLE (Degree)	RAW VALUE (dBuV)	CORRECTION FACTOR (dB/m)
1	2390.00	72.2 PK	74.0	-1.8	1.97 H	138	76.40	-4.20
2	2390.00	51.7 AV	54.0	-2.3	1.97 H	138	55.90	-4.20
3	*2412.00	112.5 PK			1.97 H	138	116.60	-4.10
4	*2412.00	103.7 AV			1.97 H	138	107.80	-4.10
5	4824.00	48.7 PK	74.0	-25.3	1.40 H	112	46.40	2.30
6	4824.00	37.4 AV	54.0	-16.6	1.40 H	112	35.10	2.30

ANTENNA POLARITY & TEST DISTANCE: VERTICAL AT 3 M

NO.	FREQ. (MHz)	EMISSION LEVEL (dBuV/m)	LIMIT (dBuV/m)	MARGIN (dB)	ANTENNA HEIGHT (m)	TABLE ANGLE (Degree)	RAW VALUE (dBuV)	CORRECTION FACTOR (dB/m)
<b>1</b>	<b>2390.00</b>	<b>73.9 PK</b>	<b>74.0</b>	<b>-0.1</b>	<b>2.88 V</b>	<b>87</b>	<b>78.10</b>	<b>-4.20</b>
2	2390.00	53.8 AV	54.0	-0.2	2.88 V	87	58.00	-4.20
3	*2412.00	115.7 PK			2.90 V	135	119.80	-4.10
4	*2412.00	106.1 AV			2.90 V	135	110.20	-4.10
5	4824.00	55.4 PK	74.0	-18.6	2.75 V	182	53.10	2.30
6	4824.00	40.3 AV	54.0	-13.7	2.75 V	182	38.00	2.30

REMARKS:

1. Emission Level(dBuV/m) = Raw Value(dBuV) + Correction Factor(dB/m)
2. Correction Factor(dB/m) = Antenna Factor(dB/m) + Cable Factor(dB)
3. The other emission levels were very low against the limit.
4. Margin value = Emission Level – Limit value
5. " \* ": Fundamental frequency.

CHANNEL	TX Channel 6	DETECTOR FUNCTION	Peak (PK)
FREQUENCY RANGE	1GHz ~ 25GHz		Average (AV)

**ANTENNA POLARITY & TEST DISTANCE: HORIZONTAL AT 3 M**

NO.	FREQ. (MHz)	EMISSION LEVEL (dBuV/m)	LIMIT (dBuV/m)	MARGIN (dB)	ANTENNA HEIGHT (m)	TABLE ANGLE (Degree)	RAW VALUE (dBuV)	CORRECTION FACTOR (dB/m)
1	2390.00	63.0 PK	74.0	-11.0	2.01 H	108	67.20	-4.20
2	2390.00	45.9 AV	54.0	-8.1	2.01 H	108	50.10	-4.20
3	*2437.00	117.7 PK			2.01 H	108	121.70	-4.00
4	*2437.00	107.7 AV			2.01 H	108	111.70	-4.00
5	2483.50	59.7 PK	74.0	-14.3	2.01 H	108	63.70	-4.00
6	2483.50	42.4 AV	54.0	-11.6	2.01 H	108	46.40	-4.00
7	4874.00	48.6 PK	74.0	-25.4	1.46 H	89	46.10	2.50
8	4874.00	37.0 AV	54.0	-17.0	1.46 H	89	34.50	2.50
9	7311.00	47.7 PK	74.0	-26.3	2.95 H	243	38.80	8.90
10	7311.00	36.8 AV	54.0	-17.2	2.95 H	243	27.90	8.90

**ANTENNA POLARITY & TEST DISTANCE: VERTICAL AT 3 M**

NO.	FREQ. (MHz)	EMISSION LEVEL (dBuV/m)	LIMIT (dBuV/m)	MARGIN (dB)	ANTENNA HEIGHT (m)	TABLE ANGLE (Degree)	RAW VALUE (dBuV)	CORRECTION FACTOR (dB/m)
1	2390.00	69.2 PK	74.0	-4.8	2.81 V	136	73.40	-4.20
2	2390.00	53.8 AV	54.0	-0.2	2.81 V	136	58.00	-4.20
3	*2437.00	120.1 PK			2.74 V	138	124.10	-4.00
4	*2437.00	110.6 AV			2.74 V	138	114.60	-4.00
5	2483.50	69.3 PK	74.0	-4.7	2.81 V	136	73.30	-4.00
<b>6</b>	<b>2483.50</b>	<b>53.9 AV</b>	<b>54.0</b>	<b>-0.1</b>	<b>2.81 V</b>	<b>136</b>	<b>57.90</b>	<b>-4.00</b>
7	4874.00	62.0 PK	74.0	-12.0	2.70 V	186	59.50	2.50
8	4874.00	47.5 AV	54.0	-6.5	2.70 V	186	45.00	2.50
9	7311.00	47.1 PK	74.0	-26.9	3.45 V	130	38.20	8.90
10	7311.00	36.5 AV	54.0	-17.5	3.45 V	130	27.60	8.90

**REMARKS:**

1. Emission Level(dBuV/m) = Raw Value(dBuV) + Correction Factor(dB/m)
2. Correction Factor(dB/m) = Antenna Factor(dB/m) + Cable Factor(dB)
3. The other emission levels were very low against the limit.
4. Margin value = Emission Level – Limit value
5. " \* ": Fundamental frequency.

CHANNEL	TX Channel 11	DETECTOR FUNCTION	Peak (PK)
FREQUENCY RANGE	1GHz ~ 25GHz		Average (AV)

**ANTENNA POLARITY & TEST DISTANCE: HORIZONTAL AT 3 M**

NO.	FREQ. (MHz)	EMISSION LEVEL (dBuV/m)	LIMIT (dBuV/m)	MARGIN (dB)	ANTENNA HEIGHT (m)	TABLE ANGLE (Degree)	RAW VALUE (dBuV)	CORRECTION FACTOR (dB/m)
1	*2462.00	111.8 PK			2.02 H	122	115.90	-4.10
2	*2462.00	103.3 AV			2.02 H	122	107.40	-4.10
3	2483.50	71.4 PK	74.0	-2.6	2.02 H	122	75.40	-4.00
4	2483.50	51.3 AV	54.0	-2.7	2.02 H	122	55.30	-4.00
5	4924.00	48.9 PK	74.0	-25.1	1.40 H	103	46.40	2.50
6	4924.00	37.4 AV	54.0	-16.6	1.40 H	103	34.90	2.50
7	7386.00	47.7 PK	74.0	-26.3	2.98 H	229	38.40	9.30
8	7386.00	37.0 AV	54.0	-17.0	2.98 H	229	27.70	9.30

**ANTENNA POLARITY & TEST DISTANCE: VERTICAL AT 3 M**

NO.	FREQ. (MHz)	EMISSION LEVEL (dBuV/m)	LIMIT (dBuV/m)	MARGIN (dB)	ANTENNA HEIGHT (m)	TABLE ANGLE (Degree)	RAW VALUE (dBuV)	CORRECTION FACTOR (dB/m)
1	*2462.00	114.8 PK			2.57 V	136	118.90	-4.10
2	*2462.00	105.4 AV			2.57 V	136	109.50	-4.10
<b>3</b>	<b>2483.50</b>	<b>73.9 PK</b>	<b>74.0</b>	<b>-0.1</b>	<b>2.57 V</b>	<b>136</b>	<b>77.90</b>	<b>-4.00</b>
<b>4</b>	<b>2483.50</b>	<b>53.9 AV</b>	<b>54.0</b>	<b>-0.1</b>	<b>2.57 V</b>	<b>136</b>	<b>57.90</b>	<b>-4.00</b>
5	4924.00	54.6 PK	74.0	-19.4	2.73 V	211	52.10	2.50
6	4924.00	39.7 AV	54.0	-14.3	2.73 V	211	37.20	2.50
7	7386.00	47.9 PK	74.0	-26.1	3.36 V	111	38.60	9.30
8	7386.00	36.7 AV	54.0	-17.3	3.36 V	111	27.40	9.30

**REMARKS:**

1. Emission Level(dBuV/m) = Raw Value(dBuV) + Correction Factor(dB/m)
2. Correction Factor(dB/m) = Antenna Factor(dB/m) + Cable Factor(dB)
3. The other emission levels were very low against the limit.
4. Margin value = Emission Level – Limit value
5. " \* ": Fundamental frequency.

CDD Mode

Below 1GHz Worst-Case Data

802.11g

CHANNEL	TX Channel 6	DETECTOR FUNCTION	Quasi-Peak (QP)
FREQUENCY RANGE	Below 1GHz		
TEST MODE	A		

ANTENNA POLARITY & TEST DISTANCE: HORIZONTAL AT 3 M

NO.	FREQ. (MHz)	EMISSION LEVEL (dBuV/m)	LIMIT (dBuV/m)	MARGIN (dB)	ANTENNA HEIGHT (m)	TABLE ANGLE (Degree)	RAW VALUE (dBuV)	CORRECTION FACTOR (dB/m)
1	98.07	31.1 QP	43.5	-12.4	2.00 H	265	44.30	-13.20
2	209.89	34.2 QP	43.5	-9.3	1.50 H	259	45.60	-11.40
3	269.54	30.9 QP	46.0	-15.1	1.00 H	108	39.30	-8.40
4	343.72	30.7 QP	46.0	-15.3	1.00 H	331	37.20	-6.50
5	400.01	32.9 QP	46.0	-13.1	1.00 H	229	37.90	-5.00
6	800.01	33.8 QP	46.0	-12.2	1.00 H	127	30.70	3.10

ANTENNA POLARITY & TEST DISTANCE: VERTICAL AT 3 M

NO.	FREQ. (MHz)	EMISSION LEVEL (dBuV/m)	LIMIT (dBuV/m)	MARGIN (dB)	ANTENNA HEIGHT (m)	TABLE ANGLE (Degree)	RAW VALUE (dBuV)	CORRECTION FACTOR (dB/m)
1	37.98	35.8 QP	40.0	-4.2	1.00 V	360	17.40	18.40
2	72.00	35.1 QP	40.0	-4.9	1.00 V	130	18.40	16.70
3	157.07	35.1 QP	43.5	-8.4	1.00 V	104	15.80	19.30
4	302.81	34.6 QP	46.0	-11.4	1.00 V	360	14.30	20.30
5	400.01	31.9 QP	46.0	-14.1	1.00 V	186	9.30	22.60
6	644.35	30.0 QP	46.0	-16.0	2.00 V	203	2.10	27.90

**REMARKS:**

1. Emission Level(dBuV/m) = Raw Value(dBuV) + Correction Factor(dB/m)
2. Correction Factor(dB/m) = Antenna Factor(dB/m) + Cable Factor(dB)
3. The other emission levels were very low against the limit.
4. Margin value = Emission Level – Limit value



802.11g

CHANNEL	TX Channel 6	DETECTOR FUNCTION	Quasi-Peak (QP)
FREQUENCY RANGE	Below 1GHz		
TEST MODE	B		

ANTENNA POLARITY & TEST DISTANCE: HORIZONTAL AT 3 M

NO.	FREQ. (MHz)	EMISSION LEVEL (dBuV/m)	LIMIT (dBuV/m)	MARGIN (dB)	ANTENNA HEIGHT (m)	TABLE ANGLE (Degree)	RAW VALUE (dBuV)	CORRECTION FACTOR (dB/m)
1	148.30	34.2 QP	43.5	-9.3	2.00 H	110	42.61	-8.39
2	180.57	37.4 QP	43.5	-6.1	1.50 H	357	47.02	-9.58
3	274.89	35.1 QP	46.0	-10.9	1.00 H	338	43.25	-8.17
4	400.00	36.4 QP	46.0	-9.6	1.00 H	270	41.39	-5.01
5	800.00	36.3 QP	46.0	-9.7	1.00 H	307	33.25	3.07
6	900.01	34.6 QP	46.0	-11.4	1.50 H	292	30.36	4.27

ANTENNA POLARITY & TEST DISTANCE: VERTICAL AT 3 M

NO.	FREQ. (MHz)	EMISSION LEVEL (dBuV/m)	LIMIT (dBuV/m)	MARGIN (dB)	ANTENNA HEIGHT (m)	TABLE ANGLE (Degree)	RAW VALUE (dBuV)	CORRECTION FACTOR (dB/m)
1	64.36	36.3 QP	40.0	-3.7	1.00 V	275	45.65	-9.34
2	150.31	36.3 QP	43.5	-7.2	1.50 V	291	44.70	-8.40
3	180.68	36.4 QP	43.5	-7.1	1.00 V	20	46.02	-9.60
4	275.05	34.5 QP	46.0	-11.6	1.00 V	326	42.62	-8.17
5	400.00	36.3 QP	46.0	-9.8	1.00 V	307	41.26	-5.01
6	900.00	35.3 QP	46.0	-10.7	1.00 V	302	31.00	4.27

**REMARKS:**

1. Emission Level(dBuV/m) = Raw Value(dBuV) + Correction Factor(dB/m)
2. Correction Factor(dB/m) = Antenna Factor(dB/m) + Cable Factor(dB)
3. The other emission levels were very low against the limit.
4. Margin value = Emission Level – Limit value

## 4.2 Conducted Emission Measurement

### 4.2.1 Limits of Conducted Emission Measurement

Frequency (MHz)	Conducted Limit (dBuV)	
	Quasi-peak	Average
0.15 - 0.5	66 - 56	56 - 46
0.50 - 5.0	56	46
5.0 - 30.0	60	50

- Note:** 1. The lower limit shall apply at the transition frequencies.  
 2. The limit decreases in line with the logarithm of the frequency in the range of 0.15 to 0.50MHz.

### 4.2.2 Test Instruments

Description & Manufacturer	Model No.	Serial No.	Cal. Date	Cal. Due
Test Receiver R&S	ESCS 30	847124/029	Oct. 23, 2015	Oct. 22, 2016
Line-Impedance Stabilization Network (for EUT) R&S	ESH3-Z5	848773/004	Oct. 28, 2015	Oct. 27, 2016
RF Cable	5D-FB	COACAB-002	Mar. 04, 2016	Mar. 03, 2017
10 dB PAD Mini-Circuits	HAT-10+	CONATT-004	Jun. 20, 2015	Jun. 19, 2016
Software BVADT	BVADT_Cond_ V7.3.7.3	NA	NA	NA

Note:

- The test was performed in Shielded Room No. 1.
- The calibration interval of the above test instruments is 12 months and the calibrations are traceable to NML/ROC and NIST/USA.
- Tested Date: Jun. 17, 2016

#### 4.2.3 Test Procedures

- a. The EUT was placed 0.4 meters from the conducting wall of the shielded room with EUT being connected to the power mains through a line impedance stabilization network (LISN). Other support units were connected to the power mains through another LISN. The two LISNs provide 50 ohm/ 50uH of coupling impedance for the measuring instrument.
- b. Both lines of the power mains connected to the EUT were checked for maximum conducted interference.
- c. The frequency range from 150kHz to 30MHz was searched. Emission levels under (Limit - 20dB) was not recorded.

**Note:** The resolution bandwidth and video bandwidth of test receiver is 9kHz for quasi-peak detection (QP) and average detection (AV) at frequency 0.15MHz-30MHz.

#### 4.2.4 Deviation from Test Standard

No deviation.

#### 4.2.5 Test Setup

## 4.2.7 Test Results

### CDD Mode

Phase	Line (L)	Detector Function	Quasi-Peak (QP) / Average (AV)
Test Mode	A		

No	Freq. [MHz]	Corr. Factor (dB)	Reading Value [dB (uV)]		Emission Level [dB (uV)]		Limit [dB (uV)]		Margin (dB)	
			Q.P.	AV.	Q.P.	AV.	Q.P.	AV.	Q.P.	AV.
			1	0.17734	10.22	37.05	25.16	47.27	35.38	64.61
2	0.22812	10.22	30.50	21.72	40.72	31.94	62.52	52.52	-21.80	-20.58
3	0.40000	10.22	28.58	19.32	38.80	29.54	57.85	47.85	-19.05	-18.31
4	0.85313	10.25	19.83	11.18	30.08	21.43	56.00	46.00	-25.92	-24.57
5	1.61328	10.29	14.63	6.31	24.92	16.60	56.00	46.00	-31.08	-29.40
6	19.66406	11.33	26.16	23.82	37.49	35.15	60.00	50.00	-22.51	-14.85

### REMARKS:

1. Q.P. and AV. are abbreviations of quasi-peak and average individually.
2. The emission levels of other frequencies were very low against the limit.
3. Margin value = Emission level - Limit value
4. Correction factor = Insertion loss + Cable loss
5. Emission Level = Correction Factor + Reading Value.

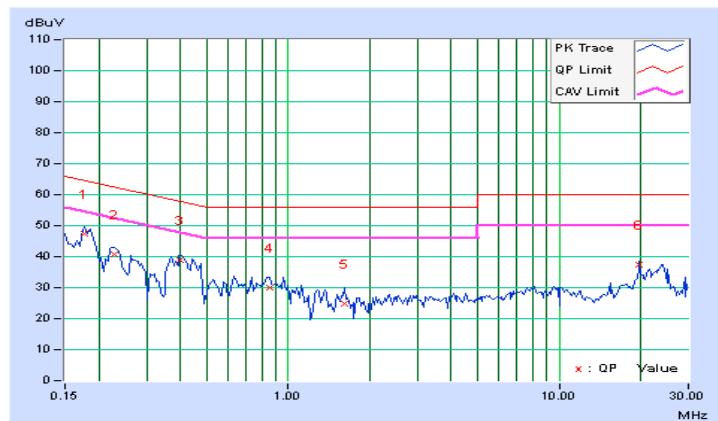

Phase	Neutral (N)	Detector Function	Quasi-Peak (QP) / Average (AV)
Test Mode	A		

No	Freq. [MHz]	Corr. Factor (dB)	Reading Value [dB (uV)]		Emission Level [dB (uV)]		Limit [dB (uV)]		Margin (dB)	
			Q.P.	AV.	Q.P.	AV.	Q.P.	AV.	Q.P.	AV.
			1	0.18125	10.20	37.33	29.24	47.53	39.44	64.43
2	0.22594	10.21	31.13	22.34	41.34	32.55	62.60	52.60	-21.26	-20.05
3	0.38047	10.20	29.60	14.43	39.80	24.63	58.27	48.27	-18.47	-23.64
4	0.84141	10.23	20.91	10.78	31.14	21.01	56.00	46.00	-24.86	-24.99
5	2.08594	10.29	17.30	8.69	27.59	18.98	56.00	46.00	-28.41	-27.02
6	19.66569	11.10	26.20	23.94	37.30	35.04	60.00	50.00	-22.70	-14.96

**REMARKS:**

1. Q.P. and AV. are abbreviations of quasi-peak and average individually.
2. The emission levels of other frequencies were very low against the limit.
3. Margin value = Emission level - Limit value
4. Correction factor = Insertion loss + Cable loss
5. Emission Level = Correction Factor + Reading Value.

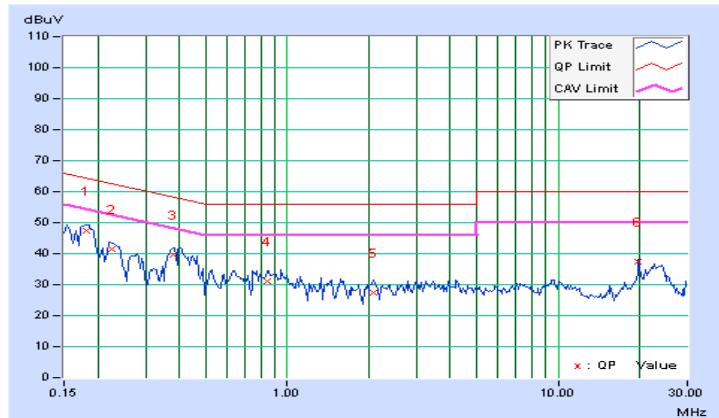

Phase	Line (L)	Detector Function	Quasi-Peak (QP) / Average (AV)
Test Mode	B		

No	Freq. [MHz]	Corr. Factor (dB)	Reading Value [dB (uV)]		Emission Level [dB (uV)]		Limit [dB (uV)]		Margin (dB)	
			Q.P.	AV.	Q.P.	AV.	Q.P.	AV.	Q.P.	AV.
			1	0.17203	10.21	35.81	23.50	46.02	33.71	64.86
2	0.22812	10.22	27.49	16.45	37.71	26.67	62.52	52.52	-24.81	-25.85
3	0.25744	10.22	26.44	16.29	36.66	26.51	61.51	51.51	-24.85	-25.00
4	0.45325	10.22	23.46	18.12	33.68	28.34	56.82	46.82	-23.13	-18.47
5	3.31250	10.30	10.36	5.01	20.66	15.31	56.00	46.00	-35.34	-30.69
6	18.40234	11.26	16.75	8.98	28.01	20.24	60.00	50.00	-31.99	-29.76

**REMARKS:**

1. Q.P. and AV. are abbreviations of quasi-peak and average individually.
2. The emission levels of other frequencies were very low against the limit.
3. Margin value = Emission level - Limit value
4. Correction factor = Insertion loss + Cable loss
5. Emission Level = Correction Factor + Reading Value.

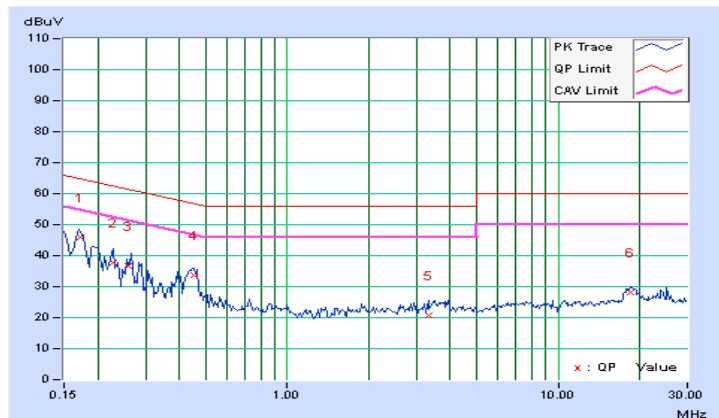

Phase	Neutral (N)	Detector Function	Quasi-Peak (QP) / Average (AV)
Test Mode	B		

No	Freq. [MHz]	Corr. Factor (dB)	Reading Value [dB (uV)]		Emission Level [dB (uV)]		Limit [dB (uV)]		Margin (dB)	
			Q.P.	AV.	Q.P.	AV.	Q.P.	AV.	Q.P.	AV.
			1	0.15000	10.19	37.97	21.69	48.16	31.88	66.00
2	0.17344	10.20	35.37	23.36	45.57	33.56	64.79	54.79	-19.22	-21.23
3	0.20078	10.21	30.07	19.34	40.28	29.55	63.58	53.58	-23.30	-24.03
4	0.45469	10.20	22.11	14.08	32.31	24.28	56.79	46.79	-24.48	-22.51
5	2.87500	10.27	5.43	-0.02	15.70	10.25	56.00	46.00	-40.30	-35.75
6	18.26172	11.04	15.13	8.17	26.17	19.21	60.00	50.00	-33.83	-30.79

**REMARKS:**

1. Q.P. and AV. are abbreviations of quasi-peak and average individually.
2. The emission levels of other frequencies were very low against the limit.
3. Margin value = Emission level - Limit value
4. Correction factor = Insertion loss + Cable loss
5. Emission Level = Correction Factor + Reading Value.

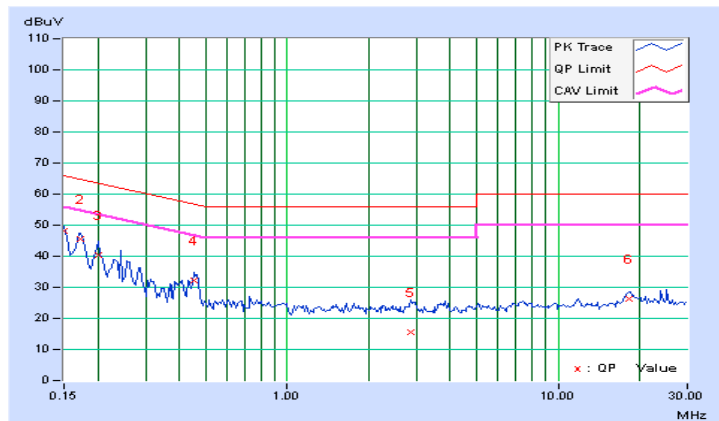

### 4.3 6dB Bandwidth Measurement

#### 4.3.1 Limits of 6dB Bandwidth Measurement

The minimum of 6dB Bandwidth Measurement is 0.5 MHz.

#### 4.3.2 Test Setup

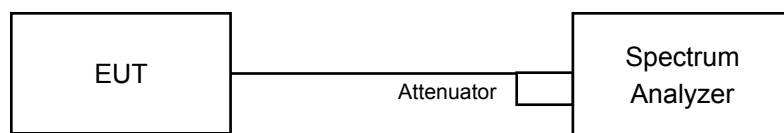

#### 4.3.3 Test Instruments

Refer to section 4.1.2 to get information of above instrument.

#### 4.3.4 Test Procedure

- Set resolution bandwidth (RBW) = 100kHz
- Set the video bandwidth (VBW)  $\geq 3 \times$  RBW, Detector = Peak.
- Trace mode = max hold.
- Sweep = auto couple.
- Measure the maximum width of the emission that is constrained by the frequencies associated with the two amplitude points (upper and lower) that are attenuated by 6 dB relative to the maximum level measured in the fundamental emission

#### 4.3.5 Deviation from Test Standard

No deviation.

#### 4.3.6 EUT Operating Conditions

The software provided by client to enable the EUT under transmission condition continuously at lowest, middle and highest channel frequencies individually.



#### 4.3.7 Test Result

#### CDD Mode

#### 2TX

#### 802.11b

Channel	Frequency (MHz)	6dB Bandwidth (MHz)		Minimum Limit (MHz)	Pass / Fail
		Chain 0	Chain 3		
1	2412	8.07	8.08	0.5	Pass
6	2437	8.08	8.06	0.5	Pass
11	2462	8.10	8.11	0.5	Pass

#### 802.11g

Channel	Frequency (MHz)	6dB Bandwidth (MHz)		Minimum Limit (MHz)	Pass / Fail
		Chain 0	Chain 3		
1	2412	15.17	15.18	0.5	Pass
6	2437	15.21	15.20	0.5	Pass
11	2462	15.17	15.18	0.5	Pass

#### 802.11n (VHT20)

Channel	Frequency (MHz)	6dB Bandwidth (MHz)		Minimum Limit (MHz)	Pass / Fail
		Chain 0	Chain 3		
1	2412	15.97	15.17	0.5	Pass
6	2437	16.35	15.76	0.5	Pass
11	2462	16.31	15.17	0.5	Pass

### Spectrum Plot of Worst Value

**802.11b**

**802.11g**

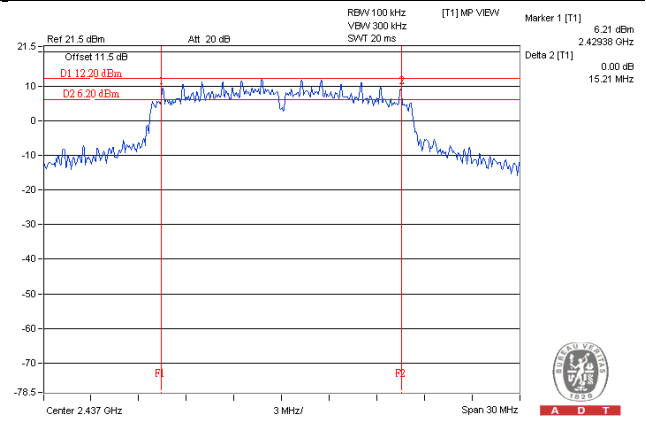
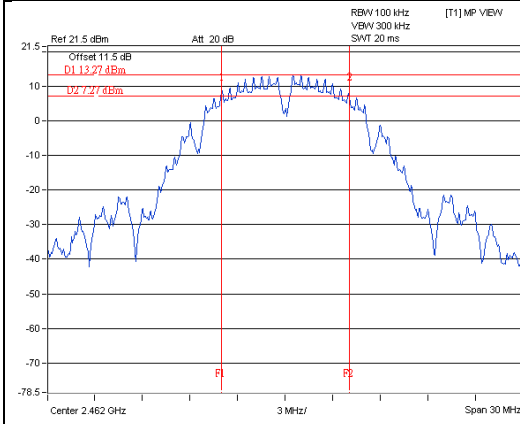

**802.11n (VHT20)**

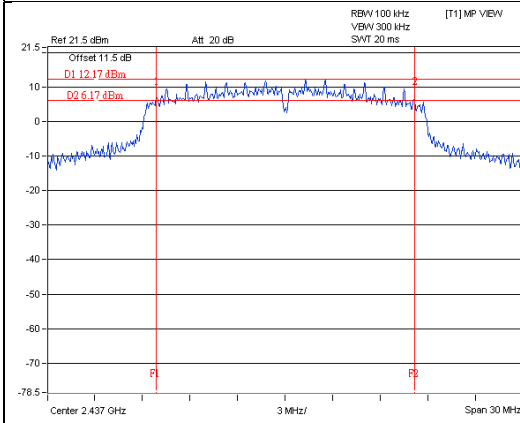

**CDD Mode**

**4TX**

**802.11b**

Channel	Frequency (MHz)	6dB Bandwidth (MHz)				Minimum Limit (MHz)	Pass / Fail
		Chain 0	Chain 1	Chain 2	Chain 3		
1	2412	8.08	8.09	8.09	8.07	0.5	Pass
6	2437	8.05	8.09	8.05	8.04	0.5	Pass
11	2462	8.12	8.06	8.10	8.06	0.5	Pass

**802.11g**

Channel	Frequency (MHz)	6dB Bandwidth (MHz)				Minimum Limit (MHz)	Pass / Fail
		Chain 0	Chain 1	Chain 2	Chain 3		
1	2412	15.18	15.13	15.13	15.17	0.5	Pass
6	2437	15.19	15.19	15.19	15.22	0.5	Pass
11	2462	15.20	15.13	15.14	15.19	0.5	Pass

**802.11n (VHT20)**

Channel	Frequency (MHz)	6dB Bandwidth (MHz)				Minimum Limit (MHz)	Pass / Fail
		Chain 0	Chain 1	Chain 2	Chain 3		
1	2412	15.17	15.77	15.18	15.15	0.5	Pass
6	2437	15.20	15.72	15.75	15.76	0.5	Pass
11	2462	15.14	15.75	15.19	15.43	0.5	Pass

### Spectrum Plot of Worst Value

**802.11b**

**802.11g**

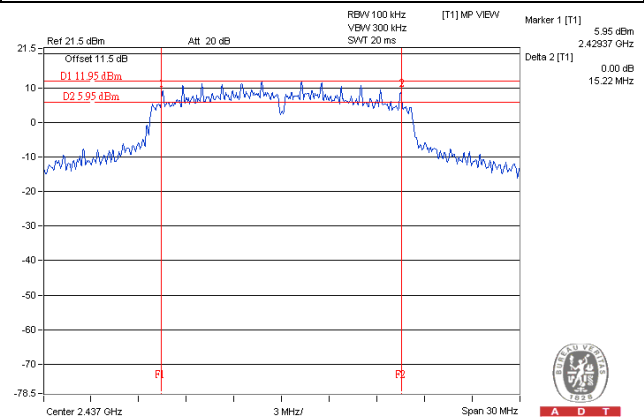
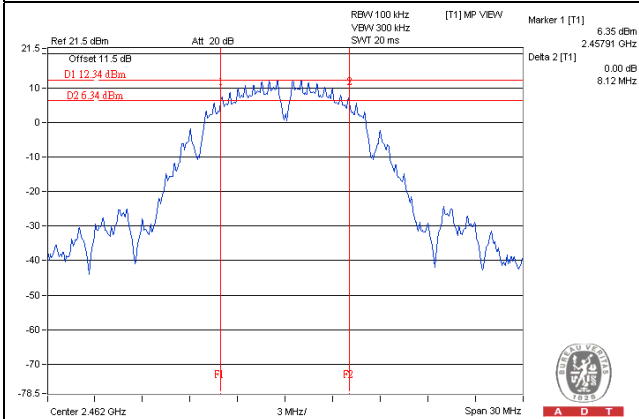

**802.11n (VHT20)**

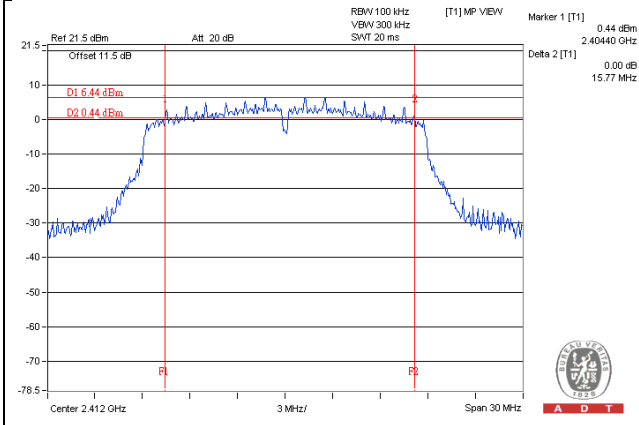

## 4.4 Conducted Output Power Measurement

### 4.4.1 Limits of Conducted Output Power Measurement

For systems using digital modulation in the 2400–2483.5 MHz bands: 1 Watt (30dBm)

Per KDB 662911 D01 Multiple Transmitter Output Method of conducted output power measurement on IEEE 802.11 devices,

Array Gain = 0 dB (i.e., no array gain) for  $N_{ANT} \leq 4$ ;

Array Gain = 0 dB (i.e., no array gain) for channel widths  $\geq 40$  MHz for any  $N_{ANT}$ ;

Array Gain =  $5 \log(N_{ANT}/N_{SS})$  dB or 3 dB, whichever is less for 20-MHz channel widths with  $N_{ANT} \geq 5$ .

For power measurements on all other devices: Array Gain =  $10 \log(N_{ANT}/N_{SS})$  dB.

### 4.4.2 Test Setup

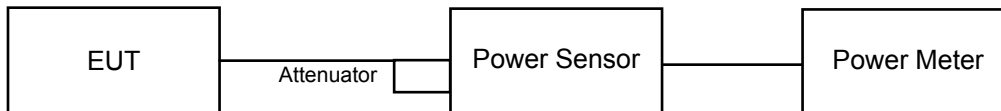

### 4.4.3 Test Instruments

Refer to section 4.1.2 to get information of above instrument.

### 4.4.4 Test Procedures

An average power sensor was used on the output port of the EUT. A power meter was used to read the response of the average power sensor. Record the power level.

### 4.4.5 Deviation from Test Standard

No deviation.

### 4.4.6 EUT Operating Conditions

Same as Item 4.3.6.

#### 4.4.7 Test Results

##### CDD Mode

##### 2TX

##### 802.11b

Chan.	Freq. (MHz)	Average Power (dBm)		Total Power (mW)	Total Power (dBm)	Limit (dBm)	Pass / Fail
		Chain 0	Chain 3				
1	2412	21.46	20.66	256.372	24.09	30.00	Pass
6	2437	22.13	21.45	302.942	24.81	30.00	Pass
11	2462	21.18	20.49	243.164	23.86	30.00	Pass

##### 802.11g

Chan.	Freq. (MHz)	Average Power (dBm)		Total Power (mW)	Total Power (dBm)	Limit (dBm)	Pass / Fail
		Chain 0	Chain 3				
1	2412	19.16	18.30	150.022	21.76	30.00	Pass
6	2437	23.04	22.16	<b>365.809</b>	25.63	30.00	Pass
11	2462	18.98	17.97	141.729	21.51	30.00	Pass

##### 802.11n (VHT20)

Chan.	Freq. (MHz)	Average Power (dBm)		Total Power (mW)	Total Power (dBm)	Limit (dBm)	Pass / Fail
		Chain 0	Chain 3				
1	2412	17.88	17.41	116.457	20.66	30.00	Pass
6	2437	23.04	22.08	362.808	25.60	30.00	Pass
11	2462	17.26	16.38	96.662	19.85	30.00	Pass

**CDD Mode**

**4TX**

**802.11b**

Chan.	Freq. (MHz)	Average Power (dBm)				Total Power (mW)	Total Power (dBm)	Limit (dBm)	Pass / Fail
		Chain 0	Chain 1	Chain 2	Chain 3				
1	2412	19.35	19.12	19.40	18.70	328.984	25.17	30.00	Pass
6	2437	20.22	19.80	19.50	19.60	381.021	25.81	30.00	Pass
11	2462	20.51	20.26	20.00	19.79	413.91	26.17	30.00	Pass

**802.11g**

Chan.	Freq. (MHz)	Average Power (dBm)				Total Power (mW)	Total Power (dBm)	Limit (dBm)	Pass / Fail
		Chain 0	Chain 1	Chain 2	Chain 3				
1	2412	17.86	17.13	17.22	16.96	215.118	23.33	30.00	Pass
6	2437	22.52	21.81	21.69	21.62	<b>623.136</b>	27.95	30.00	Pass
11	2462	16.56	17.02	16.98	17.60	203.072	23.08	30.00	Pass

**802.11n (VHT20)**

Chan.	Freq. (MHz)	Average Power (dBm)				Total Power (mW)	Total Power (dBm)	Limit (dBm)	Pass / Fail
		Chain 0	Chain 1	Chain 2	Chain 3				
1	2412	17.40	17.04	17.00	16.72	202.644	23.07	30.00	Pass
6	2437	22.24	21.55	21.55	21.41	591.629	27.72	30.00	Pass
11	2462	17.20	16.70	16.52	16.41	187.882	22.74	30.00	Pass

### Beamforming Mode

#### 2TX

#### 802.11n (VHT20)

Chan.	Freq. (MHz)	Average Power (dBm)		Total Power (mW)	Total Power (dBm)	Limit (dBm)	Pass / Fail
		Chain 0	Chain 3				
1	2412	17.88	17.41	116.457	20.66	29.02	Pass
6	2437	23.04	22.08	<b>362.808</b>	25.60	29.02	Pass
11	2462	17.26	16.38	96.662	19.85	29.02	Pass

\* Directional gain =  $10 \log[(10^{G1/20} + 10^{G2/20} + \dots + 10^{GN/20})^2/2] = 6.98\text{dBi} > 6\text{dBi}$ , so the power limit shall be reduced to  $30-(6.98-6) = 29.02\text{dBm}$ .

### Beamforming Mode

#### 4TX

#### 802.11n (VHT20)

Chan.	Freq. (MHz)	Average Power (dBm)				Total Power (mW)	Total Power (dBm)	Limit (dBm)	Pass / Fail
		Chain 0	Chain 1	Chain 2	Chain 3				
1	2412	17.40	17.04	17.00	16.72	202.644	23.07	26.20	Pass
6	2437	20.68	19.86	19.88	19.79	<b>406.333</b>	26.09	26.20	Pass
11	2462	17.20	16.70	16.52	16.41	187.882	22.74	26.20	Pass

\* Directional gain =  $10 \log[(10^{G1/20} + 10^{G2/20} + \dots + 10^{GN/20})^2/4] = 9.8\text{dBi} > 6\text{dBi}$ , so the power limit shall be reduced to  $30-(9.8-6) = 26.20\text{dBm}$ .



## 4.5 Power Spectral Density Measurement

### 4.5.1 Limits of Power Spectral Density Measurement

The Maximum of Power Spectral Density Measurement is 8dBm.

### 4.5.2 Test Setup

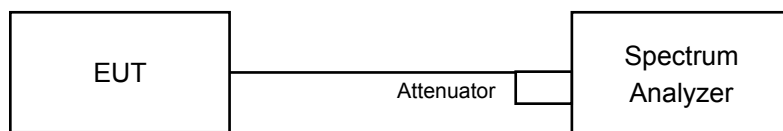

### 4.5.3 Test Instruments

Refer to section 4.1.2 to get information of above instrument.

### 4.5.4 Test Procedure

- a. Set instrument center frequency to DTS channel center frequency.
- b. Set span to at least 1.5 times the OBW.
- c. Set RBW to:  $3 \text{ kHz} \leq \text{RBW} \leq 100 \text{ kHz}$ .
- d. Set VBW  $\geq 3 \times \text{RBW}$ .
- e. Detector = power averaging (RMS) or sample detector (when RMS not available).
- f. Ensure that the number of measurement points in the sweep  $\geq 2 \times \text{span}/\text{RBW}$ .
- g. Sweep time = auto couple.
- h. Employ trace averaging (RMS) mode over a minimum of 100 traces.
- i. Use the peak marker function to determine the maximum amplitude level.

#### 4.5.5 Deviation from Test Standard

No deviation.

#### 4.5.6 EUT Operating Condition

Same as Item 4.3.6

#### 4.5.7 Test Results

##### CDD Mode

##### 2TX

##### 802.11b

TX chain	Chan.	Freq. (MHz)	PSD (dBm/10kHz)	10 log (N=2) dB	Total PSD (dBm/10kHz)	Limit (dBm/3kHz)	Pass / Fail
0	1	2412	-6.16	3.01	-3.15	7.02	Pass
	6	2437	-6.13	3.01	-3.12	7.02	Pass
	11	2462	-6.45	3.01	-3.44	7.02	Pass
3	1	2412	-6.16	3.01	-3.15	7.02	Pass
	6	2437	-5.26	3.01	-2.25	7.02	Pass
	11	2462	-6.28	3.01	-3.27	7.02	Pass

Note: Directional gain =  $10 \log[(10^{G1/20} + 10^{G2/20} + \dots + 10^{GN/20})^2/2] = 6.98\text{dBi} > 6\text{dBi}$ , so the power density limit shall be reduced to  $8-(6.98-6) = 7.02\text{dBm}$ .

##### 802.11g

TX chain	Chan.	Freq. (MHz)	PSD (dBm/10kHz)	10 log (N=2) dB	Total PSD (dBm/10kHz)	Limit (dBm/3kHz)	Pass / Fail
0	1	2412	-10.34	3.01	-7.33	7.02	Pass
	6	2437	-5.41	3.01	-2.40	7.02	Pass
	11	2462	-10.68	3.01	-7.67	7.02	Pass
3	1	2412	-8.90	3.01	-5.89	7.02	Pass
	6	2437	-4.77	3.01	-1.76	7.02	Pass
	11	2462	-9.37	3.01	-6.36	7.02	Pass

Note: Directional gain =  $10 \log[(10^{G1/20} + 10^{G2/20} + \dots + 10^{GN/20})^2/2] = 6.98\text{dBi} > 6\text{dBi}$ , so the power density limit shall be reduced to  $8-(6.98-6) = 7.02\text{dBm}$ .

802.11n (VHT20)

TX chain	Chan.	Freq. (MHz)	PSD (dBm/10kHz)	10 log (N=2) dB	Total PSD (dBm/10kHz)	Limit (dBm/3kHz)	Pass / Fail
0	1	2412	-11.81	3.01	-8.80	7.02	Pass
	6	2437	-7.12	3.01	-4.11	7.02	Pass
	11	2462	-13.41	3.01	-10.40	7.02	Pass
3	1	2412	-11.11	3.01	-8.10	7.02	Pass
	6	2437	-5.83	3.01	-2.82	7.02	Pass
	11	2462	-12.64	3.01	-9.63	7.02	Pass

Note: Directional gain =  $10 \log[(10^{G1/20} + 10^{G2/20} + \dots + 10^{GN/20})^2/2]$  = 6.98dBi > 6dBi, so the power density limit shall be reduced to  $8-(6.98-6) = 7.02$ dBm.

### Spectrum Plot of Worst Value

802.11b

802.11g

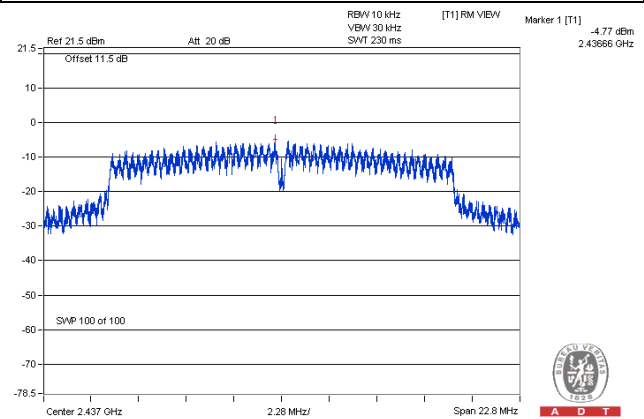
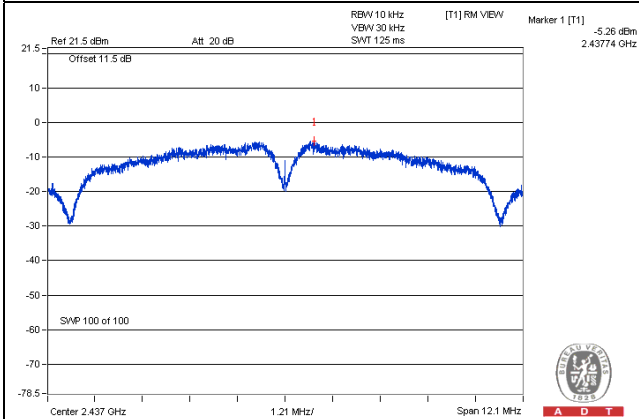

802.11n (VHT20)

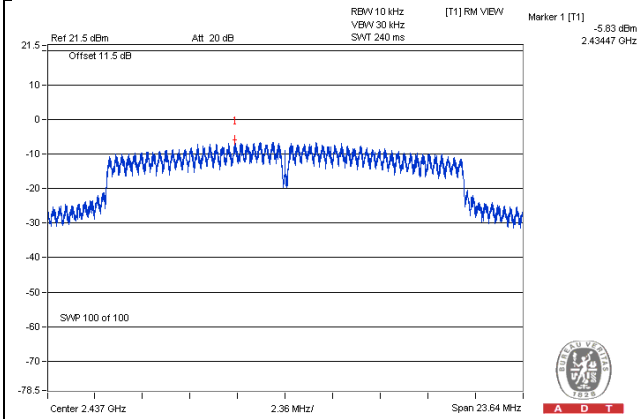

**CDD Mode**

**4TX**

**802.11b**

TX chain	Chan.	Freq. (MHz)	PSD (dBm/10kHz)	10 log (N=4) dB	Total PSD (dBm/10kHz)	Limit (dBm/3kHz)	Pass / Fail
0	1	2412	-7.63	6.02	-1.61	4.20	Pass
	6	2437	-7.21	6.02	-1.19	4.20	Pass
	11	2462	-7.22	6.02	-1.20	4.20	Pass
1	1	2412	-7.97	6.02	-1.95	4.20	Pass
	6	2437	-8.06	6.02	-2.04	4.20	Pass
	11	2462	-7.41	6.02	-1.39	4.20	Pass
2	1	2412	-8.72	6.02	-2.70	4.20	Pass
	6	2437	-7.92	6.02	-1.90	4.20	Pass
	11	2462	-7.46	6.02	-1.44	4.20	Pass
3	1	2412	-8.01	6.02	-1.99	4.20	Pass
	6	2437	-8.05	6.02	-2.03	4.20	Pass
	11	2462	-7.06	6.02	-1.04	4.20	Pass

Note: Directional gain =  $10 \log[(10^{G1/20} + 10^{G2/20} + \dots + 10^{GN/20})^2/4] = 9.8\text{dBi} > 6\text{dBi}$ , so the power density limit shall be reduced to  $8-(9.8-6) = 4.20\text{dBm}$ .

802.11g

TX chain	Chan.	Freq. (MHz)	PSD (dBm/10kHz)	10 log (N=4) dB	Total PSD (dBm/10kHz)	Limit (dBm/3kHz)	Pass / Fail
0	1	2412	-10.55	6.02	-4.53	4.20	Pass
	6	2437	-5.76	6.02	0.26	4.20	Pass
	11	2462	-11.32	6.02	-5.30	4.20	Pass
1	1	2412	-10.87	6.02	-4.85	4.20	Pass
	6	2437	-6.37	6.02	-0.35	4.20	Pass
	11	2462	-11.88	6.02	-5.86	4.20	Pass
2	1	2412	-10.93	6.02	-4.91	4.20	Pass
	6	2437	-6.51	6.02	-0.49	4.20	Pass
	11	2462	-12.24	6.02	-6.22	4.20	Pass
3	1	2412	-11.57	6.02	-5.55	4.20	Pass
	6	2437	-6.90	6.02	-0.88	4.20	Pass
	11	2462	-12.00	6.02	-5.98	4.20	Pass

Note: Directional gain =  $10 \log[(10^{G1/20} + 10^{G2/20} + \dots + 10^{GN/20})^2/4] = 9.8\text{dBi} > 6\text{dBi}$ , so the power density limit shall be reduced to  $8-(9.8-6) = 4.20\text{dBm}$ .

802.11n (VHT20)

TX chain	Chan.	Freq. (MHz)	PSD (dBm/10kHz)	10 log (N=4) dB	Total PSD (dBm/10kHz)	Limit (dBm/3kHz)	Pass / Fail
0	1	2412	-12.01	6.02	-5.99	4.20	Pass
	6	2437	-6.82	6.02	-0.80	4.20	Pass
	11	2462	-12.37	6.02	-6.35	4.20	Pass
1	1	2412	-12.54	6.02	-6.52	4.20	Pass
	6	2437	-7.53	6.02	-1.51	4.20	Pass
	11	2462	-13.20	6.02	-7.18	4.20	Pass
2	1	2412	-11.72	6.02	-5.70	4.20	Pass
	6	2437	-7.69	6.02	-1.67	4.20	Pass
	11	2462	-13.23	6.02	-7.21	4.20	Pass
3	1	2412	-12.57	6.02	-6.55	4.20	Pass
	6	2437	-8.01	6.02	-1.99	4.20	Pass
	11	2462	-13.20	6.02	-7.18	4.20	Pass

Note: Directional gain =  $10 \log[(10^{G1/20} + 10^{G2/20} + \dots + 10^{GN/20})^2/4] = 9.8\text{dBi} > 6\text{dBi}$ , so the power density limit shall be reduced to  $8 - (9.8 - 6) = 4.20\text{dBm}$ .

### Spectrum Plot of Worst Value

802.11b

802.11g

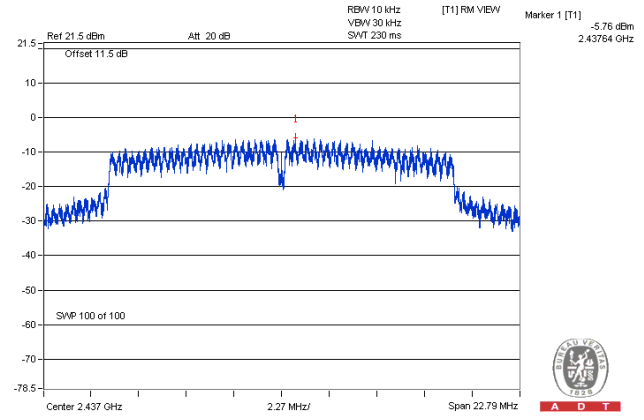
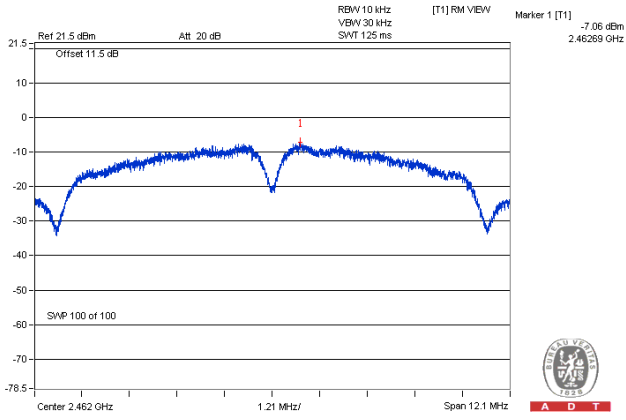

802.11n (VHT20)

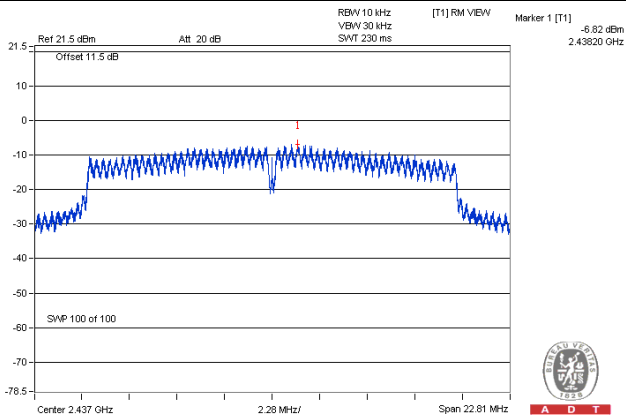



## 4.6 Conducted Out of Band Emission Measurement

### 4.6.1 Limits of Conducted Out of Band Emission Measurement

Below 30dB of the highest emission level of operating band (in 100kHz Resolution Bandwidth).

### 4.6.2 Test Setup

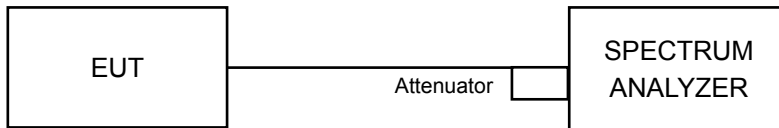

### 4.6.3 Test Instruments

Refer to section 4.1.2 to get information of above instrument.

### 4.6.4 Test Procedure

#### MEASUREMENT PROCEDURE REF

- Set the RBW = 100 kHz.
- Set the VBW  $\geq$  300 kHz.
- Detector = average.
- Sweep time = auto couple.
- Trace mode = max hold.
- Allow trace to fully stabilize.
- Use the peak marker function to determine the maximum power level in any 100 kHz band segment within the fundamental EBW.

#### MEASUREMENT PROCEDURE OOB

- Set RBW = 100 kHz.
- Set VBW  $\geq$  300 kHz.
- Ensure that the number of measurement points  $\geq$  span/RBW
- According to measurement points to set differ measurement span.
- Detector = average.
- Trace Mode = max hold.
- Sweep = auto couple.

#### **4.6.5 Deviation from Test Standard**

No deviation.

#### **4.6.6 EUT Operating Condition**

Same as Item 4.3.6

#### **4.6.7 Test Results**

The spectrum plots are attached on the following pages. D1 line indicates the highest level, and D2 line indicates the 30dB offset below D1. It shows compliance with the requirement.

**CDD Mode: 2TX**  
802.11b

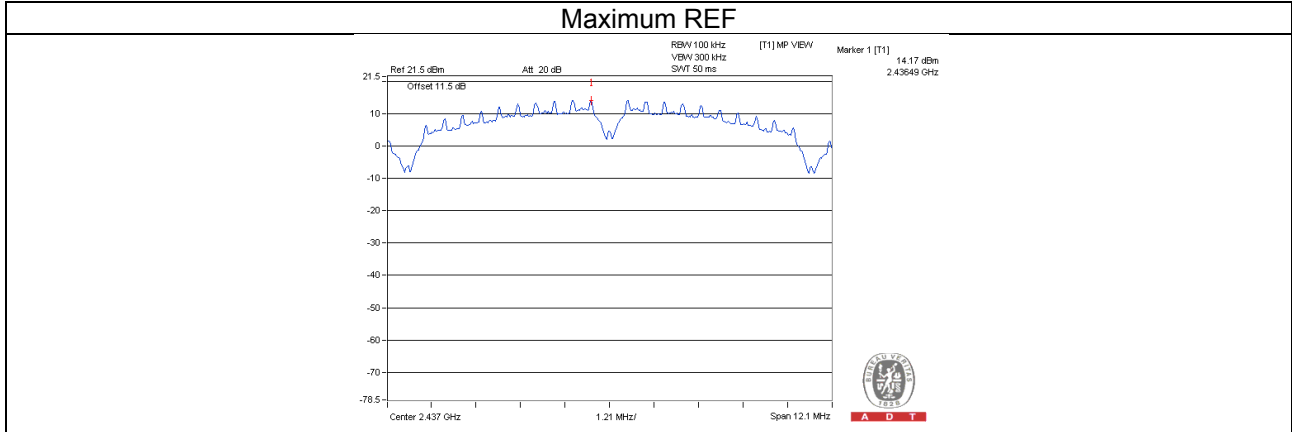

802.11b\_Chain 0

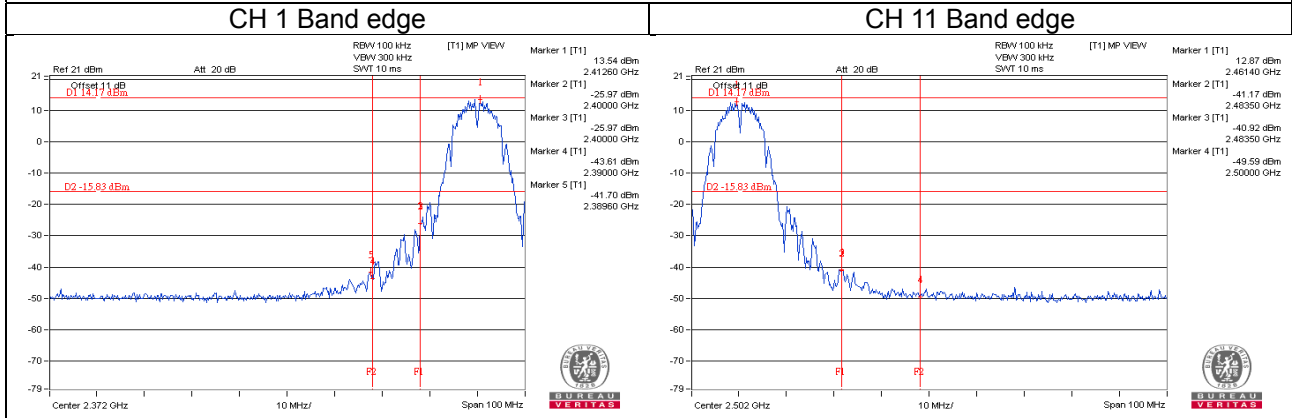
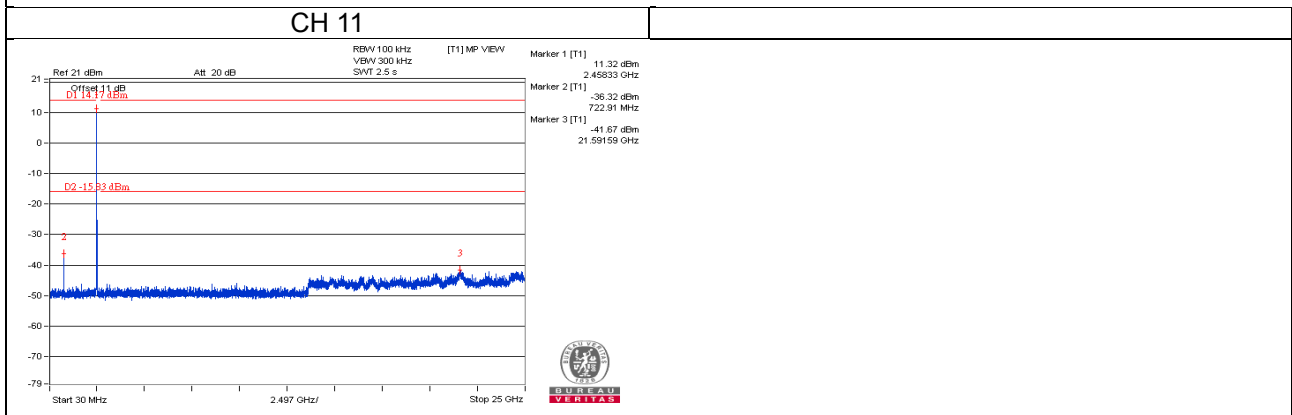
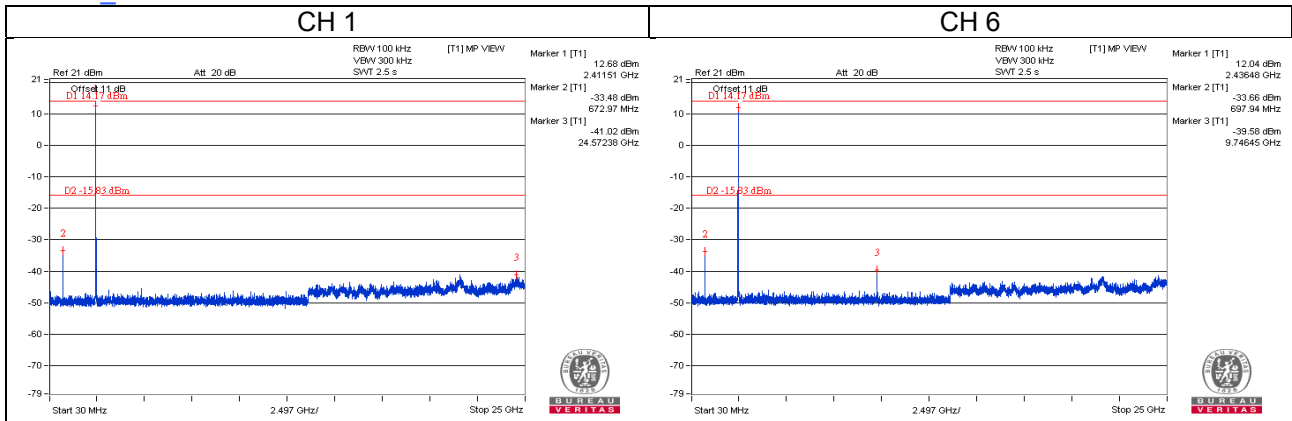

### 802.11b\_Chain 3

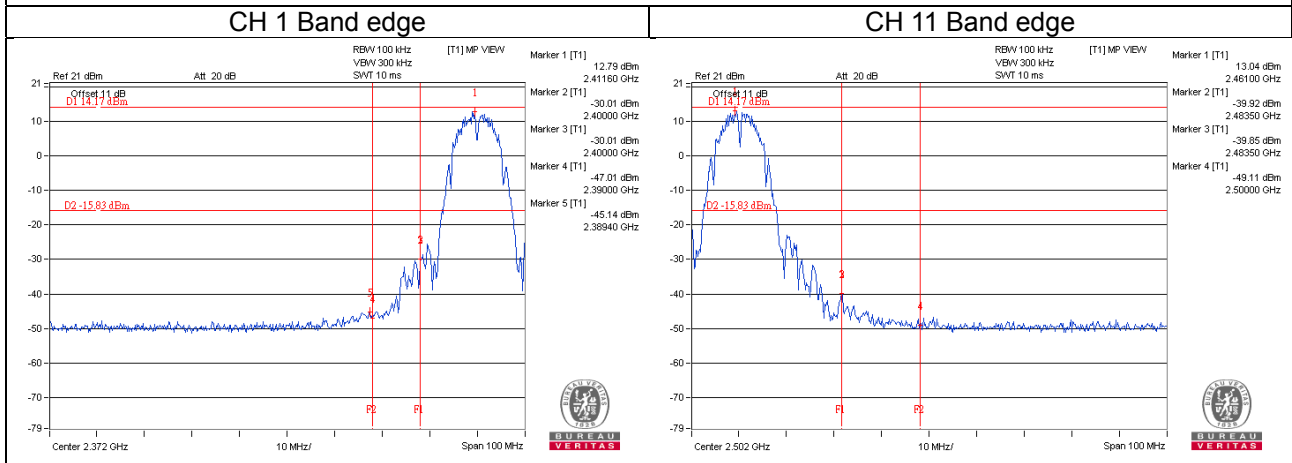
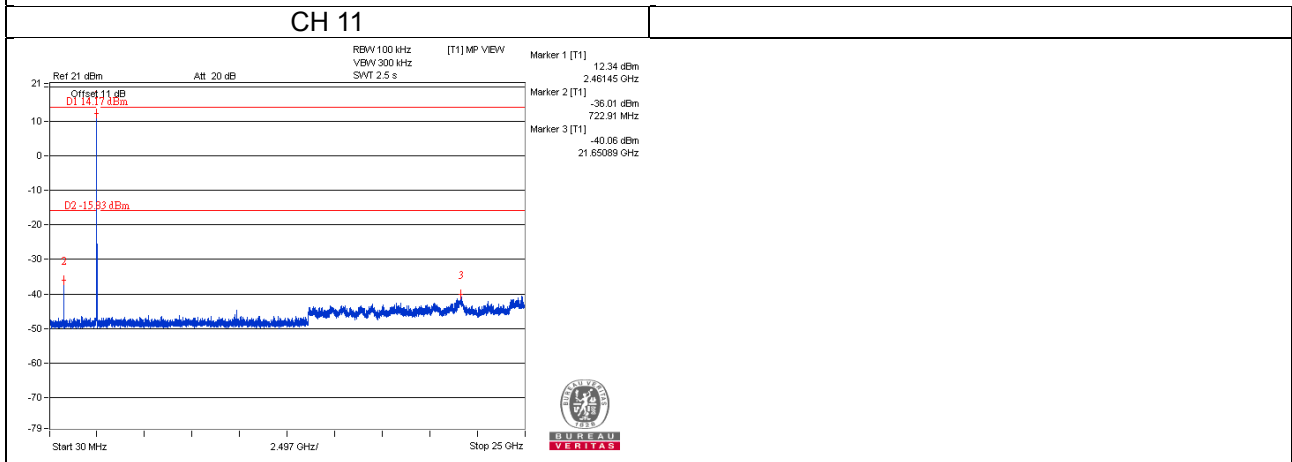
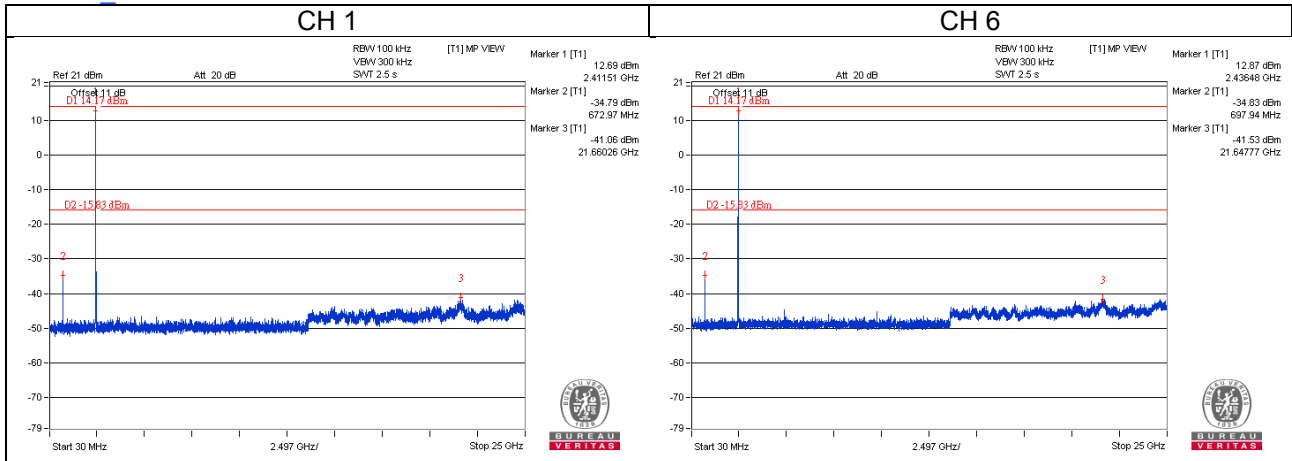

802.11g

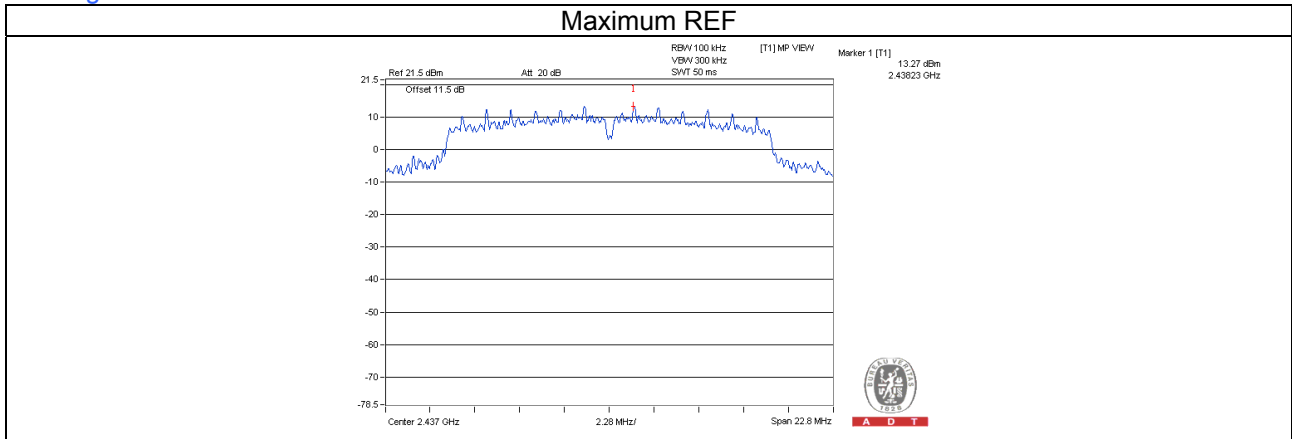

802.11g\_Chain 0

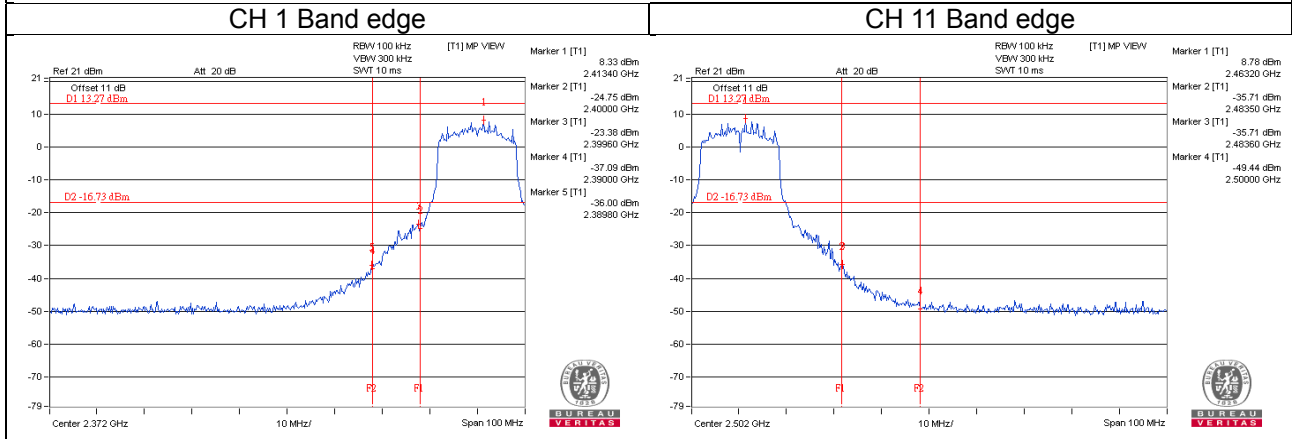
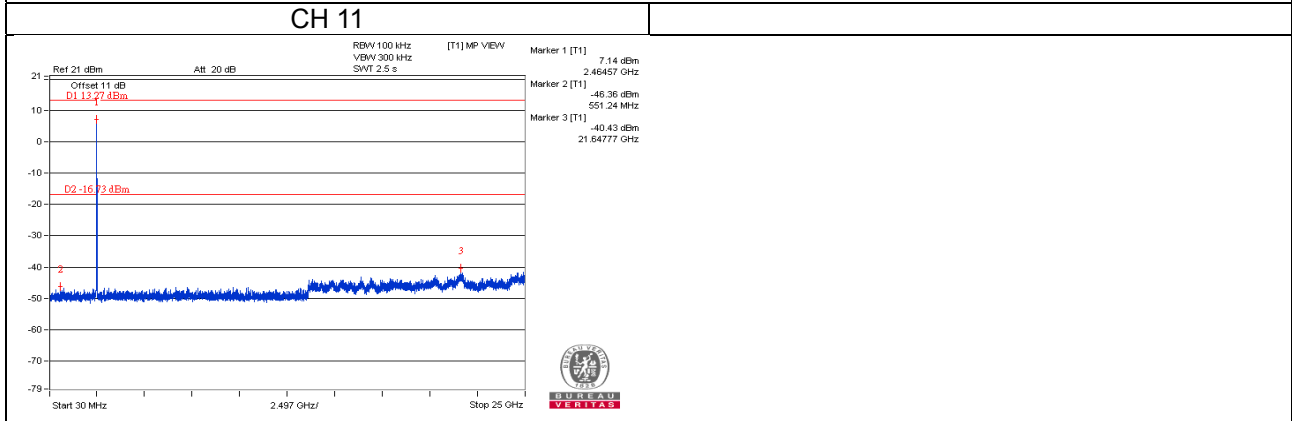
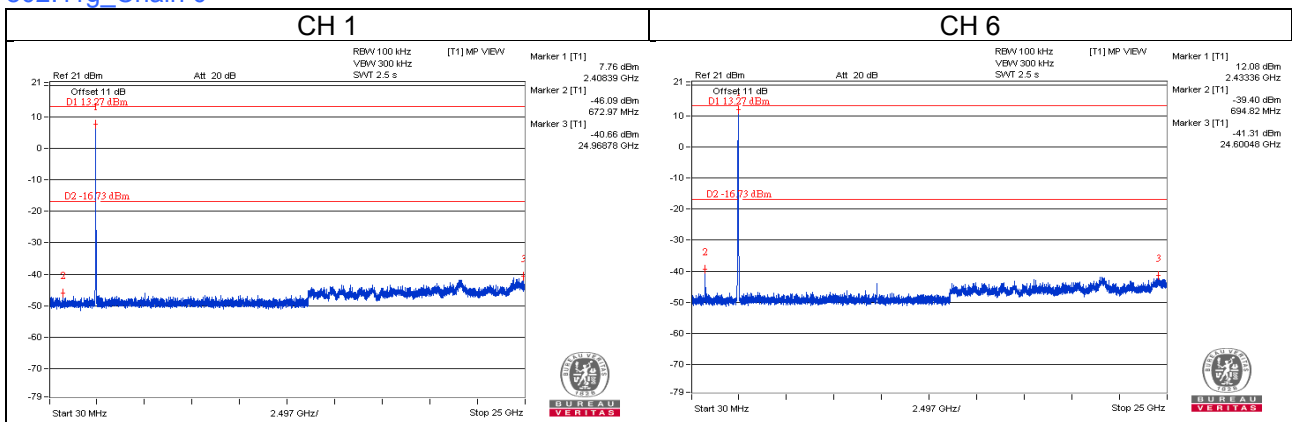

# 802.11g\_Chain 3

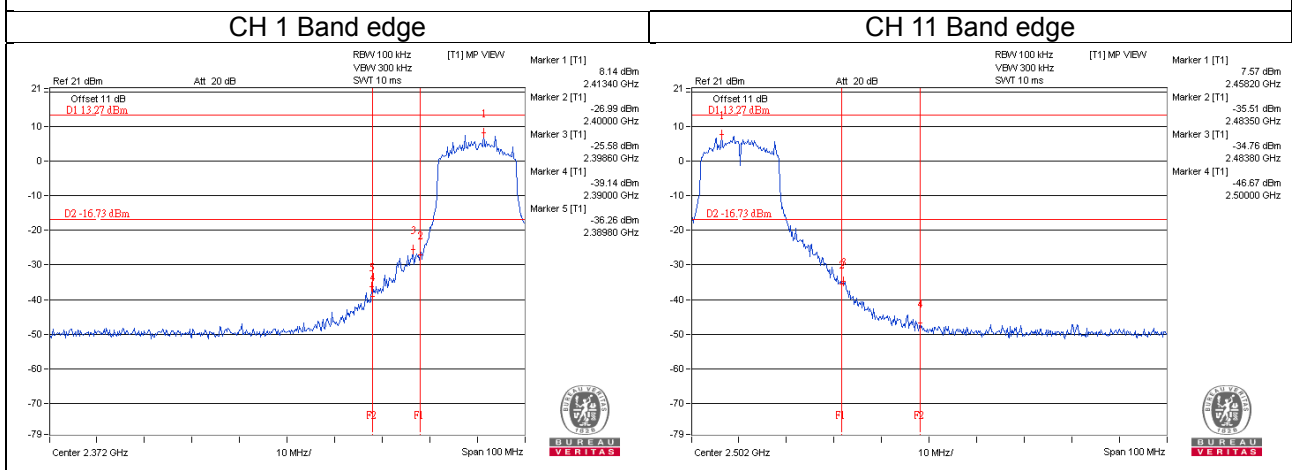
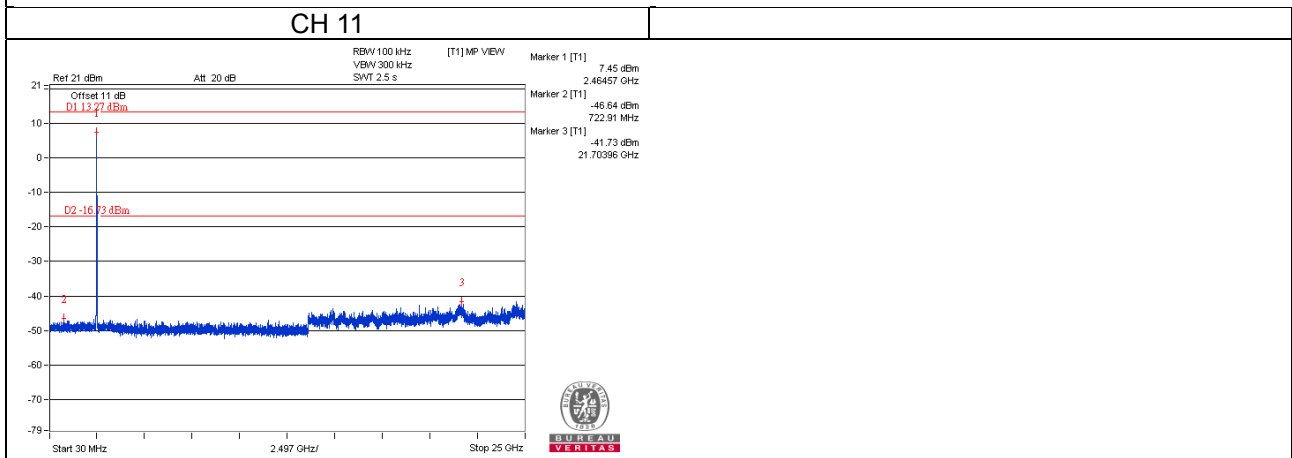
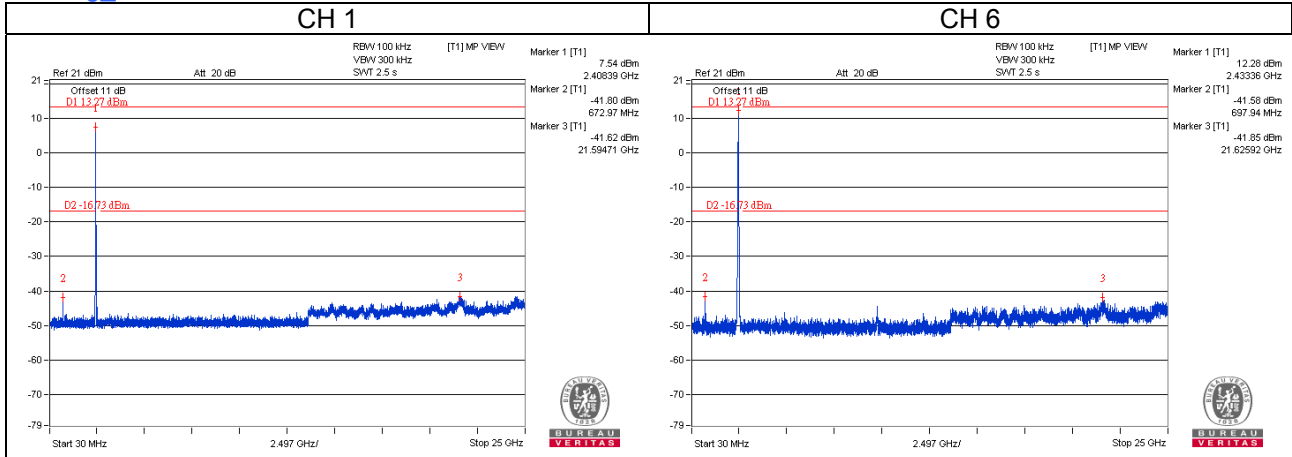

### 802.11n (VHT20)

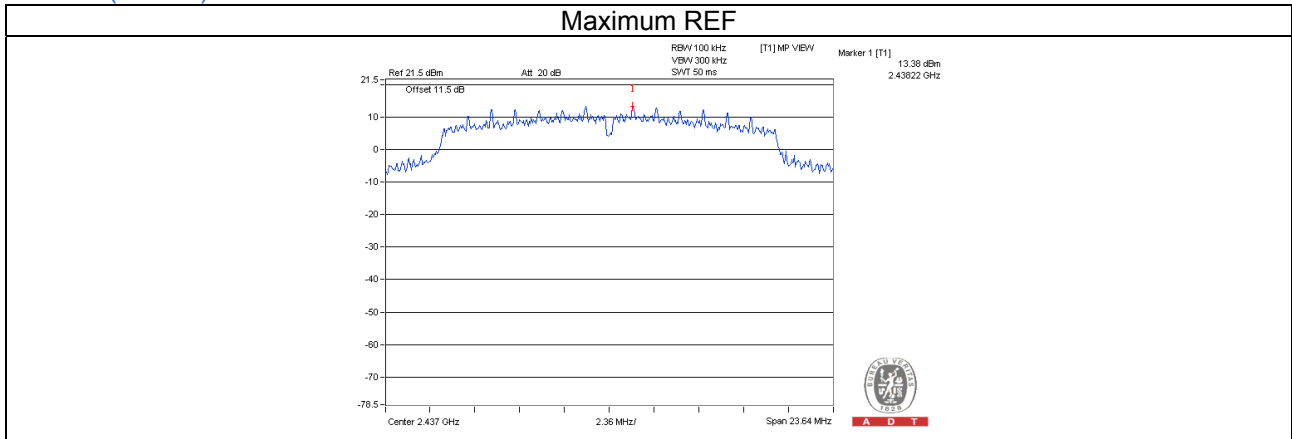

### 802.11n (VHT20)\_Chain 0

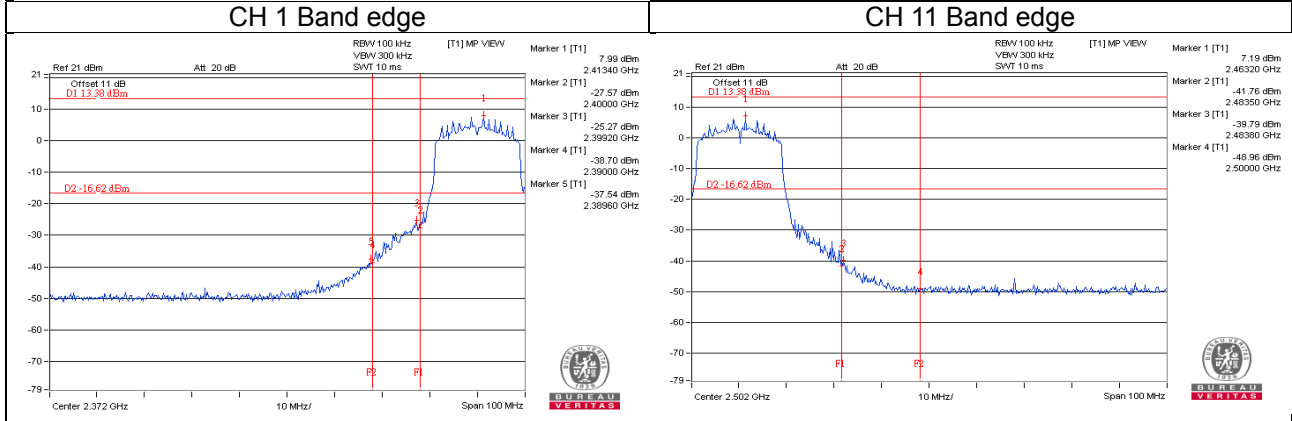
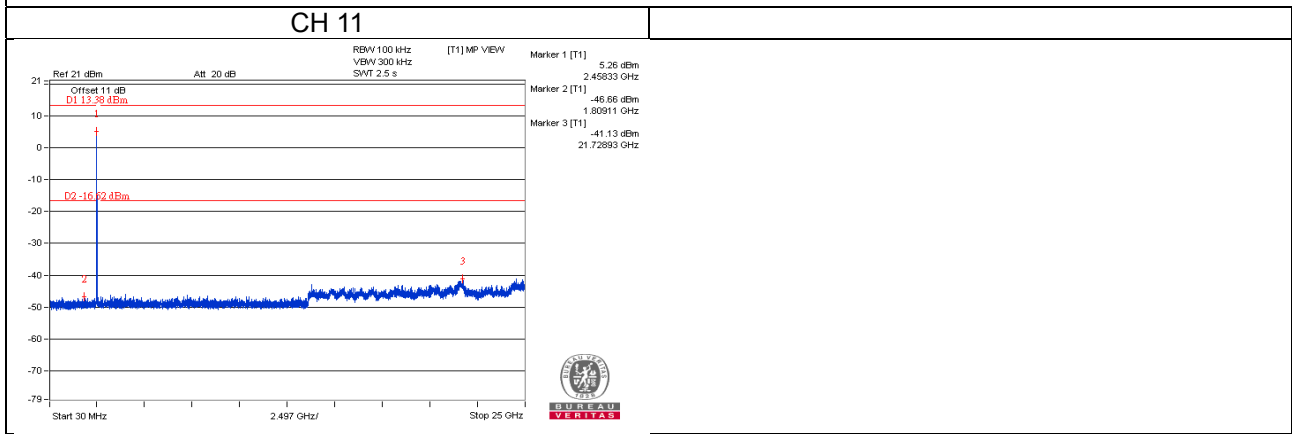
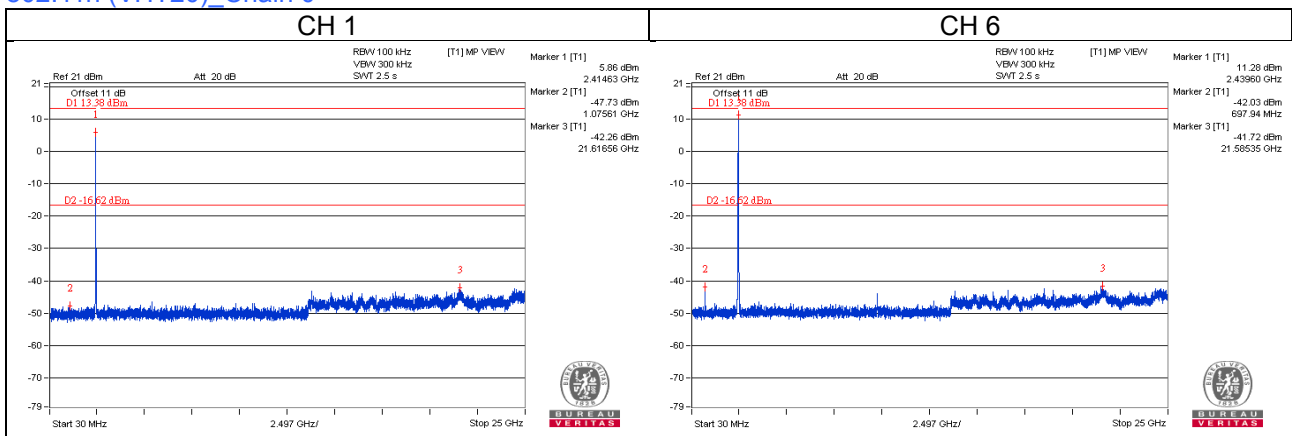

# 802.11n (VHT20)\_Chain 3

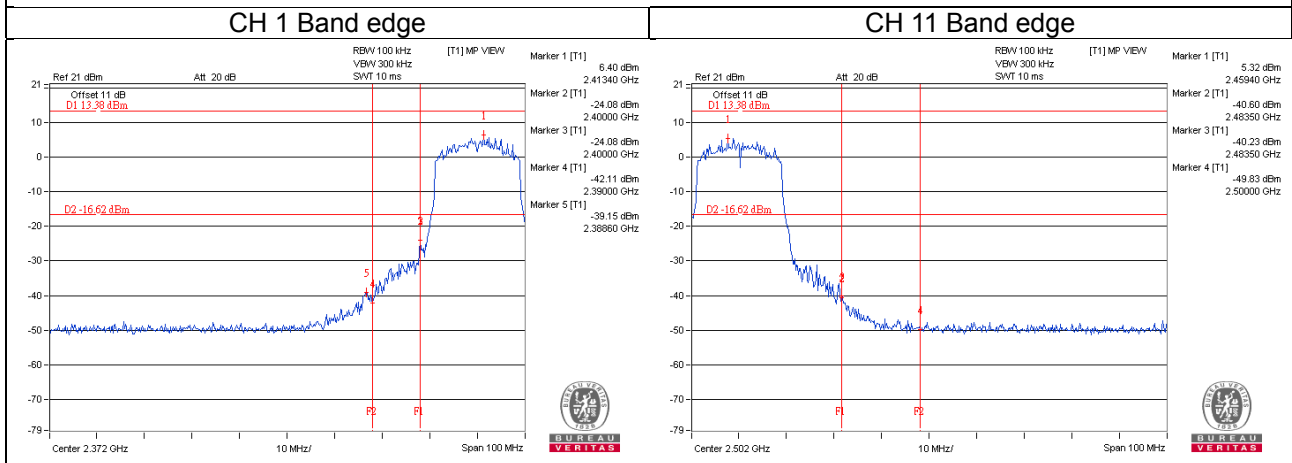
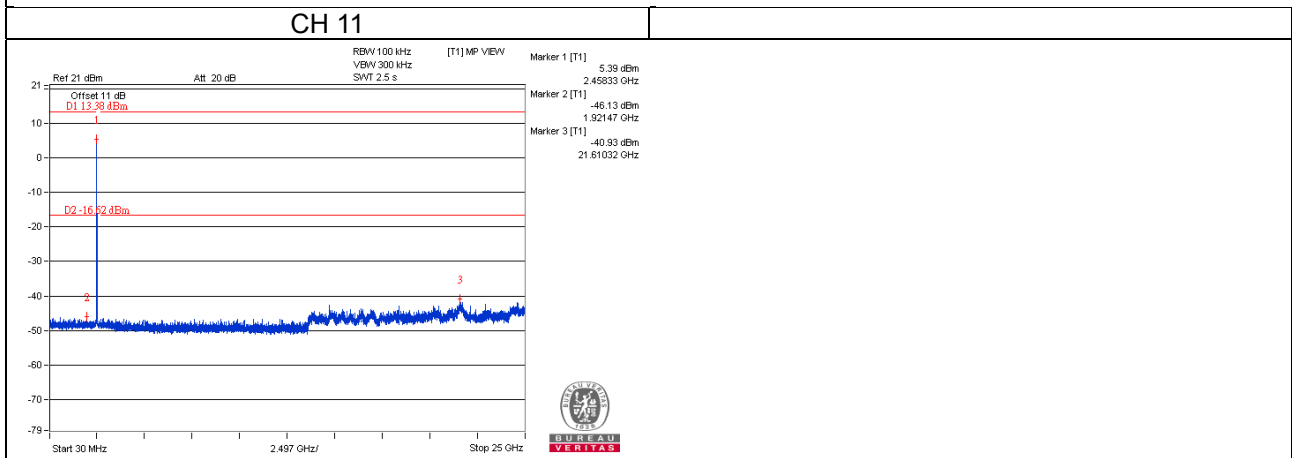
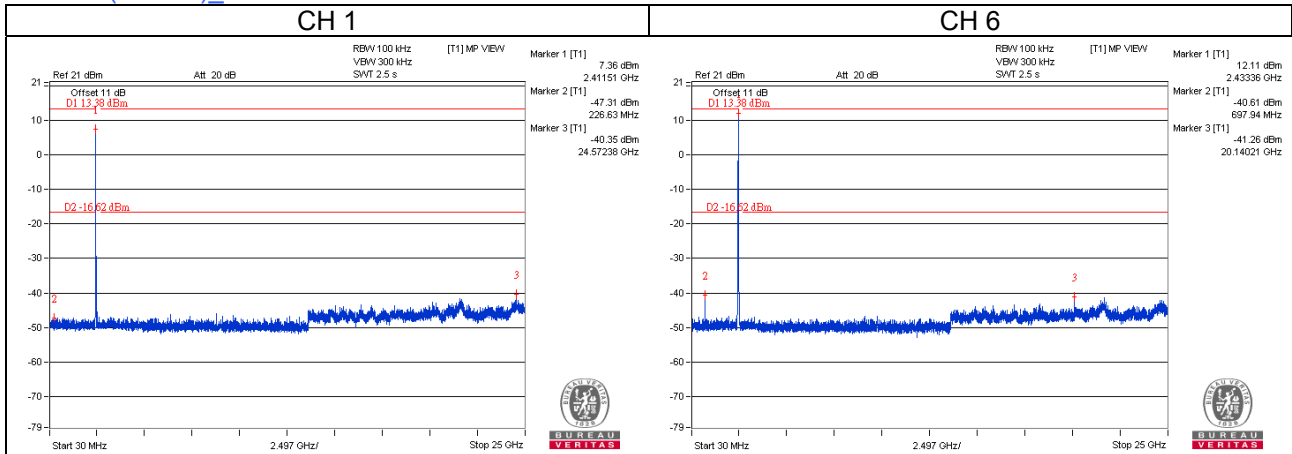



**CDD Mode: 4TX**  
802.11b

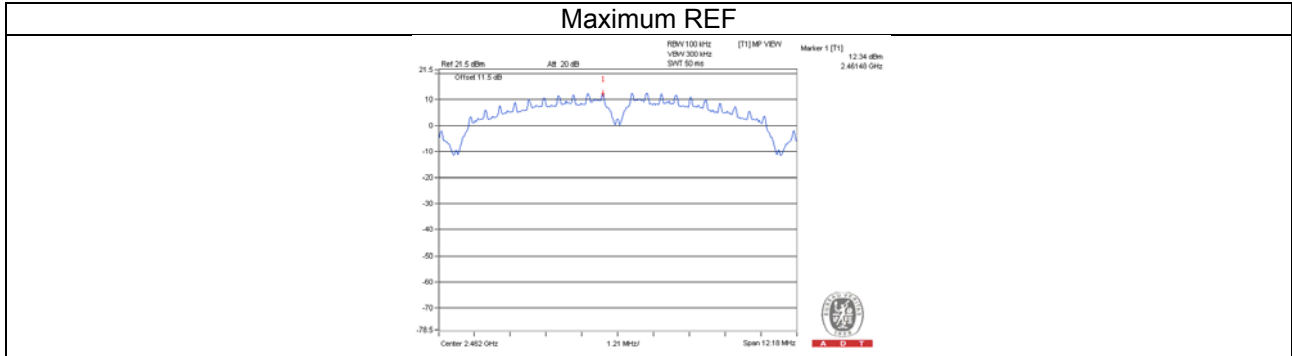

802.11b\_Chain 0

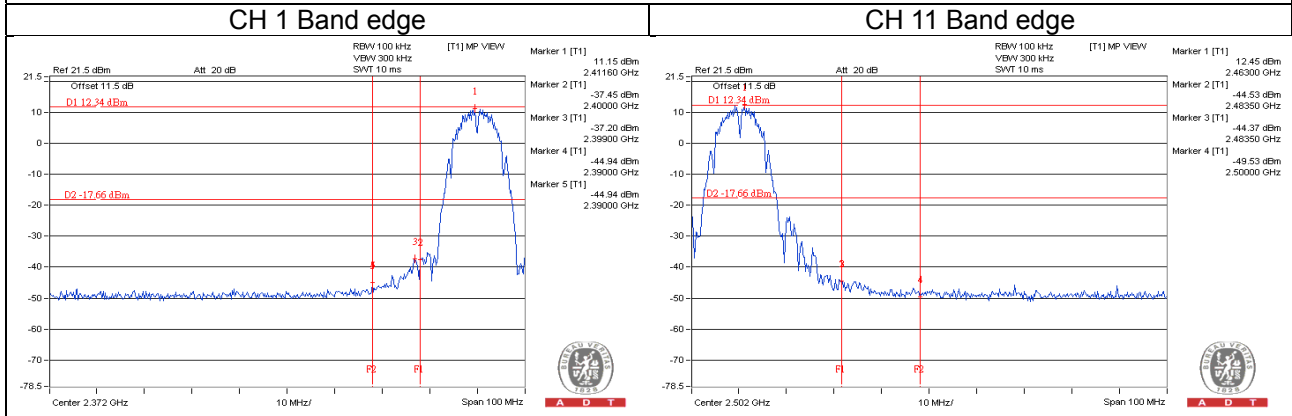
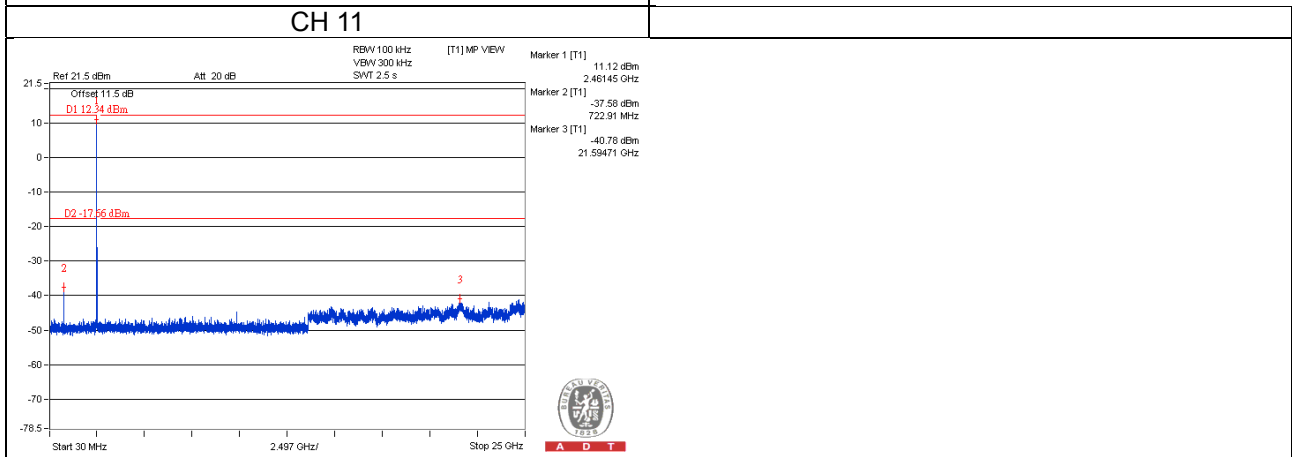
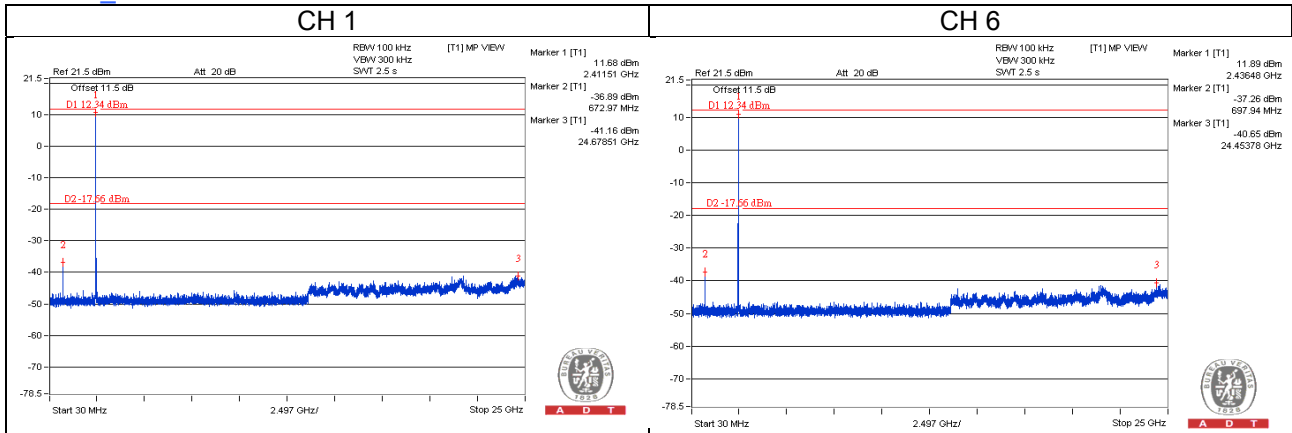

# 802.11b\_Chain 1

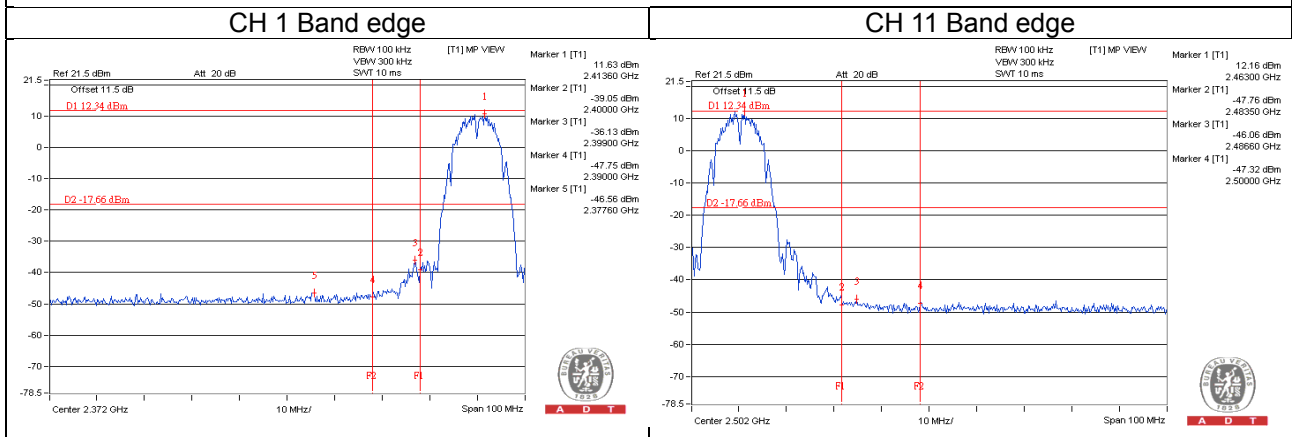
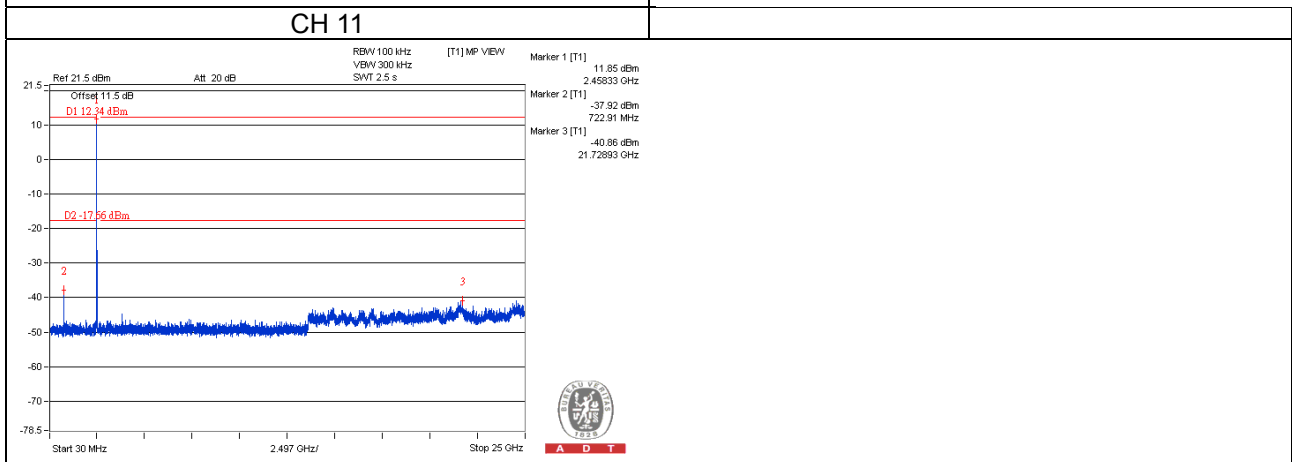
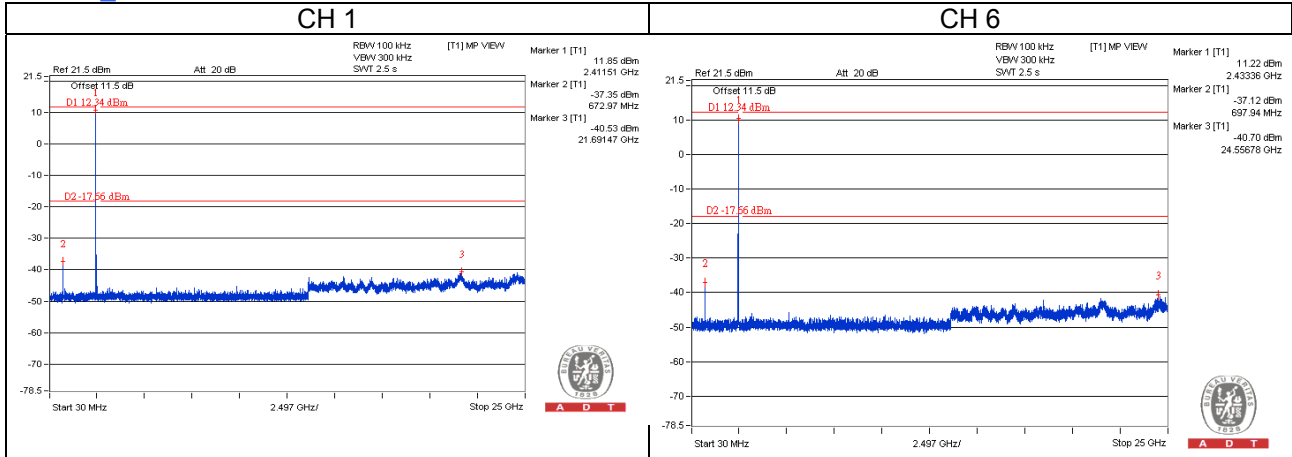

# 802.11b\_Chain 2

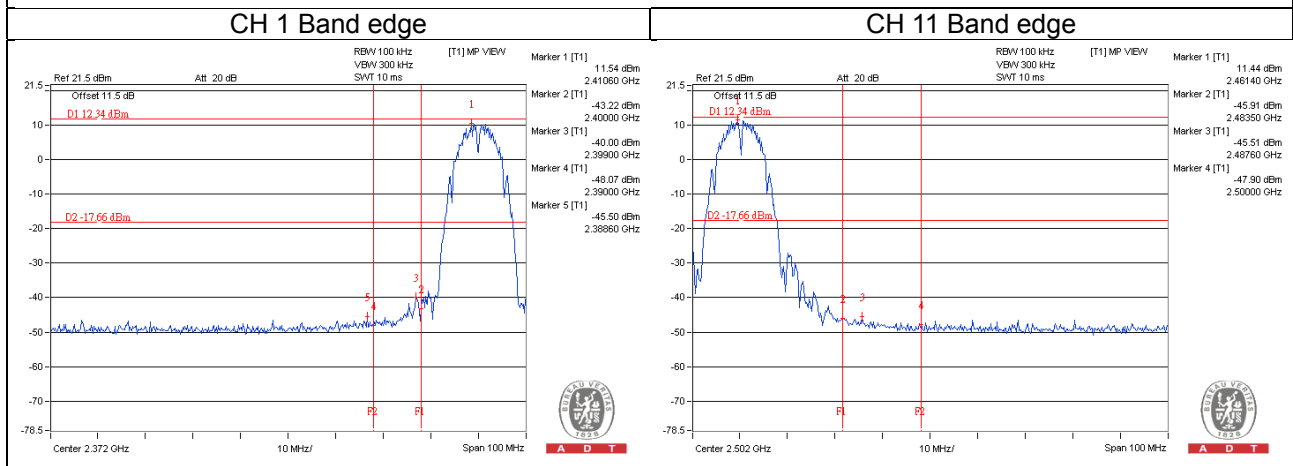
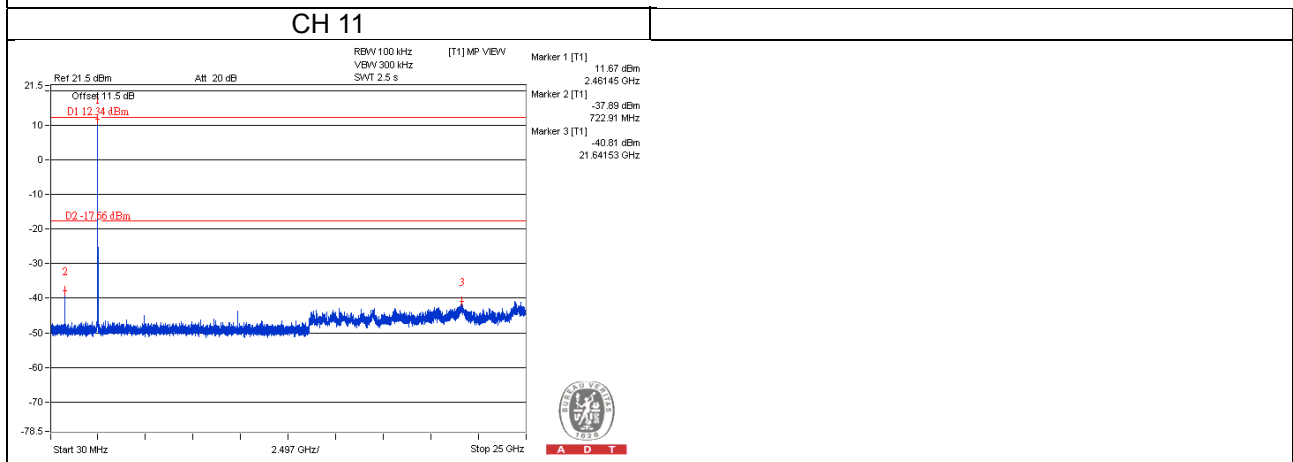
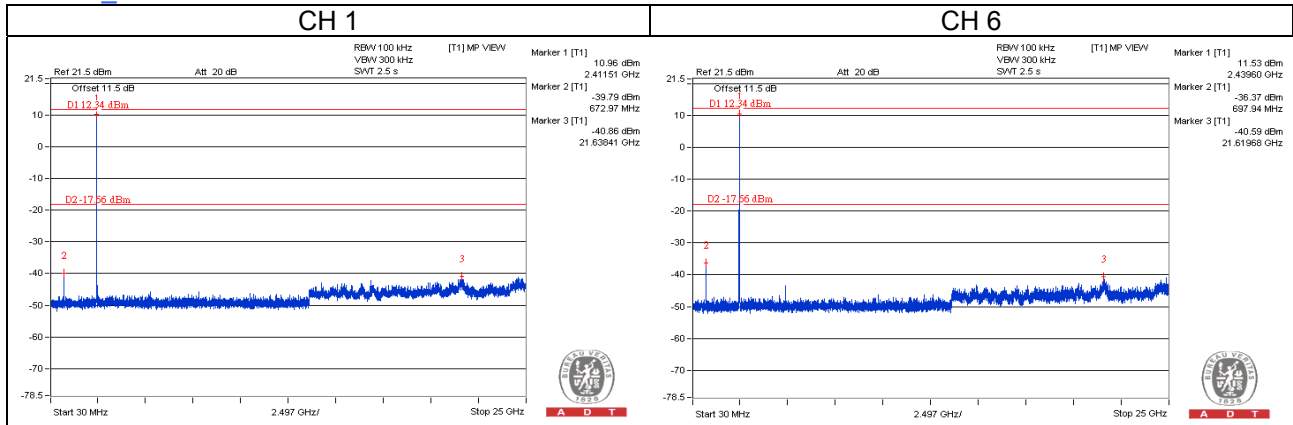

### 802.11b\_Chain 3

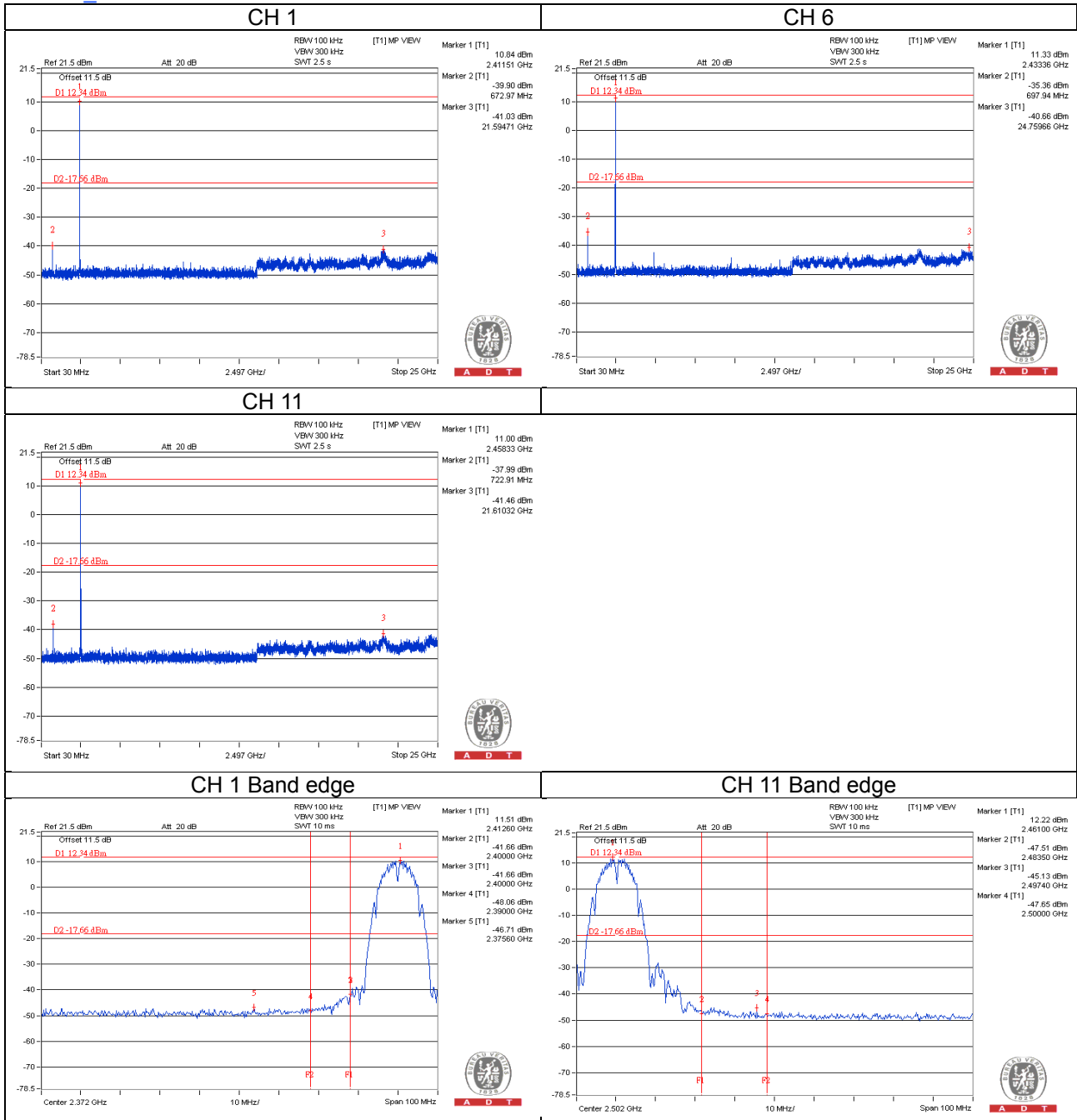

802.11g\_Chain 0

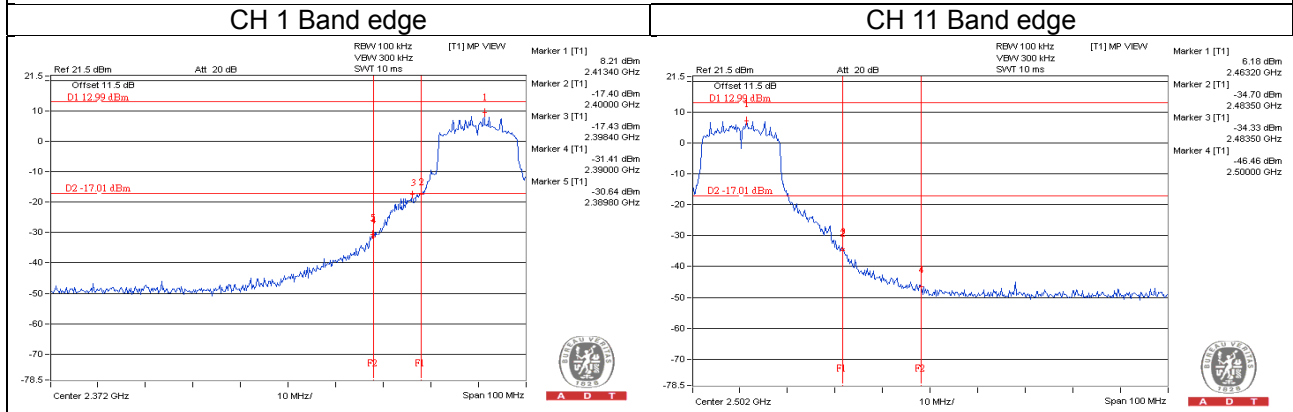
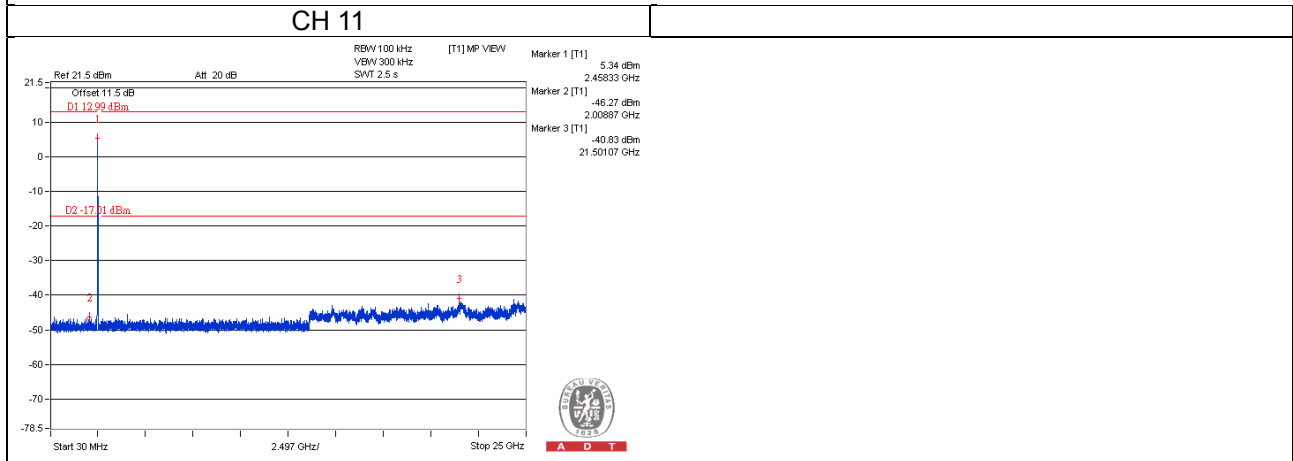
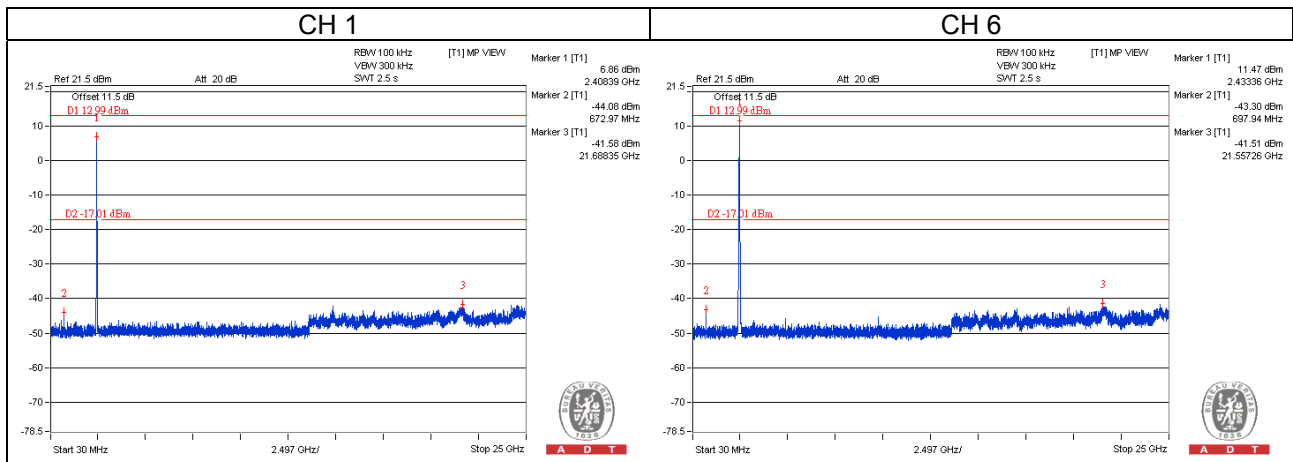
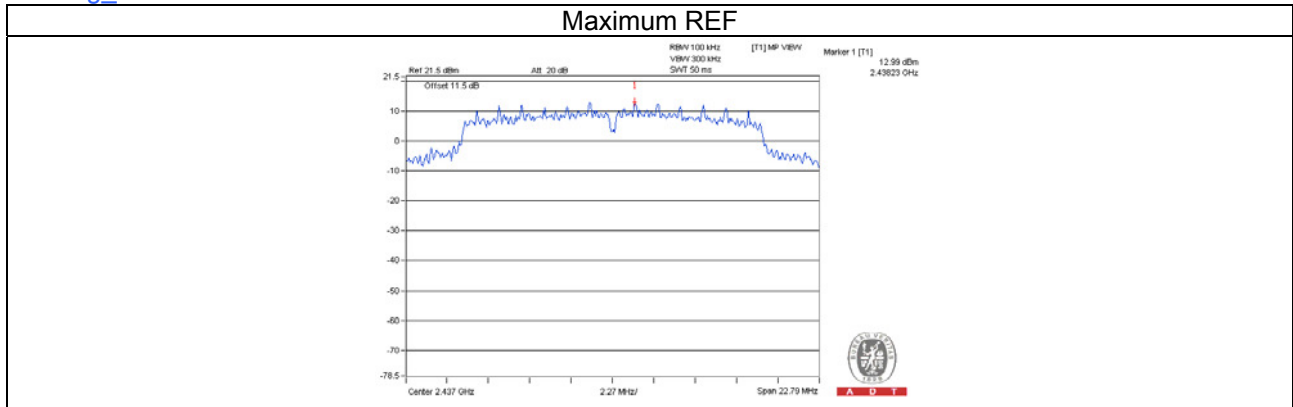

# 802.11g\_Chain 1

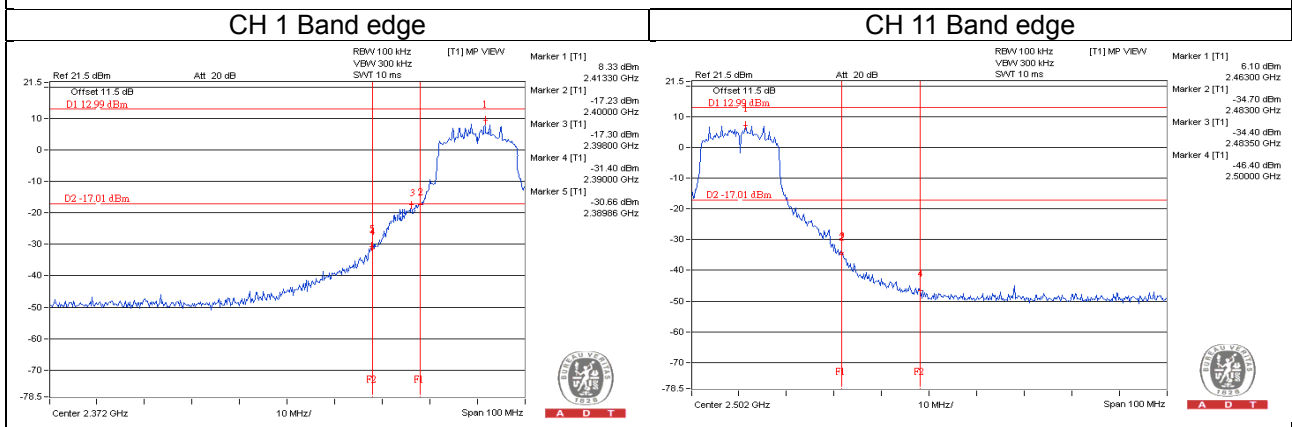
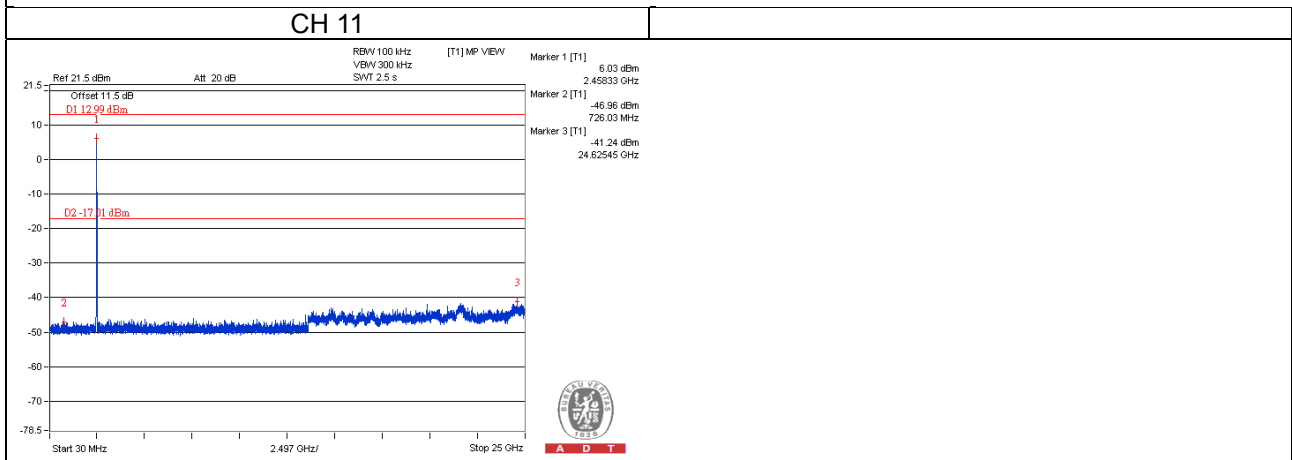
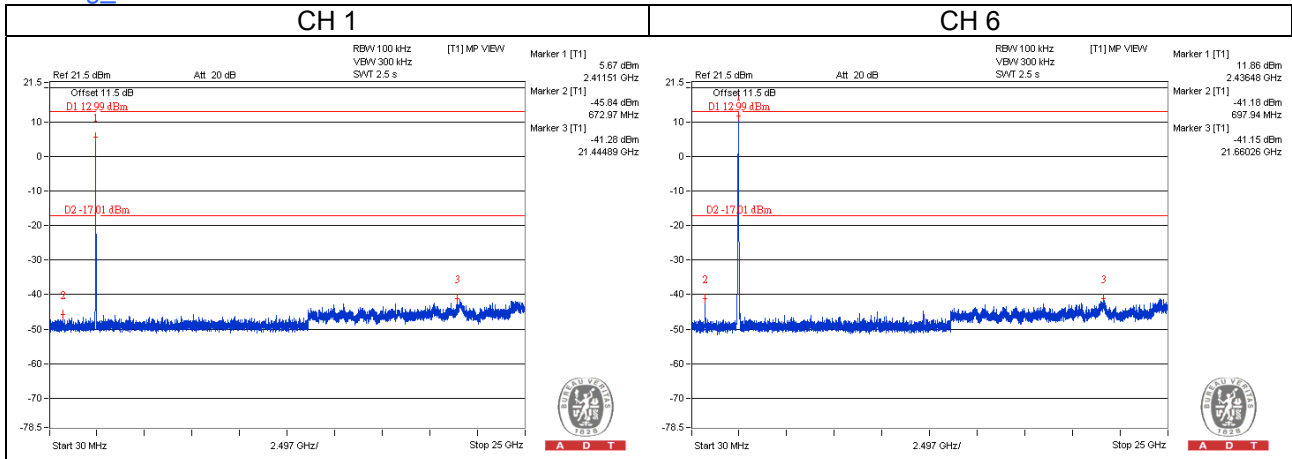

# 802.11g\_Chain 2

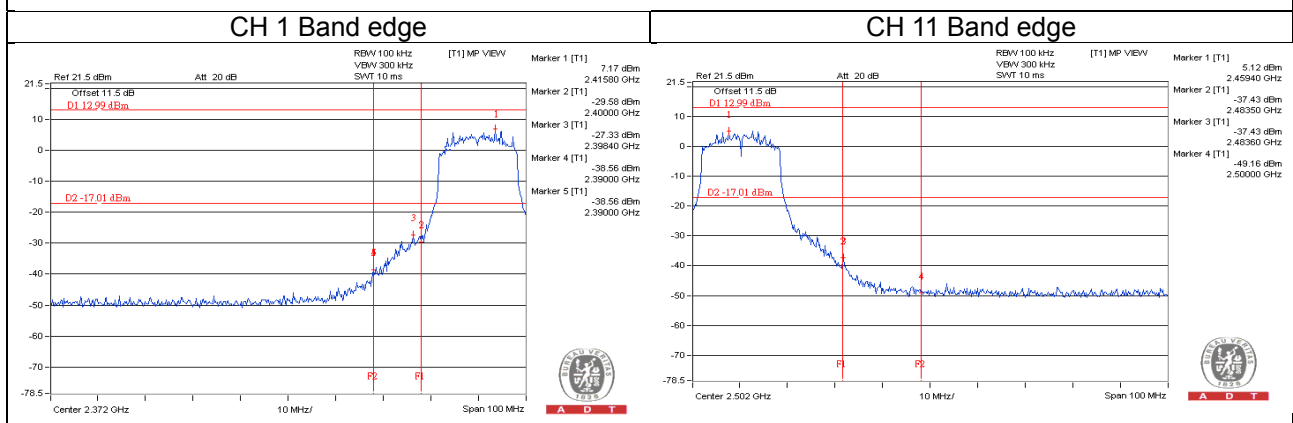
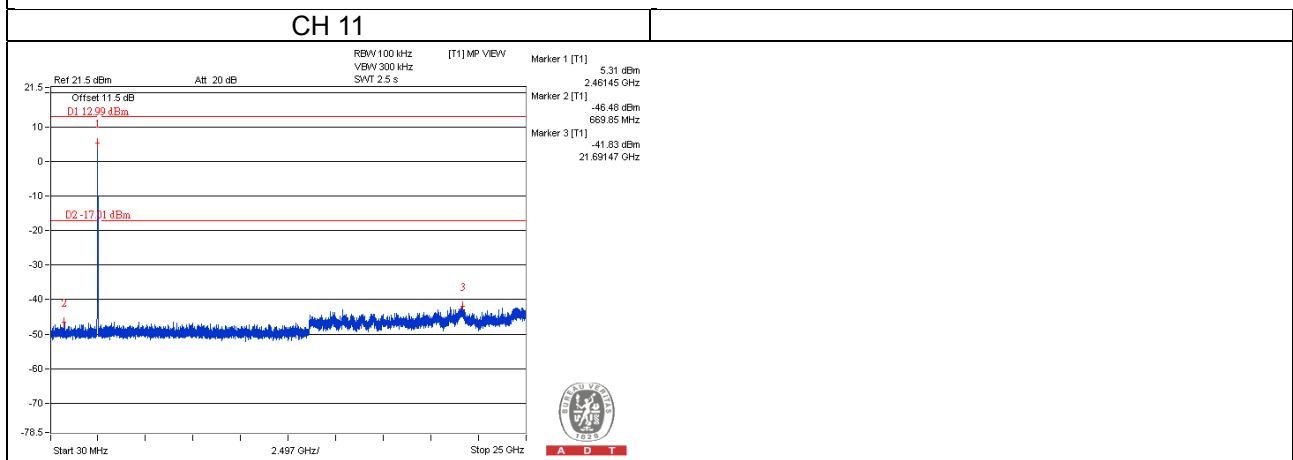
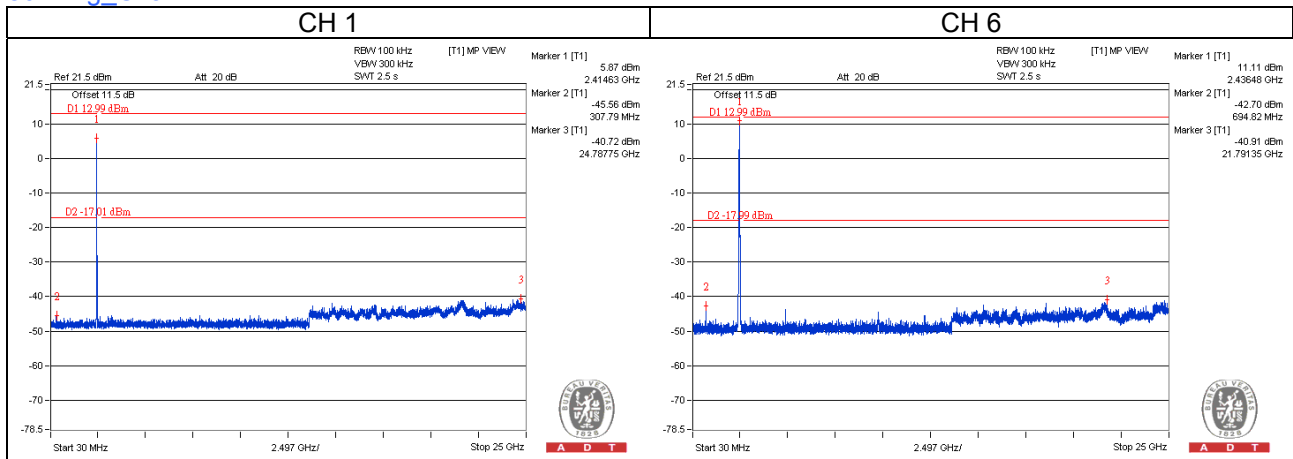

# 802.11g\_Chain 3

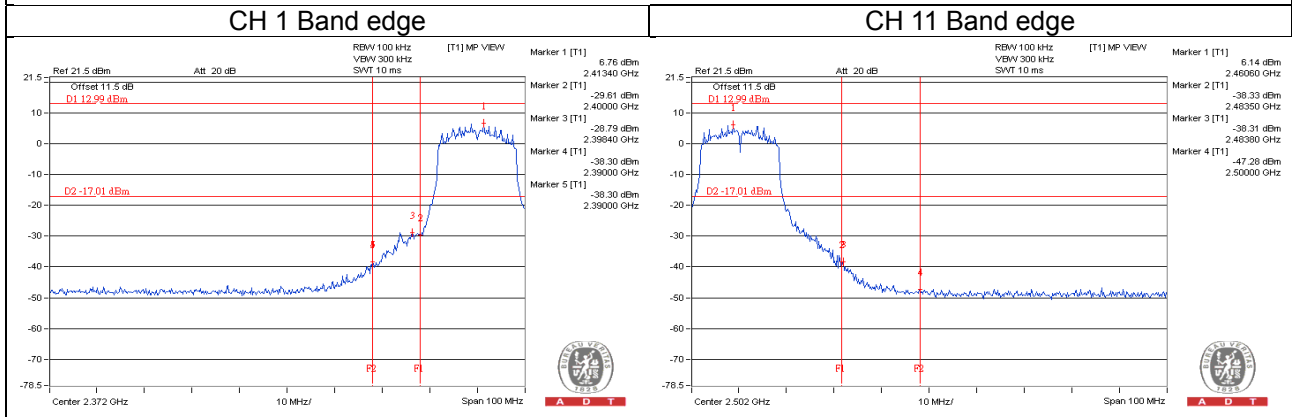
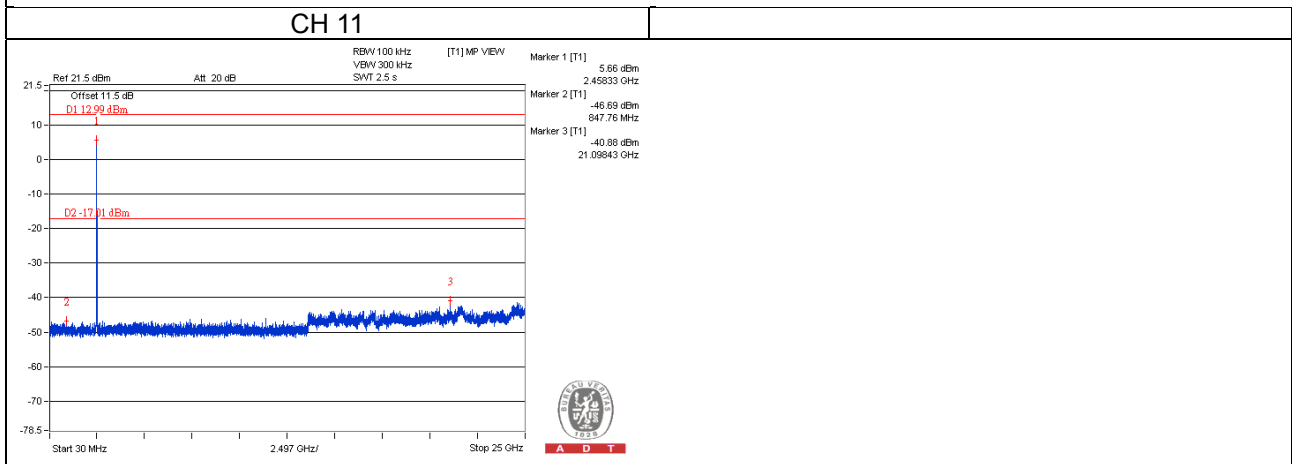
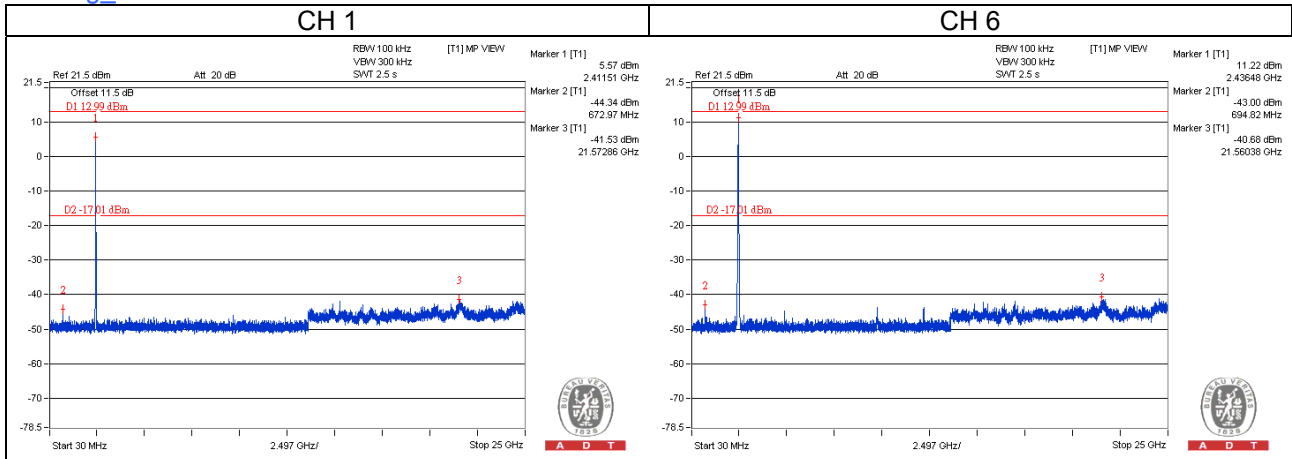



### 802.11n (VHT20)\_Chain 0

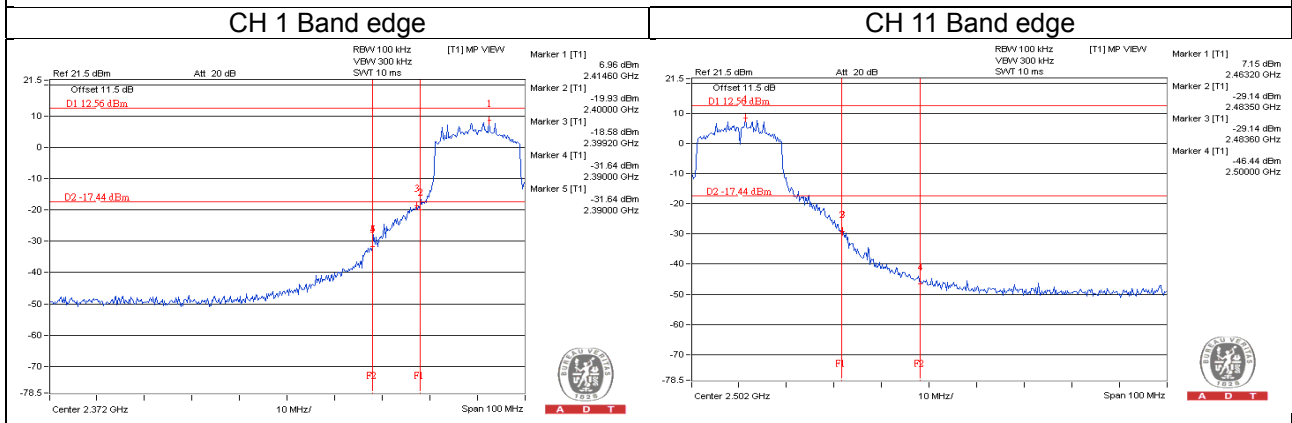
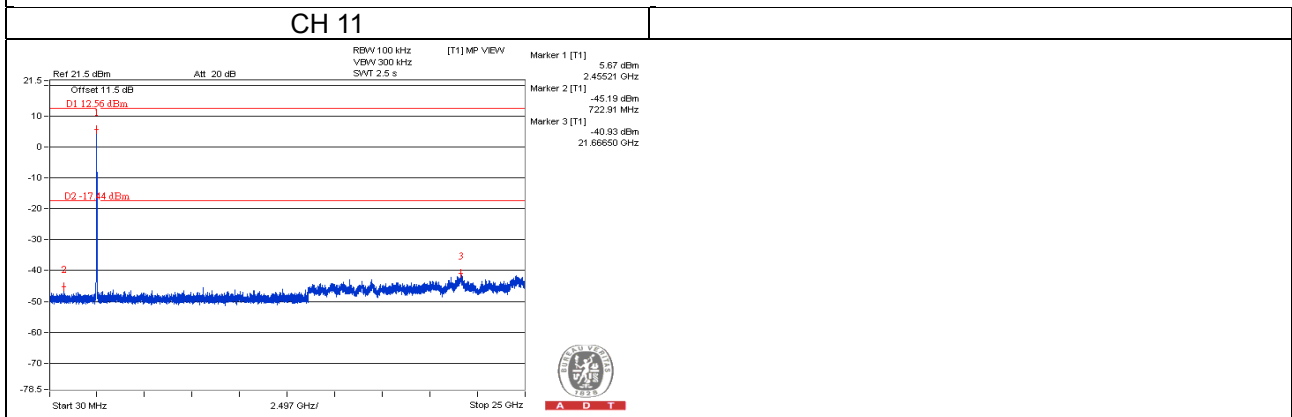
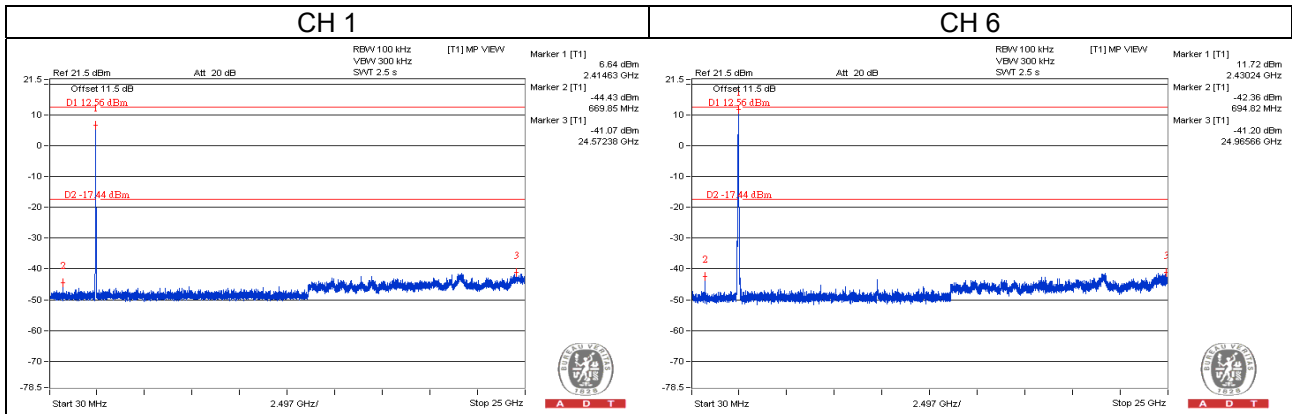
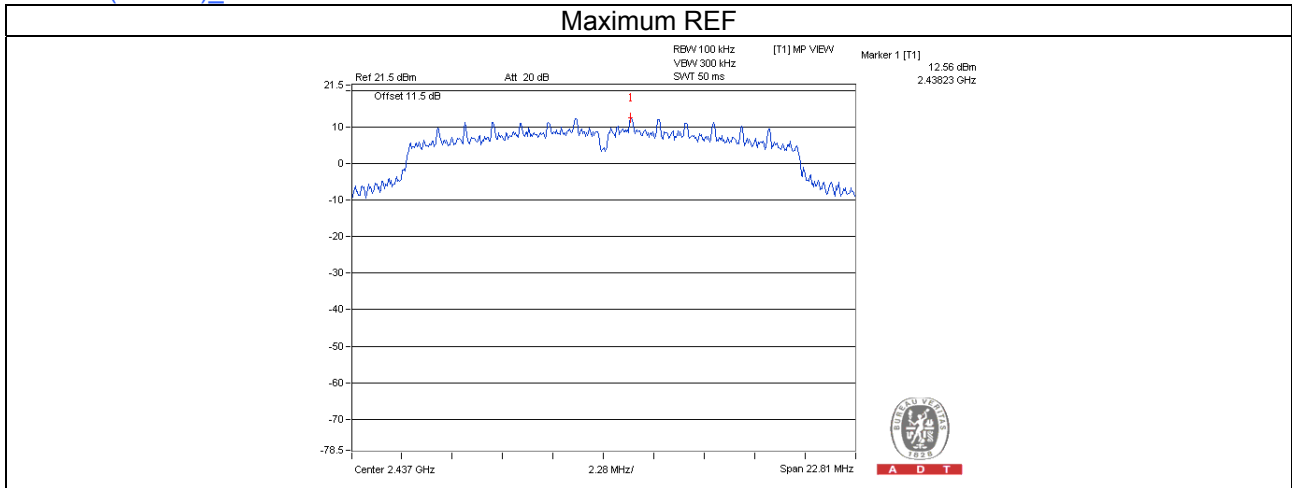

### 802.11n (VHT20)\_Chain 1

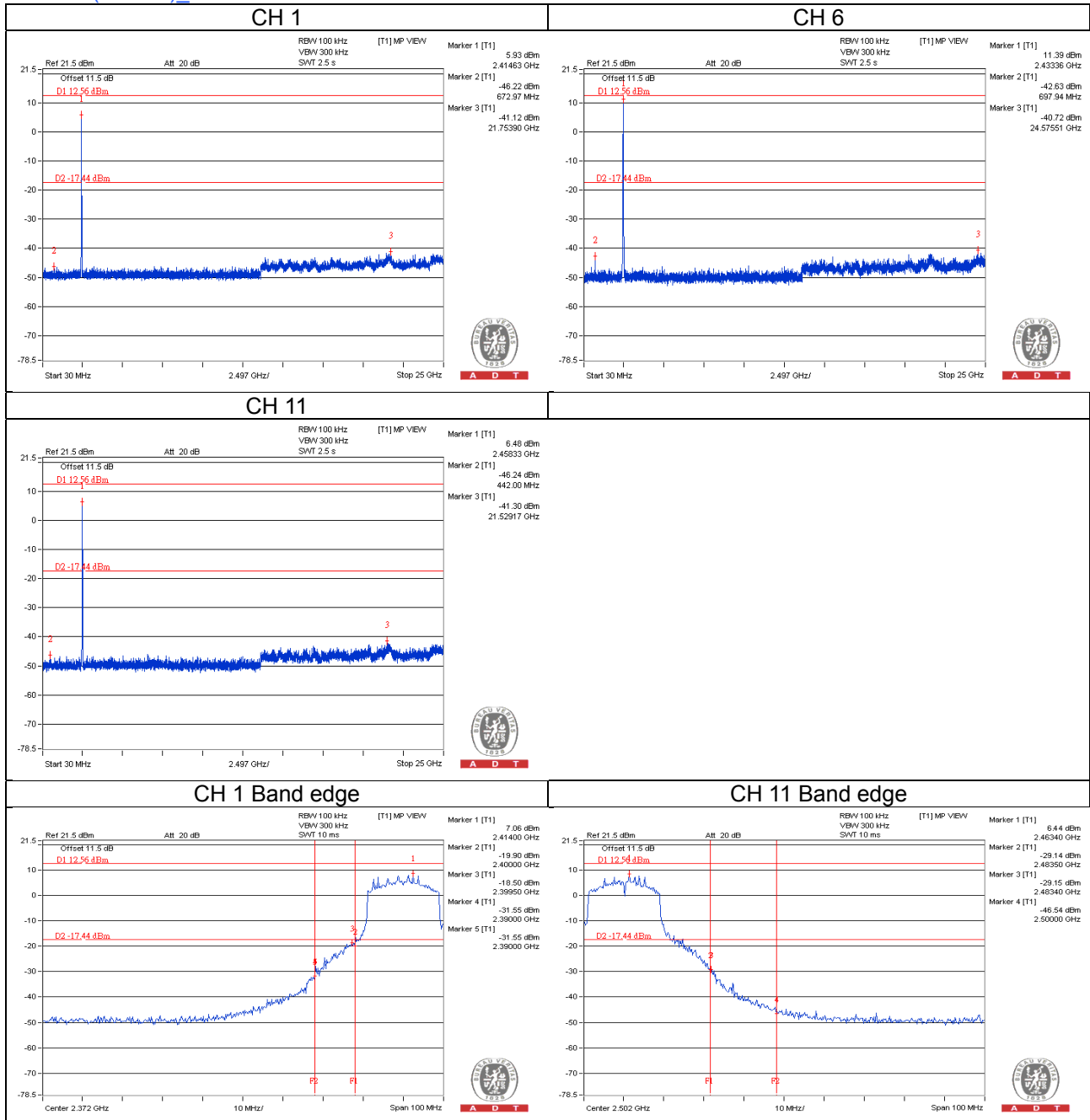

### 802.11n (VHT20)\_Chain 2

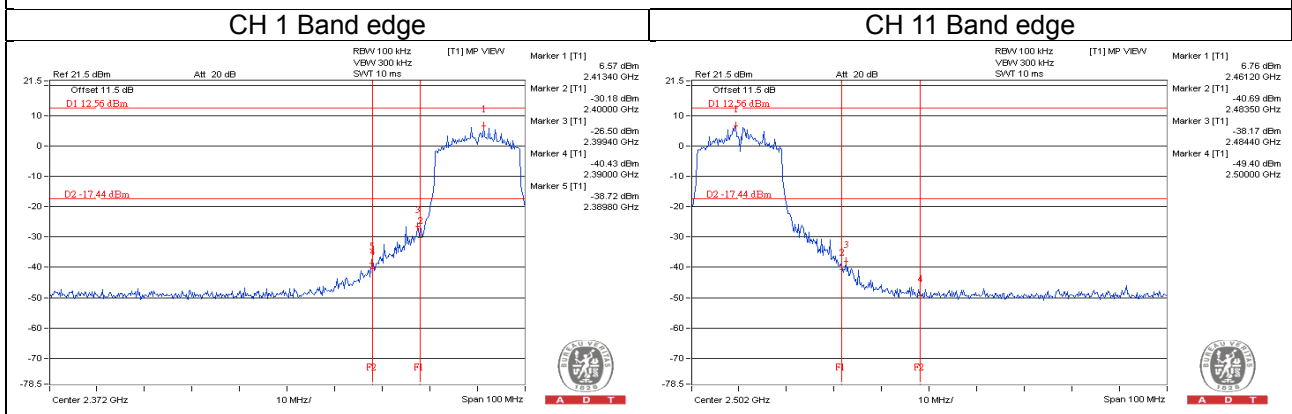
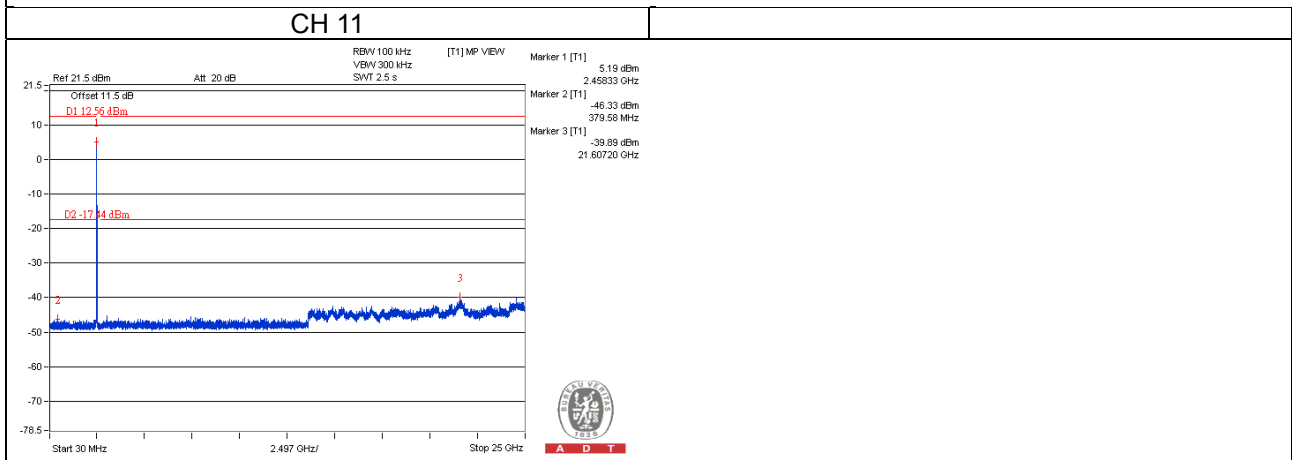
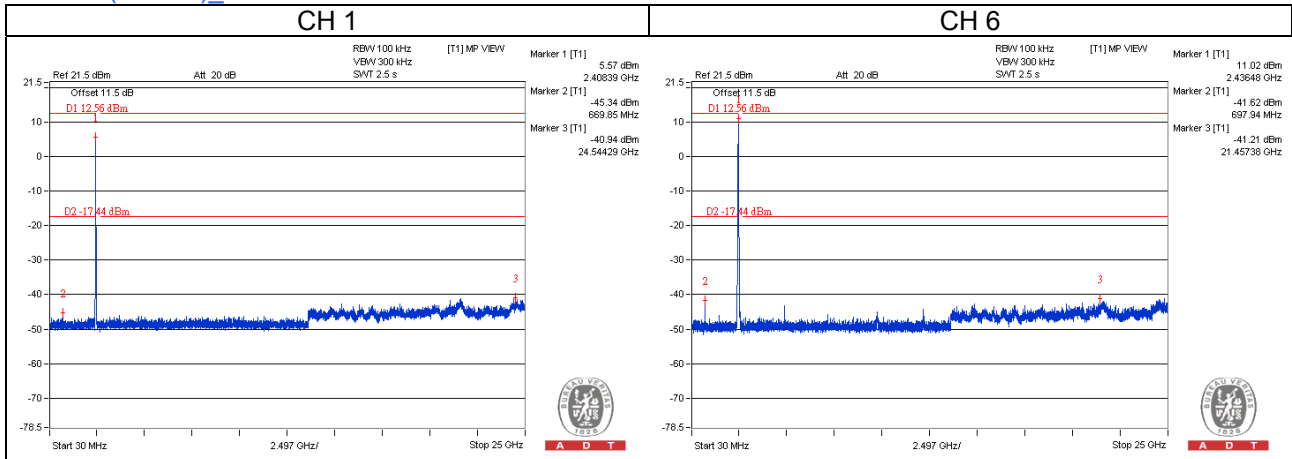

### 802.11n (VHT20)\_Chain 3

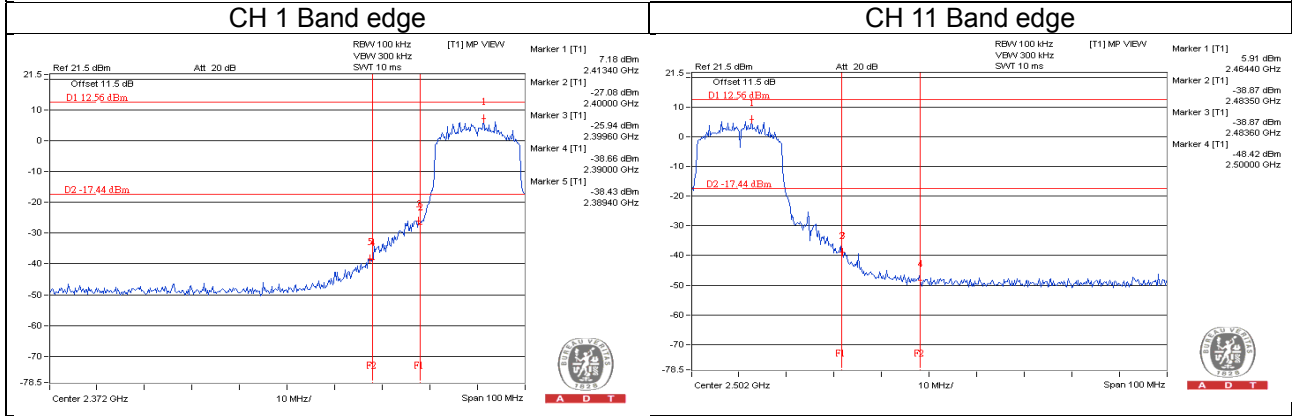
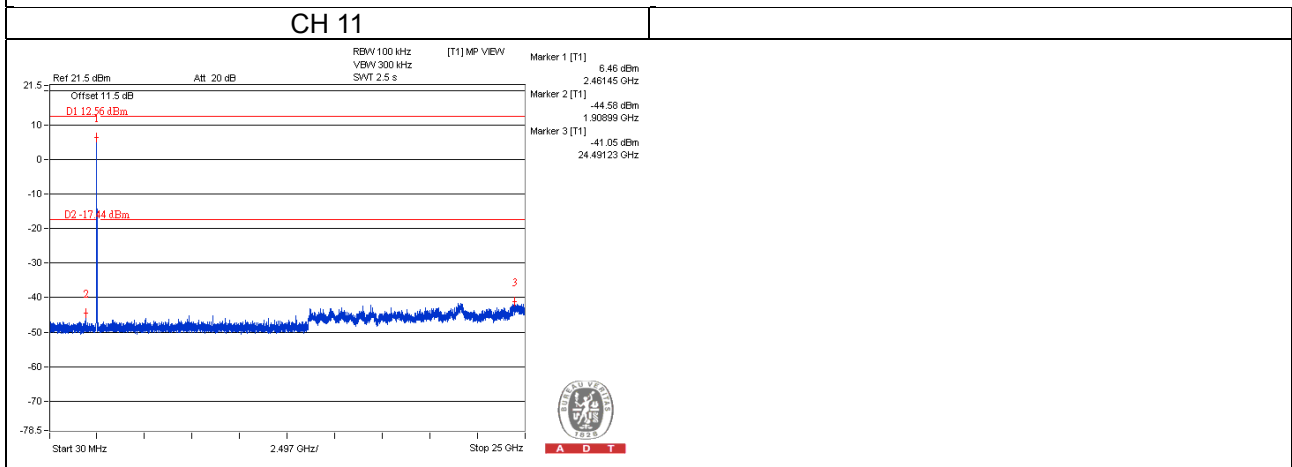
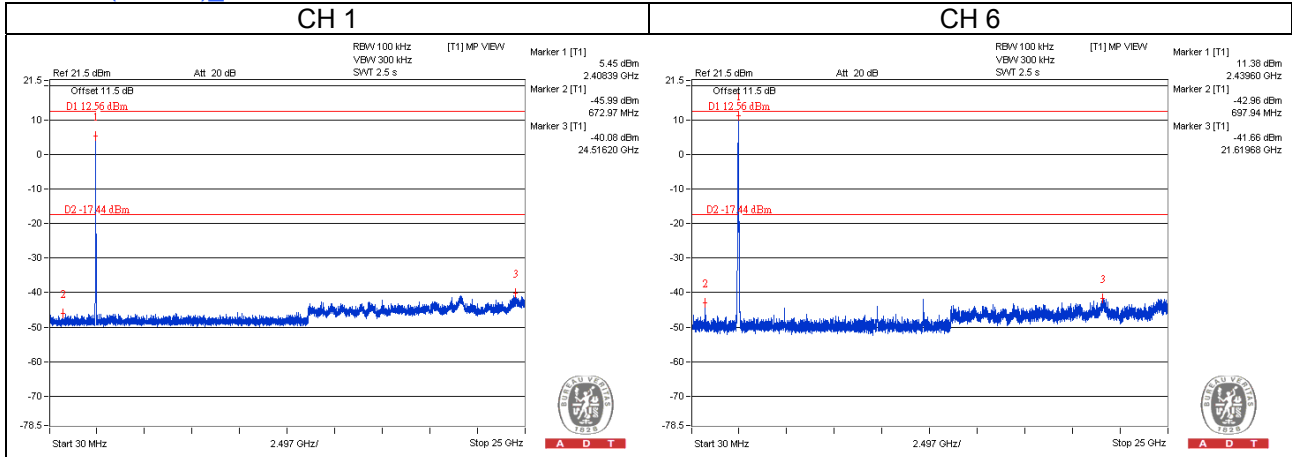

## **5 Pictures of Test Arrangements**

Please refer to the attached file (Test Setup Photo).

## Appendix – Information on the Testing Laboratories

We, Bureau Veritas Consumer Products Services (H.K.) Ltd., Taoyuan Branch, were founded in 1988 to provide our best service in EMC, Radio, Telecom and Safety consultation. Our laboratories are accredited and approved according to ISO/IEC 17025.

If you have any comments, please feel free to contact us at the following:

### **Linko EMC/RF Lab**

Tel: 886-2-26052180

Fax: 886-2-26051924

### **Hsin Chu EMC/RF/Telecom Lab**

Tel: 886-3-6668565

Fax: 886-3-6668323

### **Hwa Ya EMC/RF/Safety Lab**

Tel: 886-3-3183232

Fax: 886-3-3270892

**Email:** [service.adt@tw.bureauveritas.com](mailto:service.adt@tw.bureauveritas.com)

**Web Site:** [www.bureauveritas-adt.com](http://www.bureauveritas-adt.com)

The address and road map of all our labs can be found in our web site also.

--- END ---