

FCC Test Report

Report No.: RF151116E02-3

FCC ID: WBV-AP250

Test Model: AP250

Received Date: Nov. 16, 2015

Test Date: Dec. 03, 2015 to Mar. 11, 2016

Issued Date: June 29, 2016

Applicant: Aerohive Networks Inc.

Address: 1011 McCarthy Blvd, Milpitas, CA 95035, USA

Issued By: Bureau Veritas Consumer Products Services (H.K.) Ltd., Taoyuan Branch
Hsin Chu Laboratory

Lab Address: E-2, No.1, Li Hsin 1st Road, Hsinchu Science Park, Hsinchu City 300,
Taiwan R.O.C.

Test Location (1): E-2, No.1, Li Hsin 1st Road, Hsinchu Science Park, Hsinchu City 300,
Taiwan R.O.C.

Test Location (2): No. 49, Ln. 206, Wende Rd., Shangshan Tsuen, Chiung Lin Hsiang, Hsin
Chu Hsien 307, Taiwan R.O.C.



This report is for your exclusive use. Any copying or replication of this report to or for any other person or entity, or use of our name or trademark, is permitted only with our prior written permission. This report sets forth our findings solely with respect to the test samples identified herein. The results set forth in this report are not indicative or representative of the quality or characteristics of the lot from which a test sample was taken or any similar or identical product unless specifically and expressly noted. Our report includes all of the tests requested by you and the results thereof based upon the information that you provided to us. You have 60 days from date of issuance of this report to notify us of any material error or omission caused by our negligence, provided, however, that such notice shall be in writing and shall specifically address the issue you wish to raise. A failure to raise such issue within the prescribed time shall constitute your unqualified acceptance of the completeness of this report, the tests conducted and the correctness of the report contents. Unless specific mention, the uncertainty of measurement has been explicitly taken into account to declare the compliance or non-compliance to the specification. The report must not be used by the client to claim product certification, approval, or endorsement by TAF or any government agencies.

Table of Contents

Release Control Record	4
1 Certificate of Conformity	5
2 Summary of Test Results	6
2.1 Measurement Uncertainty	6
2.2 Modification Record	6
3 General Information	7
3.1 General Description of EUT (DFS Band)	7
3.2 Description of Test Modes	11
3.2.1 Test Mode Applicability and Tested Channel Detail	12
3.3 Duty Cycle of Test Signal	25
3.4 Description of Support Units	26
3.4.1 Configuration of System under Test	27
3.5 General Description of Applied Standard	29
4 Test Types and Results	30
4.1 Radiated Emission and Bandedge Measurement	30
4.1.1 Limits of Radiated Emission and Bandedge Measurement	30
4.1.2 Test Instruments	31
4.1.3 Test Procedure	37
4.1.4 Deviation from Test Standard	37
4.1.5 Test Setup	38
4.1.6 EUT Operating Condition	39
4.1.7 Test Results (Mode 1)	40
4.1.8 Test Results (Mode 2)	113
4.1.9 Test Results (Mode 3)	258
4.1.10 Test Results (Mode 4)	259
4.2 Conducted Emission Measurement	260
4.2.1 Limits of Conducted Emission Measurement	260
4.2.2 Test Instruments	260
4.2.3 Test Procedure	261
4.2.4 Deviation from Test Standard	261
4.2.5 Test Setup	261
4.2.6 EUT Operating Condition	261
4.2.7 Test Results (Mode 1)	262
4.2.8 Test Results (Mode 2)	264
4.2.9 Test Results (Mode 3)	266
4.2.10 Test Results (Mode 4)	268
4.3 Transmit Power Measurement	270
4.3.1 Limits of Transmit Power Measurement	270
4.3.2 Test Setup	271
4.3.3 Test Instruments	271
4.3.4 Test Procedure	272
4.3.5 Deviation from Test Standard	272
4.3.6 EUT Operating Condition	272
4.3.7 Test Result (Mode 1)	273
4.3.8 Test Result (Mode 2)	308
4.4 Peak Power Spectral Density Measurement	339
4.4.1 Limits of Peak Power Spectral Density Measurement	339
4.4.2 Test Setup	339
4.4.3 Test Instruments	339
4.4.4 Test Procedure	340
4.4.5 Deviation from Test Standard	340
4.4.6 EUT Operating Condition	340
4.4.7 Test Results (Mode 1)	341

4.4.8	Test Results (Mode 2).....	361
4.5	Frequency Stability Measurement.....	378
4.5.1	Limits of Frequency Stability Measurement	378
4.5.2	Test Setup.....	378
4.5.3	Test Instruments	378
4.5.4	Test Procedure	378
4.5.5	Deviation from Test Standard	378
4.5.6	EUT Operating Condition	378
4.5.7	Test Results (Mode 1).....	379
4.5.8	Test Results (Mode 2).....	380
4.6	6dB Bandwidth Measurement.....	381
4.6.1	Limits of 6dB Bandwidth Measurement.....	381
4.6.2	Test Setup.....	381
4.6.3	Test Instruments	381
4.6.4	Test Procedure	381
4.6.5	Deviation from Test Standard	381
4.6.6	EUT Operating Condition	381
4.6.7	Test Results (Mode 1).....	382
4.6.8	Test Results (Mode 2).....	388
5	Pictures of Test Arrangements.....	394
	Appendix – Information on the Testing Laboratories	395



Release Control Record

Issue No.	Description	Date Issued
RF151116E02-3	Original release.	June 29, 2016

1 Certificate of Conformity

Product: Access Point

Brand: Aerohive

Test Model: AP250

Sample Status: Engineer Sample (DVT2)

Applicant: Aerohive Networks Inc.

Test Date: Dec. 03, 2015 to Mar. 11, 2016

Standard: 47 CFR FCC Part 15, Subpart E (Section 15.407)
ANSI C63.10: 2013

The above equipment has been tested by **Bureau Veritas Consumer Products Services (H.K.) Ltd., Taoyuan Branch**, and found compliance with the requirement of the above standards. The test record, data evaluation & Equipment Under Test (EUT) configurations represented herein are true and accurate accounts of the measurements of the sample's EMC characteristics under the conditions specified in this report.

Prepared by :  , **Date:** June 29, 2016
Claire Kuan / Specialist

Approved by :  , **Date:** June 29, 2016
May Chen / Manager

2 Summary of Test Results

47 CFR FCC Part 15, Subpart E (SECTION 15.407)			
FCC Clause	Test Item	Result	Remarks
15.407(b)(6)	AC Power Conducted Emissions	PASS	Meet the requirement of limit. Minimum passing margin is -5.28dB at 17.69141MHz.
15.407(b) (1/2/3/4/6)	Radiated Emissions & Band Edge Measurement	PASS	Meet the requirement of limit. Minimum passing margin is -0.1dB at 5350.00MHz & 5420.00MHz & 5470.00MHz & 5725.00MHz & 5730.00MHz & 5870.00MHz & 5880.00MHz.
15.407(a)(1/2 /3)	Max Average Transmit Power	PASS	Meet the requirement of limit.
15.407(a)(1/2 /3)	Peak Power Spectral Density	PASS	Meet the requirement of limit.
15.407(e)	6dB bandwidth	PASS	Meet the requirement of limit. (U-NII-3 Band only)
15.407(g)	Frequency Stability	PASS	Meet the requirement of limit.
15.203	Antenna Requirement	PASS	Antenna connector is i-pex (MHF) not a standard connector.

2.1 Measurement Uncertainty

Where relevant, the following measurement uncertainty levels have been estimated for tests performed on the EUT as specified in CISPR 16-4-2:

Measurement	Frequency	Expanded Uncertainty (k=2) (\pm)
Conducted Emissions at mains ports	150kHz ~ 30MHz	2.86 dB
Radiated Emissions up to 1 GHz	30MHz ~ 1GHz	5.37 dB
Radiated Emissions above 1 GHz	1GHz ~ 6GHz	3.65 dB
	6GHz ~ 18GHz	3.88 dB
	18GHz ~ 40GHz	4.11 dB

2.2 Modification Record

There were no modifications required for compliance.

3 General Information

3.1 General Description of EUT (DFS Band)

Product	Access Point
Brand	Aerohive
Test Model	AP250
Status of EUT	Engineer Sample (DVT2)
Power Supply Rating	48Vdc or 55Vdc from POE
Modulation Type	64QAM, 16QAM, QPSK, BPSK for OFDM 256QAM for OFDM in 11ac mode
Modulation Technology	OFDM
Transfer Rate	802.11a: up to 54Mbps 802.11n: up to 450Mbps 802.11ac: up to 1300Mbps
Operating Frequency	5.26GHz ~ 5.32GHz, 5.5GHz ~ 5.72GHz
Number of Channel	16 for 802.11a, 802.11n (HT20), 802.11ac (VHT20) 8 for 802.11n (HT40), 802.11ac (VHT40) 4 for 802.11ac (VHT80)
Output Power	<p>Radio 1</p> <p>5GHz (5.26 ~ 5.32GHz): 3TX CDD Mode: 199.289mW Beamforming Mode: 98.669mW</p> <p>2TX CDD Mode: 208.329mW Beamforming Mode: 142.595mW</p> <p>1TX 114.551mW</p> <p>5GHz (5.5 ~ 5.72GHz): 3TX CDD Mode: 197.175mW Beamforming Mode: 98.682mW</p> <p>2TX CDD Mode: 220.367mW Beamforming Mode: 145.93mW</p> <p>1TX 114.288mW</p> <p>Radio 2</p> <p>5GHz (5.26 ~ 5.32GHz): 3TX CDD Mode: 195.708mW Beamforming Mode: 98.315mW</p> <p>2TX CDD Mode: 227.816mW Beamforming Mode: 130.76mW</p> <p>1TX 145.211mW</p> <p>5GHz (5.5 ~ 5.72GHz): 3TX CDD Mode: 190.472mW Beamforming Mode: 98.824mW</p> <p>2TX CDD Mode: 229.934mW Beamforming Mode: 142.222mW</p> <p>1TX 133.968mW</p>

Antenna Type	Refer to Note
Antenna Connector	Refer to Note
Accessory Device	Adapter x 1
Data Cable Supplied	NA

Note:

1. This report is prepared for FCC class II permissive change. The difference compared with the Report No.: RF151116E02-1 design is as the following:
 - ◆ Add DFS band <5.26GHz ~ 5.32GHz, 5.5GHz ~ 5.72GHz>
2. According to above condition, all test items need to be performed. And all data weres verified to meet the requirements.
3. The EUT has three radio tranceivers, radio 1 is WLAN technologies for dual band (2.4GHz & 5GHz), radio 2 is WLAN technologies for signle band (5GHz), and radio 3 is Bluetooth low energy (BLE) technology only.
4. The emission of the simultaneous operation (WLAN & BT) has been evaluated and no non-compliance was found.

5. The antennas provided to the EUT, please refer to the following table:

Radio 1									
WLAN - 2.4GHz + 5GHz									
Antenna NO.	Transmitter Circuit	Brand	Model No.	Ant. Gain (dBi) Including cable loss	Frequency Range (GHz)	Antenna Type	Connecter Type	Cable Loss(dB)	Cable Length
ANT1	Chain (0)	N/A	XKAA-N08	5.14 5.41 5.02 5.25 5.13	2.4~2.4835 5.15~5.25 5.25~5.35 5.47~5.725 5.725~5.85	PIFA	i-pex (MHF)	0.21	54mm
ANT2	Chain (1)	N/A	XKAA-N08	4.28 4.82 5.16 5.14 5.31	2.4~2.4835 5.15~5.25 5.25~5.35 5.47~5.725 5.725~5.85	PIFA	i-pex (MHF)	0.19	49mm
ANT3	Chain (2)	N/A	XKAA-N08	2.80 5.25 5.46 5.37 5.65	2.4~2.4835 5.15~5.25 5.25~5.35 5.47~5.725 5.725~5.85	PIFA	i-pex (MHF)	0.39	101mm
Radio 2									
WLAN - 5GHz									
Antenna NO.	Transmitter Circuit	Brand	Model No.	Ant. Gain (dBi) Including cable loss	Frequency Range (GHz)	Antenna Type	Connecter Type	Cable Loss(dB)	Cable Length
ANT5	Chain (0)	N/A	XKAA-N08	5.32 5.78 5.26 5.3	5.15~5.25 5.25~5.35 5.47~5.725 5.725~5.85	V-pol PIFA	i-pex (MHF)	0.82	213mm
ANT6	Chain (1)	N/A	XKAA-N08	5.54 5.72 5.56 5.1	5.15~5.25 5.25~5.35 5.47~5.725 5.725~5.85	V-pol PIFA	i-pex (MHF)	0.25	66mm
ANT7	Chain (1)	N/A	XKAA-N08	5.24 6.38 5.36 5.27	5.15~5.25 5.25~5.35 5.47~5.725 5.725~5.85	H-pol Dipole	i-pex (MHF)	0.58	150mm
ANT8	Chain (2)	N/A	XKAA-N08	4.88 4.27 4.84 5.19	5.15~5.25 5.25~5.35 5.47~5.725 5.725~5.85	H-pol Dipole	i-pex (MHF)	0.77	201mm
ANT9	Chain (0)	N/A	XKAA-N08	4.41 4.55 4.79 4.87	5.15~5.25 5.25~5.35 5.47~5.725 5.725~5.85	H-pol Dipole	i-pex (MHF)	0.73	190mm
Radio 3									
Bluetooth - 2.4GHz									
ANT4	Chain (0)	N/A	XKAA-N08	4.24	2.4~2.4835	Dipole	i-pex (MHF)	0.62	160mm

6. The EUT power needs to be supplied from POE(only for test), the information is as below table:

No.	Brand	Model No.	Spec.
1	PowerDsine	PD-9001GR/AT/AC	Input: 100-240V, 0.67A, 50/60Hz Output: 55V, 0.6A
2	PowerDsine	PD-3501G/AC	Input: 100-240V, 0.43A, 50/60Hz Output: 48V, 0.35A

For radiated emission above 1GHz test, the EUT was pre-tested with POE 1 & 2, the worst case was found in POE 1. Therefore only the test data of the POE 1 was recorded in this report.

7. The EUT incorporates a MIMO function.

Radio 1			
WLAN – 2.4GHz			
MODULATION MODE	DATA RATE (MCS)	TX & RX CONFIGURATION	
802.11b	1 ~ 11Mbps	3TX	3RX
802.11g	6 ~ 54Mbps	3TX	3RX
802.11n (HT20)	MCS 0~7	3TX	3RX
	MCS 8~15	3TX	3RX
	MCS 16~23	3TX	3RX
VHT20	MCS0~8 Nss=1	3TX	3RX
	MCS0~8 Nss=2	3TX	3RX
	MCS0~9 Nss=3	3TX	3RX
Radio 1 and Radio 2			
WLAN – 5GHz			
MODULATION MODE	DATA RATE (MCS)	TX & RX CONFIGURATION	
802.11a	6 ~ 54Mbps	3TX	3RX
802.11n (HT20)	MCS 0~7	3TX	3RX
	MCS 8~15	3TX	3RX
	MCS 16~23	3TX	3RX
802.11n (HT40)	MCS 0~7	3TX	3RX
	MCS 8~15	3TX	3RX
	MCS 16~23	3TX	3RX
802.11ac (VHT20)	MCS0~8 Nss=1	3TX	3RX
	MCS0~8 Nss=2	3TX	3RX
	MCS0~9 Nss=3	3TX	3RX
802.11ac (VHT40)	MCS0~9 Nss=1	3TX	3RX
	MCS0~9 Nss=2	3TX	3RX
	MCS0~9 Nss=3	3TX	3RX
802.11ac (VHT80)	MCS0~9 Nss=1	3TX	3RX
	MCS0~9 Nss=2	3TX	3RX
	MCS0~8 Nss=3	3TX	3RX

Note. : 1. The modulation and bandwidth are similar for 802.11n mode for 20MHz (40MHz) and 802.11ac mode for 20MHz (40MHz), therefore investigated worst case to representative mode in test report. (Final test mode refer section 3.2.1)
2. All of modulation mode support beamforming function except 802.11a/b/g modulation.

8. The above EUT information is declared by manufacturer and for more detailed features description, please refer to the manufacturer's specifications or user's manual.

3.2 Description of Test Modes

FOR 5260 ~ 5320MHz

4 channels are provided for 802.11a, 802.11n (HT20), 802.11ac (VHT20):

Channel	Frequency	Channel	Frequency
52	5260 MHz	60	5300 MHz
56	5280 MHz	64	5320 MHz

2 channels are provided for 802.11n (HT40), 802.11ac (VHT40):

Channel	Frequency	Channel	Frequency
54	5270 MHz	62	5310 MHz

1 channel is provided for 802.11ac (VHT80):

Channel	Frequency
58	5290MHz

FOR 5500 ~ 5720MHz

12 channels are provided for 802.11a, 802.11n (HT20), 802.11ac (VHT20):

Channel	Frequency	Channel	Frequency
100	5500 MHz	124	5620 MHz
104	5520 MHz	128	5640 MHz
108	5540 MHz	132	5660 MHz
112	5560 MHz	136	5680 MHz
116	5580 MHz	140	5700 MHz
120	5600 MHz	144	5720 MHz

6 channels are provided for 802.11n (HT40), 802.11ac (VHT40):

Channel	Frequency	Channel	Frequency
102	5510 MHz	126	5630 MHz
110	5550 MHz	134	5670 MHz
118	5590 MHz	142	5710 MHz

3 channels are provided for 802.11ac (VHT80):

Channel	Frequency	Channel	Frequency
106	5530MHz	138	5690 MHz
122	5610 MHz		

3.2.1 Test Mode Applicability and Tested Channel Detail

EUT CONFIGURE MODE	APPLICABLE TO				DESCRIPTION
	RE \geq 1G	RE $<$ 1G	PLC	APCM	
1	√	√	√	√	For Radio 1 with POE1(PD-9001GR)
2	√	√	√	√	For Radio 2 with POE1(PD-9001GR)
3	-	√	√	-	For Radio 1 with POE2(PD-3501G)
4	-	√	√	-	For Radio 2 with POE2(PD-3501G)

Where **RE \geq 1G**: Radiated Emission above 1GHz **RE $<$ 1G**: Radiated Emission below 1GHz
PLC: Power Line Conducted Emission **APCM**: Antenna Port Conducted Measurement

NOTE:

- The EUT had been pre-tested on the positioned of each 2 axis. The worst case was following as below.
 - ◆ For the Radio 1 was found when positioned on X-plane.
 - ◆ For the Radio 2 (3TX) below 1GHz was found when positioned on X-plane and above 1GHz (ANT7, ANT8, ANT9) was found when positioned on X-plane.
 - ◆ For the Radio 2 (3TX) below 1GHz was found when positioned on X-plane and above 1GHz (ANT5, ANT6, ANT8) was found when positioned on Y-plane.
 - ◆ For the Radio 2 (2TX) below 1GHz was found when positioned on X-plane and above 1GHz (ANT7, ANT9) was found when positioned on X-plane.
 - ◆ For the Radio 2 (2TX) below 1GHz was found when positioned on X-plane and above 1GHz (ANT5, ANT6) was found when positioned on Y-plane.
 - ◆ For the Radio 2 (1TX) below 1GHz was found when positioned on X-plane and above 1GHz (ANT9) was found when positioned on X-plane.
 - ◆ For the Radio 2 (1TX) below 1GHz was found when positioned on X-plane and above 1GHz (ANT5) was found when positioned on Y-plane.
- "-" means no effect.

Radiated Emission Test (Above 1GHz):

- Pre-Scan has been conducted to determine the worst-case mode from all possible combinations between available modulations, data rates and antenna ports (if EUT with antenna diversity architecture).
- Following channel(s) was (were) selected for the final test as listed below.

For Radio 1 : 3Tx Configuration								
MODE	ANTENNA COMBINATIION	FREQ. BAND (MHz)	AVAILABLE CHANNEL	TESTED CHANNEL	MODULATION TECHNOLOGY	MODULATION TYPE	DATA RATE (Mbps)	
802.11a	CDD	ANT1, ANT2, ANT3	5260-5320	52 to 64	52, 60, 64	OFDM	BPSK	6
802.11ac (VHT20)				52 to 64	52, 60, 64	OFDM	BPSK	6.5
802.11ac (VHT40)				54 to 62	54, 62	OFDM	BPSK	13.5
802.11ac (VHT80)				58	58	OFDM	BPSK	29.3
802.11a	CDD	ANT1, ANT2, ANT3	5500-5720	100 to 144	100, 116, 140, 144	OFDM	BPSK	6
802.11ac (VHT20)				100 to 144	100, 116, 140, 144	OFDM	BPSK	6.5
802.11ac (VHT40)				102 to 142	102, 110, 134, 142	OFDM	BPSK	13.5
802.11ac (VHT80)				106 to 138	106, 122, 138	OFDM	BPSK	29.3



For Radio 1 : 2Tx Configuration

MODE	ANTENNA COMBINATIION	FREQ. BAND (MHz)	AVAILABLE CHANNEL	TESTED CHANNEL	MODULATION TECHNOLOGY	MODULATION TYPE	DATA RATE (Mbps)	
802.11a	CDD	ANT2, ANT3	5260-5320	52 to 64	52, 60, 64	OFDM	BPSK	6
802.11ac (VHT20)				52 to 64	52, 60, 64	OFDM	BPSK	6.5
802.11ac (VHT40)				54 to 62	54, 62	OFDM	BPSK	13.5
802.11ac (VHT80)				58	58	OFDM	BPSK	29.3
802.11a	CDD	ANT1, ANT3	5500-5720	100 to 144	100, 116, 140, 144	OFDM	BPSK	6
802.11ac (VHT20)				100 to 144	100, 116, 140, 144	OFDM	BPSK	6.5
802.11ac (VHT40)				102 to 142	102, 110, 134, 142	OFDM	BPSK	13.5
802.11ac (VHT80)				106 to 138	106, 122, 138	OFDM	BPSK	29.3

For Radio 1 : 1Tx Configuration

MODE	ANTENNA COMBINATIION	FREQ. BAND (MHz)	AVAILABLE CHANNEL	TESTED CHANNEL	MODULATION TECHNOLOGY	MODULATION TYPE	DATA RATE (Mbps)					
802.11a	ANT3	5260-5320	52 to 64	52, 60, 64	OFDM	BPSK	6					
802.11ac (VHT20)								52 to 64	52, 60, 64	OFDM	BPSK	6.5
802.11ac (VHT40)								54 to 62	54, 62	OFDM	BPSK	13.5
802.11ac (VHT80)								58	58	OFDM	BPSK	29.3
802.11a	ANT3	5500-5720	100 to 144	100, 116, 140, 144	OFDM	BPSK	6					
802.11ac (VHT20)								100 to 144	100, 116, 140, 144	OFDM	BPSK	6.5
802.11ac (VHT40)								102 to 142	102, 110, 134, 142	OFDM	BPSK	13.5
802.11ac (VHT80)								106 to 138	106, 122, 138	OFDM	BPSK	29.3

For Radio 2 : 3Tx Configuration

MODE	ANTENNA COMBINATIION	FREQ. BAND (MHz)	AVAILABLE CHANNEL	TESTED CHANNEL	MODULATION TECHNOLOGY	MODULATION TYPE	DATA RATE (Mbps)	
802.11a	CDD	5260-5320	ANT 7, ANT 8, ANT 9	52 to 64	52, 60, 64	OFDM	BPSK	6
802.11ac (VHT20)				52 to 64	52, 60, 64	OFDM	BPSK	6.5
802.11ac (VHT40)				54 to 62	54, 62	OFDM	BPSK	13.5
802.11ac (VHT80)				58	58	OFDM	BPSK	29.3
802.11a			ANT 5, ANT 6, ANT 8	52 to 64	52, 60, 64	OFDM	BPSK	6
802.11ac (VHT20)				52 to 64	52, 60, 64	OFDM	BPSK	6.5
802.11ac (VHT40)				54 to 62	54, 62	OFDM	BPSK	13.5
802.11ac (VHT80)				58	58	OFDM	BPSK	29.3
802.11a	CDD	5500-5720	ANT 7, ANT 8, ANT 9	100 to 144	100, 116, 140, 144	OFDM	BPSK	6
802.11ac (VHT20)				100 to 144	100, 116, 140, 144	OFDM	BPSK	6.5
802.11ac (VHT40)				102 to 142	102, 110, 134, 142	OFDM	BPSK	13.5
802.11ac (VHT80)				106 to 138	106, 122, 138	OFDM	BPSK	29.3
802.11a			ANT 5, ANT 6, ANT 8	100 to 144	100, 116, 140, 144	OFDM	BPSK	6
802.11ac (VHT20)				100 to 144	100, 116, 140, 144	OFDM	BPSK	6.5
802.11ac (VHT40)				102 to 142	102, 110, 134, 142	OFDM	BPSK	13.5
802.11ac (VHT80)				106 to 138	106, 122, 138	OFDM	BPSK	29.3



For Radio 2 : 2Tx Configuration

MODE	ANTENNA COMBINATIION	FREQ. BAND (MHz)	AVAILABLE CHANNEL	TESTED CHANNEL	MODULATION TECHNOLOGY	MODULATION TYPE	DATA RATE (Mbps)	
802.11a	CDD	5260-5320	ANT 7, ANT 9	52 to 64	52, 60, 64	OFDM	BPSK	6
802.11ac (VHT20)				52 to 64	52, 60, 64	OFDM	BPSK	6.5
802.11ac (VHT40)				54 to 62	54, 62	OFDM	BPSK	13.5
802.11ac (VHT80)				58	58	OFDM	BPSK	29.3
802.11a			ANT 5, ANT 6	52 to 64	52, 60, 64	OFDM	BPSK	6
802.11ac (VHT20)				52 to 64	52, 60, 64	OFDM	BPSK	6.5
802.11ac (VHT40)				54 to 62	54, 62	OFDM	BPSK	13.5
802.11ac (VHT80)				58	58	OFDM	BPSK	29.3
802.11a	CDD	5500-5720	ANT 7, ANT 9	100 to 144	100, 116, 140, 144	OFDM	BPSK	6
802.11ac (VHT20)				100 to 144	100, 116, 140, 144	OFDM	BPSK	6.5
802.11ac (VHT40)				102 to 142	102, 110, 134, 142	OFDM	BPSK	13.5
802.11ac (VHT80)				106 to 138	106, 122, 138	OFDM	BPSK	29.3
802.11a			ANT 5, ANT 6	100 to 144	100, 116, 140, 144	OFDM	BPSK	6
802.11ac (VHT20)				100 to 144	100, 116, 140, 144	OFDM	BPSK	6.5
802.11ac (VHT40)				102 to 142	102, 110, 134, 142	OFDM	BPSK	13.5
802.11ac (VHT80)				106 to 138	106, 122, 138	OFDM	BPSK	29.3

For Radio 2 : 1Tx Configuration							
MODE	ANTENNA COMBINATIION	FREQ. BAND (MHz)	AVAILABLE CHANNEL	TESTED CHANNEL	MODULATION TECHNOLOGY	MODULATION TYPE	DATA RATE (Mbps)
802.11a	ANT 9	5260-5320	52 to 64	52, 60, 64	OFDM	BPSK	6
802.11ac (VHT20)			52 to 64	52, 60, 64	OFDM	BPSK	6.5
802.11ac (VHT40)			54 to 62	54, 62	OFDM	BPSK	13.5
802.11ac (VHT80)			58	58	OFDM	BPSK	29.3
802.11a	ANT 5		52 to 64	52, 60, 64	OFDM	BPSK	6
802.11ac (VHT20)			52 to 64	52, 60, 64	OFDM	BPSK	6.5
802.11ac (VHT40)			54 to 62	54, 62	OFDM	BPSK	13.5
802.11ac (VHT80)			58	58	OFDM	BPSK	29.3
802.11a	ANT 9	5500-5720	100 to 144	100, 116, 140, 144	OFDM	BPSK	6
802.11ac (VHT20)			100 to 144	100, 116, 140, 144	OFDM	BPSK	6.5
802.11ac (VHT40)			102 to 142	102, 110, 134, 142	OFDM	BPSK	13.5
802.11ac (VHT80)			106 to 138	106, 122, 138	OFDM	BPSK	29.3
802.11a	ANT 5		100 to 144	100, 116, 140, 144	OFDM	BPSK	6
802.11ac (VHT20)			100 to 144	100, 116, 140, 144	OFDM	BPSK	6.5
802.11ac (VHT40)			102 to 142	102, 110, 134, 142	OFDM	BPSK	13.5
802.11ac (VHT80)			106 to 138	106, 122, 138	OFDM	BPSK	29.3

Radiated Emission Test (Below 1GHz):

- Pre-Scan has been conducted to determine the worst-case mode from all possible combinations between available modulations, data rates and antenna ports (if EUT with antenna diversity architecture).
- Following channel(s) was (were) selected for the final test as listed below.

For Radio 1 : 3Tx Configuration							
MODE	ANTENNA COMBINATIION	FREQ. BAND (MHz)	AVAILABLE CHANNEL	TESTED CHANNEL	MODULATION TECHNOLOGY	MODULATION TYPE	DATA RATE (Mbps)
802.11ac (VHT40)	CDD	ANT 1, ANT 2, ANT 3	5260-5320	54 to 62	54	OFDM	BPSK
			5500-5720	100 to 144			
For Radio 2 : 3Tx Configuration							
MODE	ANTENNA COMBINATIION	FREQ. BAND (MHz)	AVAILABLE CHANNEL	TESTED CHANNEL	MODULATION TECHNOLOGY	MODULATION TYPE	DATA RATE (Mbps)
802.11ac (VHT40)	CDD	ANT 7, ANT 8, ANT 9	5260-5320	54 to 62	54	OFDM	BPSK
			5500-5720	100 to 144			

Power Line Conducted Emission Test:

- Pre-Scan has been conducted to determine the worst-case mode from all possible combinations between available modulations, data rates and antenna ports (if EUT with antenna diversity architecture).
- Following channel(s) was (were) selected for the final test as listed below.

For Radio 1 : 3Tx Configuration								
MODE		ANTENNA COMBINATIION	FREQ. BAND (MHz)	AVAILABLE CHANNEL	TESTED CHANNEL	MODULATION TECHNOLOGY	MODULATION TYPE	DATA RATE (Mbps)
802.11ac (VHT40)	CDD	ANT 1, ANT 2, ANT 3	5260-5320	54 to 62	54	OFDM	BPSK	13.5
			5500-5720	100 to 144				
For Radio 2 : 3Tx Configuration								
MODE		ANTENNA COMBINATIION	FREQ. BAND (MHz)	AVAILABLE CHANNEL	TESTED CHANNEL	MODULATION TECHNOLOGY	MODULATION TYPE	DATA RATE (Mbps)
802.11ac (VHT40)	CDD	ANT 5, ANT 6, ANT 8	5260-5320	54 to 62	54	OFDM	BPSK	13.5
			5500-5720	100 to 144				

Transmit Power Measurement:

- This item includes all test value of each mode, but only includes spectrum plot of worst value of each mode.
- Pre-Scan has been conducted to determine the worst-case mode from all possible combinations between available modulations, data rates and antenna ports (if EUT with antenna diversity architecture).
- Following channel(s) was (were) selected for the final test as listed below.

For Radio 1 : 3Tx Configuration

MODE	ANTENNA COMBINATIION	FREQ. BAND (MHz)	AVAILABLE CHANNEL	TESTED CHANNEL	MODULATION TECHNOLOGY	MODULATION TYPE	DATA RATE (Mbps)	
802.11a	CDD	5260-5320	52 to 64	52, 60, 64	OFDM	BPSK	6	
802.11ac (VHT20)			52 to 64	52, 60, 64	OFDM	BPSK	6.5	
802.11ac (VHT40)			54 to 62	54, 62	OFDM	BPSK	13.5	
802.11ac (VHT80)			58	58	OFDM	BPSK	29.3	
802.11ac (VHT20)			TxBF	52 to 64	52, 60, 64	OFDM	BPSK	6.5
802.11ac (VHT40)				54 to 62	54, 62	OFDM	BPSK	13.5
802.11ac (VHT80)				58	58	OFDM	BPSK	29.3
802.11a				CDD	5500-5720	100 to 144	100, 116, 140, 144	OFDM
802.11ac (VHT20)	100 to 144	100, 116, 140, 144	OFDM			BPSK	6.5	
802.11ac (VHT40)	102 to 142	102, 110, 134, 142	OFDM			BPSK	13.5	
802.11ac (VHT80)	106 to 138	106, 122, 138	OFDM			BPSK	29.3	
802.11ac (VHT20)	TxBF	100 to 144	100, 116, 140, 144			OFDM	BPSK	6.5
802.11ac (VHT40)		102 to 142	102, 110, 134, 142			OFDM	BPSK	13.5
802.11ac (VHT80)		106 to 138	106, 122, 138			OFDM	BPSK	29.3
802.11a		ANT1, ANT2, ANT3	5260-5320			52 to 64	52, 60, 64	OFDM
802.11ac (VHT20)	52 to 64			52, 60, 64	OFDM	BPSK	6.5	
802.11ac (VHT40)	54 to 62			54, 62	OFDM	BPSK	13.5	
802.11ac (VHT80)	58			58	OFDM	BPSK	29.3	
802.11ac (VHT20)	TxBF			52 to 64	52, 60, 64	OFDM	BPSK	6.5
802.11ac (VHT40)				54 to 62	54, 62	OFDM	BPSK	13.5
802.11ac (VHT80)				58	58	OFDM	BPSK	29.3
802.11a				ANT1, ANT2, ANT3	5500-5720	100 to 144	100, 116, 140, 144	OFDM
802.11ac (VHT20)	100 to 144	100, 116, 140, 144	OFDM			BPSK	6.5	
802.11ac (VHT40)	102 to 142	102, 110, 134, 142	OFDM			BPSK	13.5	
802.11ac (VHT80)	106 to 138	106, 122, 138	OFDM			BPSK	29.3	
802.11ac (VHT20)	TxBF	100 to 144	100, 116, 140, 144			OFDM	BPSK	6.5
802.11ac (VHT40)		102 to 142	102, 110, 134, 142			OFDM	BPSK	13.5
802.11ac (VHT80)		106 to 138	106, 122, 138			OFDM	BPSK	29.3

For Radio 1 : 2Tx Configuration

MODE	ANTENNA COMBINATIION	FREQ. BAND (MHz)	AVAILABLE CHANNEL	TESTED CHANNEL	MODULATION TECHNOLOGY	MODULATION TYPE	DATA RATE (Mbps)
802.11a	CDD	5260-5320	52 to 64	52, 60, 64	OFDM	BPSK	6
802.11ac (VHT20)			52 to 64	52, 60, 64	OFDM	BPSK	6.5
802.11ac (VHT40)			54 to 62	54, 62	OFDM	BPSK	13.5
802.11ac (VHT80)			58	58	OFDM	BPSK	29.3
802.11ac (VHT20)	TxBF	5260-5320	52 to 64	52, 60, 64	OFDM	BPSK	6.5
802.11ac (VHT40)			54 to 62	54, 62	OFDM	BPSK	13.5
802.11ac (VHT80)			58	58	OFDM	BPSK	29.3
802.11a	CDD	5500-5720	100 to 144	100, 116, 140, 144	OFDM	BPSK	6
802.11ac (VHT20)			100 to 144	100, 116, 140, 144	OFDM	BPSK	6.5
802.11ac (VHT40)			102 to 142	102, 110, 134, 142	OFDM	BPSK	13.5
802.11ac (VHT80)			106 to 138	106, 122, 138	OFDM	BPSK	29.3
802.11ac (VHT20)	TxBF	5500-5720	100 to 144	100, 116, 140, 144	OFDM	BPSK	6.5
802.11ac (VHT40)			102 to 142	102, 110, 134, 142	OFDM	BPSK	13.5
802.11ac (VHT80)			106 to 138	106, 122, 138	OFDM	BPSK	29.3

For Radio 1 : 1Tx Configuration

MODE	ANTENNA COMBINATIION	FREQ. BAND (MHz)	AVAILABLE CHANNEL	TESTED CHANNEL	MODULATION TECHNOLOGY	MODULATION TYPE	DATA RATE (Mbps)
802.11a	ANT 3	5260-5320	52 to 64	52, 60, 64	OFDM	BPSK	6
802.11ac (VHT20)			52 to 64	52, 60, 64	OFDM	BPSK	6.5
802.11ac (VHT40)			54 to 62	54, 62	OFDM	BPSK	13.5
802.11ac (VHT80)			58	58	OFDM	BPSK	29.3
802.11a	ANT 3	5500-5720	100 to 144	100, 116, 140, 144	OFDM	BPSK	6
802.11ac (VHT20)			100 to 144	100, 116, 140, 144	OFDM	BPSK	6.5
802.11ac (VHT40)			102 to 142	102, 110, 134, 142	OFDM	BPSK	13.5
802.11ac (VHT80)			106 to 138	106, 122, 138	OFDM	BPSK	29.3



For Radio 2 : 3Tx Configuration

MODE	ANTENNA COMBINATIION	FREQ. BAND (MHz)	AVAILABL E CHANNEL	TESTED CHANNEL	MODULATION TECHNOLOGY	MODULATION TYPE	DATA RATE (Mbps)		
802.11a	CDD	5260-5320	ANT 7, ANT 8, ANT 9 / ANT 5, ANT 6, ANT 8	52 to 64	52, 60, 64	OFDM	BPSK	6	
802.11ac (VHT20)				52 to 64	52, 60, 64	OFDM	BPSK	6.5	
802.11ac (VHT40)				54 to 62	54, 62	OFDM	BPSK	13.5	
802.11ac (VHT80)				58	58	OFDM	BPSK	29.3	
802.11ac (VHT20)				TxBF	52 to 64	52, 60, 64	OFDM	BPSK	6.5
802.11ac (VHT40)					54 to 62	54, 62	OFDM	BPSK	13.5
802.11ac (VHT80)					58	58	OFDM	BPSK	29.3
802.11a	CDD	5500-5720	ANT 7, ANT 8, ANT 9 / ANT 5, ANT 6, ANT 8	100 to 144	100, 116, 140, 144	OFDM	BPSK	6	
802.11ac (VHT20)				100 to 144	100, 116, 140, 144	OFDM	BPSK	6.5	
802.11ac (VHT40)				102 to 142	102, 110, 134, 142	OFDM	BPSK	13.5	
802.11ac (VHT80)				106 to 138	106, 122, 138	OFDM	BPSK	29.3	
802.11ac (VHT20)	TxBF	100 to 144	100, 116, 140, 144	OFDM	BPSK	6.5			
802.11ac (VHT40)		102 to 142	102, 110, 134, 142	OFDM	BPSK	13.5			
802.11ac (VHT80)		106 to 138	106, 122, 138	OFDM	BPSK	29.3			

For Radio 2 : 2Tx Configuration

MODE	ANTENNA COMBINATIION	FREQ. BAND (MHz)	AVAILABLE CHANNEL	TESTED CHANNEL	MODULATION TECHNOLOGY	MODULATION TYPE	DATA RATE (Mbps)
802.11a	CDD	5260-5320	52 to 64	52, 60, 64	OFDM	BPSK	6
802.11ac (VHT20)			52 to 64	52, 60, 64	OFDM	BPSK	6.5
802.11ac (VHT40)			54 to 62	54, 62	OFDM	BPSK	13.5
802.11ac (VHT80)			58	58	OFDM	BPSK	29.3
802.11ac (VHT20)	TxBF	5260-5320	52 to 64	52, 60, 64	OFDM	BPSK	6.5
802.11ac (VHT40)			54 to 62	54, 62	OFDM	BPSK	13.5
802.11ac (VHT80)			58	58	OFDM	BPSK	29.3
802.11a	CDD	5500-5720	100 to 144	100, 116, 140, 144	OFDM	BPSK	6
802.11ac (VHT20)			100 to 144	100, 116, 140, 144	OFDM	BPSK	6.5
802.11ac (VHT40)			102 to 142	102, 110, 134, 142	OFDM	BPSK	13.5
802.11ac (VHT80)			106 to 138	106, 122, 138	OFDM	BPSK	29.3
802.11ac (VHT20)	TxBF	5500-5720	100 to 144	100, 116, 140, 144	OFDM	BPSK	6.5
802.11ac (VHT40)			102 to 142	102, 110, 134, 142	OFDM	BPSK	13.5
802.11ac (VHT80)			106 to 138	106, 122, 138	OFDM	BPSK	29.3

For Radio 2 : 1Tx Configuration

MODE	ANTENNA COMBINATIION	FREQ. BAND (MHz)	AVAILABLE CHANNEL	TESTED CHANNEL	MODULATION TECHNOLOGY	MODULATION TYPE	DATA RATE (Mbps)
802.11a	ANT 9 / ANT 5	5260-5320	52 to 64	52, 60, 64	OFDM	BPSK	6
802.11ac (VHT20)			52 to 64	52, 60, 64	OFDM	BPSK	6.5
802.11ac (VHT40)			54 to 62	54, 62	OFDM	BPSK	13.5
802.11ac (VHT80)			58	58	OFDM	BPSK	29.3
802.11a	ANT 9 / ANT 5	5500-5720	100 to 144	100, 116, 140, 144	OFDM	BPSK	6
802.11ac (VHT20)			100 to 144	100, 116, 140, 144	OFDM	BPSK	6.5
802.11ac (VHT40)			102 to 142	102, 110, 134, 142	OFDM	BPSK	13.5
802.11ac (VHT80)			106 to 138	106, 122, 138	OFDM	BPSK	29.3

Peak Power Spectral Density, 6dB Bandwidth Measurement:

- This item includes all test value of each mode, but only includes spectrum plot of worst value of each mode.
- Pre-Scan has been conducted to determine the worst-case mode from all possible combinations between available modulations, data rates and antenna ports (if EUT with antenna diversity architecture).
- Following channel(s) was (were) selected for the final test as listed below.

For Radio 1 : 3Tx Configuration								
MODE		ANTENNA COMBINATIION	FREQ. BAND (MHz)	AVAILABLE CHANNEL	TESTED CHANNEL	MODULATION TECHNOLOGY	MODULATION TYPE	DATA RATE (Mbps)
802.11a	CDD	ANT 1, ANT 2, ANT 3	5260-5320	52 to 64	52, 60, 64	OFDM	BPSK	6
802.11ac (VHT20)				52 to 64	52, 60, 64	OFDM	BPSK	6.5
802.11ac (VHT40)				54 to 62	54, 62	OFDM	BPSK	13.5
802.11ac (VHT80)				58	58	OFDM	BPSK	29.3
802.11a	CDD	ANT 1, ANT 2, ANT 3	5500-5720	100 to 144	100, 116, 140, 144	OFDM	BPSK	6
802.11ac (VHT20)				100 to 144	100, 116, 140, 144	OFDM	BPSK	6.5
802.11ac (VHT40)				102 to 142	102, 110, 134, 142	OFDM	BPSK	13.5
802.11ac (VHT80)				106 to 138	106, 122, 138	OFDM	BPSK	29.3
For Radio 1 : 2Tx Configuration								
MODE		ANTENNA COMBINATIION	FREQ. BAND (MHz)	AVAILABLE CHANNEL	TESTED CHANNEL	MODULATION TECHNOLOGY	MODULATION TYPE	DATA RATE (Mbps)
802.11a	CDD	ANT 2, ANT 3	5260-5320	52 to 64	52, 60, 64	OFDM	BPSK	6
802.11ac (VHT20)				52 to 64	52, 60, 64	OFDM	BPSK	6.5
802.11ac (VHT40)				54 to 62	54, 62	OFDM	BPSK	13.5
802.11ac (VHT80)				58	58	OFDM	BPSK	29.3
802.11a	CDD	ANT 1, ANT 3	5500-5720	100 to 144	100, 116, 140, 144	OFDM	BPSK	6
802.11ac (VHT20)				100 to 144	100, 116, 140, 144	OFDM	BPSK	6.5
802.11ac (VHT40)				102 to 142	102, 110, 134, 142	OFDM	BPSK	13.5
802.11ac (VHT80)				106 to 138	106, 122, 138	OFDM	BPSK	29.3

For Radio 1 : 1Tx Configuration

MODE	ANTENNA COMBINATIION	FREQ. BAND (MHz)	AVAILABLE CHANNEL	TESTED CHANNEL	MODULATION TECHNOLOGY	MODULATION TYPE	DATA RATE (Mbps)
802.11a	ANT 3	5260-5320	52 to 64	52, 60, 64	OFDM	BPSK	6
802.11ac (VHT20)			52 to 64	52, 60, 64	OFDM	BPSK	6.5
802.11ac (VHT40)			54 to 62	54, 62	OFDM	BPSK	13.5
802.11ac (VHT80)			58	58	OFDM	BPSK	29.3
802.11a	ANT 3	5500-5720	100 to 144	100, 116, 140, 144	OFDM	BPSK	6
802.11ac (VHT20)			100 to 144	100, 116, 140, 144	OFDM	BPSK	6.5
802.11ac (VHT40)			102 to 142	102, 110, 134, 142	OFDM	BPSK	13.5
802.11ac (VHT80)			106 to 138	106, 122, 138	OFDM	BPSK	29.3

For Radio 2 : 3Tx Configuration

MODE	ANTENNA COMBINATIION	FREQ. BAND (MHz)	AVAILABLE CHANNEL	TESTED CHANNEL	MODULATION TECHNOLOGY	MODULATION TYPE	DATA RATE (Mbps)
802.11a	CDD ANT 7, ANT 8, ANT 9 / ANT 5, ANT 6, ANT 8	5260-5320	52 to 64	52, 60, 64	OFDM	BPSK	6
802.11ac (VHT20)			52 to 64	52, 60, 64	OFDM	BPSK	6.5
802.11ac (VHT40)			54 to 62	54, 62	OFDM	BPSK	13.5
802.11ac (VHT80)			58	58	OFDM	BPSK	29.3
802.11a	CDD ANT 7, ANT 8, ANT 9 / ANT 5, ANT 6, ANT 8	5500-5720	100 to 144	100, 116, 140, 144	OFDM	BPSK	6
802.11ac (VHT20)			100 to 144	100, 116, 140, 144	OFDM	BPSK	6.5
802.11ac (VHT40)			102 to 142	102, 110, 134, 142	OFDM	BPSK	13.5
802.11ac (VHT80)			106 to 138	106, 122, 138	OFDM	BPSK	29.3

For Radio 2 : 2Tx Configuration

MODE	ANTENNA COMBINATIION	FREQ. BAND (MHz)	AVAILABLE CHANNEL	TESTED CHANNEL	MODULATION TECHNOLOGY	MODULATION TYPE	DATA RATE (Mbps)
802.11a	CDD ANT 7, ANT 9 / ANT 5, ANT 6	5260-5320	52 to 64	52, 60, 64	OFDM	BPSK	6
802.11ac (VHT20)			52 to 64	52, 60, 64	OFDM	BPSK	6.5
802.11ac (VHT40)			54 to 62	54, 62	OFDM	BPSK	13.5
802.11ac (VHT80)			58	58	OFDM	BPSK	29.3
802.11a	CDD ANT 7, ANT 9 / ANT 5, ANT 6	5500-5720	100 to 144	100, 116, 140, 144	OFDM	BPSK	6
802.11ac (VHT20)			100 to 144	100, 116, 140, 144	OFDM	BPSK	6.5
802.11ac (VHT40)			102 to 142	102, 110, 134, 142	OFDM	BPSK	13.5
802.11ac (VHT80)			106 to 138	106, 122, 138	OFDM	BPSK	29.3

For Radio 2 : 1Tx Configuration

MODE	ANTENNA COMBINATIION	FREQ. BAND (MHz)	AVAILABLE CHANNEL	TESTED CHANNEL	MODULATION TECHNOLOGY	MODULATION TYPE	DATA RATE (Mbps)
802.11a	ANT 9 / ANT 5	5260-5320	52 to 64	52, 60, 64	OFDM	BPSK	6
802.11ac (VHT20)			52 to 64	52, 60, 64	OFDM	BPSK	6.5
802.11ac (VHT40)			54 to 62	54, 62	OFDM	BPSK	13.5
802.11ac (VHT80)			58	58	OFDM	BPSK	29.3
802.11a	ANT 9 / ANT 5	5500-5720	100 to 144	100, 116, 140, 144	OFDM	BPSK	6
802.11ac (VHT20)			100 to 144	100, 116, 140, 144	OFDM	BPSK	6.5
802.11ac (VHT40)			102 to 142	102, 110, 134, 142	OFDM	BPSK	13.5
802.11ac (VHT80)			106 to 138	106, 122, 138	OFDM	BPSK	29.3

Test Condition:

APPLICABLE TO	ENVIRONMENTAL CONDITIONS	INPUT POWER	TESTED BY
RE≥1G	26deg. C, 69%RH	120Vac, 60Hz	Weiwei Lo
	19deg. C, 63%RH	120Vac, 60Hz	Robet Cheng
	25deg. C, 65%RH	120Vac, 60Hz	Tim Ho
RE<1G	25deg. C, 65%RH	120Vac, 60Hz	Nelson Teng
PLC	20deg. C, 61%RH	120Vac, 60Hz	Eagle Chen
APCM	25deg. C, 61%RH	120Vac, 60Hz	Robert Cheng

3.3 Duty Cycle of Test Signal

If duty cycle of test signal is $\geq 98\%$, duty factor is not required.

If duty cycle of test signal is $< 98\%$, duty factor shall be considered.

802.11a: Duty cycle = $2.06 \text{ ms} / 2.082 \text{ ms} = 0.989$

802.11ac (VHT20): Duty cycle = $1.926 \text{ ms} / 1.946 \text{ ms} = 0.99$

802.11ac (VHT40): Duty cycle = $0.952 \text{ ms} / 0.971 \text{ ms} = 0.98$

802.11ac (VHT80): Duty cycle = $0.46 \text{ ms} / 0.479 \text{ ms} = 0.96$, Duty factor = $10 * \log(1/0.96) = 0.18$

802.11a

802.11ac (VHT20)

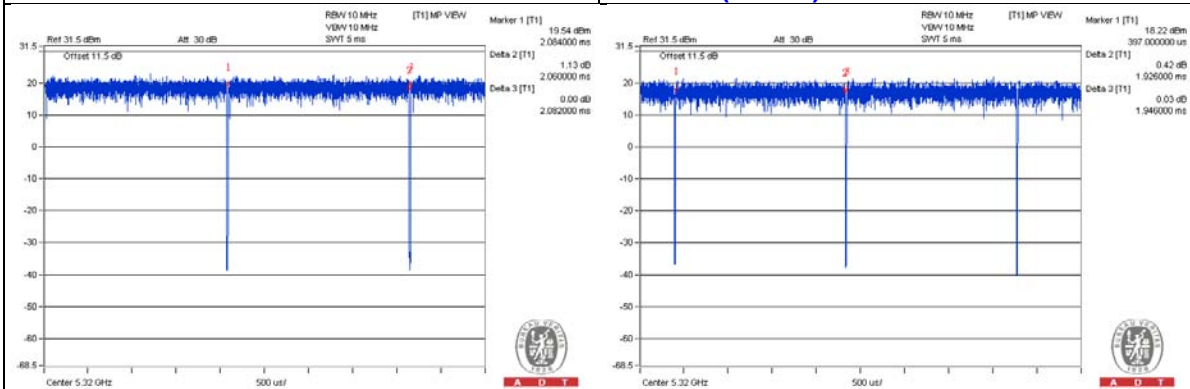

802.11ac (VHT40)

802.11ac (VHT80)

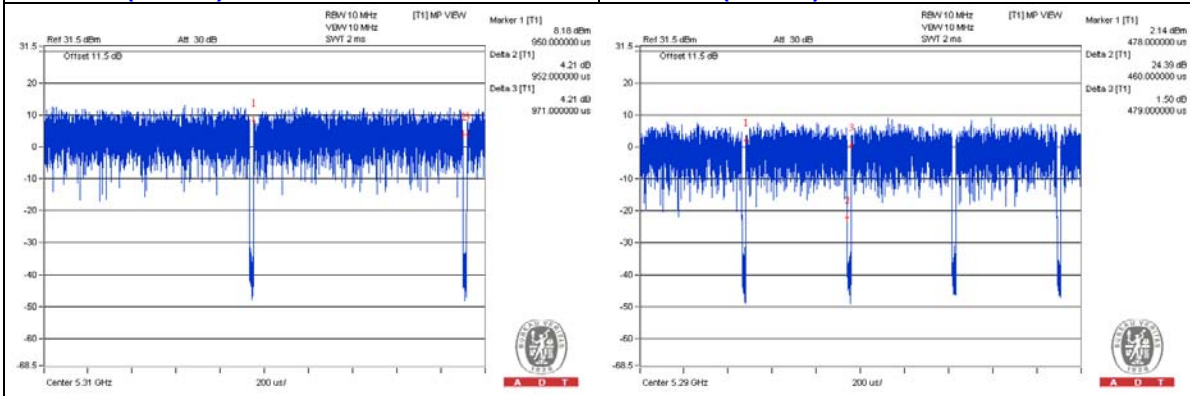

3.4 Description of Support Units

The EUT has been tested as an independent unit together with other necessary accessories or support units. The following support units or accessories were used to form a representative test configuration during the tests.

ID	Product	Brand	Model No.	Serial No.	FCC ID	Remarks
A.	iPod shuffle	Apple	MC749TA/A	CC4DN25WDFDM	NA	Provided by Lab
B.	POE	PowerDsine	PD-9001GR/AT/AC	NA	NA	Supplied by Client
			PD-3501G/AC	NA	NA	Supplied by Client
C.	NOTEBOOK COMPUTER	DELL	E5440	6FC7F12	FCC DoC	Provided by Lab
D.	NOTEBOOK COMPUTER	DELL	E5430	GM1SKV1	FCC DoC	Provided by Lab
E.	Flash Disk	SanDisk	SDCZ50-008G	NA	NA	Supplied by Client

Note:

1. All power cords of the above support units are non-shielded (1.8m).

ID	Descriptions	Qty.	Length (m)	Shielding (Yes/No)	Cores (Qty.)	Remarks
1.	RJ45 to RJ232	1	1.5	No	0	Provided by Lab
2.	USB	1	0.1	Yes	0	Provided by Lab
3.	UTP RJ45	1	10	No	0	Provided by Lab
4.	UTP RJ45	1	10	No	0	Provided by Lab
5.	UTP RJ45	1	1.8	No	0	Provided by Lab
6.	AC	1	1.8	No	0	Provided by Lab

3.4.1 Configuration of System under Test

For conducted emission test:

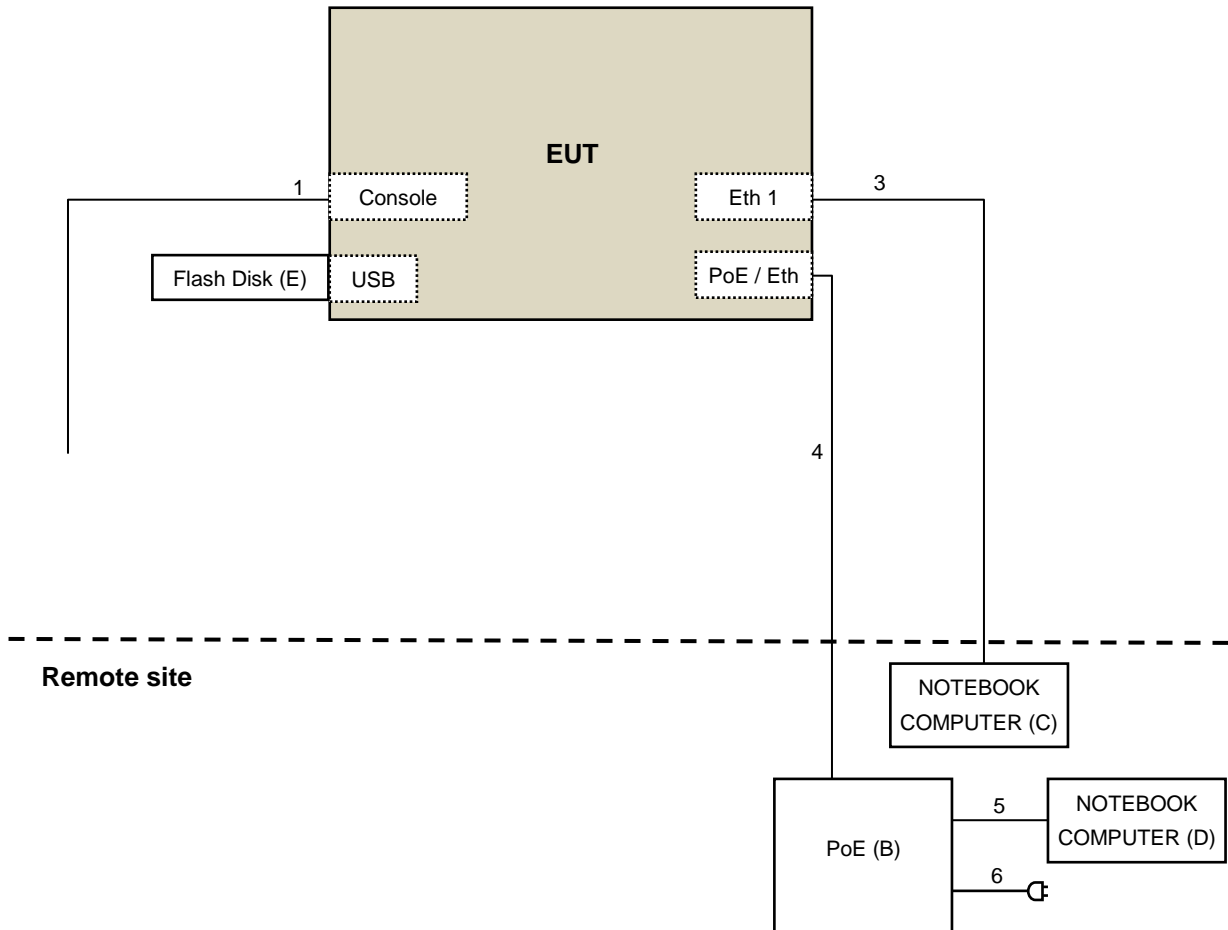

For other test items:

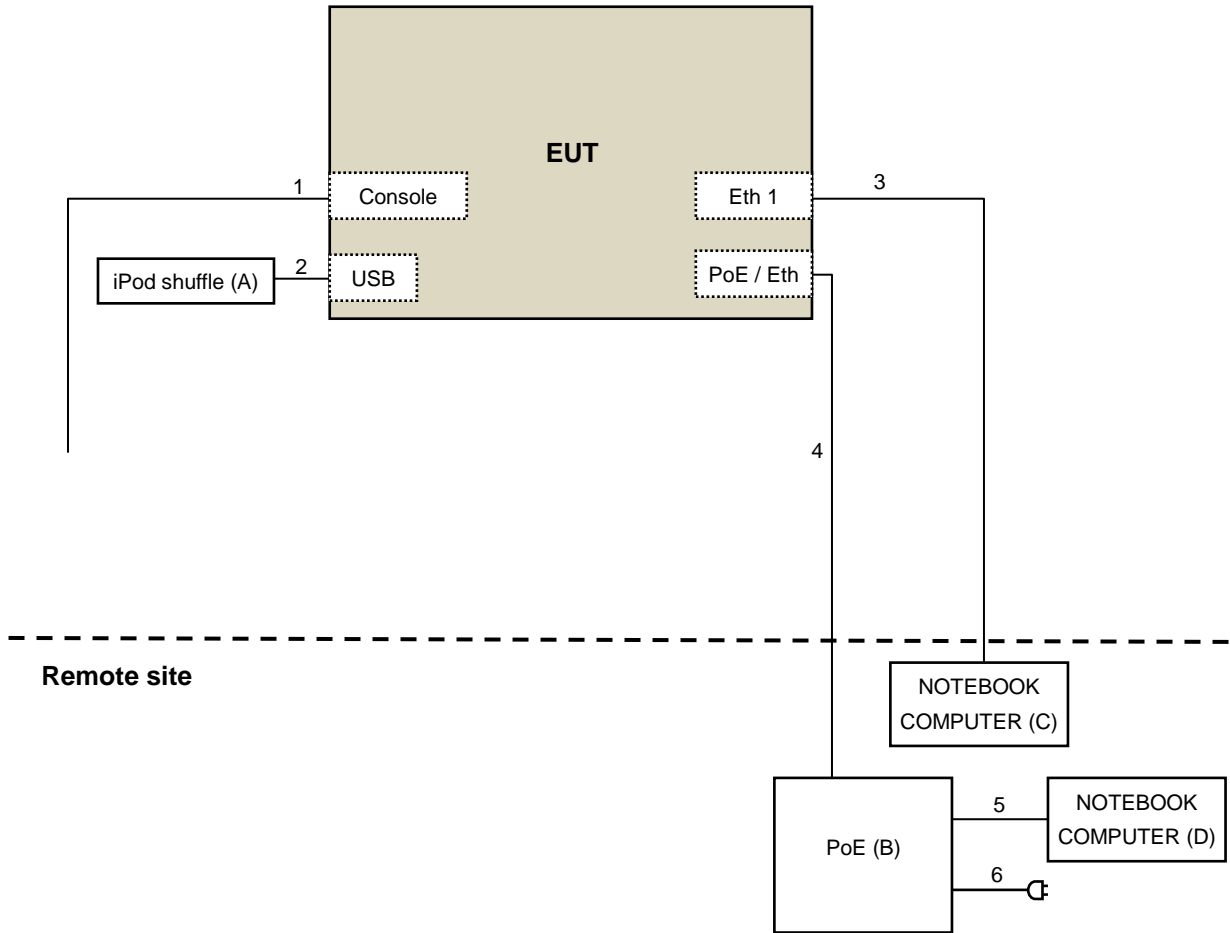

3.5 General Description of Applied Standard

The EUT is a RF Product. According to the specifications of the manufacturer, it must comply with the requirements of the following standards:

FCC Part 15, Subpart E (15.407)

KDB 789033 D02 General UNII Test Procedure New Rules v01r01

KDB 662911 D01 Multiple Transmitter Output v02r01

ANSI C63.10-2013

All test items have been performed and recorded as per the above standards.

4 Test Types and Results

4.1 Radiated Emission and Bandedge Measurement

4.1.1 Limits of Radiated Emission and Bandedge Measurement

Radiated emissions which fall in the restricted bands must comply with the radiated emission limits specified as below table.

Frequencies (MHz)	Field Strength (microvolts/meter)	Measurement Distance (meters)
0.009 ~ 0.490	2400/F(kHz)	300
0.490 ~ 1.705	24000/F(kHz)	30
1.705 ~ 30.0	30	30
30 ~ 88	100	3
88 ~ 216	150	3
216 ~ 960	200	3
Above 960	500	3

NOTE:

1. The lower limit shall apply at the transition frequencies.
2. Emission level (dBuV/m) = 20 log Emission level (uV/m).
3. For frequencies above 1000MHz, the field strength limits are based on average detector, however, the peak field strength of any emission shall not exceed the maximum permitted average limits, specified above by more than 20dB under any condition of modulation.

LIMITS OF UNWANTED EMISSION OUT OF THE RESTRICTED BANDS

APPLICABLE TO	LIMIT	
789033 D02 General UNII Test Procedure New Rules v01r01	FIELD STRENGTH AT 3m	
	PK:74 (dBuV/m)	AV:54 (dBuV/m)
APPLICABLE TO	EIRP LIMIT	EQUIVALENT FIELD STRENGTH AT 3m
15.407(b)(1)	PK:-27 (dBm/MHz)	PK:68.2(dBuV/m)
15.407(b)(2)		
15.407(b)(3)		
15.407(b)(4)	PK:-27 (dBm/MHz) ^{*1} PK:-17 (dBm/MHz) ^{*2}	PK: 68.2(dBuV/m) ^{*1} PK:78.2 (dBuV/m) ^{*2}

NOTE: ^{*1} beyond 10MHz of the band edge ^{*2} within 10 MHz of band edge

The following formula is used to convert the equipment isotropic radiated power (eirp) to field strength:

$$E = \frac{1000000\sqrt{30P}}{3} \mu\text{V/m, where P is the eirp (Watts).$$

4.1.2 Test Instruments

For radio 1 test:

DESCRIPTION & MANUFACTURER	MODEL NO.	SERIAL NO.	CALIBRATED DATE	CALIBRATED UNTIL
Test Receiver Agilent	N9038A	MY54450088	July 24, 2015	July 23, 2016
Pre-Amplifier ^(*) EMCI	EMC001340	980142	Jan. 20, 2016	Jan. 19, 2018
Loop Antenna ^(*) Electro-Metrics	EM-6879	264	Dec. 16, 2014	Dec. 15, 2016
RF Cable	NA	LOOPCAB-001 LOOPCAB-002	Jan. 18, 2016	Jan. 17, 2017
Pre-Amplifier Mini-Circuits	ZFL-1000VH2 B	AMP-ZFL-01	Nov. 11, 2015	Nov. 10, 2016
Trilog Broadband Antenna SCHWARZBECK	VULB 9168	9168-406	Jan. 04, 2016	Jan. 03, 2017
RF Cable	8D	966-4-1 966-4-2 966-4-3	Apr. 03, 2015	Apr. 02, 2016
Horn_Antenna SCHWARZBECK	BBHA 9120D	9120D-783	Jan. 19, 2016	Jan. 18, 2017
Pre-Amplifier Agilent	8449B	3008A01922	Sep. 19, 2015	Sep. 18, 2016
RF Cable	EMC104-SM- SM-2000 EMC104-SM- SM-5000 EMC104-SM- SM-5000	150318 150323 150324	Mar. 31, 2015	Mar. 30, 2016
Pre-Amplifier EMCI	EMC184045	980143	Jan. 15, 2016	Jan. 14, 2017
Horn_Antenna SCHWARZBECK	BBHA 9170	BBHA9170608	Jan. 08, 2016	Jan. 07, 2017
RF Cable	SUCOFLEX 102	36432/2 36441/2	Jan. 16, 2016	Jan. 15, 2017
Software	ADT_Radiated _V8.7.07	NA	NA	NA
Antenna Tower & Turn Table CT	NA	NA	NA	NA
Boresight Antenna Fixture	NA	NA	NA	NA
Power Meter Anritsu	ML2495A	1014008	Apr. 28, 2015	Apr. 27, 2016
Power Sensor Anritsu	MA2411B	0917122	Apr. 28, 2015	Apr. 27, 2016
Temperature & Humidity Chamber TERCHY	MHU-225AU	911033	Dec. 03, 2015	Dec. 02, 2016
Spectrum Analyzer R&S	FSP40	100060	May 08, 2015	May 07, 2016



Note:

1. The calibration interval of the above test instruments is 12 months and the calibrations are traceable to NML/ROC and NIST/USA.
2. The test was performed in 966 Chamber No. 4.
3. The FCC Site Registration No. is 292998
4. The CANADA Site Registration No. is 20331-2
5. Tested Date: Mar. 01 to 08, 2016
- 6.

**For radio 2 test:
2T (Ant 7, 9 / Ant 5, 6), 1T(Ant 5)**

DESCRIPTION & MANUFACTURER	MODEL NO.	SERIAL NO.	CALIBRATED DATE	CALIBRATED UNTIL
Test Receiver Agilent	N9038A	MY50010156	Aug. 12, 2015	Aug. 11, 2016
Pre-Amplifier ^(*) EMCI	EMC001340	980142	Jan. 13, 2014	Jan. 12, 2016
Loop Antenna ^(*) Electro-Metrics	EM-6879	264	Dec. 16, 2014	Dec. 15, 2016
RF Cable	NA	LOOPCAB-001 LOOPCAB-002	Jan. 18, 2015	Jan. 17, 2016
Pre-Amplifier Mini-Circuits	ZFL-1000VH2 B	AMP-ZFL-07	May 08, 2015	May 07, 2016
Trilog Broadband Antenna SCHWARZBECK	VULB 9168	138	Jan. 18, 2016	Jan. 17, 2017
RF Cable	8D	966-3-1 966-3-2 966-3-3	Apr. 03, 2015	Apr. 02, 2016
Horn_Antenna SCHWARZBECK	BBHA9120-D	9120D-406	Jan. 20, 2016	Jan. 19, 2017
Pre-Amplifier Agilent	8449B	3008A02465	Apr. 06, 2015	Apr. 05, 2016
RF Cable	EMC104-SM- SM-2000 EMC104-SM- SM-5000 EMC104-SM- SM-5000	150317 150321 150322	Mar. 31, 2015	Mar. 30, 2016
Spectrum Analyzer Keysight	N9030A	MY54490520	July 26, 2015	July 25, 2016
Pre-Amplifier EMCI	EMC184045	980143	Jan. 15, 2016	Jan. 14, 2017
Horn_Antenna SCHWARZBECK	BBHA 9170	BBHA9170608	Jan. 08, 2016	Jan. 07, 2017
RF Cable	SUCOFLEX 102	36432/2 36441/2	Jan. 16, 2016	Jan. 15, 2017
Software	ADT_Radiated _V8.7.07	NA	NA	NA
Antenna Tower & Turn Table CT	NA	NA	NA	NA
Boresight Antenna Fixture	NA	NA	NA	NA
Power Meter Anritsu	ML2495A	1014008	Apr. 28, 2015	Apr. 27, 2016
Power Sensor Anritsu	MA2411B	0917122	Apr. 28, 2015	Apr. 27, 2016
Temperature & Humidity Chamber TERCHY	MHU-225AU	911033	Dec. 03, 2015	Dec. 02, 2016
Spectrum Analyzer R&S	FSP40	100060	May 08, 2015	May 07, 2016



Note:

1. The calibration interval of the above test instruments is 12 months and the calibrations are traceable to NML/ROC and NIST/USA.
2. The test was performed in 966 Chamber No. 3.
3. The FCC Site Registration No. is 147459
4. The CANADA Site Registration No. is 20331-1
5. Tested Date: Dec. 03, 2015 to Jan. 05, 2016





3T (Ant 7, 8, 9 / Ant 5, 6, 8), 1T(Ant 9)

DESCRIPTION & MANUFACTURER	MODEL NO.	SERIAL NO.	CALIBRATED DATE	CALIBRATED UNTIL
Test Receiver Agilent	N9038A	MY50010156	Aug. 12, 2015	Aug. 11, 2016
Pre-Amplifier ^(*) EMCI	EMC001340	980142	Jan. 20, 2016	Jan. 19, 2018
Loop Antenna ^(*) Electro-Metrics	EM-6879	264	Dec. 16, 2014	Dec. 15, 2016
RF Cable	NA	LOOPCAB-001 LOOPCAB-002	Jan. 18, 2016	Jan. 17, 2017
Pre-Amplifier Mini-Circuits	ZFL-1000VH2 B	AMP-ZFL-07	May 08, 2015	May 07, 2016
Trilog Broadband Antenna SCHWARZBECK	VULB 9168	138	Jan. 18, 2016	Jan. 17, 2017
RF Cable	8D	966-3-1 966-3-2 966-3-3	Apr. 03, 2015	Apr. 02, 2016
Horn_Antenna SCHWARZBECK	BBHA9120-D	9120D-406	Jan. 20, 2016	Jan. 19, 2017
Pre-Amplifier Agilent	8449B	3008A02465	Apr. 06, 2015	Apr. 05, 2016
RF Cable	EMC104-SM- SM-2000 EMC104-SM- SM-5000 EMC104-SM- SM-5000	150317 150321 150322	Mar. 31, 2015	Mar. 30, 2016
Spectrum Analyzer Keysight	N9030A	MY54490520	July 26, 2015	July 25, 2016
Pre-Amplifier EMCI	EMC184045	980143	Jan. 15, 2016	Jan. 14, 2017
Horn_Antenna SCHWARZBECK	BBHA 9170	BBHA9170608	Jan. 08, 2016	Jan. 07, 2017
RF Cable	SUCOFLEX 102	36432/2 36441/2	Jan. 16, 2016	Jan. 15, 2017
Software	ADT_Radiated _V8.7.07	NA	NA	NA
Antenna Tower & Turn Table CT	NA	NA	NA	NA
Boresight Antenna Fixture	NA	NA	NA	NA
Power Meter Anritsu	ML2495A	1014008	Apr. 28, 2015	Apr. 27, 2016
Power Sensor Anritsu	MA2411B	0917122	Apr. 28, 2015	Apr. 27, 2016
Temperature & Humidity Chamber TERCHY	MHU-225AU	911033	Dec. 03, 2015	Dec. 02, 2016
Spectrum Analyzer R&S	FSP40	100060	May 08, 2015	May 07, 2016



Note:

1. The calibration interval of the above test instruments is 12 months and the calibrations are traceable to NML/ROC and NIST/USA.
2. The test was performed in 966 Chamber No. 3.
3. The FCC Site Registration No. is 147459
4. The CANADA Site Registration No. is 20331-1
5. Tested Date: Mar. 10 to 11, 2016

4.1.3 Test Procedure

- a. The EUT was placed on the top of a rotating table 0.8 meters (for below 1GHz) / 1.5 meters (for above 1GHz) above the ground at 3 meter chamber room for test. The table was rotated 360 degrees to determine the position of the highest radiation.
- b. The EUT was set 3 meters away from the interference-receiving antenna, which was mounted on the top of a variable-height antenna tower.
- c. The height of antenna is varied from one meter to four meters above the ground to determine the maximum value of the field strength. Both horizontal and vertical polarizations of the antenna are set to make the measurement.
- d. For each suspected emission, the EUT was arranged to its worst case and then the antenna was tuned to heights from 1 meter to 4 meters and the rotatable table was turned from 0 degrees to 360 degrees to find the maximum reading.
- e. The test-receiver system was set to quasi-peak detect function and specified bandwidth with maximum hold mode when the test frequency is below 1 GHz.
- f. The test-receiver system was set to peak and average detect function and specified bandwidth with maximum hold mode when the test frequency is above 1 GHz. If the peak reading value also meets average limit, measurement with the average detector is unnecessary.

Note:

1. The resolution bandwidth and video bandwidth of test receiver/spectrum analyzer is 120kHz for Quasi-peak detection (QP) at frequency below 1GHz.
2. The resolution bandwidth of test receiver/spectrum analyzer is 1 MHz and the video bandwidth is 3 MHz for Peak detection (PK) at frequency above 1GHz.
3. The resolution bandwidth of test receiver/spectrum analyzer is 1MHz and the video bandwidth is 3MHz for RMS Average (Duty cycle < 98%) for Average detection (AV) at frequency above 1GHz, then the measurement results was added to a correction factor ($10 \log(1/\text{duty cycle})$).
4. The resolution bandwidth of test receiver/spectrum analyzer is 1MHz and the video bandwidth is 10Hz (Duty cycle $\geq 98\%$) for Average detection (AV) at frequency above 1GHz.
5. All modes of operation were investigated and the worst-case emissions are reported.

4.1.4 Deviation from Test Standard

No deviation.

4.1.5 Test Setup

<Frequency Range below 1GHz>

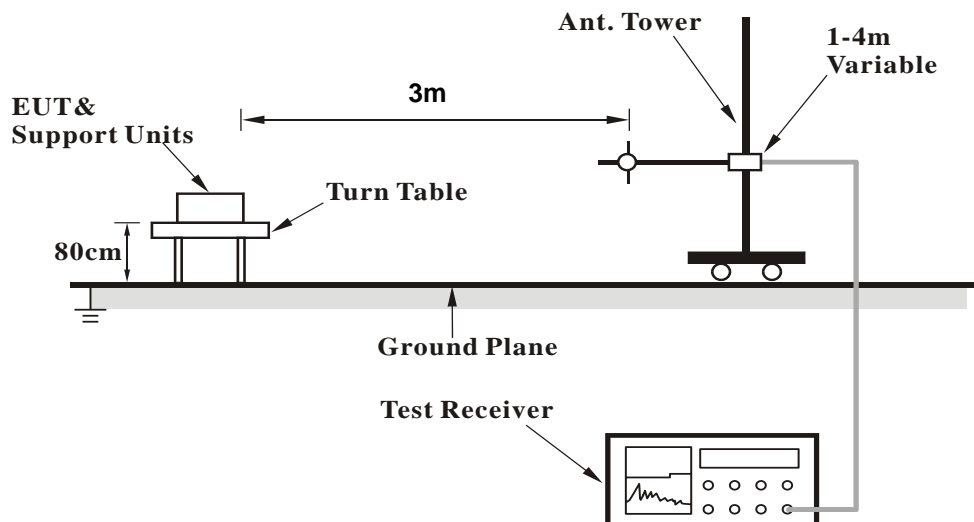

<Frequency Range above 1GHz>

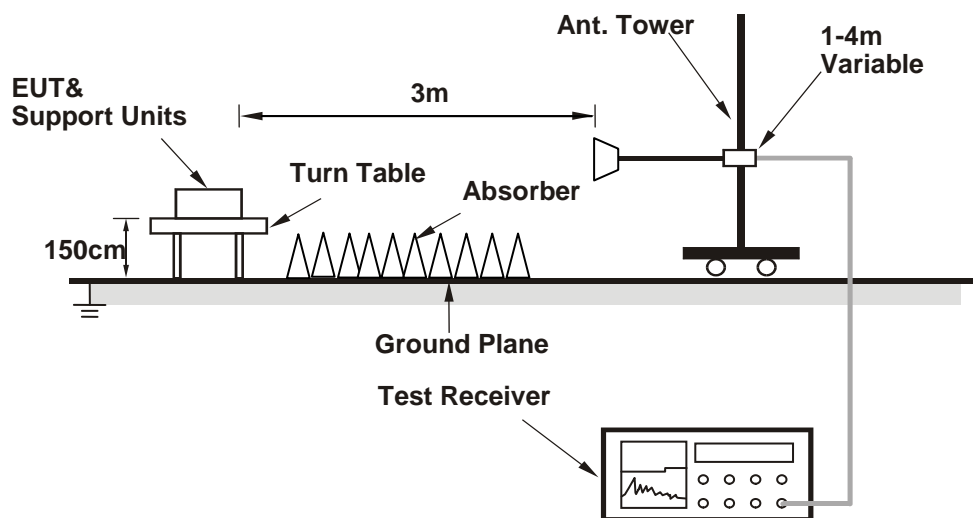

For the actual test configuration, please refer to the attached file (Test Setup Photo).



4.1.6 EUT Operating Condition

1. Placed the EUT on testing table.
2. Connect the EUT with the support unit C (Notebook Computer) which is placed in a remote area.
3. The communication partner run test program "Mtool.exe[ver 2.0.2.8]" to enable EUT under transmission/receiving condition continuously at specific channel frequency.

4.1.7 Test Results (Mode 1)

ABOVE 1GHz DATA :

3TX

ANT1, ANT2, ANT3

802.11a

CHANNEL	TX Channel 52	DETECTOR FUNCTION	Peak (PK)
FREQUENCY RANGE	1GHz ~ 40GHz		Average (AV)

ANTENNA POLARITY & TEST DISTANCE: HORIZONTAL AT 3 M

NO.	FREQ. (MHz)	EMISSION LEVEL (dBuV/m)	LIMIT (dBuV/m)	MARGIN (dB)	ANTENNA HEIGHT (m)	TABLE ANGLE (Degree)	RAW VALUE (dBuV)	CORRECTION FACTOR (dB/m)
1	5100.00	50.8 PK	74.0	-23.2	1.66 H	31	50.13	0.67
2	5100.00	41.0 AV	54.0	-13.0	1.66 H	31	40.33	0.67
3	*5260.00	108.6 PK			1.47 H	83	107.45	1.15
4	*5260.00	97.9 AV			1.47 H	83	96.75	1.15
5	5420.00	58.5 PK	74.0	-15.5	1.84 H	65	57.15	1.35
6	5420.00	42.7 AV	54.0	-11.3	1.84 H	65	41.35	1.35
7	#10520.00	57.0 PK	74.0	-17.0	1.14 H	226	45.75	11.25
8	#10520.00	45.5 AV	54.0	-8.5	1.14 H	226	34.25	11.25
9	15780.00	56.9 PK	74.0	-17.1	1.00 H	58	44.65	12.25
10	15780.00	45.3 AV	54.0	-8.7	1.00 H	58	33.05	12.25

ANTENNA POLARITY & TEST DISTANCE: VERTICAL AT 3 M

NO.	FREQ. (MHz)	EMISSION LEVEL (dBuV/m)	LIMIT (dBuV/m)	MARGIN (dB)	ANTENNA HEIGHT (m)	TABLE ANGLE (Degree)	RAW VALUE (dBuV)	CORRECTION FACTOR (dB/m)
1	5100.00	59.8 PK	74.0	-14.2	2.82 V	360	59.13	0.67
2	5100.00	50.4 AV	54.0	-3.6	2.82 V	360	49.73	0.67
3	*5260.00	116.3 PK			2.82 V	5	115.15	1.15
4	*5260.00	106.7 AV			2.82 V	5	105.55	1.15
5	5420.00	61.2 PK	74.0	-12.8	3.00 V	183	59.85	1.35
6	5420.00	52.4 AV	54.0	-1.6	3.00 V	183	51.05	1.35
7	#10520.00	58.4 PK	74.0	-15.6	2.08 V	166	47.15	11.25
8	#10520.00	43.7 AV	54.0	-10.3	2.08 V	166	32.45	11.25
9	15780.00	59.6 PK	74.0	-14.4	2.10 V	325	47.35	12.25
10	15780.00	47.2 AV	54.0	-6.8	2.10 V	325	34.95	12.25

REMARKS:

1. Emission Level(dBuV/m) = Raw Value(dBuV) + Correction Factor(dB/m)
2. Correction Factor(dB/m) = Antenna Factor(dB/m) + Cable Factor(dB) – Pre-Amplifier Factor(dB)
3. The other emission levels were very low against the limit.
4. Margin value = Emission Level – Limit value
5. " * ": Fundamental frequency.
6. " # ": The radiated frequency is out of the restricted band.

CHANNEL	TX Channel 60	DETECTOR FUNCTION	Peak (PK)
FREQUENCY RANGE	1GHz ~ 40GHz		Average (AV)

ANTENNA POLARITY & TEST DISTANCE: HORIZONTAL AT 3 M

NO.	FREQ. (MHz)	EMISSION LEVEL (dBuV/m)	LIMIT (dBuV/m)	MARGIN (dB)	ANTENNA HEIGHT (m)	TABLE ANGLE (Degree)	RAW VALUE (dBuV)	CORRECTION FACTOR (dB/m)
1	5140.00	58.7 PK	74.0	-15.3	1.73 H	63	57.93	0.77
2	5140.00	43.3 AV	54.0	-10.7	1.73 H	63	42.53	0.77
3	*5300.00	108.8 PK			1.53 H	60	107.53	1.27
4	*5300.00	98.1 AV			1.53 H	60	96.83	1.27
5	5460.00	51.1 PK	74.0	-22.9	1.64 H	33	49.66	1.44
6	5460.00	41.2 AV	54.0	-12.8	1.64 H	33	39.76	1.44
7	10600.00	57.0 PK	74.0	-17.0	1.17 H	222	45.36	11.64
8	10600.00	45.8 AV	54.0	-8.2	1.17 H	222	34.16	11.64
9	15900.00	56.9 PK	74.0	-17.1	1.00 H	78	44.43	12.47
10	15900.00	45.2 AV	54.0	-8.8	1.00 H	78	32.73	12.47

ANTENNA POLARITY & TEST DISTANCE: VERTICAL AT 3 M

NO.	FREQ. (MHz)	EMISSION LEVEL (dBuV/m)	LIMIT (dBuV/m)	MARGIN (dB)	ANTENNA HEIGHT (m)	TABLE ANGLE (Degree)	RAW VALUE (dBuV)	CORRECTION FACTOR (dB/m)
1	5140.00	59.8 PK	74.0	-14.2	3.00 V	0	59.03	0.77
2	5140.00	50.8 AV	54.0	-3.2	3.00 V	0	50.03	0.77
3	*5300.00	116.7 PK			3.00 V	179	115.43	1.27
4	*5300.00	107.0 AV			3.00 V	179	105.73	1.27
5	5460.00	60.9 PK	74.0	-13.1	2.82 V	0	59.46	1.44
6	5460.00	51.7 AV	54.0	-2.3	2.82 V	0	50.26	1.44
7	10600.00	58.5 PK	74.0	-15.5	2.03 V	149	46.86	11.64
8	10600.00	44.2 AV	54.0	-9.8	2.03 V	149	32.56	11.64
9	15900.00	58.8 PK	74.0	-15.2	2.06 V	334	46.33	12.47
10	15900.00	46.3 AV	54.0	-7.7	2.06 V	334	33.83	12.47

REMARKS:

1. Emission Level(dBuV/m) = Raw Value(dBuV) + Correction Factor(dB/m)
2. Correction Factor(dB/m) = Antenna Factor(dB/m) + Cable Factor(dB) – Pre-Amplifier Factor(dB)
3. The other emission levels were very low against the limit.
4. Margin value = Emission Level – Limit value
5. " * ": Fundamental frequency.

CHANNEL	TX Channel 64	DETECTOR FUNCTION	Peak (PK)
FREQUENCY RANGE	1GHz ~ 40GHz		Average (AV)

ANTENNA POLARITY & TEST DISTANCE: HORIZONTAL AT 3 M

NO.	FREQ. (MHz)	EMISSION LEVEL (dBuV/m)	LIMIT (dBuV/m)	MARGIN (dB)	ANTENNA HEIGHT (m)	TABLE ANGLE (Degree)	RAW VALUE (dBuV)	CORRECTION FACTOR (dB/m)
1	*5320.00	108.8 PK			1.51 H	69	107.52	1.28
2	*5320.00	98.3 AV			1.51 H	69	97.02	1.28
3	5400.00	50.6 PK	74.0	-23.4	1.69 H	26	49.29	1.31
4	5400.00	40.7 AV	54.0	-13.3	1.69 H	26	39.39	1.31
5	#5480.00	58.8 PK	74.0	-15.2	1.68 H	74	57.33	1.47
6	#5480.00	43.5 AV	54.0	-10.5	1.68 H	74	42.03	1.47
7	10640.00	56.8 PK	74.0	-17.2	1.18 H	224	45.12	11.68
8	10640.00	45.5 AV	54.0	-8.5	1.18 H	224	33.82	11.68
9	15960.00	56.7 PK	74.0	-17.3	1.00 H	92	44.25	12.45
10	15960.00	45.2 AV	54.0	-8.8	1.00 H	92	32.75	12.45

ANTENNA POLARITY & TEST DISTANCE: VERTICAL AT 3 M

NO.	FREQ. (MHz)	EMISSION LEVEL (dBuV/m)	LIMIT (dBuV/m)	MARGIN (dB)	ANTENNA HEIGHT (m)	TABLE ANGLE (Degree)	RAW VALUE (dBuV)	CORRECTION FACTOR (dB/m)
1	*5320.00	117.1 PK			2.60 V	178	115.82	1.28
2	*5320.00	107.0 AV			2.60 V	178	105.72	1.28
3	5400.00	63.2 PK	74.0	-10.8	2.99 V	319	61.89	1.31
4	5400.00	52.0 AV	54.0	-2.0	2.99 V	319	50.69	1.31
5	#5480.00	61.9 PK	74.0	-12.1	2.99 V	314	60.43	1.47
6	#5480.00	51.9 AV	54.0	-2.1	2.99 V	314	50.43	1.47
7	10640.00	58.2 PK	74.0	-15.8	2.09 V	160	46.52	11.68
8	10640.00	43.9 AV	54.0	-10.1	2.09 V	160	32.22	11.68
9	15960.00	59.2 PK	74.0	-14.8	2.08 V	306	46.75	12.45
10	15960.00	47.0 AV	54.0	-7.0	2.08 V	306	34.55	12.45

REMARKS:

1. Emission Level(dBuV/m) = Raw Value(dBuV) + Correction Factor(dB/m)
2. Correction Factor(dB/m) = Antenna Factor(dB/m) + Cable Factor(dB) – Pre-Amplifier Factor(dB)
3. The other emission levels were very low against the limit.
4. Margin value = Emission Level – Limit value
5. " * ": Fundamental frequency.
6. " # ": The radiated frequency is out of the restricted band.

CHANNEL	TX Channel 100	DETECTOR FUNCTION	Peak (PK)
FREQUENCY RANGE	1GHz ~ 40GHz		Average (AV)

ANTENNA POLARITY & TEST DISTANCE: HORIZONTAL AT 3 M

NO.	FREQ. (MHz)	EMISSION LEVEL (dBuV/m)	LIMIT (dBuV/m)	MARGIN (dB)	ANTENNA HEIGHT (m)	TABLE ANGLE (Degree)	RAW VALUE (dBuV)	CORRECTION FACTOR (dB/m)
1	#5340.00	50.5 PK	74.0	-23.5	1.69 H	65	49.21	1.29
2	#5340.00	40.7 AV	54.0	-13.3	1.69 H	65	39.41	1.29
3	5420.00	58.4 PK	74.0	-15.6	1.78 H	57	57.05	1.35
4	5420.00	42.8 AV	54.0	-11.2	1.78 H	57	41.45	1.35
5	*5500.00	106.5 PK			1.50 H	70	104.99	1.51
6	*5500.00	97.6 AV			1.50 H	70	96.09	1.51
7	#5729.00	51.9 PK	74.0	-22.1	1.59 H	106	49.95	1.95
8	#5729.00	41.5 AV	54.0	-12.5	1.59 H	106	39.55	1.95
9	11000.00	57.7 PK	74.0	-16.3	1.08 H	232	44.66	13.04
10	11000.00	45.7 AV	54.0	-8.3	1.08 H	232	32.66	13.04
11	#16500.00	57.5 PK	74.0	-16.5	1.07 H	87	42.23	15.27
12	#16500.00	46.0 AV	54.0	-8.0	1.07 H	87	30.73	15.27

ANTENNA POLARITY & TEST DISTANCE: VERTICAL AT 3 M

NO.	FREQ. (MHz)	EMISSION LEVEL (dBuV/m)	LIMIT (dBuV/m)	MARGIN (dB)	ANTENNA HEIGHT (m)	TABLE ANGLE (Degree)	RAW VALUE (dBuV)	CORRECTION FACTOR (dB/m)
1	#5340.00	61.1 PK	74.0	-12.9	2.82 V	169	59.81	1.29
2	#5340.00	50.9 AV	54.0	-3.1	2.82 V	169	49.61	1.29
3	5420.00	60.7 PK	74.0	-13.3	2.81 V	169	59.35	1.35
4	5420.00	51.5 AV	54.0	-2.5	2.81 V	169	50.15	1.35
5	*5500.00	115.1 PK			2.82 V	193	113.59	1.51
6	*5500.00	106.6 AV			2.82 V	193	105.09	1.51
7	#5729.00	60.9 PK	74.0	-13.1	2.37 V	180	58.95	1.95
8	#5729.00	52.2 AV	54.0	-1.8	2.37 V	180	50.25	1.95
9	11000.00	58.1 PK	74.0	-15.9	2.06 V	166	45.06	13.04
10	11000.00	43.7 AV	54.0	-10.3	2.06 V	166	30.66	13.04
11	#16500.00	59.2 PK	74.0	-14.8	2.06 V	319	43.93	15.27
12	#16500.00	47.3 AV	54.0	-6.7	2.06 V	319	32.03	15.27

REMARKS:

1. Emission Level(dBuV/m) = Raw Value(dBuV) + Correction Factor(dB/m)
2. Correction Factor(dB/m) = Antenna Factor(dB/m) + Cable Factor(dB) – Pre-Amplifier Factor(dB)
3. The other emission levels were very low against the limit.
4. Margin value = Emission Level – Limit value
5. " * ": Fundamental frequency.
6. " # ": The radiated frequency is out of the restricted band.

CHANNEL	TX Channel 116	DETECTOR FUNCTION	Peak (PK)
FREQUENCY RANGE	1GHz ~ 40GHz		Average (AV)

ANTENNA POLARITY & TEST DISTANCE: HORIZONTAL AT 3 M

NO.	FREQ. (MHz)	EMISSION LEVEL (dBuV/m)	LIMIT (dBuV/m)	MARGIN (dB)	ANTENNA HEIGHT (m)	TABLE ANGLE (Degree)	RAW VALUE (dBuV)	CORRECTION FACTOR (dB/m)
1	5420.00	58.3 PK	74.0	-15.7	1.74 H	58	56.95	1.35
2	5420.00	42.4 AV	54.0	-11.6	1.74 H	58	41.05	1.35
3	*5580.00	107.1 PK			1.48 H	55	105.44	1.66
4	*5580.00	97.1 AV			1.48 H	55	95.44	1.66
5	#5740.00	51.7 PK	74.0	-22.3	1.60 H	116	49.74	1.96
6	#5740.00	41.1 AV	54.0	-12.9	1.60 H	116	39.14	1.96
7	11160.00	57.8 PK	74.0	-16.2	1.05 H	247	44.98	12.82
8	11160.00	46.0 AV	54.0	-8.0	1.05 H	247	33.18	12.82
9	#16740.00	57.4 PK	74.0	-16.6	1.01 H	82	41.41	15.99
10	#16740.00	45.6 AV	54.0	-8.4	1.01 H	82	29.61	15.99

ANTENNA POLARITY & TEST DISTANCE: VERTICAL AT 3 M

NO.	FREQ. (MHz)	EMISSION LEVEL (dBuV/m)	LIMIT (dBuV/m)	MARGIN (dB)	ANTENNA HEIGHT (m)	TABLE ANGLE (Degree)	RAW VALUE (dBuV)	CORRECTION FACTOR (dB/m)
1	5420.00	60.5 PK	74.0	-13.5	2.98 V	176	59.15	1.35
2	5420.00	51.6 AV	54.0	-2.4	2.98 V	176	50.25	1.35
3	*5580.00	115.9 PK			2.81 V	129	114.24	1.66
4	*5580.00	106.3 AV			2.81 V	129	104.64	1.66
5	#5740.00	61.4 PK	74.0	-12.6	2.85 V	176	59.44	1.96
6	#5740.00	51.3 AV	54.0	-2.7	2.85 V	176	49.34	1.96
7	11160.00	58.6 PK	74.0	-15.4	2.03 V	156	45.78	12.82
8	11160.00	44.1 AV	54.0	-9.9	2.03 V	156	31.28	12.82
9	#16740.00	59.7 PK	74.0	-14.3	2.03 V	313	43.71	15.99
10	#16740.00	47.8 AV	54.0	-6.2	2.03 V	313	31.81	15.99

REMARKS:

1. Emission Level(dBuV/m) = Raw Value(dBuV) + Correction Factor(dB/m)
2. Correction Factor(dB/m) = Antenna Factor(dB/m) + Cable Factor(dB) – Pre-Amplifier Factor(dB)
3. The other emission levels were very low against the limit.
4. Margin value = Emission Level – Limit value
5. " * ": Fundamental frequency.
6. " # ": The radiated frequency is out of the restricted band.

CHANNEL	TX Channel 140	DETECTOR FUNCTION	Peak (PK)
FREQUENCY RANGE	1GHz ~ 40GHz		Average (AV)

ANTENNA POLARITY & TEST DISTANCE: HORIZONTAL AT 3 M

NO.	FREQ. (MHz)	EMISSION LEVEL (dBuV/m)	LIMIT (dBuV/m)	MARGIN (dB)	ANTENNA HEIGHT (m)	TABLE ANGLE (Degree)	RAW VALUE (dBuV)	CORRECTION FACTOR (dB/m)
1	#5225.00	50.1 PK	74.0	-23.9	1.68 H	79	49.07	1.03
2	#5225.00	40.3 AV	54.0	-13.7	1.68 H	79	39.27	1.03
3	*5700.00	107.9 PK			1.49 H	48	106.01	1.89
4	*5700.00	97.7 AV			1.49 H	48	95.81	1.89
5	#5725.00	58.6 PK	74.0	-15.4	1.79 H	46	56.67	1.93
6	#5725.00	43.0 AV	54.0	-11.0	1.79 H	46	41.07	1.93
7	#5780.00	51.7 PK	74.0	-22.3	1.56 H	92	49.64	2.06
8	#5780.00	41.5 AV	54.0	-12.5	1.56 H	92	39.44	2.06
9	11400.00	58.2 PK	74.0	-15.8	1.11 H	262	45.32	12.88
10	11400.00	46.3 AV	54.0	-7.7	1.11 H	262	33.42	12.88
11	#17100.00	57.3 PK	74.0	-16.7	1.00 H	76	39.99	17.31
12	#17100.00	45.8 AV	54.0	-8.2	1.00 H	76	28.49	17.31

ANTENNA POLARITY & TEST DISTANCE: VERTICAL AT 3 M

NO.	FREQ. (MHz)	EMISSION LEVEL (dBuV/m)	LIMIT (dBuV/m)	MARGIN (dB)	ANTENNA HEIGHT (m)	TABLE ANGLE (Degree)	RAW VALUE (dBuV)	CORRECTION FACTOR (dB/m)
1	#5225.00	55.1 PK	74.0	-18.9	2.66 V	126	54.07	1.03
2	#5225.00	49.6 AV	54.0	-4.4	2.66 V	126	48.57	1.03
3	*5700.00	116.0 PK			3.01 V	178	114.11	1.89
4	*5700.00	106.4 AV			3.01 V	178	104.51	1.89
5	#5725.00	69.5 PK	74.0	-4.5	2.76 V	178	67.57	1.93
6	#5725.00	51.8 AV	54.0	-2.2	2.76 V	178	49.87	1.93
7	#5780.00	62.8 PK	74.0	-11.2	2.76 V	176	60.74	2.06
8	#5780.00	50.7 AV	54.0	-3.3	2.76 V	176	48.64	2.06
9	11400.00	59.0 PK	74.0	-15.0	2.03 V	163	46.12	12.88
10	11400.00	44.6 AV	54.0	-9.4	2.03 V	163	31.72	12.88
11	#17100.00	59.4 PK	74.0	-14.6	1.98 V	301	42.09	17.31
12	#17100.00	47.5 AV	54.0	-6.5	1.98 V	301	30.19	17.31

REMARKS:

1. Emission Level(dBuV/m) = Raw Value(dBuV) + Correction Factor(dB/m)
2. Correction Factor(dB/m) = Antenna Factor(dB/m) + Cable Factor(dB) – Pre-Amplifier Factor(dB)
3. The other emission levels were very low against the limit.
4. Margin value = Emission Level – Limit value
5. " * ": Fundamental frequency.
6. " # ": The radiated frequency is out of the restricted band.

CHANNEL	TX Channel 144	DETECTOR FUNCTION	Peak (PK)
FREQUENCY RANGE	1GHz ~ 40GHz		Average (AV)

ANTENNA POLARITY & TEST DISTANCE: HORIZONTAL AT 3 M

NO.	FREQ. (MHz)	EMISSION LEVEL (dBuV/m)	LIMIT (dBuV/m)	MARGIN (dB)	ANTENNA HEIGHT (m)	TABLE ANGLE (Degree)	RAW VALUE (dBuV)	CORRECTION FACTOR (dB/m)
1	#5243.00	52.1 PK	74.0	-21.9	1.61 H	80	51.01	1.09
2	#5243.00	41.9 AV	54.0	-12.1	1.61 H	80	40.81	1.09
3	*5720.00	109.7 PK			1.65 H	48	107.78	1.92
4	*5720.00	98.6 AV			1.65 H	48	96.68	1.92
5	#5880.00	58.5 PK	74.0	-15.5	1.82 H	43	56.36	2.14
6	#5880.00	42.9 AV	54.0	-11.1	1.82 H	43	40.76	2.14
7	11440.00	58.0 PK	74.0	-16.0	1.12 H	275	45.13	12.87
8	11440.00	46.1 AV	54.0	-7.9	1.12 H	275	33.23	12.87
9	#17160.00	56.8 PK	74.0	-17.2	1.09 H	62	39.41	17.39
10	#17160.00	45.6 AV	54.0	-8.4	1.09 H	62	28.21	17.39

ANTENNA POLARITY & TEST DISTANCE: VERTICAL AT 3 M

NO.	FREQ. (MHz)	EMISSION LEVEL (dBuV/m)	LIMIT (dBuV/m)	MARGIN (dB)	ANTENNA HEIGHT (m)	TABLE ANGLE (Degree)	RAW VALUE (dBuV)	CORRECTION FACTOR (dB/m)
1	#5243.00	51.7 PK	74.0	-22.3	2.41 V	27	50.61	1.09
2	#5243.00	46.3 AV	54.0	-7.7	2.41 V	27	45.21	1.09
3	*5720.00	118.0 PK			2.54 V	76	116.08	1.92
4	*5720.00	107.3 AV			2.54 V	76	105.38	1.92
5	#5880.00	62.4 PK	74.0	-11.7	2.54 V	75	60.21	2.14
6	#5880.00	52.6 AV	54.0	-1.4	2.54 V	75	50.46	2.14
7	11440.00	59.6 PK	74.0	-14.4	1.99 V	148	46.73	12.87
8	11440.00	45.1 AV	54.0	-8.9	1.99 V	148	32.23	12.87
9	#17160.00	59.3 PK	74.0	-14.7	1.95 V	309	41.91	17.39
10	#17160.00	47.2 AV	54.0	-6.8	1.95 V	309	29.81	17.39

REMARKS:

1. Emission Level(dBuV/m) = Raw Value(dBuV) + Correction Factor(dB/m)
2. Correction Factor(dB/m) = Antenna Factor(dB/m) + Cable Factor(dB) – Pre-Amplifier Factor(dB)
3. The other emission levels were very low against the limit.
4. Margin value = Emission Level – Limit value
5. " * ": Fundamental frequency.
6. " # ": The radiated frequency is out of the restricted band.

802.11ac VHT20

CHANNEL	TX Channel 52	DETECTOR FUNCTION	Peak (PK)
FREQUENCY RANGE	1GHz ~ 40GHz		Average (AV)

ANTENNA POLARITY & TEST DISTANCE: HORIZONTAL AT 3 M

NO.	FREQ. (MHz)	EMISSION LEVEL (dBuV/m)	LIMIT (dBuV/m)	MARGIN (dB)	ANTENNA HEIGHT (m)	TABLE ANGLE (Degree)	RAW VALUE (dBuV)	CORRECTION FACTOR (dB/m)
1	5100.00	59.0 PK	74.0	-15.0	1.87 H	65	58.33	0.67
2	5100.00	43.0 AV	54.0	-11.0	1.87 H	65	42.33	0.67
3	*5260.00	108.6 PK			1.66 H	88	107.45	1.15
4	*5260.00	98.6 AV			1.66 H	88	97.45	1.15
5	5420.00	50.9 PK	74.0	-23.1	1.71 H	45	49.55	1.35
6	5420.00	40.9 AV	54.0	-13.1	1.71 H	45	39.55	1.35
7	#10520.00	57.0 PK	74.0	-17.0	1.11 H	235	45.75	11.25
8	#10520.00	45.6 AV	54.0	-8.4	1.11 H	235	34.35	11.25
9	15780.00	56.8 PK	74.0	-17.2	1.00 H	57	44.55	12.25
10	15780.00	45.0 AV	54.0	-9.0	1.00 H	57	32.75	12.25

ANTENNA POLARITY & TEST DISTANCE: VERTICAL AT 3 M

NO.	FREQ. (MHz)	EMISSION LEVEL (dBuV/m)	LIMIT (dBuV/m)	MARGIN (dB)	ANTENNA HEIGHT (m)	TABLE ANGLE (Degree)	RAW VALUE (dBuV)	CORRECTION FACTOR (dB/m)
1	5100.00	61.0 PK	74.0	-13.0	3.14 V	181	60.33	0.67
2	5100.00	51.2 AV	54.0	-2.8	3.14 V	181	50.53	0.67
3	*5260.00	116.0 PK			2.88 V	181	114.85	1.15
4	*5260.00	106.3 AV			2.88 V	181	105.15	1.15
5	5420.00	61.4 PK	74.0	-12.6	2.88 V	180	60.05	1.35
6	5420.00	52.0 AV	54.0	-2.0	2.88 V	180	50.65	1.35
7	#10520.00	58.5 PK	74.0	-15.5	2.05 V	190	47.25	11.25
8	#10520.00	44.0 AV	54.0	-10.0	2.05 V	190	32.75	11.25
9	15780.00	56.9 PK	74.0	-17.1	2.07 V	340	44.65	12.25
10	15780.00	45.8 AV	54.0	-8.2	2.07 V	340	33.55	12.25

REMARKS:

- Emission Level(dBuV/m) = Raw Value(dBuV) + Correction Factor(dB/m)
- Correction Factor(dB/m) = Antenna Factor(dB/m) + Cable Factor(dB) – Pre-Amplifier Factor(dB)
- The other emission levels were very low against the limit.
- Margin value = Emission Level – Limit value
- " * ": Fundamental frequency.
- " # ": The radiated frequency is out of the restricted band.

CHANNEL	TX Channel 60	DETECTOR FUNCTION	Peak (PK)
FREQUENCY RANGE	1GHz ~ 40GHz		Average (AV)

ANTENNA POLARITY & TEST DISTANCE: HORIZONTAL AT 3 M

NO.	FREQ. (MHz)	EMISSION LEVEL (dBuV/m)	LIMIT (dBuV/m)	MARGIN (dB)	ANTENNA HEIGHT (m)	TABLE ANGLE (Degree)	RAW VALUE (dBuV)	CORRECTION FACTOR (dB/m)
1	5130.00	59.1 PK	74.0	-14.9	1.85 H	55	58.36	0.74
2	5130.00	43.2 AV	54.0	-10.8	1.85 H	55	42.46	0.74
3	*5300.00	109.0 PK			1.65 H	76	107.73	1.27
4	*5300.00	98.8 AV			1.65 H	76	97.53	1.27
5	5380.00	50.4 PK	74.0	-23.6	1.77 H	34	49.10	1.30
6	5380.00	40.6 AV	54.0	-13.4	1.77 H	34	39.30	1.30
7	10600.00	57.2 PK	74.0	-16.8	1.12 H	232	45.56	11.64
8	10600.00	45.6 AV	54.0	-8.4	1.12 H	232	33.96	11.64
9	15900.00	56.7 PK	74.0	-17.3	1.00 H	66	44.23	12.47
10	15900.00	44.9 AV	54.0	-9.1	1.00 H	66	32.43	12.47

ANTENNA POLARITY & TEST DISTANCE: VERTICAL AT 3 M

NO.	FREQ. (MHz)	EMISSION LEVEL (dBuV/m)	LIMIT (dBuV/m)	MARGIN (dB)	ANTENNA HEIGHT (m)	TABLE ANGLE (Degree)	RAW VALUE (dBuV)	CORRECTION FACTOR (dB/m)
1	5130.00	61.6 PK	74.0	-12.4	3.10 V	181	60.86	0.74
2	5130.00	51.3 AV	54.0	-2.7	3.10 V	181	50.56	0.74
3	*5300.00	116.3 PK			3.19 V	180	115.03	1.27
4	*5300.00	106.3 AV			3.19 V	180	105.03	1.27
5	5380.00	63.1 PK	74.0	-10.9	2.97 V	179	61.80	1.30
6	5380.00	52.0 AV	54.0	-2.0	2.97 V	179	50.70	1.30
7	10600.00	59.1 PK	74.0	-14.9	2.07 V	186	47.46	11.64
8	10600.00	44.8 AV	54.0	-9.2	2.07 V	186	33.16	11.64
9	15900.00	57.6 PK	74.0	-16.4	2.04 V	331	45.13	12.47
10	15900.00	46.6 AV	54.0	-7.4	2.04 V	331	34.13	12.47

REMARKS:

1. Emission Level(dBuV/m) = Raw Value(dBuV) + Correction Factor(dB/m)
2. Correction Factor(dB/m) = Antenna Factor(dB/m) + Cable Factor(dB) – Pre-Amplifier Factor(dB)
3. The other emission levels were very low against the limit.
4. Margin value = Emission Level – Limit value
5. " * ": Fundamental frequency.

CHANNEL	TX Channel 64	DETECTOR FUNCTION	Peak (PK)
FREQUENCY RANGE	1GHz ~ 40GHz		Average (AV)

ANTENNA POLARITY & TEST DISTANCE: HORIZONTAL AT 3 M

NO.	FREQ. (MHz)	EMISSION LEVEL (dBuV/m)	LIMIT (dBuV/m)	MARGIN (dB)	ANTENNA HEIGHT (m)	TABLE ANGLE (Degree)	RAW VALUE (dBuV)	CORRECTION FACTOR (dB/m)
1	*5320.00	108.0 PK			1.71 H	72	106.72	1.28
2	*5320.00	98.2 AV			1.71 H	72	96.92	1.28
3	5350.00	58.6 PK	74.0	-15.4	1.88 H	54	57.30	1.30
4	5350.00	42.9 AV	54.0	-11.1	1.88 H	54	41.60	1.30
5	5400.00	51.2 PK	74.0	-22.8	1.74 H	49	49.89	1.31
6	5400.00	40.9 AV	54.0	-13.1	1.74 H	49	39.59	1.31
7	#5480.00	59.5 PK	74.0	-14.5	1.92 H	66	58.03	1.47
8	#5480.00	43.2 AV	54.0	-10.8	1.92 H	66	41.73	1.47
9	10640.00	56.8 PK	74.0	-17.2	1.07 H	234	45.12	11.68
10	10640.00	45.5 AV	54.0	-8.5	1.07 H	234	33.82	11.68
11	15960.00	56.5 PK	74.0	-17.5	1.00 H	62	44.05	12.45
12	15960.00	45.0 AV	54.0	-9.0	1.00 H	62	32.55	12.45

ANTENNA POLARITY & TEST DISTANCE: VERTICAL AT 3 M

NO.	FREQ. (MHz)	EMISSION LEVEL (dBuV/m)	LIMIT (dBuV/m)	MARGIN (dB)	ANTENNA HEIGHT (m)	TABLE ANGLE (Degree)	RAW VALUE (dBuV)	CORRECTION FACTOR (dB/m)
1	*5320.00	117.8 PK			2.73 V	178	116.52	1.28
2	*5320.00	107.4 AV			2.73 V	178	106.12	1.28
3	5350.00	69.9 PK	74.0	-4.1	2.58 V	128	68.60	1.30
4	5350.00	49.3 AV	54.0	-4.7	2.58 V	128	48.00	1.30
5	5400.00	62.6 PK	74.0	-11.4	2.85 V	178	61.29	1.31
6	5400.00	49.8 AV	54.0	-4.2	2.85 V	178	48.49	1.31
7	#5480.00	61.8 PK	74.0	-12.2	1.00 V	253	60.33	1.47
8	#5480.00	51.9 AV	54.0	-2.1	1.00 V	253	50.43	1.47
9	10640.00	58.8 PK	74.0	-15.2	2.07 V	198	47.12	11.68
10	10640.00	44.1 AV	54.0	-9.9	2.07 V	198	32.42	11.68
11	15960.00	57.6 PK	74.0	-16.4	2.05 V	321	45.15	12.45
12	15960.00	46.3 AV	54.0	-7.7	2.05 V	321	33.85	12.45

REMARKS:

1. Emission Level(dBuV/m) = Raw Value(dBuV) + Correction Factor(dB/m)
2. Correction Factor(dB/m) = Antenna Factor(dB/m) + Cable Factor(dB) – Pre-Amplifier Factor(dB)
3. The other emission levels were very low against the limit.
4. Margin value = Emission Level – Limit value
5. " * ": Fundamental frequency.
6. " # ": The radiated frequency is out of the restricted band.

CHANNEL	TX Channel 100	DETECTOR FUNCTION	Peak (PK)
FREQUENCY RANGE	1GHz ~ 40GHz		Average (AV)

ANTENNA POLARITY & TEST DISTANCE: HORIZONTAL AT 3 M

NO.	FREQ. (MHz)	EMISSION LEVEL (dBuV/m)	LIMIT (dBuV/m)	MARGIN (dB)	ANTENNA HEIGHT (m)	TABLE ANGLE (Degree)	RAW VALUE (dBuV)	CORRECTION FACTOR (dB/m)
1	#5340.00	50.8 PK	74.0	-23.2	1.78 H	33	49.51	1.29
2	#5340.00	40.5 AV	54.0	-13.5	1.78 H	33	39.21	1.29
3	5420.00	58.4 PK	74.0	-15.6	1.91 H	53	57.05	1.35
4	5420.00	42.7 AV	54.0	-11.3	1.91 H	53	41.35	1.35
5	*5500.00	109.6 PK			1.77 H	60	108.09	1.51
6	*5500.00	98.6 AV			1.77 H	60	97.09	1.51
7	11000.00	56.5 PK	74.0	-17.5	1.08 H	245	43.46	13.04
8	11000.00	45.1 AV	54.0	-8.9	1.08 H	245	32.06	13.04
9	#16500.00	56.8 PK	74.0	-17.2	1.00 H	73	41.53	15.27
10	#16500.00	45.1 AV	54.0	-8.9	1.00 H	73	29.83	15.27

ANTENNA POLARITY & TEST DISTANCE: VERTICAL AT 3 M

NO.	FREQ. (MHz)	EMISSION LEVEL (dBuV/m)	LIMIT (dBuV/m)	MARGIN (dB)	ANTENNA HEIGHT (m)	TABLE ANGLE (Degree)	RAW VALUE (dBuV)	CORRECTION FACTOR (dB/m)
1	#5340.00	61.2 PK	74.0	-12.8	2.63 V	178	59.91	1.29
2	#5340.00	51.4 AV	54.0	-2.6	2.63 V	178	50.11	1.29
3	5420.00	61.8 PK	74.0	-12.2	2.67 V	176	60.45	1.35
4	5420.00	51.3 AV	54.0	-2.7	2.67 V	176	49.95	1.35
5	*5500.00	116.8 PK			2.66 V	177	115.29	1.51
6	*5500.00	106.3 AV			2.66 V	177	104.79	1.51
7	11000.00	58.7 PK	74.0	-15.3	2.09 V	205	45.66	13.04
8	11000.00	44.0 AV	54.0	-10.0	2.09 V	205	30.96	13.04
9	#16500.00	57.2 PK	74.0	-16.8	2.08 V	314	41.93	15.27
10	#16500.00	45.9 AV	54.0	-8.1	2.08 V	314	30.63	15.27

REMARKS:

1. Emission Level(dBuV/m) = Raw Value(dBuV) + Correction Factor(dB/m)
2. Correction Factor(dB/m) = Antenna Factor(dB/m) + Cable Factor(dB) – Pre-Amplifier Factor(dB)
3. The other emission levels were very low against the limit.
4. Margin value = Emission Level – Limit value
5. " * ": Fundamental frequency.
6. " # ": The radiated frequency is out of the restricted band.

CHANNEL	TX Channel 116	DETECTOR FUNCTION	Peak (PK)
FREQUENCY RANGE	1GHz ~ 40GHz		Average (AV)

ANTENNA POLARITY & TEST DISTANCE: HORIZONTAL AT 3 M

NO.	FREQ. (MHz)	EMISSION LEVEL (dBuV/m)	LIMIT (dBuV/m)	MARGIN (dB)	ANTENNA HEIGHT (m)	TABLE ANGLE (Degree)	RAW VALUE (dBuV)	CORRECTION FACTOR (dB/m)
1	5420.00	51.3 PK	74.0	-22.7	1.48 H	35	49.95	1.35
2	5420.00	41.7 AV	54.0	-12.3	1.48 H	35	40.35	1.35
3	*5580.00	110.0 PK			1.62 H	53	108.34	1.66
4	*5580.00	100.1 AV			1.62 H	53	98.44	1.66
5	#5740.00	57.9 PK	74.0	-16.1	1.70 H	58	55.94	1.96
6	#5740.00	42.7 AV	54.0	-11.3	1.70 H	58	40.74	1.96
7	11160.00	57.4 PK	74.0	-16.6	1.13 H	272	44.58	12.82
8	11160.00	45.7 AV	54.0	-8.3	1.13 H	272	32.88	12.82
9	#16740.00	58.7 PK	74.0	-15.3	1.03 H	54	42.71	15.99
10	#16740.00	47.6 AV	54.0	-6.4	1.03 H	54	31.61	15.99

ANTENNA POLARITY & TEST DISTANCE: VERTICAL AT 3 M

NO.	FREQ. (MHz)	EMISSION LEVEL (dBuV/m)	LIMIT (dBuV/m)	MARGIN (dB)	ANTENNA HEIGHT (m)	TABLE ANGLE (Degree)	RAW VALUE (dBuV)	CORRECTION FACTOR (dB/m)
1	5420.00	59.7 PK	74.0	-14.3	2.95 V	176	58.35	1.35
2	5420.00	51.4 AV	54.0	-2.6	2.95 V	176	50.05	1.35
3	*5580.00	116.6 PK			2.71 V	179	114.94	1.66
4	*5580.00	106.5 AV			2.71 V	179	104.84	1.66
5	#5740.00	61.9 PK	74.0	-12.1	2.66 V	180	59.94	1.96
6	#5740.00	51.7 AV	54.0	-2.3	2.66 V	180	49.74	1.96
7	11160.00	58.4 PK	74.0	-15.6	2.13 V	207	45.58	12.82
8	11160.00	43.8 AV	54.0	-10.2	2.13 V	207	30.98	12.82
9	#16740.00	57.0 PK	74.0	-17.0	2.11 V	307	41.01	15.99
10	#16740.00	45.6 AV	54.0	-8.4	2.11 V	307	29.61	15.99

REMARKS:

1. Emission Level(dBuV/m) = Raw Value(dBuV) + Correction Factor(dB/m)
2. Correction Factor(dB/m) = Antenna Factor(dB/m) + Cable Factor(dB) – Pre-Amplifier Factor(dB)
3. The other emission levels were very low against the limit.
4. Margin value = Emission Level – Limit value
5. " * ": Fundamental frequency.
6. " # ": The radiated frequency is out of the restricted band.

CHANNEL	TX Channel 140	DETECTOR FUNCTION	Peak (PK)
FREQUENCY RANGE	1GHz ~ 40GHz		Average (AV)

ANTENNA POLARITY & TEST DISTANCE: HORIZONTAL AT 3 M

NO.	FREQ. (MHz)	EMISSION LEVEL (dBuV/m)	LIMIT (dBuV/m)	MARGIN (dB)	ANTENNA HEIGHT (m)	TABLE ANGLE (Degree)	RAW VALUE (dBuV)	CORRECTION FACTOR (dB/m)
1	*5700.00	107.9 PK			1.75 H	84	106.01	1.89
2	*5700.00	98.1 AV			1.75 H	84	96.21	1.89
3	#5725.00	58.0 PK	74.0	-16.0	1.72 H	52	56.07	1.93
4	#5725.00	43.0 AV	54.0	-11.0	1.72 H	52	41.07	1.93
5	#5860.00	65.9 PK	68.2	-2.3	1.77 H	55	63.77	2.13
6	11400.00	56.7 PK	74.0	-17.3	1.12 H	223	43.82	12.88
7	11400.00	45.7 AV	54.0	-8.3	1.12 H	223	32.82	12.88
8	#17100.00	55.9 PK	74.0	-18.1	1.03 H	70	38.59	17.31
9	#17100.00	44.6 AV	54.0	-9.4	1.03 H	70	27.29	17.31

ANTENNA POLARITY & TEST DISTANCE: VERTICAL AT 3 M

NO.	FREQ. (MHz)	EMISSION LEVEL (dBuV/m)	LIMIT (dBuV/m)	MARGIN (dB)	ANTENNA HEIGHT (m)	TABLE ANGLE (Degree)	RAW VALUE (dBuV)	CORRECTION FACTOR (dB/m)
1	*5700.00	116.2 PK			2.30 V	179	114.31	1.89
2	*5700.00	106.8 AV			2.30 V	179	104.91	1.89
3	#5725.00	70.6 PK	74.0	-3.4	2.90 V	131	68.67	1.93
4	#5725.00	53.3 AV	54.0	-0.7	2.90 V	131	51.37	1.93
5	#5860.00	66.8 PK	68.2	-1.4	2.29 V	68	64.67	2.13
6	11400.00	58.2 PK	74.0	-15.8	2.09 V	202	45.32	12.88
7	11400.00	43.5 AV	54.0	-10.5	2.09 V	202	30.62	12.88
8	#17100.00	57.0 PK	74.0	-17.0	2.13 V	295	39.69	17.31
9	#17100.00	45.6 AV	54.0	-8.4	2.13 V	295	28.29	17.31

REMARKS:

1. Emission Level(dBuV/m) = Raw Value(dBuV) + Correction Factor(dB/m)
2. Correction Factor(dB/m) = Antenna Factor(dB/m) + Cable Factor(dB) – Pre-Amplifier Factor(dB)
3. The other emission levels were very low against the limit.
4. Margin value = Emission Level – Limit value
5. " * ": Fundamental frequency.
6. " # ": The radiated frequency is out of the restricted band.

CHANNEL	TX Channel 144	DETECTOR FUNCTION	Peak (PK)
FREQUENCY RANGE	1GHz ~ 40GHz		Average (AV)

ANTENNA POLARITY & TEST DISTANCE: HORIZONTAL AT 3 M

NO.	FREQ. (MHz)	EMISSION LEVEL (dBuV/m)	LIMIT (dBuV/m)	MARGIN (dB)	ANTENNA HEIGHT (m)	TABLE ANGLE (Degree)	RAW VALUE (dBuV)	CORRECTION FACTOR (dB/m)
1	*5720.00	110.3 PK			1.78 H	98	108.38	1.92
2	*5720.00	99.9 AV			1.78 H	98	97.98	1.92
3	#5880.00	58.0 PK	74.0	-16.0	1.76 H	36	55.86	2.14
4	#5880.00	42.5 AV	54.0	-11.5	1.76 H	36	40.36	2.14
5	11440.00	57.3 PK	74.0	-16.7	1.08 H	223	44.43	12.87
6	11440.00	46.2 AV	54.0	-7.8	1.08 H	223	33.33	12.87
7	#17160.00	55.2 PK	74.0	-18.8	1.00 H	69	37.81	17.39
8	#17160.00	44.1 AV	54.0	-9.9	1.00 H	69	26.71	17.39

ANTENNA POLARITY & TEST DISTANCE: VERTICAL AT 3 M

NO.	FREQ. (MHz)	EMISSION LEVEL (dBuV/m)	LIMIT (dBuV/m)	MARGIN (dB)	ANTENNA HEIGHT (m)	TABLE ANGLE (Degree)	RAW VALUE (dBuV)	CORRECTION FACTOR (dB/m)
1	*5720.00	117.8 PK			2.29 V	78	115.88	1.92
2	*5720.00	107.8 AV			2.29 V	78	105.88	1.92
3	#5880.00	62.4 PK	74.0	-11.6	2.68 V	80	60.26	2.14
4	#5880.00	52.6 AV	54.0	-1.5	2.68 V	80	50.41	2.14
5	11440.00	58.5 PK	74.0	-15.5	2.11 V	200	45.63	12.87
6	11440.00	43.9 AV	54.0	-10.1	2.11 V	200	31.03	12.87
7	#17160.00	56.5 PK	74.0	-17.5	2.10 V	309	39.11	17.39
8	#17160.00	45.4 AV	54.0	-8.6	2.10 V	309	28.01	17.39

REMARKS:

1. Emission Level(dBuV/m) = Raw Value(dBuV) + Correction Factor(dB/m)
2. Correction Factor(dB/m) = Antenna Factor(dB/m) + Cable Factor(dB) – Pre-Amplifier Factor(dB)
3. The other emission levels were very low against the limit.
4. Margin value = Emission Level – Limit value
5. " * ": Fundamental frequency.
6. " # ": The radiated frequency is out of the restricted band.

802.11ac VHT40

CHANNEL	TX Channel 54	DETECTOR FUNCTION	Peak (PK)
FREQUENCY RANGE	1GHz ~ 40GHz		Average (AV)

ANTENNA POLARITY & TEST DISTANCE: HORIZONTAL AT 3 M

NO.	FREQ. (MHz)	EMISSION LEVEL (dBuV/m)	LIMIT (dBuV/m)	MARGIN (dB)	ANTENNA HEIGHT (m)	TABLE ANGLE (Degree)	RAW VALUE (dBuV)	CORRECTION FACTOR (dB/m)
1	5110.00	52.0 PK	74.0	-22.0	1.78 H	138	51.30	0.70
2	5110.00	41.5 AV	54.0	-12.5	1.78 H	138	40.80	0.70
3	*5270.00	109.4 PK			1.84 H	77	108.23	1.17
4	*5270.00	99.1 AV			1.84 H	77	97.93	1.17
5	5350.00	52.4 PK	74.0	-21.6	1.75 H	110	51.10	1.30
6	5350.00	41.9 AV	54.0	-12.1	1.75 H	110	40.60	1.30
7	5430.00	58.1 PK	74.0	-15.9	1.85 H	94	56.73	1.37
8	5430.00	42.8 AV	54.0	-11.2	1.85 H	94	41.43	1.37
9	#10540.00	57.6 PK	74.0	-16.4	1.08 H	229	46.25	11.35
10	#10540.00	46.3 AV	54.0	-7.7	1.08 H	229	34.95	11.35
11	15810.00	54.8 PK	74.0	-19.2	1.09 H	79	42.54	12.26
12	15810.00	43.6 AV	54.0	-10.4	1.09 H	79	31.34	12.26

ANTENNA POLARITY & TEST DISTANCE: VERTICAL AT 3 M

NO.	FREQ. (MHz)	EMISSION LEVEL (dBuV/m)	LIMIT (dBuV/m)	MARGIN (dB)	ANTENNA HEIGHT (m)	TABLE ANGLE (Degree)	RAW VALUE (dBuV)	CORRECTION FACTOR (dB/m)
1	5110.00	61.1 PK	74.0	-12.9	2.93 V	181	60.40	0.70
2	5110.00	51.0 AV	54.0	-3.0	2.93 V	181	50.30	0.70
3	*5270.00	115.9 PK			2.93 V	178	114.73	1.17
4	*5270.00	106.0 AV			2.93 V	178	104.83	1.17
5	5350.00	65.9 PK	74.0	-8.1	2.84 V	176	64.60	1.30
6	5350.00	52.4 AV	54.0	-1.6	2.84 V	176	51.10	1.30
7	5430.00	59.9 PK	74.0	-14.1	2.81 V	179	58.53	1.37
8	5430.00	51.2 AV	54.0	-2.8	2.81 V	179	49.83	1.37
9	#10540.00	58.2 PK	74.0	-15.8	2.11 V	191	46.85	11.35
10	#10540.00	44.0 AV	54.0	-10.0	2.11 V	191	32.65	11.35
11	15810.00	56.5 PK	74.0	-17.5	2.05 V	307	44.24	12.26
12	15810.00	45.4 AV	54.0	-8.6	2.05 V	307	33.14	12.26

REMARKS:

1. Emission Level(dBuV/m) = Raw Value(dBuV) + Correction Factor(dB/m)
2. Correction Factor(dB/m) = Antenna Factor(dB/m) + Cable Factor(dB) – Pre-Amplifier Factor(dB)
3. The other emission levels were very low against the limit.
4. Margin value = Emission Level – Limit value
5. " * ": Fundamental frequency.
6. " # ": The radiated frequency is out of the restricted band.

CHANNEL	TX Channel 62	DETECTOR FUNCTION	Peak (PK)
FREQUENCY RANGE	1GHz ~ 40GHz		Average (AV)

ANTENNA POLARITY & TEST DISTANCE: HORIZONTAL AT 3 M

NO.	FREQ. (MHz)	EMISSION LEVEL (dBuV/m)	LIMIT (dBuV/m)	MARGIN (dB)	ANTENNA HEIGHT (m)	TABLE ANGLE (Degree)	RAW VALUE (dBuV)	CORRECTION FACTOR (dB/m)
1	*5310.00	104.0 PK			1.84 H	88	102.73	1.27
2	*5310.00	93.1 AV			1.84 H	88	91.83	1.27
3	5350.00	53.1 PK	74.0	-20.9	1.71 H	113	51.80	1.30
4	5350.00	42.3 AV	54.0	-11.7	1.71 H	113	41.00	1.30
5	10620.00	58.0 PK	74.0	-16.0	1.03 H	221	46.35	11.65
6	10620.00	46.8 AV	54.0	-7.2	1.03 H	221	35.15	11.65
7	15930.00	54.4 PK	74.0	-19.6	1.15 H	88	41.94	12.46
8	15930.00	43.2 AV	54.0	-10.8	1.15 H	88	30.74	12.46

ANTENNA POLARITY & TEST DISTANCE: VERTICAL AT 3 M

NO.	FREQ. (MHz)	EMISSION LEVEL (dBuV/m)	LIMIT (dBuV/m)	MARGIN (dB)	ANTENNA HEIGHT (m)	TABLE ANGLE (Degree)	RAW VALUE (dBuV)	CORRECTION FACTOR (dB/m)
1	*5310.00	110.7 PK			2.77 V	179	109.43	1.27
2	*5310.00	100.2 AV			2.77 V	179	98.93	1.27
3	5350.00	67.5 PK	74.0	-6.5	2.76 V	137	66.20	1.30
4	5350.00	53.2 AV	54.0	-0.8	2.76 V	137	51.90	1.30
5	10620.00	57.5 PK	74.0	-16.5	2.10 V	202	45.85	11.65
6	10620.00	43.5 AV	54.0	-10.5	2.10 V	202	31.85	11.65
7	15930.00	56.3 PK	74.0	-17.7	2.08 V	308	43.84	12.46
8	15930.00	45.4 AV	54.0	-8.6	2.08 V	308	32.94	12.46

REMARKS:

1. Emission Level(dBuV/m) = Raw Value(dBuV) + Correction Factor(dB/m)
2. Correction Factor(dB/m) = Antenna Factor(dB/m) + Cable Factor(dB) – Pre-Amplifier Factor(dB)
3. The other emission levels were very low against the limit.
4. Margin value = Emission Level – Limit value
5. " * ": Fundamental frequency.

CHANNEL	TX Channel 102	DETECTOR FUNCTION	Peak (PK)
FREQUENCY RANGE	1GHz ~ 40GHz		Average (AV)

ANTENNA POLARITY & TEST DISTANCE: HORIZONTAL AT 3 M

NO.	FREQ. (MHz)	EMISSION LEVEL (dBuV/m)	LIMIT (dBuV/m)	MARGIN (dB)	ANTENNA HEIGHT (m)	TABLE ANGLE (Degree)	RAW VALUE (dBuV)	CORRECTION FACTOR (dB/m)
1	#5470.00	52.6 PK	74.0	-21.4	1.72 H	103	51.15	1.45
2	#5470.00	42.0 AV	54.0	-12.0	1.72 H	103	40.55	1.45
3	*5510.00	103.8 PK			1.89 H	82	102.28	1.52
4	*5510.00	93.0 AV			1.89 H	82	91.48	1.52
5	#5970.00	53.2 PK	74.0	-20.8	1.71 H	123	50.78	2.42
6	#5970.00	42.1 AV	54.0	-11.9	1.71 H	123	39.68	2.42
7	11020.00	58.5 PK	74.0	-15.5	1.04 H	208	45.49	13.01
8	11020.00	47.1 AV	54.0	-6.9	1.04 H	208	34.09	13.01
9	#16530.00	54.0 PK	74.0	-20.0	1.15 H	98	38.59	15.41
10	#16530.00	43.0 AV	54.0	-11.0	1.15 H	98	27.59	15.41

ANTENNA POLARITY & TEST DISTANCE: VERTICAL AT 3 M

NO.	FREQ. (MHz)	EMISSION LEVEL (dBuV/m)	LIMIT (dBuV/m)	MARGIN (dB)	ANTENNA HEIGHT (m)	TABLE ANGLE (Degree)	RAW VALUE (dBuV)	CORRECTION FACTOR (dB/m)
1	#5470.00	69.8 PK	74.0	-4.2	2.82 V	179	68.35	1.45
2	#5470.00	53.5 AV	54.0	-0.5	2.82 V	179	52.05	1.45
3	*5510.00	110.1 PK			2.71 V	178	108.58	1.52
4	*5510.00	100.0 AV			2.71 V	178	98.48	1.52
5	#5970.00	57.5 PK	74.0	-16.5	2.77 V	178	55.08	2.42
6	#5970.00	51.0 AV	54.0	-3.0	2.77 V	178	48.58	2.42
7	11020.00	57.3 PK	74.0	-16.7	2.15 V	210	44.29	13.01
8	11020.00	43.1 AV	54.0	-10.9	2.15 V	210	30.09	13.01
9	#16530.00	56.8 PK	74.0	-17.2	2.09 V	306	41.39	15.41
10	#16530.00	45.8 AV	54.0	-8.2	2.09 V	306	30.39	15.41

REMARKS:

1. Emission Level(dBuV/m) = Raw Value(dBuV) + Correction Factor(dB/m)
2. Correction Factor(dB/m) = Antenna Factor(dB/m) + Cable Factor(dB) – Pre-Amplifier Factor(dB)
3. The other emission levels were very low against the limit.
4. Margin value = Emission Level – Limit value
5. " * ": Fundamental frequency.
6. " # ": The radiated frequency is out of the restricted band.

CHANNEL	TX Channel 110	DETECTOR FUNCTION	Peak (PK)
FREQUENCY RANGE	1GHz ~ 40GHz		Average (AV)

ANTENNA POLARITY & TEST DISTANCE: HORIZONTAL AT 3 M

NO.	FREQ. (MHz)	EMISSION LEVEL (dBuV/m)	LIMIT (dBuV/m)	MARGIN (dB)	ANTENNA HEIGHT (m)	TABLE ANGLE (Degree)	RAW VALUE (dBuV)	CORRECTION FACTOR (dB/m)
1	#5470.00	52.7 PK	74.0	-21.3	1.72 H	98	51.25	1.45
2	#5470.00	42.0 AV	54.0	-12.0	1.72 H	98	40.55	1.45
3	*5550.00	108.2 PK			1.87 H	90	106.60	1.60
4	*5550.00	97.1 AV			1.87 H	90	95.50	1.60
5	#5725.00	53.8 PK	74.0	-20.2	1.70 H	112	51.87	1.93
6	#5725.00	42.6 AV	54.0	-11.4	1.70 H	112	40.67	1.93
7	11100.00	58.1 PK	74.0	-15.9	1.01 H	201	45.23	12.87
8	11100.00	46.9 AV	54.0	-7.1	1.01 H	201	34.03	12.87
9	#16650.00	54.0 PK	74.0	-20.0	1.15 H	109	38.19	15.81
10	#16650.00	43.0 AV	54.0	-11.0	1.15 H	109	27.19	15.81

ANTENNA POLARITY & TEST DISTANCE: VERTICAL AT 3 M

NO.	FREQ. (MHz)	EMISSION LEVEL (dBuV/m)	LIMIT (dBuV/m)	MARGIN (dB)	ANTENNA HEIGHT (m)	TABLE ANGLE (Degree)	RAW VALUE (dBuV)	CORRECTION FACTOR (dB/m)
1	#5470.00	67.4 PK	74.0	-6.6	2.68 V	180	65.95	1.45
2	#5470.00	52.4 AV	54.0	-1.6	2.68 V	180	50.95	1.45
3	*5550.00	114.4 PK			2.73 V	124	112.80	1.60
4	*5550.00	103.5 AV			2.73 V	124	101.90	1.60
5	#5725.00	59.2 PK	74.0	-14.8	2.68 V	160	57.27	1.93
6	#5725.00	48.6 AV	54.0	-5.4	2.68 V	160	46.67	1.93
7	11100.00	57.5 PK	74.0	-16.5	2.09 V	196	44.63	12.87
8	11100.00	43.0 AV	54.0	-11.0	2.09 V	196	30.13	12.87
9	#16650.00	56.8 PK	74.0	-17.2	2.14 V	304	40.99	15.81
10	#16650.00	45.8 AV	54.0	-8.2	2.14 V	304	29.99	15.81

REMARKS:

1. Emission Level(dBuV/m) = Raw Value(dBuV) + Correction Factor(dB/m)
2. Correction Factor(dB/m) = Antenna Factor(dB/m) + Cable Factor(dB) – Pre-Amplifier Factor(dB)
3. The other emission levels were very low against the limit.
4. Margin value = Emission Level – Limit value
5. " * ": Fundamental frequency.
6. " # ": The radiated frequency is out of the restricted band.

CHANNEL	TX Channel 134	DETECTOR FUNCTION	Peak (PK)
FREQUENCY RANGE	1GHz ~ 40GHz		Average (AV)

ANTENNA POLARITY & TEST DISTANCE: HORIZONTAL AT 3 M

NO.	FREQ. (MHz)	EMISSION LEVEL (dBuV/m)	LIMIT (dBuV/m)	MARGIN (dB)	ANTENNA HEIGHT (m)	TABLE ANGLE (Degree)	RAW VALUE (dBuV)	CORRECTION FACTOR (dB/m)
1	*5670.00	109.8 PK			1.84 H	85	107.97	1.83
2	*5670.00	98.8 AV			1.84 H	85	96.97	1.83
3	#5725.00	53.3 PK	74.0	-20.7	1.70 H	112	51.37	1.93
4	#5725.00	42.2 AV	54.0	-11.8	1.70 H	112	40.27	1.93
5	11340.00	57.8 PK	74.0	-16.2	1.00 H	216	44.59	13.21
6	11340.00	46.8 AV	54.0	-7.2	1.00 H	216	33.59	13.21
7	#17010.00	53.9 PK	74.0	-20.1	1.20 H	93	36.89	17.01
8	#17010.00	42.9 AV	54.0	-11.1	1.20 H	93	25.89	17.01

ANTENNA POLARITY & TEST DISTANCE: VERTICAL AT 3 M

NO.	FREQ. (MHz)	EMISSION LEVEL (dBuV/m)	LIMIT (dBuV/m)	MARGIN (dB)	ANTENNA HEIGHT (m)	TABLE ANGLE (Degree)	RAW VALUE (dBuV)	CORRECTION FACTOR (dB/m)
1	*5670.00	116.3 PK			2.78 V	181	114.47	1.83
2	*5670.00	105.8 AV			2.78 V	181	103.97	1.83
3	#5725.00	73.7 PK	74.0	-0.3	2.78 V	176	71.77	1.93
4	#5725.00	53.3 AV	54.0	-0.7	2.78 V	176	51.37	1.93
5	11340.00	57.1 PK	74.0	-16.9	2.07 V	211	43.89	13.21
6	11340.00	42.6 AV	54.0	-11.4	2.07 V	211	29.39	13.21
7	#17010.00	56.8 PK	74.0	-17.2	2.14 V	309	39.79	17.01
8	#17010.00	46.1 AV	54.0	-7.9	2.14 V	309	29.09	17.01

REMARKS:

1. Emission Level(dBuV/m) = Raw Value(dBuV) + Correction Factor(dB/m)
2. Correction Factor(dB/m) = Antenna Factor(dB/m) + Cable Factor(dB) – Pre-Amplifier Factor(dB)
3. The other emission levels were very low against the limit.
4. Margin value = Emission Level – Limit value
5. " * ": Fundamental frequency.
6. " # ": The radiated frequency is out of the restricted band.

CHANNEL	TX Channel 142	DETECTOR FUNCTION	Peak (PK)
FREQUENCY RANGE	1GHz ~ 40GHz		Average (AV)

ANTENNA POLARITY & TEST DISTANCE: HORIZONTAL AT 3 M

NO.	FREQ. (MHz)	EMISSION LEVEL (dBuV/m)	LIMIT (dBuV/m)	MARGIN (dB)	ANTENNA HEIGHT (m)	TABLE ANGLE (Degree)	RAW VALUE (dBuV)	CORRECTION FACTOR (dB/m)
1	5460.00	52.8 PK	74.0	-21.2	1.69 H	86	51.36	1.44
2	5460.00	42.2 AV	54.0	-11.8	1.69 H	86	40.76	1.44
3	*5710.00	110.6 PK			1.92 H	94	108.69	1.91
4	*5710.00	99.6 AV			1.92 H	94	97.69	1.91
5	#5870.00	53.9 PK	74.0	-20.1	1.74 H	122	51.75	2.15
6	#5870.00	42.4 AV	54.0	-11.6	1.74 H	122	40.25	2.15
7	11420.00	57.8 PK	74.0	-16.2	1.01 H	211	44.92	12.88
8	11420.00	47.1 AV	54.0	-6.9	1.01 H	211	34.22	12.88
9	#17130.00	53.8 PK	74.0	-20.2	1.23 H	100	36.46	17.34
10	#17130.00	42.8 AV	54.0	-11.2	1.23 H	100	25.46	17.34

ANTENNA POLARITY & TEST DISTANCE: VERTICAL AT 3 M

NO.	FREQ. (MHz)	EMISSION LEVEL (dBuV/m)	LIMIT (dBuV/m)	MARGIN (dB)	ANTENNA HEIGHT (m)	TABLE ANGLE (Degree)	RAW VALUE (dBuV)	CORRECTION FACTOR (dB/m)
1	5460.00	57.6 PK	74.0	-16.4	2.83 V	80	56.16	1.44
2	5460.00	47.3 AV	54.0	-6.7	2.83 V	80	45.86	1.44
3	*5710.00	116.9 PK			2.93 V	80	114.99	1.91
4	*5710.00	106.5 AV			2.93 V	80	104.59	1.91
5	#5870.00	64.8 PK	74.0	-9.2	2.83 V	80	62.65	2.15
6	#5870.00	52.9 AV	54.0	-1.1	2.83 V	80	50.75	2.15
7	11420.00	56.9 PK	74.0	-17.1	2.03 V	217	44.02	12.88
8	11420.00	42.5 AV	54.0	-11.5	2.03 V	217	29.62	12.88
9	#17130.00	56.8 PK	74.0	-17.2	2.18 V	297	39.46	17.34
10	#17130.00	46.4 AV	54.0	-7.6	2.18 V	297	29.06	17.34

REMARKS:

1. Emission Level(dBuV/m) = Raw Value(dBuV) + Correction Factor(dB/m)
2. Correction Factor(dB/m) = Antenna Factor(dB/m) + Cable Factor(dB) – Pre-Amplifier Factor(dB)
3. The other emission levels were very low against the limit.
4. Margin value = Emission Level – Limit value
5. " * ": Fundamental frequency.
6. " # ": The radiated frequency is out of the restricted band.

802.11ac VHT80

CHANNEL	TX Channel 58	DETECTOR FUNCTION	Peak (PK)
FREQUENCY RANGE	1GHz ~ 40GHz		Average (AV)

ANTENNA POLARITY & TEST DISTANCE: HORIZONTAL AT 3 M

NO.	FREQ. (MHz)	EMISSION LEVEL (dBuV/m)	LIMIT (dBuV/m)	MARGIN (dB)	ANTENNA HEIGHT (m)	TABLE ANGLE (Degree)	RAW VALUE (dBuV)	CORRECTION FACTOR (dB/m)
1	*5290.00	101.6 PK			1.62 H	55	100.37	1.23
2	*5290.00	90.1 AV			1.62 H	55	88.87	1.23
3	5350.00	57.8 PK	74.0	-16.2	1.79 H	59	56.50	1.30
4	5350.00	42.5 AV	54.0	-11.5	1.79 H	59	41.20	1.30
5	#10580.00	58.3 PK	74.0	-15.7	1.06 H	213	46.75	11.55
6	#10580.00	47.2 AV	54.0	-6.8	1.06 H	213	35.65	11.55
7	15870.00	53.6 PK	74.0	-20.4	1.30 H	114	41.20	12.40
8	15870.00	42.9 AV	54.0	-11.1	1.30 H	114	30.50	12.40

ANTENNA POLARITY & TEST DISTANCE: VERTICAL AT 3 M

NO.	FREQ. (MHz)	EMISSION LEVEL (dBuV/m)	LIMIT (dBuV/m)	MARGIN (dB)	ANTENNA HEIGHT (m)	TABLE ANGLE (Degree)	RAW VALUE (dBuV)	CORRECTION FACTOR (dB/m)
1	*5290.00	106.9 PK			2.82 V	178	105.67	1.23
2	*5290.00	95.6 AV			2.82 V	178	94.37	1.23
3	5350.00	68.6 PK	74.0	-5.4	2.81 V	180	67.30	1.30
4	5350.00	53.4 AV	54.0	-0.6	2.81 V	180	52.10	1.30
5	#10580.00	56.5 PK	74.0	-17.5	1.96 V	233	44.95	11.55
6	#10580.00	42.0 AV	54.0	-12.0	1.96 V	233	30.45	11.55
7	15870.00	56.1 PK	74.0	-17.9	2.09 V	277	43.70	12.40
8	15870.00	45.4 AV	54.0	-8.6	2.09 V	277	33.00	12.40

REMARKS:

- Emission Level(dBuV/m) = Raw Value(dBuV) + Correction Factor(dB/m)
- Correction Factor(dB/m) = Antenna Factor(dB/m) + Cable Factor(dB) – Pre-Amplifier Factor(dB)
- The other emission levels were very low against the limit.
- Margin value = Emission Level – Limit value
- " * ": Fundamental frequency.
- " # ": The radiated frequency is out of the restricted band.

CHANNEL	TX Channel 106	DETECTOR FUNCTION	Peak (PK)
FREQUENCY RANGE	1GHz ~ 40GHz		Average (AV)

ANTENNA POLARITY & TEST DISTANCE: HORIZONTAL AT 3 M

NO.	FREQ. (MHz)	EMISSION LEVEL (dBuV/m)	LIMIT (dBuV/m)	MARGIN (dB)	ANTENNA HEIGHT (m)	TABLE ANGLE (Degree)	RAW VALUE (dBuV)	CORRECTION FACTOR (dB/m)
1	#5470.00	58.3 PK	74.0	-15.7	1.82 H	49	56.85	1.45
2	#5470.00	42.8 AV	54.0	-11.2	1.82 H	49	41.35	1.45
3	*5530.00	100.4 PK			1.60 H	51	98.84	1.56
4	*5530.00	89.0 AV			1.60 H	51	87.44	1.56
5	11060.00	57.4 PK	74.0	-16.6	1.13 H	223	44.46	12.94
6	11060.00	46.7 AV	54.0	-7.3	1.13 H	223	33.76	12.94
7	#16590.00	53.4 PK	74.0	-20.6	1.30 H	93	37.73	15.67
8	#16590.00	43.0 AV	54.0	-11.0	1.30 H	93	27.33	15.67

ANTENNA POLARITY & TEST DISTANCE: VERTICAL AT 3 M

NO.	FREQ. (MHz)	EMISSION LEVEL (dBuV/m)	LIMIT (dBuV/m)	MARGIN (dB)	ANTENNA HEIGHT (m)	TABLE ANGLE (Degree)	RAW VALUE (dBuV)	CORRECTION FACTOR (dB/m)
1	#5470.00	70.6 PK	74.0	-3.4	2.84 V	180	69.15	1.45
2	#5470.00	53.7 AV	54.0	-0.3	2.84 V	180	52.25	1.45
3	*5530.00	106.1 PK			2.72 V	179	104.54	1.56
4	*5530.00	95.1 AV			2.72 V	179	93.54	1.56
5	11060.00	56.7 PK	74.0	-17.3	2.01 V	232	43.76	12.94
6	11060.00	42.0 AV	54.0	-12.0	2.01 V	232	29.06	12.94
7	#16590.00	56.4 PK	74.0	-17.6	2.10 V	262	40.73	15.67
8	#16590.00	46.0 AV	54.0	-8.0	2.10 V	262	30.33	15.67

REMARKS:

1. Emission Level(dBuV/m) = Raw Value(dBuV) + Correction Factor(dB/m)
2. Correction Factor(dB/m) = Antenna Factor(dB/m) + Cable Factor(dB) – Pre-Amplifier Factor(dB)
3. The other emission levels were very low against the limit.
4. Margin value = Emission Level – Limit value
5. " * ": Fundamental frequency.
6. " # ": The radiated frequency is out of the restricted band.

CHANNEL	TX Channel 122	DETECTOR FUNCTION	Peak (PK)
FREQUENCY RANGE	1GHz ~ 40GHz		Average (AV)

ANTENNA POLARITY & TEST DISTANCE: HORIZONTAL AT 3 M

NO.	FREQ. (MHz)	EMISSION LEVEL (dBuV/m)	LIMIT (dBuV/m)	MARGIN (dB)	ANTENNA HEIGHT (m)	TABLE ANGLE (Degree)	RAW VALUE (dBuV)	CORRECTION FACTOR (dB/m)
1	#5470.00	57.7 PK	74.0	-16.3	1.85 H	62	56.25	1.45
2	#5470.00	42.4 AV	54.0	-11.6	1.85 H	62	40.95	1.45
3	*5610.00	106.2 PK			1.55 H	57	104.49	1.71
4	*5610.00	94.5 AV			1.55 H	57	92.79	1.71
5	#5725.00	57.8 PK	74.0	-16.2	1.79 H	59	55.87	1.93
6	#5725.00	42.5 AV	54.0	-11.5	1.79 H	59	40.57	1.93
7	11220.00	57.8 PK	74.0	-16.2	1.05 H	207	44.88	12.92
8	11220.00	46.8 AV	54.0	-7.2	1.05 H	207	33.88	12.92
9	#16830.00	53.5 PK	74.0	-20.5	1.31 H	115	37.22	16.28
10	#16830.00	43.1 AV	54.0	-10.9	1.31 H	115	26.82	16.28

ANTENNA POLARITY & TEST DISTANCE: VERTICAL AT 3 M

NO.	FREQ. (MHz)	EMISSION LEVEL (dBuV/m)	LIMIT (dBuV/m)	MARGIN (dB)	ANTENNA HEIGHT (m)	TABLE ANGLE (Degree)	RAW VALUE (dBuV)	CORRECTION FACTOR (dB/m)
1	#5470.00	65.3 PK	74.0	-8.7	2.67 V	178	63.85	1.45
2	#5470.00	50.7 AV	54.0	-3.3	2.67 V	178	49.25	1.45
3	*5610.00	112.3 PK			2.75 V	176	110.59	1.71
4	*5610.00	100.9 AV			2.75 V	176	99.19	1.71
5	#5725.00	69.9 PK	74.0	-4.1	2.68 V	178	67.97	1.93
6	#5725.00	53.1 AV	54.0	-0.9	2.68 V	178	51.17	1.93
7	11220.00	56.2 PK	74.0	-17.8	1.93 V	235	43.28	12.92
8	11220.00	41.7 AV	54.0	-12.3	1.93 V	235	28.78	12.92
9	#16830.00	56.1 PK	74.0	-17.9	2.19 V	273	39.82	16.28
10	#16830.00	45.7 AV	54.0	-8.3	2.19 V	273	29.42	16.28

REMARKS:

1. Emission Level(dBuV/m) = Raw Value(dBuV) + Correction Factor(dB/m)
2. Correction Factor(dB/m) = Antenna Factor(dB/m) + Cable Factor(dB) – Pre-Amplifier Factor(dB)
3. The other emission levels were very low against the limit.
4. Margin value = Emission Level – Limit value
5. " * ": Fundamental frequency.
6. " # ": The radiated frequency is out of the restricted band.

CHANNEL	TX Channel 138	DETECTOR FUNCTION	Peak (PK)
FREQUENCY RANGE	1GHz ~ 40GHz		Average (AV)

ANTENNA POLARITY & TEST DISTANCE: HORIZONTAL AT 3 M

NO.	FREQ. (MHz)	EMISSION LEVEL (dBuV/m)	LIMIT (dBuV/m)	MARGIN (dB)	ANTENNA HEIGHT (m)	TABLE ANGLE (Degree)	RAW VALUE (dBuV)	CORRECTION FACTOR (dB/m)
1	*5690.00	112.5 PK			1.57 H	67	110.63	1.87
2	*5690.00	98.1 AV			1.57 H	67	96.23	1.87
3	#5850.00	58.1 PK	78.2	-20.1	1.74 H	44	55.97	2.13
4	#5860.00	57.6 PK	74.0	-16.4	1.86 H	75	55.47	2.13
5	#5860.00	42.4 AV	54.0	-11.6	1.86 H	75	40.27	2.13
6	11380.00	57.5 PK	74.0	-16.5	1.12 H	214	44.52	12.98
7	11380.00	46.5 AV	54.0	-7.5	1.12 H	214	33.52	12.98
8	#17070.00	52.4 PK	74.0	-21.6	1.32 H	113	35.18	17.22
9	#17070.00	42.3 AV	54.0	-11.7	1.32 H	113	25.08	17.22

ANTENNA POLARITY & TEST DISTANCE: VERTICAL AT 3 M

NO.	FREQ. (MHz)	EMISSION LEVEL (dBuV/m)	LIMIT (dBuV/m)	MARGIN (dB)	ANTENNA HEIGHT (m)	TABLE ANGLE (Degree)	RAW VALUE (dBuV)	CORRECTION FACTOR (dB/m)
1	*5690.00	118.0 PK			2.44 V	78	116.13	1.87
2	*5690.00	104.0 AV			2.44 V	78	102.13	1.87
3	#5850.00	72.6 PK	78.2	-5.6	2.73 V	76	70.47	2.13
4	#5860.00	67.5 PK	74.0	-6.5	2.06 V	316	65.37	2.13
5	#5860.00	53.0 AV	54.0	-1.0	2.06 V	316	50.87	2.13
6	11380.00	56.7 PK	74.0	-17.3	2.02 V	228	43.72	12.98
7	11380.00	42.1 AV	54.0	-11.9	2.02 V	228	29.12	12.98
8	#17070.00	55.9 PK	74.0	-18.1	2.13 V	282	38.68	17.22
9	#17070.00	45.7 AV	54.0	-8.3	2.13 V	282	28.48	17.22

REMARKS:

1. Emission Level(dBuV/m) = Raw Value(dBuV) + Correction Factor(dB/m)
2. Correction Factor(dB/m) = Antenna Factor(dB/m) + Cable Factor(dB) – Pre-Amplifier Factor(dB)
3. The other emission levels were very low against the limit.
4. Margin value = Emission Level – Limit value
5. " * ": Fundamental frequency.
6. " # ": The radiated frequency is out of the restricted band.

2TX

ANT2, ANT3

802.11a

CHANNEL	TX Channel 52	DETECTOR FUNCTION	Peak (PK)
FREQUENCY RANGE	1GHz ~ 40GHz		Average (AV)

ANTENNA POLARITY & TEST DISTANCE: HORIZONTAL AT 3 M

NO.	FREQ. (MHz)	EMISSION LEVEL (dBuV/m)	LIMIT (dBuV/m)	MARGIN (dB)	ANTENNA HEIGHT (m)	TABLE ANGLE (Degree)	RAW VALUE (dBuV)	CORRECTION FACTOR (dB/m)
1	5100.00	52.4 PK	74.0	-21.6	1.68 H	34	51.73	0.67
2	5100.00	43.4 AV	54.0	-10.6	1.68 H	34	42.73	0.67
3	*5260.00	107.2 PK			1.54 H	33	106.05	1.15
4	*5260.00	98.7 AV			1.54 H	33	97.55	1.15
5	5420.00	51.8 PK	74.0	-22.2	1.62 H	94	50.45	1.35
6	5420.00	41.6 AV	54.0	-12.4	1.62 H	94	40.25	1.35
7	#10520.00	57.7 PK	74.0	-16.3	1.03 H	239	46.45	11.25
8	#10520.00	45.8 AV	54.0	-8.2	1.03 H	239	34.55	11.25
9	15780.00	56.7 PK	74.0	-17.3	1.07 H	82	44.45	12.25
10	15780.00	45.7 AV	54.0	-8.3	1.07 H	82	33.45	12.25

ANTENNA POLARITY & TEST DISTANCE: VERTICAL AT 3 M

NO.	FREQ. (MHz)	EMISSION LEVEL (dBuV/m)	LIMIT (dBuV/m)	MARGIN (dB)	ANTENNA HEIGHT (m)	TABLE ANGLE (Degree)	RAW VALUE (dBuV)	CORRECTION FACTOR (dB/m)
1	5100.00	60.8 PK	74.0	-13.2	2.41 V	301	60.13	0.67
2	5100.00	51.3 AV	54.0	-2.7	2.41 V	301	50.63	0.67
3	*5260.00	118.1 PK			2.33 V	301	116.95	1.15
4	*5260.00	108.0 AV			2.33 V	301	106.85	1.15
5	5420.00	61.4 PK	74.0	-12.6	2.44 V	303	60.05	1.35
6	5420.00	53.2 AV	54.0	-0.8	2.44 V	303	51.85	1.35
7	#10520.00	59.4 PK	74.0	-14.6	2.15 V	140	48.15	11.25
8	#10520.00	44.6 AV	54.0	-9.4	2.15 V	140	33.35	11.25
9	15780.00	57.4 PK	74.0	-16.6	2.06 V	339	45.15	12.25
10	15780.00	45.6 AV	54.0	-8.4	2.06 V	339	33.35	12.25

REMARKS:

- Emission Level(dBuV/m) = Raw Value(dBuV) + Correction Factor(dB/m)
- Correction Factor(dB/m) = Antenna Factor(dB/m) + Cable Factor(dB) – Pre-Amplifier Factor(dB)
- The other emission levels were very low against the limit.
- Margin value = Emission Level – Limit value
- " * ": Fundamental frequency.
- " # ": The radiated frequency is out of the restricted band.

CHANNEL	TX Channel 60	DETECTOR FUNCTION	Peak (PK)
FREQUENCY RANGE	1GHz ~ 40GHz		Average (AV)

ANTENNA POLARITY & TEST DISTANCE: HORIZONTAL AT 3 M

NO.	FREQ. (MHz)	EMISSION LEVEL (dBuV/m)	LIMIT (dBuV/m)	MARGIN (dB)	ANTENNA HEIGHT (m)	TABLE ANGLE (Degree)	RAW VALUE (dBuV)	CORRECTION FACTOR (dB/m)
1	5140.00	52.5 PK	74.0	-21.5	1.70 H	93	51.73	0.77
2	5140.00	42.1 AV	54.0	-11.9	1.70 H	93	41.33	0.77
3	*5300.00	107.8 PK			1.60 H	41	106.53	1.27
4	*5300.00	98.7 AV			1.60 H	41	97.43	1.27
5	5460.00	52.0 PK	74.0	-22.0	1.76 H	48	50.56	1.44
6	5460.00	42.8 AV	54.0	-11.2	1.76 H	48	41.36	1.44
7	10600.00	57.7 PK	74.0	-16.3	1.06 H	259	46.06	11.64
8	10600.00	45.8 AV	54.0	-8.2	1.06 H	259	34.16	11.64
9	15900.00	57.5 PK	74.0	-16.5	1.02 H	62	45.03	12.47
10	15900.00	46.4 AV	54.0	-7.6	1.02 H	62	33.93	12.47

ANTENNA POLARITY & TEST DISTANCE: VERTICAL AT 3 M

NO.	FREQ. (MHz)	EMISSION LEVEL (dBuV/m)	LIMIT (dBuV/m)	MARGIN (dB)	ANTENNA HEIGHT (m)	TABLE ANGLE (Degree)	RAW VALUE (dBuV)	CORRECTION FACTOR (dB/m)
1	5140.00	61.5 PK	74.0	-12.5	2.96 V	301	60.73	0.77
2	5140.00	51.8 AV	54.0	-2.2	2.96 V	301	51.03	0.77
3	*5300.00	116.9 PK			2.96 V	302	115.63	1.27
4	*5300.00	107.8 AV			2.96 V	302	106.53	1.27
5	5460.00	62.5 PK	74.0	-11.5	2.78 V	300	61.06	1.44
6	5460.00	53.2 AV	54.0	-0.8	2.78 V	300	51.76	1.44
7	10600.00	59.0 PK	74.0	-15.0	2.16 V	140	47.36	11.64
8	10600.00	44.0 AV	54.0	-10.0	2.16 V	140	32.36	11.64
9	15900.00	57.3 PK	74.0	-16.7	2.08 V	337	44.83	12.47
10	15900.00	45.3 AV	54.0	-8.7	2.08 V	337	32.83	12.47

REMARKS:

1. Emission Level(dBuV/m) = Raw Value(dBuV) + Correction Factor(dB/m)
2. Correction Factor(dB/m) = Antenna Factor(dB/m) + Cable Factor(dB) – Pre-Amplifier Factor(dB)
3. The other emission levels were very low against the limit.
4. Margin value = Emission Level – Limit value
5. " * ": Fundamental frequency.

CHANNEL	TX Channel 64	DETECTOR FUNCTION	Peak (PK)
FREQUENCY RANGE	1GHz ~ 40GHz		Average (AV)

ANTENNA POLARITY & TEST DISTANCE: HORIZONTAL AT 3 M

NO.	FREQ. (MHz)	EMISSION LEVEL (dBuV/m)	LIMIT (dBuV/m)	MARGIN (dB)	ANTENNA HEIGHT (m)	TABLE ANGLE (Degree)	RAW VALUE (dBuV)	CORRECTION FACTOR (dB/m)
1	*5320.00	107.8 PK			1.53 H	35	106.52	1.28
2	*5320.00	99.3 AV			1.53 H	35	98.02	1.28
3	5350.00	52.1 PK	74.0	-21.9	1.65 H	97	50.80	1.30
4	5350.00	41.6 AV	54.0	-12.4	1.65 H	97	40.30	1.30
5	#5480.00	52.6 PK	74.0	-21.4	1.67 H	35	51.13	1.47
6	#5480.00	43.4 AV	54.0	-10.6	1.67 H	35	41.93	1.47
7	10640.00	57.0 PK	74.0	-17.0	1.00 H	258	45.32	11.68
8	10640.00	45.4 AV	54.0	-8.6	1.00 H	258	33.72	11.68
9	15960.00	57.5 PK	74.0	-16.5	1.08 H	81	45.05	12.45
10	15960.00	46.2 AV	54.0	-7.8	1.08 H	81	33.75	12.45

ANTENNA POLARITY & TEST DISTANCE: VERTICAL AT 3 M

NO.	FREQ. (MHz)	EMISSION LEVEL (dBuV/m)	LIMIT (dBuV/m)	MARGIN (dB)	ANTENNA HEIGHT (m)	TABLE ANGLE (Degree)	RAW VALUE (dBuV)	CORRECTION FACTOR (dB/m)
1	*5320.00	116.8 PK			2.73 V	303	115.52	1.28
2	*5320.00	108.0 AV			2.73 V	303	106.72	1.28
3	5350.00	72.3 PK	74.0	-1.7	2.27 V	303	71.00	1.30
4	5350.00	53.4 AV	54.0	-0.6	2.27 V	303	52.10	1.30
5	#5480.00	63.5 PK	74.0	-10.5	2.71 V	297	62.03	1.47
6	#5480.00	53.1 AV	54.0	-0.9	2.71 V	297	51.63	1.47
7	10640.00	59.2 PK	74.0	-14.8	2.08 V	160	47.52	11.68
8	10640.00	44.4 AV	54.0	-9.6	2.08 V	160	32.72	11.68
9	15960.00	57.6 PK	74.0	-16.4	2.07 V	332	45.15	12.45
10	15960.00	45.7 AV	54.0	-8.3	2.07 V	332	33.25	12.45

REMARKS:

1. Emission Level(dBuV/m) = Raw Value(dBuV) + Correction Factor(dB/m)
2. Correction Factor(dB/m) = Antenna Factor(dB/m) + Cable Factor(dB) – Pre-Amplifier Factor(dB)
3. The other emission levels were very low against the limit.
4. Margin value = Emission Level – Limit value
5. " * ": Fundamental frequency.
6. " # ": The radiated frequency is out of the restricted band.

ANT1, ANT3

CHANNEL	TX Channel 100	DETECTOR FUNCTION	Peak (PK)
FREQUENCY RANGE	1GHz ~ 40GHz		Average (AV)

ANTENNA POLARITY & TEST DISTANCE: HORIZONTAL AT 3 M

NO.	FREQ. (MHz)	EMISSION LEVEL (dBuV/m)	LIMIT (dBuV/m)	MARGIN (dB)	ANTENNA HEIGHT (m)	TABLE ANGLE (Degree)	RAW VALUE (dBuV)	CORRECTION FACTOR (dB/m)
1	5420.00	51.6 PK	74.0	-22.4	1.71 H	47	50.25	1.35
2	5420.00	43.7 AV	54.0	-10.3	1.71 H	47	42.35	1.35
3	*5500.00	109.1 PK			1.55 H	49	107.59	1.51
4	*5500.00	99.5 AV			1.55 H	49	97.99	1.51
5	#5729.00	47.8 PK	74.0	-26.2	1.63 H	95	45.85	1.95
6	#5729.00	41.3 AV	54.0	-12.7	1.63 H	95	39.35	1.95
7	11000.00	57.0 PK	74.0	-17.0	1.07 H	252	43.96	13.04
8	11000.00	45.2 AV	54.0	-8.8	1.07 H	252	32.16	13.04
9	#16500.00	57.6 PK	74.0	-16.4	1.13 H	73	42.33	15.27
10	#16500.00	46.5 AV	54.0	-7.5	1.13 H	73	31.23	15.27

ANTENNA POLARITY & TEST DISTANCE: VERTICAL AT 3 M

NO.	FREQ. (MHz)	EMISSION LEVEL (dBuV/m)	LIMIT (dBuV/m)	MARGIN (dB)	ANTENNA HEIGHT (m)	TABLE ANGLE (Degree)	RAW VALUE (dBuV)	CORRECTION FACTOR (dB/m)
1	5420.00	61.2 PK	74.0	-12.8	2.20 V	294	59.85	1.35
2	5420.00	53.5 AV	54.0	-0.5	2.20 V	294	52.15	1.35
3	*5500.00	117.5 PK			2.50 V	296	115.99	1.51
4	*5500.00	107.9 AV			2.50 V	296	106.39	1.51
5	#5729.00	57.2 PK	74.0	-16.8	2.14 V	300	55.25	1.95
6	#5729.00	50.6 AV	54.0	-3.4	2.14 V	300	48.65	1.95
7	11000.00	59.2 PK	74.0	-14.8	2.02 V	152	46.16	13.04
8	11000.00	44.2 AV	54.0	-9.8	2.02 V	152	31.16	13.04
9	#16500.00	58.2 PK	74.0	-15.8	2.06 V	347	42.93	15.27
10	#16500.00	46.2 AV	54.0	-7.8	2.06 V	347	30.93	15.27

REMARKS:

1. Emission Level(dBuV/m) = Raw Value(dBuV) + Correction Factor(dB/m)
2. Correction Factor(dB/m) = Antenna Factor(dB/m) + Cable Factor(dB) – Pre-Amplifier Factor(dB)
3. The other emission levels were very low against the limit.
4. Margin value = Emission Level – Limit value
5. " * ": Fundamental frequency.
6. " # ": The radiated frequency is out of the restricted band.

CHANNEL	TX Channel 116	DETECTOR FUNCTION	Peak (PK)
FREQUENCY RANGE	1GHz ~ 40GHz		Average (AV)

ANTENNA POLARITY & TEST DISTANCE: HORIZONTAL AT 3 M

NO.	FREQ. (MHz)	EMISSION LEVEL (dBuV/m)	LIMIT (dBuV/m)	MARGIN (dB)	ANTENNA HEIGHT (m)	TABLE ANGLE (Degree)	RAW VALUE (dBuV)	CORRECTION FACTOR (dB/m)
1	5420.00	58.5 PK	74.0	-15.5	1.67 H	76	57.15	1.35
2	5420.00	42.7 AV	54.0	-11.3	1.67 H	76	41.35	1.35
3	*5580.00	108.0 PK			1.54 H	36	106.34	1.66
4	*5580.00	98.8 AV			1.54 H	36	97.14	1.66
5	#5740.00	52.8 PK	74.0	-21.2	1.66 H	76	50.84	1.96
6	#5740.00	42.1 AV	54.0	-11.9	1.66 H	76	40.14	1.96
7	11160.00	58.3 PK	74.0	-15.7	1.08 H	254	45.48	12.82
8	11160.00	46.3 AV	54.0	-7.7	1.08 H	254	33.48	12.82
9	#16740.00	57.6 PK	74.0	-16.4	1.03 H	58	41.61	15.99
10	#16740.00	46.4 AV	54.0	-7.6	1.03 H	58	30.41	15.99

ANTENNA POLARITY & TEST DISTANCE: VERTICAL AT 3 M

NO.	FREQ. (MHz)	EMISSION LEVEL (dBuV/m)	LIMIT (dBuV/m)	MARGIN (dB)	ANTENNA HEIGHT (m)	TABLE ANGLE (Degree)	RAW VALUE (dBuV)	CORRECTION FACTOR (dB/m)
1	5420.00	60.6 PK	74.0	-13.4	2.31 V	249	59.25	1.35
2	5420.00	52.6 AV	54.0	-1.4	2.31 V	249	51.25	1.35
3	*5580.00	116.0 PK			2.50 V	294	114.34	1.66
4	*5580.00	107.5 AV			2.50 V	294	105.84	1.66
5	#5740.00	60.7 PK	74.0	-13.3	2.27 V	246	58.74	1.96
6	#5740.00	52.7 AV	54.0	-1.3	2.27 V	246	50.74	1.96
7	11160.00	58.3 PK	74.0	-15.7	2.05 V	170	45.48	12.82
8	11160.00	43.6 AV	54.0	-10.4	2.05 V	170	30.78	12.82
9	#16740.00	57.7 PK	74.0	-16.3	2.18 V	335	41.71	15.99
10	#16740.00	45.9 AV	54.0	-8.1	2.18 V	335	29.91	15.99

REMARKS:

1. Emission Level(dBuV/m) = Raw Value(dBuV) + Correction Factor(dB/m)
2. Correction Factor(dB/m) = Antenna Factor(dB/m) + Cable Factor(dB) – Pre-Amplifier Factor(dB)
3. The other emission levels were very low against the limit.
4. Margin value = Emission Level – Limit value
5. " * ": Fundamental frequency.
6. " # ": The radiated frequency is out of the restricted band.

CHANNEL	TX Channel 140	DETECTOR FUNCTION	Peak (PK)
FREQUENCY RANGE	1GHz ~ 40GHz		Average (AV)

ANTENNA POLARITY & TEST DISTANCE: HORIZONTAL AT 3 M

NO.	FREQ. (MHz)	EMISSION LEVEL (dBuV/m)	LIMIT (dBuV/m)	MARGIN (dB)	ANTENNA HEIGHT (m)	TABLE ANGLE (Degree)	RAW VALUE (dBuV)	CORRECTION FACTOR (dB/m)
1	#5225.00	50.2 PK	74.0	-23.8	1.60 H	47	49.17	1.03
2	#5225.00	41.0 AV	54.0	-13.0	1.60 H	47	39.97	1.03
3	*5700.00	107.7 PK			1.49 H	44	105.81	1.89
4	*5700.00	99.2 AV			1.49 H	44	97.31	1.89
5	#5725.00	58.7 PK	74.0	-15.3	1.69 H	60	56.77	1.93
6	#5725.00	42.8 AV	54.0	-11.2	1.69 H	60	40.87	1.93
7	#5780.00	52.2 PK	74.0	-21.8	1.57 H	103	50.14	2.06
8	#5780.00	41.4 AV	54.0	-12.6	1.57 H	103	39.34	2.06
9	11400.00	57.7 PK	74.0	-16.3	1.00 H	247	44.82	12.88
10	11400.00	45.9 AV	54.0	-8.1	1.00 H	247	33.02	12.88
11	#17100.00	57.8 PK	74.0	-16.2	1.07 H	79	40.49	17.31
12	#17100.00	46.6 AV	54.0	-7.4	1.07 H	79	29.29	17.31

ANTENNA POLARITY & TEST DISTANCE: VERTICAL AT 3 M

NO.	FREQ. (MHz)	EMISSION LEVEL (dBuV/m)	LIMIT (dBuV/m)	MARGIN (dB)	ANTENNA HEIGHT (m)	TABLE ANGLE (Degree)	RAW VALUE (dBuV)	CORRECTION FACTOR (dB/m)
1	#5225.00	55.5 PK	74.0	-18.5	2.16 V	243	54.47	1.03
2	#5225.00	47.8 AV	54.0	-6.2	2.16 V	243	46.77	1.03
3	*5700.00	115.7 PK			2.29 V	290	113.81	1.89
4	*5700.00	107.3 AV			2.29 V	290	105.41	1.89
5	#5725.00	69.8 PK	74.0	-4.2	2.30 V	242	67.87	1.93
6	#5725.00	53.1 AV	54.0	-0.9	2.30 V	242	51.17	1.93
7	#5780.00	62.8 PK	74.0	-11.2	2.16 V	244	60.74	2.06
8	#5780.00	53.6 AV	54.0	-0.4	2.16 V	244	51.54	2.06
9	11400.00	58.1 PK	74.0	-15.9	2.04 V	178	45.22	12.88
10	11400.00	43.3 AV	54.0	-10.7	2.04 V	178	30.42	12.88
11	#17100.00	58.0 PK	74.0	-16.0	2.15 V	323	40.69	17.31
12	#17100.00	46.0 AV	54.0	-8.0	2.15 V	323	28.69	17.31

REMARKS:

1. Emission Level(dBuV/m) = Raw Value(dBuV) + Correction Factor(dB/m)
2. Correction Factor(dB/m) = Antenna Factor(dB/m) + Cable Factor(dB) – Pre-Amplifier Factor(dB)
3. The other emission levels were very low against the limit.
4. Margin value = Emission Level – Limit value
5. " * ": Fundamental frequency.
6. " # ": The radiated frequency is out of the restricted band.

CHANNEL	TX Channel 144	DETECTOR FUNCTION	Peak (PK)
FREQUENCY RANGE	1GHz ~ 40GHz		Average (AV)

ANTENNA POLARITY & TEST DISTANCE: HORIZONTAL AT 3 M

NO.	FREQ. (MHz)	EMISSION LEVEL (dBuV/m)	LIMIT (dBuV/m)	MARGIN (dB)	ANTENNA HEIGHT (m)	TABLE ANGLE (Degree)	RAW VALUE (dBuV)	CORRECTION FACTOR (dB/m)
1	#5243.00	52.9 PK	74.0	-21.1	1.62 H	90	51.81	1.09
2	#5243.00	41.9 AV	54.0	-12.1	1.62 H	90	40.81	1.09
3	*5720.00	109.5 PK			1.50 H	45	107.58	1.92
4	*5720.00	99.2 AV			1.50 H	45	97.28	1.92
5	#5880.00	58.8 PK	74.0	-15.2	1.66 H	79	56.66	2.14
6	#5880.00	42.9 AV	54.0	-11.1	1.66 H	79	40.76	2.14
7	11440.00	58.2 PK	74.0	-15.8	1.05 H	251	45.33	12.87
8	11440.00	46.2 AV	54.0	-7.8	1.05 H	251	33.33	12.87
9	#17160.00	57.4 PK	74.0	-16.6	1.03 H	78	40.01	17.39
10	#17160.00	46.2 AV	54.0	-7.8	1.03 H	78	28.81	17.39

ANTENNA POLARITY & TEST DISTANCE: VERTICAL AT 3 M

NO.	FREQ. (MHz)	EMISSION LEVEL (dBuV/m)	LIMIT (dBuV/m)	MARGIN (dB)	ANTENNA HEIGHT (m)	TABLE ANGLE (Degree)	RAW VALUE (dBuV)	CORRECTION FACTOR (dB/m)
1	#5243.00	53.9 PK	74.0	-20.1	2.55 V	304	52.81	1.09
2	#5243.00	48.7 AV	54.0	-5.3	2.55 V	304	47.61	1.09
3	*5720.00	117.6 PK			2.52 V	310	115.68	1.92
4	*5720.00	108.0 AV			2.52 V	310	106.08	1.92
5	#5880.00	63.9 PK	74.0	-10.1	2.51 V	313	61.76	2.14
6	#5880.00	53.4 AV	54.0	-0.6	2.51 V	313	51.26	2.14
7	11440.00	57.9 PK	74.0	-16.1	2.00 V	192	45.03	12.87
8	11440.00	42.9 AV	54.0	-11.1	2.00 V	192	30.03	12.87
9	#17160.00	58.0 PK	74.0	-16.0	2.12 V	337	40.61	17.39
10	#17160.00	45.9 AV	54.0	-8.1	2.12 V	337	28.51	17.39

REMARKS:

1. Emission Level(dBuV/m) = Raw Value(dBuV) + Correction Factor(dB/m)
2. Correction Factor(dB/m) = Antenna Factor(dB/m) + Cable Factor(dB) – Pre-Amplifier Factor(dB)
3. The other emission levels were very low against the limit.
4. Margin value = Emission Level – Limit value
5. " * ": Fundamental frequency.
6. " # ": The radiated frequency is out of the restricted band.

ANT2, ANT3
802.11ac VHT20

CHANNEL	TX Channel 52	DETECTOR FUNCTION	Peak (PK)
FREQUENCY RANGE	1GHz ~ 40GHz		Average (AV)

ANTENNA POLARITY & TEST DISTANCE: HORIZONTAL AT 3 M

NO.	FREQ. (MHz)	EMISSION LEVEL (dBuV/m)	LIMIT (dBuV/m)	MARGIN (dB)	ANTENNA HEIGHT (m)	TABLE ANGLE (Degree)	RAW VALUE (dBuV)	CORRECTION FACTOR (dB/m)
1	5100.00	59.0 PK	74.0	-15.0	1.53 H	79	58.33	0.67
2	5100.00	43.6 AV	54.0	-10.4	1.53 H	79	42.93	0.67
3	*5260.00	110.2 PK			1.51 H	66	109.05	1.15
4	*5260.00	100.5 AV			1.51 H	66	99.35	1.15
5	5420.00	50.2 PK	74.0	-23.8	1.76 H	57	48.85	1.35
6	5420.00	41.4 AV	54.0	-12.6	1.76 H	57	40.05	1.35
7	#10520.00	58.3 PK	74.0	-15.7	1.00 H	265	47.05	11.25
8	#10520.00	46.3 AV	54.0	-7.7	1.00 H	265	35.05	11.25
9	15780.00	57.5 PK	74.0	-16.5	1.10 H	88	45.25	12.25
10	15780.00	45.9 AV	54.0	-8.1	1.10 H	88	33.65	12.25

ANTENNA POLARITY & TEST DISTANCE: VERTICAL AT 3 M

NO.	FREQ. (MHz)	EMISSION LEVEL (dBuV/m)	LIMIT (dBuV/m)	MARGIN (dB)	ANTENNA HEIGHT (m)	TABLE ANGLE (Degree)	RAW VALUE (dBuV)	CORRECTION FACTOR (dB/m)
1	5100.00	62.9 PK	74.0	-11.1	3.17 V	196	62.23	0.67
2	5100.00	52.9 AV	54.0	-1.1	3.17 V	196	52.23	0.67
3	*5260.00	117.4 PK			2.86 V	194	116.25	1.15
4	*5260.00	107.7 AV			2.86 V	194	106.55	1.15
5	5420.00	63.0 PK	74.0	-11.0	2.93 V	186	61.65	1.35
6	5420.00	53.6 AV	54.0	-0.4	2.93 V	186	52.25	1.35
7	#10520.00	58.2 PK	74.0	-15.8	1.96 V	158	46.95	11.25
8	#10520.00	43.2 AV	54.0	-10.8	1.96 V	158	31.95	11.25
9	15780.00	57.5 PK	74.0	-16.5	2.17 V	356	45.25	12.25
10	15780.00	45.3 AV	54.0	-8.7	2.17 V	356	33.05	12.25

REMARKS:

- Emission Level(dBuV/m) = Raw Value(dBuV) + Correction Factor(dB/m)
- Correction Factor(dB/m) = Antenna Factor(dB/m) + Cable Factor(dB) – Pre-Amplifier Factor(dB)
- The other emission levels were very low against the limit.
- Margin value = Emission Level – Limit value
- " * ": Fundamental frequency.
- " # ": The radiated frequency is out of the restricted band.

CHANNEL	TX Channel 60	DETECTOR FUNCTION	Peak (PK)
FREQUENCY RANGE	1GHz ~ 40GHz		Average (AV)

ANTENNA POLARITY & TEST DISTANCE: HORIZONTAL AT 3 M

NO.	FREQ. (MHz)	EMISSION LEVEL (dBuV/m)	LIMIT (dBuV/m)	MARGIN (dB)	ANTENNA HEIGHT (m)	TABLE ANGLE (Degree)	RAW VALUE (dBuV)	CORRECTION FACTOR (dB/m)
1	5130.00	58.5 PK	74.0	-15.5	1.48 H	72	57.76	0.74
2	5130.00	43.4 AV	54.0	-10.6	1.48 H	72	42.66	0.74
3	*5300.00	110.3 PK			1.48 H	64	109.03	1.27
4	*5300.00	100.4 AV			1.48 H	64	99.13	1.27
5	5380.00	49.7 PK	74.0	-24.3	1.74 H	64	48.40	1.30
6	5380.00	41.0 AV	54.0	-13.0	1.74 H	64	39.70	1.30
7	10600.00	58.5 PK	74.0	-15.5	1.00 H	264	46.86	11.64
8	10600.00	46.7 AV	54.0	-7.3	1.00 H	264	35.06	11.64
9	15900.00	56.9 PK	74.0	-17.1	1.11 H	85	44.43	12.47
10	15900.00	45.4 AV	54.0	-8.6	1.11 H	85	32.93	12.47

ANTENNA POLARITY & TEST DISTANCE: VERTICAL AT 3 M

NO.	FREQ. (MHz)	EMISSION LEVEL (dBuV/m)	LIMIT (dBuV/m)	MARGIN (dB)	ANTENNA HEIGHT (m)	TABLE ANGLE (Degree)	RAW VALUE (dBuV)	CORRECTION FACTOR (dB/m)
1	5130.00	62.8 PK	74.0	-11.2	3.07 V	197	62.06	0.74
2	5130.00	52.7 AV	54.0	-1.3	3.07 V	197	51.96	0.74
3	*5300.00	117.6 PK			3.17 V	165	116.33	1.27
4	*5300.00	107.7 AV			3.17 V	165	106.43	1.27
5	5380.00	64.3 PK	74.0	-9.7	3.03 V	187	63.00	1.30
6	5380.00	53.5 AV	54.0	-0.5	3.03 V	187	52.20	1.30
7	10600.00	57.5 PK	74.0	-16.5	2.03 V	161	45.86	11.64
8	10600.00	42.8 AV	54.0	-11.2	2.03 V	161	31.16	11.64
9	15900.00	57.0 PK	74.0	-17.0	2.17 V	347	44.53	12.47
10	15900.00	44.6 AV	54.0	-9.4	2.17 V	347	32.13	12.47

REMARKS:

1. Emission Level(dBuV/m) = Raw Value(dBuV) + Correction Factor(dB/m)
2. Correction Factor(dB/m) = Antenna Factor(dB/m) + Cable Factor(dB) – Pre-Amplifier Factor(dB)
3. The other emission levels were very low against the limit.
4. Margin value = Emission Level – Limit value
5. " * ": Fundamental frequency.

CHANNEL	TX Channel 64	DETECTOR FUNCTION	Peak (PK)
FREQUENCY RANGE	1GHz ~ 40GHz		Average (AV)

ANTENNA POLARITY & TEST DISTANCE: HORIZONTAL AT 3 M

NO.	FREQ. (MHz)	EMISSION LEVEL (dBuV/m)	LIMIT (dBuV/m)	MARGIN (dB)	ANTENNA HEIGHT (m)	TABLE ANGLE (Degree)	RAW VALUE (dBuV)	CORRECTION FACTOR (dB/m)
1	*5320.00	110.3 PK			1.42 H	71	109.02	1.28
2	*5320.00	100.1 AV			1.42 H	71	98.82	1.28
3	5350.00	51.5 PK	74.0	-22.5	1.58 H	21	50.20	1.30
4	5350.00	41.4 AV	54.0	-12.6	1.58 H	21	40.10	1.30
5	5400.00	58.3 PK	74.0	-15.7	1.52 H	106	56.99	1.31
6	5400.00	43.3 AV	54.0	-10.7	1.52 H	106	41.99	1.31
7	#5480.00	51.0 PK	74.0	-23.0	1.81 H	42	49.53	1.47
8	#5480.00	41.6 AV	54.0	-12.4	1.81 H	42	40.13	1.47
9	10640.00	58.3 PK	74.0	-15.7	1.00 H	250	46.62	11.68
10	10640.00	46.5 AV	54.0	-7.5	1.00 H	250	34.82	11.68
11	15960.00	57.1 PK	74.0	-16.9	1.15 H	89	44.65	12.45
12	15960.00	45.7 AV	54.0	-8.3	1.15 H	89	33.25	12.45

ANTENNA POLARITY & TEST DISTANCE: VERTICAL AT 3 M

NO.	FREQ. (MHz)	EMISSION LEVEL (dBuV/m)	LIMIT (dBuV/m)	MARGIN (dB)	ANTENNA HEIGHT (m)	TABLE ANGLE (Degree)	RAW VALUE (dBuV)	CORRECTION FACTOR (dB/m)
1	*5320.00	118.0 PK			2.73 V	177	116.72	1.28
2	*5320.00	107.4 AV			2.73 V	177	106.12	1.28
3	5350.00	70.6 PK	74.0	-3.4	2.60 V	129	69.30	1.30
4	5350.00	50.3 AV	54.0	-3.7	2.60 V	129	49.00	1.30
5	5400.00	63.8 PK	74.0	-10.2	2.82 V	177	62.49	1.31
6	5400.00	51.2 AV	54.0	-2.8	2.82 V	177	49.89	1.31
7	#5480.00	63.5 PK	74.0	-10.5	1.04 V	267	62.03	1.47
8	#5480.00	53.8 AV	54.0	-0.2	1.04 V	267	52.33	1.47
9	10640.00	57.4 PK	74.0	-16.6	2.00 V	175	45.72	11.68
10	10640.00	42.6 AV	54.0	-11.4	2.00 V	175	30.92	11.68
11	15960.00	57.2 PK	74.0	-16.8	2.20 V	355	44.75	12.45
12	15960.00	45.3 AV	54.0	-8.7	2.20 V	355	32.85	12.45

REMARKS:

1. Emission Level(dBuV/m) = Raw Value(dBuV) + Correction Factor(dB/m)
2. Correction Factor(dB/m) = Antenna Factor(dB/m) + Cable Factor(dB) – Pre-Amplifier Factor(dB)
3. The other emission levels were very low against the limit.
4. Margin value = Emission Level – Limit value
5. " * ": Fundamental frequency.
6. " # ": The radiated frequency is out of the restricted band.

ANT1, ANT3

CHANNEL	TX Channel 100	DETECTOR FUNCTION	Peak (PK)
FREQUENCY RANGE	1GHz ~ 40GHz		Average (AV)

ANTENNA POLARITY & TEST DISTANCE: HORIZONTAL AT 3 M

NO.	FREQ. (MHz)	EMISSION LEVEL (dBuV/m)	LIMIT (dBuV/m)	MARGIN (dB)	ANTENNA HEIGHT (m)	TABLE ANGLE (Degree)	RAW VALUE (dBuV)	CORRECTION FACTOR (dB/m)
1	#5340.00	58.5 PK	74.0	-15.5	1.48 H	104	57.21	1.29
2	#5340.00	43.5 AV	54.0	-10.5	1.48 H	104	42.21	1.29
3	5420.00	52.1 PK	74.0	-21.9	1.56 H	25	50.75	1.35
4	5420.00	41.8 AV	54.0	-12.2	1.56 H	25	40.45	1.35
5	#5470.00	51.1 PK	74.0	-22.9	1.85 H	49	49.65	1.45
6	#5470.00	41.8 AV	54.0	-12.2	1.85 H	49	40.35	1.45
7	*5500.00	110.2 PK			1.37 H	66	108.69	1.51
8	*5500.00	100.3 AV			1.37 H	66	98.79	1.51
9	11000.00	58.9 PK	74.0	-15.1	1.00 H	265	45.86	13.04
10	11000.00	46.8 AV	54.0	-7.2	1.00 H	265	33.76	13.04
11	#16500.00	57.1 PK	74.0	-16.9	1.20 H	81	41.83	15.27
12	#16500.00	45.6 AV	54.0	-8.4	1.20 H	81	30.33	15.27

ANTENNA POLARITY & TEST DISTANCE: VERTICAL AT 3 M

NO.	FREQ. (MHz)	EMISSION LEVEL (dBuV/m)	LIMIT (dBuV/m)	MARGIN (dB)	ANTENNA HEIGHT (m)	TABLE ANGLE (Degree)	RAW VALUE (dBuV)	CORRECTION FACTOR (dB/m)
1	#5340.00	62.3 PK	74.0	-11.7	2.56 V	308	61.01	1.29
2	#5340.00	52.2 AV	54.0	-1.8	2.56 V	308	50.91	1.29
3	5420.00	63.2 PK	74.0	-10.8	2.61 V	297	61.85	1.35
4	5420.00	52.5 AV	54.0	-1.5	2.61 V	297	51.15	1.35
5	#5470.00	73.9 PK	74.0	-0.1	2.59 V	308	72.45	1.45
6	#5470.00	53.0 AV	54.0	-1.0	2.59 V	308	51.55	1.45
7	*5500.00	118.3 PK			2.59 V	312	116.79	1.51
8	*5500.00	107.6 AV			2.59 V	312	106.09	1.51
9	11000.00	57.5 PK	74.0	-16.5	1.99 V	175	44.46	13.04
10	11000.00	42.5 AV	54.0	-11.5	1.99 V	175	29.46	13.04
11	#16500.00	57.4 PK	74.0	-16.6	2.14 V	360	42.13	15.27
12	#16500.00	45.6 AV	54.0	-8.4	2.14 V	360	30.33	15.27

REMARKS:

1. Emission Level(dBuV/m) = Raw Value(dBuV) + Correction Factor(dB/m)
2. Correction Factor(dB/m) = Antenna Factor(dB/m) + Cable Factor(dB) – Pre-Amplifier Factor(dB)
3. The other emission levels were very low against the limit.
4. Margin value = Emission Level – Limit value
5. " * ": Fundamental frequency.
6. " # ": The radiated frequency is out of the restricted band.

CHANNEL	TX Channel 116	DETECTOR FUNCTION	Peak (PK)
FREQUENCY RANGE	1GHz ~ 40GHz		Average (AV)

ANTENNA POLARITY & TEST DISTANCE: HORIZONTAL AT 3 M

NO.	FREQ. (MHz)	EMISSION LEVEL (dBuV/m)	LIMIT (dBuV/m)	MARGIN (dB)	ANTENNA HEIGHT (m)	TABLE ANGLE (Degree)	RAW VALUE (dBuV)	CORRECTION FACTOR (dB/m)
1	5420.00	52.0 PK	74.0	-22.0	1.59 H	22	50.65	1.35
2	5420.00	42.0 AV	54.0	-12.0	1.59 H	22	40.65	1.35
3	*5580.00	111.6 PK			1.42 H	57	109.94	1.66
4	*5580.00	100.6 AV			1.42 H	57	98.94	1.66
5	#5740.00	50.6 PK	74.0	-23.4	1.91 H	47	48.64	1.96
6	#5740.00	41.6 AV	54.0	-12.4	1.91 H	47	39.64	1.96
7	11160.00	58.7 PK	74.0	-15.3	1.00 H	256	45.88	12.82
8	11160.00	46.5 AV	54.0	-7.5	1.00 H	256	33.68	12.82
9	#16740.00	57.3 PK	74.0	-16.7	1.16 H	67	41.31	15.99
10	#16740.00	45.9 AV	54.0	-8.1	1.16 H	67	29.91	15.99

ANTENNA POLARITY & TEST DISTANCE: VERTICAL AT 3 M

NO.	FREQ. (MHz)	EMISSION LEVEL (dBuV/m)	LIMIT (dBuV/m)	MARGIN (dB)	ANTENNA HEIGHT (m)	TABLE ANGLE (Degree)	RAW VALUE (dBuV)	CORRECTION FACTOR (dB/m)
1	5420.00	61.5 PK	74.0	-12.5	2.93 V	162	60.15	1.35
2	5420.00	53.0 AV	54.0	-1.0	2.93 V	162	51.65	1.35
3	*5580.00	118.6 PK			2.68 V	188	116.94	1.66
4	*5580.00	108.3 AV			2.68 V	188	106.64	1.66
5	#5740.00	63.2 PK	74.0	-10.8	2.70 V	171	61.24	1.96
6	#5740.00	53.1 AV	54.0	-0.9	2.70 V	171	51.14	1.96
7	11160.00	57.1 PK	74.0	-16.9	2.00 V	169	44.28	12.82
8	11160.00	42.3 AV	54.0	-11.7	2.00 V	169	29.48	12.82
9	#16740.00	57.5 PK	74.0	-16.5	2.20 V	352	41.51	15.99
10	#16740.00	46.0 AV	54.0	-8.0	2.20 V	352	30.01	15.99

REMARKS:

1. Emission Level(dBuV/m) = Raw Value(dBuV) + Correction Factor(dB/m)
2. Correction Factor(dB/m) = Antenna Factor(dB/m) + Cable Factor(dB) – Pre-Amplifier Factor(dB)
3. The other emission levels were very low against the limit.
4. Margin value = Emission Level – Limit value
5. " * ": Fundamental frequency.
6. " # ": The radiated frequency is out of the restricted band.

CHANNEL	TX Channel 140	DETECTOR FUNCTION	Peak (PK)
FREQUENCY RANGE	1GHz ~ 40GHz		Average (AV)

ANTENNA POLARITY & TEST DISTANCE: HORIZONTAL AT 3 M

NO.	FREQ. (MHz)	EMISSION LEVEL (dBuV/m)	LIMIT (dBuV/m)	MARGIN (dB)	ANTENNA HEIGHT (m)	TABLE ANGLE (Degree)	RAW VALUE (dBuV)	CORRECTION FACTOR (dB/m)
1	*5700.00	107.9 PK			1.41 H	68	106.01	1.89
2	*5700.00	97.9 AV			1.41 H	68	96.01	1.89
3	#5725.00	60.7 PK	74.0	-13.3	1.91 H	33	58.77	1.93
4	#5725.00	43.7 AV	54.0	-10.3	1.91 H	33	41.77	1.93
5	11400.00	58.8 PK	74.0	-15.2	1.01 H	264	45.92	12.88
6	11400.00	46.5 AV	54.0	-7.5	1.01 H	264	33.62	12.88
7	#17100.00	57.4 PK	74.0	-16.6	1.14 H	51	40.09	17.31
8	#17100.00	46.3 AV	54.0	-7.7	1.14 H	51	28.99	17.31

ANTENNA POLARITY & TEST DISTANCE: VERTICAL AT 3 M

NO.	FREQ. (MHz)	EMISSION LEVEL (dBuV/m)	LIMIT (dBuV/m)	MARGIN (dB)	ANTENNA HEIGHT (m)	TABLE ANGLE (Degree)	RAW VALUE (dBuV)	CORRECTION FACTOR (dB/m)
1	*5700.00	115.3 PK			2.90 V	127	113.41	1.89
2	*5700.00	105.9 AV			2.90 V	127	104.01	1.89
3	#5725.00	70.5 PK	74.0	-3.5	2.88 V	124	68.57	1.93
4	#5725.00	53.4 AV	54.0	-0.6	2.88 V	124	51.47	1.93
5	11400.00	56.9 PK	74.0	-17.1	2.03 V	154	44.02	12.88
6	11400.00	42.3 AV	54.0	-11.7	2.03 V	154	29.42	12.88
7	#17100.00	57.8 PK	74.0	-16.2	2.16 V	360	40.49	17.31
8	#17100.00	46.4 AV	54.0	-7.6	2.16 V	360	29.09	17.31

REMARKS:

1. Emission Level(dBuV/m) = Raw Value(dBuV) + Correction Factor(dB/m)
2. Correction Factor(dB/m) = Antenna Factor(dB/m) + Cable Factor(dB) – Pre-Amplifier Factor(dB)
3. The other emission levels were very low against the limit.
4. Margin value = Emission Level – Limit value
5. " * ": Fundamental frequency.
6. " # ": The radiated frequency is out of the restricted band.

CHANNEL	TX Channel 144	DETECTOR FUNCTION	Peak (PK)
FREQUENCY RANGE	1GHz ~ 40GHz		Average (AV)

ANTENNA POLARITY & TEST DISTANCE: HORIZONTAL AT 3 M

NO.	FREQ. (MHz)	EMISSION LEVEL (dBuV/m)	LIMIT (dBuV/m)	MARGIN (dB)	ANTENNA HEIGHT (m)	TABLE ANGLE (Degree)	RAW VALUE (dBuV)	CORRECTION FACTOR (dB/m)
1	*5720.00	109.5 PK			1.44 H	53	107.58	1.92
2	*5720.00	99.0 AV			1.44 H	53	97.08	1.92
3	#5880.00	52.7 PK	74.0	-21.3	1.66 H	100	50.56	2.14
4	#5880.00	42.0 AV	54.0	-12.0	1.66 H	100	39.86	2.14
5	11440.00	58.3 PK	74.0	-15.7	1.07 H	245	45.43	12.87
6	11440.00	46.3 AV	54.0	-7.7	1.07 H	245	33.43	12.87
7	#17160.00	57.6 PK	74.0	-16.4	1.02 H	68	40.21	17.39
8	#17160.00	46.7 AV	54.0	-7.3	1.02 H	68	29.31	17.39

ANTENNA POLARITY & TEST DISTANCE: VERTICAL AT 3 M

NO.	FREQ. (MHz)	EMISSION LEVEL (dBuV/m)	LIMIT (dBuV/m)	MARGIN (dB)	ANTENNA HEIGHT (m)	TABLE ANGLE (Degree)	RAW VALUE (dBuV)	CORRECTION FACTOR (dB/m)
1	*5720.00	117.9 PK			2.48 V	311	115.98	1.92
2	*5720.00	107.6 AV			2.48 V	311	105.68	1.92
3	#5880.00	62.9 PK	74.0	-11.1	2.37 V	266	60.76	2.14
4	#5880.00	53.2 AV	54.0	-0.8	2.37 V	266	51.06	2.14
5	11440.00	57.2 PK	74.0	-16.8	2.06 V	167	44.33	12.87
6	11440.00	42.7 AV	54.0	-11.3	2.06 V	167	29.83	12.87
7	#17160.00	57.8 PK	74.0	-16.2	2.19 V	360	40.41	17.39
8	#17160.00	46.1 AV	54.0	-7.9	2.19 V	360	28.71	17.39

REMARKS:

1. Emission Level(dBuV/m) = Raw Value(dBuV) + Correction Factor(dB/m)
2. Correction Factor(dB/m) = Antenna Factor(dB/m) + Cable Factor(dB) – Pre-Amplifier Factor(dB)
3. The other emission levels were very low against the limit.
4. Margin value = Emission Level – Limit value
5. " * ": Fundamental frequency.
6. " # ": The radiated frequency is out of the restricted band.

ANT2, ANT3
802.11ac VHT40

CHANNEL	TX Channel 54	DETECTOR FUNCTION	Peak (PK)
FREQUENCY RANGE	1GHz ~ 40GHz		Average (AV)

ANTENNA POLARITY & TEST DISTANCE: HORIZONTAL AT 3 M

NO.	FREQ. (MHz)	EMISSION LEVEL (dBuV/m)	LIMIT (dBuV/m)	MARGIN (dB)	ANTENNA HEIGHT (m)	TABLE ANGLE (Degree)	RAW VALUE (dBuV)	CORRECTION FACTOR (dB/m)
1	5110.00	45.8 PK	74.0	-28.2	1.41 H	12	45.10	0.70
2	5110.00	36.3 AV	54.0	-17.7	1.41 H	12	35.60	0.70
3	*5270.00	110.4 PK			1.48 H	96	109.23	1.17
4	*5270.00	96.6 AV			1.48 H	96	95.43	1.17
5	5350.00	58.3 PK	74.0	-15.7	1.46 H	122	57.00	1.30
6	5350.00	46.8 AV	54.0	-7.2	1.46 H	122	45.50	1.30
7	5430.00	59.4 PK	74.0	-14.6	1.56 H	118	58.03	1.37
8	5430.00	43.9 AV	54.0	-10.1	1.56 H	118	42.53	1.37
9	#10540.00	58.4 PK	74.0	-15.6	1.07 H	272	47.05	11.35
10	#10540.00	46.9 AV	54.0	-7.1	1.07 H	272	35.55	11.35
11	15810.00	58.2 PK	74.0	-15.8	1.06 H	60	45.94	12.26
12	15810.00	47.5 AV	54.0	-6.5	1.06 H	60	35.24	12.26

ANTENNA POLARITY & TEST DISTANCE: VERTICAL AT 3 M

NO.	FREQ. (MHz)	EMISSION LEVEL (dBuV/m)	LIMIT (dBuV/m)	MARGIN (dB)	ANTENNA HEIGHT (m)	TABLE ANGLE (Degree)	RAW VALUE (dBuV)	CORRECTION FACTOR (dB/m)
1	5110.00	60.9 PK	74.0	-13.1	2.31 V	307	60.20	0.70
2	5110.00	49.5 AV	54.0	-4.5	2.31 V	307	48.80	0.70
3	*5270.00	116.1 PK			2.74 V	234	114.93	1.17
4	*5270.00	105.2 AV			2.74 V	234	104.03	1.17
5	5350.00	69.2 PK	74.0	-4.8	2.33 V	304	67.90	1.30
6	5350.00	53.7 AV	54.0	-0.3	2.33 V	304	52.40	1.30
7	5430.00	61.7 PK	74.0	-12.3	2.28 V	258	60.33	1.37
8	5430.00	50.9 AV	54.0	-3.1	2.28 V	258	49.53	1.37
9	#10540.00	56.2 PK	74.0	-17.8	2.26 V	175	44.85	11.35
10	#10540.00	42.0 AV	54.0	-12.0	2.26 V	175	30.65	11.35
11	15810.00	59.2 PK	74.0	-14.8	2.28 V	360	46.94	12.26
12	15810.00	48.0 AV	54.0	-6.0	2.28 V	360	35.74	12.26

REMARKS:

1. Emission Level(dBuV/m) = Raw Value(dBuV) + Correction Factor(dB/m)
2. Correction Factor(dB/m) = Antenna Factor(dB/m) + Cable Factor(dB) – Pre-Amplifier Factor(dB)
3. The other emission levels were very low against the limit.
4. Margin value = Emission Level – Limit value
5. " * ": Fundamental frequency.
6. " # ": The radiated frequency is out of the restricted band.

CHANNEL	TX Channel 62	DETECTOR FUNCTION	Peak (PK)
FREQUENCY RANGE	1GHz ~ 40GHz		Average (AV)

ANTENNA POLARITY & TEST DISTANCE: HORIZONTAL AT 3 M

NO.	FREQ. (MHz)	EMISSION LEVEL (dBuV/m)	LIMIT (dBuV/m)	MARGIN (dB)	ANTENNA HEIGHT (m)	TABLE ANGLE (Degree)	RAW VALUE (dBuV)	CORRECTION FACTOR (dB/m)
1	*5310.00	103.5 PK			1.42 H	98	102.23	1.27
2	*5310.00	89.7 AV			1.42 H	98	88.43	1.27
3	5350.00	59.0 PK	74.0	-15.0	1.48 H	0	57.70	1.30
4	5350.00	47.7 AV	54.0	-6.3	1.48 H	0	46.40	1.30
5	10620.00	58.6 PK	74.0	-15.4	1.04 H	271	46.95	11.65
6	10620.00	46.8 AV	54.0	-7.2	1.04 H	271	35.15	11.65
7	15930.00	58.2 PK	74.0	-15.8	1.11 H	44	45.74	12.46
8	15930.00	47.5 AV	54.0	-6.5	1.11 H	44	35.04	12.46

ANTENNA POLARITY & TEST DISTANCE: VERTICAL AT 3 M

NO.	FREQ. (MHz)	EMISSION LEVEL (dBuV/m)	LIMIT (dBuV/m)	MARGIN (dB)	ANTENNA HEIGHT (m)	TABLE ANGLE (Degree)	RAW VALUE (dBuV)	CORRECTION FACTOR (dB/m)
1	*5310.00	110.2 PK			2.61 V	302	108.93	1.27
2	*5310.00	99.0 AV			2.61 V	302	97.73	1.27
3	5350.00	68.6 PK	74.0	-5.4	2.61 V	309	67.30	1.30
4	5350.00	53.3 AV	54.0	-0.7	2.61 V	309	52.00	1.30
5	10620.00	56.4 PK	74.0	-17.6	2.20 V	175	44.75	11.65
6	10620.00	42.2 AV	54.0	-11.8	2.20 V	175	30.55	11.65
7	15930.00	58.8 PK	74.0	-15.2	2.27 V	360	46.34	12.46
8	15930.00	47.7 AV	54.0	-6.3	2.27 V	360	35.24	12.46

REMARKS:

1. Emission Level(dBuV/m) = Raw Value(dBuV) + Correction Factor(dB/m)
2. Correction Factor(dB/m) = Antenna Factor(dB/m) + Cable Factor(dB) – Pre-Amplifier Factor(dB)
3. The other emission levels were very low against the limit.
4. Margin value = Emission Level – Limit value
5. " * ": Fundamental frequency.

ANT1, ANT3

CHANNEL	TX Channel 102	DETECTOR FUNCTION	Peak (PK)
FREQUENCY RANGE	1GHz ~ 40GHz		Average (AV)

ANTENNA POLARITY & TEST DISTANCE: HORIZONTAL AT 3 M

NO.	FREQ. (MHz)	EMISSION LEVEL (dBuV/m)	LIMIT (dBuV/m)	MARGIN (dB)	ANTENNA HEIGHT (m)	TABLE ANGLE (Degree)	RAW VALUE (dBuV)	CORRECTION FACTOR (dB/m)
1	#5470.00	58.5 PK	74.0	-15.5	1.48 H	0	57.05	1.45
2	#5470.00	47.2 AV	54.0	-6.8	1.48 H	0	45.75	1.45
3	*5510.00	102.3 PK			1.52 H	100	100.78	1.52
4	*5510.00	90.2 AV			1.52 H	100	88.68	1.52
5	#5970.00	59.7 PK	74.0	-14.3	1.61 H	119	57.28	2.42
6	#5970.00	44.2 AV	54.0	-9.8	1.61 H	119	41.78	2.42
7	11020.00	58.5 PK	74.0	-15.5	1.08 H	258	45.49	13.01
8	11020.00	47.0 AV	54.0	-7.0	1.08 H	258	33.99	13.01
9	#16530.00	58.1 PK	74.0	-15.9	1.05 H	54	42.69	15.41
10	#16530.00	47.3 AV	54.0	-6.7	1.05 H	54	31.89	15.41

ANTENNA POLARITY & TEST DISTANCE: VERTICAL AT 3 M

NO.	FREQ. (MHz)	EMISSION LEVEL (dBuV/m)	LIMIT (dBuV/m)	MARGIN (dB)	ANTENNA HEIGHT (m)	TABLE ANGLE (Degree)	RAW VALUE (dBuV)	CORRECTION FACTOR (dB/m)
1	#5470.00	69.0 PK	74.0	-5.0	2.29 V	305	67.55	1.45
2	#5470.00	53.7 AV	54.0	-0.3	2.29 V	305	52.25	1.45
3	*5510.00	108.1 PK			2.48 V	256	106.58	1.52
4	*5510.00	98.7 AV			2.48 V	256	97.18	1.52
5	#5970.00	55.2 PK	74.0	-18.8	2.46 V	256	52.78	2.42
6	#5970.00	46.4 AV	54.0	-7.6	2.46 V	256	43.98	2.42
7	11020.00	55.6 PK	74.0	-18.4	2.24 V	180	42.59	13.01
8	11020.00	41.6 AV	54.0	-12.4	2.24 V	180	28.59	13.01
9	#16530.00	59.5 PK	74.0	-14.5	2.28 V	360	44.09	15.41
10	#16530.00	48.1 AV	54.0	-5.9	2.28 V	360	32.69	15.41

REMARKS:

1. Emission Level(dBuV/m) = Raw Value(dBuV) + Correction Factor(dB/m)
2. Correction Factor(dB/m) = Antenna Factor(dB/m) + Cable Factor(dB) – Pre-Amplifier Factor(dB)
3. The other emission levels were very low against the limit.
4. Margin value = Emission Level – Limit value
5. " * ": Fundamental frequency.
6. " # ": The radiated frequency is out of the restricted band.

CHANNEL	TX Channel 110	DETECTOR FUNCTION	Peak (PK)
FREQUENCY RANGE	1GHz ~ 40GHz		Average (AV)

ANTENNA POLARITY & TEST DISTANCE: HORIZONTAL AT 3 M

NO.	FREQ. (MHz)	EMISSION LEVEL (dBuV/m)	LIMIT (dBuV/m)	MARGIN (dB)	ANTENNA HEIGHT (m)	TABLE ANGLE (Degree)	RAW VALUE (dBuV)	CORRECTION FACTOR (dB/m)
1	#5470.00	59.0 PK	74.0	-15.0	1.49 H	100	57.55	1.45
2	#5470.00	47.2 AV	54.0	-6.8	1.49 H	100	45.75	1.45
3	*5550.00	110.4 PK			1.53 H	88	108.80	1.60
4	*5550.00	96.8 AV			1.53 H	88	95.20	1.60
5	#5725.00	59.5 PK	74.0	-14.5	1.61 H	119	57.57	1.93
6	#5725.00	44.2 AV	54.0	-9.8	1.61 H	119	42.27	1.93
7	11100.00	58.6 PK	74.0	-15.4	1.13 H	266	45.73	12.87
8	11100.00	47.2 AV	54.0	-6.8	1.13 H	266	34.33	12.87
9	#16650.00	57.9 PK	74.0	-16.1	1.05 H	70	42.09	15.81
10	#16650.00	47.2 AV	54.0	-6.8	1.05 H	70	31.39	15.81

ANTENNA POLARITY & TEST DISTANCE: VERTICAL AT 3 M

NO.	FREQ. (MHz)	EMISSION LEVEL (dBuV/m)	LIMIT (dBuV/m)	MARGIN (dB)	ANTENNA HEIGHT (m)	TABLE ANGLE (Degree)	RAW VALUE (dBuV)	CORRECTION FACTOR (dB/m)
1	#5470.00	72.7 PK	74.0	-1.3	2.66 V	259	71.25	1.45
2	#5470.00	53.3 AV	54.0	-0.7	2.66 V	259	51.85	1.45
3	*5550.00	117.2 PK			2.54 V	302	115.60	1.60
4	*5550.00	105.9 AV			2.54 V	302	104.30	1.60
5	#5725.00	60.9 PK	74.0	-13.1	2.24 V	247	58.97	1.93
6	#5725.00	49.6 AV	54.0	-4.4	2.24 V	247	47.67	1.93
7	11100.00	55.9 PK	74.0	-18.1	2.26 V	159	43.03	12.87
8	11100.00	41.7 AV	54.0	-12.3	2.26 V	159	28.83	12.87
9	#16650.00	59.7 PK	74.0	-14.3	2.32 V	360	43.89	15.81
10	#16650.00	48.5 AV	54.0	-5.5	2.32 V	360	32.69	15.81

REMARKS:

1. Emission Level(dBuV/m) = Raw Value(dBuV) + Correction Factor(dB/m)
2. Correction Factor(dB/m) = Antenna Factor(dB/m) + Cable Factor(dB) – Pre-Amplifier Factor(dB)
3. The other emission levels were very low against the limit.
4. Margin value = Emission Level – Limit value
5. " * ": Fundamental frequency.
6. " # ": The radiated frequency is out of the restricted band.

CHANNEL	TX Channel 134	DETECTOR FUNCTION	Peak (PK)
FREQUENCY RANGE	1GHz ~ 40GHz		Average (AV)

ANTENNA POLARITY & TEST DISTANCE: HORIZONTAL AT 3 M

NO.	FREQ. (MHz)	EMISSION LEVEL (dBuV/m)	LIMIT (dBuV/m)	MARGIN (dB)	ANTENNA HEIGHT (m)	TABLE ANGLE (Degree)	RAW VALUE (dBuV)	CORRECTION FACTOR (dB/m)
1	*5670.00	108.3 PK			1.53 H	73	106.47	1.83
2	*5670.00	94.4 AV			1.53 H	73	92.57	1.83
3	#5725.00	59.6 PK	74.0	-14.4	1.60 H	109	57.67	1.93
4	#5725.00	44.2 AV	54.0	-9.8	1.60 H	109	42.27	1.93
5	11340.00	59.1 PK	74.0	-14.9	1.18 H	275	45.89	13.21
6	11340.00	47.5 AV	54.0	-6.5	1.18 H	275	34.29	13.21
7	#17010.00	58.0 PK	74.0	-16.0	1.00 H	77	40.99	17.01
8	#17010.00	47.0 AV	54.0	-7.0	1.00 H	77	29.99	17.01

ANTENNA POLARITY & TEST DISTANCE: VERTICAL AT 3 M

NO.	FREQ. (MHz)	EMISSION LEVEL (dBuV/m)	LIMIT (dBuV/m)	MARGIN (dB)	ANTENNA HEIGHT (m)	TABLE ANGLE (Degree)	RAW VALUE (dBuV)	CORRECTION FACTOR (dB/m)
1	*5670.00	115.1 PK			2.50 V	306	113.27	1.83
2	*5670.00	103.5 AV			2.50 V	306	101.67	1.83
3	#5725.00	73.9 PK	74.0	-0.1	2.54 V	307	71.97	1.93
4	#5725.00	53.4 AV	54.0	-0.6	2.54 V	307	51.47	1.93
5	11340.00	56.1 PK	74.0	-17.9	2.26 V	154	42.89	13.21
6	11340.00	42.2 AV	54.0	-11.8	2.26 V	154	28.99	13.21
7	#17010.00	59.8 PK	74.0	-14.2	2.30 V	360	42.79	17.01
8	#17010.00	48.4 AV	54.0	-5.6	2.30 V	360	31.39	17.01

REMARKS:

1. Emission Level(dBuV/m) = Raw Value(dBuV) + Correction Factor(dB/m)
2. Correction Factor(dB/m) = Antenna Factor(dB/m) + Cable Factor(dB) – Pre-Amplifier Factor(dB)
3. The other emission levels were very low against the limit.
4. Margin value = Emission Level – Limit value
5. " * ": Fundamental frequency.
6. " # ": The radiated frequency is out of the restricted band.

CHANNEL	TX Channel 142	DETECTOR FUNCTION	Peak (PK)
FREQUENCY RANGE	1GHz ~ 40GHz		Average (AV)

ANTENNA POLARITY & TEST DISTANCE: HORIZONTAL AT 3 M

NO.	FREQ. (MHz)	EMISSION LEVEL (dBuV/m)	LIMIT (dBuV/m)	MARGIN (dB)	ANTENNA HEIGHT (m)	TABLE ANGLE (Degree)	RAW VALUE (dBuV)	CORRECTION FACTOR (dB/m)
1	#5470.00	48.3 PK	74.0	-25.7	1.46 H	101	46.85	1.45
2	#5470.00	40.2 AV	54.0	-13.8	1.46 H	101	38.75	1.45
3	*5710.00	112.7 PK			1.58 H	82	110.79	1.91
4	*5710.00	97.2 AV			1.58 H	82	95.29	1.91
5	#5850.00	57.4 PK	78.2	-20.8	1.63 H	111	55.27	2.13
6	11420.00	58.9 PK	74.0	-15.1	1.19 H	282	46.02	12.88
7	11420.00	47.5 AV	54.0	-6.5	1.19 H	282	34.62	12.88
8	#17130.00	57.3 PK	74.0	-16.7	1.03 H	92	39.96	17.34
9	#17130.00	46.6 AV	54.0	-7.4	1.03 H	92	29.26	17.34

ANTENNA POLARITY & TEST DISTANCE: VERTICAL AT 3 M

NO.	FREQ. (MHz)	EMISSION LEVEL (dBuV/m)	LIMIT (dBuV/m)	MARGIN (dB)	ANTENNA HEIGHT (m)	TABLE ANGLE (Degree)	RAW VALUE (dBuV)	CORRECTION FACTOR (dB/m)
1	#5470.00	58.3 PK	74.0	-15.7	2.33 V	307	56.85	1.45
2	#5470.00	47.4 AV	54.0	-6.6	2.33 V	307	45.95	1.45
3	*5710.00	119.3 PK			2.28 V	304	117.39	1.91
4	*5710.00	106.5 AV			2.28 V	304	104.59	1.91
5	#5850.00	67.7 PK	78.2	-10.5	2.43 V	254	65.57	2.13
6	11420.00	56.1 PK	74.0	-17.9	2.20 V	142	43.22	12.88
7	11420.00	42.5 AV	54.0	-11.5	2.20 V	142	29.62	12.88
8	#17130.00	59.4 PK	74.0	-14.6	2.29 V	360	42.06	17.34
9	#17130.00	48.0 AV	54.0	-6.0	2.29 V	360	30.66	17.34

REMARKS:

1. Emission Level(dBuV/m) = Raw Value(dBuV) + Correction Factor(dB/m)
2. Correction Factor(dB/m) = Antenna Factor(dB/m) + Cable Factor(dB) – Pre-Amplifier Factor(dB)
3. The other emission levels were very low against the limit.
4. Margin value = Emission Level – Limit value
5. " * ": Fundamental frequency.
6. " # ": The radiated frequency is out of the restricted band.

ANT2, ANT3
802.11ac VHT80

CHANNEL	TX Channel 58	DETECTOR FUNCTION	Peak (PK)
FREQUENCY RANGE	1GHz ~ 40GHz		Average (AV)

ANTENNA POLARITY & TEST DISTANCE: HORIZONTAL AT 3 M

NO.	FREQ. (MHz)	EMISSION LEVEL (dBuV/m)	LIMIT (dBuV/m)	MARGIN (dB)	ANTENNA HEIGHT (m)	TABLE ANGLE (Degree)	RAW VALUE (dBuV)	CORRECTION FACTOR (dB/m)
1	4702.00	46.0 PK	74.0	-28.0	1.39 H	24	46.37	-0.37
2	4702.00	40.3 AV	54.0	-13.7	1.39 H	24	40.67	-0.37
3	5150.00	59.4 PK	74.0	-14.6	1.53 H	125	58.60	0.80
4	5150.00	44.1 AV	54.0	-9.9	1.53 H	125	43.30	0.80
5	*5290.00	99.1 PK			1.55 H	122	97.87	1.23
6	*5290.00	84.1 AV			1.55 H	122	82.87	1.23
7	5350.00	58.0 PK	74.0	-16.0	1.41 H	117	56.70	1.30
8	5350.00	46.6 AV	54.0	-7.4	1.41 H	117	45.30	1.30
9	#10580.00	59.1 PK	74.0	-14.9	1.21 H	317	47.55	11.55
10	#10580.00	47.6 AV	54.0	-6.4	1.21 H	317	36.05	11.55
11	15870.00	56.6 PK	74.0	-17.4	1.14 H	119	44.20	12.40
12	15870.00	45.2 AV	54.0	-8.8	1.14 H	119	32.80	12.40

ANTENNA POLARITY & TEST DISTANCE: VERTICAL AT 3 M

NO.	FREQ. (MHz)	EMISSION LEVEL (dBuV/m)	LIMIT (dBuV/m)	MARGIN (dB)	ANTENNA HEIGHT (m)	TABLE ANGLE (Degree)	RAW VALUE (dBuV)	CORRECTION FACTOR (dB/m)
1	4702.00	54.3 PK	74.0	-19.7	2.23 V	304	54.67	-0.37
2	4702.00	45.5 AV	54.0	-8.5	2.23 V	304	45.87	-0.37
3	5150.00	56.2 PK	74.0	-17.8	2.23 V	304	55.40	0.80
4	5150.00	45.3 AV	54.0	-8.7	2.23 V	304	44.50	0.80
5	*5290.00	105.5 PK			2.21 V	306	104.27	1.23
6	*5290.00	93.1 AV			2.21 V	306	91.87	1.23
7	5350.00	68.5 PK	74.0	-5.5	2.26 V	309	67.20	1.30
8	5350.00	53.3 AV	54.0	-0.7	2.26 V	309	52.00	1.30
9	#10580.00	56.3 PK	74.0	-17.7	2.23 V	155	44.75	11.55
10	#10580.00	42.5 AV	54.0	-11.5	2.23 V	155	30.95	11.55
11	15870.00	59.6 PK	74.0	-14.4	2.34 V	352	47.20	12.40
12	15870.00	47.6 AV	54.0	-6.4	2.34 V	352	35.20	12.40

REMARKS:

1. Emission Level(dBuV/m) = Raw Value(dBuV) + Correction Factor(dB/m)
2. Correction Factor(dB/m) = Antenna Factor(dB/m) + Cable Factor(dB) – Pre-Amplifier Factor(dB)
3. The other emission levels were very low against the limit.
4. Margin value = Emission Level – Limit value
5. " * ": Fundamental frequency.
6. " # ": The radiated frequency is out of the restricted band.

ANT1, ANT3

CHANNEL	TX Channel 106	DETECTOR FUNCTION	Peak (PK)
FREQUENCY RANGE	1GHz ~ 40GHz		Average (AV)

ANTENNA POLARITY & TEST DISTANCE: HORIZONTAL AT 3 M

NO.	FREQ. (MHz)	EMISSION LEVEL (dBuV/m)	LIMIT (dBuV/m)	MARGIN (dB)	ANTENNA HEIGHT (m)	TABLE ANGLE (Degree)	RAW VALUE (dBuV)	CORRECTION FACTOR (dB/m)
1	#5470.00	57.4 PK	74.0	-16.6	1.53 H	109	55.95	1.45
2	#5470.00	43.2 AV	54.0	-10.8	1.53 H	109	41.75	1.45
3	*5530.00	95.6 PK			1.65 H	91	94.04	1.56
4	*5530.00	81.6 AV			1.65 H	91	80.04	1.56
5	11060.00	58.8 PK	74.0	-15.2	1.26 H	314	45.86	12.94
6	11060.00	47.4 AV	54.0	-6.6	1.26 H	314	34.46	12.94
7	#16590.00	56.2 PK	74.0	-17.8	1.14 H	115	40.53	15.67
8	#16590.00	45.0 AV	54.0	-9.0	1.14 H	115	29.33	15.67

ANTENNA POLARITY & TEST DISTANCE: VERTICAL AT 3 M

NO.	FREQ. (MHz)	EMISSION LEVEL (dBuV/m)	LIMIT (dBuV/m)	MARGIN (dB)	ANTENNA HEIGHT (m)	TABLE ANGLE (Degree)	RAW VALUE (dBuV)	CORRECTION FACTOR (dB/m)
1	#5470.00	70.6 PK	74.0	-3.4	2.19 V	303	69.15	1.45
2	#5470.00	53.6 AV	54.0	-0.4	2.19 V	303	52.15	1.45
3	*5530.00	106.3 PK			2.19 V	307	104.74	1.56
4	*5530.00	93.1 AV			2.19 V	307	91.54	1.56
5	11060.00	56.1 PK	74.0	-17.9	2.30 V	151	43.16	12.94
6	11060.00	42.4 AV	54.0	-11.6	2.30 V	151	29.46	12.94
7	#16590.00	59.5 PK	74.0	-14.5	2.34 V	360	43.83	15.67
8	#16590.00	47.7 AV	54.0	-6.3	2.34 V	360	32.03	15.67

REMARKS:

1. Emission Level(dBuV/m) = Raw Value(dBuV) + Correction Factor(dB/m)
2. Correction Factor(dB/m) = Antenna Factor(dB/m) + Cable Factor(dB) – Pre-Amplifier Factor(dB)
3. The other emission levels were very low against the limit.
4. Margin value = Emission Level – Limit value
5. " * ": Fundamental frequency.
6. " # ": The radiated frequency is out of the restricted band.

CHANNEL	TX Channel 122	DETECTOR FUNCTION	Peak (PK)
FREQUENCY RANGE	1GHz ~ 40GHz		Average (AV)

ANTENNA POLARITY & TEST DISTANCE: HORIZONTAL AT 3 M

NO.	FREQ. (MHz)	EMISSION LEVEL (dBuV/m)	LIMIT (dBuV/m)	MARGIN (dB)	ANTENNA HEIGHT (m)	TABLE ANGLE (Degree)	RAW VALUE (dBuV)	CORRECTION FACTOR (dB/m)
1	#5470.00	58.0 PK	74.0	-16.0	1.39 H	128	56.55	1.45
2	#5470.00	46.9 AV	54.0	-7.1	1.39 H	128	45.45	1.45
3	*5610.00	106.1 PK			1.61 H	114	104.39	1.71
4	*5610.00	90.4 AV			1.61 H	114	88.69	1.71
5	#5725.00	59.8 PK	74.0	-14.2	1.49 H	138	57.87	1.93
6	#5725.00	44.3 AV	54.0	-9.7	1.49 H	138	42.37	1.93
7	11220.00	58.9 PK	74.0	-15.1	1.17 H	313	45.98	12.92
8	11220.00	47.7 AV	54.0	-6.3	1.17 H	313	34.78	12.92
9	#16830.00	56.7 PK	74.0	-17.3	1.13 H	113	40.42	16.28
10	#16830.00	45.3 AV	54.0	-8.7	1.13 H	113	29.02	16.28

ANTENNA POLARITY & TEST DISTANCE: VERTICAL AT 3 M

NO.	FREQ. (MHz)	EMISSION LEVEL (dBuV/m)	LIMIT (dBuV/m)	MARGIN (dB)	ANTENNA HEIGHT (m)	TABLE ANGLE (Degree)	RAW VALUE (dBuV)	CORRECTION FACTOR (dB/m)
1	#5470.00	65.8 PK	74.0	-8.2	2.11 V	307	64.35	1.45
2	#5470.00	49.8 AV	54.0	-4.2	2.11 V	307	48.35	1.45
3	*5610.00	112.1 PK			2.16 V	305	110.39	1.71
4	*5610.00	99.2 AV			2.16 V	305	97.49	1.71
5	#5725.00	66.8 PK	74.0	-7.2	2.11 V	307	64.87	1.93
6	#5725.00	53.6 AV	54.0	-0.4	2.11 V	307	51.67	1.93
7	11220.00	55.7 PK	74.0	-18.3	2.20 V	166	42.78	12.92
8	11220.00	42.4 AV	54.0	-11.6	2.20 V	166	29.48	12.92
9	#16830.00	59.5 PK	74.0	-14.5	2.40 V	360	43.22	16.28
10	#16830.00	47.7 AV	54.0	-6.3	2.40 V	360	31.42	16.28

REMARKS:

1. Emission Level(dBuV/m) = Raw Value(dBuV) + Correction Factor(dB/m)
2. Correction Factor(dB/m) = Antenna Factor(dB/m) + Cable Factor(dB) – Pre-Amplifier Factor(dB)
3. The other emission levels were very low against the limit.
4. Margin value = Emission Level – Limit value
5. " * ": Fundamental frequency.
6. " # ": The radiated frequency is out of the restricted band.

CHANNEL	TX Channel 138	DETECTOR FUNCTION	Peak (PK)
FREQUENCY RANGE	1GHz ~ 40GHz		Average (AV)

ANTENNA POLARITY & TEST DISTANCE: HORIZONTAL AT 3 M

NO.	FREQ. (MHz)	EMISSION LEVEL (dBuV/m)	LIMIT (dBuV/m)	MARGIN (dB)	ANTENNA HEIGHT (m)	TABLE ANGLE (Degree)	RAW VALUE (dBuV)	CORRECTION FACTOR (dB/m)
1	*5690.00	106.4 PK			1.64 H	114	104.53	1.87
2	*5690.00	91.2 AV			1.64 H	114	89.33	1.87
3	#5850.00	63.5 PK	78.2	-14.7	1.48 H	146	61.37	2.13
4	#5860.00	66.8 PK	74.0	-7.2	1.39 H	119	64.67	2.13
5	#5860.00	52.7 AV	54.0	-1.3	1.39 H	119	50.57	2.13
6	11380.00	59.4 PK	74.0	-14.6	1.15 H	319	46.42	12.98
7	11380.00	48.1 AV	54.0	-5.9	1.15 H	319	35.12	12.98
8	#17070.00	56.7 PK	74.0	-17.3	1.02 H	140	39.48	17.22
9	#17070.00	45.5 AV	54.0	-8.5	1.02 H	140	28.28	17.22

ANTENNA POLARITY & TEST DISTANCE: VERTICAL AT 3 M

NO.	FREQ. (MHz)	EMISSION LEVEL (dBuV/m)	LIMIT (dBuV/m)	MARGIN (dB)	ANTENNA HEIGHT (m)	TABLE ANGLE (Degree)	RAW VALUE (dBuV)	CORRECTION FACTOR (dB/m)
1	*5690.00	112.7 PK			2.16 V	307	110.83	1.87
2	*5690.00	99.9 AV			2.16 V	307	98.03	1.87
3	#5850.00	73.1 PK	78.2	-5.1	2.68 V	80	70.97	2.13
4	#5860.00	67.9 PK	74.0	-6.1	2.10 V	316	65.77	2.13
5	#5860.00	53.6 AV	54.0	-0.4	2.10 V	316	51.47	2.13
6	11380.00	56.3 PK	74.0	-17.7	2.22 V	150	43.32	12.98
7	11380.00	42.9 AV	54.0	-11.1	2.22 V	150	29.92	12.98
8	#17070.00	59.6 PK	74.0	-14.4	2.39 V	360	42.38	17.22
9	#17070.00	48.0 AV	54.0	-6.0	2.39 V	360	30.78	17.22

REMARKS:

1. Emission Level(dBuV/m) = Raw Value(dBuV) + Correction Factor(dB/m)
2. Correction Factor(dB/m) = Antenna Factor(dB/m) + Cable Factor(dB) – Pre-Amplifier Factor(dB)
3. The other emission levels were very low against the limit.
4. Margin value = Emission Level – Limit value
5. " * ": Fundamental frequency.
6. " # ": The radiated frequency is out of the restricted band.

1TX
 ANT3
 802.11a

CHANNEL	TX Channel 52	DETECTOR FUNCTION	Peak (PK)
FREQUENCY RANGE	1GHz ~ 40GHz		Average (AV)

ANTENNA POLARITY & TEST DISTANCE: HORIZONTAL AT 3 M								
NO.	FREQ. (MHz)	EMISSION LEVEL (dBuV/m)	LIMIT (dBuV/m)	MARGIN (dB)	ANTENNA HEIGHT (m)	TABLE ANGLE (Degree)	RAW VALUE (dBuV)	CORRECTION FACTOR (dB/m)
1	5100.00	51.3 PK	74.0	-22.7	1.65 H	80	50.63	0.67
2	5100.00	42.4 AV	54.0	-11.6	1.65 H	80	41.73	0.67
3	*5260.00	109.9 PK			1.63 H	58	108.75	1.15
4	*5260.00	98.9 AV			1.63 H	58	97.75	1.15
5	5420.00	51.5 PK	74.0	-22.5	1.67 H	83	50.15	1.35
6	5420.00	43.6 AV	54.0	-10.4	1.67 H	83	42.25	1.35
7	#10520.00	57.6 PK	74.0	-16.4	1.11 H	276	46.35	11.25
8	#10520.00	45.4 AV	54.0	-8.6	1.11 H	276	34.15	11.25
9	15780.00	57.5 PK	74.0	-16.5	1.14 H	89	45.25	12.25
10	15780.00	46.0 AV	54.0	-8.0	1.14 H	89	33.75	12.25

ANTENNA POLARITY & TEST DISTANCE: VERTICAL AT 3 M								
NO.	FREQ. (MHz)	EMISSION LEVEL (dBuV/m)	LIMIT (dBuV/m)	MARGIN (dB)	ANTENNA HEIGHT (m)	TABLE ANGLE (Degree)	RAW VALUE (dBuV)	CORRECTION FACTOR (dB/m)
1	5100.00	61.5 PK	74.0	-12.5	2.38 V	294	60.83	0.67
2	5100.00	52.7 AV	54.0	-1.3	2.38 V	294	52.03	0.67
3	*5260.00	118.0 PK			2.36 V	293	116.85	1.15
4	*5260.00	107.7 AV			2.36 V	293	106.55	1.15
5	5420.00	61.4 PK	74.0	-12.6	2.41 V	291	60.05	1.35
6	5420.00	53.3 AV	54.0	-0.7	2.41 V	291	51.95	1.35
7	#10520.00	58.2 PK	74.0	-15.8	2.07 V	147	46.95	11.25
8	#10520.00	43.8 AV	54.0	-10.2	2.07 V	147	32.55	11.25
9	15780.00	57.7 PK	74.0	-16.3	2.15 V	346	45.45	12.25
10	15780.00	46.2 AV	54.0	-7.8	2.15 V	346	33.95	12.25

REMARKS:

1. Emission Level(dBuV/m) = Raw Value(dBuV) + Correction Factor(dB/m)
2. Correction Factor(dB/m) = Antenna Factor(dB/m) + Cable Factor(dB) – Pre-Amplifier Factor(dB)
3. The other emission levels were very low against the limit.
4. Margin value = Emission Level – Limit value
5. " * ": Fundamental frequency.
6. " # ": The radiated frequency is out of the restricted band.

CHANNEL	TX Channel 60	DETECTOR FUNCTION	Peak (PK)
FREQUENCY RANGE	1GHz ~ 40GHz		Average (AV)

ANTENNA POLARITY & TEST DISTANCE: HORIZONTAL AT 3 M

NO.	FREQ. (MHz)	EMISSION LEVEL (dBuV/m)	LIMIT (dBuV/m)	MARGIN (dB)	ANTENNA HEIGHT (m)	TABLE ANGLE (Degree)	RAW VALUE (dBuV)	CORRECTION FACTOR (dB/m)
1	5140.00	51.3 PK	74.0	-22.7	1.69 H	73	50.53	0.77
2	5140.00	41.5 AV	54.0	-12.5	1.69 H	73	40.73	0.77
3	*5300.00	108.2 PK			1.68 H	58	106.93	1.27
4	*5300.00	98.3 AV			1.68 H	58	97.03	1.27
5	5380.00	52.4 PK	74.0	-21.6	1.63 H	81	51.10	1.30
6	5380.00	43.2 AV	54.0	-10.8	1.63 H	81	41.90	1.30
7	5460.00	52.2 PK	74.0	-21.8	1.60 H	63	50.76	1.44
8	5460.00	42.1 AV	54.0	-11.9	1.60 H	63	40.66	1.44
9	10600.00	57.2 PK	74.0	-16.8	1.06 H	272	45.56	11.64
10	10600.00	45.5 AV	54.0	-8.5	1.06 H	272	33.86	11.64
11	15900.00	56.9 PK	74.0	-17.1	1.16 H	78	44.43	12.47
12	15900.00	45.6 AV	54.0	-8.4	1.16 H	78	33.13	12.47

ANTENNA POLARITY & TEST DISTANCE: VERTICAL AT 3 M

NO.	FREQ. (MHz)	EMISSION LEVEL (dBuV/m)	LIMIT (dBuV/m)	MARGIN (dB)	ANTENNA HEIGHT (m)	TABLE ANGLE (Degree)	RAW VALUE (dBuV)	CORRECTION FACTOR (dB/m)
1	5140.00	61.4 PK	74.0	-12.6	2.96 V	308	60.63	0.77
2	5140.00	51.8 AV	54.0	-2.2	2.96 V	308	51.03	0.77
3	*5300.00	116.3 PK			2.94 V	293	115.03	1.27
4	*5300.00	107.4 AV			2.94 V	293	106.13	1.27
5	5380.00	62.1 PK	74.0	-11.9	2.83 V	310	60.80	1.30
6	5380.00	52.8 AV	54.0	-1.2	2.83 V	310	51.50	1.30
7	5460.00	62.2 PK	74.0	-11.8	2.49 V	314	60.76	1.44
8	5460.00	52.3 AV	54.0	-1.7	2.49 V	314	50.86	1.44
9	10600.00	58.5 PK	74.0	-15.5	2.00 V	160	46.86	11.64
10	10600.00	44.5 AV	54.0	-9.5	2.00 V	160	32.86	11.64
11	15900.00	57.7 PK	74.0	-16.3	2.16 V	336	45.23	12.47
12	15900.00	45.9 AV	54.0	-8.1	2.16 V	336	33.43	12.47

REMARKS:

1. Emission Level(dBuV/m) = Raw Value(dBuV) + Correction Factor(dB/m)
2. Correction Factor(dB/m) = Antenna Factor(dB/m) + Cable Factor(dB) – Pre-Amplifier Factor(dB)
3. The other emission levels were very low against the limit.
4. Margin value = Emission Level – Limit value
5. " * ": Fundamental frequency.
6. " # ": The radiated frequency is out of the restricted band.

CHANNEL	TX Channel 64	DETECTOR FUNCTION	Peak (PK)
FREQUENCY RANGE	1GHz ~ 40GHz		Average (AV)

ANTENNA POLARITY & TEST DISTANCE: HORIZONTAL AT 3 M

NO.	FREQ. (MHz)	EMISSION LEVEL (dBuV/m)	LIMIT (dBuV/m)	MARGIN (dB)	ANTENNA HEIGHT (m)	TABLE ANGLE (Degree)	RAW VALUE (dBuV)	CORRECTION FACTOR (dB/m)
1	*5320.00	106.5 PK			1.63 H	52	105.22	1.28
2	*5320.00	97.1 AV			1.63 H	52	95.82	1.28
3	5350.00	62.3 PK	74.0	-11.7	1.65 H	86	61.00	1.30
4	5350.00	43.4 AV	54.0	-10.6	1.65 H	86	42.10	1.30
5	#5480.00	54.2 PK	74.0	-19.8	1.65 H	72	52.73	1.47
6	#5480.00	43.8 AV	54.0	-10.2	1.65 H	72	42.33	1.47
7	10640.00	57.8 PK	74.0	-16.2	1.09 H	278	46.12	11.68
8	10640.00	45.7 AV	54.0	-8.3	1.09 H	278	34.02	11.68
9	15960.00	56.8 PK	74.0	-17.2	1.15 H	74	44.35	12.45
10	15960.00	45.5 AV	54.0	-8.5	1.15 H	74	33.05	12.45

ANTENNA POLARITY & TEST DISTANCE: VERTICAL AT 3 M

NO.	FREQ. (MHz)	EMISSION LEVEL (dBuV/m)	LIMIT (dBuV/m)	MARGIN (dB)	ANTENNA HEIGHT (m)	TABLE ANGLE (Degree)	RAW VALUE (dBuV)	CORRECTION FACTOR (dB/m)
1	*5320.00	114.6 PK			2.69 V	288	113.32	1.28
2	*5320.00	105.7 AV			2.69 V	288	104.42	1.28
3	5350.00	72.5 PK	74.0	-1.5	2.29 V	295	71.20	1.30
4	5350.00	53.6 AV	54.0	-0.4	2.29 V	295	52.30	1.30
5	#5480.00	63.9 PK	74.0	-10.1	2.69 V	283	62.43	1.47
6	#5480.00	53.3 AV	54.0	-0.7	2.69 V	283	51.83	1.47
7	10640.00	58.6 PK	74.0	-15.4	2.08 V	151	46.92	11.68
8	10640.00	44.4 AV	54.0	-9.6	2.08 V	151	32.72	11.68
9	15960.00	57.8 PK	74.0	-16.2	2.20 V	336	45.35	12.45
10	15960.00	46.1 AV	54.0	-7.9	2.20 V	336	33.65	12.45

REMARKS:

1. Emission Level(dBuV/m) = Raw Value(dBuV) + Correction Factor(dB/m)
2. Correction Factor(dB/m) = Antenna Factor(dB/m) + Cable Factor(dB) – Pre-Amplifier Factor(dB)
3. The other emission levels were very low against the limit.
4. Margin value = Emission Level – Limit value
5. " * ": Fundamental frequency.
6. " # ": The radiated frequency is out of the restricted band.

CHANNEL	TX Channel 100	DETECTOR FUNCTION	Peak (PK)
FREQUENCY RANGE	1GHz ~ 40GHz		Average (AV)

ANTENNA POLARITY & TEST DISTANCE: HORIZONTAL AT 3 M

NO.	FREQ. (MHz)	EMISSION LEVEL (dBuV/m)	LIMIT (dBuV/m)	MARGIN (dB)	ANTENNA HEIGHT (m)	TABLE ANGLE (Degree)	RAW VALUE (dBuV)	CORRECTION FACTOR (dB/m)
1	5420.00	48.9 PK	74.0	-25.1	1.63 H	61	47.55	1.35
2	5420.00	41.4 AV	54.0	-12.6	1.63 H	61	40.05	1.35
3	#5470.00	61.8 PK	74.0	-12.2	1.60 H	74	60.35	1.45
4	#5470.00	43.5 AV	54.0	-10.5	1.60 H	74	42.05	1.45
5	*5500.00	107.7 PK			1.61 H	54	106.19	1.51
6	*5500.00	97.9 AV			1.61 H	54	96.39	1.51
7	#5729.00	47.3 PK	74.0	-26.7	1.63 H	82	45.35	1.95
8	#5729.00	40.7 AV	54.0	-13.3	1.63 H	82	38.75	1.95
9	11000.00	57.5 PK	74.0	-16.5	1.14 H	286	44.46	13.04
10	11000.00	45.6 AV	54.0	-8.4	1.14 H	286	32.56	13.04
11	#16500.00	56.8 PK	74.0	-17.2	1.14 H	94	41.53	15.27
12	#16500.00	45.4 AV	54.0	-8.6	1.14 H	94	30.13	15.27

ANTENNA POLARITY & TEST DISTANCE: VERTICAL AT 3 M

NO.	FREQ. (MHz)	EMISSION LEVEL (dBuV/m)	LIMIT (dBuV/m)	MARGIN (dB)	ANTENNA HEIGHT (m)	TABLE ANGLE (Degree)	RAW VALUE (dBuV)	CORRECTION FACTOR (dB/m)
1	5420.00	58.9 PK	74.0	-15.1	2.23 V	310	57.55	1.35
2	5420.00	51.3 AV	54.0	-2.7	2.23 V	310	49.95	1.35
3	#5470.00	72.3 PK	74.0	-1.7	2.25 V	323	70.85	1.45
4	#5470.00	53.7 AV	54.0	-0.3	2.25 V	323	52.25	1.45
5	*5500.00	115.7 PK			2.53 V	289	114.19	1.51
6	*5500.00	106.4 AV			2.53 V	289	104.89	1.51
7	#5729.00	57.4 PK	74.0	-16.6	2.09 V	305	55.45	1.95
8	#5729.00	50.6 AV	54.0	-3.4	2.09 V	305	48.65	1.95
9	11000.00	58.3 PK	74.0	-15.7	2.03 V	166	45.26	13.04
10	11000.00	43.8 AV	54.0	-10.2	2.03 V	166	30.76	13.04
11	#16500.00	57.9 PK	74.0	-16.1	2.19 V	353	42.63	15.27
12	#16500.00	46.1 AV	54.0	-7.9	2.19 V	353	30.83	15.27

REMARKS:

1. Emission Level(dBuV/m) = Raw Value(dBuV) + Correction Factor(dB/m)
2. Correction Factor(dB/m) = Antenna Factor(dB/m) + Cable Factor(dB) – Pre-Amplifier Factor(dB)
3. The other emission levels were very low against the limit.
4. Margin value = Emission Level – Limit value
5. " * ": Fundamental frequency.
6. " # ": The radiated frequency is out of the restricted band.

CHANNEL	TX Channel 116	DETECTOR FUNCTION	Peak (PK)
FREQUENCY RANGE	1GHz ~ 40GHz		Average (AV)

ANTENNA POLARITY & TEST DISTANCE: HORIZONTAL AT 3 M

NO.	FREQ. (MHz)	EMISSION LEVEL (dBuV/m)	LIMIT (dBuV/m)	MARGIN (dB)	ANTENNA HEIGHT (m)	TABLE ANGLE (Degree)	RAW VALUE (dBuV)	CORRECTION FACTOR (dB/m)
1	5420.00	51.0 PK	74.0	-23.0	1.66 H	58	49.65	1.35
2	5420.00	42.9 AV	54.0	-11.1	1.66 H	58	41.55	1.35
3	*5580.00	108.2 PK			1.65 H	54	106.54	1.66
4	*5580.00	99.7 AV			1.65 H	54	98.04	1.66
5	#5740.00	54.0 PK	74.0	-20.0	1.66 H	63	52.04	1.96
6	#5740.00	43.5 AV	54.0	-10.5	1.66 H	63	41.54	1.96
7	11160.00	57.3 PK	74.0	-16.7	1.11 H	259	44.48	12.82
8	11160.00	45.3 AV	54.0	-8.7	1.11 H	259	32.48	12.82
9	#16740.00	57.5 PK	74.0	-16.5	1.12 H	64	41.51	15.99
10	#16740.00	46.0 AV	54.0	-8.0	1.12 H	64	30.01	15.99

ANTENNA POLARITY & TEST DISTANCE: VERTICAL AT 3 M

NO.	FREQ. (MHz)	EMISSION LEVEL (dBuV/m)	LIMIT (dBuV/m)	MARGIN (dB)	ANTENNA HEIGHT (m)	TABLE ANGLE (Degree)	RAW VALUE (dBuV)	CORRECTION FACTOR (dB/m)
1	5420.00	61.0 PK	74.0	-13.0	2.27 V	262	59.65	1.35
2	5420.00	53.0 AV	54.0	-1.0	2.27 V	262	51.65	1.35
3	*5580.00	116.2 PK			2.47 V	292	114.54	1.66
4	*5580.00	108.1 AV			2.47 V	292	106.44	1.66
5	#5740.00	64.3 PK	74.0	-9.7	2.23 V	312	62.34	1.96
6	#5740.00	53.8 AV	54.0	-0.2	2.23 V	312	51.84	1.96
7	11160.00	58.0 PK	74.0	-16.0	1.99 V	156	45.18	12.82
8	11160.00	43.9 AV	54.0	-10.1	1.99 V	156	31.08	12.82
9	#16740.00	57.3 PK	74.0	-16.7	2.14 V	348	41.31	15.99
10	#16740.00	45.7 AV	54.0	-8.3	2.14 V	348	29.71	15.99

REMARKS:

1. Emission Level(dBuV/m) = Raw Value(dBuV) + Correction Factor(dB/m)
2. Correction Factor(dB/m) = Antenna Factor(dB/m) + Cable Factor(dB) – Pre-Amplifier Factor(dB)
3. The other emission levels were very low against the limit.
4. Margin value = Emission Level – Limit value
5. " * ": Fundamental frequency.
6. " # ": The radiated frequency is out of the restricted band.

CHANNEL	TX Channel 140	DETECTOR FUNCTION	Peak (PK)
FREQUENCY RANGE	1GHz ~ 40GHz		Average (AV)

ANTENNA POLARITY & TEST DISTANCE: HORIZONTAL AT 3 M

NO.	FREQ. (MHz)	EMISSION LEVEL (dBuV/m)	LIMIT (dBuV/m)	MARGIN (dB)	ANTENNA HEIGHT (m)	TABLE ANGLE (Degree)	RAW VALUE (dBuV)	CORRECTION FACTOR (dB/m)
1	#5225.00	45.9 PK	74.0	-28.1	1.64 H	60	44.87	1.03
2	#5225.00	38.0 AV	54.0	-16.0	1.64 H	60	36.97	1.03
3	*5700.00	106.5 PK			1.63 H	60	104.61	1.89
4	*5700.00	98.2 AV			1.63 H	60	96.31	1.89
5	#5725.00	59.5 PK	74.0	-14.5	1.65 H	60	57.57	1.93
6	#5725.00	42.7 AV	54.0	-11.3	1.65 H	60	40.77	1.93
7	#5780.00	52.9 PK	74.0	-21.1	1.61 H	61	50.84	2.06
8	#5780.00	43.7 AV	54.0	-10.3	1.61 H	61	41.64	2.06
9	11400.00	57.5 PK	74.0	-16.5	1.16 H	274	44.62	12.88
10	11400.00	45.7 AV	54.0	-8.3	1.16 H	274	32.82	12.88
11	#17100.00	57.2 PK	74.0	-16.8	1.13 H	66	39.89	17.31
12	#17100.00	45.9 AV	54.0	-8.1	1.13 H	66	28.59	17.31

ANTENNA POLARITY & TEST DISTANCE: VERTICAL AT 3 M

NO.	FREQ. (MHz)	EMISSION LEVEL (dBuV/m)	LIMIT (dBuV/m)	MARGIN (dB)	ANTENNA HEIGHT (m)	TABLE ANGLE (Degree)	RAW VALUE (dBuV)	CORRECTION FACTOR (dB/m)
1	#5225.00	56.0 PK	74.0	-18.0	2.13 V	240	54.97	1.03
2	#5225.00	48.3 AV	54.0	-5.7	2.13 V	240	47.27	1.03
3	*5700.00	114.5 PK			2.24 V	297	112.61	1.89
4	*5700.00	106.6 AV			2.24 V	297	104.71	1.89
5	#5725.00	70.1 PK	74.0	-3.9	2.24 V	253	68.17	1.93
6	#5725.00	53.1 AV	54.0	-0.9	2.24 V	253	51.17	1.93
7	#5780.00	62.4 PK	74.0	-11.6	2.17 V	228	60.34	2.06
8	#5780.00	53.3 AV	54.0	-0.7	2.17 V	228	51.24	2.06
9	11400.00	58.4 PK	74.0	-15.6	2.08 V	165	45.52	12.88
10	11400.00	44.1 AV	54.0	-9.9	2.08 V	165	31.22	12.88
11	#17100.00	58.0 PK	74.0	-16.0	2.15 V	355	40.69	17.31
12	#17100.00	46.0 AV	54.0	-8.0	2.15 V	355	28.69	17.31

REMARKS:

1. Emission Level(dBuV/m) = Raw Value(dBuV) + Correction Factor(dB/m)
2. Correction Factor(dB/m) = Antenna Factor(dB/m) + Cable Factor(dB) – Pre-Amplifier Factor(dB)
3. The other emission levels were very low against the limit.
4. Margin value = Emission Level – Limit value
5. " * ": Fundamental frequency.
6. " # ": The radiated frequency is out of the restricted band.

CHANNEL	TX Channel 144	DETECTOR FUNCTION	Peak (PK)
FREQUENCY RANGE	1GHz ~ 40GHz		Average (AV)

ANTENNA POLARITY & TEST DISTANCE: HORIZONTAL AT 3 M

NO.	FREQ. (MHz)	EMISSION LEVEL (dBuV/m)	LIMIT (dBuV/m)	MARGIN (dB)	ANTENNA HEIGHT (m)	TABLE ANGLE (Degree)	RAW VALUE (dBuV)	CORRECTION FACTOR (dB/m)
1	#5243.00	44.4 PK	74.0	-29.6	1.66 H	63	43.31	1.09
2	#5243.00	38.8 AV	54.0	-15.2	1.66 H	63	37.71	1.09
3	*5720.00	111.5 PK			1.64 H	57	109.58	1.92
4	*5720.00	101.5 AV			1.64 H	57	99.58	1.92
5	#5880.00	53.6 PK	74.0	-20.4	1.68 H	74	51.46	2.14
6	#5880.00	43.5 AV	54.0	-10.5	1.68 H	74	41.36	2.14
7	11440.00	57.3 PK	74.0	-16.7	1.15 H	271	44.43	12.87
8	11440.00	45.0 AV	54.0	-9.0	1.15 H	271	32.13	12.87
9	#17160.00	57.3 PK	74.0	-16.7	1.16 H	66	39.91	17.39
10	#17160.00	45.7 AV	54.0	-8.3	1.16 H	66	28.31	17.39

ANTENNA POLARITY & TEST DISTANCE: VERTICAL AT 3 M

NO.	FREQ. (MHz)	EMISSION LEVEL (dBuV/m)	LIMIT (dBuV/m)	MARGIN (dB)	ANTENNA HEIGHT (m)	TABLE ANGLE (Degree)	RAW VALUE (dBuV)	CORRECTION FACTOR (dB/m)
1	#5243.00	53.9 PK	74.0	-20.1	2.56 V	305	52.81	1.09
2	#5243.00	48.5 AV	54.0	-5.5	2.56 V	305	47.41	1.09
3	*5720.00	119.4 PK			2.49 V	298	117.48	1.92
4	*5720.00	109.8 AV			2.49 V	298	107.88	1.92
5	#5880.00	63.4 PK	74.0	-10.6	2.54 V	304	61.26	2.14
6	#5880.00	53.3 AV	54.0	-0.7	2.54 V	304	51.16	2.14
7	11440.00	57.9 PK	74.0	-16.1	2.00 V	174	45.03	12.87
8	11440.00	43.5 AV	54.0	-10.5	2.00 V	174	30.63	12.87
9	#17160.00	57.4 PK	74.0	-16.6	2.25 V	341	40.01	17.39
10	#17160.00	45.7 AV	54.0	-8.3	2.25 V	341	28.31	17.39

REMARKS:

1. Emission Level(dBuV/m) = Raw Value(dBuV) + Correction Factor(dB/m)
2. Correction Factor(dB/m) = Antenna Factor(dB/m) + Cable Factor(dB) – Pre-Amplifier Factor(dB)
3. The other emission levels were very low against the limit.
4. Margin value = Emission Level – Limit value
5. " * ": Fundamental frequency.
6. " # ": The radiated frequency is out of the restricted band.

802.11ac VHT20

CHANNEL	TX Channel 52	DETECTOR FUNCTION	Peak (PK)
FREQUENCY RANGE	1GHz ~ 40GHz		Average (AV)

ANTENNA POLARITY & TEST DISTANCE: HORIZONTAL AT 3 M

NO.	FREQ. (MHz)	EMISSION LEVEL (dBuV/m)	LIMIT (dBuV/m)	MARGIN (dB)	ANTENNA HEIGHT (m)	TABLE ANGLE (Degree)	RAW VALUE (dBuV)	CORRECTION FACTOR (dB/m)
1	5100.00	52.9 PK	74.0	-21.1	1.62 H	79	52.23	0.67
2	5100.00	42.9 AV	54.0	-11.1	1.62 H	79	42.23	0.67
3	*5260.00	109.8 PK			1.61 H	122	108.65	1.15
4	*5260.00	99.7 AV			1.61 H	122	98.55	1.15
5	5420.00	52.3 PK	74.0	-21.7	1.64 H	67	50.95	1.35
6	5420.00	42.9 AV	54.0	-11.1	1.64 H	67	41.55	1.35
7	#10520.00	57.8 PK	74.0	-16.2	1.21 H	256	46.55	11.25
8	#10520.00	45.5 AV	54.0	-8.5	1.21 H	256	34.25	11.25
9	15780.00	56.4 PK	74.0	-17.6	1.14 H	90	44.15	12.25
10	15780.00	45.2 AV	54.0	-8.8	1.14 H	90	32.95	12.25

ANTENNA POLARITY & TEST DISTANCE: VERTICAL AT 3 M

NO.	FREQ. (MHz)	EMISSION LEVEL (dBuV/m)	LIMIT (dBuV/m)	MARGIN (dB)	ANTENNA HEIGHT (m)	TABLE ANGLE (Degree)	RAW VALUE (dBuV)	CORRECTION FACTOR (dB/m)
1	5100.00	62.4 PK	74.0	-11.6	2.66 V	310	61.73	0.67
2	5100.00	52.7 AV	54.0	-1.3	2.66 V	310	52.03	0.67
3	*5260.00	117.5 PK			2.71 V	307	116.35	1.15
4	*5260.00	107.9 AV			2.71 V	307	106.75	1.15
5	5420.00	62.6 PK	74.0	-11.4	2.77 V	309	61.25	1.35
6	5420.00	53.4 AV	54.0	-0.6	2.77 V	309	52.05	1.35
7	#10520.00	58.4 PK	74.0	-15.6	2.09 V	156	47.15	11.25
8	#10520.00	44.0 AV	54.0	-10.0	2.09 V	156	32.75	11.25
9	15780.00	58.2 PK	74.0	-15.8	2.24 V	350	45.95	12.25
10	15780.00	46.2 AV	54.0	-7.8	2.24 V	350	33.95	12.25

REMARKS:

1. Emission Level(dBuV/m) = Raw Value(dBuV) + Correction Factor(dB/m)
2. Correction Factor(dB/m) = Antenna Factor(dB/m) + Cable Factor(dB) – Pre-Amplifier Factor(dB)
3. The other emission levels were very low against the limit.
4. Margin value = Emission Level – Limit value
5. " * ": Fundamental frequency.
6. " # ": The radiated frequency is out of the restricted band.

CHANNEL	TX Channel 60	DETECTOR FUNCTION	Peak (PK)
FREQUENCY RANGE	1GHz ~ 40GHz		Average (AV)

ANTENNA POLARITY & TEST DISTANCE: HORIZONTAL AT 3 M

NO.	FREQ. (MHz)	EMISSION LEVEL (dBuV/m)	LIMIT (dBuV/m)	MARGIN (dB)	ANTENNA HEIGHT (m)	TABLE ANGLE (Degree)	RAW VALUE (dBuV)	CORRECTION FACTOR (dB/m)
1	5130.00	52.9 PK	74.0	-21.1	1.70 H	59	52.16	0.74
2	5130.00	42.7 AV	54.0	-11.3	1.70 H	59	41.96	0.74
3	*5300.00	110.4 PK			1.62 H	126	109.13	1.27
4	*5300.00	100.2 AV			1.62 H	126	98.93	1.27
5	5380.00	54.0 PK	74.0	-20.0	1.62 H	56	52.70	1.30
6	5380.00	43.2 AV	54.0	-10.8	1.62 H	56	41.90	1.30
7	10600.00	57.1 PK	74.0	-16.9	1.19 H	253	45.46	11.64
8	10600.00	45.1 AV	54.0	-8.9	1.19 H	253	33.46	11.64
9	15900.00	56.2 PK	74.0	-17.8	1.10 H	84	43.73	12.47
10	15900.00	45.2 AV	54.0	-8.8	1.10 H	84	32.73	12.47

ANTENNA POLARITY & TEST DISTANCE: VERTICAL AT 3 M

NO.	FREQ. (MHz)	EMISSION LEVEL (dBuV/m)	LIMIT (dBuV/m)	MARGIN (dB)	ANTENNA HEIGHT (m)	TABLE ANGLE (Degree)	RAW VALUE (dBuV)	CORRECTION FACTOR (dB/m)
1	5130.00	62.9 PK	74.0	-11.1	2.66 V	323	62.16	0.74
2	5130.00	52.5 AV	54.0	-1.5	2.66 V	323	51.76	0.74
3	*5300.00	118.0 PK			2.76 V	305	116.73	1.27
4	*5300.00	108.1 AV			2.76 V	305	106.83	1.27
5	5380.00	64.1 PK	74.0	-9.9	2.77 V	300	62.80	1.30
6	5380.00	53.5 AV	54.0	-0.5	2.77 V	300	52.20	1.30
7	10600.00	58.5 PK	74.0	-15.5	2.00 V	154	46.86	11.64
8	10600.00	44.0 AV	54.0	-10.0	2.00 V	154	32.36	11.64
9	15900.00	57.7 PK	74.0	-16.3	2.20 V	353	45.23	12.47
10	15900.00	46.1 AV	54.0	-7.9	2.20 V	353	33.63	12.47

REMARKS:

1. Emission Level(dBuV/m) = Raw Value(dBuV) + Correction Factor(dB/m)
2. Correction Factor(dB/m) = Antenna Factor(dB/m) + Cable Factor(dB) – Pre-Amplifier Factor(dB)
3. The other emission levels were very low against the limit.
4. Margin value = Emission Level – Limit value
5. " * ": Fundamental frequency.

CHANNEL	TX Channel 64	DETECTOR FUNCTION	Peak (PK)
FREQUENCY RANGE	1GHz ~ 40GHz		Average (AV)

ANTENNA POLARITY & TEST DISTANCE: HORIZONTAL AT 3 M

NO.	FREQ. (MHz)	EMISSION LEVEL (dBuV/m)	LIMIT (dBuV/m)	MARGIN (dB)	ANTENNA HEIGHT (m)	TABLE ANGLE (Degree)	RAW VALUE (dBuV)	CORRECTION FACTOR (dB/m)
1	*5320.00	110.6 PK			1.65 H	119	109.32	1.28
2	*5320.00	100.5 AV			1.65 H	119	99.22	1.28
3	5350.00	64.0 PK	74.0	-10.0	1.68 H	65	62.70	1.30
4	5350.00	43.3 AV	54.0	-10.7	1.68 H	65	42.00	1.30
5	5400.00	54.1 PK	74.0	-19.9	1.76 H	55	52.79	1.31
6	5400.00	41.3 AV	54.0	-12.7	1.76 H	55	39.99	1.31
7	#5480.00	52.6 PK	74.0	-21.4	1.70 H	56	51.13	1.47
8	#5480.00	43.0 AV	54.0	-11.0	1.70 H	56	41.53	1.47
9	10640.00	57.6 PK	74.0	-16.4	1.19 H	256	45.92	11.68
10	10640.00	45.5 AV	54.0	-8.5	1.19 H	256	33.82	11.68
11	15960.00	56.6 PK	74.0	-17.4	1.17 H	100	44.15	12.45
12	15960.00	45.2 AV	54.0	-8.8	1.17 H	100	32.75	12.45

ANTENNA POLARITY & TEST DISTANCE: VERTICAL AT 3 M

NO.	FREQ. (MHz)	EMISSION LEVEL (dBuV/m)	LIMIT (dBuV/m)	MARGIN (dB)	ANTENNA HEIGHT (m)	TABLE ANGLE (Degree)	RAW VALUE (dBuV)	CORRECTION FACTOR (dB/m)
1	*5320.00	118.2 PK			2.75 V	167	116.92	1.28
2	*5320.00	107.8 AV			2.75 V	167	106.52	1.28
3	5350.00	73.8 PK	74.0	-0.2	2.62 V	314	72.50	1.30
4	5350.00	53.3 AV	54.0	-0.7	2.62 V	314	52.00	1.30
5	5400.00	64.3 PK	74.0	-9.7	2.77 V	192	62.99	1.31
6	5400.00	51.6 AV	54.0	-2.4	2.77 V	192	50.29	1.31
7	#5480.00	62.3 PK	74.0	-11.7	1.01 V	280	60.83	1.47
8	#5480.00	52.8 AV	54.0	-1.2	1.01 V	280	51.33	1.47
9	10640.00	58.4 PK	74.0	-15.6	2.06 V	148	46.72	11.68
10	10640.00	44.1 AV	54.0	-9.9	2.06 V	148	32.42	11.68
11	15960.00	58.1 PK	74.0	-15.9	2.15 V	347	45.65	12.45
12	15960.00	46.2 AV	54.0	-7.8	2.15 V	347	33.75	12.45

REMARKS:

1. Emission Level(dBuV/m) = Raw Value(dBuV) + Correction Factor(dB/m)
2. Correction Factor(dB/m) = Antenna Factor(dB/m) + Cable Factor(dB) – Pre-Amplifier Factor(dB)
3. The other emission levels were very low against the limit.
4. Margin value = Emission Level – Limit value
5. " * ": Fundamental frequency.
6. " # ": The radiated frequency is out of the restricted band.

CHANNEL	TX Channel 100	DETECTOR FUNCTION	Peak (PK)
FREQUENCY RANGE	1GHz ~ 40GHz		Average (AV)

ANTENNA POLARITY & TEST DISTANCE: HORIZONTAL AT 3 M

NO.	FREQ. (MHz)	EMISSION LEVEL (dBuV/m)	LIMIT (dBuV/m)	MARGIN (dB)	ANTENNA HEIGHT (m)	TABLE ANGLE (Degree)	RAW VALUE (dBuV)	CORRECTION FACTOR (dB/m)
1	#5340.00	52.5 PK	74.0	-21.5	1.73 H	51	51.21	1.29
2	#5340.00	42.3 AV	54.0	-11.7	1.73 H	51	41.01	1.29
3	5420.00	53.5 PK	74.0	-20.5	1.70 H	46	52.15	1.35
4	5420.00	42.5 AV	54.0	-11.5	1.70 H	46	41.15	1.35
5	#5470.00	64.0 PK	74.0	-10.0	1.65 H	53	62.55	1.45
6	#5470.00	43.6 AV	54.0	-10.4	1.65 H	53	42.15	1.45
7	*5500.00	110.2 PK			1.55 H	127	108.69	1.51
8	*5500.00	100.0 AV			1.55 H	127	98.49	1.51
9	11000.00	58.1 PK	74.0	-15.9	1.19 H	277	45.06	13.04
10	11000.00	45.8 AV	54.0	-8.2	1.19 H	277	32.76	13.04
11	#16500.00	56.2 PK	74.0	-17.8	1.13 H	101	40.93	15.27
12	#16500.00	45.3 AV	54.0	-8.7	1.13 H	101	30.03	15.27

ANTENNA POLARITY & TEST DISTANCE: VERTICAL AT 3 M

NO.	FREQ. (MHz)	EMISSION LEVEL (dBuV/m)	LIMIT (dBuV/m)	MARGIN (dB)	ANTENNA HEIGHT (m)	TABLE ANGLE (Degree)	RAW VALUE (dBuV)	CORRECTION FACTOR (dB/m)
1	#5340.00	61.8 PK	74.0	-12.2	2.59 V	313	60.51	1.29
2	#5340.00	51.8 AV	54.0	-2.2	2.59 V	313	50.51	1.29
3	5420.00	63.8 PK	74.0	-10.2	2.61 V	287	62.45	1.35
4	5420.00	53.0 AV	54.0	-1.0	2.61 V	287	51.65	1.35
5	#5470.00	73.7 PK	74.0	-0.3	2.53 V	314	72.25	1.45
6	#5470.00	53.1 AV	54.0	-0.9	2.53 V	314	51.65	1.45
7	*5500.00	117.8 PK			2.61 V	324	116.29	1.51
8	*5500.00	107.2 AV			2.61 V	324	105.69	1.51
9	11000.00	58.4 PK	74.0	-15.6	2.05 V	169	45.36	13.04
10	11000.00	44.0 AV	54.0	-10.0	2.05 V	169	30.96	13.04
11	#16500.00	57.4 PK	74.0	-16.6	2.21 V	355	42.13	15.27
12	#16500.00	45.6 AV	54.0	-8.4	2.21 V	355	30.33	15.27

REMARKS:

1. Emission Level(dBuV/m) = Raw Value(dBuV) + Correction Factor(dB/m)
2. Correction Factor(dB/m) = Antenna Factor(dB/m) + Cable Factor(dB) – Pre-Amplifier Factor(dB)
3. The other emission levels were very low against the limit.
4. Margin value = Emission Level – Limit value
5. " * ": Fundamental frequency.
6. " # ": The radiated frequency is out of the restricted band.

CHANNEL	TX Channel 116	DETECTOR FUNCTION	Peak (PK)
FREQUENCY RANGE	1GHz ~ 40GHz		Average (AV)

ANTENNA POLARITY & TEST DISTANCE: HORIZONTAL AT 3 M

NO.	FREQ. (MHz)	EMISSION LEVEL (dBuV/m)	LIMIT (dBuV/m)	MARGIN (dB)	ANTENNA HEIGHT (m)	TABLE ANGLE (Degree)	RAW VALUE (dBuV)	CORRECTION FACTOR (dB/m)
1	5420.00	52.9 PK	74.0	-21.1	1.76 H	52	51.55	1.35
2	5420.00	43.8 AV	54.0	-10.2	1.76 H	52	42.45	1.35
3	*5580.00	112.4 PK			1.65 H	134	110.74	1.66
4	*5580.00	101.4 AV			1.65 H	134	99.74	1.66
5	#5740.00	53.5 PK	74.0	-20.5	1.75 H	72	51.54	1.96
6	#5740.00	43.4 AV	54.0	-10.6	1.75 H	72	41.44	1.96
7	11160.00	57.3 PK	74.0	-16.7	1.21 H	270	44.48	12.82
8	11160.00	45.2 AV	54.0	-8.8	1.21 H	270	32.38	12.82
9	#16740.00	56.6 PK	74.0	-17.4	1.21 H	73	40.61	15.99
10	#16740.00	45.5 AV	54.0	-8.5	1.21 H	73	29.51	15.99

ANTENNA POLARITY & TEST DISTANCE: VERTICAL AT 3 M

NO.	FREQ. (MHz)	EMISSION LEVEL (dBuV/m)	LIMIT (dBuV/m)	MARGIN (dB)	ANTENNA HEIGHT (m)	TABLE ANGLE (Degree)	RAW VALUE (dBuV)	CORRECTION FACTOR (dB/m)
1	5420.00	62.7 PK	74.0	-11.3	2.56 V	309	61.35	1.35
2	5420.00	53.9 AV	54.0	-0.1	2.56 V	309	52.55	1.35
3	*5580.00	119.0 PK			2.51 V	285	117.34	1.66
4	*5580.00	108.7 AV			2.51 V	285	107.04	1.66
5	#5740.00	63.7 PK	74.0	-10.3	2.54 V	306	61.74	1.96
6	#5740.00	53.7 AV	54.0	-0.3	2.54 V	306	51.74	1.96
7	11160.00	57.9 PK	74.0	-16.1	2.04 V	157	45.08	12.82
8	11160.00	43.6 AV	54.0	-10.4	2.04 V	157	30.78	12.82
9	#16740.00	57.6 PK	74.0	-16.4	2.26 V	342	41.61	15.99
10	#16740.00	45.9 AV	54.0	-8.1	2.26 V	342	29.91	15.99

REMARKS:

- Emission Level(dBuV/m) = Raw Value(dBuV) + Correction Factor(dB/m)
- Correction Factor(dB/m) = Antenna Factor(dB/m) + Cable Factor(dB) – Pre-Amplifier Factor(dB)
- The other emission levels were very low against the limit.
- Margin value = Emission Level – Limit value
- " * ": Fundamental frequency.
- " # ": The radiated frequency is out of the restricted band.

CHANNEL	TX Channel 140	DETECTOR FUNCTION	Peak (PK)
FREQUENCY RANGE	1GHz ~ 40GHz		Average (AV)

ANTENNA POLARITY & TEST DISTANCE: HORIZONTAL AT 3 M

NO.	FREQ. (MHz)	EMISSION LEVEL (dBuV/m)	LIMIT (dBuV/m)	MARGIN (dB)	ANTENNA HEIGHT (m)	TABLE ANGLE (Degree)	RAW VALUE (dBuV)	CORRECTION FACTOR (dB/m)
1	*5700.00	107.6 PK			1.63 H	113	105.71	1.89
2	*5700.00	97.2 AV			1.63 H	113	95.31	1.89
3	#5725.00	60.5 PK	74.0	-13.5	1.72 H	57	58.57	1.93
4	#5725.00	43.0 AV	54.0	-11.0	1.72 H	57	41.07	1.93
5	11400.00	58.2 PK	74.0	-15.8	1.22 H	261	45.32	12.88
6	11400.00	46.1 AV	54.0	-7.9	1.22 H	261	33.22	12.88
7	#17100.00	56.3 PK	74.0	-17.7	1.18 H	100	38.99	17.31
8	#17100.00	45.1 AV	54.0	-8.9	1.18 H	100	27.79	17.31

ANTENNA POLARITY & TEST DISTANCE: VERTICAL AT 3 M

NO.	FREQ. (MHz)	EMISSION LEVEL (dBuV/m)	LIMIT (dBuV/m)	MARGIN (dB)	ANTENNA HEIGHT (m)	TABLE ANGLE (Degree)	RAW VALUE (dBuV)	CORRECTION FACTOR (dB/m)
1	*5700.00	114.2 PK			2.86 V	117	112.31	1.89
2	*5700.00	104.5 AV			2.86 V	117	102.61	1.89
3	#5725.00	70.3 PK	74.0	-3.7	2.82 V	131	68.37	1.93
4	#5725.00	53.1 AV	54.0	-0.9	2.82 V	131	51.17	1.93
5	11400.00	58.8 PK	74.0	-15.2	2.07 V	158	45.92	12.88
6	11400.00	44.5 AV	54.0	-9.5	2.07 V	158	31.62	12.88
7	#17100.00	57.4 PK	74.0	-16.6	2.21 V	342	40.09	17.31
8	#17100.00	45.5 AV	54.0	-8.5	2.21 V	342	28.19	17.31

REMARKS:

1. Emission Level(dBuV/m) = Raw Value(dBuV) + Correction Factor(dB/m)
2. Correction Factor(dB/m) = Antenna Factor(dB/m) + Cable Factor(dB) – Pre-Amplifier Factor(dB)
3. The other emission levels were very low against the limit.
4. Margin value = Emission Level – Limit value
5. " * ": Fundamental frequency.
6. " # ": The radiated frequency is out of the restricted band.

CHANNEL	TX Channel 144	DETECTOR FUNCTION	Peak (PK)
FREQUENCY RANGE	1GHz ~ 40GHz		Average (AV)

ANTENNA POLARITY & TEST DISTANCE: HORIZONTAL AT 3 M

NO.	FREQ. (MHz)	EMISSION LEVEL (dBuV/m)	LIMIT (dBuV/m)	MARGIN (dB)	ANTENNA HEIGHT (m)	TABLE ANGLE (Degree)	RAW VALUE (dBuV)	CORRECTION FACTOR (dB/m)
1	*5720.00	112.3 PK			1.66 H	130	110.38	1.92
2	*5720.00	101.5 AV			1.66 H	130	99.58	1.92
3	#5880.00	55.1 PK	74.0	-18.9	1.67 H	72	52.96	2.14
4	#5880.00	44.4 AV	54.0	-9.6	1.67 H	72	42.26	2.14
5	11440.00	57.3 PK	74.0	-16.7	1.16 H	258	44.43	12.87
6	11440.00	45.2 AV	54.0	-8.8	1.16 H	258	32.33	12.87
7	#17160.00	55.8 PK	74.0	-18.2	1.18 H	87	38.41	17.39
8	#17160.00	44.9 AV	54.0	-9.1	1.18 H	87	27.51	17.39

ANTENNA POLARITY & TEST DISTANCE: VERTICAL AT 3 M

NO.	FREQ. (MHz)	EMISSION LEVEL (dBuV/m)	LIMIT (dBuV/m)	MARGIN (dB)	ANTENNA HEIGHT (m)	TABLE ANGLE (Degree)	RAW VALUE (dBuV)	CORRECTION FACTOR (dB/m)
1	*5720.00	118.9 PK			2.52 V	303	116.98	1.92
2	*5720.00	108.8 AV			2.52 V	303	106.88	1.92
3	#5880.00	64.5 PK	74.0	-9.5	2.34 V	261	62.36	2.14
4	#5880.00	53.9 AV	54.0	-0.1	2.34 V	261	51.76	2.14
5	11440.00	57.8 PK	74.0	-16.2	2.10 V	152	44.93	12.87
6	11440.00	43.8 AV	54.0	-10.2	2.10 V	152	30.93	12.87
7	#17160.00	57.3 PK	74.0	-16.7	2.25 V	357	39.91	17.39
8	#17160.00	45.8 AV	54.0	-8.2	2.25 V	357	28.41	17.39

REMARKS:

1. Emission Level(dBuV/m) = Raw Value(dBuV) + Correction Factor(dB/m)
2. Correction Factor(dB/m) = Antenna Factor(dB/m) + Cable Factor(dB) – Pre-Amplifier Factor(dB)
3. The other emission levels were very low against the limit.
4. Margin value = Emission Level – Limit value
5. " * ": Fundamental frequency.
6. " # ": The radiated frequency is out of the restricted band.

802.11ac VHT40

CHANNEL	TX Channel 54	DETECTOR FUNCTION	Peak (PK)
FREQUENCY RANGE	1GHz ~ 40GHz		Average (AV)

ANTENNA POLARITY & TEST DISTANCE: HORIZONTAL AT 3 M								
NO.	FREQ. (MHz)	EMISSION LEVEL (dBuV/m)	LIMIT (dBuV/m)	MARGIN (dB)	ANTENNA HEIGHT (m)	TABLE ANGLE (Degree)	RAW VALUE (dBuV)	CORRECTION FACTOR (dB/m)
1	5110.00	50.7 PK	74.0	-23.3	1.71 H	41	50.00	0.70
2	5110.00	39.6 AV	54.0	-14.4	1.71 H	41	38.90	0.70
3	*5270.00	107.5 PK			1.64 H	123	106.33	1.17
4	*5270.00	97.4 AV			1.64 H	123	96.23	1.17
5	5350.00	59.8 PK	74.0	-14.2	1.71 H	37	58.50	1.30
6	5350.00	44.2 AV	54.0	-9.8	1.71 H	37	42.90	1.30
7	5430.00	52.7 PK	74.0	-21.3	1.62 H	63	51.33	1.37
8	5430.00	41.4 AV	54.0	-12.6	1.62 H	63	40.03	1.37
9	#10540.00	57.5 PK	74.0	-16.5	1.18 H	260	46.15	11.35
10	#10540.00	45.2 AV	54.0	-8.8	1.18 H	260	33.85	11.35
11	15810.00	56.8 PK	74.0	-17.2	1.11 H	80	44.54	12.26
12	15810.00	45.4 AV	54.0	-8.6	1.11 H	80	33.14	12.26

ANTENNA POLARITY & TEST DISTANCE: VERTICAL AT 3 M								
NO.	FREQ. (MHz)	EMISSION LEVEL (dBuV/m)	LIMIT (dBuV/m)	MARGIN (dB)	ANTENNA HEIGHT (m)	TABLE ANGLE (Degree)	RAW VALUE (dBuV)	CORRECTION FACTOR (dB/m)
1	5110.00	60.8 PK	74.0	-13.2	2.36 V	296	60.10	0.70
2	5110.00	49.6 AV	54.0	-4.4	2.36 V	296	48.90	0.70
3	*5270.00	113.9 PK			2.74 V	245	112.73	1.17
4	*5270.00	104.2 AV			2.74 V	245	103.03	1.17
5	5350.00	69.4 PK	74.0	-4.6	2.29 V	288	68.10	1.30
6	5350.00	53.9 AV	54.0	-0.1	2.29 V	288	52.60	1.30
7	5430.00	62.3 PK	74.0	-11.7	2.27 V	252	60.93	1.37
8	5430.00	51.2 AV	54.0	-2.8	2.27 V	252	49.83	1.37
9	#10540.00	58.1 PK	74.0	-15.9	2.04 V	145	46.75	11.35
10	#10540.00	43.5 AV	54.0	-10.5	2.04 V	145	32.15	11.35
11	15810.00	56.8 PK	74.0	-17.2	2.18 V	354	44.54	12.26
12	15810.00	45.3 AV	54.0	-8.7	2.18 V	354	33.04	12.26

REMARKS:

1. Emission Level(dBuV/m) = Raw Value(dBuV) + Correction Factor(dB/m)
2. Correction Factor(dB/m) = Antenna Factor(dB/m) + Cable Factor(dB) – Pre-Amplifier Factor(dB)
3. The other emission levels were very low against the limit.
4. Margin value = Emission Level – Limit value
5. " * ": Fundamental frequency.
6. " # ": The radiated frequency is out of the restricted band.

CHANNEL	TX Channel 62	DETECTOR FUNCTION	Peak (PK)
FREQUENCY RANGE	1GHz ~ 40GHz		Average (AV)

ANTENNA POLARITY & TEST DISTANCE: HORIZONTAL AT 3 M

NO.	FREQ. (MHz)	EMISSION LEVEL (dBuV/m)	LIMIT (dBuV/m)	MARGIN (dB)	ANTENNA HEIGHT (m)	TABLE ANGLE (Degree)	RAW VALUE (dBuV)	CORRECTION FACTOR (dB/m)
1	*5310.00	103.6 PK			1.66 H	103	102.33	1.27
2	*5310.00	92.1 AV			1.66 H	103	90.83	1.27
3	5350.00	58.5 PK	74.0	-15.5	1.65 H	51	57.20	1.30
4	5350.00	43.2 AV	54.0	-10.8	1.65 H	51	41.90	1.30
5	10620.00	56.9 PK	74.0	-17.1	1.24 H	270	45.25	11.65
6	10620.00	45.1 AV	54.0	-8.9	1.24 H	270	33.45	11.65
7	15930.00	55.9 PK	74.0	-18.1	1.16 H	90	43.44	12.46
8	15930.00	45.0 AV	54.0	-9.0	1.16 H	90	32.54	12.46

ANTENNA POLARITY & TEST DISTANCE: VERTICAL AT 3 M

NO.	FREQ. (MHz)	EMISSION LEVEL (dBuV/m)	LIMIT (dBuV/m)	MARGIN (dB)	ANTENNA HEIGHT (m)	TABLE ANGLE (Degree)	RAW VALUE (dBuV)	CORRECTION FACTOR (dB/m)
1	*5310.00	109.9 PK			2.60 V	312	108.63	1.27
2	*5310.00	98.9 AV			2.60 V	312	97.63	1.27
3	5350.00	68.8 PK	74.0	-5.2	2.59 V	306	67.50	1.30
4	5350.00	53.5 AV	54.0	-0.5	2.59 V	306	52.20	1.30
5	10620.00	57.9 PK	74.0	-16.1	2.02 V	146	46.25	11.65
6	10620.00	43.5 AV	54.0	-10.5	2.02 V	146	31.85	11.65
7	15930.00	57.4 PK	74.0	-16.6	2.16 V	349	44.94	12.46
8	15930.00	45.8 AV	54.0	-8.2	2.16 V	349	33.34	12.46

REMARKS:

1. Emission Level(dBuV/m) = Raw Value(dBuV) + Correction Factor(dB/m)
2. Correction Factor(dB/m) = Antenna Factor(dB/m) + Cable Factor(dB) – Pre-Amplifier Factor(dB)
3. The other emission levels were very low against the limit.
4. Margin value = Emission Level – Limit value
5. " * ": Fundamental frequency.

CHANNEL	TX Channel 102	DETECTOR FUNCTION	Peak (PK)
FREQUENCY RANGE	1GHz ~ 40GHz		Average (AV)

ANTENNA POLARITY & TEST DISTANCE: HORIZONTAL AT 3 M

NO.	FREQ. (MHz)	EMISSION LEVEL (dBuV/m)	LIMIT (dBuV/m)	MARGIN (dB)	ANTENNA HEIGHT (m)	TABLE ANGLE (Degree)	RAW VALUE (dBuV)	CORRECTION FACTOR (dB/m)
1	#5470.00	58.7 PK	74.0	-15.3	1.65 H	64	57.25	1.45
2	#5470.00	43.5 AV	54.0	-10.5	1.65 H	64	42.05	1.45
3	*5510.00	102.1 PK			1.61 H	124	100.58	1.52
4	*5510.00	91.8 AV			1.61 H	124	90.28	1.52
5	#5970.00	45.5 PK	74.0	-28.5	1.78 H	34	43.08	2.42
6	#5970.00	36.7 AV	54.0	-17.3	1.78 H	34	34.28	2.42
7	11020.00	57.9 PK	74.0	-16.1	1.20 H	256	44.89	13.01
8	11020.00	45.9 AV	54.0	-8.1	1.20 H	256	32.89	13.01
9	#16530.00	56.2 PK	74.0	-17.8	1.21 H	94	40.79	15.41
10	#16530.00	44.9 AV	54.0	-9.1	1.21 H	94	29.49	15.41

ANTENNA POLARITY & TEST DISTANCE: VERTICAL AT 3 M

NO.	FREQ. (MHz)	EMISSION LEVEL (dBuV/m)	LIMIT (dBuV/m)	MARGIN (dB)	ANTENNA HEIGHT (m)	TABLE ANGLE (Degree)	RAW VALUE (dBuV)	CORRECTION FACTOR (dB/m)
1	#5470.00	69.0 PK	74.0	-5.0	2.27 V	289	67.55	1.45
2	#5470.00	53.6 AV	54.0	-0.4	2.27 V	289	52.15	1.45
3	*5510.00	108.3 PK			2.43 V	262	106.78	1.52
4	*5510.00	98.7 AV			2.43 V	262	97.18	1.52
5	#5970.00	55.0 PK	74.0	-19.0	2.51 V	246	52.58	2.42
6	#5970.00	46.3 AV	54.0	-7.7	2.51 V	246	43.88	2.42
7	11020.00	57.6 PK	74.0	-16.4	2.06 V	161	44.59	13.01
8	11020.00	43.6 AV	54.0	-10.4	2.06 V	161	30.59	13.01
9	#16530.00	57.8 PK	74.0	-16.2	2.23 V	342	42.39	15.41
10	#16530.00	46.1 AV	54.0	-7.9	2.23 V	342	30.69	15.41

REMARKS:

1. Emission Level(dBuV/m) = Raw Value(dBuV) + Correction Factor(dB/m)
2. Correction Factor(dB/m) = Antenna Factor(dB/m) + Cable Factor(dB) – Pre-Amplifier Factor(dB)
3. The other emission levels were very low against the limit.
4. Margin value = Emission Level – Limit value
5. " * ": Fundamental frequency.
6. " # ": The radiated frequency is out of the restricted band.

CHANNEL	TX Channel 110	DETECTOR FUNCTION	Peak (PK)
FREQUENCY RANGE	1GHz ~ 40GHz		Average (AV)

ANTENNA POLARITY & TEST DISTANCE: HORIZONTAL AT 3 M

NO.	FREQ. (MHz)	EMISSION LEVEL (dBuV/m)	LIMIT (dBuV/m)	MARGIN (dB)	ANTENNA HEIGHT (m)	TABLE ANGLE (Degree)	RAW VALUE (dBuV)	CORRECTION FACTOR (dB/m)
1	#5470.00	62.5 PK	74.0	-11.5	1.71 H	52	61.05	1.45
2	#5470.00	43.2 AV	54.0	-10.8	1.71 H	52	41.75	1.45
3	*5550.00	111.2 PK			1.58 H	117	109.60	1.60
4	*5550.00	99.0 AV			1.58 H	117	97.40	1.60
5	#5725.00	49.9 PK	74.0	-24.1	1.78 H	52	47.97	1.93
6	#5725.00	39.0 AV	54.0	-15.0	1.78 H	52	37.07	1.93
7	11100.00	57.8 PK	74.0	-16.2	1.15 H	273	44.93	12.87
8	11100.00	45.6 AV	54.0	-8.4	1.15 H	273	32.73	12.87
9	#16650.00	55.9 PK	74.0	-18.1	1.18 H	80	40.09	15.81
10	#16650.00	45.0 AV	54.0	-9.0	1.18 H	80	29.19	15.81

ANTENNA POLARITY & TEST DISTANCE: VERTICAL AT 3 M

NO.	FREQ. (MHz)	EMISSION LEVEL (dBuV/m)	LIMIT (dBuV/m)	MARGIN (dB)	ANTENNA HEIGHT (m)	TABLE ANGLE (Degree)	RAW VALUE (dBuV)	CORRECTION FACTOR (dB/m)
1	#5470.00	73.0 PK	74.0	-1.0	2.71 V	273	71.55	1.45
2	#5470.00	53.5 AV	54.0	-0.5	2.71 V	273	52.05	1.45
3	*5550.00	117.3 PK			2.56 V	315	115.70	1.60
4	*5550.00	105.7 AV			2.56 V	315	104.10	1.60
5	#5725.00	60.3 PK	74.0	-13.7	2.23 V	243	58.37	1.93
6	#5725.00	49.3 AV	54.0	-4.7	2.23 V	243	47.37	1.93
7	11100.00	57.9 PK	74.0	-16.1	2.10 V	163	45.03	12.87
8	11100.00	43.8 AV	54.0	-10.2	2.10 V	163	30.93	12.87
9	#16650.00	58.1 PK	74.0	-15.9	2.16 V	345	42.29	15.81
10	#16650.00	46.3 AV	54.0	-7.7	2.16 V	345	30.49	15.81

REMARKS:

1. Emission Level(dBuV/m) = Raw Value(dBuV) + Correction Factor(dB/m)
2. Correction Factor(dB/m) = Antenna Factor(dB/m) + Cable Factor(dB) – Pre-Amplifier Factor(dB)
3. The other emission levels were very low against the limit.
4. Margin value = Emission Level – Limit value
5. " * ": Fundamental frequency.
6. " # ": The radiated frequency is out of the restricted band.

CHANNEL	TX Channel 134	DETECTOR FUNCTION	Peak (PK)
FREQUENCY RANGE	1GHz ~ 40GHz		Average (AV)

ANTENNA POLARITY & TEST DISTANCE: HORIZONTAL AT 3 M

NO.	FREQ. (MHz)	EMISSION LEVEL (dBuV/m)	LIMIT (dBuV/m)	MARGIN (dB)	ANTENNA HEIGHT (m)	TABLE ANGLE (Degree)	RAW VALUE (dBuV)	CORRECTION FACTOR (dB/m)
1	*5670.00	109.2 PK			1.65 H	129	107.37	1.83
2	*5670.00	97.2 AV			1.65 H	129	95.37	1.83
3	#5725.00	63.5 PK	74.0	-10.5	1.64 H	65	61.57	1.93
4	#5725.00	43.4 AV	54.0	-10.6	1.64 H	65	41.47	1.93
5	11340.00	57.8 PK	74.0	-16.2	1.15 H	253	44.59	13.21
6	11340.00	45.9 AV	54.0	-8.1	1.15 H	253	32.69	13.21
7	#17010.00	56.6 PK	74.0	-17.4	1.10 H	76	39.59	17.01
8	#17010.00	45.3 AV	54.0	-8.7	1.10 H	76	28.29	17.01

ANTENNA POLARITY & TEST DISTANCE: VERTICAL AT 3 M

NO.	FREQ. (MHz)	EMISSION LEVEL (dBuV/m)	LIMIT (dBuV/m)	MARGIN (dB)	ANTENNA HEIGHT (m)	TABLE ANGLE (Degree)	RAW VALUE (dBuV)	CORRECTION FACTOR (dB/m)
1	*5670.00	115.3 PK			2.50 V	294	113.47	1.83
2	*5670.00	103.9 AV			2.50 V	294	102.07	1.83
3	#5725.00	73.6 PK	74.0	-0.4	2.48 V	317	71.67	1.93
4	#5725.00	53.2 AV	54.0	-0.8	2.48 V	317	51.27	1.93
5	11340.00	58.0 PK	74.0	-16.0	2.11 V	166	44.79	13.21
6	11340.00	43.9 AV	54.0	-10.1	2.11 V	166	30.69	13.21
7	#17010.00	57.2 PK	74.0	-16.8	2.14 V	337	40.19	17.01
8	#17010.00	45.5 AV	54.0	-8.5	2.14 V	337	28.49	17.01

REMARKS:

1. Emission Level(dBuV/m) = Raw Value(dBuV) + Correction Factor(dB/m)
2. Correction Factor(dB/m) = Antenna Factor(dB/m) + Cable Factor(dB) – Pre-Amplifier Factor(dB)
3. The other emission levels were very low against the limit.
4. Margin value = Emission Level – Limit value
5. " * ": Fundamental frequency.
6. " # ": The radiated frequency is out of the restricted band.

CHANNEL	TX Channel 142	DETECTOR FUNCTION	Peak (PK)
FREQUENCY RANGE	1GHz ~ 40GHz		Average (AV)

ANTENNA POLARITY & TEST DISTANCE: HORIZONTAL AT 3 M

NO.	FREQ. (MHz)	EMISSION LEVEL (dBuV/m)	LIMIT (dBuV/m)	MARGIN (dB)	ANTENNA HEIGHT (m)	TABLE ANGLE (Degree)	RAW VALUE (dBuV)	CORRECTION FACTOR (dB/m)
1	#5470.00	48.6 PK	74.0	-25.4	1.60 H	55	47.15	1.45
2	#5470.00	37.5 AV	54.0	-16.5	1.60 H	55	36.05	1.45
3	*5710.00	113.5 PK			1.64 H	105	111.59	1.91
4	*5710.00	100.4 AV			1.64 H	105	98.49	1.91
5	#5850.00	55.6 PK	78.2	-22.6	1.68 H	49	53.47	2.13
6	11420.00	57.2 PK	74.0	-16.8	1.16 H	278	44.32	12.88
7	11420.00	45.2 AV	54.0	-8.8	1.16 H	278	32.32	12.88
8	#17130.00	56.8 PK	74.0	-17.2	1.14 H	88	39.46	17.34
9	#17130.00	45.5 AV	54.0	-8.5	1.14 H	88	28.16	17.34

ANTENNA POLARITY & TEST DISTANCE: VERTICAL AT 3 M

NO.	FREQ. (MHz)	EMISSION LEVEL (dBuV/m)	LIMIT (dBuV/m)	MARGIN (dB)	ANTENNA HEIGHT (m)	TABLE ANGLE (Degree)	RAW VALUE (dBuV)	CORRECTION FACTOR (dB/m)
1	#5470.00	58.6 PK	74.0	-15.4	2.33 V	304	57.15	1.45
2	#5470.00	47.7 AV	54.0	-6.3	2.33 V	304	46.25	1.45
3	*5710.00	119.6 PK			2.24 V	314	117.69	1.91
4	*5710.00	107.0 AV			2.24 V	314	105.09	1.91
5	#5850.00	65.3 PK	78.2	-12.9	2.41 V	253	63.17	2.13
6	11420.00	58.2 PK	74.0	-15.8	2.07 V	175	45.32	12.88
7	11420.00	44.0 AV	54.0	-10.0	2.07 V	175	31.12	12.88
8	#17130.00	57.7 PK	74.0	-16.3	2.20 V	358	40.36	17.34
9	#17130.00	45.8 AV	54.0	-8.2	2.20 V	358	28.46	17.34

REMARKS:

1. Emission Level(dBuV/m) = Raw Value(dBuV) + Correction Factor(dB/m)
2. Correction Factor(dB/m) = Antenna Factor(dB/m) + Cable Factor(dB) – Pre-Amplifier Factor(dB)
3. The other emission levels were very low against the limit.
4. Margin value = Emission Level – Limit value
5. " * ": Fundamental frequency.
6. " # ": The radiated frequency is out of the restricted band.

802.11ac (VHT80)

CHANNEL	TX Channel 58	DETECTOR FUNCTION	Peak (PK)
FREQUENCY RANGE	1GHz ~ 40GHz		Average (AV)

ANTENNA POLARITY & TEST DISTANCE: HORIZONTAL AT 3 M

NO.	FREQ. (MHz)	EMISSION LEVEL (dBuV/m)	LIMIT (dBuV/m)	MARGIN (dB)	ANTENNA HEIGHT (m)	TABLE ANGLE (Degree)	RAW VALUE (dBuV)	CORRECTION FACTOR (dB/m)
1	4702.00	44.9 PK	74.0	-29.1	1.72 H	46	45.27	-0.37
2	4702.00	35.8 AV	54.0	-18.2	1.72 H	46	36.17	-0.37
3	5150.00	46.8 PK	74.0	-27.2	1.68 H	57	46.00	0.80
4	5150.00	35.7 AV	54.0	-18.3	1.68 H	57	34.90	0.80
5	*5290.00	99.5 PK			1.58 H	104	98.27	1.23
6	*5290.00	86.4 AV			1.58 H	104	85.17	1.23
7	5350.00	58.7 PK	74.0	-15.3	1.74 H	41	57.40	1.30
8	5350.00	43.2 AV	54.0	-10.8	1.74 H	41	41.90	1.30
9	#10580.00	57.4 PK	74.0	-16.6	1.14 H	279	45.85	11.55
10	#10580.00	45.2 AV	54.0	-8.8	1.14 H	279	33.65	11.55
11	15870.00	56.2 PK	74.0	-17.8	1.13 H	103	43.80	12.40
12	15870.00	45.1 AV	54.0	-8.9	1.13 H	103	32.70	12.40

ANTENNA POLARITY & TEST DISTANCE: VERTICAL AT 3 M

NO.	FREQ. (MHz)	EMISSION LEVEL (dBuV/m)	LIMIT (dBuV/m)	MARGIN (dB)	ANTENNA HEIGHT (m)	TABLE ANGLE (Degree)	RAW VALUE (dBuV)	CORRECTION FACTOR (dB/m)
1	4702.00	54.6 PK	74.0	-19.4	2.25 V	292	54.97	-0.37
2	4702.00	45.6 AV	54.0	-8.4	2.25 V	292	45.97	-0.37
3	5150.00	56.3 PK	74.0	-17.7	2.28 V	293	55.50	0.80
4	5150.00	45.2 AV	54.0	-8.8	2.28 V	293	44.40	0.80
5	*5290.00	105.4 PK			2.16 V	321	104.17	1.23
6	*5290.00	92.8 AV			2.16 V	321	91.57	1.23
7	5350.00	68.6 PK	74.0	-5.4	2.24 V	297	67.30	1.30
8	5350.00	53.3 AV	54.0	-0.7	2.24 V	297	52.00	1.30
9	#10580.00	58.7 PK	74.0	-15.3	2.02 V	175	47.15	11.55
10	#10580.00	44.5 AV	54.0	-9.5	2.02 V	175	32.95	11.55
11	15870.00	57.9 PK	74.0	-16.1	2.24 V	356	45.50	12.40
12	15870.00	46.0 AV	54.0	-8.0	2.24 V	356	33.60	12.40

REMARKS:

1. Emission Level(dBuV/m) = Raw Value(dBuV) + Correction Factor(dB/m)
2. Correction Factor(dB/m) = Antenna Factor(dB/m) + Cable Factor(dB) – Pre-Amplifier Factor(dB)
3. The other emission levels were very low against the limit.
4. Margin value = Emission Level – Limit value
5. " * ": Fundamental frequency.
6. " # ": The radiated frequency is out of the restricted band.

CHANNEL	TX Channel 106	DETECTOR FUNCTION	Peak (PK)
FREQUENCY RANGE	1GHz ~ 40GHz		Average (AV)

ANTENNA POLARITY & TEST DISTANCE: HORIZONTAL AT 3 M

NO.	FREQ. (MHz)	EMISSION LEVEL (dBuV/m)	LIMIT (dBuV/m)	MARGIN (dB)	ANTENNA HEIGHT (m)	TABLE ANGLE (Degree)	RAW VALUE (dBuV)	CORRECTION FACTOR (dB/m)
1	#5470.00	60.2 PK	74.0	-13.8	1.64 H	50	58.75	1.45
2	#5470.00	43.3 AV	54.0	-10.7	1.64 H	50	41.85	1.45
3	*5530.00	101.0 PK			1.56 H	110	99.44	1.56
4	*5530.00	87.3 AV			1.56 H	110	85.74	1.56
5	11060.00	57.3 PK	74.0	-16.7	1.17 H	277	44.36	12.94
6	11060.00	45.2 AV	54.0	-8.8	1.17 H	277	32.26	12.94
7	#16590.00	55.9 PK	74.0	-18.1	1.20 H	86	40.23	15.67
8	#16590.00	44.7 AV	54.0	-9.3	1.20 H	86	29.03	15.67

ANTENNA POLARITY & TEST DISTANCE: VERTICAL AT 3 M

NO.	FREQ. (MHz)	EMISSION LEVEL (dBuV/m)	LIMIT (dBuV/m)	MARGIN (dB)	ANTENNA HEIGHT (m)	TABLE ANGLE (Degree)	RAW VALUE (dBuV)	CORRECTION FACTOR (dB/m)
1	#5470.00	70.6 PK	74.0	-3.4	2.15 V	297	69.15	1.45
2	#5470.00	53.5 AV	54.0	-0.5	2.15 V	297	52.05	1.45
3	*5530.00	106.8 PK			2.13 V	307	105.24	1.56
4	*5530.00	93.6 AV			2.13 V	307	92.04	1.56
5	11060.00	58.4 PK	74.0	-15.6	2.05 V	152	45.46	12.94
6	11060.00	44.1 AV	54.0	-9.9	2.05 V	152	31.16	12.94
7	#16590.00	57.7 PK	74.0	-16.3	2.22 V	357	42.03	15.67
8	#16590.00	45.8 AV	54.0	-8.2	2.22 V	357	30.13	15.67

REMARKS:

1. Emission Level(dBuV/m) = Raw Value(dBuV) + Correction Factor(dB/m)
2. Correction Factor(dB/m) = Antenna Factor(dB/m) + Cable Factor(dB) – Pre-Amplifier Factor(dB)
3. The other emission levels were very low against the limit.
4. Margin value = Emission Level – Limit value
5. " * ": Fundamental frequency.
6. " # ": The radiated frequency is out of the restricted band.

CHANNEL	TX Channel 122	DETECTOR FUNCTION	Peak (PK)
FREQUENCY RANGE	1GHz ~ 40GHz		Average (AV)

ANTENNA POLARITY & TEST DISTANCE: HORIZONTAL AT 3 M

NO.	FREQ. (MHz)	EMISSION LEVEL (dBuV/m)	LIMIT (dBuV/m)	MARGIN (dB)	ANTENNA HEIGHT (m)	TABLE ANGLE (Degree)	RAW VALUE (dBuV)	CORRECTION FACTOR (dB/m)
1	#5470.00	56.3 PK	74.0	-17.7	1.77 H	43	54.85	1.45
2	#5470.00	40.6 AV	54.0	-13.4	1.77 H	43	39.15	1.45
3	*5610.00	106.2 PK			1.64 H	128	104.49	1.71
4	*5610.00	93.1 AV			1.64 H	128	91.39	1.71
5	#5725.00	56.6 PK	74.0	-17.4	1.66 H	51	54.67	1.93
6	#5725.00	43.0 AV	54.0	-11.0	1.66 H	51	41.07	1.93
7	11220.00	57.9 PK	74.0	-16.1	1.17 H	272	44.98	12.92
8	11220.00	45.7 AV	54.0	-8.3	1.17 H	272	32.78	12.92
9	#16830.00	56.5 PK	74.0	-17.5	1.20 H	105	40.22	16.28
10	#16830.00	45.3 AV	54.0	-8.7	1.20 H	105	29.02	16.28

ANTENNA POLARITY & TEST DISTANCE: VERTICAL AT 3 M

NO.	FREQ. (MHz)	EMISSION LEVEL (dBuV/m)	LIMIT (dBuV/m)	MARGIN (dB)	ANTENNA HEIGHT (m)	TABLE ANGLE (Degree)	RAW VALUE (dBuV)	CORRECTION FACTOR (dB/m)
1	#5470.00	66.0 PK	74.0	-8.0	2.08 V	319	64.55	1.45
2	#5470.00	50.2 AV	54.0	-3.8	2.08 V	319	48.75	1.45
3	*5610.00	111.9 PK			2.11 V	297	110.19	1.71
4	*5610.00	99.2 AV			2.11 V	297	97.49	1.71
5	#5725.00	66.7 PK	74.0	-7.3	2.12 V	306	64.77	1.93
6	#5725.00	53.2 AV	54.0	-0.8	2.12 V	306	51.27	1.93
7	11220.00	58.2 PK	74.0	-15.8	2.00 V	162	45.28	12.92
8	11220.00	44.2 AV	54.0	-9.8	2.00 V	162	31.28	12.92
9	#16830.00	58.0 PK	74.0	-16.0	2.21 V	360	41.72	16.28
10	#16830.00	46.2 AV	54.0	-7.8	2.21 V	360	29.92	16.28

REMARKS:

1. Emission Level(dBuV/m) = Raw Value(dBuV) + Correction Factor(dB/m)
2. Correction Factor(dB/m) = Antenna Factor(dB/m) + Cable Factor(dB) – Pre-Amplifier Factor(dB)
3. The other emission levels were very low against the limit.
4. Margin value = Emission Level – Limit value
5. " * ": Fundamental frequency.
6. " # ": The radiated frequency is out of the restricted band.

CHANNEL	TX Channel 138	DETECTOR FUNCTION	Peak (PK)
FREQUENCY RANGE	1GHz ~ 40GHz		Average (AV)

ANTENNA POLARITY & TEST DISTANCE: HORIZONTAL AT 3 M

NO.	FREQ. (MHz)	EMISSION LEVEL (dBuV/m)	LIMIT (dBuV/m)	MARGIN (dB)	ANTENNA HEIGHT (m)	TABLE ANGLE (Degree)	RAW VALUE (dBuV)	CORRECTION FACTOR (dB/m)
1	*5690.00	106.9 PK			1.67 H	122	105.03	1.87
2	*5690.00	93.7 AV			1.67 H	122	91.83	1.87
3	#5850.00	63.7 PK	78.2	-14.5	1.64 H	66	61.57	2.13
4	#5860.00	56.5 PK	74.0	-17.5	1.69 H	50	54.37	2.13
5	#5860.00	43.0 AV	54.0	-11.0	1.69 H	50	40.87	2.13
6	11380.00	57.7 PK	74.0	-16.3	1.14 H	260	44.72	12.98
7	11380.00	45.4 AV	54.0	-8.6	1.14 H	260	32.42	12.98
8	#17070.00	56.6 PK	74.0	-17.4	1.20 H	101	39.38	17.22
9	#17070.00	45.1 AV	54.0	-8.9	1.20 H	101	27.88	17.22

ANTENNA POLARITY & TEST DISTANCE: VERTICAL AT 3 M

NO.	FREQ. (MHz)	EMISSION LEVEL (dBuV/m)	LIMIT (dBuV/m)	MARGIN (dB)	ANTENNA HEIGHT (m)	TABLE ANGLE (Degree)	RAW VALUE (dBuV)	CORRECTION FACTOR (dB/m)
1	*5690.00	112.5 PK			2.11 V	321	110.63	1.87
2	*5690.00	99.7 AV			2.11 V	321	97.83	1.87
3	#5850.00	73.6 PK	78.2	-4.6	2.72 V	75	71.47	2.13
4	#5860.00	67.0 PK	74.0	-7.0	2.07 V	326	64.87	2.13
5	#5860.00	53.3 AV	54.0	-0.7	2.07 V	326	51.17	2.13
6	11380.00	58.0 PK	74.0	-16.0	2.07 V	151	45.02	12.98
7	11380.00	43.6 AV	54.0	-10.4	2.07 V	151	30.62	12.98
8	#17070.00	57.8 PK	74.0	-16.2	2.25 V	354	40.58	17.22
9	#17070.00	45.8 AV	54.0	-8.2	2.25 V	354	28.58	17.22

REMARKS:

1. Emission Level(dBuV/m) = Raw Value(dBuV) + Correction Factor(dB/m)
2. Correction Factor(dB/m) = Antenna Factor(dB/m) + Cable Factor(dB) – Pre-Amplifier Factor(dB)
3. The other emission levels were very low against the limit.
4. Margin value = Emission Level – Limit value
5. " * ": Fundamental frequency.
6. " # ": The radiated frequency is out of the restricted band.

BELOW 1GHz WORST-CASE DATA
802.11ac (VHT 40)
ANT1, ANT2, ANT3

CHANNEL	TX Channel 54	DETECTOR FUNCTION	Quasi-Peak (QP)
FREQUENCY RANGE	Below 1GHz		

ANTENNA POLARITY & TEST DISTANCE: HORIZONTAL AT 3 M

NO.	FREQ. (MHz)	EMISSION LEVEL (dBuV/m)	LIMIT (dBuV/m)	MARGIN (dB)	ANTENNA HEIGHT (m)	TABLE ANGLE (Degree)	RAW VALUE (dBuV)	CORRECTION FACTOR (dB/m)
1	39.38	33.2 QP	40.0	-6.9	1.00 H	194	48.95	-15.80
2	88.83	34.1 QP	43.5	-9.4	2.00 H	58	55.11	-20.97
3	146.06	34.1 QP	43.5	-9.4	2.00 H	62	49.41	-15.32
4	164.49	30.6 QP	43.5	-12.9	1.50 H	88	45.89	-15.29
5	799.99	39.1 QP	46.0	-6.9	1.00 H	291	42.68	-3.57
6	999.98	35.0 QP	54.0	-19.0	1.50 H	320	35.98	-0.99

ANTENNA POLARITY & TEST DISTANCE: VERTICAL AT 3 M

NO.	FREQ. (MHz)	EMISSION LEVEL (dBuV/m)	LIMIT (dBuV/m)	MARGIN (dB)	ANTENNA HEIGHT (m)	TABLE ANGLE (Degree)	RAW VALUE (dBuV)	CORRECTION FACTOR (dB/m)
1	30.61	35.2 QP	40.0	-4.8	1.00 V	67	51.76	-16.53
2	73.99	34.6 QP	40.0	-5.4	1.50 V	287	53.27	-18.68
3	106.73	38.4 QP	43.5	-5.1	1.50 V	239	56.86	-18.42
4	146.57	33.6 QP	43.5	-9.9	1.50 V	123	48.85	-15.29
5	250.00	27.2 QP	46.0	-18.8	1.00 V	4	43.38	-16.14
6	1000.00	36.0 QP	54.0	-18.1	1.00 V	333	36.94	-0.99

REMARKS:

1. Emission Level(dBuV/m) = Raw Value(dBuV) + Correction Factor(dB/m)
2. Correction Factor(dB/m) = Antenna Factor(dB/m) + Cable Factor(dB) – Pre-Amplifier Factor(dB)
3. The other emission levels were very low against the limit.
4. Margin value = Emission Level – Limit value

4.1.8 Test Results (Mode 2)

ABOVE 1GHz DATA :

3TX

ANT7, ANT8, ANT9

802.11a

CHANNEL	TX Channel 52	DETECTOR FUNCTION	Peak (PK)
FREQUENCY RANGE	1GHz ~ 40GHz		Average (AV)

ANTENNA POLARITY & TEST DISTANCE: HORIZONTAL AT 3 M

NO.	FREQ. (MHz)	EMISSION LEVEL (dBuV/m)	LIMIT (dBuV/m)	MARGIN (dB)	ANTENNA HEIGHT (m)	TABLE ANGLE (Degree)	RAW VALUE (dBuV)	CORRECTION FACTOR (dB/m)
1	5100.00	60.4 PK	74.0	-13.6	1.00 H	360	58.08	2.32
2	5100.00	43.9 AV	54.0	-10.1	1.00 H	360	41.58	2.32
3	*5260.00	115.3 PK			3.31 H	348	112.76	2.54
4	*5260.00	105.4 AV			3.31 H	348	102.86	2.54
5	5420.00	63.0 PK	74.0	-11.0	1.03 H	354	60.27	2.73
6	5420.00	45.6 AV	54.0	-8.4	1.03 H	354	42.87	2.73
7	#10520.00	50.3 PK	74.0	-23.7	2.01 H	129	37.90	12.40
8	#10520.00	37.9 AV	54.0	-16.1	2.01 H	129	25.50	12.40
9	15780.00	51.4 PK	74.0	-22.6	2.14 H	136	36.58	14.82
10	15780.00	39.1 AV	54.0	-14.9	2.14 H	136	24.28	14.82

ANTENNA POLARITY & TEST DISTANCE: VERTICAL AT 3 M

NO.	FREQ. (MHz)	EMISSION LEVEL (dBuV/m)	LIMIT (dBuV/m)	MARGIN (dB)	ANTENNA HEIGHT (m)	TABLE ANGLE (Degree)	RAW VALUE (dBuV)	CORRECTION FACTOR (dB/m)
1	5100.00	62.7 PK	74.0	-11.3	2.34 V	52	60.38	2.32
2	5100.00	52.5 AV	54.0	-1.5	2.34 V	52	50.18	2.32
3	*5260.00	119.5 PK			2.27 V	301	116.96	2.54
4	*5260.00	109.1 AV			2.27 V	301	106.56	2.54
5	5420.00	63.7 PK	74.0	-10.3	2.20 V	300	60.97	2.73
6	5420.00	53.7 AV	54.0	-0.3	2.20 V	300	50.97	2.73
7	#10520.00	50.9 PK	74.0	-23.1	2.37 V	196	38.50	12.40
8	#10520.00	40.6 AV	54.0	-13.4	2.37 V	196	28.20	12.40
9	15780.00	55.3 PK	74.0	-18.7	2.49 V	315	40.48	14.82
10	15780.00	44.2 AV	54.0	-9.8	2.49 V	315	29.38	14.82

REMARKS:

1. Emission Level(dBuV/m) = Raw Value(dBuV) + Correction Factor(dB/m)
2. Correction Factor(dB/m) = Antenna Factor(dB/m) + Cable Factor(dB) – Pre-Amplifier Factor(dB)
3. The other emission levels were very low against the limit.
4. Margin value = Emission Level – Limit value
5. " * ": Fundamental frequency.
6. " # ": The radiated frequency is out of the restricted band.

CHANNEL	TX Channel 60	DETECTOR FUNCTION	Peak (PK)
FREQUENCY RANGE	1GHz ~ 40GHz		Average (AV)

ANTENNA POLARITY & TEST DISTANCE: HORIZONTAL AT 3 M

NO.	FREQ. (MHz)	EMISSION LEVEL (dBuV/m)	LIMIT (dBuV/m)	MARGIN (dB)	ANTENNA HEIGHT (m)	TABLE ANGLE (Degree)	RAW VALUE (dBuV)	CORRECTION FACTOR (dB/m)
1	5140.00	60.1 PK	74.0	-13.9	1.04 H	360	57.73	2.37
2	5140.00	43.5 AV	54.0	-10.5	1.04 H	360	41.13	2.37
3	*5300.00	114.8 PK			3.26 H	321	112.19	2.61
4	*5300.00	105.2 AV			3.26 H	321	102.59	2.61
5	5460.00	62.7 PK	74.0	-11.3	1.11 H	360	59.92	2.78
6	5460.00	45.1 AV	54.0	-8.9	1.11 H	360	42.32	2.78
7	10600.00	50.5 PK	74.0	-23.5	1.97 H	123	37.64	12.86
8	10600.00	38.2 AV	54.0	-15.8	1.97 H	123	25.34	12.86
9	15900.00	52.6 PK	74.0	-21.4	2.17 H	134	37.73	14.87
10	15900.00	39.8 AV	54.0	-14.2	2.17 H	134	24.93	14.87

ANTENNA POLARITY & TEST DISTANCE: VERTICAL AT 3 M

NO.	FREQ. (MHz)	EMISSION LEVEL (dBuV/m)	LIMIT (dBuV/m)	MARGIN (dB)	ANTENNA HEIGHT (m)	TABLE ANGLE (Degree)	RAW VALUE (dBuV)	CORRECTION FACTOR (dB/m)
1	5140.00	62.3 PK	74.0	-11.7	2.53 V	54	59.93	2.37
2	5140.00	52.2 AV	54.0	-1.8	2.53 V	54	49.83	2.37
3	*5300.00	118.2 PK			2.01 V	315	115.59	2.61
4	*5300.00	108.1 AV			2.01 V	315	105.49	2.61
5	5460.00	63.9 PK	74.0	-10.1	2.32 V	296	61.12	2.78
6	5460.00	53.6 AV	54.0	-0.4	2.32 V	296	50.82	2.78
7	10600.00	51.5 PK	74.0	-22.5	2.40 V	215	38.64	12.86
8	10600.00	41.1 AV	54.0	-12.9	2.40 V	215	28.24	12.86
9	15900.00	55.4 PK	74.0	-18.6	2.46 V	328	40.53	14.87
10	15900.00	44.4 AV	54.0	-9.6	2.46 V	328	29.53	14.87

REMARKS:

1. Emission Level(dBuV/m) = Raw Value(dBuV) + Correction Factor(dB/m)
2. Correction Factor(dB/m) = Antenna Factor(dB/m) + Cable Factor(dB) – Pre-Amplifier Factor(dB)
3. The other emission levels were very low against the limit.
4. Margin value = Emission Level – Limit value
5. " * ": Fundamental frequency.

CHANNEL	TX Channel 64	DETECTOR FUNCTION	Peak (PK)
FREQUENCY RANGE	1GHz ~ 40GHz		Average (AV)

ANTENNA POLARITY & TEST DISTANCE: HORIZONTAL AT 3 M

NO.	FREQ. (MHz)	EMISSION LEVEL (dBuV/m)	LIMIT (dBuV/m)	MARGIN (dB)	ANTENNA HEIGHT (m)	TABLE ANGLE (Degree)	RAW VALUE (dBuV)	CORRECTION FACTOR (dB/m)
1	*5320.00	113.9 PK			3.30 H	330	111.27	2.63
2	*5320.00	103.6 AV			3.30 H	330	100.97	2.63
3	5350.00	62.4 PK	74.0	-11.6	1.13 H	360	59.75	2.65
4	5350.00	45.0 AV	54.0	-9.0	1.13 H	360	42.35	2.65
5	10640.00	50.3 PK	74.0	-23.7	1.97 H	146	37.42	12.88
6	10640.00	38.3 AV	54.0	-15.7	1.97 H	146	25.42	12.88
7	15960.00	51.8 PK	74.0	-22.2	2.09 H	134	36.87	14.93
8	15960.00	39.5 AV	54.0	-14.5	2.09 H	134	24.57	14.93

ANTENNA POLARITY & TEST DISTANCE: VERTICAL AT 3 M

NO.	FREQ. (MHz)	EMISSION LEVEL (dBuV/m)	LIMIT (dBuV/m)	MARGIN (dB)	ANTENNA HEIGHT (m)	TABLE ANGLE (Degree)	RAW VALUE (dBuV)	CORRECTION FACTOR (dB/m)
1	*5320.00	116.9 PK			2.24 V	299	114.27	2.63
2	*5320.00	106.2 AV			2.24 V	299	103.57	2.63
3	5350.00	71.0 PK	74.0	-3.0	2.32 V	62	68.35	2.65
4	5350.00	53.6 AV	54.0	-0.4	2.32 V	62	50.95	2.65
5	10640.00	52.0 PK	74.0	-22.0	2.45 V	188	39.12	12.88
6	10640.00	39.0 AV	54.0	-15.0	2.45 V	188	26.12	12.88
7	15960.00	55.7 PK	74.0	-18.3	2.54 V	327	40.77	14.93
8	15960.00	43.2 AV	54.0	-10.8	2.54 V	327	28.27	14.93

REMARKS:

1. Emission Level(dBuV/m) = Raw Value(dBuV) + Correction Factor(dB/m)
2. Correction Factor(dB/m) = Antenna Factor(dB/m) + Cable Factor(dB) – Pre-Amplifier Factor(dB)
3. The other emission levels were very low against the limit.
4. Margin value = Emission Level – Limit value
5. " * ": Fundamental frequency.

CHANNEL	TX Channel 100	DETECTOR FUNCTION	Peak (PK)
FREQUENCY RANGE	1GHz ~ 40GHz		Average (AV)

ANTENNA POLARITY & TEST DISTANCE: HORIZONTAL AT 3 M

NO.	FREQ. (MHz)	EMISSION LEVEL (dBuV/m)	LIMIT (dBuV/m)	MARGIN (dB)	ANTENNA HEIGHT (m)	TABLE ANGLE (Degree)	RAW VALUE (dBuV)	CORRECTION FACTOR (dB/m)
1	#5470.00	60.1 PK	74.0	-13.9	1.00 H	360	57.31	2.79
2	#5470.00	43.7 AV	54.0	-10.3	1.00 H	360	40.91	2.79
3	*5500.00	111.2 PK			3.33 H	340	108.37	2.83
4	*5500.00	101.7 AV			3.33 H	340	98.87	2.83
5	#5735.00	62.8 PK	74.0	-11.2	1.05 H	360	59.43	3.37
6	#5735.00	45.5 AV	54.0	-8.5	1.05 H	360	42.13	3.37
7	11000.00	50.9 PK	74.0	-23.1	2.01 H	141	37.26	13.64
8	11000.00	38.5 AV	54.0	-15.5	2.01 H	141	24.86	13.64
9	#16500.00	51.5 PK	74.0	-22.5	2.12 H	128	32.86	18.64
10	#16500.00	39.1 AV	54.0	-14.9	2.12 H	128	20.46	18.64

ANTENNA POLARITY & TEST DISTANCE: VERTICAL AT 3 M

NO.	FREQ. (MHz)	EMISSION LEVEL (dBuV/m)	LIMIT (dBuV/m)	MARGIN (dB)	ANTENNA HEIGHT (m)	TABLE ANGLE (Degree)	RAW VALUE (dBuV)	CORRECTION FACTOR (dB/m)
1	#5470.00	71.1 PK	74.0	-2.9	2.25 V	302	68.31	2.79
2	#5470.00	53.2 AV	54.0	-0.8	2.25 V	302	50.41	2.79
3	*5500.00	116.1 PK			2.36 V	305	113.27	2.83
4	*5500.00	105.9 AV			2.36 V	305	103.07	2.83
5	#5735.00	64.3 PK	74.0	-9.7	2.15 V	61	60.93	3.37
6	#5735.00	53.7 AV	54.0	-0.3	2.15 V	61	50.33	3.37
7	11000.00	52.2 PK	74.0	-21.8	2.46 V	197	38.56	13.64
8	11000.00	39.2 AV	54.0	-14.8	2.46 V	197	25.56	13.64
9	#16500.00	55.4 PK	74.0	-18.6	2.49 V	325	36.76	18.64
10	#16500.00	42.8 AV	54.0	-11.2	2.49 V	325	24.16	18.64

REMARKS:

1. Emission Level(dBuV/m) = Raw Value(dBuV) + Correction Factor(dB/m)
2. Correction Factor(dB/m) = Antenna Factor(dB/m) + Cable Factor(dB) – Pre-Amplifier Factor(dB)
3. The other emission levels were very low against the limit.
4. Margin value = Emission Level – Limit value
5. " * ": Fundamental frequency.
6. " # ": The radiated frequency is out of the restricted band.

CHANNEL	TX Channel 116	DETECTOR FUNCTION	Peak (PK)
FREQUENCY RANGE	1GHz ~ 40GHz		Average (AV)

ANTENNA POLARITY & TEST DISTANCE: HORIZONTAL AT 3 M

NO.	FREQ. (MHz)	EMISSION LEVEL (dBuV/m)	LIMIT (dBuV/m)	MARGIN (dB)	ANTENNA HEIGHT (m)	TABLE ANGLE (Degree)	RAW VALUE (dBuV)	CORRECTION FACTOR (dB/m)
1	5420.00	62.5 PK	74.0	-11.5	1.09 H	352	59.77	2.73
2	5420.00	44.9 AV	54.0	-9.1	1.09 H	352	42.17	2.73
3	*5580.00	113.9 PK			3.32 H	346	110.84	3.06
4	*5580.00	103.2 AV			3.32 H	346	100.14	3.06
5	#5740.00	62.7 PK	74.0	-11.3	1.10 H	360	59.33	3.37
6	#5740.00	45.4 AV	54.0	-8.6	1.10 H	360	42.03	3.37
7	11160.00	50.6 PK	74.0	-23.4	1.96 H	145	36.98	13.62
8	11160.00	38.5 AV	54.0	-15.5	1.96 H	145	24.88	13.62
9	#16740.00	52.6 PK	74.0	-21.4	2.18 H	138	33.01	19.59
10	#16740.00	39.8 AV	54.0	-14.2	2.18 H	138	20.21	19.59

ANTENNA POLARITY & TEST DISTANCE: VERTICAL AT 3 M

NO.	FREQ. (MHz)	EMISSION LEVEL (dBuV/m)	LIMIT (dBuV/m)	MARGIN (dB)	ANTENNA HEIGHT (m)	TABLE ANGLE (Degree)	RAW VALUE (dBuV)	CORRECTION FACTOR (dB/m)
1	5420.00	64.0 PK	74.0	-10.0	2.39 V	293	61.27	2.73
2	5420.00	53.7 AV	54.0	-0.3	2.39 V	293	50.97	2.73
3	*5580.00	116.9 PK			2.39 V	295	113.84	3.06
4	*5580.00	106.2 AV			2.39 V	295	103.14	3.06
5	#5740.00	63.3 PK	74.0	-10.7	2.38 V	294	59.93	3.37
6	#5740.00	53.7 AV	54.0	-0.3	2.38 V	294	50.33	3.37
7	11160.00	52.7 PK	74.0	-21.3	2.47 V	194	39.08	13.62
8	11160.00	39.5 AV	54.0	-14.5	2.47 V	194	25.88	13.62
9	#16740.00	55.3 PK	74.0	-18.7	2.45 V	314	35.71	19.59
10	#16740.00	42.8 AV	54.0	-11.2	2.45 V	314	23.21	19.59

REMARKS:

1. Emission Level(dBuV/m) = Raw Value(dBuV) + Correction Factor(dB/m)
2. Correction Factor(dB/m) = Antenna Factor(dB/m) + Cable Factor(dB) – Pre-Amplifier Factor(dB)
3. The other emission levels were very low against the limit.
4. Margin value = Emission Level – Limit value
5. " * ": Fundamental frequency.
6. " # ": The radiated frequency is out of the restricted band.

CHANNEL	TX Channel 140	DETECTOR FUNCTION	Peak (PK)
FREQUENCY RANGE	1GHz ~ 40GHz		Average (AV)

ANTENNA POLARITY & TEST DISTANCE: HORIZONTAL AT 3 M

NO.	FREQ. (MHz)	EMISSION LEVEL (dBuV/m)	LIMIT (dBuV/m)	MARGIN (dB)	ANTENNA HEIGHT (m)	TABLE ANGLE (Degree)	RAW VALUE (dBuV)	CORRECTION FACTOR (dB/m)
1	*5700.00	111.2 PK			3.33 H	332	107.88	3.32
2	*5700.00	101.7 AV			3.33 H	332	98.38	3.32
3	#5725.00	62.0 PK	74.0	-12.0	1.07 H	344	58.64	3.36
4	#5725.00	44.7 AV	54.0	-9.3	1.07 H	344	41.34	3.36
5	#5780.00	60.6 PK	74.0	-13.4	1.03 H	360	57.18	3.42
6	#5780.00	44.0 AV	54.0	-10.0	1.03 H	360	40.58	3.42
7	11400.00	50.7 PK	74.0	-23.3	1.96 H	134	37.09	13.61
8	11400.00	38.4 AV	54.0	-15.6	1.96 H	134	24.79	13.61
9	#17100.00	52.0 PK	74.0	-22.0	2.15 H	141	31.10	20.90
10	#17100.00	39.4 AV	54.0	-14.6	2.15 H	141	18.50	20.90

ANTENNA POLARITY & TEST DISTANCE: VERTICAL AT 3 M

NO.	FREQ. (MHz)	EMISSION LEVEL (dBuV/m)	LIMIT (dBuV/m)	MARGIN (dB)	ANTENNA HEIGHT (m)	TABLE ANGLE (Degree)	RAW VALUE (dBuV)	CORRECTION FACTOR (dB/m)
1	*5700.00	114.9 PK			2.20 V	296	111.58	3.32
2	*5700.00	105.0 AV			2.20 V	296	101.68	3.32
3	#5725.00	72.7 PK	74.0	-1.3	2.41 V	291	69.34	3.36
4	#5725.00	53.4 AV	54.0	-0.6	2.41 V	291	50.04	3.36
5	#5780.00	63.6 PK	74.0	-10.4	2.37 V	295	60.18	3.42
6	#5780.00	52.2 AV	54.0	-1.8	2.37 V	295	48.78	3.42
7	11400.00	51.6 PK	74.0	-22.4	2.31 V	146	37.99	13.61
8	11400.00	38.5 AV	54.0	-15.5	2.31 V	146	24.89	13.61
9	#17100.00	53.5 PK	74.0	-20.5	2.36 V	287	32.60	20.90
10	#17100.00	41.6 AV	54.0	-12.4	2.36 V	287	20.70	20.90

REMARKS:

1. Emission Level(dBuV/m) = Raw Value(dBuV) + Correction Factor(dB/m)
2. Correction Factor(dB/m) = Antenna Factor(dB/m) + Cable Factor(dB) – Pre-Amplifier Factor(dB)
3. The other emission levels were very low against the limit.
4. Margin value = Emission Level – Limit value
5. " * ": Fundamental frequency.
6. " # ": The radiated frequency is out of the restricted band.

CHANNEL	TX Channel 144	DETECTOR FUNCTION	Peak (PK)
FREQUENCY RANGE	1GHz ~ 40GHz		Average (AV)

ANTENNA POLARITY & TEST DISTANCE: HORIZONTAL AT 3 M

NO.	FREQ. (MHz)	EMISSION LEVEL (dBuV/m)	LIMIT (dBuV/m)	MARGIN (dB)	ANTENNA HEIGHT (m)	TABLE ANGLE (Degree)	RAW VALUE (dBuV)	CORRECTION FACTOR (dB/m)
1	*5720.00	116.4 PK			3.34 H	335	113.05	3.35
2	*5720.00	105.7 AV			3.34 H	335	102.35	3.35
3	#5880.00	62.3 PK	74.0	-11.7	1.12 H	343	58.78	3.52
4	#5880.00	44.8 AV	54.0	-9.2	1.12 H	343	41.28	3.52
5	11440.00	50.3 PK	74.0	-23.7	1.94 H	145	36.74	13.56
6	11440.00	37.9 AV	54.0	-16.1	1.94 H	145	24.34	13.56
7	#17160.00	52.0 PK	74.0	-22.0	2.10 H	122	31.22	20.78
8	#17160.00	39.7 AV	54.0	-14.3	2.10 H	122	18.92	20.78

ANTENNA POLARITY & TEST DISTANCE: VERTICAL AT 3 M

NO.	FREQ. (MHz)	EMISSION LEVEL (dBuV/m)	LIMIT (dBuV/m)	MARGIN (dB)	ANTENNA HEIGHT (m)	TABLE ANGLE (Degree)	RAW VALUE (dBuV)	CORRECTION FACTOR (dB/m)
1	*5720.00	119.2 PK			2.41 V	128	115.85	3.35
2	*5720.00	110.0 AV			2.41 V	128	106.65	3.35
3	#5880.00	63.4 PK	74.0	-10.6	2.27 V	114	59.88	3.52
4	#5880.00	53.7 AV	54.0	-0.3	2.27 V	114	50.18	3.52
5	11440.00	51.1 PK	74.0	-22.9	2.46 V	196	37.54	13.56
6	11440.00	40.7 AV	54.0	-13.3	2.46 V	196	27.14	13.56
7	#17160.00	56.0 PK	74.0	-18.0	2.55 V	328	35.22	20.78
8	#17160.00	44.8 AV	54.0	-9.2	2.55 V	328	24.02	20.78

REMARKS:

1. Emission Level(dBuV/m) = Raw Value(dBuV) + Correction Factor(dB/m)
2. Correction Factor(dB/m) = Antenna Factor(dB/m) + Cable Factor(dB) – Pre-Amplifier Factor(dB)
3. The other emission levels were very low against the limit.
4. Margin value = Emission Level – Limit value
5. " * ": Fundamental frequency.
6. " # ": The radiated frequency is out of the restricted band.

802.11ac VHT20

CHANNEL	TX Channel 52	DETECTOR FUNCTION	Peak (PK)
FREQUENCY RANGE	1GHz ~ 40GHz		Average (AV)

ANTENNA POLARITY & TEST DISTANCE: HORIZONTAL AT 3 M

NO.	FREQ. (MHz)	EMISSION LEVEL (dBuV/m)	LIMIT (dBuV/m)	MARGIN (dB)	ANTENNA HEIGHT (m)	TABLE ANGLE (Degree)	RAW VALUE (dBuV)	CORRECTION FACTOR (dB/m)
1	5100.00	60.7 PK	74.0	-13.3	1.02 H	357	58.38	2.32
2	5100.00	44.2 AV	54.0	-9.8	1.02 H	357	41.88	2.32
3	*5260.00	114.4 PK			3.22 H	325	111.86	2.54
4	*5260.00	104.5 AV			3.22 H	325	101.96	2.54
5	5420.00	62.1 PK	74.0	-11.9	1.09 H	336	59.37	2.73
6	5420.00	44.8 AV	54.0	-9.2	1.09 H	336	42.07	2.73
7	#10520.00	50.5 PK	74.0	-23.5	1.99 H	151	38.10	12.40
8	#10520.00	38.4 AV	54.0	-15.6	1.99 H	151	26.00	12.40
9	15780.00	51.8 PK	74.0	-22.2	2.13 H	142	36.98	14.82
10	15780.00	39.2 AV	54.0	-14.8	2.13 H	142	24.38	14.82

ANTENNA POLARITY & TEST DISTANCE: VERTICAL AT 3 M

NO.	FREQ. (MHz)	EMISSION LEVEL (dBuV/m)	LIMIT (dBuV/m)	MARGIN (dB)	ANTENNA HEIGHT (m)	TABLE ANGLE (Degree)	RAW VALUE (dBuV)	CORRECTION FACTOR (dB/m)
1	5100.00	62.1 PK	74.0	-11.9	2.40 V	58	59.78	2.32
2	5100.00	52.4 AV	54.0	-1.6	2.40 V	58	50.08	2.32
3	*5260.00	118.9 PK			2.27 V	307	116.36	2.54
4	*5260.00	108.5 AV			2.27 V	307	105.96	2.54
5	5420.00	63.2 PK	74.0	-10.8	2.31 V	299	60.47	2.73
6	5420.00	53.4 AV	54.0	-0.6	2.31 V	299	50.67	2.73
7	#10520.00	50.6 PK	74.0	-23.4	2.45 V	207	38.20	12.40
8	#10520.00	40.4 AV	54.0	-13.6	2.45 V	207	28.00	12.40
9	15780.00	55.9 PK	74.0	-18.1	2.53 V	308	41.08	14.82
10	15780.00	44.8 AV	54.0	-9.2	2.53 V	308	29.98	14.82

REMARKS:

- Emission Level(dBuV/m) = Raw Value(dBuV) + Correction Factor(dB/m)
- Correction Factor(dB/m) = Antenna Factor(dB/m) + Cable Factor(dB) – Pre-Amplifier Factor(dB)
- The other emission levels were very low against the limit.
- Margin value = Emission Level – Limit value
- " * ": Fundamental frequency.
- " # ": The radiated frequency is out of the restricted band.

CHANNEL	TX Channel 60	DETECTOR FUNCTION	Peak (PK)
FREQUENCY RANGE	1GHz ~ 40GHz		Average (AV)

ANTENNA POLARITY & TEST DISTANCE: HORIZONTAL AT 3 M

NO.	FREQ. (MHz)	EMISSION LEVEL (dBuV/m)	LIMIT (dBuV/m)	MARGIN (dB)	ANTENNA HEIGHT (m)	TABLE ANGLE (Degree)	RAW VALUE (dBuV)	CORRECTION FACTOR (dB/m)
1	5140.00	60.9 PK	74.0	-13.1	1.05 H	360	58.53	2.37
2	5140.00	44.2 AV	54.0	-9.8	1.05 H	360	41.83	2.37
3	*5300.00	114.7 PK			3.34 H	341	112.09	2.61
4	*5300.00	104.9 AV			3.34 H	341	102.29	2.61
5	5460.00	62.0 PK	74.0	-12.0	1.10 H	341	59.22	2.78
6	5460.00	44.7 AV	54.0	-9.3	1.10 H	341	41.92	2.78
7	10600.00	50.3 PK	74.0	-23.7	2.03 H	149	37.44	12.86
8	10600.00	38.3 AV	54.0	-15.7	2.03 H	149	25.44	12.86
9	15900.00	51.6 PK	74.0	-22.4	2.11 H	135	36.73	14.87
10	15900.00	39.2 AV	54.0	-14.8	2.11 H	135	24.33	14.87

ANTENNA POLARITY & TEST DISTANCE: VERTICAL AT 3 M

NO.	FREQ. (MHz)	EMISSION LEVEL (dBuV/m)	LIMIT (dBuV/m)	MARGIN (dB)	ANTENNA HEIGHT (m)	TABLE ANGLE (Degree)	RAW VALUE (dBuV)	CORRECTION FACTOR (dB/m)
1	5140.00	62.5 PK	74.0	-11.5	2.25 V	59	60.13	2.37
2	5140.00	52.2 AV	54.0	-1.8	2.25 V	59	49.83	2.37
3	*5300.00	119.3 PK			2.26 V	301	116.69	2.61
4	*5300.00	108.5 AV			2.26 V	301	105.89	2.61
5	5460.00	63.6 PK	74.0	-10.4	2.36 V	294	60.82	2.78
6	5460.00	53.2 AV	54.0	-0.8	2.36 V	294	50.42	2.78
7	10600.00	50.7 PK	74.0	-23.3	2.44 V	217	37.84	12.86
8	10600.00	40.6 AV	54.0	-13.4	2.44 V	217	27.74	12.86
9	15900.00	56.4 PK	74.0	-17.6	2.48 V	317	41.53	14.87
10	15900.00	45.0 AV	54.0	-9.0	2.48 V	317	30.13	14.87

REMARKS:

1. Emission Level(dBuV/m) = Raw Value(dBuV) + Correction Factor(dB/m)
2. Correction Factor(dB/m) = Antenna Factor(dB/m) + Cable Factor(dB) – Pre-Amplifier Factor(dB)
3. The other emission levels were very low against the limit.
4. Margin value = Emission Level – Limit value
5. " * ": Fundamental frequency.

CHANNEL	TX Channel 64	DETECTOR FUNCTION	Peak (PK)
FREQUENCY RANGE	1GHz ~ 40GHz		Average (AV)

ANTENNA POLARITY & TEST DISTANCE: HORIZONTAL AT 3 M

NO.	FREQ. (MHz)	EMISSION LEVEL (dBuV/m)	LIMIT (dBuV/m)	MARGIN (dB)	ANTENNA HEIGHT (m)	TABLE ANGLE (Degree)	RAW VALUE (dBuV)	CORRECTION FACTOR (dB/m)
1	*5320.00	113.6 PK			3.29 H	335	110.97	2.63
2	*5320.00	103.1 AV			3.29 H	335	100.47	2.63
3	5350.00	62.9 PK	74.0	-11.1	1.14 H	344	60.25	2.65
4	5350.00	45.1 AV	54.0	-8.9	1.14 H	344	42.45	2.65
5	#5480.00	51.8 PK	74.0	-22.2	1.18 H	360	49.00	2.80
6	#5480.00	38.4 AV	54.0	-15.6	1.18 H	360	35.60	2.80
7	10640.00	51.1 PK	74.0	-22.9	2.05 H	148	38.22	12.88
8	10640.00	38.5 AV	54.0	-15.5	2.05 H	148	25.62	12.88
9	15960.00	51.5 PK	74.0	-22.5	2.17 H	143	36.57	14.93
10	15960.00	39.1 AV	54.0	-14.9	2.17 H	143	24.17	14.93

ANTENNA POLARITY & TEST DISTANCE: VERTICAL AT 3 M

NO.	FREQ. (MHz)	EMISSION LEVEL (dBuV/m)	LIMIT (dBuV/m)	MARGIN (dB)	ANTENNA HEIGHT (m)	TABLE ANGLE (Degree)	RAW VALUE (dBuV)	CORRECTION FACTOR (dB/m)
1	*5320.00	117.1 PK			2.25 V	305	114.47	2.63
2	*5320.00	106.4 AV			2.25 V	305	103.77	2.63
3	5350.00	71.9 PK	74.0	-2.1	2.26 V	301	69.25	2.65
4	5350.00	53.2 AV	54.0	-0.8	2.26 V	301	50.55	2.65
5	#5480.00	62.3 PK	74.0	-11.7	2.28 V	300	59.50	2.80
6	#5480.00	51.4 AV	54.0	-2.6	2.28 V	300	48.60	2.80
7	10640.00	52.5 PK	74.0	-21.5	2.41 V	198	39.62	12.88
8	10640.00	39.3 AV	54.0	-14.7	2.41 V	198	26.42	12.88
9	15960.00	55.6 PK	74.0	-18.4	2.49 V	312	40.67	14.93
10	15960.00	42.9 AV	54.0	-11.1	2.49 V	312	27.97	14.93

REMARKS:

1. Emission Level(dBuV/m) = Raw Value(dBuV) + Correction Factor(dB/m)
2. Correction Factor(dB/m) = Antenna Factor(dB/m) + Cable Factor(dB) – Pre-Amplifier Factor(dB)
3. The other emission levels were very low against the limit.
4. Margin value = Emission Level – Limit value
5. " * ": Fundamental frequency.
6. " # ": The radiated frequency is out of the restricted band.

CHANNEL	TX Channel 100	DETECTOR FUNCTION	Peak (PK)
FREQUENCY RANGE	1GHz ~ 40GHz		Average (AV)

ANTENNA POLARITY & TEST DISTANCE: HORIZONTAL AT 3 M

NO.	FREQ. (MHz)	EMISSION LEVEL (dBuV/m)	LIMIT (dBuV/m)	MARGIN (dB)	ANTENNA HEIGHT (m)	TABLE ANGLE (Degree)	RAW VALUE (dBuV)	CORRECTION FACTOR (dB/m)
1	#5470.00	59.6 PK	74.0	-14.4	1.04 H	360	56.81	2.79
2	#5470.00	43.2 AV	54.0	-10.8	1.04 H	360	40.41	2.79
3	*5500.00	114.1 PK			3.24 H	338	111.27	2.83
4	*5500.00	103.5 AV			3.24 H	338	100.67	2.83
5	#5730.00	62.5 PK	74.0	-11.5	1.17 H	335	59.15	3.35
6	#5730.00	44.8 AV	54.0	-9.2	1.17 H	335	41.45	3.35
7	11000.00	51.1 PK	74.0	-22.9	2.03 H	153	37.46	13.64
8	11000.00	38.6 AV	54.0	-15.4	2.03 H	153	24.96	13.64
9	#16500.00	51.5 PK	74.0	-22.5	2.14 H	124	32.86	18.64
10	#16500.00	39.0 AV	54.0	-15.0	2.14 H	124	20.36	18.64

ANTENNA POLARITY & TEST DISTANCE: VERTICAL AT 3 M

NO.	FREQ. (MHz)	EMISSION LEVEL (dBuV/m)	LIMIT (dBuV/m)	MARGIN (dB)	ANTENNA HEIGHT (m)	TABLE ANGLE (Degree)	RAW VALUE (dBuV)	CORRECTION FACTOR (dB/m)
1	#5470.00	72.7 PK	74.0	-1.3	1.04 V	62	69.91	2.79
2	#5470.00	52.9 AV	54.0	-1.1	1.04 V	62	50.11	2.79
3	*5500.00	116.8 PK			2.21 V	302	113.97	2.83
4	*5500.00	106.5 AV			2.21 V	302	103.67	2.83
5	#5730.00	64.7 PK	74.0	-9.3	2.21 V	61	61.35	3.35
6	#5730.00	53.6 AV	54.0	-0.4	2.21 V	61	50.25	3.35
7	11000.00	51.9 PK	74.0	-22.1	2.48 V	195	38.26	13.64
8	11000.00	39.1 AV	54.0	-14.9	2.48 V	195	25.46	13.64
9	#16500.00	55.4 PK	74.0	-18.6	2.54 V	329	36.76	18.64
10	#16500.00	43.1 AV	54.0	-10.9	2.54 V	329	24.46	18.64

REMARKS:

1. Emission Level(dBuV/m) = Raw Value(dBuV) + Correction Factor(dB/m)
2. Correction Factor(dB/m) = Antenna Factor(dB/m) + Cable Factor(dB) – Pre-Amplifier Factor(dB)
3. The other emission levels were very low against the limit.
4. Margin value = Emission Level – Limit value
5. " * ": Fundamental frequency.
6. " # ": The radiated frequency is out of the restricted band.

CHANNEL	TX Channel 116	DETECTOR FUNCTION	Peak (PK)
FREQUENCY RANGE	1GHz ~ 40GHz		Average (AV)

ANTENNA POLARITY & TEST DISTANCE: HORIZONTAL AT 3 M

NO.	FREQ. (MHz)	EMISSION LEVEL (dBuV/m)	LIMIT (dBuV/m)	MARGIN (dB)	ANTENNA HEIGHT (m)	TABLE ANGLE (Degree)	RAW VALUE (dBuV)	CORRECTION FACTOR (dB/m)
1	5420.00	62.5 PK	74.0	-11.5	1.17 H	352	59.77	2.73
2	5420.00	44.9 AV	54.0	-9.1	1.17 H	352	42.17	2.73
3	*5580.00	111.8 PK			3.28 H	336	108.74	3.06
4	*5580.00	102.1 AV			3.28 H	336	99.04	3.06
5	#5740.00	60.4 PK	74.0	-13.6	1.08 H	360	57.03	3.37
6	#5740.00	43.7 AV	54.0	-10.3	1.08 H	360	40.33	3.37
7	11160.00	51.1 PK	74.0	-22.9	2.00 H	132	37.48	13.62
8	11160.00	38.6 AV	54.0	-15.4	2.00 H	132	24.98	13.62
9	#16740.00	52.4 PK	74.0	-21.6	2.09 H	133	32.81	19.59
10	#16740.00	39.7 AV	54.0	-14.3	2.09 H	133	20.11	19.59

ANTENNA POLARITY & TEST DISTANCE: VERTICAL AT 3 M

NO.	FREQ. (MHz)	EMISSION LEVEL (dBuV/m)	LIMIT (dBuV/m)	MARGIN (dB)	ANTENNA HEIGHT (m)	TABLE ANGLE (Degree)	RAW VALUE (dBuV)	CORRECTION FACTOR (dB/m)
1	5420.00	62.9 PK	74.0	-11.1	1.00 V	61	60.17	2.73
2	5420.00	53.8 AV	54.0	-0.2	1.00 V	61	51.07	2.73
3	*5580.00	115.3 PK			1.02 V	324	112.24	3.06
4	*5580.00	105.2 AV			1.02 V	324	102.14	3.06
5	#5740.00	61.5 PK	74.0	-12.5	1.00 V	62	58.13	3.37
6	#5740.00	52.9 AV	54.0	-1.1	1.00 V	62	49.53	3.37
7	11160.00	51.8 PK	74.0	-22.2	2.48 V	197	38.18	13.62
8	11160.00	39.1 AV	54.0	-14.9	2.48 V	197	25.48	13.62
9	#16740.00	55.3 PK	74.0	-18.7	2.45 V	309	35.71	19.59
10	#16740.00	42.8 AV	54.0	-11.2	2.45 V	309	23.21	19.59

REMARKS:

1. Emission Level(dBuV/m) = Raw Value(dBuV) + Correction Factor(dB/m)
2. Correction Factor(dB/m) = Antenna Factor(dB/m) + Cable Factor(dB) – Pre-Amplifier Factor(dB)
3. The other emission levels were very low against the limit.
4. Margin value = Emission Level – Limit value
5. " * ": Fundamental frequency.
6. " # ": The radiated frequency is out of the restricted band.

CHANNEL	TX Channel 140	DETECTOR FUNCTION	Peak (PK)
FREQUENCY RANGE	1GHz ~ 40GHz		Average (AV)

ANTENNA POLARITY & TEST DISTANCE: HORIZONTAL AT 3 M

NO.	FREQ. (MHz)	EMISSION LEVEL (dBuV/m)	LIMIT (dBuV/m)	MARGIN (dB)	ANTENNA HEIGHT (m)	TABLE ANGLE (Degree)	RAW VALUE (dBuV)	CORRECTION FACTOR (dB/m)
1	5460.00	62.3 PK	74.0	-11.7	1.08 H	333	59.52	2.78
2	5460.00	44.9 AV	54.0	-9.1	1.08 H	333	42.12	2.78
3	*5700.00	111.7 PK			3.27 H	326	108.38	3.32
4	*5700.00	101.8 AV			3.27 H	326	98.48	3.32
5	#5725.00	59.7 PK	74.0	-14.3	1.04 H	360	56.34	3.36
6	#5725.00	43.3 AV	54.0	-10.7	1.04 H	360	39.94	3.36
7	11400.00	50.2 PK	74.0	-23.8	2.04 H	134	36.59	13.61
8	11400.00	38.1 AV	54.0	-15.9	2.04 H	134	24.49	13.61
9	#17100.00	51.6 PK	74.0	-22.4	2.19 H	113	30.70	20.90
10	#17100.00	39.2 AV	54.0	-14.8	2.19 H	113	18.30	20.90

ANTENNA POLARITY & TEST DISTANCE: VERTICAL AT 3 M

NO.	FREQ. (MHz)	EMISSION LEVEL (dBuV/m)	LIMIT (dBuV/m)	MARGIN (dB)	ANTENNA HEIGHT (m)	TABLE ANGLE (Degree)	RAW VALUE (dBuV)	CORRECTION FACTOR (dB/m)
1	5460.00	63.9 PK	74.0	-10.1	1.02 V	59	61.12	2.78
2	5460.00	53.3 AV	54.0	-0.7	1.02 V	59	50.52	2.78
3	*5700.00	115.6 PK			1.01 V	62	112.28	3.32
4	*5700.00	104.6 AV			1.01 V	62	101.28	3.32
5	#5725.00	68.8 PK	74.0	-5.2	1.20 V	34	65.44	3.36
6	#5725.00	53.2 AV	54.0	-0.8	1.20 V	34	49.84	3.36
7	11400.00	51.6 PK	74.0	-22.4	2.26 V	169	37.99	13.61
8	11400.00	38.5 AV	54.0	-15.5	2.26 V	169	24.89	13.61
9	#17100.00	53.7 PK	74.0	-20.3	2.44 V	309	32.80	20.90
10	#17100.00	41.8 AV	54.0	-12.2	2.44 V	309	20.90	20.90

REMARKS:

1. Emission Level(dBuV/m) = Raw Value(dBuV) + Correction Factor(dB/m)
2. Correction Factor(dB/m) = Antenna Factor(dB/m) + Cable Factor(dB) – Pre-Amplifier Factor(dB)
3. The other emission levels were very low against the limit.
4. Margin value = Emission Level – Limit value
5. " * ": Fundamental frequency.
6. " # ": The radiated frequency is out of the restricted band.

CHANNEL	TX Channel 144	DETECTOR FUNCTION	Peak (PK)
FREQUENCY RANGE	1GHz ~ 40GHz		Average (AV)

ANTENNA POLARITY & TEST DISTANCE: HORIZONTAL AT 3 M

NO.	FREQ. (MHz)	EMISSION LEVEL (dBuV/m)	LIMIT (dBuV/m)	MARGIN (dB)	ANTENNA HEIGHT (m)	TABLE ANGLE (Degree)	RAW VALUE (dBuV)	CORRECTION FACTOR (dB/m)
1	*5720.00	116.9 PK			3.28 H	320	113.55	3.35
2	*5720.00	106.4 AV			3.28 H	320	103.05	3.35
3	#5880.00	59.6 PK	68.2	-8.6	1.03 H	328	56.08	3.52
4	11440.00	50.7 PK	74.0	-23.3	2.02 H	141	37.14	13.56
5	11440.00	38.4 AV	54.0	-15.6	2.02 H	141	24.84	13.56
6	#17160.00	51.9 PK	68.2	-16.3	2.12 H	125	31.12	20.78

ANTENNA POLARITY & TEST DISTANCE: VERTICAL AT 3 M

NO.	FREQ. (MHz)	EMISSION LEVEL (dBuV/m)	LIMIT (dBuV/m)	MARGIN (dB)	ANTENNA HEIGHT (m)	TABLE ANGLE (Degree)	RAW VALUE (dBuV)	CORRECTION FACTOR (dB/m)
1	*5720.00	119.6 PK			1.06 V	120	116.25	3.35
2	*5720.00	109.4 AV			1.06 V	120	106.05	3.35
3	#5880.00	66.0 PK	68.2	-2.2	1.15 V	240	62.48	3.52
4	11440.00	50.9 PK	74.0	-23.1	2.43 V	233	37.34	13.56
5	11440.00	40.2 AV	54.0	-13.8	2.43 V	233	26.64	13.56
6	#17160.00	55.9 PK	68.2	-12.3	2.51 V	333	35.12	20.78

REMARKS:

1. Emission Level(dBuV/m) = Raw Value(dBuV) + Correction Factor(dB/m)
2. Correction Factor(dB/m) = Antenna Factor(dB/m) + Cable Factor(dB) – Pre-Amplifier Factor(dB)
3. The other emission levels were very low against the limit.
4. Margin value = Emission Level – Limit value
5. " * ": Fundamental frequency.
6. " # ": The radiated frequency is out of the restricted band.

802.11ac VHT40

CHANNEL	TX Channel 54	DETECTOR FUNCTION	Peak (PK)
FREQUENCY RANGE	1GHz ~ 40GHz		Average (AV)

ANTENNA POLARITY & TEST DISTANCE: HORIZONTAL AT 3 M

NO.	FREQ. (MHz)	EMISSION LEVEL (dBuV/m)	LIMIT (dBuV/m)	MARGIN (dB)	ANTENNA HEIGHT (m)	TABLE ANGLE (Degree)	RAW VALUE (dBuV)	CORRECTION FACTOR (dB/m)
1	5110.00	60.1 PK	74.0	-13.9	1.06 H	360	57.78	2.32
2	5110.00	43.7 AV	54.0	-10.3	1.06 H	360	41.38	2.32
3	*5270.00	111.4 PK			3.34 H	349	108.84	2.56
4	*5270.00	101.8 AV			3.34 H	349	99.24	2.56
5	5350.00	62.9 PK	74.0	-11.1	1.07 H	337	60.25	2.65
6	5350.00	45.2 AV	54.0	-8.8	1.07 H	337	42.55	2.65
7	#5855.00	52.2 PK	74.0	-21.8	1.20 H	360	48.71	3.49
8	#5855.00	38.8 AV	54.0	-15.2	1.20 H	360	35.31	3.49
9	#10540.00	50.7 PK	74.0	-23.3	1.95 H	123	38.18	12.52
10	#10540.00	38.3 AV	54.0	-15.7	1.95 H	123	25.78	12.52
11	15810.00	52.0 PK	74.0	-22.0	2.18 H	121	37.24	14.76
12	15810.00	39.6 AV	54.0	-14.4	2.18 H	121	24.84	14.76

ANTENNA POLARITY & TEST DISTANCE: VERTICAL AT 3 M

NO.	FREQ. (MHz)	EMISSION LEVEL (dBuV/m)	LIMIT (dBuV/m)	MARGIN (dB)	ANTENNA HEIGHT (m)	TABLE ANGLE (Degree)	RAW VALUE (dBuV)	CORRECTION FACTOR (dB/m)
1	5110.00	61.2 PK	74.0	-12.8	1.02 V	118	58.88	2.32
2	5110.00	51.1 AV	54.0	-2.9	1.02 V	118	48.78	2.32
3	*5270.00	115.8 PK			1.01 V	126	113.24	2.56
4	*5270.00	105.5 AV			1.01 V	126	102.94	2.56
5	5350.00	60.3 PK	74.0	-13.7	1.02 V	117	57.65	2.65
6	5350.00	53.3 AV	54.0	-0.7	1.02 V	117	50.65	2.65
7	#5855.00	56.7 PK	74.0	-17.3	1.02 V	119	53.21	3.49
8	#5855.00	50.4 AV	54.0	-3.6	1.02 V	119	46.91	3.49
9	#10540.00	50.3 PK	74.0	-23.7	2.33 V	151	37.78	12.52
10	#10540.00	37.7 AV	54.0	-16.3	2.33 V	151	25.18	12.52
11	15810.00	51.3 PK	74.0	-22.7	2.46 V	278	36.54	14.76
12	15810.00	39.0 AV	54.0	-15.0	2.46 V	278	24.24	14.76

REMARKS:

1. Emission Level(dBuV/m) = Raw Value(dBuV) + Correction Factor(dB/m)
2. Correction Factor(dB/m) = Antenna Factor(dB/m) + Cable Factor(dB) – Pre-Amplifier Factor(dB)
3. The other emission levels were very low against the limit.
4. Margin value = Emission Level – Limit value
5. " * ": Fundamental frequency.
6. " # ": The radiated frequency is out of the restricted band.

CHANNEL	TX Channel 62	DETECTOR FUNCTION	Peak (PK)
FREQUENCY RANGE	1GHz ~ 40GHz		Average (AV)

ANTENNA POLARITY & TEST DISTANCE: HORIZONTAL AT 3 M

NO.	FREQ. (MHz)	EMISSION LEVEL (dBuV/m)	LIMIT (dBuV/m)	MARGIN (dB)	ANTENNA HEIGHT (m)	TABLE ANGLE (Degree)	RAW VALUE (dBuV)	CORRECTION FACTOR (dB/m)
1	*5310.00	107.3 PK			3.33 H	332	104.69	2.61
2	*5310.00	96.3 AV			3.33 H	332	93.69	2.61
3	5350.00	62.8 PK	74.0	-11.2	1.09 H	336	60.15	2.65
4	5350.00	45.1 AV	54.0	-8.9	1.09 H	336	42.45	2.65
5	10620.00	50.9 PK	74.0	-23.1	2.02 H	124	38.02	12.88
6	10620.00	38.4 AV	54.0	-15.6	2.02 H	124	25.52	12.88
7	15930.00	52.2 PK	74.0	-21.8	2.12 H	118	37.30	14.90
8	15930.00	39.4 AV	54.0	-14.6	2.12 H	118	24.50	14.90

ANTENNA POLARITY & TEST DISTANCE: VERTICAL AT 3 M

NO.	FREQ. (MHz)	EMISSION LEVEL (dBuV/m)	LIMIT (dBuV/m)	MARGIN (dB)	ANTENNA HEIGHT (m)	TABLE ANGLE (Degree)	RAW VALUE (dBuV)	CORRECTION FACTOR (dB/m)
1	*5310.00	110.9 PK			1.00 V	133	108.29	2.61
2	*5310.00	100.2 AV			1.00 V	133	97.59	2.61
3	5350.00	67.2 PK	74.0	-6.8	1.00 V	127	64.55	2.65
4	5350.00	53.3 AV	54.0	-0.7	1.00 V	127	50.65	2.65
5	10620.00	49.5 PK	74.0	-24.5	2.34 V	177	36.62	12.88
6	10620.00	37.7 AV	54.0	-16.3	2.34 V	177	24.82	12.88
7	15930.00	52.0 PK	74.0	-22.0	2.50 V	279	37.10	14.90
8	15930.00	39.7 AV	54.0	-14.3	2.50 V	279	24.80	14.90

REMARKS:

1. Emission Level(dBuV/m) = Raw Value(dBuV) + Correction Factor(dB/m)
2. Correction Factor(dB/m) = Antenna Factor(dB/m) + Cable Factor(dB) – Pre-Amplifier Factor(dB)
3. The other emission levels were very low against the limit.
4. Margin value = Emission Level – Limit value
5. " * ": Fundamental frequency.

CHANNEL	TX Channel 102	DETECTOR FUNCTION	Peak (PK)
FREQUENCY RANGE	1GHz ~ 40GHz		Average (AV)

ANTENNA POLARITY & TEST DISTANCE: HORIZONTAL AT 3 M

NO.	FREQ. (MHz)	EMISSION LEVEL (dBuV/m)	LIMIT (dBuV/m)	MARGIN (dB)	ANTENNA HEIGHT (m)	TABLE ANGLE (Degree)	RAW VALUE (dBuV)	CORRECTION FACTOR (dB/m)
1	#5470.00	61.9 PK	74.0	-12.1	1.16 H	345	59.11	2.79
2	#5470.00	44.3 AV	54.0	-9.7	1.16 H	345	41.51	2.79
3	*5510.00	109.6 PK			3.29 H	324	106.75	2.85
4	*5510.00	99.2 AV			3.29 H	324	96.35	2.85
5	#5750.00	51.8 PK	74.0	-22.2	1.21 H	348	48.42	3.38
6	#5750.00	38.5 AV	54.0	-15.5	1.21 H	348	35.12	3.38
7	11020.00	51.3 PK	74.0	-22.7	1.96 H	131	37.66	13.64
8	11020.00	38.8 AV	54.0	-15.2	1.96 H	131	25.16	13.64
9	#16530.00	52.2 PK	74.0	-21.8	2.12 H	136	33.38	18.82
10	#16530.00	39.8 AV	54.0	-14.2	2.12 H	136	20.98	18.82

ANTENNA POLARITY & TEST DISTANCE: VERTICAL AT 3 M

NO.	FREQ. (MHz)	EMISSION LEVEL (dBuV/m)	LIMIT (dBuV/m)	MARGIN (dB)	ANTENNA HEIGHT (m)	TABLE ANGLE (Degree)	RAW VALUE (dBuV)	CORRECTION FACTOR (dB/m)
1	#5470.00	72.1 PK	74.0	-1.9	1.89 V	130	69.31	2.79
2	#5470.00	53.2 AV	54.0	-0.8	1.89 V	130	50.41	2.79
3	*5510.00	113.4 PK			1.06 V	240	110.55	2.85
4	*5510.00	102.1 AV			1.06 V	240	99.25	2.85
5	#5750.00	58.2 PK	74.0	-15.8	2.05 V	125	54.82	3.38
6	#5750.00	47.2 AV	54.0	-6.8	2.05 V	125	43.82	3.38
7	11020.00	50.2 PK	74.0	-23.8	2.29 V	164	36.56	13.64
8	11020.00	38.1 AV	54.0	-15.9	2.29 V	164	24.46	13.64
9	#16530.00	52.2 PK	74.0	-21.8	2.45 V	274	33.38	18.82
10	#16530.00	39.9 AV	54.0	-14.1	2.45 V	274	21.08	18.82

REMARKS:

1. Emission Level(dBuV/m) = Raw Value(dBuV) + Correction Factor(dB/m)
2. Correction Factor(dB/m) = Antenna Factor(dB/m) + Cable Factor(dB) – Pre-Amplifier Factor(dB)
3. The other emission levels were very low against the limit.
4. Margin value = Emission Level – Limit value
5. " * ": Fundamental frequency.
6. " # ": The radiated frequency is out of the restricted band.

CHANNEL	TX Channel 110	DETECTOR FUNCTION	Peak (PK)
FREQUENCY RANGE	1GHz ~ 40GHz		Average (AV)

ANTENNA POLARITY & TEST DISTANCE: HORIZONTAL AT 3 M

NO.	FREQ. (MHz)	EMISSION LEVEL (dBuV/m)	LIMIT (dBuV/m)	MARGIN (dB)	ANTENNA HEIGHT (m)	TABLE ANGLE (Degree)	RAW VALUE (dBuV)	CORRECTION FACTOR (dB/m)
1	5390.00	61.9 PK	74.0	-12.1	1.09 H	350	59.20	2.70
2	5390.00	44.6 AV	54.0	-9.4	1.09 H	350	41.90	2.70
3	*5550.00	111.6 PK			3.28 H	347	108.62	2.98
4	*5550.00	102.0 AV			3.28 H	347	99.02	2.98
5	#5725.00	60.3 PK	74.0	-13.7	1.05 H	356	56.94	3.36
6	#5725.00	43.7 AV	54.0	-10.3	1.05 H	356	40.34	3.36
7	11100.00	50.4 PK	74.0	-23.6	1.98 H	150	36.78	13.62
8	11100.00	38.3 AV	54.0	-15.7	1.98 H	150	24.68	13.62
9	#16650.00	52.1 PK	74.0	-21.9	2.10 H	117	32.71	19.39
10	#16650.00	39.4 AV	54.0	-14.6	2.10 H	117	20.01	19.39

ANTENNA POLARITY & TEST DISTANCE: VERTICAL AT 3 M

NO.	FREQ. (MHz)	EMISSION LEVEL (dBuV/m)	LIMIT (dBuV/m)	MARGIN (dB)	ANTENNA HEIGHT (m)	TABLE ANGLE (Degree)	RAW VALUE (dBuV)	CORRECTION FACTOR (dB/m)
1	5390.00	64.5 PK	74.0	-9.5	1.02 V	241	61.80	2.70
2	5390.00	53.5 AV	54.0	-0.5	1.02 V	241	50.80	2.70
3	*5550.00	115.8 PK			1.07 V	116	112.82	2.98
4	*5550.00	104.9 AV			1.07 V	116	101.92	2.98
5	#5725.00	62.7 PK	74.0	-11.3	1.08 V	242	59.34	3.36
6	#5725.00	52.8 AV	54.0	-1.2	1.08 V	242	49.44	3.36
7	11100.00	49.8 PK	74.0	-24.2	2.31 V	176	36.18	13.62
8	11100.00	37.8 AV	54.0	-16.2	2.31 V	176	24.18	13.62
9	#16650.00	51.8 PK	74.0	-22.2	2.48 V	272	32.41	19.39
10	#16650.00	39.2 AV	54.0	-14.8	2.48 V	272	19.81	19.39

REMARKS:

1. Emission Level(dBuV/m) = Raw Value(dBuV) + Correction Factor(dB/m)
2. Correction Factor(dB/m) = Antenna Factor(dB/m) + Cable Factor(dB) – Pre-Amplifier Factor(dB)
3. The other emission levels were very low against the limit.
4. Margin value = Emission Level – Limit value
5. " * ": Fundamental frequency.
6. " # ": The radiated frequency is out of the restricted band.

CHANNEL	TX Channel 134	DETECTOR FUNCTION	Peak (PK)
FREQUENCY RANGE	1GHz ~ 40GHz		Average (AV)

ANTENNA POLARITY & TEST DISTANCE: HORIZONTAL AT 3 M

NO.	FREQ. (MHz)	EMISSION LEVEL (dBuV/m)	LIMIT (dBuV/m)	MARGIN (dB)	ANTENNA HEIGHT (m)	TABLE ANGLE (Degree)	RAW VALUE (dBuV)	CORRECTION FACTOR (dB/m)
1	5430.00	51.9 PK	74.0	-22.1	1.19 H	360	49.16	2.74
2	5430.00	39.0 AV	54.0	-15.0	1.19 H	360	36.26	2.74
3	*5670.00	108.4 PK			3.33 H	340	105.14	3.26
4	*5670.00	98.3 AV			3.33 H	340	95.04	3.26
5	#5725.00	62.2 PK	74.0	-11.8	1.13 H	350	58.84	3.36
6	#5725.00	45.0 AV	54.0	-9.0	1.13 H	350	41.64	3.36
7	11340.00	50.3 PK	74.0	-23.7	2.04 H	153	36.60	13.70
8	11340.00	38.2 AV	54.0	-15.8	2.04 H	153	24.50	13.70
9	#17010.00	51.6 PK	74.0	-22.4	2.14 H	118	30.83	20.77
10	#17010.00	39.4 AV	54.0	-14.6	2.14 H	118	18.63	20.77

ANTENNA POLARITY & TEST DISTANCE: VERTICAL AT 3 M

NO.	FREQ. (MHz)	EMISSION LEVEL (dBuV/m)	LIMIT (dBuV/m)	MARGIN (dB)	ANTENNA HEIGHT (m)	TABLE ANGLE (Degree)	RAW VALUE (dBuV)	CORRECTION FACTOR (dB/m)
1	5430.00	59.3 PK	74.0	-14.7	1.20 V	236	56.56	2.74
2	5430.00	49.1 AV	54.0	-4.9	1.20 V	236	46.36	2.74
3	*5670.00	114.2 PK			1.09 V	244	110.94	3.26
4	*5670.00	102.5 AV			1.09 V	244	99.24	3.26
5	#5725.00	71.6 PK	74.0	-2.4	1.07 V	241	68.24	3.36
6	#5725.00	53.7 AV	54.0	-0.3	1.07 V	241	50.34	3.36
7	11340.00	50.5 PK	74.0	-23.5	2.32 V	177	36.80	13.70
8	11340.00	37.4 AV	54.0	-16.6	2.32 V	177	23.70	13.70
9	#17010.00	51.5 PK	74.0	-22.5	2.52 V	274	30.73	20.77
10	#17010.00	39.5 AV	54.0	-14.5	2.52 V	274	18.73	20.77

REMARKS:

1. Emission Level(dBuV/m) = Raw Value(dBuV) + Correction Factor(dB/m)
2. Correction Factor(dB/m) = Antenna Factor(dB/m) + Cable Factor(dB) – Pre-Amplifier Factor(dB)
3. The other emission levels were very low against the limit.
4. Margin value = Emission Level – Limit value
5. " * ": Fundamental frequency.
6. " # ": The radiated frequency is out of the restricted band.

CHANNEL	TX Channel 142	DETECTOR FUNCTION	Peak (PK)
FREQUENCY RANGE	1GHz ~ 40GHz		Average (AV)

ANTENNA POLARITY & TEST DISTANCE: HORIZONTAL AT 3 M

NO.	FREQ. (MHz)	EMISSION LEVEL (dBuV/m)	LIMIT (dBuV/m)	MARGIN (dB)	ANTENNA HEIGHT (m)	TABLE ANGLE (Degree)	RAW VALUE (dBuV)	CORRECTION FACTOR (dB/m)
1	5460.00	60.2 PK	74.0	-13.8	1.00 H	354	57.42	2.78
2	5460.00	43.4 AV	54.0	-10.6	1.00 H	354	40.62	2.78
3	*5710.00	113.3 PK			3.34 H	334	109.96	3.34
4	*5710.00	102.5 AV			3.34 H	334	99.16	3.34
5	#5870.00	62.6 PK	74.0	-11.4	1.16 H	330	59.09	3.51
6	#5870.00	45.0 AV	54.0	-9.0	1.16 H	330	41.49	3.51
7	11420.00	50.6 PK	74.0	-23.4	2.04 H	138	37.01	13.59
8	11420.00	38.4 AV	54.0	-15.6	2.04 H	138	24.81	13.59
9	#17130.00	51.6 PK	74.0	-22.4	2.15 H	117	30.77	20.83
10	#17130.00	39.0 AV	54.0	-15.0	2.15 H	117	18.17	20.83

ANTENNA POLARITY & TEST DISTANCE: VERTICAL AT 3 M

NO.	FREQ. (MHz)	EMISSION LEVEL (dBuV/m)	LIMIT (dBuV/m)	MARGIN (dB)	ANTENNA HEIGHT (m)	TABLE ANGLE (Degree)	RAW VALUE (dBuV)	CORRECTION FACTOR (dB/m)
1	5460.00	62.3 PK	74.0	-11.7	1.03 V	243	59.52	2.78
2	5460.00	52.9 AV	54.0	-1.1	1.03 V	243	50.12	2.78
3	*5710.00	116.7 PK			1.03 V	116	113.36	3.34
4	*5710.00	105.7 AV			1.03 V	116	102.36	3.34
5	#5870.00	64.3 PK	74.0	-9.7	1.00 V	119	60.79	3.51
6	#5870.00	53.9 AV	54.0	-0.1	1.00 V	119	50.39	3.51
7	11420.00	50.2 PK	74.0	-23.8	2.37 V	190	36.61	13.59
8	11420.00	37.7 AV	54.0	-16.3	2.37 V	190	24.11	13.59
9	#17130.00	52.2 PK	74.0	-21.8	2.52 V	267	31.37	20.83
10	#17130.00	39.7 AV	54.0	-14.3	2.52 V	267	18.87	20.83

REMARKS:

1. Emission Level(dBuV/m) = Raw Value(dBuV) + Correction Factor(dB/m)
2. Correction Factor(dB/m) = Antenna Factor(dB/m) + Cable Factor(dB) – Pre-Amplifier Factor(dB)
3. The other emission levels were very low against the limit.
4. Margin value = Emission Level – Limit value
5. " * ": Fundamental frequency.
6. " # ": The radiated frequency is out of the restricted band.

802.11ac VHT80

CHANNEL	TX Channel 58	DETECTOR FUNCTION	Peak (PK)
FREQUENCY RANGE	1GHz ~ 40GHz		Average (AV)

ANTENNA POLARITY & TEST DISTANCE: HORIZONTAL AT 3 M

NO.	FREQ. (MHz)	EMISSION LEVEL (dBuV/m)	LIMIT (dBuV/m)	MARGIN (dB)	ANTENNA HEIGHT (m)	TABLE ANGLE (Degree)	RAW VALUE (dBuV)	CORRECTION FACTOR (dB/m)
1	5150.00	52.1 PK	74.0	-21.9	1.20 H	353	49.73	2.37
2	5150.00	35.7 AV	54.0	-18.3	1.20 H	353	33.33	2.37
3	*5290.00	102.3 PK			3.22 H	339	99.71	2.59
4	*5290.00	91.2 AV			3.22 H	339	88.61	2.59
5	5350.00	62.9 PK	74.0	-11.1	1.18 H	358	60.25	2.65
6	5350.00	45.1 AV	54.0	-8.9	1.18 H	358	42.45	2.65
7	#10580.00	50.9 PK	74.0	-23.1	2.06 H	125	38.15	12.75
8	#10580.00	38.4 AV	54.0	-15.6	2.06 H	125	25.65	12.75
9	15870.00	51.5 PK	74.0	-22.5	2.08 H	131	36.67	14.83
10	15870.00	39.1 AV	54.0	-14.9	2.08 H	131	24.27	14.83

ANTENNA POLARITY & TEST DISTANCE: VERTICAL AT 3 M

NO.	FREQ. (MHz)	EMISSION LEVEL (dBuV/m)	LIMIT (dBuV/m)	MARGIN (dB)	ANTENNA HEIGHT (m)	TABLE ANGLE (Degree)	RAW VALUE (dBuV)	CORRECTION FACTOR (dB/m)
1	5150.00	57.4 PK	74.0	-16.6	2.52 V	260	55.03	2.37
2	5150.00	43.2 AV	54.0	-10.8	2.52 V	260	40.83	2.37
3	*5290.00	105.9 PK			1.05 V	135	103.31	2.59
4	*5290.00	94.5 AV			1.05 V	135	91.91	2.59
5	5350.00	64.0 PK	74.0	-10.0	1.07 V	131	61.35	2.65
6	5350.00	53.1 AV	54.0	-0.9	1.07 V	131	50.45	2.65
7	#10580.00	50.2 PK	74.0	-23.8	2.37 V	162	37.45	12.75
8	#10580.00	37.8 AV	54.0	-16.2	2.37 V	162	25.05	12.75
9	15870.00	51.9 PK	74.0	-22.1	2.55 V	274	37.07	14.83
10	15870.00	39.4 AV	54.0	-14.6	2.55 V	274	24.57	14.83

REMARKS:

1. Emission Level(dBuV/m) = Raw Value(dBuV) + Correction Factor(dB/m)
2. Correction Factor(dB/m) = Antenna Factor(dB/m) + Cable Factor(dB) – Pre-Amplifier Factor(dB)
3. The other emission levels were very low against the limit.
4. Margin value = Emission Level – Limit value
5. " * ": Fundamental frequency.
6. " # ": The radiated frequency is out of the restricted band.

CHANNEL	TX Channel 106	DETECTOR FUNCTION	Peak (PK)
FREQUENCY RANGE	1GHz ~ 40GHz		Average (AV)

ANTENNA POLARITY & TEST DISTANCE: HORIZONTAL AT 3 M

NO.	FREQ. (MHz)	EMISSION LEVEL (dBuV/m)	LIMIT (dBuV/m)	MARGIN (dB)	ANTENNA HEIGHT (m)	TABLE ANGLE (Degree)	RAW VALUE (dBuV)	CORRECTION FACTOR (dB/m)
1	#5470.00	62.1 PK	74.0	-11.9	1.17 H	328	59.31	2.79
2	#5470.00	44.6 AV	54.0	-9.4	1.17 H	328	41.81	2.79
3	*5530.00	105.8 PK			3.32 H	338	102.88	2.92
4	*5530.00	92.5 AV			3.32 H	338	89.58	2.92
5	11060.00	50.0 PK	74.0	-24.0	1.97 H	130	36.37	13.63
6	11060.00	37.9 AV	54.0	-16.1	1.97 H	130	24.27	13.63
7	#16590.00	52.2 PK	74.0	-21.8	2.18 H	120	33.02	19.18
8	#16590.00	39.5 AV	54.0	-14.5	2.18 H	120	20.32	19.18

ANTENNA POLARITY & TEST DISTANCE: VERTICAL AT 3 M

NO.	FREQ. (MHz)	EMISSION LEVEL (dBuV/m)	LIMIT (dBuV/m)	MARGIN (dB)	ANTENNA HEIGHT (m)	TABLE ANGLE (Degree)	RAW VALUE (dBuV)	CORRECTION FACTOR (dB/m)
1	#5470.00	69.6 PK	74.0	-4.4	1.00 V	241	66.81	2.79
2	#5470.00	53.5 AV	54.0	-0.5	1.00 V	241	50.71	2.79
3	*5530.00	109.0 PK			1.14 V	244	106.08	2.92
4	*5530.00	96.1 AV			1.14 V	244	93.18	2.92
5	11060.00	50.7 PK	74.0	-23.3	2.34 V	190	37.07	13.63
6	11060.00	38.5 AV	54.0	-15.5	2.34 V	190	24.87	13.63
7	#16590.00	51.3 PK	74.0	-22.7	2.51 V	272	32.12	19.18
8	#16590.00	39.3 AV	54.0	-14.7	2.51 V	272	20.12	19.18

REMARKS:

1. Emission Level(dBuV/m) = Raw Value(dBuV) + Correction Factor(dB/m)
2. Correction Factor(dB/m) = Antenna Factor(dB/m) + Cable Factor(dB) – Pre-Amplifier Factor(dB)
3. The other emission levels were very low against the limit.
4. Margin value = Emission Level – Limit value
5. " * ": Fundamental frequency.
6. " # ": The radiated frequency is out of the restricted band.

CHANNEL	TX Channel 122	DETECTOR FUNCTION	Peak (PK)
FREQUENCY RANGE	1GHz ~ 40GHz		Average (AV)

ANTENNA POLARITY & TEST DISTANCE: HORIZONTAL AT 3 M

NO.	FREQ. (MHz)	EMISSION LEVEL (dBuV/m)	LIMIT (dBuV/m)	MARGIN (dB)	ANTENNA HEIGHT (m)	TABLE ANGLE (Degree)	RAW VALUE (dBuV)	CORRECTION FACTOR (dB/m)
1	#5470.00	51.7 PK	74.0	-22.3	1.23 H	354	48.91	2.79
2	#5470.00	38.5 AV	54.0	-15.5	1.23 H	354	35.71	2.79
3	*5610.00	107.9 PK			3.25 H	339	104.75	3.15
4	*5610.00	95.1 AV			3.25 H	339	91.95	3.15
5	#5725.00	62.8 PK	74.0	-11.2	1.17 H	349	59.44	3.36
6	#5725.00	45.2 AV	54.0	-8.8	1.17 H	349	41.84	3.36
7	11220.00	51.1 PK	74.0	-22.9	1.99 H	123	37.46	13.64
8	11220.00	38.6 AV	54.0	-15.4	1.99 H	123	24.96	13.64
9	#16830.00	51.9 PK	74.0	-22.1	2.08 H	139	32.05	19.85
10	#16830.00	39.6 AV	54.0	-14.4	2.08 H	139	19.75	19.85

ANTENNA POLARITY & TEST DISTANCE: VERTICAL AT 3 M

NO.	FREQ. (MHz)	EMISSION LEVEL (dBuV/m)	LIMIT (dBuV/m)	MARGIN (dB)	ANTENNA HEIGHT (m)	TABLE ANGLE (Degree)	RAW VALUE (dBuV)	CORRECTION FACTOR (dB/m)
1	#5470.00	66.5 PK	74.0	-7.5	1.00 V	244	63.71	2.79
2	#5470.00	50.0 AV	54.0	-4.0	1.00 V	244	47.21	2.79
3	*5610.00	111.8 PK			1.07 V	244	108.65	3.15
4	*5610.00	98.5 AV			1.07 V	244	95.35	3.15
5	#5725.00	67.8 PK	74.0	-6.2	1.08 V	243	64.44	3.36
6	#5725.00	53.1 AV	54.0	-0.9	1.08 V	243	49.74	3.36
7	11220.00	51.0 PK	74.0	-23.0	2.32 V	169	37.36	13.64
8	11220.00	38.4 AV	54.0	-15.6	2.32 V	169	24.76	13.64
9	#16830.00	52.2 PK	74.0	-21.8	2.52 V	293	32.35	19.85
10	#16830.00	40.0 AV	54.0	-14.0	2.52 V	293	20.15	19.85

REMARKS:

- Emission Level(dBuV/m) = Raw Value(dBuV) + Correction Factor(dB/m)
- Correction Factor(dB/m) = Antenna Factor(dB/m) + Cable Factor(dB) – Pre-Amplifier Factor(dB)
- The other emission levels were very low against the limit.
- Margin value = Emission Level – Limit value
- " * ": Fundamental frequency.
- " # ": The radiated frequency is out of the restricted band.

CHANNEL	TX Channel 138	DETECTOR FUNCTION	Peak (PK)
FREQUENCY RANGE	1GHz ~ 40GHz		Average (AV)

ANTENNA POLARITY & TEST DISTANCE: HORIZONTAL AT 3 M

NO.	FREQ. (MHz)	EMISSION LEVEL (dBuV/m)	LIMIT (dBuV/m)	MARGIN (dB)	ANTENNA HEIGHT (m)	TABLE ANGLE (Degree)	RAW VALUE (dBuV)	CORRECTION FACTOR (dB/m)
1	#5470.00	52.1 PK	74.0	-21.9	1.19 H	360	49.31	2.79
2	#5470.00	38.7 AV	54.0	-15.3	1.19 H	360	35.91	2.79
3	*5690.00	108.5 PK			3.23 H	347	105.20	3.30
4	*5690.00	98.3 AV			3.23 H	347	95.00	3.30
5	#5850.00	60.2 PK	78.2	-18.0	1.00 H	347	56.71	3.49
6	11380.00	50.6 PK	74.0	-23.4	2.04 H	135	36.97	13.63
7	11380.00	38.1 AV	54.0	-15.9	2.04 H	135	24.47	13.63
8	#17070.00	51.8 PK	74.0	-22.2	2.10 H	136	30.95	20.85
9	#17070.00	39.1 AV	54.0	-14.9	2.10 H	136	18.25	20.85

ANTENNA POLARITY & TEST DISTANCE: VERTICAL AT 3 M

NO.	FREQ. (MHz)	EMISSION LEVEL (dBuV/m)	LIMIT (dBuV/m)	MARGIN (dB)	ANTENNA HEIGHT (m)	TABLE ANGLE (Degree)	RAW VALUE (dBuV)	CORRECTION FACTOR (dB/m)
1	#5470.00	61.0 PK	74.0	-13.0	1.03 V	118	58.21	2.79
2	#5470.00	49.8 AV	54.0	-4.2	1.03 V	118	47.01	2.79
3	*5690.00	114.4 PK			1.11 V	116	111.10	3.30
4	*5690.00	101.7 AV			1.11 V	116	98.40	3.30
5	#5850.00	68.1 PK	78.2	-10.1	1.03 V	116	64.61	3.49
6	11380.00	49.9 PK	74.0	-24.1	2.32 V	173	36.27	13.63
7	11380.00	37.6 AV	54.0	-16.4	2.32 V	173	23.97	13.63
8	#17070.00	52.1 PK	74.0	-21.9	2.54 V	278	31.25	20.85
9	#17070.00	39.8 AV	54.0	-14.2	2.54 V	278	18.95	20.85

REMARKS:

1. Emission Level(dBuV/m) = Raw Value(dBuV) + Correction Factor(dB/m)
2. Correction Factor(dB/m) = Antenna Factor(dB/m) + Cable Factor(dB) – Pre-Amplifier Factor(dB)
3. The other emission levels were very low against the limit.
4. Margin value = Emission Level – Limit value
5. " * ": Fundamental frequency.
6. " # ": The radiated frequency is out of the restricted band.

3TX

ANT5, ANT6, ANT8

802.11a

CHANNEL	TX Channel 52	DETECTOR FUNCTION	Peak (PK)
FREQUENCY RANGE	1GHz ~ 40GHz		Average (AV)

ANTENNA POLARITY & TEST DISTANCE: HORIZONTAL AT 3 M

NO.	FREQ. (MHz)	EMISSION LEVEL (dBuV/m)	LIMIT (dBuV/m)	MARGIN (dB)	ANTENNA HEIGHT (m)	TABLE ANGLE (Degree)	RAW VALUE (dBuV)	CORRECTION FACTOR (dB/m)
1	5100.00	52.0 PK	74.0	-22.0	1.17 H	357	49.68	2.32
2	5100.00	38.8 AV	54.0	-15.2	1.17 H	357	36.48	2.32
3	*5260.00	114.7 PK			1.82 H	293	112.16	2.54
4	*5260.00	104.6 AV			1.82 H	293	102.06	2.54
5	5420.00	58.2 PK	74.0	-15.8	1.17 H	354	55.47	2.73
6	5420.00	42.0 AV	54.0	-12.0	1.17 H	354	39.27	2.73
7	#10520.00	50.7 PK	74.0	-23.3	2.08 H	126	38.30	12.40
8	#10520.00	38.3 AV	54.0	-15.7	2.08 H	126	25.90	12.40
9	15780.00	52.0 PK	74.0	-22.0	2.05 H	143	37.18	14.82
10	15780.00	39.5 AV	54.0	-14.5	2.05 H	143	24.68	14.82

ANTENNA POLARITY & TEST DISTANCE: VERTICAL AT 3 M

NO.	FREQ. (MHz)	EMISSION LEVEL (dBuV/m)	LIMIT (dBuV/m)	MARGIN (dB)	ANTENNA HEIGHT (m)	TABLE ANGLE (Degree)	RAW VALUE (dBuV)	CORRECTION FACTOR (dB/m)
1	5100.00	59.8 PK	74.0	-14.2	2.55 V	50	57.48	2.32
2	5100.00	49.6 AV	54.0	-4.4	2.55 V	50	47.28	2.32
3	*5260.00	117.5 PK			2.55 V	50	114.96	2.54
4	*5260.00	107.3 AV			2.55 V	50	104.76	2.54
5	5420.00	61.4 PK	74.0	-12.6	2.55 V	50	58.67	2.73
6	5420.00	50.2 AV	54.0	-3.8	2.55 V	50	47.47	2.73
7	#10520.00	51.1 PK	74.0	-22.9	2.46 V	194	38.70	12.40
8	#10520.00	40.5 AV	54.0	-13.5	2.46 V	194	28.10	12.40
9	15780.00	56.6 PK	74.0	-17.4	2.43 V	321	41.78	14.82
10	15780.00	45.8 AV	54.0	-8.2	2.43 V	321	30.98	14.82

REMARKS:

1. Emission Level(dBuV/m) = Raw Value(dBuV) + Correction Factor(dB/m)
2. Correction Factor(dB/m) = Antenna Factor(dB/m) + Cable Factor(dB) – Pre-Amplifier Factor(dB)
3. The other emission levels were very low against the limit.
4. Margin value = Emission Level – Limit value
5. " * ": Fundamental frequency.
6. " # ": The radiated frequency is out of the restricted band.

CHANNEL	TX Channel 60	DETECTOR FUNCTION	Peak (PK)
FREQUENCY RANGE	1GHz ~ 40GHz		Average (AV)

ANTENNA POLARITY & TEST DISTANCE: HORIZONTAL AT 3 M

NO.	FREQ. (MHz)	EMISSION LEVEL (dBuV/m)	LIMIT (dBuV/m)	MARGIN (dB)	ANTENNA HEIGHT (m)	TABLE ANGLE (Degree)	RAW VALUE (dBuV)	CORRECTION FACTOR (dB/m)
1	5140.00	58.7 PK	74.0	-15.3	1.00 H	360	56.33	2.37
2	5140.00	42.9 AV	54.0	-11.1	1.00 H	360	40.53	2.37
3	*5300.00	114.4 PK			1.83 H	302	111.79	2.61
4	*5300.00	104.3 AV			1.83 H	302	101.69	2.61
5	5460.00	51.7 PK	74.0	-22.3	1.14 H	360	48.92	2.78
6	5460.00	38.4 AV	54.0	-15.6	1.14 H	360	35.62	2.78
7	10600.00	50.7 PK	74.0	-23.3	2.03 H	133	37.84	12.86
8	10600.00	38.2 AV	54.0	-15.8	2.03 H	133	25.34	12.86
9	15900.00	52.3 PK	74.0	-21.7	2.09 H	135	37.43	14.87
10	15900.00	39.7 AV	54.0	-14.3	2.09 H	135	24.83	14.87

ANTENNA POLARITY & TEST DISTANCE: VERTICAL AT 3 M

NO.	FREQ. (MHz)	EMISSION LEVEL (dBuV/m)	LIMIT (dBuV/m)	MARGIN (dB)	ANTENNA HEIGHT (m)	TABLE ANGLE (Degree)	RAW VALUE (dBuV)	CORRECTION FACTOR (dB/m)
1	5140.00	60.2 PK	74.0	-13.8	2.54 V	50	57.83	2.37
2	5140.00	50.8 AV	54.0	-3.2	2.54 V	50	48.43	2.37
3	*5300.00	116.6 PK			2.54 V	51	113.99	2.61
4	*5300.00	107.5 AV			2.54 V	51	104.89	2.61
5	5460.00	64.5 PK	74.0	-9.5	2.54 V	50	61.72	2.78
6	5460.00	49.9 AV	54.0	-4.1	2.54 V	50	47.12	2.78
7	10600.00	51.7 PK	74.0	-22.3	2.42 V	180	38.84	12.86
8	10600.00	41.0 AV	54.0	-13.0	2.42 V	180	28.14	12.86
9	15900.00	57.0 PK	74.0	-17.0	2.51 V	315	42.13	14.87
10	15900.00	46.0 AV	54.0	-8.0	2.51 V	315	31.13	14.87

REMARKS:

1. Emission Level(dBuV/m) = Raw Value(dBuV) + Correction Factor(dB/m)
2. Correction Factor(dB/m) = Antenna Factor(dB/m) + Cable Factor(dB) – Pre-Amplifier Factor(dB)
3. The other emission levels were very low against the limit.
4. Margin value = Emission Level – Limit value
5. " * ": Fundamental frequency.

CHANNEL	TX Channel 64	DETECTOR FUNCTION	Peak (PK)
FREQUENCY RANGE	1GHz ~ 40GHz		Average (AV)

ANTENNA POLARITY & TEST DISTANCE: HORIZONTAL AT 3 M

NO.	FREQ. (MHz)	EMISSION LEVEL (dBuV/m)	LIMIT (dBuV/m)	MARGIN (dB)	ANTENNA HEIGHT (m)	TABLE ANGLE (Degree)	RAW VALUE (dBuV)	CORRECTION FACTOR (dB/m)
1	*5320.00	111.2 PK			1.86 H	285	108.57	2.63
2	*5320.00	101.0 AV			1.86 H	285	98.37	2.63
3	5350.00	62.6 PK	74.0	-11.4	1.02 H	355	59.95	2.65
4	5350.00	45.6 AV	54.0	-8.4	1.02 H	355	42.95	2.65
5	10640.00	50.8 PK	74.0	-23.2	2.08 H	131	37.92	12.88
6	10640.00	38.3 AV	54.0	-15.7	2.08 H	131	25.42	12.88
7	15960.00	51.9 PK	74.0	-22.1	2.12 H	123	36.97	14.93
8	15960.00	39.6 AV	54.0	-14.4	2.12 H	123	24.67	14.93

ANTENNA POLARITY & TEST DISTANCE: VERTICAL AT 3 M

NO.	FREQ. (MHz)	EMISSION LEVEL (dBuV/m)	LIMIT (dBuV/m)	MARGIN (dB)	ANTENNA HEIGHT (m)	TABLE ANGLE (Degree)	RAW VALUE (dBuV)	CORRECTION FACTOR (dB/m)
1	*5320.00	114.2 PK			2.52 V	54	111.57	2.63
2	*5320.00	103.9 AV			2.52 V	54	101.27	2.63
3	5350.00	67.4 PK	74.0	-6.6	2.54 V	50	64.75	2.65
4	5350.00	53.2 AV	54.0	-0.8	2.54 V	50	50.55	2.65
5	10640.00	50.6 PK	74.0	-23.4	2.37 V	184	37.72	12.88
6	10640.00	40.2 AV	54.0	-13.8	2.37 V	184	27.32	12.88
7	15960.00	54.9 PK	74.0	-19.1	2.48 V	321	39.97	14.93
8	15960.00	44.2 AV	54.0	-9.8	2.48 V	321	29.27	14.93

REMARKS:

1. Emission Level(dBuV/m) = Raw Value(dBuV) + Correction Factor(dB/m)
2. Correction Factor(dB/m) = Antenna Factor(dB/m) + Cable Factor(dB) – Pre-Amplifier Factor(dB)
3. The other emission levels were very low against the limit.
4. Margin value = Emission Level – Limit value
5. " * ": Fundamental frequency.

CHANNEL	TX Channel 100	DETECTOR FUNCTION	Peak (PK)
FREQUENCY RANGE	1GHz ~ 40GHz		Average (AV)

ANTENNA POLARITY & TEST DISTANCE: HORIZONTAL AT 3 M

NO.	FREQ. (MHz)	EMISSION LEVEL (dBuV/m)	LIMIT (dBuV/m)	MARGIN (dB)	ANTENNA HEIGHT (m)	TABLE ANGLE (Degree)	RAW VALUE (dBuV)	CORRECTION FACTOR (dB/m)
1	#5470.00	62.9 PK	74.0	-11.1	1.09 H	353	60.11	2.79
2	#5470.00	45.7 AV	54.0	-8.3	1.09 H	353	42.91	2.79
3	*5500.00	111.7 PK			1.83 H	299	108.87	2.83
4	*5500.00	102.1 AV			1.83 H	299	99.27	2.83
5	#5735.00	58.6 PK	74.0	-15.4	1.03 H	359	55.23	3.37
6	#5735.00	42.7 AV	54.0	-11.3	1.03 H	359	39.33	3.37
7	11000.00	50.8 PK	74.0	-23.2	2.00 H	126	37.16	13.64
8	11000.00	38.4 AV	54.0	-15.6	2.00 H	126	24.76	13.64
9	#16500.00	52.0 PK	74.0	-22.0	2.07 H	137	33.36	18.64
10	#16500.00	39.3 AV	54.0	-14.7	2.07 H	137	20.66	18.64

ANTENNA POLARITY & TEST DISTANCE: VERTICAL AT 3 M

NO.	FREQ. (MHz)	EMISSION LEVEL (dBuV/m)	LIMIT (dBuV/m)	MARGIN (dB)	ANTENNA HEIGHT (m)	TABLE ANGLE (Degree)	RAW VALUE (dBuV)	CORRECTION FACTOR (dB/m)
1	#5470.00	71.1 PK	74.0	-2.9	2.66 V	60	68.31	2.79
2	#5470.00	53.2 AV	54.0	-0.8	2.66 V	60	50.41	2.79
3	*5500.00	114.6 PK			2.59 V	60	111.77	2.83
4	*5500.00	104.9 AV			2.59 V	60	102.07	2.83
5	#5735.00	62.6 PK	74.0	-11.4	2.66 V	36	59.23	3.37
6	#5735.00	51.6 AV	54.0	-2.4	2.66 V	36	48.23	3.37
7	11000.00	50.4 PK	74.0	-23.6	2.38 V	186	36.76	13.64
8	11000.00	39.6 AV	54.0	-14.4	2.38 V	186	25.96	13.64
9	#16500.00	55.6 PK	74.0	-18.4	2.44 V	297	36.96	18.64
10	#16500.00	44.9 AV	54.0	-9.1	2.44 V	297	26.26	18.64

REMARKS:

1. Emission Level(dBuV/m) = Raw Value(dBuV) + Correction Factor(dB/m)
2. Correction Factor(dB/m) = Antenna Factor(dB/m) + Cable Factor(dB) – Pre-Amplifier Factor(dB)
3. The other emission levels were very low against the limit.
4. Margin value = Emission Level – Limit value
5. " * ": Fundamental frequency.
6. " # ": The radiated frequency is out of the restricted band.

CHANNEL	TX Channel 116	DETECTOR FUNCTION	Peak (PK)
FREQUENCY RANGE	1GHz ~ 40GHz		Average (AV)

ANTENNA POLARITY & TEST DISTANCE: HORIZONTAL AT 3 M

NO.	FREQ. (MHz)	EMISSION LEVEL (dBuV/m)	LIMIT (dBuV/m)	MARGIN (dB)	ANTENNA HEIGHT (m)	TABLE ANGLE (Degree)	RAW VALUE (dBuV)	CORRECTION FACTOR (dB/m)
1	5420.00	62.8 PK	74.0	-11.2	1.02 H	352	60.07	2.73
2	5420.00	45.6 AV	54.0	-8.4	1.02 H	352	42.87	2.73
3	*5580.00	113.0 PK			1.93 H	296	109.94	3.06
4	*5580.00	103.4 AV			1.93 H	296	100.34	3.06
5	#5740.00	59.3 PK	74.0	-14.7	1.04 H	352	55.93	3.37
6	#5740.00	43.1 AV	54.0	-10.9	1.04 H	352	39.73	3.37
7	11160.00	51.1 PK	74.0	-22.9	2.08 H	145	37.48	13.62
8	11160.00	38.3 AV	54.0	-15.7	2.08 H	145	24.68	13.62
9	#16740.00	52.5 PK	74.0	-21.5	2.09 H	132	32.91	19.59
10	#16740.00	39.9 AV	54.0	-14.1	2.09 H	132	20.31	19.59

ANTENNA POLARITY & TEST DISTANCE: VERTICAL AT 3 M

NO.	FREQ. (MHz)	EMISSION LEVEL (dBuV/m)	LIMIT (dBuV/m)	MARGIN (dB)	ANTENNA HEIGHT (m)	TABLE ANGLE (Degree)	RAW VALUE (dBuV)	CORRECTION FACTOR (dB/m)
1	5420.00	62.5 PK	74.0	-11.5	2.53 V	59	59.77	2.73
2	5420.00	53.8 AV	54.0	-0.2	2.53 V	59	51.07	2.73
3	*5580.00	116.1 PK			2.53 V	59	113.04	3.06
4	*5580.00	106.7 AV			2.53 V	59	103.64	3.06
5	#5740.00	60.1 PK	74.0	-13.9	2.53 V	59	56.73	3.37
6	#5740.00	51.6 AV	54.0	-2.4	2.53 V	59	48.23	3.37
7	11160.00	51.9 PK	74.0	-22.1	2.42 V	168	38.28	13.62
8	11160.00	41.4 AV	54.0	-12.6	2.42 V	168	27.78	13.62
9	#16740.00	56.6 PK	74.0	-17.4	2.49 V	302	37.01	19.59
10	#16740.00	45.6 AV	54.0	-8.4	2.49 V	302	26.01	19.59

REMARKS:

1. Emission Level(dBuV/m) = Raw Value(dBuV) + Correction Factor(dB/m)
2. Correction Factor(dB/m) = Antenna Factor(dB/m) + Cable Factor(dB) – Pre-Amplifier Factor(dB)
3. The other emission levels were very low against the limit.
4. Margin value = Emission Level – Limit value
5. " * ": Fundamental frequency.
6. " # ": The radiated frequency is out of the restricted band.

CHANNEL	TX Channel 140	DETECTOR FUNCTION	Peak (PK)
FREQUENCY RANGE	1GHz ~ 40GHz		Average (AV)

ANTENNA POLARITY & TEST DISTANCE: HORIZONTAL AT 3 M

NO.	FREQ. (MHz)	EMISSION LEVEL (dBuV/m)	LIMIT (dBuV/m)	MARGIN (dB)	ANTENNA HEIGHT (m)	TABLE ANGLE (Degree)	RAW VALUE (dBuV)	CORRECTION FACTOR (dB/m)
1	5455.00	59.3 PK	74.0	-14.7	1.07 H	358	56.53	2.77
2	5455.00	43.0 AV	54.0	-11.0	1.07 H	358	40.23	2.77
3	*5700.00	109.4 PK			1.92 H	295	106.08	3.32
4	*5700.00	99.8 AV			1.92 H	295	96.48	3.32
5	#5725.00	62.2 PK	74.0	-11.8	1.06 H	360	58.84	3.36
6	#5725.00	44.9 AV	54.0	-9.1	1.06 H	360	41.54	3.36
7	11400.00	50.5 PK	74.0	-23.5	1.98 H	132	36.89	13.61
8	11400.00	38.1 AV	54.0	-15.9	1.98 H	132	24.49	13.61
9	#17100.00	52.7 PK	74.0	-21.3	2.03 H	149	31.80	20.90
10	#17100.00	40.1 AV	54.0	-13.9	2.03 H	149	19.20	20.90

ANTENNA POLARITY & TEST DISTANCE: VERTICAL AT 3 M

NO.	FREQ. (MHz)	EMISSION LEVEL (dBuV/m)	LIMIT (dBuV/m)	MARGIN (dB)	ANTENNA HEIGHT (m)	TABLE ANGLE (Degree)	RAW VALUE (dBuV)	CORRECTION FACTOR (dB/m)
1	5455.00	62.3 PK	74.0	-11.7	2.51 V	59	59.53	2.77
2	5455.00	52.5 AV	54.0	-1.5	2.51 V	59	49.73	2.77
3	*5700.00	111.7 PK			2.51 V	58	108.38	3.32
4	*5700.00	102.3 AV			2.51 V	58	98.98	3.32
5	#5725.00	72.6 PK	74.0	-1.4	2.53 V	59	69.24	3.36
6	#5725.00	53.8 AV	54.0	-0.2	2.53 V	59	50.44	3.36
7	11400.00	50.3 PK	74.0	-23.7	2.36 V	177	36.69	13.61
8	11400.00	39.8 AV	54.0	-14.2	2.36 V	177	26.19	13.61
9	#17100.00	55.2 PK	74.0	-18.8	2.50 V	314	34.30	20.90
10	#17100.00	44.4 AV	54.0	-9.6	2.50 V	314	23.50	20.90

REMARKS:

1. Emission Level(dBuV/m) = Raw Value(dBuV) + Correction Factor(dB/m)
2. Correction Factor(dB/m) = Antenna Factor(dB/m) + Cable Factor(dB) – Pre-Amplifier Factor(dB)
3. The other emission levels were very low against the limit.
4. Margin value = Emission Level – Limit value
5. " * ": Fundamental frequency.
6. " # ": The radiated frequency is out of the restricted band.

CHANNEL	TX Channel 144	DETECTOR FUNCTION	Peak (PK)
FREQUENCY RANGE	1GHz ~ 40GHz		Average (AV)

ANTENNA POLARITY & TEST DISTANCE: HORIZONTAL AT 3 M

NO.	FREQ. (MHz)	EMISSION LEVEL (dBuV/m)	LIMIT (dBuV/m)	MARGIN (dB)	ANTENNA HEIGHT (m)	TABLE ANGLE (Degree)	RAW VALUE (dBuV)	CORRECTION FACTOR (dB/m)
1	*5720.00	114.3 PK			1.86 H	302	110.95	3.35
2	*5720.00	104.3 AV			1.86 H	302	100.95	3.35
3	#5880.00	59.4 PK	74.0	-14.6	1.06 H	360	55.88	3.52
4	#5880.00	43.3 AV	54.0	-10.7	1.06 H	360	39.78	3.52
5	11440.00	51.1 PK	74.0	-22.9	2.08 H	134	37.54	13.56
6	11440.00	38.4 AV	54.0	-15.6	2.08 H	134	24.84	13.56
7	#17160.00	52.5 PK	74.0	-21.5	2.04 H	122	31.72	20.78
8	#17160.00	40.1 AV	54.0	-13.9	2.04 H	122	19.32	20.78

ANTENNA POLARITY & TEST DISTANCE: VERTICAL AT 3 M

NO.	FREQ. (MHz)	EMISSION LEVEL (dBuV/m)	LIMIT (dBuV/m)	MARGIN (dB)	ANTENNA HEIGHT (m)	TABLE ANGLE (Degree)	RAW VALUE (dBuV)	CORRECTION FACTOR (dB/m)
1	*5720.00	117.1 PK			2.42 V	360	113.75	3.35
2	*5720.00	107.3 AV			2.42 V	360	103.95	3.35
3	#5880.00	63.8 PK	74.0	-10.2	2.42 V	57	60.28	3.52
4	#5880.00	53.3 AV	54.0	-0.7	2.42 V	57	49.78	3.52
5	11440.00	52.1 PK	74.0	-21.9	2.43 V	170	38.54	13.56
6	11440.00	41.4 AV	54.0	-12.6	2.43 V	170	27.84	13.56
7	#17160.00	56.7 PK	74.0	-17.3	2.46 V	317	35.92	20.78
8	#17160.00	45.6 AV	54.0	-8.4	2.46 V	317	24.82	20.78

REMARKS:

1. Emission Level(dBuV/m) = Raw Value(dBuV) + Correction Factor(dB/m)
2. Correction Factor(dB/m) = Antenna Factor(dB/m) + Cable Factor(dB) – Pre-Amplifier Factor(dB)
3. The other emission levels were very low against the limit.
4. Margin value = Emission Level – Limit value
5. " * ": Fundamental frequency.
6. " # ": The radiated frequency is out of the restricted band.

802.11ac VHT20

CHANNEL	TX Channel 52	DETECTOR FUNCTION	Peak (PK)
FREQUENCY RANGE	1GHz ~ 40GHz		Average (AV)

ANTENNA POLARITY & TEST DISTANCE: HORIZONTAL AT 3 M

NO.	FREQ. (MHz)	EMISSION LEVEL (dBuV/m)	LIMIT (dBuV/m)	MARGIN (dB)	ANTENNA HEIGHT (m)	TABLE ANGLE (Degree)	RAW VALUE (dBuV)	CORRECTION FACTOR (dB/m)
1	5100.00	52.1 PK	74.0	-21.9	1.18 H	342	49.78	2.32
2	5100.00	38.7 AV	54.0	-15.3	1.18 H	342	36.38	2.32
3	*5260.00	113.4 PK			1.91 H	297	110.86	2.54
4	*5260.00	103.7 AV			1.91 H	297	101.16	2.54
5	5420.00	51.0 PK	74.0	-23.0	1.14 H	344	48.27	2.73
6	5420.00	38.1 AV	54.0	-15.9	1.14 H	344	35.37	2.73
7	#10520.00	49.7 PK	74.0	-24.3	1.99 H	130	37.30	12.40
8	#10520.00	37.5 AV	54.0	-16.5	1.99 H	130	25.10	12.40
9	15780.00	52.5 PK	74.0	-21.5	2.17 H	136	37.68	14.82
10	15780.00	39.7 AV	54.0	-14.3	2.17 H	136	24.88	14.82

ANTENNA POLARITY & TEST DISTANCE: VERTICAL AT 3 M

NO.	FREQ. (MHz)	EMISSION LEVEL (dBuV/m)	LIMIT (dBuV/m)	MARGIN (dB)	ANTENNA HEIGHT (m)	TABLE ANGLE (Degree)	RAW VALUE (dBuV)	CORRECTION FACTOR (dB/m)
1	5100.00	57.0 PK	74.0	-17.0	2.89 V	99	54.68	2.32
2	5100.00	47.6 AV	54.0	-6.4	2.89 V	99	45.28	2.32
3	*5260.00	116.3 PK			2.89 V	99	113.76	2.54
4	*5260.00	106.3 AV			2.89 V	99	103.76	2.54
5	5420.00	58.8 PK	74.0	-15.2	2.89 V	99	56.07	2.73
6	5420.00	49.6 AV	54.0	-4.4	2.89 V	99	46.87	2.73
7	#10520.00	51.7 PK	74.0	-22.3	2.41 V	189	39.30	12.40
8	#10520.00	40.8 AV	54.0	-13.2	2.41 V	189	28.40	12.40
9	15780.00	56.9 PK	74.0	-17.1	2.49 V	311	42.08	14.82
10	15780.00	45.8 AV	54.0	-8.2	2.49 V	311	30.98	14.82

REMARKS:

- Emission Level(dBuV/m) = Raw Value(dBuV) + Correction Factor(dB/m)
- Correction Factor(dB/m) = Antenna Factor(dB/m) + Cable Factor(dB) – Pre-Amplifier Factor(dB)
- The other emission levels were very low against the limit.
- Margin value = Emission Level – Limit value
- " * ": Fundamental frequency.
- " # ": The radiated frequency is out of the restricted band.

CHANNEL	TX Channel 60	DETECTOR FUNCTION	Peak (PK)
FREQUENCY RANGE	1GHz ~ 40GHz		Average (AV)

ANTENNA POLARITY & TEST DISTANCE: HORIZONTAL AT 3 M

NO.	FREQ. (MHz)	EMISSION LEVEL (dBuV/m)	LIMIT (dBuV/m)	MARGIN (dB)	ANTENNA HEIGHT (m)	TABLE ANGLE (Degree)	RAW VALUE (dBuV)	CORRECTION FACTOR (dB/m)
1	5140.00	51.7 PK	74.0	-22.3	1.04 H	360	49.33	2.37
2	5140.00	39.0 AV	54.0	-15.0	1.04 H	360	36.63	2.37
3	*5300.00	113.2 PK			1.88 H	289	110.59	2.61
4	*5300.00	103.5 AV			1.88 H	289	100.89	2.61
5	5460.00	51.5 PK	74.0	-22.5	1.12 H	360	48.72	2.78
6	5460.00	38.4 AV	54.0	-15.6	1.12 H	360	35.62	2.78
7	10600.00	50.4 PK	74.0	-23.6	1.98 H	123	37.54	12.86
8	10600.00	38.2 AV	54.0	-15.8	1.98 H	123	25.34	12.86
9	15900.00	52.2 PK	74.0	-21.8	2.15 H	138	37.33	14.87
10	15900.00	39.5 AV	54.0	-14.5	2.15 H	138	24.63	14.87

ANTENNA POLARITY & TEST DISTANCE: VERTICAL AT 3 M

NO.	FREQ. (MHz)	EMISSION LEVEL (dBuV/m)	LIMIT (dBuV/m)	MARGIN (dB)	ANTENNA HEIGHT (m)	TABLE ANGLE (Degree)	RAW VALUE (dBuV)	CORRECTION FACTOR (dB/m)
1	5140.00	57.7 PK	74.0	-16.3	2.86 V	98	55.33	2.37
2	5140.00	48.9 AV	54.0	-5.1	2.86 V	98	46.53	2.37
3	*5300.00	116.4 PK			2.86 V	98	113.79	2.61
4	*5300.00	106.3 AV			2.86 V	98	103.69	2.61
5	5460.00	61.6 PK	74.0	-12.4	2.86 V	98	58.82	2.78
6	5460.00	49.7 AV	54.0	-4.3	2.86 V	98	46.92	2.78
7	10600.00	51.1 PK	74.0	-22.9	2.50 V	183	38.24	12.86
8	10600.00	40.6 AV	54.0	-13.4	2.50 V	183	27.74	12.86
9	15900.00	56.2 PK	74.0	-17.8	2.43 V	309	41.33	14.87
10	15900.00	45.2 AV	54.0	-8.8	2.43 V	309	30.33	14.87

REMARKS:

1. Emission Level(dBuV/m) = Raw Value(dBuV) + Correction Factor(dB/m)
2. Correction Factor(dB/m) = Antenna Factor(dB/m) + Cable Factor(dB) – Pre-Amplifier Factor(dB)
3. The other emission levels were very low against the limit.
4. Margin value = Emission Level – Limit value
5. " * ": Fundamental frequency.

CHANNEL	TX Channel 64	DETECTOR FUNCTION	Peak (PK)
FREQUENCY RANGE	1GHz ~ 40GHz		Average (AV)

ANTENNA POLARITY & TEST DISTANCE: HORIZONTAL AT 3 M

NO.	FREQ. (MHz)	EMISSION LEVEL (dBuV/m)	LIMIT (dBuV/m)	MARGIN (dB)	ANTENNA HEIGHT (m)	TABLE ANGLE (Degree)	RAW VALUE (dBuV)	CORRECTION FACTOR (dB/m)
1	*5320.00	111.9 PK			1.91 H	303	109.27	2.63
2	*5320.00	102.0 AV			1.91 H	303	99.37	2.63
3	5350.00	62.8 PK	74.0	-11.2	1.11 H	352	60.15	2.65
4	5350.00	45.7 AV	54.0	-8.3	1.11 H	352	43.05	2.65
5	10640.00	50.6 PK	74.0	-23.4	2.03 H	124	37.72	12.88
6	10640.00	38.2 AV	54.0	-15.8	2.03 H	124	25.32	12.88
7	15960.00	52.1 PK	74.0	-21.9	2.18 H	157	37.17	14.93
8	15960.00	39.4 AV	54.0	-14.6	2.18 H	157	24.47	14.93

ANTENNA POLARITY & TEST DISTANCE: VERTICAL AT 3 M

NO.	FREQ. (MHz)	EMISSION LEVEL (dBuV/m)	LIMIT (dBuV/m)	MARGIN (dB)	ANTENNA HEIGHT (m)	TABLE ANGLE (Degree)	RAW VALUE (dBuV)	CORRECTION FACTOR (dB/m)
1	*5320.00	114.2 PK			2.70 V	100	111.57	2.63
2	*5320.00	104.6 AV			2.70 V	100	101.97	2.63
3	5350.00	70.6 PK	74.0	-3.4	2.70 V	100	67.95	2.65
4	5350.00	53.6 AV	54.0	-0.4	2.70 V	100	50.95	2.65
5	10640.00	50.5 PK	74.0	-23.5	2.40 V	174	37.62	12.88
6	10640.00	39.9 AV	54.0	-14.1	2.40 V	174	27.02	12.88
7	15960.00	55.0 PK	74.0	-19.0	2.52 V	307	40.07	14.93
8	15960.00	44.4 AV	54.0	-9.6	2.52 V	307	29.47	14.93

REMARKS:

1. Emission Level(dBuV/m) = Raw Value(dBuV) + Correction Factor(dB/m)
2. Correction Factor(dB/m) = Antenna Factor(dB/m) + Cable Factor(dB) – Pre-Amplifier Factor(dB)
3. The other emission levels were very low against the limit.
4. Margin value = Emission Level – Limit value
5. " * ": Fundamental frequency.

CHANNEL	TX Channel 100	DETECTOR FUNCTION	Peak (PK)
FREQUENCY RANGE	1GHz ~ 40GHz		Average (AV)

ANTENNA POLARITY & TEST DISTANCE: HORIZONTAL AT 3 M

NO.	FREQ. (MHz)	EMISSION LEVEL (dBuV/m)	LIMIT (dBuV/m)	MARGIN (dB)	ANTENNA HEIGHT (m)	TABLE ANGLE (Degree)	RAW VALUE (dBuV)	CORRECTION FACTOR (dB/m)
1	#5470.00	62.0 PK	74.0	-12.0	1.07 H	342	59.21	2.79
2	#5470.00	44.7 AV	54.0	-9.3	1.07 H	342	41.91	2.79
3	*5500.00	112.6 PK			1.85 H	290	109.77	2.83
4	*5500.00	103.0 AV			1.85 H	290	100.17	2.83
5	11000.00	49.7 PK	74.0	-24.3	2.06 H	133	36.06	13.64
6	11000.00	37.6 AV	54.0	-16.4	2.06 H	133	23.96	13.64
7	#16500.00	51.9 PK	74.0	-22.1	2.15 H	144	33.26	18.64
8	#16500.00	39.5 AV	54.0	-14.5	2.15 H	144	20.86	18.64

ANTENNA POLARITY & TEST DISTANCE: VERTICAL AT 3 M

NO.	FREQ. (MHz)	EMISSION LEVEL (dBuV/m)	LIMIT (dBuV/m)	MARGIN (dB)	ANTENNA HEIGHT (m)	TABLE ANGLE (Degree)	RAW VALUE (dBuV)	CORRECTION FACTOR (dB/m)
1	#5470.00	70.7 PK	74.0	-3.3	2.68 V	61	67.91	2.79
2	#5470.00	53.5 AV	54.0	-0.5	2.68 V	61	50.71	2.79
3	*5500.00	115.1 PK			2.68 V	61	112.27	2.83
4	*5500.00	105.5 AV			2.68 V	61	102.67	2.83
5	11000.00	50.7 PK	74.0	-23.3	2.35 V	173	37.06	13.64
6	11000.00	40.1 AV	54.0	-13.9	2.35 V	173	26.46	13.64
7	#16500.00	55.1 PK	74.0	-18.9	2.48 V	308	36.46	18.64
8	#16500.00	44.6 AV	54.0	-9.4	2.48 V	308	25.96	18.64

REMARKS:

1. Emission Level(dBuV/m) = Raw Value(dBuV) + Correction Factor(dB/m)
2. Correction Factor(dB/m) = Antenna Factor(dB/m) + Cable Factor(dB) – Pre-Amplifier Factor(dB)
3. The other emission levels were very low against the limit.
4. Margin value = Emission Level – Limit value
5. " * ": Fundamental frequency.
6. " # ": The radiated frequency is out of the restricted band.

CHANNEL	TX Channel 116	DETECTOR FUNCTION	Peak (PK)
FREQUENCY RANGE	1GHz ~ 40GHz		Average (AV)

ANTENNA POLARITY & TEST DISTANCE: HORIZONTAL AT 3 M

NO.	FREQ. (MHz)	EMISSION LEVEL (dBuV/m)	LIMIT (dBuV/m)	MARGIN (dB)	ANTENNA HEIGHT (m)	TABLE ANGLE (Degree)	RAW VALUE (dBuV)	CORRECTION FACTOR (dB/m)
1	5420.00	62.2 PK	74.0	-11.8	1.09 H	343	59.47	2.73
2	5420.00	45.0 AV	54.0	-9.0	1.09 H	343	42.27	2.73
3	*5580.00	113.2 PK			1.84 H	283	110.14	3.06
4	*5580.00	103.5 AV			1.84 H	283	100.44	3.06
5	#5740.00	59.7 PK	74.0	-14.3	1.02 H	350	56.33	3.37
6	#5740.00	43.3 AV	54.0	-10.7	1.02 H	350	39.93	3.37
7	11160.00	50.1 PK	74.0	-23.9	2.05 H	147	36.48	13.62
8	11160.00	38.1 AV	54.0	-15.9	2.05 H	147	24.48	13.62
9	#16740.00	52.1 PK	74.0	-21.9	2.17 H	128	32.51	19.59
10	#16740.00	39.7 AV	54.0	-14.3	2.17 H	128	20.11	19.59

ANTENNA POLARITY & TEST DISTANCE: VERTICAL AT 3 M

NO.	FREQ. (MHz)	EMISSION LEVEL (dBuV/m)	LIMIT (dBuV/m)	MARGIN (dB)	ANTENNA HEIGHT (m)	TABLE ANGLE (Degree)	RAW VALUE (dBuV)	CORRECTION FACTOR (dB/m)
1	5420.00	63.8 PK	74.0	-10.2	2.74 V	51	61.07	2.73
2	5420.00	53.3 AV	54.0	-0.7	2.74 V	51	50.57	2.73
3	*5580.00	116.3 PK			2.70 V	342	113.24	3.06
4	*5580.00	106.2 AV			2.70 V	342	103.14	3.06
5	#5740.00	61.7 PK	74.0	-12.3	2.78 V	347	58.33	3.37
6	#5740.00	51.8 AV	54.0	-2.2	2.78 V	347	48.43	3.37
7	11160.00	51.4 PK	74.0	-22.6	2.41 V	188	37.78	13.62
8	11160.00	40.9 AV	54.0	-13.1	2.41 V	188	27.28	13.62
9	#16740.00	56.2 PK	74.0	-17.8	2.41 V	301	36.61	19.59
10	#16740.00	45.3 AV	54.0	-8.7	2.41 V	301	25.71	19.59

REMARKS:

1. Emission Level(dBuV/m) = Raw Value(dBuV) + Correction Factor(dB/m)
2. Correction Factor(dB/m) = Antenna Factor(dB/m) + Cable Factor(dB) – Pre-Amplifier Factor(dB)
3. The other emission levels were very low against the limit.
4. Margin value = Emission Level – Limit value
5. " * ": Fundamental frequency.
6. " # ": The radiated frequency is out of the restricted band.

CHANNEL	TX Channel 140	DETECTOR FUNCTION	Peak (PK)
FREQUENCY RANGE	1GHz ~ 40GHz		Average (AV)

ANTENNA POLARITY & TEST DISTANCE: HORIZONTAL AT 3 M

NO.	FREQ. (MHz)	EMISSION LEVEL (dBuV/m)	LIMIT (dBuV/m)	MARGIN (dB)	ANTENNA HEIGHT (m)	TABLE ANGLE (Degree)	RAW VALUE (dBuV)	CORRECTION FACTOR (dB/m)
1	5460.00	59.0 PK	74.0	-15.0	1.00 H	353	56.22	2.78
2	5460.00	42.9 AV	54.0	-11.1	1.00 H	353	40.12	2.78
3	*5700.00	111.2 PK			1.92 H	287	107.88	3.32
4	*5700.00	101.3 AV			1.92 H	287	97.98	3.32
5	#5725.00	62.5 PK	74.0	-11.5	1.08 H	348	59.14	3.36
6	#5725.00	45.4 AV	54.0	-8.6	1.08 H	348	42.04	3.36
7	11400.00	50.3 PK	74.0	-23.7	2.03 H	137	36.69	13.61
8	11400.00	38.0 AV	54.0	-16.0	2.03 H	137	24.39	13.61
9	#17100.00	52.7 PK	74.0	-21.3	2.19 H	156	31.80	20.90
10	#17100.00	39.7 AV	54.0	-14.3	2.19 H	156	18.80	20.90

ANTENNA POLARITY & TEST DISTANCE: VERTICAL AT 3 M

NO.	FREQ. (MHz)	EMISSION LEVEL (dBuV/m)	LIMIT (dBuV/m)	MARGIN (dB)	ANTENNA HEIGHT (m)	TABLE ANGLE (Degree)	RAW VALUE (dBuV)	CORRECTION FACTOR (dB/m)
1	5460.00	58.5 PK	74.0	-15.5	2.68 V	344	55.72	2.78
2	5460.00	51.2 AV	54.0	-2.8	2.68 V	344	48.42	2.78
3	*5700.00	114.2 PK			2.55 V	346	110.88	3.32
4	*5700.00	103.9 AV			2.55 V	346	100.58	3.32
5	#5725.00	73.5 PK	74.0	-0.5	2.47 V	343	70.14	3.36
6	#5725.00	53.1 AV	54.0	-0.9	2.47 V	343	49.74	3.36
7	11400.00	51.1 PK	74.0	-22.9	2.39 V	184	37.49	13.61
8	11400.00	40.3 AV	54.0	-13.7	2.39 V	184	26.69	13.61
9	#17100.00	55.6 PK	74.0	-18.4	2.46 V	313	34.70	20.90
10	#17100.00	45.0 AV	54.0	-9.0	2.46 V	313	24.10	20.90

REMARKS:

1. Emission Level(dBuV/m) = Raw Value(dBuV) + Correction Factor(dB/m)
2. Correction Factor(dB/m) = Antenna Factor(dB/m) + Cable Factor(dB) – Pre-Amplifier Factor(dB)
3. The other emission levels were very low against the limit.
4. Margin value = Emission Level – Limit value
5. " * ": Fundamental frequency.
6. " # ": The radiated frequency is out of the restricted band.

CHANNEL	TX Channel 144	DETECTOR FUNCTION	Peak (PK)
FREQUENCY RANGE	1GHz ~ 40GHz		Average (AV)

ANTENNA POLARITY & TEST DISTANCE: HORIZONTAL AT 3 M

NO.	FREQ. (MHz)	EMISSION LEVEL (dBuV/m)	LIMIT (dBuV/m)	MARGIN (dB)	ANTENNA HEIGHT (m)	TABLE ANGLE (Degree)	RAW VALUE (dBuV)	CORRECTION FACTOR (dB/m)
1	*5720.00	115.0 PK			1.87 H	300	111.65	3.35
2	*5720.00	105.1 AV			1.87 H	300	101.75	3.35
3	#5880.00	62.7 PK	74.0	-11.3	1.01 H	353	59.18	3.52
4	#5880.00	45.5 AV	54.0	-8.5	1.01 H	353	41.98	3.52
5	11440.00	50.4 PK	74.0	-23.6	1.98 H	130	36.84	13.56
6	11440.00	38.1 AV	54.0	-15.9	1.98 H	130	24.54	13.56
7	#17160.00	51.7 PK	74.0	-22.3	2.10 H	147	30.92	20.78
8	#17160.00	38.8 AV	54.0	-15.2	2.10 H	147	18.02	20.78

ANTENNA POLARITY & TEST DISTANCE: VERTICAL AT 3 M

NO.	FREQ. (MHz)	EMISSION LEVEL (dBuV/m)	LIMIT (dBuV/m)	MARGIN (dB)	ANTENNA HEIGHT (m)	TABLE ANGLE (Degree)	RAW VALUE (dBuV)	CORRECTION FACTOR (dB/m)
1	*5720.00	117.6 PK			2.64 V	12	114.25	3.35
2	*5720.00	107.3 AV			2.64 V	12	103.95	3.35
3	#5880.00	63.8 PK	74.0	-10.2	2.82 V	13	60.28	3.52
4	#5880.00	53.7 AV	54.0	-0.3	2.82 V	13	50.18	3.52
5	11440.00	51.9 PK	74.0	-22.1	2.50 V	177	38.34	13.56
6	11440.00	41.3 AV	54.0	-12.7	2.50 V	177	27.74	13.56
7	#17160.00	56.9 PK	74.0	-17.1	2.41 V	301	36.12	20.78
8	#17160.00	45.8 AV	54.0	-8.2	2.41 V	301	25.02	20.78

REMARKS:

1. Emission Level(dBuV/m) = Raw Value(dBuV) + Correction Factor(dB/m)
2. Correction Factor(dB/m) = Antenna Factor(dB/m) + Cable Factor(dB) – Pre-Amplifier Factor(dB)
3. The other emission levels were very low against the limit.
4. Margin value = Emission Level – Limit value
5. " * ": Fundamental frequency.
6. " # ": The radiated frequency is out of the restricted band.

802.11ac VHT40

CHANNEL	TX Channel 54	DETECTOR FUNCTION	Peak (PK)
FREQUENCY RANGE	1GHz ~ 40GHz		Average (AV)

ANTENNA POLARITY & TEST DISTANCE: HORIZONTAL AT 3 M

NO.	FREQ. (MHz)	EMISSION LEVEL (dBuV/m)	LIMIT (dBuV/m)	MARGIN (dB)	ANTENNA HEIGHT (m)	TABLE ANGLE (Degree)	RAW VALUE (dBuV)	CORRECTION FACTOR (dB/m)
1	5120.00	51.6 PK	74.0	-22.4	1.17 H	360	49.25	2.35
2	5120.00	38.5 AV	54.0	-15.5	1.17 H	360	36.15	2.35
3	*5270.00	110.0 PK			1.83 H	302	107.44	2.56
4	*5270.00	100.1 AV			1.83 H	302	97.54	2.56
5	5350.00	62.1 PK	74.0	-11.9	1.06 H	344	59.45	2.65
6	5350.00	44.7 AV	54.0	-9.3	1.06 H	344	42.05	2.65
7	#10540.00	50.2 PK	74.0	-23.8	2.00 H	135	37.68	12.52
8	#10540.00	38.1 AV	54.0	-15.9	2.00 H	135	25.58	12.52
9	15810.00	52.5 PK	74.0	-21.5	2.09 H	139	37.74	14.76
10	15810.00	39.6 AV	54.0	-14.4	2.09 H	139	24.84	14.76

ANTENNA POLARITY & TEST DISTANCE: VERTICAL AT 3 M

NO.	FREQ. (MHz)	EMISSION LEVEL (dBuV/m)	LIMIT (dBuV/m)	MARGIN (dB)	ANTENNA HEIGHT (m)	TABLE ANGLE (Degree)	RAW VALUE (dBuV)	CORRECTION FACTOR (dB/m)
1	5120.00	57.1 PK	74.0	-16.9	2.81 V	227	54.75	2.35
2	5120.00	47.4 AV	54.0	-6.6	2.81 V	227	45.05	2.35
3	*5270.00	112.7 PK			2.81 V	227	110.14	2.56
4	*5270.00	102.9 AV			2.81 V	227	100.34	2.56
5	5350.00	67.0 PK	74.0	-7.0	2.81 V	227	64.35	2.65
6	5350.00	53.3 AV	54.0	-0.7	2.81 V	227	50.65	2.65
7	#10540.00	51.1 PK	74.0	-22.9	2.39 V	171	38.58	12.52
8	#10540.00	38.1 AV	54.0	-15.9	2.39 V	171	25.58	12.52
9	15810.00	52.2 PK	74.0	-21.8	2.46 V	278	37.44	14.76
10	15810.00	39.9 AV	54.0	-14.1	2.46 V	278	25.14	14.76

REMARKS:

1. Emission Level(dBuV/m) = Raw Value(dBuV) + Correction Factor(dB/m)
2. Correction Factor(dB/m) = Antenna Factor(dB/m) + Cable Factor(dB) – Pre-Amplifier Factor(dB)
3. The other emission levels were very low against the limit.
4. Margin value = Emission Level – Limit value
5. " * ": Fundamental frequency.
6. " # ": The radiated frequency is out of the restricted band.

CHANNEL	TX Channel 62	DETECTOR FUNCTION	Peak (PK)
FREQUENCY RANGE	1GHz ~ 40GHz		Average (AV)

ANTENNA POLARITY & TEST DISTANCE: HORIZONTAL AT 3 M

NO.	FREQ. (MHz)	EMISSION LEVEL (dBuV/m)	LIMIT (dBuV/m)	MARGIN (dB)	ANTENNA HEIGHT (m)	TABLE ANGLE (Degree)	RAW VALUE (dBuV)	CORRECTION FACTOR (dB/m)
1	*5310.00	105.7 PK			1.83 H	297	103.09	2.61
2	*5310.00	95.3 AV			1.83 H	297	92.69	2.61
3	5350.00	62.8 PK	74.0	-11.2	1.09 H	356	60.15	2.65
4	5350.00	45.7 AV	54.0	-8.3	1.09 H	356	43.05	2.65
5	10620.00	50.0 PK	74.0	-24.0	2.06 H	129	37.12	12.88
6	10620.00	37.7 AV	54.0	-16.3	2.06 H	129	24.82	12.88
7	15930.00	51.9 PK	74.0	-22.1	2.17 H	139	37.00	14.90
8	15930.00	39.3 AV	54.0	-14.7	2.17 H	139	24.40	14.90

ANTENNA POLARITY & TEST DISTANCE: VERTICAL AT 3 M

NO.	FREQ. (MHz)	EMISSION LEVEL (dBuV/m)	LIMIT (dBuV/m)	MARGIN (dB)	ANTENNA HEIGHT (m)	TABLE ANGLE (Degree)	RAW VALUE (dBuV)	CORRECTION FACTOR (dB/m)
1	*5310.00	108.6 PK			2.81 V	227	105.99	2.61
2	*5310.00	98.2 AV			2.81 V	227	95.59	2.61
3	5350.00	72.2 PK	74.0	-1.8	2.81 V	227	69.55	2.65
4	5350.00	53.2 AV	54.0	-0.8	2.81 V	227	50.55	2.65
5	10620.00	50.5 PK	74.0	-23.5	2.36 V	167	37.62	12.88
6	10620.00	37.8 AV	54.0	-16.2	2.36 V	167	24.92	12.88
7	15930.00	51.7 PK	74.0	-22.3	2.46 V	287	36.80	14.90
8	15930.00	39.5 AV	54.0	-14.5	2.46 V	287	24.60	14.90

REMARKS:

1. Emission Level(dBuV/m) = Raw Value(dBuV) + Correction Factor(dB/m)
2. Correction Factor(dB/m) = Antenna Factor(dB/m) + Cable Factor(dB) – Pre-Amplifier Factor(dB)
3. The other emission levels were very low against the limit.
4. Margin value = Emission Level – Limit value
5. " * ": Fundamental frequency.

CHANNEL	TX Channel 102	DETECTOR FUNCTION	Peak (PK)
FREQUENCY RANGE	1GHz ~ 40GHz		Average (AV)

ANTENNA POLARITY & TEST DISTANCE: HORIZONTAL AT 3 M

NO.	FREQ. (MHz)	EMISSION LEVEL (dBuV/m)	LIMIT (dBuV/m)	MARGIN (dB)	ANTENNA HEIGHT (m)	TABLE ANGLE (Degree)	RAW VALUE (dBuV)	CORRECTION FACTOR (dB/m)
1	#5470.00	62.8 PK	74.0	-11.2	1.02 H	360	60.01	2.79
2	#5470.00	45.5 AV	54.0	-8.5	1.02 H	360	42.71	2.79
3	*5510.00	107.8 PK			1.77 H	311	104.95	2.85
4	*5510.00	96.8 AV			1.77 H	311	93.95	2.85
5	#5970.00	51.4 PK	74.0	-22.6	1.09 H	354	47.67	3.73
6	#5970.00	38.2 AV	54.0	-15.8	1.09 H	354	34.47	3.73
7	11020.00	50.6 PK	74.0	-23.4	2.06 H	146	36.96	13.64
8	11020.00	38.3 AV	54.0	-15.7	2.06 H	146	24.66	13.64
9	#16530.00	52.1 PK	74.0	-21.9	2.13 H	131	33.28	18.82
10	#16530.00	39.7 AV	54.0	-14.3	2.13 H	131	20.88	18.82

ANTENNA POLARITY & TEST DISTANCE: VERTICAL AT 3 M

NO.	FREQ. (MHz)	EMISSION LEVEL (dBuV/m)	LIMIT (dBuV/m)	MARGIN (dB)	ANTENNA HEIGHT (m)	TABLE ANGLE (Degree)	RAW VALUE (dBuV)	CORRECTION FACTOR (dB/m)
1	#5470.00	72.2 PK	74.0	-1.8	2.83 V	341	69.41	2.79
2	#5470.00	53.3 AV	54.0	-0.7	2.83 V	341	50.51	2.79
3	*5510.00	110.5 PK			2.83 V	341	107.65	2.85
4	*5510.00	99.7 AV			2.83 V	341	96.85	2.85
5	#5970.00	55.9 PK	74.0	-18.1	2.83 V	341	52.17	3.73
6	#5970.00	47.6 AV	54.0	-6.4	2.83 V	341	43.87	3.73
7	11020.00	51.5 PK	74.0	-22.5	2.39 V	143	37.86	13.64
8	11020.00	38.6 AV	54.0	-15.4	2.39 V	143	24.96	13.64
9	#16530.00	52.7 PK	74.0	-21.3	2.42 V	301	33.88	18.82
10	#16530.00	40.2 AV	54.0	-13.8	2.42 V	301	21.38	18.82

REMARKS:

1. Emission Level(dBuV/m) = Raw Value(dBuV) + Correction Factor(dB/m)
2. Correction Factor(dB/m) = Antenna Factor(dB/m) + Cable Factor(dB) – Pre-Amplifier Factor(dB)
3. The other emission levels were very low against the limit.
4. Margin value = Emission Level – Limit value
5. " * ": Fundamental frequency.
6. " # ": The radiated frequency is out of the restricted band.

CHANNEL	TX Channel 110	DETECTOR FUNCTION	Peak (PK)
FREQUENCY RANGE	1GHz ~ 40GHz		Average (AV)

ANTENNA POLARITY & TEST DISTANCE: HORIZONTAL AT 3 M

NO.	FREQ. (MHz)	EMISSION LEVEL (dBuV/m)	LIMIT (dBuV/m)	MARGIN (dB)	ANTENNA HEIGHT (m)	TABLE ANGLE (Degree)	RAW VALUE (dBuV)	CORRECTION FACTOR (dB/m)
1	5460.00	62.3 PK	74.0	-11.7	1.08 H	360	59.52	2.78
2	5460.00	45.1 AV	54.0	-8.9	1.08 H	360	42.32	2.78
3	*5550.00	111.7 PK			1.83 H	315	108.72	2.98
4	*5550.00	101.6 AV			1.83 H	315	98.62	2.98
5	#5725.00	51.2 PK	74.0	-22.8	1.14 H	360	47.84	3.36
6	#5725.00	38.2 AV	54.0	-15.8	1.14 H	360	34.84	3.36
7	11100.00	50.3 PK	74.0	-23.7	1.96 H	147	36.68	13.62
8	11100.00	38.0 AV	54.0	-16.0	1.96 H	147	24.38	13.62
9	#16650.00	52.0 PK	74.0	-22.0	2.13 H	129	32.61	19.39
10	#16650.00	39.6 AV	54.0	-14.4	2.13 H	129	20.21	19.39

ANTENNA POLARITY & TEST DISTANCE: VERTICAL AT 3 M

NO.	FREQ. (MHz)	EMISSION LEVEL (dBuV/m)	LIMIT (dBuV/m)	MARGIN (dB)	ANTENNA HEIGHT (m)	TABLE ANGLE (Degree)	RAW VALUE (dBuV)	CORRECTION FACTOR (dB/m)
1	5460.00	66.1 PK	74.0	-7.9	2.64 V	340	63.32	2.78
2	5460.00	53.2 AV	54.0	-0.8	2.64 V	340	50.42	2.78
3	*5550.00	114.3 PK			2.75 V	340	111.32	2.98
4	*5550.00	104.0 AV			2.75 V	340	101.02	2.98
5	#5725.00	58.1 PK	74.0	-15.9	2.64 V	340	54.74	3.36
6	#5725.00	48.7 AV	54.0	-5.3	2.64 V	340	45.34	3.36
7	11100.00	51.1 PK	74.0	-22.9	2.39 V	139	37.48	13.62
8	11100.00	38.2 AV	54.0	-15.8	2.39 V	139	24.58	13.62
9	#16650.00	53.5 PK	74.0	-20.5	2.50 V	310	34.11	19.39
10	#16650.00	40.8 AV	54.0	-13.2	2.50 V	310	21.41	19.39

REMARKS:

1. Emission Level(dBuV/m) = Raw Value(dBuV) + Correction Factor(dB/m)
2. Correction Factor(dB/m) = Antenna Factor(dB/m) + Cable Factor(dB) – Pre-Amplifier Factor(dB)
3. The other emission levels were very low against the limit.
4. Margin value = Emission Level – Limit value
5. " * ": Fundamental frequency.
6. " # ": The radiated frequency is out of the restricted band.

CHANNEL	TX Channel 134	DETECTOR FUNCTION	Peak (PK)
FREQUENCY RANGE	1GHz ~ 40GHz		Average (AV)

ANTENNA POLARITY & TEST DISTANCE: HORIZONTAL AT 3 M

NO.	FREQ. (MHz)	EMISSION LEVEL (dBuV/m)	LIMIT (dBuV/m)	MARGIN (dB)	ANTENNA HEIGHT (m)	TABLE ANGLE (Degree)	RAW VALUE (dBuV)	CORRECTION FACTOR (dB/m)
1	*5670.00	108.9 PK			1.83 H	310	105.64	3.26
2	*5670.00	98.0 AV			1.83 H	310	94.74	3.26
3	#5725.00	63.0 PK	74.0	-11.0	1.08 H	360	59.64	3.36
4	#5725.00	45.6 AV	54.0	-8.4	1.08 H	360	42.24	3.36
5	11340.00	50.8 PK	74.0	-23.2	2.04 H	141	37.10	13.70
6	11340.00	38.5 AV	54.0	-15.5	2.04 H	141	24.80	13.70
7	#17010.00	52.7 PK	74.0	-21.3	2.18 H	140	31.93	20.77
8	#17010.00	39.8 AV	54.0	-14.2	2.18 H	140	19.03	20.77

ANTENNA POLARITY & TEST DISTANCE: VERTICAL AT 3 M

NO.	FREQ. (MHz)	EMISSION LEVEL (dBuV/m)	LIMIT (dBuV/m)	MARGIN (dB)	ANTENNA HEIGHT (m)	TABLE ANGLE (Degree)	RAW VALUE (dBuV)	CORRECTION FACTOR (dB/m)
1	*5670.00	111.1 PK			2.64 V	340	107.84	3.26
2	*5670.00	100.8 AV			2.64 V	340	97.54	3.26
3	#5725.00	67.7 PK	74.0	-6.3	2.39 V	283	64.34	3.36
4	#5725.00	53.5 AV	54.0	-0.5	2.39 V	283	50.14	3.36
5	11340.00	51.5 PK	74.0	-22.5	2.37 V	128	37.80	13.70
6	11340.00	39.0 AV	54.0	-15.0	2.37 V	128	25.30	13.70
7	#17010.00	53.6 PK	74.0	-20.4	2.42 V	302	32.83	20.77
8	#17010.00	40.7 AV	54.0	-13.3	2.42 V	302	19.93	20.77

REMARKS:

1. Emission Level(dBuV/m) = Raw Value(dBuV) + Correction Factor(dB/m)
2. Correction Factor(dB/m) = Antenna Factor(dB/m) + Cable Factor(dB) – Pre-Amplifier Factor(dB)
3. The other emission levels were very low against the limit.
4. Margin value = Emission Level – Limit value
5. " * ": Fundamental frequency.
6. " # ": The radiated frequency is out of the restricted band.

CHANNEL	TX Channel 142	DETECTOR FUNCTION	Peak (PK)
FREQUENCY RANGE	1GHz ~ 40GHz		Average (AV)

ANTENNA POLARITY & TEST DISTANCE: HORIZONTAL AT 3 M

NO.	FREQ. (MHz)	EMISSION LEVEL (dBuV/m)	LIMIT (dBuV/m)	MARGIN (dB)	ANTENNA HEIGHT (m)	TABLE ANGLE (Degree)	RAW VALUE (dBuV)	CORRECTION FACTOR (dB/m)
1	5460.00	59.4 PK	74.0	-14.6	1.03 H	337	56.62	2.78
2	5460.00	43.2 AV	54.0	-10.8	1.03 H	337	40.42	2.78
3	*5710.00	110.0 PK			1.84 H	302	106.66	3.34
4	*5710.00	100.2 AV			1.84 H	302	96.86	3.34
5	#5870.00	59.7 PK	74.0	-14.3	1.02 H	359	56.19	3.51
6	#5870.00	43.2 AV	54.0	-10.8	1.02 H	359	39.69	3.51
7	11420.00	49.8 PK	74.0	-24.2	1.97 H	144	36.21	13.59
8	11420.00	37.6 AV	54.0	-16.4	1.97 H	144	24.01	13.59
9	#17130.00	52.1 PK	74.0	-21.9	2.16 H	143	31.27	20.83
10	#17130.00	39.1 AV	54.0	-14.9	2.16 H	143	18.27	20.83

ANTENNA POLARITY & TEST DISTANCE: VERTICAL AT 3 M

NO.	FREQ. (MHz)	EMISSION LEVEL (dBuV/m)	LIMIT (dBuV/m)	MARGIN (dB)	ANTENNA HEIGHT (m)	TABLE ANGLE (Degree)	RAW VALUE (dBuV)	CORRECTION FACTOR (dB/m)
1	5460.00	61.6 PK	74.0	-12.4	2.66 V	318	58.82	2.78
2	5460.00	51.6 AV	54.0	-2.4	2.66 V	318	48.82	2.78
3	*5710.00	114.1 PK			3.06 V	316	110.76	3.34
4	*5710.00	102.9 AV			3.06 V	316	99.56	3.34
5	#5870.00	63.3 PK	74.0	-10.7	2.81 V	360	59.79	3.51
6	#5870.00	51.9 AV	54.0	-2.1	2.81 V	360	48.39	3.51
7	11420.00	51.1 PK	74.0	-22.9	2.44 V	127	37.51	13.59
8	11420.00	38.5 AV	54.0	-15.5	2.44 V	127	24.91	13.59
9	#17130.00	53.3 PK	74.0	-20.7	2.53 V	315	32.47	20.83
10	#17130.00	40.8 AV	54.0	-13.2	2.53 V	315	19.97	20.83

REMARKS:

1. Emission Level(dBuV/m) = Raw Value(dBuV) + Correction Factor(dB/m)
2. Correction Factor(dB/m) = Antenna Factor(dB/m) + Cable Factor(dB) – Pre-Amplifier Factor(dB)
3. The other emission levels were very low against the limit.
4. Margin value = Emission Level – Limit value
5. " * ": Fundamental frequency.
6. " # ": The radiated frequency is out of the restricted band.

802.11ac VHT80

CHANNEL	TX Channel 58	DETECTOR FUNCTION	Peak (PK)
FREQUENCY RANGE	1GHz ~ 40GHz		Average (AV)

ANTENNA POLARITY & TEST DISTANCE: HORIZONTAL AT 3 M

NO.	FREQ. (MHz)	EMISSION LEVEL (dBuV/m)	LIMIT (dBuV/m)	MARGIN (dB)	ANTENNA HEIGHT (m)	TABLE ANGLE (Degree)	RAW VALUE (dBuV)	CORRECTION FACTOR (dB/m)
1	5150.00	48.0 PK	74.0	-26.0	1.17 H	336	45.63	2.37
2	5150.00	33.8 AV	54.0	-20.2	1.17 H	336	31.43	2.37
3	*5290.00	102.3 PK			1.87 H	307	99.71	2.59
4	*5290.00	91.2 AV			1.87 H	307	88.61	2.59
5	5350.00	62.1 PK	74.0	-11.9	1.03 H	359	59.45	2.65
6	5350.00	45.0 AV	54.0	-9.0	1.03 H	359	42.35	2.65
7	#10580.00	50.7 PK	74.0	-23.3	1.99 H	134	37.95	12.75
8	#10580.00	38.2 AV	54.0	-15.8	1.99 H	134	25.45	12.75
9	15870.00	52.6 PK	74.0	-21.4	2.17 H	130	37.77	14.83
10	15870.00	39.8 AV	54.0	-14.2	2.17 H	130	24.97	14.83

ANTENNA POLARITY & TEST DISTANCE: VERTICAL AT 3 M

NO.	FREQ. (MHz)	EMISSION LEVEL (dBuV/m)	LIMIT (dBuV/m)	MARGIN (dB)	ANTENNA HEIGHT (m)	TABLE ANGLE (Degree)	RAW VALUE (dBuV)	CORRECTION FACTOR (dB/m)
1	5150.00	57.9 PK	74.0	-16.1	2.46 V	272	55.53	2.37
2	5150.00	43.5 AV	54.0	-10.5	2.46 V	272	41.13	2.37
3	*5290.00	105.7 PK			2.46 V	272	103.11	2.59
4	*5290.00	94.1 AV			2.46 V	272	91.51	2.59
5	5350.00	71.3 PK	74.0	-2.7	2.46 V	272	68.65	2.65
6	5350.00	53.3 AV	54.0	-0.7	2.46 V	272	50.65	2.65
7	#10580.00	51.3 PK	74.0	-22.7	2.37 V	137	38.55	12.75
8	#10580.00	38.8 AV	54.0	-15.2	2.37 V	137	26.05	12.75
9	15870.00	53.2 PK	74.0	-20.8	2.50 V	319	38.37	14.83
10	15870.00	40.3 AV	54.0	-13.7	2.50 V	319	25.47	14.83

REMARKS:

- Emission Level(dBuV/m) = Raw Value(dBuV) + Correction Factor(dB/m)
- Correction Factor(dB/m) = Antenna Factor(dB/m) + Cable Factor(dB) – Pre-Amplifier Factor(dB)
- The other emission levels were very low against the limit.
- Margin value = Emission Level – Limit value
- " * ": Fundamental frequency.
- " # ": The radiated frequency is out of the restricted band.

CHANNEL	TX Channel 106	DETECTOR FUNCTION	Peak (PK)
FREQUENCY RANGE	1GHz ~ 40GHz		Average (AV)

ANTENNA POLARITY & TEST DISTANCE: HORIZONTAL AT 3 M

NO.	FREQ. (MHz)	EMISSION LEVEL (dBuV/m)	LIMIT (dBuV/m)	MARGIN (dB)	ANTENNA HEIGHT (m)	TABLE ANGLE (Degree)	RAW VALUE (dBuV)	CORRECTION FACTOR (dB/m)
1	#5470.00	62.6 PK	74.0	-11.4	1.12 H	347	59.81	2.79
2	#5470.00	45.6 AV	54.0	-8.4	1.12 H	347	42.81	2.79
3	*5530.00	105.0 PK			1.83 H	304	102.08	2.92
4	*5530.00	93.0 AV			1.83 H	304	90.08	2.92
5	11060.00	49.9 PK	74.0	-24.1	1.96 H	123	36.27	13.63
6	11060.00	37.9 AV	54.0	-16.1	1.96 H	123	24.27	13.63
7	#16590.00	52.2 PK	74.0	-21.8	2.19 H	149	33.02	19.18
8	#16590.00	39.3 AV	54.0	-14.7	2.19 H	149	20.12	19.18

ANTENNA POLARITY & TEST DISTANCE: VERTICAL AT 3 M

NO.	FREQ. (MHz)	EMISSION LEVEL (dBuV/m)	LIMIT (dBuV/m)	MARGIN (dB)	ANTENNA HEIGHT (m)	TABLE ANGLE (Degree)	RAW VALUE (dBuV)	CORRECTION FACTOR (dB/m)
1	#5470.00	73.9 PK	74.0	-0.1	2.45 V	284	71.11	2.79
2	#5470.00	53.8 AV	54.0	-0.2	2.45 V	284	51.01	2.79
3	*5530.00	107.5 PK			2.45 V	284	104.58	2.92
4	*5530.00	95.4 AV			2.45 V	284	92.48	2.92
5	11060.00	50.9 PK	74.0	-23.1	2.44 V	119	37.27	13.63
6	11060.00	38.5 AV	54.0	-15.5	2.44 V	119	24.87	13.63
7	#16590.00	53.4 PK	74.0	-20.6	2.48 V	309	34.22	19.18
8	#16590.00	40.8 AV	54.0	-13.2	2.48 V	309	21.62	19.18

REMARKS:

1. Emission Level(dBuV/m) = Raw Value(dBuV) + Correction Factor(dB/m)
2. Correction Factor(dB/m) = Antenna Factor(dB/m) + Cable Factor(dB) – Pre-Amplifier Factor(dB)
3. The other emission levels were very low against the limit.
4. Margin value = Emission Level – Limit value
5. " * ": Fundamental frequency.
6. " # ": The radiated frequency is out of the restricted band.

CHANNEL	TX Channel 122	DETECTOR FUNCTION	Peak (PK)
FREQUENCY RANGE	1GHz ~ 40GHz		Average (AV)

ANTENNA POLARITY & TEST DISTANCE: HORIZONTAL AT 3 M

NO.	FREQ. (MHz)	EMISSION LEVEL (dBuV/m)	LIMIT (dBuV/m)	MARGIN (dB)	ANTENNA HEIGHT (m)	TABLE ANGLE (Degree)	RAW VALUE (dBuV)	CORRECTION FACTOR (dB/m)
1	#5470.00	52.1 PK	74.0	-21.9	1.11 H	349	49.31	2.79
2	#5470.00	38.8 AV	54.0	-15.2	1.11 H	349	36.01	2.79
3	*5610.00	105.6 PK			1.78 H	314	102.45	3.15
4	*5610.00	93.4 AV			1.78 H	314	90.25	3.15
5	#5725.00	62.4 PK	74.0	-11.6	1.05 H	360	59.04	3.36
6	#5725.00	45.1 AV	54.0	-8.9	1.05 H	360	41.74	3.36
7	11220.00	50.3 PK	74.0	-23.7	2.02 H	132	36.66	13.64
8	11220.00	38.1 AV	54.0	-15.9	2.02 H	132	24.46	13.64
9	#16830.00	51.6 PK	74.0	-22.4	2.14 H	150	31.75	19.85
10	#16830.00	38.9 AV	54.0	-15.1	2.14 H	150	19.05	19.85

ANTENNA POLARITY & TEST DISTANCE: VERTICAL AT 3 M

NO.	FREQ. (MHz)	EMISSION LEVEL (dBuV/m)	LIMIT (dBuV/m)	MARGIN (dB)	ANTENNA HEIGHT (m)	TABLE ANGLE (Degree)	RAW VALUE (dBuV)	CORRECTION FACTOR (dB/m)
1	#5470.00	61.6 PK	74.0	-12.4	2.52 V	285	58.81	2.79
2	#5470.00	49.3 AV	54.0	-4.7	2.52 V	285	46.51	2.79
3	*5610.00	108.4 PK			2.52 V	285	105.25	3.15
4	*5610.00	96.5 AV			2.52 V	285	93.35	3.15
5	#5725.00	69.1 PK	74.0	-4.9	2.52 V	285	65.74	3.36
6	#5725.00	53.1 AV	54.0	-0.9	2.52 V	285	49.74	3.36
7	11220.00	51.7 PK	74.0	-22.3	2.46 V	146	38.06	13.64
8	11220.00	38.8 AV	54.0	-15.2	2.46 V	146	25.16	13.64
9	#16830.00	52.6 PK	74.0	-21.4	2.50 V	310	32.75	19.85
10	#16830.00	40.2 AV	54.0	-13.8	2.50 V	310	20.35	19.85

REMARKS:

1. Emission Level(dBuV/m) = Raw Value(dBuV) + Correction Factor(dB/m)
2. Correction Factor(dB/m) = Antenna Factor(dB/m) + Cable Factor(dB) – Pre-Amplifier Factor(dB)
3. The other emission levels were very low against the limit.
4. Margin value = Emission Level – Limit value
5. " * ": Fundamental frequency.
6. " # ": The radiated frequency is out of the restricted band.

CHANNEL	TX Channel 138	DETECTOR FUNCTION	Peak (PK)
FREQUENCY RANGE	1GHz ~ 40GHz		Average (AV)

ANTENNA POLARITY & TEST DISTANCE: HORIZONTAL AT 3 M

NO.	FREQ. (MHz)	EMISSION LEVEL (dBuV/m)	LIMIT (dBuV/m)	MARGIN (dB)	ANTENNA HEIGHT (m)	TABLE ANGLE (Degree)	RAW VALUE (dBuV)	CORRECTION FACTOR (dB/m)
1	*5690.00	109.2 PK			1.87 H	315	105.90	3.30
2	*5690.00	95.9 AV			1.87 H	315	92.60	3.30
3	#5850.00	56.7 PK	78.2	-21.5	1.14 H	342	53.21	3.49
4	11380.00	49.8 PK	74.0	-24.2	2.02 H	122	36.17	13.63
5	11380.00	37.7 AV	54.0	-16.3	2.02 H	122	24.07	13.63
6	#17070.00	52.1 PK	74.0	-21.9	2.09 H	155	31.25	20.85
7	#17070.00	39.5 AV	54.0	-14.5	2.09 H	155	18.65	20.85

ANTENNA POLARITY & TEST DISTANCE: VERTICAL AT 3 M

NO.	FREQ. (MHz)	EMISSION LEVEL (dBuV/m)	LIMIT (dBuV/m)	MARGIN (dB)	ANTENNA HEIGHT (m)	TABLE ANGLE (Degree)	RAW VALUE (dBuV)	CORRECTION FACTOR (dB/m)
1	*5690.00	112.7 PK			2.80 V	360	109.40	3.30
2	*5690.00	99.1 AV			2.80 V	360	95.80	3.30
3	#5850.00	68.1 PK	78.2	-10.1	2.80 V	360	64.61	3.49
4	11380.00	51.6 PK	74.0	-22.4	2.46 V	124	37.97	13.63
5	11380.00	38.7 AV	54.0	-15.3	2.46 V	124	25.07	13.63
6	#17070.00	52.7 PK	74.0	-21.3	2.47 V	295	31.85	20.85
7	#17070.00	40.0 AV	54.0	-14.0	2.47 V	295	19.15	20.85

REMARKS:

- Emission Level(dBuV/m) = Raw Value(dBuV) + Correction Factor(dB/m)
- Correction Factor(dB/m) = Antenna Factor(dB/m) + Cable Factor(dB) – Pre-Amplifier Factor(dB)
- The other emission levels were very low against the limit.
- Margin value = Emission Level – Limit value
- " * ": Fundamental frequency.
- " # ": The radiated frequency is out of the restricted band.

2TX

ANT7, ANT9

802.11a

CHANNEL	TX Channel 52	DETECTOR FUNCTION	Peak (PK)
FREQUENCY RANGE	1GHz ~ 40GHz		Average (AV)

ANTENNA POLARITY & TEST DISTANCE: HORIZONTAL AT 3 M

NO.	FREQ. (MHz)	EMISSION LEVEL (dBuV/m)	LIMIT (dBuV/m)	MARGIN (dB)	ANTENNA HEIGHT (m)	TABLE ANGLE (Degree)	RAW VALUE (dBuV)	CORRECTION FACTOR (dB/m)
1	5100.00	48.8 PK	74.0	-25.2	1.13 H	356	46.48	2.32
2	5100.00	39.6 AV	54.0	-14.4	1.13 H	356	37.28	2.32
3	*5260.00	107.8 PK			1.18 H	343	105.26	2.54
4	*5260.00	97.9 AV			1.18 H	343	95.36	2.54
5	5420.00	52.0 PK	74.0	-22.0	1.18 H	360	49.27	2.73
6	5420.00	41.9 AV	54.0	-12.1	1.18 H	360	39.17	2.73
7	#10520.00	50.0 PK	74.0	-24.0	2.02 H	119	37.60	12.40
8	#10520.00	37.4 AV	54.0	-16.6	2.02 H	119	25.00	12.40
9	15780.00	52.5 PK	74.0	-21.5	2.10 H	138	37.68	14.82
10	15780.00	39.9 AV	54.0	-14.1	2.10 H	138	25.08	14.82

ANTENNA POLARITY & TEST DISTANCE: VERTICAL AT 3 M

NO.	FREQ. (MHz)	EMISSION LEVEL (dBuV/m)	LIMIT (dBuV/m)	MARGIN (dB)	ANTENNA HEIGHT (m)	TABLE ANGLE (Degree)	RAW VALUE (dBuV)	CORRECTION FACTOR (dB/m)
1	5100.00	59.0 PK	74.0	-15.0	1.07 V	323	56.68	2.32
2	5100.00	49.7 AV	54.0	-4.3	1.07 V	323	47.38	2.32
3	*5260.00	117.9 PK			2.27 V	285	115.36	2.54
4	*5260.00	108.1 AV			2.27 V	285	105.56	2.54
5	5420.00	62.1 PK	74.0	-11.9	1.03 V	300	59.37	2.73
6	5420.00	52.0 AV	54.0	-2.0	1.03 V	300	49.27	2.73
7	#10520.00	51.2 PK	74.0	-22.8	2.51 V	164	38.80	12.40
8	#10520.00	38.8 AV	54.0	-15.2	2.51 V	164	26.40	12.40
9	15780.00	53.3 PK	74.0	-20.7	2.44 V	279	38.48	14.82
10	15780.00	41.1 AV	54.0	-12.9	2.44 V	279	26.28	14.82

REMARKS:

1. Emission Level(dBuV/m) = Raw Value(dBuV) + Correction Factor(dB/m)
2. Correction Factor(dB/m) = Antenna Factor(dB/m) + Cable Factor(dB) – Pre-Amplifier Factor(dB)
3. The other emission levels were very low against the limit.
4. Margin value = Emission Level – Limit value
5. " * ": Fundamental frequency.
6. " # ": The radiated frequency is out of the restricted band.

CHANNEL	TX Channel 60	DETECTOR FUNCTION	Peak (PK)
FREQUENCY RANGE	1GHz ~ 40GHz		Average (AV)

ANTENNA POLARITY & TEST DISTANCE: HORIZONTAL AT 3 M

NO.	FREQ. (MHz)	EMISSION LEVEL (dBuV/m)	LIMIT (dBuV/m)	MARGIN (dB)	ANTENNA HEIGHT (m)	TABLE ANGLE (Degree)	RAW VALUE (dBuV)	CORRECTION FACTOR (dB/m)
1	5140.00	49.9 PK	74.0	-24.1	1.17 H	360	47.53	2.37
2	5140.00	40.4 AV	54.0	-13.6	1.17 H	360	38.03	2.37
3	*5300.00	107.0 PK			1.21 H	351	104.39	2.61
4	*5300.00	96.7 AV			1.21 H	351	94.09	2.61
5	5460.00	50.9 PK	74.0	-23.1	1.14 H	360	48.12	2.78
6	5460.00	41.1 AV	54.0	-12.9	1.14 H	360	38.32	2.78
7	10600.00	50.1 PK	74.0	-23.9	1.96 H	114	37.24	12.86
8	10600.00	37.7 AV	54.0	-16.3	1.96 H	114	24.84	12.86
9	15900.00	51.9 PK	74.0	-22.1	2.14 H	144	37.03	14.87
10	15900.00	39.4 AV	54.0	-14.6	2.14 H	144	24.53	14.87

ANTENNA POLARITY & TEST DISTANCE: VERTICAL AT 3 M

NO.	FREQ. (MHz)	EMISSION LEVEL (dBuV/m)	LIMIT (dBuV/m)	MARGIN (dB)	ANTENNA HEIGHT (m)	TABLE ANGLE (Degree)	RAW VALUE (dBuV)	CORRECTION FACTOR (dB/m)
1	5140.00	59.8 PK	74.0	-14.2	1.00 V	317	57.43	2.37
2	5140.00	50.3 AV	54.0	-3.7	1.00 V	317	47.93	2.37
3	*5300.00	117.2 PK			2.01 V	315	114.59	2.61
4	*5300.00	107.1 AV			2.01 V	315	104.49	2.61
5	5460.00	61.3 PK	74.0	-12.7	1.00 V	65	58.52	2.78
6	5460.00	51.5 AV	54.0	-2.5	1.00 V	65	48.72	2.78
7	10600.00	50.7 PK	74.0	-23.3	2.41 V	162	37.84	12.86
8	10600.00	38.0 AV	54.0	-16.0	2.41 V	162	25.14	12.86
9	15900.00	53.3 PK	74.0	-20.7	2.46 V	297	38.43	14.87
10	15900.00	40.7 AV	54.0	-13.3	2.46 V	297	25.83	14.87

REMARKS:

1. Emission Level(dBuV/m) = Raw Value(dBuV) + Correction Factor(dB/m)
2. Correction Factor(dB/m) = Antenna Factor(dB/m) + Cable Factor(dB) – Pre-Amplifier Factor(dB)
3. The other emission levels were very low against the limit.
4. Margin value = Emission Level – Limit value
5. " * ": Fundamental frequency.

CHANNEL	TX Channel 64	DETECTOR FUNCTION	Peak (PK)
FREQUENCY RANGE	1GHz ~ 40GHz		Average (AV)

ANTENNA POLARITY & TEST DISTANCE: HORIZONTAL AT 3 M

NO.	FREQ. (MHz)	EMISSION LEVEL (dBuV/m)	LIMIT (dBuV/m)	MARGIN (dB)	ANTENNA HEIGHT (m)	TABLE ANGLE (Degree)	RAW VALUE (dBuV)	CORRECTION FACTOR (dB/m)
1	*5320.00	107.2 PK			1.23 H	351	104.57	2.63
2	*5320.00	96.2 AV			1.23 H	351	93.57	2.63
3	5350.00	61.0 PK	74.0	-13.0	1.12 H	349	58.35	2.65
4	5350.00	43.6 AV	54.0	-10.4	1.12 H	349	40.95	2.65
5	10640.00	49.5 PK	74.0	-24.5	1.95 H	127	36.62	12.88
6	10640.00	36.7 AV	54.0	-17.3	1.95 H	127	23.82	12.88
7	15960.00	52.2 PK	74.0	-21.8	2.16 H	158	37.27	14.93
8	15960.00	39.7 AV	54.0	-14.3	2.16 H	158	24.77	14.93

ANTENNA POLARITY & TEST DISTANCE: VERTICAL AT 3 M

NO.	FREQ. (MHz)	EMISSION LEVEL (dBuV/m)	LIMIT (dBuV/m)	MARGIN (dB)	ANTENNA HEIGHT (m)	TABLE ANGLE (Degree)	RAW VALUE (dBuV)	CORRECTION FACTOR (dB/m)
1	*5320.00	117.4 PK			2.19 V	283	114.77	2.63
2	*5320.00	106.5 AV			2.19 V	283	103.87	2.63
3	5350.00	70.5 PK	74.0	-3.5	2.27 V	73	67.85	2.65
4	5350.00	53.2 AV	54.0	-0.8	2.27 V	73	50.55	2.65
5	10640.00	51.1 PK	74.0	-22.9	2.49 V	138	38.22	12.88
6	10640.00	38.4 AV	54.0	-15.6	2.49 V	138	25.52	12.88
7	15960.00	52.8 PK	74.0	-21.2	2.37 V	289	37.87	14.93
8	15960.00	40.6 AV	54.0	-13.4	2.37 V	289	25.67	14.93

REMARKS:

1. Emission Level(dBuV/m) = Raw Value(dBuV) + Correction Factor(dB/m)
2. Correction Factor(dB/m) = Antenna Factor(dB/m) + Cable Factor(dB) – Pre-Amplifier Factor(dB)
3. The other emission levels were very low against the limit.
4. Margin value = Emission Level – Limit value
5. " * ": Fundamental frequency.

CHANNEL	TX Channel 100	DETECTOR FUNCTION	Peak (PK)
FREQUENCY RANGE	1GHz ~ 40GHz		Average (AV)

ANTENNA POLARITY & TEST DISTANCE: HORIZONTAL AT 3 M

NO.	FREQ. (MHz)	EMISSION LEVEL (dBuV/m)	LIMIT (dBuV/m)	MARGIN (dB)	ANTENNA HEIGHT (m)	TABLE ANGLE (Degree)	RAW VALUE (dBuV)	CORRECTION FACTOR (dB/m)
1	#5470.00	61.5 PK	74.0	-12.5	1.22 H	345	58.71	2.79
2	#5470.00	43.7 AV	54.0	-10.3	1.22 H	345	40.91	2.79
3	*5500.00	106.6 PK			1.17 H	360	103.77	2.83
4	*5500.00	95.7 AV			1.17 H	360	92.87	2.83
5	#5735.00	51.6 PK	74.0	-22.4	1.18 H	360	48.23	3.37
6	#5735.00	41.8 AV	54.0	-12.2	1.18 H	360	38.43	3.37
7	11000.00	49.8 PK	74.0	-24.2	1.99 H	125	36.16	13.64
8	11000.00	37.2 AV	54.0	-16.8	1.99 H	125	23.56	13.64
9	#16500.00	52.3 PK	74.0	-21.7	2.08 H	149	33.66	18.64
10	#16500.00	39.6 AV	54.0	-14.4	2.08 H	149	20.96	18.64

ANTENNA POLARITY & TEST DISTANCE: VERTICAL AT 3 M

NO.	FREQ. (MHz)	EMISSION LEVEL (dBuV/m)	LIMIT (dBuV/m)	MARGIN (dB)	ANTENNA HEIGHT (m)	TABLE ANGLE (Degree)	RAW VALUE (dBuV)	CORRECTION FACTOR (dB/m)
1	#5470.00	71.1 PK	74.0	-2.9	2.25 V	302	68.31	2.79
2	#5470.00	53.2 AV	54.0	-0.8	2.25 V	302	50.41	2.79
3	*5500.00	116.7 PK			1.02 V	62	113.87	2.83
4	*5500.00	106.0 AV			1.02 V	62	103.17	2.83
5	#5735.00	61.6 PK	74.0	-12.4	1.28 V	67	58.23	3.37
6	#5735.00	51.7 AV	54.0	-2.3	1.28 V	67	48.33	3.37
7	11000.00	50.5 PK	74.0	-23.5	2.45 V	153	36.86	13.64
8	11000.00	38.0 AV	54.0	-16.0	2.45 V	153	24.36	13.64
9	#16500.00	53.6 PK	74.0	-20.4	2.41 V	300	34.96	18.64
10	#16500.00	41.1 AV	54.0	-12.9	2.41 V	300	22.46	18.64

REMARKS:

1. Emission Level(dBuV/m) = Raw Value(dBuV) + Correction Factor(dB/m)
2. Correction Factor(dB/m) = Antenna Factor(dB/m) + Cable Factor(dB) – Pre-Amplifier Factor(dB)
3. The other emission levels were very low against the limit.
4. Margin value = Emission Level – Limit value
5. " * ": Fundamental frequency.
6. " # ": The radiated frequency is out of the restricted band.

CHANNEL	TX Channel 116	DETECTOR FUNCTION	Peak (PK)
FREQUENCY RANGE	1GHz ~ 40GHz		Average (AV)

ANTENNA POLARITY & TEST DISTANCE: HORIZONTAL AT 3 M

NO.	FREQ. (MHz)	EMISSION LEVEL (dBuV/m)	LIMIT (dBuV/m)	MARGIN (dB)	ANTENNA HEIGHT (m)	TABLE ANGLE (Degree)	RAW VALUE (dBuV)	CORRECTION FACTOR (dB/m)
1	5420.00	54.1 PK	74.0	-19.9	1.13 H	342	51.37	2.73
2	5420.00	43.8 AV	54.0	-10.2	1.13 H	342	41.07	2.73
3	*5580.00	107.3 PK			1.22 H	347	104.24	3.06
4	*5580.00	96.7 AV			1.22 H	347	93.64	3.06
5	#5740.00	53.0 PK	74.0	-21.0	1.17 H	360	49.63	3.37
6	#5740.00	43.4 AV	54.0	-10.6	1.17 H	360	40.03	3.37
7	11160.00	50.0 PK	74.0	-24.0	2.00 H	135	36.38	13.62
8	11160.00	37.2 AV	54.0	-16.8	2.00 H	135	23.58	13.62
9	#16740.00	52.6 PK	74.0	-21.4	2.18 H	130	33.01	19.59
10	#16740.00	39.8 AV	54.0	-14.2	2.18 H	130	20.21	19.59

ANTENNA POLARITY & TEST DISTANCE: VERTICAL AT 3 M

NO.	FREQ. (MHz)	EMISSION LEVEL (dBuV/m)	LIMIT (dBuV/m)	MARGIN (dB)	ANTENNA HEIGHT (m)	TABLE ANGLE (Degree)	RAW VALUE (dBuV)	CORRECTION FACTOR (dB/m)
1	5420.00	64.4 PK	74.0	-9.6	1.00 V	312	61.67	2.73
2	5420.00	53.9 AV	54.0	-0.1	1.00 V	312	51.17	2.73
3	*5580.00	117.4 PK			1.02 V	62	114.34	3.06
4	*5580.00	106.6 AV			1.02 V	62	103.54	3.06
5	#5740.00	63.3 PK	74.0	-10.7	1.00 V	75	59.93	3.37
6	#5740.00	53.8 AV	54.0	-0.2	1.00 V	75	50.43	3.37
7	11160.00	50.5 PK	74.0	-23.5	2.41 V	151	36.88	13.62
8	11160.00	38.2 AV	54.0	-15.8	2.41 V	151	24.58	13.62
9	#16740.00	53.4 PK	74.0	-20.6	2.42 V	296	33.81	19.59
10	#16740.00	40.9 AV	54.0	-13.1	2.42 V	296	21.31	19.59

REMARKS:

- Emission Level(dBuV/m) = Raw Value(dBuV) + Correction Factor(dB/m)
- Correction Factor(dB/m) = Antenna Factor(dB/m) + Cable Factor(dB) – Pre-Amplifier Factor(dB)
- The other emission levels were very low against the limit.
- Margin value = Emission Level – Limit value
- " * ": Fundamental frequency.
- " # ": The radiated frequency is out of the restricted band.

CHANNEL	TX Channel 140	DETECTOR FUNCTION	Peak (PK)
FREQUENCY RANGE	1GHz ~ 40GHz		Average (AV)

ANTENNA POLARITY & TEST DISTANCE: HORIZONTAL AT 3 M

NO.	FREQ. (MHz)	EMISSION LEVEL (dBuV/m)	LIMIT (dBuV/m)	MARGIN (dB)	ANTENNA HEIGHT (m)	TABLE ANGLE (Degree)	RAW VALUE (dBuV)	CORRECTION FACTOR (dB/m)
1	*5700.00	103.6 PK			1.15 H	352	100.28	3.32
2	*5700.00	93.8 AV			1.15 H	352	90.48	3.32
3	#5725.00	62.0 PK	74.0	-12.0	1.19 H	360	58.64	3.36
4	#5725.00	43.6 AV	54.0	-10.4	1.19 H	360	40.24	3.36
5	#5780.00	54.0 PK	74.0	-20.0	1.20 H	341	50.58	3.42
6	#5780.00	42.4 AV	54.0	-11.6	1.20 H	341	38.98	3.42
7	11400.00	49.9 PK	74.0	-24.1	1.92 H	120	36.29	13.61
8	11400.00	37.3 AV	54.0	-16.7	1.92 H	120	23.69	13.61
9	#17100.00	52.4 PK	74.0	-21.6	2.14 H	150	31.50	20.90
10	#17100.00	39.9 AV	54.0	-14.1	2.14 H	150	19.00	20.90

ANTENNA POLARITY & TEST DISTANCE: VERTICAL AT 3 M

NO.	FREQ. (MHz)	EMISSION LEVEL (dBuV/m)	LIMIT (dBuV/m)	MARGIN (dB)	ANTENNA HEIGHT (m)	TABLE ANGLE (Degree)	RAW VALUE (dBuV)	CORRECTION FACTOR (dB/m)
1	*5700.00	113.6 PK			1.08 V	62	110.28	3.32
2	*5700.00	104.0 AV			1.08 V	62	100.68	3.32
3	#5725.00	72.2 PK	74.0	-1.8	1.07 V	73	68.84	3.36
4	#5725.00	53.6 AV	54.0	-0.4	1.07 V	73	50.24	3.36
5	#5780.00	63.3 PK	74.0	-10.7	1.01 V	49	59.88	3.42
6	#5780.00	52.0 AV	54.0	-2.0	1.01 V	49	48.58	3.42
7	11400.00	51.1 PK	74.0	-22.9	2.42 V	164	37.49	13.61
8	11400.00	38.7 AV	54.0	-15.3	2.42 V	164	25.09	13.61
9	#17100.00	52.9 PK	74.0	-21.1	2.42 V	286	32.00	20.90
10	#17100.00	40.8 AV	54.0	-13.2	2.42 V	286	19.90	20.90

REMARKS:

1. Emission Level(dBuV/m) = Raw Value(dBuV) + Correction Factor(dB/m)
2. Correction Factor(dB/m) = Antenna Factor(dB/m) + Cable Factor(dB) – Pre-Amplifier Factor(dB)
3. The other emission levels were very low against the limit.
4. Margin value = Emission Level – Limit value
5. " * ": Fundamental frequency.
6. " # ": The radiated frequency is out of the restricted band.

CHANNEL	TX Channel 144	DETECTOR FUNCTION	Peak (PK)
FREQUENCY RANGE	1GHz ~ 40GHz		Average (AV)

ANTENNA POLARITY & TEST DISTANCE: HORIZONTAL AT 3 M

NO.	FREQ. (MHz)	EMISSION LEVEL (dBuV/m)	LIMIT (dBuV/m)	MARGIN (dB)	ANTENNA HEIGHT (m)	TABLE ANGLE (Degree)	RAW VALUE (dBuV)	CORRECTION FACTOR (dB/m)
1	*5720.00	107.9 PK			1.20 H	355	104.55	3.35
2	*5720.00	98.0 AV			1.20 H	355	94.65	3.35
3	#5880.00	53.8 PK	68.2	-14.4	1.14 H	360	50.28	3.52
4	11440.00	50.1 PK	74.0	-23.9	2.02 H	130	36.54	13.56
5	11440.00	37.2 AV	54.0	-16.8	2.02 H	130	23.64	13.56
6	#17160.00	51.6 PK	68.2	-16.6	2.11 H	148	30.82	20.78

ANTENNA POLARITY & TEST DISTANCE: VERTICAL AT 3 M

NO.	FREQ. (MHz)	EMISSION LEVEL (dBuV/m)	LIMIT (dBuV/m)	MARGIN (dB)	ANTENNA HEIGHT (m)	TABLE ANGLE (Degree)	RAW VALUE (dBuV)	CORRECTION FACTOR (dB/m)
1	*5720.00	117.9 PK			1.08 V	63	114.55	3.35
2	*5720.00	107.9 AV			1.08 V	63	104.55	3.35
3	#5880.00	63.7 PK	68.2	-4.5	1.07 V	88	60.18	3.52
4	11440.00	51.5 PK	74.0	-22.5	2.45 V	153	37.94	13.56
5	11440.00	38.8 AV	54.0	-15.2	2.45 V	153	25.24	13.56
6	#17160.00	53.2 PK	68.2	-15.0	2.49 V	302	32.42	20.78

REMARKS:

1. Emission Level(dBuV/m) = Raw Value(dBuV) + Correction Factor(dB/m)
2. Correction Factor(dB/m) = Antenna Factor(dB/m) + Cable Factor(dB) – Pre-Amplifier Factor(dB)
3. The other emission levels were very low against the limit.
4. Margin value = Emission Level – Limit value
5. " * ": Fundamental frequency.
6. " # ": The radiated frequency is out of the restricted band.

802.11ac VHT20

CHANNEL	TX Channel 52	DETECTOR FUNCTION	Peak (PK)
FREQUENCY RANGE	1GHz ~ 40GHz		Average (AV)

ANTENNA POLARITY & TEST DISTANCE: HORIZONTAL AT 3 M

NO.	FREQ. (MHz)	EMISSION LEVEL (dBuV/m)	LIMIT (dBuV/m)	MARGIN (dB)	ANTENNA HEIGHT (m)	TABLE ANGLE (Degree)	RAW VALUE (dBuV)	CORRECTION FACTOR (dB/m)
1	5100.00	50.9 PK	74.0	-23.1	1.22 H	359	48.58	2.32
2	5100.00	40.9 AV	54.0	-13.1	1.22 H	359	38.58	2.32
3	*5260.00	106.8 PK			1.19 H	340	104.26	2.54
4	*5260.00	97.4 AV			1.19 H	340	94.86	2.54
5	5420.00	51.3 PK	74.0	-22.7	1.13 H	345	48.57	2.73
6	5420.00	41.2 AV	54.0	-12.8	1.13 H	345	38.47	2.73
7	#10520.00	50.2 PK	74.0	-23.8	2.04 H	125	37.80	12.40
8	#10520.00	37.6 AV	54.0	-16.4	2.04 H	125	25.20	12.40
9	15780.00	52.0 PK	74.0	-22.0	2.08 H	132	37.18	14.82
10	15780.00	39.3 AV	54.0	-14.7	2.08 H	132	24.48	14.82

ANTENNA POLARITY & TEST DISTANCE: VERTICAL AT 3 M

NO.	FREQ. (MHz)	EMISSION LEVEL (dBuV/m)	LIMIT (dBuV/m)	MARGIN (dB)	ANTENNA HEIGHT (m)	TABLE ANGLE (Degree)	RAW VALUE (dBuV)	CORRECTION FACTOR (dB/m)
1	5100.00	60.1 PK	74.0	-13.9	1.01 V	306	57.78	2.32
2	5100.00	50.4 AV	54.0	-3.6	1.01 V	306	48.08	2.32
3	*5260.00	116.7 PK			1.03 V	296	114.16	2.54
4	*5260.00	107.3 AV			1.03 V	296	104.76	2.54
5	5420.00	61.2 PK	74.0	-12.8	1.08 V	303	58.47	2.73
6	5420.00	51.4 AV	54.0	-2.6	1.08 V	303	48.67	2.73
7	#10520.00	50.8 PK	74.0	-23.2	2.51 V	136	38.40	12.40
8	#10520.00	38.2 AV	54.0	-15.8	2.51 V	136	25.80	12.40
9	15780.00	52.7 PK	74.0	-21.3	2.39 V	293	37.88	14.82
10	15780.00	40.4 AV	54.0	-13.6	2.39 V	293	25.58	14.82

REMARKS:

- Emission Level(dBuV/m) = Raw Value(dBuV) + Correction Factor(dB/m)
- Correction Factor(dB/m) = Antenna Factor(dB/m) + Cable Factor(dB) – Pre-Amplifier Factor(dB)
- The other emission levels were very low against the limit.
- Margin value = Emission Level – Limit value
- " * ": Fundamental frequency.
- " # ": The radiated frequency is out of the restricted band.

CHANNEL	TX Channel 60	DETECTOR FUNCTION	Peak (PK)
FREQUENCY RANGE	1GHz ~ 40GHz		Average (AV)

ANTENNA POLARITY & TEST DISTANCE: HORIZONTAL AT 3 M

NO.	FREQ. (MHz)	EMISSION LEVEL (dBuV/m)	LIMIT (dBuV/m)	MARGIN (dB)	ANTENNA HEIGHT (m)	TABLE ANGLE (Degree)	RAW VALUE (dBuV)	CORRECTION FACTOR (dB/m)
1	5140.00	50.4 PK	74.0	-23.6	1.14 H	360	48.03	2.37
2	5140.00	40.7 AV	54.0	-13.3	1.14 H	360	38.33	2.37
3	*5300.00	106.2 PK			1.23 H	360	103.59	2.61
4	*5300.00	97.0 AV			1.23 H	360	94.39	2.61
5	5460.00	51.4 PK	74.0	-22.6	1.21 H	354	48.62	2.78
6	5460.00	41.4 AV	54.0	-12.6	1.21 H	354	38.62	2.78
7	10600.00	49.4 PK	74.0	-24.6	1.99 H	132	36.54	12.86
8	10600.00	36.7 AV	54.0	-17.3	1.99 H	132	23.84	12.86
9	15900.00	51.7 PK	74.0	-22.3	2.14 H	134	36.83	14.87
10	15900.00	39.1 AV	54.0	-14.9	2.14 H	134	24.23	14.87

ANTENNA POLARITY & TEST DISTANCE: VERTICAL AT 3 M

NO.	FREQ. (MHz)	EMISSION LEVEL (dBuV/m)	LIMIT (dBuV/m)	MARGIN (dB)	ANTENNA HEIGHT (m)	TABLE ANGLE (Degree)	RAW VALUE (dBuV)	CORRECTION FACTOR (dB/m)
1	5140.00	60.6 PK	74.0	-13.4	1.04 V	318	58.23	2.37
2	5140.00	50.8 AV	54.0	-3.2	1.04 V	318	48.43	2.37
3	*5300.00	116.7 PK			1.02 V	290	114.09	2.61
4	*5300.00	107.4 AV			1.02 V	290	104.79	2.61
5	5460.00	61.4 PK	74.0	-12.6	1.03 V	308	58.62	2.78
6	5460.00	51.5 AV	54.0	-2.5	1.03 V	308	48.72	2.78
7	10600.00	51.2 PK	74.0	-22.8	2.52 V	152	38.34	12.86
8	10600.00	38.5 AV	54.0	-15.5	2.52 V	152	25.64	12.86
9	15900.00	53.4 PK	74.0	-20.6	2.40 V	295	38.53	14.87
10	15900.00	41.0 AV	54.0	-13.0	2.40 V	295	26.13	14.87

REMARKS:

1. Emission Level(dBuV/m) = Raw Value(dBuV) + Correction Factor(dB/m)
2. Correction Factor(dB/m) = Antenna Factor(dB/m) + Cable Factor(dB) – Pre-Amplifier Factor(dB)
3. The other emission levels were very low against the limit.
4. Margin value = Emission Level – Limit value
5. " * ": Fundamental frequency.

CHANNEL	TX Channel 64	DETECTOR FUNCTION	Peak (PK)
FREQUENCY RANGE	1GHz ~ 40GHz		Average (AV)

ANTENNA POLARITY & TEST DISTANCE: HORIZONTAL AT 3 M

NO.	FREQ. (MHz)	EMISSION LEVEL (dBuV/m)	LIMIT (dBuV/m)	MARGIN (dB)	ANTENNA HEIGHT (m)	TABLE ANGLE (Degree)	RAW VALUE (dBuV)	CORRECTION FACTOR (dB/m)
1	*5320.00	105.6 PK			1.11 H	360	102.97	2.63
2	*5320.00	95.1 AV			1.11 H	360	92.47	2.63
3	5350.00	62.4 PK	74.0	-11.6	1.15 H	360	59.75	2.65
4	5350.00	43.5 AV	54.0	-10.5	1.15 H	360	40.85	2.65
5	#5480.00	51.7 PK	74.0	-22.3	1.22 H	347	48.90	2.80
6	#5480.00	41.3 AV	54.0	-12.7	1.22 H	347	38.50	2.80
7	10640.00	50.4 PK	74.0	-23.6	2.03 H	127	37.52	12.88
8	10640.00	37.6 AV	54.0	-16.4	2.03 H	127	24.72	12.88
9	15960.00	51.6 PK	74.0	-22.4	2.15 H	142	36.67	14.93
10	15960.00	39.2 AV	54.0	-14.8	2.15 H	142	24.27	14.93

ANTENNA POLARITY & TEST DISTANCE: VERTICAL AT 3 M

NO.	FREQ. (MHz)	EMISSION LEVEL (dBuV/m)	LIMIT (dBuV/m)	MARGIN (dB)	ANTENNA HEIGHT (m)	TABLE ANGLE (Degree)	RAW VALUE (dBuV)	CORRECTION FACTOR (dB/m)
1	*5320.00	115.9 PK			1.00 V	290	113.27	2.63
2	*5320.00	105.2 AV			1.00 V	290	102.57	2.63
3	5350.00	72.4 PK	74.0	-1.6	1.02 V	293	69.75	2.65
4	5350.00	53.4 AV	54.0	-0.6	1.02 V	293	50.75	2.65
5	#5480.00	61.8 PK	74.0	-12.2	1.05 V	332	59.00	2.80
6	#5480.00	51.1 AV	54.0	-2.9	1.05 V	332	48.30	2.80
7	10640.00	51.1 PK	74.0	-22.9	2.43 V	145	38.22	12.88
8	10640.00	38.8 AV	54.0	-15.2	2.43 V	145	25.92	12.88
9	15960.00	53.7 PK	74.0	-20.3	2.40 V	289	38.77	14.93
10	15960.00	41.1 AV	54.0	-12.9	2.40 V	289	26.17	14.93

REMARKS:

1. Emission Level(dBuV/m) = Raw Value(dBuV) + Correction Factor(dB/m)
2. Correction Factor(dB/m) = Antenna Factor(dB/m) + Cable Factor(dB) – Pre-Amplifier Factor(dB)
3. The other emission levels were very low against the limit.
4. Margin value = Emission Level – Limit value
5. " * ": Fundamental frequency.
6. " # ": The radiated frequency is out of the restricted band.

CHANNEL	TX Channel 100	DETECTOR FUNCTION	Peak (PK)
FREQUENCY RANGE	1GHz ~ 40GHz		Average (AV)

ANTENNA POLARITY & TEST DISTANCE: HORIZONTAL AT 3 M

NO.	FREQ. (MHz)	EMISSION LEVEL (dBuV/m)	LIMIT (dBuV/m)	MARGIN (dB)	ANTENNA HEIGHT (m)	TABLE ANGLE (Degree)	RAW VALUE (dBuV)	CORRECTION FACTOR (dB/m)
1	5420.00	51.1 PK	74.0	-22.9	1.18 H	355	48.37	2.73
2	5420.00	38.5 AV	54.0	-15.5	1.18 H	355	35.77	2.73
3	#5470.00	62.8 PK	74.0	-11.2	1.15 H	358	60.01	2.79
4	#5470.00	43.1 AV	54.0	-10.9	1.15 H	358	40.31	2.79
5	*5500.00	104.7 PK			1.12 H	343	101.87	2.83
6	*5500.00	94.9 AV			1.12 H	343	92.07	2.83
7	#5730.00	55.0 PK	74.0	-19.0	1.20 H	360	51.65	3.35
8	#5730.00	43.6 AV	54.0	-10.4	1.20 H	360	40.25	3.35
9	11000.00	49.5 PK	74.0	-24.5	2.02 H	133	35.86	13.64
10	11000.00	37.1 AV	54.0	-16.9	2.02 H	133	23.46	13.64
11	#16500.00	51.9 PK	74.0	-22.1	2.16 H	144	33.26	18.64
12	#16500.00	39.4 AV	54.0	-14.6	2.16 H	144	20.76	18.64

ANTENNA POLARITY & TEST DISTANCE: VERTICAL AT 3 M

NO.	FREQ. (MHz)	EMISSION LEVEL (dBuV/m)	LIMIT (dBuV/m)	MARGIN (dB)	ANTENNA HEIGHT (m)	TABLE ANGLE (Degree)	RAW VALUE (dBuV)	CORRECTION FACTOR (dB/m)
1	5420.00	61.4 PK	74.0	-12.6	1.03 V	329	58.67	2.73
2	5420.00	48.9 AV	54.0	-5.1	1.03 V	329	46.17	2.73
3	#5470.00	72.4 PK	74.0	-1.6	1.08 V	324	69.61	2.79
4	#5470.00	52.9 AV	54.0	-1.1	1.08 V	324	50.11	2.79
5	*5500.00	115.5 PK			1.01 V	345	112.67	2.83
6	*5500.00	105.4 AV			1.01 V	345	102.57	2.83
7	#5730.00	65.0 PK	74.0	-9.0	1.09 V	340	61.65	3.35
8	#5730.00	53.9 AV	54.0	-0.1	1.09 V	340	50.55	3.35
9	11000.00	51.1 PK	74.0	-22.9	2.51 V	142	37.46	13.64
10	11000.00	38.7 AV	54.0	-15.3	2.51 V	142	25.06	13.64
11	#16500.00	53.4 PK	74.0	-20.6	2.41 V	291	34.76	18.64
12	#16500.00	40.9 AV	54.0	-13.1	2.41 V	291	22.26	18.64

REMARKS:

1. Emission Level(dBuV/m) = Raw Value(dBuV) + Correction Factor(dB/m)
2. Correction Factor(dB/m) = Antenna Factor(dB/m) + Cable Factor(dB) – Pre-Amplifier Factor(dB)
3. The other emission levels were very low against the limit.
4. Margin value = Emission Level – Limit value
5. " * ": Fundamental frequency.
6. " # ": The radiated frequency is out of the restricted band.

CHANNEL	TX Channel 116	DETECTOR FUNCTION	Peak (PK)
FREQUENCY RANGE	1GHz ~ 40GHz		Average (AV)

ANTENNA POLARITY & TEST DISTANCE: HORIZONTAL AT 3 M

NO.	FREQ. (MHz)	EMISSION LEVEL (dBuV/m)	LIMIT (dBuV/m)	MARGIN (dB)	ANTENNA HEIGHT (m)	TABLE ANGLE (Degree)	RAW VALUE (dBuV)	CORRECTION FACTOR (dB/m)
1	5420.00	52.6 PK	74.0	-21.4	1.18 H	360	49.87	2.73
2	5420.00	43.4 AV	54.0	-10.6	1.18 H	360	40.67	2.73
3	*5580.00	104.9 PK			1.21 H	360	101.84	3.06
4	*5580.00	94.6 AV			1.21 H	360	91.54	3.06
5	#5740.00	51.8 PK	74.0	-22.2	1.20 H	359	48.43	3.37
6	#5740.00	43.0 AV	54.0	-11.0	1.20 H	359	39.63	3.37
7	11160.00	50.0 PK	74.0	-24.0	1.94 H	138	36.38	13.62
8	11160.00	37.3 AV	54.0	-16.7	1.94 H	138	23.68	13.62
9	#16740.00	52.2 PK	74.0	-21.8	2.16 H	157	32.61	19.59
10	#16740.00	39.5 AV	54.0	-14.5	2.16 H	157	19.91	19.59

ANTENNA POLARITY & TEST DISTANCE: VERTICAL AT 3 M

NO.	FREQ. (MHz)	EMISSION LEVEL (dBuV/m)	LIMIT (dBuV/m)	MARGIN (dB)	ANTENNA HEIGHT (m)	TABLE ANGLE (Degree)	RAW VALUE (dBuV)	CORRECTION FACTOR (dB/m)
1	5420.00	63.1 PK	74.0	-10.9	1.06 V	332	60.37	2.73
2	5420.00	53.8 AV	54.0	-0.2	1.06 V	332	51.07	2.73
3	*5580.00	115.2 PK			1.12 V	335	112.14	3.06
4	*5580.00	105.0 AV			1.12 V	335	101.94	3.06
5	#5740.00	61.1 PK	74.0	-12.9	1.06 V	330	57.73	3.37
6	#5740.00	52.6 AV	54.0	-1.4	1.06 V	330	49.23	3.37
7	11160.00	51.4 PK	74.0	-22.6	2.41 V	151	37.78	13.62
8	11160.00	38.8 AV	54.0	-15.2	2.41 V	151	25.18	13.62
9	#16740.00	53.2 PK	74.0	-20.8	2.38 V	284	33.61	19.59
10	#16740.00	40.9 AV	54.0	-13.1	2.38 V	284	21.31	19.59

REMARKS:

1. Emission Level(dBuV/m) = Raw Value(dBuV) + Correction Factor(dB/m)
2. Correction Factor(dB/m) = Antenna Factor(dB/m) + Cable Factor(dB) – Pre-Amplifier Factor(dB)
3. The other emission levels were very low against the limit.
4. Margin value = Emission Level – Limit value
5. " * ": Fundamental frequency.
6. " # ": The radiated frequency is out of the restricted band.

CHANNEL	TX Channel 140	DETECTOR FUNCTION	Peak (PK)
FREQUENCY RANGE	1GHz ~ 40GHz		Average (AV)

ANTENNA POLARITY & TEST DISTANCE: HORIZONTAL AT 3 M

NO.	FREQ. (MHz)	EMISSION LEVEL (dBuV/m)	LIMIT (dBuV/m)	MARGIN (dB)	ANTENNA HEIGHT (m)	TABLE ANGLE (Degree)	RAW VALUE (dBuV)	CORRECTION FACTOR (dB/m)
1	5460.00	53.6 PK	74.0	-20.4	1.17 H	360	50.82	2.78
2	5460.00	43.1 AV	54.0	-10.9	1.17 H	360	40.32	2.78
3	*5700.00	105.9 PK			1.20 H	356	102.58	3.32
4	*5700.00	95.1 AV			1.20 H	356	91.78	3.32
5	#5725.00	59.6 PK	74.0	-14.4	1.20 H	338	56.24	3.36
6	#5725.00	43.7 AV	54.0	-10.3	1.20 H	338	40.34	3.36
7	11400.00	49.9 PK	74.0	-24.1	1.98 H	139	36.29	13.61
8	11400.00	37.4 AV	54.0	-16.6	1.98 H	139	23.79	13.61
9	#17100.00	52.1 PK	74.0	-21.9	2.18 H	150	31.20	20.90
10	#17100.00	39.3 AV	54.0	-14.7	2.18 H	150	18.40	20.90

ANTENNA POLARITY & TEST DISTANCE: VERTICAL AT 3 M

NO.	FREQ. (MHz)	EMISSION LEVEL (dBuV/m)	LIMIT (dBuV/m)	MARGIN (dB)	ANTENNA HEIGHT (m)	TABLE ANGLE (Degree)	RAW VALUE (dBuV)	CORRECTION FACTOR (dB/m)
1	5460.00	63.5 PK	74.0	-10.5	1.06 V	323	60.72	2.78
2	5460.00	53.0 AV	54.0	-1.0	1.06 V	323	50.22	2.78
3	*5700.00	115.7 PK			1.05 V	330	112.38	3.32
4	*5700.00	104.8 AV			1.05 V	330	101.48	3.32
5	#5725.00	69.0 PK	74.0	-5.0	1.03 V	338	65.64	3.36
6	#5725.00	53.3 AV	54.0	-0.7	1.03 V	338	49.94	3.36
7	11400.00	50.7 PK	74.0	-23.3	2.51 V	150	37.09	13.61
8	11400.00	38.3 AV	54.0	-15.7	2.51 V	150	24.69	13.61
9	#17100.00	52.5 PK	74.0	-21.5	2.37 V	286	31.60	20.90
10	#17100.00	40.4 AV	54.0	-13.6	2.37 V	286	19.50	20.90

REMARKS:

1. Emission Level(dBuV/m) = Raw Value(dBuV) + Correction Factor(dB/m)
2. Correction Factor(dB/m) = Antenna Factor(dB/m) + Cable Factor(dB) – Pre-Amplifier Factor(dB)
3. The other emission levels were very low against the limit.
4. Margin value = Emission Level – Limit value
5. " * ": Fundamental frequency.
6. " # ": The radiated frequency is out of the restricted band.

CHANNEL	TX Channel 144	DETECTOR FUNCTION	Peak (PK)
FREQUENCY RANGE	1GHz ~ 40GHz		Average (AV)

ANTENNA POLARITY & TEST DISTANCE: HORIZONTAL AT 3 M

NO.	FREQ. (MHz)	EMISSION LEVEL (dBuV/m)	LIMIT (dBuV/m)	MARGIN (dB)	ANTENNA HEIGHT (m)	TABLE ANGLE (Degree)	RAW VALUE (dBuV)	CORRECTION FACTOR (dB/m)
1	*5720.00	108.1 PK			1.16 H	359	104.75	3.35
2	*5720.00	98.1 AV			1.16 H	359	94.75	3.35
3	#5880.00	53.7 PK	68.2	-14.5	1.11 H	360	50.18	3.52
4	11440.00	49.9 PK	74.0	-24.1	1.96 H	115	36.34	13.56
5	11440.00	37.2 AV	54.0	-16.8	1.96 H	115	23.64	13.56
6	#17160.00	51.7 PK	68.2	-16.5	2.10 H	161	30.92	20.78

ANTENNA POLARITY & TEST DISTANCE: VERTICAL AT 3 M

NO.	FREQ. (MHz)	EMISSION LEVEL (dBuV/m)	LIMIT (dBuV/m)	MARGIN (dB)	ANTENNA HEIGHT (m)	TABLE ANGLE (Degree)	RAW VALUE (dBuV)	CORRECTION FACTOR (dB/m)
1	*5720.00	118.0 PK			1.05 V	76	114.65	3.35
2	*5720.00	108.2 AV			1.05 V	76	104.85	3.35
3	#5880.00	63.4 PK	68.2	-4.8	1.15 V	58	59.88	3.52
4	11440.00	51.3 PK	74.0	-22.7	2.40 V	146	37.74	13.56
5	11440.00	38.5 AV	54.0	-15.5	2.40 V	146	24.94	13.56
6	#17160.00	52.8 PK	68.2	-15.4	2.47 V	285	32.02	20.78

REMARKS:

1. Emission Level(dBuV/m) = Raw Value(dBuV) + Correction Factor(dB/m)
2. Correction Factor(dB/m) = Antenna Factor(dB/m) + Cable Factor(dB) – Pre-Amplifier Factor(dB)
3. The other emission levels were very low against the limit.
4. Margin value = Emission Level – Limit value
5. " * ": Fundamental frequency.
6. " # ": The radiated frequency is out of the restricted band.

802.11ac VHT40

CHANNEL	TX Channel 54	DETECTOR FUNCTION	Peak (PK)
FREQUENCY RANGE	1GHz ~ 40GHz		Average (AV)

ANTENNA POLARITY & TEST DISTANCE: HORIZONTAL AT 3 M

NO.	FREQ. (MHz)	EMISSION LEVEL (dBuV/m)	LIMIT (dBuV/m)	MARGIN (dB)	ANTENNA HEIGHT (m)	TABLE ANGLE (Degree)	RAW VALUE (dBuV)	CORRECTION FACTOR (dB/m)
1	5110.00	50.6 PK	74.0	-23.4	1.21 H	345	48.28	2.32
2	5110.00	40.9 AV	54.0	-13.1	1.21 H	345	38.58	2.32
3	*5270.00	104.1 PK			1.17 H	344	101.54	2.56
4	*5270.00	93.7 AV			1.17 H	344	91.14	2.56
5	5350.00	58.8 PK	74.0	-15.2	1.12 H	348	56.15	2.65
6	5350.00	43.6 AV	54.0	-10.4	1.12 H	348	40.95	2.65
7	#5855.00	46.1 PK	74.0	-27.9	1.22 H	343	42.61	3.49
8	#5855.00	40.1 AV	54.0	-13.9	1.22 H	343	36.61	3.49
9	#10540.00	50.1 PK	74.0	-23.9	2.02 H	129	37.58	12.52
10	#10540.00	37.4 AV	54.0	-16.6	2.02 H	129	24.88	12.52
11	15810.00	52.3 PK	74.0	-21.7	2.13 H	153	37.54	14.76
12	15810.00	39.7 AV	54.0	-14.3	2.13 H	153	24.94	14.76

ANTENNA POLARITY & TEST DISTANCE: VERTICAL AT 3 M

NO.	FREQ. (MHz)	EMISSION LEVEL (dBuV/m)	LIMIT (dBuV/m)	MARGIN (dB)	ANTENNA HEIGHT (m)	TABLE ANGLE (Degree)	RAW VALUE (dBuV)	CORRECTION FACTOR (dB/m)
1	5110.00	60.8 PK	74.0	-13.2	1.01 V	121	58.48	2.32
2	5110.00	50.8 AV	54.0	-3.2	1.01 V	121	48.48	2.32
3	*5270.00	113.9 PK			1.04 V	131	111.34	2.56
4	*5270.00	103.6 AV			1.04 V	131	101.04	2.56
5	5350.00	68.7 PK	74.0	-5.3	1.02 V	104	66.05	2.65
6	5350.00	53.7 AV	54.0	-0.3	1.02 V	104	51.05	2.65
7	#5855.00	56.6 PK	74.0	-17.4	1.07 V	110	53.11	3.49
8	#5855.00	50.3 AV	54.0	-3.7	1.07 V	110	46.81	3.49
9	#10540.00	50.9 PK	74.0	-23.1	2.46 V	147	38.38	12.52
10	#10540.00	38.5 AV	54.0	-15.5	2.46 V	147	25.98	12.52
11	15810.00	53.1 PK	74.0	-20.9	2.47 V	284	38.34	14.76
12	15810.00	41.1 AV	54.0	-12.9	2.47 V	284	26.34	14.76

REMARKS:

1. Emission Level(dBuV/m) = Raw Value(dBuV) + Correction Factor(dB/m)
2. Correction Factor(dB/m) = Antenna Factor(dB/m) + Cable Factor(dB) – Pre-Amplifier Factor(dB)
3. The other emission levels were very low against the limit.
4. Margin value = Emission Level – Limit value
5. " * ": Fundamental frequency.
6. " # ": The radiated frequency is out of the restricted band.

CHANNEL	TX Channel 62	DETECTOR FUNCTION	Peak (PK)
FREQUENCY RANGE	1GHz ~ 40GHz		Average (AV)

ANTENNA POLARITY & TEST DISTANCE: HORIZONTAL AT 3 M

NO.	FREQ. (MHz)	EMISSION LEVEL (dBuV/m)	LIMIT (dBuV/m)	MARGIN (dB)	ANTENNA HEIGHT (m)	TABLE ANGLE (Degree)	RAW VALUE (dBuV)	CORRECTION FACTOR (dB/m)
1	*5310.00	99.5 PK			1.17 H	345	96.89	2.61
2	*5310.00	88.5 AV			1.17 H	345	85.89	2.61
3	5350.00	61.9 PK	74.0	-12.1	1.22 H	359	59.25	2.65
4	5350.00	43.8 AV	54.0	-10.2	1.22 H	359	41.15	2.65
5	10620.00	49.8 PK	74.0	-24.2	1.95 H	121	36.92	12.88
6	10620.00	37.4 AV	54.0	-16.6	1.95 H	121	24.52	12.88
7	15930.00	52.5 PK	74.0	-21.5	2.18 H	138	37.60	14.90
8	15930.00	39.8 AV	54.0	-14.2	2.18 H	138	24.90	14.90

ANTENNA POLARITY & TEST DISTANCE: VERTICAL AT 3 M

NO.	FREQ. (MHz)	EMISSION LEVEL (dBuV/m)	LIMIT (dBuV/m)	MARGIN (dB)	ANTENNA HEIGHT (m)	TABLE ANGLE (Degree)	RAW VALUE (dBuV)	CORRECTION FACTOR (dB/m)
1	*5310.00	109.6 PK			1.03 V	107	106.99	2.61
2	*5310.00	98.9 AV			1.03 V	107	96.29	2.61
3	5350.00	71.9 PK	74.0	-2.1	1.08 V	112	69.25	2.65
4	5350.00	53.8 AV	54.0	-0.2	1.08 V	112	51.15	2.65
5	10620.00	50.3 PK	74.0	-23.7	2.46 V	153	37.42	12.88
6	10620.00	38.0 AV	54.0	-16.0	2.46 V	153	25.12	12.88
7	15930.00	52.6 PK	74.0	-21.4	2.45 V	303	37.70	14.90
8	15930.00	40.5 AV	54.0	-13.5	2.45 V	303	25.60	14.90

REMARKS:

1. Emission Level(dBuV/m) = Raw Value(dBuV) + Correction Factor(dB/m)
2. Correction Factor(dB/m) = Antenna Factor(dB/m) + Cable Factor(dB) – Pre-Amplifier Factor(dB)
3. The other emission levels were very low against the limit.
4. Margin value = Emission Level – Limit value
5. " * ": Fundamental frequency.

CHANNEL	TX Channel 102	DETECTOR FUNCTION	Peak (PK)
FREQUENCY RANGE	1GHz ~ 40GHz		Average (AV)

ANTENNA POLARITY & TEST DISTANCE: HORIZONTAL AT 3 M

NO.	FREQ. (MHz)	EMISSION LEVEL (dBuV/m)	LIMIT (dBuV/m)	MARGIN (dB)	ANTENNA HEIGHT (m)	TABLE ANGLE (Degree)	RAW VALUE (dBuV)	CORRECTION FACTOR (dB/m)
1	#5470.00	61.9 PK	74.0	-12.1	1.19 H	360	59.11	2.79
2	#5470.00	43.3 AV	54.0	-10.7	1.19 H	360	40.51	2.79
3	*5510.00	100.5 PK			1.16 H	343	97.65	2.85
4	*5510.00	89.8 AV			1.16 H	343	86.95	2.85
5	#5750.00	48.0 PK	74.0	-26.0	1.21 H	352	44.62	3.38
6	#5750.00	36.9 AV	54.0	-17.1	1.21 H	352	33.52	3.38
7	11020.00	49.9 PK	74.0	-24.1	1.95 H	110	36.26	13.64
8	11020.00	37.3 AV	54.0	-16.7	1.95 H	110	23.66	13.64
9	#16530.00	52.2 PK	74.0	-21.8	2.19 H	144	33.38	18.82
10	#16530.00	39.8 AV	54.0	-14.2	2.19 H	144	20.98	18.82

ANTENNA POLARITY & TEST DISTANCE: VERTICAL AT 3 M

NO.	FREQ. (MHz)	EMISSION LEVEL (dBuV/m)	LIMIT (dBuV/m)	MARGIN (dB)	ANTENNA HEIGHT (m)	TABLE ANGLE (Degree)	RAW VALUE (dBuV)	CORRECTION FACTOR (dB/m)
1	#5470.00	72.4 PK	74.0	-1.6	1.84 V	123	69.61	2.79
2	#5470.00	53.6 AV	54.0	-0.4	1.84 V	123	50.81	2.79
3	*5510.00	110.4 PK			1.06 V	228	107.55	2.85
4	*5510.00	99.9 AV			1.06 V	228	97.05	2.85
5	#5750.00	58.1 PK	74.0	-15.9	2.04 V	134	54.72	3.38
6	#5750.00	47.3 AV	54.0	-6.7	2.04 V	134	43.92	3.38
7	11020.00	50.7 PK	74.0	-23.3	2.47 V	138	37.06	13.64
8	11020.00	38.1 AV	54.0	-15.9	2.47 V	138	24.46	13.64
9	#16530.00	53.8 PK	74.0	-20.2	2.48 V	310	34.98	18.82
10	#16530.00	41.2 AV	54.0	-12.8	2.48 V	310	22.38	18.82

REMARKS:

1. Emission Level(dBuV/m) = Raw Value(dBuV) + Correction Factor(dB/m)
2. Correction Factor(dB/m) = Antenna Factor(dB/m) + Cable Factor(dB) – Pre-Amplifier Factor(dB)
3. The other emission levels were very low against the limit.
4. Margin value = Emission Level – Limit value
5. " * ": Fundamental frequency.
6. " # ": The radiated frequency is out of the restricted band.

CHANNEL	TX Channel 110	DETECTOR FUNCTION	Peak (PK)
FREQUENCY RANGE	1GHz ~ 40GHz		Average (AV)

ANTENNA POLARITY & TEST DISTANCE: HORIZONTAL AT 3 M

NO.	FREQ. (MHz)	EMISSION LEVEL (dBuV/m)	LIMIT (dBuV/m)	MARGIN (dB)	ANTENNA HEIGHT (m)	TABLE ANGLE (Degree)	RAW VALUE (dBuV)	CORRECTION FACTOR (dB/m)
1	5390.00	52.4 PK	74.0	-21.6	1.12 H	339	49.70	2.70
2	5390.00	41.0 AV	54.0	-13.0	1.12 H	339	38.30	2.70
3	*5550.00	103.6 PK			1.18 H	341	100.62	2.98
4	*5550.00	92.3 AV			1.18 H	341	89.32	2.98
5	#5725.00	50.1 PK	74.0	-23.9	1.16 H	360	46.74	3.36
6	#5725.00	40.4 AV	54.0	-13.6	1.16 H	360	37.04	3.36
7	11100.00	50.2 PK	74.0	-23.8	2.02 H	134	36.58	13.62
8	11100.00	37.4 AV	54.0	-16.6	2.02 H	134	23.78	13.62
9	#16650.00	52.5 PK	74.0	-21.5	2.07 H	140	33.11	19.39
10	#16650.00	40.0 AV	54.0	-14.0	2.07 H	140	20.61	19.39

ANTENNA POLARITY & TEST DISTANCE: VERTICAL AT 3 M

NO.	FREQ. (MHz)	EMISSION LEVEL (dBuV/m)	LIMIT (dBuV/m)	MARGIN (dB)	ANTENNA HEIGHT (m)	TABLE ANGLE (Degree)	RAW VALUE (dBuV)	CORRECTION FACTOR (dB/m)
1	5390.00	62.6 PK	74.0	-11.4	1.00 V	249	59.90	2.70
2	5390.00	51.3 AV	54.0	-2.7	1.00 V	249	48.60	2.70
3	*5550.00	113.5 PK			1.02 V	131	110.52	2.98
4	*5550.00	102.5 AV			1.02 V	131	99.52	2.98
5	#5725.00	60.9 PK	74.0	-13.1	1.10 V	232	57.54	3.36
6	#5725.00	50.9 AV	54.0	-3.1	1.10 V	232	47.54	3.36
7	11100.00	50.9 PK	74.0	-23.1	2.43 V	147	37.28	13.62
8	11100.00	38.1 AV	54.0	-15.9	2.43 V	147	24.48	13.62
9	#16650.00	53.0 PK	74.0	-21.0	2.47 V	304	33.61	19.39
10	#16650.00	40.6 AV	54.0	-13.4	2.47 V	304	21.21	19.39

REMARKS:

1. Emission Level(dBuV/m) = Raw Value(dBuV) + Correction Factor(dB/m)
2. Correction Factor(dB/m) = Antenna Factor(dB/m) + Cable Factor(dB) – Pre-Amplifier Factor(dB)
3. The other emission levels were very low against the limit.
4. Margin value = Emission Level – Limit value
5. " * ": Fundamental frequency.
6. " # ": The radiated frequency is out of the restricted band.

CHANNEL	TX Channel 134	DETECTOR FUNCTION	Peak (PK)
FREQUENCY RANGE	1GHz ~ 40GHz		Average (AV)

ANTENNA POLARITY & TEST DISTANCE: HORIZONTAL AT 3 M

NO.	FREQ. (MHz)	EMISSION LEVEL (dBuV/m)	LIMIT (dBuV/m)	MARGIN (dB)	ANTENNA HEIGHT (m)	TABLE ANGLE (Degree)	RAW VALUE (dBuV)	CORRECTION FACTOR (dB/m)
1	5430.00	49.5 PK	74.0	-24.5	1.11 H	349	46.76	2.74
2	5430.00	39.5 AV	54.0	-14.5	1.11 H	349	36.76	2.74
3	*5670.00	102.9 PK			1.14 H	360	99.64	3.26
4	*5670.00	90.5 AV			1.14 H	360	87.24	3.26
5	#5725.00	61.7 PK	74.0	-12.3	1.21 H	345	58.34	3.36
6	#5725.00	43.9 AV	54.0	-10.1	1.21 H	345	40.54	3.36
7	11340.00	50.4 PK	74.0	-23.6	1.94 H	128	36.70	13.70
8	11340.00	37.6 AV	54.0	-16.4	1.94 H	128	23.90	13.70
9	#17010.00	52.8 PK	74.0	-21.2	2.10 H	140	32.03	20.77
10	#17010.00	40.0 AV	54.0	-14.0	2.10 H	140	19.23	20.77

ANTENNA POLARITY & TEST DISTANCE: VERTICAL AT 3 M

NO.	FREQ. (MHz)	EMISSION LEVEL (dBuV/m)	LIMIT (dBuV/m)	MARGIN (dB)	ANTENNA HEIGHT (m)	TABLE ANGLE (Degree)	RAW VALUE (dBuV)	CORRECTION FACTOR (dB/m)
1	5430.00	59.5 PK	74.0	-14.5	1.15 V	221	56.76	2.74
2	5430.00	49.3 AV	54.0	-4.7	1.15 V	221	46.56	2.74
3	*5670.00	112.7 PK			1.03 V	115	109.44	3.26
4	*5670.00	100.4 AV			1.03 V	115	97.14	3.26
5	#5725.00	71.3 PK	74.0	-2.7	1.08 V	244	67.94	3.36
6	#5725.00	53.5 AV	54.0	-0.5	1.08 V	244	50.14	3.36
7	11340.00	50.9 PK	74.0	-23.1	2.51 V	139	37.20	13.70
8	11340.00	38.1 AV	54.0	-15.9	2.51 V	139	24.40	13.70
9	#17010.00	52.8 PK	74.0	-21.2	2.41 V	300	32.03	20.77
10	#17010.00	40.7 AV	54.0	-13.3	2.41 V	300	19.93	20.77

REMARKS:

1. Emission Level(dBuV/m) = Raw Value(dBuV) + Correction Factor(dB/m)
2. Correction Factor(dB/m) = Antenna Factor(dB/m) + Cable Factor(dB) – Pre-Amplifier Factor(dB)
3. The other emission levels were very low against the limit.
4. Margin value = Emission Level – Limit value
5. " * ": Fundamental frequency.
6. " # ": The radiated frequency is out of the restricted band.

CHANNEL	TX Channel 142	DETECTOR FUNCTION	Peak (PK)
FREQUENCY RANGE	1GHz ~ 40GHz		Average (AV)

ANTENNA POLARITY & TEST DISTANCE: HORIZONTAL AT 3 M

NO.	FREQ. (MHz)	EMISSION LEVEL (dBuV/m)	LIMIT (dBuV/m)	MARGIN (dB)	ANTENNA HEIGHT (m)	TABLE ANGLE (Degree)	RAW VALUE (dBuV)	CORRECTION FACTOR (dB/m)
1	5460.00	51.1 PK	74.0	-22.9	1.15 H	342	48.32	2.78
2	5460.00	40.3 AV	54.0	-13.7	1.15 H	342	37.52	2.78
3	*5710.00	105.4 PK			1.22 H	343	102.06	3.34
4	*5710.00	94.2 AV			1.22 H	343	90.86	3.34
5	#5870.00	52.1 PK	74.0	-21.9	1.21 H	360	48.59	3.51
6	#5870.00	42.2 AV	54.0	-11.8	1.21 H	360	38.69	3.51
7	11420.00	50.1 PK	74.0	-23.9	2.00 H	139	36.51	13.59
8	11420.00	37.7 AV	54.0	-16.3	2.00 H	139	24.11	13.59
9	#17130.00	52.0 PK	74.0	-22.0	2.10 H	133	31.17	20.83
10	#17130.00	39.2 AV	54.0	-14.8	2.10 H	133	18.37	20.83

ANTENNA POLARITY & TEST DISTANCE: VERTICAL AT 3 M

NO.	FREQ. (MHz)	EMISSION LEVEL (dBuV/m)	LIMIT (dBuV/m)	MARGIN (dB)	ANTENNA HEIGHT (m)	TABLE ANGLE (Degree)	RAW VALUE (dBuV)	CORRECTION FACTOR (dB/m)
1	5460.00	61.0 PK	74.0	-13.0	1.09 V	232	58.22	2.78
2	5460.00	50.3 AV	54.0	-3.7	1.09 V	232	47.52	2.78
3	*5710.00	115.3 PK			1.03 V	118	111.96	3.34
4	*5710.00	103.9 AV			1.03 V	118	100.56	3.34
5	#5870.00	62.5 PK	74.0	-11.5	1.01 V	257	58.99	3.51
6	#5870.00	52.6 AV	54.0	-1.4	1.01 V	257	49.09	3.51
7	11420.00	51.2 PK	74.0	-22.8	2.52 V	142	37.61	13.59
8	11420.00	38.7 AV	54.0	-15.3	2.52 V	142	25.11	13.59
9	#17130.00	52.8 PK	74.0	-21.2	2.45 V	308	31.97	20.83
10	#17130.00	40.7 AV	54.0	-13.3	2.45 V	308	19.87	20.83

REMARKS:

1. Emission Level(dBuV/m) = Raw Value(dBuV) + Correction Factor(dB/m)
2. Correction Factor(dB/m) = Antenna Factor(dB/m) + Cable Factor(dB) – Pre-Amplifier Factor(dB)
3. The other emission levels were very low against the limit.
4. Margin value = Emission Level – Limit value
5. " * ": Fundamental frequency.
6. " # ": The radiated frequency is out of the restricted band.

802.11ac VHT80

CHANNEL	TX Channel 58	DETECTOR FUNCTION	Peak (PK)
FREQUENCY RANGE	1GHz ~ 40GHz		Average (AV)

ANTENNA POLARITY & TEST DISTANCE: HORIZONTAL AT 3 M

NO.	FREQ. (MHz)	EMISSION LEVEL (dBuV/m)	LIMIT (dBuV/m)	MARGIN (dB)	ANTENNA HEIGHT (m)	TABLE ANGLE (Degree)	RAW VALUE (dBuV)	CORRECTION FACTOR (dB/m)
1	*5290.00	96.0 PK			1.22 H	360	93.41	2.59
2	*5290.00	84.2 AV			1.22 H	360	81.61	2.59
3	5350.00	53.7 PK	74.0	-20.3	1.15 H	360	51.05	2.65
4	5350.00	42.4 AV	54.0	-11.6	1.15 H	360	39.75	2.65
5	#10580.00	50.1 PK	74.0	-23.9	2.00 H	130	37.35	12.75
6	#10580.00	37.6 AV	54.0	-16.4	2.00 H	130	24.85	12.75
7	15870.00	52.1 PK	74.0	-21.9	2.08 H	140	37.27	14.83
8	15870.00	39.6 AV	54.0	-14.4	2.08 H	140	24.77	14.83

ANTENNA POLARITY & TEST DISTANCE: VERTICAL AT 3 M

NO.	FREQ. (MHz)	EMISSION LEVEL (dBuV/m)	LIMIT (dBuV/m)	MARGIN (dB)	ANTENNA HEIGHT (m)	TABLE ANGLE (Degree)	RAW VALUE (dBuV)	CORRECTION FACTOR (dB/m)
1	*5290.00	105.7 PK			1.10 V	144	103.11	2.59
2	*5290.00	94.1 AV			1.10 V	144	91.51	2.59
3	5350.00	63.8 PK	74.0	-10.2	1.12 V	125	61.15	2.65
4	5350.00	52.7 AV	54.0	-1.3	1.12 V	125	50.05	2.65
5	#10580.00	51.1 PK	74.0	-22.9	2.50 V	144	38.35	12.75
6	#10580.00	38.6 AV	54.0	-15.4	2.50 V	144	25.85	12.75
7	15870.00	52.9 PK	74.0	-21.1	2.46 V	281	38.07	14.83
8	15870.00	40.7 AV	54.0	-13.3	2.46 V	281	25.87	14.83

REMARKS:

1. Emission Level(dBuV/m) = Raw Value(dBuV) + Correction Factor(dB/m)
2. Correction Factor(dB/m) = Antenna Factor(dB/m) + Cable Factor(dB) – Pre-Amplifier Factor(dB)
3. The other emission levels were very low against the limit.
4. Margin value = Emission Level – Limit value
5. " * ": Fundamental frequency.
6. " # ": The radiated frequency is out of the restricted band.

CHANNEL	TX Channel 106	DETECTOR FUNCTION	Peak (PK)
FREQUENCY RANGE	1GHz ~ 40GHz		Average (AV)

ANTENNA POLARITY & TEST DISTANCE: HORIZONTAL AT 3 M

NO.	FREQ. (MHz)	EMISSION LEVEL (dBuV/m)	LIMIT (dBuV/m)	MARGIN (dB)	ANTENNA HEIGHT (m)	TABLE ANGLE (Degree)	RAW VALUE (dBuV)	CORRECTION FACTOR (dB/m)
1	#5470.00	60.7 PK	74.0	-13.3	1.14 H	360	57.91	2.79
2	#5470.00	44.0 AV	54.0	-10.0	1.14 H	360	41.21	2.79
3	*5530.00	98.2 PK			1.22 H	338	95.28	2.92
4	*5530.00	86.1 AV			1.22 H	338	83.18	2.92
5	#5725.00	46.1 PK	74.0	-27.9	1.17 H	353	42.74	3.36
6	#5725.00	35.3 AV	54.0	-18.7	1.17 H	353	31.94	3.36
7	11060.00	50.3 PK	74.0	-23.7	2.00 H	115	36.67	13.63
8	11060.00	37.7 AV	54.0	-16.3	2.00 H	115	24.07	13.63
9	#16590.00	52.4 PK	74.0	-21.6	2.12 H	140	33.22	19.18
10	#16590.00	39.6 AV	54.0	-14.4	2.12 H	140	20.42	19.18

ANTENNA POLARITY & TEST DISTANCE: VERTICAL AT 3 M

NO.	FREQ. (MHz)	EMISSION LEVEL (dBuV/m)	LIMIT (dBuV/m)	MARGIN (dB)	ANTENNA HEIGHT (m)	TABLE ANGLE (Degree)	RAW VALUE (dBuV)	CORRECTION FACTOR (dB/m)
1	#5470.00	70.0 PK	74.0	-4.0	1.07 V	237	67.21	2.79
2	#5470.00	53.6 AV	54.0	-0.4	1.07 V	237	50.81	2.79
3	*5530.00	108.0 PK			1.17 V	233	105.08	2.92
4	*5530.00	96.0 AV			1.17 V	233	93.08	2.92
5	#5725.00	56.4 PK	74.0	-17.6	1.01 V	231	53.04	3.36
6	#5725.00	45.7 AV	54.0	-8.3	1.01 V	231	42.34	3.36
7	11060.00	51.0 PK	74.0	-23.0	2.50 V	148	37.37	13.63
8	11060.00	38.4 AV	54.0	-15.6	2.50 V	148	24.77	13.63
9	#16590.00	53.2 PK	74.0	-20.8	2.47 V	292	34.02	19.18
10	#16590.00	41.1 AV	54.0	-12.9	2.47 V	292	21.92	19.18

REMARKS:

1. Emission Level(dBuV/m) = Raw Value(dBuV) + Correction Factor(dB/m)
2. Correction Factor(dB/m) = Antenna Factor(dB/m) + Cable Factor(dB) – Pre-Amplifier Factor(dB)
3. The other emission levels were very low against the limit.
4. Margin value = Emission Level – Limit value
5. " * ": Fundamental frequency.
6. " # ": The radiated frequency is out of the restricted band.

CHANNEL	TX Channel 122	DETECTOR FUNCTION	Peak (PK)
FREQUENCY RANGE	1GHz ~ 40GHz		Average (AV)

ANTENNA POLARITY & TEST DISTANCE: HORIZONTAL AT 3 M

NO.	FREQ. (MHz)	EMISSION LEVEL (dBuV/m)	LIMIT (dBuV/m)	MARGIN (dB)	ANTENNA HEIGHT (m)	TABLE ANGLE (Degree)	RAW VALUE (dBuV)	CORRECTION FACTOR (dB/m)
1	#5470.00	56.6 PK	74.0	-17.4	1.13 H	351	53.81	2.79
2	#5470.00	39.9 AV	54.0	-14.1	1.13 H	351	37.11	2.79
3	*5610.00	99.5 PK			1.12 H	360	96.35	3.15
4	*5610.00	87.3 AV			1.12 H	360	84.15	3.15
5	#5725.00	58.4 PK	74.0	-15.6	1.12 H	360	55.04	3.36
6	#5725.00	43.3 AV	54.0	-10.7	1.12 H	360	39.94	3.36
7	11220.00	49.5 PK	74.0	-24.5	1.94 H	112	35.86	13.64
8	11220.00	37.1 AV	54.0	-16.9	1.94 H	112	23.46	13.64
9	#16830.00	52.0 PK	74.0	-22.0	2.17 H	154	32.15	19.85
10	#16830.00	39.5 AV	54.0	-14.5	2.17 H	154	19.65	19.85

ANTENNA POLARITY & TEST DISTANCE: VERTICAL AT 3 M

NO.	FREQ. (MHz)	EMISSION LEVEL (dBuV/m)	LIMIT (dBuV/m)	MARGIN (dB)	ANTENNA HEIGHT (m)	TABLE ANGLE (Degree)	RAW VALUE (dBuV)	CORRECTION FACTOR (dB/m)
1	#5470.00	67.1 PK	74.0	-6.9	1.01 V	240	64.31	2.79
2	#5470.00	50.3 AV	54.0	-3.7	1.01 V	240	47.51	2.79
3	*5610.00	109.7 PK			1.06 V	247	106.55	3.15
4	*5610.00	97.3 AV			1.06 V	247	94.15	3.15
5	#5725.00	67.9 PK	74.0	-6.1	1.07 V	231	64.54	3.36
6	#5725.00	53.0 AV	54.0	-1.0	1.07 V	231	49.64	3.36
7	11220.00	51.4 PK	74.0	-22.6	2.45 V	158	37.76	13.64
8	11220.00	38.5 AV	54.0	-15.5	2.45 V	158	24.86	13.64
9	#16830.00	52.9 PK	74.0	-21.1	2.48 V	290	33.05	19.85
10	#16830.00	40.5 AV	54.0	-13.5	2.48 V	290	20.65	19.85

REMARKS:

- Emission Level(dBuV/m) = Raw Value(dBuV) + Correction Factor(dB/m)
- Correction Factor(dB/m) = Antenna Factor(dB/m) + Cable Factor(dB) – Pre-Amplifier Factor(dB)
- The other emission levels were very low against the limit.
- Margin value = Emission Level – Limit value
- " * ": Fundamental frequency.
- " # ": The radiated frequency is out of the restricted band.

CHANNEL	TX Channel 138	DETECTOR FUNCTION	Peak (PK)
FREQUENCY RANGE	1GHz ~ 40GHz		Average (AV)

ANTENNA POLARITY & TEST DISTANCE: HORIZONTAL AT 3 M

NO.	FREQ. (MHz)	EMISSION LEVEL (dBuV/m)	LIMIT (dBuV/m)	MARGIN (dB)	ANTENNA HEIGHT (m)	TABLE ANGLE (Degree)	RAW VALUE (dBuV)	CORRECTION FACTOR (dB/m)
1	#5470.00	50.4 PK	74.0	-23.6	1.13 H	343	47.61	2.79
2	#5470.00	38.9 AV	54.0	-15.1	1.13 H	343	36.11	2.79
3	*5690.00	104.2 PK			1.18 H	347	100.90	3.30
4	*5690.00	91.5 AV			1.18 H	347	88.20	3.30
5	#5850.00	58.1 PK	78.2	-20.1	1.21 H	360	54.61	3.49
6	11380.00	49.8 PK	74.0	-24.2	1.95 H	135	36.17	13.63
7	11380.00	37.2 AV	54.0	-16.8	1.95 H	135	23.57	13.63
8	#17070.00	51.6 PK	74.0	-22.4	2.16 H	156	30.75	20.85
9	#17070.00	39.1 AV	54.0	-14.9	2.16 H	156	18.25	20.85

ANTENNA POLARITY & TEST DISTANCE: VERTICAL AT 3 M

NO.	FREQ. (MHz)	EMISSION LEVEL (dBuV/m)	LIMIT (dBuV/m)	MARGIN (dB)	ANTENNA HEIGHT (m)	TABLE ANGLE (Degree)	RAW VALUE (dBuV)	CORRECTION FACTOR (dB/m)
1	#5470.00	60.4 PK	74.0	-13.6	1.04 V	138	57.61	2.79
2	#5470.00	49.0 AV	54.0	-5.0	1.04 V	138	46.21	2.79
3	*5690.00	113.7 PK			1.12 V	128	110.40	3.30
4	*5690.00	101.1 AV			1.12 V	128	97.80	3.30
5	#5850.00	68.0 PK	78.2	-10.2	1.06 V	123	64.51	3.49
6	11380.00	51.0 PK	74.0	-23.0	2.51 V	151	37.37	13.63
7	11380.00	38.6 AV	54.0	-15.4	2.51 V	151	24.97	13.63
8	#17070.00	53.0 PK	74.0	-21.0	2.43 V	302	32.15	20.85
9	#17070.00	40.9 AV	54.0	-13.1	2.43 V	302	20.05	20.85

REMARKS:

1. Emission Level(dBuV/m) = Raw Value(dBuV) + Correction Factor(dB/m)
2. Correction Factor(dB/m) = Antenna Factor(dB/m) + Cable Factor(dB) – Pre-Amplifier Factor(dB)
3. The other emission levels were very low against the limit.
4. Margin value = Emission Level – Limit value
5. " * ": Fundamental frequency.
6. " # ": The radiated frequency is out of the restricted band.

2TX

ANT5, ANT6

802.11a

CHANNEL	TX Channel 52	DETECTOR FUNCTION	Peak (PK)
FREQUENCY RANGE	1GHz ~ 40GHz		Average (AV)

ANTENNA POLARITY & TEST DISTANCE: HORIZONTAL AT 3 M

NO.	FREQ. (MHz)	EMISSION LEVEL (dBuV/m)	LIMIT (dBuV/m)	MARGIN (dB)	ANTENNA HEIGHT (m)	TABLE ANGLE (Degree)	RAW VALUE (dBuV)	CORRECTION FACTOR (dB/m)
1	5100.00	49.9 PK	74.0	-24.1	1.11 H	337	47.58	2.32
2	5100.00	39.1 AV	54.0	-14.9	1.11 H	337	36.78	2.32
3	*5260.00	105.3 PK			1.10 H	353	102.76	2.54
4	*5260.00	95.7 AV			1.10 H	353	93.16	2.54
5	5420.00	51.0 PK	74.0	-23.0	1.10 H	346	48.27	2.73
6	5420.00	40.2 AV	54.0	-13.8	1.10 H	346	37.47	2.73
7	#10520.00	50.3 PK	74.0	-23.7	2.08 H	129	37.90	12.40
8	#10520.00	37.5 AV	54.0	-16.5	2.08 H	129	25.10	12.40
9	15780.00	52.3 PK	74.0	-21.7	2.04 H	136	37.48	14.82
10	15780.00	39.5 AV	54.0	-14.5	2.04 H	136	24.68	14.82

ANTENNA POLARITY & TEST DISTANCE: VERTICAL AT 3 M

NO.	FREQ. (MHz)	EMISSION LEVEL (dBuV/m)	LIMIT (dBuV/m)	MARGIN (dB)	ANTENNA HEIGHT (m)	TABLE ANGLE (Degree)	RAW VALUE (dBuV)	CORRECTION FACTOR (dB/m)
1	5100.00	59.8 PK	74.0	-14.2	2.60 V	62	57.48	2.32
2	5100.00	49.3 AV	54.0	-4.7	2.60 V	62	46.98	2.32
3	*5260.00	115.8 PK			2.63 V	59	113.26	2.54
4	*5260.00	106.0 AV			2.63 V	59	103.46	2.54
5	5420.00	60.9 PK	74.0	-13.1	2.60 V	51	58.17	2.73
6	5420.00	50.2 AV	54.0	-3.8	2.60 V	51	47.47	2.73
7	#10520.00	51.1 PK	74.0	-22.9	2.48 V	149	38.70	12.40
8	#10520.00	38.2 AV	54.0	-15.8	2.48 V	149	25.80	12.40
9	15780.00	53.1 PK	74.0	-20.9	2.49 V	299	38.28	14.82
10	15780.00	40.6 AV	54.0	-13.4	2.49 V	299	25.78	14.82

REMARKS:

1. Emission Level(dBuV/m) = Raw Value(dBuV) + Correction Factor(dB/m)
2. Correction Factor(dB/m) = Antenna Factor(dB/m) + Cable Factor(dB) – Pre-Amplifier Factor(dB)
3. The other emission levels were very low against the limit.
4. Margin value = Emission Level – Limit value
5. " * ": Fundamental frequency.
6. " # ": The radiated frequency is out of the restricted band.

CHANNEL	TX Channel 60	DETECTOR FUNCTION	Peak (PK)
FREQUENCY RANGE	1GHz ~ 40GHz		Average (AV)

ANTENNA POLARITY & TEST DISTANCE: HORIZONTAL AT 3 M

NO.	FREQ. (MHz)	EMISSION LEVEL (dBuV/m)	LIMIT (dBuV/m)	MARGIN (dB)	ANTENNA HEIGHT (m)	TABLE ANGLE (Degree)	RAW VALUE (dBuV)	CORRECTION FACTOR (dB/m)
1	5140.00	49.9 PK	74.0	-24.1	1.20 H	343	47.53	2.37
2	5140.00	40.6 AV	54.0	-13.4	1.20 H	343	38.23	2.37
3	*5300.00	105.9 PK			1.14 H	352	103.29	2.61
4	*5300.00	96.1 AV			1.14 H	352	93.49	2.61
5	5460.00	53.6 PK	74.0	-20.4	1.12 H	340	50.82	2.78
6	5460.00	39.2 AV	54.0	-14.8	1.12 H	340	36.42	2.78
7	10600.00	51.0 PK	74.0	-23.0	2.05 H	118	38.14	12.86
8	10600.00	38.7 AV	54.0	-15.3	2.05 H	118	25.84	12.86
9	15900.00	52.5 PK	74.0	-21.5	2.11 H	119	37.63	14.87
10	15900.00	39.7 AV	54.0	-14.3	2.11 H	119	24.83	14.87

ANTENNA POLARITY & TEST DISTANCE: VERTICAL AT 3 M

NO.	FREQ. (MHz)	EMISSION LEVEL (dBuV/m)	LIMIT (dBuV/m)	MARGIN (dB)	ANTENNA HEIGHT (m)	TABLE ANGLE (Degree)	RAW VALUE (dBuV)	CORRECTION FACTOR (dB/m)
1	5140.00	60.2 PK	74.0	-13.8	2.49 V	51	57.83	2.37
2	5140.00	50.8 AV	54.0	-3.2	2.49 V	51	48.43	2.37
3	*5300.00	115.7 PK			2.53 V	77	113.09	2.61
4	*5300.00	105.7 AV			2.53 V	77	103.09	2.61
5	5460.00	64.2 PK	74.0	-9.8	2.53 V	64	61.42	2.78
6	5460.00	49.6 AV	54.0	-4.4	2.53 V	64	46.82	2.78
7	10600.00	50.5 PK	74.0	-23.5	2.45 V	155	37.64	12.86
8	10600.00	37.5 AV	54.0	-16.5	2.45 V	155	24.64	12.86
9	15900.00	53.7 PK	74.0	-20.3	2.46 V	316	38.83	14.87
10	15900.00	40.9 AV	54.0	-13.1	2.46 V	316	26.03	14.87

REMARKS:

1. Emission Level(dBuV/m) = Raw Value(dBuV) + Correction Factor(dB/m)
2. Correction Factor(dB/m) = Antenna Factor(dB/m) + Cable Factor(dB) – Pre-Amplifier Factor(dB)
3. The other emission levels were very low against the limit.
4. Margin value = Emission Level – Limit value
5. " * ": Fundamental frequency.

CHANNEL	TX Channel 64	DETECTOR FUNCTION	Peak (PK)
FREQUENCY RANGE	1GHz ~ 40GHz		Average (AV)

ANTENNA POLARITY & TEST DISTANCE: HORIZONTAL AT 3 M

NO.	FREQ. (MHz)	EMISSION LEVEL (dBuV/m)	LIMIT (dBuV/m)	MARGIN (dB)	ANTENNA HEIGHT (m)	TABLE ANGLE (Degree)	RAW VALUE (dBuV)	CORRECTION FACTOR (dB/m)
1	*5320.00	103.7 PK			1.12 H	336	101.07	2.63
2	*5320.00	93.5 AV			1.12 H	336	90.87	2.63
3	5350.00	57.0 PK	74.0	-17.0	1.14 H	355	54.35	2.65
4	5350.00	42.9 AV	54.0	-11.1	1.14 H	355	40.25	2.65
5	10640.00	50.8 PK	74.0	-23.2	2.04 H	138	37.92	12.88
6	10640.00	37.8 AV	54.0	-16.2	2.04 H	138	24.92	12.88
7	15960.00	52.5 PK	74.0	-21.5	2.13 H	143	37.57	14.93
8	15960.00	40.0 AV	54.0	-14.0	2.13 H	143	25.07	14.93

ANTENNA POLARITY & TEST DISTANCE: VERTICAL AT 3 M

NO.	FREQ. (MHz)	EMISSION LEVEL (dBuV/m)	LIMIT (dBuV/m)	MARGIN (dB)	ANTENNA HEIGHT (m)	TABLE ANGLE (Degree)	RAW VALUE (dBuV)	CORRECTION FACTOR (dB/m)
1	*5320.00	113.8 PK			2.48 V	46	111.17	2.63
2	*5320.00	103.6 AV			2.48 V	46	100.97	2.63
3	5350.00	67.4 PK	74.0	-6.6	2.56 V	57	64.75	2.65
4	5350.00	53.2 AV	54.0	-0.8	2.56 V	57	50.55	2.65
5	10640.00	50.8 PK	74.0	-23.2	2.37 V	138	37.92	12.88
6	10640.00	38.0 AV	54.0	-16.0	2.37 V	138	25.12	12.88
7	15960.00	52.7 PK	74.0	-21.3	2.50 V	277	37.77	14.93
8	15960.00	40.0 AV	54.0	-14.0	2.50 V	277	25.07	14.93

REMARKS:

1. Emission Level(dBuV/m) = Raw Value(dBuV) + Correction Factor(dB/m)
2. Correction Factor(dB/m) = Antenna Factor(dB/m) + Cable Factor(dB) – Pre-Amplifier Factor(dB)
3. The other emission levels were very low against the limit.
4. Margin value = Emission Level – Limit value
5. " * ": Fundamental frequency.

CHANNEL	TX Channel 100	DETECTOR FUNCTION	Peak (PK)
FREQUENCY RANGE	1GHz ~ 40GHz		Average (AV)

ANTENNA POLARITY & TEST DISTANCE: HORIZONTAL AT 3 M

NO.	FREQ. (MHz)	EMISSION LEVEL (dBuV/m)	LIMIT (dBuV/m)	MARGIN (dB)	ANTENNA HEIGHT (m)	TABLE ANGLE (Degree)	RAW VALUE (dBuV)	CORRECTION FACTOR (dB/m)
1	#5470.00	61.3 PK	74.0	-12.7	1.12 H	341	58.51	2.79
2	#5470.00	43.3 AV	54.0	-10.7	1.12 H	341	40.51	2.79
3	*5500.00	105.3 PK			1.19 H	349	102.47	2.83
4	*5500.00	95.3 AV			1.19 H	349	92.47	2.83
5	#5735.00	52.9 PK	74.0	-21.1	1.09 H	333	49.53	3.37
6	#5735.00	42.0 AV	54.0	-12.0	1.09 H	333	38.63	3.37
7	11000.00	50.1 PK	74.0	-23.9	1.98 H	116	36.46	13.64
8	11000.00	37.6 AV	54.0	-16.4	1.98 H	116	23.96	13.64
9	#16500.00	52.6 PK	74.0	-21.4	2.04 H	131	33.96	18.64
10	#16500.00	39.7 AV	54.0	-14.3	2.04 H	131	21.06	18.64

ANTENNA POLARITY & TEST DISTANCE: VERTICAL AT 3 M

NO.	FREQ. (MHz)	EMISSION LEVEL (dBuV/m)	LIMIT (dBuV/m)	MARGIN (dB)	ANTENNA HEIGHT (m)	TABLE ANGLE (Degree)	RAW VALUE (dBuV)	CORRECTION FACTOR (dB/m)
1	#5470.00	71.5 PK	74.0	-2.5	2.69 V	48	68.71	2.79
2	#5470.00	53.7 AV	54.0	-0.3	2.69 V	48	50.91	2.79
3	*5500.00	115.1 PK			2.64 V	72	112.27	2.83
4	*5500.00	105.3 AV			2.64 V	72	102.47	2.83
5	#5735.00	62.6 PK	74.0	-11.4	2.67 V	48	59.23	3.37
6	#5735.00	51.9 AV	54.0	-2.1	2.67 V	48	48.53	3.37
7	11000.00	51.5 PK	74.0	-22.5	2.38 V	144	37.86	13.64
8	11000.00	38.6 AV	54.0	-15.4	2.38 V	144	24.96	13.64
9	#16500.00	53.0 PK	74.0	-21.0	2.51 V	305	34.36	18.64
10	#16500.00	40.6 AV	54.0	-13.4	2.51 V	305	21.96	18.64

REMARKS:

- Emission Level(dBuV/m) = Raw Value(dBuV) + Correction Factor(dB/m)
- Correction Factor(dB/m) = Antenna Factor(dB/m) + Cable Factor(dB) – Pre-Amplifier Factor(dB)
- The other emission levels were very low against the limit.
- Margin value = Emission Level – Limit value
- " * ": Fundamental frequency.
- " # ": The radiated frequency is out of the restricted band.

CHANNEL	TX Channel 116	DETECTOR FUNCTION	Peak (PK)
FREQUENCY RANGE	1GHz ~ 40GHz		Average (AV)

ANTENNA POLARITY & TEST DISTANCE: HORIZONTAL AT 3 M

NO.	FREQ. (MHz)	EMISSION LEVEL (dBuV/m)	LIMIT (dBuV/m)	MARGIN (dB)	ANTENNA HEIGHT (m)	TABLE ANGLE (Degree)	RAW VALUE (dBuV)	CORRECTION FACTOR (dB/m)
1	5420.00	53.2 PK	74.0	-20.8	1.18 H	359	50.47	2.73
2	5420.00	43.8 AV	54.0	-10.2	1.18 H	359	41.07	2.73
3	*5580.00	105.9 PK			1.13 H	337	102.84	3.06
4	*5580.00	96.1 AV			1.13 H	337	93.04	3.06
5	#5740.00	49.4 PK	74.0	-24.6	1.12 H	338	46.03	3.37
6	#5740.00	41.1 AV	54.0	-12.9	1.12 H	338	37.73	3.37
7	11160.00	50.5 PK	74.0	-23.5	2.08 H	120	36.88	13.62
8	11160.00	37.5 AV	54.0	-16.5	2.08 H	120	23.88	13.62
9	#16740.00	52.2 PK	74.0	-21.8	2.13 H	130	32.61	19.59
10	#16740.00	39.5 AV	54.0	-14.5	2.13 H	130	19.91	19.59

ANTENNA POLARITY & TEST DISTANCE: VERTICAL AT 3 M

NO.	FREQ. (MHz)	EMISSION LEVEL (dBuV/m)	LIMIT (dBuV/m)	MARGIN (dB)	ANTENNA HEIGHT (m)	TABLE ANGLE (Degree)	RAW VALUE (dBuV)	CORRECTION FACTOR (dB/m)
1	5420.00	63.1 PK	74.0	-10.9	2.58 V	73	60.37	2.73
2	5420.00	53.9 AV	54.0	-0.1	2.58 V	73	51.17	2.73
3	*5580.00	115.9 PK			2.48 V	65	112.84	3.06
4	*5580.00	106.4 AV			2.48 V	65	103.34	3.06
5	#5740.00	59.5 PK	74.0	-14.5	2.54 V	50	56.13	3.37
6	#5740.00	51.3 AV	54.0	-2.7	2.54 V	50	47.93	3.37
7	11160.00	51.0 PK	74.0	-23.0	2.46 V	143	37.38	13.62
8	11160.00	38.4 AV	54.0	-15.6	2.46 V	143	24.78	13.62
9	#16740.00	52.5 PK	74.0	-21.5	2.54 V	293	32.91	19.59
10	#16740.00	39.9 AV	54.0	-14.1	2.54 V	293	20.31	19.59

REMARKS:

1. Emission Level(dBuV/m) = Raw Value(dBuV) + Correction Factor(dB/m)
2. Correction Factor(dB/m) = Antenna Factor(dB/m) + Cable Factor(dB) – Pre-Amplifier Factor(dB)
3. The other emission levels were very low against the limit.
4. Margin value = Emission Level – Limit value
5. " * ": Fundamental frequency.
6. " # ": The radiated frequency is out of the restricted band.

CHANNEL	TX Channel 140	DETECTOR FUNCTION	Peak (PK)
FREQUENCY RANGE	1GHz ~ 40GHz		Average (AV)

ANTENNA POLARITY & TEST DISTANCE: HORIZONTAL AT 3 M

NO.	FREQ. (MHz)	EMISSION LEVEL (dBuV/m)	LIMIT (dBuV/m)	MARGIN (dB)	ANTENNA HEIGHT (m)	TABLE ANGLE (Degree)	RAW VALUE (dBuV)	CORRECTION FACTOR (dB/m)
1	5455.00	51.8 PK	74.0	-22.2	1.11 H	337	49.03	2.77
2	5455.00	42.5 AV	54.0	-11.5	1.11 H	337	39.73	2.77
3	*5700.00	101.5 PK			1.12 H	343	98.18	3.32
4	*5700.00	92.7 AV			1.12 H	343	89.38	3.32
5	#5725.00	62.2 PK	74.0	-11.8	1.09 H	337	58.84	3.36
6	#5725.00	43.4 AV	54.0	-10.6	1.09 H	337	40.04	3.36
7	11400.00	50.6 PK	74.0	-23.4	2.06 H	139	36.99	13.61
8	11400.00	37.7 AV	54.0	-16.3	2.06 H	139	24.09	13.61
9	#17100.00	53.1 PK	74.0	-20.9	2.05 H	139	32.20	20.90
10	#17100.00	40.3 AV	54.0	-13.7	2.05 H	139	19.40	20.90

ANTENNA POLARITY & TEST DISTANCE: VERTICAL AT 3 M

NO.	FREQ. (MHz)	EMISSION LEVEL (dBuV/m)	LIMIT (dBuV/m)	MARGIN (dB)	ANTENNA HEIGHT (m)	TABLE ANGLE (Degree)	RAW VALUE (dBuV)	CORRECTION FACTOR (dB/m)
1	5455.00	61.7 PK	74.0	-12.3	2.46 V	67	58.93	2.77
2	5455.00	52.1 AV	54.0	-1.9	2.46 V	67	49.33	2.77
3	*5700.00	111.3 PK			2.56 V	48	107.98	3.32
4	*5700.00	102.2 AV			2.56 V	48	98.88	3.32
5	#5725.00	72.5 PK	74.0	-1.5	2.55 V	73	69.14	3.36
6	#5725.00	53.4 AV	54.0	-0.6	2.55 V	73	50.04	3.36
7	11400.00	51.5 PK	74.0	-22.5	2.37 V	142	37.89	13.61
8	11400.00	38.5 AV	54.0	-15.5	2.37 V	142	24.89	13.61
9	#17100.00	52.6 PK	74.0	-21.4	2.52 V	305	31.70	20.90
10	#17100.00	40.0 AV	54.0	-14.0	2.52 V	305	19.10	20.90

REMARKS:

1. Emission Level(dBuV/m) = Raw Value(dBuV) + Correction Factor(dB/m)
2. Correction Factor(dB/m) = Antenna Factor(dB/m) + Cable Factor(dB) – Pre-Amplifier Factor(dB)
3. The other emission levels were very low against the limit.
4. Margin value = Emission Level – Limit value
5. " * ": Fundamental frequency.
6. " # ": The radiated frequency is out of the restricted band.

CHANNEL	TX Channel 144	DETECTOR FUNCTION	Peak (PK)
FREQUENCY RANGE	1GHz ~ 40GHz		Average (AV)

ANTENNA POLARITY & TEST DISTANCE: HORIZONTAL AT 3 M

NO.	FREQ. (MHz)	EMISSION LEVEL (dBuV/m)	LIMIT (dBuV/m)	MARGIN (dB)	ANTENNA HEIGHT (m)	TABLE ANGLE (Degree)	RAW VALUE (dBuV)	CORRECTION FACTOR (dB/m)
1	*5720.00	105.1 PK			1.16 H	359	101.75	3.35
2	*5720.00	95.3 AV			1.16 H	359	91.95	3.35
3	#5880.00	53.2 PK	74.0	-20.8	1.11 H	342	49.68	3.52
4	#5880.00	43.2 AV	54.0	-10.8	1.11 H	342	39.68	3.52
5	11440.00	50.3 PK	74.0	-23.7	2.09 H	123	36.74	13.56
6	11440.00	37.2 AV	54.0	-16.8	2.09 H	123	23.64	13.56
7	#17160.00	52.3 PK	74.0	-21.7	2.09 H	149	31.52	20.78
8	#17160.00	39.8 AV	54.0	-14.2	2.09 H	149	19.02	20.78

ANTENNA POLARITY & TEST DISTANCE: VERTICAL AT 3 M

NO.	FREQ. (MHz)	EMISSION LEVEL (dBuV/m)	LIMIT (dBuV/m)	MARGIN (dB)	ANTENNA HEIGHT (m)	TABLE ANGLE (Degree)	RAW VALUE (dBuV)	CORRECTION FACTOR (dB/m)
1	*5720.00	115.0 PK			2.37 V	360	111.65	3.35
2	*5720.00	105.1 AV			2.37 V	360	101.75	3.35
3	#5880.00	63.5 PK	74.0	-10.5	2.42 V	50	59.98	3.52
4	#5880.00	53.7 AV	54.0	-0.3	2.42 V	50	50.18	3.52
5	11440.00	50.9 PK	74.0	-23.1	2.41 V	145	37.34	13.56
6	11440.00	38.2 AV	54.0	-15.8	2.41 V	145	24.64	13.56
7	#17160.00	52.5 PK	74.0	-21.5	2.48 V	278	31.72	20.78
8	#17160.00	40.2 AV	54.0	-13.8	2.48 V	278	19.42	20.78

REMARKS:

1. Emission Level(dBuV/m) = Raw Value(dBuV) + Correction Factor(dB/m)
2. Correction Factor(dB/m) = Antenna Factor(dB/m) + Cable Factor(dB) – Pre-Amplifier Factor(dB)
3. The other emission levels were very low against the limit.
4. Margin value = Emission Level – Limit value
5. " * ": Fundamental frequency.
6. " # ": The radiated frequency is out of the restricted band.

802.11ac VHT20

CHANNEL	TX Channel 52	DETECTOR FUNCTION	Peak (PK)
FREQUENCY RANGE	1GHz ~ 40GHz		Average (AV)

ANTENNA POLARITY & TEST DISTANCE: HORIZONTAL AT 3 M

NO.	FREQ. (MHz)	EMISSION LEVEL (dBuV/m)	LIMIT (dBuV/m)	MARGIN (dB)	ANTENNA HEIGHT (m)	TABLE ANGLE (Degree)	RAW VALUE (dBuV)	CORRECTION FACTOR (dB/m)
1	5100.00	46.8 PK	74.0	-27.2	1.19 H	351	44.48	2.32
2	5100.00	37.2 AV	54.0	-16.8	1.19 H	351	34.88	2.32
3	*5260.00	104.7 PK			1.19 H	340	102.16	2.54
4	*5260.00	94.4 AV			1.19 H	340	91.86	2.54
5	5420.00	48.9 PK	74.0	-25.1	1.14 H	357	46.17	2.73
6	5420.00	39.5 AV	54.0	-14.5	1.14 H	357	36.77	2.73
7	#10520.00	50.8 PK	74.0	-23.2	1.99 H	118	38.40	12.40
8	#10520.00	37.9 AV	54.0	-16.1	1.99 H	118	25.50	12.40
9	15780.00	52.4 PK	74.0	-21.6	2.05 H	130	37.58	14.82
10	15780.00	39.8 AV	54.0	-14.2	2.05 H	130	24.98	14.82

ANTENNA POLARITY & TEST DISTANCE: VERTICAL AT 3 M

NO.	FREQ. (MHz)	EMISSION LEVEL (dBuV/m)	LIMIT (dBuV/m)	MARGIN (dB)	ANTENNA HEIGHT (m)	TABLE ANGLE (Degree)	RAW VALUE (dBuV)	CORRECTION FACTOR (dB/m)
1	5100.00	56.7 PK	74.0	-17.3	2.92 V	109	54.38	2.32
2	5100.00	47.2 AV	54.0	-6.8	2.92 V	109	44.88	2.32
3	*5260.00	114.9 PK			2.55 V	135	112.36	2.54
4	*5260.00	104.4 AV			2.55 V	135	101.86	2.54
5	5420.00	59.0 PK	74.0	-15.0	2.85 V	83	56.27	2.73
6	5420.00	49.6 AV	54.0	-4.4	2.85 V	83	46.87	2.73
7	#10520.00	51.1 PK	74.0	-22.9	2.39 V	147	38.70	12.40
8	#10520.00	38.2 AV	54.0	-15.8	2.39 V	147	25.80	12.40
9	15780.00	53.4 PK	74.0	-20.6	2.43 V	286	38.58	14.82
10	15780.00	40.8 AV	54.0	-13.2	2.43 V	286	25.98	14.82

REMARKS:

1. Emission Level(dBuV/m) = Raw Value(dBuV) + Correction Factor(dB/m)
2. Correction Factor(dB/m) = Antenna Factor(dB/m) + Cable Factor(dB) – Pre-Amplifier Factor(dB)
3. The other emission levels were very low against the limit.
4. Margin value = Emission Level – Limit value
5. " * ": Fundamental frequency.
6. " # ": The radiated frequency is out of the restricted band.

CHANNEL	TX Channel 60	DETECTOR FUNCTION	Peak (PK)
FREQUENCY RANGE	1GHz ~ 40GHz		Average (AV)

ANTENNA POLARITY & TEST DISTANCE: HORIZONTAL AT 3 M

NO.	FREQ. (MHz)	EMISSION LEVEL (dBuV/m)	LIMIT (dBuV/m)	MARGIN (dB)	ANTENNA HEIGHT (m)	TABLE ANGLE (Degree)	RAW VALUE (dBuV)	CORRECTION FACTOR (dB/m)
1	5140.00	47.5 PK	74.0	-26.5	1.11 H	351	45.13	2.37
2	5140.00	38.7 AV	54.0	-15.3	1.11 H	351	36.33	2.37
3	*5300.00	105.1 PK			1.18 H	338	102.49	2.61
4	*5300.00	94.6 AV			1.18 H	338	91.99	2.61
5	5460.00	51.7 PK	74.0	-22.3	1.20 H	334	48.92	2.78
6	5460.00	39.5 AV	54.0	-14.5	1.20 H	334	36.72	2.78
7	10600.00	50.2 PK	74.0	-23.8	2.00 H	139	37.34	12.86
8	10600.00	37.2 AV	54.0	-16.8	2.00 H	139	24.34	12.86
9	15900.00	53.1 PK	74.0	-20.9	2.08 H	141	38.23	14.87
10	15900.00	40.0 AV	54.0	-14.0	2.08 H	141	25.13	14.87

ANTENNA POLARITY & TEST DISTANCE: VERTICAL AT 3 M

NO.	FREQ. (MHz)	EMISSION LEVEL (dBuV/m)	LIMIT (dBuV/m)	MARGIN (dB)	ANTENNA HEIGHT (m)	TABLE ANGLE (Degree)	RAW VALUE (dBuV)	CORRECTION FACTOR (dB/m)
1	5140.00	57.6 PK	74.0	-16.4	2.87 V	84	55.23	2.37
2	5140.00	48.9 AV	54.0	-5.1	2.87 V	84	46.53	2.37
3	*5300.00	115.3 PK			2.50 V	139	112.69	2.61
4	*5300.00	104.7 AV			2.50 V	139	102.09	2.61
5	5460.00	61.6 PK	74.0	-12.4	2.86 V	107	58.82	2.78
6	5460.00	49.5 AV	54.0	-4.5	2.86 V	107	46.72	2.78
7	10600.00	51.5 PK	74.0	-22.5	2.41 V	159	38.64	12.86
8	10600.00	38.6 AV	54.0	-15.4	2.41 V	159	25.74	12.86
9	15900.00	53.4 PK	74.0	-20.6	2.45 V	287	38.53	14.87
10	15900.00	40.8 AV	54.0	-13.2	2.45 V	287	25.93	14.87

REMARKS:

1. Emission Level(dBuV/m) = Raw Value(dBuV) + Correction Factor(dB/m)
2. Correction Factor(dB/m) = Antenna Factor(dB/m) + Cable Factor(dB) – Pre-Amplifier Factor(dB)
3. The other emission levels were very low against the limit.
4. Margin value = Emission Level – Limit value
5. " * ": Fundamental frequency.

CHANNEL	TX Channel 64	DETECTOR FUNCTION	Peak (PK)
FREQUENCY RANGE	1GHz ~ 40GHz		Average (AV)

ANTENNA POLARITY & TEST DISTANCE: HORIZONTAL AT 3 M

NO.	FREQ. (MHz)	EMISSION LEVEL (dBuV/m)	LIMIT (dBuV/m)	MARGIN (dB)	ANTENNA HEIGHT (m)	TABLE ANGLE (Degree)	RAW VALUE (dBuV)	CORRECTION FACTOR (dB/m)
1	*5320.00	103.1 PK			1.17 H	342	100.47	2.63
2	*5320.00	93.0 AV			1.17 H	342	90.37	2.63
3	5350.00	59.8 PK	74.0	-14.2	1.20 H	357	57.15	2.65
4	5350.00	42.6 AV	54.0	-11.4	1.20 H	357	39.95	2.65
5	10640.00	50.0 PK	74.0	-24.0	2.02 H	112	37.12	12.88
6	10640.00	37.0 AV	54.0	-17.0	2.02 H	112	24.12	12.88
7	15960.00	52.6 PK	74.0	-21.4	2.03 H	156	37.67	14.93
8	15960.00	39.9 AV	54.0	-14.1	2.03 H	156	24.97	14.93

ANTENNA POLARITY & TEST DISTANCE: VERTICAL AT 3 M

NO.	FREQ. (MHz)	EMISSION LEVEL (dBuV/m)	LIMIT (dBuV/m)	MARGIN (dB)	ANTENNA HEIGHT (m)	TABLE ANGLE (Degree)	RAW VALUE (dBuV)	CORRECTION FACTOR (dB/m)
1	*5320.00	113.6 PK			2.75 V	104	110.97	2.63
2	*5320.00	103.4 AV			2.75 V	104	100.77	2.63
3	5350.00	70.3 PK	74.0	-3.7	2.74 V	87	67.65	2.65
4	5350.00	53.1 AV	54.0	-0.9	2.74 V	87	50.45	2.65
5	10640.00	50.9 PK	74.0	-23.1	2.38 V	135	38.02	12.88
6	10640.00	38.4 AV	54.0	-15.6	2.38 V	135	25.52	12.88
7	15960.00	53.1 PK	74.0	-20.9	2.51 V	294	38.17	14.93
8	15960.00	40.7 AV	54.0	-13.3	2.51 V	294	25.77	14.93

REMARKS:

1. Emission Level(dBuV/m) = Raw Value(dBuV) + Correction Factor(dB/m)
2. Correction Factor(dB/m) = Antenna Factor(dB/m) + Cable Factor(dB) – Pre-Amplifier Factor(dB)
3. The other emission levels were very low against the limit.
4. Margin value = Emission Level – Limit value
5. " * ": Fundamental frequency.

CHANNEL	TX Channel 100	DETECTOR FUNCTION	Peak (PK)
FREQUENCY RANGE	1GHz ~ 40GHz		Average (AV)

ANTENNA POLARITY & TEST DISTANCE: HORIZONTAL AT 3 M

NO.	FREQ. (MHz)	EMISSION LEVEL (dBuV/m)	LIMIT (dBuV/m)	MARGIN (dB)	ANTENNA HEIGHT (m)	TABLE ANGLE (Degree)	RAW VALUE (dBuV)	CORRECTION FACTOR (dB/m)
1	#5470.00	60.7 PK	74.0	-13.3	1.09 H	355	57.91	2.79
2	#5470.00	43.1 AV	54.0	-10.9	1.09 H	355	40.31	2.79
3	*5500.00	103.8 PK			1.12 H	342	100.97	2.83
4	*5500.00	94.1 AV			1.12 H	342	91.27	2.83
5	11000.00	50.3 PK	74.0	-23.7	2.01 H	128	36.66	13.64
6	11000.00	37.2 AV	54.0	-16.8	2.01 H	128	23.56	13.64
7	#16500.00	53.4 PK	74.0	-20.6	2.03 H	144	34.76	18.64
8	#16500.00	40.4 AV	54.0	-13.6	2.03 H	144	21.76	18.64

ANTENNA POLARITY & TEST DISTANCE: VERTICAL AT 3 M

NO.	FREQ. (MHz)	EMISSION LEVEL (dBuV/m)	LIMIT (dBuV/m)	MARGIN (dB)	ANTENNA HEIGHT (m)	TABLE ANGLE (Degree)	RAW VALUE (dBuV)	CORRECTION FACTOR (dB/m)
1	#5470.00	70.5 PK	74.0	-3.5	2.71 V	55	67.71	2.79
2	#5470.00	53.0 AV	54.0	-1.0	2.71 V	55	50.21	2.79
3	*5500.00	113.7 PK			2.70 V	65	110.87	2.83
4	*5500.00	104.2 AV			2.70 V	65	101.37	2.83
5	11000.00	51.3 PK	74.0	-22.7	2.43 V	145	37.66	13.64
6	11000.00	38.6 AV	54.0	-15.4	2.43 V	145	24.96	13.64
7	#16500.00	52.5 PK	74.0	-21.5	2.50 V	289	33.86	18.64
8	#16500.00	39.9 AV	54.0	-14.1	2.50 V	289	21.26	18.64

REMARKS:

1. Emission Level(dBuV/m) = Raw Value(dBuV) + Correction Factor(dB/m)
2. Correction Factor(dB/m) = Antenna Factor(dB/m) + Cable Factor(dB) – Pre-Amplifier Factor(dB)
3. The other emission levels were very low against the limit.
4. Margin value = Emission Level – Limit value
5. " * ": Fundamental frequency.
6. " # ": The radiated frequency is out of the restricted band.

CHANNEL	TX Channel 116	DETECTOR FUNCTION	Peak (PK)
FREQUENCY RANGE	1GHz ~ 40GHz		Average (AV)

ANTENNA POLARITY & TEST DISTANCE: HORIZONTAL AT 3 M

NO.	FREQ. (MHz)	EMISSION LEVEL (dBuV/m)	LIMIT (dBuV/m)	MARGIN (dB)	ANTENNA HEIGHT (m)	TABLE ANGLE (Degree)	RAW VALUE (dBuV)	CORRECTION FACTOR (dB/m)
1	5420.00	52.8 PK	74.0	-21.2	1.10 H	339	50.07	2.73
2	5420.00	42.6 AV	54.0	-11.4	1.10 H	339	39.87	2.73
3	*5580.00	105.8 PK			1.13 H	344	102.74	3.06
4	*5580.00	96.1 AV			1.13 H	344	93.04	3.06
5	#5740.00	51.8 PK	74.0	-22.2	1.08 H	339	48.43	3.37
6	#5740.00	41.1 AV	54.0	-12.9	1.08 H	339	37.73	3.37
7	11160.00	50.5 PK	74.0	-23.5	1.98 H	128	36.88	13.62
8	11160.00	37.8 AV	54.0	-16.2	1.98 H	128	24.18	13.62
9	#16740.00	52.4 PK	74.0	-21.6	2.03 H	129	32.81	19.59
10	#16740.00	39.5 AV	54.0	-14.5	2.03 H	129	19.91	19.59

ANTENNA POLARITY & TEST DISTANCE: VERTICAL AT 3 M

NO.	FREQ. (MHz)	EMISSION LEVEL (dBuV/m)	LIMIT (dBuV/m)	MARGIN (dB)	ANTENNA HEIGHT (m)	TABLE ANGLE (Degree)	RAW VALUE (dBuV)	CORRECTION FACTOR (dB/m)
1	5420.00	62.9 PK	74.0	-11.1	3.24 V	231	60.17	2.73
2	5420.00	53.0 AV	54.0	-1.0	3.24 V	231	50.27	2.73
3	*5580.00	115.6 PK			2.70 V	342	112.54	3.06
4	*5580.00	105.8 AV			2.70 V	342	102.74	3.06
5	#5740.00	62.3 PK	74.0	-11.7	3.21 V	225	58.93	3.37
6	#5740.00	51.6 AV	54.0	-2.4	3.21 V	225	48.23	3.37
7	11160.00	50.7 PK	74.0	-23.3	2.38 V	132	37.08	13.62
8	11160.00	37.9 AV	54.0	-16.1	2.38 V	132	24.28	13.62
9	#16740.00	52.6 PK	74.0	-21.4	2.51 V	282	33.01	19.59
10	#16740.00	40.3 AV	54.0	-13.7	2.51 V	282	20.71	19.59

REMARKS:

1. Emission Level(dBuV/m) = Raw Value(dBuV) + Correction Factor(dB/m)
2. Correction Factor(dB/m) = Antenna Factor(dB/m) + Cable Factor(dB) – Pre-Amplifier Factor(dB)
3. The other emission levels were very low against the limit.
4. Margin value = Emission Level – Limit value
5. " * ": Fundamental frequency.
6. " # ": The radiated frequency is out of the restricted band.

CHANNEL	TX Channel 140	DETECTOR FUNCTION	Peak (PK)
FREQUENCY RANGE	1GHz ~ 40GHz		Average (AV)

ANTENNA POLARITY & TEST DISTANCE: HORIZONTAL AT 3 M

NO.	FREQ. (MHz)	EMISSION LEVEL (dBuV/m)	LIMIT (dBuV/m)	MARGIN (dB)	ANTENNA HEIGHT (m)	TABLE ANGLE (Degree)	RAW VALUE (dBuV)	CORRECTION FACTOR (dB/m)
1	5460.00	49.0 PK	74.0	-25.0	1.17 H	344	46.22	2.78
2	5460.00	41.9 AV	54.0	-12.1	1.17 H	344	39.12	2.78
3	*5700.00	104.6 PK			1.11 H	339	101.28	3.32
4	*5700.00	94.5 AV			1.11 H	339	91.18	3.32
5	#5725.00	64.0 PK	74.0	-10.0	1.11 H	340	60.64	3.36
6	#5725.00	43.2 AV	54.0	-10.8	1.11 H	340	39.84	3.36
7	11400.00	50.2 PK	74.0	-23.8	1.99 H	138	36.59	13.61
8	11400.00	37.5 AV	54.0	-16.5	1.99 H	138	23.89	13.61
9	#17100.00	52.8 PK	74.0	-21.2	2.05 H	148	31.90	20.90
10	#17100.00	39.9 AV	54.0	-14.1	2.05 H	148	19.00	20.90

ANTENNA POLARITY & TEST DISTANCE: VERTICAL AT 3 M

NO.	FREQ. (MHz)	EMISSION LEVEL (dBuV/m)	LIMIT (dBuV/m)	MARGIN (dB)	ANTENNA HEIGHT (m)	TABLE ANGLE (Degree)	RAW VALUE (dBuV)	CORRECTION FACTOR (dB/m)
1	5460.00	59.0 PK	74.0	-15.0	2.69 V	356	56.22	2.78
2	5460.00	51.7 AV	54.0	-2.3	2.69 V	356	48.92	2.78
3	*5700.00	114.2 PK			2.50 V	336	110.88	3.32
4	*5700.00	104.1 AV			2.50 V	336	100.78	3.32
5	#5725.00	73.8 PK	74.0	-0.2	2.53 V	341	70.44	3.36
6	#5725.00	53.1 AV	54.0	-0.9	2.53 V	341	49.74	3.36
7	11400.00	51.4 PK	74.0	-22.6	2.41 V	149	37.79	13.61
8	11400.00	38.7 AV	54.0	-15.3	2.41 V	149	25.09	13.61
9	#17100.00	53.2 PK	74.0	-20.8	2.51 V	306	32.30	20.90
10	#17100.00	40.8 AV	54.0	-13.2	2.51 V	306	19.90	20.90

REMARKS:

1. Emission Level(dBuV/m) = Raw Value(dBuV) + Correction Factor(dB/m)
2. Correction Factor(dB/m) = Antenna Factor(dB/m) + Cable Factor(dB) – Pre-Amplifier Factor(dB)
3. The other emission levels were very low against the limit.
4. Margin value = Emission Level – Limit value
5. " * ": Fundamental frequency.
6. " # ": The radiated frequency is out of the restricted band.

CHANNEL	TX Channel 144	DETECTOR FUNCTION	Peak (PK)
FREQUENCY RANGE	1GHz ~ 40GHz		Average (AV)

ANTENNA POLARITY & TEST DISTANCE: HORIZONTAL AT 3 M

NO.	FREQ. (MHz)	EMISSION LEVEL (dBuV/m)	LIMIT (dBuV/m)	MARGIN (dB)	ANTENNA HEIGHT (m)	TABLE ANGLE (Degree)	RAW VALUE (dBuV)	CORRECTION FACTOR (dB/m)
1	*5720.00	106.0 PK			1.08 H	344	102.65	3.35
2	*5720.00	95.4 AV			1.08 H	344	92.05	3.35
3	#5880.00	54.1 PK	74.0	-19.9	1.16 H	351	50.58	3.52
4	#5880.00	43.1 AV	54.0	-10.9	1.16 H	351	39.58	3.52
5	11440.00	50.2 PK	74.0	-23.8	2.07 H	117	36.64	13.56
6	11440.00	37.2 AV	54.0	-16.8	2.07 H	117	23.64	13.56
7	#17160.00	52.7 PK	74.0	-21.3	2.13 H	136	31.92	20.78
8	#17160.00	40.1 AV	54.0	-13.9	2.13 H	136	19.32	20.78

ANTENNA POLARITY & TEST DISTANCE: VERTICAL AT 3 M

NO.	FREQ. (MHz)	EMISSION LEVEL (dBuV/m)	LIMIT (dBuV/m)	MARGIN (dB)	ANTENNA HEIGHT (m)	TABLE ANGLE (Degree)	RAW VALUE (dBuV)	CORRECTION FACTOR (dB/m)
1	*5720.00	115.7 PK			2.68 V	18	112.35	3.35
2	*5720.00	105.4 AV			2.68 V	18	102.05	3.35
3	#5880.00	64.1 PK	74.0	-9.9	2.38 V	218	60.58	3.52
4	#5880.00	53.3 AV	54.0	-0.7	2.38 V	218	49.78	3.52
5	11440.00	50.8 PK	74.0	-23.2	2.38 V	132	37.24	13.56
6	11440.00	38.3 AV	54.0	-15.7	2.38 V	132	24.74	13.56
7	#17160.00	52.8 PK	74.0	-21.2	2.44 V	298	32.02	20.78
8	#17160.00	40.2 AV	54.0	-13.8	2.44 V	298	19.42	20.78

REMARKS:

1. Emission Level(dBuV/m) = Raw Value(dBuV) + Correction Factor(dB/m)
2. Correction Factor(dB/m) = Antenna Factor(dB/m) + Cable Factor(dB) – Pre-Amplifier Factor(dB)
3. The other emission levels were very low against the limit.
4. Margin value = Emission Level – Limit value
5. " * ": Fundamental frequency.
6. " # ": The radiated frequency is out of the restricted band.

802.11ac VHT40

CHANNEL	TX Channel 54	DETECTOR FUNCTION	Peak (PK)
FREQUENCY RANGE	1GHz ~ 40GHz		Average (AV)

ANTENNA POLARITY & TEST DISTANCE: HORIZONTAL AT 3 M

NO.	FREQ. (MHz)	EMISSION LEVEL (dBuV/m)	LIMIT (dBuV/m)	MARGIN (dB)	ANTENNA HEIGHT (m)	TABLE ANGLE (Degree)	RAW VALUE (dBuV)	CORRECTION FACTOR (dB/m)
1	5120.00	46.7 PK	74.0	-27.3	1.14 H	345	44.35	2.35
2	5120.00	37.5 AV	54.0	-16.5	1.14 H	345	35.15	2.35
3	*5270.00	101.9 PK			1.08 H	351	99.34	2.56
4	*5270.00	91.5 AV			1.08 H	351	88.94	2.56
5	5350.00	57.0 PK	74.0	-17.0	1.16 H	352	54.35	2.65
6	5350.00	43.8 AV	54.0	-10.2	1.16 H	352	41.15	2.65
7	#10540.00	50.3 PK	74.0	-23.7	2.02 H	130	37.78	12.52
8	#10540.00	37.8 AV	54.0	-16.2	2.02 H	130	25.28	12.52
9	15810.00	52.5 PK	74.0	-21.5	2.08 H	130	37.74	14.76
10	15810.00	39.7 AV	54.0	-14.3	2.08 H	130	24.94	14.76

ANTENNA POLARITY & TEST DISTANCE: VERTICAL AT 3 M

NO.	FREQ. (MHz)	EMISSION LEVEL (dBuV/m)	LIMIT (dBuV/m)	MARGIN (dB)	ANTENNA HEIGHT (m)	TABLE ANGLE (Degree)	RAW VALUE (dBuV)	CORRECTION FACTOR (dB/m)
1	5120.00	56.9 PK	74.0	-17.1	2.78 V	229	54.55	2.35
2	5120.00	47.5 AV	54.0	-6.5	2.78 V	229	45.15	2.35
3	*5270.00	111.4 PK			2.75 V	211	108.84	2.56
4	*5270.00	101.3 AV			2.75 V	211	98.74	2.56
5	5350.00	67.0 PK	74.0	-7.0	2.79 V	212	64.35	2.65
6	5350.00	53.6 AV	54.0	-0.4	2.79 V	212	50.95	2.65
7	#10540.00	50.3 PK	74.0	-23.7	2.42 V	149	37.78	12.52
8	#10540.00	37.8 AV	54.0	-16.2	2.42 V	149	25.28	12.52
9	15810.00	53.1 PK	74.0	-20.9	2.48 V	292	38.34	14.76
10	15810.00	40.6 AV	54.0	-13.4	2.48 V	292	25.84	14.76

REMARKS:

1. Emission Level(dBuV/m) = Raw Value(dBuV) + Correction Factor(dB/m)
2. Correction Factor(dB/m) = Antenna Factor(dB/m) + Cable Factor(dB) – Pre-Amplifier Factor(dB)
3. The other emission levels were very low against the limit.
4. Margin value = Emission Level – Limit value
5. " * ": Fundamental frequency.
6. " # ": The radiated frequency is out of the restricted band.

CHANNEL	TX Channel 62	DETECTOR FUNCTION	Peak (PK)
FREQUENCY RANGE	1GHz ~ 40GHz		Average (AV)

ANTENNA POLARITY & TEST DISTANCE: HORIZONTAL AT 3 M

NO.	FREQ. (MHz)	EMISSION LEVEL (dBuV/m)	LIMIT (dBuV/m)	MARGIN (dB)	ANTENNA HEIGHT (m)	TABLE ANGLE (Degree)	RAW VALUE (dBuV)	CORRECTION FACTOR (dB/m)
1	*5310.00	98.1 PK			1.15 H	353	95.49	2.61
2	*5310.00	87.6 AV			1.15 H	353	84.99	2.61
3	5350.00	61.4 PK	74.0	-12.6	1.09 H	341	58.75	2.65
4	5350.00	42.9 AV	54.0	-11.1	1.09 H	341	40.25	2.65
5	10620.00	50.2 PK	74.0	-23.8	2.04 H	139	37.32	12.88
6	10620.00	37.7 AV	54.0	-16.3	2.04 H	139	24.82	12.88
7	15930.00	52.5 PK	74.0	-21.5	2.12 H	151	37.60	14.90
8	15930.00	39.7 AV	54.0	-14.3	2.12 H	151	24.80	14.90

ANTENNA POLARITY & TEST DISTANCE: VERTICAL AT 3 M

NO.	FREQ. (MHz)	EMISSION LEVEL (dBuV/m)	LIMIT (dBuV/m)	MARGIN (dB)	ANTENNA HEIGHT (m)	TABLE ANGLE (Degree)	RAW VALUE (dBuV)	CORRECTION FACTOR (dB/m)
1	*5310.00	107.8 PK			2.85 V	238	105.19	2.61
2	*5310.00	97.2 AV			2.85 V	238	94.59	2.61
3	5350.00	72.1 PK	74.0	-1.9	2.86 V	215	69.45	2.65
4	5350.00	53.3 AV	54.0	-0.7	2.86 V	215	50.65	2.65
5	10620.00	50.6 PK	74.0	-23.4	2.45 V	136	37.72	12.88
6	10620.00	37.7 AV	54.0	-16.3	2.45 V	136	24.82	12.88
7	15930.00	53.0 PK	74.0	-21.0	2.46 V	301	38.10	14.90
8	15930.00	40.5 AV	54.0	-13.5	2.46 V	301	25.60	14.90

REMARKS:

1. Emission Level(dBuV/m) = Raw Value(dBuV) + Correction Factor(dB/m)
2. Correction Factor(dB/m) = Antenna Factor(dB/m) + Cable Factor(dB) – Pre-Amplifier Factor(dB)
3. The other emission levels were very low against the limit.
4. Margin value = Emission Level – Limit value
5. " * ": Fundamental frequency.

CHANNEL	TX Channel 102	DETECTOR FUNCTION	Peak (PK)
FREQUENCY RANGE	1GHz ~ 40GHz		Average (AV)

ANTENNA POLARITY & TEST DISTANCE: HORIZONTAL AT 3 M

NO.	FREQ. (MHz)	EMISSION LEVEL (dBuV/m)	LIMIT (dBuV/m)	MARGIN (dB)	ANTENNA HEIGHT (m)	TABLE ANGLE (Degree)	RAW VALUE (dBuV)	CORRECTION FACTOR (dB/m)
1	#5470.00	62.5 PK	74.0	-11.5	1.12 H	349	59.71	2.79
2	#5470.00	43.7 AV	54.0	-10.3	1.12 H	349	40.91	2.79
3	*5510.00	101.2 PK			1.18 H	356	98.35	2.85
4	*5510.00	90.3 AV			1.18 H	356	87.45	2.85
5	#5970.00	45.5 PK	74.0	-28.5	1.15 H	357	41.77	3.73
6	#5970.00	37.2 AV	54.0	-16.8	1.15 H	357	33.47	3.73
7	11020.00	50.1 PK	74.0	-23.9	2.00 H	115	36.46	13.64
8	11020.00	37.3 AV	54.0	-16.7	2.00 H	115	23.66	13.64
9	#16530.00	52.2 PK	74.0	-21.8	2.13 H	132	33.38	18.82
10	#16530.00	39.7 AV	54.0	-14.3	2.13 H	132	20.88	18.82

ANTENNA POLARITY & TEST DISTANCE: VERTICAL AT 3 M

NO.	FREQ. (MHz)	EMISSION LEVEL (dBuV/m)	LIMIT (dBuV/m)	MARGIN (dB)	ANTENNA HEIGHT (m)	TABLE ANGLE (Degree)	RAW VALUE (dBuV)	CORRECTION FACTOR (dB/m)
1	#5470.00	72.4 PK	74.0	-1.6	2.78 V	325	69.61	2.79
2	#5470.00	53.8 AV	54.0	-0.2	2.78 V	325	51.01	2.79
3	*5510.00	110.8 PK			2.87 V	352	107.95	2.85
4	*5510.00	99.8 AV			2.87 V	352	96.95	2.85
5	#5970.00	55.9 PK	74.0	-18.1	2.83 V	355	52.17	3.73
6	#5970.00	47.7 AV	54.0	-6.3	2.83 V	355	43.97	3.73
7	11020.00	50.8 PK	74.0	-23.2	2.44 V	150	37.16	13.64
8	11020.00	37.9 AV	54.0	-16.1	2.44 V	150	24.26	13.64
9	#16530.00	52.8 PK	74.0	-21.2	2.49 V	280	33.98	18.82
10	#16530.00	40.3 AV	54.0	-13.7	2.49 V	280	21.48	18.82

REMARKS:

1. Emission Level(dBuV/m) = Raw Value(dBuV) + Correction Factor(dB/m)
2. Correction Factor(dB/m) = Antenna Factor(dB/m) + Cable Factor(dB) – Pre-Amplifier Factor(dB)
3. The other emission levels were very low against the limit.
4. Margin value = Emission Level – Limit value
5. " * ": Fundamental frequency.
6. " # ": The radiated frequency is out of the restricted band.

CHANNEL	TX Channel 110	DETECTOR FUNCTION	Peak (PK)
FREQUENCY RANGE	1GHz ~ 40GHz		Average (AV)

ANTENNA POLARITY & TEST DISTANCE: HORIZONTAL AT 3 M

NO.	FREQ. (MHz)	EMISSION LEVEL (dBuV/m)	LIMIT (dBuV/m)	MARGIN (dB)	ANTENNA HEIGHT (m)	TABLE ANGLE (Degree)	RAW VALUE (dBuV)	CORRECTION FACTOR (dB/m)
1	#5470.00	55.8 PK	74.0	-18.2	1.10 H	337	53.01	2.79
2	#5470.00	43.0 AV	54.0	-11.0	1.10 H	337	40.21	2.79
3	*5550.00	103.4 PK			1.15 H	339	100.42	2.98
4	*5550.00	92.8 AV			1.15 H	339	89.82	2.98
5	#5725.00	48.7 PK	74.0	-25.3	1.13 H	349	45.34	3.36
6	#5725.00	38.8 AV	54.0	-15.2	1.13 H	349	35.44	3.36
7	11100.00	49.7 PK	74.0	-24.3	1.97 H	112	36.08	13.62
8	11100.00	37.1 AV	54.0	-16.9	1.97 H	112	23.48	13.62
9	#16650.00	52.8 PK	74.0	-21.2	2.08 H	156	33.41	19.39
10	#16650.00	40.1 AV	54.0	-13.9	2.08 H	156	20.71	19.39

ANTENNA POLARITY & TEST DISTANCE: VERTICAL AT 3 M

NO.	FREQ. (MHz)	EMISSION LEVEL (dBuV/m)	LIMIT (dBuV/m)	MARGIN (dB)	ANTENNA HEIGHT (m)	TABLE ANGLE (Degree)	RAW VALUE (dBuV)	CORRECTION FACTOR (dB/m)
1	#5470.00	66.4 PK	74.0	-7.6	2.59 V	355	63.61	2.79
2	#5470.00	53.4 AV	54.0	-0.6	2.59 V	355	50.61	2.79
3	*5550.00	113.6 PK			2.69 V	333	110.62	2.98
4	*5550.00	103.0 AV			2.69 V	333	100.02	2.98
5	#5725.00	58.3 PK	74.0	-15.7	2.60 V	325	54.94	3.36
6	#5725.00	48.6 AV	54.0	-5.4	2.60 V	325	45.24	3.36
7	11100.00	50.5 PK	74.0	-23.5	2.45 V	131	36.88	13.62
8	11100.00	37.9 AV	54.0	-16.1	2.45 V	131	24.28	13.62
9	#16650.00	53.4 PK	74.0	-20.6	2.48 V	305	34.01	19.39
10	#16650.00	40.6 AV	54.0	-13.4	2.48 V	305	21.21	19.39

REMARKS:

1. Emission Level(dBuV/m) = Raw Value(dBuV) + Correction Factor(dB/m)
2. Correction Factor(dB/m) = Antenna Factor(dB/m) + Cable Factor(dB) – Pre-Amplifier Factor(dB)
3. The other emission levels were very low against the limit.
4. Margin value = Emission Level – Limit value
5. " * ": Fundamental frequency.
6. " # ": The radiated frequency is out of the restricted band.

CHANNEL	TX Channel 134	DETECTOR FUNCTION	Peak (PK)
FREQUENCY RANGE	1GHz ~ 40GHz		Average (AV)

ANTENNA POLARITY & TEST DISTANCE: HORIZONTAL AT 3 M

NO.	FREQ. (MHz)	EMISSION LEVEL (dBuV/m)	LIMIT (dBuV/m)	MARGIN (dB)	ANTENNA HEIGHT (m)	TABLE ANGLE (Degree)	RAW VALUE (dBuV)	CORRECTION FACTOR (dB/m)
1	*5670.00	98.8 PK			1.09 H	352	95.54	3.26
2	*5670.00	88.8 AV			1.09 H	352	85.54	3.26
3	#5725.00	57.8 PK	74.0	-16.2	1.15 H	344	54.44	3.36
4	#5725.00	43.6 AV	54.0	-10.4	1.15 H	344	40.24	3.36
5	11340.00	50.3 PK	74.0	-23.7	2.08 H	132	36.60	13.70
6	11340.00	37.3 AV	54.0	-16.7	2.08 H	132	23.60	13.70
7	#17010.00	52.8 PK	74.0	-21.2	2.06 H	135	32.03	20.77
8	#17010.00	39.7 AV	54.0	-14.3	2.06 H	135	18.93	20.77

ANTENNA POLARITY & TEST DISTANCE: VERTICAL AT 3 M

NO.	FREQ. (MHz)	EMISSION LEVEL (dBuV/m)	LIMIT (dBuV/m)	MARGIN (dB)	ANTENNA HEIGHT (m)	TABLE ANGLE (Degree)	RAW VALUE (dBuV)	CORRECTION FACTOR (dB/m)
1	*5670.00	109.1 PK			2.61 V	335	105.84	3.26
2	*5670.00	99.0 AV			2.61 V	335	95.74	3.26
3	#5725.00	67.6 PK	74.0	-6.4	2.39 V	295	64.24	3.36
4	#5725.00	53.6 AV	54.0	-0.4	2.39 V	295	50.24	3.36
5	11340.00	50.8 PK	74.0	-23.2	2.45 V	159	37.10	13.70
6	11340.00	37.8 AV	54.0	-16.2	2.45 V	159	24.10	13.70
7	#17010.00	52.9 PK	74.0	-21.1	2.45 V	303	32.13	20.77
8	#17010.00	40.2 AV	54.0	-13.8	2.45 V	303	19.43	20.77

REMARKS:

1. Emission Level(dBuV/m) = Raw Value(dBuV) + Correction Factor(dB/m)
2. Correction Factor(dB/m) = Antenna Factor(dB/m) + Cable Factor(dB) – Pre-Amplifier Factor(dB)
3. The other emission levels were very low against the limit.
4. Margin value = Emission Level – Limit value
5. " * ": Fundamental frequency.
6. " # ": The radiated frequency is out of the restricted band.

CHANNEL	TX Channel 142	DETECTOR FUNCTION	Peak (PK)
FREQUENCY RANGE	1GHz ~ 40GHz		Average (AV)

ANTENNA POLARITY & TEST DISTANCE: HORIZONTAL AT 3 M

NO.	FREQ. (MHz)	EMISSION LEVEL (dBuV/m)	LIMIT (dBuV/m)	MARGIN (dB)	ANTENNA HEIGHT (m)	TABLE ANGLE (Degree)	RAW VALUE (dBuV)	CORRECTION FACTOR (dB/m)
1	5460.00	52.3 PK	74.0	-21.7	1.11 H	353	49.52	2.78
2	5460.00	42.0 AV	54.0	-12.0	1.11 H	353	39.22	2.78
3	*5710.00	103.3 PK			1.12 H	348	99.96	3.34
4	*5710.00	92.6 AV			1.12 H	348	89.26	3.34
5	#5870.00	52.7 PK	74.0	-21.3	1.19 H	333	49.19	3.51
6	#5870.00	41.2 AV	54.0	-12.8	1.19 H	333	37.69	3.51
7	11420.00	49.9 PK	74.0	-24.1	2.03 H	141	36.31	13.59
8	11420.00	37.3 AV	54.0	-16.7	2.03 H	141	23.71	13.59
9	#17130.00	53.5 PK	74.0	-20.5	2.10 H	129	32.67	20.83
10	#17130.00	40.4 AV	54.0	-13.6	2.10 H	129	19.57	20.83

ANTENNA POLARITY & TEST DISTANCE: VERTICAL AT 3 M

NO.	FREQ. (MHz)	EMISSION LEVEL (dBuV/m)	LIMIT (dBuV/m)	MARGIN (dB)	ANTENNA HEIGHT (m)	TABLE ANGLE (Degree)	RAW VALUE (dBuV)	CORRECTION FACTOR (dB/m)
1	5460.00	61.8 PK	74.0	-12.2	2.67 V	331	59.02	2.78
2	5460.00	51.6 AV	54.0	-2.4	2.67 V	331	48.82	2.78
3	*5710.00	114.0 PK			3.01 V	325	110.66	3.34
4	*5710.00	103.0 AV			3.01 V	325	99.66	3.34
5	#5870.00	62.8 PK	74.0	-11.2	2.78 V	360	59.29	3.51
6	#5870.00	51.4 AV	54.0	-2.6	2.78 V	360	47.89	3.51
7	11420.00	50.9 PK	74.0	-23.1	2.36 V	156	37.31	13.59
8	11420.00	38.0 AV	54.0	-16.0	2.36 V	156	24.41	13.59
9	#17130.00	52.2 PK	74.0	-21.8	2.47 V	291	31.37	20.83
10	#17130.00	39.8 AV	54.0	-14.2	2.47 V	291	18.97	20.83

REMARKS:

1. Emission Level(dBuV/m) = Raw Value(dBuV) + Correction Factor(dB/m)
2. Correction Factor(dB/m) = Antenna Factor(dB/m) + Cable Factor(dB) – Pre-Amplifier Factor(dB)
3. The other emission levels were very low against the limit.
4. Margin value = Emission Level – Limit value
5. " * ": Fundamental frequency.
6. " # ": The radiated frequency is out of the restricted band.

802.11ac VHT80

CHANNEL	TX Channel 58	DETECTOR FUNCTION	Peak (PK)
FREQUENCY RANGE	1GHz ~ 40GHz		Average (AV)

ANTENNA POLARITY & TEST DISTANCE: HORIZONTAL AT 3 M

NO.	FREQ. (MHz)	EMISSION LEVEL (dBuV/m)	LIMIT (dBuV/m)	MARGIN (dB)	ANTENNA HEIGHT (m)	TABLE ANGLE (Degree)	RAW VALUE (dBuV)	CORRECTION FACTOR (dB/m)
1	5150.00	48.3 PK	74.0	-25.7	1.19 H	350	45.93	2.37
2	5150.00	33.9 AV	54.0	-20.1	1.19 H	350	31.53	2.37
3	*5290.00	94.5 PK			1.18 H	348	91.91	2.59
4	*5290.00	83.1 AV			1.18 H	348	80.51	2.59
5	5350.00	61.3 PK	74.0	-12.7	1.18 H	338	58.65	2.65
6	5350.00	43.0 AV	54.0	-11.0	1.18 H	338	40.35	2.65
7	#10580.00	49.8 PK	74.0	-24.2	2.06 H	128	37.05	12.75
8	#10580.00	37.3 AV	54.0	-16.7	2.06 H	128	24.55	12.75
9	15870.00	52.2 PK	74.0	-21.8	2.07 H	148	37.37	14.83
10	15870.00	39.5 AV	54.0	-14.5	2.07 H	148	24.67	14.83

ANTENNA POLARITY & TEST DISTANCE: VERTICAL AT 3 M

NO.	FREQ. (MHz)	EMISSION LEVEL (dBuV/m)	LIMIT (dBuV/m)	MARGIN (dB)	ANTENNA HEIGHT (m)	TABLE ANGLE (Degree)	RAW VALUE (dBuV)	CORRECTION FACTOR (dB/m)
1	5150.00	58.4 PK	74.0	-15.6	2.52 V	260	56.03	2.37
2	5150.00	43.9 AV	54.0	-10.1	2.52 V	260	41.53	2.37
3	*5290.00	104.4 PK			2.47 V	269	101.81	2.59
4	*5290.00	93.1 AV			2.47 V	269	90.51	2.59
5	5350.00	71.8 PK	74.0	-2.2	2.44 V	261	69.15	2.65
6	5350.00	53.5 AV	54.0	-0.5	2.44 V	261	50.85	2.65
7	#10580.00	51.4 PK	74.0	-22.6	2.36 V	158	38.65	12.75
8	#10580.00	38.5 AV	54.0	-15.5	2.36 V	158	25.75	12.75
9	15870.00	52.8 PK	74.0	-21.2	2.53 V	275	37.97	14.83
10	15870.00	40.4 AV	54.0	-13.6	2.53 V	275	25.57	14.83

REMARKS:

- Emission Level(dBuV/m) = Raw Value(dBuV) + Correction Factor(dB/m)
- Correction Factor(dB/m) = Antenna Factor(dB/m) + Cable Factor(dB) – Pre-Amplifier Factor(dB)
- The other emission levels were very low against the limit.
- Margin value = Emission Level – Limit value
- " * ": Fundamental frequency.
- " # ": The radiated frequency is out of the restricted band.

CHANNEL	TX Channel 106	DETECTOR FUNCTION	Peak (PK)
FREQUENCY RANGE	1GHz ~ 40GHz		Average (AV)

ANTENNA POLARITY & TEST DISTANCE: HORIZONTAL AT 3 M

NO.	FREQ. (MHz)	EMISSION LEVEL (dBuV/m)	LIMIT (dBuV/m)	MARGIN (dB)	ANTENNA HEIGHT (m)	TABLE ANGLE (Degree)	RAW VALUE (dBuV)	CORRECTION FACTOR (dB/m)
1	#5470.00	63.4 PK	74.0	-10.6	1.11 H	340	60.61	2.79
2	#5470.00	43.3 AV	54.0	-10.7	1.11 H	340	40.51	2.79
3	*5530.00	97.1 PK			1.12 H	334	94.18	2.92
4	*5530.00	84.8 AV			1.12 H	334	81.88	2.92
5	11060.00	50.5 PK	74.0	-23.5	2.02 H	129	36.87	13.63
6	11060.00	37.9 AV	54.0	-16.1	2.02 H	129	24.27	13.63
7	#16590.00	52.8 PK	74.0	-21.2	2.07 H	141	33.62	19.18
8	#16590.00	39.8 AV	54.0	-14.2	2.07 H	141	20.62	19.18

ANTENNA POLARITY & TEST DISTANCE: VERTICAL AT 3 M

NO.	FREQ. (MHz)	EMISSION LEVEL (dBuV/m)	LIMIT (dBuV/m)	MARGIN (dB)	ANTENNA HEIGHT (m)	TABLE ANGLE (Degree)	RAW VALUE (dBuV)	CORRECTION FACTOR (dB/m)
1	#5470.00	73.7 PK	74.0	-0.3	2.43 V	293	70.91	2.79
2	#5470.00	53.6 AV	54.0	-0.4	2.43 V	293	50.81	2.79
3	*5530.00	107.1 PK			2.41 V	292	104.18	2.92
4	*5530.00	94.8 AV			2.41 V	292	91.88	2.92
5	11060.00	51.3 PK	74.0	-22.7	2.42 V	147	37.67	13.63
6	11060.00	38.6 AV	54.0	-15.4	2.42 V	147	24.97	13.63
7	#16590.00	52.4 PK	74.0	-21.6	2.48 V	292	33.22	19.18
8	#16590.00	39.9 AV	54.0	-14.1	2.48 V	292	20.72	19.18

REMARKS:

1. Emission Level(dBuV/m) = Raw Value(dBuV) + Correction Factor(dB/m)
2. Correction Factor(dB/m) = Antenna Factor(dB/m) + Cable Factor(dB) – Pre-Amplifier Factor(dB)
3. The other emission levels were very low against the limit.
4. Margin value = Emission Level – Limit value
5. " * ": Fundamental frequency.
6. " # ": The radiated frequency is out of the restricted band.

CHANNEL	TX Channel 122	DETECTOR FUNCTION	Peak (PK)
FREQUENCY RANGE	1GHz ~ 40GHz		Average (AV)

ANTENNA POLARITY & TEST DISTANCE: HORIZONTAL AT 3 M

NO.	FREQ. (MHz)	EMISSION LEVEL (dBuV/m)	LIMIT (dBuV/m)	MARGIN (dB)	ANTENNA HEIGHT (m)	TABLE ANGLE (Degree)	RAW VALUE (dBuV)	CORRECTION FACTOR (dB/m)
1	#5470.00	52.2 PK	74.0	-21.8	1.17 H	339	49.41	2.79
2	#5470.00	39.6 AV	54.0	-14.4	1.17 H	339	36.81	2.79
3	*5610.00	97.8 PK			1.19 H	343	94.65	3.15
4	*5610.00	85.7 AV			1.19 H	343	82.55	3.15
5	#5725.00	59.6 PK	74.0	-14.4	1.14 H	353	56.24	3.36
6	#5725.00	43.4 AV	54.0	-10.6	1.14 H	353	40.04	3.36
7	11220.00	50.5 PK	74.0	-23.5	2.00 H	140	36.86	13.64
8	11220.00	37.6 AV	54.0	-16.4	2.00 H	140	23.96	13.64
9	#16830.00	52.7 PK	74.0	-21.3	2.07 H	154	32.85	19.85
10	#16830.00	40.0 AV	54.0	-14.0	2.07 H	154	20.15	19.85

ANTENNA POLARITY & TEST DISTANCE: VERTICAL AT 3 M

NO.	FREQ. (MHz)	EMISSION LEVEL (dBuV/m)	LIMIT (dBuV/m)	MARGIN (dB)	ANTENNA HEIGHT (m)	TABLE ANGLE (Degree)	RAW VALUE (dBuV)	CORRECTION FACTOR (dB/m)
1	#5470.00	62.0 PK	74.0	-12.0	2.47 V	276	59.21	2.79
2	#5470.00	49.6 AV	54.0	-4.4	2.47 V	276	46.81	2.79
3	*5610.00	107.5 PK			2.51 V	274	104.35	3.15
4	*5610.00	95.3 AV			2.51 V	274	92.15	3.15
5	#5725.00	69.5 PK	74.0	-4.5	2.50 V	275	66.14	3.36
6	#5725.00	53.3 AV	54.0	-0.7	2.50 V	275	49.94	3.36
7	11220.00	51.2 PK	74.0	-22.8	2.37 V	143	37.56	13.64
8	11220.00	38.7 AV	54.0	-15.3	2.37 V	143	25.06	13.64
9	#16830.00	52.8 PK	74.0	-21.2	2.47 V	296	32.95	19.85
10	#16830.00	40.4 AV	54.0	-13.6	2.47 V	296	20.55	19.85

REMARKS:

1. Emission Level(dBuV/m) = Raw Value(dBuV) + Correction Factor(dB/m)
2. Correction Factor(dB/m) = Antenna Factor(dB/m) + Cable Factor(dB) – Pre-Amplifier Factor(dB)
3. The other emission levels were very low against the limit.
4. Margin value = Emission Level – Limit value
5. " * ": Fundamental frequency.
6. " # ": The radiated frequency is out of the restricted band.

CHANNEL	TX Channel 138	DETECTOR FUNCTION	Peak (PK)
FREQUENCY RANGE	1GHz ~ 40GHz		Average (AV)

ANTENNA POLARITY & TEST DISTANCE: HORIZONTAL AT 3 M

NO.	FREQ. (MHz)	EMISSION LEVEL (dBuV/m)	LIMIT (dBuV/m)	MARGIN (dB)	ANTENNA HEIGHT (m)	TABLE ANGLE (Degree)	RAW VALUE (dBuV)	CORRECTION FACTOR (dB/m)
1	*5690.00	99.2 PK			1.15 H	359	95.90	3.30
2	*5690.00	87.2 AV			1.15 H	359	83.90	3.30
3	#5850.00	54.0 PK	78.2	-24.2	1.12 H	347	50.51	3.49
4	11380.00	50.1 PK	74.0	-23.9	2.01 H	137	36.47	13.63
5	11380.00	37.4 AV	54.0	-16.6	2.01 H	137	23.77	13.63
6	#17070.00	52.7 PK	74.0	-21.3	2.07 H	144	31.85	20.85
7	#17070.00	39.8 AV	54.0	-14.2	2.07 H	144	18.95	20.85

ANTENNA POLARITY & TEST DISTANCE: VERTICAL AT 3 M

NO.	FREQ. (MHz)	EMISSION LEVEL (dBuV/m)	LIMIT (dBuV/m)	MARGIN (dB)	ANTENNA HEIGHT (m)	TABLE ANGLE (Degree)	RAW VALUE (dBuV)	CORRECTION FACTOR (dB/m)
1	*5690.00	108.6 PK			2.86 V	360	105.30	3.30
2	*5690.00	96.7 AV			2.86 V	360	93.40	3.30
3	#5850.00	63.6 PK	78.2	-14.6	2.79 V	360	60.11	3.49
4	11380.00	51.1 PK	74.0	-22.9	2.37 V	146	37.47	13.63
5	11380.00	38.4 AV	54.0	-15.6	2.37 V	146	24.77	13.63
6	#17070.00	53.2 PK	74.0	-20.8	2.49 V	283	32.35	20.85
7	#17070.00	40.5 AV	54.0	-13.5	2.49 V	283	19.65	20.85

REMARKS:

1. Emission Level(dBuV/m) = Raw Value(dBuV) + Correction Factor(dB/m)
2. Correction Factor(dB/m) = Antenna Factor(dB/m) + Cable Factor(dB) – Pre-Amplifier Factor(dB)
3. The other emission levels were very low against the limit.
4. Margin value = Emission Level – Limit value
5. " * ": Fundamental frequency.
6. " # ": The radiated frequency is out of the restricted band.

1TX
 ANT9
 802.11a

CHANNEL	TX Channel 52	DETECTOR FUNCTION	Peak (PK)
FREQUENCY RANGE	1GHz ~ 40GHz		Average (AV)

ANTENNA POLARITY & TEST DISTANCE: HORIZONTAL AT 3 M								
NO.	FREQ. (MHz)	EMISSION LEVEL (dBuV/m)	LIMIT (dBuV/m)	MARGIN (dB)	ANTENNA HEIGHT (m)	TABLE ANGLE (Degree)	RAW VALUE (dBuV)	CORRECTION FACTOR (dB/m)
1	5100.00	55.1 PK	74.0	-18.9	1.14 H	348	52.78	2.32
2	5100.00	44.9 AV	54.0	-9.1	1.14 H	348	42.58	2.32
3	*5260.00	111.3 PK			1.17 H	338	108.76	2.54
4	*5260.00	101.4 AV			1.17 H	338	98.86	2.54
5	5420.00	52.4 PK	74.0	-21.6	1.19 H	334	49.67	2.73
6	5420.00	42.5 AV	54.0	-11.5	1.19 H	334	39.77	2.73
7	#10520.00	52.6 PK	74.0	-21.4	1.98 H	117	40.20	12.40
8	#10520.00	41.8 AV	54.0	-12.2	1.98 H	117	29.40	12.40
9	15780.00	56.4 PK	74.0	-17.6	2.22 H	138	41.58	14.82
10	15780.00	45.5 AV	54.0	-8.5	2.22 H	138	30.68	14.82

ANTENNA POLARITY & TEST DISTANCE: VERTICAL AT 3 M								
NO.	FREQ. (MHz)	EMISSION LEVEL (dBuV/m)	LIMIT (dBuV/m)	MARGIN (dB)	ANTENNA HEIGHT (m)	TABLE ANGLE (Degree)	RAW VALUE (dBuV)	CORRECTION FACTOR (dB/m)
1	5100.00	59.2 PK	74.0	-14.8	1.09 V	308	56.88	2.32
2	5100.00	49.0 AV	54.0	-5.0	1.09 V	308	46.68	2.32
3	*5260.00	114.5 PK			2.28 V	279	111.96	2.54
4	*5260.00	104.9 AV			2.28 V	279	102.36	2.54
5	5420.00	56.5 PK	74.0	-17.5	1.01 V	288	53.77	2.73
6	5420.00	46.4 AV	54.0	-7.6	1.01 V	288	43.67	2.73
7	#10520.00	51.8 PK	74.0	-22.2	2.50 V	186	39.40	12.40
8	#10520.00	41.6 AV	54.0	-12.4	2.50 V	186	29.20	12.40
9	15780.00	56.3 PK	74.0	-17.7	2.40 V	261	41.48	14.82
10	15780.00	45.2 AV	54.0	-8.8	2.40 V	261	30.38	14.82

REMARKS:

1. Emission Level(dBuV/m) = Raw Value(dBuV) + Correction Factor(dB/m)
2. Correction Factor(dB/m) = Antenna Factor(dB/m) + Cable Factor(dB) – Pre-Amplifier Factor(dB)
3. The other emission levels were very low against the limit.
4. Margin value = Emission Level – Limit value
5. " * ": Fundamental frequency.
6. " # ": The radiated frequency is out of the restricted band.

CHANNEL	TX Channel 60	DETECTOR FUNCTION	Peak (PK)
FREQUENCY RANGE	1GHz ~ 40GHz		Average (AV)

ANTENNA POLARITY & TEST DISTANCE: HORIZONTAL AT 3 M

NO.	FREQ. (MHz)	EMISSION LEVEL (dBuV/m)	LIMIT (dBuV/m)	MARGIN (dB)	ANTENNA HEIGHT (m)	TABLE ANGLE (Degree)	RAW VALUE (dBuV)	CORRECTION FACTOR (dB/m)
1	5140.00	49.5 PK	74.0	-24.5	1.20 H	339	47.13	2.37
2	5140.00	40.4 AV	54.0	-13.6	1.20 H	339	38.03	2.37
3	*5300.00	110.3 PK			1.16 H	358	107.69	2.61
4	*5300.00	100.0 AV			1.16 H	358	97.39	2.61
5	5460.00	52.4 PK	74.0	-21.6	1.18 H	338	49.62	2.78
6	5460.00	42.9 AV	54.0	-11.1	1.18 H	338	40.12	2.78
7	10600.00	52.7 PK	74.0	-21.3	2.04 H	138	39.84	12.86
8	10600.00	41.8 AV	54.0	-12.2	2.04 H	138	28.94	12.86
9	15900.00	56.8 PK	74.0	-17.2	2.23 H	128	41.93	14.87
10	15900.00	45.7 AV	54.0	-8.3	2.23 H	128	30.83	14.87

ANTENNA POLARITY & TEST DISTANCE: VERTICAL AT 3 M

NO.	FREQ. (MHz)	EMISSION LEVEL (dBuV/m)	LIMIT (dBuV/m)	MARGIN (dB)	ANTENNA HEIGHT (m)	TABLE ANGLE (Degree)	RAW VALUE (dBuV)	CORRECTION FACTOR (dB/m)
1	5140.00	53.9 PK	74.0	-20.1	1.05 V	311	51.53	2.37
2	5140.00	44.6 AV	54.0	-9.4	1.05 V	311	42.23	2.37
3	*5300.00	114.5 PK			1.97 V	308	111.89	2.61
4	*5300.00	104.2 AV			1.97 V	308	101.59	2.61
5	5460.00	56.7 PK	74.0	-17.3	1.05 V	70	53.92	2.78
6	5460.00	47.0 AV	54.0	-7.0	1.05 V	70	44.22	2.78
7	10600.00	51.8 PK	74.0	-22.2	2.49 V	172	38.94	12.86
8	10600.00	41.5 AV	54.0	-12.5	2.49 V	172	28.64	12.86
9	15900.00	56.1 PK	74.0	-17.9	2.29 V	261	41.23	14.87
10	15900.00	45.2 AV	54.0	-8.8	2.29 V	261	30.33	14.87

REMARKS:

1. Emission Level(dBuV/m) = Raw Value(dBuV) + Correction Factor(dB/m)
2. Correction Factor(dB/m) = Antenna Factor(dB/m) + Cable Factor(dB) – Pre-Amplifier Factor(dB)
3. The other emission levels were very low against the limit.
4. Margin value = Emission Level – Limit value
5. " * ": Fundamental frequency.

CHANNEL	TX Channel 64	DETECTOR FUNCTION	Peak (PK)
FREQUENCY RANGE	1GHz ~ 40GHz		Average (AV)

ANTENNA POLARITY & TEST DISTANCE: HORIZONTAL AT 3 M

NO.	FREQ. (MHz)	EMISSION LEVEL (dBuV/m)	LIMIT (dBuV/m)	MARGIN (dB)	ANTENNA HEIGHT (m)	TABLE ANGLE (Degree)	RAW VALUE (dBuV)	CORRECTION FACTOR (dB/m)
1	*5320.00	110.4 PK			1.19 H	342	107.77	2.63
2	*5320.00	99.6 AV			1.19 H	342	96.97	2.63
3	5350.00	66.5 PK	74.0	-7.5	1.15 H	354	63.85	2.65
4	5350.00	49.3 AV	54.0	-4.7	1.15 H	354	46.65	2.65
5	10640.00	52.2 PK	74.0	-21.8	1.99 H	112	39.32	12.88
6	10640.00	41.6 AV	54.0	-12.4	1.99 H	112	28.72	12.88
7	15960.00	56.2 PK	74.0	-17.8	2.17 H	143	41.27	14.93
8	15960.00	45.3 AV	54.0	-8.7	2.17 H	143	30.37	14.93

ANTENNA POLARITY & TEST DISTANCE: VERTICAL AT 3 M

NO.	FREQ. (MHz)	EMISSION LEVEL (dBuV/m)	LIMIT (dBuV/m)	MARGIN (dB)	ANTENNA HEIGHT (m)	TABLE ANGLE (Degree)	RAW VALUE (dBuV)	CORRECTION FACTOR (dB/m)
1	*5320.00	114.0 PK			2.19 V	274	111.37	2.63
2	*5320.00	103.2 AV			2.19 V	274	100.57	2.63
3	5350.00	70.5 PK	74.0	-3.5	2.32 V	70	67.85	2.65
4	5350.00	53.1 AV	54.0	-0.9	2.32 V	70	50.45	2.65
5	10640.00	51.5 PK	74.0	-22.5	2.41 V	183	38.62	12.88
6	10640.00	41.5 AV	54.0	-12.5	2.41 V	183	28.62	12.88
7	15960.00	56.7 PK	74.0	-17.3	2.32 V	257	41.77	14.93
8	15960.00	45.8 AV	54.0	-8.2	2.32 V	257	30.87	14.93

REMARKS:

1. Emission Level(dBuV/m) = Raw Value(dBuV) + Correction Factor(dB/m)
2. Correction Factor(dB/m) = Antenna Factor(dB/m) + Cable Factor(dB) – Pre-Amplifier Factor(dB)
3. The other emission levels were very low against the limit.
4. Margin value = Emission Level – Limit value
5. " * ": Fundamental frequency.

CHANNEL	TX Channel 100	DETECTOR FUNCTION	Peak (PK)
FREQUENCY RANGE	1GHz ~ 40GHz		Average (AV)

ANTENNA POLARITY & TEST DISTANCE: HORIZONTAL AT 3 M

NO.	FREQ. (MHz)	EMISSION LEVEL (dBuV/m)	LIMIT (dBuV/m)	MARGIN (dB)	ANTENNA HEIGHT (m)	TABLE ANGLE (Degree)	RAW VALUE (dBuV)	CORRECTION FACTOR (dB/m)
1	#5470.00	66.8 PK	74.0	-7.2	1.23 H	338	64.01	2.79
2	#5470.00	48.9 AV	54.0	-5.1	1.23 H	338	46.11	2.79
3	*5500.00	110.4 PK			1.13 H	337	107.57	2.83
4	*5500.00	99.9 AV			1.13 H	337	97.07	2.83
5	#5735.00	57.7 PK	74.0	-16.3	1.13 H	339	54.33	3.37
6	#5735.00	47.6 AV	54.0	-6.4	1.13 H	339	44.23	3.37
7	11000.00	53.0 PK	74.0	-21.0	2.01 H	116	39.36	13.64
8	11000.00	42.2 AV	54.0	-11.8	2.01 H	116	28.56	13.64
9	#16500.00	57.0 PK	74.0	-17.0	2.19 H	118	38.36	18.64
10	#16500.00	46.0 AV	54.0	-8.0	2.19 H	118	27.36	18.64

ANTENNA POLARITY & TEST DISTANCE: VERTICAL AT 3 M

NO.	FREQ. (MHz)	EMISSION LEVEL (dBuV/m)	LIMIT (dBuV/m)	MARGIN (dB)	ANTENNA HEIGHT (m)	TABLE ANGLE (Degree)	RAW VALUE (dBuV)	CORRECTION FACTOR (dB/m)
1	#5470.00	70.6 PK	74.0	-3.4	2.22 V	299	67.81	2.79
2	#5470.00	53.0 AV	54.0	-1.0	2.22 V	299	50.21	2.79
3	*5500.00	114.7 PK			1.02 V	61	111.87	2.83
4	*5500.00	104.0 AV			1.02 V	61	101.17	2.83
5	#5735.00	61.6 PK	74.0	-12.4	1.22 V	73	58.23	3.37
6	#5735.00	51.6 AV	54.0	-2.4	1.22 V	73	48.23	3.37
7	11000.00	50.8 PK	74.0	-23.2	2.40 V	198	37.16	13.64
8	11000.00	40.8 AV	54.0	-13.2	2.40 V	198	27.16	13.64
9	#16500.00	56.1 PK	74.0	-17.9	2.37 V	271	37.46	18.64
10	#16500.00	45.4 AV	54.0	-8.6	2.37 V	271	26.76	18.64

REMARKS:

1. Emission Level(dBuV/m) = Raw Value(dBuV) + Correction Factor(dB/m)
2. Correction Factor(dB/m) = Antenna Factor(dB/m) + Cable Factor(dB) – Pre-Amplifier Factor(dB)
3. The other emission levels were very low against the limit.
4. Margin value = Emission Level – Limit value
5. " * ": Fundamental frequency.
6. " # ": The radiated frequency is out of the restricted band.

CHANNEL	TX Channel 116	DETECTOR FUNCTION	Peak (PK)
FREQUENCY RANGE	1GHz ~ 40GHz		Average (AV)

ANTENNA POLARITY & TEST DISTANCE: HORIZONTAL AT 3 M

NO.	FREQ. (MHz)	EMISSION LEVEL (dBuV/m)	LIMIT (dBuV/m)	MARGIN (dB)	ANTENNA HEIGHT (m)	TABLE ANGLE (Degree)	RAW VALUE (dBuV)	CORRECTION FACTOR (dB/m)
1	5420.00	55.3 PK	74.0	-18.7	1.22 H	360	52.57	2.73
2	5420.00	45.6 AV	54.0	-8.4	1.22 H	360	42.87	2.73
3	*5580.00	111.2 PK			1.15 H	343	108.14	3.06
4	*5580.00	100.6 AV			1.15 H	343	97.54	3.06
5	#5740.00	56.2 PK	74.0	-17.8	1.21 H	360	52.83	3.37
6	#5740.00	46.8 AV	54.0	-7.2	1.21 H	360	43.43	3.37
7	#5820.00	56.4 PK	74.0	-17.6	1.12 H	346	52.93	3.47
8	#5820.00	46.6 AV	54.0	-7.4	1.12 H	346	43.13	3.47
9	11160.00	53.0 PK	74.0	-21.0	1.99 H	130	39.38	13.62
10	11160.00	42.1 AV	54.0	-11.9	1.99 H	130	28.48	13.62
11	#16740.00	56.5 PK	74.0	-17.5	2.25 H	135	36.91	19.59
12	#16740.00	45.4 AV	54.0	-8.6	2.25 H	135	25.81	19.59

ANTENNA POLARITY & TEST DISTANCE: VERTICAL AT 3 M

NO.	FREQ. (MHz)	EMISSION LEVEL (dBuV/m)	LIMIT (dBuV/m)	MARGIN (dB)	ANTENNA HEIGHT (m)	TABLE ANGLE (Degree)	RAW VALUE (dBuV)	CORRECTION FACTOR (dB/m)
1	5420.00	59.6 PK	74.0	-14.4	1.04 V	56	56.87	2.73
2	5420.00	49.9 AV	54.0	-4.1	1.04 V	56	47.17	2.73
3	*5580.00	115.3 PK			1.06 V	70	112.24	3.06
4	*5580.00	104.8 AV			1.06 V	70	101.74	3.06
5	#5740.00	60.3 PK	74.0	-13.7	1.06 V	74	56.93	3.37
6	#5740.00	50.6 AV	54.0	-3.4	1.06 V	74	47.23	3.37
7	#5820.00	59.9 PK	74.0	-14.1	1.09 V	63	56.43	3.47
8	#5820.00	50.3 AV	54.0	-3.7	1.09 V	63	46.83	3.47
9	11160.00	51.5 PK	74.0	-22.5	2.45 V	177	37.88	13.62
10	11160.00	41.5 AV	54.0	-12.5	2.45 V	177	27.88	13.62
11	#16740.00	56.0 PK	74.0	-18.0	2.33 V	271	36.41	19.59
12	#16740.00	45.2 AV	54.0	-8.8	2.33 V	271	25.61	19.59

REMARKS:

1. Emission Level(dBuV/m) = Raw Value(dBuV) + Correction Factor(dB/m)
2. Correction Factor(dB/m) = Antenna Factor(dB/m) + Cable Factor(dB) – Pre-Amplifier Factor(dB)
3. The other emission levels were very low against the limit.
4. Margin value = Emission Level – Limit value
5. " * ": Fundamental frequency.
6. " # ": The radiated frequency is out of the restricted band.

CHANNEL	TX Channel 140	DETECTOR FUNCTION	Peak (PK)
FREQUENCY RANGE	1GHz ~ 40GHz		Average (AV)

ANTENNA POLARITY & TEST DISTANCE: HORIZONTAL AT 3 M

NO.	FREQ. (MHz)	EMISSION LEVEL (dBuV/m)	LIMIT (dBuV/m)	MARGIN (dB)	ANTENNA HEIGHT (m)	TABLE ANGLE (Degree)	RAW VALUE (dBuV)	CORRECTION FACTOR (dB/m)
1	*5700.00	106.7 PK			1.22 H	349	103.38	3.32
2	*5700.00	97.1 AV			1.22 H	349	93.78	3.32
3	#5725.00	68.2 PK	74.0	-5.8	1.13 H	343	64.84	3.36
4	#5725.00	49.4 AV	54.0	-4.6	1.13 H	343	46.04	3.36
5	#5780.00	52.4 PK	74.0	-21.6	1.16 H	345	48.98	3.42
6	#5780.00	41.4 AV	54.0	-12.6	1.16 H	345	37.98	3.42
7	11400.00	52.7 PK	74.0	-21.3	2.06 H	125	39.09	13.61
8	11400.00	42.0 AV	54.0	-12.0	2.06 H	125	28.39	13.61
9	#17100.00	56.4 PK	74.0	-17.6	2.18 H	143	35.50	20.90
10	#17100.00	45.6 AV	54.0	-8.4	2.18 H	143	24.70	20.90

ANTENNA POLARITY & TEST DISTANCE: VERTICAL AT 3 M

NO.	FREQ. (MHz)	EMISSION LEVEL (dBuV/m)	LIMIT (dBuV/m)	MARGIN (dB)	ANTENNA HEIGHT (m)	TABLE ANGLE (Degree)	RAW VALUE (dBuV)	CORRECTION FACTOR (dB/m)
1	*5700.00	110.6 PK			1.09 V	50	107.28	3.32
2	*5700.00	101.1 AV			1.09 V	50	97.78	3.32
3	#5725.00	72.5 PK	74.0	-1.5	1.04 V	79	69.14	3.36
4	#5725.00	53.8 AV	54.0	-0.2	1.04 V	79	50.44	3.36
5	#5780.00	56.1 PK	74.0	-17.9	1.08 V	60	52.68	3.42
6	#5780.00	45.2 AV	54.0	-8.8	1.08 V	60	41.78	3.42
7	11400.00	50.7 PK	74.0	-23.3	2.44 V	181	37.09	13.61
8	11400.00	40.7 AV	54.0	-13.3	2.44 V	181	27.09	13.61
9	#17100.00	56.3 PK	74.0	-17.7	2.31 V	255	35.40	20.90
10	#17100.00	45.3 AV	54.0	-8.7	2.31 V	255	24.40	20.90

REMARKS:

1. Emission Level(dBuV/m) = Raw Value(dBuV) + Correction Factor(dB/m)
2. Correction Factor(dB/m) = Antenna Factor(dB/m) + Cable Factor(dB) – Pre-Amplifier Factor(dB)
3. The other emission levels were very low against the limit.
4. Margin value = Emission Level – Limit value
5. " * ": Fundamental frequency.
6. " # ": The radiated frequency is out of the restricted band.

CHANNEL	TX Channel 144	DETECTOR FUNCTION	Peak (PK)
FREQUENCY RANGE	1GHz ~ 40GHz		Average (AV)

ANTENNA POLARITY & TEST DISTANCE: HORIZONTAL AT 3 M

NO.	FREQ. (MHz)	EMISSION LEVEL (dBuV/m)	LIMIT (dBuV/m)	MARGIN (dB)	ANTENNA HEIGHT (m)	TABLE ANGLE (Degree)	RAW VALUE (dBuV)	CORRECTION FACTOR (dB/m)
1	*5720.00	109.6 PK			1.17 H	358	106.25	3.35
2	*5720.00	99.8 AV			1.17 H	358	96.45	3.35
3	#5880.00	55.9 PK	74.0	-18.1	1.12 H	343	52.38	3.52
4	#5880.00	46.6 AV	54.0	-7.4	1.12 H	343	43.08	3.52
5	11440.00	52.9 PK	74.0	-21.1	2.07 H	126	39.34	13.56
6	11440.00	42.1 AV	54.0	-11.9	2.07 H	126	28.54	13.56
7	#17160.00	56.4 PK	74.0	-17.6	2.20 H	135	35.62	20.78
8	#17160.00	45.4 AV	54.0	-8.6	2.20 H	135	24.62	20.78

ANTENNA POLARITY & TEST DISTANCE: VERTICAL AT 3 M

NO.	FREQ. (MHz)	EMISSION LEVEL (dBuV/m)	LIMIT (dBuV/m)	MARGIN (dB)	ANTENNA HEIGHT (m)	TABLE ANGLE (Degree)	RAW VALUE (dBuV)	CORRECTION FACTOR (dB/m)
1	*5720.00	114.1 PK			1.12 V	62	110.75	3.35
2	*5720.00	104.1 AV			1.12 V	62	100.75	3.35
3	#5880.00	60.0 PK	74.0	-14.0	1.13 V	90	56.48	3.52
4	#5880.00	50.9 AV	54.0	-3.1	1.13 V	90	47.38	3.52
5	11440.00	51.6 PK	74.0	-22.4	2.45 V	201	38.04	13.56
6	11440.00	41.3 AV	54.0	-12.7	2.45 V	201	27.74	13.56
7	#17160.00	56.2 PK	74.0	-17.8	2.31 V	260	35.42	20.78
8	#17160.00	45.5 AV	54.0	-8.5	2.31 V	260	24.72	20.78

REMARKS:

1. Emission Level(dBuV/m) = Raw Value(dBuV) + Correction Factor(dB/m)
2. Correction Factor(dB/m) = Antenna Factor(dB/m) + Cable Factor(dB) – Pre-Amplifier Factor(dB)
3. The other emission levels were very low against the limit.
4. Margin value = Emission Level – Limit value
5. " * ": Fundamental frequency.
6. " # ": The radiated frequency is out of the restricted band.

802.11ac VHT20

CHANNEL	TX Channel 52	DETECTOR FUNCTION	Peak (PK)
FREQUENCY RANGE	1GHz ~ 40GHz		Average (AV)

ANTENNA POLARITY & TEST DISTANCE: HORIZONTAL AT 3 M

NO.	FREQ. (MHz)	EMISSION LEVEL (dBuV/m)	LIMIT (dBuV/m)	MARGIN (dB)	ANTENNA HEIGHT (m)	TABLE ANGLE (Degree)	RAW VALUE (dBuV)	CORRECTION FACTOR (dB/m)
1	5100.00	53.1 PK	74.0	-20.9	1.18 H	354	50.78	2.32
2	5100.00	43.3 AV	54.0	-10.7	1.18 H	354	40.98	2.32
3	*5260.00	111.1 PK			1.20 H	339	108.56	2.54
4	*5260.00	101.4 AV			1.20 H	339	98.86	2.54
5	5420.00	55.1 PK	74.0	-18.9	1.22 H	341	52.37	2.73
6	5420.00	45.2 AV	54.0	-8.8	1.22 H	341	42.47	2.73
7	#10520.00	52.2 PK	74.0	-21.8	2.07 H	125	39.80	12.40
8	#10520.00	41.3 AV	54.0	-12.7	2.07 H	125	28.90	12.40
9	15780.00	57.0 PK	74.0	-17.0	2.23 H	131	42.18	14.82
10	15780.00	45.9 AV	54.0	-8.1	2.23 H	131	31.08	14.82

ANTENNA POLARITY & TEST DISTANCE: VERTICAL AT 3 M

NO.	FREQ. (MHz)	EMISSION LEVEL (dBuV/m)	LIMIT (dBuV/m)	MARGIN (dB)	ANTENNA HEIGHT (m)	TABLE ANGLE (Degree)	RAW VALUE (dBuV)	CORRECTION FACTOR (dB/m)
1	5100.00	56.9 PK	74.0	-17.1	1.03 V	296	54.58	2.32
2	5100.00	47.4 AV	54.0	-6.6	1.03 V	296	45.08	2.32
3	*5260.00	114.9 PK			1.07 V	294	112.36	2.54
4	*5260.00	105.1 AV			1.07 V	294	102.56	2.54
5	5420.00	58.8 PK	74.0	-15.2	1.08 V	307	56.07	2.73
6	5420.00	48.9 AV	54.0	-5.1	1.08 V	307	46.17	2.73
7	#10520.00	51.6 PK	74.0	-22.4	2.40 V	192	39.20	12.40
8	#10520.00	41.2 AV	54.0	-12.8	2.40 V	192	28.80	12.40
9	15780.00	56.4 PK	74.0	-17.6	2.38 V	273	41.58	14.82
10	15780.00	45.3 AV	54.0	-8.7	2.38 V	273	30.48	14.82

REMARKS:

1. Emission Level(dBuV/m) = Raw Value(dBuV) + Correction Factor(dB/m)
2. Correction Factor(dB/m) = Antenna Factor(dB/m) + Cable Factor(dB) – Pre-Amplifier Factor(dB)
3. The other emission levels were very low against the limit.
4. Margin value = Emission Level – Limit value
5. " * ": Fundamental frequency.
6. " # ": The radiated frequency is out of the restricted band.

CHANNEL	TX Channel 60	DETECTOR FUNCTION	Peak (PK)
FREQUENCY RANGE	1GHz ~ 40GHz		Average (AV)

ANTENNA POLARITY & TEST DISTANCE: HORIZONTAL AT 3 M

NO.	FREQ. (MHz)	EMISSION LEVEL (dBuV/m)	LIMIT (dBuV/m)	MARGIN (dB)	ANTENNA HEIGHT (m)	TABLE ANGLE (Degree)	RAW VALUE (dBuV)	CORRECTION FACTOR (dB/m)
1	5140.00	53.6 PK	74.0	-20.4	1.23 H	357	51.23	2.37
2	5140.00	43.6 AV	54.0	-10.4	1.23 H	357	41.23	2.37
3	*5300.00	110.2 PK			1.20 H	339	107.59	2.61
4	*5300.00	100.9 AV			1.20 H	339	98.29	2.61
5	5460.00	54.8 PK	74.0	-19.2	1.17 H	350	52.02	2.78
6	5460.00	44.8 AV	54.0	-9.2	1.17 H	350	42.02	2.78
7	10600.00	53.1 PK	74.0	-20.9	2.04 H	130	40.24	12.86
8	10600.00	42.1 AV	54.0	-11.9	2.04 H	130	29.24	12.86
9	15900.00	56.3 PK	74.0	-17.7	2.23 H	119	41.43	14.87
10	15900.00	45.5 AV	54.0	-8.5	2.23 H	119	30.63	14.87

ANTENNA POLARITY & TEST DISTANCE: VERTICAL AT 3 M

NO.	FREQ. (MHz)	EMISSION LEVEL (dBuV/m)	LIMIT (dBuV/m)	MARGIN (dB)	ANTENNA HEIGHT (m)	TABLE ANGLE (Degree)	RAW VALUE (dBuV)	CORRECTION FACTOR (dB/m)
1	5140.00	57.8 PK	74.0	-16.2	1.08 V	310	55.43	2.37
2	5140.00	47.9 AV	54.0	-6.1	1.08 V	310	45.53	2.37
3	*5300.00	113.8 PK			1.07 V	302	111.19	2.61
4	*5300.00	104.4 AV			1.07 V	302	101.79	2.61
5	5460.00	58.7 PK	74.0	-15.3	1.05 V	302	55.92	2.78
6	5460.00	48.9 AV	54.0	-5.1	1.05 V	302	46.12	2.78
7	10600.00	51.6 PK	74.0	-22.4	2.46 V	192	38.74	12.86
8	10600.00	41.2 AV	54.0	-12.8	2.46 V	192	28.34	12.86
9	15900.00	56.9 PK	74.0	-17.1	2.35 V	282	42.03	14.87
10	15900.00	45.8 AV	54.0	-8.2	2.35 V	282	30.93	14.87

REMARKS:

1. Emission Level(dBuV/m) = Raw Value(dBuV) + Correction Factor(dB/m)
2. Correction Factor(dB/m) = Antenna Factor(dB/m) + Cable Factor(dB) – Pre-Amplifier Factor(dB)
3. The other emission levels were very low against the limit.
4. Margin value = Emission Level – Limit value
5. " * ": Fundamental frequency.

CHANNEL	TX Channel 64	DETECTOR FUNCTION	Peak (PK)
FREQUENCY RANGE	1GHz ~ 40GHz		Average (AV)

ANTENNA POLARITY & TEST DISTANCE: HORIZONTAL AT 3 M

NO.	FREQ. (MHz)	EMISSION LEVEL (dBuV/m)	LIMIT (dBuV/m)	MARGIN (dB)	ANTENNA HEIGHT (m)	TABLE ANGLE (Degree)	RAW VALUE (dBuV)	CORRECTION FACTOR (dB/m)
1	*5320.00	109.9 PK			1.14 H	335	107.27	2.63
2	*5320.00	98.7 AV			1.14 H	335	96.07	2.63
3	5350.00	68.7 PK	74.0	-5.3	1.21 H	332	66.05	2.65
4	5350.00	49.4 AV	54.0	-4.6	1.21 H	332	46.75	2.65
5	#5480.00	57.4 PK	74.0	-16.6	1.21 H	347	54.60	2.80
6	#5480.00	46.5 AV	54.0	-7.5	1.21 H	347	43.70	2.80
7	10640.00	52.6 PK	74.0	-21.4	2.00 H	136	39.72	12.88
8	10640.00	41.6 AV	54.0	-12.4	2.00 H	136	28.72	12.88
9	15960.00	56.2 PK	74.0	-17.8	2.25 H	126	41.27	14.93
10	15960.00	45.5 AV	54.0	-8.5	2.25 H	126	30.57	14.93

ANTENNA POLARITY & TEST DISTANCE: VERTICAL AT 3 M

NO.	FREQ. (MHz)	EMISSION LEVEL (dBuV/m)	LIMIT (dBuV/m)	MARGIN (dB)	ANTENNA HEIGHT (m)	TABLE ANGLE (Degree)	RAW VALUE (dBuV)	CORRECTION FACTOR (dB/m)
1	*5320.00	113.5 PK			1.06 V	287	110.87	2.63
2	*5320.00	102.3 AV			1.06 V	287	99.67	2.63
3	5350.00	72.0 PK	74.0	-2.0	1.06 V	300	69.35	2.65
4	5350.00	53.0 AV	54.0	-1.0	1.06 V	300	50.35	2.65
5	#5480.00	61.3 PK	74.0	-12.7	1.08 V	334	58.50	2.80
6	#5480.00	50.6 AV	54.0	-3.4	1.08 V	334	47.80	2.80
7	10640.00	51.3 PK	74.0	-22.7	2.49 V	192	38.42	12.88
8	10640.00	41.1 AV	54.0	-12.9	2.49 V	192	28.22	12.88
9	15960.00	56.5 PK	74.0	-17.5	2.32 V	268	41.57	14.93
10	15960.00	45.3 AV	54.0	-8.7	2.32 V	268	30.37	14.93

REMARKS:

1. Emission Level(dBuV/m) = Raw Value(dBuV) + Correction Factor(dB/m)
2. Correction Factor(dB/m) = Antenna Factor(dB/m) + Cable Factor(dB) – Pre-Amplifier Factor(dB)
3. The other emission levels were very low against the limit.
4. Margin value = Emission Level – Limit value
5. " * ": Fundamental frequency.
6. " # ": The radiated frequency is out of the restricted band.

CHANNEL	TX Channel 100	DETECTOR FUNCTION	Peak (PK)
FREQUENCY RANGE	1GHz ~ 40GHz		Average (AV)

ANTENNA POLARITY & TEST DISTANCE: HORIZONTAL AT 3 M

NO.	FREQ. (MHz)	EMISSION LEVEL (dBuV/m)	LIMIT (dBuV/m)	MARGIN (dB)	ANTENNA HEIGHT (m)	TABLE ANGLE (Degree)	RAW VALUE (dBuV)	CORRECTION FACTOR (dB/m)
1	5420.00	57.2 PK	74.0	-16.8	1.17 H	359	54.47	2.73
2	5420.00	45.0 AV	54.0	-9.0	1.17 H	359	42.27	2.73
3	#5470.00	69.1 PK	74.0	-4.9	1.13 H	342	66.31	2.79
4	#5470.00	49.5 AV	54.0	-4.5	1.13 H	342	46.71	2.79
5	*5500.00	109.2 PK			1.21 H	339	106.37	2.83
6	*5500.00	99.1 AV			1.21 H	339	96.27	2.83
7	#5730.00	60.7 PK	74.0	-13.3	1.15 H	333	57.35	3.35
8	#5730.00	49.3 AV	54.0	-4.7	1.15 H	333	45.95	3.35
9	11000.00	52.3 PK	74.0	-21.7	2.08 H	129	38.66	13.64
10	11000.00	41.4 AV	54.0	-12.6	2.08 H	129	27.76	13.64
11	#16500.00	56.4 PK	74.0	-17.6	2.22 H	119	37.76	18.64
12	#16500.00	45.6 AV	54.0	-8.4	2.22 H	119	26.96	18.64

ANTENNA POLARITY & TEST DISTANCE: VERTICAL AT 3 M

NO.	FREQ. (MHz)	EMISSION LEVEL (dBuV/m)	LIMIT (dBuV/m)	MARGIN (dB)	ANTENNA HEIGHT (m)	TABLE ANGLE (Degree)	RAW VALUE (dBuV)	CORRECTION FACTOR (dB/m)
1	5420.00	61.7 PK	74.0	-12.3	1.05 V	336	58.97	2.73
2	5420.00	49.3 AV	54.0	-4.7	1.05 V	336	46.57	2.73
3	#5470.00	72.9 PK	74.0	-1.1	1.12 V	337	70.11	2.79
4	#5470.00	53.3 AV	54.0	-0.7	1.12 V	337	50.51	2.79
5	*5500.00	112.7 PK			1.00 V	330	109.87	2.83
6	*5500.00	102.8 AV			1.00 V	330	99.97	2.83
7	#5730.00	64.9 PK	74.0	-9.1	1.07 V	349	61.55	3.35
8	#5730.00	53.6 AV	54.0	-0.4	1.07 V	349	50.25	3.35
9	11000.00	51.1 PK	74.0	-22.9	2.42 V	188	37.46	13.64
10	11000.00	41.2 AV	54.0	-12.8	2.42 V	188	27.56	13.64
11	#16500.00	56.8 PK	74.0	-17.2	2.33 V	263	38.16	18.64
12	#16500.00	45.9 AV	54.0	-8.1	2.33 V	263	27.26	18.64

REMARKS:

1. Emission Level(dBuV/m) = Raw Value(dBuV) + Correction Factor(dB/m)
2. Correction Factor(dB/m) = Antenna Factor(dB/m) + Cable Factor(dB) – Pre-Amplifier Factor(dB)
3. The other emission levels were very low against the limit.
4. Margin value = Emission Level – Limit value
5. " * ": Fundamental frequency.
6. " # ": The radiated frequency is out of the restricted band.

CHANNEL	TX Channel 116	DETECTOR FUNCTION	Peak (PK)
FREQUENCY RANGE	1GHz ~ 40GHz		Average (AV)

ANTENNA POLARITY & TEST DISTANCE: HORIZONTAL AT 3 M

NO.	FREQ. (MHz)	EMISSION LEVEL (dBuV/m)	LIMIT (dBuV/m)	MARGIN (dB)	ANTENNA HEIGHT (m)	TABLE ANGLE (Degree)	RAW VALUE (dBuV)	CORRECTION FACTOR (dB/m)
1	5420.00	55.5 PK	74.0	-18.5	1.13 H	356	52.77	2.73
2	5420.00	46.4 AV	54.0	-7.6	1.13 H	356	43.67	2.73
3	*5580.00	107.7 PK			1.16 H	332	104.64	3.06
4	*5580.00	97.7 AV			1.16 H	332	94.64	3.06
5	#5740.00	54.1 PK	74.0	-19.9	1.19 H	350	50.73	3.37
6	#5740.00	45.5 AV	54.0	-8.5	1.19 H	350	42.13	3.37
7	11160.00	52.6 PK	74.0	-21.4	2.05 H	125	38.98	13.62
8	11160.00	42.0 AV	54.0	-12.0	2.05 H	125	28.38	13.62
9	#16740.00	57.0 PK	74.0	-17.0	2.22 H	118	37.41	19.59
10	#16740.00	46.1 AV	54.0	-7.9	2.22 H	118	26.51	19.59

ANTENNA POLARITY & TEST DISTANCE: VERTICAL AT 3 M

NO.	FREQ. (MHz)	EMISSION LEVEL (dBuV/m)	LIMIT (dBuV/m)	MARGIN (dB)	ANTENNA HEIGHT (m)	TABLE ANGLE (Degree)	RAW VALUE (dBuV)	CORRECTION FACTOR (dB/m)
1	5420.00	59.6 PK	74.0	-14.4	1.06 V	327	56.87	2.73
2	5420.00	50.5 AV	54.0	-3.5	1.06 V	327	47.77	2.73
3	*5580.00	111.8 PK			1.17 V	348	108.74	3.06
4	*5580.00	101.7 AV			1.17 V	348	98.64	3.06
5	#5740.00	58.0 PK	74.0	-16.0	1.04 V	335	54.63	3.37
6	#5740.00	49.3 AV	54.0	-4.7	1.04 V	335	45.93	3.37
7	11160.00	51.9 PK	74.0	-22.1	2.41 V	196	38.28	13.62
8	11160.00	41.5 AV	54.0	-12.5	2.41 V	196	27.88	13.62
9	#16740.00	56.6 PK	74.0	-17.4	2.31 V	272	37.01	19.59
10	#16740.00	45.5 AV	54.0	-8.5	2.31 V	272	25.91	19.59

REMARKS:

1. Emission Level(dBuV/m) = Raw Value(dBuV) + Correction Factor(dB/m)
2. Correction Factor(dB/m) = Antenna Factor(dB/m) + Cable Factor(dB) – Pre-Amplifier Factor(dB)
3. The other emission levels were very low against the limit.
4. Margin value = Emission Level – Limit value
5. " * ": Fundamental frequency.
6. " # ": The radiated frequency is out of the restricted band.

CHANNEL	TX Channel 140	DETECTOR FUNCTION	Peak (PK)
FREQUENCY RANGE	1GHz ~ 40GHz		Average (AV)

ANTENNA POLARITY & TEST DISTANCE: HORIZONTAL AT 3 M

NO.	FREQ. (MHz)	EMISSION LEVEL (dBuV/m)	LIMIT (dBuV/m)	MARGIN (dB)	ANTENNA HEIGHT (m)	TABLE ANGLE (Degree)	RAW VALUE (dBuV)	CORRECTION FACTOR (dB/m)
1	5460.00	56.5 PK	74.0	-17.5	1.16 H	360	53.72	2.78
2	5460.00	45.8 AV	54.0	-8.2	1.16 H	360	43.02	2.78
3	*5700.00	106.4 PK			1.23 H	360	103.08	3.32
4	*5700.00	95.3 AV			1.23 H	360	91.98	3.32
5	#5725.00	64.9 PK	74.0	-9.1	1.15 H	355	61.54	3.36
6	#5725.00	49.0 AV	54.0	-5.0	1.15 H	355	45.64	3.36
7	11400.00	53.0 PK	74.0	-21.0	2.01 H	106	39.39	13.61
8	11400.00	42.2 AV	54.0	-11.8	2.01 H	106	28.59	13.61
9	#17100.00	56.5 PK	74.0	-17.5	2.25 H	133	35.60	20.90
10	#17100.00	45.5 AV	54.0	-8.5	2.25 H	133	24.60	20.90

ANTENNA POLARITY & TEST DISTANCE: VERTICAL AT 3 M

NO.	FREQ. (MHz)	EMISSION LEVEL (dBuV/m)	LIMIT (dBuV/m)	MARGIN (dB)	ANTENNA HEIGHT (m)	TABLE ANGLE (Degree)	RAW VALUE (dBuV)	CORRECTION FACTOR (dB/m)
1	5460.00	60.7 PK	74.0	-13.3	1.04 V	331	57.92	2.78
2	5460.00	50.3 AV	54.0	-3.7	1.04 V	331	47.52	2.78
3	*5700.00	110.7 PK			1.03 V	322	107.38	3.32
4	*5700.00	99.5 AV			1.03 V	322	96.18	3.32
5	#5725.00	69.2 PK	74.0	-4.8	1.05 V	348	65.84	3.36
6	#5725.00	53.3 AV	54.0	-0.7	1.05 V	348	49.94	3.36
7	11400.00	51.4 PK	74.0	-22.6	2.48 V	181	37.79	13.61
8	11400.00	41.3 AV	54.0	-12.7	2.48 V	181	27.69	13.61
9	#17100.00	56.6 PK	74.0	-17.4	2.36 V	255	35.70	20.90
10	#17100.00	45.4 AV	54.0	-8.6	2.36 V	255	24.50	20.90

REMARKS:

1. Emission Level(dBuV/m) = Raw Value(dBuV) + Correction Factor(dB/m)
2. Correction Factor(dB/m) = Antenna Factor(dB/m) + Cable Factor(dB) – Pre-Amplifier Factor(dB)
3. The other emission levels were very low against the limit.
4. Margin value = Emission Level – Limit value
5. " * ": Fundamental frequency.
6. " # ": The radiated frequency is out of the restricted band.

CHANNEL	TX Channel 144	DETECTOR FUNCTION	Peak (PK)
FREQUENCY RANGE	1GHz ~ 40GHz		Average (AV)

ANTENNA POLARITY & TEST DISTANCE: HORIZONTAL AT 3 M

NO.	FREQ. (MHz)	EMISSION LEVEL (dBuV/m)	LIMIT (dBuV/m)	MARGIN (dB)	ANTENNA HEIGHT (m)	TABLE ANGLE (Degree)	RAW VALUE (dBuV)	CORRECTION FACTOR (dB/m)
1	*5720.00	111.2 PK			1.14 H	351	107.85	3.35
2	*5720.00	100.8 AV			1.14 H	351	97.45	3.35
3	#5880.00	55.8 PK	74.0	-18.2	1.15 H	340	52.28	3.52
4	#5880.00	47.2 AV	54.0	-6.8	1.15 H	340	43.68	3.52
5	11440.00	52.4 PK	74.0	-21.6	1.99 H	119	38.84	13.56
6	11440.00	41.5 AV	54.0	-12.5	1.99 H	119	27.94	13.56
7	#17160.00	56.7 PK	74.0	-17.3	2.21 H	141	35.92	20.78
8	#17160.00	45.8 AV	54.0	-8.2	2.21 H	141	25.02	20.78

ANTENNA POLARITY & TEST DISTANCE: VERTICAL AT 3 M

NO.	FREQ. (MHz)	EMISSION LEVEL (dBuV/m)	LIMIT (dBuV/m)	MARGIN (dB)	ANTENNA HEIGHT (m)	TABLE ANGLE (Degree)	RAW VALUE (dBuV)	CORRECTION FACTOR (dB/m)
1	*5720.00	114.6 PK			1.10 V	76	111.25	3.35
2	*5720.00	104.5 AV			1.10 V	76	101.15	3.35
3	#5880.00	59.8 PK	74.0	-14.2	1.11 V	86	56.28	3.52
4	#5880.00	50.9 AV	54.0	-3.1	1.11 V	86	47.38	3.52
5	11440.00	51.1 PK	74.0	-22.9	2.39 V	199	37.54	13.56
6	11440.00	40.8 AV	54.0	-13.2	2.39 V	199	27.24	13.56
7	#17160.00	56.8 PK	74.0	-17.2	2.33 V	260	36.02	20.78
8	#17160.00	45.5 AV	54.0	-8.5	2.33 V	260	24.72	20.78

REMARKS:

1. Emission Level(dBuV/m) = Raw Value(dBuV) + Correction Factor(dB/m)
2. Correction Factor(dB/m) = Antenna Factor(dB/m) + Cable Factor(dB) – Pre-Amplifier Factor(dB)
3. The other emission levels were very low against the limit.
4. Margin value = Emission Level – Limit value
5. " * ": Fundamental frequency.
6. " # ": The radiated frequency is out of the restricted band.

802.11ac VHT40

CHANNEL	TX Channel 54	DETECTOR FUNCTION	Peak (PK)
FREQUENCY RANGE	1GHz ~ 40GHz		Average (AV)

ANTENNA POLARITY & TEST DISTANCE: HORIZONTAL AT 3 M

NO.	FREQ. (MHz)	EMISSION LEVEL (dBuV/m)	LIMIT (dBuV/m)	MARGIN (dB)	ANTENNA HEIGHT (m)	TABLE ANGLE (Degree)	RAW VALUE (dBuV)	CORRECTION FACTOR (dB/m)
1	5110.00	57.1 PK	74.0	-16.9	1.14 H	351	54.78	2.32
2	5110.00	47.1 AV	54.0	-6.9	1.14 H	351	44.78	2.32
3	*5270.00	108.3 PK			1.16 H	349	105.74	2.56
4	*5270.00	97.7 AV			1.16 H	349	95.14	2.56
5	5350.00	64.9 PK	74.0	-9.1	1.13 H	337	62.25	2.65
6	5350.00	49.9 AV	54.0	-4.1	1.13 H	337	47.25	2.65
7	#5855.00	52.6 PK	74.0	-21.4	1.19 H	358	49.11	3.49
8	#5855.00	46.4 AV	54.0	-7.6	1.19 H	358	42.91	3.49
9	#10540.00	52.5 PK	74.0	-21.5	2.02 H	134	39.98	12.52
10	#10540.00	41.5 AV	54.0	-12.5	2.02 H	134	28.98	12.52
11	15810.00	57.0 PK	74.0	-17.0	2.19 H	125	42.24	14.76
12	15810.00	45.9 AV	54.0	-8.1	2.19 H	125	31.14	14.76

ANTENNA POLARITY & TEST DISTANCE: VERTICAL AT 3 M

NO.	FREQ. (MHz)	EMISSION LEVEL (dBuV/m)	LIMIT (dBuV/m)	MARGIN (dB)	ANTENNA HEIGHT (m)	TABLE ANGLE (Degree)	RAW VALUE (dBuV)	CORRECTION FACTOR (dB/m)
1	5110.00	60.8 PK	74.0	-13.2	1.05 V	118	58.48	2.32
2	5110.00	50.8 AV	54.0	-3.2	1.05 V	118	48.48	2.32
3	*5270.00	111.9 PK			1.12 V	340	109.34	2.56
4	*5270.00	101.2 AV			1.12 V	340	98.64	2.56
5	5350.00	68.6 PK	74.0	-5.4	1.05 V	115	65.95	2.65
6	5350.00	53.4 AV	54.0	-0.6	1.05 V	115	50.75	2.65
7	#5855.00	56.6 PK	74.0	-17.4	1.01 V	109	53.11	3.49
8	#5855.00	50.6 AV	54.0	-3.4	1.01 V	109	47.11	3.49
9	#10540.00	51.1 PK	74.0	-22.9	2.40 V	192	38.58	12.52
10	#10540.00	40.9 AV	54.0	-13.1	2.40 V	192	28.38	12.52
11	15810.00	56.5 PK	74.0	-17.5	2.39 V	251	41.74	14.76
12	15810.00	45.3 AV	54.0	-8.7	2.39 V	251	30.54	14.76

REMARKS:

1. Emission Level(dBuV/m) = Raw Value(dBuV) + Correction Factor(dB/m)
2. Correction Factor(dB/m) = Antenna Factor(dB/m) + Cable Factor(dB) – Pre-Amplifier Factor(dB)
3. The other emission levels were very low against the limit.
4. Margin value = Emission Level – Limit value
5. " * ": Fundamental frequency.
6. " # ": The radiated frequency is out of the restricted band.

CHANNEL	TX Channel 62	DETECTOR FUNCTION	Peak (PK)
FREQUENCY RANGE	1GHz ~ 40GHz		Average (AV)

ANTENNA POLARITY & TEST DISTANCE: HORIZONTAL AT 3 M

NO.	FREQ. (MHz)	EMISSION LEVEL (dBuV/m)	LIMIT (dBuV/m)	MARGIN (dB)	ANTENNA HEIGHT (m)	TABLE ANGLE (Degree)	RAW VALUE (dBuV)	CORRECTION FACTOR (dB/m)
1	*5310.00	103.6 PK			1.23 H	345	100.99	2.61
2	*5310.00	93.1 AV			1.23 H	345	90.49	2.61
3	5350.00	67.3 PK	74.0	-6.7	1.15 H	357	64.65	2.65
4	5350.00	49.1 AV	54.0	-4.9	1.15 H	357	46.45	2.65
5	10620.00	52.2 PK	74.0	-21.8	2.01 H	131	39.32	12.88
6	10620.00	41.3 AV	54.0	-12.7	2.01 H	131	28.42	12.88
7	15930.00	57.4 PK	74.0	-16.6	2.25 H	137	42.50	14.90
8	15930.00	46.2 AV	54.0	-7.8	2.25 H	137	31.30	14.90

ANTENNA POLARITY & TEST DISTANCE: VERTICAL AT 3 M

NO.	FREQ. (MHz)	EMISSION LEVEL (dBuV/m)	LIMIT (dBuV/m)	MARGIN (dB)	ANTENNA HEIGHT (m)	TABLE ANGLE (Degree)	RAW VALUE (dBuV)	CORRECTION FACTOR (dB/m)
1	*5310.00	107.0 PK			1.07 V	117	104.39	2.61
2	*5310.00	96.6 AV			1.07 V	117	93.99	2.61
3	5350.00	71.7 PK	74.0	-2.3	1.11 V	108	69.05	2.65
4	5350.00	53.5 AV	54.0	-0.5	1.11 V	108	50.85	2.65
5	10620.00	51.4 PK	74.0	-22.6	2.40 V	189	38.52	12.88
6	10620.00	41.3 AV	54.0	-12.7	2.40 V	189	28.42	12.88
7	15930.00	56.5 PK	74.0	-17.5	2.38 V	257	41.60	14.90
8	15930.00	45.6 AV	54.0	-8.4	2.38 V	257	30.70	14.90

REMARKS:

1. Emission Level(dBuV/m) = Raw Value(dBuV) + Correction Factor(dB/m)
2. Correction Factor(dB/m) = Antenna Factor(dB/m) + Cable Factor(dB) – Pre-Amplifier Factor(dB)
3. The other emission levels were very low against the limit.
4. Margin value = Emission Level – Limit value
5. " * ": Fundamental frequency.

CHANNEL	TX Channel 102	DETECTOR FUNCTION	Peak (PK)
FREQUENCY RANGE	1GHz ~ 40GHz		Average (AV)

ANTENNA POLARITY & TEST DISTANCE: HORIZONTAL AT 3 M

NO.	FREQ. (MHz)	EMISSION LEVEL (dBuV/m)	LIMIT (dBuV/m)	MARGIN (dB)	ANTENNA HEIGHT (m)	TABLE ANGLE (Degree)	RAW VALUE (dBuV)	CORRECTION FACTOR (dB/m)
1	#5470.00	68.8 PK	74.0	-5.2	1.23 H	344	66.01	2.79
2	#5470.00	49.7 AV	54.0	-4.3	1.23 H	344	46.91	2.79
3	*5510.00	103.7 PK			1.17 H	352	100.85	2.85
4	*5510.00	93.0 AV			1.17 H	352	90.15	2.85
5	#5750.00	53.5 PK	74.0	-20.5	1.17 H	359	50.12	3.38
6	#5750.00	43.1 AV	54.0	-10.9	1.17 H	359	39.72	3.38
7	11020.00	52.9 PK	74.0	-21.1	2.00 H	132	39.26	13.64
8	11020.00	42.0 AV	54.0	-12.0	2.00 H	132	28.36	13.64
9	#16530.00	56.6 PK	74.0	-17.4	2.21 H	119	37.78	18.82
10	#16530.00	45.8 AV	54.0	-8.2	2.21 H	119	26.98	18.82

ANTENNA POLARITY & TEST DISTANCE: VERTICAL AT 3 M

NO.	FREQ. (MHz)	EMISSION LEVEL (dBuV/m)	LIMIT (dBuV/m)	MARGIN (dB)	ANTENNA HEIGHT (m)	TABLE ANGLE (Degree)	RAW VALUE (dBuV)	CORRECTION FACTOR (dB/m)
1	#5470.00	72.2 PK	74.0	-1.8	1.84 V	113	69.41	2.79
2	#5470.00	53.4 AV	54.0	-0.6	1.84 V	113	50.61	2.79
3	*5510.00	108.1 PK			1.10 V	240	105.25	2.85
4	*5510.00	97.4 AV			1.10 V	240	94.55	2.85
5	#5750.00	57.7 PK	74.0	-16.3	2.06 V	144	54.32	3.38
6	#5750.00	47.1 AV	54.0	-6.9	2.06 V	144	43.72	3.38
7	11020.00	51.6 PK	74.0	-22.4	2.41 V	197	37.96	13.64
8	11020.00	41.7 AV	54.0	-12.3	2.41 V	197	28.06	13.64
9	#16530.00	57.0 PK	74.0	-17.0	2.39 V	257	38.18	18.82
10	#16530.00	45.8 AV	54.0	-8.2	2.39 V	257	26.98	18.82

REMARKS:

1. Emission Level(dBuV/m) = Raw Value(dBuV) + Correction Factor(dB/m)
2. Correction Factor(dB/m) = Antenna Factor(dB/m) + Cable Factor(dB) – Pre-Amplifier Factor(dB)
3. The other emission levels were very low against the limit.
4. Margin value = Emission Level – Limit value
5. " * ": Fundamental frequency.
6. " # ": The radiated frequency is out of the restricted band.

CHANNEL	TX Channel 110	DETECTOR FUNCTION	Peak (PK)
FREQUENCY RANGE	1GHz ~ 40GHz		Average (AV)

ANTENNA POLARITY & TEST DISTANCE: HORIZONTAL AT 3 M

NO.	FREQ. (MHz)	EMISSION LEVEL (dBuV/m)	LIMIT (dBuV/m)	MARGIN (dB)	ANTENNA HEIGHT (m)	TABLE ANGLE (Degree)	RAW VALUE (dBuV)	CORRECTION FACTOR (dB/m)
1	5390.00	58.9 PK	74.0	-15.1	1.15 H	355	56.20	2.70
2	5390.00	47.6 AV	54.0	-6.4	1.15 H	355	44.90	2.70
3	*5550.00	108.6 PK			1.16 H	360	105.62	2.98
4	*5550.00	97.2 AV			1.16 H	360	94.22	2.98
5	#5725.00	56.5 PK	74.0	-17.5	1.17 H	343	53.14	3.36
6	#5725.00	46.4 AV	54.0	-7.6	1.17 H	343	43.04	3.36
7	11100.00	52.3 PK	74.0	-21.7	2.01 H	127	38.68	13.62
8	11100.00	41.3 AV	54.0	-12.7	2.01 H	127	27.68	13.62
9	#16650.00	56.5 PK	74.0	-17.5	2.16 H	116	37.11	19.39
10	#16650.00	45.6 AV	54.0	-8.4	2.16 H	116	26.21	19.39

ANTENNA POLARITY & TEST DISTANCE: VERTICAL AT 3 M

NO.	FREQ. (MHz)	EMISSION LEVEL (dBuV/m)	LIMIT (dBuV/m)	MARGIN (dB)	ANTENNA HEIGHT (m)	TABLE ANGLE (Degree)	RAW VALUE (dBuV)	CORRECTION FACTOR (dB/m)
1	5390.00	62.8 PK	74.0	-11.2	1.05 V	248	60.10	2.70
2	5390.00	51.3 AV	54.0	-2.7	1.05 V	248	48.60	2.70
3	*5550.00	112.8 PK			1.07 V	139	109.82	2.98
4	*5550.00	101.6 AV			1.07 V	139	98.62	2.98
5	#5725.00	60.6 PK	74.0	-13.4	1.09 V	227	57.24	3.36
6	#5725.00	50.7 AV	54.0	-3.3	1.09 V	227	47.34	3.36
7	11100.00	51.5 PK	74.0	-22.5	2.41 V	194	37.88	13.62
8	11100.00	41.3 AV	54.0	-12.7	2.41 V	194	27.68	13.62
9	#16650.00	56.6 PK	74.0	-17.4	2.33 V	253	37.21	19.39
10	#16650.00	45.7 AV	54.0	-8.3	2.33 V	253	26.31	19.39

REMARKS:

1. Emission Level(dBuV/m) = Raw Value(dBuV) + Correction Factor(dB/m)
2. Correction Factor(dB/m) = Antenna Factor(dB/m) + Cable Factor(dB) – Pre-Amplifier Factor(dB)
3. The other emission levels were very low against the limit.
4. Margin value = Emission Level – Limit value
5. " * ": Fundamental frequency.
6. " # ": The radiated frequency is out of the restricted band.

CHANNEL	TX Channel 134	DETECTOR FUNCTION	Peak (PK)
FREQUENCY RANGE	1GHz ~ 40GHz		Average (AV)

ANTENNA POLARITY & TEST DISTANCE: HORIZONTAL AT 3 M

NO.	FREQ. (MHz)	EMISSION LEVEL (dBuV/m)	LIMIT (dBuV/m)	MARGIN (dB)	ANTENNA HEIGHT (m)	TABLE ANGLE (Degree)	RAW VALUE (dBuV)	CORRECTION FACTOR (dB/m)
1	5430.00	54.6 PK	74.0	-19.4	1.21 H	347	51.86	2.74
2	5430.00	44.4 AV	54.0	-9.6	1.21 H	347	41.66	2.74
3	*5670.00	105.0 PK			1.12 H	348	101.74	3.26
4	*5670.00	93.0 AV			1.12 H	348	89.74	3.26
5	#5725.00	66.9 PK	74.0	-7.1	1.19 H	352	63.54	3.36
6	#5725.00	49.3 AV	54.0	-4.7	1.19 H	352	45.94	3.36
7	11340.00	52.8 PK	74.0	-21.2	2.04 H	136	39.10	13.70
8	11340.00	41.7 AV	54.0	-12.3	2.04 H	136	28.00	13.70
9	#17010.00	56.0 PK	74.0	-18.0	2.15 H	130	35.23	20.77
10	#17010.00	45.4 AV	54.0	-8.6	2.15 H	130	24.63	20.77

ANTENNA POLARITY & TEST DISTANCE: VERTICAL AT 3 M

NO.	FREQ. (MHz)	EMISSION LEVEL (dBuV/m)	LIMIT (dBuV/m)	MARGIN (dB)	ANTENNA HEIGHT (m)	TABLE ANGLE (Degree)	RAW VALUE (dBuV)	CORRECTION FACTOR (dB/m)
1	5430.00	59.1 PK	74.0	-14.9	1.17 V	205	56.36	2.74
2	5430.00	48.8 AV	54.0	-5.2	1.17 V	205	46.06	2.74
3	*5670.00	108.7 PK			1.08 V	102	105.44	3.26
4	*5670.00	96.6 AV			1.08 V	102	93.34	3.26
5	#5725.00	71.2 PK	74.0	-2.8	1.11 V	243	67.84	3.36
6	#5725.00	53.3 AV	54.0	-0.7	1.11 V	243	49.94	3.36
7	11340.00	51.6 PK	74.0	-22.4	2.43 V	178	37.90	13.70
8	11340.00	41.4 AV	54.0	-12.6	2.43 V	178	27.70	13.70
9	#17010.00	56.9 PK	74.0	-17.1	2.39 V	259	36.13	20.77
10	#17010.00	45.9 AV	54.0	-8.1	2.39 V	259	25.13	20.77

REMARKS:

1. Emission Level(dBuV/m) = Raw Value(dBuV) + Correction Factor(dB/m)
2. Correction Factor(dB/m) = Antenna Factor(dB/m) + Cable Factor(dB) – Pre-Amplifier Factor(dB)
3. The other emission levels were very low against the limit.
4. Margin value = Emission Level – Limit value
5. " * ": Fundamental frequency.
6. " # ": The radiated frequency is out of the restricted band.

CHANNEL	TX Channel 142	DETECTOR FUNCTION	Peak (PK)
FREQUENCY RANGE	1GHz ~ 40GHz		Average (AV)

ANTENNA POLARITY & TEST DISTANCE: HORIZONTAL AT 3 M

NO.	FREQ. (MHz)	EMISSION LEVEL (dBuV/m)	LIMIT (dBuV/m)	MARGIN (dB)	ANTENNA HEIGHT (m)	TABLE ANGLE (Degree)	RAW VALUE (dBuV)	CORRECTION FACTOR (dB/m)
1	5460.00	53.0 PK	74.0	-21.0	1.14 H	360	50.22	2.78
2	5460.00	42.0 AV	54.0	-12.0	1.14 H	360	39.22	2.78
3	*5710.00	109.5 PK			1.15 H	353	106.16	3.34
4	*5710.00	97.7 AV			1.15 H	353	94.36	3.34
5	#5870.00	55.2 PK	74.0	-18.8	1.19 H	343	51.69	3.51
6	#5870.00	45.3 AV	54.0	-8.7	1.19 H	343	41.79	3.51
7	11420.00	53.1 PK	74.0	-20.9	2.04 H	108	39.51	13.59
8	11420.00	42.1 AV	54.0	-11.9	2.04 H	108	28.51	13.59
9	#17130.00	56.3 PK	74.0	-17.7	2.22 H	114	35.47	20.83
10	#17130.00	45.5 AV	54.0	-8.5	2.22 H	114	24.67	20.83

ANTENNA POLARITY & TEST DISTANCE: VERTICAL AT 3 M

NO.	FREQ. (MHz)	EMISSION LEVEL (dBuV/m)	LIMIT (dBuV/m)	MARGIN (dB)	ANTENNA HEIGHT (m)	TABLE ANGLE (Degree)	RAW VALUE (dBuV)	CORRECTION FACTOR (dB/m)
1	5460.00	56.9 PK	74.0	-17.1	1.12 V	230	54.12	2.78
2	5460.00	46.1 AV	54.0	-7.9	1.12 V	230	43.32	2.78
3	*5710.00	112.9 PK			1.08 V	132	109.56	3.34
4	*5710.00	101.4 AV			1.08 V	132	98.06	3.34
5	#5870.00	58.8 PK	74.0	-15.2	1.09 V	246	55.29	3.51
6	#5870.00	48.8 AV	54.0	-5.2	1.09 V	246	45.29	3.51
7	11420.00	51.8 PK	74.0	-22.2	2.49 V	192	38.21	13.59
8	11420.00	41.3 AV	54.0	-12.7	2.49 V	192	27.71	13.59
9	#17130.00	56.9 PK	74.0	-17.1	2.39 V	258	36.07	20.83
10	#17130.00	46.0 AV	54.0	-8.0	2.39 V	258	25.17	20.83

REMARKS:

1. Emission Level(dBuV/m) = Raw Value(dBuV) + Correction Factor(dB/m)
2. Correction Factor(dB/m) = Antenna Factor(dB/m) + Cable Factor(dB) – Pre-Amplifier Factor(dB)
3. The other emission levels were very low against the limit.
4. Margin value = Emission Level – Limit value
5. " * ": Fundamental frequency.
6. " # ": The radiated frequency is out of the restricted band.

802.11ac VHT80

CHANNEL	TX Channel 58	DETECTOR FUNCTION	Peak (PK)
FREQUENCY RANGE	1GHz ~ 40GHz		Average (AV)

ANTENNA POLARITY & TEST DISTANCE: HORIZONTAL AT 3 M

NO.	FREQ. (MHz)	EMISSION LEVEL (dBuV/m)	LIMIT (dBuV/m)	MARGIN (dB)	ANTENNA HEIGHT (m)	TABLE ANGLE (Degree)	RAW VALUE (dBuV)	CORRECTION FACTOR (dB/m)
1	5150.00	58.4 PK	74.0	-15.6	1.24 H	50	56.03	2.37
2	5150.00	43.7 AV	54.0	-10.3	1.24 H	50	41.33	2.37
3	*5290.00	98.9 PK			1.13 H	360	96.31	2.59
4	*5290.00	87.4 AV			1.13 H	360	84.81	2.59
5	5350.00	60.5 PK	74.0	-13.5	1.12 H	346	57.85	2.65
6	5350.00	49.3 AV	54.0	-4.7	1.12 H	346	46.65	2.65
7	#10580.00	52.5 PK	74.0	-21.5	1.97 H	108	39.75	12.75
8	#10580.00	41.8 AV	54.0	-12.2	1.97 H	108	29.05	12.75
9	15870.00	56.6 PK	74.0	-17.4	2.22 H	126	41.77	14.83
10	15870.00	45.8 AV	54.0	-8.2	2.22 H	126	30.97	14.83

ANTENNA POLARITY & TEST DISTANCE: VERTICAL AT 3 M

NO.	FREQ. (MHz)	EMISSION LEVEL (dBuV/m)	LIMIT (dBuV/m)	MARGIN (dB)	ANTENNA HEIGHT (m)	TABLE ANGLE (Degree)	RAW VALUE (dBuV)	CORRECTION FACTOR (dB/m)
1	5150.00	45.8 PK	74.0	-28.2	1.24 V	80	43.43	2.37
2	5150.00	32.4 AV	54.0	-21.6	1.24 V	80	30.03	2.37
3	*5290.00	103.5 PK			1.16 V	150	100.91	2.59
4	*5290.00	91.8 AV			1.16 V	150	89.21	2.59
5	5350.00	65.2 PK	74.0	-8.8	1.08 V	123	62.55	2.65
6	5350.00	53.8 AV	54.0	-0.2	1.08 V	123	51.15	2.65
7	#10580.00	51.2 PK	74.0	-22.8	2.48 V	189	38.45	12.75
8	#10580.00	41.0 AV	54.0	-13.0	2.48 V	189	28.25	12.75
9	15870.00	55.9 PK	74.0	-18.1	2.34 V	260	41.07	14.83
10	15870.00	45.2 AV	54.0	-8.8	2.34 V	260	30.37	14.83

REMARKS:

- Emission Level(dBuV/m) = Raw Value(dBuV) + Correction Factor(dB/m)
- Correction Factor(dB/m) = Antenna Factor(dB/m) + Cable Factor(dB) – Pre-Amplifier Factor(dB)
- The other emission levels were very low against the limit.
- Margin value = Emission Level – Limit value
- " * ": Fundamental frequency.
- " # ": The radiated frequency is out of the restricted band.

CHANNEL	TX Channel 106	DETECTOR FUNCTION	Peak (PK)
FREQUENCY RANGE	1GHz ~ 40GHz		Average (AV)

ANTENNA POLARITY & TEST DISTANCE: HORIZONTAL AT 3 M

NO.	FREQ. (MHz)	EMISSION LEVEL (dBuV/m)	LIMIT (dBuV/m)	MARGIN (dB)	ANTENNA HEIGHT (m)	TABLE ANGLE (Degree)	RAW VALUE (dBuV)	CORRECTION FACTOR (dB/m)
1	#5470.00	65.6 PK	74.0	-8.4	1.19 H	347	62.81	2.79
2	#5470.00	49.4 AV	54.0	-4.6	1.19 H	347	46.61	2.79
3	*5530.00	100.7 PK			1.18 H	350	97.78	2.92
4	*5530.00	89.0 AV			1.18 H	350	86.08	2.92
5	#5725.00	52.5 PK	74.0	-21.5	1.17 H	339	49.14	3.36
6	#5725.00	41.4 AV	54.0	-12.6	1.17 H	339	38.04	3.36
7	11060.00	52.7 PK	74.0	-21.3	2.06 H	108	39.07	13.63
8	11060.00	41.8 AV	54.0	-12.2	2.06 H	108	28.17	13.63
9	#16590.00	56.3 PK	74.0	-17.7	2.18 H	132	37.12	19.18
10	#16590.00	45.3 AV	54.0	-8.7	2.18 H	132	26.12	19.18

ANTENNA POLARITY & TEST DISTANCE: VERTICAL AT 3 M

NO.	FREQ. (MHz)	EMISSION LEVEL (dBuV/m)	LIMIT (dBuV/m)	MARGIN (dB)	ANTENNA HEIGHT (m)	TABLE ANGLE (Degree)	RAW VALUE (dBuV)	CORRECTION FACTOR (dB/m)
1	#5470.00	70.2 PK	74.0	-3.8	1.06 V	247	67.41	2.79
2	#5470.00	53.8 AV	54.0	-0.2	1.06 V	247	51.01	2.79
3	*5530.00	104.9 PK			1.21 V	240	101.98	2.92
4	*5530.00	93.2 AV			1.21 V	240	90.28	2.92
5	#5725.00	56.6 PK	74.0	-17.4	1.06 V	237	53.24	3.36
6	#5725.00	45.7 AV	54.0	-8.3	1.06 V	237	42.34	3.36
7	11060.00	50.9 PK	74.0	-23.1	2.47 V	192	37.27	13.63
8	11060.00	40.8 AV	54.0	-13.2	2.47 V	192	27.17	13.63
9	#16590.00	56.9 PK	74.0	-17.1	2.37 V	267	37.72	19.18
10	#16590.00	45.8 AV	54.0	-8.2	2.37 V	267	26.62	19.18

REMARKS:

1. Emission Level(dBuV/m) = Raw Value(dBuV) + Correction Factor(dB/m)
2. Correction Factor(dB/m) = Antenna Factor(dB/m) + Cable Factor(dB) – Pre-Amplifier Factor(dB)
3. The other emission levels were very low against the limit.
4. Margin value = Emission Level – Limit value
5. " * ": Fundamental frequency.
6. " # ": The radiated frequency is out of the restricted band.

CHANNEL	TX Channel 122	DETECTOR FUNCTION	Peak (PK)
FREQUENCY RANGE	1GHz ~ 40GHz		Average (AV)

ANTENNA POLARITY & TEST DISTANCE: HORIZONTAL AT 3 M

NO.	FREQ. (MHz)	EMISSION LEVEL (dBuV/m)	LIMIT (dBuV/m)	MARGIN (dB)	ANTENNA HEIGHT (m)	TABLE ANGLE (Degree)	RAW VALUE (dBuV)	CORRECTION FACTOR (dB/m)
1	#5470.00	62.9 PK	74.0	-11.1	1.17 H	349	60.11	2.79
2	#5470.00	46.5 AV	54.0	-7.5	1.17 H	349	43.71	2.79
3	*5610.00	102.5 PK			1.16 H	337	99.35	3.15
4	*5610.00	89.9 AV			1.16 H	337	86.75	3.15
5	#5725.00	63.4 PK	74.0	-10.6	1.20 H	356	60.04	3.36
6	#5725.00	48.6 AV	54.0	-5.4	1.20 H	356	45.24	3.36
7	11220.00	52.3 PK	74.0	-21.7	2.06 H	116	38.66	13.64
8	11220.00	41.4 AV	54.0	-12.6	2.06 H	116	27.76	13.64
9	#16830.00	56.4 PK	74.0	-17.6	2.22 H	122	36.55	19.85
10	#16830.00	45.4 AV	54.0	-8.6	2.22 H	122	25.55	19.85

ANTENNA POLARITY & TEST DISTANCE: VERTICAL AT 3 M

NO.	FREQ. (MHz)	EMISSION LEVEL (dBuV/m)	LIMIT (dBuV/m)	MARGIN (dB)	ANTENNA HEIGHT (m)	TABLE ANGLE (Degree)	RAW VALUE (dBuV)	CORRECTION FACTOR (dB/m)
1	#5470.00	67.5 PK	74.0	-6.5	1.04 V	231	64.71	2.79
2	#5470.00	50.8 AV	54.0	-3.2	1.04 V	231	48.01	2.79
3	*5610.00	106.8 PK			1.04 V	263	103.65	3.15
4	*5610.00	94.4 AV			1.04 V	263	91.25	3.15
5	#5725.00	67.2 PK	74.0	-6.8	1.01 V	239	63.84	3.36
6	#5725.00	52.6 AV	54.0	-1.4	1.01 V	239	49.24	3.36
7	11220.00	50.8 PK	74.0	-23.2	2.49 V	194	37.16	13.64
8	11220.00	40.8 AV	54.0	-13.2	2.49 V	194	27.16	13.64
9	#16830.00	56.7 PK	74.0	-17.3	2.32 V	253	36.85	19.85
10	#16830.00	45.5 AV	54.0	-8.5	2.32 V	253	25.65	19.85

REMARKS:

1. Emission Level(dBuV/m) = Raw Value(dBuV) + Correction Factor(dB/m)
2. Correction Factor(dB/m) = Antenna Factor(dB/m) + Cable Factor(dB) – Pre-Amplifier Factor(dB)
3. The other emission levels were very low against the limit.
4. Margin value = Emission Level – Limit value
5. " * ": Fundamental frequency.
6. " # ": The radiated frequency is out of the restricted band.

CHANNEL	TX Channel 138	DETECTOR FUNCTION	Peak (PK)
FREQUENCY RANGE	1GHz ~ 40GHz		Average (AV)

ANTENNA POLARITY & TEST DISTANCE: HORIZONTAL AT 3 M

NO.	FREQ. (MHz)	EMISSION LEVEL (dBuV/m)	LIMIT (dBuV/m)	MARGIN (dB)	ANTENNA HEIGHT (m)	TABLE ANGLE (Degree)	RAW VALUE (dBuV)	CORRECTION FACTOR (dB/m)
1	#5470.00	53.7 PK	74.0	-20.3	1.20 H	333	50.91	2.79
2	#5470.00	42.6 AV	54.0	-11.4	1.20 H	333	39.81	2.79
3	*5690.00	105.0 PK			1.15 H	345	101.70	3.30
4	*5690.00	91.8 AV			1.15 H	345	88.50	3.30
5	#5850.00	59.7 PK	78.2	-18.5	1.22 H	360	56.21	3.49
6	11380.00	52.3 PK	74.0	-21.7	2.06 H	129	38.67	13.63
7	11380.00	41.4 AV	54.0	-12.6	2.06 H	129	27.77	13.63
8	#17070.00	56.6 PK	74.0	-17.4	2.16 H	123	35.75	20.85
9	#17070.00	45.7 AV	54.0	-8.3	2.16 H	123	24.85	20.85

ANTENNA POLARITY & TEST DISTANCE: VERTICAL AT 3 M

NO.	FREQ. (MHz)	EMISSION LEVEL (dBuV/m)	LIMIT (dBuV/m)	MARGIN (dB)	ANTENNA HEIGHT (m)	TABLE ANGLE (Degree)	RAW VALUE (dBuV)	CORRECTION FACTOR (dB/m)
1	#5470.00	58.3 PK	74.0	-15.7	2.02 V	253	55.51	2.79
2	#5470.00	47.0 AV	54.0	-7.0	2.02 V	253	44.21	2.79
3	*5690.00	109.1 PK			2.02 V	261	105.80	3.30
4	*5690.00	95.9 AV			2.02 V	261	92.60	3.30
5	#5850.00	64.1 PK	78.2	-14.1	1.02 V	108	60.61	3.49
6	11380.00	51.7 PK	74.0	-22.3	2.42 V	184	38.07	13.63
7	11380.00	41.3 AV	54.0	-12.7	2.42 V	184	27.67	13.63
8	#17070.00	56.2 PK	74.0	-17.8	2.30 V	275	35.35	20.85
9	#17070.00	45.0 AV	54.0	-9.0	2.30 V	275	24.15	20.85

REMARKS:

1. Emission Level(dBuV/m) = Raw Value(dBuV) + Correction Factor(dB/m)
2. Correction Factor(dB/m) = Antenna Factor(dB/m) + Cable Factor(dB) – Pre-Amplifier Factor(dB)
3. The other emission levels were very low against the limit.
4. Margin value = Emission Level – Limit value
5. " * ": Fundamental frequency.
6. " # ": The radiated frequency is out of the restricted band.

1TX
 ANT5
 802.11a

CHANNEL	TX Channel 52	DETECTOR FUNCTION	Peak (PK)
FREQUENCY RANGE	1GHz ~ 40GHz		Average (AV)

ANTENNA POLARITY & TEST DISTANCE: HORIZONTAL AT 3 M								
NO.	FREQ. (MHz)	EMISSION LEVEL (dBuV/m)	LIMIT (dBuV/m)	MARGIN (dB)	ANTENNA HEIGHT (m)	TABLE ANGLE (Degree)	RAW VALUE (dBuV)	CORRECTION FACTOR (dB/m)
1	5100.00	44.5 PK	74.0	-29.5	1.18 H	360	42.18	2.32
2	5100.00	33.9 AV	54.0	-20.1	1.18 H	360	31.58	2.32
3	*5260.00	101.4 PK			1.16 H	340	98.86	2.54
4	*5260.00	91.2 AV			1.16 H	340	88.66	2.54
5	5420.00	46.5 PK	74.0	-27.5	1.17 H	350	43.77	2.73
6	5420.00	35.6 AV	54.0	-18.4	1.17 H	350	32.87	2.73
7	#10520.00	52.7 PK	74.0	-21.3	2.03 H	125	40.30	12.40
8	#10520.00	41.6 AV	54.0	-12.4	2.03 H	125	29.20	12.40
9	15780.00	56.3 PK	74.0	-17.7	2.18 H	118	41.48	14.82
10	15780.00	45.0 AV	54.0	-9.0	2.18 H	118	30.18	14.82

ANTENNA POLARITY & TEST DISTANCE: VERTICAL AT 3 M								
NO.	FREQ. (MHz)	EMISSION LEVEL (dBuV/m)	LIMIT (dBuV/m)	MARGIN (dB)	ANTENNA HEIGHT (m)	TABLE ANGLE (Degree)	RAW VALUE (dBuV)	CORRECTION FACTOR (dB/m)
1	5100.00	57.2 PK	74.0	-16.8	2.63 V	65	54.88	2.32
2	5100.00	46.8 AV	54.0	-7.2	2.63 V	65	44.48	2.32
3	*5260.00	113.8 PK			2.61 V	34	111.26	2.54
4	*5260.00	103.7 AV			2.61 V	34	101.16	2.54
5	5420.00	59.6 PK	74.0	-14.4	2.62 V	37	56.87	2.73
6	5420.00	48.9 AV	54.0	-5.1	2.62 V	37	46.17	2.73
7	#10520.00	50.9 PK	74.0	-23.1	2.54 V	200	38.50	12.40
8	#10520.00	40.7 AV	54.0	-13.3	2.54 V	200	28.30	12.40
9	15780.00	56.2 PK	74.0	-17.8	2.42 V	286	41.38	14.82
10	15780.00	44.9 AV	54.0	-9.1	2.42 V	286	30.08	14.82

REMARKS:

1. Emission Level(dBuV/m) = Raw Value(dBuV) + Correction Factor(dB/m)
2. Correction Factor(dB/m) = Antenna Factor(dB/m) + Cable Factor(dB) – Pre-Amplifier Factor(dB)
3. The other emission levels were very low against the limit.
4. Margin value = Emission Level – Limit value
5. " * ": Fundamental frequency.
6. " # ": The radiated frequency is out of the restricted band.

CHANNEL	TX Channel 60	DETECTOR FUNCTION	Peak (PK)
FREQUENCY RANGE	1GHz ~ 40GHz		Average (AV)

ANTENNA POLARITY & TEST DISTANCE: HORIZONTAL AT 3 M

NO.	FREQ. (MHz)	EMISSION LEVEL (dBuV/m)	LIMIT (dBuV/m)	MARGIN (dB)	ANTENNA HEIGHT (m)	TABLE ANGLE (Degree)	RAW VALUE (dBuV)	CORRECTION FACTOR (dB/m)
1	5140.00	42.5 PK	74.0	-31.5	1.13 H	336	40.13	2.37
2	5140.00	33.4 AV	54.0	-20.6	1.13 H	336	31.03	2.37
3	*5300.00	102.0 PK			1.18 H	349	99.39	2.61
4	*5300.00	91.8 AV			1.18 H	349	89.19	2.61
5	5460.00	50.9 PK	74.0	-23.1	1.12 H	345	48.12	2.78
6	5460.00	36.0 AV	54.0	-18.0	1.12 H	345	33.22	2.78
7	10600.00	50.7 PK	74.0	-23.3	2.07 H	123	37.84	12.86
8	10600.00	38.4 AV	54.0	-15.6	2.07 H	123	25.54	12.86
9	15900.00	52.4 PK	74.0	-21.6	2.13 H	127	37.53	14.87
10	15900.00	39.8 AV	54.0	-14.2	2.13 H	127	24.93	14.87

ANTENNA POLARITY & TEST DISTANCE: VERTICAL AT 3 M

NO.	FREQ. (MHz)	EMISSION LEVEL (dBuV/m)	LIMIT (dBuV/m)	MARGIN (dB)	ANTENNA HEIGHT (m)	TABLE ANGLE (Degree)	RAW VALUE (dBuV)	CORRECTION FACTOR (dB/m)
1	5140.00	55.4 PK	74.0	-18.6	2.52 V	56	53.03	2.37
2	5140.00	46.1 AV	54.0	-7.9	2.52 V	56	43.73	2.37
3	*5300.00	115.4 PK			2.52 V	64	112.79	2.61
4	*5300.00	105.3 AV			2.52 V	64	102.69	2.61
5	5460.00	63.5 PK	74.0	-10.5	2.58 V	52	60.72	2.78
6	5460.00	48.6 AV	54.0	-5.4	2.58 V	52	45.82	2.78
7	10600.00	50.6 PK	74.0	-23.4	2.39 V	170	37.74	12.86
8	10600.00	37.3 AV	54.0	-16.7	2.39 V	170	24.44	12.86
9	15900.00	54.0 PK	74.0	-20.0	2.40 V	330	39.13	14.87
10	15900.00	41.3 AV	54.0	-12.7	2.40 V	330	26.43	14.87

REMARKS:

1. Emission Level(dBuV/m) = Raw Value(dBuV) + Correction Factor(dB/m)
2. Correction Factor(dB/m) = Antenna Factor(dB/m) + Cable Factor(dB) – Pre-Amplifier Factor(dB)
3. The other emission levels were very low against the limit.
4. Margin value = Emission Level – Limit value
5. " * ": Fundamental frequency.

CHANNEL	TX Channel 64	DETECTOR FUNCTION	Peak (PK)
FREQUENCY RANGE	1GHz ~ 40GHz		Average (AV)

ANTENNA POLARITY & TEST DISTANCE: HORIZONTAL AT 3 M

NO.	FREQ. (MHz)	EMISSION LEVEL (dBuV/m)	LIMIT (dBuV/m)	MARGIN (dB)	ANTENNA HEIGHT (m)	TABLE ANGLE (Degree)	RAW VALUE (dBuV)	CORRECTION FACTOR (dB/m)
1	*5320.00	101.5 PK			1.21 H	333	98.87	2.63
2	*5320.00	91.0 AV			1.21 H	333	88.37	2.63
3	5350.00	54.4 PK	74.0	-19.6	1.18 H	340	51.75	2.65
4	5350.00	40.5 AV	54.0	-13.5	1.18 H	340	37.85	2.65
5	10640.00	52.7 PK	74.0	-21.3	2.02 H	124	39.82	12.88
6	10640.00	41.6 AV	54.0	-12.4	2.02 H	124	28.72	12.88
7	15960.00	55.8 PK	74.0	-18.2	2.11 H	129	40.87	14.93
8	15960.00	44.9 AV	54.0	-9.1	2.11 H	129	29.97	14.93

ANTENNA POLARITY & TEST DISTANCE: VERTICAL AT 3 M

NO.	FREQ. (MHz)	EMISSION LEVEL (dBuV/m)	LIMIT (dBuV/m)	MARGIN (dB)	ANTENNA HEIGHT (m)	TABLE ANGLE (Degree)	RAW VALUE (dBuV)	CORRECTION FACTOR (dB/m)
1	*5320.00	114.2 PK			2.43 V	37	111.57	2.63
2	*5320.00	103.9 AV			2.43 V	37	101.27	2.63
3	5350.00	67.6 PK	74.0	-6.4	2.51 V	51	64.95	2.65
4	5350.00	53.6 AV	54.0	-0.4	2.51 V	51	50.95	2.65
5	10640.00	51.4 PK	74.0	-22.6	2.49 V	192	38.52	12.88
6	10640.00	40.8 AV	54.0	-13.2	2.49 V	192	27.92	12.88
7	15960.00	56.2 PK	74.0	-17.8	2.44 V	308	41.27	14.93
8	15960.00	44.9 AV	54.0	-9.1	2.44 V	308	29.97	14.93

REMARKS:

1. Emission Level(dBuV/m) = Raw Value(dBuV) + Correction Factor(dB/m)
2. Correction Factor(dB/m) = Antenna Factor(dB/m) + Cable Factor(dB) – Pre-Amplifier Factor(dB)
3. The other emission levels were very low against the limit.
4. Margin value = Emission Level – Limit value
5. " * ": Fundamental frequency.

CHANNEL	TX Channel 100	DETECTOR FUNCTION	Peak (PK)
FREQUENCY RANGE	1GHz ~ 40GHz		Average (AV)

ANTENNA POLARITY & TEST DISTANCE: HORIZONTAL AT 3 M

NO.	FREQ. (MHz)	EMISSION LEVEL (dBuV/m)	LIMIT (dBuV/m)	MARGIN (dB)	ANTENNA HEIGHT (m)	TABLE ANGLE (Degree)	RAW VALUE (dBuV)	CORRECTION FACTOR (dB/m)
1	#5470.00	58.7 PK	74.0	-15.3	1.17 H	347	55.91	2.79
2	#5470.00	40.7 AV	54.0	-13.3	1.17 H	347	37.91	2.79
3	*5500.00	100.6 PK			1.14 H	342	97.77	2.83
4	*5500.00	90.6 AV			1.14 H	342	87.77	2.83
5	#5735.00	49.5 PK	74.0	-24.5	1.12 H	352	46.13	3.37
6	#5735.00	39.1 AV	54.0	-14.9	1.12 H	352	35.73	3.37
7	11000.00	52.7 PK	74.0	-21.3	1.96 H	121	39.06	13.64
8	11000.00	42.0 AV	54.0	-12.0	1.96 H	121	28.36	13.64
9	#16500.00	55.7 PK	74.0	-18.3	2.16 H	129	37.06	18.64
10	#16500.00	44.6 AV	54.0	-9.4	2.16 H	129	25.96	18.64

ANTENNA POLARITY & TEST DISTANCE: VERTICAL AT 3 M

NO.	FREQ. (MHz)	EMISSION LEVEL (dBuV/m)	LIMIT (dBuV/m)	MARGIN (dB)	ANTENNA HEIGHT (m)	TABLE ANGLE (Degree)	RAW VALUE (dBuV)	CORRECTION FACTOR (dB/m)
1	#5470.00	71.9 PK	74.0	-2.1	2.71 V	63	69.11	2.79
2	#5470.00	53.9 AV	54.0	-0.1	2.71 V	63	51.11	2.79
3	*5500.00	113.8 PK			2.66 V	75	110.97	2.83
4	*5500.00	103.7 AV			2.66 V	75	100.87	2.83
5	#5735.00	62.7 PK	74.0	-11.3	2.73 V	50	59.33	3.37
6	#5735.00	52.0 AV	54.0	-2.0	2.73 V	50	48.63	3.37
7	11000.00	51.5 PK	74.0	-22.5	2.44 V	195	37.86	13.64
8	11000.00	41.3 AV	54.0	-12.7	2.44 V	195	27.66	13.64
9	#16500.00	56.7 PK	74.0	-17.3	2.35 V	284	38.06	18.64
10	#16500.00	45.3 AV	54.0	-8.7	2.35 V	284	26.66	18.64

REMARKS:

- Emission Level(dBuV/m) = Raw Value(dBuV) + Correction Factor(dB/m)
- Correction Factor(dB/m) = Antenna Factor(dB/m) + Cable Factor(dB) – Pre-Amplifier Factor(dB)
- The other emission levels were very low against the limit.
- Margin value = Emission Level – Limit value
- " * ": Fundamental frequency.
- " # ": The radiated frequency is out of the restricted band.

CHANNEL	TX Channel 116	DETECTOR FUNCTION	Peak (PK)
FREQUENCY RANGE	1GHz ~ 40GHz		Average (AV)

ANTENNA POLARITY & TEST DISTANCE: HORIZONTAL AT 3 M

NO.	FREQ. (MHz)	EMISSION LEVEL (dBuV/m)	LIMIT (dBuV/m)	MARGIN (dB)	ANTENNA HEIGHT (m)	TABLE ANGLE (Degree)	RAW VALUE (dBuV)	CORRECTION FACTOR (dB/m)
1	5420.00	46.9 PK	74.0	-27.1	1.12 H	341	44.17	2.73
2	5420.00	38.0 AV	54.0	-16.0	1.12 H	341	35.27	2.73
3	*5580.00	100.3 PK			1.12 H	356	97.24	3.06
4	*5580.00	90.0 AV			1.12 H	356	86.94	3.06
5	#5740.00	44.2 PK	74.0	-29.8	1.18 H	334	40.83	3.37
6	#5740.00	35.9 AV	54.0	-18.1	1.18 H	334	32.53	3.37
7	11160.00	52.9 PK	74.0	-21.1	2.05 H	126	39.28	13.62
8	11160.00	42.0 AV	54.0	-12.0	2.05 H	126	28.38	13.62
9	#16740.00	56.4 PK	74.0	-17.6	2.15 H	142	36.81	19.59
10	#16740.00	45.3 AV	54.0	-8.7	2.15 H	142	25.71	19.59

ANTENNA POLARITY & TEST DISTANCE: VERTICAL AT 3 M

NO.	FREQ. (MHz)	EMISSION LEVEL (dBuV/m)	LIMIT (dBuV/m)	MARGIN (dB)	ANTENNA HEIGHT (m)	TABLE ANGLE (Degree)	RAW VALUE (dBuV)	CORRECTION FACTOR (dB/m)
1	5420.00	60.0 PK	74.0	-14.0	2.63 V	80	57.27	2.73
2	5420.00	50.9 AV	54.0	-3.1	2.63 V	80	48.17	2.73
3	*5580.00	113.5 PK			2.44 V	80	110.44	3.06
4	*5580.00	103.1 AV			2.44 V	80	100.04	3.06
5	#5740.00	56.7 PK	74.0	-17.3	2.50 V	34	53.33	3.37
6	#5740.00	48.5 AV	54.0	-5.5	2.50 V	34	45.13	3.37
7	11160.00	52.0 PK	74.0	-22.0	2.48 V	190	38.38	13.62
8	11160.00	41.7 AV	54.0	-12.3	2.48 V	190	28.08	13.62
9	#16740.00	56.3 PK	74.0	-17.7	2.39 V	304	36.71	19.59
10	#16740.00	45.2 AV	54.0	-8.8	2.39 V	304	25.61	19.59

REMARKS:

1. Emission Level(dBuV/m) = Raw Value(dBuV) + Correction Factor(dB/m)
2. Correction Factor(dB/m) = Antenna Factor(dB/m) + Cable Factor(dB) – Pre-Amplifier Factor(dB)
3. The other emission levels were very low against the limit.
4. Margin value = Emission Level – Limit value
5. " * ": Fundamental frequency.
6. " # ": The radiated frequency is out of the restricted band.

CHANNEL	TX Channel 140	DETECTOR FUNCTION	Peak (PK)
FREQUENCY RANGE	1GHz ~ 40GHz		Average (AV)

ANTENNA POLARITY & TEST DISTANCE: HORIZONTAL AT 3 M

NO.	FREQ. (MHz)	EMISSION LEVEL (dBuV/m)	LIMIT (dBuV/m)	MARGIN (dB)	ANTENNA HEIGHT (m)	TABLE ANGLE (Degree)	RAW VALUE (dBuV)	CORRECTION FACTOR (dB/m)
1	5455.00	48.3 PK	74.0	-25.7	1.20 H	354	45.53	2.77
2	5455.00	38.6 AV	54.0	-15.4	1.20 H	354	35.83	2.77
3	*5700.00	98.8 PK			1.17 H	356	95.48	3.32
4	*5700.00	89.8 AV			1.17 H	356	86.48	3.32
5	#5725.00	59.5 PK	74.0	-14.5	1.19 H	357	56.14	3.36
6	#5725.00	40.2 AV	54.0	-13.8	1.19 H	357	36.84	3.36
7	11400.00	53.2 PK	74.0	-20.8	2.03 H	133	39.59	13.61
8	11400.00	42.0 AV	54.0	-12.0	2.03 H	133	28.39	13.61
9	#17100.00	56.3 PK	74.0	-17.7	2.19 H	141	35.40	20.90
10	#17100.00	45.0 AV	54.0	-9.0	2.19 H	141	24.10	20.90

ANTENNA POLARITY & TEST DISTANCE: VERTICAL AT 3 M

NO.	FREQ. (MHz)	EMISSION LEVEL (dBuV/m)	LIMIT (dBuV/m)	MARGIN (dB)	ANTENNA HEIGHT (m)	TABLE ANGLE (Degree)	RAW VALUE (dBuV)	CORRECTION FACTOR (dB/m)
1	5455.00	61.7 PK	74.0	-12.3	2.46 V	71	58.93	2.77
2	5455.00	51.9 AV	54.0	-2.1	2.46 V	71	49.13	2.77
3	*5700.00	111.2 PK			2.62 V	60	107.88	3.32
4	*5700.00	102.3 AV			2.62 V	60	98.98	3.32
5	#5725.00	72.4 PK	74.0	-1.6	2.56 V	83	69.04	3.36
6	#5725.00	53.0 AV	54.0	-1.0	2.56 V	83	49.64	3.36
7	11400.00	52.1 PK	74.0	-21.9	2.55 V	184	38.49	13.61
8	11400.00	41.5 AV	54.0	-12.5	2.55 V	184	27.89	13.61
9	#17100.00	55.6 PK	74.0	-18.4	2.35 V	304	34.70	20.90
10	#17100.00	44.7 AV	54.0	-9.3	2.35 V	304	23.80	20.90

REMARKS:

1. Emission Level(dBuV/m) = Raw Value(dBuV) + Correction Factor(dB/m)
2. Correction Factor(dB/m) = Antenna Factor(dB/m) + Cable Factor(dB) – Pre-Amplifier Factor(dB)
3. The other emission levels were very low against the limit.
4. Margin value = Emission Level – Limit value
5. " * ": Fundamental frequency.
6. " # ": The radiated frequency is out of the restricted band.

CHANNEL	TX Channel 144	DETECTOR FUNCTION	Peak (PK)
FREQUENCY RANGE	1GHz ~ 40GHz		Average (AV)

ANTENNA POLARITY & TEST DISTANCE: HORIZONTAL AT 3 M

NO.	FREQ. (MHz)	EMISSION LEVEL (dBuV/m)	LIMIT (dBuV/m)	MARGIN (dB)	ANTENNA HEIGHT (m)	TABLE ANGLE (Degree)	RAW VALUE (dBuV)	CORRECTION FACTOR (dB/m)
1	*5720.00	101.9 PK			1.18 H	335	98.55	3.35
2	*5720.00	91.8 AV			1.18 H	335	88.45	3.35
3	#5880.00	49.9 PK	74.0	-24.1	1.22 H	357	46.38	3.52
4	#5880.00	39.6 AV	54.0	-14.4	1.22 H	357	36.08	3.52
5	11440.00	52.7 PK	74.0	-21.3	2.07 H	131	39.14	13.56
6	11440.00	41.8 AV	54.0	-12.2	2.07 H	131	28.24	13.56
7	#17160.00	55.8 PK	74.0	-18.2	2.17 H	114	35.02	20.78
8	#17160.00	44.9 AV	54.0	-9.1	2.17 H	114	24.12	20.78

ANTENNA POLARITY & TEST DISTANCE: VERTICAL AT 3 M

NO.	FREQ. (MHz)	EMISSION LEVEL (dBuV/m)	LIMIT (dBuV/m)	MARGIN (dB)	ANTENNA HEIGHT (m)	TABLE ANGLE (Degree)	RAW VALUE (dBuV)	CORRECTION FACTOR (dB/m)
1	*5720.00	114.6 PK			2.41 V	360	111.25	3.35
2	*5720.00	104.4 AV			2.41 V	360	101.05	3.35
3	#5880.00	62.7 PK	74.0	-11.3	2.44 V	44	59.18	3.52
4	#5880.00	52.7 AV	54.0	-1.3	2.44 V	44	49.18	3.52
5	11440.00	51.8 PK	74.0	-22.2	2.48 V	186	38.24	13.56
6	11440.00	41.7 AV	54.0	-12.3	2.48 V	186	28.14	13.56
7	#17160.00	56.3 PK	74.0	-17.7	2.41 V	276	35.52	20.78
8	#17160.00	45.1 AV	54.0	-8.9	2.41 V	276	24.32	20.78

REMARKS:

1. Emission Level(dBuV/m) = Raw Value(dBuV) + Correction Factor(dB/m)
2. Correction Factor(dB/m) = Antenna Factor(dB/m) + Cable Factor(dB) – Pre-Amplifier Factor(dB)
3. The other emission levels were very low against the limit.
4. Margin value = Emission Level – Limit value
5. " * ": Fundamental frequency.
6. " # ": The radiated frequency is out of the restricted band.

802.11ac VHT20

CHANNEL	TX Channel 52	DETECTOR FUNCTION	Peak (PK)
FREQUENCY RANGE	1GHz ~ 40GHz		Average (AV)

ANTENNA POLARITY & TEST DISTANCE: HORIZONTAL AT 3 M

NO.	FREQ. (MHz)	EMISSION LEVEL (dBuV/m)	LIMIT (dBuV/m)	MARGIN (dB)	ANTENNA HEIGHT (m)	TABLE ANGLE (Degree)	RAW VALUE (dBuV)	CORRECTION FACTOR (dB/m)
1	5100.00	42.5 PK	74.0	-31.5	1.20 H	350	40.18	2.32
2	5100.00	32.8 AV	54.0	-21.2	1.20 H	350	30.48	2.32
3	*5260.00	100.3 PK			1.16 H	336	97.76	2.54
4	*5260.00	90.6 AV			1.16 H	336	88.06	2.54
5	5420.00	43.1 PK	74.0	-30.9	1.11 H	354	40.37	2.73
6	5420.00	34.0 AV	54.0	-20.0	1.11 H	354	31.27	2.73
7	#10520.00	53.0 PK	74.0	-21.0	2.05 H	124	40.60	12.40
8	#10520.00	42.0 AV	54.0	-12.0	2.05 H	124	29.60	12.40
9	15780.00	55.5 PK	74.0	-18.5	2.19 H	121	40.68	14.82
10	15780.00	44.7 AV	54.0	-9.3	2.19 H	121	29.88	14.82

ANTENNA POLARITY & TEST DISTANCE: VERTICAL AT 3 M

NO.	FREQ. (MHz)	EMISSION LEVEL (dBuV/m)	LIMIT (dBuV/m)	MARGIN (dB)	ANTENNA HEIGHT (m)	TABLE ANGLE (Degree)	RAW VALUE (dBuV)	CORRECTION FACTOR (dB/m)
1	5100.00	55.4 PK	74.0	-18.6	2.94 V	99	53.08	2.32
2	5100.00	45.6 AV	54.0	-8.4	2.94 V	99	43.28	2.32
3	*5260.00	112.9 PK			2.54 V	136	110.36	2.54
4	*5260.00	103.3 AV			2.54 V	136	100.76	2.54
5	5420.00	56.2 PK	74.0	-17.8	2.80 V	86	53.47	2.73
6	5420.00	47.1 AV	54.0	-6.9	2.80 V	86	44.37	2.73
7	#10520.00	51.2 PK	74.0	-22.8	2.53 V	174	38.80	12.40
8	#10520.00	40.9 AV	54.0	-13.1	2.53 V	174	28.50	12.40
9	15780.00	56.5 PK	74.0	-17.5	2.36 V	287	41.68	14.82
10	15780.00	45.2 AV	54.0	-8.8	2.36 V	287	30.38	14.82

REMARKS:

1. Emission Level(dBuV/m) = Raw Value(dBuV) + Correction Factor(dB/m)
2. Correction Factor(dB/m) = Antenna Factor(dB/m) + Cable Factor(dB) – Pre-Amplifier Factor(dB)
3. The other emission levels were very low against the limit.
4. Margin value = Emission Level – Limit value
5. " * ": Fundamental frequency.
6. " # ": The radiated frequency is out of the restricted band.

CHANNEL	TX Channel 60	DETECTOR FUNCTION	Peak (PK)
FREQUENCY RANGE	1GHz ~ 40GHz		Average (AV)

ANTENNA POLARITY & TEST DISTANCE: HORIZONTAL AT 3 M

NO.	FREQ. (MHz)	EMISSION LEVEL (dBuV/m)	LIMIT (dBuV/m)	MARGIN (dB)	ANTENNA HEIGHT (m)	TABLE ANGLE (Degree)	RAW VALUE (dBuV)	CORRECTION FACTOR (dB/m)
1	5140.00	41.9 PK	74.0	-32.1	1.18 H	353	39.53	2.37
2	5140.00	33.5 AV	54.0	-20.5	1.18 H	353	31.13	2.37
3	*5300.00	99.0 PK			1.15 H	332	96.39	2.61
4	*5300.00	90.0 AV			1.15 H	332	87.39	2.61
5	5460.00	47.8 PK	74.0	-26.2	1.14 H	347	45.02	2.78
6	5460.00	35.2 AV	54.0	-18.8	1.14 H	347	32.42	2.78
7	10600.00	52.3 PK	74.0	-21.7	1.96 H	126	39.44	12.86
8	10600.00	41.6 AV	54.0	-12.4	1.96 H	126	28.74	12.86
9	15900.00	56.2 PK	74.0	-17.8	2.22 H	143	41.33	14.87
10	15900.00	45.0 AV	54.0	-9.0	2.22 H	143	30.13	14.87

ANTENNA POLARITY & TEST DISTANCE: VERTICAL AT 3 M

NO.	FREQ. (MHz)	EMISSION LEVEL (dBuV/m)	LIMIT (dBuV/m)	MARGIN (dB)	ANTENNA HEIGHT (m)	TABLE ANGLE (Degree)	RAW VALUE (dBuV)	CORRECTION FACTOR (dB/m)
1	5140.00	55.4 PK	74.0	-18.6	2.87 V	88	53.03	2.37
2	5140.00	46.9 AV	54.0	-7.1	2.87 V	88	44.53	2.37
3	*5300.00	112.6 PK			2.51 V	139	109.99	2.61
4	*5300.00	103.4 AV			2.51 V	139	100.79	2.61
5	5460.00	60.1 PK	74.0	-13.9	2.85 V	122	57.32	2.78
6	5460.00	47.8 AV	54.0	-6.2	2.85 V	122	45.02	2.78
7	10600.00	51.0 PK	74.0	-23.0	2.49 V	186	38.14	12.86
8	10600.00	40.7 AV	54.0	-13.3	2.49 V	186	27.84	12.86
9	15900.00	56.6 PK	74.0	-17.4	2.45 V	293	41.73	14.87
10	15900.00	45.2 AV	54.0	-8.8	2.45 V	293	30.33	14.87

REMARKS:

1. Emission Level(dBuV/m) = Raw Value(dBuV) + Correction Factor(dB/m)
2. Correction Factor(dB/m) = Antenna Factor(dB/m) + Cable Factor(dB) – Pre-Amplifier Factor(dB)
3. The other emission levels were very low against the limit.
4. Margin value = Emission Level – Limit value
5. " * ": Fundamental frequency.

CHANNEL	TX Channel 64	DETECTOR FUNCTION	Peak (PK)
FREQUENCY RANGE	1GHz ~ 40GHz		Average (AV)

ANTENNA POLARITY & TEST DISTANCE: HORIZONTAL AT 3 M

NO.	FREQ. (MHz)	EMISSION LEVEL (dBuV/m)	LIMIT (dBuV/m)	MARGIN (dB)	ANTENNA HEIGHT (m)	TABLE ANGLE (Degree)	RAW VALUE (dBuV)	CORRECTION FACTOR (dB/m)
1	*5320.00	100.9 PK			1.19 H	347	98.27	2.63
2	*5320.00	90.5 AV			1.19 H	347	87.87	2.63
3	5350.00	56.9 PK	74.0	-17.1	1.18 H	350	54.25	2.65
4	5350.00	39.9 AV	54.0	-14.1	1.18 H	350	37.25	2.65
5	10640.00	53.2 PK	74.0	-20.8	2.04 H	110	40.32	12.88
6	10640.00	42.4 AV	54.0	-11.6	2.04 H	110	29.52	12.88
7	15960.00	56.6 PK	74.0	-17.4	2.14 H	139	41.67	14.93
8	15960.00	45.3 AV	54.0	-8.7	2.14 H	139	30.37	14.93

ANTENNA POLARITY & TEST DISTANCE: VERTICAL AT 3 M

NO.	FREQ. (MHz)	EMISSION LEVEL (dBuV/m)	LIMIT (dBuV/m)	MARGIN (dB)	ANTENNA HEIGHT (m)	TABLE ANGLE (Degree)	RAW VALUE (dBuV)	CORRECTION FACTOR (dB/m)
1	*5320.00	113.2 PK			2.79 V	109	110.57	2.63
2	*5320.00	103.1 AV			2.79 V	109	100.47	2.63
3	5350.00	70.5 PK	74.0	-3.5	2.76 V	91	67.85	2.65
4	5350.00	53.3 AV	54.0	-0.7	2.76 V	91	50.65	2.65
5	10640.00	51.5 PK	74.0	-22.5	2.43 V	200	38.62	12.88
6	10640.00	41.3 AV	54.0	-12.7	2.43 V	200	28.42	12.88
7	15960.00	56.7 PK	74.0	-17.3	2.34 V	296	41.77	14.93
8	15960.00	45.2 AV	54.0	-8.8	2.34 V	296	30.27	14.93

REMARKS:

1. Emission Level(dBuV/m) = Raw Value(dBuV) + Correction Factor(dB/m)
2. Correction Factor(dB/m) = Antenna Factor(dB/m) + Cable Factor(dB) – Pre-Amplifier Factor(dB)
3. The other emission levels were very low against the limit.
4. Margin value = Emission Level – Limit value
5. " * ": Fundamental frequency.

CHANNEL	TX Channel 100	DETECTOR FUNCTION	Peak (PK)
FREQUENCY RANGE	1GHz ~ 40GHz		Average (AV)

ANTENNA POLARITY & TEST DISTANCE: HORIZONTAL AT 3 M

NO.	FREQ. (MHz)	EMISSION LEVEL (dBuV/m)	LIMIT (dBuV/m)	MARGIN (dB)	ANTENNA HEIGHT (m)	TABLE ANGLE (Degree)	RAW VALUE (dBuV)	CORRECTION FACTOR (dB/m)
1	#5470.00	57.4 PK	74.0	-16.6	1.16 H	351	54.61	2.79
2	#5470.00	40.1 AV	54.0	-13.9	1.16 H	351	37.31	2.79
3	*5500.00	99.8 PK			1.22 H	351	96.97	2.83
4	*5500.00	89.9 AV			1.22 H	351	87.07	2.83
5	11000.00	52.2 PK	74.0	-21.8	2.04 H	111	38.56	13.64
6	11000.00	41.6 AV	54.0	-12.4	2.04 H	111	27.96	13.64
7	#16500.00	55.9 PK	74.0	-18.1	2.15 H	136	37.26	18.64
8	#16500.00	44.8 AV	54.0	-9.2	2.15 H	136	26.16	18.64

ANTENNA POLARITY & TEST DISTANCE: VERTICAL AT 3 M

NO.	FREQ. (MHz)	EMISSION LEVEL (dBuV/m)	LIMIT (dBuV/m)	MARGIN (dB)	ANTENNA HEIGHT (m)	TABLE ANGLE (Degree)	RAW VALUE (dBuV)	CORRECTION FACTOR (dB/m)
1	#5470.00	70.6 PK	74.0	-3.4	2.69 V	64	67.81	2.79
2	#5470.00	53.1 AV	54.0	-0.9	2.69 V	64	50.31	2.79
3	*5500.00	112.7 PK			2.66 V	49	109.87	2.83
4	*5500.00	103.1 AV			2.66 V	49	100.27	2.83
5	11000.00	51.6 PK	74.0	-22.4	2.54 V	191	37.96	13.64
6	11000.00	41.1 AV	54.0	-12.9	2.54 V	191	27.46	13.64
7	#16500.00	56.5 PK	74.0	-17.5	2.35 V	290	37.86	18.64
8	#16500.00	45.5 AV	54.0	-8.5	2.35 V	290	26.86	18.64

REMARKS:

1. Emission Level(dBuV/m) = Raw Value(dBuV) + Correction Factor(dB/m)
2. Correction Factor(dB/m) = Antenna Factor(dB/m) + Cable Factor(dB) – Pre-Amplifier Factor(dB)
3. The other emission levels were very low against the limit.
4. Margin value = Emission Level – Limit value
5. " * ": Fundamental frequency.
6. " # ": The radiated frequency is out of the restricted band.

CHANNEL	TX Channel 116	DETECTOR FUNCTION	Peak (PK)
FREQUENCY RANGE	1GHz ~ 40GHz		Average (AV)

ANTENNA POLARITY & TEST DISTANCE: HORIZONTAL AT 3 M

NO.	FREQ. (MHz)	EMISSION LEVEL (dBuV/m)	LIMIT (dBuV/m)	MARGIN (dB)	ANTENNA HEIGHT (m)	TABLE ANGLE (Degree)	RAW VALUE (dBuV)	CORRECTION FACTOR (dB/m)
1	5420.00	48.7 PK	74.0	-25.3	1.18 H	338	45.97	2.73
2	5420.00	38.9 AV	54.0	-15.1	1.18 H	338	36.17	2.73
3	*5580.00	99.5 PK			1.12 H	358	96.44	3.06
4	*5580.00	90.2 AV			1.12 H	358	87.14	3.06
5	#5740.00	46.9 PK	74.0	-27.1	1.14 H	347	43.53	3.37
6	#5740.00	36.4 AV	54.0	-17.6	1.14 H	347	33.03	3.37
7	11160.00	52.6 PK	74.0	-21.4	2.06 H	116	38.98	13.62
8	11160.00	41.9 AV	54.0	-12.1	2.06 H	116	28.28	13.62
9	#16740.00	56.0 PK	74.0	-18.0	2.19 H	116	36.41	19.59
10	#16740.00	44.7 AV	54.0	-9.3	2.19 H	116	25.11	19.59

ANTENNA POLARITY & TEST DISTANCE: VERTICAL AT 3 M

NO.	FREQ. (MHz)	EMISSION LEVEL (dBuV/m)	LIMIT (dBuV/m)	MARGIN (dB)	ANTENNA HEIGHT (m)	TABLE ANGLE (Degree)	RAW VALUE (dBuV)	CORRECTION FACTOR (dB/m)
1	5420.00	61.3 PK	74.0	-12.7	3.27 V	242	58.57	2.73
2	5420.00	51.5 AV	54.0	-2.5	3.27 V	242	48.77	2.73
3	*5580.00	113.2 PK			2.73 V	351	110.14	3.06
4	*5580.00	103.6 AV			2.73 V	351	100.54	3.06
5	#5740.00	60.1 PK	74.0	-13.9	3.20 V	230	56.73	3.37
6	#5740.00	49.5 AV	54.0	-4.5	3.20 V	230	46.13	3.37
7	11160.00	51.1 PK	74.0	-22.9	2.50 V	190	37.48	13.62
8	11160.00	40.8 AV	54.0	-13.2	2.50 V	190	27.18	13.62
9	#16740.00	56.1 PK	74.0	-17.9	2.39 V	281	36.51	19.59
10	#16740.00	44.8 AV	54.0	-9.2	2.39 V	281	25.21	19.59

REMARKS:

1. Emission Level(dBuV/m) = Raw Value(dBuV) + Correction Factor(dB/m)
2. Correction Factor(dB/m) = Antenna Factor(dB/m) + Cable Factor(dB) – Pre-Amplifier Factor(dB)
3. The other emission levels were very low against the limit.
4. Margin value = Emission Level – Limit value
5. " * ": Fundamental frequency.
6. " # ": The radiated frequency is out of the restricted band.

CHANNEL	TX Channel 140	DETECTOR FUNCTION	Peak (PK)
FREQUENCY RANGE	1GHz ~ 40GHz		Average (AV)

ANTENNA POLARITY & TEST DISTANCE: HORIZONTAL AT 3 M

NO.	FREQ. (MHz)	EMISSION LEVEL (dBuV/m)	LIMIT (dBuV/m)	MARGIN (dB)	ANTENNA HEIGHT (m)	TABLE ANGLE (Degree)	RAW VALUE (dBuV)	CORRECTION FACTOR (dB/m)
1	5460.00	46.6 PK	74.0	-27.4	1.14 H	360	43.82	2.78
2	5460.00	39.4 AV	54.0	-14.6	1.14 H	360	36.62	2.78
3	*5700.00	97.4 PK			1.15 H	345	94.08	3.32
4	*5700.00	87.7 AV			1.15 H	345	84.38	3.32
5	#5725.00	60.6 PK	74.0	-13.4	1.12 H	354	57.24	3.36
6	#5725.00	39.9 AV	54.0	-14.1	1.12 H	354	36.54	3.36
7	11400.00	52.5 PK	74.0	-21.5	1.98 H	120	38.89	13.61
8	11400.00	41.6 AV	54.0	-12.4	1.98 H	120	27.99	13.61
9	#17100.00	56.6 PK	74.0	-17.4	2.15 H	123	35.70	20.90
10	#17100.00	45.6 AV	54.0	-8.4	2.15 H	123	24.70	20.90

ANTENNA POLARITY & TEST DISTANCE: VERTICAL AT 3 M

NO.	FREQ. (MHz)	EMISSION LEVEL (dBuV/m)	LIMIT (dBuV/m)	MARGIN (dB)	ANTENNA HEIGHT (m)	TABLE ANGLE (Degree)	RAW VALUE (dBuV)	CORRECTION FACTOR (dB/m)
1	5460.00	59.1 PK	74.0	-14.9	2.72 V	349	56.32	2.78
2	5460.00	52.0 AV	54.0	-2.0	2.72 V	349	49.22	2.78
3	*5700.00	111.0 PK			2.54 V	345	107.68	3.32
4	*5700.00	101.1 AV			2.54 V	345	97.78	3.32
5	#5725.00	73.6 PK	74.0	-0.4	2.52 V	329	70.24	3.36
6	#5725.00	53.1 AV	54.0	-0.9	2.52 V	329	49.74	3.36
7	11400.00	51.5 PK	74.0	-22.5	2.49 V	196	37.89	13.61
8	11400.00	41.2 AV	54.0	-12.8	2.49 V	196	27.59	13.61
9	#17100.00	56.8 PK	74.0	-17.2	2.43 V	288	35.90	20.90
10	#17100.00	45.5 AV	54.0	-8.5	2.43 V	288	24.60	20.90

REMARKS:

1. Emission Level(dBuV/m) = Raw Value(dBuV) + Correction Factor(dB/m)
2. Correction Factor(dB/m) = Antenna Factor(dB/m) + Cable Factor(dB) – Pre-Amplifier Factor(dB)
3. The other emission levels were very low against the limit.
4. Margin value = Emission Level – Limit value
5. " * ": Fundamental frequency.
6. " # ": The radiated frequency is out of the restricted band.

CHANNEL	TX Channel 144	DETECTOR FUNCTION	Peak (PK)
FREQUENCY RANGE	1GHz ~ 40GHz		Average (AV)

ANTENNA POLARITY & TEST DISTANCE: HORIZONTAL AT 3 M

NO.	FREQ. (MHz)	EMISSION LEVEL (dBuV/m)	LIMIT (dBuV/m)	MARGIN (dB)	ANTENNA HEIGHT (m)	TABLE ANGLE (Degree)	RAW VALUE (dBuV)	CORRECTION FACTOR (dB/m)
1	*5720.00	101.8 PK			1.19 H	353	98.45	3.35
2	*5720.00	91.5 AV			1.19 H	353	88.15	3.35
3	#5880.00	50.8 PK	74.0	-23.2	1.11 H	346	47.28	3.52
4	#5880.00	39.8 AV	54.0	-14.2	1.11 H	346	36.28	3.52
5	11440.00	52.9 PK	74.0	-21.1	1.99 H	117	39.34	13.56
6	11440.00	42.0 AV	54.0	-12.0	1.99 H	117	28.44	13.56
7	#17160.00	56.6 PK	74.0	-17.4	2.14 H	130	35.82	20.78
8	#17160.00	45.5 AV	54.0	-8.5	2.14 H	130	24.72	20.78

ANTENNA POLARITY & TEST DISTANCE: VERTICAL AT 3 M

NO.	FREQ. (MHz)	EMISSION LEVEL (dBuV/m)	LIMIT (dBuV/m)	MARGIN (dB)	ANTENNA HEIGHT (m)	TABLE ANGLE (Degree)	RAW VALUE (dBuV)	CORRECTION FACTOR (dB/m)
1	*5720.00	115.4 PK			2.66 V	7	112.05	3.35
2	*5720.00	104.9 AV			2.66 V	7	101.55	3.35
3	#5880.00	63.7 PK	74.0	-10.3	2.33 V	215	60.18	3.52
4	#5880.00	52.7 AV	54.0	-1.3	2.33 V	215	49.18	3.52
5	11440.00	50.9 PK	74.0	-23.1	2.50 V	183	37.34	13.56
6	11440.00	40.9 AV	54.0	-13.1	2.50 V	183	27.34	13.56
7	#17160.00	56.2 PK	74.0	-17.8	2.39 V	286	35.42	20.78
8	#17160.00	44.7 AV	54.0	-9.3	2.39 V	286	23.92	20.78

REMARKS:

1. Emission Level(dBuV/m) = Raw Value(dBuV) + Correction Factor(dB/m)
2. Correction Factor(dB/m) = Antenna Factor(dB/m) + Cable Factor(dB) – Pre-Amplifier Factor(dB)
3. The other emission levels were very low against the limit.
4. Margin value = Emission Level – Limit value
5. " * ": Fundamental frequency.
6. " # ": The radiated frequency is out of the restricted band.

802.11ac VHT40

CHANNEL	TX Channel 54	DETECTOR FUNCTION	Peak (PK)
FREQUENCY RANGE	1GHz ~ 40GHz		Average (AV)

ANTENNA POLARITY & TEST DISTANCE: HORIZONTAL AT 3 M

NO.	FREQ. (MHz)	EMISSION LEVEL (dBuV/m)	LIMIT (dBuV/m)	MARGIN (dB)	ANTENNA HEIGHT (m)	TABLE ANGLE (Degree)	RAW VALUE (dBuV)	CORRECTION FACTOR (dB/m)
1	5120.00	43.0 PK	74.0	-31.0	1.16 H	358	40.65	2.35
2	5120.00	33.9 AV	54.0	-20.1	1.16 H	358	31.55	2.35
3	*5270.00	98.7 PK			1.18 H	359	96.14	2.56
4	*5270.00	88.3 AV			1.18 H	359	85.74	2.56
5	5350.00	54.7 PK	74.0	-19.3	1.17 H	360	52.05	2.65
6	5350.00	41.3 AV	54.0	-12.7	1.17 H	360	38.65	2.65
7	#10540.00	53.0 PK	74.0	-21.0	2.06 H	111	40.48	12.52
8	#10540.00	41.8 AV	54.0	-12.2	2.06 H	111	29.28	12.52
9	15810.00	55.6 PK	74.0	-18.4	2.21 H	128	40.84	14.76
10	15810.00	44.7 AV	54.0	-9.3	2.21 H	128	29.94	14.76

ANTENNA POLARITY & TEST DISTANCE: VERTICAL AT 3 M

NO.	FREQ. (MHz)	EMISSION LEVEL (dBuV/m)	LIMIT (dBuV/m)	MARGIN (dB)	ANTENNA HEIGHT (m)	TABLE ANGLE (Degree)	RAW VALUE (dBuV)	CORRECTION FACTOR (dB/m)
1	5120.00	56.5 PK	74.0	-17.5	2.84 V	226	54.15	2.35
2	5120.00	47.4 AV	54.0	-6.6	2.84 V	226	45.05	2.35
3	*5270.00	111.3 PK			2.72 V	221	108.74	2.56
4	*5270.00	101.0 AV			2.72 V	221	98.44	2.56
5	5350.00	67.3 PK	74.0	-6.7	2.77 V	198	64.65	2.65
6	5350.00	53.9 AV	54.0	-0.1	2.77 V	198	51.25	2.65
7	#10540.00	51.8 PK	74.0	-22.2	2.49 V	191	39.28	12.52
8	#10540.00	41.7 AV	54.0	-12.3	2.49 V	191	29.18	12.52
9	15810.00	56.0 PK	74.0	-18.0	2.40 V	300	41.24	14.76
10	15810.00	44.9 AV	54.0	-9.1	2.40 V	300	30.14	14.76

REMARKS:

1. Emission Level(dBuV/m) = Raw Value(dBuV) + Correction Factor(dB/m)
2. Correction Factor(dB/m) = Antenna Factor(dB/m) + Cable Factor(dB) – Pre-Amplifier Factor(dB)
3. The other emission levels were very low against the limit.
4. Margin value = Emission Level – Limit value
5. " * ": Fundamental frequency.
6. " # ": The radiated frequency is out of the restricted band.

CHANNEL	TX Channel 62	DETECTOR FUNCTION	Peak (PK)
FREQUENCY RANGE	1GHz ~ 40GHz		Average (AV)

ANTENNA POLARITY & TEST DISTANCE: HORIZONTAL AT 3 M

NO.	FREQ. (MHz)	EMISSION LEVEL (dBuV/m)	LIMIT (dBuV/m)	MARGIN (dB)	ANTENNA HEIGHT (m)	TABLE ANGLE (Degree)	RAW VALUE (dBuV)	CORRECTION FACTOR (dB/m)
1	*5310.00	94.3 PK			1.13 H	348	91.69	2.61
2	*5310.00	83.8 AV			1.13 H	348	81.19	2.61
3	5350.00	58.6 PK	74.0	-15.4	1.23 H	333	55.95	2.65
4	5350.00	39.7 AV	54.0	-14.3	1.23 H	333	37.05	2.65
5	10620.00	53.1 PK	74.0	-20.9	2.06 H	112	40.22	12.88
6	10620.00	42.4 AV	54.0	-11.6	2.06 H	112	29.52	12.88
7	15930.00	56.0 PK	74.0	-18.0	2.19 H	126	41.10	14.90
8	15930.00	44.7 AV	54.0	-9.3	2.19 H	126	29.80	14.90

ANTENNA POLARITY & TEST DISTANCE: VERTICAL AT 3 M

NO.	FREQ. (MHz)	EMISSION LEVEL (dBuV/m)	LIMIT (dBuV/m)	MARGIN (dB)	ANTENNA HEIGHT (m)	TABLE ANGLE (Degree)	RAW VALUE (dBuV)	CORRECTION FACTOR (dB/m)
1	*5310.00	107.6 PK			2.84 V	223	104.99	2.61
2	*5310.00	97.1 AV			2.84 V	223	94.49	2.61
3	5350.00	71.7 PK	74.0	-2.3	2.89 V	218	69.05	2.65
4	5350.00	52.8 AV	54.0	-1.2	2.89 V	218	50.15	2.65
5	10620.00	51.5 PK	74.0	-22.5	2.52 V	184	38.62	12.88
6	10620.00	41.4 AV	54.0	-12.6	2.52 V	184	28.52	12.88
7	15930.00	56.8 PK	74.0	-17.2	2.44 V	284	41.90	14.90
8	15930.00	45.4 AV	54.0	-8.6	2.44 V	284	30.50	14.90

REMARKS:

1. Emission Level(dBuV/m) = Raw Value(dBuV) + Correction Factor(dB/m)
2. Correction Factor(dB/m) = Antenna Factor(dB/m) + Cable Factor(dB) – Pre-Amplifier Factor(dB)
3. The other emission levels were very low against the limit.
4. Margin value = Emission Level – Limit value
5. " * ": Fundamental frequency.

CHANNEL	TX Channel 102	DETECTOR FUNCTION	Peak (PK)
FREQUENCY RANGE	1GHz ~ 40GHz		Average (AV)

ANTENNA POLARITY & TEST DISTANCE: HORIZONTAL AT 3 M

NO.	FREQ. (MHz)	EMISSION LEVEL (dBuV/m)	LIMIT (dBuV/m)	MARGIN (dB)	ANTENNA HEIGHT (m)	TABLE ANGLE (Degree)	RAW VALUE (dBuV)	CORRECTION FACTOR (dB/m)
1	#5470.00	58.3 PK	74.0	-15.7	1.14 H	348	55.51	2.79
2	#5470.00	39.9 AV	54.0	-14.1	1.14 H	348	37.11	2.79
3	*5510.00	96.2 PK			1.15 H	360	93.35	2.85
4	*5510.00	85.6 AV			1.15 H	360	82.75	2.85
5	#5970.00	42.9 PK	74.0	-31.1	1.17 H	355	39.17	3.73
6	#5970.00	34.4 AV	54.0	-19.6	1.17 H	355	30.67	3.73
7	11020.00	52.6 PK	74.0	-21.4	2.01 H	130	38.96	13.64
8	11020.00	41.5 AV	54.0	-12.5	2.01 H	130	27.86	13.64
9	#16530.00	56.2 PK	74.0	-17.8	2.16 H	138	37.38	18.82
10	#16530.00	45.0 AV	54.0	-9.0	2.16 H	138	26.18	18.82

ANTENNA POLARITY & TEST DISTANCE: VERTICAL AT 3 M

NO.	FREQ. (MHz)	EMISSION LEVEL (dBuV/m)	LIMIT (dBuV/m)	MARGIN (dB)	ANTENNA HEIGHT (m)	TABLE ANGLE (Degree)	RAW VALUE (dBuV)	CORRECTION FACTOR (dB/m)
1	#5470.00	71.7 PK	74.0	-2.3	2.81 V	325	68.91	2.79
2	#5470.00	53.4 AV	54.0	-0.6	2.81 V	325	50.61	2.79
3	*5510.00	109.1 PK			2.91 V	360	106.25	2.85
4	*5510.00	98.3 AV			2.91 V	360	95.45	2.85
5	#5970.00	55.9 PK	74.0	-18.1	2.87 V	352	52.17	3.73
6	#5970.00	47.4 AV	54.0	-6.6	2.87 V	352	43.67	3.73
7	11020.00	51.4 PK	74.0	-22.6	2.44 V	202	37.76	13.64
8	11020.00	41.4 AV	54.0	-12.6	2.44 V	202	27.76	13.64
9	#16530.00	55.6 PK	74.0	-18.4	2.35 V	283	36.78	18.82
10	#16530.00	44.7 AV	54.0	-9.3	2.35 V	283	25.88	18.82

REMARKS:

1. Emission Level(dBuV/m) = Raw Value(dBuV) + Correction Factor(dB/m)
2. Correction Factor(dB/m) = Antenna Factor(dB/m) + Cable Factor(dB) – Pre-Amplifier Factor(dB)
3. The other emission levels were very low against the limit.
4. Margin value = Emission Level – Limit value
5. " * ": Fundamental frequency.
6. " # ": The radiated frequency is out of the restricted band.

CHANNEL	TX Channel 110	DETECTOR FUNCTION	Peak (PK)
FREQUENCY RANGE	1GHz ~ 40GHz		Average (AV)

ANTENNA POLARITY & TEST DISTANCE: HORIZONTAL AT 3 M

NO.	FREQ. (MHz)	EMISSION LEVEL (dBuV/m)	LIMIT (dBuV/m)	MARGIN (dB)	ANTENNA HEIGHT (m)	TABLE ANGLE (Degree)	RAW VALUE (dBuV)	CORRECTION FACTOR (dB/m)
1	#5470.00	51.5 PK	74.0	-22.5	1.14 H	337	48.71	2.79
2	#5470.00	38.9 AV	54.0	-15.1	1.14 H	337	36.11	2.79
3	*5550.00	99.1 PK			1.15 H	351	96.12	2.98
4	*5550.00	88.5 AV			1.15 H	351	85.52	2.98
5	#5725.00	43.6 PK	74.0	-30.4	1.14 H	351	40.24	3.36
6	#5725.00	33.8 AV	54.0	-20.2	1.14 H	351	30.44	3.36
7	11100.00	53.0 PK	74.0	-21.0	2.05 H	110	39.38	13.62
8	11100.00	42.0 AV	54.0	-12.0	2.05 H	110	28.38	13.62
9	#16650.00	55.9 PK	74.0	-18.1	2.12 H	142	36.51	19.39
10	#16650.00	44.9 AV	54.0	-9.1	2.12 H	142	25.51	19.39

ANTENNA POLARITY & TEST DISTANCE: VERTICAL AT 3 M

NO.	FREQ. (MHz)	EMISSION LEVEL (dBuV/m)	LIMIT (dBuV/m)	MARGIN (dB)	ANTENNA HEIGHT (m)	TABLE ANGLE (Degree)	RAW VALUE (dBuV)	CORRECTION FACTOR (dB/m)
1	#5470.00	64.9 PK	74.0	-9.1	2.58 V	360	62.11	2.79
2	#5470.00	52.1 AV	54.0	-1.9	2.58 V	360	49.31	2.79
3	*5550.00	112.2 PK			2.71 V	332	109.22	2.98
4	*5550.00	101.6 AV			2.71 V	332	98.62	2.98
5	#5725.00	56.2 PK	74.0	-17.8	2.59 V	310	52.84	3.36
6	#5725.00	46.5 AV	54.0	-7.5	2.59 V	310	43.14	3.36
7	11100.00	50.9 PK	74.0	-23.1	2.44 V	201	37.28	13.62
8	11100.00	40.8 AV	54.0	-13.2	2.44 V	201	27.18	13.62
9	#16650.00	57.0 PK	74.0	-17.0	2.44 V	277	37.61	19.39
10	#16650.00	45.5 AV	54.0	-8.5	2.44 V	277	26.11	19.39

REMARKS:

1. Emission Level(dBuV/m) = Raw Value(dBuV) + Correction Factor(dB/m)
2. Correction Factor(dB/m) = Antenna Factor(dB/m) + Cable Factor(dB) – Pre-Amplifier Factor(dB)
3. The other emission levels were very low against the limit.
4. Margin value = Emission Level – Limit value
5. " * ": Fundamental frequency.
6. " # ": The radiated frequency is out of the restricted band.

CHANNEL	TX Channel 134	DETECTOR FUNCTION	Peak (PK)
FREQUENCY RANGE	1GHz ~ 40GHz		Average (AV)

ANTENNA POLARITY & TEST DISTANCE: HORIZONTAL AT 3 M

NO.	FREQ. (MHz)	EMISSION LEVEL (dBuV/m)	LIMIT (dBuV/m)	MARGIN (dB)	ANTENNA HEIGHT (m)	TABLE ANGLE (Degree)	RAW VALUE (dBuV)	CORRECTION FACTOR (dB/m)
1	*5670.00	95.3 PK			1.23 H	340	92.04	3.26
2	*5670.00	85.4 AV			1.23 H	340	82.14	3.26
3	#5725.00	54.3 PK	74.0	-19.7	1.14 H	351	50.94	3.36
4	#5725.00	40.6 AV	54.0	-13.4	1.14 H	351	37.24	3.36
5	11340.00	52.9 PK	74.0	-21.1	1.99 H	104	39.20	13.70
6	11340.00	41.9 AV	54.0	-12.1	1.99 H	104	28.20	13.70
7	#17010.00	55.9 PK	74.0	-18.1	2.12 H	132	35.13	20.77
8	#17010.00	45.1 AV	54.0	-8.9	2.12 H	132	24.33	20.77

ANTENNA POLARITY & TEST DISTANCE: VERTICAL AT 3 M

NO.	FREQ. (MHz)	EMISSION LEVEL (dBuV/m)	LIMIT (dBuV/m)	MARGIN (dB)	ANTENNA HEIGHT (m)	TABLE ANGLE (Degree)	RAW VALUE (dBuV)	CORRECTION FACTOR (dB/m)
1	*5670.00	108.0 PK			2.55 V	343	104.74	3.26
2	*5670.00	98.1 AV			2.55 V	343	94.84	3.26
3	#5725.00	67.4 PK	74.0	-6.6	2.43 V	303	64.04	3.36
4	#5725.00	53.7 AV	54.0	-0.3	2.43 V	303	50.34	3.36
5	11340.00	51.8 PK	74.0	-22.2	2.46 V	190	38.10	13.70
6	11340.00	41.4 AV	54.0	-12.6	2.46 V	190	27.70	13.70
7	#17010.00	56.7 PK	74.0	-17.3	2.46 V	297	35.93	20.77
8	#17010.00	45.5 AV	54.0	-8.5	2.46 V	297	24.73	20.77

REMARKS:

1. Emission Level(dBuV/m) = Raw Value(dBuV) + Correction Factor(dB/m)
2. Correction Factor(dB/m) = Antenna Factor(dB/m) + Cable Factor(dB) – Pre-Amplifier Factor(dB)
3. The other emission levels were very low against the limit.
4. Margin value = Emission Level – Limit value
5. " * ": Fundamental frequency.
6. " # ": The radiated frequency is out of the restricted band.

CHANNEL	TX Channel 142	DETECTOR FUNCTION	Peak (PK)
FREQUENCY RANGE	1GHz ~ 40GHz		Average (AV)

ANTENNA POLARITY & TEST DISTANCE: HORIZONTAL AT 3 M

NO.	FREQ. (MHz)	EMISSION LEVEL (dBuV/m)	LIMIT (dBuV/m)	MARGIN (dB)	ANTENNA HEIGHT (m)	TABLE ANGLE (Degree)	RAW VALUE (dBuV)	CORRECTION FACTOR (dB/m)
1	5460.00	44.5 PK	74.0	-29.5	1.19 H	348	41.72	2.78
2	5460.00	34.4 AV	54.0	-19.6	1.19 H	348	31.62	2.78
3	*5710.00	98.2 PK			1.17 H	353	94.86	3.34
4	*5710.00	87.0 AV			1.17 H	353	83.66	3.34
5	#5870.00	45.1 PK	74.0	-28.9	1.20 H	353	41.59	3.51
6	#5870.00	33.7 AV	54.0	-20.3	1.20 H	353	30.19	3.51
7	11420.00	53.1 PK	74.0	-20.9	1.99 H	128	39.51	13.59
8	11420.00	42.2 AV	54.0	-11.8	1.99 H	128	28.61	13.59
9	#17130.00	55.6 PK	74.0	-18.4	2.15 H	131	34.77	20.83
10	#17130.00	44.6 AV	54.0	-9.4	2.15 H	131	23.77	20.83

ANTENNA POLARITY & TEST DISTANCE: VERTICAL AT 3 M

NO.	FREQ. (MHz)	EMISSION LEVEL (dBuV/m)	LIMIT (dBuV/m)	MARGIN (dB)	ANTENNA HEIGHT (m)	TABLE ANGLE (Degree)	RAW VALUE (dBuV)	CORRECTION FACTOR (dB/m)
1	5460.00	57.7 PK	74.0	-16.3	2.64 V	343	54.92	2.78
2	5460.00	47.3 AV	54.0	-6.7	2.64 V	343	44.52	2.78
3	*5710.00	111.5 PK			2.96 V	335	108.16	3.34
4	*5710.00	100.2 AV			2.96 V	335	96.86	3.34
5	#5870.00	58.5 PK	74.0	-15.5	2.79 V	360	54.99	3.51
6	#5870.00	47.0 AV	54.0	-7.0	2.79 V	360	43.49	3.51
7	11420.00	51.2 PK	74.0	-22.8	2.52 V	196	37.61	13.59
8	11420.00	40.8 AV	54.0	-13.2	2.52 V	196	27.21	13.59
9	#17130.00	56.7 PK	74.0	-17.3	2.35 V	297	35.87	20.83
10	#17130.00	45.2 AV	54.0	-8.8	2.35 V	297	24.37	20.83

REMARKS:

1. Emission Level(dBuV/m) = Raw Value(dBuV) + Correction Factor(dB/m)
2. Correction Factor(dB/m) = Antenna Factor(dB/m) + Cable Factor(dB) – Pre-Amplifier Factor(dB)
3. The other emission levels were very low against the limit.
4. Margin value = Emission Level – Limit value
5. " * ": Fundamental frequency.
6. " # ": The radiated frequency is out of the restricted band.

802.11ac VHT80

CHANNEL	TX Channel 58	DETECTOR FUNCTION	Peak (PK)
FREQUENCY RANGE	1GHz ~ 40GHz		Average (AV)

ANTENNA POLARITY & TEST DISTANCE: HORIZONTAL AT 3 M

NO.	FREQ. (MHz)	EMISSION LEVEL (dBuV/m)	LIMIT (dBuV/m)	MARGIN (dB)	ANTENNA HEIGHT (m)	TABLE ANGLE (Degree)	RAW VALUE (dBuV)	CORRECTION FACTOR (dB/m)
1	5150.00	44.9 PK	74.0	-29.1	1.20 H	334	42.53	2.37
2	5150.00	30.4 AV	54.0	-23.6	1.20 H	334	28.03	2.37
3	*5290.00	91.1 PK			1.21 H	357	88.51	2.59
4	*5290.00	79.8 AV			1.21 H	357	77.21	2.59
5	5350.00	59.2 PK	74.0	-14.8	1.16 H	360	56.55	2.65
6	5350.00	40.7 AV	54.0	-13.3	1.16 H	360	38.05	2.65
7	#10580.00	52.6 PK	74.0	-21.4	1.99 H	110	39.85	12.75
8	#10580.00	41.7 AV	54.0	-12.3	1.99 H	110	28.95	12.75
9	15870.00	56.1 PK	74.0	-17.9	2.14 H	115	41.27	14.83
10	15870.00	45.0 AV	54.0	-9.0	2.14 H	115	30.17	14.83

ANTENNA POLARITY & TEST DISTANCE: VERTICAL AT 3 M

NO.	FREQ. (MHz)	EMISSION LEVEL (dBuV/m)	LIMIT (dBuV/m)	MARGIN (dB)	ANTENNA HEIGHT (m)	TABLE ANGLE (Degree)	RAW VALUE (dBuV)	CORRECTION FACTOR (dB/m)
1	5150.00	58.1 PK	74.0	-15.9	2.50 V	265	55.73	2.37
2	5150.00	43.5 AV	54.0	-10.5	2.50 V	265	41.13	2.37
3	*5290.00	103.9 PK			2.42 V	260	101.31	2.59
4	*5290.00	92.7 AV			2.42 V	260	90.11	2.59
5	5350.00	72.1 PK	74.0	-1.9	2.44 V	259	69.45	2.65
6	5350.00	53.8 AV	54.0	-0.2	2.44 V	259	51.15	2.65
7	#10580.00	51.5 PK	74.0	-22.5	2.52 V	194	38.75	12.75
8	#10580.00	41.2 AV	54.0	-12.8	2.52 V	194	28.45	12.75
9	15870.00	56.5 PK	74.0	-17.5	2.44 V	307	41.67	14.83
10	15870.00	45.4 AV	54.0	-8.6	2.44 V	307	30.57	14.83

REMARKS:

- Emission Level(dBuV/m) = Raw Value(dBuV) + Correction Factor(dB/m)
- Correction Factor(dB/m) = Antenna Factor(dB/m) + Cable Factor(dB) – Pre-Amplifier Factor(dB)
- The other emission levels were very low against the limit.
- Margin value = Emission Level – Limit value
- " * ": Fundamental frequency.
- " # ": The radiated frequency is out of the restricted band.

CHANNEL	TX Channel 106	DETECTOR FUNCTION	Peak (PK)
FREQUENCY RANGE	1GHz ~ 40GHz		Average (AV)

ANTENNA POLARITY & TEST DISTANCE: HORIZONTAL AT 3 M

NO.	FREQ. (MHz)	EMISSION LEVEL (dBuV/m)	LIMIT (dBuV/m)	MARGIN (dB)	ANTENNA HEIGHT (m)	TABLE ANGLE (Degree)	RAW VALUE (dBuV)	CORRECTION FACTOR (dB/m)
1	#5470.00	60.6 PK	74.0	-13.4	1.17 H	339	57.81	2.79
2	#5470.00	40.6 AV	54.0	-13.4	1.17 H	339	37.81	2.79
3	*5530.00	93.4 PK			1.12 H	341	90.48	2.92
4	*5530.00	80.7 AV			1.12 H	341	77.78	2.92
5	11060.00	52.8 PK	74.0	-21.2	1.96 H	110	39.17	13.63
6	11060.00	41.7 AV	54.0	-12.3	1.96 H	110	28.07	13.63
7	#16590.00	56.1 PK	74.0	-17.9	2.20 H	144	36.92	19.18
8	#16590.00	45.0 AV	54.0	-9.0	2.20 H	144	25.82	19.18

ANTENNA POLARITY & TEST DISTANCE: VERTICAL AT 3 M

NO.	FREQ. (MHz)	EMISSION LEVEL (dBuV/m)	LIMIT (dBuV/m)	MARGIN (dB)	ANTENNA HEIGHT (m)	TABLE ANGLE (Degree)	RAW VALUE (dBuV)	CORRECTION FACTOR (dB/m)
1	#5470.00	73.4 PK	74.0	-0.6	2.43 V	295	70.61	2.79
2	#5470.00	53.2 AV	54.0	-0.8	2.43 V	295	50.41	2.79
3	*5530.00	105.9 PK			2.46 V	285	102.98	2.92
4	*5530.00	93.3 AV			2.46 V	285	90.38	2.92
5	11060.00	51.4 PK	74.0	-22.6	2.46 V	188	37.77	13.63
6	11060.00	41.4 AV	54.0	-12.6	2.46 V	188	27.77	13.63
7	#16590.00	56.6 PK	74.0	-17.4	2.36 V	300	37.42	19.18
8	#16590.00	45.2 AV	54.0	-8.8	2.36 V	300	26.02	19.18

REMARKS:

1. Emission Level(dBuV/m) = Raw Value(dBuV) + Correction Factor(dB/m)
2. Correction Factor(dB/m) = Antenna Factor(dB/m) + Cable Factor(dB) – Pre-Amplifier Factor(dB)
3. The other emission levels were very low against the limit.
4. Margin value = Emission Level – Limit value
5. " * ": Fundamental frequency.
6. " # ": The radiated frequency is out of the restricted band.

CHANNEL	TX Channel 122	DETECTOR FUNCTION	Peak (PK)
FREQUENCY RANGE	1GHz ~ 40GHz		Average (AV)

ANTENNA POLARITY & TEST DISTANCE: HORIZONTAL AT 3 M

NO.	FREQ. (MHz)	EMISSION LEVEL (dBuV/m)	LIMIT (dBuV/m)	MARGIN (dB)	ANTENNA HEIGHT (m)	TABLE ANGLE (Degree)	RAW VALUE (dBuV)	CORRECTION FACTOR (dB/m)
1	#5470.00	48.5 PK	74.0	-25.5	1.17 H	360	45.71	2.79
2	#5470.00	36.5 AV	54.0	-17.5	1.17 H	360	33.71	2.79
3	*5610.00	94.4 PK			1.17 H	334	91.25	3.15
4	*5610.00	82.3 AV			1.17 H	334	79.15	3.15
5	#5725.00	56.9 PK	74.0	-17.1	1.23 H	334	53.54	3.36
6	#5725.00	40.7 AV	54.0	-13.3	1.23 H	334	37.34	3.36
7	11220.00	52.9 PK	74.0	-21.1	2.03 H	114	39.26	13.64
8	11220.00	41.8 AV	54.0	-12.2	2.03 H	114	28.16	13.64
9	#16830.00	56.2 PK	74.0	-17.8	2.21 H	118	36.35	19.85
10	#16830.00	44.9 AV	54.0	-9.1	2.21 H	118	25.05	19.85

ANTENNA POLARITY & TEST DISTANCE: VERTICAL AT 3 M

NO.	FREQ. (MHz)	EMISSION LEVEL (dBuV/m)	LIMIT (dBuV/m)	MARGIN (dB)	ANTENNA HEIGHT (m)	TABLE ANGLE (Degree)	RAW VALUE (dBuV)	CORRECTION FACTOR (dB/m)
1	#5470.00	61.8 PK	74.0	-12.2	2.53 V	277	59.01	2.79
2	#5470.00	49.6 AV	54.0	-4.4	2.53 V	277	46.81	2.79
3	*5610.00	107.6 PK			2.56 V	259	104.45	3.15
4	*5610.00	95.6 AV			2.56 V	259	92.45	3.15
5	#5725.00	70.0 PK	74.0	-4.0	2.47 V	290	66.64	3.36
6	#5725.00	53.6 AV	54.0	-0.4	2.47 V	290	50.24	3.36
7	11220.00	51.4 PK	74.0	-22.6	2.47 V	194	37.76	13.64
8	11220.00	40.9 AV	54.0	-13.1	2.47 V	194	27.26	13.64
9	#16830.00	56.5 PK	74.0	-17.5	2.41 V	303	36.65	19.85
10	#16830.00	45.5 AV	54.0	-8.5	2.41 V	303	25.65	19.85

REMARKS:

- Emission Level(dBuV/m) = Raw Value(dBuV) + Correction Factor(dB/m)
- Correction Factor(dB/m) = Antenna Factor(dB/m) + Cable Factor(dB) – Pre-Amplifier Factor(dB)
- The other emission levels were very low against the limit.
- Margin value = Emission Level – Limit value
- " * ": Fundamental frequency.
- " # ": The radiated frequency is out of the restricted band.

CHANNEL	TX Channel 138	DETECTOR FUNCTION	Peak (PK)
FREQUENCY RANGE	1GHz ~ 40GHz		Average (AV)

ANTENNA POLARITY & TEST DISTANCE: HORIZONTAL AT 3 M

NO.	FREQ. (MHz)	EMISSION LEVEL (dBuV/m)	LIMIT (dBuV/m)	MARGIN (dB)	ANTENNA HEIGHT (m)	TABLE ANGLE (Degree)	RAW VALUE (dBuV)	CORRECTION FACTOR (dB/m)
1	*5690.00	94.1 PK			1.16 H	360	90.80	3.30
2	*5690.00	82.0 AV			1.16 H	360	78.70	3.30
3	#5850.00	51.0 PK	78.2	-27.2	1.21 H	344	47.51	3.49
4	11380.00	52.7 PK	74.0	-21.3	2.07 H	126	39.07	13.63
5	11380.00	42.0 AV	54.0	-12.0	2.07 H	126	28.37	13.63
6	#17070.00	56.1 PK	74.0	-17.9	2.14 H	113	35.25	20.85
7	#17070.00	45.0 AV	54.0	-9.0	2.14 H	113	24.15	20.85

ANTENNA POLARITY & TEST DISTANCE: VERTICAL AT 3 M

NO.	FREQ. (MHz)	EMISSION LEVEL (dBuV/m)	LIMIT (dBuV/m)	MARGIN (dB)	ANTENNA HEIGHT (m)	TABLE ANGLE (Degree)	RAW VALUE (dBuV)	CORRECTION FACTOR (dB/m)
1	*5690.00	107.6 PK			2.80 V	360	104.30	3.30
2	*5690.00	95.5 AV			2.80 V	360	92.20	3.30
3	#5850.00	63.7 PK	78.2	-14.5	2.82 V	360	60.21	3.49
4	11380.00	51.9 PK	74.0	-22.1	2.46 V	176	38.27	13.63
5	11380.00	41.3 AV	54.0	-12.7	2.46 V	176	27.67	13.63
6	#17070.00	56.8 PK	74.0	-17.2	2.45 V	293	35.95	20.85
7	#17070.00	45.5 AV	54.0	-8.5	2.45 V	293	24.65	20.85

REMARKS:

1. Emission Level(dBuV/m) = Raw Value(dBuV) + Correction Factor(dB/m)
2. Correction Factor(dB/m) = Antenna Factor(dB/m) + Cable Factor(dB) – Pre-Amplifier Factor(dB)
3. The other emission levels were very low against the limit.
4. Margin value = Emission Level – Limit value
5. " * ": Fundamental frequency.
6. " # ": The radiated frequency is out of the restricted band.

BELOW 1GHz WORST-CASE DATA
802.11ac (VHT 40)
ANT7, ANT8, ANT9

CHANNEL	TX Channel 54	DETECTOR FUNCTION	Quasi-Peak (QP)
FREQUENCY RANGE	Below 1GHz		

ANTENNA POLARITY & TEST DISTANCE: HORIZONTAL AT 3 M

NO.	FREQ. (MHz)	EMISSION LEVEL (dBuV/m)	LIMIT (dBuV/m)	MARGIN (dB)	ANTENNA HEIGHT (m)	TABLE ANGLE (Degree)	RAW VALUE (dBuV)	CORRECTION FACTOR (dB/m)
1	39.53	34.0 QP	40.0	-6.0	1.00 H	78	49.75	-15.79
2	147.52	35.9 QP	43.5	-7.7	2.00 H	66	51.09	-15.24
3	239.47	38.4 QP	46.0	-7.6	1.50 H	271	54.99	-16.62
4	400.01	41.7 QP	46.0	-4.3	1.00 H	66	53.51	-11.78
5	800.01	39.8 QP	46.0	-6.2	1.00 H	283	43.41	-3.57
6	1000.00	34.8 QP	54.0	-19.2	1.50 H	320	35.76	-0.99

ANTENNA POLARITY & TEST DISTANCE: VERTICAL AT 3 M

NO.	FREQ. (MHz)	EMISSION LEVEL (dBuV/m)	LIMIT (dBuV/m)	MARGIN (dB)	ANTENNA HEIGHT (m)	TABLE ANGLE (Degree)	RAW VALUE (dBuV)	CORRECTION FACTOR (dB/m)
1	38.95	34.4 QP	40.0	-5.7	1.00 V	260	50.18	-15.83
2	74.01	34.7 QP	40.0	-5.3	1.50 V	263	53.37	-18.68
3	106.73	39.4 QP	43.5	-4.1	1.00 V	242	57.78	-18.42
4	145.36	32.6 QP	43.5	-10.9	1.00 V	95	47.84	-15.28
5	400.01	40.8 QP	46.0	-5.2	1.50 V	200	52.59	-11.78
6	1000.00	36.0 QP	54.0	-18.0	1.50 V	206	36.95	-0.99

REMARKS:

1. Emission Level(dBuV/m) = Raw Value(dBuV) + Correction Factor(dB/m)
2. Correction Factor(dB/m) = Antenna Factor(dB/m) + Cable Factor(dB) – Pre-Amplifier Factor(dB)
3. The other emission levels were very low against the limit.
4. Margin value = Emission Level – Limit value

4.1.9 Test Results (Mode 3)

BELOW 1GHz WORST-CASE DATA

802.11ac (VHT 40)

ANT1, ANT2, ANT3

CHANNEL	TX Channel 54	DETECTOR FUNCTION	Quasi-Peak (QP)
FREQUENCY RANGE	Below 1GHz		

ANTENNA POLARITY & TEST DISTANCE: HORIZONTAL AT 3 M

NO.	FREQ. (MHz)	EMISSION LEVEL (dBuV/m)	LIMIT (dBuV/m)	MARGIN (dB)	ANTENNA HEIGHT (m)	TABLE ANGLE (Degree)	RAW VALUE (dBuV)	CORRECTION FACTOR (dB/m)
1	39.11	33.4 QP	40.0	-6.6	1.24 H	301	49.23	-15.82
2	88.24	34.4 QP	43.5	-9.1	1.24 H	100	55.42	-21.00
3	146.12	34.3 QP	43.5	-9.2	1.24 H	100	49.62	-15.31
4	164.21	30.4 QP	43.5	-13.1	1.42 H	100	45.67	-15.25
5	799.74	39.4 QP	46.0	-6.6	1.24 H	124	42.99	-3.57
6	999.72	34.7 QP	54.0	-19.3	1.24 H	99	35.71	-0.99

ANTENNA POLARITY & TEST DISTANCE: VERTICAL AT 3 M

NO.	FREQ. (MHz)	EMISSION LEVEL (dBuV/m)	LIMIT (dBuV/m)	MARGIN (dB)	ANTENNA HEIGHT (m)	TABLE ANGLE (Degree)	RAW VALUE (dBuV)	CORRECTION FACTOR (dB/m)
1	30.12	35.0 QP	40.0	-5.0	1.24 V	100	51.51	-16.50
2	73.74	34.1 QP	40.0	-5.9	1.67 V	104	52.72	-18.60
3	106.41	38.2 QP	43.5	-5.3	1.24 V	100	56.66	-18.45
4	146.12	33.2 QP	43.5	-10.3	1.64 V	78	48.52	-15.31
5	249.55	27.0 QP	46.0	-19.0	1.68 V	86	43.16	-16.15
6	1000.00	35.7 QP	54.0	-18.3	1.00 V	333	36.71	-0.99

REMARKS:

1. Emission Level(dBuV/m) = Raw Value(dBuV) + Correction Factor(dB/m)
2. Correction Factor(dB/m) = Antenna Factor(dB/m) + Cable Factor(dB) – Pre-Amplifier Factor(dB)
3. The other emission levels were very low against the limit.
4. Margin value = Emission Level – Limit value

4.1.10 Test Results (Mode 4)

BELOW 1GHz WORST-CASE DATA

802.11ac (VHT 40)

ANT7, ANT8, ANT9

CHANNEL	TX Channel 54	DETECTOR FUNCTION	Quasi-Peak (QP)
FREQUENCY RANGE	Below 1GHz		

ANTENNA POLARITY & TEST DISTANCE: HORIZONTAL AT 3 M

NO.	FREQ. (MHz)	EMISSION LEVEL (dBuV/m)	LIMIT (dBuV/m)	MARGIN (dB)	ANTENNA HEIGHT (m)	TABLE ANGLE (Degree)	RAW VALUE (dBuV)	CORRECTION FACTOR (dB/m)
1	39.92	33.5 QP	40.0	-6.6	1.42 H	100	49.21	-15.76
2	147.24	35.5 QP	43.5	-8.0	1.24 H	100	50.76	-15.25
3	239.12	38.7 QP	46.0	-7.3	1.24 H	66	55.30	-16.63
4	400.12	41.4 QP	46.0	-4.6	1.24 H	99	53.20	-11.78
5	800.24	39.7 QP	46.0	-6.3	1.85 H	57	43.28	-3.56
6	998.50	34.5 QP	54.0	-19.5	1.54 H	240	35.52	-1.01

ANTENNA POLARITY & TEST DISTANCE: VERTICAL AT 3 M

NO.	FREQ. (MHz)	EMISSION LEVEL (dBuV/m)	LIMIT (dBuV/m)	MARGIN (dB)	ANTENNA HEIGHT (m)	TABLE ANGLE (Degree)	RAW VALUE (dBuV)	CORRECTION FACTOR (dB/m)
1	38.72	34.5 QP	40.0	-5.5	1.24 V	211	50.36	-15.85
2	74.21	34.4 QP	40.0	-5.6	1.24 V	214	53.16	-18.74
3	106.62	39.5 QP	43.5	-4.0	1.42 V	120	57.95	-18.43
4	145.24	32.9 QP	43.5	-10.7	1.24 V	124	48.12	-15.27
5	400.12	40.5 QP	46.0	-5.5	1.24 V	301	52.30	-11.78
6	996.70	35.4 QP	54.0	-18.6	1.45 V	24	36.47	-1.05

REMARKS:

1. Emission Level(dBuV/m) = Raw Value(dBuV) + Correction Factor(dB/m)
2. Correction Factor(dB/m) = Antenna Factor(dB/m) + Cable Factor(dB) – Pre-Amplifier Factor(dB)
3. The other emission levels were very low against the limit.
4. Margin value = Emission Level – Limit value

4.2 Conducted Emission Measurement

4.2.1 Limits of Conducted Emission Measurement

Frequency (MHz)	Conducted Limit (dBuV)	
	Quasi-peak	Average
0.15 - 0.5	66 - 56	56 - 46
0.50 - 5.0	56	46
5.0 - 30.0	60	50

Note: 1. The lower limit shall apply at the transition frequencies.

2. The limit decreases in line with the logarithm of the frequency in the range of 0.15 to 0.50MHz.

4.2.2 Test Instruments

DESCRIPTION & MANUFACTURER	MODEL NO.	SERIAL NO.	CALIBRATED DATE	CALIBRATED UNTIL
Test Receiver R&S	ESCS 30	100375	May 06, 2015	May 05, 2016
Line-Impedance Stabilization Network (for EUT) SCHWARZBECK	NSLK-8127	8127-522	Sep. 01, 2015	Aug. 31, 2016
Line-Impedance Stabilization Network (for Peripheral) R&S	ENV216	100072	June 11, 2015	June 10, 2016
RF Cable	5D-FB	COCCAB-001	Mar. 09, 2015	Mar. 08, 2016
50 ohms Terminator	N/A	EMC-03	Sep. 23, 2015	Sep. 22, 2016
50 ohms Terminator	N/A	EMC-02	Oct. 01, 2015	Sep. 30, 2016
Software BVADT	BVADT_Cond_ V7.3.7.3	NA	NA	NA

Note:

1. The calibration interval of the above test instruments are 12 months and the calibrations are traceable to NML/ROC and NIST/USA.
2. The test was performed in Shielded Room No. C.
3. The VCCI Con C Registration No. is C-3611.
4. Tested Date: Dec. 15, 2015 to Mar. 11, 2016

4.2.3 Test Procedure

- The EUT was placed 0.4 meters from the conducting wall of the shielded room with EUT being connected to the power mains through a line impedance stabilization network (LISN). Other support units were connected to the power mains through another LISN. The two LISNs provide 50 ohm/ 50uH of coupling impedance for the measuring instrument.
- Both lines of the power mains connected to the EUT were checked for maximum conducted interference.
- The frequency range from 150kHz to 30MHz was searched. Emission levels under (Limit - 20dB) was not recorded.

NOTE: All modes of operation were investigated and the worst-case emissions are reported.

4.2.4 Deviation from Test Standard

No deviation.

4.2.5 Test Setup

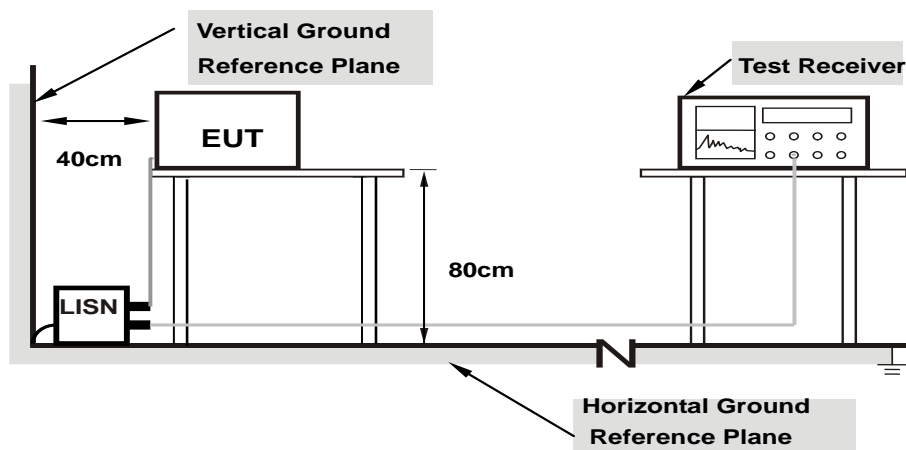

Note: 1.Support units were connected to second LISN.

For the actual test configuration, please refer to the attached file (Test Setup Photo).

4.2.6 EUT Operating Condition

Same as 4.1.6.

4.2.7 Test Results (Mode 1)

Phase	Line (L)	Detector Function	Quasi-Peak (QP) / Average (AV)
-------	----------	-------------------	--------------------------------

Phase Of Power : Line (L)										
No	Frequency (MHz)	Correction Factor (dB)	Reading Value (dBuV)		Emission Level (dBuV)		Limit (dBuV)		Margin (dB)	
			Q.P.	AV.	Q.P.	AV.	Q.P.	AV.	Q.P.	AV.
1	0.15000	10.26	30.95	18.14	41.21	28.40	66.00	56.00	-24.79	-27.60
2	0.16562	10.25	27.75	7.91	38.00	18.16	65.18	55.18	-27.18	-37.02
3	0.21156	10.22	25.73	17.63	35.95	27.85	63.14	53.14	-27.19	-25.29
4	0.25156	10.23	21.45	14.56	31.68	24.79	61.71	51.71	-30.03	-26.92
5	0.42734	10.24	31.25	27.07	41.49	37.31	57.30	47.30	-15.82	-10.00
6	17.69531	10.85	34.38	32.30	45.23	43.15	60.00	50.00	-14.77	-6.85
7	23.89453	10.97	33.61	28.84	44.58	39.81	60.00	50.00	-15.42	-10.19

Remarks:

1. Q.P. and AV. are abbreviations of quasi-peak and average individually.
2. The emission levels of other frequencies were very low against the limit.
3. Margin value = Emission level – Limit value
4. Correction factor = Insertion loss + Cable loss
5. Emission Level = Correction Factor + Reading Value

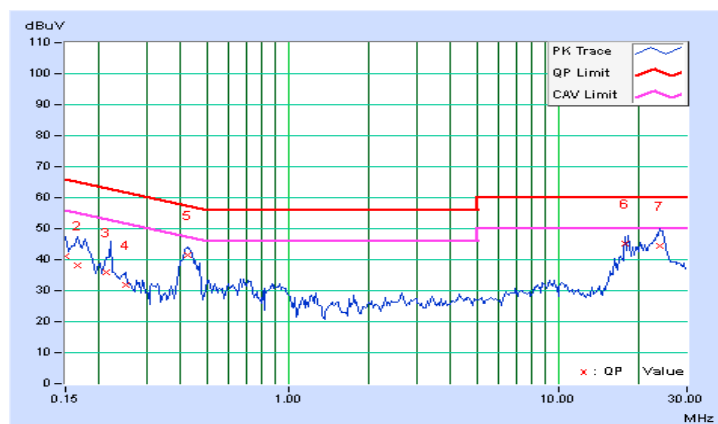

Phase	Neutral (N)	Detector Function	Quasi-Peak (QP) / Average (AV)
-------	-------------	-------------------	--------------------------------

Phase Of Power : Neutral (N)										
No	Frequency (MHz)	Correction Factor (dB)	Reading Value (dBuV)		Emission Level (dBuV)		Limit (dBuV)		Margin (dB)	
			Q.P.	AV.	Q.P.	AV.	Q.P.	AV.	Q.P.	AV.
1	0.15000	10.24	31.99	19.43	42.23	29.67	66.00	56.00	-23.77	-26.33
2	0.17734	10.22	31.38	23.02	41.60	33.24	64.61	54.61	-23.01	-21.37
3	0.20078	10.20	22.08	4.70	32.28	14.90	63.58	53.58	-31.30	-38.68
4	0.27500	10.21	16.54	3.90	26.75	14.11	60.97	50.97	-34.22	-36.86
5	0.41953	10.22	31.82	24.69	42.04	34.91	57.46	47.46	-15.42	-12.55
6	17.69466	10.88	35.70	33.78	46.58	44.66	60.00	50.00	-13.42	-5.34
7	24.23047	10.99	34.35	29.72	45.34	40.71	60.00	50.00	-14.66	-9.29

Remarks:

1. Q.P. and AV. are abbreviations of quasi-peak and average individually.
2. The emission levels of other frequencies were very low against the limit.
3. Margin value = Emission level – Limit value
4. Correction factor = Insertion loss + Cable loss
5. Emission Level = Correction Factor + Reading Value

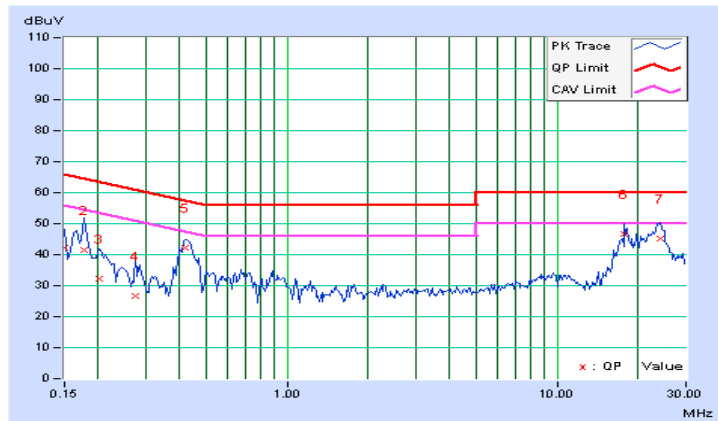

4.2.8 Test Results (Mode 2)

Phase	Line (L)	Detector Function	Quasi-Peak (QP) / Average (AV)
-------	----------	-------------------	--------------------------------

Phase Of Power : Line (L)										
No	Frequency (MHz)	Correction Factor (dB)	Reading Value (dBuV)		Emission Level (dBuV)		Limit (dBuV)		Margin (dB)	
			Q.P.	AV.	Q.P.	AV.	Q.P.	AV.	Q.P.	AV.
1	0.15000	10.26	30.71	17.14	40.97	27.40	66.00	56.00	-25.03	-28.60
2	0.16953	10.24	27.77	11.57	38.01	21.81	64.98	54.98	-26.97	-33.17
3	0.20859	10.22	25.17	14.00	35.39	24.22	63.26	53.26	-27.87	-29.04
4	0.42344	10.24	31.36	26.19	41.60	36.43	57.38	47.38	-15.78	-10.95
5	17.69141	10.85	33.53	32.03	44.38	42.88	60.00	50.00	-15.62	-7.12
6	19.71094	10.91	31.99	29.63	42.90	40.54	60.00	50.00	-17.10	-9.46
7	24.14063	10.97	33.66	28.85	44.63	39.82	60.00	50.00	-15.37	-10.18

Remarks:

1. Q.P. and AV. are abbreviations of quasi-peak and average individually.
2. The emission levels of other frequencies were very low against the limit.
3. Margin value = Emission level – Limit value
4. Correction factor = Insertion loss + Cable loss
5. Emission Level = Correction Factor + Reading Value

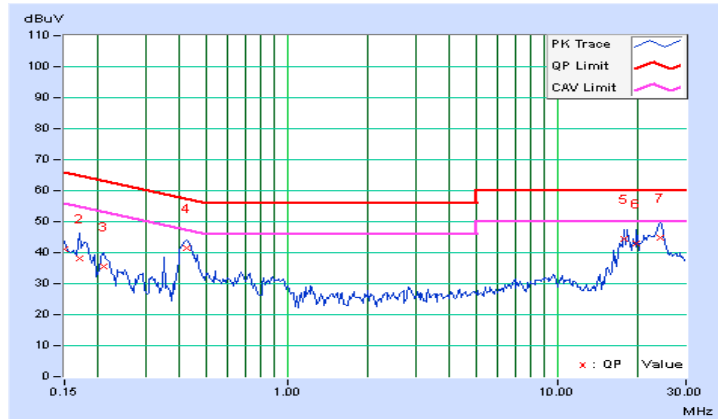

Phase	Neutral (N)	Detector Function	Quasi-Peak (QP) / Average (AV)
-------	-------------	-------------------	--------------------------------

Phase Of Power : Neutral (N)										
No	Frequency (MHz)	Correction Factor (dB)	Reading Value (dBuV)		Emission Level (dBuV)		Limit (dBuV)		Margin (dB)	
			Q.P.	AV.	Q.P.	AV.	Q.P.	AV.	Q.P.	AV.
1	0.16172	10.23	26.85	7.81	37.08	18.04	65.38	55.38	-28.29	-37.33
2	0.20859	10.20	25.45	15.57	35.65	25.77	63.26	53.26	-27.61	-27.49
3	0.42344	10.22	32.44	27.41	42.66	37.63	57.38	47.38	-14.72	-9.75
4	0.46250	10.21	24.56	19.24	34.77	29.45	56.65	46.65	-21.87	-17.19
5	17.69141	10.88	35.38	33.84	46.26	44.72	60.00	50.00	-13.74	-5.28
6	19.70916	10.94	34.22	31.99	45.16	42.93	60.00	50.00	-14.84	-7.07
7	23.87891	10.98	34.98	30.09	45.96	41.07	60.00	50.00	-14.04	-8.93

Remarks:

1. Q.P. and AV. are abbreviations of quasi-peak and average individually.
2. The emission levels of other frequencies were very low against the limit.
3. Margin value = Emission level – Limit value
4. Correction factor = Insertion loss + Cable loss
5. Emission Level = Correction Factor + Reading Value

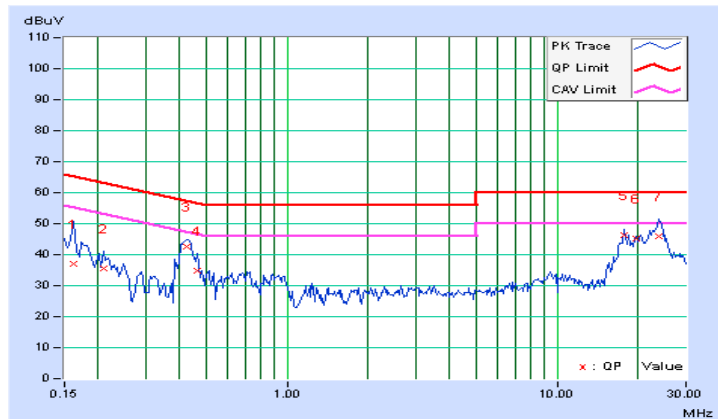

4.2.9 Test Results (Mode 3)

Phase	Line (L)	Detector Function	Quasi-Peak (QP) / Average (AV)
-------	----------	-------------------	--------------------------------

Phase Of Power : Line (L)										
No	Frequency (MHz)	Correction Factor (dB)	Reading Value (dBuV)		Emission Level (dBuV)		Limit (dBuV)		Margin (dB)	
			Q.P.	AV.	Q.P.	AV.	Q.P.	AV.	Q.P.	AV.
1	0.16562	10.25	35.20	10.79	45.45	21.04	65.18	55.18	-19.73	-34.14
2	0.18906	10.23	35.97	26.58	46.20	36.81	64.08	54.08	-17.88	-17.27
3	0.22031	10.22	28.44	3.06	38.66	13.28	62.81	52.81	-24.15	-39.53
4	0.23594	10.22	29.35	19.08	39.57	29.30	62.24	52.24	-22.66	-22.93
5	0.49766	10.23	21.53	7.99	31.76	18.22	56.04	46.04	-24.28	-27.82
6	23.86328	10.97	34.50	29.65	45.47	40.62	60.00	50.00	-14.53	-9.38

Remarks:

1. Q.P. and AV. are abbreviations of quasi-peak and average individually.
2. The emission levels of other frequencies were very low against the limit.
3. Margin value = Emission level – Limit value
4. Correction factor = Insertion loss + Cable loss
5. Emission Level = Correction Factor + Reading Value

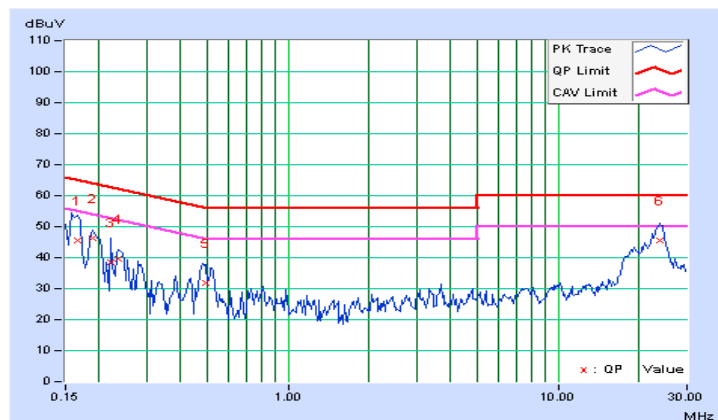

Phase	Neutral (N)	Detector Function	Quasi-Peak (QP) / Average (AV)
-------	-------------	-------------------	--------------------------------

Phase Of Power : Neutral (N)										
No	Frequency (MHz)	Correction Factor (dB)	Reading Value (dBuV)		Emission Level (dBuV)		Limit (dBuV)		Margin (dB)	
			Q.P.	AV.	Q.P.	AV.	Q.P.	AV.	Q.P.	AV.
1	0.15000	10.24	35.92	21.83	46.16	32.07	66.00	56.00	-19.84	-23.93
2	0.16172	10.23	33.75	9.89	43.98	20.12	65.38	55.38	-21.39	-35.25
3	0.19297	10.21	35.53	26.70	45.74	36.91	63.91	53.91	-18.17	-17.00
4	0.21641	10.20	24.79	2.28	34.99	12.48	62.96	52.96	-27.96	-40.47
5	0.52109	10.21	25.49	22.61	35.70	32.82	56.00	46.00	-20.30	-13.18
6	20.13281	10.95	28.76	23.94	39.71	34.89	60.00	50.00	-20.29	-15.11
7	23.91016	10.99	36.02	31.19	47.01	42.18	60.00	50.00	-12.99	-7.82

Remarks:

1. Q.P. and AV. are abbreviations of quasi-peak and average individually.
2. The emission levels of other frequencies were very low against the limit.
3. Margin value = Emission level – Limit value
4. Correction factor = Insertion loss + Cable loss
5. Emission Level = Correction Factor + Reading Value

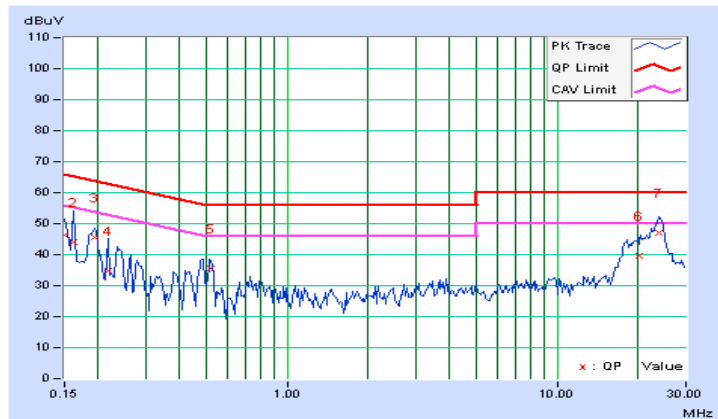

4.2.10 Test Results (Mode 4)

Phase	Line (L)	Detector Function	Quasi-Peak (QP) / Average (AV)
-------	----------	-------------------	--------------------------------

Phase Of Power : Line (L)										
No	Frequency (MHz)	Correction Factor (dB)	Reading Value (dBuV)		Emission Level (dBuV)		Limit (dBuV)		Margin (dB)	
			Q.P.	AV.	Q.P.	AV.	Q.P.	AV.	Q.P.	AV.
1	0.16172	10.25	30.84	8.77	41.09	19.02	65.38	55.38	-24.28	-36.35
2	0.19297	10.23	34.45	25.58	44.68	35.81	63.91	53.91	-19.23	-18.10
3	0.21641	10.22	23.86	1.30	34.08	11.52	62.96	52.96	-28.87	-41.43
4	0.35313	10.24	8.35	-3.12	18.59	7.12	58.89	48.89	-40.30	-41.77
5	0.52109	10.23	24.33	21.26	34.56	31.49	56.00	46.00	-21.44	-14.51
6	20.15234	10.92	27.21	22.44	38.13	33.36	60.00	50.00	-21.87	-16.64
7	24.22266	10.97	34.69	29.96	45.66	40.93	60.00	50.00	-14.34	-9.07

Remarks:

1. Q.P. and AV. are abbreviations of quasi-peak and average individually.
2. The emission levels of other frequencies were very low against the limit.
3. Margin value = Emission level – Limit value
4. Correction factor = Insertion loss + Cable loss
5. Emission Level = Correction Factor + Reading Value

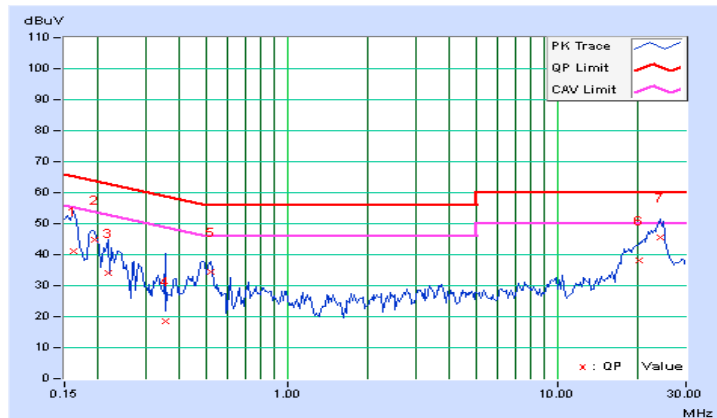

Phase	Neutral (N)	Detector Function	Quasi-Peak (QP) / Average (AV)
-------	-------------	-------------------	--------------------------------

Phase Of Power : Neutral (N)										
No	Frequency (MHz)	Correction Factor (dB)	Reading Value (dBuV)		Emission Level (dBuV)		Limit (dBuV)		Margin (dB)	
			Q.P.	AV.	Q.P.	AV.	Q.P.	AV.	Q.P.	AV.
1	0.15781	10.23	28.94	8.55	39.17	18.78	65.58	55.58	-26.40	-36.79
2	0.16562	10.23	34.91	8.85	45.14	19.08	65.18	55.18	-20.04	-36.10
3	0.19297	10.21	34.63	26.28	44.84	36.49	63.91	53.91	-19.07	-17.42
4	0.22812	10.20	20.05	5.92	30.25	16.12	62.52	52.52	-32.27	-36.40
5	0.52109	10.21	25.86	23.06	36.07	33.27	56.00	46.00	-19.93	-12.73
6	19.92969	10.95	28.96	23.97	39.91	34.92	60.00	50.00	-20.09	-15.08
7	23.68359	10.98	35.65	30.86	46.63	41.84	60.00	50.00	-13.37	-8.16

Remarks:

1. Q.P. and AV. are abbreviations of quasi-peak and average individually.
2. The emission levels of other frequencies were very low against the limit.
3. Margin value = Emission level – Limit value
4. Correction factor = Insertion loss + Cable loss
5. Emission Level = Correction Factor + Reading Value

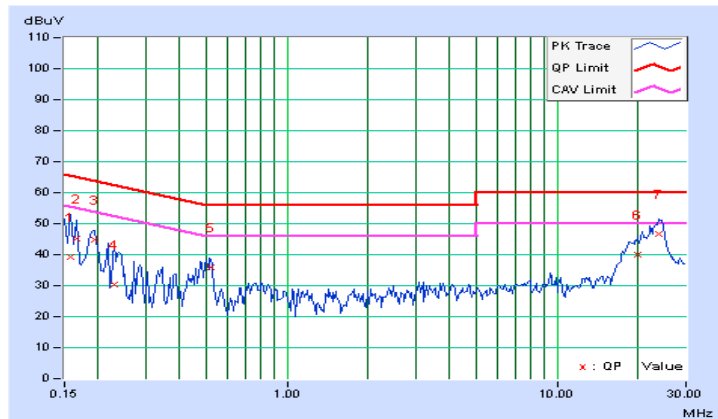

4.3 Transmit Power Measurement

4.3.1 Limits of Transmit Power Measurement

Operation Band	EUT Category		LIMIT
U-NII-1		Outdoor Access Point	1 Watt (30 dBm) (Max. e.i.r.p \leq 125mW(21 dBm) at any elevation angle above 30 degrees as measured from the horizon)
		Fixed point-to-point Access Point	1 Watt (30 dBm)
		Indoor Access Point	1 Watt (30 dBm)
		Mobile and Portable client device	250mW (24 dBm)
U-NII-2A		√	250mW (24 dBm) or 11 dBm+10 log B*
U-NII-2C		√	250mW (24 dBm) or 11 dBm+10 log B*
U-NII-3		√	1 Watt (30 dBm)

*B is the 26 dB emission bandwidth in megahertz

Per KDB 662911 Method of conducted output power measurement on IEEE 802.11 devices,

Array Gain = 0 dB (i.e., no array gain) for $N_{ANT} \leq 4$;

Array Gain = 0 dB (i.e., no array gain) for channel widths \geq 40 MHz for any N_{ANT} ;

Array Gain = $5 \log(N_{ANT}/N_{SS})$ dB or 3 dB, whichever is less for 20-MHz channel widths with $N_{ANT} \geq 5$.

For power measurements on all other devices: Array Gain = $10 \log(N_{ANT}/N_{SS})$ dB.

4.3.2 Test Setup

FOR POWER OUTPUT MEASUREMENT

For channel straddling 5725MHz:

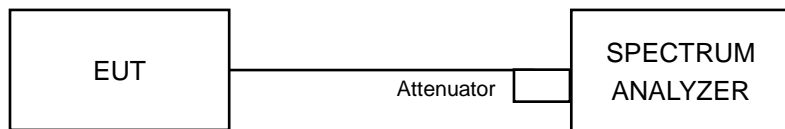

For other channels:

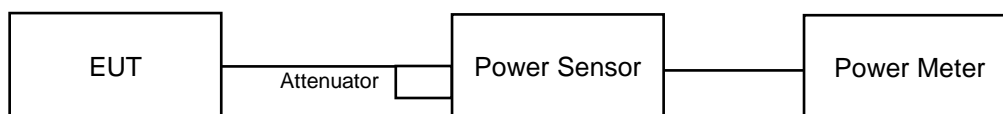

FOR 26dB OCCUPIED BANDWIDTH

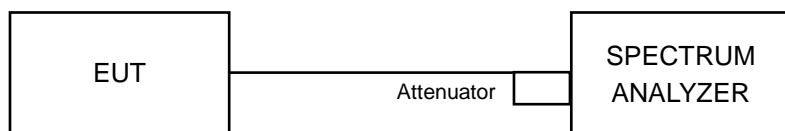

4.3.3 Test Instruments

Refer to section 4.1.2 to get information of above instrument.

4.3.4 Test Procedure

For POWER OUTPUT MEASUREMENT:

For channel straddling 5725MHz:

Follow FCC KDB 789033 UNII test procedure:

802.11ac (VHT80)

Method SA-2

1. Set span to encompass the emission bandwidth (EBW) of the signal.
2. Set RBW =1MHz.
3. Set the VBW $\geq 3 \times$ RBW.
4. Number of points in sweep ≥ 2 Span / RBW.
5. Sweep time = auto.
6. Detector = RMS.
7. Trace average at least 100 traces in power averaging mode
8. Compute power by integrating the spectrum across the 26 dB EBW of the signal.
9. Duty factor need added to measured value (duty cycle < 98 percent).

Other Modulation mode

Method SA-1

1. Set span to encompass the entire emission bandwidth (EBW) of the signal.
2. Set RBW =1MHz.
3. Set the VBW $\geq 3 \times$ RBW.
4. Number of points in sweep ≥ 2 Span / RBW.
5. Sweep time = auto.
6. Set trigger to free run (duty cycle ≥ 98 percent) ; Set video trigger (duty cycle < 98 percent)
7. Detector = RMS.
8. Trace average at least 100 traces in power averaging mode
9. Compute power by integrating the spectrum across the 26 dB EBW of the signal.

For other channels:

Method PM is used to perform output power measurement, trigger and gating function of wide band power meter is enabled to measure max output power of TX on burst. Duty factor is not added to measured value.

FOR 26dB OCCUPIED BANDWIDTH

1. Set RBW = approximately 1% of the emission bandwidth.
2. Set the VBW > RBW.
3. Detector = Peak.
4. Trace mode = max hold.
5. Measure the maximum width of the emission that is 26 dB down from the peak of the emission. Compare this with the RBW setting of the analyzer. Readjust RBW and repeat measurement as needed until the RBW/EBW ratio is approximately 1%.

4.3.5 Deviation from Test Standard

No deviation.

4.3.6 EUT Operating Condition

The software provided by client to enable the EUT under transmission condition continuously at lowest, middle and highest channel frequencies individually.

4.3.7 Test Result (Mode 1)

POWER OUTPUT:

3TX

CDD Mode:

802.11a

Chan.	Chan. Freq. (MHz)	Average Power (dBm)			Total Power (mW)	Total Power (dBm)	Limit (dBm)	Pass / Fail
		Chain 0	Chain 1	Chain 2				
52	5260	15.47	15.32	14.86	99.898	20.00	24	Pass
60	5300	15.53	15.30	14.83	100.02	20.00	24	Pass
64	5320	15.52	15.26	14.79	99.349	19.97	24	Pass
100	5500	15.16	14.91	15.21	96.973	19.87	24	Pass
116	5580	15.21	14.88	15.01	95.646	19.81	24	Pass
140	5700	15.21	14.91	15.21	97.352	19.88	24	Pass
144 (UNII-2C Band)	5720	10.82	11.81	11.52	41.44	16.17	22.85	Pass
144 (UNII-3 Band)	5720	4.73	5.12	4.85	9.278	9.67	30	Pass

26dB BANDWIDTH:

Channel	Frequency (MHz)	26dBc Bandwidth (MHz)		
		Chain 0	Chain 1	Chain 2
52	5260	20.66	20.97	20.42
60	5300	20.40	21.20	20.45
64	5320	20.54	20.31	20.39
100	5500	20.54	20.42	20.40
116	5580	20.49	20.30	20.26
140	5700	20.35	20.38	20.55
144 (UNII-2C Band)	5720	15.44	15.34	15.35

Note: For FCC output power limitation is determined based on 26dB bandwidth.



Power Limit = 11dBm + 10logB < U-NII-2A, U-NII-2C >			
Channel Number	Freq.(MHz)	Min. B(MHz)	Determined Conducted Limit (dBm)
52	5260	20.42	24.1 > 24
60	5300	20.40	24.09 > 24
64	5320	20.31	24.07 > 24
100	5500	20.40	24.09 > 24
116	5580	20.26	24.06 > 24
140	5700	20.35	24.08 > 24
144 (UNII-2C Band)	5720	15.34	22.85 < 24

802.11ac (VHT20)
OUTPUT POWER:

Chan.	Chan. Freq. (MHz)	Average Power (dBm)			Total Power (mW)	Total Power (dBm)	Limit (dBm)	Pass / Fail
		Chain 0	Chain 1	Chain 2				
52	5260	15.51	15.20	14.67	97.985	19.91	24	Pass
60	5300	15.56	15.18	14.62	97.909	19.91	24	Pass
64	5320	15.58	15.17	14.71	98.606	19.94	24	Pass
100	5500	15.21	14.96	15.17	97.407	19.89	24	Pass
116	5580	15.14	15.01	15.16	97.165	19.88	24	Pass
140	5700	15.17	14.92	15.06	95.994	19.82	24	Pass
144 (UNII-2C Band)	5720	10.98	11.58	11.28	40.347	16.06	22.88	Pass
144 (UNII-3 Band)	5720	4.90	5.49	5.21	9.949	9.98	30	Pass

26dB BANDWIDTH:

Channel	Frequency (MHz)	26dBc Bandwidth (MHz)		
		Chain 0	Chain 1	Chain 2
52	5260	21.09	21.63	21.65
60	5300	20.67	20.76	21.79
64	5320	21.02	20.46	21.29
100	5500	20.77	20.56	20.63
116	5580	20.93	20.57	20.86
140	5700	20.80	20.56	21.37
144 (UNII-2C Band)	5720	15.42	15.57	15.47

Note: For FCC output power limitation is determined based on 26dB bandwidth.

Power Limit = 11dBm + 10logB < U-NII-2A, U-NII-2C >			
Channel Number	Freq.(MHz)	Min. B(MHz)	Determined Conducted Limit (dBm)
52	5260	21.09	24.24 > 24
60	5300	20.67	24.15 > 24
64	5320	20.46	24.1 > 24
100	5500	20.56	24.13 > 24
116	5580	20.57	24.13 > 24
140	5700	20.56	24.13 > 24
144 (UNII-2C Band)	5720	15.42	22.88 < 24

802.11ac (VHT40)
OUTPUT POWER:

Chan.	Chan. Freq. (MHz)	Average Power (dBm)			Total Power (mW)	Total Power (dBm)	Limit (dBm)	Pass / Fail
		Chain 0	Chain 1	Chain 2				
54	5270	18.67	18.11	17.85	199.289	22.99	24	Pass
62	5310	12.50	11.96	11.43	47.387	16.76	24	Pass
102	5510	12.46	12.69	12.52	54.063	17.33	24	Pass
110	5550	18.27	18.17	18.09	197.175	22.95	24	Pass
134	5670	17.36	17.15	17.14	158.091	21.99	24	Pass
142 (UNII-2C Band)	5710	14.28	14.81	14.46	84.986	19.29	24	Pass
142 (UNII-3 Band)	5710	3.64	4.27	3.87	7.423	8.71	30	Pass

26dB BANDWIDTH:

Channel	Frequency (MHz)	26dBc Bandwidth (MHz)		
		Chain 0	Chain 1	Chain 2
54	5270	92.64	81.21	74.22
62	5310	41.69	41.13	41.02
102	5510	41.65	41.08	40.88
110	5550	48.60	47.32	51.17
134	5670	76.27	76.73	73.75
142 (UNII-2C Band)	5710	49.58	51.16	51.20

Note: For FCC output power limitation is determined based on 26dB bandwidth.

Power Limit = 11dBm + 10logB < U-NII-2A, U-NII-2C >			
Channel Number	Freq.(MHz)	Min. B(MHz)	Determined Conducted Limit (dBm)
54	5270	74.22	29.7 > 24
62	5310	41.02	27.12 > 24
102	5510	40.88	27.11 > 24
110	5550	47.32	27.75 > 24
134	5670	73.75	29.67 > 24
142 (UNII-2C Band)	5710	49.58	27.95 > 24

802.11ac (VHT80)

OUTPUT POWER:

Chan.	Chan. Freq. (MHz)	Average Power (dBm)			Total Power (mW)	Total Power (dBm)	Limit (dBm)	Pass / Fail
		Chain 0	Chain 1	Chain 2				
58	5290	12.01	11.61	11.31	43.894	16.42	24	Pass
106	5530	11.96	11.95	11.98	47.148	16.73	24	Pass
122	5610	17.49	17.16	17.56	165.121	22.18	24	Pass
138 (UNII-2C Band)	5690	15.32	15.85	15.56	112.995	20.53	24	Pass
138 (UNII-3 Band)	5690	1.16	1.79	1.53	4.415	6.45	30	Pass

26dB BANDWIDTH:

Channel	Frequency (MHz)	26dBc Bandwidth (MHz)		
		Chain 0	Chain 1	Chain 2
58	5290	83.15	82.67	82.32
106	5530	83.02	83.03	82.43
122	5610	102.51	113.09	118.11
138 (UNII-2C Band)	5690	105.46	114.42	113.82

Note: For FCC output power limitation is determined based on 26dB bandwidth.

Power Limit = 11dBm + 10logB < U-NII-2A, U-NII-2C >			
Channel Number	Freq.(MHz)	Min. B(MHz)	Determined Conducted Limit (dBm)
58	5290	82.32	30.15 > 24
106	5530	82.43	30.16 > 24
122	5610	102.51	31.01 > 24
138 (UNII-2C Band)	5690	105.46	31.23 > 24

SPECTRUM PLOT OF WORST VALUE

802.11a – Chain (1): CH 144 (UNII-2C Band)

802.11ac (VHT20) – Chain (0): CH 144 (UNII-2C Band)

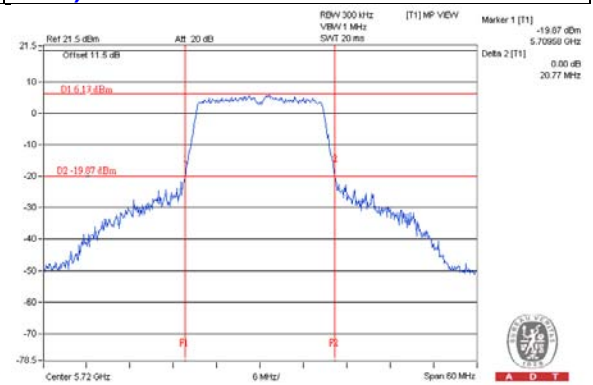
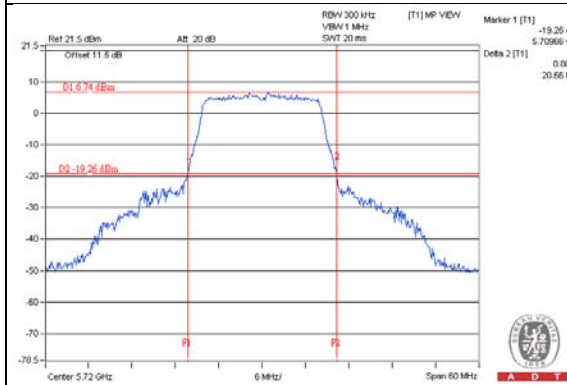

802.11ac (VHT40) – Chain (2): CH 102

802.11ac (VHT80) – Chain (2): CH 58

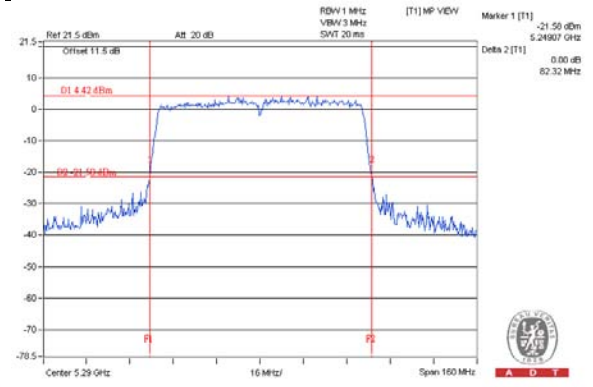
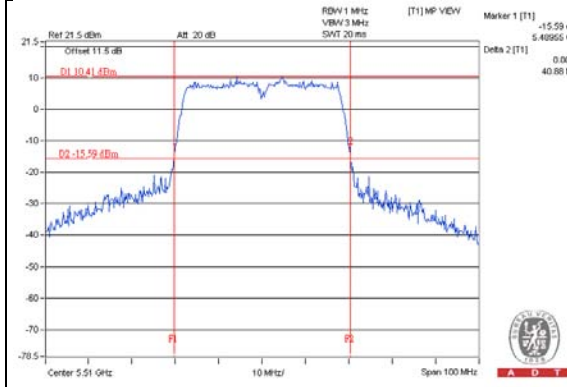

NOTE:

1. For CH144 (UNII-2C Band) = 5725 MHz - Marker 1

TxBF Mode:

802.11ac (VHT20)

OUTPUT POWER:

Chan.	Chan. Freq. (MHz)	Average Power (dBm)			Total Power (mW)	Total Power (dBm)	Limit (dBm)	Pass / Fail
		Chain 0	Chain 1	Chain 2				
52	5260	15.51	15.20	14.67	97.985	19.91	20.01	Pass
60	5300	15.56	15.18	14.62	97.909	19.91	20.01	Pass
64	5320	15.58	15.17	14.71	98.606	19.94	20.01	Pass
100	5500	15.21	14.96	15.17	97.407	19.89	19.97	Pass
116	5580	15.14	15.01	15.16	97.165	19.88	19.97	Pass
140	5700	15.17	14.92	15.06	95.994	19.82	19.97	Pass
144 (UNII-2C Band)	5720	10.98	11.58	11.28	40.347	16.06	18.85	Pass
144 (UNII-3 Band)	5720	4.90	5.49	5.21	9.949	9.98	25.86	Pass

- NOTE:** 1. For UNII-2A Band: Directional gain = $10 \log[(10^{G1/20} + 10^{G2/20} + 10^{G3/20})^2 / 3] = 9.99\text{dBi} > 6\text{dBi}$, therefore the limit needs to reduce, so the power limit shall be reduced to "Determined Conducted Limit-(9.99-6)"
2. For UNII-2C Band: Directional gain = $10 \log[(10^{G1/20} + 10^{G2/20} + 10^{G3/20})^2 / 3] = 10.03\text{dBi} > 6\text{dBi}$, therefore the limit needs to reduce, so the power limit shall be reduced to "Determined Conducted Limit-(10.03-6)"
3. For UNII-3 Band: Directional gain = $10 \log[(10^{G1/20} + 10^{G2/20} + 10^{G3/20})^2 / 3] = 10.14\text{dBi} > 6\text{dBi}$, so the power limit shall be reduced to $30-(10.14-6) = 25.86\text{dBm}$.

26dB BANDWIDTH:

Channel	Frequency (MHz)	26dBc Bandwidth (MHz)		
		Chain 0	Chain 1	Chain 2
52	5260	21.09	21.63	21.65
60	5300	20.67	20.76	21.79
64	5320	21.02	20.46	21.29
100	5500	20.77	20.56	20.63
116	5580	20.93	20.57	20.86
140	5700	20.80	20.56	21.37
144 (UNII-2C Band)	5720	15.42	15.57	15.47

Note: For FCC output power limitation is determined based on 26dB bandwidth.



Power Limit = 11dBm + 10logB < U-NII-2A, U-NII-2C >			
Channel Number	Freq.(MHz)	Min. B(MHz)	Determined Conducted Limit (dBm)
52	5260	21.09	24.24 > 24
60	5300	20.67	24.15 > 24
64	5320	20.46	24.1 > 24
100	5500	20.56	24.13 > 24
116	5580	20.57	24.13 > 24
140	5700	20.56	24.13 > 24
144 (UNII-2C Band)	5720	15.42	22.88 < 24

802.11ac (VHT40)
OUTPUT POWER:

Chan.	Chan. Freq. (MHz)	Average Power (dBm)			Total Power (mW)	Total Power (dBm)	Limit (dBm)	Pass / Fail
		Chain 0	Chain 1	Chain 2				
54	5270	15.61	15.09	14.77	98.669	19.94	20.01	Pass
62	5310	12.50	11.96	11.43	47.387	16.76	20.01	Pass
102	5510	12.46	12.69	12.52	54.063	17.33	19.97	Pass
110	5550	15.19	15.11	15.02	97.24	19.88	19.97	Pass
134	5670	15.31	15.09	15.11	98.682	19.94	19.97	Pass
142 (UNII-2C Band)	5710	11.40	11.43	11.32	41.256	16.15	19.97	Pass
142 (UNII-3 Band)	5710	0.76	0.86	0.68	3.579	5.54	25.86	Pass

- NOTE:** 1. For UNII-2A Band: Directional gain = $10 \log[(10^{G1/20} + 10^{G2/20} + 10^{G3/20})^2 / 3] = 9.99\text{dBi} > 6\text{dBi}$, therefore the limit needs to reduce, so the power limit shall be reduced to "Determined Conducted Limit-(9.99-6)"
2. For UNII-2C Band: Directional gain = $10 \log[(10^{G1/20} + 10^{G2/20} + 10^{G3/20})^2 / 3] = 10.03\text{dBi} > 6\text{dBi}$, therefore the limit needs to reduce, so the power limit shall be reduced to "Determined Conducted Limit-(10.03-6)"
3. For UNII-3 Band: Directional gain = $10 \log[(10^{G1/20} + 10^{G2/20} + 10^{G3/20})^2 / 3] = 10.14\text{dBi} > 6\text{dBi}$, so the power limit shall be reduced to $30-(10.14-6) = 25.86\text{dBm}$.

26dB BANDWIDTH:

Channel	Frequency (MHz)	26dBc Bandwidth (MHz)		
		Chain 0	Chain 1	Chain 2
54	5270	92.64	81.21	74.22
62	5310	41.69	41.13	41.02
102	5510	41.65	41.08	40.88
110	5550	48.60	47.32	51.17
134	5670	76.27	76.73	73.75
142 (UNII-2C Band)	5710	49.58	51.16	51.20

Note: For FCC output power limitation is determined based on 26dB bandwidth.



Power Limit = 11dBm + 10logB < U-NII-2A, U-NII-2C >			
Channel Number	Freq.(MHz)	Min. B(MHz)	Determined Conducted Limit (dBm)
54	5270	74.22	29.7 > 24
62	5310	41.02	27.12 > 24
102	5510	41.08	27.11 > 24
110	5550	47.32	27.75 > 24
134	5670	73.75	29.67 > 24
142 (UNII-2C Band)	5710	49.58	27.95 > 24

802.11ac (VHT80)
OUTPUT POWER:

Chan.	Chan. Freq. (MHz)	Average Power (dBm)			Total Power (mW)	Total Power (dBm)	Limit (dBm)	Pass / Fail
		Chain 0	Chain 1	Chain 2				
58	5290	12.01	11.61	11.31	43.894	16.42	20.01	Pass
106	5530	11.96	11.95	11.98	47.148	16.73	19.97	Pass
122	5610	15.21	14.96	15.27	98.173	19.92	19.97	Pass
138 (UNII-2C Band)	5690	11.24	11.24	11.26	41.627	16.19	19.97	Pass
138 (UNII-3 Band)	5690	-3.07	-2.93	-2.98	1.5682	1.95	25.86	Pass

- NOTE:** 1. For UNII-2A Band: Directional gain = $10 \log[(10^{G1/20} + 10^{G2/20} + 10^{G3/20})^2 / 3] = 9.99\text{dBi} > 6\text{dBi}$, therefore the limit needs to reduce, so the power limit shall be reduced to "Determined Conducted Limit-(9.99-6)"
2. For UNII-2C Band: Directional gain = $10 \log[(10^{G1/20} + 10^{G2/20} + 10^{G3/20})^2 / 3] = 10.03\text{dBi} > 6\text{dBi}$, therefore the limit needs to reduce, so the power limit shall be reduced to "Determined Conducted Limit-(10.03-6)"
3. For UNII-3 Band: Directional gain = $10 \log[(10^{G1/20} + 10^{G2/20} + 10^{G3/20})^2 / 3] = 10.14\text{dBi} > 6\text{dBi}$, so the power limit shall be reduced to $30 - (10.14 - 6) = 25.86\text{dBm}$.

26dB BANDWIDTH:

Channel	Frequency (MHz)	26dBc Bandwidth (MHz)		
		Chain 0	Chain 1	Chain 2
58	5290	83.15	82.67	82.32
106	5530	83.02	83.03	82.43
122	5610	102.51	113.09	118.11
138 (UNII-2C Band)	5690	105.46	114.42	113.82

Note: For FCC output power limitation is determined based on 26dB bandwidth.

Power Limit = 11dBm + 10logB < U-NII-2A, U-NII-2C >			
Channel Number	Freq.(MHz)	Min. B(MHz)	Determined Conducted Limit (dBm)
58	5290	82.32	30.15 > 24
106	5530	82.43	30.16 > 24
122	5610	102.51	31.01 > 24
138 (UNII-2C Band)	5690	105.46	31.23 > 24

SPECTRUM PLOT OF WORST VALUE

802.11ac (VHT20) – Chain (0): CH 144 (UNII-2C Band) 802.11ac (VHT40) – Chain (2): CH 102 Band

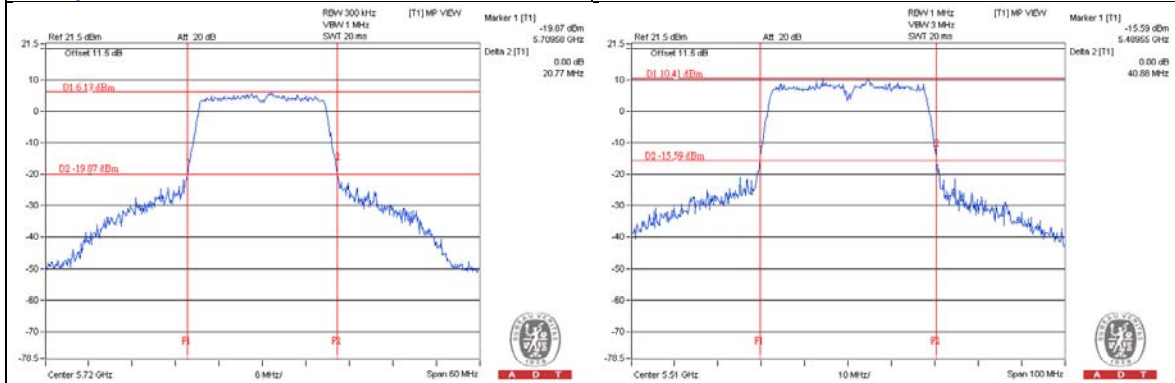

802.11ac (VHT80) – Chain (2): CH 58

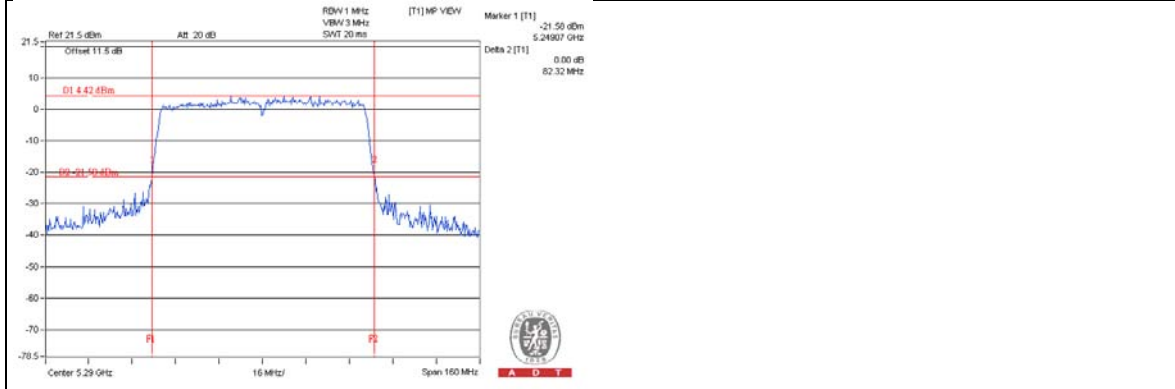

NOTE:

- 1. For CH144 (UNII-2C Band) = 5725 MHz - Marker 1

2TX
 CDD Mode:
 802.11a

Chan.	Chan. Freq. (MHz)	Average Power (dBm)		Total Power (mW)	Total Power (dBm)	Limit (dBm)	Pass / Fail
		Chain 1	Chain 2				
52	5260	17.79	17.09	111.285	20.46	24	Pass
60	5300	17.83	17.16	112.674	20.52	24	Pass
64	5320	17.86	17.23	113.939	20.57	24	Pass

26dB BANDWIDTH:

Channel	Frequency (MHz)	26dBc Bandwidth (MHz)	
		Chain 1	Chain 2
52	5260	32.81	28.72
60	5300	33.00	28.38
64	5320	29.57	26.62

Note: For FCC output power limitation is determined based on 26dB bandwidth.

Power Limit = 11dBm + 10logB < U-NII-2A >			
Channel Number	Freq.(MHz)	Min. B(MHz)	Determined Conducted Limit (dBm)
52	5260	28.72	25.58 > 24
60	5300	28.38	25.53 > 24
64	5320	26.62	25.25 > 24

802.11ac (VHT20)
OUTPUT POWER:

Chan.	Chan. Freq. (MHz)	Average Power (dBm)		Total Power (mW)	Total Power (dBm)	Limit (dBm)	Pass / Fail
		Chain 1	Chain 2				
52	5260	17.69	17.03	109.215	20.38	24	Pass
60	5300	17.72	17.06	109.972	20.41	24	Pass
64	5320	17.76	17.15	111.584	20.48	24	Pass

26dB BANDWIDTH:

Channel	Frequency (MHz)	26dBc Bandwidth (MHz)	
		Chain 1	Chain 2
52	5260	33.64	28.84
60	5300	33.54	26.22
64	5320	29.01	26.22

Note: For FCC output power limitation is determined based on 26dB bandwidth.

Power Limit = 11dBm + 10logB < U-NII-2A >			
Channel Number	Freq.(MHz)	Min. B(MHz)	Determined Conducted Limit (dBm)
52	5260	28.84	25.59 > 24
60	5300	26.22	25.18 > 24
64	5320	26.22	25.18 > 24



802.11ac (VHT40)

OUTPUT POWER:

Chan.	Chan. Freq. (MHz)	Average Power (dBm)		Total Power (mW)	Total Power (dBm)	Limit (dBm)	Pass / Fail
		Chain 1	Chain 2				
54	5270	20.42	19.92	208.329	23.19	24	Pass
62	5310	13.06	12.61	38.469	15.85	24	Pass

26dB BANDWIDTH:

Channel	Frequency (MHz)	26dBc Bandwidth (MHz)	
		Chain 1	Chain 2
54	5270	90.54	88.02
62	5310	41.02	41.35

Note: For FCC output power limitation is determined based on 26dB bandwidth.

Power Limit = 11dBm + 10logB < U-NII-2A >			
Channel Number	Freq.(MHz)	Min. B(MHz)	Determined Conducted Limit (dBm)
54	5270	88.02	30.44 > 24
62	5310	41.02	27.12 > 24



802.11ac (VHT80)

OUTPUT POWER:

Chan.	Chan. Freq. (MHz)	Average Power (dBm)		Total Power (mW)	Total Power (dBm)	Limit (dBm)	Pass / Fail
		Chain 1	Chain 2				
58	5290	12.55	12.27	34.855	15.42	24	Pass

26dB BANDWIDTH:

Channel	Frequency (MHz)	26dBc Bandwidth (MHz)	
		Chain 1	Chain 2
58	5290	82.48	83.30

Note: For FCC output power limitation is determined based on 26dB bandwidth.

Power Limit = 11dBm + 10logB < U-NII-2A >			
Channel Number	Freq.(MHz)	Min. B(MHz)	Determined Conducted Limit (dBm)
58	5290	82.48	30.16 > 24

SPECTRUM PLOT OF WORST VALUE

802.11a – Chain (2): CH 64

802.11ac (VHT20) – Chain (2): CH 64

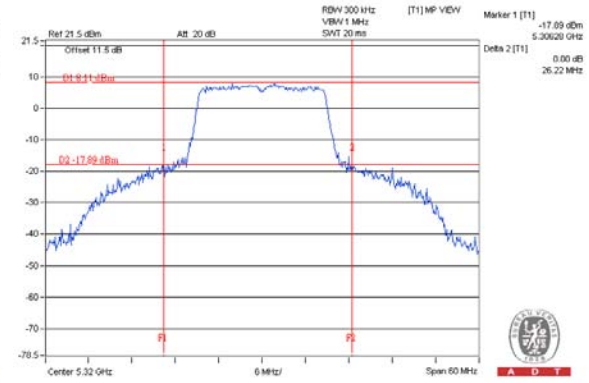
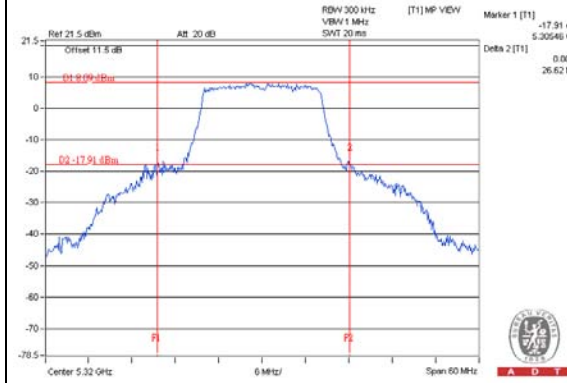

802.11ac (VHT40) – Chain (1): CH 62

802.11ac (VHT80) – Chain (1): CH 58

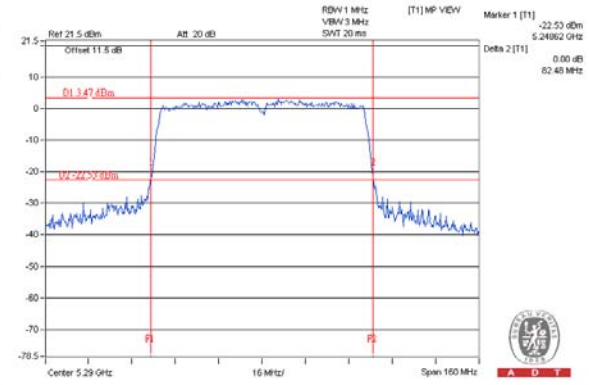
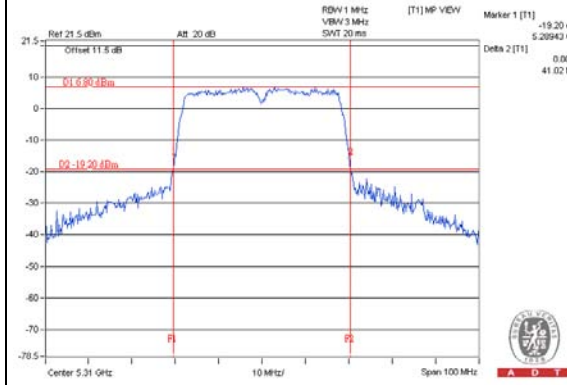



802.11a

Chan.	Chan. Freq. (MHz)	Average Power (dBm)		Total Power (mW)	Total Power (dBm)	Limit (dBm)	Pass / Fail
		Chain 0	Chain 2				
100	5500	18.02	17.81	123.782	20.93	24	Pass
116	5580	18.77	18.51	146.294	21.65	24	Pass
140	5700	17.81	17.76	120.099	20.80	24	Pass
144 (UNII-2C Band)	5720	14.89	14.41	58.438	17.67	24	Pass
144 (UNII-3 Band)	5720	8.29	7.93	12.954	11.12	30	Pass

26dB BANDWIDTH:

Channel	Frequency (MHz)	26dBc Bandwidth (MHz)	
		Chain 0	Chain 2
100	5500	29.00	28.32
116	5580	30.69	30.66
140	5700	29.14	29.48
144 (UNII-2C Band)	5720	21.67	21.74

Note: For FCC output power limitation is determined based on 26dB bandwidth.

Power Limit = 11dBm + 10logB < U-NII-2C >			
Channel Number	Freq.(MHz)	Min. B(MHz)	Determined Conducted Limit (dBm)
100	5500	28.32	25.52 > 24
116	5580	30.66	25.86 > 24
140	5700	29.14	25.64 > 24
144 (UNII-2C Band)	5720	21.67	24.35 < 24

802.11ac (VHT20)
OUTPUT POWER:

Chan.	Chan. Freq. (MHz)	Average Power (dBm)		Total Power (mW)	Total Power (dBm)	Limit (dBm)	Pass / Fail
		Chain 0	Chain 2				
100	5500	18.52	18.23	137.648	21.39	24	Pass
116	5580	18.73	18.53	145.93	21.64	24	Pass
140	5700	15.72	15.57	73.383	18.66	24	Pass
144 (UNII-2C Band)	5720	14.59	14.36	56.064	17.49	24	Pass
144 (UNII-3 Band)	5720	8.64	8.37	14.182	11.52	30	Pass

26dB BANDWIDTH:

Channel	Frequency (MHz)	26dBc Bandwidth (MHz)	
		Chain 0	Chain 2
100	5500	34.36	29.96
116	5580	35.66	31.49
140	5700	21.95	24.72
144 (UNII-2C Band)	5720	24.36	23.51

Note: For FCC output power limitation is determined based on 26dB bandwidth.

Power Limit = 11dBm + 10logB < U-NII-2C >			
Channel Number	Freq.(MHz)	Min. B(MHz)	Determined Conducted Limit (dBm)
100	5500	29.96	25.76 > 24
116	5580	31.49	25.98 > 24
140	5700	21.95	24.41 > 24
144 (UNII-2C Band)	5720	23.51	24.71 < 24

802.11ac (VHT40)
OUTPUT POWER:

Chan.	Chan. Freq. (MHz)	Average Power (dBm)		Total Power (mW)	Total Power (dBm)	Limit (dBm)	Pass / Fail
		Chain 0	Chain 2				
102	5510	13.46	13.36	43.859	16.42	24	Pass
110	5550	20.52	20.32	220.367	23.43	24	Pass
134	5670	17.78	17.67	118.458	20.74	24	Pass
142 (UNII-2C Band)	5710	17.31	17.13	105.469	20.23	24	Pass
142 (UNII-3 Band)	5710	6.94	6.72	9.642	9.84	30	Pass

26dB BANDWIDTH:

Channel	Frequency (MHz)	26dBc Bandwidth (MHz)	
		Chain 0	Chain 2
102	5510	41.51	41.52
110	5550	94.97	89.03
134	5670	67.26	76.16
142 (UNII-2C Band)	5710	62.90	63.89

Note: For FCC output power limitation is determined based on 26dB bandwidth.

Power Limit = 11dBm + 10logB < U-NII-2C >			
Channel Number	Freq.(MHz)	Min. B(MHz)	Determined Conducted Limit (dBm)
102	5510	41.51	27.18 > 24
110	5550	89.03	30.49 > 24
134	5670	67.26	29.27 > 24
142 (UNII-2C Band)	5710	62.90	28.98 > 24

802.11ac (VHT80)
OUTPUT POWER:

Chan.	Chan. Freq. (MHz)	Average Power (dBm)		Total Power (mW)	Total Power (dBm)	Limit (dBm)	Pass / Fail
		Chain 0	Chain 2				
106	5530	12.25	12.46	34.408	15.37	24	Pass
122	5610	18.48	18.26	137.457	21.38	24	Pass
138 (UNII-2C Band)	5690	16.19	16.14	86.122	19.35	24	Pass
138 (UNII-3 Band)	5690	2.07	1.93	3.302	5.19	30	Pass

26dB BANDWIDTH:

Channel	Frequency (MHz)	26dBc Bandwidth (MHz)	
		Chain 0	Chain 2
106	5530	82.93	83.03
122	5610	135.36	125.28
138 (UNII-2C Band)	5690	115.00	115.00

Note: For FCC output power limitation is determined based on 26dB bandwidth.

Power Limit = 11dBm + 10logB < U-NII-2C >			
Channel Number	Freq.(MHz)	Min. B(MHz)	Determined Conducted Limit (dBm)
106	5530	82.93	30.18 > 24
122	5610	125.28	31.97 > 24
138 (UNII-2C Band)	5690	115.00	31.6 > 24

SPECTRUM PLOT OF WORST VALUE

802.11a – Chain (0): CH 144 (UNII-2C Band)

802.11ac (VHT20) – Chain (0): CH 140

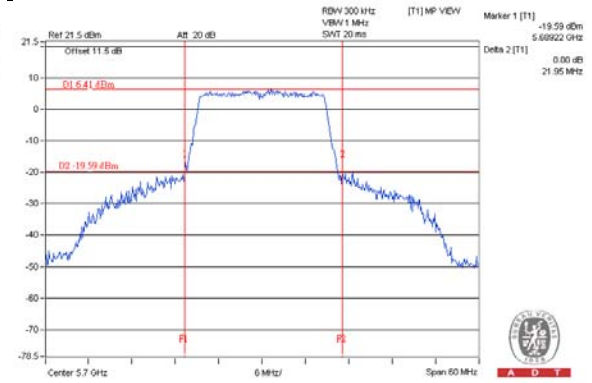
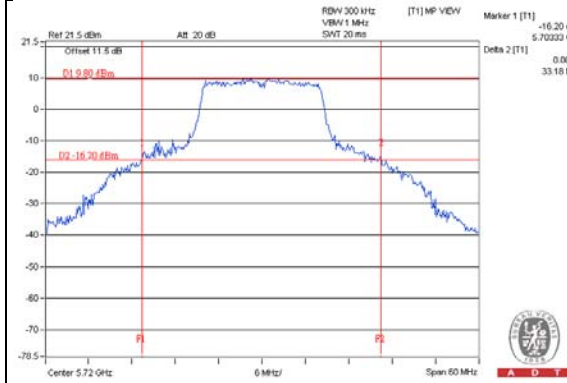

802.11ac (VHT40) – Chain (0): CH 102

802.11ac (VHT80) – Chain (0): CH 106

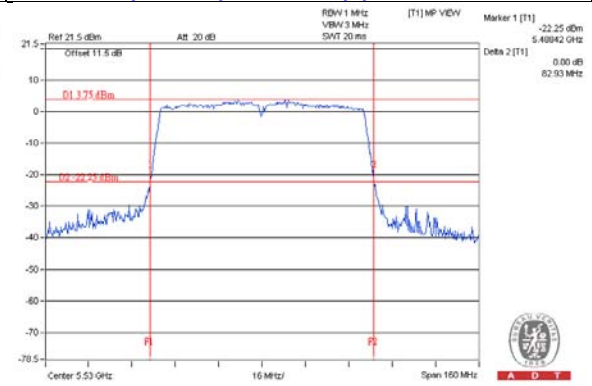
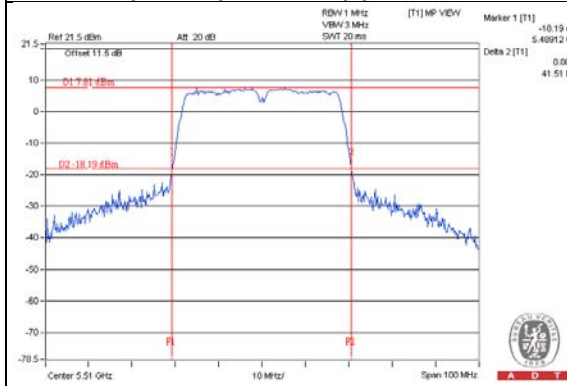

NOTE:

1. For CH144 (UNII-2C Band) = 5725 MHz - Marker 1

TxBF Mode:

802.11ac (VHT20)

OUTPUT POWER:

Chan.	Chan. Freq. (MHz)	Average Power (dBm)		Total Power (mW)	Total Power (dBm)	Limit (dBm)	Pass / Fail
		Chain 1	Chain 2				
52	5260	17.69	17.03	109.215	20.38	21.68	Pass
60	5300	17.72	17.06	109.972	20.41	21.68	Pass
64	5320	17.76	17.15	111.584	20.48	21.68	Pass

NOTE:

Directional gain = $10 \log[(10^{G1/20} + 10^{G2/20})^2 / 2]$ = 8.32dBi > 6dBi , therefore the limit needs to reduce, so the power limit shall be reduced to "Determined Conducted Limit-(8.32-6)"

26dB BANDWIDTH:

Channel	Frequency (MHz)	26dBc Bandwidth (MHz)	
		Chain 1	Chain 2
52	5260	33.64	28.84
60	5300	33.54	26.22
64	5320	29.01	26.22

Note: For FCC output power limitation is determined based on 26dB bandwidth.

Power Limit = 11dBm + 10logB < U-NII-2A >			
Channel Number	Freq.(MHz)	Min. B(MHz)	Determined Conducted Limit (dBm)
52	5260	28.84	25.59 > 24
60	5300	26.22	25.18 > 24
64	5320	26.22	25.18 > 24



802.11ac (VHT40)

OUTPUT POWER:

Chan.	Chan. Freq. (MHz)	Average Power (dBm)		Total Power (mW)	Total Power (dBm)	Limit (dBm)	Pass / Fail
		Chain 1	Chain 2				
54	5270	18.61	18.45	142.595	21.54	21.68	Pass
62	5310	13.06	12.61	38.469	15.85	21.68	Pass

NOTE:

Directional gain = $10 \log[(10^{G1/20} + 10^{G2/20})^2 / 2]$ = 8.32dBi > 6dBi , therefore the limit needs to reduce, so the power limit shall be reduced to "Determined Conducted Limit-(8.32-6)"

26dB BANDWIDTH:

Channel	Frequency (MHz)	26dBc Bandwidth (MHz)	
		Chain 1	Chain 2
54	5270	90.54	88.02
62	5310	41.02	41.35

Note: For FCC output power limitation is determined based on 26dB bandwidth.

Power Limit = 11dBm + 10logB < U-NII-2A >			
Channel Number	Freq.(MHz)	Min. B(MHz)	Determined Conducted Limit (dBm)
54	5270	88.02	30.44 > 24
62	5310	41.02	27.12 > 24



802.11ac (VHT80)

OUTPUT POWER:

Chan.	Chan. Freq. (MHz)	Average Power (dBm)		Total Power (mW)	Total Power (dBm)	Limit (dBm)	Pass / Fail
		Chain 1	Chain 2				
58	5290	12.55	12.27	34.855	15.42	21.68	Pass

NOTE:

Directional gain = $10 \log[(10^{G1/20} + 10^{G2/20})^2 / 2]$ = 8.32dBi > 6dBi , therefore the limit needs to reduce, so the power limit shall be reduced to "Determined Conducted Limit-(8.32-6)"

26dB BANDWIDTH:

Channel	Frequency (MHz)	26dBc Bandwidth (MHz)	
		Chain 1	Chain 2
58	5290	82.48	83.30

Note: For FCC output power limitation is determined based on 26dB bandwidth.

Power Limit = 11dBm + 10logB < U-NII-2A >			
Channel Number	Freq.(MHz)	Min. B(MHz)	Determined Conducted Limit (dBm)
58	5290	82.48	30.16 > 24

SPECTRUM PLOT OF WORST VALUE

802.11ac (VHT20) – Chain (2): CH 64

802.11ac (VHT40) – Chain (1): CH 62

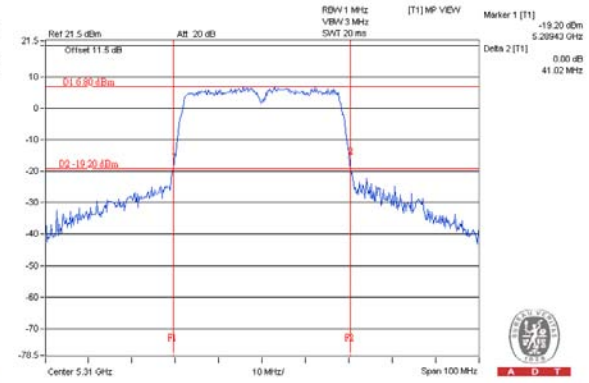
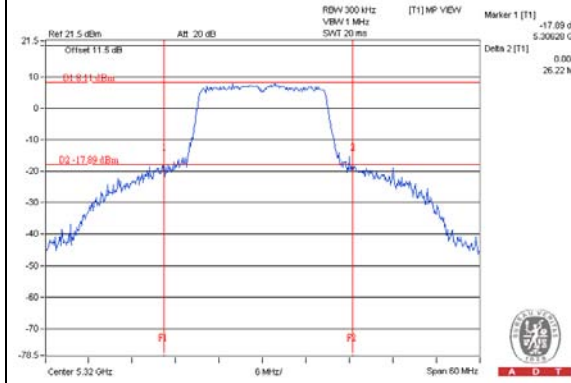

802.11ac (VHT80) – Chain (1): CH 58

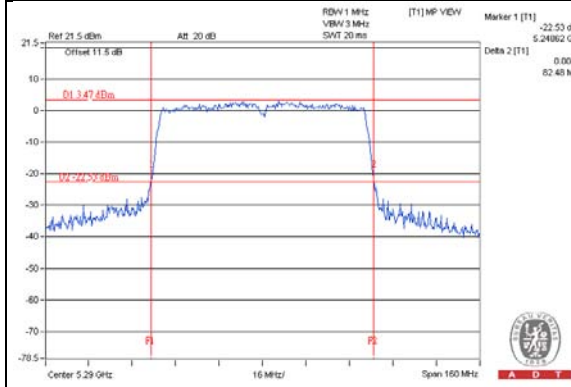

802.11ac (VHT20)
OUTPUT POWER:

Chan.	Chan. Freq. (MHz)	Average Power (dBm)		Total Power (mW)	Total Power (dBm)	Limit (dBm)	Pass / Fail
		Chain 0	Chain 2				
100	5500	18.52	18.23	137.648	21.39	21.68	Pass
116	5580	18.73	18.53	145.93	21.64	21.68	Pass
140	5700	15.72	15.57	73.383	18.66	21.68	Pass
144 (UNII-2C Band)	5720	14.59	14.36	56.064	17.49	21.68	Pass
144 (UNII-3 Band)	5720	8.64	8.37	14.182	11.52	27.60	Pass

NOTE:

For U-NII-2C: Directional gain = $10 \log[(10^{G1/20} + 10^{G2/20})^2 / 2] = 8.32\text{dBi} > 6\text{dBi}$, therefore the limit needs to reduce, so the power limit shall be reduced to "Determined Conducted Limit-(8.32-6)"

For U-NII-3: Directional gain = $10 \log[(10^{G1/20} + 10^{G2/20})^2 / 2] = 8.4\text{dBi} > 6\text{dBi}$, so the power limit shall be reduced to $30-(8.4-6) = 27.60\text{dBm}$.

26dB BANDWIDTH:

Channel	Frequency (MHz)	26dBc Bandwidth (MHz)	
		Chain 0	Chain 2
100	5500	34.36	29.96
116	5580	35.66	31.49
140	5700	21.95	24.72
144 (UNII-2C Band)	5720	24.36	23.51

Note: For FCC output power limitation is determined based on 26dB bandwidth.

Power Limit = $11\text{dBm} + 10\log B < \text{U-NII-2C} >$			
Channel Number	Freq.(MHz)	Min. B(MHz)	Determined Conducted Limit (dBm)
100	5500	29.96	25.76 > 24
116	5580	31.49	25.98 > 24
140	5700	21.95	24.41 > 24
144 (UNII-2C Band)	5720	23.51	24.71 < 24

802.11ac (VHT40)
OUTPUT POWER:

Chan.	Chan. Freq. (MHz)	Average Power (dBm)		Total Power (mW)	Total Power (dBm)	Limit (dBm)	Pass / Fail
		Chain 0	Chain 2				
102	5510	13.46	13.36	43.859	16.42	21.68	Pass
110	5550	18.52	18.35	139.512	21.45	21.68	Pass
134	5670	17.78	17.67	118.458	20.74	21.68	Pass
142 (UNII-2C Band)	5710	13.25	13.15	41.789	16.21	21.68	Pass
142 (UNII-3 Band)	5710	4.24	4.05	5.196	7.16	27.60	Pass

NOTE:

For U-NII-2C: Directional gain = $10 \log[(10^{G1/20} + 10^{G2/20})^2 / 2] = 8.32\text{dBi} > 6\text{dBi}$, therefore the limit needs to reduce, so the power limit shall be reduced to "Determined Conducted Limit-(8.32-6)"

For U-NII-3: Directional gain = $10 \log[(10^{G1/20} + 10^{G2/20})^2 / 2] = 8.4\text{dBi} > 6\text{dBi}$, so the power limit shall be reduced to $30-(8.4-6) = 27.60\text{dBm}$.

26dB BANDWIDTH:

Channel	Frequency (MHz)	26dBc Bandwidth (MHz)	
		Chain 0	Chain 2
102	5510	41.51	41.52
110	5550	94.97	89.03
134	5670	67.26	76.16
142 (UNII-2C Band)	5710	62.90	63.89

Note: For FCC output power limitation is determined based on 26dB bandwidth.

Power Limit = $11\text{dBm} + 10\log B < \text{U-NII-2C} >$			
Channel Number	Freq.(MHz)	Min. B(MHz)	Determined Conducted Limit (dBm)
102	5510	41.51	27.18 > 24
110	5550	89.03	30.49 > 24
134	5670	67.26	29.27 > 24
142 (UNII-2C Band)	5710	62.90	28.98 > 24

802.11ac (VHT80)
OUTPUT POWER:

Chan.	Chan. Freq. (MHz)	Average Power (dBm)		Total Power (mW)	Total Power (dBm)	Limit (dBm)	Pass / Fail
		Chain 0	Chain 2				
106	5530	12.25	12.46	34.408	15.37	21.68	Pass
122	5610	18.48	18.26	137.457	21.38	21.68	Pass
138 (UNII-2C Band)	5690	14.91	14.86	64.138	18.07	21.68	Pass
138 (UNII-3 Band)	5690	0.80	0.71	2.478	3.94	27.60	Pass

NOTE:

For U-NII-2C: Directional gain = $10 \log[(10^{G1/20} + 10^{G2/20})^2 / 2] = 8.32\text{dBi} > 6\text{dBi}$, therefore the limit needs to reduce, so the power limit shall be reduced to "Determined Conducted Limit-(8.32-6)"

For U-NII-3: Directional gain = $10 \log[(10^{G1/20} + 10^{G2/20})^2 / 2] = 8.4\text{dBi} > 6\text{dBi}$, so the power limit shall be reduced to $30-(8.4-6) = 27.60\text{dBm}$.

26dB BANDWIDTH:

Channel	Frequency (MHz)	26dBc Bandwidth (MHz)	
		Chain 0	Chain 2
106	5530	82.93	83.03
122	5610	135.36	125.28
138 (UNII-2C Band)	5690	115.00	115.00

Note: For FCC output power limitation is determined based on 26dB bandwidth.

Power Limit = 11dBm + 10logB < U-NII-2C >			
Channel Number	Freq.(MHz)	Min. B(MHz)	Determined Conducted Limit (dBm)
106	5530	82.93	30.18 > 24
122	5610	125.28	31.97 > 24
138 (UNII-2C Band)	5690	115.00	31.6 > 24

SPECTRUM PLOT OF WORST VALUE

802.11ac (VHT20) – Chain (0): CH 140

802.11ac (VHT40) – Chain (0): CH 102

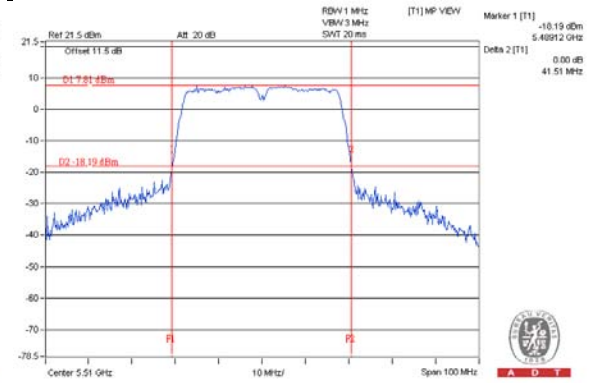
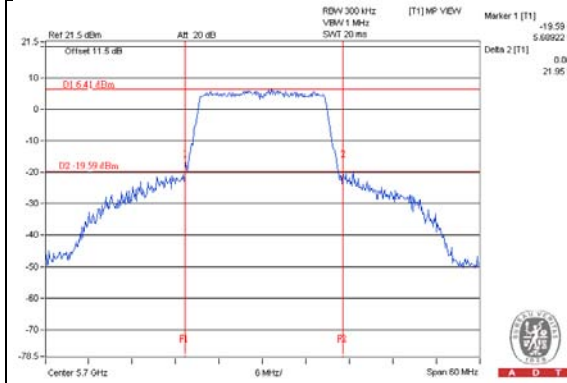

802.11ac (VHT80) – Chain (0): CH 106

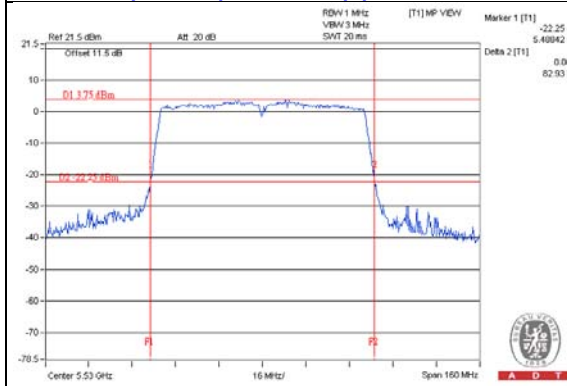

NOTE:

1TX
Chain 2
802.11a

Chan.	Chan. Freq. (MHz)	Average Power (mW)	Average Power (dBm)	Limit (dBm)	Pass / Fail
52	5260	114.551	20.59	24	Pass
60	5300	97.499	19.89	24	Pass
64	5320	66.222	18.21	24	Pass
100	5500	77.804	18.91	24	Pass
116	5580	104.954	20.21	24	Pass
140	5700	66.222	18.21	24	Pass
144 (UNII-2C Band)	5720	44.259	16.46	24	Pass
144 (UNII-3 Band)	5720	11.246	10.51	30	Pass

26dB BANDWIDTH:

Channel	Frequency (MHz)	26dBc Bandwidth (MHz)
52	5260	44.63
60	5300	38.87
64	5320	36.25
100	5500	29.93
116	5580	39.41
140	5700	31.74
144 (UNII-2C Band)	5720	27.73

Note: For FCC output power limitation is determined based on 26dB bandwidth.

Power Limit = 11dBm + 10logB < U-NII-2A, U-NII-2C >			
Channel Number	Freq.(MHz)	Min. B(MHz)	Determined Conducted Limit (dBm)
52	5260	44.63	27.49 > 24
60	5300	38.87	26.89 > 24
64	5320	36.25	26.59 > 24
100	5500	29.93	25.76 > 24
116	5580	39.41	26.95 > 24
140	5700	31.74	26.01 > 24
144 (UNII-2C Band)	5720	27.73	25.42 > 24

802.11ac (VHT20)
OUTPUT POWER:

Chan.	Chan. Freq. (MHz)	Average Power (mW)	Average Power (dBm)	Limit (dBm)	Pass / Fail
52	5260	90.365	19.56	24	Pass
60	5300	76.208	18.82	24	Pass
64	5320	56.105	17.49	24	Pass
100	5500	76.208	18.82	24	Pass
116	5580	99.77	19.99	24	Pass
140	5700	39.902	16.01	24	Pass
144 (UNII-2C Band)	5720	42.462	16.28	24	Pass
144 (UNII-3 Band)	5720	10.765	10.32	30	Pass

26dB BANDWIDTH:

Channel	Frequency (MHz)	26dBc Bandwidth (MHz)
52	5260	42.43
60	5300	37.12
64	5320	27.47
100	5500	30.66
116	5580	37.25
140	5700	22.77
144 (UNII-2C Band)	5720	27.63

Note: For FCC output power limitation is determined based on 26dB bandwidth.

Power Limit = 11dBm + 10logB < U-NII-2A, U-NII-2C >			
Channel Number	Freq.(MHz)	Min. B(MHz)	Determined Conducted Limit (dBm)
52	5260	42.43	27.27 > 24
60	5300	37.12	26.69 > 24
64	5320	27.47	25.38 > 24
100	5500	30.66	25.86 > 24
116	5580	37.25	26.71 > 24
140	5700	22.77	24.57 > 24
144 (UNII-2C Band)	5720	27.63	25.41 > 24

802.11ac (VHT40)
OUTPUT POWER:

Chan.	Chan. Freq. (MHz)	Average Power (mW)	Average Power (dBm)	Limit (dBm)	Pass / Fail
54	5270	102.565	20.11	24	Pass
62	5310	19.32	12.86	24	Pass
102	5510	22.961	13.61	24	Pass
110	5550	114.288	20.58	24	Pass
134	5670	64.714	18.11	24	Pass
142 (UNII-2C Band)	5710	51.642	17.13	24	Pass
142 (UNII-3 Band)	5710	4.699	6.72	30	Pass

26dB BANDWIDTH:

Channel	Frequency (MHz)	26dBc Bandwidth (MHz)
54	5270	92.19
62	5310	41.54
102	5510	41.27
110	5550	91.89
134	5670	76.04
142 (UNII-2C Band)	5710	63.89

Note: For FCC output power limitation is determined based on 26dB bandwidth.

Power Limit = 11dBm + 10logB < U-NII-2A, U-NII-2C >			
Channel Number	Freq.(MHz)	Min. B(MHz)	Determined Conducted Limit (dBm)
54	5270	92.19	30.64 > 24
62	5310	41.54	27.18 > 24
102	5510	41.27	27.15 > 24
110	5550	91.89	30.63 > 24
134	5670	76.04	29.81 > 24
142 (UNII-2C Band)	5710	63.89	29.05 > 24

802.11ac (VHT80)
OUTPUT POWER:

Chan.	Chan. Freq. (MHz)	Average Power (mW)	Average Power (dBm)	Limit (dBm)	Pass / Fail
58	5290	17.906	12.53	24	Pass
106	5530	18.664	12.71	24	Pass
122	5610	71.285	18.53	24	Pass
138 (UNII-2C Band)	5690	39.411	15.96	24	Pass
138 (UNII-3 Band)	5690	1.475	1.69	30	Pass

26dB BANDWIDTH:

Channel	Frequency (MHz)	26dBc Bandwidth (MHz)
58	5290	82.79
106	5530	82.76
122	5610	140.57
138 (UNII-2C Band)	5690	115.00

Note: For FCC output power limitation is determined based on 26dB bandwidth.

Power Limit = 11dBm + 10logB < U-NII-2A, U-NII-2C >			
Channel Number	Freq.(MHz)	Min. B(MHz)	Determined Conducted Limit (dBm)
58	5290	82.79	30.17 > 24
106	5530	82.76	30.17 > 24
122	5610	140.57	32.47 > 24
138 (UNII-2C Band)	5690	115.00	31.6 > 24

SPECTRUM PLOT OF WORST VALUE

802.11a: CH 144 (UNII-2C Band)

802.11ac (VHT20): CH 140

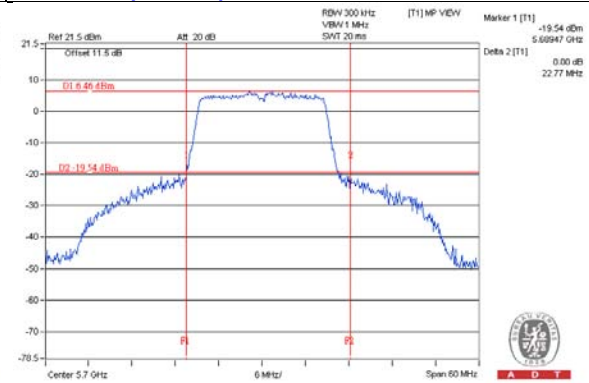
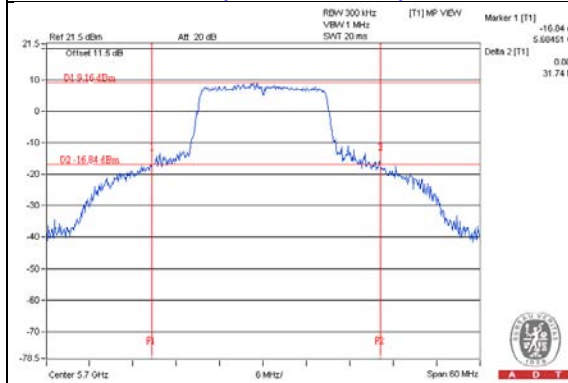

802.11ac (VHT40): CH 102

802.11ac (VHT80): CH 106

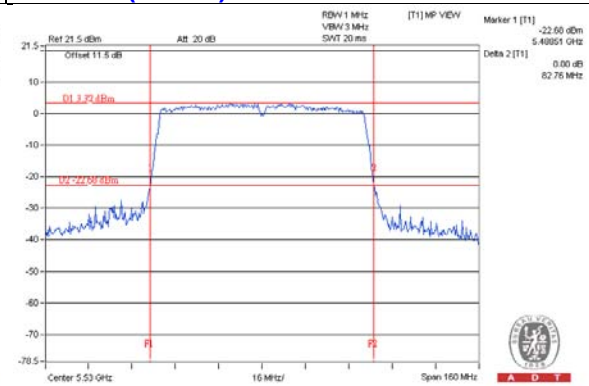
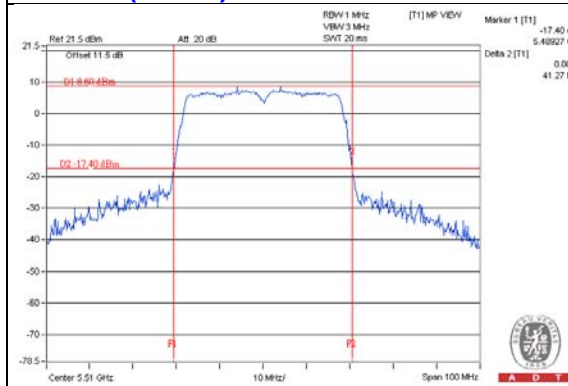

NOTE:

- 1. For CH144 (UNII-2C Band) = 5725 MHz - Marker 1

4.3.8 Test Result (Mode 2)

POWER OUTPUT:

3TX

CDD Mode:

802.11a

Chan.	Chan. Freq. (MHz)	Average Power (dBm)			Total Power (mW)	Total Power (dBm)	Limit (dBm)	Pass / Fail
		Chain 0	Chain 1	Chain 2				
52	5260	15.86	14.17	15.31	98.633	19.94	23.62	Pass
60	5300	15.83	14.11	15.21	97.234	19.88	23.62	Pass
64	5320	15.81	14.26	15.27	98.427	19.93	23.62	Pass
100	5500	15.68	14.30	15.02	95.667	19.81	24	Pass
116	5580	15.53	14.15	14.73	91.446	19.61	24	Pass
140	5700	15.13	14.12	14.66	87.649	19.43	24	Pass
144 (UNII-2C Band)	5720	11.82	10.37	11.54	40.35	16.06	22.96	Pass
144 (UNII-3 Band)	5720	5.66	4.35	5.38	9.855	9.94	30	Pass

NOTE:

For U-NII-2A: Directional gain = 6.38dBi > 6dBi, therefore the limit needs to reduce, so the power limit shall be reduced to "Determined Conducted Limit-(6.38-6)"

26dB BANDWIDTH:

Channel	Frequency (MHz)	26dBc Bandwidth (MHz)		
		Chain 0	Chain 1	Chain 2
52	5260	21.80	21.65	21.72
60	5300	21.65	21.61	21.62
64	5320	21.86	21.68	21.62
100	5500	21.66	21.56	21.50
116	5580	21.76	21.63	21.71
140	5700	21.74	21.67	21.38
144 (UNII-2C Band)	5720	15.92	15.76	15.73

Note: For FCC output power limitation is determined based on 26dB bandwidth.



Power Limit = $11\text{dBm} + 10\log B$ < U-NII-2A, U-NII-2C >			
Channel Number	Freq.(MHz)	Min. B(MHz)	Determined Conducted Limit (dBm)
52	5260	21.65	24.35 > 24
60	5300	21.61	24.34 > 24
64	5320	21.62	24.34 > 24
100	5500	21.50	24.32 > 24
116	5580	21.63	24.35 > 24
140	5700	21.38	24.3 > 24
144 (UNII-2C Band)	5720	15.73	22.96 < 24

802.11ac (VHT20)

OUTPUT POWER:

Chan.	Chan. Freq. (MHz)	Average Power (dBm)			Total Power (mW)	Total Power (dBm)	Limit (dBm)	Pass / Fail
		Chain 0	Chain 1	Chain 2				
52	5260	15.91	14.22	15.27	99.069	19.96	23.62	Pass
60	5300	15.86	14.22	15.23	98.315	19.93	23.62	Pass
64	5320	15.83	14.27	15.21	98.201	19.92	23.62	Pass
100	5500	15.81	14.13	14.99	95.539	19.80	24	Pass
116	5580	15.80	14.31	14.92	96.042	19.82	24	Pass
140	5700	15.52	14.45	15.04	95.421	19.80	24	Pass
144 (UNII-2C Band)	5720	11.60	10.35	11.40	39.097	15.92	23.02	Pass
144 (UNII-3 Band)	5720	5.85	4.65	5.73	10.504	10.21	30	Pass

NOTE:

For U-NII-2A: Directional gain = 6.38dBi > 6dBi, therefore the limit needs to reduce, so the power limit shall be reduced to "Determined Conducted Limit-(6.38-6)"

26dB BANDWIDTH:

Channel	Frequency (MHz)	26dBc Bandwidth (MHz)		
		Chain 0	Chain 1	Chain 2
52	5260	21.89	21.63	21.97
60	5300	21.99	21.80	21.81
64	5320	22.05	21.81	21.81
100	5500	21.97	21.62	21.71
116	5580	21.99	21.81	21.76
140	5700	21.84	21.73	21.71
144 (UNII-2C Band)	5720	16.16	15.94	15.97

Note: For FCC output power limitation is determined based on 26dB bandwidth.



Power Limit = 11dBm + 10logB < U-NII-2A, U-NII-2C >			
Channel Number	Freq.(MHz)	Min. B(MHz)	Determined Conducted Limit (dBm)
52	5260	21.63	24.35 > 24
60	5300	21.80	24.38 > 24
64	5320	21.81	24.38 > 24
100	5500	21.62	24.34 > 24
116	5580	21.76	24.37 > 24
140	5700	21.71	24.36 > 24
144 (UNII-2C Band)	5720	15.94	23.02 < 24

802.11ac (VHT40)
OUTPUT POWER:

Chan.	Chan. Freq. (MHz)	Average Power (dBm)			Total Power (mW)	Total Power (dBm)	Limit (dBm)	Pass / Fail
		Chain 0	Chain 1	Chain 2				
54	5270	18.83	17.11	18.32	195.708	22.92	23.62	Pass
62	5310	16.56	15.27	16.44	122.996	20.90	23.62	Pass
102	5510	17.13	16.22	16.85	141.938	21.52	24	Pass
110	5550	18.27	17.59	18.19	190.472	22.80	24	Pass
134	5670	18.11	17.54	18.07	185.589	22.69	24	Pass
142 (UNII-2C Band)	5710	14.64	14.52	14.76	87.344	19.41	24	Pass
142 (UNII-3 Band)	5710	4.28	4.24	4.48	8.139	9.11	30	Pass

NOTE:

For U-NII-2A: Directional gain = 6.38dBi > 6dBi, therefore the limit needs to reduce, so the power limit shall be reduced to "Determined Conducted Limit-(6.38-6)"

26dB BANDWIDTH:

Channel	Frequency (MHz)	26dBc Bandwidth (MHz)		
		Chain 0	Chain 1	Chain 2
54	5270	59.09	44.19	41.34
62	5310	44.01	41.49	41.29
102	5510	41.76	41.47	41.20
110	5550	47.03	43.68	41.13
134	5670	49.08	55.90	41.28
142 (UNII-2C Band)	5710	37.86	38.36	35.71

Note: For FCC output power limitation is determined based on 26dB bandwidth.

Power Limit = 11dBm + 10logB < U-NII-2A, U-NII-2C >			
Channel Number	Freq.(MHz)	Min. B(MHz)	Determined Conducted Limit (dBm)
54	5270	41.34	27.16 > 24
62	5310	41.29	27.15 > 24
102	5510	41.20	27.14 > 24
110	5550	41.13	27.14 > 24
134	5670	41.28	27.15 > 24
142 (UNII-2C Band)	5710	35.71	26.52 > 24

802.11ac (VHT80)

OUTPUT POWER:

Chan.	Chan. Freq. (MHz)	Average Power (dBm)			Total Power (mW)	Total Power (dBm)	Limit (dBm)	Pass / Fail
		Chain 0	Chain 1	Chain 2				
58	5290	14.76	13.42	14.25	78.509	18.95	23.62	Pass
106	5530	16.73	15.06	15.51	114.724	20.60	24	Pass
122	5610	18.15	17.46	17.75	180.598	22.57	24	Pass
138 (UNII-2C Band)	5690	16.12	15.44	15.77	118.415	20.73	24	Pass
138 (UNII-3 Band)	5690	2.09	1.77	2.12	4.948	6.94	30	Pass

NOTE:

For U-NII-2A: Directional gain = 6.38dBi > 6dBi, therefore the limit needs to reduce, so the power limit shall be reduced to "Determined Conducted Limit-(6.38-6)"

26dB BANDWIDTH:

Channel	Frequency (MHz)	26dBc Bandwidth (MHz)		
		Chain 0	Chain 1	Chain 2
58	5290	82.71	82.19	82.49
106	5530	82.60	82.06	82.13
122	5610	106.76	82.10	82.49
138 (UNII-2C Band)	5690	103.58	76.08	76.13

Note: For FCC output power limitation is determined based on 26dB bandwidth.

Power Limit = 11dBm + 10logB < U-NII-2A, U-NII-2C >			
Channel Number	Freq.(MHz)	Min. B(MHz)	Determined Conducted Limit (dBm)
58	5290	82.19	30.14 > 24
106	5530	82.06	30.14 > 24
122	5610	82.10	30.14 > 24
138 (UNII-2C Band)	5690	76.08	29.81 > 24

SPECTRUM PLOT OF WORST VALUE

802.11a – Chain (1): CH 144 (UNII-2C Band)

802.11ac (VHT20) – Chain (1): CH 144 (UNII-2C Band)

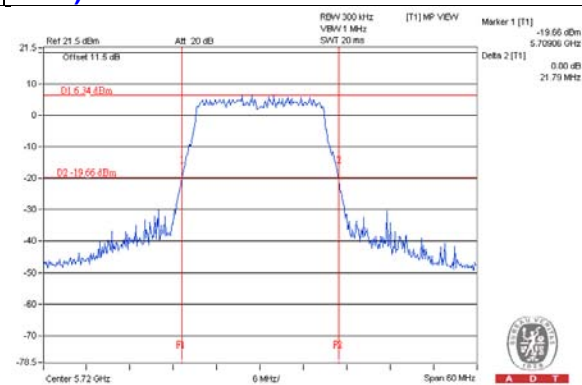
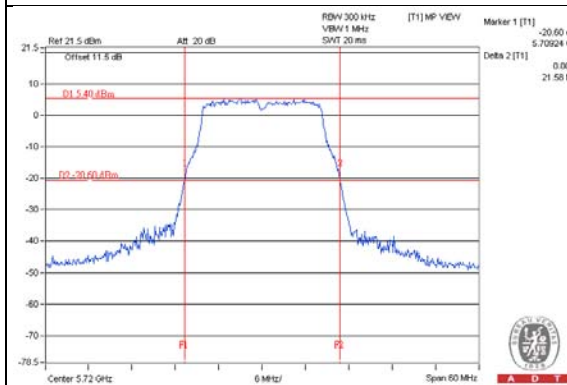

802.11ac (VHT40) – Chain (1): CH 142 (UNII-2C Band)

802.11ac (VHT80) – Chain (1): 138 (UNII-2C Band)

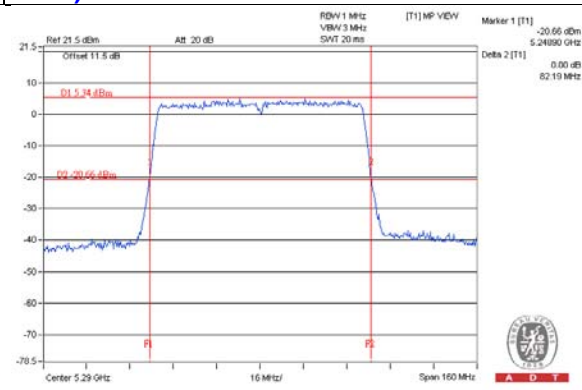
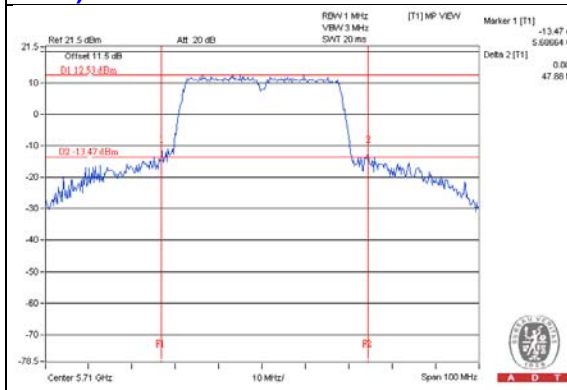

NOTE:

1. For CH144 (UNII-2C Band) = 5725 MHz - Marker 1
2. For CH142 (UNII-2C Band) = 5725 MHz - Marker 1
3. For CH138 (UNII-2C Band) = 5725 MHz - Marker 1

TxBF Mode:

802.11ac (VHT20)

OUTPUT POWER:

Chan.	Chan. Freq. (MHz)	Average Power (dBm)			Total Power (mW)	Total Power (dBm)	Limit (dBm)	Pass / Fail
		Chain 0	Chain 1	Chain 2				
52	5260	15.86	14.17	15.22	97.936	19.91	19.94	Pass
60	5300	15.86	14.22	15.23	98.315	19.93	19.94	Pass
64	5320	15.83	14.27	15.21	98.201	19.92	19.94	Pass
100	5500	15.81	14.13	14.99	95.539	19.80	20.00	Pass
116	5580	15.80	14.31	14.92	96.042	19.82	20.00	Pass
140	5700	15.52	14.45	15.04	95.421	19.80	20.00	Pass
144 (UNII-2C Band)	5720	11.60	10.35	11.40	39.097	15.92	19.02	Pass
144 (UNII-3 Band)	5720	5.85	4.65	5.73	10.504	10.21	26.03	Pass

NOTE: 1. For U-NII-2A: Directional gain = $10 \log[(10^{G1/20} + 10^{G2/20} + 10^{G3/20})^2 / 3] = 10.06\text{dBi} > 6\text{dBi}$, therefore the limit needs to reduce, so the power limit shall be reduced to "Determined Conducted Limit-(10.06-6)"

2. For U-NII-2C: Directional gain = $10 \log[(10^{G1/20} + 10^{G2/20} + 10^{G3/20})^2 / 3] = 10\text{dBi} > 6\text{dBi}$, therefore the limit needs to reduce, so the power limit shall be reduced to "Determined Conducted Limit-(10-6)"

26dB BANDWIDTH:

Channel	Frequency (MHz)	26dBc Bandwidth (MHz)		
		Chain 0	Chain 1	Chain 2
52	5260	21.89	21.63	21.97
60	5300	21.99	21.80	21.81
64	5320	22.05	21.81	21.81
100	5500	21.97	21.62	21.71
116	5580	21.99	21.81	21.76
140	5700	21.84	21.73	21.71
144 (UNII-2C Band)	5720	16.16	15.94	15.97

Note: For FCC output power limitation is determined based on 26dB bandwidth.



Power Limit = $11\text{dBm} + 10\log B$ < U-NII-2A, U-NII-2C >			
Channel Number	Freq.(MHz)	Min. B(MHz)	Determined Conducted Limit (dBm)
52	5260	21.63	24.35 > 24
60	5300	21.80	24.38 > 24
64	5320	21.81	24.38 > 24
100	5500	21.62	24.34 > 24
116	5580	21.76	24.37 > 24
140	5700	21.71	24.36 > 24
144 (UNII-2C Band)	5720	15.94	23.02 < 24

802.11ac (VHT40)

OUTPUT POWER:

Chan.	Chan. Freq. (MHz)	Average Power (dBm)			Total Power (mW)	Total Power (dBm)	Limit (dBm)	Pass / Fail
		Chain 0	Chain 1	Chain 2				
54	5270	15.86	13.98	15.24	96.971	19.87	19.94	Pass
62	5310	15.47	14.27	15.37	96.402	19.84	19.94	Pass
102	5510	15.55	14.34	15.31	97.019	19.87	20.00	Pass
110	5550	15.40	14.59	15.00	95.071	19.78	20.00	Pass
134	5670	15.27	14.82	15.42	98.824	19.95	20.00	Pass
142 (UNII-2C Band)	5710	10.37	10.44	10.36	32.819	15.16	20.00	Pass
142 (UNII-3 Band)	5710	-0.14	-0.06	-0.12	2.9273	4.66	26.03	Pass

- NOTE:**
1. For U-NII-2A: Directional gain = $10 \log[(10^{G1/20} + 10^{G2/20} + 10^{G3/20})^2 / 3] = 10.06\text{dBi} > 6\text{dBi}$, therefore the limit needs to reduce, so the power limit shall be reduced to "Determined Conducted Limit-(10.06-6)"
 2. For U-NII-2C: Directional gain = $10 \log[(10^{G1/20} + 10^{G2/20} + 10^{G3/20})^2 / 3] = 10\text{dBi} > 6\text{dBi}$, therefore the limit needs to reduce, so the power limit shall be reduced to "Determined Conducted Limit-(10-6)"
 3. For U-NII-3: Directional gain = $10 \log[(10^{G1/20} + 10^{G2/20} + 10^{G3/20})^2 / 3] = 9.97\text{dBi} > 6\text{dBi}$, so the power limit shall be reduced to $30-(9.97-6) = 26.03\text{dBm}$.

26dB BANDWIDTH:

Channel	Frequency (MHz)	26dBc Bandwidth (MHz)		
		Chain 0	Chain 1	Chain 2
54	5270	59.09	44.19	41.34
62	5310	44.01	41.49	41.29
102	5510	41.76	41.47	41.20
110	5550	47.03	43.68	41.13
134	5670	49.08	55.90	41.28
142 (UNII-2C Band)	5710	37.86	38.36	35.71

Note: For FCC output power limitation is determined based on 26dB bandwidth.



Power Limit = $11\text{dBm} + 10\log B$ < U-NII-2A, U-NII-2C >			
Channel Number	Freq.(MHz)	Min. B(MHz)	Determined Conducted Limit (dBm)
54	5270	41.34	27.16 > 24
62	5310	41.29	27.15 > 24
102	5510	41.20	27.14 > 24
110	5550	41.13	27.14 > 24
134	5670	41.28	27.15 > 24
142 (UNII-2C Band)	5710	35.71	26.52 > 24

802.11ac (VHT80)

OUTPUT POWER:

Chan.	Chan. Freq. (MHz)	Average Power (dBm)			Total Power (mW)	Total Power (dBm)	Limit (dBm)	Pass / Fail
		Chain 0	Chain 1	Chain 2				
58	5290	14.76	13.42	14.25	78.509	18.95	19.94	Pass
106	5530	15.96	14.25	14.73	95.77	19.81	20.00	Pass
122	5610	15.55	14.72	15.11	97.974	19.91	20.00	Pass
138 (UNII-2C Band)	5690	11.02	10.93	11.05	39.33	15.95	20.00	Pass
138 (UNII-3 Band)	5690	-3.31	-3.38	-3.23	1.4591	1.64	26.03	Pass

- NOTE:**
1. For U-NII-2A: Directional gain = $10 \log[(10^{G1/20} + 10^{G2/20} + 10^{G3/20})^2 / 3] = 10.06\text{dBi} > 6\text{dBi}$, therefore the limit needs to reduce, so the power limit shall be reduced to "Determined Conducted Limit-(10.06-6)"
 2. For U-NII-2C: Directional gain = $10 \log[(10^{G1/20} + 10^{G2/20} + 10^{G3/20})^2 / 3] = 10\text{dBi} > 6\text{dBi}$, therefore the limit needs to reduce, so the power limit shall be reduced to "Determined Conducted Limit-(10-6)"
 3. For U-NII-3: Directional gain = $10 \log[(10^{G1/20} + 10^{G2/20} + 10^{G3/20})^2 / 3] = 9.97\text{dBi} > 6\text{dBi}$, so the power limit shall be reduced to $30-(9.97-6) = 26.03\text{dBm}$.

26dB BANDWIDTH:

Channel	Frequency (MHz)	26dBc Bandwidth (MHz)		
		Chain 0	Chain 1	Chain 2
58	5290	82.71	82.19	82.49
106	5530	82.60	82.06	82.13
122	5610	106.76	82.10	82.49
138 (UNII-2C Band)	5690	103.58	76.08	76.13

Note: For FCC output power limitation is determined based on 26dB bandwidth.

Power Limit = 11dBm + 10logB < U-NII-2A, U-NII-2C >			
Channel Number	Freq.(MHz)	Min. B(MHz)	Determined Conducted Limit (dBm)
58	5290	82.19	30.14 > 24
106	5530	82.06	30.14 > 24
122	5610	82.10	30.14 > 24
138 (UNII-2C Band)	5690	76.08	29.81 > 24

SPECTRUM PLOT OF WORST VALUE

802.11ac (VHT20) – Chain (1): CH 144 (UNII-2C Band)

802.11ac (VHT40) – Chain (1): CH 142 (UNII-2C Band)

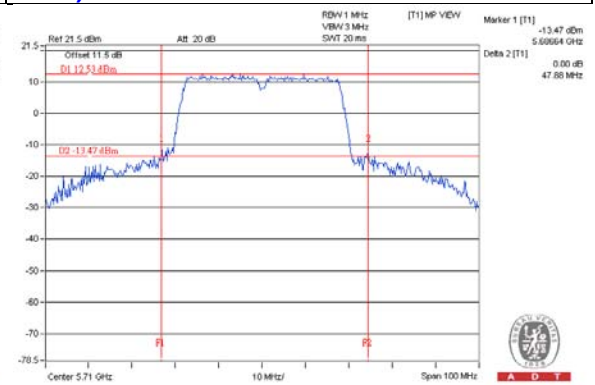
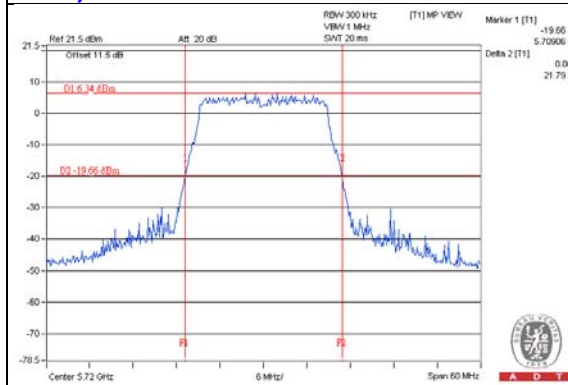

802.11ac (VHT80) – Chain (1): CH 58

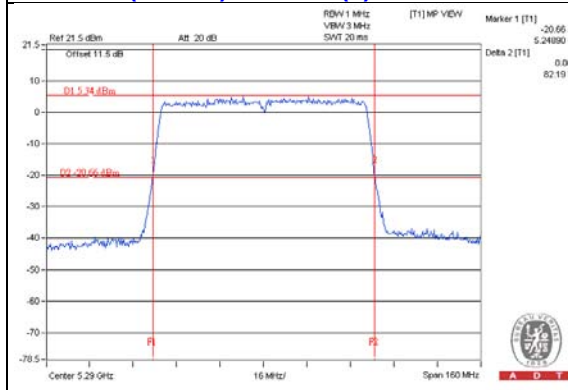

NOTE:

- 1. For CH144 (UNII-2C Band) = 5725 MHz - Marker 1
- 2. For CH142 (UNII-2C Band) = 5725 MHz - Marker 1

2TX
CDD Mode:
802.11a
OUTPUT POWER:

Chan.	Chan. Freq. (MHz)	Average Power (dBm)		Total Power (mW)	Total Power (dBm)	Limit (dBm)	Pass / Fail
		Chain 0	Chain 1				
52	5260	18.71	17.26	127.513	21.06	21.24	Pass
60	5300	18.84	17.34	130.76	21.16	21.24	Pass
64	5320	18.72	17.46	130.192	21.15	21.24	Pass
100	5500	19.03	17.32	133.934	21.27	21.58	Pass
116	5580	19.36	17.38	141	21.49	21.58	Pass
140	5700	19.20	17.47	139.023	21.43	21.58	Pass
144 (UNII-2C Band)	5720	15.42	13.58	57.637	17.61	20.63	Pass
144 (UNII-3 Band)	5720	9.76	7.99	15.757	11.97	27.79	Pass

- NOTE:** 1. For U-NII-2A: Directional gain = $10 \log[(10^{G1/20} + 10^{G2/20})^2 / 2] = 8.76\text{dBi} > 6\text{dBi}$, therefore the limit needs to reduce, so the power limit shall be reduced to "Determined Conducted Limit-(8.76-6)"
2. For U-NII-2C: Directional gain = $10 \log[(10^{G1/20} + 10^{G2/20})^2 / 2] = 8.42\text{dBi} > 6\text{dBi}$, therefore the limit needs to reduce, so the power limit shall be reduced to "Determined Conducted Limit-(8.42-6)"
3. For U-NII-3: Directional gain = $10 \log[(10^{G1/20} + 10^{G2/20})^2 / 2] = 8.21\text{dBi} > 6\text{dBi}$, so the power limit shall be reduced to $30-(8.21-6) = 27.79\text{dBm}$.

26dB BANDWIDTH:

Channel	Frequency (MHz)	26dBc Bandwidth (MHz)	
		Chain 0	Chain 1
52	5260	22.05	21.98
60	5300	25.22	21.95
64	5320	22.00	21.90
100	5500	21.85	21.80
116	5580	21.71	21.71
140	5700	21.71	21.76
144 (UNII-2C Band)	5720	16.18	15.94

Note: For FCC output power limitation is determined based on 26dB bandwidth.



Power Limit = 11dBm + 10logB < U-NII-2A, U-NII-2C >			
Channel Number	Freq.(MHz)	Min. B(MHz)	Determined Conducted Limit (dBm)
52	5260	21.98	24.42 > 24
60	5300	21.95	24.41 > 24
64	5320	21.90	24.4 > 24
100	5500	21.80	24.38 > 24
116	5580	21.71	24.36 > 24
140	5700	21.71	24.36 > 24
144 (UNII-2C Band)	5720	15.94	23.02 < 24

802.11ac (VHT20)
OUTPUT POWER:

Chan.	Chan. Freq. (MHz)	Average Power (dBm)		Total Power (mW)	Total Power (dBm)	Limit (dBm)	Pass / Fail
		Chain 0	Chain 1				
52	5260	19.07	17.51	137.088	21.37	23.62	Pass
60	5300	19.19	17.59	140.397	21.47	23.62	Pass
64	5320	19.03	17.71	139.003	21.43	23.62	Pass
100	5500	19.03	17.32	133.934	21.27	24.00	Pass
116	5580	19.36	17.38	141	21.49	24.00	Pass
140	5700	19.20	17.47	139.023	21.43	24.00	Pass
144 (UNII-2C Band)	5720	15.42	13.58	57.637	17.61	23.05	Pass
144 (UNII-3 Band)	5720	9.76	7.99	15.757	11.97	30.00	Pass

NOTE: 1. For U-NII-2A: Directional gain = 6.38dBi > 6dBi , therefore the limit needs to reduce, so the power limit shall be reduced to "Determined Conducted Limit-(6.38-6)"

26dB BANDWIDTH:

Channel	Frequency (MHz)	26dBc Bandwidth (MHz)	
		Chain 0	Chain 1
52	5260	25.11	22.09
60	5300	24.20	22.20
64	5320	24.27	22.27
100	5500	22.06	22.12
116	5580	22.53	22.20
140	5700	24.53	22.38
144 (UNII-2C Band)	5720	16.17	16.05

Note: For FCC output power limitation is determined based on 26dB bandwidth.



Power Limit = 11dBm + 10logB < U-NII-2A, U-NII-2C >			
Channel Number	Freq.(MHz)	Min. B(MHz)	Determined Conducted Limit (dBm)
52	5260	22.09	24.44 > 24
60	5300	22.20	24.46 > 24
64	5320	22.27	24.47 > 24
100	5500	22.06	24.43 > 24
116	5580	22.20	24.46 > 24
140	5700	22.38	24.49 > 24
144 (UNII-2C Band)	5720	16.05	23.05 < 24

802.11ac (VHT40)
OUTPUT POWER:

Chan.	Chan. Freq. (MHz)	Average Power (dBm)		Total Power (mW)	Total Power (dBm)	Limit (dBm)	Pass / Fail
		Chain 0	Chain 1				
54	5270	21.15	19.89	227.816	23.58	23.62	Pass
62	5310	17.12	15.93	90.697	19.58	23.62	Pass
102	5510	17.92	16.93	111.261	20.46	24.00	Pass
110	5550	20.96	20.22	229.934	23.62	24.00	Pass
134	5670	18.76	18.11	139.876	21.46	24.00	Pass
142 (UNII-2C Band)	5710	18.19	17.44	121.38	20.84	24.00	Pass
142 (UNII-3 Band)	5710	7.89	7.26	11.473	10.60	30.00	Pass

NOTE: For U-NII-2A: Directional gain = 6.38dBi > 6dBi , therefore the limit needs to reduce, so the power limit shall be reduced to "Determined Conducted Limit-(6.38-6)"

26dB BANDWIDTH:

Channel	Frequency (MHz)	26dBc Bandwidth (MHz)	
		Chain 0	Chain 1
54	5270	84.13	65.01
62	5310	42.28	41.65
102	5510	41.63	41.78
110	5550	70.20	65.71
134	5670	57.26	60.54
142 (UNII-2C Band)	5710	57.43	61.43

Note: For FCC output power limitation is determined based on 26dB bandwidth.

Power Limit = 11dBm + 10logB < U-NII-2A, U-NII-2C >			
Channel Number	Freq.(MHz)	Min. B(MHz)	Determined Conducted Limit (dBm)
54	5270	65.01	29.12 > 24
62	5310	41.65	27.19 > 24
102	5510	41.63	27.19 > 24
110	5550	65.71	29.17 > 24
134	5670	57.26	28.57 > 24
142 (UNII-2C Band)	5710	57.43	28.59 > 24

802.11ac (VHT80)
OUTPUT POWER:

Chan.	Chan. Freq. (MHz)	Average Power (dBm)		Total Power (mW)	Total Power (dBm)	Limit (dBm)	Pass / Fail
		Chain 0	Chain 1				
58	5290	17.11	15.82	89.598	19.52	23.62	Pass
106	5530	17.64	16.25	100.246	20.01	24.00	Pass
122	5610	19.02	18.61	152.41	21.83	24.00	Pass
138 (UNII-2C Band)	5690	17.92	17.69	125.722	20.99	24.00	Pass
138 (UNII-3 Band)	5690	4.00	4.17	5.338	7.27	30.00	Pass

NOTE: For 5290MHz: Directional gain = 6.38dBi > 6dBi , therefore the limit needs to reduce, so the power limit shall be reduced to "Determined Conducted Limit-(6.38-6)"

26dB BANDWIDTH:

Channel	Frequency (MHz)	26dBc Bandwidth (MHz)	
		Chain 0	Chain 1
58	5290	82.96	82.59
106	5530	82.88	82.67
122	5610	86.20	103.93
138 (UNII-2C Band)	5690	106.41	114.63

Note: For FCC output power limitation is determined based on 26dB bandwidth.

Power Limit = 11dBm + 10logB < U-NII-2A, U-NII-2C >			
Channel Number	Freq.(MHz)	Min. B(MHz)	Determined Conducted Limit (dBm)
58	5290	82.59	30.16 > 24
106	5530	82.67	30.17 > 24
122	5610	86.20	30.35 > 24
138 (UNII-2C Band)	5690	106.41	31.26 > 24

SPECTRUM PLOT OF WORST VALUE

802.11a – Chain (1): CH 144 (UNII-3 Band)

802.11ac (VHT20) – Chain (1): CH 144 (UNII-3 Band)

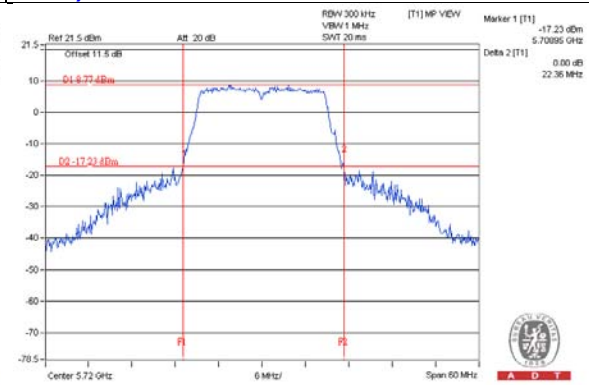
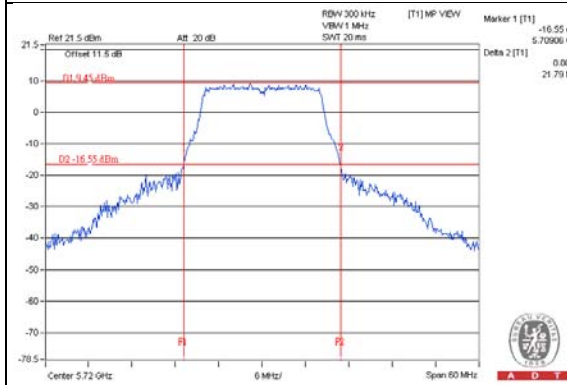

802.11ac (VHT40) – Chain (0): : CH 102

802.11ac (VHT80) – Chain (1): : CH 58

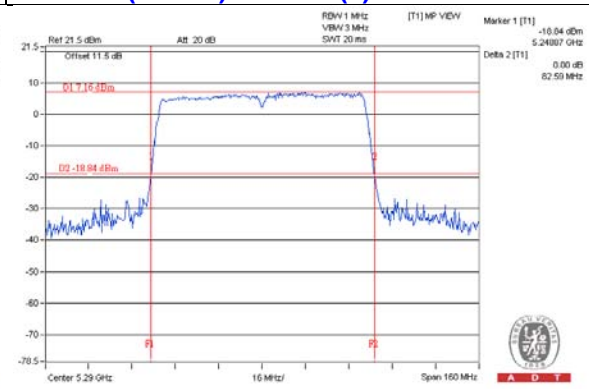
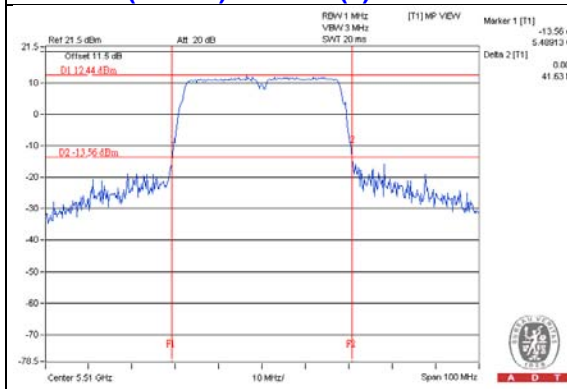

NOTE:

1. For CH144 (UNII-2C Band) = 5725 MHz - Marker 1



TxBF Mode:

802.11ac (VHT20)

OUTPUT POWER:

Chan.	Chan. Freq. (MHz)	Average Power (dBm)		Total Power (mW)	Total Power (dBm)	Limit (dBm)	Pass / Fail
		Chain 0	Chain 1				
52	5260	18.71	17.26	127.513	21.06	21.24	Pass
60	5300	18.84	17.34	130.76	21.16	21.24	Pass
64	5320	18.72	17.46	130.192	21.15	21.24	Pass
100	5500	19.03	17.32	133.934	21.27	21.58	Pass
116	5580	19.36	17.38	141	21.49	21.58	Pass
140	5700	19.20	17.47	139.023	21.43	21.58	Pass
144 (UNII-2C Band)	5720	15.42	13.58	57.637	17.61	20.63	Pass
144 (UNII-3 Band)	5720	9.76	7.99	15.757	11.97	27.79	Pass

- NOTE:** 1. For U-NII-2A: Directional gain = $10 \log[(10^{G1/20} + 10^{G2/20})^2 / 2]$ = 8.76dBi > 6dBi , therefore the limit needs to reduce, so the power limit shall be reduced to "Determined Conducted Limit-(8.76-6)"
2. For U-NII-2C: Directional gain = $10 \log[(10^{G1/20} + 10^{G2/20})^2 / 2]$ = 8.42dBi > 6dBi , therefore the limit needs to reduce, so the power limit shall be reduced to "Determined Conducted Limit-(8.42-6)"
3. For U-NII-3: Directional gain = $10 \log[(10^{G1/20} + 10^{G2/20})^2 / 2]$ = 8.21dBi > 6dBi , so the power limit shall be reduced to 30-(8.21-6) = 27.79dBm.

26dB BANDWIDTH:

Channel	Frequency (MHz)	26dBc Bandwidth (MHz)	
		Chain 0	Chain 1
52	5260	25.11	22.09
60	5300	24.20	22.20
64	5320	24.27	22.27
100	5500	22.06	22.12
116	5580	22.53	22.20
140	5700	24.53	22.38
144 (UNII-2C Band)	5720	16.17	16.05

Note: For FCC output power limitation is determined based on 26dB bandwidth.

Power Limit = 11dBm + 10logB < U-NII-2A, U-NII-2C >			
Channel Number	Freq.(MHz)	Min. B(MHz)	Determined Conducted Limit (dBm)
52	5260	22.09	24.44 > 24
60	5300	22.20	24.46 > 24
64	5320	22.27	24.47 > 24
100	5500	22.06	24.43 > 24
116	5580	22.20	24.46 > 24
140	5700	22.38	24.49 > 24
144 (UNII-2C Band)	5720	16.05	23.05 < 24

802.11ac (VHT40)
OUTPUT POWER:

Chan.	Chan. Freq. (MHz)	Average Power (dBm)		Total Power (mW)	Total Power (dBm)	Limit (dBm)	Pass / Fail
		Chain 0	Chain 1				
54	5270	18.71	17.46	130.021	21.14	21.24	Pass
62	5310	17.12	15.93	90.697	19.58	21.24	Pass
102	5510	17.92	16.93	111.261	20.46	21.58	Pass
110	5550	18.93	17.82	138.697	21.42	21.58	Pass
134	5670	18.76	18.11	139.876	21.46	21.58	Pass
142 (UNII-2C Band)	5710	14.23	14.34	53.649	17.30	21.58	Pass
142 (UNII-3 Band)	5710	3.70	3.74	4.71	6.73	27.79	Pass

- NOTE:** 1. For U-NII-2A: Directional gain = $10 \log[(10^{G1/20} + 10^{G2/20})^2 / 2] = 8.76\text{dBi} > 6\text{dBi}$, therefore the limit needs to reduce, so the power limit shall be reduced to "Determined Conducted Limit-(8.76-6)"
2. For U-NII-2C: Directional gain = $10 \log[(10^{G1/20} + 10^{G2/20})^2 / 2] = 8.42\text{dBi} > 6\text{dBi}$, therefore the limit needs to reduce, so the power limit shall be reduced to "Determined Conducted Limit-(8.42-6)"
3. For U-NII-3: Directional gain = $10 \log[(10^{G1/20} + 10^{G2/20})^2 / 2] = 8.21\text{dBi} > 6\text{dBi}$, so the power limit shall be reduced to $30-(8.21-6) = 27.79\text{dBm}$.

26dB BANDWIDTH:

Channel	Frequency (MHz)	26dBc Bandwidth (MHz)	
		Chain 0	Chain 1
54	5270	84.13	65.01
62	5310	42.28	41.65
102	5510	41.63	41.78
110	5550	70.20	65.71
134	5670	57.26	60.54
142 (UNII-2C Band)	5710	57.43	61.43

Note: For FCC output power limitation is determined based on 26dB bandwidth.



Power Limit = 11dBm + 10logB < U-NII-2A, U-NII-2C >			
Channel Number	Freq.(MHz)	Min. B(MHz)	Determined Conducted Limit (dBm)
54	5270	65.01	29.12 > 24
62	5310	41.65	27.19 > 24
102	5510	41.63	27.19 > 24
110	5550	65.71	29.17 > 24
134	5670	57.26	28.57 > 24
142 (UNII-2C Band)	5710	57.43	28.59 > 24

802.11ac (VHT80)
OUTPUT POWER:

Chan.	Chan. Freq. (MHz)	Average Power (dBm)		Total Power (mW)	Total Power (dBm)	Limit (dBm)	Pass / Fail
		Chain 0	Chain 1				
58	5290	17.11	15.82	89.598	19.52	21.24	Pass
106	5530	17.64	16.25	100.246	20.01	21.58	Pass
122	5610	18.71	18.32	142.222	21.53	21.58	Pass
138 (UNII-2C Band)	5690	15.06	14.99	66.24	18.21	21.58	Pass
138 (UNII-3 Band)	5690	0.92	0.84	2.55	4.07	27.79	Pass

- NOTE:** 1. For U-NII-2A: Directional gain = $10 \log[(10^{G1/20} + 10^{G2/20})^2 / 2] = 8.76\text{dBi} > 6\text{dBi}$, therefore the limit needs to reduce, so the power limit shall be reduced to "Determined Conducted Limit-(8.76-6)"
2. For U-NII-2C: Directional gain = $10 \log[(10^{G1/20} + 10^{G2/20})^2 / 2] = 8.42\text{dBi} > 6\text{dBi}$, therefore the limit needs to reduce, so the power limit shall be reduced to "Determined Conducted Limit-(8.42-6)"
3. For U-NII-3: Directional gain = $10 \log[(10^{G1/20} + 10^{G2/20})^2 / 2] = 8.21\text{dBi} > 6\text{dBi}$, so the power limit shall be reduced to $30-(8.21-6) = 27.79\text{dBm}$.

26dB BANDWIDTH:

Channel	Frequency (MHz)	26dBc Bandwidth (MHz)	
		Chain 0	Chain 1
58	5290	82.96	82.59
106	5530	82.88	82.67
122	5610	86.20	103.93
138 (UNII-2C Band)	5690	106.41	114.63

Note: For FCC output power limitation is determined based on 26dB bandwidth.

Power Limit = 11dBm + 10logB < U-NII-2A, U-NII-2C >			
Channel Number	Freq.(MHz)	Min. B(MHz)	Determined Conducted Limit (dBm)
58	5290	82.59	30.16 > 24
106	5530	82.67	30.17 > 24
122	5610	86.20	30.35 > 24
138 (UNII-2C Band)	5690	106.41	31.26 > 24

SPECTRUM PLOT OF WORST VALUE

802.11ac (VHT20) – Chain (1): CH 144 (UNII-2C Band) **802.11ac (VHT40) – Chain (1): : CH 62**

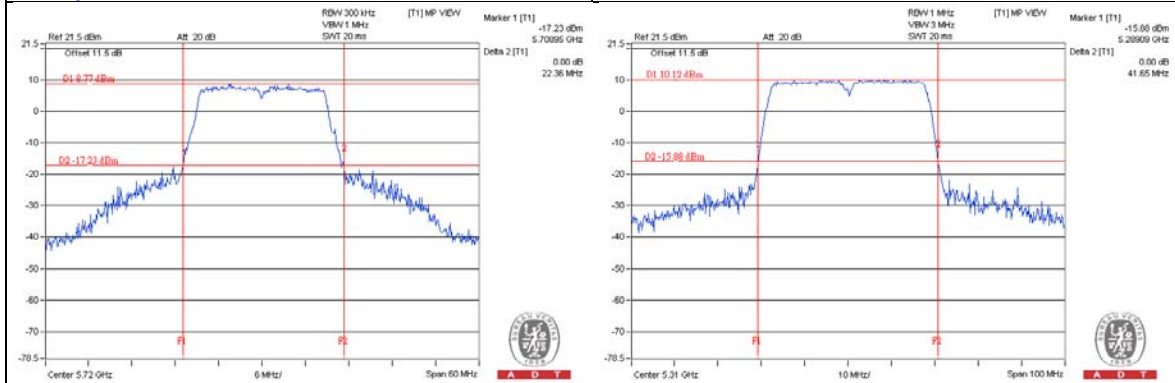

802.11ac (VHT80) – Chain (1): CH 58

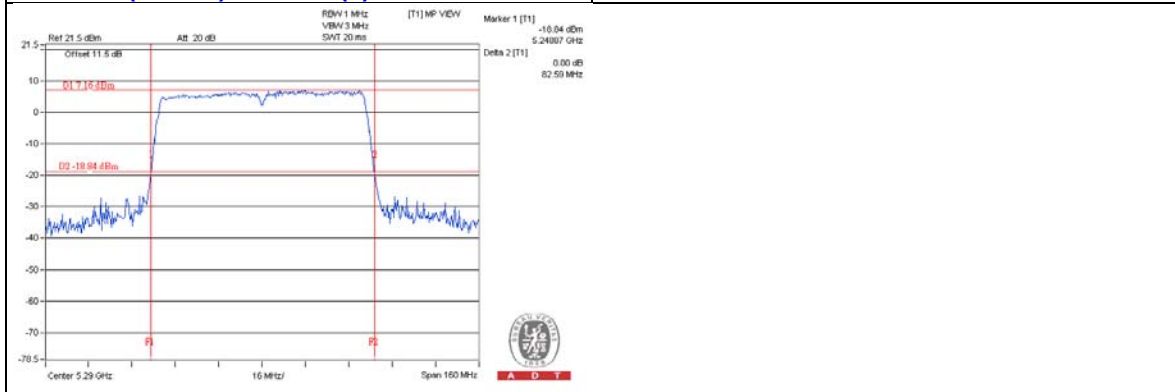

NOTE:

1. For CH144 (UNII-2C Band) = 5725 MHz - Marker 1

1TX
Chain 0
802.11a

Chan.	Chan. Freq. (MHz)	Average Power (mW)	Average Power (dBm)	Limit (dBm)	Pass / Fail
52	5260	132.434	21.22	24	Pass
60	5300	133.968	21.27	24	Pass
64	5320	104.954	20.21	24	Pass
100	5500	129.122	21.11	24	Pass
116	5580	133.968	21.27	24	Pass
140	5700	92.47	19.66	24	Pass
144 (UNII-2C Band)	5720	62.373	17.95	24	Pass
144 (UNII-3 Band)	5720	14.997	11.76	30	Pass

26dB BANDWIDTH:

Channel	Frequency (MHz)	26dBc Bandwidth (MHz)
52	5260	32.76
60	5300	32.67
64	5320	26.06
100	5500	25.77
116	5580	31.04
140	5700	24.27
144 (UNII-2C Band)	5720	21.78

Note: For FCC output power limitation is determined based on 26dB bandwidth.

Power Limit = 11dBm + 10logB < U-NII-2A, U-NII-2C >			
Channel Number	Freq.(MHz)	Min. B(MHz)	Determined Conducted Limit (dBm)
52	5260	32.76	26.15 > 24
60	5300	32.67	26.14 > 24
64	5320	26.06	25.15 > 24
100	5500	25.77	25.11 > 24
116	5580	31.04	25.91 > 24
140	5700	24.27	24.85 > 24
144 (UNII-2C Band)	5720	21.78	24.38 > 24

802.11ac (VHT20)
OUTPUT POWER:

Chan.	Chan. Freq. (MHz)	Average Power (mW)	Average Power (dBm)	Limit (dBm)	Pass / Fail
52	5260	131.522	21.19	24	Pass
60	5300	130.918	21.17	24	Pass
64	5320	94.189	19.74	24	Pass
100	5500	106.414	20.27	24	Pass
116	5580	132.13	21.21	24	Pass
140	5700	92.257	19.65	24	Pass
144 (UNII-2C Band)	5720	56.234	17.50	24	Pass
144 (UNII-3 Band)	5720	15.066	11.78	30	Pass

26dB BANDWIDTH:

Channel	Frequency (MHz)	26dBc Bandwidth (MHz)
52	5260	40.58
60	5300	36.77
64	5320	28.36
100	5500	23.62
116	5580	37.13
140	5700	24.79
144 (UNII-2C Band)	5720	24.33

Note: For FCC output power limitation is determined based on 26dB bandwidth.

Power Limit = 11dBm + 10logB < U-NII-2A, U-NII-2C >			
Channel Number	Freq.(MHz)	Min. B(MHz)	Determined Conducted Limit (dBm)
52	5260	40.58	27.08 > 24
60	5300	36.77	26.65 > 24
64	5320	28.36	25.52 > 24
100	5500	23.62	24.73 > 24
116	5580	37.13	26.69 > 24
140	5700	24.79	24.94 > 24
144 (UNII-2C Band)	5720	24.33	24.86 > 24

802.11ac (VHT40)
OUTPUT POWER:

Chan.	Chan. Freq. (MHz)	Average Power (mW)	Average Power (dBm)	Limit (dBm)	Pass / Fail
54	5270	145.211	21.62	24	Pass
62	5310	53.827	17.31	24	Pass
102	5510	64.714	18.11	24	Pass
110	5550	124.738	20.96	24	Pass
134	5670	89.331	19.51	24	Pass
142 (UNII-2C Band)	5710	65.917	18.19	24	Pass
142 (UNII-3 Band)	5710	6.152	7.89	30	Pass

26dB BANDWIDTH:

Channel	Frequency (MHz)	26dBc Bandwidth (MHz)
54	5270	88.44
62	5310	42.29
102	5510	41.56
110	5550	70.20
134	5670	62.89
142 (UNII-2C Band)	5710	57.43

Note: For FCC output power limitation is determined based on 26dB bandwidth.

Power Limit = 11dBm + 10logB < U-NII-2A, U-NII-2C >			
Channel Number	Freq.(MHz)	Min. B(MHz)	Determined Conducted Limit (dBm)
54	5270	88.44	30.46 > 24
62	5310	42.29	27.26 > 24
102	5510	41.56	27.18 > 24
110	5550	70.20	29.46 > 24
134	5670	62.89	28.98 > 24
142 (UNII-2C Band)	5710	57.43	28.59 > 24

802.11ac (VHT80)
OUTPUT POWER:

Chan.	Chan. Freq. (MHz)	Average Power (mW)	Average Power (dBm)	Limit (dBm)	Pass / Fail
58	5290	54.828	17.39	24	Pass
106	5530	60.814	17.84	24	Pass
122	5610	97.051	19.87	24	Pass
138 (UNII-2C Band)	5690	64.525	18.10	24	Pass
138 (UNII-3 Band)	5690	2.617	4.18	30	Pass

26dB BANDWIDTH:

Channel	Frequency (MHz)	26dBc Bandwidth (MHz)
58	5290	82.54
106	5530	82.83
122	5610	126.48
138 (UNII-2C Band)	5690	106.41

Note: For FCC output power limitation is determined based on 26dB bandwidth.

Power Limit = 11dBm + 10logB < U-NII-2A, U-NII-2C >			
Channel Number	Freq.(MHz)	Min. B(MHz)	Determined Conducted Limit (dBm)
58	5290	82.54	30.16 > 24
106	5530	82.83	30.18 > 24
122	5610	126.48	32.02 > 24
138 (UNII-2C Band)	5690	106.41	31.26 > 24

SPECTRUM PLOT OF WORST VALUE

802.11a: CH 144 (UNII-2C Band)

802.11ac (VHT20): CH 100

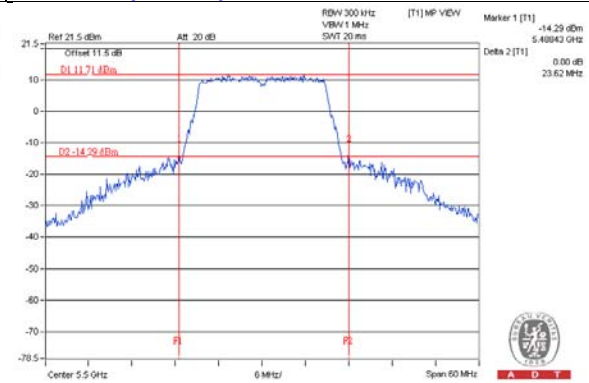
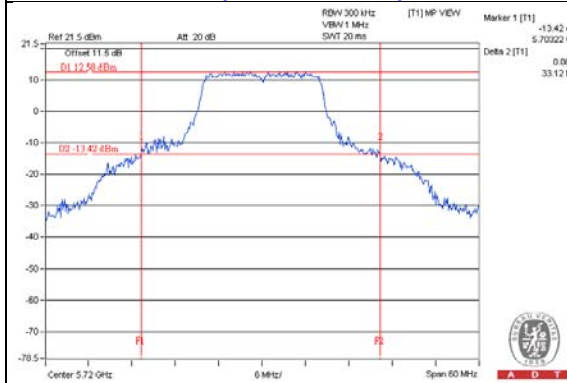

802.11ac (VHT40): CH 102

802.11ac (VHT80): CH 58

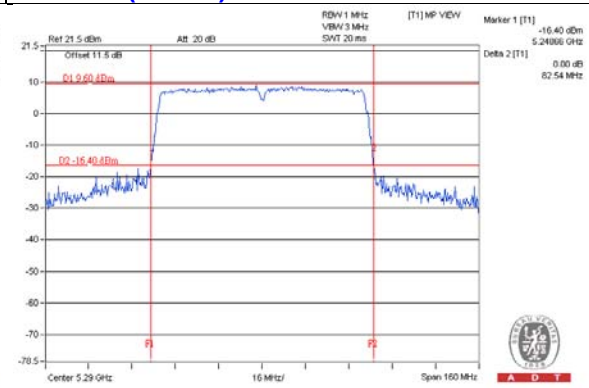
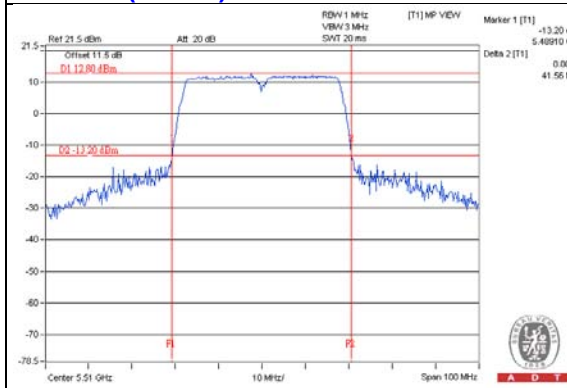

NOTE:

- 1. For CH144 (UNII-2C Band) = 5725 MHz - Marker 1

4.4 Peak Power Spectral Density Measurement

4.4.1 Limits of Peak Power Spectral Density Measurement

Operation Band	EUT Category		LIMIT
U-NII-1		Outdoor Access Point	17dBm/ MHz
		Fixed point-to-point Access Point	
		Indoor Access Point	
		Mobile and Portable client device	11dBm/ MHz
U-NII-2A	√		11dBm/ MHz
U-NII-2C	√		11dBm/ MHz
U-NII-3	√		30dBm/ 500kHz

4.4.2 Test Setup

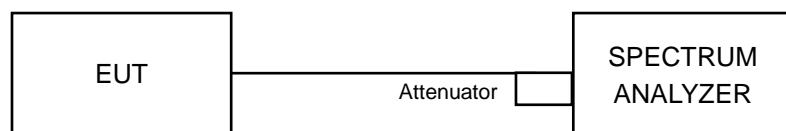

4.4.3 Test Instruments

Refer to section 4.1.2 to get information of above instrument.

4.4.4 Test Procedure

※For U-NII-1, U-NII-2A & U-NII-2C:

1. Set span to encompass the entire emission bandwidth (EBW) of the signal.
2. Set RBW = 1 MHz, Set VBW \geq 3 MHz, Detector = RMS
3. Sweep time = auto, trigger set to "free run".
4. Trace average at least 100 traces in power averaging mode.
5. Record the max value and for duty cycle of test signal is $<$ 98% add $10 \log (1/\text{duty cycle})$

※For U-NII-3:

1. Set span to encompass the entire emission bandwidth (EBW) of the signal.
2. Set RBW = 300 kHz, Set VBW \geq 1 MHz, Detector = RMS
3. Use the peak marker function to determine the maximum power level in any 300 kHz band segment within the fundamental EBW.
4. Scale the observed power level to an equivalent value in 500 kHz by adjusting (reducing) the measured power by a bandwidth correction factor (BWCF) where $\text{BWCF} = 10 \log(500 \text{ kHz}/300 \text{ kHz})$
5. Sweep time = auto, trigger set to "free run".
6. Trace average at least 100 traces in power averaging mode.
7. Record the max value and for duty cycle of test signal is $<$ 98% add $10 \log (1/\text{duty cycle})$

4.4.5 Deviation from Test Standard

No deviation.

4.4.6 EUT Operating Condition

Same as Item 4.3.6.

4.4.7 Test Results (Mode 1)

3TX

CDD MODE

For U-NII-2A, U-NII-2C Band

802.11a

Chan.	Chan. Freq. (MHz)	PSD (dBm)			Total Power Density (dBm)	MAX. Limit (dBm)	Pass / Fail
		Chain 0	Chain 1	Chain 2			
52	5260	1.47	1.53	1.14	6.15	7.01	Pass
60	5300	1.51	1.72	1.72	6.42	7.01	Pass
64	5320	2.12	1.22	1.08	6.27	7.01	Pass
100	5500	1.53	0.94	2.01	6.29	6.97	Pass
116	5580	1.51	1.67	1.45	6.32	6.97	Pass
140	5700	1.24	1.68	2.03	6.43	6.97	Pass
144 (UNII-2C Band)	5720	0.85	1.95	1.64	6.28	6.97	Pass

NOTE: 1. Method a) of power density measurement of KDB 662911 is using for calculating total power density. Total power density is summing entire spectra across corresponding frequency bins on the various outputs by computer.

2. For U-NII-2A: Directional gain = $10 \log[(10^{G1/20} + 10^{G2/20} + 10^{G3/20})^2 / 3]$ = 9.99dBi > 6dBi , so the power density limit shall be reduced to 11-(9.99-6) = 7.01dBm.

3. For U-NII-2C: Directional gain = $10 \log[(10^{G1/20} + 10^{G2/20} + 10^{G3/20})^2 / 3]$ = 10.03dBi > 6dBi , so the power density limit shall be reduced to 11-(10.03-6) = 6.97dBm.

802.11ac (VHT20)

Chan.	Chan. Freq. (MHz)	PSD (dBm)			Total Power Density (dBm)	MAX. Limit (dBm)	Pass / Fail
		Chain 0	Chain 1	Chain 2			
52	5260	1.36	1.41	0.79	5.97	7.01	Pass
60	5300	1.56	1.11	1.38	6.13	7.01	Pass
64	5320	1.38	1.54	1.27	6.17	7.01	Pass
100	5500	1.37	0.48	1.75	6.00	6.97	Pass
116	5580	1.10	0.75	1.75	5.99	6.97	Pass
140	5700	0.99	1.54	1.42	6.09	6.97	Pass
144 (UNII-2C Band)	5720	0.96	1.57	1.14	6.00	6.97	Pass

NOTE: 1. Method a) of power density measurement of KDB 662911 is using for calculating total power density. Total power density is summing entire spectra across corresponding frequency bins on the various outputs by computer.

2. For U-NII-2A: Directional gain = $10 \log[(10^{G1/20} + 10^{G2/20} + 10^{G3/20})^2 / 3]$ = 9.99dBi > 6dBi , so the power density limit shall be reduced to 11-(9.99-6) = 7.01dBm.

3. For U-NII-2C: Directional gain = $10 \log[(10^{G1/20} + 10^{G2/20} + 10^{G3/20})^2 / 3]$ = 10.03dBi > 6dBi , so the power density limit shall be reduced to 11-(10.03-6) = 6.97dBm.

802.11ac (VHT40)

Chan.	Chan. Freq. (MHz)	PSD (dBm)			Total Power Density (dBm)	MAX. Limit (dBm)	Pass / Fail
		Chain 0	Chain 1	Chain 2			
54	5270	1.62	0.86	0.98	5.94	7.01	Pass
62	5310	-4.21	-4.16	-4.46	0.50	7.01	Pass
102	5510	-2.98	-2.96	-2.45	1.98	6.97	Pass
110	5550	1.47	1.57	1.42	6.26	6.97	Pass
134	5670	0.56	1.27	1.15	5.78	6.97	Pass
142 (UNII-2C Band)	5710	0.79	1.30	1.06	5.83	6.97	Pass

- NOTE:** 1. Method a) of power density measurement of KDB 662911 is using for calculating total power density. Total power density is summing entire spectra across corresponding frequency bins on the various outputs by computer.
2. For U-NII-2A: Directional gain = $10 \log[(10^{G1/20} + 10^{G2/20} + 10^{G3/20})^2 / 3] = 9.99\text{dBi} > 6\text{dBi}$, so the power density limit shall be reduced to $11-(9.99-6) = 7.01\text{dBm}$.
3. For U-NII-2C: Directional gain = $10 \log[(10^{G1/20} + 10^{G2/20} + 10^{G3/20})^2 / 3] = 10.03\text{dBi} > 6\text{dBi}$, so the power density limit shall be reduced to $11-(10.03-6) = 6.97\text{dBm}$.

802.11ac (VHT80)

Chan.	Chan. Freq. (MHz)	PSD W/O Duty Factor (dBm)			Duty Factor (dB)	Total PSD With Duty Factor (dBm)	MAX. Limit (dBm)	Pass / Fail
		Chain 0	Chain 1	Chain 2				
58	5290	-7.52	-7.64	-7.92	0.18	-2.74	7.01	Pass
106	5530	-6.45	-6.78	-6.27	0.18	-1.54	6.97	Pass
122	5610	-1.27	-1.45	-1.21	0.18	3.64	6.97	Pass
138 (UNII-2C Band)	5690	-1.47	-1.06	-1.25	0.18	3.69	6.97	Pass

- NOTE:** 1. Method a) of power density measurement of KDB 662911 is using for calculating total power density. Total power density is summing entire spectra across corresponding frequency bins on the various outputs by computer.
2. For U-NII-2A: Directional gain = $10 \log[(10^{G1/20} + 10^{G2/20} + 10^{G3/20})^2 / 3] = 9.99\text{dBi} > 6\text{dBi}$, so the power density limit shall be reduced to $11-(9.99-6) = 7.01\text{dBm}$.
3. For U-NII-2C: Directional gain = $10 \log[(10^{G1/20} + 10^{G2/20} + 10^{G3/20})^2 / 3] = 10.03\text{dBi} > 6\text{dBi}$, so the power density limit shall be reduced to $11-(10.03-6) = 6.97\text{dBm}$.
4. Refer to section 3.3 for duty cycle spectrum plot.

SPECTRUM PLOT OF WORST VALUE

802.11a – Chain (0): CH 64

802.11ac (VHT20) – Chain (2): CH 100

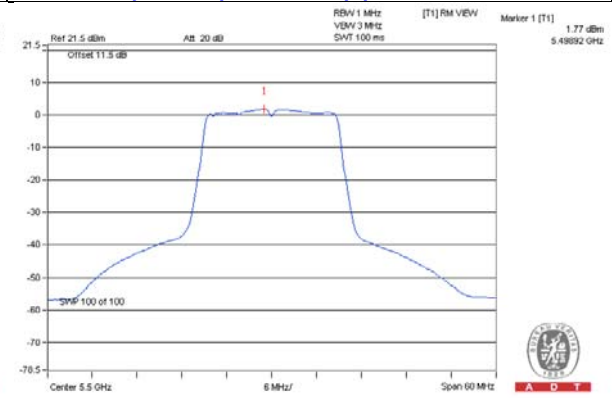
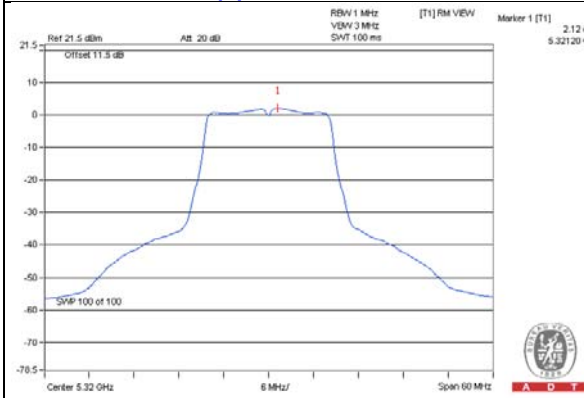

802.11ac (VHT40) – Chain (0): CH 54

802.11ac (VHT80) – Chain (1): CH 138 (UNII-2C Band)

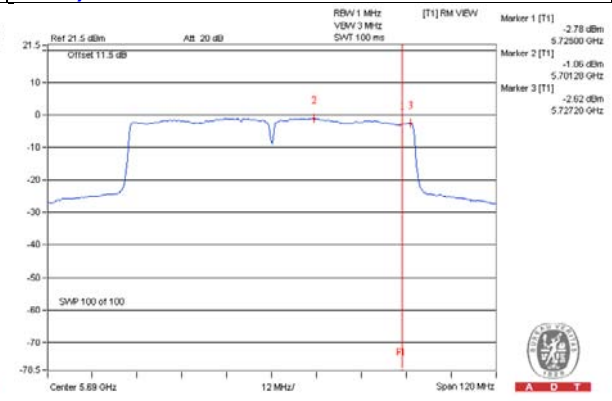
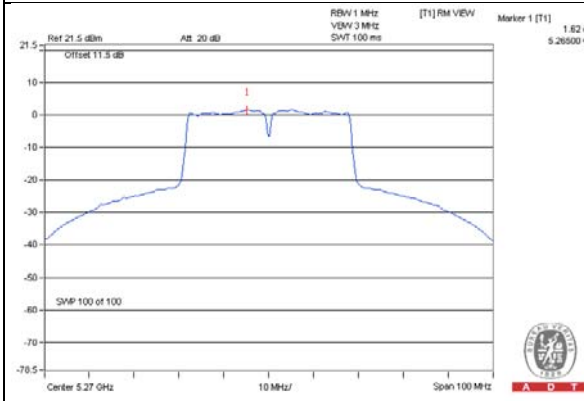

For U-NII-3 Band
802.11a

TX Chain	Channel	Frequency (MHz)	PSD (dBm/300kHz)	PSD (dBm/500kHz)	10 log (N=3) dB	Total PSD (dBm/500kHz)	Limit (dBm/500kHz)	Pass /Fail
0	144 (UNII-3 Band)	5720	-8.19	-5.97	4.77	-1.20	25.86	Pass
1	144 (UNII-3 Band)	5720	-7.10	-4.88	4.77	-0.11	25.86	Pass
2	144 (UNII-3 Band)	5720	-7.41	-5.19	4.77	-0.42	25.86	Pass

NOTE: 1. Directional gain = $10 \log[(10^{G1/20} + 10^{G2/20} + 10^{G3/20})^2 / 3] = 10.14\text{dBi} > 6\text{dBi}$, so the power density limit shall be reduced to $30-(10.14-6) = 25.86\text{dBm}$.

802.11ac (VHT20)

TX Chain	Channel	Frequency (MHz)	PSD (dBm/300kHz)	PSD (dBm/500kHz)	10 log (N=3) dB	Total PSD (dBm/500kHz)	Limit (dBm/500kHz)	Pass /Fail
0	144 (UNII-3 Band)	5720	-8.07	-5.85	4.77	-1.08	25.86	Pass
1	144 (UNII-3 Band)	5720	-7.50	-5.28	4.77	-0.51	25.86	Pass
2	144 (UNII-3 Band)	5720	-7.69	-5.47	4.77	-0.70	25.86	Pass

NOTE: 1. Directional gain = $10 \log[(10^{G1/20} + 10^{G2/20} + 10^{G3/20})^2 / 3] = 10.14\text{dBi} > 6\text{dBi}$, so the power density limit shall be reduced to $30-(10.14-6) = 25.86\text{dBm}$.

802.11ac (VHT40)

TX Chain	Channel	Frequency (MHz)	PSD (dBm/300kHz)	PSD (dBm/500kHz)	10 log (N=3) dB	Total PSD (dBm/500kHz)	Limit (dBm/500kHz)	Pass /Fail
0	142 (UNII-2C Band)	5710	-8.76	-6.54	4.77	-1.77	25.86	Pass
1	142 (UNII-2C Band)	5710	-8.18	-5.96	4.77	-1.19	25.86	Pass
2	142 (UNII-2C Band)	5710	-8.29	-6.07	4.77	-1.30	25.86	Pass

NOTE: 1. Directional gain = $10 \log[(10^{G1/20} + 10^{G2/20} + 10^{G3/20})^2 / 3] = 10.14\text{dBi} > 6\text{dBi}$, so the power density limit shall be reduced to $30-(10.14-6) = 25.86\text{dBm}$.

802.11ac (VHT80)

TX chain	Chan.	Chan. Freq. (MHz)	PSD W/O Duty Factor		10 log (N=3) dB	Duty Factor (dB)	Total PSD With Duty Factor (dBm/500kHz)	Limit (dBm/500kHz)	Pass /Fail
			(dBm/300kHz)	(dBm/500kHz)					
0	138 (UNII-2C Band)	5690	-11.33	-9.11	4.77	0.18	-4.16	25.86	Pass
1	138 (UNII-2C Band)	5690	-11.04	-8.82	4.77	0.18	-3.87	25.86	Pass
2	138 (UNII-2C Band)	5690	-11.20	-8.98	4.77	0.18	-4.03	25.86	Pass

NOTE: 1. Directional gain = $10 \log[(10^{G1/20} + 10^{G2/20} + 10^{G3/20})^2 / 3] = 10.14\text{dBi} > 6\text{dBi}$, so the power density limit shall be reduced to $30-(10.14-6) = 25.86\text{dBm}$.

2. Refer to section 3.3 for duty cycle spectrum plot.

SPECTRUM PLOT OF WORST VALUE

802.11a – Chain (1): CH 144 (UNII-3 Band)

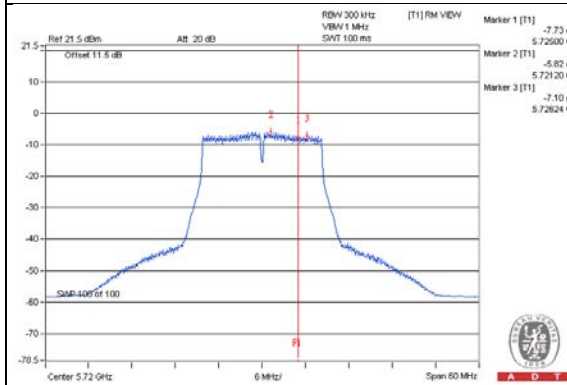

802.11ac (VHT20) – Chain (1): CH 144 (UNII-3 Band)

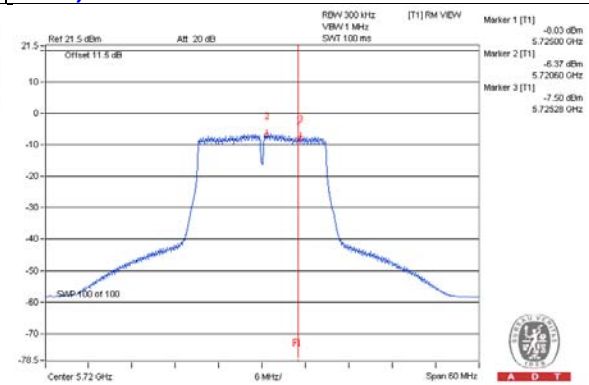

802.11ac (VHT40) – Chain (1): CH 142 (UNII-3 Band)

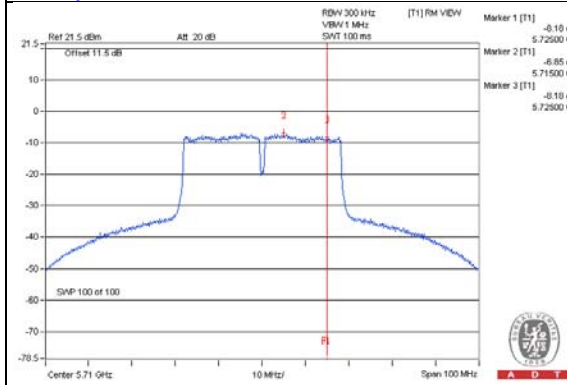

802.11ac (VHT80) – Chain (1): CH 138 (UNII-3 Band)

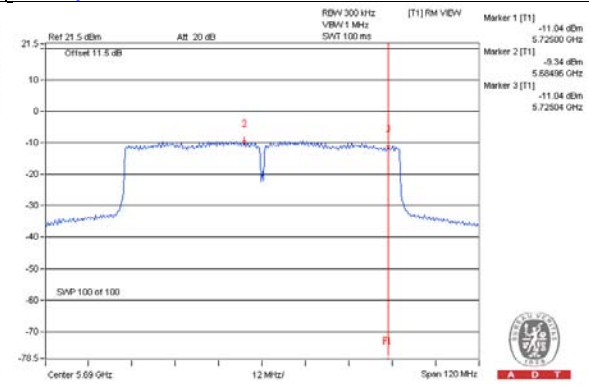

2TX
CDD MODE
For U-NII-2A Band
802.11a

Chan.	Chan. Freq. (MHz)	PSD (dBm)		Total Power Density (dBm)	MAX. Limit (dBm)	Pass / Fail
		Chain 1	Chain 2			
52	5260	3.28	2.81	6.06	8.68	Pass
60	5300	3.73	3.07	6.42	8.68	Pass
64	5320	3.61	3.28	6.46	8.68	Pass

NOTE: 1. Method a) of power density measurement of KDB 662911 is using for calculating total power density. Total power density is summing entire spectra across corresponding frequency bins on the various outputs by computer.

2. Directional gain = $10 \log[(10^{G1/20} + 10^{G2/20})^2 / 2] = 8.32\text{dBi} > 6\text{dBi}$, so the power density limit shall be reduced to $11-(8.32-6) = 8.68\text{dBm}$.

802.11ac (VHT20)

Chan.	Chan. Freq. (MHz)	PSD (dBm)		Total Power Density (dBm)	MAX. Limit (dBm)	Pass / Fail
		Chain 1	Chain 2			
52	5260	3.17	2.49	5.85	8.68	Pass
60	5300	3.23	2.87	6.06	8.68	Pass
64	5320	3.28	2.90	6.10	8.68	Pass

NOTE: 1. Method a) of power density measurement of KDB 662911 is using for calculating total power density. Total power density is summing entire spectra across corresponding frequency bins on the various outputs by computer.

2. Directional gain = $10 \log[(10^{G1/20} + 10^{G2/20})^2 / 2] = 8.32\text{dBi} > 6\text{dBi}$, so the power density limit shall be reduced to $11-(8.32-6) = 8.68\text{dBm}$.

802.11ac (VHT40)

Chan.	Chan. Freq. (MHz)	PSD (dBm)		Total Power Density (dBm)	MAX. Limit (dBm)	Pass / Fail
		Chain 1	Chain 2			
54	5270	2.01	1.98	5.01	8.68	Pass
62	5310	-4.81	-4.83	-1.81	8.68	Pass

NOTE: 1. Method a) of power density measurement of KDB 662911 is using for calculating total power density. Total power density is summing entire spectra across corresponding frequency bins on the various outputs by computer.

2. Directional gain = $10 \log[(10^{G1/20} + 10^{G2/20})^2 / 2] = 8.32\text{dBi} > 6\text{dBi}$, so the power density limit shall be reduced to $11 - (8.32 - 6) = 8.68\text{dBm}$.

802.11ac (VHT80)

Chan.	Chan. Freq. (MHz)	PSD W/O Duty Factor (dBm)		Duty Factor (dB)	Total PSD With Duty Factor (dBm)	MAX. Limit (dBm)	Pass / Fail
		Chain 1	Chain 2				
58	5290	-8.65	-8.68	0.18	-5.48	8.68	Pass

NOTE: 1. Method a) of power density measurement of KDB 662911 is using for calculating total power density. Total power density is summing entire spectra across corresponding frequency bins on the various outputs by computer.

2. Directional gain = $10 \log[(10^{G1/20} + 10^{G2/20})^2 / 2] = 8.32\text{dBi} > 6\text{dBi}$, so the power density limit shall be reduced to $11 - (8.32 - 6) = 8.68\text{dBm}$.

4. Refer to section 3.3 for duty cycle spectrum plot.

SPECTRUM PLOT OF WORST VALUE

802.11a – Chain (1): CH 60

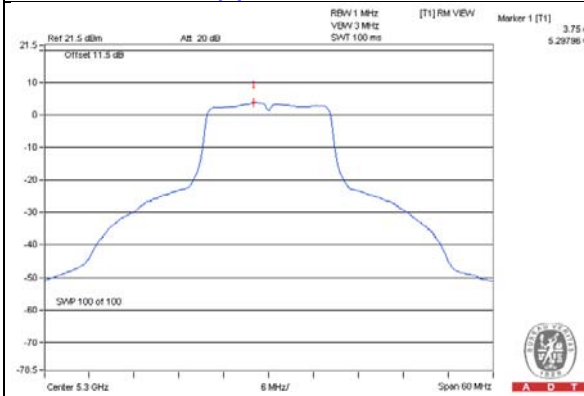

802.11ac (VHT20) – Chain (1): CH 64

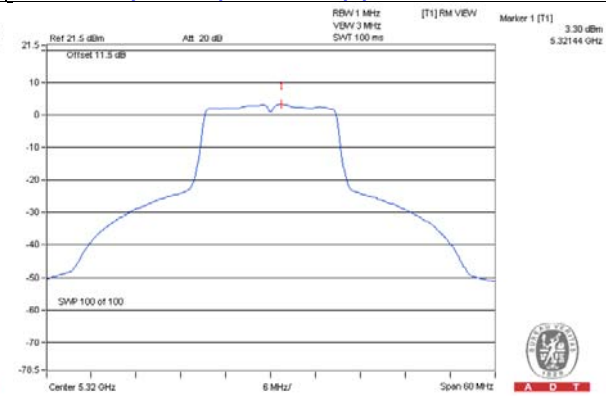

802.11ac (VHT40) – Chain (1): CH 54

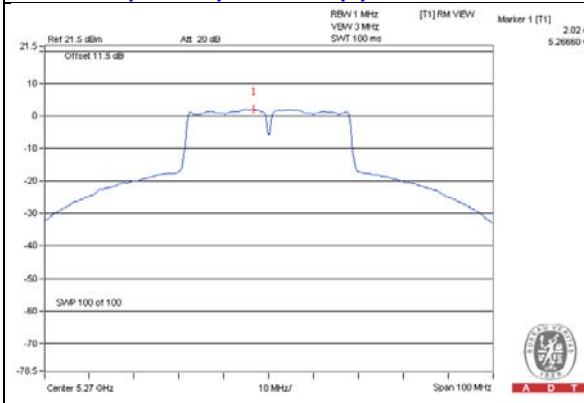

802.11ac (VHT80) – Chain (1): CH 58

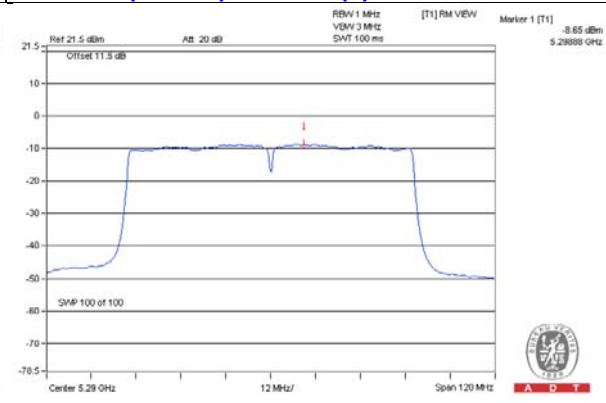

For U-NII-2C Band
802.11a

Chan.	Chan. Freq. (MHz)	PSD (dBm)		Total Power Density (dBm)	MAX. Limit (dBm)	Pass / Fail
		Chain 0	Chain 2			
100	5500	4.71	4.66	7.70	8.68	Pass
116	5580	5.40	4.91	8.17	8.68	Pass
140	5700	3.95	3.56	6.77	8.68	Pass
144 (UNII-2C Band)	5720	4.88	4.38	7.65	8.68	Pass

NOTE: 1. Method a) of power density measurement of KDB 662911 is using for calculating total power density. Total power density is summing entire spectra across corresponding frequency bins on the various outputs by computer.

2. Directional gain = $10 \log[(10^{G1/20} + 10^{G2/20})^2 / 2] = 8.32\text{dBi} > 6\text{dBi}$, so the power density limit shall be reduced to $11-(8.32-6) = 8.68\text{dBm}$.

802.11ac (VHT20)

Chan.	Chan. Freq. (MHz)	PSD (dBm)		Total Power Density (dBm)	MAX. Limit (dBm)	Pass / Fail
		Chain 0	Chain 2			
100	5500	5.10	4.64	7.89	8.68	Pass
116	5580	4.92	4.51	7.73	8.68	Pass
140	5700	1.32	1.12	4.23	8.68	Pass
144 (UNII-2C Band)	5720	4.54	4.13	7.35	8.68	Pass

NOTE: 1. Method a) of power density measurement of KDB 662911 is using for calculating total power density. Total power density is summing entire spectra across corresponding frequency bins on the various outputs by computer.

2. Directional gain = $10 \log[(10^{G1/20} + 10^{G2/20})^2 / 2] = 8.32\text{dBi} > 6\text{dBi}$, so the power density limit shall be reduced to $11-(8.32-6) = 8.68\text{dBm}$.

802.11ac (VHT40)

Chan.	Chan. Freq. (MHz)	PSD (dBm)		Total Power Density (dBm)	MAX. Limit (dBm)	Pass / Fail
		Chain 0	Chain 2			
102	5510	-3.19	-3.40	-0.28	8.68	Pass
110	5550	4.31	3.75	7.05	8.68	Pass
134	5670	0.51	0.05	3.30	8.68	Pass
142 (UNII-2C Band)	5710	3.90	3.48	6.71	8.68	Pass

- NOTE:** 1. Method a) of power density measurement of KDB 662911 is using for calculating total power density. Total power density is summing entire spectra across corresponding frequency bins on the various outputs by computer.
2. Directional gain = $10 \log[(10^{G1/20} + 10^{G2/20})^2 / 2] = 8.32\text{dBi} > 6\text{dBi}$, so the power density limit shall be reduced to $11-(8.32-6) = 8.68\text{dBm}$.

802.11ac (VHT80)

Chan.	Chan. Freq. (MHz)	PSD W/O Duty Factor (dBm)		Duty Factor (dB)	Total PSD With Duty Factor (dBm)	MAX. Limit (dBm)	Pass / Fail
		Chain 0	Chain 2				
106	5530	-7.52	-7.63	0.18	-4.39	8.68	Pass
122	5610	-1.93	-2.22	0.18	1.11	8.68	Pass
138 (UNII-2C Band)	5690	-0.65	-0.78	0.18	2.47	8.68	Pass

- NOTE:** 1. Method a) of power density measurement of KDB 662911 is using for calculating total power density. Total power density is summing entire spectra across corresponding frequency bins on the various outputs by computer.
2. Directional gain = $10 \log[(10^{G1/20} + 10^{G2/20})^2 / 2] = 8.32\text{dBi} > 6\text{dBi}$, so the power density limit shall be reduced to $11-(8.32-6) = 8.68\text{dBm}$.
3. Refer to section 3.3 for duty cycle spectrum plot.

SPECTRUM PLOT OF WORST VALUE

802.11a – Chain (0): CH 116

802.11ac (VHT20) – Chain (0): CH 116

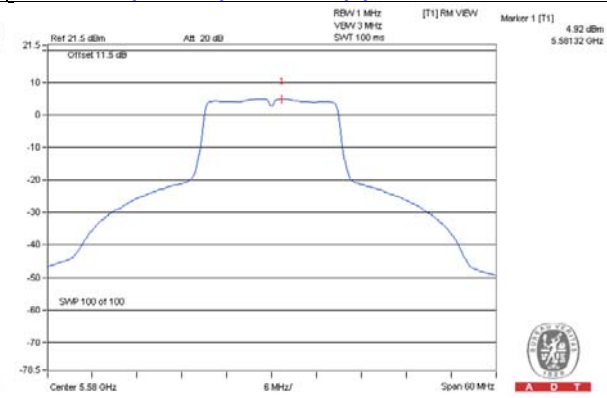
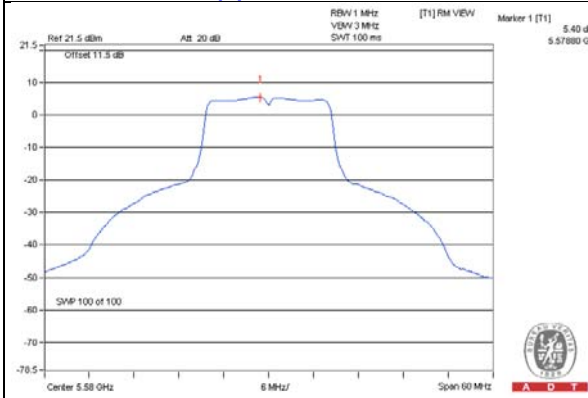

802.11ac (VHT40) – Chain (0): CH 46

802.11ac (VHT80) – Chain (2): CH 138 (UNII-2C Band)

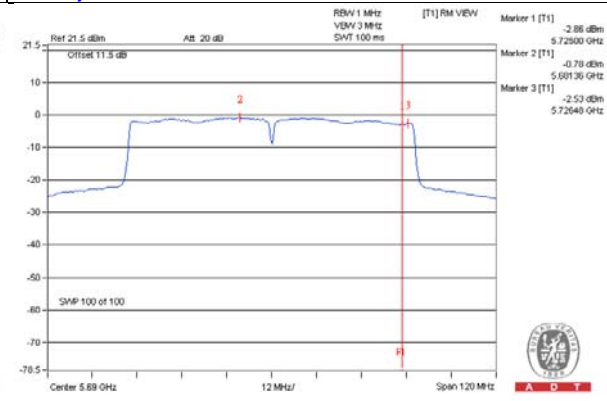
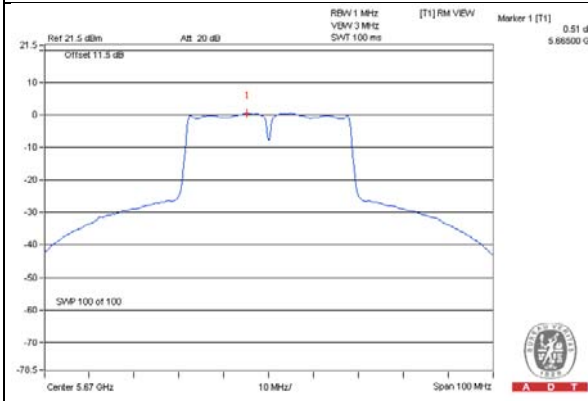

For U-NII-3 Band
802.11a

TX Chain	Channel	Frequency (MHz)	PSD (dBm/300kHz)	PSD (dBm/500kHz)	10 log (N=2) dB	Total PSD (dBm/500kHz)	Limit (dBm/500kHz)	Pass /Fail
0	144 (UNII-3 Band)	5720	-3.78	-1.56	3.01	1.45	27.60	Pass
2	144 (UNII-3 Band)	5720	-3.74	-1.52	3.01	1.49	27.60	Pass

NOTE: 1. Directional gain = $10 \log[(10^{G1/20} + 10^{G2/20})^2 / 2] = 8.4\text{dBi} > 6\text{dBi}$, so the power density limit shall be reduced to $30-(8.4-6) = 27.60\text{dBm}$.

802.11ac (VHT20)

TX Chain	Channel	Frequency (MHz)	PSD (dBm/300kHz)	PSD (dBm/500kHz)	10 log (N=2) dB	Total PSD (dBm/500kHz)	Limit (dBm/500kHz)	Pass /Fail
0	144 (UNII-3 Band)	5720	-3.97	-1.75	3.01	1.26	27.60	Pass
2	144 (UNII-3 Band)	5720	-4.18	-1.96	3.01	1.05	27.60	Pass

NOTE: 1. Directional gain = $10 \log[(10^{G1/20} + 10^{G2/20})^2 / 2] = 8.4\text{dBi} > 6\text{dBi}$, so the power density limit shall be reduced to $30-(8.4-6) = 27.60\text{dBm}$.

802.11ac (VHT40)

TX Chain	Channel	Frequency (MHz)	PSD (dBm/300kHz)	PSD (dBm/500kHz)	10 log (N=2) dB	Total PSD (dBm/500kHz)	Limit (dBm/500kHz)	Pass /Fail
0	142 (UNII-2C Band)	5710	-5.16	-2.94	3.01	0.07	27.60	Pass
2	142 (UNII-2C Band)	5710	-5.44	-3.22	3.01	-0.21	27.60	Pass

NOTE: 1. Directional gain = $10 \log[(10^{G1/20} + 10^{G2/20})^2 / 2] = 8.4\text{dBi} > 6\text{dBi}$, so the power density limit shall be reduced to $30-(8.4-6) = 27.60\text{dBm}$.

802.11ac (VHT80)

TX chain	Chan.	Chan. Freq. (MHz)	PSD W/O Duty Factor		10 log (N=2) dB	Duty Factor (dB)	Total PSD With Duty Factor (dBm/500kHz)	Limit (dBm/500kHz)	Pass /Fail
			(dBm/300kHz)	(dBm/500kHz)					
0	138 (UNII-2C Band)	5690	-10.40	-8.18	3.01	0.18	-4.99	27.60	Pass
2	138 (UNII-2C Band)	5690	-10.41	-8.19	3.01	0.18	-5.00	27.60	Pass

NOTE: 1. Directional gain = $10 \log[(10^{G1/20} + 10^{G2/20})^2 / 2] = 8.4\text{dBi} > 6\text{dBi}$, so the power density limit shall be reduced to $30-(8.4-6) = 27.60\text{dBm}$.

2. Refer to section 3.3 for duty cycle spectrum plot.

SPECTRUM PLOT OF WORST VALUE

802.11a – Chain (2): CH 144 (UNII-3 Band)

802.11ac (VHT20) – Chain (0): CH 144 (UNII-3 Band)

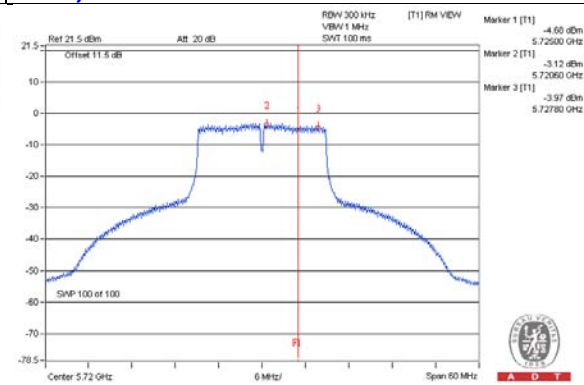
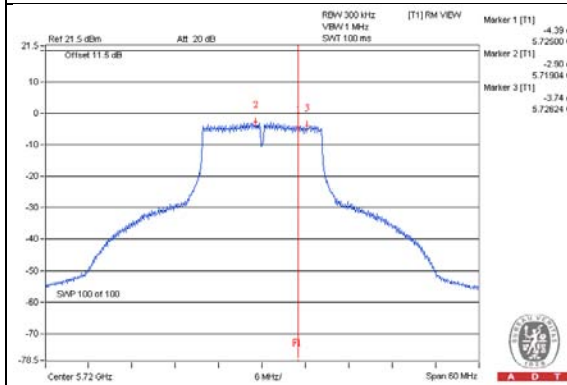

802.11ac (VHT40) – Chain (0): CH 142 (UNII-3 Band)

802.11ac (VHT80) – Chain (0): CH 138 (UNII-3 Band)

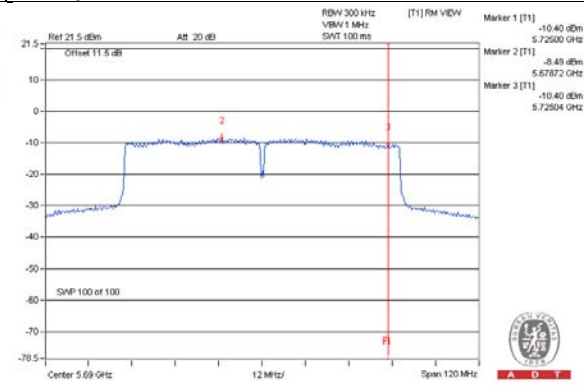
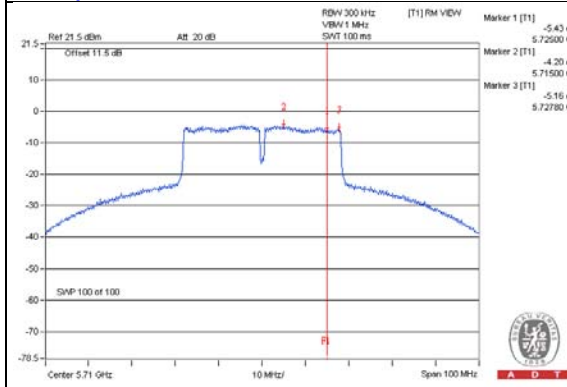

1TX
For U-NII-2A, U-NII-2C Band
Chain 2
802.11a

Chan.	Chan. Freq. (MHz)	PSD (dBm/MHz)	MAX. Limit (dBm/MHz)	Pass / Fail
52	5260	5.88	11	Pass
60	5300	5.22	11	Pass
64	5320	4.03	11	Pass
100	5500	5.20	11	Pass
116	5580	5.84	11	Pass
140	5700	3.53	11	Pass
144 (UNII-2C Band)	5720	6.38	11	Pass

802.11ac (VHT20)

Chan.	Chan. Freq. (MHz)	PSD (dBm/MHz)	MAX. Limit (dBm/MHz)	Pass / Fail
52	5260	4.78	11	Pass
60	5300	4.37	11	Pass
64	5320	3.10	11	Pass
100	5500	4.84	11	Pass
116	5580	5.50	11	Pass
140	5700	1.21	11	Pass
144 (UNII-2C Band)	5720	6.20	11	Pass



802.11ac (VHT40)

Chan.	Chan. Freq. (MHz)	PSD (dBm/MHz)	MAX. Limit (dBm/MHz)	Pass / Fail
54	5270	2.05	11	Pass
62	5310	-4.66	11	Pass
102	5510	-3.30	11	Pass
110	5500	4.02	11	Pass
134	5670	0.41	11	Pass
142 (UNII-2C Band)	5710	3.55	11	Pass

802.11ac (VHT80)

Chan.	Chan. Freq. (MHz)	PSD W/O Duty Factor (dBm/MHz)	Duty Factor (dB)	PSD With Duty Factor (dBm/MHz)	MAX. Limit (dBm/MHz)	Pass / Fail
58	5290	-8.15	0.18	-7.98	11	Pass
106	5530	-7.75	0.18	-7.57	11	Pass
122	5610	-2.05	0.18	-1.87	11	Pass
138 (UNII-2C Band)	5690	-1.11	0.18	-0.93	11	Pass

Note: Refer to section 3.3 for duty cycle spectrum plot.

SPECTRUM PLOT OF WORST VALUE

802.11a – Chain (2): CH 144 (UNII-2C Band)

802.11ac (VHT20) –Chain (2): CH 144 (UNII-2C Band)

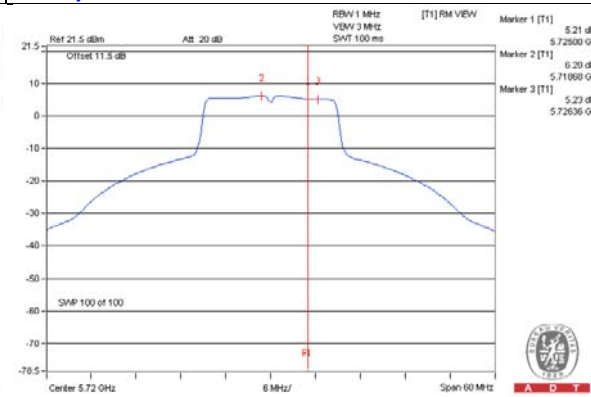
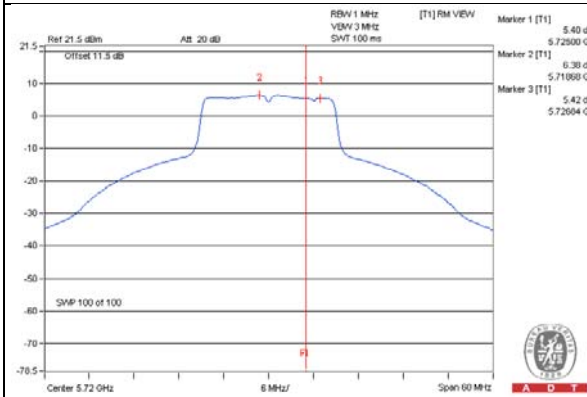

802.11ac (VHT40) – Chain (2): CH 110

802.11ac (VHT80) – Chain (2): CH 138 (UNII-2C Band)

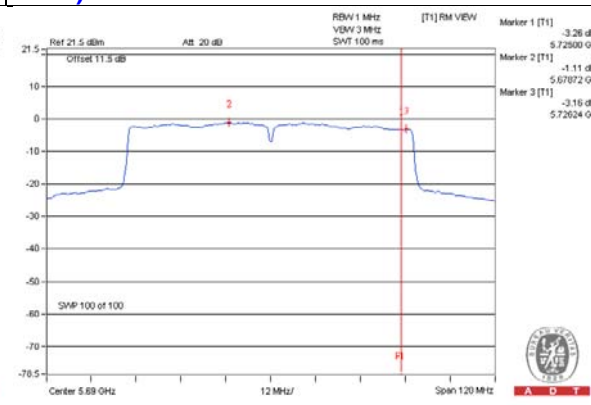
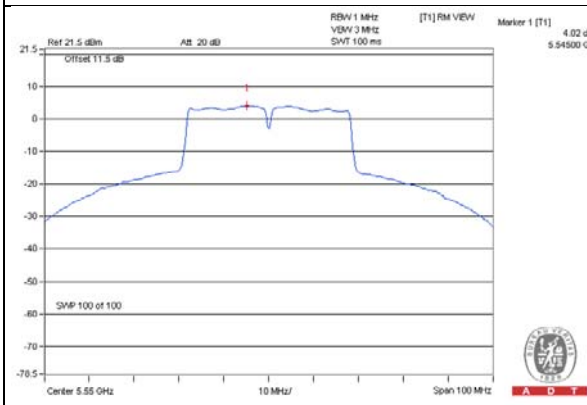

For U-NII-3 Band
802.11a

TX Chain	Channel	Frequency (MHz)	PSD (dBm/300kHz)	PSD (dBm/500kHz)	Total PSD (dBm/500kHz)	Limit (dBm/500kHz)	Pass /Fail
2	144 (UNII-3 Band)	5720	-1.79	0.43	0.43	30	Pass

802.11ac (VHT20)

TX Chain	Channel	Frequency (MHz)	PSD (dBm/300kHz)	PSD (dBm/500kHz)	Total PSD (dBm/500kHz)	Limit (dBm/500kHz)	Pass /Fail
2	144 (UNII-3 Band)	5720	-2.03	0.19	0.19	30	Pass

802.11ac (VHT40)

TX Chain	Channel	Frequency (MHz)	PSD (dBm/300kHz)	PSD (dBm/500kHz)	Total PSD (dBm/500kHz)	Limit (dBm/500kHz)	Pass /Fail
2	142 (UNII-2C Band)	5710	-5.44	-3.22	-3.22	30	Pass

802.11ac (VHT80)

TX chain	Chan.	Chan. Freq. (MHz)	PSD W/O Duty Factor		Duty Factor (dB)	Total PSD With Duty Factor (dBm/500kHz)	Limit (dBm/500kHz)	Pass /Fail
			(dBm/300kHz)	(dBm/500kHz)				
2	138 (UNII-2C Band)	5690	-10.91	-8.69	0.18	-8.51	30	Pass

NOTE: Refer to section 3.3 for duty cycle spectrum plot.

SPECTRUM PLOT OF WORST VALUE

802.11a – Chain (2): CH 144 (UNII-3 Band)

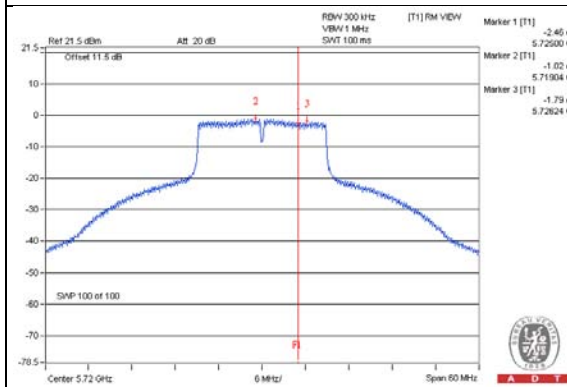

802.11ac (VHT20) – Chain (2): CH 144 (UNII-3 Band)

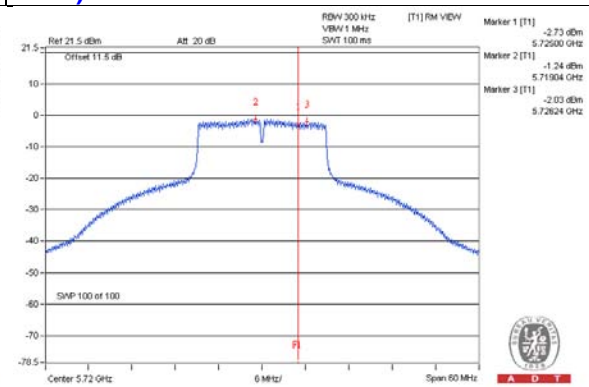

802.11ac (VHT40) – Chain (2): CH 142 (UNII-3 Band)

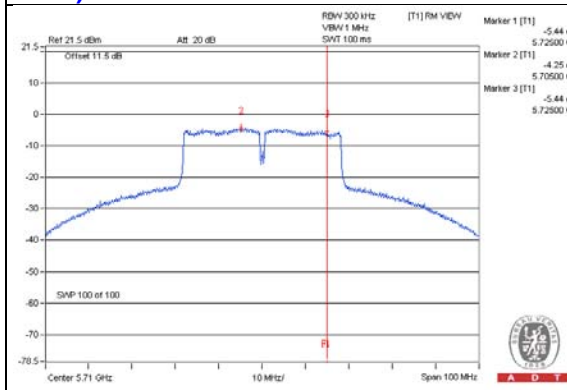

802.11ac (VHT80) – Chain (2): CH 138 (UNII-3 Band)

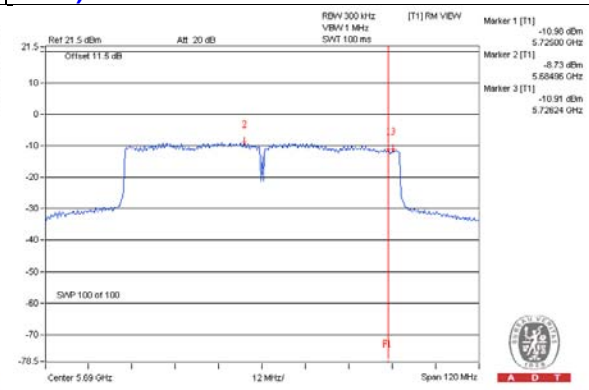

4.4.8 Test Results (Mode 2)

3TX

CDD MODE

For U-NII-2A, U-NII-2C Band

802.11a

Chan.	Chan. Freq. (MHz)	PSD (dBm)			Total Power Density (dBm)	MAX. Limit (dBm)	Pass / Fail
		Chain 0	Chain 1	Chain 2			
52	5260	1.32	-0.24	0.84	5.46	7.11	Pass
60	5300	1.63	0.10	1.11	5.76	7.11	Pass
64	5320	1.70	0.04	0.82	5.68	7.11	Pass
100	5500	1.60	0.11	0.89	5.68	7.00	Pass
116	5580	1.51	-0.23	0.63	5.47	7.00	Pass
140	5700	1.53	0.07	0.86	5.63	7.00	Pass
144 (UNII-2C Band)	5720	1.57	0.36	1.18	5.84	7.00	Pass

- NOTE:** 1. Method a) of power density measurement of KDB 662911 is using for calculating total power density. Total power density is summing entire spectra across corresponding frequency bins on the various outputs by computer.
2. For 5260~5320MHz: Directional gain = $10 \log[(10^{G1/20} + 10^{G2/20} + 10^{G3/20})^2 / 3] = 9.89\text{dBi} > 6\text{dBi}$, so the power density limit shall be reduced to $11-(9.89-6) = 7.11\text{dBm}$.
3. For 5500~5720MHz: Directional gain = $10 \log[(10^{G1/20} + 10^{G2/20} + 10^{G3/20})^2 / 3] = 10\text{dBi} > 6\text{dBi}$, so the power density limit shall be reduced to $11-(10-6) = 7.00\text{dBm}$.

802.11ac (VHT20)

Chan.	Chan. Freq. (MHz)	PSD (dBm)			Total Power Density (dBm)	MAX. Limit (dBm)	Pass / Fail
		Chain 0	Chain 1	Chain 2			
52	5260	1.04	-0.63	0.77	5.22	7.11	Pass
60	5300	1.10	-0.32	0.68	5.30	7.11	Pass
64	5320	1.16	-0.42	0.63	5.28	7.11	Pass
100	5500	1.38	-0.30	0.51	5.36	7.00	Pass
116	5580	1.08	-0.37	0.07	5.07	7.00	Pass
140	5700	1.06	-0.23	0.74	5.33	7.00	Pass
144 (UNII-2C Band)	5720	1.14	-0.21	0.83	5.40	7.00	Pass

- NOTE:** 1. Method a) of power density measurement of KDB 662911 is using for calculating total power density. Total power density is summing entire spectra across corresponding frequency bins on the various outputs by computer.
2. For 5260~5320MHz: Directional gain = $10 \log[(10^{G1/20} + 10^{G2/20} + 10^{G3/20})^2 / 3] = 9.89\text{dBi} > 6\text{dBi}$, so the power density limit shall be reduced to $11-(9.89-6) = 7.11\text{dBm}$.
3. For 5500~5720MHz: Directional gain = $10 \log[(10^{G1/20} + 10^{G2/20} + 10^{G3/20})^2 / 3] = 10\text{dBi} > 6\text{dBi}$, so the power density limit shall be reduced to $11-(10-6) = 7.00\text{dBm}$.

802.11ac (VHT40)

Chan.	Chan. Freq. (MHz)	PSD (dBm)			Total Power Density (dBm)	MAX. Limit (dBm)	Pass / Fail
		Chain 0	Chain 1	Chain 2			
54	5270	0.83	-0.58	0.72	5.14	7.11	Pass
62	5310	-0.85	-2.18	-1.05	3.45	7.11	Pass
102	5510	-0.38	-1.03	-0.73	4.07	7.00	Pass
110	5550	0.59	0.13	0.69	5.25	7.00	Pass
134	5670	0.67	-0.04	0.37	5.11	7.00	Pass
142 (UNII-2C Band)	5710	0.76	0.43	0.67	5.39	7.00	Pass

- NOTE:** 1. Method a) of power density measurement of KDB 662911 is using for calculating total power density. Total power density is summing entire spectra across corresponding frequency bins on the various outputs by computer.
2. For 5270~5310MHz: Directional gain = $10 \log[(10^{G1/20} + 10^{G2/20} + 10^{G3/20})^2 / 3] = 9.89\text{dBi} > 6\text{dBi}$, so the power density limit shall be reduced to $11-(9.89-6) = 7.11\text{dBm}$.
3. For 5510~5710MHz: Directional gain = $10 \log[(10^{G1/20} + 10^{G2/20} + 10^{G3/20})^2 / 3] = 10\text{dBi} > 6\text{dBi}$, so the power density limit shall be reduced to $11-(10-6) = 7.00\text{dBm}$.

802.11ac (VHT80)

Chan.	Chan. Freq. (MHz)	PSD W/O Duty Factor (dBm)			Duty Factor (dB)	Total PSD With Duty Factor (dBm)	MAX. Limit (dBm)	Pass / Fail
		Chain 0	Chain 1	Chain 2				
58	5290	-5.96	-6.78	-6.25	0.18	-1.37	7.11	Pass
106	5530	-3.77	-5.42	-4.88	0.18	0.32	7.00	Pass
122	5610	-2.07	-2.92	-2.75	0.18	2.39	7.00	Pass
138 (UNII-2C Band)	5690	-1.26	-1.62	-1.28	0.18	3.57	7.00	Pass

- NOTE:** 1. Method a) of power density measurement of KDB 662911 is using for calculating total power density. Total power density is summing entire spectra across corresponding frequency bins on the various outputs by computer.
2. For 5290MHz: Directional gain = $10 \log[(10^{G1/20} + 10^{G2/20} + 10^{G3/20})^2 / 3] = 9.89\text{dBi} > 6\text{dBi}$, so the power density limit shall be reduced to $11-(9.89-6) = 7.11\text{dBm}$.
3. Directional gain = $10 \log[(10^{G1/20} + 10^{G2/20} + 10^{G3/20})^2 / 3] = 10\text{dBi} > 6\text{dBi}$, so the power density limit shall be reduced to $11-(10-6) = 7.00\text{dBm}$.
4. Refer to section 3.3 for duty cycle spectrum plot.

SPECTRUM PLOT OF WORST VALUE

802.11a – Chain (0): CH 64

802.11ac (VHT20) – Chain (0): CH 100

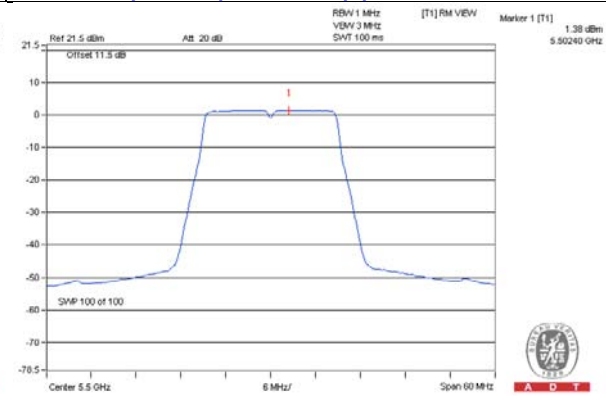
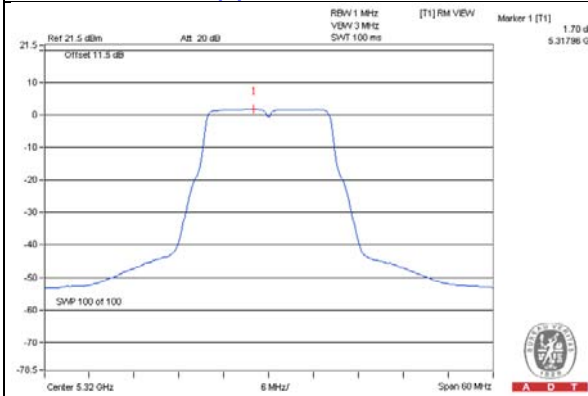

802.11ac (VHT40) – Chain (0): CH 54

802.11ac (VHT80) – Chain (0): CH 138 (UNII-2C Band)

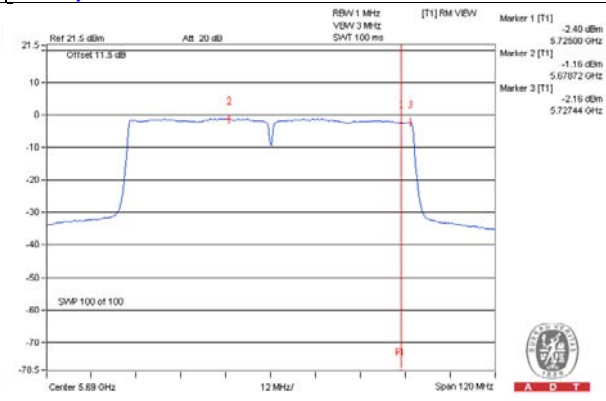
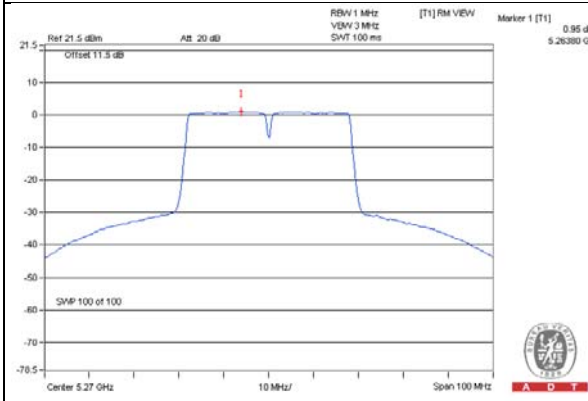

**For U-NII-3 Band
802.11a**

TX Chain	Channel	Frequency (MHz)	PSD (dBm/300kHz)	PSD (dBm/500kHz)	10 log (N=3) dB	Total PSD (dBm/500kHz)	Limit (dBm/500kHz)	Pass /Fail
0	144 (UNII-3 Band)	5720	-6.47	-4.25	4.77	0.52	26.03	Pass
1	144 (UNII-3 Band)	5720	-7.57	-5.35	4.77	-0.58	26.03	Pass
2	144 (UNII-3 Band)	5720	-6.81	-4.59	4.77	0.18	26.03	Pass

NOTE: 1. Directional gain = $10 \log[(10^{G1/20} + 10^{G2/20} + 10^{G3/20})^2 / 3] = 9.97\text{dBi} > 6\text{dBi}$, so the power density limit shall be reduced to $30-(9.97-6) = 26.03\text{dBm}$.

802.11ac (VHT20)

TX Chain	Channel	Frequency (MHz)	PSD (dBm/300kHz)	PSD (dBm/500kHz)	10 log (N=3) dB	Total PSD (dBm/500kHz)	Limit (dBm/500kHz)	Pass /Fail
0	144 (UNII-3 Band)	5720	-7.04	-4.82	4.77	-0.05	26.03	Pass
1	144 (UNII-3 Band)	5720	-8.09	-5.87	4.77	-1.10	26.03	Pass
2	144 (UNII-3 Band)	5720	-7.34	-5.12	4.77	-0.35	26.03	Pass

NOTE: 1. Directional gain = $10 \log[(10^{G1/20} + 10^{G2/20} + 10^{G3/20})^2 / 3] = 9.97\text{dBi} > 6\text{dBi}$, so the power density limit shall be reduced to $30-(9.97-6) = 26.03\text{dBm}$.

802.11ac (VHT40)

TX Chain	Channel	Frequency (MHz)	PSD (dBm/300kHz)	PSD (dBm/500kHz)	10 log (N=3) dB	Total PSD (dBm/500kHz)	Limit (dBm/500kHz)	Pass /Fail
0	142 (UNII-2C Band)	5710	-7.97	-5.75	4.77	-0.98	26.03	Pass
1	142 (UNII-2C Band)	5710	-8.13	-5.91	4.77	-1.14	26.03	Pass
2	142 (UNII-2C Band)	5710	-7.93	-5.71	4.77	-0.94	26.03	Pass

NOTE: 1. Directional gain = $10 \log[(10^{G1/20} + 10^{G2/20} + 10^{G3/20})^2 / 3] = 9.97\text{dBi} > 6\text{dBi}$, so the power density limit shall be reduced to $30 - (9.97 - 6) = 26.03\text{dBm}$.

802.11ac (VHT80)

TX chain	Chan.	Chan. Freq. (MHz)	PSD W/O Duty Factor		10 log (N=3) dB	Duty Factor (dB)	Total PSD With Duty Factor (dBm/500kHz)	Limit (dBm/500kHz)	Pass /Fail
			(dBm/300kHz)	(dBm/500kHz)					
0	138 (UNII-2C Band)	5690	-10.43	-8.21	4.77	0.18	-3.26	26.03	Pass
1	138 (UNII-2C Band)	5690	-10.89	-8.67	4.77	0.18	-3.72	26.03	Pass
2	138 (UNII-2C Band)	5690	-10.66	-8.44	4.77	0.18	-3.49	26.03	Pass

NOTE: 1. Directional gain = $10 \log[(10^{G1/20} + 10^{G2/20} + 10^{G3/20})^2 / 3] = 9.97\text{dBi} > 6\text{dBi}$, so the power density limit shall be reduced to $30 - (9.97 - 6) = 26.03\text{dBm}$.

2. Refer to section 3.3 for duty cycle spectrum plot.

SPECTRUM PLOT OF WORST VALUE

802.11a – Chain (0): CH 144 (UNII-3 Band)

802.11ac (VHT20) – Chain (0): CH 144 (UNII-3 Band)

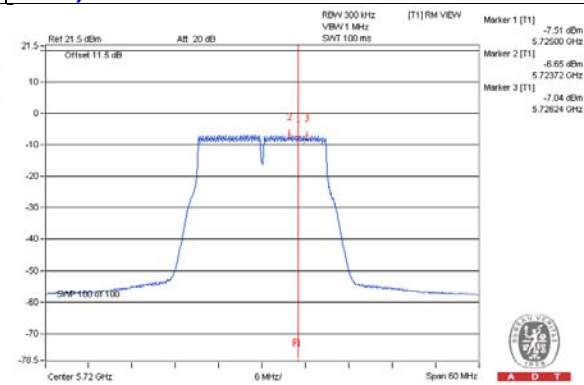
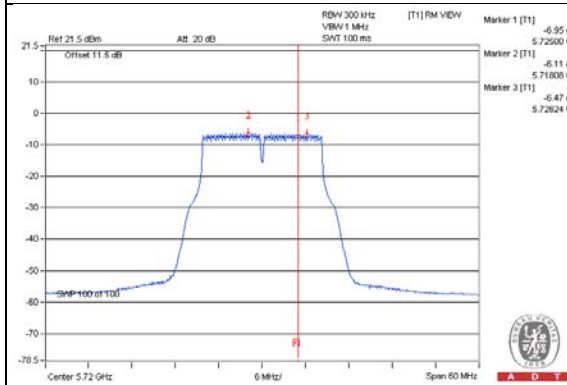

802.11ac (VHT40) – Chain (2): CH 142 (UNII-3 Band)

802.11ac (VHT80) – Chain (0): CH 138 (UNII-3 Band)

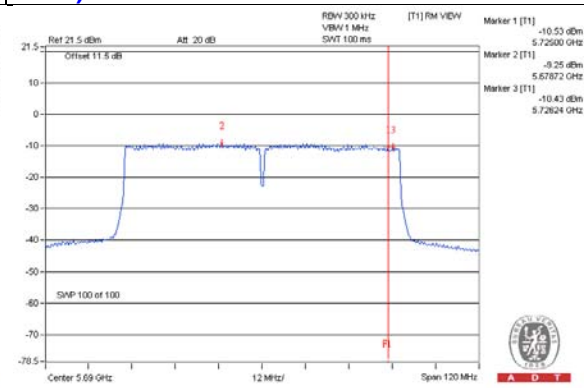
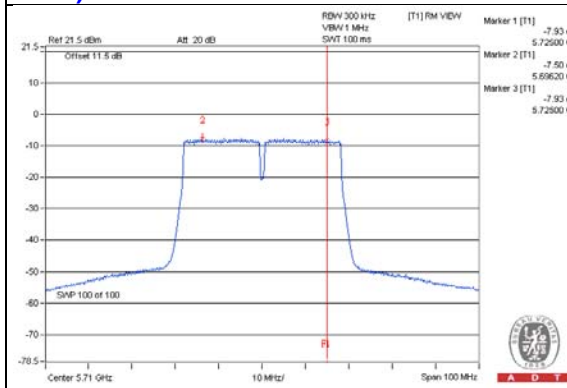

2TX
CDD MODE
For U-NII-2A, U-NII-2C Band
802.11a

Chan.	Chan. Freq. (MHz)	PSD (dBm)		Total Power Density (dBm)	MAX. Limit (dBm)	Pass / Fail
		Chain 0	Chain 1			
52	5260	5.37	3.57	7.57	8.48	Pass
60	5300	5.44	3.80	7.71	8.48	Pass
64	5320	5.28	3.78	7.60	8.48	Pass
100	5500	5.32	3.59	7.55	8.58	Pass
116	5580	5.40	3.86	7.71	8.58	Pass
140	5700	5.43	3.92	7.75	8.58	Pass
144 (UNII-2C Band)	5720	5.37	3.79	7.66	8.58	Pass

NOTE: 1. Method a) of power density measurement of KDB 662911 is using for calculating total power density. Total power density is summing entire spectra across corresponding frequency bins on the various outputs by computer.

2. For 5260~5320MHz: Directional gain = $10 \log[(10^{G1/20} + 10^{G2/20})^2 / 2] = 8.52\text{dBi} > 6\text{dBi}$, so the power density limit shall be reduced to $11-(8.52-6) = 8.48\text{dBm}$.

3. For 5500~5720MHz: Directional gain = $10 \log[(10^{G1/20} + 10^{G2/20})^2 / 2] = 8.42\text{dBi} > 6\text{dBi}$, so the power density limit shall be reduced to $11-(8.52-6) = 8.48\text{dBm}$.

802.11ac (VHT20)

Chan.	Chan. Freq. (MHz)	PSD (dBm)		Total Power Density (dBm)	MAX. Limit (dBm)	Pass / Fail
		Chain 0	Chain 1			
52	5260	4.90	3.40	7.22	8.48	Pass
60	5300	4.94	3.57	7.32	8.48	Pass
64	5320	5.03	3.76	7.45	8.48	Pass
100	5500	4.89	3.32	7.19	8.58	Pass
116	5580	5.07	3.25	7.26	8.58	Pass
140	5700	5.08	3.29	7.29	8.58	Pass
144 (UNII-2C Band)	5720	4.96	3.09	7.14	8.58	Pass

NOTE: 1. Method a) of power density measurement of KDB 662911 is using for calculating total power density. Total power density is summing entire spectra across corresponding frequency bins on the various outputs by computer.

2. For U-NII-2A: Directional gain = $10 \log[(10^{G1/20} + 10^{G2/20})^2 / 2] = 8.52\text{dBi} > 6\text{dBi}$, so the power density limit shall be reduced to $11-(8.52-6) = 8.48\text{dBm}$.

3. For U-NII-2C: Directional gain = $10 \log[(10^{G1/20} + 10^{G2/20})^2 / 2] = 8.42\text{dBi} > 6\text{dBi}$, so the power density limit shall be reduced to $11-(8.42-6) = 8.58\text{dBm}$.

802.11ac (VHT40)

Chan.	Chan. Freq. (MHz)	PSD (dBm)		Total Power Density (dBm)	MAX. Limit (dBm)	Pass / Fail
		Chain 0	Chain 1			
54	5270	3.79	2.80	6.33	8.48	Pass
62	5310	-0.01	-1.11	2.49	8.48	Pass
102	5510	0.92	-0.02	3.49	8.58	Pass
110	5550	3.98	3.26	6.65	8.58	Pass
134	5670	1.64	0.80	4.25	8.58	Pass
142 (UNII-2C Band)	5710	4.18	3.28	6.76	8.58	Pass

- NOTE:** 1. Method a) of power density measurement of KDB 662911 is using for calculating total power density. Total power density is summing entire spectra across corresponding frequency bins on the various outputs by computer.
2. For U-NII-2A: Directional gain = $10 \log[(10^{G1/20} + 10^{G2/20})^2 / 2] = 8.52\text{dBi} > 6\text{dBi}$, so the power density limit shall be reduced to $11-(8.52-6) = 8.48\text{dBm}$.
3. For U-NII-2C: Directional gain = $10 \log[(10^{G1/20} + 10^{G2/20})^2 / 2] = 8.42\text{dBi} > 6\text{dBi}$, so the power density limit shall be reduced to $11-(8.42-6) = 8.58\text{dBm}$.

802.11ac (VHT80)

Chan.	Chan. Freq. (MHz)	PSD W/O Duty Factor (dBm)		Duty Factor (dB)	Total PSD With Duty Factor (dBm)	MAX. Limit (dBm)	Pass / Fail
		Chain 0	Chain 1				
58	5290	-2.98	-4.03	0.18	-0.28	8.48	Pass
106	5530	-2.20	-3.79	0.18	0.27	8.58	Pass
122	5610	-0.87	-1.36	0.18	2.08	8.58	Pass
138 (UNII-2C Band)	5690	0.75	0.45	0.18	3.79	8.58	Pass

- NOTE:** 1. Method a) of power density measurement of KDB 662911 is using for calculating total power density. Total power density is summing entire spectra across corresponding frequency bins on the various outputs by computer.
2. For U-NII-2A: Directional gain = $10 \log[(10^{G1/20} + 10^{G2/20})^2 / 2] = 8.52\text{dBi} > 6\text{dBi}$, so the power density limit shall be reduced to $11-(8.52-6) = 8.48\text{dBm}$.
3. For U-NII-2C: Directional gain = $10 \log[(10^{G1/20} + 10^{G2/20})^2 / 2] = 8.42\text{dBi} > 6\text{dBi}$, so the power density limit shall be reduced to $11-(8.42-6) = 8.58\text{dBm}$.

SPECTRUM PLOT OF WORST VALUE

802.11a – Chain (0): CH 60

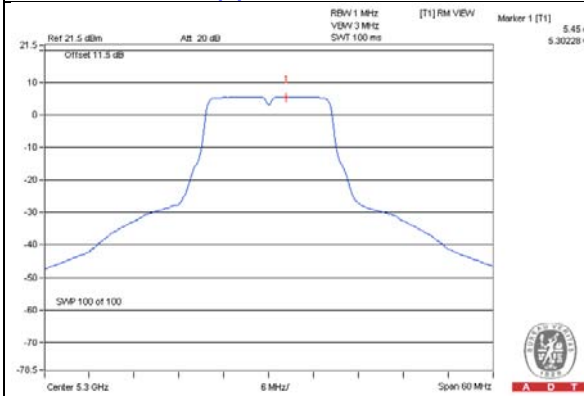

802.11ac (VHT20) – Chain (0): CH 140

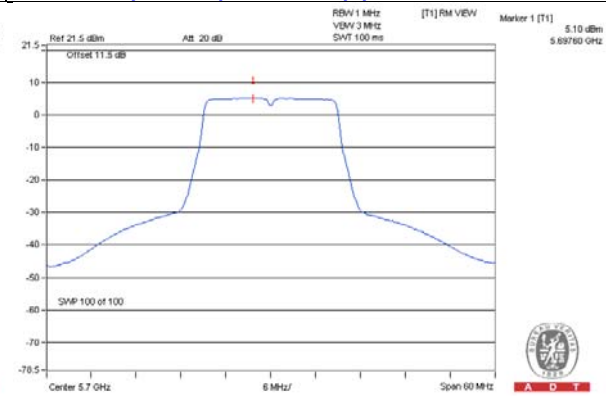

802.11ac (VHT40) – Chain (0): CH 142 (UNII-2C Band)

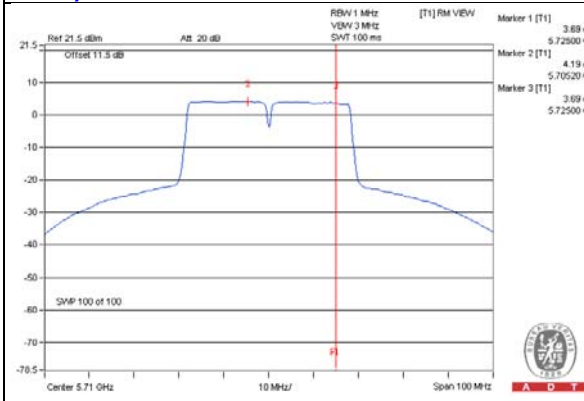

802.11ac (VHT80) – Chain (0): CH 138 (UNII-2C Band)

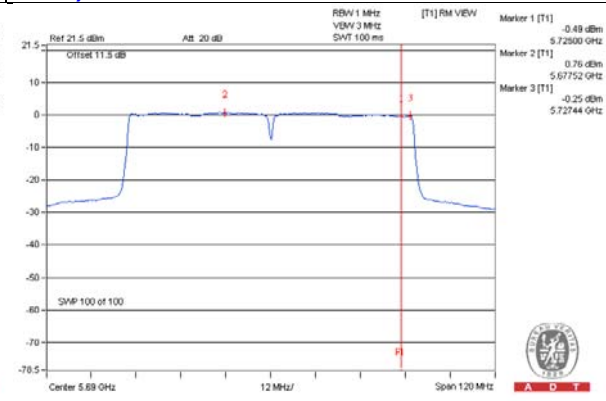

**For U-NII-3 Band
802.11a**

TX Chain	Channel	Frequency (MHz)	PSD (dBm/300kHz)	PSD (dBm/500kHz)	10 log (N=2) dB	Total PSD (dBm/500kHz)	Limit (dBm/500kHz)	Pass /Fail
0	144 (UNII-3 Band)	5720	-2.69	-0.47	3.01	2.54	27.79	Pass
1	144 (UNII-3 Band)	5720	-4.31	-2.09	3.01	0.92	27.79	Pass

NOTE: 1. Directional gain = $10 \log[(10^{G1/20} + 10^{G2/20})^2 / 2] = 8.21\text{dBi} > 6\text{dBi}$, so the power density limit shall be reduced to $30-(8.21-6) = 27.79\text{dBm}$.

802.11ac (VHT20)

TX Chain	Channel	Frequency (MHz)	PSD (dBm/300kHz)	PSD (dBm/500kHz)	10 log (N=2) dB	Total PSD (dBm/500kHz)	Limit (dBm/500kHz)	Pass /Fail
0	144 (UNII-3 Band)	5720	-3.11	-0.89	3.01	2.12	27.79	Pass
1	144 (UNII-3 Band)	5720	-4.87	-2.65	3.01	0.36	27.79	Pass

NOTE: 1. Directional gain = $10 \log[(10^{G1/20} + 10^{G2/20})^2 / 2] = 8.21\text{dBi} > 6\text{dBi}$, so the power density limit shall be reduced to $30-(8.21-6) = 27.79\text{dBm}$.

802.11ac (VHT40)

TX Chain	Channel	Frequency (MHz)	PSD (dBm/300kHz)	PSD (dBm/500kHz)	10 log (N=2) dB	Total PSD (dBm/500kHz)	Limit (dBm/500kHz)	Pass /Fail
0	142 (UNII-2C Band)	5710	-4.26	-2.04	3.01	0.97	27.79	Pass
1	142 (UNII-2C Band)	5710	-4.86	-2.64	3.01	0.37	27.79	Pass

NOTE: 1. Directional gain = $10 \log[(10^{G1/20} + 10^{G2/20})^2 / 2] = 8.21\text{dBi} > 6\text{dBi}$, so the power density limit shall be reduced to $30-(8.21-6) = 27.79\text{dBm}$.

802.11ac (VHT80)

TX chain	Chan.	Chan. Freq. (MHz)	PSD W/O Duty Factor		10 log (N=2) dB	Duty Factor (dB)	Total PSD With Duty Factor (dBm/500kHz)	Limit (dBm/500kHz)	Pass /Fail
			(dBm/300kHz)	(dBm/500kHz)					
0	138 (UNII-2C Band)	5690	-8.73	-6.51	3.01	0.18	-3.32	27.79	Pass
1	138 (UNII-2C Band)	5690	-8.66	-6.44	3.01	0.18	-3.25	27.79	Pass

NOTE: 1. Directional gain = $10 \log[(10^{G1/20} + 10^{G2/20})^2 / 2] = 8.21\text{dBi} > 6\text{dBi}$, so the power density limit shall be reduced to $30-(8.21-6) = 27.79\text{dBm}$.

2. Refer to section 3.3 for duty cycle spectrum plot.

SPECTRUM PLOT OF WORST VALUE

802.11a – Chain (0): CH 144 (UNII-3 Band)

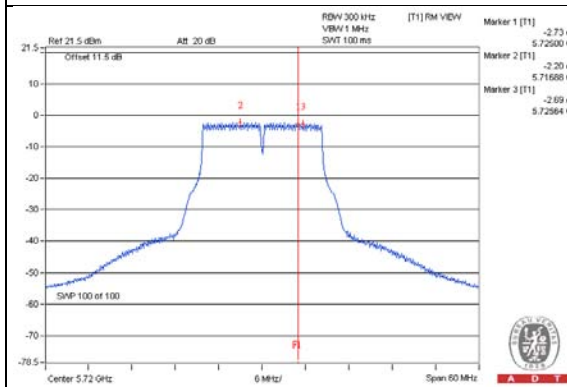

802.11ac (VHT20) – Chain (0): CH 144 (UNII-3 Band)

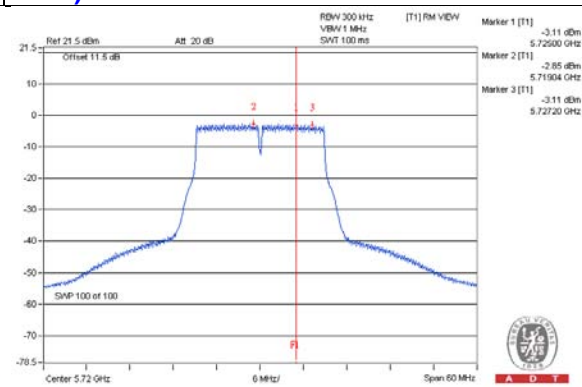

802.11ac (VHT40) – Chain (0): CH 142 (UNII-3 Band)

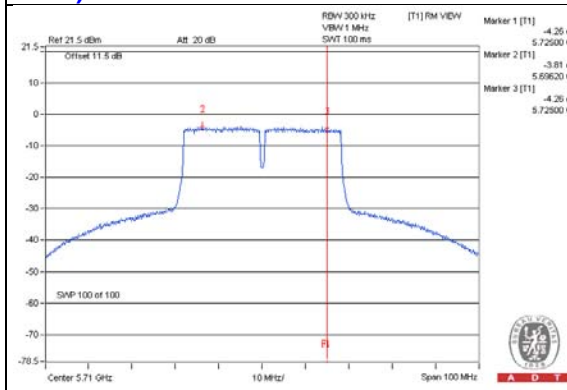

802.11ac (VHT80) – Chain (1): CH 138 (UNII-3 Band)

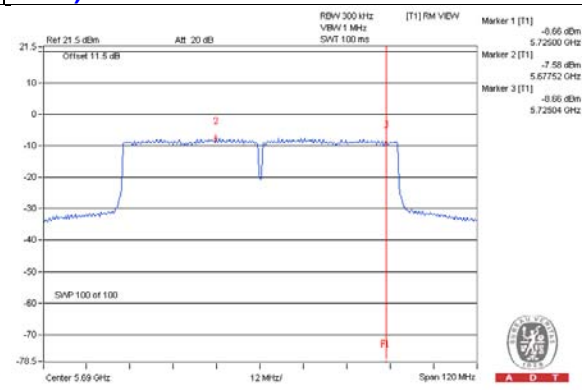

1TX
CDD MODE
For U-NII-2A, U-NII-2C Band
Chain 0
802.11a

Chan.	Chan. Freq. (MHz)	PSD (dBm/MHz)	MAX. Limit (dBm/MHz)	Pass / Fail
52	5260	7.30	11	Pass
60	5300	7.44	11	Pass
64	5320	6.33	11	Pass
100	5500	7.47	11	Pass
116	5580	7.45	11	Pass
140	5700	5.84	11	Pass
144 (UNII-2C Band)	5720	7.77	11	Pass

802.11ac (VHT20)

Chan.	Chan. Freq. (MHz)	PSD (dBm/MHz)	MAX. Limit (dBm/MHz)	Pass / Fail
52	5260	7.02	11	Pass
60	5300	7.06	11	Pass
64	5320	5.63	11	Pass
100	5500	6.10	11	Pass
116	5580	7.10	11	Pass
140	5700	5.57	11	Pass
144 (UNII-2C Band)	5720	7.11	11	Pass



802.11ac (VHT40)

Chan.	Chan. Freq. (MHz)	PSD (dBm/MHz)	MAX. Limit (dBm/MHz)	Pass / Fail
54	5270	4.64	11	Pass
62	5310	0.33	11	Pass
102	5510	1.15	11	Pass
110	5550	4.00	11	Pass
134	5670	2.45	11	Pass
142 (UNII-2C Band)	5710	4.19	11	Pass

802.11ac (VHT80)

Chan.	Chan. Freq. (MHz)	PSD W/O Duty Factor (dBm/MHz)	Duty Factor (dB)	PSD With Duty Factor (dBm/MHz)	MAX. Limit (dBm/MHz)	Pass / Fail
58	5290	-2.50	0.18	-2.32	11	Pass
106	5530	-2.16	0.18	-1.98	11	Pass
122	5610	-0.15	0.18	0.03	11	Pass
138 (UNII-2C Band)	5690	0.76	0.18	0.94	11	Pass

Note: Refer to section 3.3 for duty cycle spectrum plot.

SPECTRUM PLOT OF WORST VALUE

802.11a – Chain (0): CH 144 (UNII-2C Band)

802.11ac (VHT20) –Chain (0): CH 144 (UNII-2C Band)

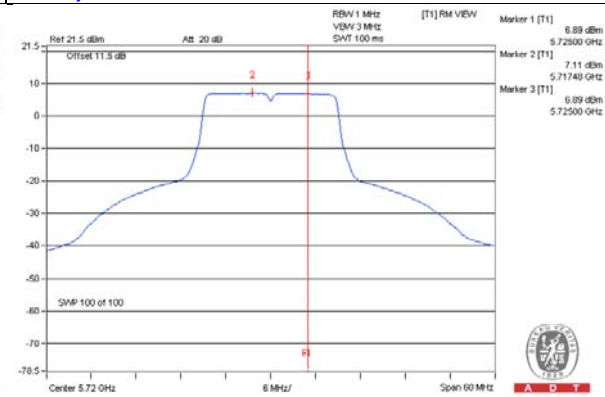
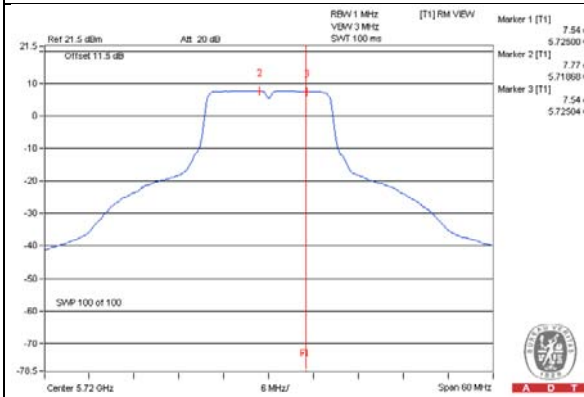

802.11ac (VHT40) –Chain (0): CH 142 (UNII-2C Band)

802.11ac (VHT80) – Chain (0): CH 138 (UNII-2C Band)

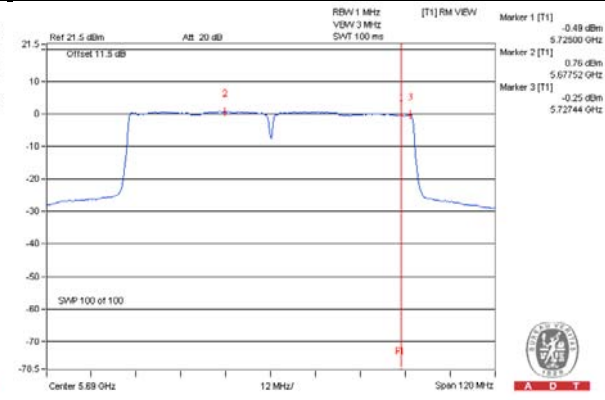
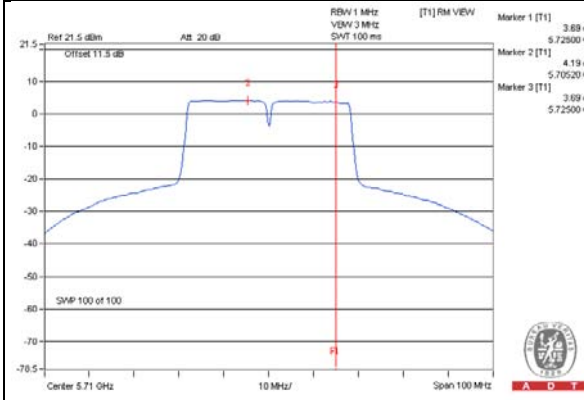

For U-NII-3 Band
802.11a

TX Chain	Channel	Frequency (MHz)	PSD (dBm/300kHz)	PSD (dBm/500kHz)	Total PSD (dBm/500kHz)	Limit (dBm/500kHz)	Pass /Fail
0	144 (UNII-3 Band)	5720	-0.50	1.72	1.72	30	Pass

802.11ac (VHT20)

TX Chain	Channel	Frequency (MHz)	PSD (dBm/300kHz)	PSD (dBm/500kHz)	Total PSD (dBm/500kHz)	Limit (dBm/500kHz)	Pass /Fail
0	144 (UNII-3 Band)	5720	-1.06	1.16	1.16	30	Pass

802.11ac (VHT40)

TX Chain	Channel	Frequency (MHz)	PSD (dBm/300kHz)	PSD (dBm/500kHz)	Total PSD (dBm/500kHz)	Limit (dBm/500kHz)	Pass /Fail
0	142 (UNII-2C Band)	5710	-4.26	-2.04	-2.04	30	Pass

802.11ac (VHT80)

TX chain	Chan.	Chan. Freq. (MHz)	PSD W/O Duty Factor		Duty Factor (dB)	Total PSD With Duty Factor (dBm/500kHz)	Limit (dBm/500kHz)	Pass /Fail
			(dBm/300kHz)	(dBm/500kHz)				
0	138 (UNII-2C Band)	5690	-8.73	-6.51	0.18	-6.33	30	Pass

NOTE: Refer to section 3.3 for duty cycle spectrum plot.

SPECTRUM PLOT OF WORST VALUE

802.11a – Chain (0): CH 144 (UNII-3 Band)

802.11ac (VHT20) – Chain (0): CH 144 (UNII-3 Band)

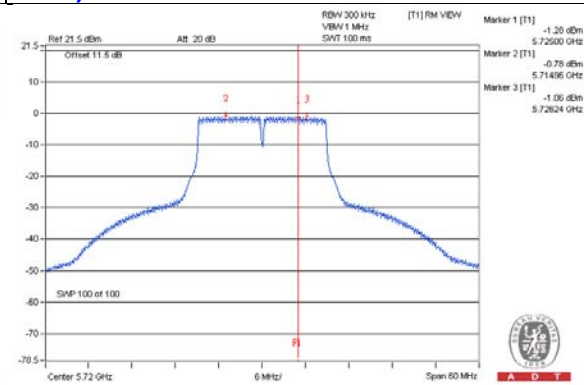
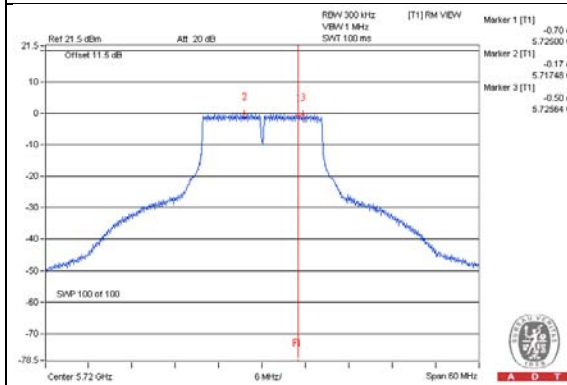

802.11ac (VHT40) – Chain (0): CH 142 (UNII-3 Band)

802.11ac (VHT80) – Chain (0): CH 138 (UNII-3 Band)

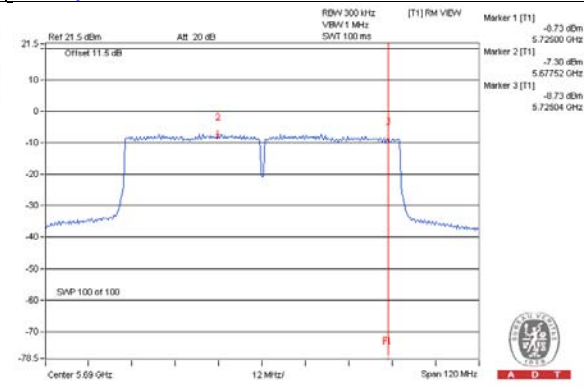
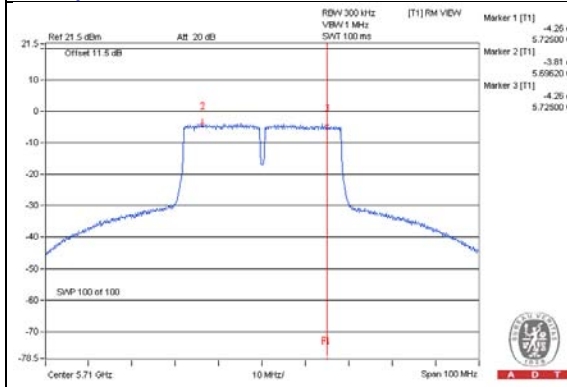

4.5 Frequency Stability Measurement

4.5.1 Limits of Frequency Stability Measurement

The frequency of the carrier signal shall be maintained within band of operation

4.5.2 Test Setup

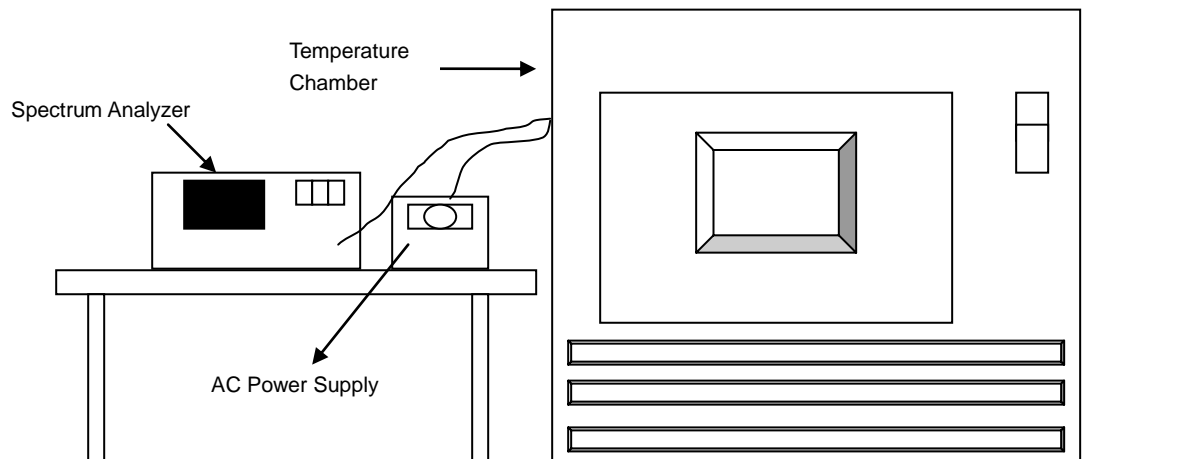

4.5.3 Test Instruments

Refer to section 4.1.2 to get information of above instrument.

4.5.4 Test Procedure

- The EUT was placed inside the environmental test chamber and powered by nominal AC voltage.
- Turn the EUT on and couple its output to a spectrum analyzer.
- Turn the EUT off and set the chamber to the highest temperature specified.
- Allow sufficient time (approximately 30 min) for the temperature of the chamber to stabilize, turn the EUT on and measure the operating frequency after 2, 5, and 10 minutes.
- Repeat step 2 and 3 with the temperature chamber set to the lowest temperature.
- The test chamber was allowed to stabilize at +20 degree C for a minimum of 30 minutes. The supply voltage was then adjusted on the EUT from 85% to 115% and the frequency record.

4.5.5 Deviation from Test Standard

No deviation.

4.5.6 EUT Operating Condition

Set the EUT transmit at un-modulation mode to test frequency stability.

4.5.7 Test Results (Mode 1)

FREQUENCY STABILITY VERSUS TEMP.									
OPERATING FREQUENCY: 5260MHz									
TEMP. (°C)	POWER SUPPLY (Vac)	0 MINUTE		2 MINUTE		5 MINUTE		10 MINUTE	
		Measured Frequency (MHz)	Frequency Drift (%)	Measured Frequency (MHz)	Frequency Drift (%)	Measured Frequency (MHz)	Frequency Drift (%)	Measured Frequency (MHz)	Frequency Drift (%)
50	120	5259.9944	-0.00011	5259.9948	-0.00010	5259.9948	-0.00010	5259.9948	-0.00010
40	120	5259.9979	-0.00004	5259.9998	0.00000	5260.0002	0.00000	5260.0012	0.00002
30	120	5259.9852	-0.00028	5259.9858	-0.00027	5259.9874	-0.00024	5259.9891	-0.00021
20	120	5260.0032	0.00006	5259.9998	0.00000	5260.001	0.00002	5259.9999	0.00000
10	120	5259.9796	-0.00039	5259.9772	-0.00043	5259.9778	-0.00042	5259.9779	-0.00042
0	120	5259.9738	-0.00050	5259.9752	-0.00047	5259.974	-0.00049	5259.9736	-0.00050
-10	120	5259.9789	-0.00040	5259.9791	-0.00040	5259.979	-0.00040	5259.9793	-0.00039
-20	120	5259.9892	-0.00021	5259.9879	-0.00023	5259.9864	-0.00026	5259.9881	-0.00023
-30	120	5260.0197	0.00037	5260.0159	0.00030	5260.0155	0.00029	5260.0192	0.00037

FREQUENCY STABILITY VERSUS VOLTAGE									
OPERATING FREQUENCY: 5260MHz									
TEMP. (°C)	POWER SUPPLY (Vac)	0 MINUTE		2 MINUTE		5 MINUTE		10 MINUTE	
		Measured Frequency (MHz)	Frequency Drift (%)	Measured Frequency (MHz)	Frequency Drift (%)	Measured Frequency (MHz)	Frequency Drift (%)	Measured Frequency (MHz)	Frequency Drift (%)
20	138	5260.0025	0.00005	5259.9989	-0.00002	5260.0008	0.00002	5259.9994	-0.00001
	120	5260.0032	0.00006	5259.9998	0.00000	5260.001	0.00002	5259.9999	0.00000
	102	5260.0027	0.00005	5259.9991	-0.00002	5260.0002	0.00000	5260.0007	0.00001



4.5.8 Test Results (Mode 2)

FREQUENCY STABILITY VERSUS TEMP.									
OPERATING FREQUENCY: 5260MHz									
TEMP. (°C)	POWER SUPPLY (Vac)	0 MINUTE		2 MINUTE		5 MINUTE		10 MINUTE	
		Measured Frequency (MHz)	Frequency Drift (%)	Measured Frequency (MHz)	Frequency Drift (%)	Measured Frequency (MHz)	Frequency Drift (%)	Measured Frequency (MHz)	Frequency Drift (%)
50	120	5260.0094	0.00018	5260.01	0.00019	5260.0104	0.00020	5260.0064	0.00012
40	120	5259.9771	-0.00044	5259.9746	-0.00048	5259.9748	-0.00048	5259.9749	-0.00048
30	120	5259.9853	-0.00028	5259.9831	-0.00032	5259.9811	-0.00036	5259.9826	-0.00033
20	120	5259.9979	-0.00004	5260.0007	0.00001	5259.999	-0.00002	5259.9972	-0.00005
10	120	5260.0206	0.00039	5260.0213	0.00040	5260.0188	0.00036	5260.0202	0.00038
0	120	5259.9788	-0.00040	5259.9784	-0.00041	5259.9796	-0.00039	5259.9756	-0.00046
-10	120	5260.0117	0.00022	5260.0076	0.00014	5260.0081	0.00015	5260.0115	0.00022
-20	120	5260.0047	0.00009	5260.0035	0.00007	5260.0069	0.00013	5260.0053	0.00010
-30	120	5259.9769	-0.00044	5259.9768	-0.00044	5259.9768	-0.00044	5259.9763	-0.00045

FREQUENCY STABILITY VERSUS VOLTAGE									
OPERATING FREQUENCY: 5260MHz									
TEMP. (°C)	POWER SUPPLY (Vac)	0 MINUTE		2 MINUTE		5 MINUTE		10 MINUTE	
		Measured Frequency (MHz)	Frequency Drift (%)	Measured Frequency (MHz)	Frequency Drift (%)	Measured Frequency (MHz)	Frequency Drift (%)	Measured Frequency (MHz)	Frequency Drift (%)
20	138	5259.9973	-0.00005	5260.0017	0.00003	5259.9996	-0.00001	5259.9978	-0.00004
	120	5259.9979	-0.00004	5260.0007	0.00001	5259.999	-0.00002	5259.9972	-0.00005
	102	5259.9988	-0.00002	5260.0012	0.00002	5260	0.00000	5259.9978	-0.00004

4.6 6dB Bandwidth Measurement

4.6.1 Limits of 6dB Bandwidth Measurement

The minimum of 6dB Bandwidth Measurement is 0.5MHz.

4.6.2 Test Setup

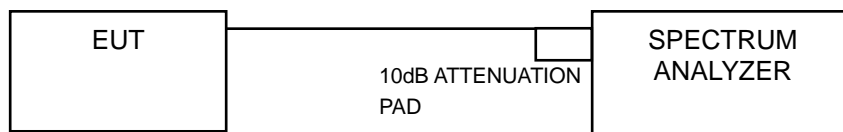

4.6.3 Test Instruments

Refer to section 4.1.2 to get information of above instrument.

4.6.4 Test Procedure

MEASUREMENT PROCEDURE REF

- Set resolution bandwidth (RBW) = 100kHz
- Set the video bandwidth (VBW) $\geq 3 \times$ RBW, Detector = Peak.
- Trace mode = max hold.
- Sweep = auto couple.
- Measure the maximum width of the emission that is constrained by the frequencies associated with the two amplitude points (upper and lower) that are attenuated by 6 dB relative to the maximum level measured in the fundamental emission

4.6.5 Deviation from Test Standard

No deviation.

4.6.6 EUT Operating Condition

The software provided by client to enable the EUT under transmission condition continuously at lowest, middle and highest channel frequencies individually.

4.6.7 Test Results (Mode 1)

CDD Mode

3TX

802.11a

Channel	Frequency (MHz)	6dB Bandwidth (MHz)			Minimum Limit (MHz)	Pass / Fail
		Chain 0	Chain 1	Chain 2		
144 (UNII-3 Band)	5720	3.77	3.12	3.15	0.5	PASS

802.11ac (VHT20)

Channel	Frequency (MHz)	6dB Bandwidth (MHz)			Minimum Limit (MHz)	Pass / Fail
		Chain 0	Chain 1	Chain 2		
144 (UNII-3 Band)	5720	3.76	3.75	3.51	0.5	PASS

802.11ac (VHT40)

Channel	Frequency (MHz)	6dB Bandwidth (MHz)			Minimum Limit (MHz)	Pass / Fail
		Chain 0	Chain 1	Chain 2		
142 (UNII-3 Band)	5710	3.11	3.13	3.13	0.5	PASS

802.11ac (VHT80)

Channel	Frequency (MHz)	6dB Bandwidth (MHz)			Minimum Limit (MHz)	Pass / Fail
		Chain 0	Chain 1	Chain 2		
138 (UNII-3 Band)	5690	2.77	2.77	2.76	0.5	PASS

Spectrum Plot of Worst Value

802.11a – Chain (1): CH 144 (UNII-3 Band)

802.11ac (VHT20) – Chain (2): CH 144 (UNII-3 Band)

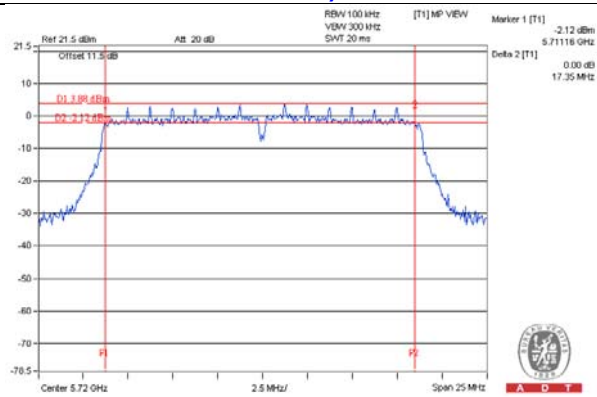
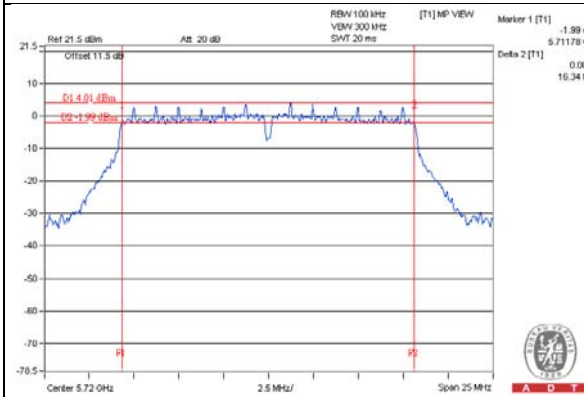

802.11ac (VHT40) – Chain (0): CH 142 (UNII-3 Band)

802.11ac (VHT80) – Chain (2): CH 138 (UNII-3 Band)

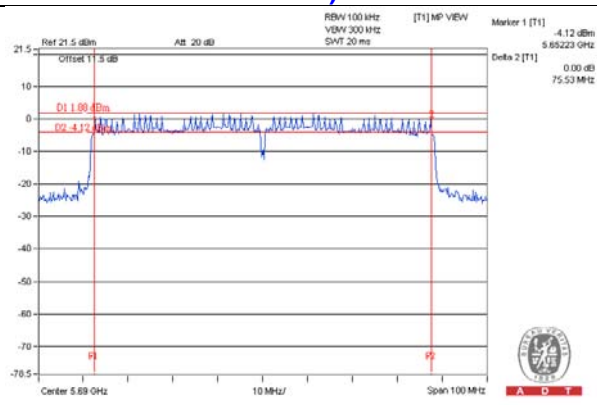
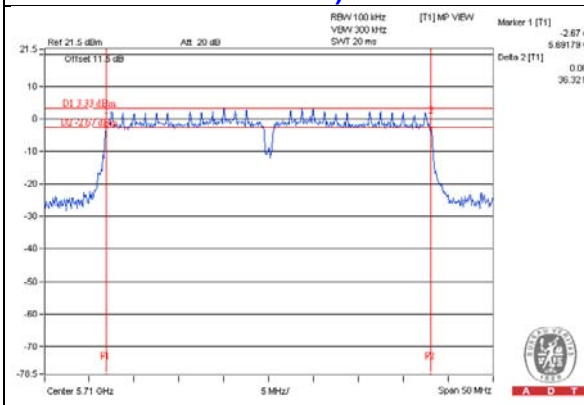

**2TX
802.11a**

Channel	Frequency (MHz)	6dB Bandwidth (MHz)		Minimum Limit (MHz)	Pass / Fail
		Chain 0	Chain 2		
144 (UNII-3 Band)	5720	3.11	3.16	0.5	PASS

802.11ac (VHT20)

Channel	Frequency (MHz)	6dB Bandwidth (MHz)		Minimum Limit (MHz)	Pass / Fail
		Chain 0	Chain 2		
144 (UNII-3 Band)	5720	3.75	3.77	0.5	PASS

802.11ac (VHT40)

Channel	Frequency (MHz)	6dB Bandwidth (MHz)		Minimum Limit (MHz)	Pass / Fail
		Chain 0	Chain 2		
142 (UNII-3 Band)	5710	2.93	2.92	0.5	PASS

802.11ac (VHT80)

Channel	Frequency (MHz)	6dB Bandwidth (MHz)		Minimum Limit (MHz)	Pass / Fail
		Chain 0	Chain 2		
138 (UNII-3 Band)	5690	2.76	2.76	0.5	PASS

Spectrum Plot of Worst Value

802.11a – Chain (0): CH 144 (UNII-3 Band)

802.11ac (VHT20) – Chain (0): CH 144 (UNII-3 Band)

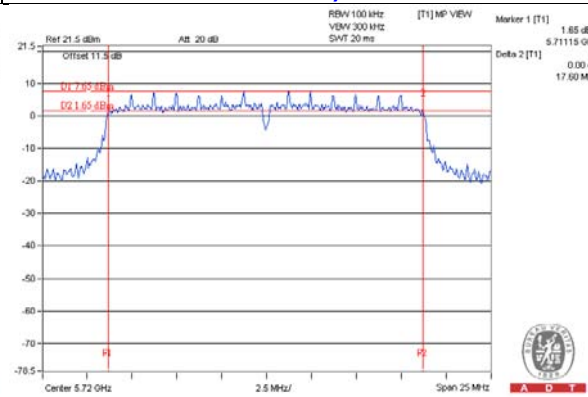
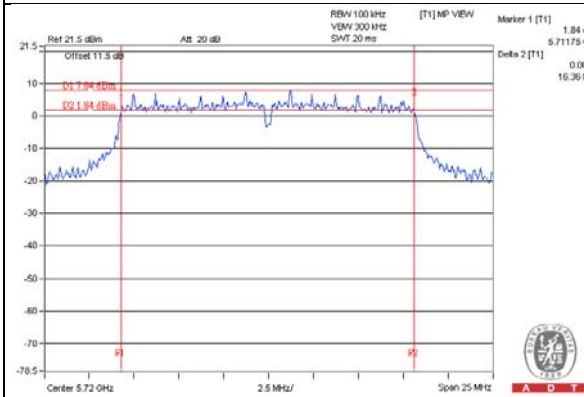

802.11ac (VHT40) – Chain (2): CH 142 (UNII-3 Band)

802.11ac (VHT80) – Chain (2): CH 138 (UNII-3 Band)

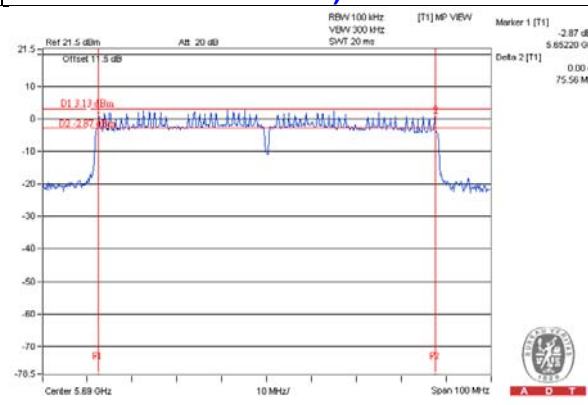
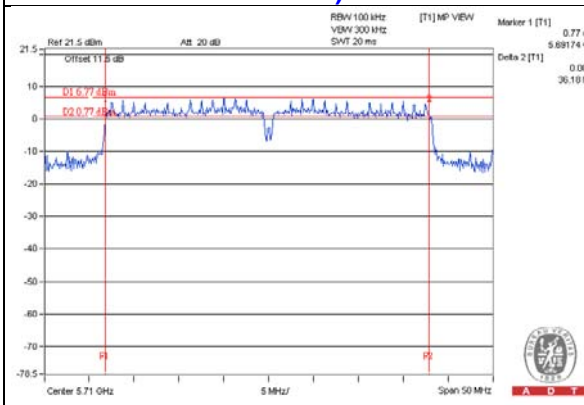

1TX**Chain 2****802.11a**

Channel	Frequency (MHz)	6dB Bandwidth (MHz)	Minimum Limit (MHz)	Pass / Fail
144 (UNII-3 Band)	5720	3.77	0.5	PASS

802.11ac (VHT20)

Channel	Frequency (MHz)	6dB Bandwidth (MHz)	Minimum Limit (MHz)	Pass / Fail
144 (UNII-3 Band)	5720	3.76	0.5	PASS

802.11ac (VHT40)

Channel	Frequency (MHz)	6dB Bandwidth (MHz)	Minimum Limit (MHz)	Pass / Fail
142 (UNII-3 Band)	5710	2.92	0.5	PASS

802.11ac (VHT80)

Channel	Frequency (MHz)	6dB Bandwidth (MHz)	Minimum Limit (MHz)	Pass / Fail
138 (UNII-3 Band)	5690	2.72	0.5	PASS

Spectrum Plot of Worst Value

802.11a – CH 144 (UNII-3 Band)

802.11ac (VHT20) – CH 144 (UNII-3 Band)

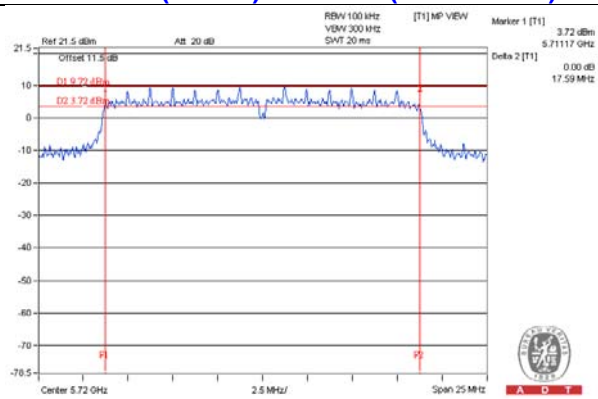
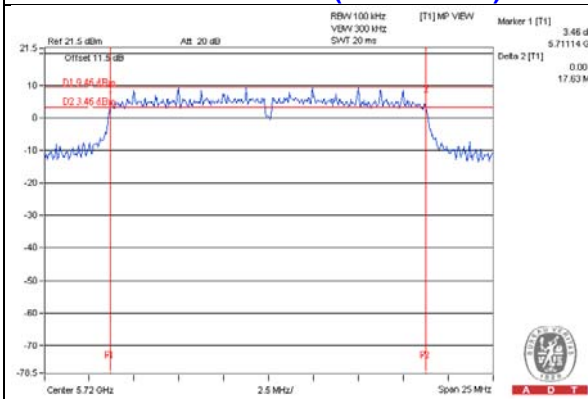

802.11ac (VHT40) – CH 142 (UNII-3 Band)

802.11ac (VHT80) – CH 138 (UNII-3 Band)

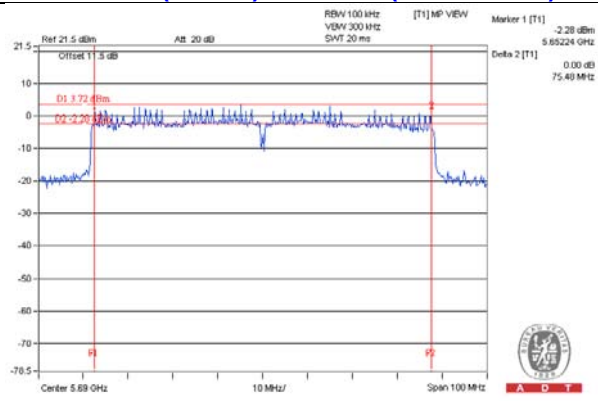
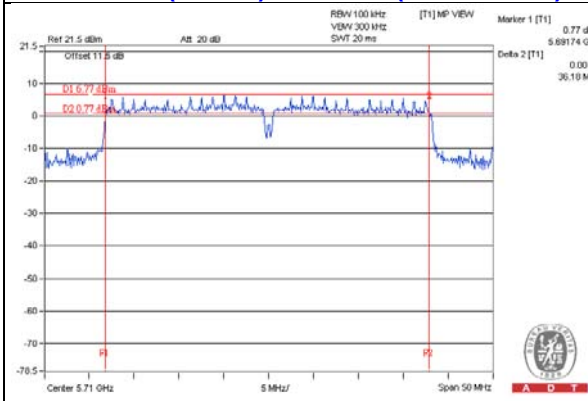

4.6.8 Test Results (Mode 2)

CDD Mode

3TX

802.11a

Channel	Frequency (MHz)	6dB Bandwidth (MHz)			Minimum Limit (MHz)	Pass / Fail
		Chain 0	Chain 1	Chain 2		
144 (UNII-3 Band)	5720	3.17	3.17	3.18	0.5	PASS

802.11ac (VHT20)

Channel	Frequency (MHz)	6dB Bandwidth (MHz)			Minimum Limit (MHz)	Pass / Fail
		Chain 0	Chain 1	Chain 2		
144 (UNII-3 Band)	5720	3.78	3.80	3.79	0.5	PASS

802.11ac (VHT40)

Channel	Frequency (MHz)	6dB Bandwidth (MHz)			Minimum Limit (MHz)	Pass / Fail
		Chain 0	Chain 1	Chain 2		
142 (UNII-3 Band)	5710	3.19	3.23	3.22	0.5	PASS

802.11ac (VHT80)

Channel	Frequency (MHz)	6dB Bandwidth (MHz)			Minimum Limit (MHz)	Pass / Fail
		Chain 0	Chain 1	Chain 2		
138 (UNII-3 Band)	5690	3.20	3.23	3.25	0.5	PASS

Spectrum Plot of Worst Value

802.11a – Chain (0): CH 144 (UNII-3 Band)

802.11ac (VHT20) – Chain (0): CH 144 (UNII-3 Band)

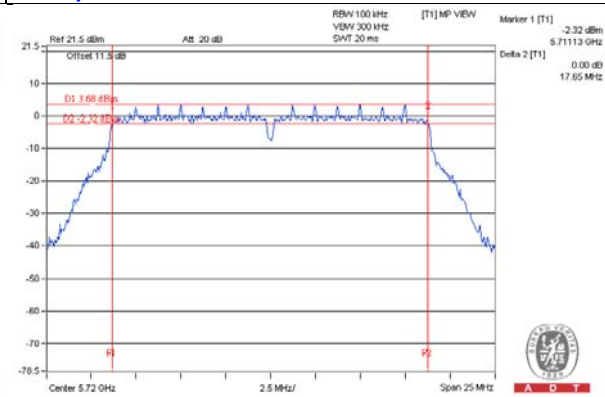
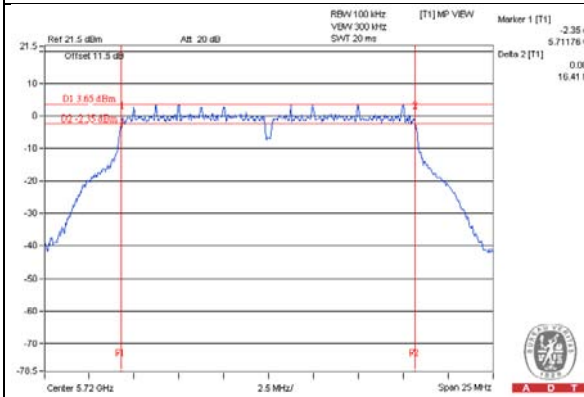

802.11ac (VHT40) – Chain (0): CH 142 (UNII-3 Band)

802.11ac (VHT80) – Chain (0): CH 138 (UNII-3 Band)

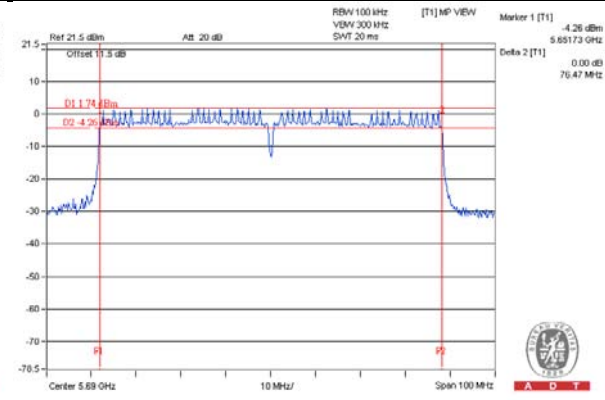
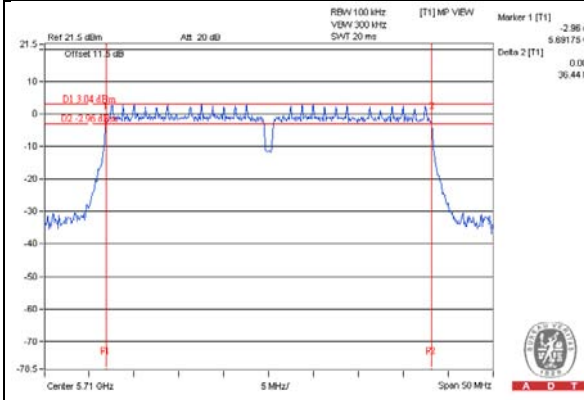

**2TX
802.11a**

Channel	Frequency (MHz)	6dB Bandwidth (MHz)		Minimum Limit (MHz)	Pass / Fail
		Chain 0	Chain 1		
144 (UNII-3 Band)	5720	2.79	2.95	0.5	PASS

802.11ac (VHT20)

Channel	Frequency (MHz)	6dB Bandwidth (MHz)		Minimum Limit (MHz)	Pass / Fail
		Chain 0	Chain 1		
144 (UNII-3 Band)	5720	3.80	3.82	0.5	PASS

802.11ac (VHT40)

Channel	Frequency (MHz)	6dB Bandwidth (MHz)		Minimum Limit (MHz)	Pass / Fail
		Chain 0	Chain 1		
142 (UNII-3 Band)	5710	3.22	3.23	0.5	PASS

802.11ac (VHT80)

Channel	Frequency (MHz)	6dB Bandwidth (MHz)		Minimum Limit (MHz)	Pass / Fail
		Chain 0	Chain 1		
138 (UNII-3 Band)	5690	2.79	2.95	0.5	PASS

Spectrum Plot of Worst Value

802.11a – Chain (0): CH 144 (UNII-3 Band)

802.11ac (VHT20) – Chain (0): CH 144 (UNII-3 Band)

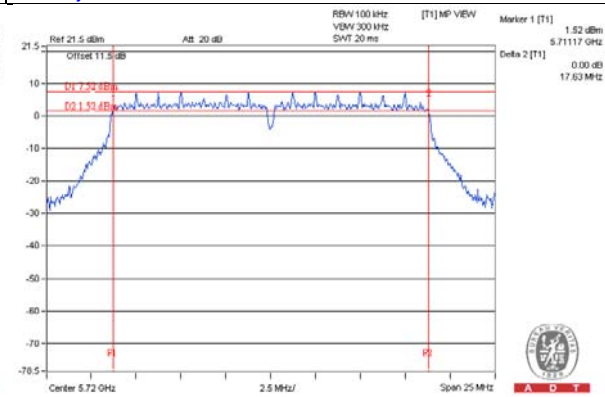
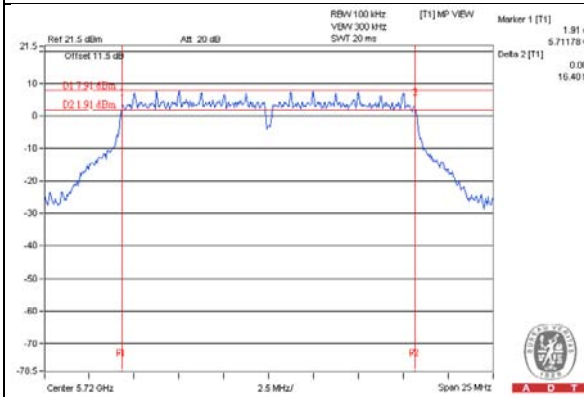

802.11ac (VHT40) – Chain (0): CH 142 (UNII-3 Band)

802.11ac (VHT80) – Chain (0): CH 138 (UNII-3 Band)

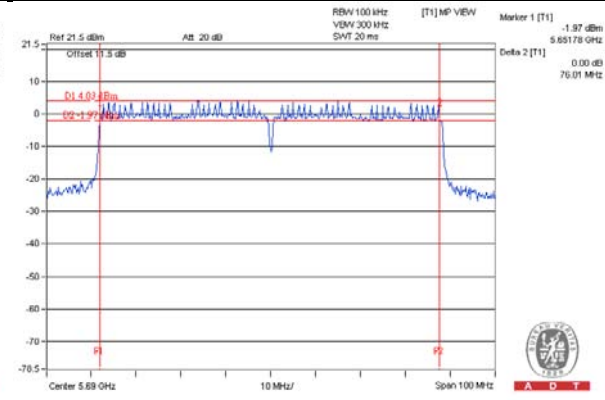
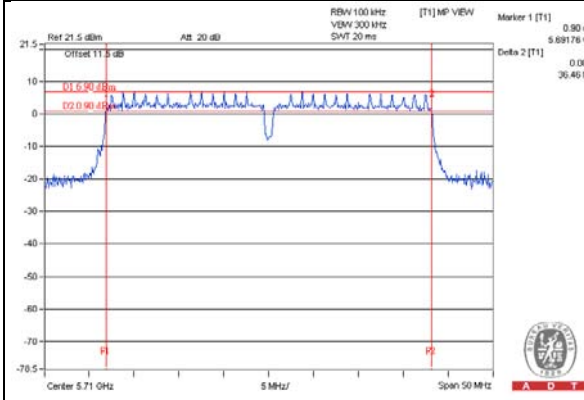

**1TX
Chain 0
802.11a**

Channel	Frequency (MHz)	6dB Bandwidth (MHz)	Minimum Limit (MHz)	Pass / Fail
		Chain 0		
144 (UNII-3 Band)	5720	3.17	0.5	PASS

802.11ac (VHT20)

Channel	Frequency (MHz)	6dB Bandwidth (MHz)	Minimum Limit (MHz)	Pass / Fail
		Chain 0		
144 (UNII-3 Band)	5720	3.81	0.5	PASS

802.11ac (VHT40)

Channel	Frequency (MHz)	6dB Bandwidth (MHz)	Minimum Limit (MHz)	Pass / Fail
		Chain 0		
142 (UNII-3 Band)	5710	3.22	0.5	PASS

802.11ac (VHT80)

Channel	Frequency (MHz)	6dB Bandwidth (MHz)	Minimum Limit (MHz)	Pass / Fail
		Chain 0		
138 (UNII-3 Band)	5690	2.79	0.5	PASS

Spectrum Plot of Worst Value

802.11a – Chain (0): CH 144 (UNII-3 Band)

802.11ac (VHT20) – Chain (0): CH 144 (UNII-3 Band)

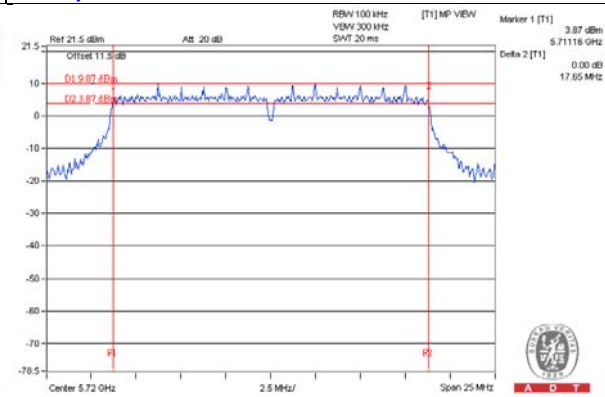
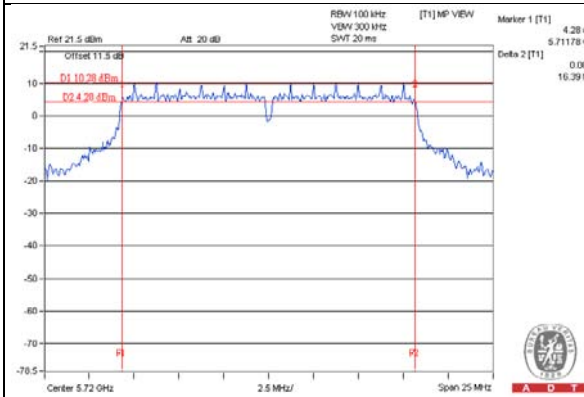

802.11ac (VHT40) – Chain (0): CH 142 (UNII-3 Band)

802.11ac (VHT80) – Chain (0): CH 138 (UNII-3 Band)

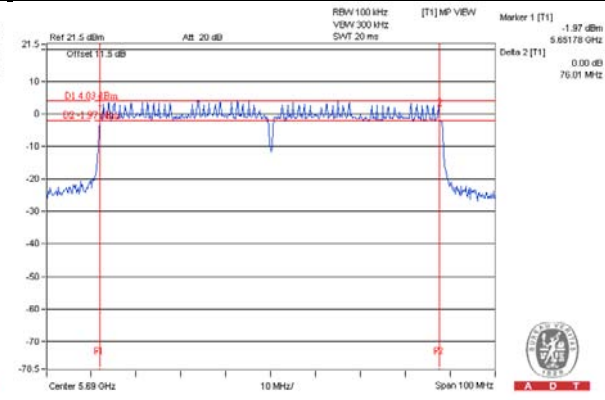
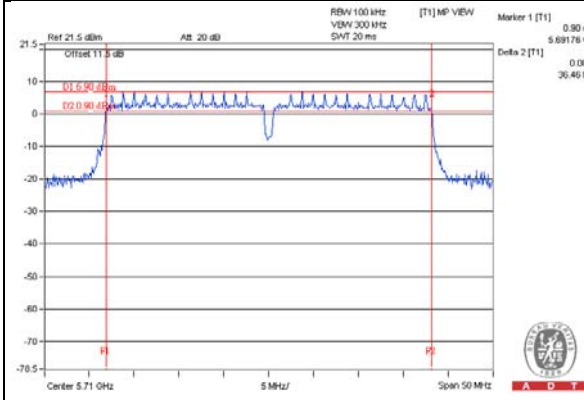



5 Pictures of Test Arrangements

Please refer to the attached file (Test Setup Photo).

Appendix – Information on the Testing Laboratories

We, Bureau Veritas Consumer Products Services (H.K.) Ltd., Taoyuan Branch, were founded in 1988 to provide our best service in EMC, Radio, Telecom and Safety consultation. Our laboratories are accredited and approved according to ISO/IEC 17025.

If you have any comments, please feel free to contact us at the following:

Linko EMC/RF Lab

Tel: 886-2-26052180

Fax: 886-2-26051924

Hsin Chu EMC/RF/Telecom Lab

Tel: 886-3-6668565

Fax: 886-3-6668323

Hwa Ya EMC/RF/Safety Lab

Tel: 886-3-3183232

Fax: 886-3-3270892

Email: service.adt@tw.bureauveritas.com

Web Site: www.bureauveritas-adt.com

The address and road map of all our labs can be found in our web site also.

--- END ---