

# FCC Test Report

**FCC ID** : WBV-AP230  
**Equipment** : Access Point  
**Model No.** : AP230  
**Brand Name** : Aerohive  
**Applicant** : Aerohive Networks Inc.  
**Address** : 330 Gibraltar Drive, Sunnyvale, CA 94089  
**Standard** : 47 CFR FCC Part 15.407  
**Received Date** : Jan. 21, 2014  
**Tested Date** : Jan. 21 ~ Feb. 19, 2014

We, International Certification Corp., would like to declare that the tested sample has been evaluated and in compliance with the requirement of the above standards. The test results contained in this report refer exclusively to the product. It may be duplicated completely for legal use with the approval of the applicant. It shall not be reproduced except in full without the written approval of our laboratory.

Approved & Reviewed by:

  
\_\_\_\_\_  
Gary Chang / Manager



---

## Table of Contents

<b>1</b>	<b>GENERAL DESCRIPTION .....</b>	<b>5</b>
1.1	Information.....	5
1.2	Local Support Equipment List.....	7
1.3	Test Setup Chart.....	8
1.4	The Equipment List .....	10
1.5	Testing Applied Standards .....	11
1.6	Measurement Uncertainty .....	11
<b>2</b>	<b>TEST CONFIGURATION.....</b>	<b>12</b>
2.1	Testing Condition .....	12
2.2	The Worst Test Modes and Channel Details.....	13
<b>3</b>	<b>TRANSMITTER TEST RESULTS .....</b>	<b>14</b>
3.1	Conducted Emissions .....	14
3.2	Emission Bandwidth.....	23
3.3	RF Output Power .....	26
3.4	Peak Power Spectral Density .....	29
3.5	Peak Excursion.....	32
3.6	Transmitter Radiated and Band Edge Emissions .....	37
3.7	Frequency Stability.....	80
<b>4</b>	<b>TEST LABORATORY INFORMATION .....</b>	<b>82</b>

---

## Release Record

Report No.	Version	Description	Issued Date
FR412201AN	Rev. 01	Initial issue	Mar. 12, 2014

## Summary of Test Results

FCC Rules	Test Items	Measured	Result
15.207	Conducted Emissions	[dBuV]: 0.154MHz 51.21 (Margin -4.57dB) - AV	Pass
15.407(b)(1)(2)(3) 15.209	Radiated Emissions	[dBuV/m at 3m]: 5150.00MHz 53.00 (Margin -1.00dB) - AV	Pass
15.407(a)(1)(2)(3)	Emission Bandwidth	Meet the requirement of limit	Pass
15.407(a)(1)(2)(3)	RF Output Power	Power [dBm]: <b>Non-beamforming mode</b> 11a: 15.91 HT20: 11.44 HT40: 14.30 VHT20: 11.53 VHT40: 14.38 VHT80: 16.05 <b>Beamforming mode</b> 11a: 15.91 HT20: 11.08 HT40: 11.24 VHT20: 11.18 VHT40: 11.32 VHT80: 11.28	Pass
15.407(a)(1)(2)(3)	Peak Power Spectral Density	Meet the requirement of limit	Pass
15.407(a)(6)	Peak Excursion	Meet the requirement of limit	Pass
15.407(g)	Frequency Stability	Meet the requirement of limit	Pass
15.203	Antenna Requirement	Meet the requirement of limit	Pass

# 1 General Description

## 1.1 Information

### 1.1.1 Specification of the Equipment under Test (EUT)

RF General Information					
IEEE Std. 802.11	Frequency Range (MHz)	Ch. Freq. (MHz)	Channel Number	Transmit Chains (N <sub>TX</sub> )	Data Rate / MCS
a	5150-5250	5180-5240	36-48 [4]	1	6-54 Mbps
n (HT20)	5150-5250	5180-5240	36-48 [4]	3	MCS 0-23
n (HT40)	5150-5250	5190-5230	38-46 [2]	3	MCS 0-23
ac (VHT20)	5150-5250	5180-5240	36-48 [4]	3	MCS 0-8
ac (VHT40)	5150-5250	5190-5230	38-46 [2]	3	MCS 0-9
ac (VHT80)	5150-5250	5210	42 [1]	3	MCS 0-9

Note 1: RF output power specifies that Maximum Conducted Output Power.  
 Note 2: 802.11a/n/ac uses a combination of OFDM-BPSK, QPSK, 16QAM, 64QAM,256QAM modulation.  
 Note 3: The EUT includes MIMO CDD function with beamforming.  
 Note 4: 1TX function transmits signal through antenna 0 only.

### 1.1.2 Antenna Details

Ant. No.	Type	Gain (dBi)	Connector	Remark
1	PIFA	6.24	UFL	---
2	PIFA	6.13	UFL	---
3	PIFA	6.70	UFL	---

### 1.1.3 Power Supply Type of Equipment under Test (EUT)

<b>Power Supply Type</b>	12Vdc from adapter 48Vdc or 55Vdc from PoE
--------------------------	---

### 1.1.4 Accessories

Accessories		
No.	Equipment	Description
1	AC adapter 1	Brand Name: DVE Model Name: DSA-24PFD-15 FUS Power Rating: I/P: 100-240Vac, 50-60Hz, 0.8A O/P: 12Vdc, 2.0A DC 1.5m non-shielded cable w/o core
2	AC adapter 2	Brand Name: Powertron Electronics Corp. Model Name: PA1024-120HUB200 Power Rating: I/P: 100-240Vac, 50-60Hz, 0.6A O/P: 12Vdc, 2.0A, 24W DC 1.5m non-shielded cable w/o core

### 1.1.5 Support Units

Support Units		
No.	Equipment	Description
1	PoE 1	Brand Name: PowerDsine Model Name: PD-3501G/AC Power Rating: I/P: 100-240Vac, 50-60Hz, 0.5A O/P: 48Vdc, 0.35A
2	PoE 2	Brand Name: PowerDsine Model Name: PD-9001GR/AT/AC Power Rating: I/P: 100-240Vac, 50-60Hz, 0.67A O/P: 55Vdc, 0.6A

### 1.1.6 Channel List

802.11 a / HT20 / VHT20		HT40 / VHT40	
Channel	Frequency(MHz)	Channel	Frequency(MHz)
36	5180	38	5190
40	5200	46	5230
44	5220	<b>VHT 80</b>	
48	5240	42	5210

### 1.1.7 Test Tool and Duty Cycle

Test Tool	Hyperterminal, Version 5.1				
Duty Cycle and Duty Factor	Mode	Beamforming		Non-Beamforming	
		Duty cycle (%)	Duty factor (dB)	Duty cycle (%)	Duty factor (dB)
	11a	99.17%	0.04	99.17%	0.04
	VHT20	99.63%	0.02	99.12%	0.04
	VHT40	98.82%	0.05	98.23%	0.08
VHT80	98.49%	0.07	95.56%	0.20	

### 1.1.8 Power Setting

Modulation Mode	Test Frequency (MHz)	Power Set	
		Beamforming	Non-Beamforming
11a	5180	59	59
11a	5200	59	59
11a	5240	59	59
HT20	5180	22	22
HT20	5200	20	22
HT20	5240	20	22
HT40	5190	22	34
HT40	5230	22	34
VHT20	5180	22	22
VHT20	5200	20	22
VHT20	5240	20	22
VHT40	5190	22	34
VHT40	5230	22	34
VHT80	5210	22	42

## 1.2 Local Support Equipment List

Support Equipment List						
No.	Equipment	Brand	Model	S/N	FCC ID	Signal cable / Length (m)
1	Notebook	DELL	E6430	---	DoC	RJ45, 1m non-shielded cable w/o core. RJ45, 10m non-shielded cable w/o core.
2	Notebook	DELL	E6430	---	DoC	---
3	Module	WNC	DNXB-AH5	---	---	---

Note: Module card is provided by applicant.

## 1.3 Test Setup Chart

### Legacy/MIMO (CDD) Non-beamforming mode

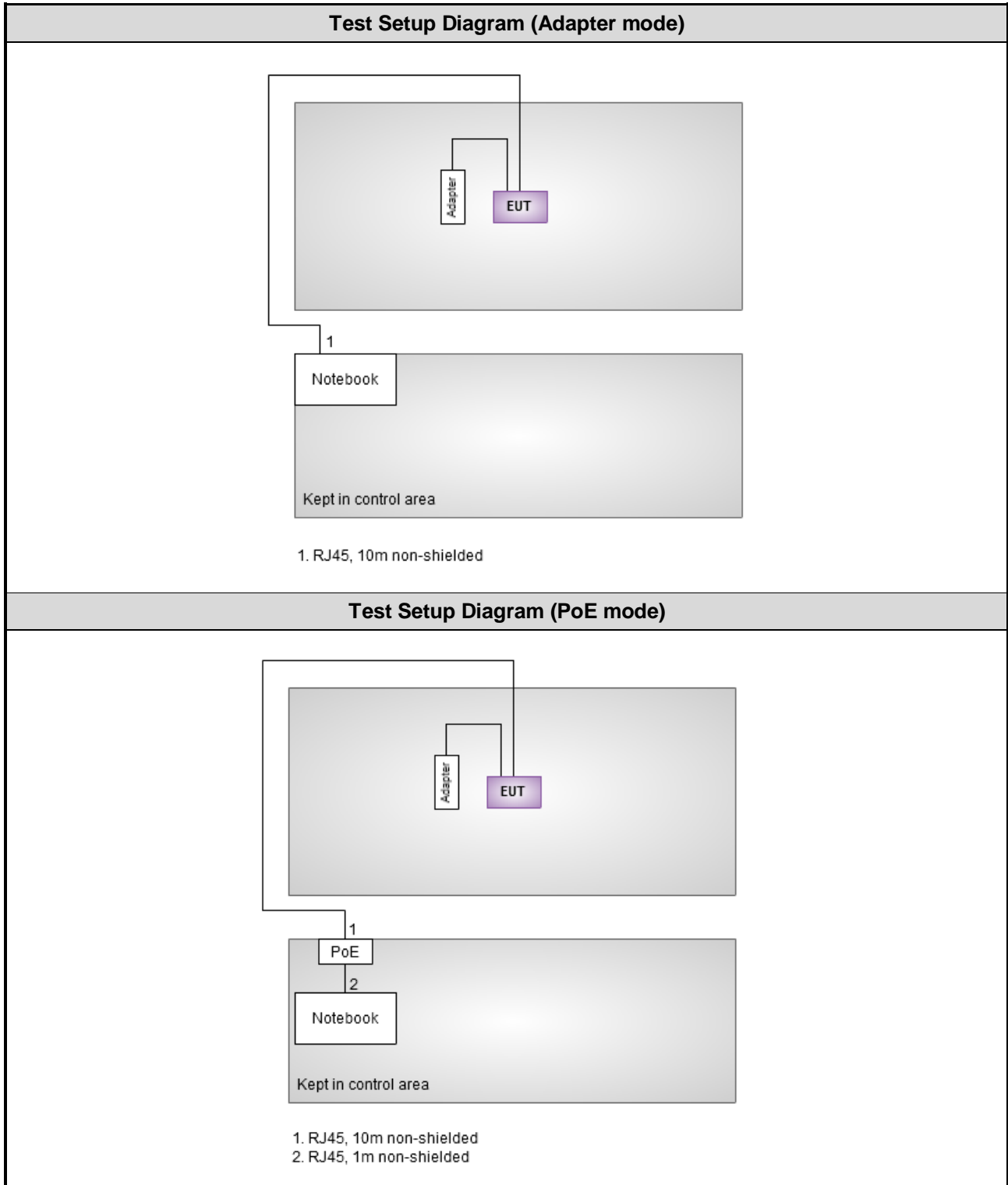



**Legacy/MIMO (CDD) beamforming mode**

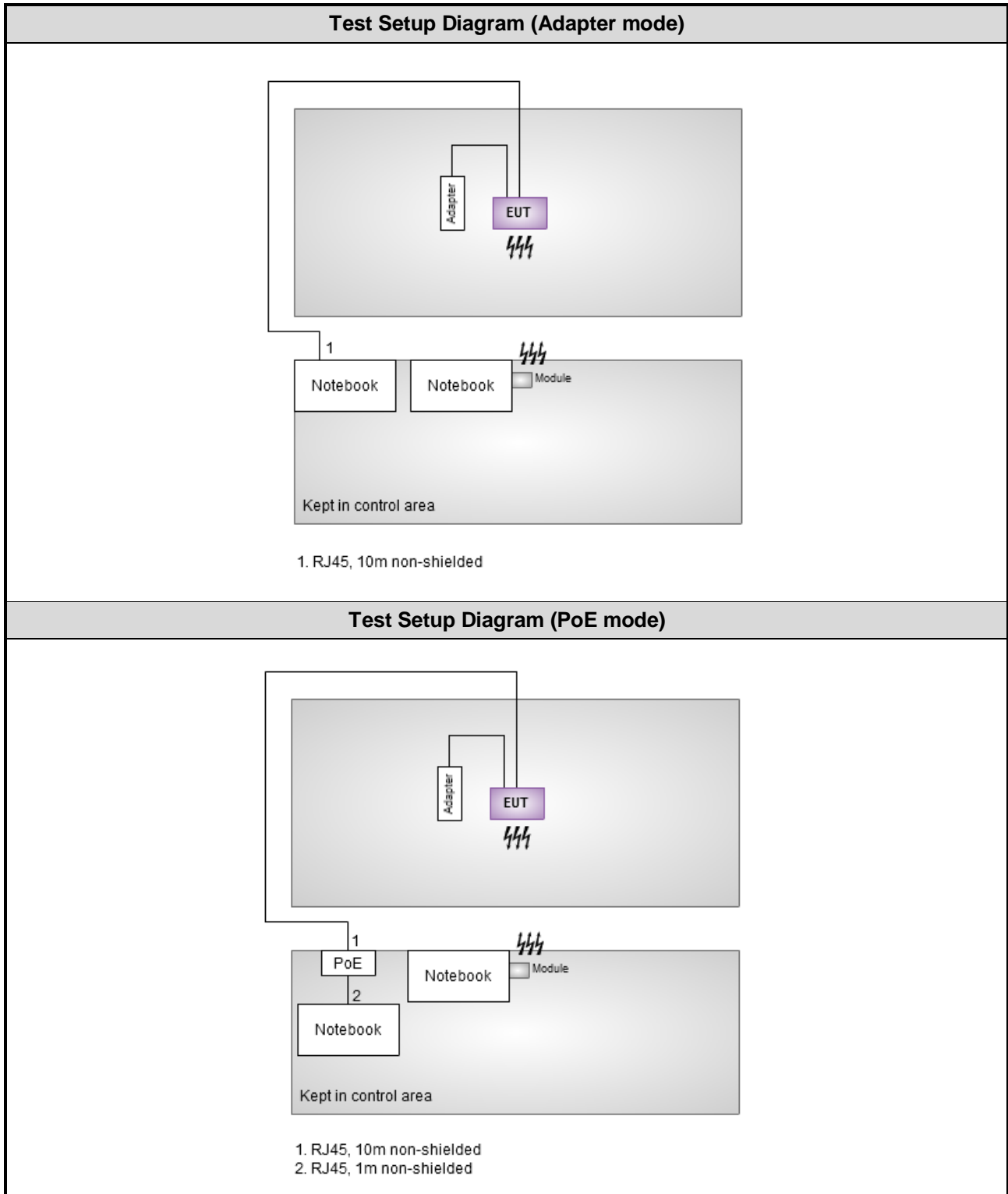

## 1.4 The Equipment List

<b>Test Item</b>	Conducted Emission				
<b>Test Site</b>	Conduction room 1 / (CO01-WS)				
<b>Test date</b>	Feb. 21, 2014				
<b>Instrument</b>	<b>Manufacturer</b>	<b>Model No.</b>	<b>Serial No.</b>	<b>Calibration Date</b>	<b>Calibration Until</b>
EMC Receiver	R&S	ESCS 30	100169	Oct. 15, 2013	Oct. 14, 2014
LISN	SCHWARZBECK	Schwarzbeck 8127	8127-667	Nov. 23, 2013	Nov. 22, 2014
LISN (Support Unit)	SCHWARZBECK	Schwarzbeck 8127	8127-666	Dec. 04, 2013	Dec. 03, 2014
RF Cable-CON	Woken	CFD200-NL	CFD200-NL-001	Apr. 24, 2013	Apr. 23, 2014
50 ohm terminal (Support Unit)	NA	50	04	Apr. 22, 2013	Apr. 21, 2014

Note: Calibration Interval of instruments listed above is one year.

<b>Test Item</b>	Radiated Emission				
<b>Test Site</b>	966 chamber 2 / (03CH02-WS)				
<b>Test date</b>	Jan. 21 ~ Feb.21, 2014				
<b>Instrument</b>	<b>Manufacturer</b>	<b>Model No.</b>	<b>Serial No.</b>	<b>Calibration Date</b>	<b>Calibration Until</b>
Spectrum Analyzer	R&S	FSP 40	100305	Mar. 20, 2013	Mar. 19, 2014
Receiver	R&S	ESR3	101657	Jan. 18, 2014	Jan. 17, 2015
Bilog Antenna	SCHWARZBECK	VULB9168	VULB9168-524	Jan. 08, 2014	Jan. 07, 2015
Horn Antenna 1G-18G	SCHWARZBECK	BBHA 9120D	BBHA 9120 D 1095	Jan. 07, 2014	Jan. 06, 2015
Horn Antenna 18G-40G	SCHWARZBECK	BBHA 9170	BBHA 9170517	Dec. 27, 2013	Dec. 26, 2014
Amplifier	Burgeon	BPA-530	100218	Dec. 09, 2013	Dec. 08, 2014
Amplifier	Agilent	83017A	MY39501309	Dec. 09, 2013	Dec. 08, 2014
RF Cable	HUBER+SUHNER	SUCOFLEX104	MY16140/4	Dec. 17, 2013	Dec. 16, 2014
RF Cable	HUBER+SUHNER	SUCOFLEX104	MY16018/4	Dec. 17, 2013	Dec. 16, 2014
RF Cable	HUBER+SUHNER	SUCOFLEX104	MY16015/4	Dec. 17, 2013	Dec. 16, 2014
RF Cable-R03m	Woken	CFD400NL-LW	CFD400NL-003	Dec. 17, 2013	Dec. 16, 2014
RF Cable-R10m	Woken	CFD400NL-LW	CFD400NL-004	Dec. 17, 2013	Dec. 16, 2014
control	EM Electronics	EM1000	060608	N/A	N/A

Note: Calibration Interval of instruments listed above is one year.

Loop Antenna	R&S	HFH2-Z2	100330	Nov. 15, 2012	Nov. 14, 2014
Amplifier	EM	EM18G40G	060572	Jun. 20, 2013	Jun. 19, 2015

Note: Calibration Interval of instruments listed above is two year.

<b>Test Item</b>	RF Conducted				
<b>Test Site</b>	(TH01-WS)				
<b>Test date</b>	Feb. 18, 2014				
<b>Instrument</b>	<b>Manufacturer</b>	<b>Model No.</b>	<b>Serial No.</b>	<b>Calibration Date</b>	<b>Calibration Until</b>
Spectrum Analyzer	R&S	FSV40	101498	Jan. 25, 2014	Jan. 24, 2015
TEMP&HUMIDITY CHAMBER	GIANT FORCE	GCT-225-40-SP-SD	MAF1212-002	Dec. 11, 2013	Dec. 10, 2014
Power Meter	Anritsu	ML2495A	1241002	Oct. 24, 2013	Oct. 23, 2014
Power Sensor	Anritsu	MA2411B	1207366	Oct. 24, 2013	Oct. 23, 2014
Note: Calibration Interval of instruments listed above is one year.					

## 1.5 Testing Applied Standards

According to the specification of EUT, the EUT must comply with following standards and KDB documents.

47 CFR FCC Part 15.407

ANSI C63.10-2009

FCC KDB 412172

FCC KDB 789033 D01 General UNII Test procedures v01r03

FCC KDB 662911 D01 Multiple Transmitter Output v02r01

Note: The EUT has been tested and complied with FCC part 15B requirement. FCC Part 15B test results are issued to another report.

## 1.6 Measurement Uncertainty

ISO/IEC 17025 requires that an estimate of the measurement uncertainties associated with the emissions test results be included in the report. The measurement uncertainties given below are based on a 95% confidence level (based on a coverage factor (k=2))

Measurement Uncertainty	
Parameters	Uncertainty
Bandwidth	±74.147 Hz
Conducted power	±0.717 dB
Power density	±2.687 dB
Frequency error	±74.147 Hz
Temperature	±0.3 °C
AC conducted emission	±2.43 dB
Radiated emission	±2.49 dB

## 2 Test Configuration

### 2.1 Testing Condition

Test Item	Test Site	Ambient Condition	Tested By
AC Conduction	CO01-WS	14°C / 58%	Skys Huang
Radiated Emissions	03CH02-WS	20°C / 66%	Anderson Hong
RF Conducted	TH01-WS	24°C / 63%	Mark Liao

- FCC site registration No.: 657002
- IC site registration No.: 10807A-2

## 2.2 The Worst Test Modes and Channel Details

Test item	Modulation Mode	Test Frequency (MHz)	Data Rate (Mbps) / MCS	Test Configuration
Conducted Emissions	VHT80	5210	MCS 0	1, 2, 3, 4
Radiated Emissions $\leq 1$ GHz	VHT80	5210	MCS 0	1, 2
RF Output Power	11a	5180 / 5200 / 5240	6 Mbps	1, 3
	HT20	5180 / 5200 / 5240	MCS 0	
	HT40	5190 / 5230	MCS 0	
	VHT20	5180 / 5200 / 5240	MCS 0	
	VHT40	5190 / 5230	MCS 0	
	VHT80	5210	MCS 0	
Radiated Emissions $> 1$ GHz Emission Bandwidth Peak Power Spectral Density	11a	5180 / 5200 / 5240	6 Mbps	1, 3
	VHT20	5180 / 5200 / 5240	MCS 0	
	VHT40	5190 / 5230	MCS 0	
	VHT80	5210	MCS 0	
Peak Excursion	11a	5200	6 Mbps	1
	VHT20	5200	MCS 0	
	VHT40	5230	MCS 0	
	VHT80	5210	MCS 0	
Peak Excursion	11a	5200	6 Mbps	3
	VHT20	5180	MCS 0	
	VHT40	5230	MCS 0	
	VHT80	5210	MCS 0	
Frequency Stability	Un-modulation	5200	---	1, 3

**NOTE:**

- The EUT was pretested with 3 orientations placed on the table for the radiated emission measurement – X, Y, and Z-plane. The **Y-plane** results were found as the worst case and were shown in this report.
- Adapter 1 and Adapter 2 had been pretested and found that **Adapter 2** was the worst case and was selected for final testing. (Adapter 1: DSA-24PFD-15 FUS; Adapter 2: PA1024-120HUB200).
- PoE 1 and PoE 2 had been pretested and found that **PoE 2** was the worst case and was selected for final testing. (PoE 1: PD-3501G/AC; PoE 2: PD-9001GR/AT/AC).
- Test configurations are listed as below:
  - Configuration 1: Legacy/MIMO (CDD) Non-beamforming mode, Adapter mode
  - Configuration 2: Legacy/MIMO (CDD) Non-beamforming mode, PoE mode
  - Configuration 3: Legacy/MIMO (CDD) beamforming mode, Adapter mode
  - Configuration 4: Legacy/MIMO (CDD) beamforming mode, PoE mode

## 3 Transmitter Test Results

### 3.1 Conducted Emissions

#### 3.1.1 Limit of Conducted Emissions

Conducted Emissions Limit		
Frequency Emission (MHz)	Quasi-Peak	Average
0.15-0.5	66 - 56 *	56 - 46 *
0.5-5	56	46
5-30	60	50

Note 1: \* Decreases with the logarithm of the frequency.

#### 3.1.2 Test Procedures

1. The device is placed on a test table, raised 80 cm above the reference ground plane. The vertical conducting plane is located 40 cm to the rear of the device.
2. The device is connected to line impedance stabilization network (LISN) and other accessories are connected to other LISN. Measured levels of AC power line conducted emission are across the 50  $\Omega$  LISN port.
3. AC conducted emission measurements is made over frequency range from 150 kHz to 30 MHz.
4. This measurement was performed with AC 120V/60Hz

#### 3.1.3 Test Setup

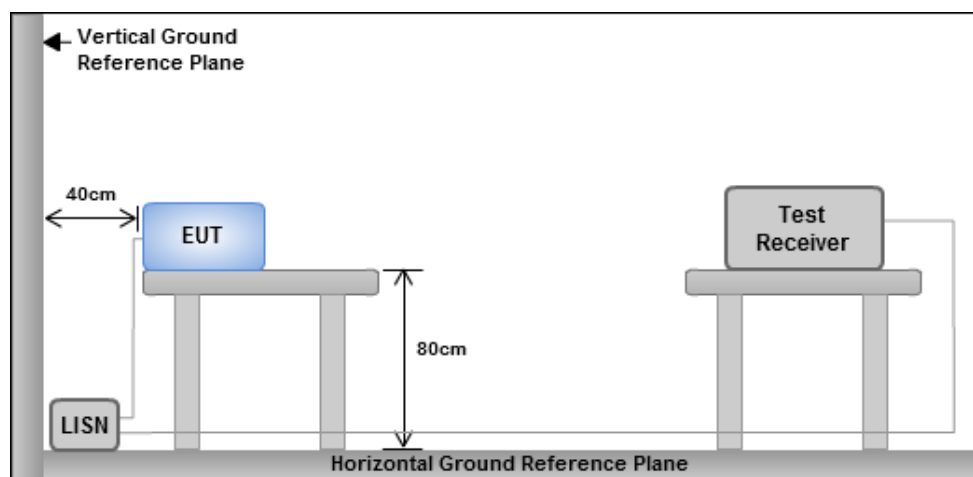

- Note: 1. Support units were connected to second LISN.  
2. Both of LISNs (AMN) are 80 cm from EUT and at least 80 cm from other units and other metal planes

### 3.1.4 Test Result of Conducted Emissions

Legacy/MIMO (CDD) Non- beamforming mode

Modulation	VHT80	Test Freq. (MHz)	5210
Power Phase	Line	Test Configuration	1

Date: 2014-02-21

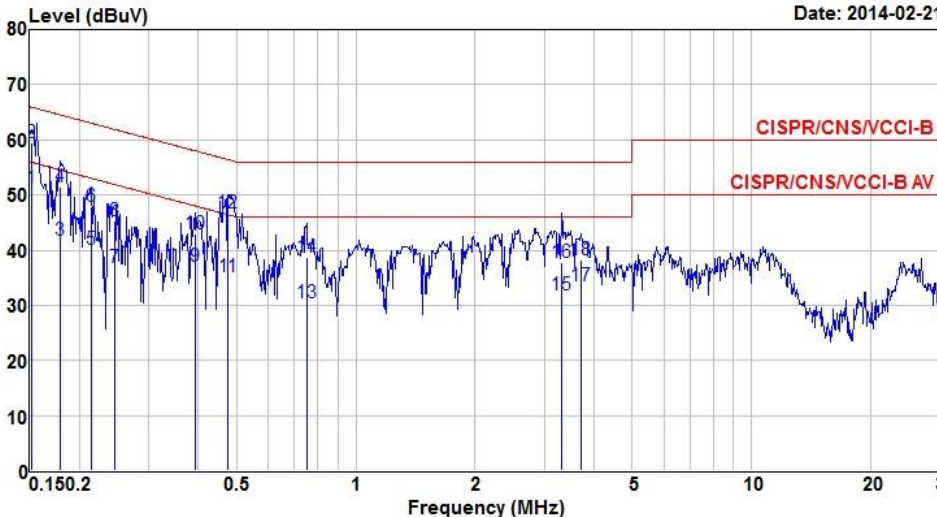

	Freq MHz	Level dBuV	Limit Line dBuV	Over Limit dB	Read Level dBuV	LISN factor dB	cable loss dB	Remark
1*	0.152	51.25	55.91	-4.66	50.78	0.41	0.06	Average
2	0.152	59.39	65.91	-6.52	58.92	0.41	0.06	QP
3	0.179	41.71	54.55	-12.84	41.16	0.42	0.13	Average
4	0.179	51.53	64.55	-13.02	50.98	0.42	0.13	QP
5	0.214	40.15	53.05	-12.90	39.55	0.43	0.17	Average
6	0.214	48.02	63.05	-15.03	47.42	0.43	0.17	QP
7	0.246	36.77	51.91	-15.14	36.18	0.45	0.14	Average
8	0.246	45.23	61.91	-16.68	44.64	0.45	0.14	QP
9	0.391	37.01	48.03	-11.02	36.43	0.53	0.05	Average
10	0.391	42.91	58.03	-15.12	42.33	0.53	0.05	QP
11	0.476	35.21	46.41	-11.20	34.59	0.57	0.05	Average
12	0.476	46.74	56.41	-9.67	46.12	0.57	0.05	QP
13	0.751	30.43	46.00	-15.57	29.72	0.67	0.04	Average
14	0.751	38.65	56.00	-17.35	37.94	0.67	0.04	QP
15	3.310	31.79	46.00	-14.21	30.52	1.05	0.22	Average
16	3.310	37.82	56.00	-18.18	36.55	1.05	0.22	QP
17	3.720	33.50	46.00	-12.50	32.21	1.06	0.23	Average
18	3.720	38.25	56.00	-17.75	36.96	1.06	0.23	QP

Note 1: Level (dBuV) = Read Level (dBuV) + LISN Factor (dB) + Cable Loss (dB).  
 Note 2: Over Limit (dB) = Level (dBuV) – Limit Line (dBuV).

<b>Modulation</b>	VHT80	<b>Test Freq. (MHz)</b>	5210
<b>Power Phase</b>	Neutral	<b>Test Configuration</b>	1

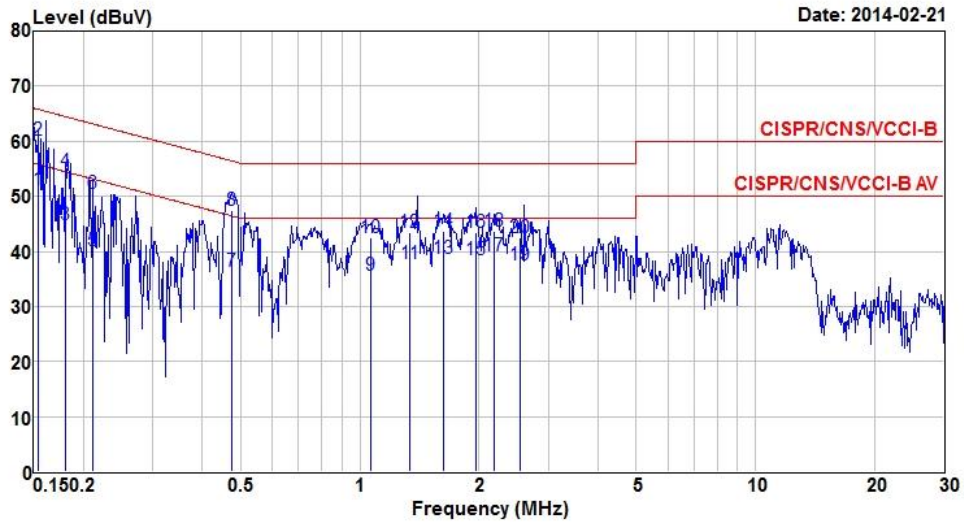

	Freq MHz	Level dBuV	Limit Line dBuV	Over Limit dB	Read Level dBuV	LISN factor dB	cable loss dB	Remark
1*	0.154	51.21	55.78	-4.57	50.65	0.49	0.07	Average
2	0.154	60.22	65.78	-5.56	59.66	0.49	0.07	QP
3	0.181	44.82	54.46	-9.64	44.18	0.50	0.14	Average
4	0.181	54.51	64.46	-9.95	53.87	0.50	0.14	QP
5	0.211	40.05	53.18	-13.13	39.36	0.52	0.17	Average
6	0.211	50.57	63.18	-12.61	49.88	0.52	0.17	QP
7	0.476	36.32	46.41	-10.09	35.62	0.65	0.05	Average
8	0.476	47.52	56.41	-8.89	46.82	0.65	0.05	QP
9	1.065	35.62	46.00	-10.38	34.74	0.83	0.05	Average
10	1.065	42.56	56.00	-13.44	41.68	0.83	0.05	QP
11	1.338	37.87	46.00	-8.13	36.86	0.92	0.09	Average
12	1.338	43.50	56.00	-12.50	42.49	0.92	0.09	QP
13	1.628	38.70	46.00	-7.30	37.58	1.00	0.12	Average
14	1.628	43.78	56.00	-12.22	42.66	1.00	0.12	QP
15	1.959	38.59	46.00	-7.41	37.35	1.08	0.16	Average
16	1.959	43.40	56.00	-12.60	42.16	1.08	0.16	QP
17	2.190	39.24	46.00	-6.76	37.97	1.10	0.17	Average
18	2.190	43.74	56.00	-12.26	42.47	1.10	0.17	QP
19	2.540	37.50	46.00	-8.50	36.21	1.10	0.19	Average
20	2.540	42.55	56.00	-13.45	41.26	1.10	0.19	QP

Note 1: Level (dBuV) = Read Level (dBuV) + LISN Factor (dB) + Cable Loss (dB).  
 2: Over Limit (dB) = Level (dBuV) – Limit Line (dBuV).



<b>Modulation</b>	VHT80	<b>Test Freq. (MHz)</b>	5210
<b>Power Phase</b>	Line	<b>Test Configuration</b>	2

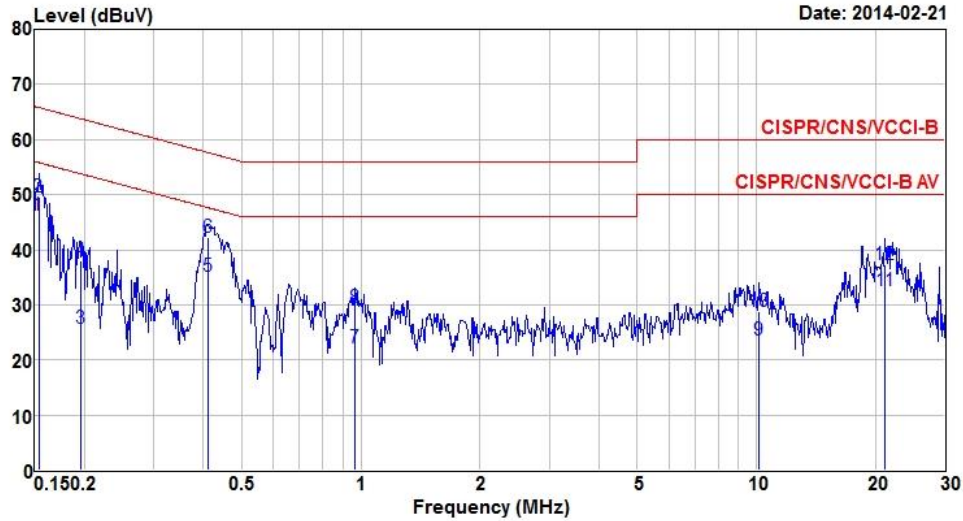

	Freq	Level	Limit	Over	Read	LISN	cable	Remark
	MHz	dBuV	Line	Limit	Level	factor	loss	
			dBuV	dB	dBuV	dB	dB	
1*	0.153	46.24	55.82	-9.58	45.77	0.40	0.07	Average
2	0.153	49.67	65.82	-16.15	49.20	0.40	0.07	QP
3	0.195	25.74	53.80	-28.06	25.18	0.39	0.17	Average
4	0.195	37.98	63.80	-25.82	37.42	0.39	0.17	QP
5	0.410	35.22	47.64	-12.42	34.78	0.39	0.05	Average
6	0.410	42.36	57.64	-15.28	41.92	0.39	0.05	QP
7	0.968	22.22	46.00	-23.78	21.77	0.41	0.04	Average
8	0.968	29.51	56.00	-26.49	29.06	0.41	0.04	QP
9	10.125	23.70	50.00	-26.30	23.05	0.54	0.11	Average
10	10.125	28.78	60.00	-31.22	28.13	0.54	0.11	QP
11	21.147	32.54	50.00	-17.46	31.72	0.55	0.27	Average
12	21.147	37.25	60.00	-22.75	36.43	0.55	0.27	QP

Note 1: Level (dBUV) = Read Level (dBUV) + LISN Factor (dB) + Cable Loss (dB).  
 2: Over Limit (dB) = Level (dBUV) – Limit Line (dBUV).

<b>Modulation</b>	VHT80	<b>Test Freq. (MHz)</b>	5210
<b>Power Phase</b>	Neutral	<b>Test Configuration</b>	2

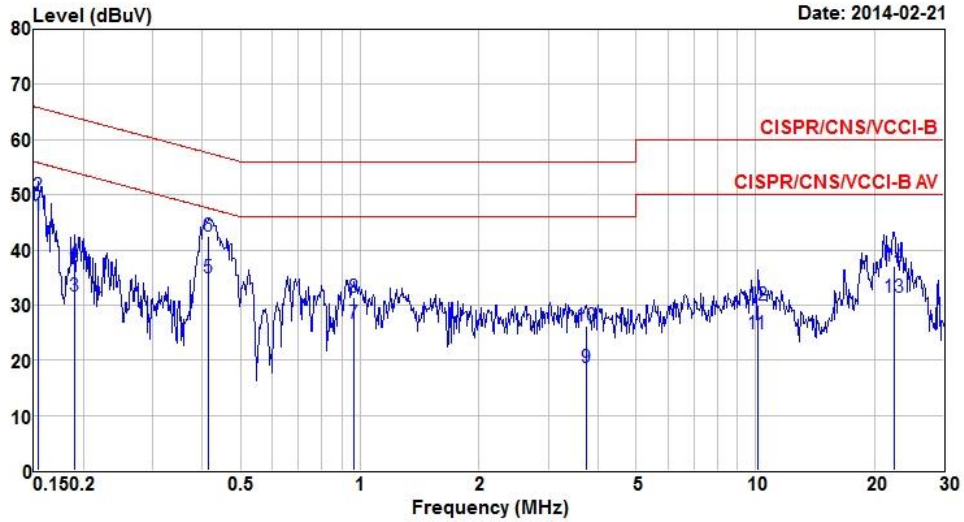

	Freq MHz	Level dBuV	Limit Line dBuV	Over Limit dB	Read Level dBuV	LISN factor dB	cable loss dB	Remark
1*	0.154	46.21	55.78	-9.57	45.66	0.48	0.07	Average
2	0.154	49.73	65.78	-16.05	49.18	0.48	0.07	QP
3	0.189	31.55	54.06	-22.51	30.91	0.48	0.16	Average
4	0.189	37.68	64.06	-26.38	37.04	0.48	0.16	QP
5	0.415	34.88	47.55	-12.67	34.36	0.47	0.05	Average
6	0.415	42.40	57.55	-15.15	41.88	0.47	0.05	QP
7	0.968	26.60	46.00	-19.40	26.08	0.48	0.04	Average
8	0.968	31.49	56.00	-24.51	30.97	0.48	0.04	QP
9	3.740	18.67	46.00	-27.33	17.92	0.52	0.23	Average
10	3.740	26.09	56.00	-29.91	25.34	0.52	0.23	QP
11	10.125	24.78	50.00	-25.22	24.11	0.56	0.11	Average
12	10.125	29.93	60.00	-30.07	29.26	0.56	0.11	QP
13	22.416	31.35	50.00	-18.65	30.46	0.55	0.34	Average
14	22.416	37.04	60.00	-22.96	36.15	0.55	0.34	QP

Note 1: Level (dBuV) = Read Level (dBuV) + LISN Factor (dB) + Cable Loss (dB).  
 2: Over Limit (dB) = Level (dBuV) – Limit Line (dBuV).

Legacy/MIMO (CDD) beamforming mode

Modulation	VHT80	Test Freq. (MHz)	5210
Power Phase	Line	Test Configuration	3

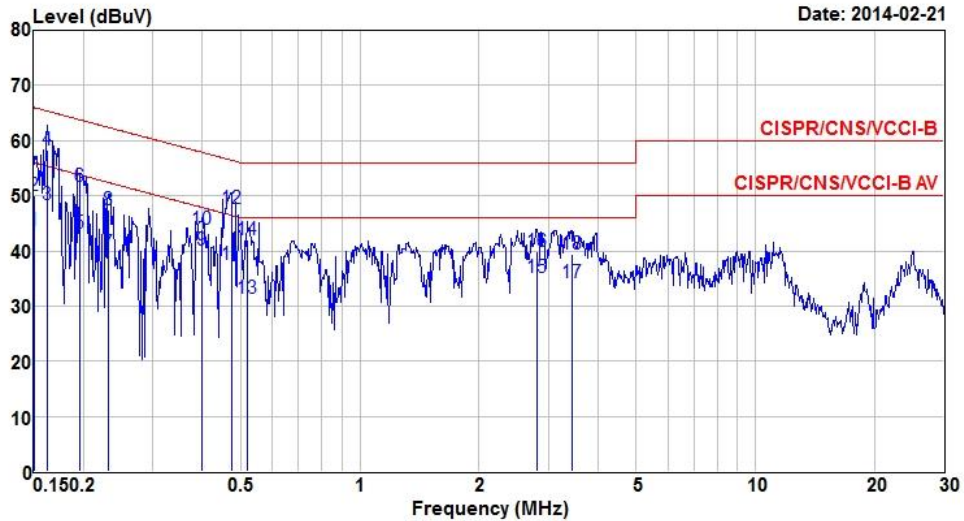

	Freq MHz	Level dBuV	Limit Line dBuV	Over Limit dB	Read Level dBuV	LISN factor dB	cable loss dB	Remark
1	0.150	43.73	56.00	-12.27	43.26	0.41	0.06	Average
2	0.150	49.95	66.00	-16.05	49.48	0.41	0.06	QP
3	0.162	48.32	55.34	-7.02	47.82	0.41	0.09	Average
4*	0.162	58.36	65.34	-6.98	57.86	0.41	0.09	QP
5	0.197	43.11	53.76	-10.65	42.52	0.42	0.17	Average
6	0.197	51.75	63.76	-12.01	51.16	0.42	0.17	QP
7	0.232	39.58	52.39	-12.81	38.99	0.44	0.15	Average
8	0.232	47.51	62.39	-14.88	46.92	0.44	0.15	QP
9	0.400	40.15	47.86	-7.71	39.57	0.53	0.05	Average
10	0.400	43.89	57.86	-13.97	43.31	0.53	0.05	QP
11	0.474	37.64	46.45	-8.81	37.02	0.57	0.05	Average
12	0.474	47.58	56.45	-8.87	46.96	0.57	0.05	QP
13	0.518	31.38	46.00	-14.62	30.74	0.59	0.05	Average
14	0.518	42.01	56.00	-13.99	41.37	0.59	0.05	QP
15	2.809	35.16	46.00	-10.84	33.92	1.04	0.20	Average
16	2.809	39.97	56.00	-16.03	38.73	1.04	0.20	QP
17	3.436	34.34	46.00	-11.66	33.06	1.06	0.22	Average
18	3.436	39.43	56.00	-16.57	38.15	1.06	0.22	QP

Note 1: Level (dBuV) = Read Level (dBuV) + LISN Factor (dB) + Cable Loss (dB).  
 2: Over Limit (dB) = Level (dBuV) – Limit Line (dBuV).

<b>Modulation</b>	VHT80	<b>Test Freq. (MHz)</b>	5210
<b>Power Phase</b>	Neutral	<b>Test Configuration</b>	3

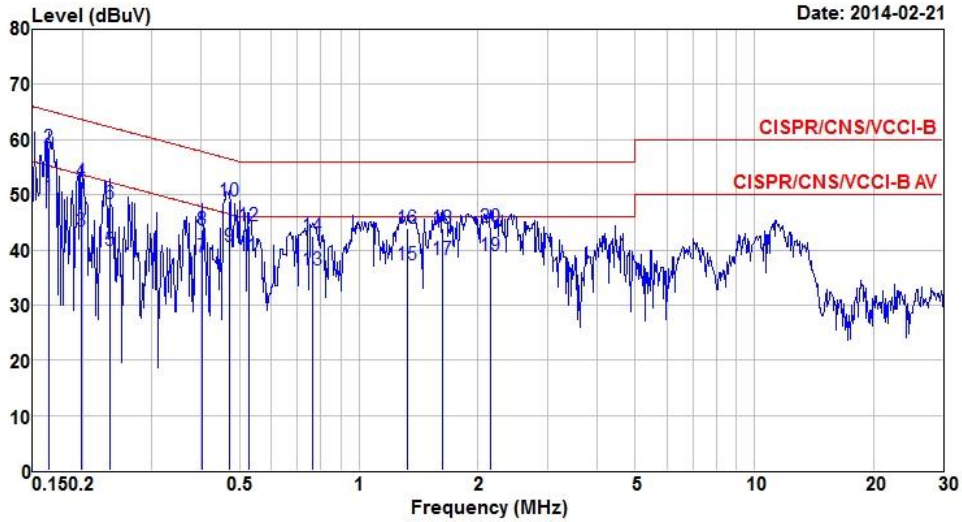

	Freq MHz	Level dBuV	Limit Line dBuV	Over Limit dB	Read Level dBuV	LISN factor dB	cable loss dB	Remark
1*	0.165	49.57	55.21	-5.64	48.97	0.50	0.10	Average
2	0.165	58.65	65.21	-6.56	58.05	0.50	0.10	QP
3	0.199	43.47	53.67	-10.20	42.78	0.51	0.18	Average
4	0.199	52.37	63.67	-11.30	51.68	0.51	0.18	QP
5	0.234	39.93	52.30	-12.37	39.25	0.53	0.15	Average
6	0.234	48.34	62.30	-13.96	47.66	0.53	0.15	QP
7	0.402	38.61	47.81	-9.20	37.95	0.61	0.05	Average
8	0.402	43.61	57.81	-14.20	42.95	0.61	0.05	QP
9	0.471	40.59	46.49	-5.90	39.90	0.64	0.05	Average
10	0.471	48.84	56.49	-7.65	48.15	0.64	0.05	QP
11	0.527	39.03	46.00	-6.97	38.31	0.67	0.05	Average
12	0.527	44.34	56.00	-11.66	43.62	0.67	0.05	QP
13	0.763	36.34	46.00	-9.66	35.56	0.74	0.04	Average
14	0.763	42.42	56.00	-13.58	41.64	0.74	0.04	QP
15	1.331	37.37	46.00	-8.63	36.36	0.92	0.09	Average
16	1.331	43.81	56.00	-12.19	42.80	0.92	0.09	QP
17	1.628	38.29	46.00	-7.71	37.17	1.00	0.12	Average
18	1.628	43.92	56.00	-12.08	42.80	1.00	0.12	QP
19	2.155	39.06	46.00	-6.94	37.80	1.09	0.17	Average
20	2.155	44.21	56.00	-11.79	42.95	1.09	0.17	QP

Note 1: Level (dBuV) = Read Level (dBuV) + LISN Factor (dB) + Cable Loss (dB).  
 2: Over Limit (dB) = Level (dBuV) – Limit Line (dBuV).

<b>Modulation</b>	VHT80	<b>Test Freq. (MHz)</b>	5210
<b>Power Phase</b>	Line	<b>Test Configuration</b>	4

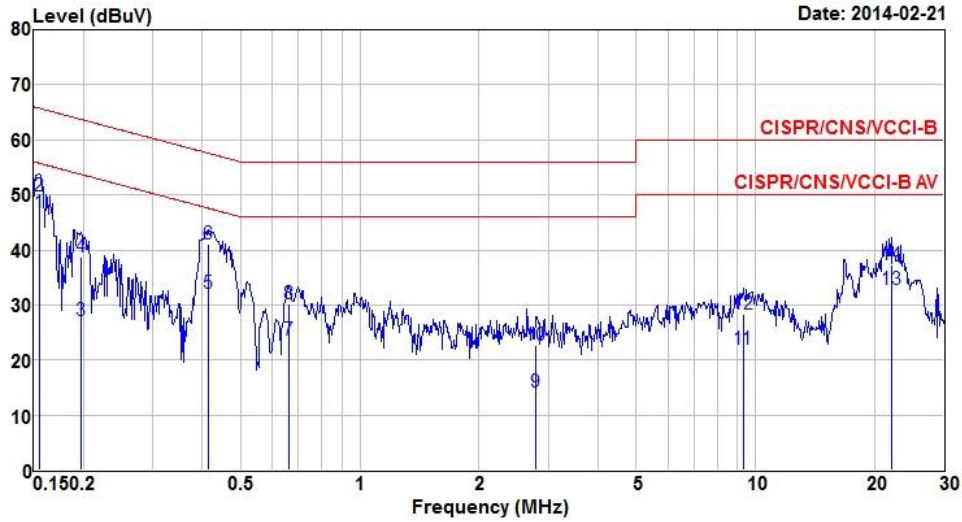

	Freq MHz	Level dBuV	Limit Line dBuV	Over Limit dB	Read Level dBuV	LISN factor dB	cable loss dB	Remark
1*	0.155	46.62	55.74	-9.12	46.15	0.40	0.07	Average
2	0.155	49.82	65.74	-15.92	49.35	0.40	0.07	QP
3	0.198	27.05	53.71	-26.66	26.48	0.39	0.18	Average
4	0.198	38.71	63.71	-25.00	38.14	0.39	0.18	QP
5	0.413	32.05	47.59	-15.54	31.61	0.39	0.05	Average
6	0.413	41.04	57.59	-16.55	40.60	0.39	0.05	QP
7	0.661	23.57	46.00	-22.43	23.13	0.40	0.04	Average
8	0.661	30.24	56.00	-25.76	29.80	0.40	0.04	QP
9	2.779	14.09	46.00	-31.91	13.45	0.44	0.20	Average
10	2.779	22.73	56.00	-33.27	22.09	0.44	0.20	QP
11	9.302	21.98	50.00	-28.02	21.33	0.53	0.12	Average
12	9.302	28.41	60.00	-31.59	27.76	0.53	0.12	QP
13	22.180	32.71	50.00	-17.29	31.83	0.55	0.33	Average
14	22.180	37.29	60.00	-22.71	36.41	0.55	0.33	QP

Note 1: Level (dBuV) = Read Level (dBuV) + LISN Factor (dB) + Cable Loss (dB).  
 2: Over Limit (dB) = Level (dBuV) – Limit Line (dBuV).

<b>Modulation</b>	VHT80	<b>Test Freq. (MHz)</b>	5210
<b>Power Phase</b>	Neutral	<b>Test Configuration</b>	4

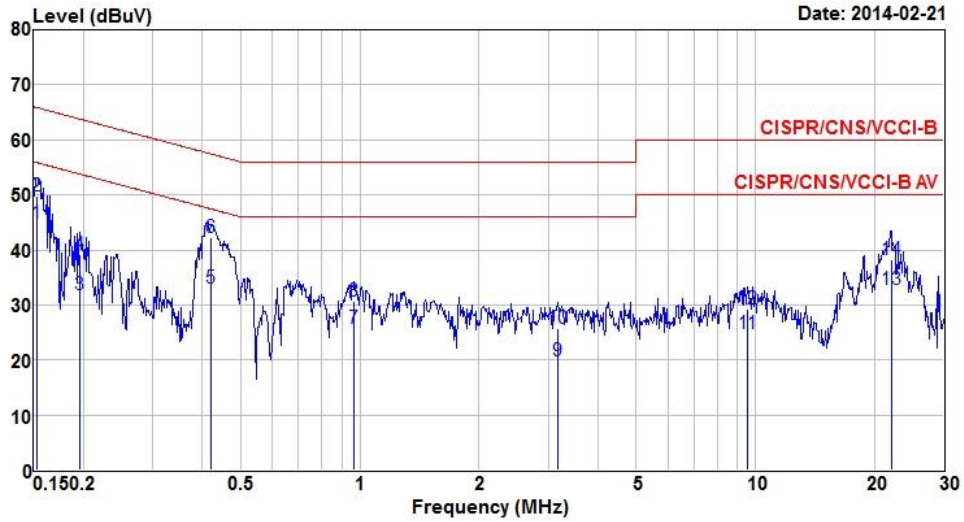

	Freq	Level	Limit	Over	Read	LISN	cable	
	MHz	dBuV	Line	Limit	Level	factor	loss	Remark
			dBuV	dB	dBuV	dB	dB	
1*	0.152	44.86	55.87	-11.01	44.31	0.48	0.07	Average
2	0.152	49.72	65.87	-16.15	49.17	0.48	0.07	QP
3	0.197	31.80	53.76	-21.96	31.15	0.48	0.17	Average
4	0.197	39.08	63.76	-24.68	38.43	0.48	0.17	QP
5	0.421	33.05	47.42	-14.37	32.53	0.47	0.05	Average
6	0.421	42.35	57.42	-15.07	41.83	0.47	0.05	QP
7	0.968	25.73	46.00	-20.27	25.21	0.48	0.04	Average
8	0.968	30.80	56.00	-25.20	30.28	0.48	0.04	QP
9	3.173	19.73	46.00	-26.27	19.01	0.51	0.21	Average
10	3.173	25.82	56.00	-30.18	25.10	0.51	0.21	QP
11	9.552	24.76	50.00	-25.24	24.08	0.56	0.12	Average
12	9.552	29.32	60.00	-30.68	28.64	0.56	0.12	QP
13	22.063	32.85	50.00	-17.15	31.98	0.55	0.32	Average
14	22.063	38.24	60.00	-21.76	37.37	0.55	0.32	QP

Note 1: Level (dBUV) = Read Level (dBUV) + LISN Factor (dB) + Cable Loss (dB).  
 Note 2: Over Limit (dB) = Level (dBUV) – Limit Line (dBUV).

## 3.2 Emission Bandwidth

### 3.2.1 Test Procedures

1. Set RBW = approximately 1% of the emission bandwidth.
2. Set the VBW > RBW, Detector = Peak.
3. Trace mode = max hold.
4. Measure the maximum width of the emission that is 26 dB down from the peak of the emission.

### 3.2.2 Test Setup

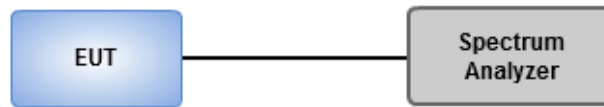

### 3.2.3 Test Result of Emission Bandwidth

#### Legacy/MIMO (CDD) Non- beamforming mode - Test Configuration 1

Emission Bandwidth										
Mode	N <sub>Tx</sub>	Freq. (MHz)	26dB Bandwidth (MHz)			99% Bandwidth (MHz)			Power Limit (dBm)	
			Chain 0	Chain 1	Chain 2	Chain 0	Chain 1	Chain 2	26dB BW	99% BW
11a	1	5180	20.35	---	---	16.90	---	---	17.00	16.28
11a	1	5200	20.23	---	---	16.93	---	---	17.00	16.29
11a	1	5240	20.35	---	---	16.97	---	---	17.00	16.30
VHT20	3	5180	20.87	20.41	20.52	17.95	17.76	17.84	17.00	16.49
VHT20	3	5200	20.81	20.64	20.58	17.95	17.76	17.80	17.00	16.49
VHT20	3	5240	20.81	20.41	20.70	17.98	17.76	17.80	17.00	16.49
VHT40	3	5190	40.93	40.46	40.46	36.73	36.47	36.60	17.00	17.00
VHT40	3	5230	41.04	40.93	40.35	36.73	36.53	36.60	17.00	17.00
VHT80	3	5210	83.01	82.32	81.62	75.65	75.53	75.65	17.00	17.00

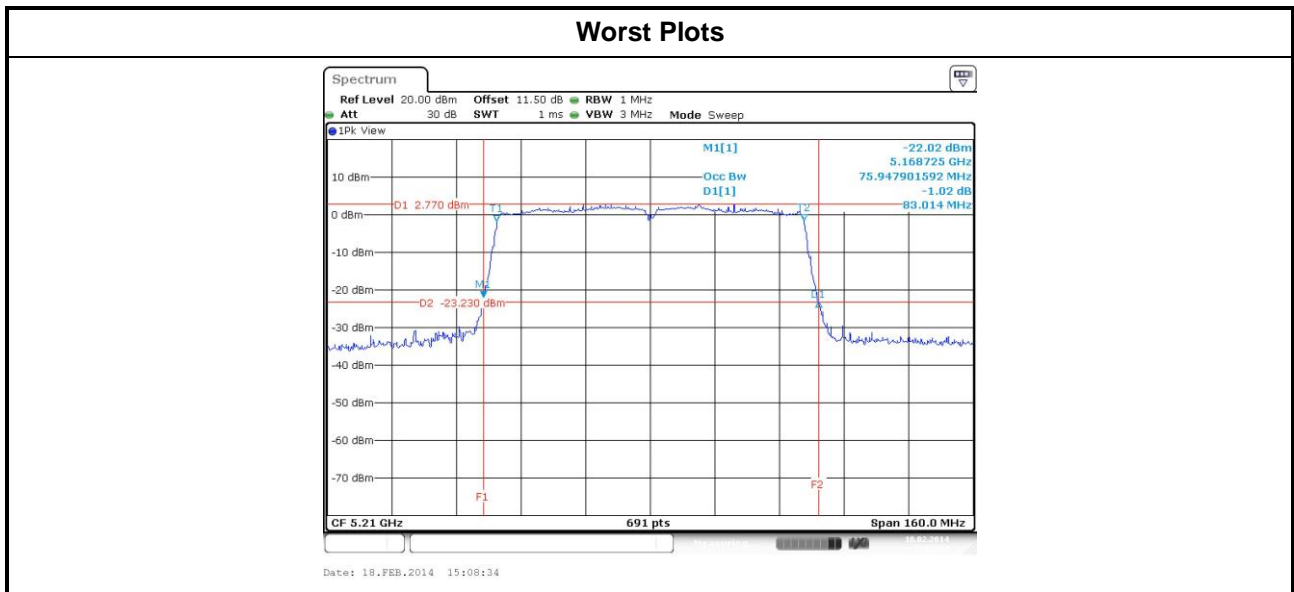



**Legacy/MIMO (CDD) beamforming mode - Test Configuration 3**

Emission Bandwidth										
Mode	N <sub>TX</sub>	Freq. (MHz)	26dB Bandwidth (MHz)			99% Bandwidth (MHz)			Power Limit (dBm)	
			Chain 0	Chain 1	Chain 2	Chain 0	Chain 1	Chain 2	26dB BW	99% BW
11a	1	5180	20.35	---	---	16.90	---	---	17.00	16.28
11a	1	5200	20.23	---	---	16.93	---	---	17.00	16.29
11a	1	5240	20.35	---	---	16.97	---	---	17.00	16.30
VHT20	3	5180	20.93	20.46	20.46	17.91	17.76	17.80	17.00	16.49
VHT20	3	5200	20.81	20.70	20.70	17.95	17.76	17.80	17.00	16.49
VHT20	3	5240	20.81	20.46	20.81	17.91	17.76	17.80	17.00	16.49
VHT40	3	5190	41.16	40.81	40.35	36.60	36.53	36.60	17.00	17.00
VHT40	3	5230	41.39	40.70	40.58	36.66	36.47	36.60	17.00	17.00
VHT80	3	5210	81.16	80.70	80.70	75.77	75.77	75.90	17.00	17.00

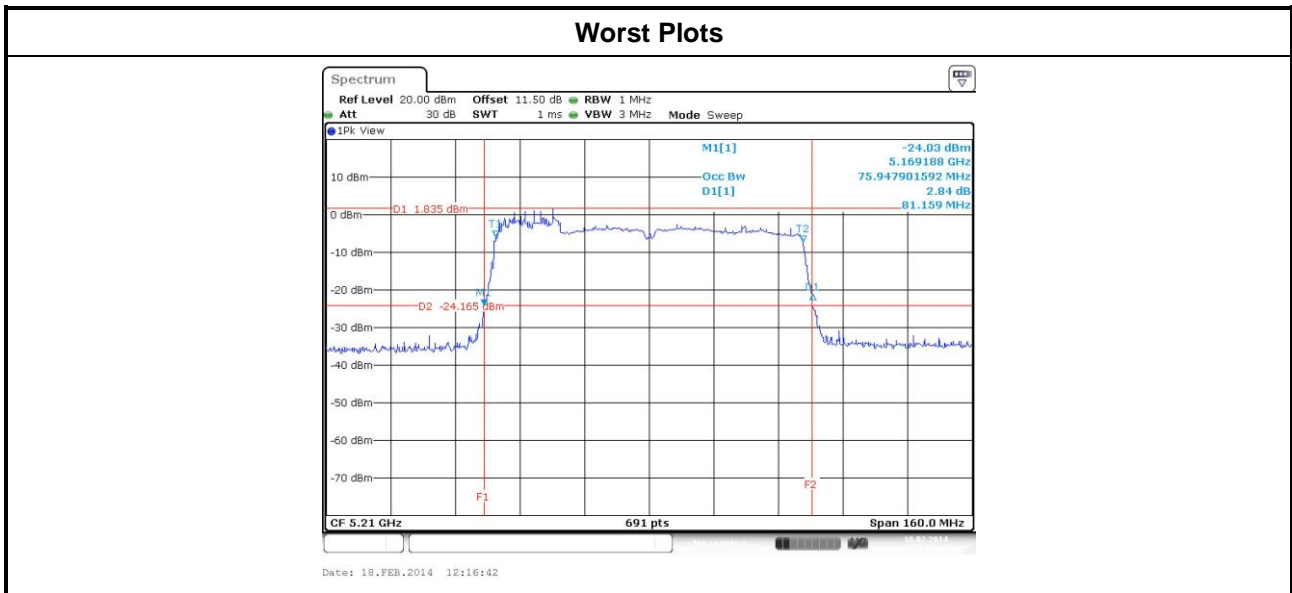

### 3.3 RF Output Power

#### 3.3.1 Limit of RF Output Power

	Frequency Band (GHz)	Limit
<input checked="" type="checkbox"/>	5.15~5.25	50mW or 4dBm+10 log B
<input type="checkbox"/>	5.25~5.35	250mW or 11dBm+10 log B
<input type="checkbox"/>	5.47~5.725	250mW or 11dBm+10 log B

Note: "B" is the 26dB emission bandwidth in MHz.

#### 3.3.2 Test Procedures

- Power meter**
  - Measurements is performed using a wideband gated RF power meter provided that the gate parameters are adjusted such that the power is measured only when the EUT is transmitting at its maximum power control level. Since the measurement is made only during the ON time of the transmitter, no duty cycle correction factor is required

#### 3.3.3 Test Setup

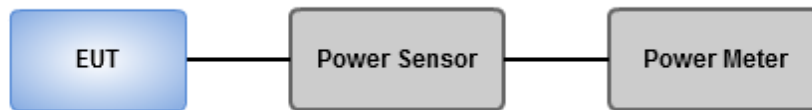

### 3.3.4 Test Result of Maximum Conducted Output Power

#### Legacy/MIMO (CDD) Non- beamforming mode - Test Configuration 1

RF Output Power (dBm)								
Mode	N <sub>TX</sub>	Freq. (MHz)	Chain 0	Chain 1	Chain 2	Total Power (mW)	Total Power (dBm)	Limit
11a	1	5180	15.83	---	---	38.282	15.83	16.76
11a	1	5200	15.91	---	---	38.994	15.91	16.76
11a	1	5240	15.82	---	---	38.194	15.82	16.76
HT20	3	5180	6.10	6.55	6.33	12.888	11.10	16.30
HT20	3	5200	6.58	6.89	6.54	13.945	11.44	16.30
HT20	3	5240	6.39	6.75	6.41	13.462	11.29	16.30
HT40	3	5190	9.33	9.96	9.23	26.854	14.29	16.30
HT40	3	5230	9.27	10.08	9.18	26.918	14.30	16.30
VHT20	3	5180	6.14	6.61	6.41	13.068	11.16	16.30
VHT20	3	5200	6.67	6.97	6.64	14.236	11.53	16.30
VHT20	3	5240	6.45	6.87	6.46	13.706	11.37	16.30
VHT40	3	5190	9.39	10.02	9.34	27.326	14.37	16.30
VHT40	3	5230	9.33	10.14	9.31	27.429	14.38	16.30
VHT80	3	5210	11.29	11.18	11.35	40.226	16.05	16.30

Note:

1. 802.11a will only transmit signal through antenna 0 which has 6.24 dBi gain > 6dBi, so the limit of output power shall be reduced to 17 dBm – (6.24 dBi – 6 dBi) =16.76 dBm
2. Maximum antenna gain is 6.7 dBi > 6 dBi, so the limit of output power shall be reduced to 17 dBm – ( 6.7 dBi – 6 dBi ) = 16.3 dBm.for HT20 / VHT20 / VHT40

**Legacy/MIMO (CDD) beamforming mode - Test Configuration 3**

RF Output Power (dBm)								
Mode	N <sub>TX</sub>	Freq. (MHz)	Chain 0	Chain 1	Chain 2	Total Power (mW)	Total Power (dBm)	Limit
11a	1	5180	15.83	---	---	38.282	15.83	16.76
11a	1	5200	15.91	---	---	38.994	15.91	16.76
11a	1	5240	15.82	---	---	38.194	15.82	16.76
HT20	3	5180	6.01	6.53	6.36	12.813	11.08	11.87
HT20	3	5200	6.17	6.03	6.13	12.251	10.88	11.87
HT20	3	5240	5.89	6.36	6.02	12.206	10.87	11.87
HT40	3	5190	6.18	6.61	6.21	12.909	11.11	11.87
HT40	3	5230	6.22	6.83	6.32	13.293	11.24	11.87
VHT20	3	5180	6.18	6.62	6.43	13.137	11.18	11.87
VHT20	3	5200	6.11	6.56	6.14	12.724	11.05	11.87
VHT20	3	5240	5.92	6.51	6.12	12.478	10.96	11.87
VHT40	3	5190	6.29	6.73	6.30	13.232	11.22	11.87
VHT40	3	5230	6.29	6.92	6.42	13.562	11.32	11.87
VHT80	3	5210	5.95	6.93	6.58	13.417	11.28	11.87

Note:

- 802.11a will only transmit signal through antenna 0 which has 6.24 dBi gain > 6dBi, so the limit of output power shall be reduced to 17 dBm – (6.24 dBi – 6 dBi) =16.76 dBm
- Directional gain =  $10 * \log((10^{6.24/20} + 10^{6.13/20} + 10^{6.7/20})/3) = 11.13 \text{ dBi} > 6 \text{ dBi}$   
Limit shall be reduced to 17 dBm – (11.13 dBi – 6 dBi) = 11.87 dBm for HT20 / VHT40 / VHT80

## 3.4 Peak Power Spectral Density

### 3.4.1 Limit of Peak Power Spectral Density

	Frequency Band (GHz)	Limit (dBm)
<input checked="" type="checkbox"/>	5.15~5.25	4
<input type="checkbox"/>	5.25~5.35	11
<input type="checkbox"/>	5.47~5.725	11

### 3.4.2 Test Procedures

- Method SA-1 ( For 802.11a / VHT20 / VHT40 )
  1. Set RBW = 1 MHz, VBW = 3 MHz, Sweep time = auto, Detector = RMS.
  2. Trace average 100 traces.
  3. Use the peak marker function to determine the maximum amplitude level.
- Method SA-2
  1. Set RBW = 1 MHz, VBW = 3 MHz, Detector = RMS.
  2. Set sweep time  $\geq 10 * (\text{number of points in sweep}) * (\text{symbol period of the transmitted signal})$ .
  3. Perform a single sweep.
  4. Use the peak marker function to determine the maximum amplitude level.
- Method SA-2 Alternative ( For 802.11ac VHT80)
  1. Set RBW = 1 MHz, VBW = 3 MHz, Detector = RMS.
  2. Set sweep time  $\geq 10 * (\text{number of points in sweep}) * (\text{total on/off period of the transmitted signal})$ .
  3. Perform a single sweep.
  4. Use the peak marker function to determine the maximum amplitude level.
  5. Add  $10 \log(1/x)$ , where x is the duty cycle.

### 3.4.3 Test Setup

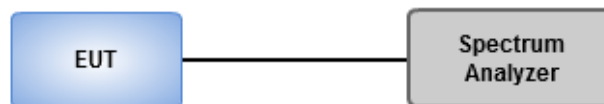

### 3.4.4 Test Result of Peak Power Spectral Density

#### Legacy/MIMO (CDD) Non- beamforming mode - Test Configuration 1

Condition			Peak Power Spectral Density (dBm)			
Modulation Mode	N <sub>TX</sub>	Freq. (MHz)	PPSD w/o D.F (dBm)	Duty factor (dB)	PPSD with D.F (dBm)	PPSD Limit (dBm)
11a	1	5180	3.44	0.00	3.44	3.76
11a	1	5200	3.59	0.00	3.59	3.76
11a	1	5240	3.65	0.00	3.65	3.76
VHT20	3	5180	-1.86	0.00	-1.86	-1.13
VHT20	3	5200	-1.29	0.00	-1.29	-1.13
VHT20	3	5240	-1.29	0.00	-1.29	-1.13
VHT40	3	5190	-1.77	0.00	-1.77	-1.13
VHT40	3	5230	-1.87	0.00	-1.87	-1.13
VHT80	3	5210	-3.43	0.20	-3.23	-1.13

Note:

- 802.11a will only transmit signal through antenna 0 which has 6.24 dBi gain > 6dBi, so the limit of output power shall be reduced to 8 dBm – (6.24 dBi – 6 dBi) = 3.76 dBm
- Test result for VHT20/VHT40/VHT80 are bin-by-bin summing measured value of each TX port.
- Directional gain =  $10 * \log((10^{6.24/20} + 10^{6.13/20} + 10^{6.70/20})^2/3) = 11.13 \text{ dBi} > 6 \text{ dBi}$   
Limit shall be reduced to 4 dBm – (11.13 dBi – 6 dBi) = -1.13 dBm

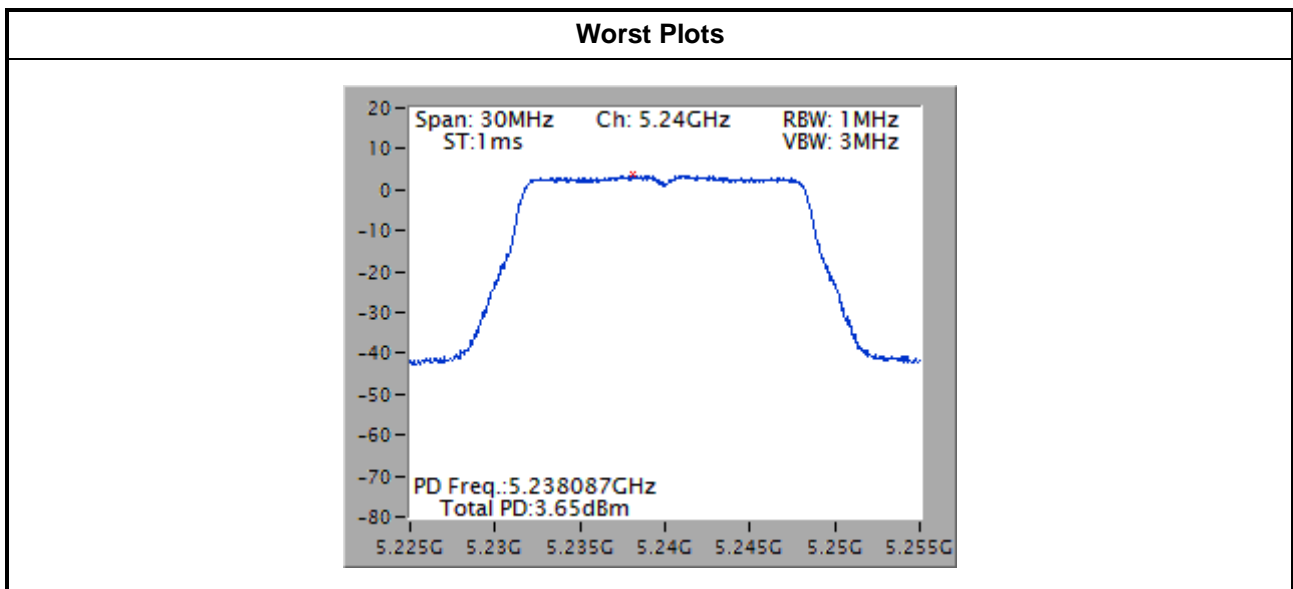

**Legacy/MIMO (CDD) beamforming mode - Test Configuration 3**

Condition			Peak Power Spectral Density (dBm)			
Modulation Mode	N <sub>TX</sub>	Freq. (MHz)	PPSD w/o D.F (dBm)	Duty factor (dB)	PPSD with D.F (dBm)	PPSD Limit (dBm)
11a	1	5180	3.44	0.00	3.44	3.76
11a	1	5200	3.59	0.00	3.59	3.76
11a	1	5240	3.65	0.00	3.65	3.76
VHT20	3	5180	-1.68	0.00	-1.68	-1.13
VHT20	3	5200	-1.80	0.00	-1.80	-1.13
VHT20	3	5240	-2.10	0.00	-2.10	-1.13
VHT40	3	5190	-4.78	0.00	-4.78	-1.13
VHT40	3	5230	-4.42	0.00	-4.42	-1.13
VHT80	3	5210	-8.46	0.00	-8.46	-1.13

Note:

1. 802.11a will only transmit signal through antenna 0 which has 6.24 dBi gain > 6dBi, so the limit of output power shall be reduced to 4 dBm – (6.24 dBi – 6 dBi) =3.76 dBm
2. Test result for VHT20/VHT40/VHT80 are bin-by-bin summing measured value of each TX port.
3. Directional gain =  $10 * \log((10^{6.24/20} + 10^{6.13/20} + 10^{6.70/20})^2/3) = 11.13 \text{ dBi} > 6 \text{ dBi}$   
Limit shall be reduced to 4 dBm – (11.13 dBi – 6 dBi) = -1.13 dBm

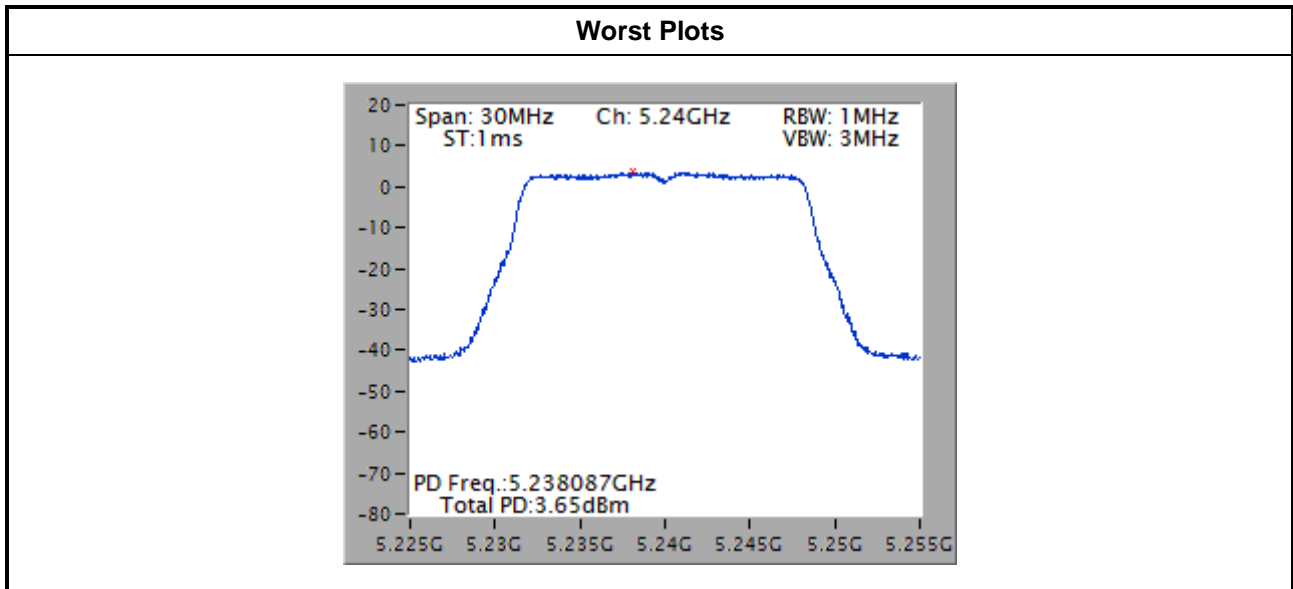

## 3.5 Peak Excursion

### 3.5.1 Peak Excursion Limit

Peak excursion of the modulation envelope shall not exceed 13 dB across any 1 MHz bandwidth.

### 3.5.2 Test Procedures

1. Set RBW = 1 MHz, VBW = 3 MHz, Detector = peak.
2. Trace mode = max-hold. Allow the sweeps to continue until the trace stabilizes.
3. Use the peak search function to find the peak of the spectrum.
4. Use the procedure of section 3.4.2 to measure the PPSD.
5. Compute the ratio of the maximum of the peak-max-hold spectrum to the PPSD

### 3.5.3 Test Setup

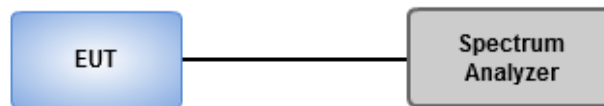



### 3.5.4 Test Result of Peak Excursion

#### Legacy/MIMO (CDD) Non- beamforming mode - Test Configuration 1

Frequency band(MHz)		5150~5250					
Mode	Modulation Mode	N <sub>TX</sub>	Freq. (MHz)	Measured value(dB)	Duty factor (dB)	Peak Excursion (dB)	Limit
11a	BPSK	1	5200	7.65	0.00	7.65	13
11a	QPSK	1	5200	8.83	0.14	8.69	13
11a	16QAM	1	5200	8.93	0.16	8.77	13
11a	64QAM	1	5200	8.64	0.22	8.42	13
VHT20	BPSK	3	5200	8.92	0.00	8.92	13
VHT20	QPSK	3	5200	9.47	0.00	9.47	13
VHT20	16QAM	3	5200	9.57	0.16	9.41	13
VHT20	64QAM	3	5200	9.71	0.32	9.39	13
VHT20	256QAM	3	5200	10.30	0.47	9.83	13
VHT40	BPSK	3	5230	9.05	0.00	9.05	13
VHT40	QPSK	3	5230	9.25	0.18	9.07	13
VHT40	16QAM	3	5230	9.98	0.32	9.66	13
VHT40	64QAM	3	5230	10.16	0.61	9.55	13
VHT40	256QAM	3	5230	10.78	0.75	10.03	13
VHT80	BPSK	3	5210	10.71	0.20	10.51	13
VHT80	QPSK	3	5210	9.93	0.35	9.58	13
VHT80	16QAM	3	5210	9.80	0.61	9.19	13
VHT80	64QAM	3	5210	10.45	0.94	9.51	13
VHT80	256QAM	3	5210	10.49	1.13	9.36	13

Note: Measured value = Peak-max-hold spectrum to the maximum of the average spectrum for continuous transmission. Since the duty cycle is < 98 %, duty factor is required to average spectrum  
Peak exclusion = Measured value – duty factor

### Worst Plots

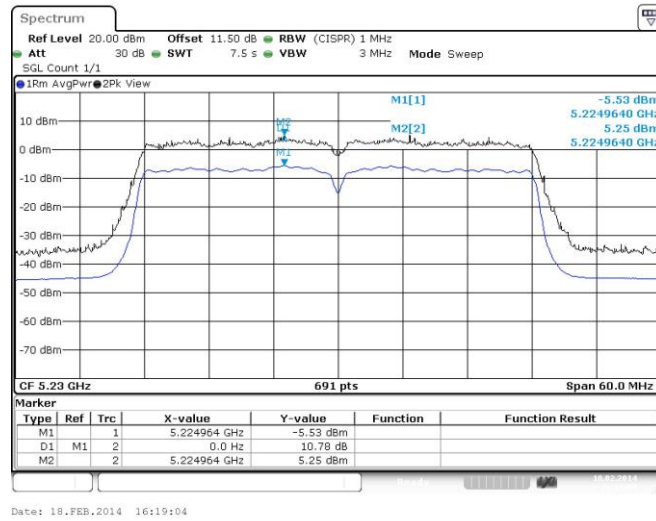

Note: The plot without duty factor

**Legacy/MIMO (CDD) beamforming mode - Test Configuration 3**

Frequency band(MHz)		5150~5250					
Mode	Modulation Mode	N <sub>TX</sub>	Freq. (MHz)	Measured value(dB)	Duty factor (dB)	Peak Excursion (dB)	Limit
11a	BPSK	1	5200	7.65	0.00	7.65	13
11a	QPSK	1	5200	8.83	0.14	8.69	13
11a	16QAM	1	5200	8.93	0.16	8.77	13
11a	64QAM	1	5200	8.64	0.22	8.42	13
VHT20	BPSK	3	5180	8.32	0.00	8.32	13
VHT20	QPSK	3	5180	9.43	0.00	9.43	13
VHT20	16QAM	3	5180	9.67	0.11	9.56	13
VHT20	64QAM	3	5180	9.73	0.19	9.54	13
VHT20	256QAM	3	5180	10.16	0.24	9.92	13
VHT40	BPSK	3	5230	8.28	0.00	8.28	13
VHT40	QPSK	3	5230	9.42	0.09	9.33	13
VHT40	16QAM	3	5230	9.52	0.18	9.34	13
VHT40	64QAM	3	5230	9.87	0.32	9.55	13
VHT40	256QAM	3	5230	10.45	0.38	10.07	13
VHT80	BPSK	3	5210	9.03	0.00	9.03	13
VHT80	QPSK	3	5210	9.89	0.18	9.71	13
VHT80	16QAM	3	5210	10.07	0.38	9.69	13
VHT80	64QAM	3	5210	10.62	0.48	10.14	13
VHT80	256QAM	3	5210	11.79	0.73	11.06	13

Note: Measured value = Peak-max-hold spectrum to the maximum of the average spectrum for continuous transmission. Since the duty cycle is < 98 %, duty factor is required to average spectrum  
Peak exclusion = Measured value – duty factor

### Worst Plots

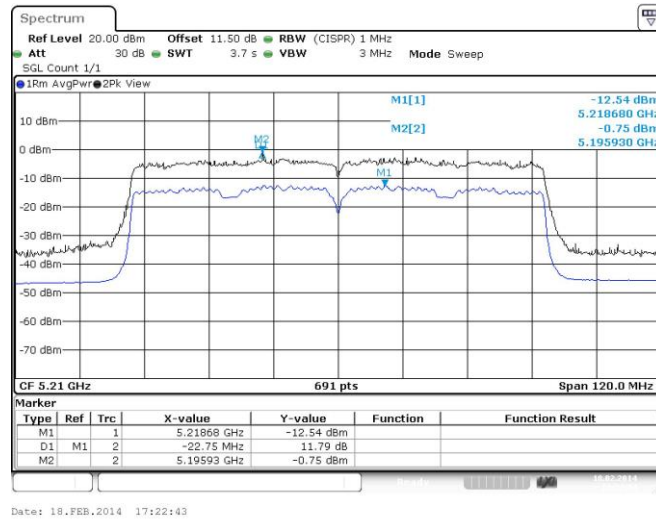

Note: The plot without duty factor

### 3.6 Transmitter Radiated and Band Edge Emissions

#### 3.6.1 Limit of Transmitter Radiated and Band Edge Emissions

Restricted Band Emissions Limit			
Frequency Range (MHz)	Field Strength (uV/m)	Field Strength (dBuV/m)	Measure Distance (m)
0.009~0.490	2400/F(kHz)	48.5 - 13.8	300
0.490~1.705	24000/F(kHz)	33.8 - 23	30
1.705~30.0	30	29	30
30~88	100	40	3
88~216	150	43.5	3
216~960	200	46	3
Above 960	500	54	3

**Note 1:**  
Qusai-Peak value is measured for frequency below 1GHz except for 9–90 kHz, 110–490 kHz frequency band. Peak and average value are measured for frequency above 1GHz. The limit on average radio frequency emission is as above table. The limit on peak radio frequency emissions is 20 dB above the maximum permitted average emission limit

**Note 2:**  
Measurements may be performed at a distance other than what is specified provided. When performing measurements at a distance other than that specified, the results shall be extrapolated to the specified distance using an extrapolation factor as below, Frequency at or above 30 MHz: 20 dB/decade Frequency below 30 MHz: 40 dB/decade.

Un-restricted band emissions above 1GHz Limit	
Operating Band	Limit
5.15 - 5.25 GHz	e.i.r.p. -27 dBm [68.2 dBuV/m@3m]
5.25 - 5.35 GHz	e.i.r.p. -27 dBm [68.2 dBuV/m@3m]
5.47 - 5.725 GHz	e.i.r.p. -27 dBm [68.2 dBuV/m@3m]
5.725 - 5.825 GHz	5.715 5.725 GHz: e.i.r.p. -17 dBm [78.2 dBuV/m@3m] 5.825 5.835 GHz: e.i.r.p. -17 dBm [78.2 dBuV/m@3m] Other un-restricted band: e.i.r.p. -27 dBm [68.2 dBuV/m@3m]

**Note 1:** Measurements may be performed at a distance other than the limit distance provided they are not performed in the near field and the emissions to be measured can be detected by the measurement equipment. When performing measurements at a distance other than that specified, the results shall be extrapolated to the specified distance using an extrapolation factor of 20 dB/decade (inverse of linear distance for field-strength measurements, inverse of linear distance-squared for power-density measurements).

### 3.6.2 Test Procedures

1. Measurement is made at a semi-anechoic chamber that incorporates a turntable allowing a EUT rotation of 360°. A continuously-rotating, remotely-controlled turntable is installed at the test site to support the EUT and facilitate determination of the direction of maximum radiation for each EUT emission frequency. The EUT is placed at a height of 0.8 m test table above the ground plane.
2. Measurement is made with the antenna positioned in both the horizontal and vertical planes of polarization. The measurement antenna is varied in height (1m ~ 4m) above the reference ground plane to obtain the maximum signal strength. Distance between EUT and antenna is 3 m.
3. This investigation is performed with the EUT rotated 360°, the antenna height scanned between 1 m and 4 m, and the antenna rotated to repeat the measurements for both the horizontal and vertical antenna polarizations.

Note:

1. 120kHz measurement bandwidth of test receiver and Quasi-peak detector is for radiated emission below 1GHz.
2. RBW=1MHz, VBW=3MHz and Peak detector is for peak measured value of radiated emission above 1GHz.
3. RBW=1MHz, VBW=1/T and Peak detector is for average measured value of radiated emission above 1GHz.

### 3.6.3 Test Setup

#### Radiated Emissions below 1 GHz

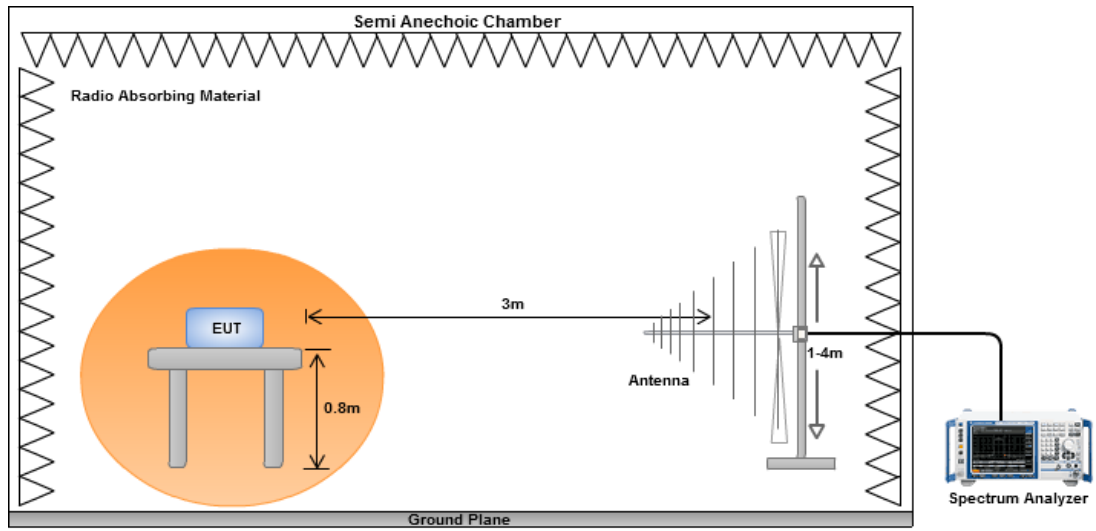

#### Radiated Emissions above 1 GHz

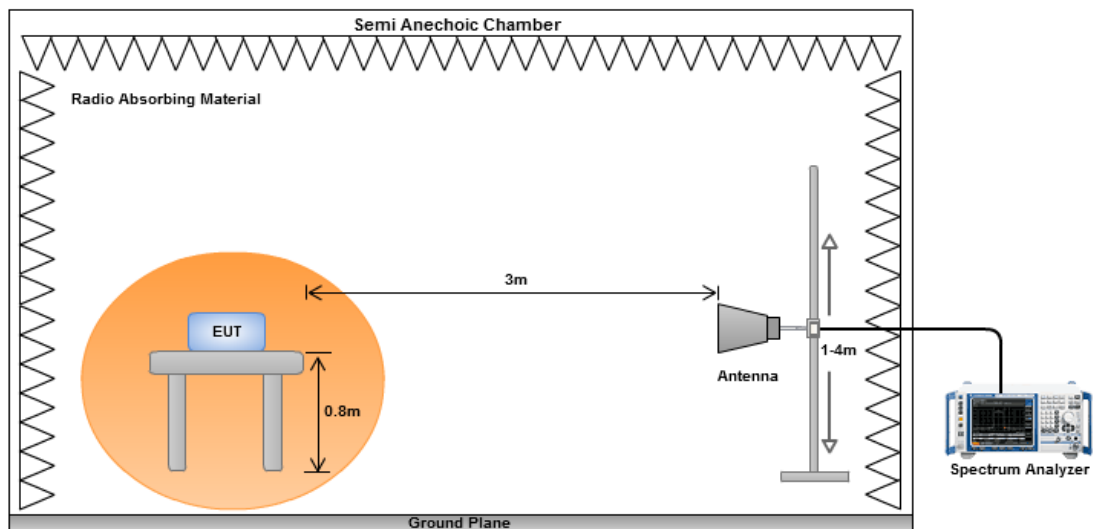

## Legacy/MIMO (CDD) Non- beamforming mode

### 3.6.4 Transmitter Radiated Unwanted Emissions (Below 1GHz)

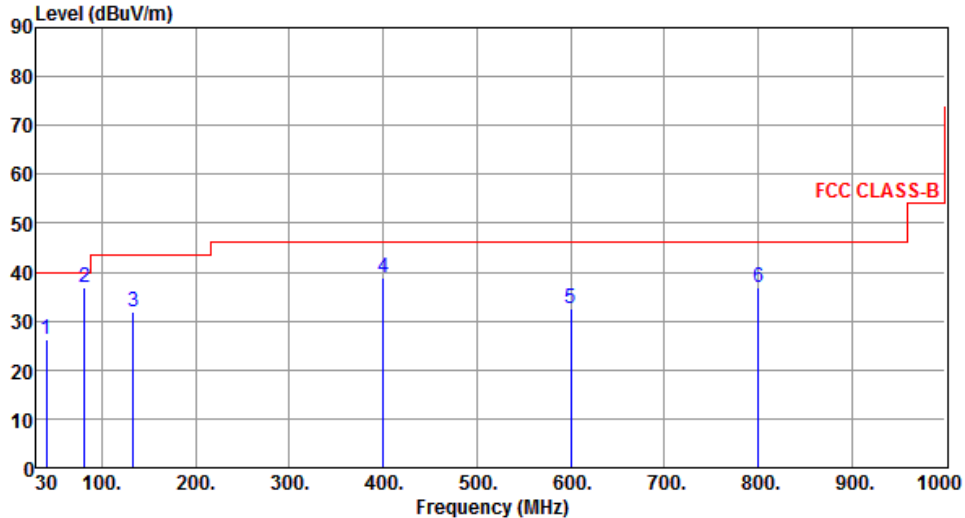
Modulation	VHT80	Test Freq. (MHz)	5210																																																															
Polarization	Horizontal	Test Configuration	1																																																															
 <p>The graph displays the transmitter radiated unwanted emissions below 1 GHz. The y-axis represents the level in dBuV/m, ranging from 0 to 90. The x-axis represents the frequency in MHz, ranging from 30 to 1000. A red line indicates the FCC CLASS-B limit, which is 40 dBuV/m from 30 MHz to 100 MHz, 45 dBuV/m from 100 MHz to 200 MHz, and 46 dBuV/m from 200 MHz to 1000 MHz. Six measured peaks are shown as blue vertical lines, labeled 1 through 6, with their corresponding frequencies and levels listed in the table below.</p>																																																																		
	<table border="1"> <thead> <tr> <th>Freq. MHz</th> <th>Emission level dBuV/m</th> <th>Limit dBuV/m</th> <th>Margin dB</th> <th>SA reading dBuV</th> <th>Factor dB</th> <th>Remark</th> <th>ANT High cm</th> <th>Turn Table deg</th> </tr> </thead> <tbody> <tr> <td>1</td> <td>40.85</td> <td>40.00</td> <td>-13.67</td> <td>43.31</td> <td>-16.98</td> <td>Peak</td> <td>---</td> <td>---</td> </tr> <tr> <td>2</td> <td>81.64</td> <td>40.00</td> <td>-3.13</td> <td>58.68</td> <td>-21.81</td> <td>Peak</td> <td>---</td> <td>---</td> </tr> <tr> <td>3</td> <td>133.52</td> <td>43.50</td> <td>-11.66</td> <td>49.66</td> <td>-17.82</td> <td>Peak</td> <td>---</td> <td>---</td> </tr> <tr> <td>4</td> <td>399.85</td> <td>46.00</td> <td>-7.26</td> <td>52.46</td> <td>-13.72</td> <td>Peak</td> <td>---</td> <td>---</td> </tr> <tr> <td>5</td> <td>600.50</td> <td>46.00</td> <td>-13.51</td> <td>42.06</td> <td>-9.57</td> <td>Peak</td> <td>---</td> <td>---</td> </tr> <tr> <td>6</td> <td>800.33</td> <td>46.00</td> <td>-9.22</td> <td>43.46</td> <td>-6.68</td> <td>Peak</td> <td>---</td> <td>---</td> </tr> </tbody> </table>	Freq. MHz	Emission level dBuV/m	Limit dBuV/m	Margin dB	SA reading dBuV	Factor dB	Remark	ANT High cm	Turn Table deg	1	40.85	40.00	-13.67	43.31	-16.98	Peak	---	---	2	81.64	40.00	-3.13	58.68	-21.81	Peak	---	---	3	133.52	43.50	-11.66	49.66	-17.82	Peak	---	---	4	399.85	46.00	-7.26	52.46	-13.72	Peak	---	---	5	600.50	46.00	-13.51	42.06	-9.57	Peak	---	---	6	800.33	46.00	-9.22	43.46	-6.68	Peak	---	---		
Freq. MHz	Emission level dBuV/m	Limit dBuV/m	Margin dB	SA reading dBuV	Factor dB	Remark	ANT High cm	Turn Table deg																																																										
1	40.85	40.00	-13.67	43.31	-16.98	Peak	---	---																																																										
2	81.64	40.00	-3.13	58.68	-21.81	Peak	---	---																																																										
3	133.52	43.50	-11.66	49.66	-17.82	Peak	---	---																																																										
4	399.85	46.00	-7.26	52.46	-13.72	Peak	---	---																																																										
5	600.50	46.00	-13.51	42.06	-9.57	Peak	---	---																																																										
6	800.33	46.00	-9.22	43.46	-6.68	Peak	---	---																																																										
<p>Note 1: Emission Level (dBuV/m) = SA Reading (dBuV/m) + Factor* (dB)            *Factor includes antenna factor , cable loss and amplifier gain            Note 2: Margin (dB) = Emission level (dBuV/m) – Limit (dBuV/m).            Note 3: All spurious emissions below 30MHz are more than 20 dB below the limit.</p>																																																																		



<b>Modulation</b>	VHT80	<b>Test Freq. (MHz)</b>	5210
<b>Polarization</b>	Vertical	<b>Test Configuration</b>	1

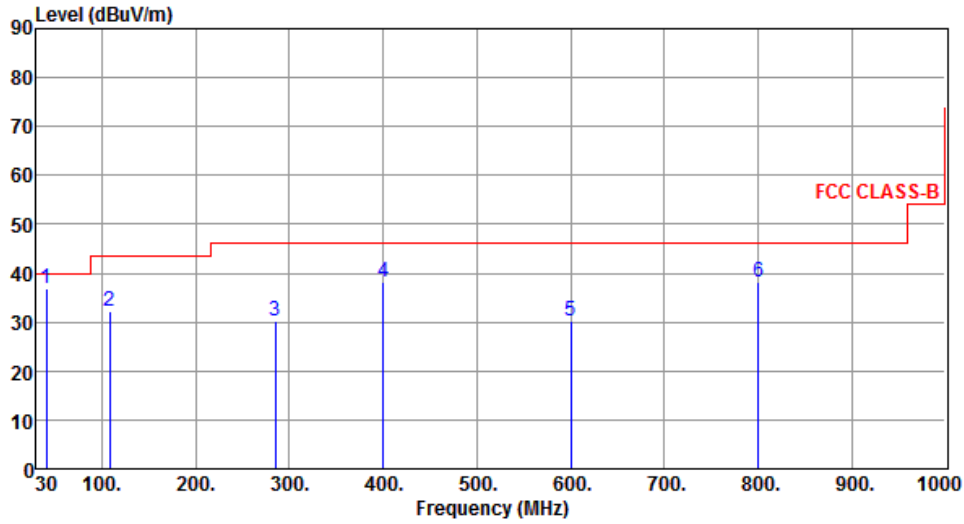

	Freq. MHz	Emission level dBuV/m	Limit dBuV/m	Margin dB	SA reading dBuV	Factor dB	Remark	ANT High cm	Turn Table deg
1	40.34	37.00	40.00	-3.00	54.01	-17.01	QP	---	---
2	108.68	32.28	43.50	-11.22	52.58	-20.30	Peak	---	---
3	285.34	30.14	46.00	-15.86	46.75	-16.61	Peak	---	---
4	399.94	38.24	46.00	-7.76	51.96	-13.72	Peak	---	---
5	600.50	30.38	46.00	-15.62	39.95	-9.57	Peak	---	---
6	800.30	38.26	46.00	-7.74	44.94	-6.68	Peak	---	---

Note 1: Emission Level (dBuV/m) = SA Reading (dBuV/m) + Factor\* (dB)

\*Factor includes antenna factor , cable loss and amplifier gain

Note 2: Margin (dB) = Emission level (dBuV/m) – Limit (dBuV/m).

Note 3: All spurious emissions below 30MHz are more than 20 dB below the limit.

<b>Modulation</b>	VHT80	<b>Test Freq. (MHz)</b>	5210
<b>Polarization</b>	Horizontal	<b>Test Configuration</b>	2

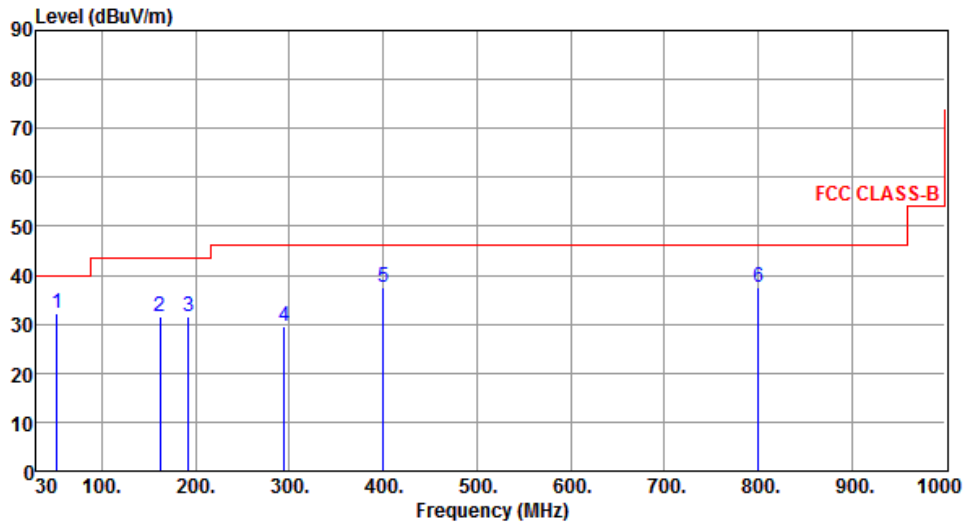

	Freq. MHz	Emission level dBuV/m	Limit dBuV/m	Margin dB	SA reading dBuV	Factor dB	Remark	ANT High cm	Turn Table deg
1	51.74	32.18	40.00	-7.82	48.65	-16.47	Peak	---	---
2	162.42	31.56	43.50	-11.94	48.45	-16.89	Peak	---	---
3	192.63	31.42	43.50	-12.08	51.03	-19.61	Peak	---	---
4	294.72	29.53	46.00	-16.47	45.88	-16.35	Peak	---	---
5	399.84	37.67	46.00	-8.33	51.39	-13.72	Peak	---	---
6	800.10	37.59	46.00	-8.41	44.27	-6.68	Peak	---	---

Note 1: Emission Level (dBuV/m) = SA Reading (dBuV/m) + Factor\* (dB)

\*Factor includes antenna factor, cable loss and amplifier gain

Note 2: Margin (dB) = Emission level (dBuV/m) – Limit (dBuV/m).

Note 3: All spurious emissions below 30MHz are more than 20 dB below the limit.

<b>Modulation</b>	VHT80	<b>Test Freq. (MHz)</b>	5210
<b>Polarization</b>	Vertical	<b>Test Configuration</b>	2

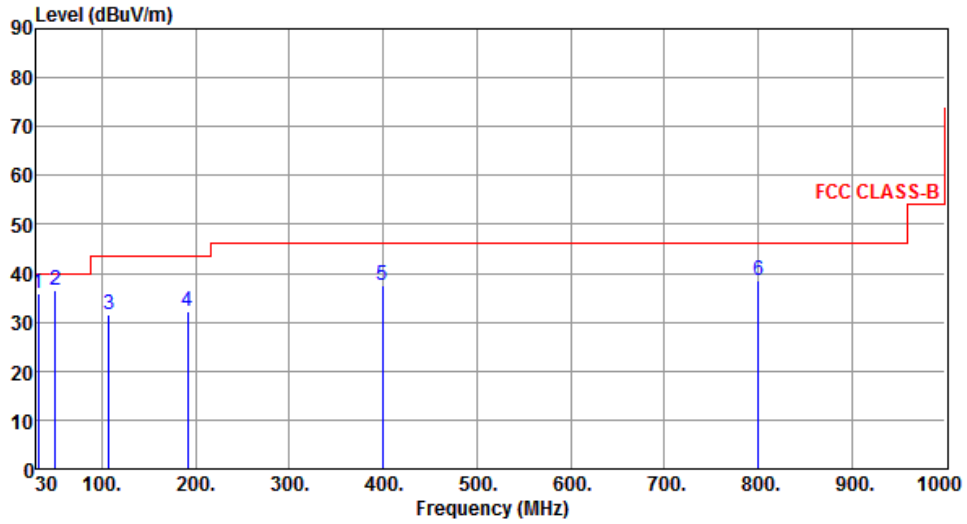

	Freq. MHz	Emission level dBuV/m	Limit dBuV/m	Margin dB	SA reading dBuV	Factor dB	Remark	ANT High cm	Turn Table deg
1	31.66	35.72	40.00	-4.28	53.40	-17.68	QP	---	---
2	50.31	36.42	40.00	-3.58	52.73	-16.31	QP	---	---
3	107.82	31.55	43.50	-11.95	51.98	-20.43	Peak	---	---
4	191.12	32.18	43.50	-11.32	51.73	-19.55	Peak	---	---
5	399.72	37.46	46.00	-8.54	51.19	-13.73	Peak	---	---
6	800.06	38.55	46.00	-7.45	45.23	-6.68	Peak	---	---

Note 1: Emission Level (dBuV/m) = SA Reading (dBuV/m) + Factor\* (dB)

\*Factor includes antenna factor , cable loss and amplifier gain

Note 2: Margin (dB) = Emission level (dBuV/m) – Limit (dBuV/m).

Note 3: All spurious emissions below 30MHz are more than 20 dB below the limit.

### 3.6.5 Transmitter Radiated Unwanted Emissions (Above 1GHz) for 11a

Modulation	11a	Test Freq. (MHz)	5180
Polarization	Horizontal	Test Configuration	1

  

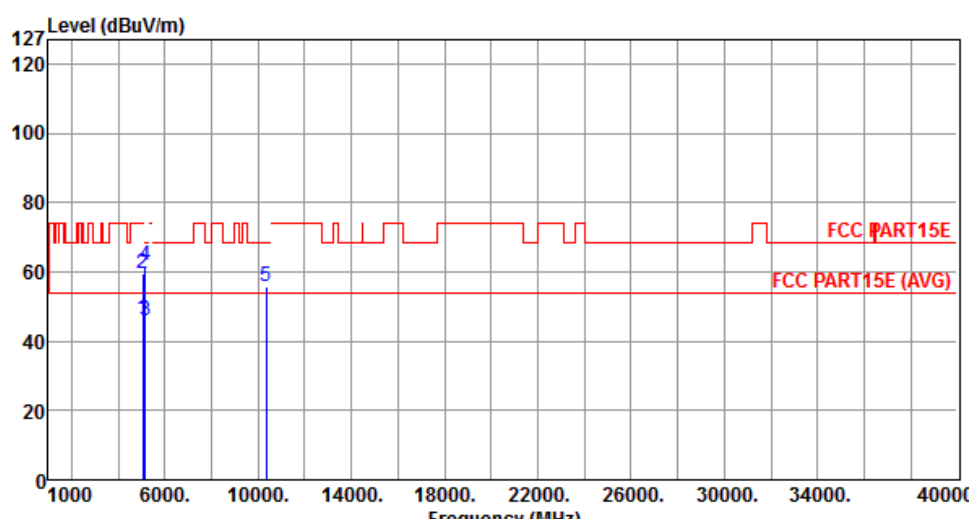

	Freq. MHz	Emission level dBuV/m	Limit dBuV/m	Margin dB	SA reading dBuV	Factor dB	Remark	ANT High cm	Turn Table deg
1	5057.00	46.20	54.00	-7.80	40.67	5.53	Average	---	---
2	5057.00	59.30	74.00	-14.70	53.77	5.53	Peak	---	---
3	5150.00	46.01	54.00	-7.99	40.30	5.71	Average	---	---
4	5150.00	62.03	74.00	-11.97	56.32	5.71	Peak	---	---
5	10360.00	55.65	68.20	-12.55	41.21	14.44	Peak	---	---

Note 1: Emission Level (dBuV/m) = SA Reading (dBuV/m) + Factor\* (dB)  
 \*Factor includes antenna factor , cable loss and amplifier gain  
 Note 2: Margin (dB) = Emission level (dBuV/m) – Limit (dBuV/m).

<b>Modulation</b>	11a	<b>Test Freq. (MHz)</b>	5180
<b>Polarization</b>	Vertical	<b>Test Configuration</b>	1

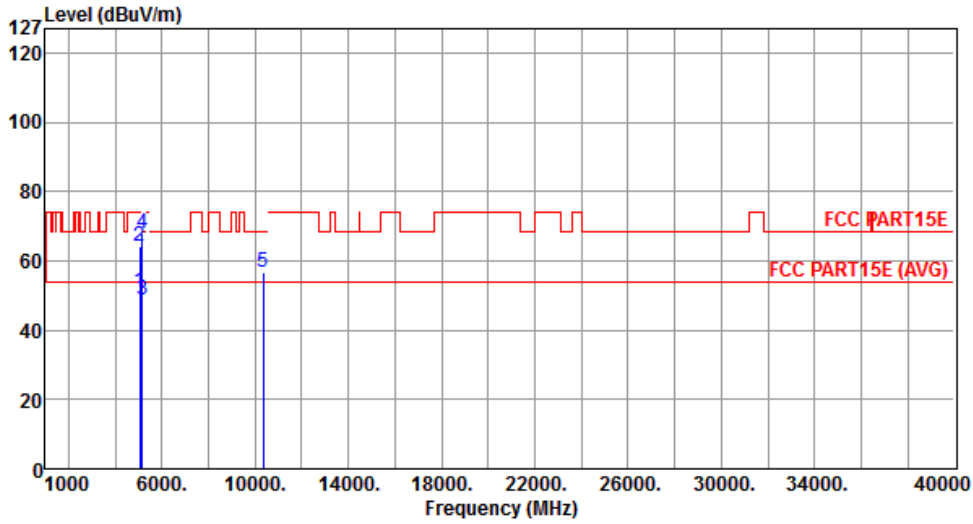

	Freq. MHz	Emission level dBuV/m	Limit dBuV/m	Margin dB	SA reading dBuV	Factor dB	Remark	ANT High cm	Turn Table deg
1	5057.00	51.28	54.00	-2.72	45.75	5.53	Average	---	---
2	5057.00	64.36	74.00	-9.64	58.83	5.53	Peak	---	---
3	5150.00	48.90	54.00	-5.10	43.19	5.71	Average	---	---
4	5150.00	67.74	74.00	-6.26	62.03	5.71	Peak	---	---
5	10360.00	56.77	68.20	-11.43	42.33	14.44	Peak	---	---

Note 1: Emission Level (dBuV/m) = SA Reading (dBuV/m) + Factor\* (dB)

\*Factor includes antenna factor , cable loss and amplifier gain

Note 2: Margin (dB) = Emission level (dBuV/m) – Limit (dBuV/m).

<b>Modulation</b>	11a	<b>Test Freq. (MHz)</b>	5200
<b>Polarization</b>	Horizontal	<b>Test Configuration</b>	1

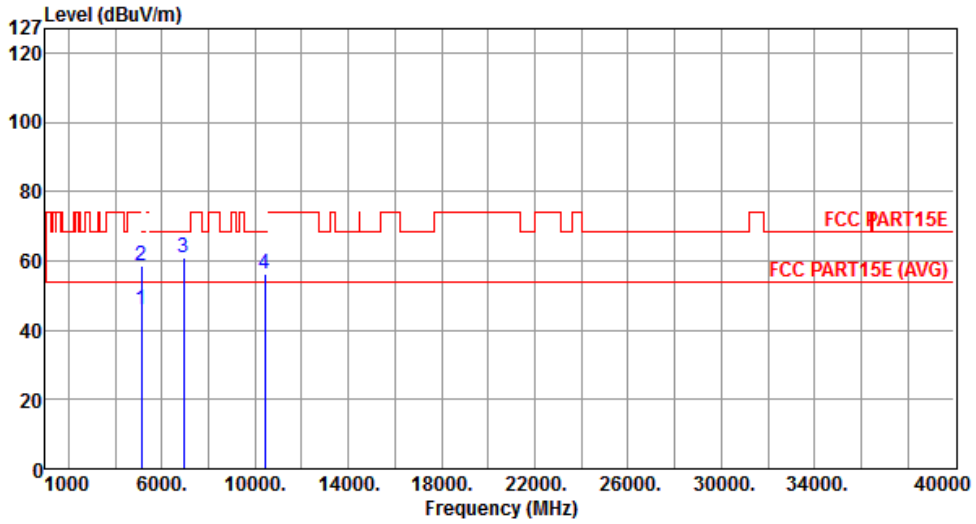

	Freq. MHz	Emission level dBuV/m	Limit dBuV/m	Margin dB	SA reading dBuV	Factor dB	Remark	ANT High cm	Turn Table deg
1	5118.00	45.88	54.00	-8.12	40.23	5.65	Average	---	---
2	5118.00	58.65	74.00	-15.35	53.00	5.65	Peak	---	---
3	6933.30	60.79	68.20	-7.41	50.96	9.83	Peak	---	---
4	10400.00	56.14	68.20	-12.06	41.64	14.50	Peak	---	---

Note 1: Emission Level (dBuV/m) = SA Reading (dBuV/m) + Factor\* (dB)

\*Factor includes antenna factor , cable loss and amplifier gain

Note 2: Margin (dB) = Emission level (dBuV/m) – Limit (dBuV/m).

<b>Modulation</b>	11a	<b>Test Freq. (MHz)</b>	5200
<b>Polarization</b>	Vertical	<b>Test Configuration</b>	1

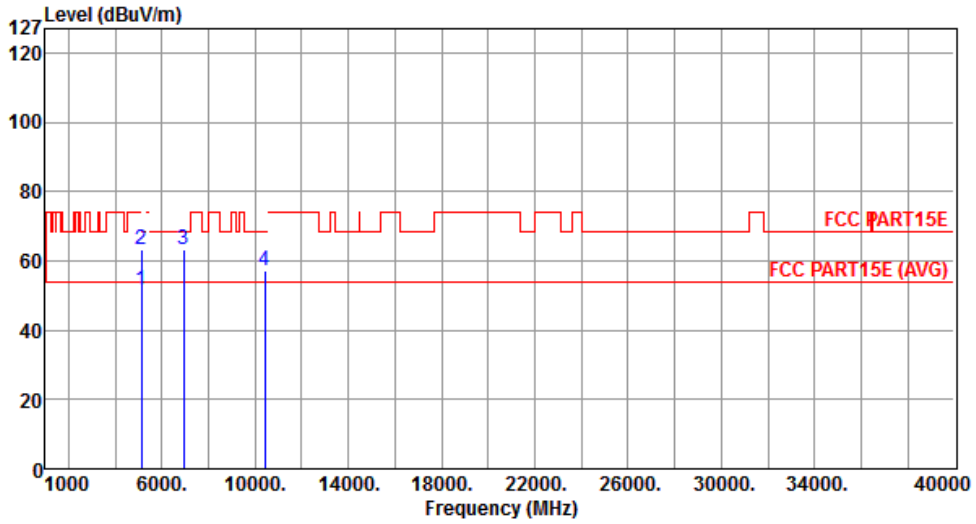

	Freq. MHz	Emission level dBuV/m	Limit dBuV/m	Margin dB	SA reading dBuV	Factor dB	Remark	ANT High cm	Turn Table deg
1	5118.00	51.43	54.00	-2.57	45.78	5.65	Average	---	---
2	5118.00	63.19	74.00	-10.81	57.54	5.65	Peak	---	---
3	6933.30	63.06	68.20	-5.14	53.23	9.83	Peak	---	---
4	10400.00	57.29	68.20	-10.91	42.79	14.50	Peak	---	---

Note 1: Emission Level (dBuV/m) = SA Reading (dBuV/m) + Factor\* (dB)

\*Factor includes antenna factor , cable loss and amplifier gain

Note 2: Margin (dB) = Emission level (dBuV/m) – Limit (dBuV/m).

<b>Modulation</b>	11a	<b>Test Freq. (MHz)</b>	5240
<b>Polarization</b>	Horizontal	<b>Test Configuration</b>	1

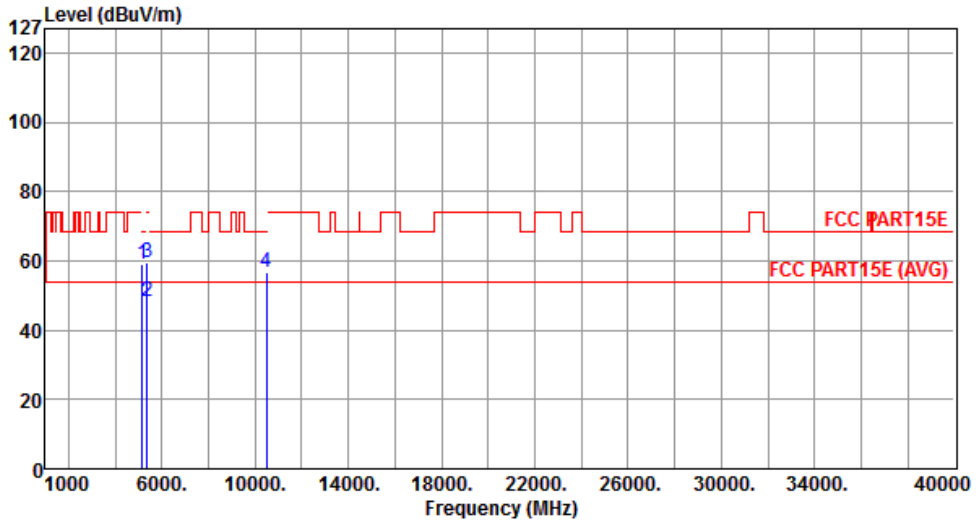

	Freq. MHz	Emission level dBuV/m	Limit dBuV/m	Margin dB	SA reading dBuV	Factor dB	Remark	ANT High cm	Turn Table deg
1	5164.00	59.13	68.20	-9.07	53.39	5.74	Peak	---	---
2	5350.00	48.09	54.00	-5.91	42.10	5.99	Average	---	---
3	5350.00	59.53	74.00	-14.47	53.54	5.99	Peak	---	---
4	10480.00	56.68	68.20	-11.52	42.05	14.63	Peak	---	---

Note 1: Emission Level (dBuV/m) = SA Reading (dBuV/m) + Factor\* (dB)

\*Factor includes antenna factor , cable loss and amplifier gain

Note 2: Margin (dB) = Emission level (dBuV/m) – Limit (dBuV/m).



<b>Modulation</b>	11a	<b>Test Freq. (MHz)</b>	5240
<b>Polarization</b>	Vertical	<b>Test Configuration</b>	1

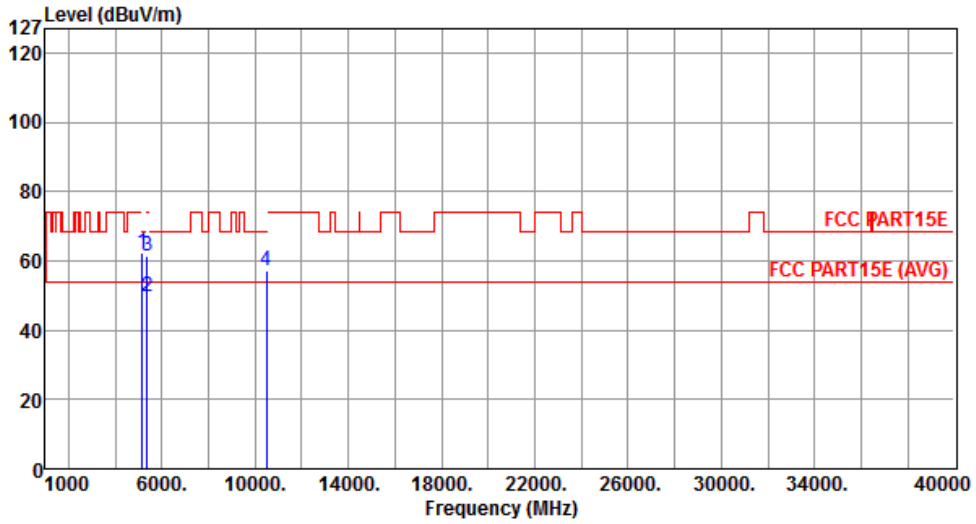

	Freq. MHz	Emission level dBuV/m	Limit dBuV/m	Margin dB	SA reading dBuV	Factor dB	Remark	ANT High cm	Turn Table deg
1	5164.00	62.48	68.20	-5.72	56.74	5.74	Peak	---	---
2	5350.00	49.89	54.00	-4.11	43.90	5.99	Average	---	---
3	5350.00	61.39	74.00	-12.61	55.40	5.99	Peak	---	---
4	10480.00	57.02	68.20	-11.18	42.39	14.63	Peak	---	---

Note 1: Emission Level (dBuV/m) = SA Reading (dBuV/m) + Factor\* (dB)

\*Factor includes antenna factor , cable loss and amplifier gain

Note 2: Margin (dB) = Emission level (dBuV/m) – Limit (dBuV/m).

### 3.6.6 Transmitter Radiated Unwanted Emissions (Above 1GHz) for VHT20

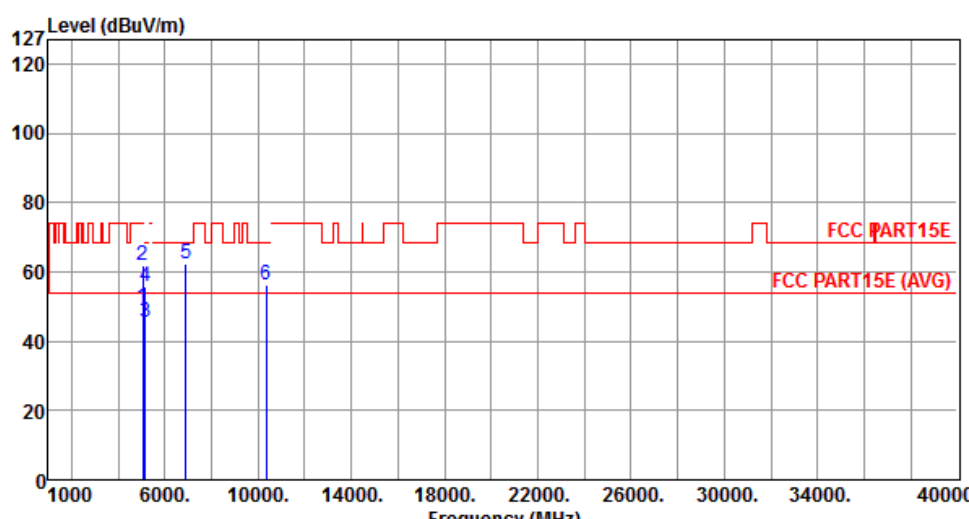
Modulation	VHT20	Test Freq. (MHz)	5180																																																																						
Polarization	Horizontal	Test Configuration	1																																																																						
																																																																									
	<table border="1"> <thead> <tr> <th>Freq.</th> <th>Emission level</th> <th>Limit</th> <th>Margin</th> <th>SA reading</th> <th>Factor</th> <th>Remark</th> <th>ANT High cm</th> <th>Turn Table deg</th> </tr> <tr> <th>MHz</th> <th>dBuV/m</th> <th>dBuV/m</th> <th>dB</th> <th>dBuV</th> <th>dB</th> <th></th> <th></th> <th></th> </tr> </thead> <tbody> <tr> <td>1</td> <td>5062.00</td> <td>49.56</td> <td>54.00</td> <td>-4.44</td> <td>44.02</td> <td>5.54</td> <td>Average</td> <td>---</td> </tr> <tr> <td>2</td> <td>5062.00</td> <td>61.71</td> <td>74.00</td> <td>-12.29</td> <td>56.17</td> <td>5.54</td> <td>Peak</td> <td>---</td> </tr> <tr> <td>3</td> <td>5150.00</td> <td>45.33</td> <td>54.00</td> <td>-8.67</td> <td>39.62</td> <td>5.71</td> <td>Average</td> <td>---</td> </tr> <tr> <td>4</td> <td>5150.00</td> <td>55.99</td> <td>74.00</td> <td>-18.01</td> <td>50.28</td> <td>5.71</td> <td>Peak</td> <td>---</td> </tr> <tr> <td>5</td> <td>6906.66</td> <td>62.55</td> <td>68.20</td> <td>-5.65</td> <td>52.83</td> <td>9.72</td> <td>Peak</td> <td>---</td> </tr> <tr> <td>6</td> <td>10360.00</td> <td>56.17</td> <td>68.20</td> <td>-12.03</td> <td>41.73</td> <td>14.44</td> <td>Peak</td> <td>---</td> </tr> </tbody> </table>	Freq.	Emission level	Limit	Margin	SA reading	Factor	Remark	ANT High cm	Turn Table deg	MHz	dBuV/m	dBuV/m	dB	dBuV	dB				1	5062.00	49.56	54.00	-4.44	44.02	5.54	Average	---	2	5062.00	61.71	74.00	-12.29	56.17	5.54	Peak	---	3	5150.00	45.33	54.00	-8.67	39.62	5.71	Average	---	4	5150.00	55.99	74.00	-18.01	50.28	5.71	Peak	---	5	6906.66	62.55	68.20	-5.65	52.83	9.72	Peak	---	6	10360.00	56.17	68.20	-12.03	41.73	14.44	Peak	---
Freq.	Emission level	Limit	Margin	SA reading	Factor	Remark	ANT High cm	Turn Table deg																																																																	
MHz	dBuV/m	dBuV/m	dB	dBuV	dB																																																																				
1	5062.00	49.56	54.00	-4.44	44.02	5.54	Average	---																																																																	
2	5062.00	61.71	74.00	-12.29	56.17	5.54	Peak	---																																																																	
3	5150.00	45.33	54.00	-8.67	39.62	5.71	Average	---																																																																	
4	5150.00	55.99	74.00	-18.01	50.28	5.71	Peak	---																																																																	
5	6906.66	62.55	68.20	-5.65	52.83	9.72	Peak	---																																																																	
6	10360.00	56.17	68.20	-12.03	41.73	14.44	Peak	---																																																																	
<p>Note 1: Emission Level (dBuV/m) = SA Reading (dBuV/m) + Factor* (dB)            *Factor includes antenna factor , cable loss and amplifier gain            Note 2: Margin (dB) = Emission level (dBuV/m) – Limit (dBuV/m).</p>																																																																									

<b>Modulation</b>	VHT20	<b>Test Freq. (MHz)</b>	5180
<b>Polarization</b>	Vertical	<b>Test Configuration</b>	1

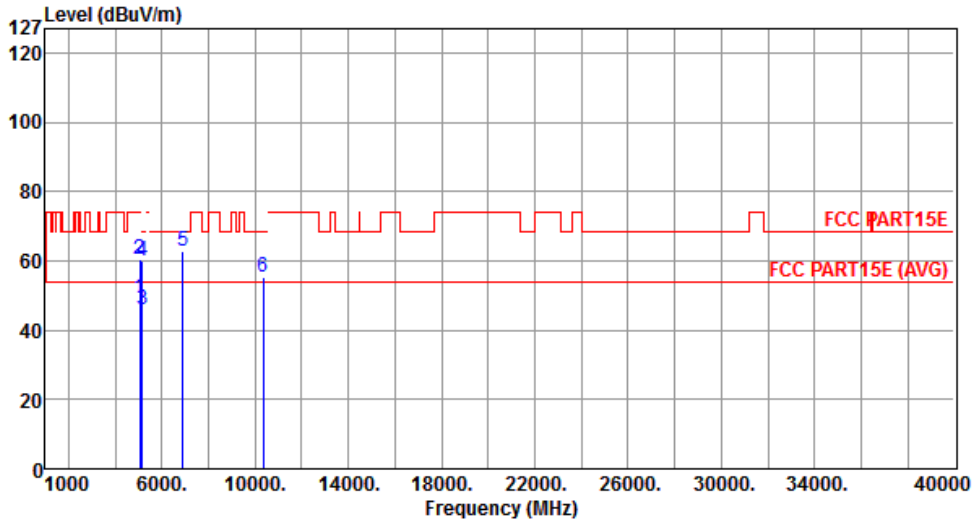

	Freq. MHz	Emission level dBuV/m	Limit dBuV/m	Margin dB	SA reading dBuV	Factor dB	Remark	ANT High cm	Turn Table deg
1	5062.00	49.02	54.00	-4.98	43.48	5.54	Average	---	---
2	5062.00	60.37	74.00	-13.63	54.83	5.54	Peak	---	---
3	5150.00	45.92	54.00	-8.08	40.21	5.71	Average	---	---
4	5150.00	60.08	74.00	-13.92	54.37	5.71	Peak	---	---
5	6906.66	62.97	68.20	-5.23	53.25	9.72	Peak	---	---
6	10360.00	55.46	68.20	-12.74	41.02	14.44	Peak	---	---

Note 1: Emission Level (dBuV/m) = SA Reading (dBuV/m) + Factor\* (dB)

\*Factor includes antenna factor , cable loss and amplifier gain

Note 2: Margin (dB) = Emission level (dBuV/m) – Limit (dBuV/m).

<b>Modulation</b>	VHT20	<b>Test Freq. (MHz)</b>	5200
<b>Polarization</b>	Horizontal	<b>Test Configuration</b>	1

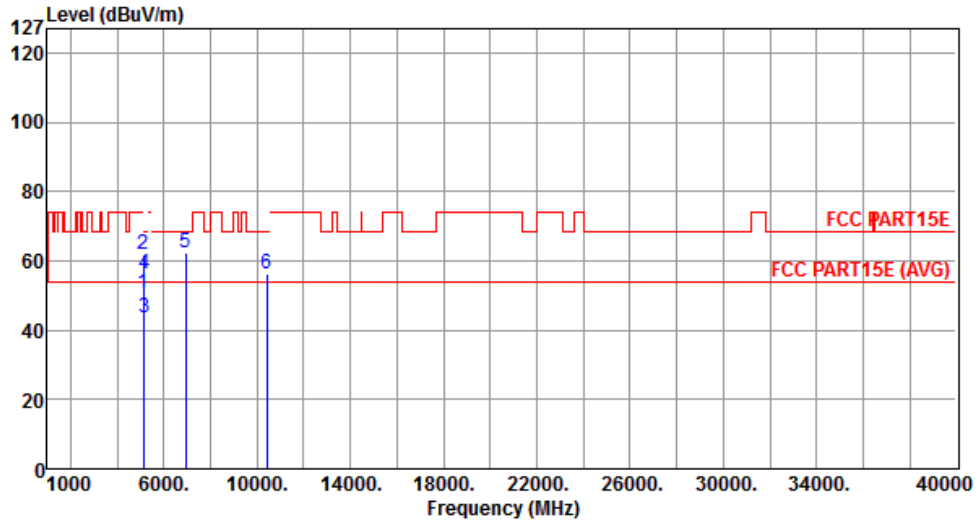

	Freq. MHz	Emission level dBuV/m	Limit dBuV/m	Margin dB	SA reading dBuV	Factor dB	Remark	ANT High cm	Turn Table deg
1	5119.00	50.48	54.00	-3.52	44.83	5.65	Average	---	---
2	5119.00	61.83	74.00	-12.17	56.18	5.65	Peak	---	---
3	5150.00	43.56	54.00	-10.44	37.85	5.71	Average	---	---
4	5150.00	56.15	74.00	-17.85	50.44	5.71	Peak	---	---
5	6933.33	62.49	68.20	-5.71	52.66	9.83	Peak	---	---
6	10400.00	56.03	68.20	-12.17	41.53	14.50	Peak	---	---

Note 1: Emission Level (dBuV/m) = SA Reading (dBuV/m) + Factor\* (dB)

\*Factor includes antenna factor , cable loss and amplifier gain

Note 2: Margin (dB) = Emission level (dBuV/m) – Limit (dBuV/m).

<b>Modulation</b>	VHT20	<b>Test Freq. (MHz)</b>	5200
<b>Polarization</b>	Vertical	<b>Test Configuration</b>	1

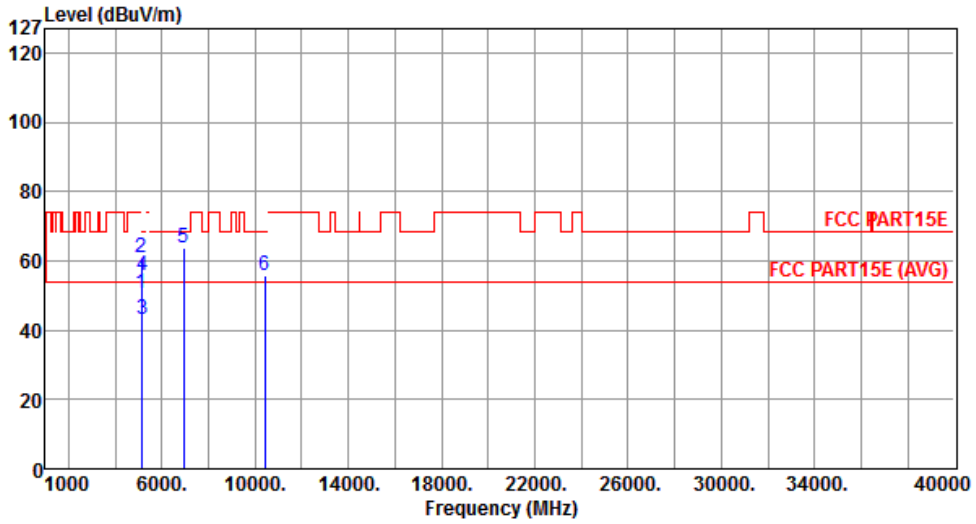

	Freq. MHz	Emission level dBuV/m	Limit dBuV/m	Margin dB	SA reading dBuV	Factor dB	Remark	ANT High cm	Turn Table deg
1	5119.00	50.50	54.00	-3.50	44.85	5.65	Average	---	---
2	5119.00	60.86	74.00	-13.14	55.21	5.65	Peak	---	---
3	5150.00	43.17	54.00	-10.83	37.46	5.71	Average	---	---
4	5150.00	55.89	74.00	-18.11	50.18	5.71	Peak	---	---
5	6933.33	63.61	68.20	-4.59	53.78	9.83	Peak	---	---
6	10400.00	55.72	68.20	-12.48	41.22	14.50	Peak	---	---

Note 1: Emission Level (dBuV/m) = SA Reading (dBuV/m) + Factor\* (dB)

\*Factor includes antenna factor , cable loss and amplifier gain

Note 2: Margin (dB) = Emission level (dBuV/m) – Limit (dBuV/m).

<b>Modulation</b>	VHT20	<b>Test Freq. (MHz)</b>	5240
<b>Polarization</b>	Horizontal	<b>Test Configuration</b>	1

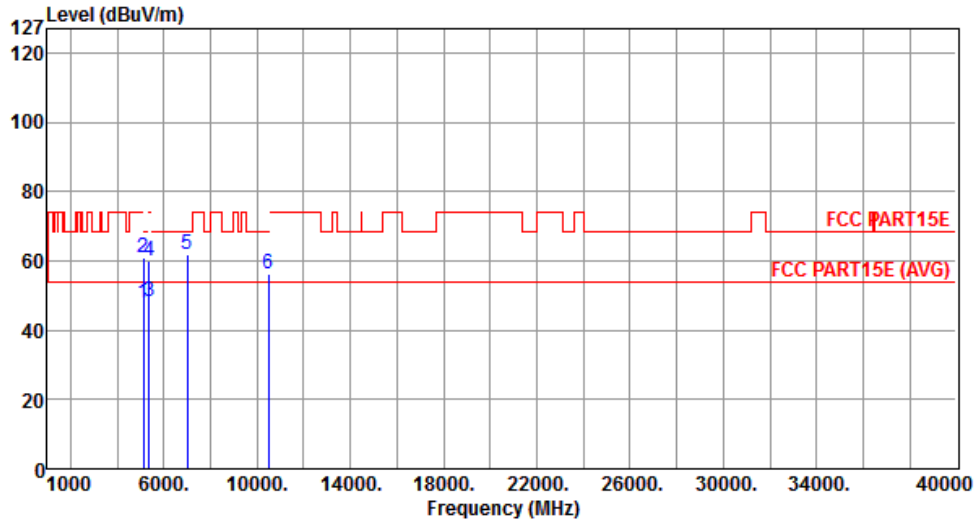

	Freq. MHz	Emission level dBuV/m	Limit dBuV/m	Margin dB	SA reading dBuV	Factor dB	Remark	ANT High cm	Turn Table deg
1	5120.00	47.87	54.00	-6.13	42.22	5.65	Average	---	---
2	5120.00	60.81	74.00	-13.19	55.16	5.65	Peak	---	---
3	5361.00	48.10	54.00	-5.90	42.10	6.00	Average	---	---
4	5361.00	60.15	74.00	-13.85	54.15	6.00	Peak	---	---
5	6986.66	61.88	68.20	-6.32	51.83	10.05	Peak	---	---
6	10480.00	56.29	68.20	-11.91	41.66	14.63	Peak	---	---

Note 1: Emission Level (dBuV/m) = SA Reading (dBuV/m) + Factor\* (dB)

\*Factor includes antenna factor , cable loss and amplifier gain

Note 2: Margin (dB) = Emission level (dBuV/m) – Limit (dBuV/m).

<b>Modulation</b>	VHT20	<b>Test Freq. (MHz)</b>	5240
<b>Polarization</b>	Vertical	<b>Test Configuration</b>	1

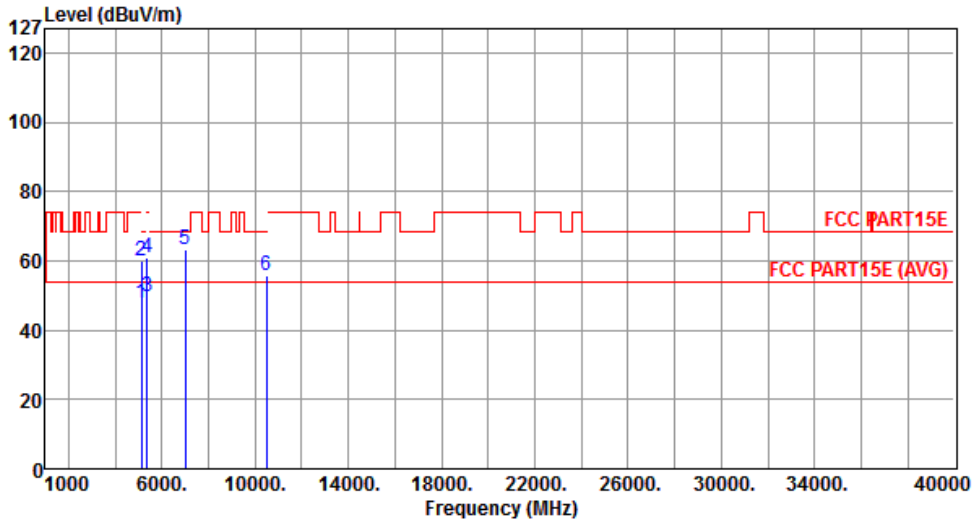

	Freq. MHz	Emission level dBuV/m	Limit dBuV/m	Margin dB	SA reading dBuV	Factor dB	Remark	ANT High cm	Turn Table deg
1	5120.00	48.02	54.00	-5.98	42.37	5.65	Average	---	---
2	5120.00	60.20	74.00	-13.80	54.55	5.65	Peak	---	---
3	5361.00	49.57	54.00	-4.43	43.57	6.00	Average	---	---
4	5361.00	60.98	74.00	-13.02	54.98	6.00	Peak	---	---
5	6986.66	63.38	68.20	-4.82	53.33	10.05	Peak	---	---
6	10480.00	55.96	68.20	-12.24	41.33	14.63	Peak	---	---

Note 1: Emission Level (dBuV/m) = SA Reading (dBuV/m) + Factor\* (dB)

\*Factor includes antenna factor , cable loss and amplifier gain

Note 2: Margin (dB) = Emission level (dBuV/m) – Limit (dBuV/m).

### 3.6.7 Transmitter Radiated Unwanted Emissions (Above 1GHz) for VHT40

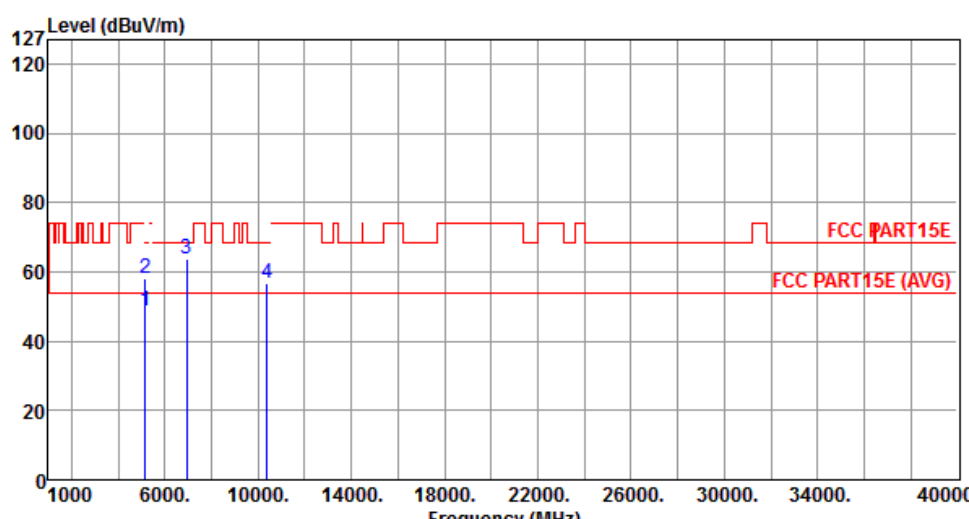
Modulation	VHT40	Test Freq. (MHz)	5190																																																							
Polarization	Horizontal	Test Configuration	1																																																							
																																																										
	<table border="1"> <thead> <tr> <th>Freq.</th> <th>Emission level</th> <th>Limit</th> <th>Margin</th> <th>SA reading</th> <th>Factor</th> <th>Remark</th> <th>ANT High</th> <th>Turn Table</th> </tr> <tr> <th>MHz</th> <th>dBuV/m</th> <th>dBuV/m</th> <th>dB</th> <th>dBuV</th> <th>dB</th> <th></th> <th>cm</th> <th>deg</th> </tr> </thead> <tbody> <tr> <td>1</td> <td>5150.00</td> <td>48.94</td> <td>54.00</td> <td>-5.06</td> <td>43.23</td> <td>5.71</td> <td>Average</td> <td>---</td> </tr> <tr> <td>2</td> <td>5150.00</td> <td>58.33</td> <td>74.00</td> <td>-15.67</td> <td>52.62</td> <td>5.71</td> <td>Peak</td> <td>---</td> </tr> <tr> <td>3</td> <td>6920.00</td> <td>63.82</td> <td>68.20</td> <td>-4.38</td> <td>54.05</td> <td>9.77</td> <td>Peak</td> <td>---</td> </tr> <tr> <td>4</td> <td>10380.00</td> <td>56.85</td> <td>68.20</td> <td>-11.35</td> <td>42.39</td> <td>14.46</td> <td>Peak</td> <td>---</td> </tr> </tbody> </table>	Freq.	Emission level	Limit	Margin	SA reading	Factor	Remark	ANT High	Turn Table	MHz	dBuV/m	dBuV/m	dB	dBuV	dB		cm	deg	1	5150.00	48.94	54.00	-5.06	43.23	5.71	Average	---	2	5150.00	58.33	74.00	-15.67	52.62	5.71	Peak	---	3	6920.00	63.82	68.20	-4.38	54.05	9.77	Peak	---	4	10380.00	56.85	68.20	-11.35	42.39	14.46	Peak	---			
Freq.	Emission level	Limit	Margin	SA reading	Factor	Remark	ANT High	Turn Table																																																		
MHz	dBuV/m	dBuV/m	dB	dBuV	dB		cm	deg																																																		
1	5150.00	48.94	54.00	-5.06	43.23	5.71	Average	---																																																		
2	5150.00	58.33	74.00	-15.67	52.62	5.71	Peak	---																																																		
3	6920.00	63.82	68.20	-4.38	54.05	9.77	Peak	---																																																		
4	10380.00	56.85	68.20	-11.35	42.39	14.46	Peak	---																																																		
<p>Note 1: Emission Level (dBuV/m) = SA Reading (dBuV/m) + Factor* (dB)            *Factor includes antenna factor , cable loss and amplifier gain            Note 2: Margin (dB) = Emission level (dBuV/m) – Limit (dBuV/m).</p>																																																										



<b>Modulation</b>	VHT40	<b>Test Freq. (MHz)</b>	5190
<b>Polarization</b>	Vertical	<b>Test Configuration</b>	1

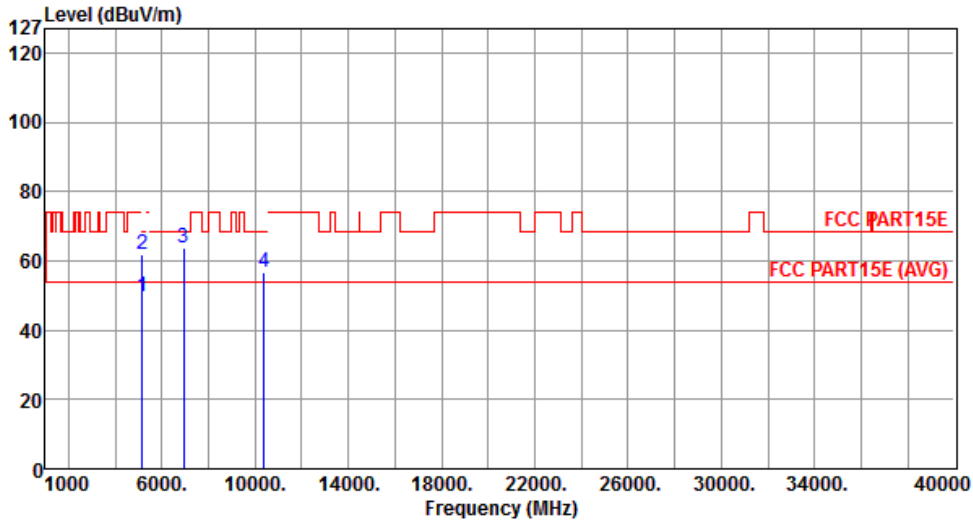

	Freq. MHz	Emission level dBuV/m	Limit dBuV/m	Margin dB	SA reading dBuV	Factor dB	Remark	ANT High cm	Turn Table deg
1	5150.00	49.74	54.00	-4.26	44.03	5.71	Average	---	---
2	5150.00	61.72	74.00	-12.28	56.01	5.71	Peak	---	---
3	6920.00	63.51	68.20	-4.69	53.74	9.77	Peak	---	---
4	10380.00	56.62	68.20	-11.58	42.16	14.46	Peak	---	---

Note 1: Emission Level (dBuV/m) = SA Reading (dBuV/m) + Factor\* (dB)

\*Factor includes antenna factor , cable loss and amplifier gain

Note 2: Margin (dB) = Emission level (dBuV/m) – Limit (dBuV/m).

<b>Modulation</b>	VHT40	<b>Test Freq. (MHz)</b>	5230
<b>Polarization</b>	Horizontal	<b>Test Configuration</b>	1

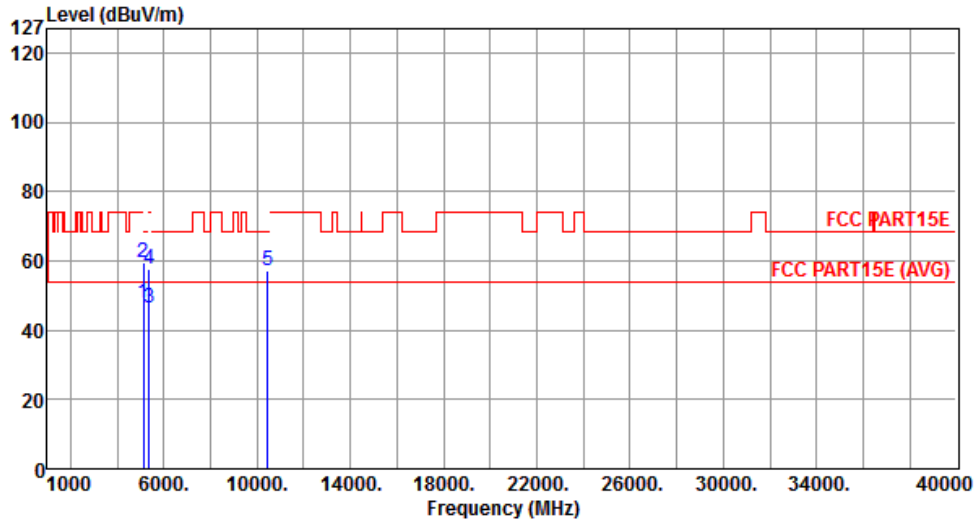

	Freq. MHz	Emission level dBuV/m	Limit dBuV/m	Margin dB	SA reading dBuV	Factor dB	Remark	ANT High cm	Turn Table deg
1	5140.00	47.67	54.00	-6.33	41.98	5.69	Average	---	---
2	5140.00	59.46	74.00	-14.54	53.77	5.69	Peak	---	---
3	5350.00	46.56	54.00	-7.44	40.57	5.99	Average	---	---
4	5350.00	57.62	74.00	-16.38	51.63	5.99	Peak	---	---
5	10460.00	57.21	68.20	-10.99	42.61	14.60	Peak	---	---

Note 1: Emission Level (dBuV/m) = SA Reading (dBuV/m) + Factor\* (dB)

\*Factor includes antenna factor , cable loss and amplifier gain

Note 2: Margin (dB) = Emission level (dBuV/m) – Limit (dBuV/m).

<b>Modulation</b>	VHT40	<b>Test Freq. (MHz)</b>	5230
<b>Polarization</b>	Vertical	<b>Test Configuration</b>	1

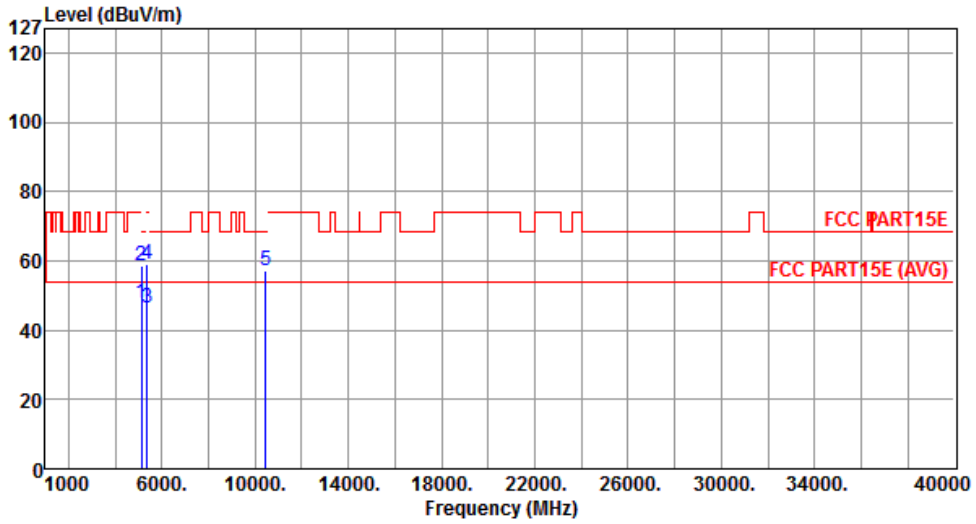

	Freq. MHz	Emission level dBuV/m	Limit dBuV/m	Margin dB	SA reading dBuV	Factor dB	Remark	ANT High cm	Turn Table deg
1	5140.00	47.81	54.00	-6.19	42.12	5.69	Average	---	---
2	5140.00	58.80	74.00	-15.20	53.11	5.69	Peak	---	---
3	5350.00	46.47	54.00	-7.53	40.48	5.99	Average	---	---
4	5350.00	59.18	74.00	-14.82	53.19	5.99	Peak	---	---
5	10460.00	57.28	68.20	-10.92	42.68	14.60	Peak	---	---

Note 1: Emission Level (dBuV/m) = SA Reading (dBuV/m) + Factor\* (dB)

\*Factor includes antenna factor , cable loss and amplifier gain

Note 2: Margin (dB) = Emission level (dBuV/m) – Limit (dBuV/m).

### 3.6.8 Transmitter Radiated Unwanted Emissions (Above 1GHz) for VHT80

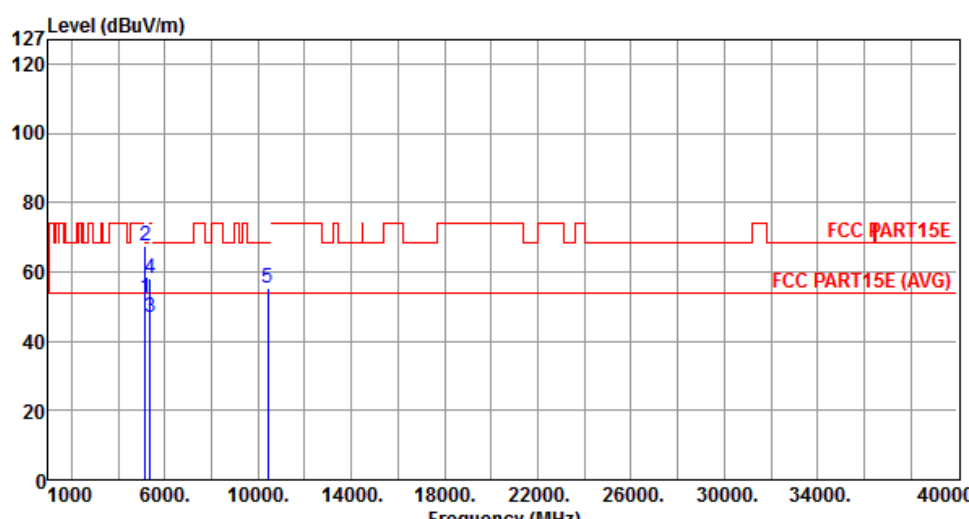
Modulation	VHT80	Test Freq. (MHz)	5210																																																																
Polarization	Horizontal	Test Configuration	1																																																																
																																																																			
	<table border="1"> <thead> <tr> <th>Freq.</th> <th>Emission level</th> <th>Limit</th> <th>Margin</th> <th>SA reading</th> <th>Factor</th> <th>Remark</th> <th>ANT High</th> <th>Turn Table</th> </tr> <tr> <th>MHz</th> <th>dBuV/m</th> <th>dBuV/m</th> <th>dB</th> <th>dBuV</th> <th>dB</th> <th></th> <th>cm</th> <th>deg</th> </tr> </thead> <tbody> <tr> <td>1</td> <td>5150.00</td> <td>52.71</td> <td>54.00</td> <td>-1.29</td> <td>47.00</td> <td>5.71</td> <td>Average</td> <td>---</td> </tr> <tr> <td>2</td> <td>5150.00</td> <td>67.36</td> <td>74.00</td> <td>-6.64</td> <td>61.65</td> <td>5.71</td> <td>Peak</td> <td>---</td> </tr> <tr> <td>3</td> <td>5350.00</td> <td>46.87</td> <td>54.00</td> <td>-7.13</td> <td>40.88</td> <td>5.99</td> <td>Average</td> <td>---</td> </tr> <tr> <td>4</td> <td>5350.00</td> <td>58.08</td> <td>74.00</td> <td>-15.92</td> <td>52.09</td> <td>5.99</td> <td>Peak</td> <td>---</td> </tr> <tr> <td>5</td> <td>10420.00</td> <td>55.48</td> <td>68.20</td> <td>-12.72</td> <td>40.94</td> <td>14.54</td> <td>Peak</td> <td>---</td> </tr> </tbody> </table>	Freq.	Emission level	Limit	Margin	SA reading	Factor	Remark	ANT High	Turn Table	MHz	dBuV/m	dBuV/m	dB	dBuV	dB		cm	deg	1	5150.00	52.71	54.00	-1.29	47.00	5.71	Average	---	2	5150.00	67.36	74.00	-6.64	61.65	5.71	Peak	---	3	5350.00	46.87	54.00	-7.13	40.88	5.99	Average	---	4	5350.00	58.08	74.00	-15.92	52.09	5.99	Peak	---	5	10420.00	55.48	68.20	-12.72	40.94	14.54	Peak	---			
Freq.	Emission level	Limit	Margin	SA reading	Factor	Remark	ANT High	Turn Table																																																											
MHz	dBuV/m	dBuV/m	dB	dBuV	dB		cm	deg																																																											
1	5150.00	52.71	54.00	-1.29	47.00	5.71	Average	---																																																											
2	5150.00	67.36	74.00	-6.64	61.65	5.71	Peak	---																																																											
3	5350.00	46.87	54.00	-7.13	40.88	5.99	Average	---																																																											
4	5350.00	58.08	74.00	-15.92	52.09	5.99	Peak	---																																																											
5	10420.00	55.48	68.20	-12.72	40.94	14.54	Peak	---																																																											
<p>Note 1: Emission Level (dBuV/m) = SA Reading (dBuV/m) + Factor* (dB)            *Factor includes antenna factor , cable loss and amplifier gain            Note 2: Margin (dB) = Emission level (dBuV/m) – Limit (dBuV/m).</p>																																																																			

<b>Modulation</b>	VHT80	<b>Test Freq. (MHz)</b>	5210
<b>Polarization</b>	Vertical	<b>Test Configuration</b>	1

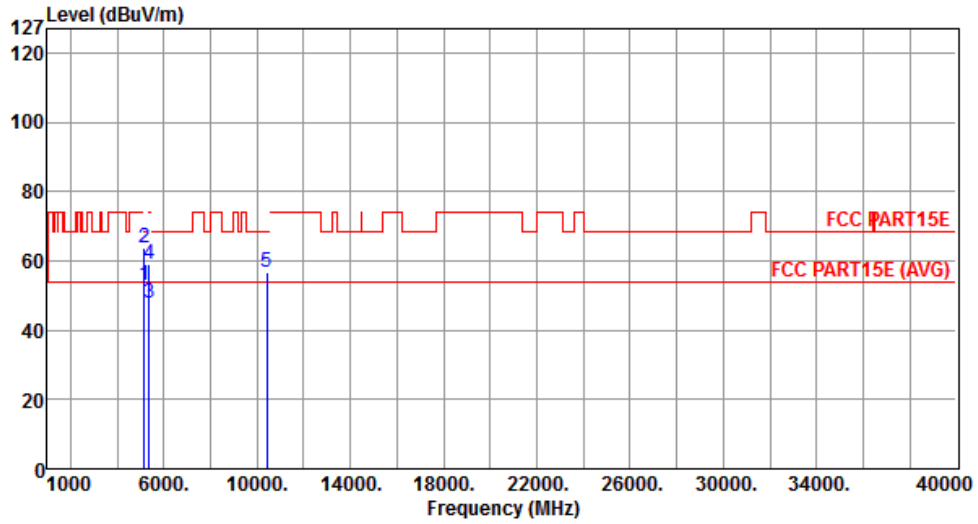

	Freq. MHz	Emission level dBuV/m	Limit dBuV/m	Margin dB	SA reading dBuV	Factor dB	Remark	ANT High cm	Turn Table deg
1	5150.00	53.00	54.00	-1.00	47.29	5.71	Average	---	---
2	5150.00	63.95	74.00	-10.05	58.24	5.71	Peak	---	---
3	5350.00	48.01	54.00	-5.99	42.02	5.99	Average	---	---
4	5350.00	59.06	74.00	-14.94	53.07	5.99	Peak	---	---
5	10420.00	56.62	68.20	-11.58	42.08	14.54	Peak	---	---

Note 1: Emission Level (dBuV/m) = SA Reading (dBuV/m) + Factor\* (dB)

\*Factor includes antenna factor , cable loss and amplifier gain

Note 2: Margin (dB) = Emission level (dBuV/m) – Limit (dBuV/m).

## Legacy/MIMO (CDD) beamforming mode

### 3.6.9 Transmitter Radiated Unwanted Emissions (Above 1GHz) for 11a

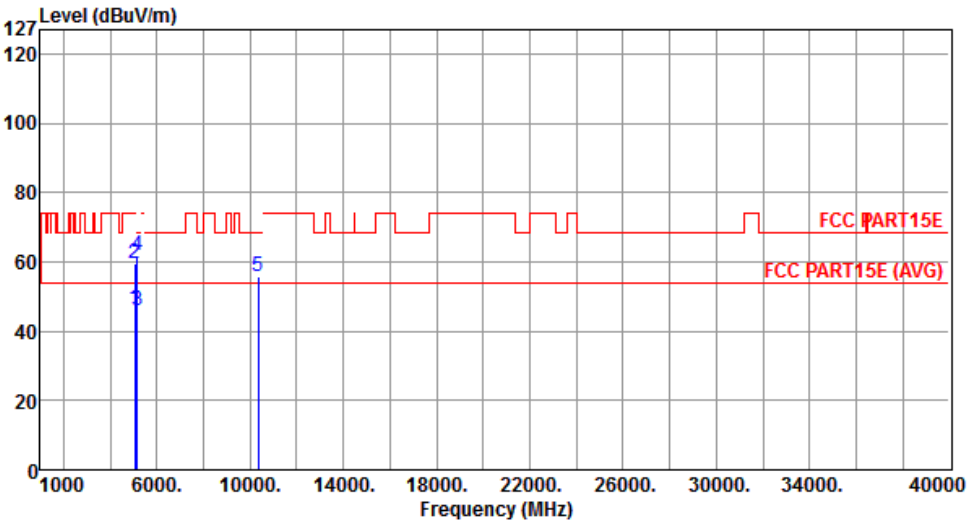
Modulation	11a	Test Freq. (MHz)	5180																																																							
Polarization	Horizontal	Test Configuration	3																																																							
																																																										
	<table border="1"> <thead> <tr> <th>Freq. MHz</th> <th>Emission level dBuV/m</th> <th>Limit dBuV/m</th> <th>Margin dB</th> <th>SA reading dBuV</th> <th>Factor dB</th> <th>Remark</th> <th>ANT High cm</th> <th>Turn Table deg</th> </tr> </thead> <tbody> <tr> <td>1</td> <td>5057.00</td> <td>46.20</td> <td>54.00</td> <td>-7.80</td> <td>40.67</td> <td>5.53</td> <td>Average</td> <td>---</td> </tr> <tr> <td>2</td> <td>5057.00</td> <td>59.30</td> <td>74.00</td> <td>-14.70</td> <td>53.77</td> <td>5.53</td> <td>Peak</td> <td>---</td> </tr> <tr> <td>3</td> <td>5150.00</td> <td>46.01</td> <td>54.00</td> <td>-7.99</td> <td>40.30</td> <td>5.71</td> <td>Average</td> <td>---</td> </tr> <tr> <td>4</td> <td>5150.00</td> <td>62.03</td> <td>74.00</td> <td>-11.97</td> <td>56.32</td> <td>5.71</td> <td>Peak</td> <td>---</td> </tr> <tr> <td>5</td> <td>10360.00</td> <td>55.65</td> <td>68.20</td> <td>-12.55</td> <td>41.21</td> <td>14.44</td> <td>Peak</td> <td>---</td> </tr> </tbody> </table>	Freq. MHz	Emission level dBuV/m	Limit dBuV/m	Margin dB	SA reading dBuV	Factor dB	Remark	ANT High cm	Turn Table deg	1	5057.00	46.20	54.00	-7.80	40.67	5.53	Average	---	2	5057.00	59.30	74.00	-14.70	53.77	5.53	Peak	---	3	5150.00	46.01	54.00	-7.99	40.30	5.71	Average	---	4	5150.00	62.03	74.00	-11.97	56.32	5.71	Peak	---	5	10360.00	55.65	68.20	-12.55	41.21	14.44	Peak	---			
Freq. MHz	Emission level dBuV/m	Limit dBuV/m	Margin dB	SA reading dBuV	Factor dB	Remark	ANT High cm	Turn Table deg																																																		
1	5057.00	46.20	54.00	-7.80	40.67	5.53	Average	---																																																		
2	5057.00	59.30	74.00	-14.70	53.77	5.53	Peak	---																																																		
3	5150.00	46.01	54.00	-7.99	40.30	5.71	Average	---																																																		
4	5150.00	62.03	74.00	-11.97	56.32	5.71	Peak	---																																																		
5	10360.00	55.65	68.20	-12.55	41.21	14.44	Peak	---																																																		
<p>Note 1: Emission Level (dBuV/m) = SA Reading (dBuV/m) + Factor* (dB)            *Factor includes antenna factor , cable loss and amplifier gain            Note 2: Margin (dB) = Emission level (dBuV/m) – Limit (dBuV/m).</p>																																																										

<b>Modulation</b>	11a	<b>Test Freq. (MHz)</b>	5180
<b>Polarization</b>	Vertical	<b>Test Configuration</b>	3

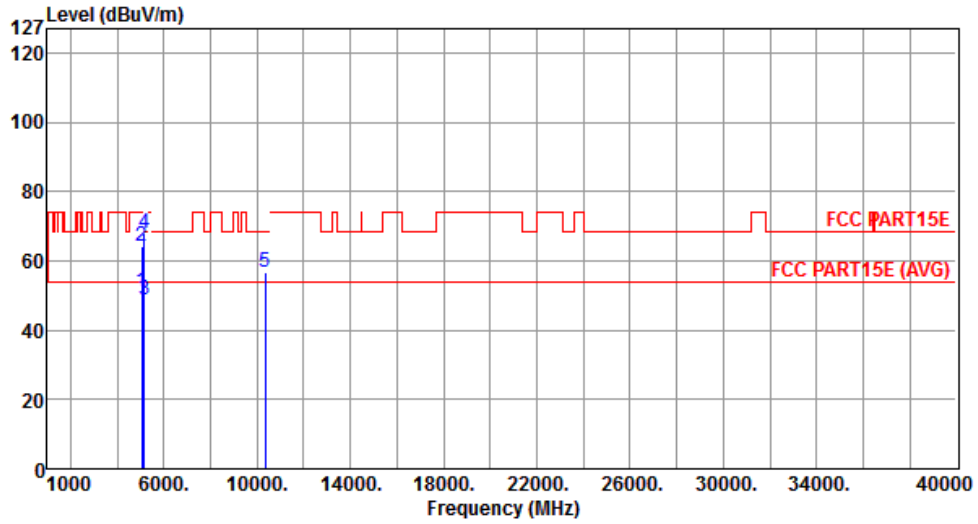

	Freq. MHz	Emission level dBuV/m	Limit dBuV/m	Margin dB	SA reading dBuV	Factor dB	Remark	ANT High cm	Turn Table deg
1	5057.00	51.28	54.00	-2.72	45.75	5.53	Average	---	---
2	5057.00	64.36	74.00	-9.64	58.83	5.53	Peak	---	---
3	5150.00	48.90	54.00	-5.10	43.19	5.71	Average	---	---
4	5150.00	67.74	74.00	-6.26	62.03	5.71	Peak	---	---
5	10360.00	56.77	68.20	-11.43	42.33	14.44	Peak	---	---

Note 1: Emission Level (dBuV/m) = SA Reading (dBuV/m) + Factor\* (dB)

\*Factor includes antenna factor , cable loss and amplifier gain

Note 2: Margin (dB) = Emission level (dBuV/m) – Limit (dBuV/m).

<b>Modulation</b>	11a	<b>Test Freq. (MHz)</b>	5200
<b>Polarization</b>	Horizontal	<b>Test Configuration</b>	3

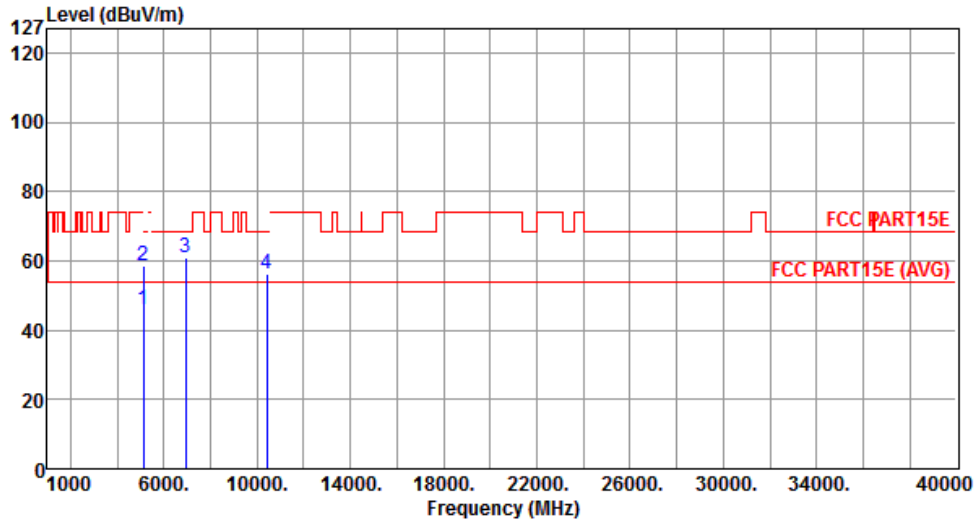

	Freq. MHz	Emission level dBuV/m	Limit dBuV/m	Margin dB	SA reading dBuV	Factor dB	Remark	ANT High cm	Turn Table deg
1	5118.00	45.88	54.00	-8.12	40.23	5.65	Average	---	---
2	5118.00	58.65	74.00	-15.35	53.00	5.65	Peak	---	---
3	6933.30	60.79	68.20	-7.41	50.96	9.83	Peak	---	---
4	10400.00	56.14	68.20	-12.06	41.64	14.50	Peak	---	---

Note 1: Emission Level (dBuV/m) = SA Reading (dBuV/m) + Factor\* (dB)

\*Factor includes antenna factor , cable loss and amplifier gain

Note 2: Margin (dB) = Emission level (dBuV/m) – Limit (dBuV/m).



<b>Modulation</b>	11a	<b>Test Freq. (MHz)</b>	5200
<b>Polarization</b>	Vertical	<b>Test Configuration</b>	3

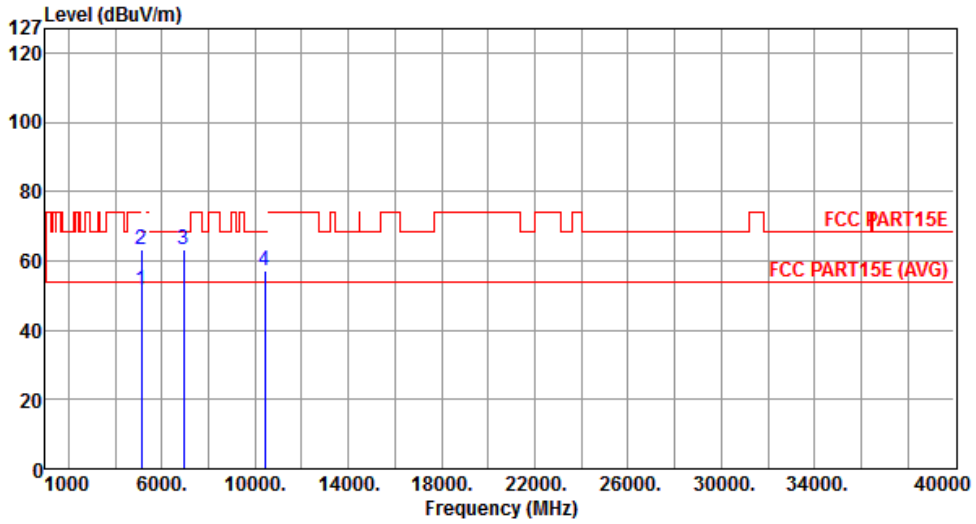

	Freq. MHz	Emission level dBuV/m	Limit dBuV/m	Margin dB	SA reading dBuV	Factor dB	Remark	ANT High cm	Turn Table deg
1	5118.00	51.43	54.00	-2.57	45.78	5.65	Average	---	---
2	5118.00	63.19	74.00	-10.81	57.54	5.65	Peak	---	---
3	6933.30	63.06	68.20	-5.14	53.23	9.83	Peak	---	---
4	10400.00	57.29	68.20	-10.91	42.79	14.50	Peak	---	---

Note 1: Emission Level (dBuV/m) = SA Reading (dBuV/m) + Factor\* (dB)

\*Factor includes antenna factor , cable loss and amplifier gain

Note 2: Margin (dB) = Emission level (dBuV/m) – Limit (dBuV/m).

<b>Modulation</b>	11a	<b>Test Freq. (MHz)</b>	5240
<b>Polarization</b>	Horizontal	<b>Test Configuration</b>	3

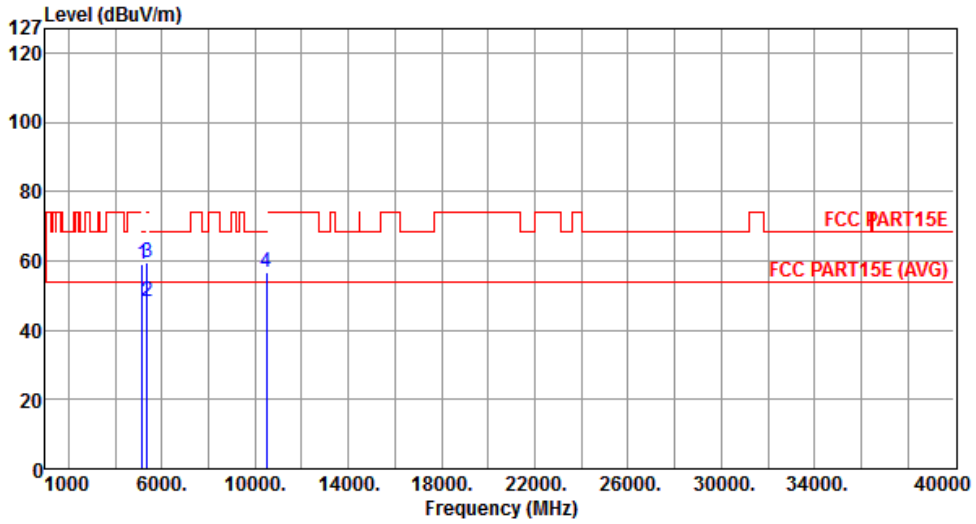

	Freq. MHz	Emission level dBuV/m	Limit dBuV/m	Margin dB	SA reading dBuV	Factor dB	Remark	ANT High cm	Turn Table deg
1	5164.00	59.13	68.20	-9.07	53.39	5.74	Peak	---	---
2	5350.00	48.09	54.00	-5.91	42.10	5.99	Average	---	---
3	5350.00	59.53	74.00	-14.47	53.54	5.99	Peak	---	---
4	10480.00	56.68	68.20	-11.52	42.05	14.63	Peak	---	---

Note 1: Emission Level (dBuV/m) = SA Reading (dBuV/m) + Factor\* (dB)

\*Factor includes antenna factor , cable loss and amplifier gain

Note 2: Margin (dB) = Emission level (dBuV/m) – Limit (dBuV/m).

<b>Modulation</b>	11a	<b>Test Freq. (MHz)</b>	5240
<b>Polarization</b>	Vertical	<b>Test Configuration</b>	3

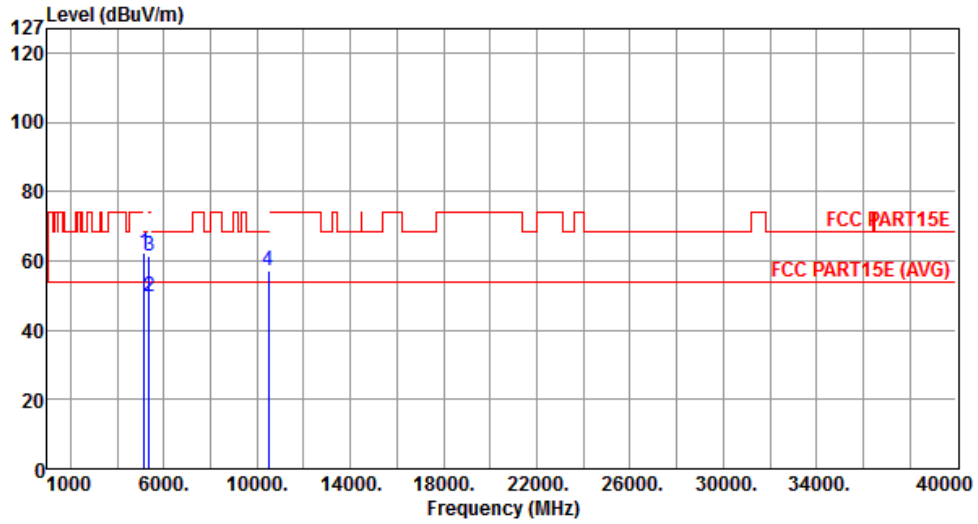

	Freq. MHz	Emission level dBuV/m	Limit dBuV/m	Margin dB	SA reading dBuV	Factor dB	Remark	ANT High cm	Turn Table deg
1	5164.00	62.48	68.20	-5.72	56.74	5.74	Peak	---	---
2	5350.00	49.89	54.00	-4.11	43.90	5.99	Average	---	---
3	5350.00	61.39	74.00	-12.61	55.40	5.99	Peak	---	---
4	10480.00	57.02	68.20	-11.18	42.39	14.63	Peak	---	---

Note 1: Emission Level (dBuV/m) = SA Reading (dBuV/m) + Factor\* (dB)

\*Factor includes antenna factor , cable loss and amplifier gain

Note 2: Margin (dB) = Emission level (dBuV/m) – Limit (dBuV/m).

### 3.6.10 Transmitter Radiated Unwanted Emissions (Above 1GHz) for VHT20

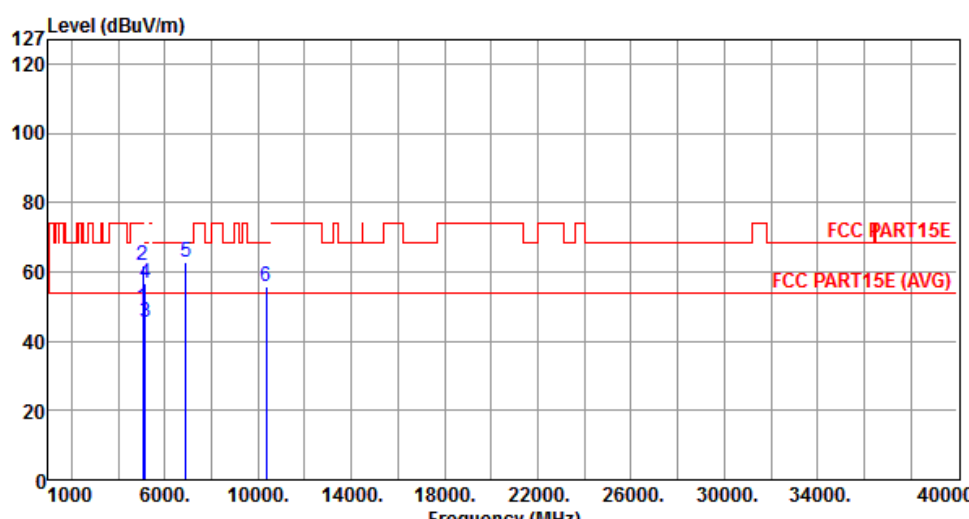
Modulation	VHT20	Test Freq. (MHz)	5180																																																																									
Polarization	Horizontal	Test Configuration	3																																																																									
																																																																												
	<table border="1"> <thead> <tr> <th>Freq.</th> <th>Emission level</th> <th>Limit</th> <th>Margin</th> <th>SA reading</th> <th>Factor</th> <th>Remark</th> <th>ANT High</th> <th>Turn Table</th> </tr> <tr> <th>MHz</th> <th>dBuV/m</th> <th>dBuV/m</th> <th>dB</th> <th>dBuV</th> <th>dB</th> <th></th> <th>cm</th> <th>deg</th> </tr> </thead> <tbody> <tr> <td>1</td> <td>5062.00</td> <td>49.72</td> <td>54.00</td> <td>-4.28</td> <td>44.18</td> <td>5.54</td> <td>Average</td> <td>---</td> </tr> <tr> <td>2</td> <td>5062.00</td> <td>61.91</td> <td>74.00</td> <td>-12.09</td> <td>56.37</td> <td>5.54</td> <td>Peak</td> <td>---</td> </tr> <tr> <td>3</td> <td>5150.00</td> <td>45.46</td> <td>54.00</td> <td>-8.54</td> <td>39.75</td> <td>5.71</td> <td>Average</td> <td>---</td> </tr> <tr> <td>4</td> <td>5150.00</td> <td>56.66</td> <td>74.00</td> <td>-17.34</td> <td>50.95</td> <td>5.71</td> <td>Peak</td> <td>---</td> </tr> <tr> <td>5</td> <td>6906.66</td> <td>62.64</td> <td>68.20</td> <td>-5.56</td> <td>52.92</td> <td>9.72</td> <td>Peak</td> <td>---</td> </tr> <tr> <td>6</td> <td>10360.00</td> <td>55.71</td> <td>68.20</td> <td>-12.49</td> <td>41.27</td> <td>14.44</td> <td>Peak</td> <td>---</td> </tr> </tbody> </table>	Freq.	Emission level	Limit	Margin	SA reading	Factor	Remark	ANT High	Turn Table	MHz	dBuV/m	dBuV/m	dB	dBuV	dB		cm	deg	1	5062.00	49.72	54.00	-4.28	44.18	5.54	Average	---	2	5062.00	61.91	74.00	-12.09	56.37	5.54	Peak	---	3	5150.00	45.46	54.00	-8.54	39.75	5.71	Average	---	4	5150.00	56.66	74.00	-17.34	50.95	5.71	Peak	---	5	6906.66	62.64	68.20	-5.56	52.92	9.72	Peak	---	6	10360.00	55.71	68.20	-12.49	41.27	14.44	Peak	---			
Freq.	Emission level	Limit	Margin	SA reading	Factor	Remark	ANT High	Turn Table																																																																				
MHz	dBuV/m	dBuV/m	dB	dBuV	dB		cm	deg																																																																				
1	5062.00	49.72	54.00	-4.28	44.18	5.54	Average	---																																																																				
2	5062.00	61.91	74.00	-12.09	56.37	5.54	Peak	---																																																																				
3	5150.00	45.46	54.00	-8.54	39.75	5.71	Average	---																																																																				
4	5150.00	56.66	74.00	-17.34	50.95	5.71	Peak	---																																																																				
5	6906.66	62.64	68.20	-5.56	52.92	9.72	Peak	---																																																																				
6	10360.00	55.71	68.20	-12.49	41.27	14.44	Peak	---																																																																				
<p>Note 1: Emission Level (dBuV/m) = SA Reading (dBuV/m) + Factor* (dB)            *Factor includes antenna factor , cable loss and amplifier gain            Note 2: Margin (dB) = Emission level (dBuV/m) – Limit (dBuV/m).</p>																																																																												

<b>Modulation</b>	VHT20	<b>Test Freq. (MHz)</b>	5180
<b>Polarization</b>	Vertical	<b>Test Configuration</b>	3

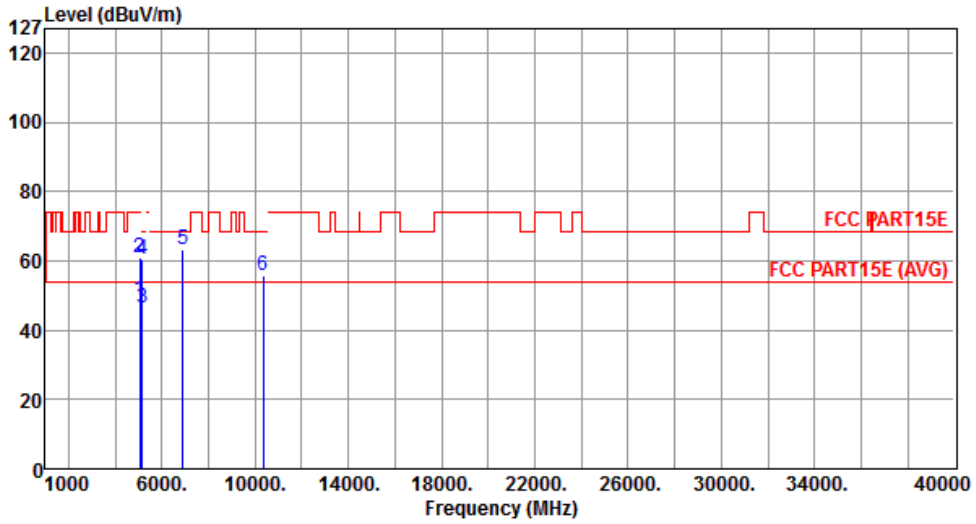

	Freq. MHz	Emission level dBuV/m	Limit dBuV/m	Margin dB	SA reading dBuV	Factor dB	Remark	ANT High cm	Turn Table deg
1	5062.00	48.66	54.00	-5.34	43.12	5.54	Average	---	---
2	5062.00	60.72	74.00	-13.28	55.18	5.54	Peak	---	---
3	5150.00	46.56	54.00	-7.44	40.85	5.71	Average	---	---
4	5150.00	60.33	74.00	-13.67	54.62	5.71	Peak	---	---
5	6906.66	63.32	68.20	-4.88	53.60	9.72	Peak	---	---
6	10360.00	55.57	68.20	-12.63	41.13	14.44	Peak	---	---

Note 1: Emission Level (dBuV/m) = SA Reading (dBuV/m) + Factor\* (dB)

\*Factor includes antenna factor , cable loss and amplifier gain

Note 2: Margin (dB) = Emission level (dBuV/m) – Limit (dBuV/m).

<b>Modulation</b>	VHT20	<b>Test Freq. (MHz)</b>	5200
<b>Polarization</b>	Horizontal	<b>Test Configuration</b>	3

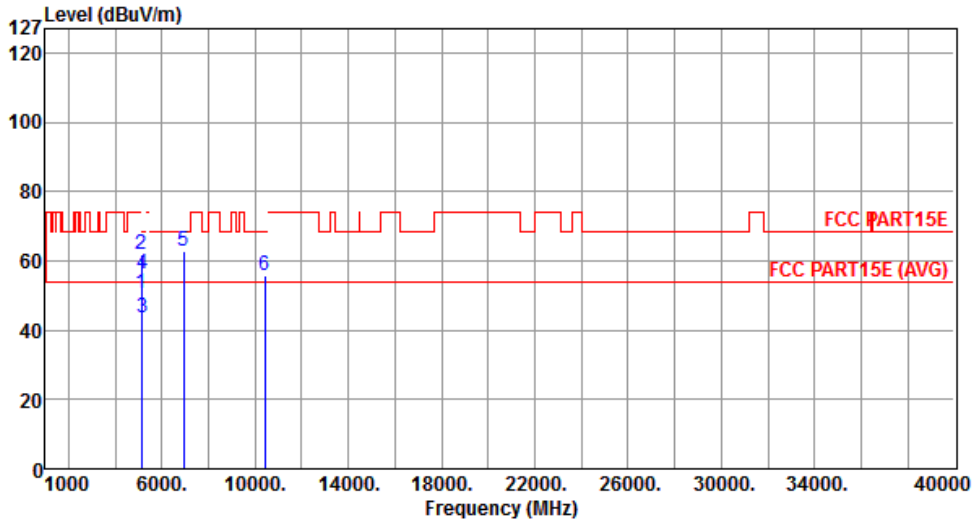

	Freq. MHz	Emission level dBuV/m	Limit dBuV/m	Margin dB	SA reading dBuV	Factor dB	Remark	ANT High cm	Turn Table deg
1	5119.00	50.72	54.00	-3.28	45.07	5.65	Average	---	---
2	5119.00	62.06	74.00	-11.94	56.41	5.65	Peak	---	---
3	5150.00	43.65	54.00	-10.35	37.94	5.71	Average	---	---
4	5150.00	56.32	74.00	-17.68	50.61	5.71	Peak	---	---
5	6933.33	62.70	68.20	-5.50	52.87	9.83	Peak	---	---
6	10400.00	55.89	68.20	-12.31	41.39	14.50	Peak	---	---

Note 1: Emission Level (dBuV/m) = SA Reading (dBuV/m) + Factor\* (dB)

\*Factor includes antenna factor , cable loss and amplifier gain

Note 2: Margin (dB) = Emission level (dBuV/m) – Limit (dBuV/m).

<b>Modulation</b>	VHT20	<b>Test Freq. (MHz)</b>	5200
<b>Polarization</b>	Vertical	<b>Test Configuration</b>	3

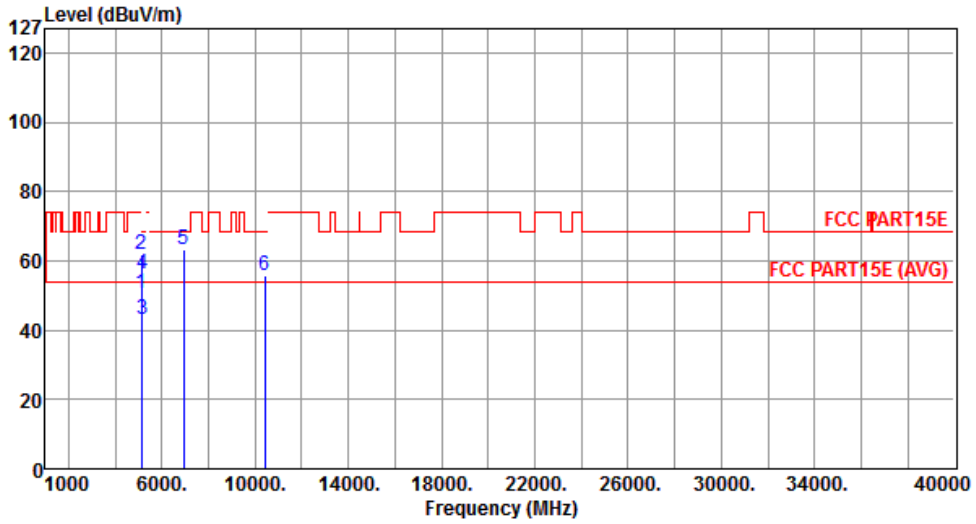

	Freq. MHz	Emission level dBuV/m	Limit dBuV/m	Margin dB	SA reading dBuV	Factor dB	Remark	ANT High cm	Turn Table deg
1	5119.00	50.74	54.00	-3.26	45.09	5.65	Average	---	---
2	5119.00	61.77	74.00	-12.23	56.12	5.65	Peak	---	---
3	5150.00	43.06	54.00	-10.94	37.35	5.71	Average	---	---
4	5150.00	56.03	74.00	-17.97	50.32	5.71	Peak	---	---
5	6933.33	63.34	68.20	-4.86	53.51	9.83	Peak	---	---
6	10400.00	55.57	68.20	-12.63	41.07	14.50	Peak	---	---

Note 1: Emission Level (dBuV/m) = SA Reading (dBuV/m) + Factor\* (dB)

\*Factor includes antenna factor , cable loss and amplifier gain

Note 2: Margin (dB) = Emission level (dBuV/m) – Limit (dBuV/m).

<b>Modulation</b>	VHT20	<b>Test Freq. (MHz)</b>	5240
<b>Polarization</b>	Horizontal	<b>Test Configuration</b>	3

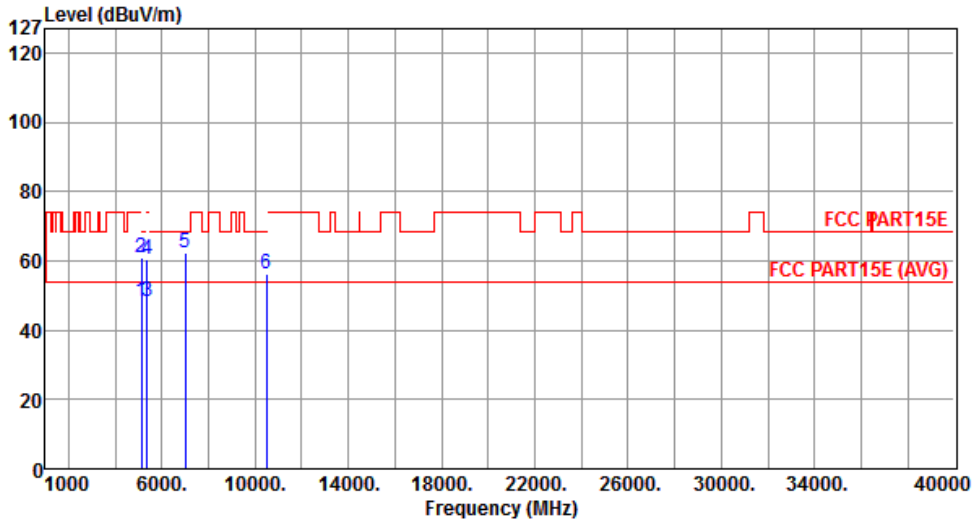

	Freq. MHz	Emission level dBuV/m	Limit dBuV/m	Margin dB	SA reading dBuV	Factor dB	Remark	ANT High cm	Turn Table deg
1	5120.00	48.27	54.00	-5.73	42.62	5.65	Average	---	---
2	5120.00	60.89	74.00	-13.11	55.24	5.65	Peak	---	---
3	5361.00	48.17	54.00	-5.83	42.17	6.00	Average	---	---
4	5361.00	60.22	74.00	-13.78	54.22	6.00	Peak	---	---
5	6986.66	62.46	68.20	-5.74	52.41	10.05	Peak	---	---
6	10480.00	56.47	68.20	-11.73	41.84	14.63	Peak	---	---

Note 1: Emission Level (dBuV/m) = SA Reading (dBuV/m) + Factor\* (dB)

\*Factor includes antenna factor , cable loss and amplifier gain

Note 2: Margin (dB) = Emission level (dBuV/m) – Limit (dBuV/m).



<b>Modulation</b>	VHT20	<b>Test Freq. (MHz)</b>	5240
<b>Polarization</b>	Vertical	<b>Test Configuration</b>	3

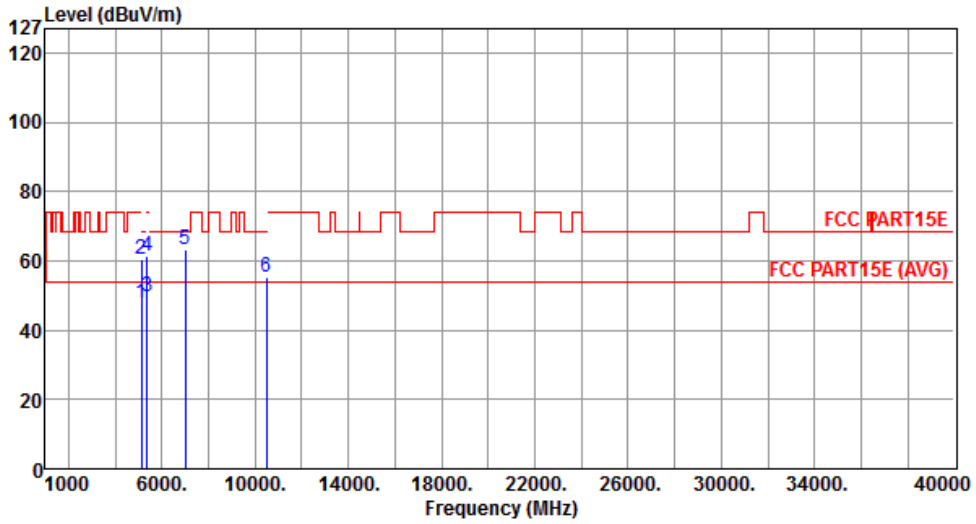

	Freq. MHz	Emission level dBuV/m	Limit dBuV/m	Margin dB	SA reading dBuV	Factor dB	Remark	ANT High cm	Turn Table deg
1	5120.00	48.01	54.00	-5.99	42.36	5.65	Average	---	---
2	5120.00	60.63	74.00	-13.37	54.98	5.65	Peak	---	---
3	5361.00	49.76	54.00	-4.24	43.76	6.00	Average	---	---
4	5361.00	61.24	74.00	-12.76	55.24	6.00	Peak	---	---
5	6986.66	63.33	68.20	-4.87	53.28	10.05	Peak	---	---
6	10480.00	55.48	68.20	-12.72	40.85	14.63	Peak	---	---

Note 1: Emission Level (dBuV/m) = SA Reading (dBuV/m) + Factor\* (dB)

\*Factor includes antenna factor , cable loss and amplifier gain

Note 2: Margin (dB) = Emission level (dBuV/m) – Limit (dBuV/m).

### 3.6.11 Transmitter Radiated Unwanted Emissions (Above 1GHz) for VHT40

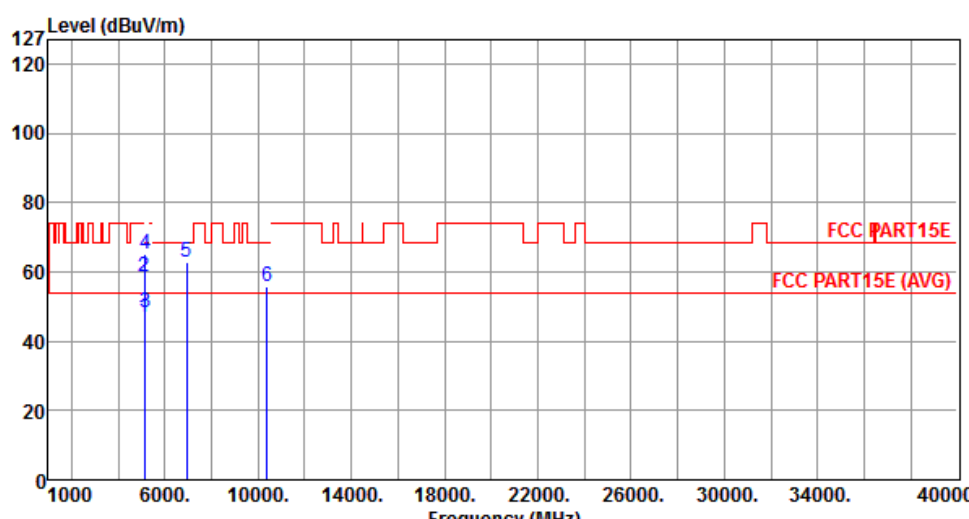
Modulation	VHT40	Test Freq. (MHz)	5190																																																																													
Polarization	Horizontal	Test Configuration	3																																																																													
																																																																																
	<table border="1"> <thead> <tr> <th>Freq.</th> <th>Emission level</th> <th>Limit</th> <th>Margin</th> <th>SA reading</th> <th>Factor</th> <th>Remark</th> <th>ANT High</th> <th>Turn Table</th> </tr> <tr> <th>MHz</th> <th>dBuV/m</th> <th>dBuV/m</th> <th>dB</th> <th>dBuV</th> <th>dB</th> <th></th> <th>cm</th> <th>deg</th> </tr> </thead> <tbody> <tr> <td>1</td> <td>5127.00</td> <td>46.85</td> <td>54.00</td> <td>-7.15</td> <td>41.19</td> <td>5.66</td> <td>Average</td> <td>---</td> </tr> <tr> <td>2</td> <td>5127.00</td> <td>58.36</td> <td>74.00</td> <td>-15.64</td> <td>52.70</td> <td>5.66</td> <td>Peak</td> <td>---</td> </tr> <tr> <td>3</td> <td>5150.00</td> <td>48.24</td> <td>54.00</td> <td>-5.76</td> <td>42.53</td> <td>5.71</td> <td>Average</td> <td>---</td> </tr> <tr> <td>4</td> <td>5150.00</td> <td>65.14</td> <td>74.00</td> <td>-8.86</td> <td>59.43</td> <td>5.71</td> <td>Peak</td> <td>---</td> </tr> <tr> <td>5</td> <td>6920.00</td> <td>62.81</td> <td>68.20</td> <td>-5.39</td> <td>53.04</td> <td>9.77</td> <td>Peak</td> <td>---</td> </tr> <tr> <td>6</td> <td>10380.00</td> <td>55.82</td> <td>68.20</td> <td>-12.38</td> <td>41.36</td> <td>14.46</td> <td>Peak</td> <td>---</td> </tr> </tbody> </table>	Freq.	Emission level	Limit	Margin	SA reading	Factor	Remark	ANT High	Turn Table	MHz	dBuV/m	dBuV/m	dB	dBuV	dB		cm	deg	1	5127.00	46.85	54.00	-7.15	41.19	5.66	Average	---	2	5127.00	58.36	74.00	-15.64	52.70	5.66	Peak	---	3	5150.00	48.24	54.00	-5.76	42.53	5.71	Average	---	4	5150.00	65.14	74.00	-8.86	59.43	5.71	Peak	---	5	6920.00	62.81	68.20	-5.39	53.04	9.77	Peak	---	6	10380.00	55.82	68.20	-12.38	41.36	14.46	Peak	---							
Freq.	Emission level	Limit	Margin	SA reading	Factor	Remark	ANT High	Turn Table																																																																								
MHz	dBuV/m	dBuV/m	dB	dBuV	dB		cm	deg																																																																								
1	5127.00	46.85	54.00	-7.15	41.19	5.66	Average	---																																																																								
2	5127.00	58.36	74.00	-15.64	52.70	5.66	Peak	---																																																																								
3	5150.00	48.24	54.00	-5.76	42.53	5.71	Average	---																																																																								
4	5150.00	65.14	74.00	-8.86	59.43	5.71	Peak	---																																																																								
5	6920.00	62.81	68.20	-5.39	53.04	9.77	Peak	---																																																																								
6	10380.00	55.82	68.20	-12.38	41.36	14.46	Peak	---																																																																								
<p>Note 1: Emission Level (dBuV/m) = SA Reading (dBuV/m) + Factor* (dB)            *Factor includes antenna factor , cable loss and amplifier gain            Note 2: Margin (dB) = Emission level (dBuV/m) – Limit (dBuV/m).</p>																																																																																

<b>Modulation</b>	VHT40	<b>Test Freq. (MHz)</b>	5190
<b>Polarization</b>	Vertical	<b>Test Configuration</b>	3

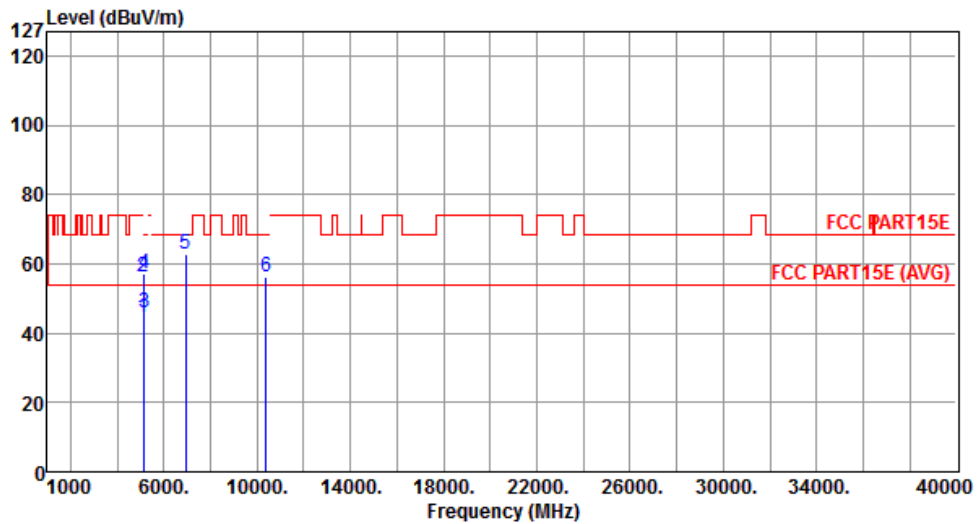

	Freq. MHz	Emission level dBuV/m	Limit dBuV/m	Margin dB	SA reading dBuV	Factor dB	Remark	ANT High cm	Turn Table deg
1	5127.00	44.34	54.00	-9.66	38.68	5.66	Average	---	---
2	5127.00	56.36	74.00	-17.64	50.70	5.66	Peak	---	---
3	5150.00	45.92	54.00	-8.08	40.21	5.71	Average	---	---
4	5150.00	56.96	74.00	-17.04	51.25	5.71	Peak	---	---
5	6920.00	62.68	68.20	-5.52	52.91	9.77	Peak	---	---
6	10380.00	56.37	68.20	-11.83	41.91	14.46	Peak	---	---

Note 1: Emission Level (dBuV/m) = SA Reading (dBuV/m) + Factor\* (dB)

\*Factor includes antenna factor , cable loss and amplifier gain

Note 2: Margin (dB) = Emission level (dBuV/m) – Limit (dBuV/m).

<b>Modulation</b>	VHT40	<b>Test Freq. (MHz)</b>	5230
<b>Polarization</b>	Horizontal	<b>Test Configuration</b>	3

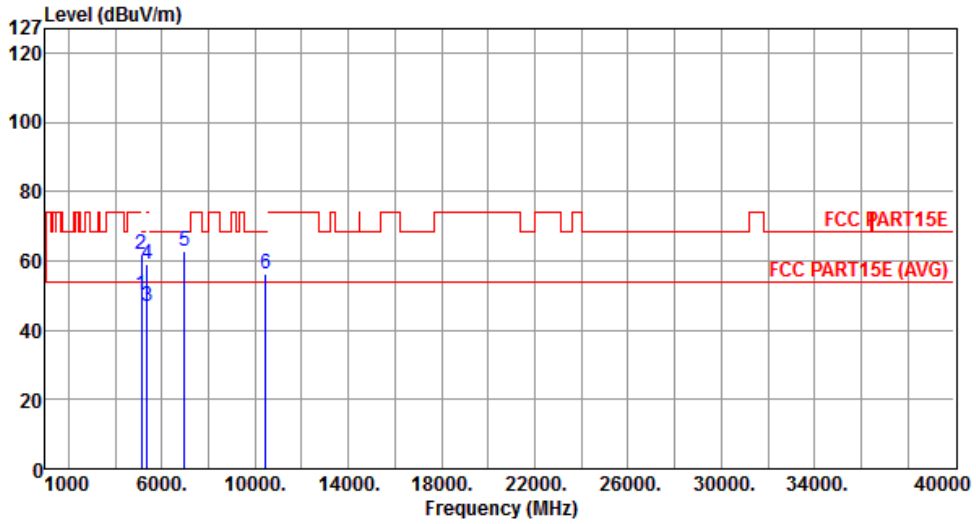

	Freq. MHz	Emission level dBuV/m	Limit dBuV/m	Margin dB	SA reading dBuV	Factor dB	Remark	ANT High cm	Turn Table deg
1	5140.00	50.34	54.00	-3.66	44.65	5.69	Average	---	---
2	5140.00	62.02	74.00	-11.98	56.33	5.69	Peak	---	---
3	5350.00	46.88	54.00	-7.12	40.89	5.99	Average	---	---
4	5350.00	59.12	74.00	-14.88	53.13	5.99	Peak	---	---
5	6973.33	62.89	68.20	-5.31	52.89	10.00	Peak	---	---
6	10460.00	56.14	68.20	-12.06	41.54	14.60	Peak	---	---

Note 1: Emission Level (dBuV/m) = SA Reading (dBuV/m) + Factor\* (dB)

\*Factor includes antenna factor , cable loss and amplifier gain

Note 2: Margin (dB) = Emission level (dBuV/m) – Limit (dBuV/m).

<b>Modulation</b>	VHT40	<b>Test Freq. (MHz)</b>	5230
<b>Polarization</b>	Vertical	<b>Test Configuration</b>	3

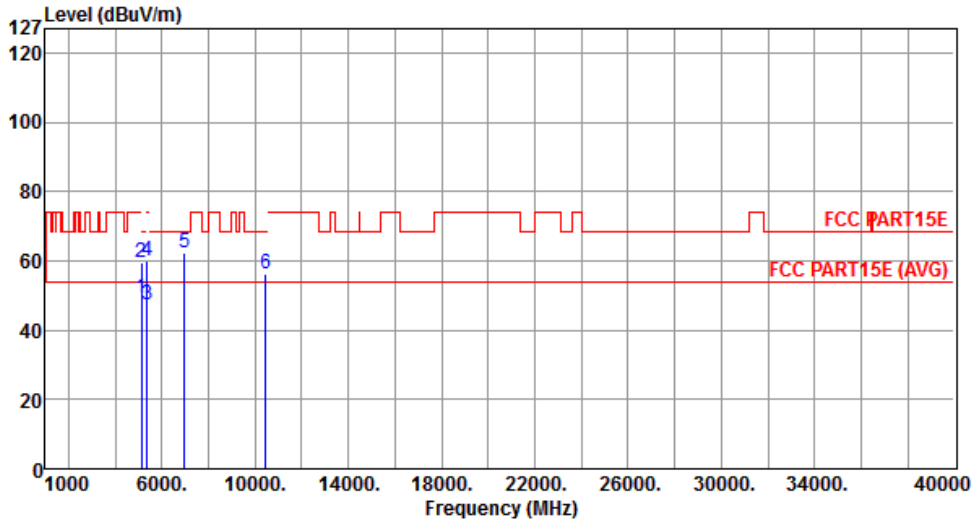

	Freq. MHz	Emission level dBuV/m	Limit dBuV/m	Margin dB	SA reading dBuV	Factor dB	Remark	ANT High cm	Turn Table deg
1	5140.00	49.21	54.00	-4.79	43.52	5.69	Average	---	---
2	5140.00	59.75	74.00	-14.25	54.06	5.69	Peak	---	---
3	5350.00	47.48	54.00	-6.52	41.49	5.99	Average	---	---
4	5350.00	59.84	74.00	-14.16	53.85	5.99	Peak	---	---
5	6973.33	62.46	68.20	-5.74	52.46	10.00	Peak	---	---
6	10460.00	56.47	68.20	-11.73	41.87	14.60	Peak	---	---

Note 1: Emission Level (dBuV/m) = SA Reading (dBuV/m) + Factor\* (dB)

\*Factor includes antenna factor , cable loss and amplifier gain

Note 2: Margin (dB) = Emission level (dBuV/m) – Limit (dBuV/m).

### 3.6.12 Transmitter Radiated Unwanted Emissions (Above 1GHz) for VHT80

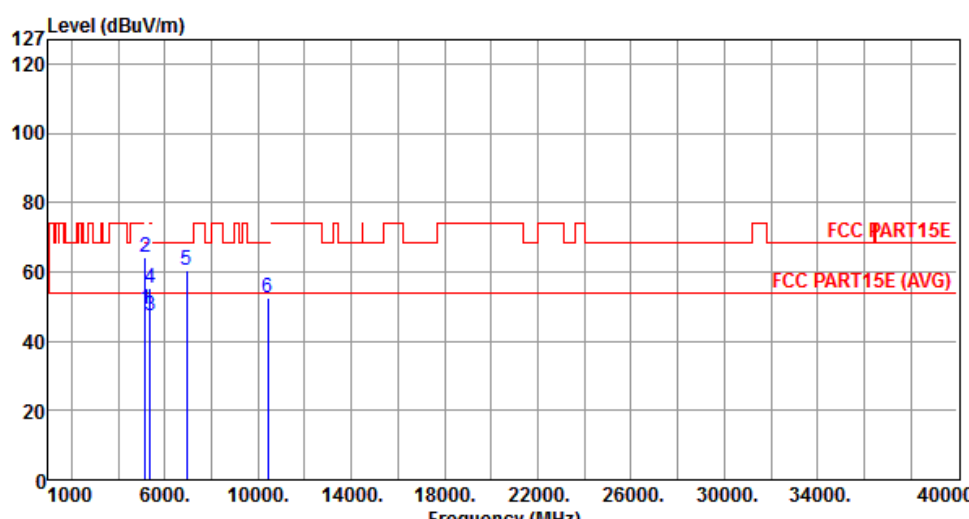
Modulation	VHT80	Test Freq. (MHz)	5210																																																																									
Polarization	Horizontal	Test Configuration	3																																																																									
																																																																												
	<table border="1"> <thead> <tr> <th>Freq.</th> <th>Emission level</th> <th>Limit</th> <th>Margin</th> <th>SA reading</th> <th>Factor</th> <th>Remark</th> <th>ANT High</th> <th>Turn Table</th> </tr> <tr> <th>MHz</th> <th>dBuV/m</th> <th>dBuV/m</th> <th>dB</th> <th>dBuV</th> <th>dB</th> <th></th> <th>cm</th> <th>deg</th> </tr> </thead> <tbody> <tr> <td>1</td> <td>5150.00</td> <td>49.39</td> <td>54.00</td> <td>-4.61</td> <td>43.68</td> <td>5.71</td> <td>Average</td> <td>---</td> </tr> <tr> <td>2</td> <td>5150.00</td> <td>64.15</td> <td>74.00</td> <td>-9.85</td> <td>58.44</td> <td>5.71</td> <td>Peak</td> <td>---</td> </tr> <tr> <td>3</td> <td>5350.00</td> <td>47.41</td> <td>54.00</td> <td>-6.59</td> <td>41.42</td> <td>5.99</td> <td>Average</td> <td>---</td> </tr> <tr> <td>4</td> <td>5350.00</td> <td>55.12</td> <td>74.00</td> <td>-18.88</td> <td>49.13</td> <td>5.99</td> <td>Peak</td> <td>---</td> </tr> <tr> <td>5</td> <td>6946.70</td> <td>60.51</td> <td>68.20</td> <td>-7.69</td> <td>50.62</td> <td>9.89</td> <td>Peak</td> <td>---</td> </tr> <tr> <td>6</td> <td>10420.00</td> <td>52.58</td> <td>68.20</td> <td>-15.62</td> <td>38.04</td> <td>14.54</td> <td>Peak</td> <td>---</td> </tr> </tbody> </table>	Freq.	Emission level	Limit	Margin	SA reading	Factor	Remark	ANT High	Turn Table	MHz	dBuV/m	dBuV/m	dB	dBuV	dB		cm	deg	1	5150.00	49.39	54.00	-4.61	43.68	5.71	Average	---	2	5150.00	64.15	74.00	-9.85	58.44	5.71	Peak	---	3	5350.00	47.41	54.00	-6.59	41.42	5.99	Average	---	4	5350.00	55.12	74.00	-18.88	49.13	5.99	Peak	---	5	6946.70	60.51	68.20	-7.69	50.62	9.89	Peak	---	6	10420.00	52.58	68.20	-15.62	38.04	14.54	Peak	---			
Freq.	Emission level	Limit	Margin	SA reading	Factor	Remark	ANT High	Turn Table																																																																				
MHz	dBuV/m	dBuV/m	dB	dBuV	dB		cm	deg																																																																				
1	5150.00	49.39	54.00	-4.61	43.68	5.71	Average	---																																																																				
2	5150.00	64.15	74.00	-9.85	58.44	5.71	Peak	---																																																																				
3	5350.00	47.41	54.00	-6.59	41.42	5.99	Average	---																																																																				
4	5350.00	55.12	74.00	-18.88	49.13	5.99	Peak	---																																																																				
5	6946.70	60.51	68.20	-7.69	50.62	9.89	Peak	---																																																																				
6	10420.00	52.58	68.20	-15.62	38.04	14.54	Peak	---																																																																				
<p>Note 1: Emission Level (dBuV/m) = SA Reading (dBuV/m) + Factor* (dB)            *Factor includes antenna factor , cable loss and amplifier gain            Note 2: Margin (dB) = Emission level (dBuV/m) – Limit (dBuV/m).</p>																																																																												

<b>Modulation</b>	VHT80	<b>Test Freq. (MHz)</b>	5210
<b>Polarization</b>	Vertical	<b>Test Configuration</b>	3

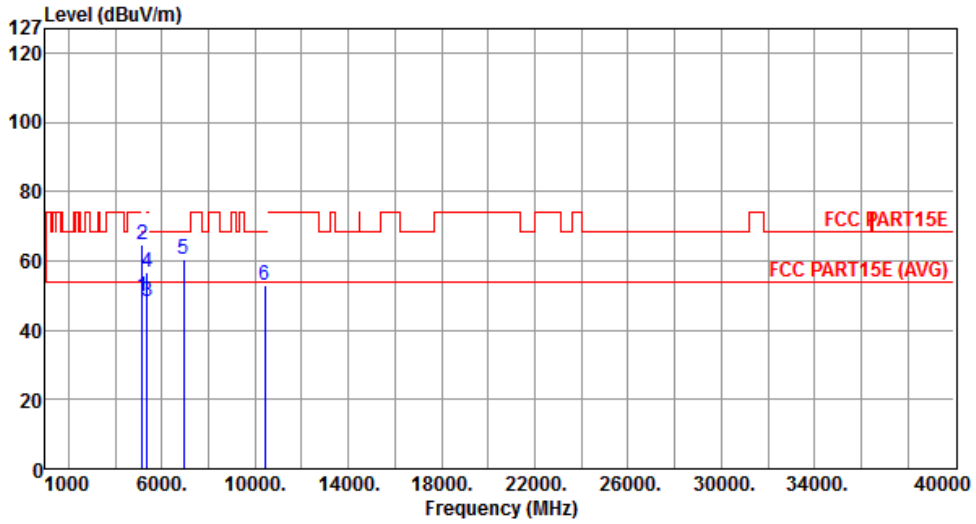

	Freq. MHz	Emission level dBuV/m	Limit dBuV/m	Margin dB	SA reading dBuV	Factor dB	Remark	ANT High cm	Turn Table deg
1	5150.00	49.57	54.00	-4.43	43.86	5.71	Average	---	---
2	5150.00	64.64	74.00	-9.36	58.93	5.71	Peak	---	---
3	5350.00	48.31	54.00	-5.69	42.32	5.99	Average	---	---
4	5350.00	56.52	74.00	-17.48	50.53	5.99	Peak	---	---
5	6946.70	60.38	68.20	-7.82	50.49	9.89	Peak	---	---
6	10420.00	53.12	68.20	-15.08	38.58	14.54	Peak	---	---

Note 1: Emission Level (dBuV/m) = SA Reading (dBuV/m) + Factor\* (dB)

\*Factor includes antenna factor , cable loss and amplifier gain

Note 2: Margin (dB) = Emission level (dBuV/m) – Limit (dBuV/m).

## 3.7 Frequency Stability

### 3.7.1 Limit of Frequency Stability

Manufacturers of U-NII devices are responsible for ensuring frequency stability such that an emission is maintained within the band of operation under all conditions of normal operation as specified in the user's manual.

### 3.7.2 Test Procedures

1. The EUT is installed in an environment test chamber with external power source.
2. Set the chamber to operate at 50 centigrade and external power source to output at nominal voltage of EUT.
3. A sufficient stabilization period at each temperature is used prior to each frequency measurement.
4. When temperature is stabled, measure the frequency stability.
5. The test shall be performed under -30 to 50 centigrade and 85 to 115 percent of the nominal voltage. Change setting of chamber and external power source to complete all conditions.

### 3.7.3 Test Setup

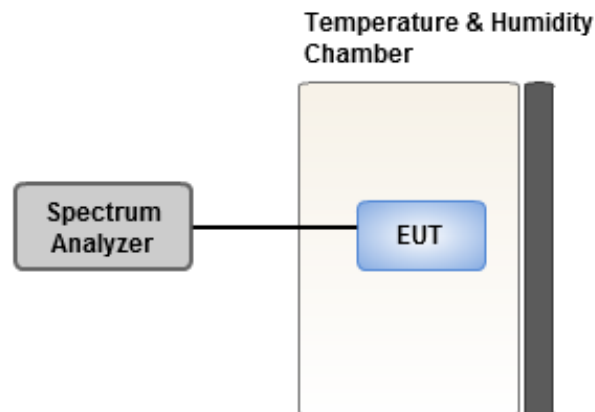



### 3.7.4 Test Result of Frequency Stability

#### Legacy/MIMO (CDD) Non- beamforming mode - Test Configuration 1

Frequency: 5200 MHz	Frequency Drift (ppm)			
Temperature (°C)	0 minute	2 minutes	5 minutes	10 minutes
T20°CVmax	2.77	2.58	3.09	2.90
T20°CVmin	4.57	4.39	4.13	3.90
T50°CVnom	3.99	3.57	3.50	3.68
T40°CVnom	-0.05	0.22	-0.14	-0.13
T30°CVnom	1.54	1.07	1.22	1.61
T20°CVnom	2.47	3.13	2.47	3.01
T10°CVnom	2.49	2.73	2.82	2.34
T0°CVnom	1.97	2.62	2.11	2.22
T-10°CVnom	2.49	2.35	2.18	2.70
T-20°CVnom	2.63	2.96	2.65	2.46
T-30°CVnom	2.24	2.35	2.93	2.53
Vnom [Vdc]: 110	Vmax [Vdc]: 126.5		Vmin [Vdc]: 93.5	
Tnom [°C]: 20	Tmax [°C]: 50		Tmin [°C]: -30	

#### Legacy/MIMO (CDD) beamforming mode - Test Configuration 3

Frequency: 5200 MHz	Frequency Drift (ppm)			
Temperature (°C)	0 minute	2 minutes	5 minutes	10 minutes
T20°CVmax	2.86	3.13	2.97	2.84
T20°CVmin	5.82	6.46	5.54	6.35
T50°CVnom	5.01	5.29	5.56	5.50
T40°CVnom	-1.17	-0.90	-1.27	-0.88
T30°CVnom	1.17	0.82	1.35	1.16
T20°CVnom	3.04	2.88	3.13	3.17
T10°CVnom	4.04	3.79	4.15	4.20
T0°CVnom	1.29	1.38	1.45	0.95
T-10°CVnom	2.08	1.87	2.58	2.01
T-20°CVnom	3.09	3.22	3.23	2.96
T-30°CVnom	1.81	2.13	1.69	1.83
Vnom [Vdc]: 110	Vmax [Vdc]: 126.5		Vmin [Vdc]: 93.5	
Tnom [°C]: 20	Tmax [°C]: 50		Tmin [°C]: -30	

## 4 Test laboratory information

Established in 2012, ICC provides foremost EMC & RF Testing and advisory consultation services by our skilled engineers and technicians. Our services employ a wide variety of advanced edge test equipment and one of the widest certification extents in the business.

International Certification Corp, it is our definitive objective is to institute long term, trust-based associations with our clients. The expectation we set up with our clients is based on outstanding service, practical expertise and devotion to a certified value structure. Our passion is to grant our clients with best EMC / RF services by oriented knowledgeable and accommodating staff.

Our Test sites are located at Linkou District and Kwei Shan Hsiang. Location map can be found on our website <http://www.icertifi.com.tw>.

### **Linkou**

Tel: 886-2-2601-1640

No. 30-2, Ding Fwu Tsuen, Lin Kou District, New Taipei City, Taiwan, R.O.C.

### **Kwei Shan**

Tel: 886-3-271-8666

No. 3-1, Lane 6, Wen San 3rd St., Kwei Shan Hsiang, Tao Yuan Hsien 333, Taiwan, R.O.C.

If you have any suggestion, please feel free to contact us as below information

Tel: 886-3-271-8666

Fax: 886-3-318-0155

Email: ICC\_Service@icertifi.com.tw

==END==