

FCC Test Report

FCC ID : WBV-AP230
Equipment : Access Point
Model No. : AP230
Brand Name : Aerohive
Applicant : Aerohive Networks Inc.
Address : 330 Gibraltar Drive, Sunnyvale, CA 94089
Standard : 47 CFR FCC Part 15.247
Received Date : Jan. 21, 2014
Tested Date : Jan. 21 ~ Feb. 21, 2014

We, International Certification Corp., would like to declare that the tested sample has been evaluated and in compliance with the requirement of the above standards. The test results contained in this report refer exclusively to the product. It may be duplicated completely for legal use with the approval of the applicant. It shall not be reproduced except in full without the written approval of our laboratory.

Approved & Reviewed by:



Gary Chang / Manager



Table of Contents

1	GENERAL DESCRIPTION	5
1.1	Information.....	5
1.2	Local Support Equipment List.....	7
1.3	Test Setup Chart.....	8
1.4	The Equipment List	10
1.5	Test Standards	11
1.6	Measurement Uncertainty	11
2	TEST CONFIGURATION.....	12
2.1	Testing Condition	12
2.2	The Worst Test Modes and Channel Details.....	12
3	TRANSMITTER TEST RESULTS	13
3.1	Conducted Emissions	13
3.2	6dB and Occupied Bandwidth	22
3.3	RF Output Power	27
3.4	Power Spectral Density	30
3.5	Unwanted Emissions into Restricted Frequency Bands	33
3.6	Unwanted Emissions into Non-Restricted Frequency Bands.....	75
4	TEST LABORATORY INFORMATION	94

Release Record

Report No.	Version	Description	Issued Date
FR412201AI	Rev. 01	Initial issue	Mar. 12, 2014

Summary of Test Results

FCC Rules	Test Items	Measured	Result
15.207	Conducted Emissions	[dBuV]: 0.168MHz 50.31 (Margin -4.77dB) - AV	Pass
15.247(d) 15.209	Radiated Emissions	[dBuV/m at 3m]: 40.42MHz 36.87 (Margin -3.13dB) - QP	Pass
15.247(b)(3)	Fundamental Emission Output Power	Power [dBm]: Non-beamforming mode 11a: 23.81 HT20: 25.02 HT40: 25.19 VHT20: 25.08 VHT40: 25.24 VHT80: 23.13 Beamforming mode 11a: 23.81 HT20: 25.09 HT40: 25.17 VHT20: 25.14 VHT40: 25.30 VHT80: 23.20	Pass
15.247(a)(2)	6dB Bandwidth	Meet the requirement of limit	Pass
15.247(e)	Power Spectral Density	Meet the requirement of limit	Pass
15.203	Antenna Requirement	Meet the requirement of limit	Pass

1 General Description

1.1 Information

1.1.1 Specification of the Equipment under Test (EUT)

RF General Information					
IEEE Std. 802.11	Frequency Range (MHz)	Ch. Freq. (MHz)	Channel Number	Transmit Chains (N _{TX})	Data Rate / MCS
a	5725-5850	5745-5825	149-165 [5]	1	6-54 Mbps
n (HT20)	5725-5850	5745-5825	149-165 [5]	3	MCS 0-23
n (HT40)	5725-5850	5755-5795	151-159 [2]	3	MCS 0-23
ac (VHT20)	5725-5850	5745-5825	149-165 [5]	3	MCS 0-8
ac (VHT40)	5725-5850	5755-5795	151-159 [2]	3	MCS 0-9
ac (VHT80)	5725-5850	5775	155 [1]	3	MCS 0-9

Note 1: RF output power specifies that Maximum Conducted Output Power.
 Note 2: 802.11a/n uses a combination of OFDM-BPSK, QPSK, 16QAM, 64QAM modulation.
 Note 3: IEEE802.11ac is draft version.
 Note 4: The EUT includes MIMO CDD function with beamforming.

1.1.2 Antenna Details

Ant. No.	Type	Gain (dBi)	Connector	Remark
1	PIFA	5.79	UFL	---
2	PIFA	5.06	UFL	---
3	PIFA	5.22	UFL	---

1.1.3 Power Supply Type of Equipment under Test (EUT)

Power Supply Type	12Vdc from adapter 48Vdc or 55Vdc from PoE
--------------------------	---

1.1.4 Accessories

Accessories		
No.	Equipment	Description
1	AC adapter 1	Brand Name: DVE Model Name: DSA-24PFD-15 FUS Power Rating: I/P: 100-240Vac, 50-60Hz, 0.8A O/P: 12Vdc, 2.0A DC 1.5m non-shielded cable w/o core
2	AC adapter 2	Brand Name: Powertron Electronics Corp. Model Name: PA1024-120HUB200 Power Rating: I/P: 100-240Vac, 50-60Hz, 0.6A O/P: 12Vdc, 2.0A, 24W DC 1.5m non-shielded cable w/o core

1.1.5 Support Units

Support Units		
No.	Equipment	Description
1	PoE 1	Brand Name: PowerDsine Model Name: PD-3501G/AC Power Rating: I/P: 100-240Vac, 50-60Hz, 0.5A O/P: 48Vdc, 0.35A
2	PoE 2	Brand Name: PowerDsine Model Name: PD-9001GR/AT/AC Power Rating: I/P: 100-240Vac, 50-60Hz, 0.67A O/P: 55Vdc, 0.6A

1.1.6 Channel List

Frequency band (MHz)		5725~5850	
802.11 a / HT20 / VHT20		HT40 / VHT40	
Channel	Frequency(MHz)	Channel	Frequency(MHz)
149	5745	151	5755
153	5765	159	5795
157	5785	VHT 80	
161	5805	155	5775
165	5825	---	---

1.1.7 Test Tool and Duty Cycle

Test Tool	Hyperterminal, Version 5.1				
Duty Cycle and Duty Factor	Mode	Beamforming		Non-Beamforming	
		Duty cycle (%)	Duty factor (dB)	Duty cycle (%)	Duty factor (dB)
	11a	99.17%	0.04	99.17%	0.04
	VHT20	99.63%	0.02	99.63%	0.02
	VHT40	98.82%	0.05	98.82%	0.05
VHT80	98.49%	0.07	98.49%	0.07	

1.1.8 Power Setting

Modulation Mode	Test Frequency (MHz)	Power Set	
		Beamforming	Non-Beamforming
11a	5745	89	89
11a	5785	94	94
11a	5825	94	94
HT20	5745	76	76
HT20	5785	79	79
HT20	5825	79	79
HT40	5755	72	72
HT40	5795	79	79
VHT20	5745	76	76
VHT20	5785	79	79
VHT20	5825	79	79
VHT40	5755	72	72
VHT40	5795	79	79
VHT80	5775	72	72

1.2 Local Support Equipment List

Support Equipment List						
No.	Equipment	Brand	Model	S/N	FCC ID	Signal cable / Length (m)
1	Notebook	DELL	E6430	---	DoC	RJ45, 1m non-shielded cable w/o core. RJ45, 10m non-shielded cable w/o core.
2	Notebook	DELL	E6430	---	DoC	---
3	Module	WNC	DNXB-AH5	---	---	---

Note: Module card is provided by applicant.

1.3 Test Setup Chart

Legacy/MIMO (CDD) Non-beamforming mode

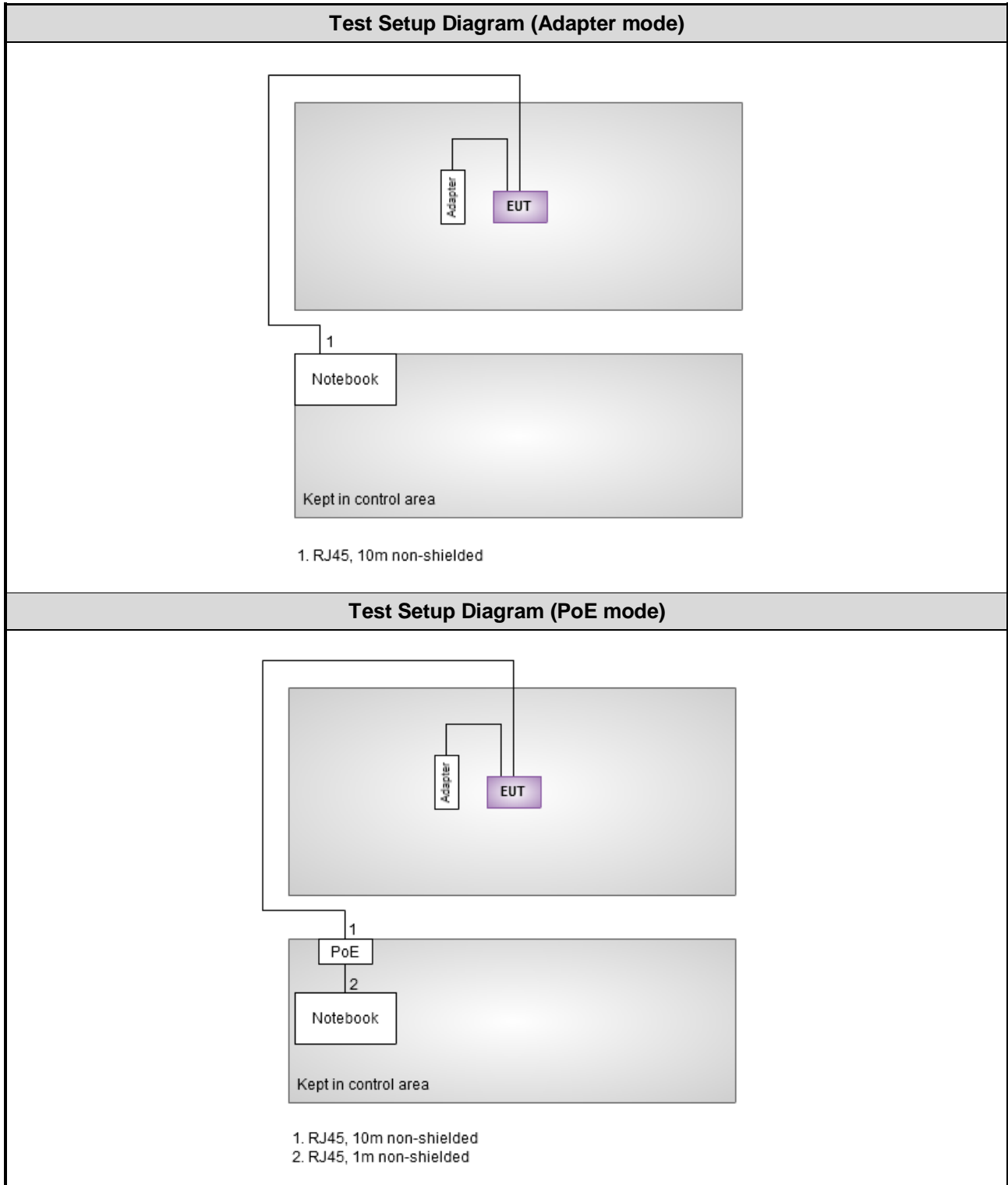

Legacy/MIMO (CDD) beamforming mode

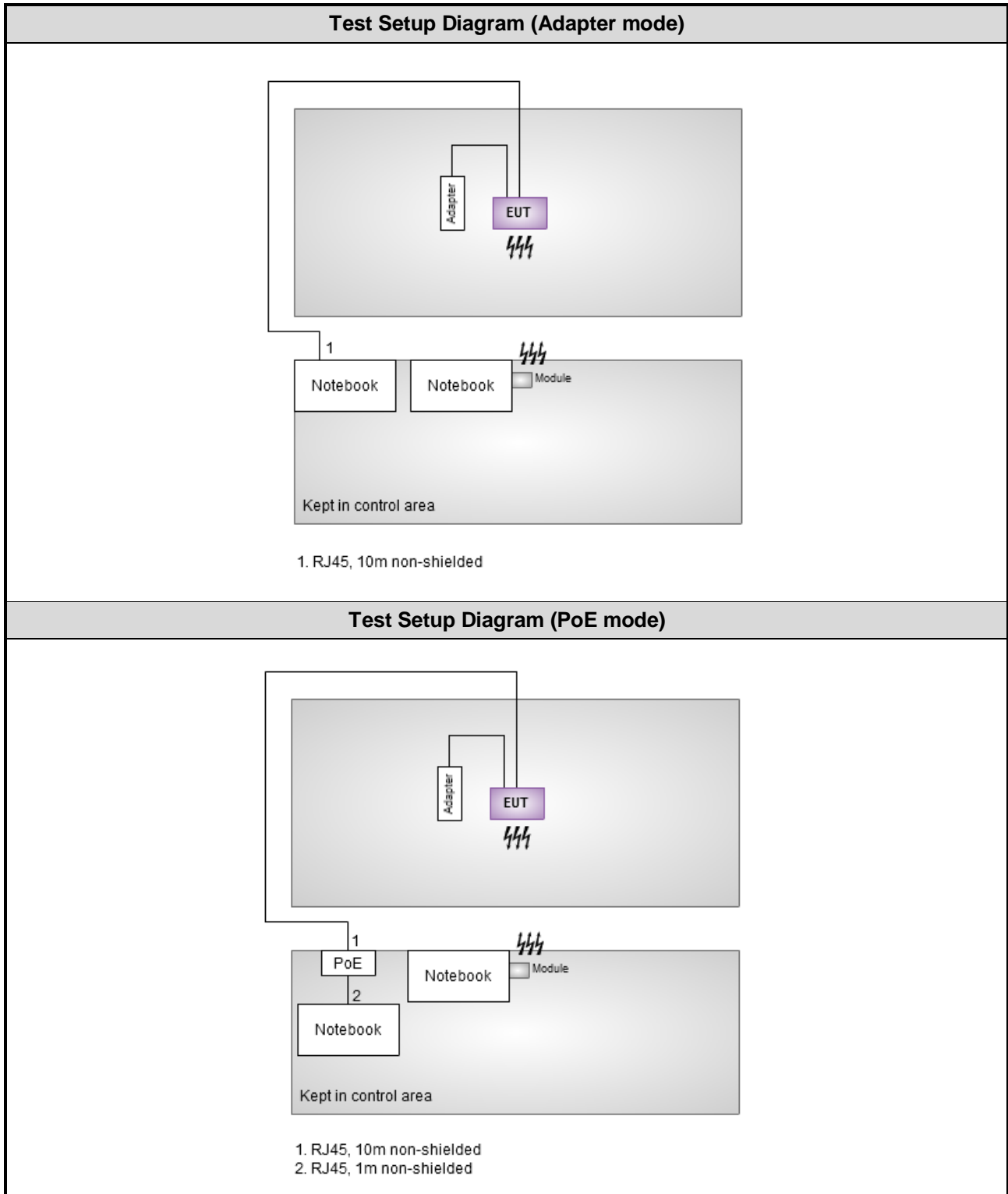

1.4 The Equipment List

Test Item	Conducted Emission				
Test Site	Conduction room 1 / (CO01-WS)				
Test date	Feb. 21, 2014				
Instrument	Manufacturer	Model No.	Serial No.	Calibration Date	Calibration Until
EMC Receiver	R&S	ESCS 30	100169	Oct. 15, 2013	Oct. 14, 2014
LISN	SCHWARZBECK	Schwarzbeck 8127	8127-667	Nov. 23, 2013	Nov. 22, 2014
LISN (Support Unit)	SCHWARZBECK	Schwarzbeck 8127	8127-666	Dec. 04, 2013	Dec. 03, 2014
RF Cable-CON	Woken	CFD200-NL	CFD200-NL-001	Apr. 24, 2013	Apr. 23, 2014
50 ohm terminal (Support Unit)	NA	50	04	Apr. 22, 2013	Apr. 21, 2014

Note: Calibration Interval of instruments listed above is one year.

Test Item	Radiated Emission				
Test Site	966 chamber 2 / (03CH02-WS)				
Test date	Jan. 18 ~ Feb. 21, 2014				
Instrument	Manufacturer	Model No.	Serial No.	Calibration Date	Calibration Until
Spectrum Analyzer	R&S	FSP 40	100305	Mar. 20, 2013	Mar. 19, 2014
Receiver	R&S	ESR3	101657	Jan. 18, 2014	Jan. 17, 2015
Bilog Antenna	SCHWARZBECK	VULB9168	VULB9168-524	Jan. 08, 2014	Jan. 07, 2015
Horn Antenna 1G-18G	SCHWARZBECK	BBHA 9120D	BBHA 9120 D 1095	Jan. 07, 2014	Jan. 06, 2015
Horn Antenna 18G-40G	SCHWARZBECK	BBHA 9170	BBHA 9170517	Dec. 27, 2013	Dec. 26, 2014
Amplifier	Burgeon	BPA-530	100218	Dec. 09, 2013	Dec. 08, 2014
Amplifier	Agilent	83017A	MY39501309	Dec. 09, 2013	Dec. 08, 2014
RF Cable	HUBER+SUHNER	SUCOFLEX104	MY16140/4	Dec. 17, 2013	Dec. 16, 2014
RF Cable	HUBER+SUHNER	SUCOFLEX104	MY16018/4	Dec. 17, 2013	Dec. 16, 2014
RF Cable	HUBER+SUHNER	SUCOFLEX104	MY16015/4	Dec. 17, 2013	Dec. 16, 2014
RF Cable-R03m	Woken	CFD400NL-LW	CFD400NL-003	Dec. 17, 2013	Dec. 16, 2014
RF Cable-R10m	Woken	CFD400NL-LW	CFD400NL-004	Dec. 17, 2013	Dec. 16, 2014
control	EM Electronics	EM1000	060608	N/A	N/A

Note: Calibration Interval of instruments listed above is one year.

Loop Antenna	R&S	HFH2-Z2	100330	Nov. 15, 2012	Nov. 14, 2014
Amplifier	EM	EM18G40G	060572	Jun. 20, 2013	Jun. 19, 2015

Note: Calibration Interval of instruments listed above is two year.

Test Item	RF Conducted				
Test Site	(TH01-WS)				
Test date	Feb. 17, 2014				
Instrument	Manufacturer	Model No.	Serial No.	Calibration Date	Calibration Until
Spectrum Analyzer	R&S	FSV40	101498	Jan. 25, 2014	Jan. 24, 2015
Power Meter	Anritsu	ML2495A	1241002	Oct. 24, 2013	Oct. 23, 2014
Power Sensor	Anritsu	MA2411B	1207366	Oct. 24, 2013	Oct. 23, 2014
Note: Calibration Interval of instruments listed above is one year.					

1.5 Test Standards

According to the specification of EUT, the EUT must comply with following standards and KDB documents.

47 CFR FCC Part 15.247

ANSI C63.10-2009

FCC KDB 558074 D01 DTS Meas Guidance v03r01

FCC KDB 662911 D01 Multiple Transmitter Output v02r01

Note: The EUT has been tested and complied with FCC part 15B requirement. FCC Part 15B test results are issued to another report.

1.6 Measurement Uncertainty

ISO/IEC 17025 requires that an estimate of the measurement uncertainties associated with the emissions test results be included in the report. The measurement uncertainties given below are based on a 95% confidence level (based on a coverage factor ($k=2$))

Measurement Uncertainty	
Parameters	Uncertainty
Bandwidth	± 35.286 Hz
Conducted power	± 0.536 dB
Frequency error	± 35.286 Hz
Temperature	± 0.3 °C
Conducted emission	± 2.946 dB
AC conducted emission	± 2.43 dB
Radiated emission	± 2.49 dB

2 Test Configuration

2.1 Testing Condition

Test Item	Test Site	Ambient Condition	Tested By
AC Conduction	CO01-WS	14°C / 58%	Skys Huang
Radiated Emissions	03CH02-WS	20°C / 66%	Anderson Hong
RF Conducted	TH01-WS	24°C / 63%	Mark Liao

➤ FCC site registration No.: 657002

➤ IC site registration No.: 10807A-2

2.2 The Worst Test Modes and Channel Details

Test item	Modulation Mode	Test Frequency (MHz)	Data Rate (Mbps) / MCS	Test Configuration
Conducted Emissions	VHT40	5795	MCS 0	1, 2, 3, 4
Radiated Emissions ≤1GHz	VHT40	5795	MCS 0	1, 2
RF Output Power	11a	5745 / 5785 / 5825	6 Mbps	1, 3
	HT20	5745 / 5785 / 5825	MCS 0	
	HT40	5755 / 5795	MCS 0	
	VHT20	5745 / 5785 / 5825	MCS 0	
	VHT40	5755 / 5795	MCS 0	
	VHT80	5775	MCS 0	
Radiated Emissions >1GHz 6dB bandwidth Power spectral density	11a	5745 / 5785 / 5825	6 Mbps	1, 3
	VHT20	5745 / 5785 / 5825	MCS 0	
	VHT40	5755 / 5795	MCS 0	
	VHT80	5775	MCS 0	

NOTE:

- The EUT was pretested with 3 orientations placed on the table for the radiated emission measurement – X, Y, and Z-plane. The **Y-plane** results were found as the worst case and were shown in this report.
- Adapter 1 and Adapter 2 had been pretested and found that **Adapter 2** was the worst case and was selected for final testing. (Adapter 1: DSA-24PFD-15 FUS; Adapter 2: PA1024-120HUB200).
- PoE 1 and PoE 2 had been pretested and found that **PoE 2** was the worst case and was selected for final testing. (PoE 1: PD-3501G/AC; PoE 2: PD-9001GR/AT/AC).
- Test configurations are listed as below:
 - Configuration 1: Legacy/MIMO (CDD) Non-beamforming mode, Adapter mode
 - Configuration 2: Legacy/MIMO (CDD) Non-beamforming mode, PoE mode
 - Configuration 3: Legacy/MIMO (CDD) beamforming mode, Adapter mode
 - Configuration 4: Legacy/MIMO (CDD) beamforming mode, PoE mode

3 Transmitter Test Results

3.1 Conducted Emissions

3.1.1 Limit of Conducted Emissions

Conducted Emissions Limit		
Frequency Emission (MHz)	Quasi-Peak	Average
0.15-0.5	66 - 56 *	56 - 46 *
0.5-5	56	46
5-30	60	50

Note 1: * Decreases with the logarithm of the frequency.

3.1.2 Test Procedures

1. The device is placed on a test table, raised 80 cm above the reference ground plane. The vertical conducting plane is located 40 cm to the rear of the device.
2. The device is connected to line impedance stabilization network (LISN) and other accessories are connected to other LISN. Measured levels of AC power line conducted emission are across the 50 Ω LISN port.
3. AC conducted emission measurements is made over frequency range from 150 kHz to 30 MHz.
4. This measurement was performed with AC 120V / 60Hz.

3.1.3 Test Setup

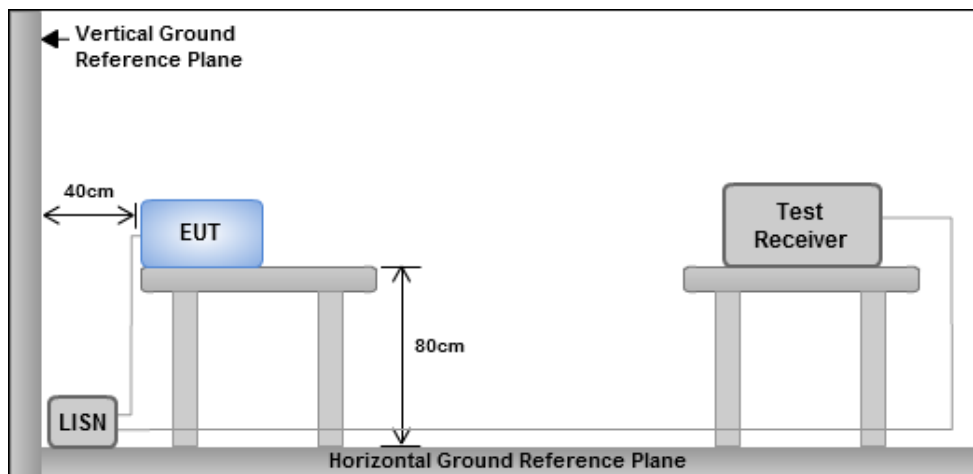

Note: 1. Support units were connected to second LISN.

2. Both of LISNs (AMN) are 80 cm from EUT and at least 80 cm from other units and other metal planes

3.1.4 Test Result of Conducted Emissions

Legacy/MIMO (CDD) Non- beamforming mode

Modulation Mode	VHT40	Test Freq. (MHz)	5795
Power Phase	Line	Test Configuration	1

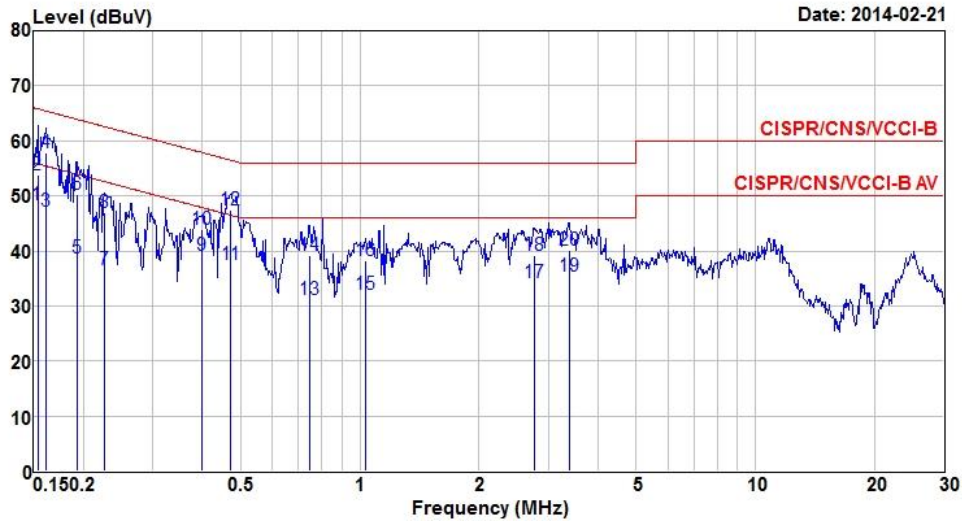

	Freq MHz	Level dBuV	Limit Line dBuV	Over Limit dB	Read Level dBuV	LISN factor dB	cable loss dB	Remark
1*	0.153	48.28	55.82	-7.54	47.80	0.41	0.07	Average
2	0.153	53.84	65.82	-11.98	53.36	0.41	0.07	QP
3	0.161	47.10	55.43	-8.33	46.60	0.41	0.09	Average
4	0.161	57.81	65.43	-7.62	57.31	0.41	0.09	QP
5	0.192	38.61	53.93	-15.32	38.02	0.42	0.17	Average
6	0.192	50.17	63.93	-13.76	49.58	0.42	0.17	QP
7	0.227	36.67	52.57	-15.90	36.07	0.44	0.16	Average
8	0.227	46.97	62.57	-15.60	46.37	0.44	0.16	QP
9	0.400	39.28	47.86	-8.58	38.70	0.53	0.05	Average
10	0.400	43.83	57.86	-14.03	43.25	0.53	0.05	QP
11	0.471	37.46	46.49	-9.03	36.84	0.57	0.05	Average
12	0.471	47.55	56.49	-8.94	46.93	0.57	0.05	QP
13	0.747	31.22	46.00	-14.78	30.51	0.67	0.04	Average
14	0.747	39.25	56.00	-16.75	38.54	0.67	0.04	QP
15	1.037	32.18	46.00	-13.82	31.39	0.74	0.05	Average
16	1.037	38.24	56.00	-17.76	37.45	0.74	0.05	QP
17	2.765	34.17	46.00	-11.83	32.93	1.04	0.20	Average
18	2.765	39.29	56.00	-16.71	38.05	1.04	0.20	QP
19	3.381	35.50	46.00	-10.50	34.22	1.06	0.22	Average
20	3.381	40.05	56.00	-15.95	38.77	1.06	0.22	QP

Note 1: Level (dBuV) = Read Level (dBuV) + LISN Factor (dB) + Cable Loss (dB).
 Note 2: Over Limit (dB) = Level (dBuV) – Limit Line (dBuV).

Modulation Mode	VHT40	Test Freq. (MHz)	5795
Power Phase	Neutral	Test Configuration	1

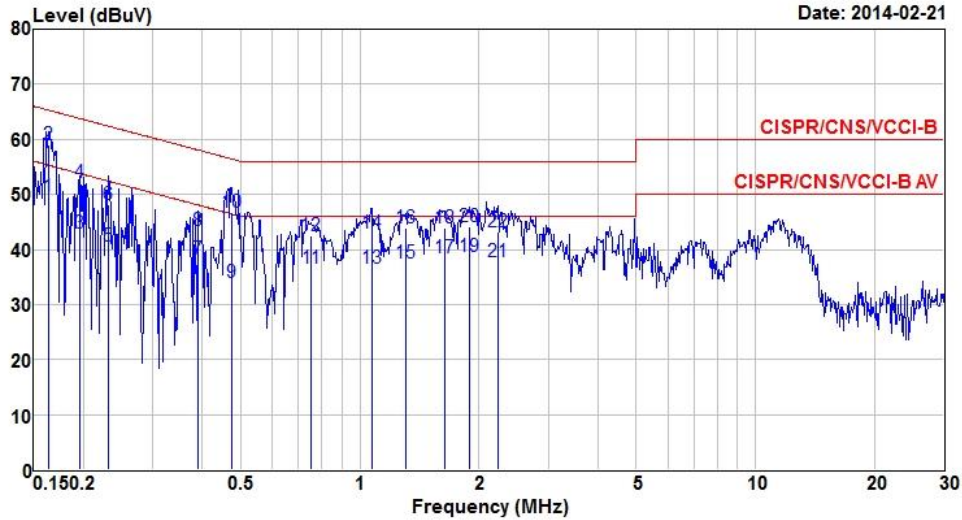

	Freq MHz	Level dBuV	Limit Line dBuV	Over Limit dB	Read Level dBuV	LISN factor dB	cable loss dB	Remark
1*	0.163	49.58	55.30	-5.72	48.99	0.50	0.09	Average
2	0.163	59.01	65.30	-6.29	58.42	0.50	0.09	QP
3	0.195	42.85	53.80	-10.95	42.17	0.51	0.17	Average
4	0.195	52.05	63.80	-11.75	51.37	0.51	0.17	QP
5	0.232	40.70	52.39	-11.69	40.02	0.53	0.15	Average
6	0.232	48.26	62.39	-14.13	47.58	0.53	0.15	QP
7	0.389	38.18	48.08	-9.90	37.51	0.61	0.06	Average
8	0.389	43.43	58.08	-14.65	42.76	0.61	0.06	QP
9	0.474	34.02	46.45	-12.43	33.32	0.65	0.05	Average
10	0.474	46.85	56.45	-9.60	46.15	0.65	0.05	QP
11	0.755	36.59	46.00	-9.41	35.81	0.74	0.04	Average
12	0.755	42.57	56.00	-13.43	41.79	0.74	0.04	QP
13	1.071	36.67	46.00	-9.33	35.79	0.83	0.05	Average
14	1.071	42.94	56.00	-13.06	42.06	0.83	0.05	QP
15	1.310	37.43	46.00	-8.57	36.43	0.91	0.09	Average
16	1.310	43.82	56.00	-12.18	42.82	0.91	0.09	QP
17	1.636	38.40	46.00	-7.60	37.28	1.00	0.12	Average
18	1.636	43.88	56.00	-12.12	42.76	1.00	0.12	QP
19	1.888	38.76	46.00	-7.24	37.54	1.07	0.15	Average
20	1.888	44.21	56.00	-11.79	42.99	1.07	0.15	QP
21	2.237	37.80	46.00	-8.20	36.53	1.10	0.17	Average
22	2.237	43.19	56.00	-12.81	41.92	1.10	0.17	QP

Note 1: Level (dBuV) = Read Level (dBuV) + LISN Factor (dB) + Cable Loss (dB).
 2: Over Limit (dB) = Level (dBuV) – Limit Line (dBuV).

Modulation Mode	VHT40	Test Freq. (MHz)	5795
Power Phase	Line	Test Configuration	2

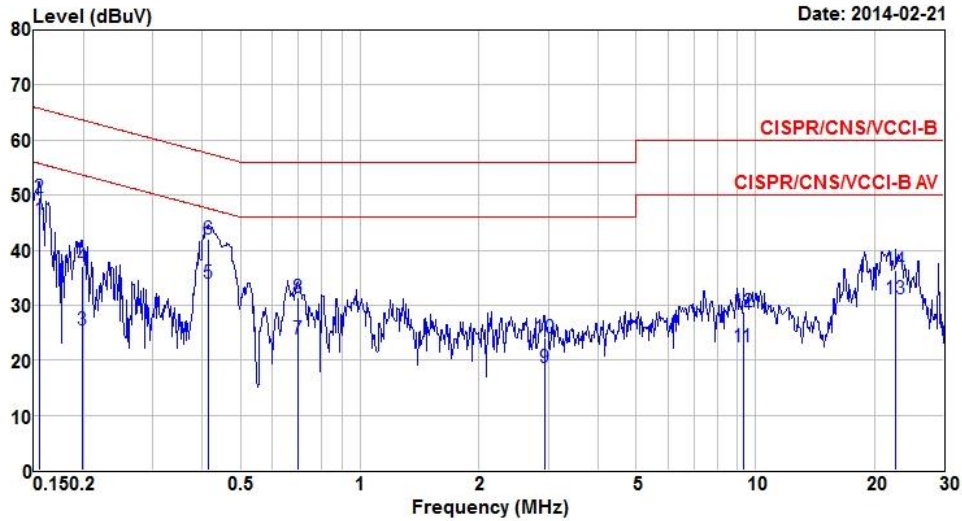

	Freq MHz	Level dBuV	Limit Line dBuV	Over Limit dB	Read Level dBuV	LISN factor dB	cable loss dB	Remark
1*	0.155	45.65	55.74	-10.09	45.18	0.40	0.07	Average
2	0.155	49.46	65.74	-16.28	48.99	0.40	0.07	QP
3	0.199	25.46	53.67	-28.21	24.89	0.39	0.18	Average
4	0.199	37.02	63.67	-26.65	36.45	0.39	0.18	QP
5	0.413	33.90	47.59	-13.69	33.46	0.39	0.05	Average
6	0.413	42.08	57.59	-15.51	41.64	0.39	0.05	QP
7	0.697	23.87	46.00	-22.13	23.43	0.40	0.04	Average
8	0.697	31.39	56.00	-24.61	30.95	0.40	0.04	QP
9	2.931	18.57	46.00	-27.43	17.92	0.45	0.20	Average
10	2.931	23.97	56.00	-32.03	23.32	0.45	0.20	QP
11	9.302	22.51	50.00	-27.49	21.86	0.53	0.12	Average
12	9.302	28.84	60.00	-31.16	28.19	0.53	0.12	QP
13	22.655	31.22	50.00	-18.78	30.31	0.55	0.36	Average
14	22.655	36.33	60.00	-23.67	35.42	0.55	0.36	QP

Note 1: Level (dBuV) = Read Level (dBuV) + LISN Factor (dB) + Cable Loss (dB).
 2: Over Limit (dB) = Level (dBuV) – Limit Line (dBuV).

Modulation Mode	VHT40	Test Freq. (MHz)	5795
Power Phase	Neutral	Test Configuration	2

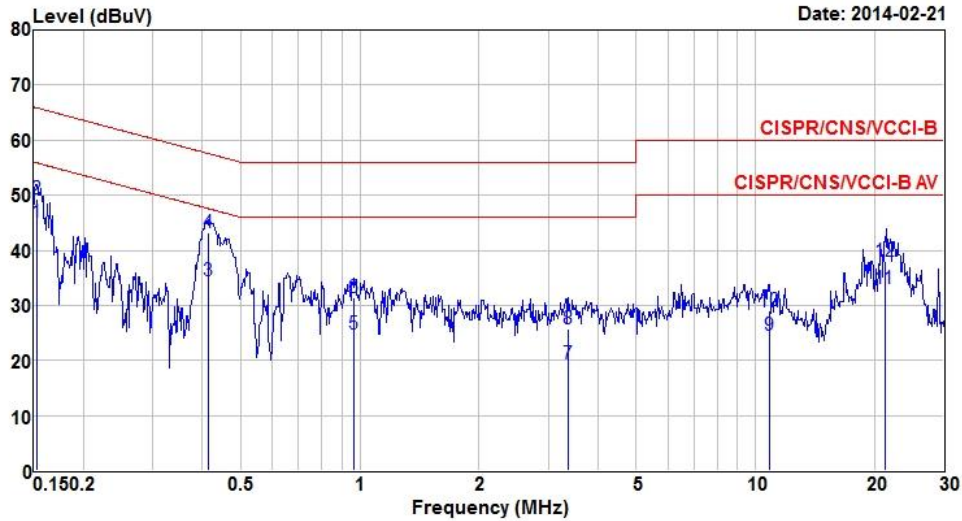

	Freq	Level	Limit	Over	Read	LISN	cable	Remark
	MHz	dBuV	Line	Limit	Level	factor	loss	
			dBuV	dB	dBuV	dB	dB	
1*	0.152	45.06	55.87	-10.81	44.51	0.48	0.07	Average
2	0.152	49.40	65.87	-16.47	48.85	0.48	0.07	QP
3	0.413	34.39	47.59	-13.20	33.87	0.47	0.05	Average
4	0.413	43.19	57.59	-14.40	42.67	0.47	0.05	QP
5	0.968	24.84	46.00	-21.16	24.32	0.48	0.04	Average
6	0.968	31.37	56.00	-24.63	30.85	0.48	0.04	QP
7	3.364	19.35	46.00	-26.65	18.62	0.51	0.22	Average
8	3.364	25.70	56.00	-30.30	24.97	0.51	0.22	QP
9	10.847	24.44	50.00	-25.56	23.77	0.56	0.11	Average
10	10.847	28.92	60.00	-31.08	28.25	0.56	0.11	QP
11	21.260	33.07	50.00	-16.93	32.24	0.55	0.28	Average
12	21.260	38.00	60.00	-22.00	37.17	0.55	0.28	QP

Note 1: Level (dBUV) = Read Level (dBUV) + LISN Factor (dB) + Cable Loss (dB).
 2: Over Limit (dB) = Level (dBUV) – Limit Line (dBUV).

Legacy/MIMO (CDD) beamforming mode

Modulation Mode	VHT40	Test Freq. (MHz)	5795
Power Phase	Line	Test Configuration	3

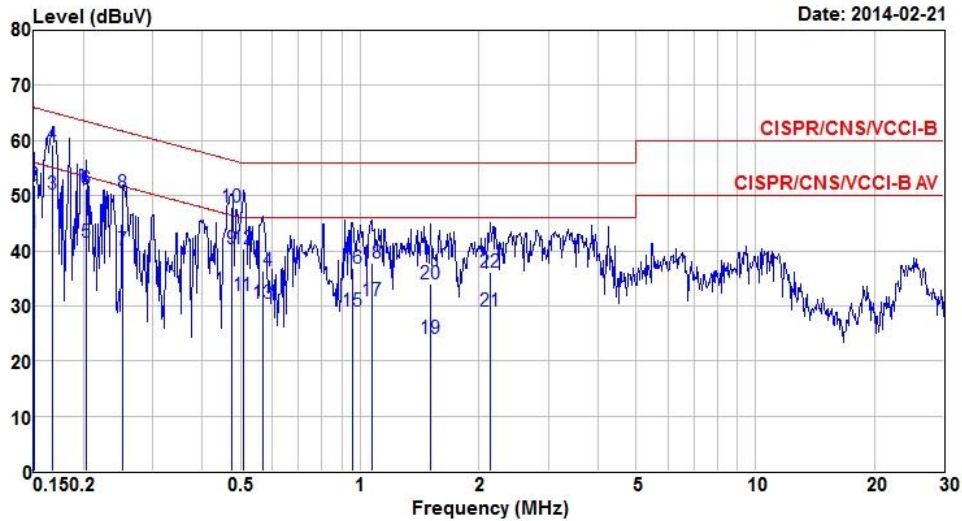

	Freq MHz	Level dBuV	Limit Line dBuV	Over Limit dB	Read Level dBuV	LISN factor dB	cable loss dB	Remark
1	0.150	43.10	56.00	-12.90	42.63	0.41	0.06	Average
2	0.150	51.86	66.00	-14.14	51.39	0.41	0.06	QP
3*	0.168	50.31	55.08	-4.77	49.79	0.41	0.11	Average
4	0.168	59.13	65.08	-5.95	58.61	0.41	0.11	QP
5	0.203	41.47	53.49	-12.02	40.87	0.42	0.18	Average
6	0.203	51.11	63.49	-12.38	50.51	0.42	0.18	QP
7	0.251	40.01	51.73	-11.72	39.41	0.46	0.14	Average
8	0.251	50.56	61.73	-11.17	49.96	0.46	0.14	QP
9	0.474	40.29	46.45	-6.16	39.67	0.57	0.05	Average
10	0.474	47.93	56.45	-8.52	47.31	0.57	0.05	QP
11	0.507	31.97	46.00	-14.03	31.34	0.58	0.05	Average
12	0.507	40.28	56.00	-15.72	39.65	0.58	0.05	QP
13	0.570	30.47	46.00	-15.53	29.81	0.61	0.05	Average
14	0.570	36.30	56.00	-19.70	35.64	0.61	0.05	QP
15	0.958	29.02	46.00	-16.98	28.26	0.72	0.04	Average
16	0.958	36.86	56.00	-19.14	36.10	0.72	0.04	QP
17	1.071	30.83	46.00	-15.17	30.02	0.76	0.05	Average
18	1.071	37.88	56.00	-18.12	37.07	0.76	0.05	QP
19	1.511	24.00	46.00	-22.00	22.99	0.90	0.11	Average
20	1.511	34.00	56.00	-22.00	32.99	0.90	0.11	QP
21	2.144	28.95	46.00	-17.05	27.76	1.02	0.17	Average
22	2.144	36.17	56.00	-19.83	34.98	1.02	0.17	QP

Note 1: Level (dBuV) = Read Level (dBuV) + LISN Factor (dB) + Cable Loss (dB).
 2: Over Limit (dB) = Level (dBuV) – Limit Line (dBuV).

Modulation Mode	VHT40	Test Freq. (MHz)	5795
Power Phase	Neutral	Test Configuration	3

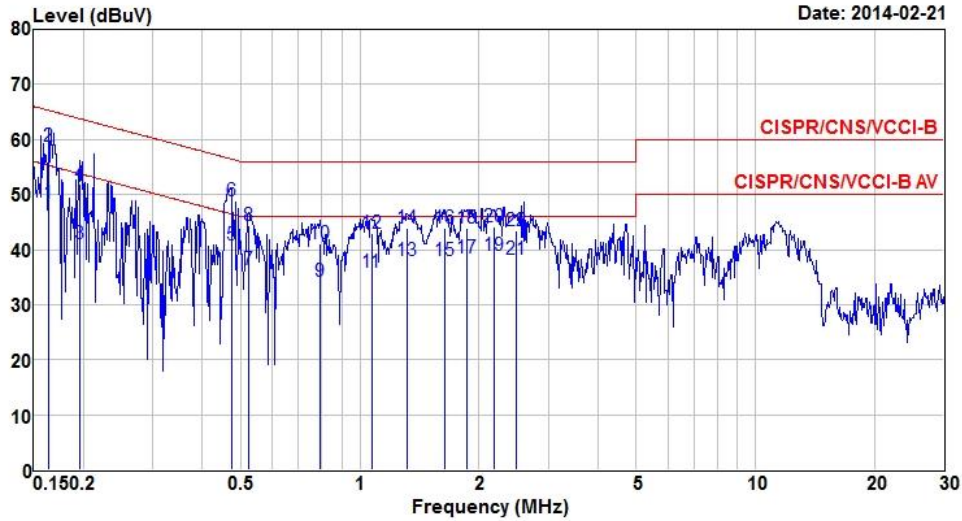

	Freq MHz	Level dBUV	Limit Line dBUV	Over Limit dB	Read Level dBUV	LISN factor dB	cable loss dB	Remark
1	0.163	48.35	55.30	-6.95	47.76	0.50	0.09	Average
2	0.163	58.69	65.30	-6.61	58.10	0.50	0.09	QP
3	0.195	41.04	53.80	-12.76	40.36	0.51	0.17	Average
4	0.195	51.93	63.80	-11.87	51.25	0.51	0.17	QP
5*	0.474	40.77	46.45	-5.68	40.07	0.65	0.05	Average
6	0.474	48.90	56.45	-7.55	48.20	0.65	0.05	QP
7	0.524	36.35	46.00	-9.65	35.63	0.67	0.05	Average
8	0.524	44.46	56.00	-11.54	43.74	0.67	0.05	QP
9	0.796	34.25	46.00	-11.75	33.46	0.75	0.04	Average
10	0.796	40.99	56.00	-15.01	40.20	0.75	0.04	QP
11	1.071	35.85	46.00	-10.15	34.97	0.83	0.05	Average
12	1.071	42.88	56.00	-13.12	42.00	0.83	0.05	QP
13	1.317	38.03	46.00	-7.97	37.02	0.92	0.09	Average
14	1.317	44.00	56.00	-12.00	42.99	0.92	0.09	QP
15	1.636	38.04	46.00	-7.96	36.92	1.00	0.12	Average
16	1.636	43.94	56.00	-12.06	42.82	1.00	0.12	QP
17	1.868	38.55	46.00	-7.45	37.34	1.06	0.15	Average
18	1.868	43.98	56.00	-12.02	42.77	1.06	0.15	QP
19	2.178	39.07	46.00	-6.93	37.80	1.10	0.17	Average
20	2.178	44.14	56.00	-11.86	42.87	1.10	0.17	QP
21	2.487	38.20	46.00	-7.80	36.91	1.10	0.19	Average
22	2.487	43.33	56.00	-12.67	42.04	1.10	0.19	QP

Note 1: Level (dBUV) = Read Level (dBUV) + LISN Factor (dB) + Cable Loss (dB).
 2: Over Limit (dB) = Level (dBUV) – Limit Line (dBUV).

Modulation Mode	VHT40	Test Freq. (MHz)	5795
Power Phase	Line	Test Configuration	4

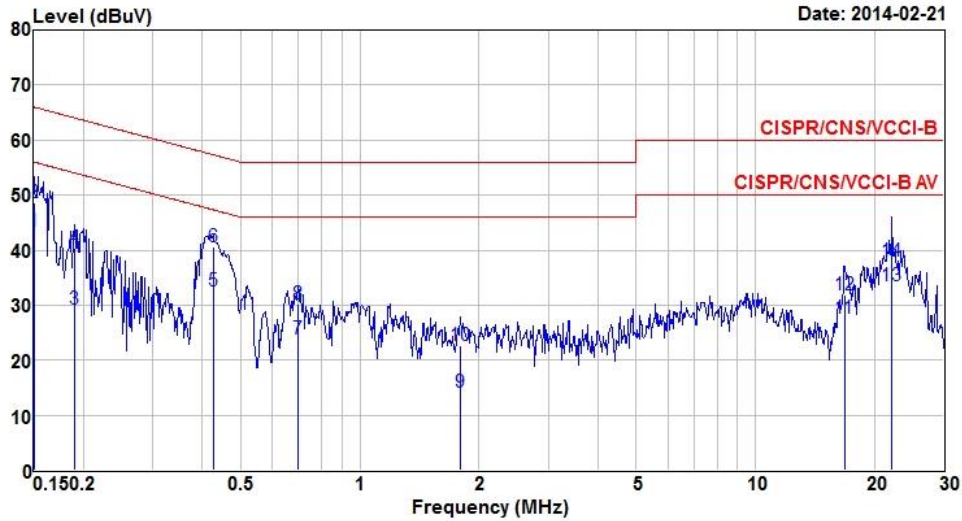

	Freq MHz	Level dBuV	Limit Line dBuV	Over Limit dB	Read Level dBuV	LISN factor dB	cable loss dB	Remark
1*	0.150	43.43	56.00	-12.57	42.97	0.40	0.06	Average
2	0.150	48.52	66.00	-17.48	48.06	0.40	0.06	QP
3	0.189	29.29	54.06	-24.77	28.74	0.39	0.16	Average
4	0.189	40.33	64.06	-23.73	39.78	0.39	0.16	QP
5	0.426	32.53	47.33	-14.80	32.09	0.39	0.05	Average
6	0.426	40.52	57.33	-16.81	40.08	0.39	0.05	QP
7	0.697	23.96	46.00	-22.04	23.52	0.40	0.04	Average
8	0.697	30.19	56.00	-25.81	29.75	0.40	0.04	QP
9	1.800	14.13	46.00	-31.87	13.56	0.43	0.14	Average
10	1.800	22.66	56.00	-33.34	22.09	0.43	0.14	QP
11	16.839	27.53	50.00	-22.47	26.83	0.55	0.15	Average
12	16.839	31.93	60.00	-28.07	31.23	0.55	0.15	QP
13	22.180	33.57	50.00	-16.43	32.69	0.55	0.33	Average
14	22.180	37.90	60.00	-22.10	37.02	0.55	0.33	QP

Note 1: Level (dBuV) = Read Level (dBuV) + LISN Factor (dB) + Cable Loss (dB).
 Note 2: Over Limit (dB) = Level (dBuV) – Limit Line (dBuV).

Modulation Mode	VHT40	Test Freq. (MHz)	5795
Power Phase	Neutral	Test Configuration	4

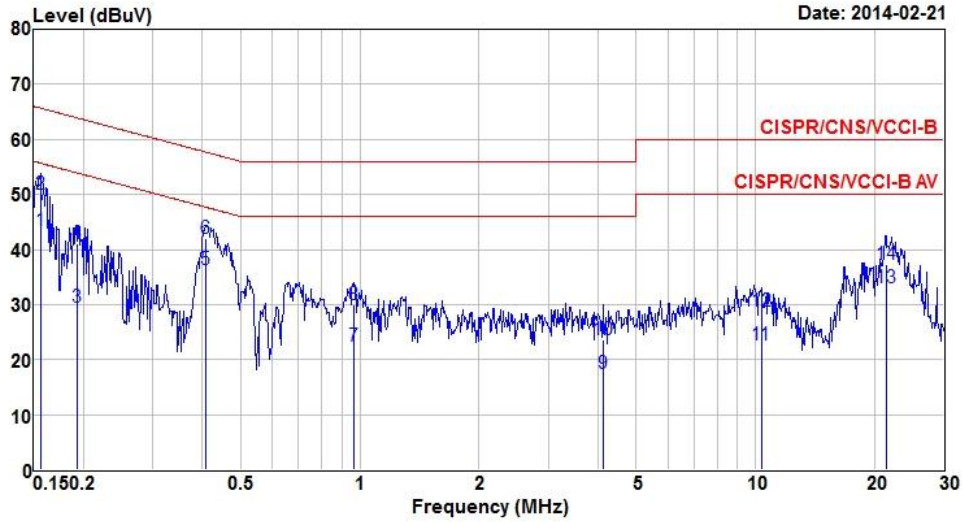

	Freq MHz	Level dBuV	Limit Line dBuV	Over Limit dB	Read Level dBuV	LISN factor dB	cable loss dB	Remark
1	0.156	43.38	55.69	-12.31	42.83	0.48	0.07	Average
2	0.156	49.99	65.69	-15.70	49.44	0.48	0.07	QP
3	0.192	29.46	53.93	-24.47	28.81	0.48	0.17	Average
4	0.192	41.15	63.93	-22.78	40.50	0.48	0.17	QP
5*	0.408	36.42	47.68	-11.26	35.90	0.47	0.05	Average
6	0.408	41.94	57.68	-15.74	41.42	0.47	0.05	QP
7	0.963	22.45	46.00	-23.55	21.93	0.48	0.04	Average
8	0.963	29.91	56.00	-26.09	29.39	0.48	0.04	QP
9	4.114	17.42	46.00	-28.58	16.66	0.52	0.24	Average
10	4.114	23.54	56.00	-32.46	22.78	0.52	0.24	QP
11	10.342	22.57	50.00	-27.43	21.90	0.56	0.11	Average
12	10.342	28.78	60.00	-31.22	28.11	0.56	0.11	QP
13	21.373	32.94	50.00	-17.06	32.11	0.55	0.28	Average
14	21.373	37.36	60.00	-22.64	36.53	0.55	0.28	QP

Note 1: Level (dBuV) = Read Level (dBuV) + LISN Factor (dB) + Cable Loss (dB).
 2: Over Limit (dB) = Level (dBuV) – Limit Line (dBuV).

3.2 6dB and Occupied Bandwidth

3.2.1 Limit of 6dB Bandwidth

The minimum 6dB bandwidth shall be at least 500 kHz.

3.2.2 Test Procedures

1. Set resolution bandwidth (RBW) = 100 kHz, Video bandwidth = 300 kHz.
2. Detector = Peak, Trace mode = max hold.
3. Sweep = auto couple, Allow the trace to stabilize.
4. Measure the maximum width of the emission that is constrained by the frequencies associated with the two outermost amplitude points (upper and lower) that are attenuated by 6dB relative to the maximum level measured in the fundamental emission.

3.2.3 Test Setup

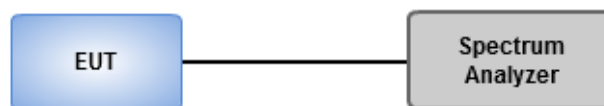

3.2.4 Test Result of 6dB and Occupied Bandwidth

Legacy/MIMO (CDD) Non-beamforming mode - Test Configuration 1

Modulation Mode	N _{TX}	Freq. (MHz)	6dB Bandwidth (MHz)				Limit (kHz)
			Chain 0	Chain 1	Chain 2	Chain 3	
11a	1	5745	16.35	---	---	---	500
11a	1	5785	16.29	---	---	---	500
11a	1	5825	16.35	---	---	---	500
VHT20	3	5745	17.62	17.62	17.62	---	500
VHT20	3	5785	17.62	17.62	17.62	---	500
VHT20	3	5825	17.57	17.62	17.57	---	500
VHT40	3	5755	36.41	36.41	36.41	---	500
VHT40	3	5795	36.41	36.41	36.41	---	500
VHT80	3	5775	76.06	76.52	75.83	---	500

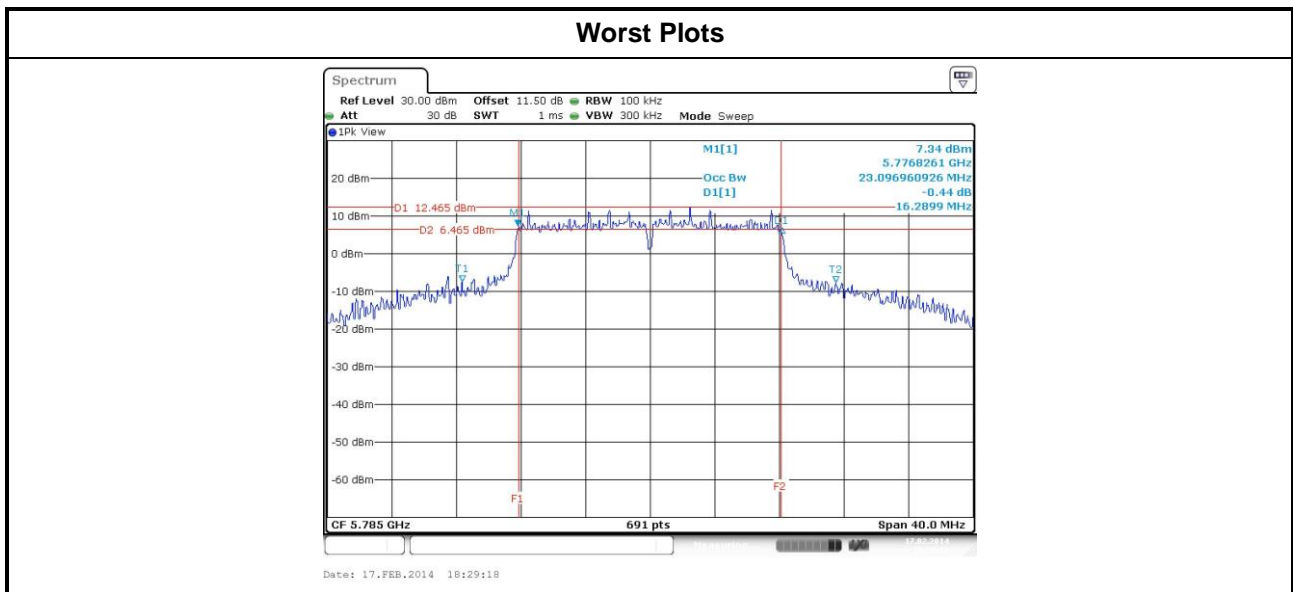

Legacy/MIMO (CDD) Non-beamforming mode - Test Configuration 1

Modulation Mode	N _{TX}	Freq. (MHz)	99% Occupied Bandwidth (MHz)			
			Chain 0	Chain 1	Chain 2	Chain 3
11a	1	5745	17.44	---	---	---
11a	1	5785	18.92	---	---	---
11a	1	5825	19.39	---	---	---
VHT20	3	5745	18.02	17.84	17.87	---
VHT20	3	5785	18.05	17.87	17.95	---
VHT20	3	5825	18.09	17.95	17.95	---
VHT40	3	5755	36.66	36.60	36.60	---
VHT40	3	5795	36.79	36.66	36.66	---
VHT80	3	5775	75.90	75.65	75.53	---

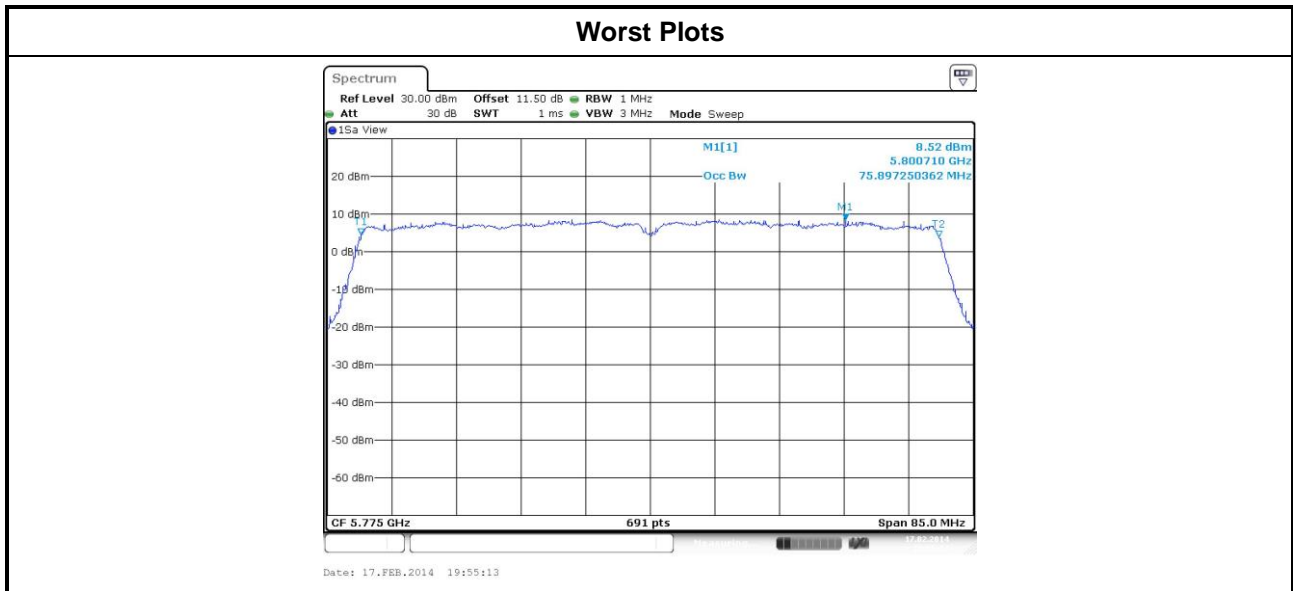

Legacy/MIMO (CDD) beamforming mode - Test Configuration 3

Modulation Mode	N _{TX}	Freq. (MHz)	6dB Bandwidth (MHz)				Limit (kHz)
			Chain 0	Chain 1	Chain 2	Chain 3	
11a	1	5745	16.35	---	---	---	500
11a	1	5785	16.29	---	---	---	500
11a	1	5825	16.35	---	---	---	500
VHT20	3	5745	17.57	17.62	17.62	---	500
VHT20	3	5785	17.57	17.62	17.62	---	500
VHT20	3	5825	17.57	17.57	17.57	---	500
VHT40	3	5755	36.52	36.29	36.41	---	500
VHT40	3	5795	36.06	36.41	35.83	---	500
VHT80	3	5775	75.13	75.13	75.36	---	500

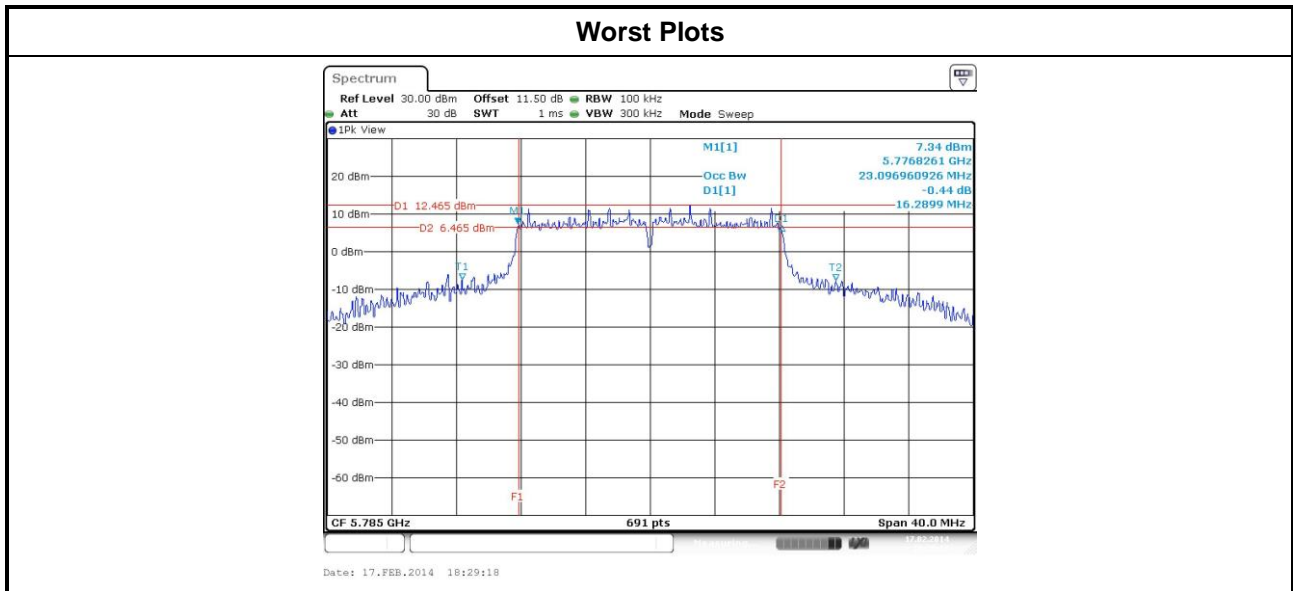

Legacy/MIMO (CDD) beamforming mode - Test Configuration 3

Modulation Mode	N _{TX}	Freq. (MHz)	99% Occupied Bandwidth (MHz)			
			Chain 0	Chain 1	Chain 2	Chain 3
11a	1	5745	17.44	---	---	---
11a	1	5785	18.92	---	---	---
11a	1	5825	19.39	---	---	---
VHT20	3	5745	17.98	17.76	17.80	---
VHT20	3	5785	18.02	17.87	17.87	---
VHT20	3	5825	18.02	17.84	17.91	---
VHT40	3	5755	36.73	36.60	36.53	---
VHT40	3	5795	36.73	36.60	36.60	---
VHT80	3	5775	75.65	75.53	75.41	---

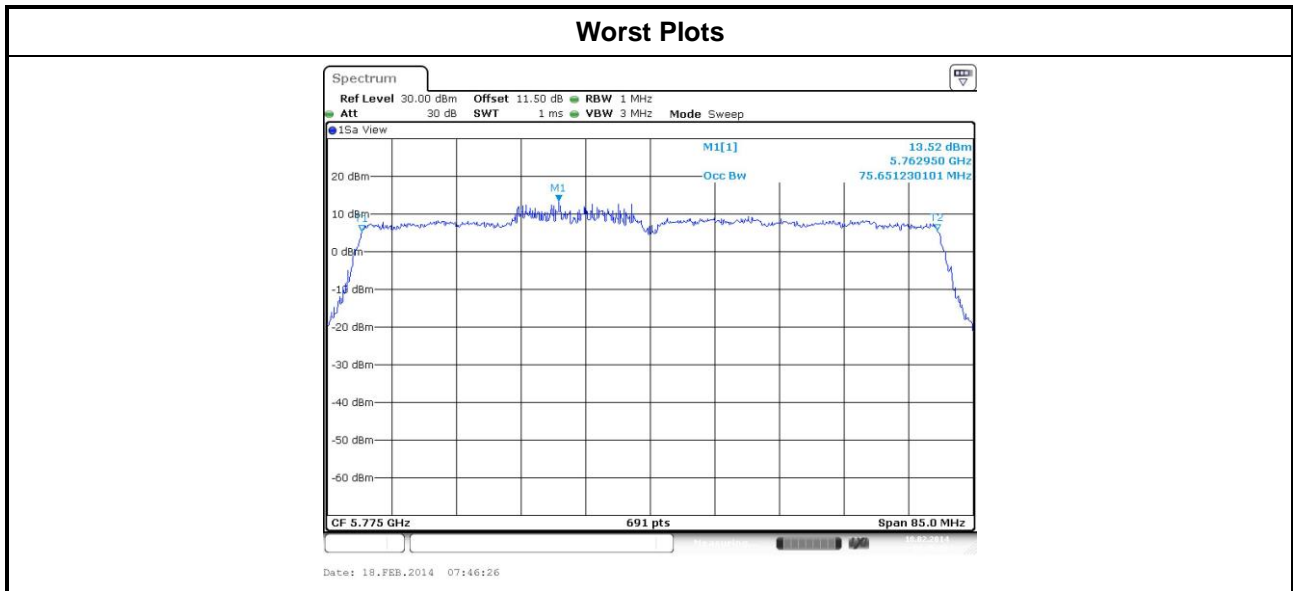

3.3 RF Output Power

3.3.1 Limit of RF Output Power

Conducted power shall not exceed 1Watt.

- Antenna gain \leq 6dBi, no any corresponding reduction is in output power limit.
- Antenna gain $>$ 6dBi
 - Non Fixed, point to point operations.
The conducted output power from the intentional radiator shall be reduced by the amount in dB that the directional gain of the antenna exceeds 6 dB
 - Fixed, point to point operations
Systems operating in the 2400–2483.5 MHz band that are used exclusively for fixed, point-to-point Operations, maximum peak output power of the intentional radiator is reduced by 1 dB for every 3 dB that the directional gain of the antenna exceeds 6 dBi.

Systems operating in the 5725–5850 MHz band that are used exclusively for fixed, point-to-point operations ,no any corresponding reduction is in transmitter peak output power

3.3.2 Test Procedures

- Maximum Peak Conducted Output Power
 - Spectrum analyzer**
 1. Set RBW = 1MHz, VBW = 3MHz, Detector = Peak.
 2. Sweep time = auto, Trace mode = max hold, Allow trace to fully stabilize.
 3. Use the spectrum analyzer channel power measurement function with the band limits set equal to the DTS bandwidth edges.
 - Power meter**
 1. A broadband Peak RF power meter is used for output power measurement. The video bandwidth of power meter is greater than DTS bandwidth of EUT. If duty cycle of test signal is not 100 %, trigger and gating function of power meter will be enabled to capture transmission burst for measuring output power.
- Maximum Conducted Output Power
 - Power meter**
 1. A broadband Average RF power meter is used for output power measurement. The video bandwidth of power meter is greater than DTS bandwidth of EUT. If duty cycle of test signal is not 100 %, trigger and gating function of power meter will be enabled to capture transmission burst for measuring output power.

3.3.3 Test Setup

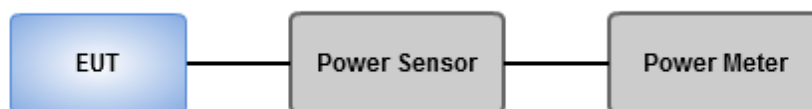

3.3.4 Test Result of Maximum Output Power

Legacy/MIMO (CDD) Non-beamforming mode - Test Configuration 1

Modulation Mode	N _{TX}	Freq. (MHz)	Conducted (average) output power (dBm)				Total Power (mW)	Total Power (dBm)	Limit (dBm)
			Chain 0	Chain 1	Chain 2	Chain 3			
11a	1	5745	22.73	---	---	---	187.499	22.73	30.00
11a	1	5785	23.81	---	---	---	240.436	23.81	30.00
11a	1	5825	23.79	---	---	---	239.332	23.79	30.00
HT20	3	5745	19.03	20.15	19.48	---	272.213	24.35	30.00
HT20	3	5785	19.99	20.46	20.27	---	317.357	25.02	30.00
HT20	3	5825	20.04	20.48	20.15	---	316.126	25.00	30.00
HT40	3	5755	18.06	19.01	18.13	---	208.602	23.19	30.00
HT40	3	5795	20.04	20.75	20.44	---	330.438	25.19	30.00
VHT20	3	5745	19.15	20.23	19.53	---	277.406	24.43	30.00
VHT20	3	5785	20.07	20.52	20.33	---	322.239	25.08	30.00
VHT20	3	5825	20.08	20.54	20.18	---	319.331	25.04	30.00
VHT40	3	5755	18.11	19.07	18.17	---	211.052	23.24	30.00
VHT40	3	5795	20.07	20.82	20.48	---	334.093	25.24	30.00
VHT80	3	5775	17.87	18.85	18.31	---	205.735	23.13	30.00

Legacy/MIMO (CDD) beamforming mode - Test Configuration 3

Modulation Mode	N _{TX}	Freq. (MHz)	Conducted (average) output power (dBm)				Total Power (mW)	Total Power (dBm)	Limit (dBm)
			Chain 0	Chain 1	Chain 2	Chain 3			
11a	1	5745	22.73	---	---	---	187.499	22.73	30.00
11a	1	5785	23.81	---	---	---	240.436	23.81	30.00
11a	1	5825	23.79	---	---	---	239.332	23.79	30.00
HT20	3	5745	19.11	20.13	19.43	---	272.209	24.35	25.87
HT20	3	5785	19.86	20.88	20.15	---	322.804	25.09	25.87
HT20	3	5825	19.73	20.63	20.14	---	312.860	24.95	25.87
HT40	3	5755	18.10	19.06	18.14	---	210.266	23.23	25.87
HT40	3	5795	20.09	20.69	20.41	---	329.214	25.17	25.87
VHT20	3	5745	19.19	20.29	19.58	---	280.673	24.48	25.87
VHT20	3	5785	20.12	20.57	20.39	---	326.222	25.14	25.87
VHT20	3	5825	20.15	20.59	20.22	---	323.262	25.10	25.87
VHT40	3	5755	18.16	19.16	18.22	---	214.252	23.31	25.87
VHT40	3	5795	20.14	20.86	20.55	---	338.676	25.30	25.87
VHT80	3	5775	17.92	18.93	18.38	---	208.972	23.20	25.87

Note1: Directional gain = $10 * \log((10^{5.79/20} + 10^{5.06/20} + 10^{5.22/20})/3) = 10.13 \text{ dBi} > 6 \text{ dBi}$
 Limit shall be reduced to $30 \text{ dBm} - (10.13 \text{ dBi} - 6 \text{ dBi}) = 25.87 \text{ dBm}$

3.4 Power Spectral Density

3.4.1 Limit of Power Spectral Density

Power spectral density shall not be greater than 8 dBm in any 3 kHz band.

3.4.2 Test Procedures

- Maximum peak conducted output power was used to demonstrate compliance to the fundamental output power limit.
 1. Set the RBW = 30kHz, VBW = 100kHz.
 2. Detector = Peak, Sweep time = auto couple.
 3. Trace mode = max hold, allow trace to fully stabilize.
 4. Use the peak marker function to determine the maximum amplitude level.
- Maximum (average) conducted output power was used to demonstrate compliance to the fundamental output power limit.
 1. Set the RBW = 30kHz, VBW = 100 kHz.
 2. Detector = RMS, Sweep time = auto couple.
 3. Set the sweep time to: $\geq 10 \times$ (number of measurement points in sweep) \times (maximum data rate per stream).
 4. Perform the measurement over a single sweep.
 5. Use the peak marker function to determine the maximum amplitude level.

3.4.3 Test Setup

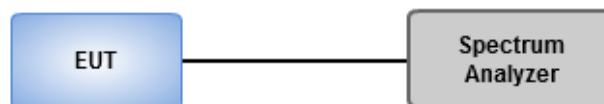

3.4.4 Test Result of Power Spectral Density

Legacy/MIMO (CDD) Non-beamforming mode - Test Configuration 1

Modulation Mode	N _{TX}	Freq. (MHz)	Total Power Spectral Density (dBm/30kHz)	Limit (dBm/3kHz)
11a	1	5745	-1.35	8
11a	1	5785	-0.70	8
11a	1	5825	-0.32	8
VHT20	3	5745	-0.60	3.87
VHT20	3	5785	0.22	3.87
VHT20	3	5825	0.60	3.87
VHT40	3	5755	-4.46	3.87
VHT40	3	5795	-1.82	3.87
VHT80	3	5775	-6.71	3.87

Note:

1. Test result for VHT20/VHT40/VHT80 are bin-by-bin summing measured value of each TX port.
2. Directional gain = $10 * \log((10^{5.79/20} + 10^{5.06/20} + 10^{5.22/20})^2 / 3) = 10.13 \text{ dBi} > 6 \text{ dBi}$
Limit shall be reduced to $8 \text{ dBm} - (10.13 \text{ dBi} - 6 \text{ dBi}) = 3.87 \text{ dBm}$

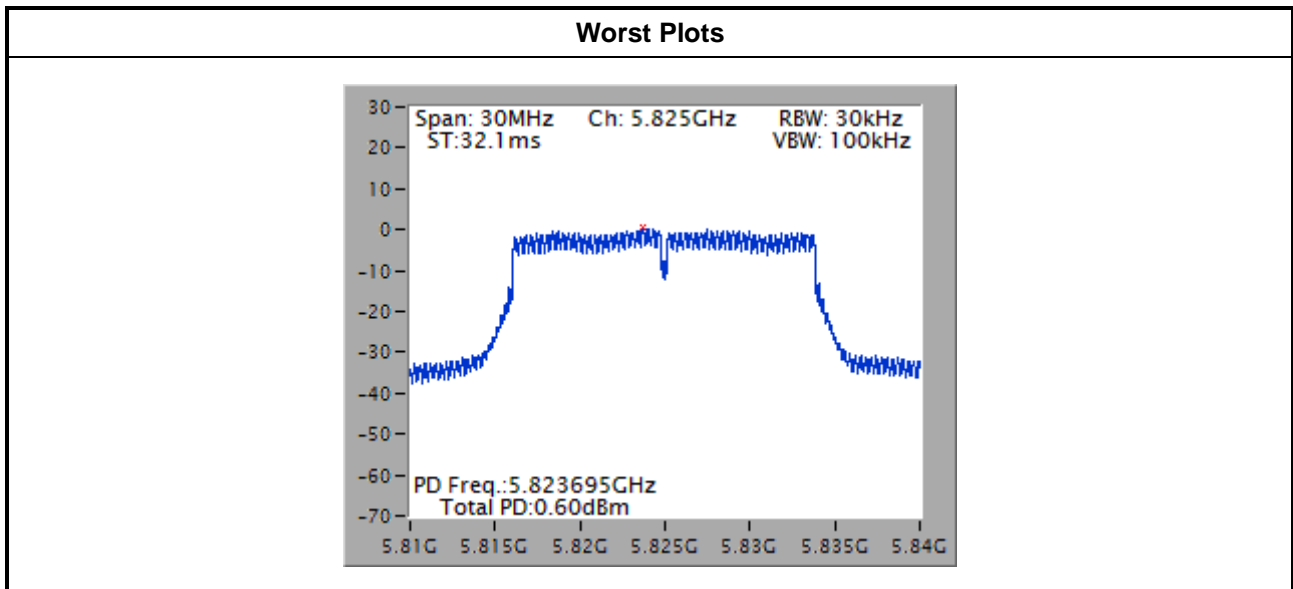

Legacy/MIMO (CDD) beamforming mode - Test Configuration 3

Modulation Mode	N _{TX}	Freq. (MHz)	Total Power Spectral Density (dBm/30kHz)	Limit (dBm/3kHz)
11a	1	5745	-1.35	8
11a	1	5785	-0.70	8
11a	1	5825	-0.32	8
VHT20	3	5745	-0.08	3.87
VHT20	3	5785	0.84	3.87
VHT20	3	5825	0.88	3.87
VHT40	3	5755	-4.37	3.87
VHT40	3	5795	-1.86	3.87
VHT80	3	5775	-5.52	3.87

Note:

1. Test result for VHT20/VHT40/VHT80 are bin-by-bin summing measured value of each TX port.
2. Directional gain = $10 * \log((10^{5.79/20} + 10^{5.06/20} + 10^{5.22/20})^2 / 3) = 10.13 \text{ dBi} > 6 \text{ dBi}$
Limit shall be reduced to 8 dBm – (10.13 dBi – 6 dBi) = 3.87 dBm

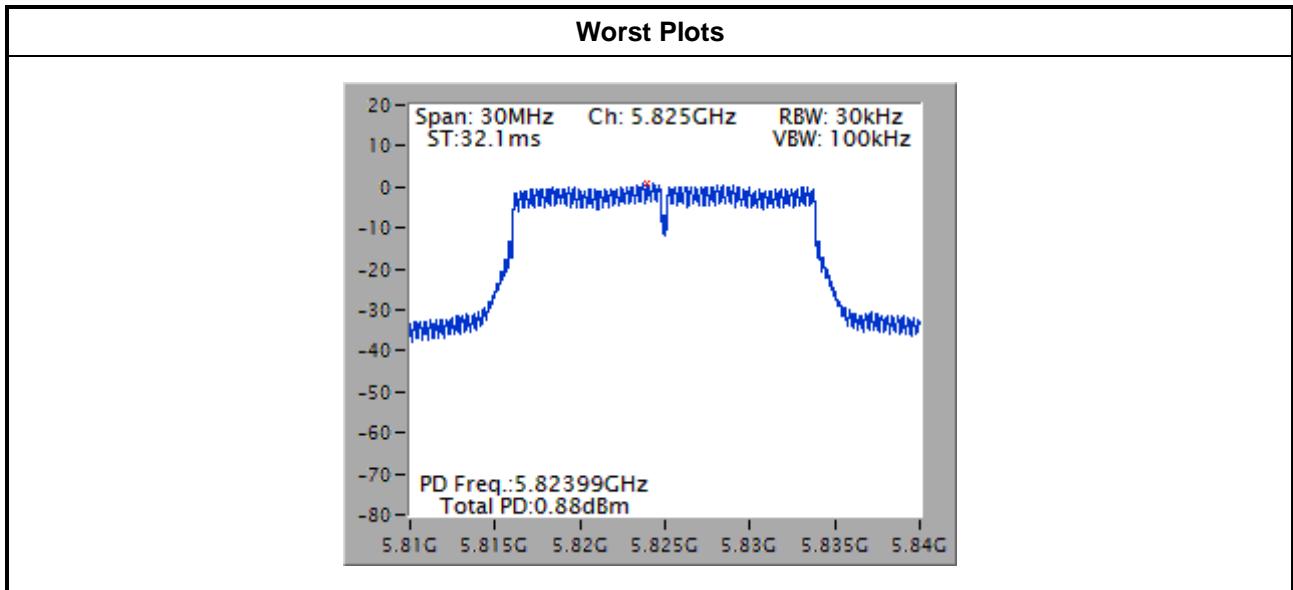

3.5 Unwanted Emissions into Restricted Frequency Bands

3.5.1 Limit of Unwanted Emissions into Restricted Frequency Bands

Restricted Band Emissions Limit			
Frequency Range (MHz)	Field Strength (uV/m)	Field Strength (dBuV/m)	Measure Distance (m)
0.009~0.490	2400/F(kHz)	48.5 - 13.8	300
0.490~1.705	24000/F(kHz)	33.8 - 23	30
1.705~30.0	30	29	30
30~88	100	40	3
88~216	150	43.5	3
216~960	200	46	3
Above 960	500	54	3

Note 1:
Quasi-Peak value is measured for frequency below 1GHz except for 9–90 kHz, 110–490 kHz frequency band. Peak and average value are measured for frequency above 1GHz. The limit on average radio frequency emission is as above table. The limit on peak radio frequency emissions is 20 dB above the maximum permitted average emission limit

Note 2:
Measurements may be performed at a distance other than what is specified provided. When performing measurements at a distance other than that specified, the results shall be extrapolated to the specified distance using an extrapolation factor as below, Frequency at or above 30 MHz: 20 dB/decade Frequency below 30 MHz: 40 dB/decade.

3.5.2 Test Procedures

1. Measurement is made at a semi-anechoic chamber that incorporates a turntable allowing a EUT rotation of 360°. A continuously-rotating, remotely-controlled turntable is installed at the test site to support the EUT and facilitate determination of the direction of maximum radiation for each EUT emission frequency. The EUT is placed at a height of 0.8 m test table above the ground plane.
2. Measurement is made with the antenna positioned in both the horizontal and vertical planes of polarization. The measurement antenna is varied in height (1m ~ 4m) above the reference ground plane to obtain the maximum signal strength. Distance between EUT and antenna is 3 m.
3. This investigation is performed with the EUT rotated 360°, the antenna height scanned between 1 m and 4 m, and the antenna rotated to repeat the measurements for both the horizontal and vertical antenna polarizations.

Note:

1. 120kHz measurement bandwidth of test receiver and Quasi-peak detector is for radiated emission below 1GHz.
2. RBW=1MHz, VBW=3MHz and Peak detector is for peak measured value of radiated emission above 1GHz.
3. RBW=1MHz, VBW=1/T and Peak detector is for average measured value of radiated emission above 1GHz.

3.5.3 Test Setup

Radiated Emissions below 1 GHz

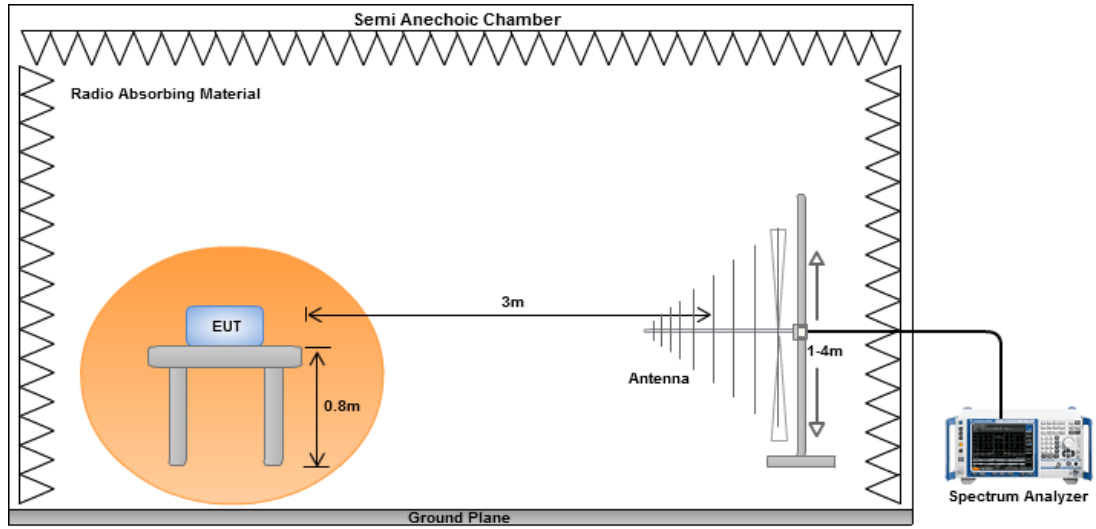

Radiated Emissions above 1 GHz

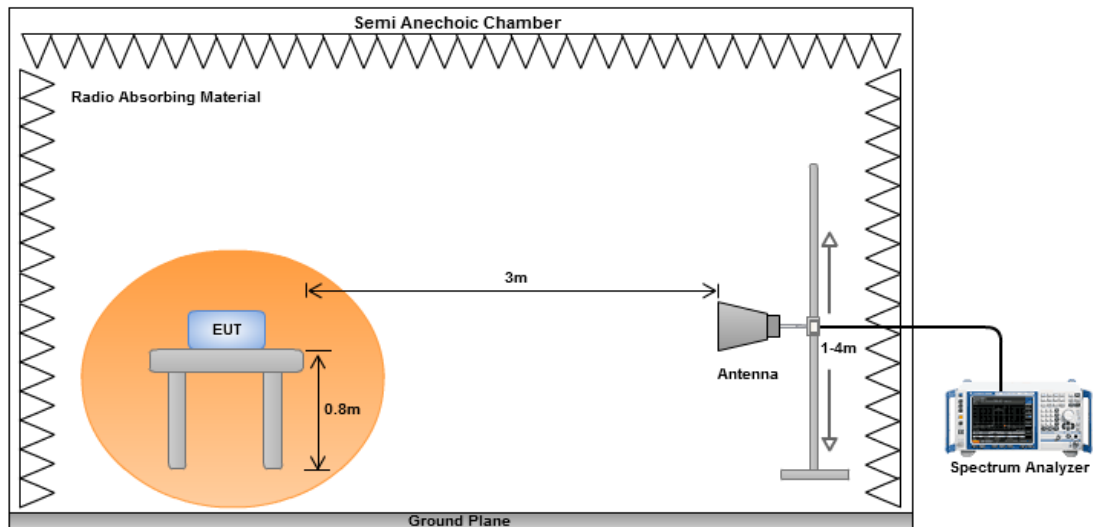

Legacy/MIMO (CDD) Non-beamforming mode

3.5.4 Transmitter Radiated Unwanted Emissions (Below 1GHz)

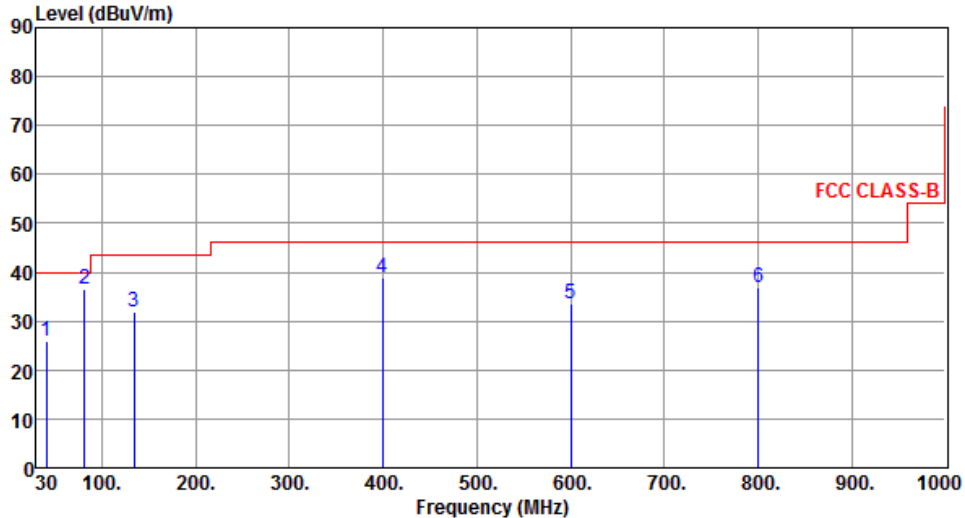
Modulation	VHT40	Test Freq. (MHz)	5795																																																																						
Polarization	Horizontal	Test Configuration	1																																																																						
 <p>The graph displays the emission level in dBuV/m on the y-axis (0 to 90) against frequency in MHz on the x-axis (30 to 1000). A red stepped line represents the FCC CLASS-B limit, which is 40 dBuV/m from 30 to 100 MHz, 45 dBuV/m from 100 to 200 MHz, 46 dBuV/m from 200 to 1000 MHz, and 75 dBuV/m at 1000 MHz. Six blue vertical lines indicate measured peaks at 40.67, 81.74, 133.85, 399.72, 600.63, and 800.12 MHz, with levels of 25.90, 36.54, 31.82, 38.73, 33.39, and 36.94 dBuV/m respectively.</p>																																																																									
<table border="1"> <thead> <tr> <th></th> <th>Freq. MHz</th> <th>Emission level dBuV/m</th> <th>Limit dBuV/m</th> <th>Margin dB</th> <th>SA reading dBuV</th> <th>Factor dB</th> <th>Remark</th> <th>ANT High cm</th> <th>Turn Table deg</th> </tr> </thead> <tbody> <tr> <td>1</td> <td>40.67</td> <td>25.90</td> <td>40.00</td> <td>-14.10</td> <td>42.89</td> <td>-16.99</td> <td>Peak</td> <td>---</td> <td>---</td> </tr> <tr> <td>2</td> <td>81.74</td> <td>36.54</td> <td>40.00</td> <td>-3.46</td> <td>58.37</td> <td>-21.83</td> <td>Peak</td> <td>---</td> <td>---</td> </tr> <tr> <td>3</td> <td>133.85</td> <td>31.82</td> <td>43.50</td> <td>-11.68</td> <td>49.61</td> <td>-17.79</td> <td>Peak</td> <td>---</td> <td>---</td> </tr> <tr> <td>4</td> <td>399.72</td> <td>38.73</td> <td>46.00</td> <td>-7.27</td> <td>52.46</td> <td>-13.73</td> <td>Peak</td> <td>---</td> <td>---</td> </tr> <tr> <td>5</td> <td>600.63</td> <td>33.39</td> <td>46.00</td> <td>-12.61</td> <td>42.95</td> <td>-9.56</td> <td>Peak</td> <td>---</td> <td>---</td> </tr> <tr> <td>6</td> <td>800.12</td> <td>36.94</td> <td>46.00</td> <td>-9.06</td> <td>43.62</td> <td>-6.68</td> <td>Peak</td> <td>---</td> <td>---</td> </tr> </tbody> </table>					Freq. MHz	Emission level dBuV/m	Limit dBuV/m	Margin dB	SA reading dBuV	Factor dB	Remark	ANT High cm	Turn Table deg	1	40.67	25.90	40.00	-14.10	42.89	-16.99	Peak	---	---	2	81.74	36.54	40.00	-3.46	58.37	-21.83	Peak	---	---	3	133.85	31.82	43.50	-11.68	49.61	-17.79	Peak	---	---	4	399.72	38.73	46.00	-7.27	52.46	-13.73	Peak	---	---	5	600.63	33.39	46.00	-12.61	42.95	-9.56	Peak	---	---	6	800.12	36.94	46.00	-9.06	43.62	-6.68	Peak	---	---
	Freq. MHz	Emission level dBuV/m	Limit dBuV/m	Margin dB	SA reading dBuV	Factor dB	Remark	ANT High cm	Turn Table deg																																																																
1	40.67	25.90	40.00	-14.10	42.89	-16.99	Peak	---	---																																																																
2	81.74	36.54	40.00	-3.46	58.37	-21.83	Peak	---	---																																																																
3	133.85	31.82	43.50	-11.68	49.61	-17.79	Peak	---	---																																																																
4	399.72	38.73	46.00	-7.27	52.46	-13.73	Peak	---	---																																																																
5	600.63	33.39	46.00	-12.61	42.95	-9.56	Peak	---	---																																																																
6	800.12	36.94	46.00	-9.06	43.62	-6.68	Peak	---	---																																																																
<p>Note 1: Emission Level (dBuV/m) = SA Reading (dBuV/m) + Factor* (dB) *Factor includes antenna factor , cable loss and amplifier gain Note 2: Margin (dB) = Emission level (dBuV/m) – Limit (dBuV/m). Note 3: All spurious emissions below 30MHz are more than 20 dB below the limit.</p>																																																																									

Modulation	VHT40	Test Freq. (MHz)	5795
Polarization	Vertical	Test Configuration	1

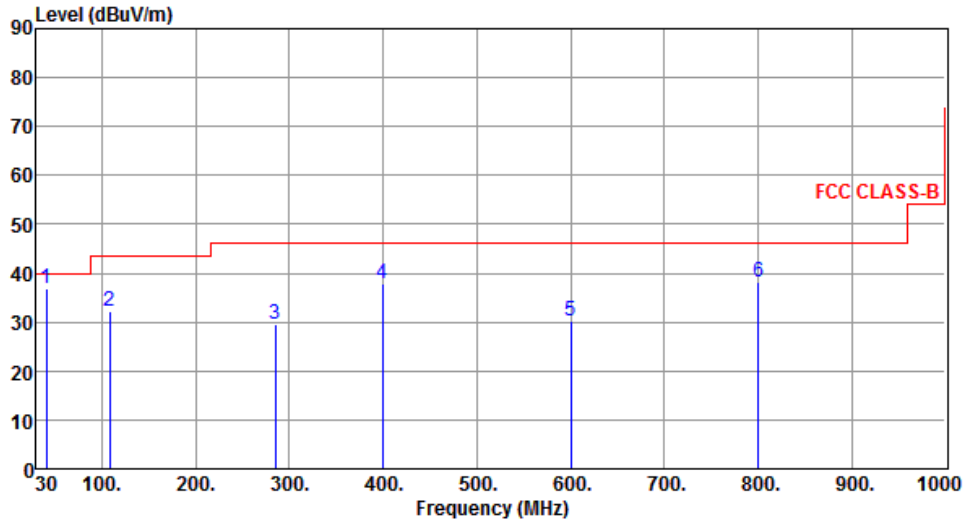

	Freq. MHz	Emission level dBuV/m	Limit dBuV/m	Margin dB	SA reading dBuV	Factor dB	Remark	ANT High cm	Turn Table deg
1	40.42	36.87	40.00	-3.13	53.87	-17.00	QP	---	---
2	108.62	32.33	43.50	-11.17	52.64	-20.31	Peak	---	---
3	285.11	29.67	46.00	-16.33	46.29	-16.62	Peak	---	---
4	399.59	37.72	46.00	-8.28	51.45	-13.73	Peak	---	---
5	600.42	30.27	46.00	-15.73	39.84	-9.57	Peak	---	---
6	800.26	38.09	46.00	-7.91	44.77	-6.68	Peak	---	---

Note 1: Emission Level (dBuV/m) = SA Reading (dBuV/m) + Factor* (dB)

*Factor includes antenna factor , cable loss and amplifier gain

Note 2: Margin (dB) = Emission level (dBuV/m) – Limit (dBuV/m).

Note 3: All spurious emissions below 30MHz are more than 20 dB below the limit.

Modulation	VHT40	Test Freq. (MHz)	5795
Polarization	Horizontal	Test Configuration	2

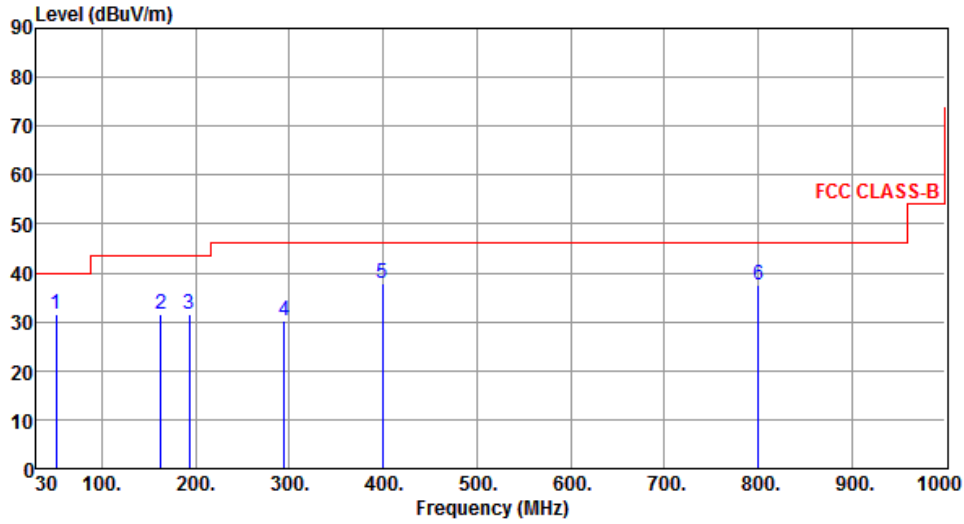

	Freq. MHz	Emission level dBuV/m	Limit dBuV/m	Margin dB	SA reading dBuV	Factor dB	Remark	ANT High cm	Turn Table deg
1	51.13	31.48	40.00	-8.52	47.88	-16.40	Peak	---	---
2	162.74	31.57	43.50	-11.93	48.49	-16.92	Peak	---	---
3	192.76	31.44	43.50	-12.06	51.05	-19.61	Peak	---	---
4	294.67	30.16	46.00	-15.84	46.51	-16.35	Peak	---	---
5	399.71	37.86	46.00	-8.14	51.59	-13.73	Peak	---	---
6	800.20	37.69	46.00	-8.31	44.37	-6.68	Peak	---	---

Note 1: Emission Level (dBuV/m) = SA Reading (dBuV/m) + Factor* (dB)

*Factor includes antenna factor, cable loss and amplifier gain

Note 2: Margin (dB) = Emission level (dBuV/m) – Limit (dBuV/m).

Note 3: All spurious emissions below 30MHz are more than 20 dB below the limit.

Modulation	VHT40	Test Freq. (MHz)	5795
Polarization	Vertical	Test Configuration	2

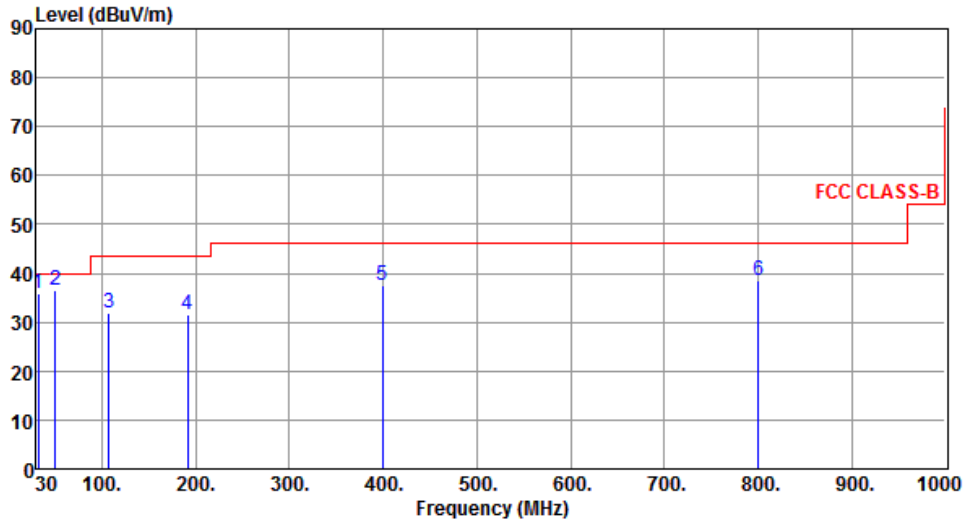

	Freq. MHz	Emission level dBuV/m	Limit dBuV/m	Margin dB	SA reading dBuV	Factor dB	Remark	ANT High cm	Turn Table deg
1	31.73	35.80	40.00	-4.20	53.48	-17.68	QP	---	---
2	50.26	36.49	40.00	-3.51	52.80	-16.31	QP	---	---
3	107.81	31.97	43.50	-11.53	52.40	-20.43	Peak	---	---
4	191.11	31.42	43.50	-12.08	50.97	-19.55	Peak	---	---
5	399.32	37.49	46.00	-8.51	51.23	-13.74	Peak	---	---
6	800.30	38.66	46.00	-7.34	45.34	-6.68	Peak	---	---

Note 1: Emission Level (dBuV/m) = SA Reading (dBuV/m) + Factor* (dB)

*Factor includes antenna factor , cable loss and amplifier gain

Note 2: Margin (dB) = Emission level (dBuV/m) – Limit (dBuV/m).

Note 3: All spurious emissions below 30MHz are more than 20 dB below the limit.

3.5.5 Transmitter Radiated Unwanted Emissions (Above 1GHz) for 11a

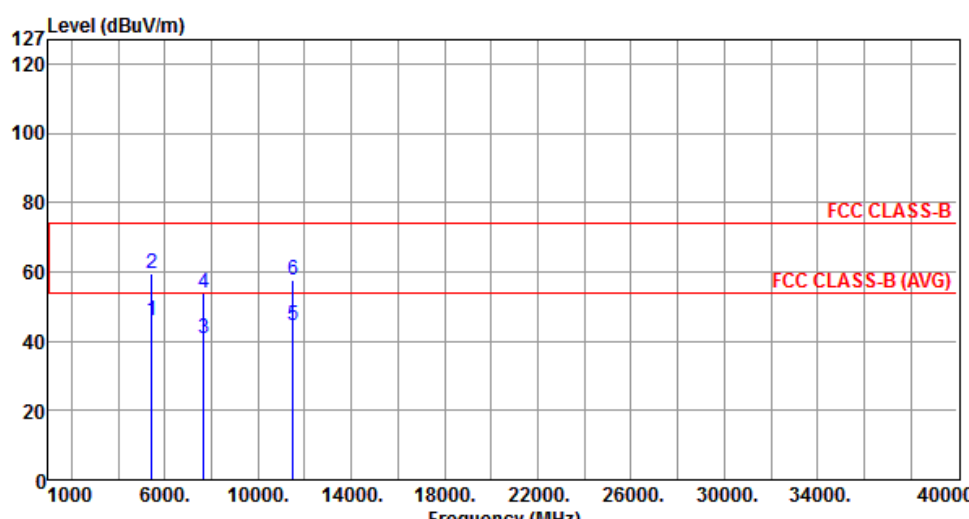
Modulation	11a	Test Freq. (MHz)	5745																																																																						
Polarization	Horizontal	Test Configuration	1																																																																						
																																																																									
	<table border="1"> <thead> <tr> <th>Freq.</th> <th>Emission level</th> <th>Limit</th> <th>Margin</th> <th>SA reading</th> <th>Factor</th> <th>Remark</th> <th>ANT High</th> <th>Turn Table</th> </tr> <tr> <th>MHz</th> <th>dBuV/m</th> <th>dBuV/m</th> <th>dB</th> <th>dBuV</th> <th>dB</th> <th></th> <th>cm</th> <th>deg</th> </tr> </thead> <tbody> <tr> <td>1</td> <td>5432.00</td> <td>45.84</td> <td>54.00</td> <td>-8.16</td> <td>39.76</td> <td>6.08</td> <td>Average</td> <td>---</td> </tr> <tr> <td>2</td> <td>5432.00</td> <td>59.56</td> <td>74.00</td> <td>-14.44</td> <td>53.48</td> <td>6.08</td> <td>Peak</td> <td>---</td> </tr> <tr> <td>3</td> <td>7660.00</td> <td>40.62</td> <td>54.00</td> <td>-13.38</td> <td>29.51</td> <td>11.11</td> <td>Average</td> <td>---</td> </tr> <tr> <td>4</td> <td>7660.00</td> <td>54.12</td> <td>74.00</td> <td>-19.88</td> <td>43.01</td> <td>11.11</td> <td>Peak</td> <td>---</td> </tr> <tr> <td>5</td> <td>11490.00</td> <td>44.48</td> <td>54.00</td> <td>-9.52</td> <td>29.28</td> <td>15.20</td> <td>Average</td> <td>---</td> </tr> <tr> <td>6</td> <td>11490.00</td> <td>57.80</td> <td>74.00</td> <td>-16.20</td> <td>42.60</td> <td>15.20</td> <td>Peak</td> <td>---</td> </tr> </tbody> </table>	Freq.	Emission level	Limit	Margin	SA reading	Factor	Remark	ANT High	Turn Table	MHz	dBuV/m	dBuV/m	dB	dBuV	dB		cm	deg	1	5432.00	45.84	54.00	-8.16	39.76	6.08	Average	---	2	5432.00	59.56	74.00	-14.44	53.48	6.08	Peak	---	3	7660.00	40.62	54.00	-13.38	29.51	11.11	Average	---	4	7660.00	54.12	74.00	-19.88	43.01	11.11	Peak	---	5	11490.00	44.48	54.00	-9.52	29.28	15.20	Average	---	6	11490.00	57.80	74.00	-16.20	42.60	15.20	Peak	---
Freq.	Emission level	Limit	Margin	SA reading	Factor	Remark	ANT High	Turn Table																																																																	
MHz	dBuV/m	dBuV/m	dB	dBuV	dB		cm	deg																																																																	
1	5432.00	45.84	54.00	-8.16	39.76	6.08	Average	---																																																																	
2	5432.00	59.56	74.00	-14.44	53.48	6.08	Peak	---																																																																	
3	7660.00	40.62	54.00	-13.38	29.51	11.11	Average	---																																																																	
4	7660.00	54.12	74.00	-19.88	43.01	11.11	Peak	---																																																																	
5	11490.00	44.48	54.00	-9.52	29.28	15.20	Average	---																																																																	
6	11490.00	57.80	74.00	-16.20	42.60	15.20	Peak	---																																																																	
<p>Note 1: Emission Level (dBuV/m) = SA Reading (dBuV/m) + Factor* (dB) *Factor includes antenna factor , cable loss and amplifier gain Note 2: Margin (dB) = Emission level (dBuV/m) – Limit (dBuV/m).</p>																																																																									

Modulation	11a	Test Freq. (MHz)	5745
Polarization	Vertical	Test Configuration	1

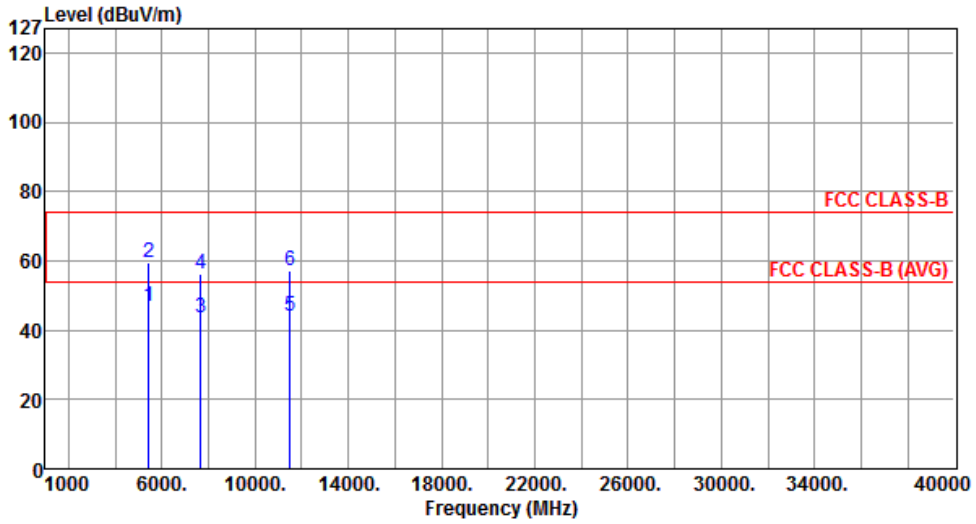

	Freq. MHz	Emission level dBuV/m	Limit dBuV/m	Margin dB	SA reading dBuV	Factor dB	Remark	ANT High cm	Turn Table deg
1	5432.00	46.82	54.00	-7.18	40.74	6.08	Average	---	---
2	5432.00	59.51	74.00	-14.49	53.43	6.08	Peak	---	---
3	7660.00	43.57	54.00	-10.43	32.46	11.11	Average	---	---
4	7660.00	56.44	74.00	-17.56	45.33	11.11	Peak	---	---
5	11490.00	44.08	54.00	-9.92	28.88	15.20	Average	---	---
6	11490.00	56.94	74.00	-17.06	41.74	15.20	Peak	---	---

Note 1: Emission Level (dBuV/m) = SA Reading (dBuV/m) + Factor* (dB)

*Factor includes antenna factor , cable loss and amplifier gain

Note 2: Margin (dB) = Emission level (dBuV/m) – Limit (dBuV/m).

Modulation	11a	Test Freq. (MHz)	5785
Polarization	Horizontal	Test Configuration	1

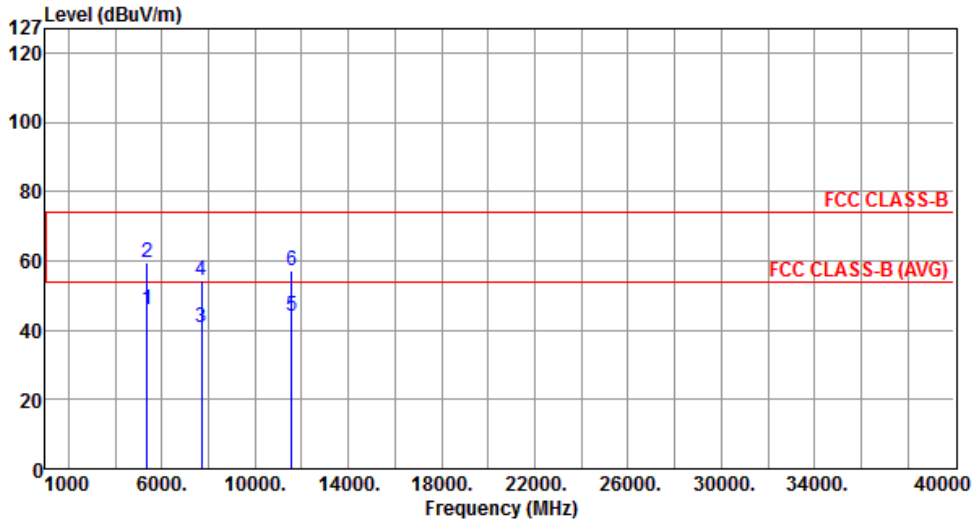

	Freq. MHz	Emission level dBuV/m	Limit dBuV/m	Margin dB	SA reading dBuV	Factor dB	Remark	ANT High cm	Turn Table deg
1	5382.00	46.13	54.00	-7.87	40.10	6.03	Average	---	---
2	5382.00	59.75	74.00	-14.25	53.72	6.03	Peak	---	---
3	7713.30	40.92	54.00	-13.08	29.85	11.07	Average	---	---
4	7713.30	54.49	74.00	-19.51	43.42	11.07	Peak	---	---
5	11570.00	44.01	54.00	-9.99	28.86	15.15	Average	---	---
6	11570.00	57.31	74.00	-16.69	42.16	15.15	Peak	---	---

Note 1: Emission Level (dBuV/m) = SA Reading (dBuV/m) + Factor* (dB)

*Factor includes antenna factor , cable loss and amplifier gain

Note 2: Margin (dB) = Emission level (dBuV/m) – Limit (dBuV/m).

Modulation	11a	Test Freq. (MHz)	5785
Polarization	Vertical	Test Configuration	1

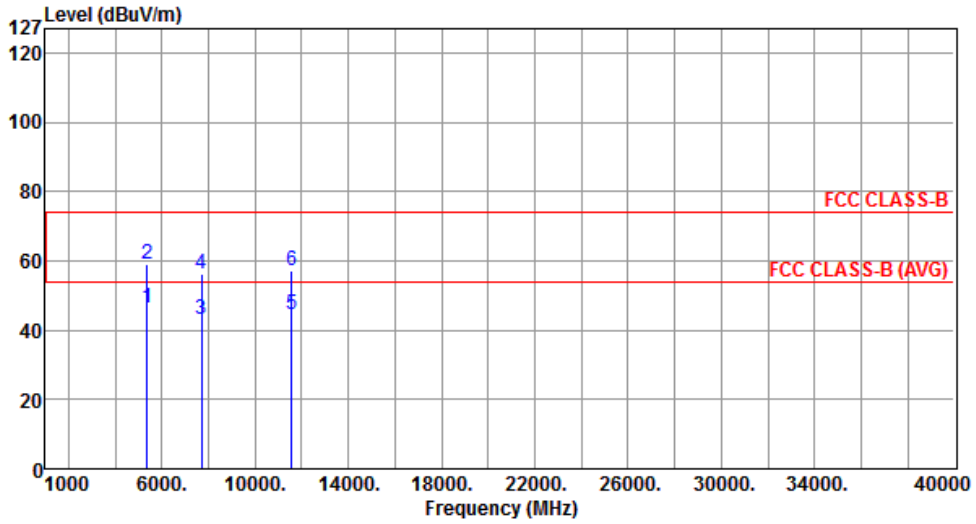

	Freq. MHz	Emission level dBuV/m	Limit dBuV/m	Margin dB	SA reading dBuV	Factor dB	Remark	ANT High cm	Turn Table deg
1	5382.00	46.55	54.00	-7.45	40.52	6.03	Average	---	---
2	5382.00	59.27	74.00	-14.73	53.24	6.03	Peak	---	---
3	7713.30	43.18	54.00	-10.82	32.11	11.07	Average	---	---
4	7713.30	56.11	74.00	-17.89	45.04	11.07	Peak	---	---
5	11570.00	44.38	54.00	-9.62	29.23	15.15	Average	---	---
6	11570.00	57.35	74.00	-16.65	42.20	15.15	Peak	---	---

Note 1: Emission Level (dBuV/m) = SA Reading (dBuV/m) + Factor* (dB)

*Factor includes antenna factor , cable loss and amplifier gain

Note 2: Margin (dB) = Emission level (dBuV/m) – Limit (dBuV/m).

Modulation	11a	Test Freq. (MHz)	5825
Polarization	Horizontal	Test Configuration	1

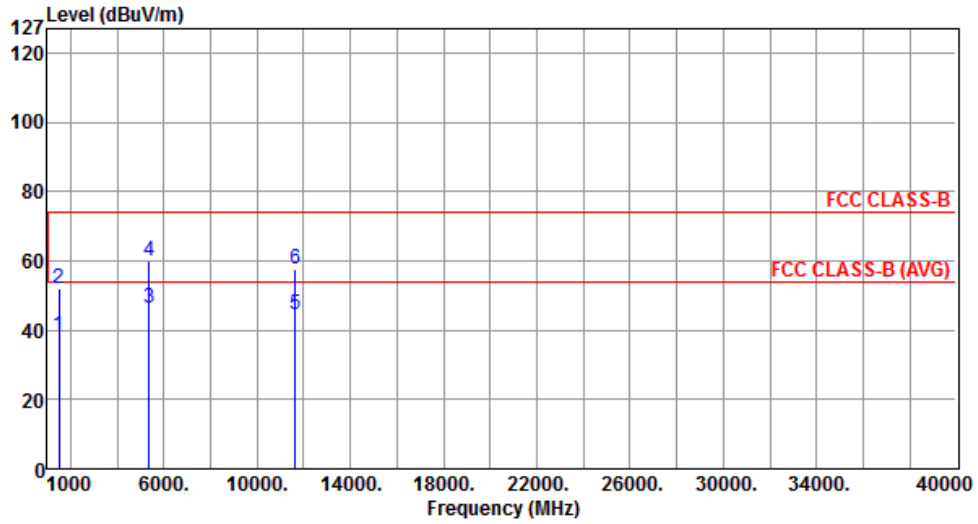

	Freq. MHz	Emission level dBuV/m	Limit dBuV/m	Margin dB	SA reading dBuV	Factor dB	Remark	ANT High cm	Turn Table deg
1	1500.00	38.65	54.00	-15.35	45.12	-6.47	Average	---	---
2	1500.00	51.98	74.00	-22.02	58.45	-6.47	Peak	---	---
3	5367.00	46.48	54.00	-7.52	40.46	6.02	Average	---	---
4	5367.00	60.10	74.00	-13.90	54.08	6.02	Peak	---	---
5	11650.00	44.49	54.00	-9.51	29.38	15.11	Average	---	---
6	11650.00	57.68	74.00	-16.32	42.57	15.11	Peak	---	---

Note 1: Emission Level (dBuV/m) = SA Reading (dBuV/m) + Factor* (dB)

*Factor includes antenna factor , cable loss and amplifier gain

Note 2: Margin (dB) = Emission level (dBuV/m) – Limit (dBuV/m).

Modulation	11a	Test Freq. (MHz)	5825
Polarization	Vertical	Test Configuration	1

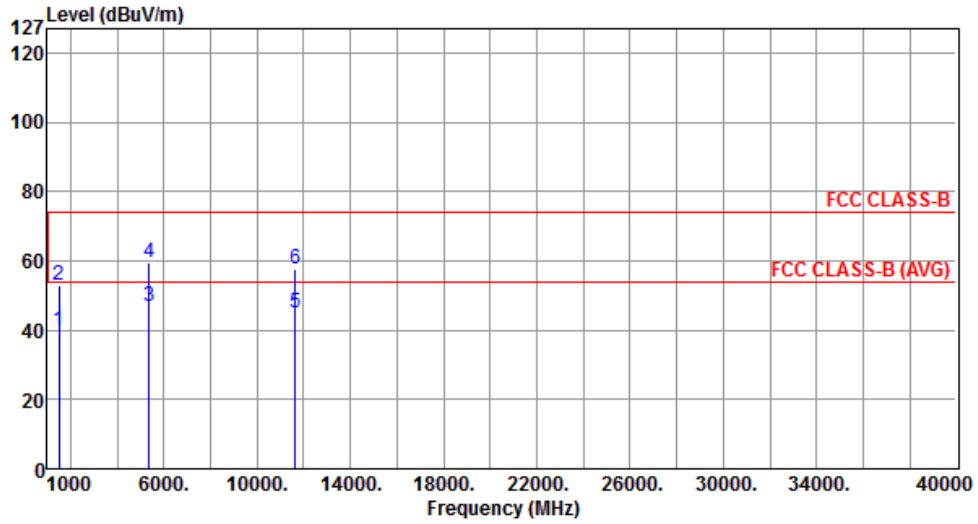

	Freq. MHz	Emission level dBuV/m	Limit dBuV/m	Margin dB	SA reading dBuV	Factor dB	Remark	ANT High cm	Turn Table deg
1	1500.00	39.60	54.00	-14.40	46.07	-6.47	Average	---	---
2	1500.00	53.09	74.00	-20.91	59.56	-6.47	Peak	---	---
3	5367.00	46.89	54.00	-7.11	40.87	6.02	Average	---	---
4	5367.00	59.62	74.00	-14.38	53.60	6.02	Peak	---	---
5	11650.00	44.84	54.00	-9.16	29.73	15.11	Average	---	---
6	11650.00	57.72	74.00	-16.28	42.61	15.11	Peak	---	---

Note 1: Emission Level (dBuV/m) = SA Reading (dBuV/m) + Factor* (dB)

*Factor includes antenna factor , cable loss and amplifier gain

Note 2: Margin (dB) = Emission level (dBuV/m) – Limit (dBuV/m).

3.5.6 Transmitter Radiated Unwanted Emissions (Above 1GHz) for VHT20

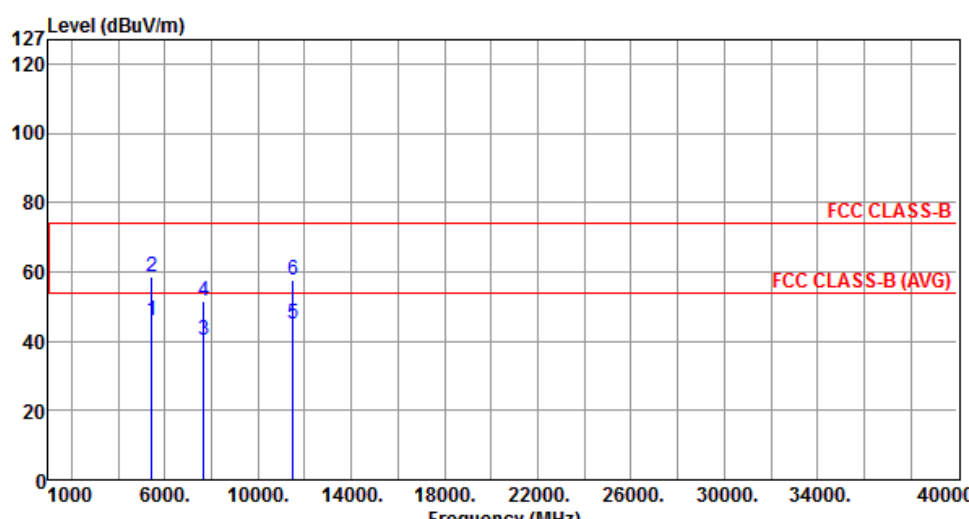
Modulation	VHT20	Test Freq. (MHz)	5745																																																																						
Polarization	Horizontal	Test Configuration	1																																																																						
																																																																									
	<table border="1"> <thead> <tr> <th>Freq.</th> <th>Emission level</th> <th>Limit</th> <th>Margin</th> <th>SA reading</th> <th>Factor</th> <th>Remark</th> <th>ANT High</th> <th>Turn Table</th> </tr> <tr> <th>MHz</th> <th>dBuV/m</th> <th>dBuV/m</th> <th>dB</th> <th>dBuV</th> <th>dB</th> <th></th> <th>cm</th> <th>deg</th> </tr> </thead> <tbody> <tr> <td>1</td> <td>5432.00</td> <td>45.77</td> <td>54.00</td> <td>-8.23</td> <td>39.69</td> <td>6.08</td> <td>Average</td> <td>---</td> </tr> <tr> <td>2</td> <td>5432.00</td> <td>58.50</td> <td>74.00</td> <td>-15.50</td> <td>52.42</td> <td>6.08</td> <td>Peak</td> <td>---</td> </tr> <tr> <td>3</td> <td>7660.00</td> <td>40.13</td> <td>54.00</td> <td>-13.87</td> <td>29.02</td> <td>11.11</td> <td>Average</td> <td>---</td> </tr> <tr> <td>4</td> <td>7660.00</td> <td>51.74</td> <td>74.00</td> <td>-22.26</td> <td>40.63</td> <td>11.11</td> <td>Peak</td> <td>---</td> </tr> <tr> <td>5</td> <td>11490.00</td> <td>44.82</td> <td>54.00</td> <td>-9.18</td> <td>29.62</td> <td>15.20</td> <td>Average</td> <td>---</td> </tr> <tr> <td>6</td> <td>11490.00</td> <td>57.68</td> <td>74.00</td> <td>-16.32</td> <td>42.48</td> <td>15.20</td> <td>Peak</td> <td>---</td> </tr> </tbody> </table>	Freq.	Emission level	Limit	Margin	SA reading	Factor	Remark	ANT High	Turn Table	MHz	dBuV/m	dBuV/m	dB	dBuV	dB		cm	deg	1	5432.00	45.77	54.00	-8.23	39.69	6.08	Average	---	2	5432.00	58.50	74.00	-15.50	52.42	6.08	Peak	---	3	7660.00	40.13	54.00	-13.87	29.02	11.11	Average	---	4	7660.00	51.74	74.00	-22.26	40.63	11.11	Peak	---	5	11490.00	44.82	54.00	-9.18	29.62	15.20	Average	---	6	11490.00	57.68	74.00	-16.32	42.48	15.20	Peak	---
Freq.	Emission level	Limit	Margin	SA reading	Factor	Remark	ANT High	Turn Table																																																																	
MHz	dBuV/m	dBuV/m	dB	dBuV	dB		cm	deg																																																																	
1	5432.00	45.77	54.00	-8.23	39.69	6.08	Average	---																																																																	
2	5432.00	58.50	74.00	-15.50	52.42	6.08	Peak	---																																																																	
3	7660.00	40.13	54.00	-13.87	29.02	11.11	Average	---																																																																	
4	7660.00	51.74	74.00	-22.26	40.63	11.11	Peak	---																																																																	
5	11490.00	44.82	54.00	-9.18	29.62	15.20	Average	---																																																																	
6	11490.00	57.68	74.00	-16.32	42.48	15.20	Peak	---																																																																	
<p>Note 1: Emission Level (dBUV/m) = SA Reading (dBUV/m) + Factor* (dB) *Factor includes antenna factor , cable loss and amplifier gain Note 2: Margin (dB) = Emission level (dBUV/m) – Limit (dBUV/m).</p>																																																																									

Modulation	VHT20	Test Freq. (MHz)	5745
Polarization	Vertical	Test Configuration	1

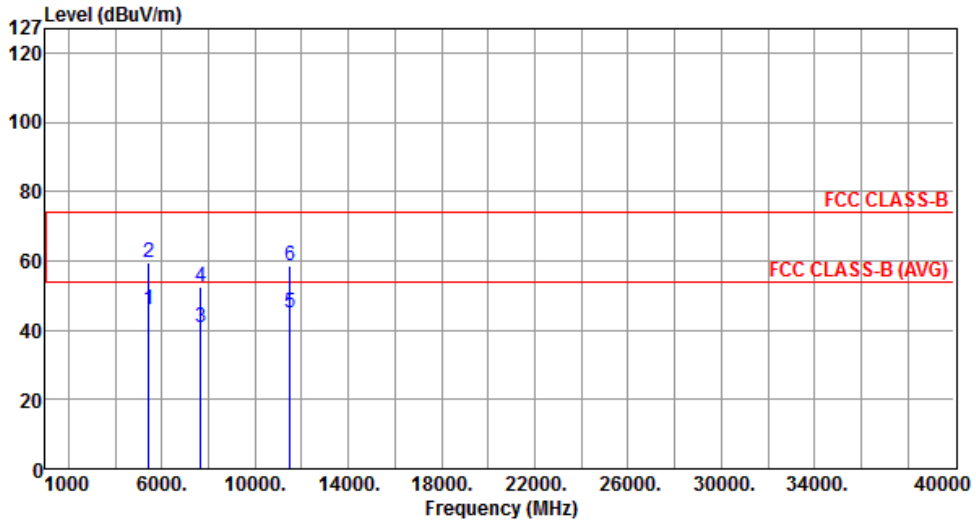

	Freq. MHz	Emission level dBuV/m	Limit dBuV/m	Margin dB	SA reading dBuV	Factor dB	Remark	ANT High cm	Turn Table deg
1	5432.00	45.82	54.00	-8.18	39.74	6.08	Average	---	---
2	5432.00	59.57	74.00	-14.43	53.49	6.08	Peak	---	---
3	7660.00	40.68	54.00	-13.32	29.57	11.11	Average	---	---
4	7660.00	52.44	74.00	-21.56	41.33	11.11	Peak	---	---
5	11490.00	45.06	54.00	-8.94	29.86	15.20	Average	---	---
6	11490.00	58.67	74.00	-15.33	43.47	15.20	Peak	---	---

Note 1: Emission Level (dBuV/m) = SA Reading (dBuV/m) + Factor* (dB)

*Factor includes antenna factor , cable loss and amplifier gain

Note 2: Margin (dB) = Emission level (dBuV/m) – Limit (dBuV/m).

Modulation	VHT20	Test Freq. (MHz)	5785
Polarization	Horizontal	Test Configuration	1

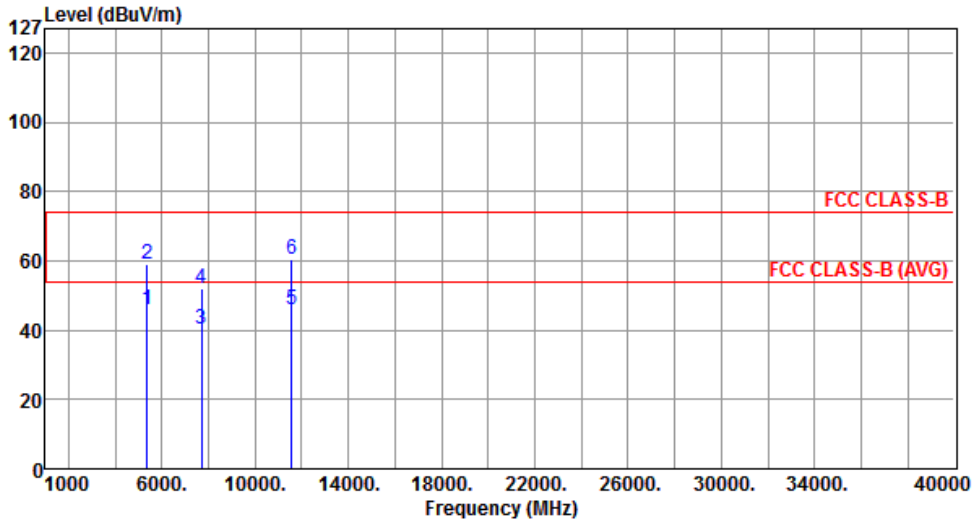

	Freq. MHz	Emission level dBuV/m	Limit dBuV/m	Margin dB	SA reading dBuV	Factor dB	Remark	ANT High cm	Turn Table deg
1	5382.00	46.14	54.00	-7.86	40.11	6.03	Average	---	---
2	5382.00	59.27	74.00	-14.73	53.24	6.03	Peak	---	---
3	7713.33	40.53	54.00	-13.47	29.46	11.07	Average	---	---
4	7713.33	51.84	74.00	-22.16	40.77	11.07	Peak	---	---
5	11570.00	46.00	54.00	-8.00	30.85	15.15	Average	---	---
6	11570.00	60.36	74.00	-13.64	45.21	15.15	Peak	---	---

Note 1: Emission Level (dBuV/m) = SA Reading (dBuV/m) + Factor* (dB)

*Factor includes antenna factor , cable loss and amplifier gain

Note 2: Margin (dB) = Emission level (dBuV/m) – Limit (dBuV/m).

Modulation	VHT20	Test Freq. (MHz)	5785
Polarization	Vertical	Test Configuration	1

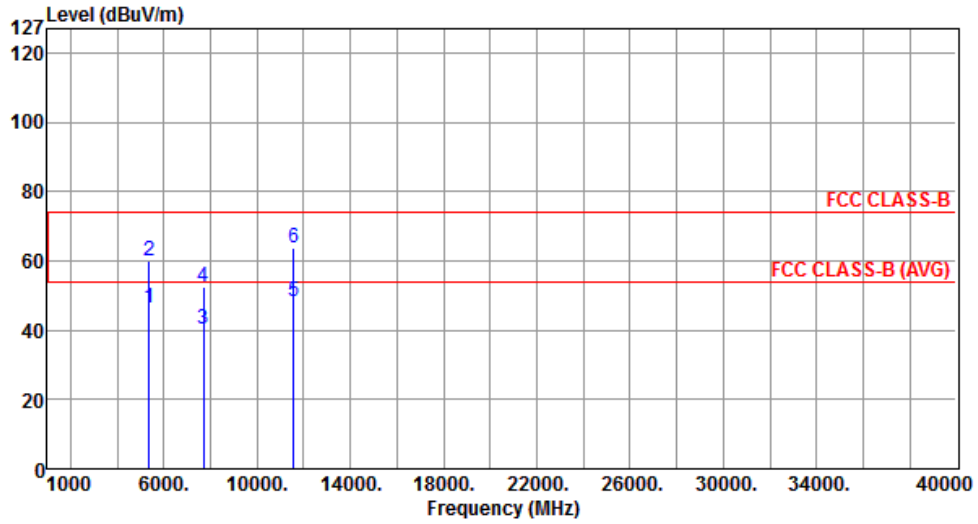

	Freq. MHz	Emission level dBuV/m	Limit dBuV/m	Margin dB	SA reading dBuV	Factor dB	Remark	ANT High cm	Turn Table deg
1	5382.00	46.36	54.00	-7.64	40.33	6.03	Average	---	---
2	5382.00	60.18	74.00	-13.82	54.15	6.03	Peak	---	---
3	7713.33	40.41	54.00	-13.59	29.34	11.07	Average	---	---
4	7713.33	52.31	74.00	-21.69	41.24	11.07	Peak	---	---
5	11570.00	48.40	54.00	-5.60	33.25	15.15	Average	---	---
6	11570.00	63.80	74.00	-10.20	48.65	15.15	Peak	---	---

Note 1: Emission Level (dBuV/m) = SA Reading (dBuV/m) + Factor* (dB)

*Factor includes antenna factor , cable loss and amplifier gain

Note 2: Margin (dB) = Emission level (dBuV/m) – Limit (dBuV/m).

Modulation	VHT20	Test Freq. (MHz)	5825
Polarization	Horizontal	Test Configuration	1

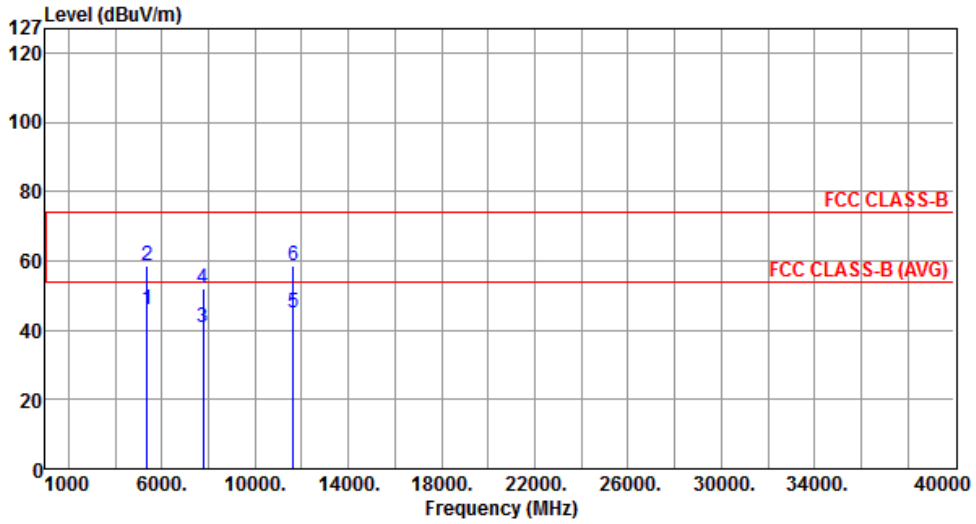

	Freq. MHz	Emission level dBuV/m	Limit dBuV/m	Margin dB	SA reading dBuV	Factor dB	Remark	ANT High cm	Turn Table deg
1	5367.00	46.14	54.00	-7.86	40.12	6.02	Average	---	---
2	5367.00	58.49	74.00	-15.51	52.47	6.02	Peak	---	---
3	7766.66	40.67	54.00	-13.33	29.63	11.04	Average	---	---
4	7766.66	52.23	74.00	-21.77	41.19	11.04	Peak	---	---
5	11650.00	44.86	54.00	-9.14	29.75	15.11	Average	---	---
6	11650.00	58.39	74.00	-15.61	43.28	15.11	Peak	---	---

Note 1: Emission Level (dBuV/m) = SA Reading (dBuV/m) + Factor* (dB)

*Factor includes antenna factor , cable loss and amplifier gain

Note 2: Margin (dB) = Emission level (dBuV/m) – Limit (dBuV/m).

Modulation	VHT20	Test Freq. (MHz)	5825
Polarization	Vertical	Test Configuration	1

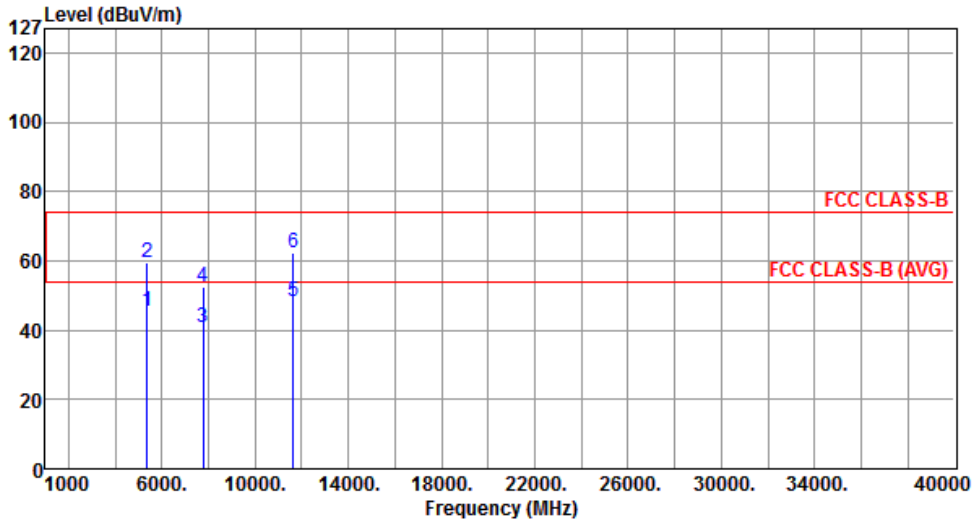

	Freq. MHz	Emission level dBuV/m	Limit dBuV/m	Margin dB	SA reading dBuV	Factor dB	Remark	ANT High cm	Turn Table deg
1	5367.00	45.69	54.00	-8.31	39.67	6.02	Average	---	---
2	5367.00	59.67	74.00	-14.33	53.65	6.02	Peak	---	---
3	7766.66	40.72	54.00	-13.28	29.68	11.04	Average	---	---
4	7766.66	52.72	74.00	-21.28	41.68	11.04	Peak	---	---
5	11650.00	48.24	54.00	-5.76	33.13	15.11	Average	---	---
6	11650.00	62.49	74.00	-11.51	47.38	15.11	Peak	---	---

Note 1: Emission Level (dBuV/m) = SA Reading (dBuV/m) + Factor* (dB)

*Factor includes antenna factor , cable loss and amplifier gain

Note 2: Margin (dB) = Emission level (dBuV/m) – Limit (dBuV/m).

3.5.7 Transmitter Radiated Unwanted Emissions (Above 1GHz) for VHT40

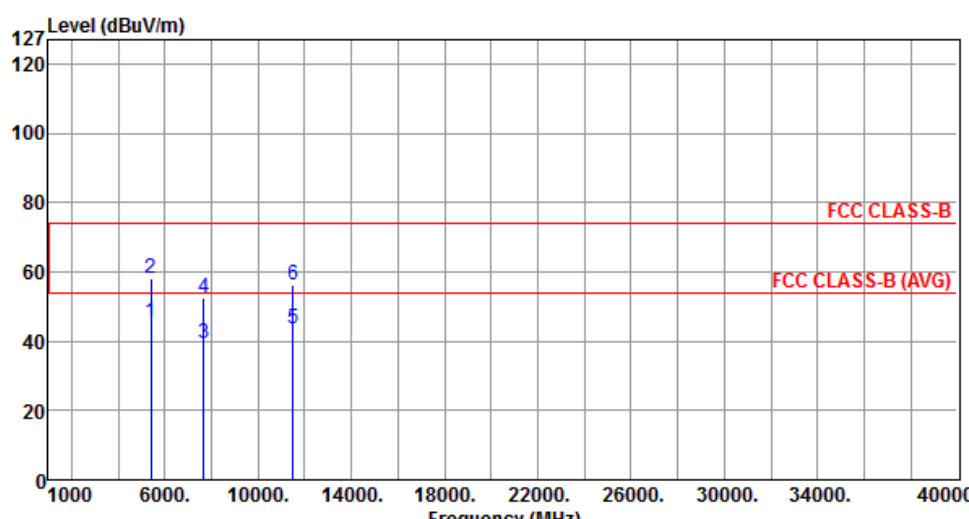
Modulation	VHT40	Test Freq. (MHz)	5755																																																																						
Polarization	Horizontal	Test Configuration	1																																																																						
																																																																									
	<table border="1"> <thead> <tr> <th>Freq.</th> <th>Emission level</th> <th>Limit</th> <th>Margin</th> <th>SA reading</th> <th>Factor</th> <th>Remark</th> <th>ANT High</th> <th>Turn Table</th> </tr> <tr> <th>MHz</th> <th>dBuV/m</th> <th>dBuV/m</th> <th>dB</th> <th>dBuV</th> <th>dB</th> <th></th> <th>cm</th> <th>deg</th> </tr> </thead> <tbody> <tr> <td>1</td> <td>5387.00</td> <td>45.59</td> <td>54.00</td> <td>-8.41</td> <td>39.56</td> <td>6.03</td> <td>Average</td> <td>---</td> </tr> <tr> <td>2</td> <td>5387.00</td> <td>58.21</td> <td>74.00</td> <td>-15.79</td> <td>52.18</td> <td>6.03</td> <td>Peak</td> <td>---</td> </tr> <tr> <td>3</td> <td>7673.33</td> <td>39.31</td> <td>54.00</td> <td>-14.69</td> <td>28.21</td> <td>11.10</td> <td>Average</td> <td>---</td> </tr> <tr> <td>4</td> <td>7673.33</td> <td>52.45</td> <td>74.00</td> <td>-21.55</td> <td>41.35</td> <td>11.10</td> <td>Peak</td> <td>---</td> </tr> <tr> <td>5</td> <td>11510.00</td> <td>43.53</td> <td>54.00</td> <td>-10.47</td> <td>28.35</td> <td>15.18</td> <td>Average</td> <td>---</td> </tr> <tr> <td>6</td> <td>11510.00</td> <td>56.39</td> <td>74.00</td> <td>-17.61</td> <td>41.21</td> <td>15.18</td> <td>Peak</td> <td>---</td> </tr> </tbody> </table>	Freq.	Emission level	Limit	Margin	SA reading	Factor	Remark	ANT High	Turn Table	MHz	dBuV/m	dBuV/m	dB	dBuV	dB		cm	deg	1	5387.00	45.59	54.00	-8.41	39.56	6.03	Average	---	2	5387.00	58.21	74.00	-15.79	52.18	6.03	Peak	---	3	7673.33	39.31	54.00	-14.69	28.21	11.10	Average	---	4	7673.33	52.45	74.00	-21.55	41.35	11.10	Peak	---	5	11510.00	43.53	54.00	-10.47	28.35	15.18	Average	---	6	11510.00	56.39	74.00	-17.61	41.21	15.18	Peak	---
Freq.	Emission level	Limit	Margin	SA reading	Factor	Remark	ANT High	Turn Table																																																																	
MHz	dBuV/m	dBuV/m	dB	dBuV	dB		cm	deg																																																																	
1	5387.00	45.59	54.00	-8.41	39.56	6.03	Average	---																																																																	
2	5387.00	58.21	74.00	-15.79	52.18	6.03	Peak	---																																																																	
3	7673.33	39.31	54.00	-14.69	28.21	11.10	Average	---																																																																	
4	7673.33	52.45	74.00	-21.55	41.35	11.10	Peak	---																																																																	
5	11510.00	43.53	54.00	-10.47	28.35	15.18	Average	---																																																																	
6	11510.00	56.39	74.00	-17.61	41.21	15.18	Peak	---																																																																	
<p>Note 1: Emission Level (dBuV/m) = SA Reading (dBuV/m) + Factor* (dB) *Factor includes antenna factor , cable loss and amplifier gain Note 2: Margin (dB) = Emission level (dBuV/m) – Limit (dBuV/m).</p>																																																																									

Modulation	VHT40	Test Freq. (MHz)	5755
Polarization	Vertical	Test Configuration	1

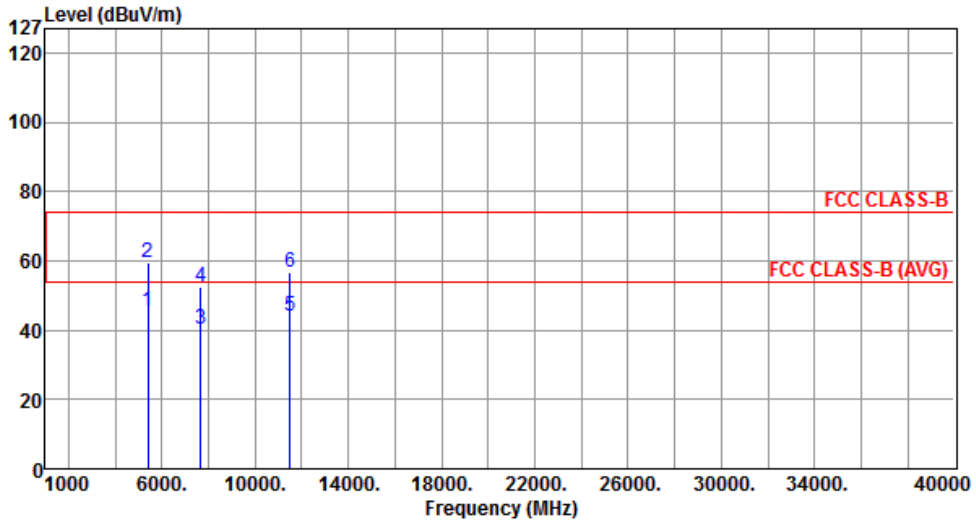

	Freq. MHz	Emission level dBuV/m	Limit dBuV/m	Margin dB	SA reading dBuV	Factor dB	Remark	ANT High cm	Turn Table deg
1	5387.00	45.60	54.00	-8.40	39.57	6.03	Average	---	---
2	5387.00	59.63	74.00	-14.37	53.60	6.03	Peak	---	---
3	7673.33	40.25	54.00	-13.75	29.15	11.10	Average	---	---
4	7673.33	52.48	74.00	-21.52	41.38	11.10	Peak	---	---
5	11510.00	43.84	54.00	-10.16	28.66	15.18	Average	---	---
6	11510.00	56.76	74.00	-17.24	41.58	15.18	Peak	---	---

Note 1: Emission Level (dBuV/m) = SA Reading (dBuV/m) + Factor* (dB)

*Factor includes antenna factor , cable loss and amplifier gain

Note 2: Margin (dB) = Emission level (dBuV/m) – Limit (dBuV/m).

Modulation	VHT40	Test Freq. (MHz)	5795
Polarization	Horizontal	Test Configuration	1

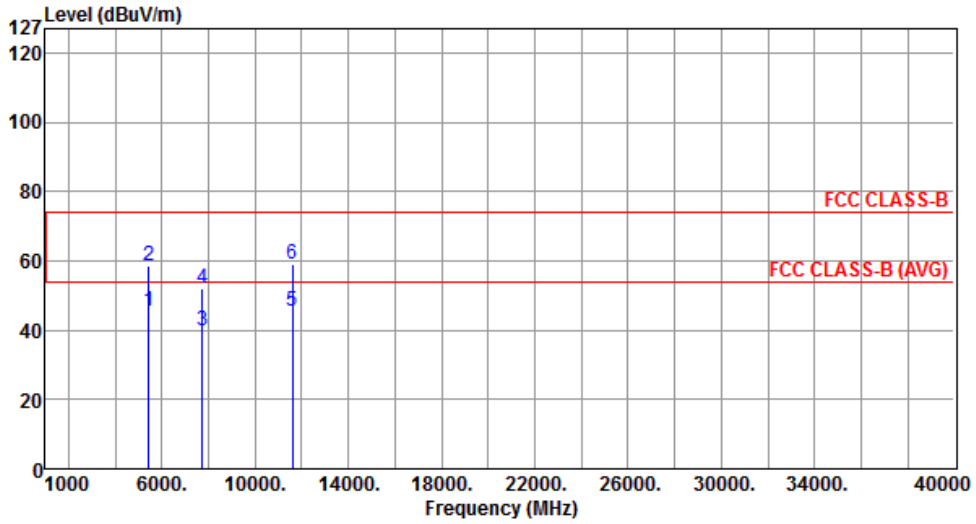

	Freq. MHz	Emission level dBuV/m	Limit dBuV/m	Margin dB	SA reading dBuV	Factor dB	Remark	ANT High cm	Turn Table deg
1	5420.00	45.42	54.00	-8.58	39.35	6.07	Average	---	---
2	5420.00	58.75	74.00	-15.25	52.68	6.07	Peak	---	---
3	7726.66	39.95	54.00	-14.05	28.89	11.06	Average	---	---
4	7726.66	52.04	74.00	-21.96	40.98	11.06	Peak	---	---
5	11590.00	45.47	54.00	-8.53	30.33	15.14	Average	---	---
6	11590.00	58.99	74.00	-15.01	43.85	15.14	Peak	---	---

Note 1: Emission Level (dBuV/m) = SA Reading (dBuV/m) + Factor* (dB)

*Factor includes antenna factor , cable loss and amplifier gain

Note 2: Margin (dB) = Emission level (dBuV/m) – Limit (dBuV/m).

Modulation	VHT40	Test Freq. (MHz)	5795
Polarization	Vertical	Test Configuration	1

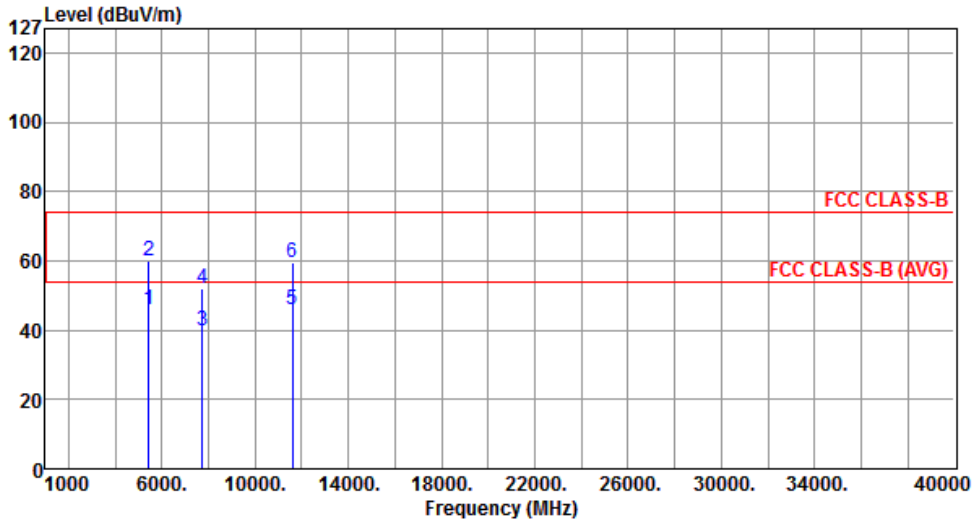

	Freq. MHz	Emission level dBuV/m	Limit dBuV/m	Margin dB	SA reading dBuV	Factor dB	Remark	ANT High cm	Turn Table deg
1	5420.00	45.73	54.00	-8.27	39.66	6.07	Average	---	---
2	5420.00	59.85	74.00	-14.15	53.78	6.07	Peak	---	---
3	7726.66	39.89	54.00	-14.11	28.83	11.06	Average	---	---
4	7726.66	52.04	74.00	-21.96	40.98	11.06	Peak	---	---
5	11590.00	45.92	54.00	-8.08	30.78	15.14	Average	---	---
6	11590.00	59.70	74.00	-14.30	44.56	15.14	Peak	---	---

Note 1: Emission Level (dBuV/m) = SA Reading (dBuV/m) + Factor* (dB)

*Factor includes antenna factor , cable loss and amplifier gain

Note 2: Margin (dB) = Emission level (dBuV/m) – Limit (dBuV/m).

3.5.8 Transmitter Radiated Unwanted Emissions (Above 1GHz) for VHT80

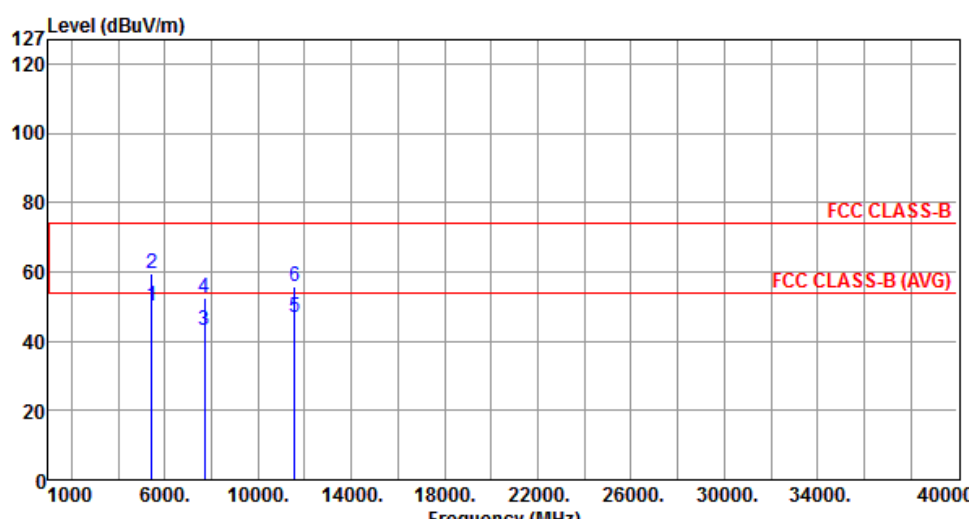
Modulation	VHT80	Test Freq. (MHz)	5775																																																																													
Polarization	Horizontal	Test Configuration	1																																																																													
																																																																																
	<table border="1"> <thead> <tr> <th>Freq.</th> <th>Emission level</th> <th>Limit</th> <th>Margin</th> <th>SA reading</th> <th>Factor</th> <th>Remark</th> <th>ANT High</th> <th>Turn Table</th> </tr> <tr> <th>MHz</th> <th>dBuV/m</th> <th>dBuV/m</th> <th>dB</th> <th>dBuV</th> <th>dB</th> <th></th> <th>cm</th> <th>deg</th> </tr> </thead> <tbody> <tr> <td>1</td> <td>5451.00</td> <td>50.13</td> <td>54.00</td> <td>-3.87</td> <td>44.02</td> <td>6.11</td> <td>Average</td> <td>---</td> </tr> <tr> <td>2</td> <td>5451.00</td> <td>59.29</td> <td>74.00</td> <td>-14.71</td> <td>53.18</td> <td>6.11</td> <td>Peak</td> <td>---</td> </tr> <tr> <td>3</td> <td>7700.00</td> <td>43.26</td> <td>54.00</td> <td>-10.74</td> <td>32.18</td> <td>11.08</td> <td>Average</td> <td>---</td> </tr> <tr> <td>4</td> <td>7700.00</td> <td>52.61</td> <td>74.00</td> <td>-21.39</td> <td>41.53</td> <td>11.08</td> <td>Peak</td> <td>---</td> </tr> <tr> <td>5</td> <td>11550.00</td> <td>46.63</td> <td>54.00</td> <td>-7.37</td> <td>31.47</td> <td>15.16</td> <td>Average</td> <td>---</td> </tr> <tr> <td>6</td> <td>11550.00</td> <td>55.69</td> <td>74.00</td> <td>-18.31</td> <td>40.53</td> <td>15.16</td> <td>Peak</td> <td>---</td> </tr> </tbody> </table>	Freq.	Emission level	Limit	Margin	SA reading	Factor	Remark	ANT High	Turn Table	MHz	dBuV/m	dBuV/m	dB	dBuV	dB		cm	deg	1	5451.00	50.13	54.00	-3.87	44.02	6.11	Average	---	2	5451.00	59.29	74.00	-14.71	53.18	6.11	Peak	---	3	7700.00	43.26	54.00	-10.74	32.18	11.08	Average	---	4	7700.00	52.61	74.00	-21.39	41.53	11.08	Peak	---	5	11550.00	46.63	54.00	-7.37	31.47	15.16	Average	---	6	11550.00	55.69	74.00	-18.31	40.53	15.16	Peak	---							
Freq.	Emission level	Limit	Margin	SA reading	Factor	Remark	ANT High	Turn Table																																																																								
MHz	dBuV/m	dBuV/m	dB	dBuV	dB		cm	deg																																																																								
1	5451.00	50.13	54.00	-3.87	44.02	6.11	Average	---																																																																								
2	5451.00	59.29	74.00	-14.71	53.18	6.11	Peak	---																																																																								
3	7700.00	43.26	54.00	-10.74	32.18	11.08	Average	---																																																																								
4	7700.00	52.61	74.00	-21.39	41.53	11.08	Peak	---																																																																								
5	11550.00	46.63	54.00	-7.37	31.47	15.16	Average	---																																																																								
6	11550.00	55.69	74.00	-18.31	40.53	15.16	Peak	---																																																																								
<p>Note 1: Emission Level (dBuV/m) = SA Reading (dBuV/m) + Factor* (dB) *Factor includes antenna factor , cable loss and amplifier gain Note 2: Margin (dB) = Emission level (dBuV/m) – Limit (dBuV/m).</p>																																																																																

Modulation	VHT80	Test Freq. (MHz)	5775
Polarization	Vertical	Test Configuration	1

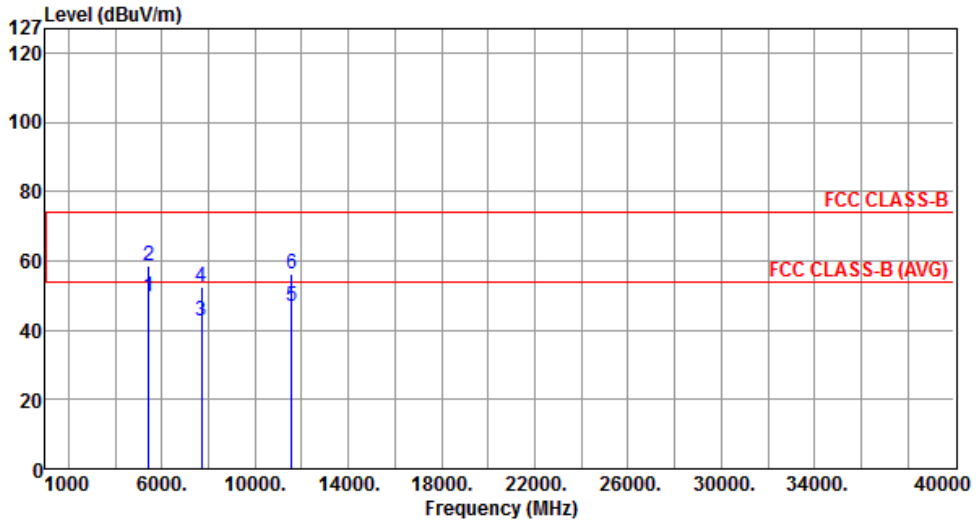

	Freq. MHz	Emission level dBuV/m	Limit dBuV/m	Margin dB	SA reading dBuV	Factor dB	Remark	ANT High cm	Turn Table deg
1	5451.00	49.66	54.00	-4.34	43.55	6.11	Average	---	---
2	5451.00	58.74	74.00	-15.26	52.63	6.11	Peak	---	---
3	7700.00	42.55	54.00	-11.45	31.47	11.08	Average	---	---
4	7700.00	52.66	74.00	-21.34	41.58	11.08	Peak	---	---
5	11550.00	47.01	54.00	-6.99	31.85	15.16	Average	---	---
6	11550.00	56.43	74.00	-17.57	41.27	15.16	Peak	---	---

Note 1: Emission Level (dBuV/m) = SA Reading (dBuV/m) + Factor* (dB)

*Factor includes antenna factor , cable loss and amplifier gain

Note 2: Margin (dB) = Emission level (dBuV/m) – Limit (dBuV/m).

Legacy/MIMO (CDD) beamforming mode

3.5.9 Transmitter Radiated Unwanted Emissions (Above 1GHz) for 11a

Modulation	11a	Test Freq. (MHz)	5745
Polarization	Horizontal	Test Configuration	3

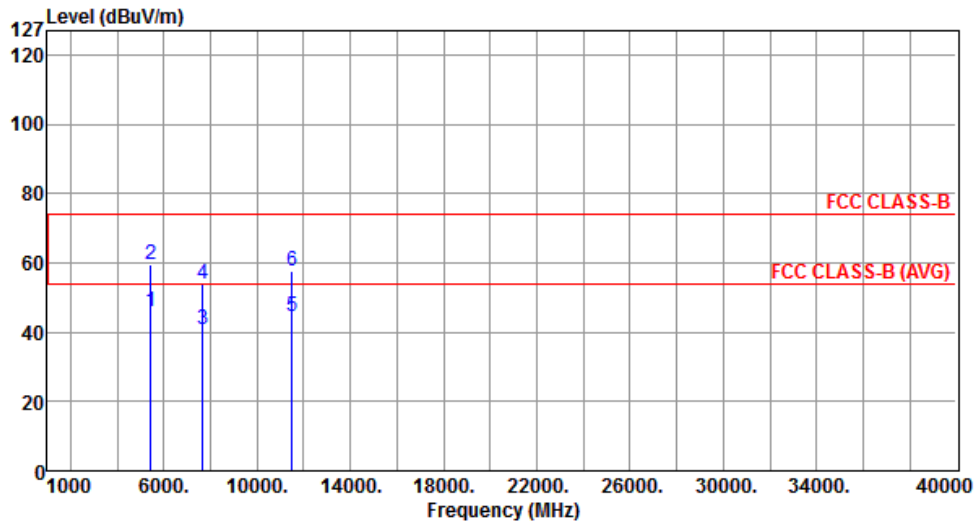

	Freq. MHz	Emission level dBuV/m	Limit dBuV/m	Margin dB	SA reading dBuV	Factor dB	Remark	ANT High cm	Turn Table deg
1	5432.00	45.84	54.00	-8.16	39.76	6.08	Average	---	---
2	5432.00	59.56	74.00	-14.44	53.48	6.08	Peak	---	---
3	7660.00	40.62	54.00	-13.38	29.51	11.11	Average	---	---
4	7660.00	54.12	74.00	-19.88	43.01	11.11	Peak	---	---
5	11490.00	44.48	54.00	-9.52	29.28	15.20	Average	---	---
6	11490.00	57.80	74.00	-16.20	42.60	15.20	Peak	---	---

Note 1: Emission Level (dBuV/m) = SA Reading (dBuV/m) + Factor* (dB)

*Factor includes antenna factor, cable loss and amplifier gain

Note 2: Margin (dB) = Emission level (dBuV/m) – Limit (dBuV/m).

Modulation	11a	Test Freq. (MHz)	5745
Polarization	Vertical	Test Configuration	3

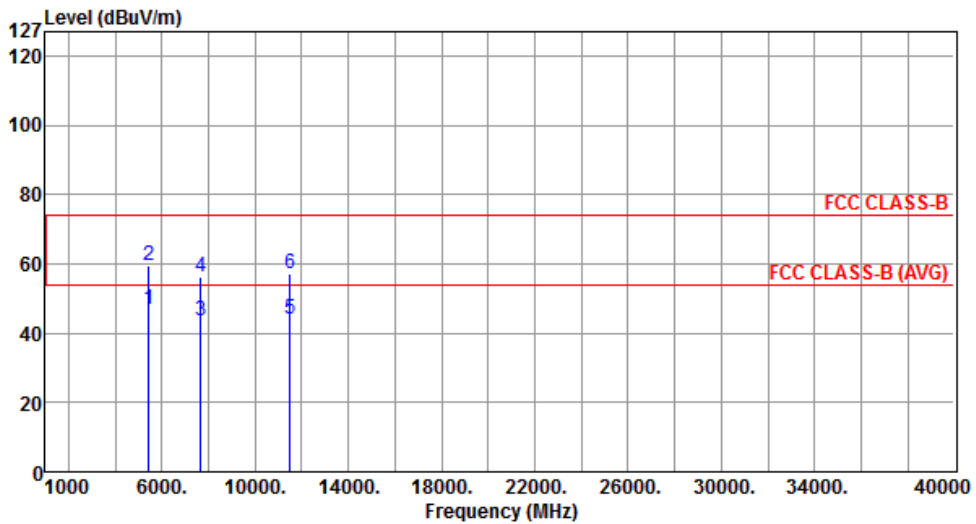

	Freq. MHz	Emission level dBuV/m	Limit dBuV/m	Margin dB	SA reading dBuV	Factor dB	Remark	ANT High cm	Turn Table deg
1	5432.00	46.82	54.00	-7.18	40.74	6.08	Average	---	---
2	5432.00	59.51	74.00	-14.49	53.43	6.08	Peak	---	---
3	7660.00	43.57	54.00	-10.43	32.46	11.11	Average	---	---
4	7660.00	56.44	74.00	-17.56	45.33	11.11	Peak	---	---
5	11490.00	44.08	54.00	-9.92	28.88	15.20	Average	---	---
6	11490.00	56.94	74.00	-17.06	41.74	15.20	Peak	---	---

Note 1: Emission Level (dBuV/m) = SA Reading (dBuV/m) + Factor* (dB)

*Factor includes antenna factor , cable loss and amplifier gain

Note 2: Margin (dB) = Emission level (dBuV/m) – Limit (dBuV/m).

Modulation	11a	Test Freq. (MHz)	5785
Polarization	Horizontal	Test Configuration	3

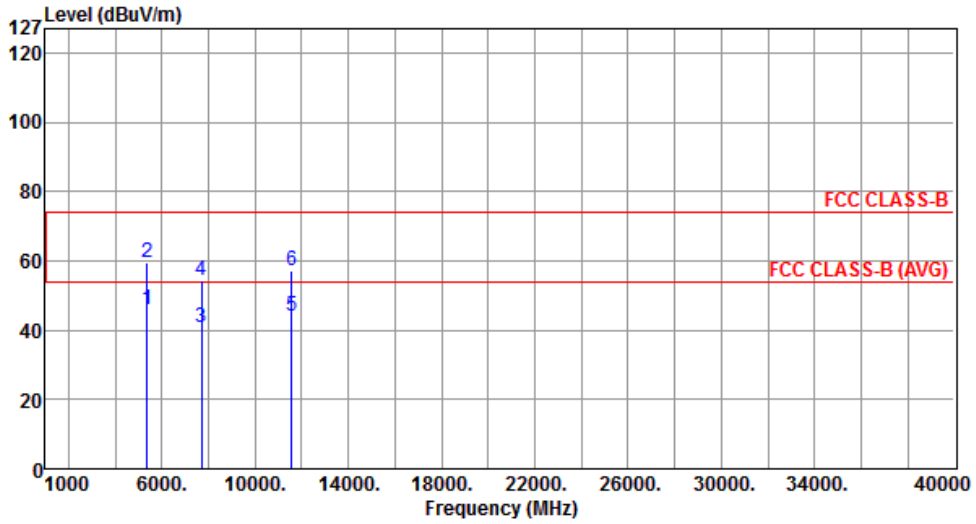

	Freq. MHz	Emission level dBuV/m	Limit dBuV/m	Margin dB	SA reading dBuV	Factor dB	Remark	ANT High cm	Turn Table deg
1	5382.00	46.13	54.00	-7.87	40.10	6.03	Average	---	---
2	5382.00	59.75	74.00	-14.25	53.72	6.03	Peak	---	---
3	7713.30	40.92	54.00	-13.08	29.85	11.07	Average	---	---
4	7713.30	54.49	74.00	-19.51	43.42	11.07	Peak	---	---
5	11570.00	44.01	54.00	-9.99	28.86	15.15	Average	---	---
6	11570.00	57.31	74.00	-16.69	42.16	15.15	Peak	---	---

Note 1: Emission Level (dBuV/m) = SA Reading (dBuV/m) + Factor* (dB)

*Factor includes antenna factor , cable loss and amplifier gain

Note 2: Margin (dB) = Emission level (dBuV/m) – Limit (dBuV/m).

Modulation	11a	Test Freq. (MHz)	5785
Polarization	Vertical	Test Configuration	3

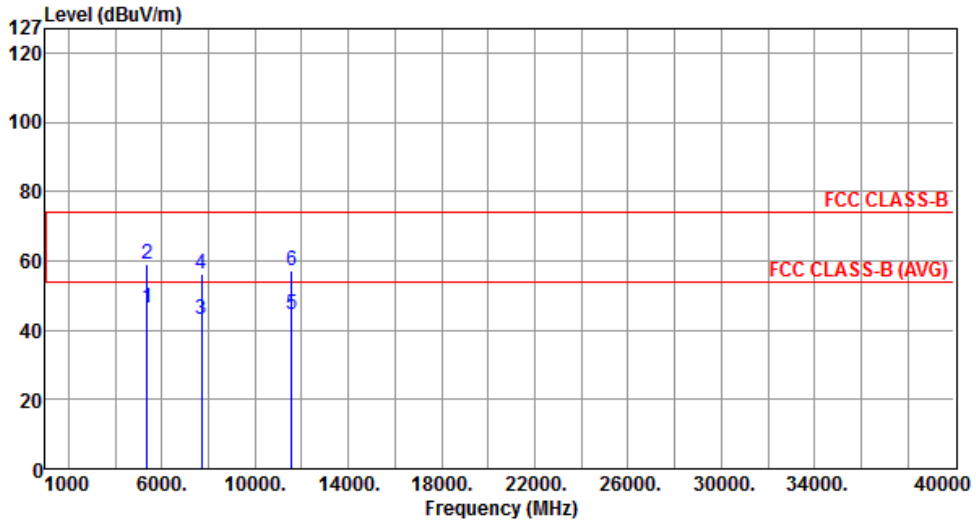

	Freq. MHz	Emission level dBuV/m	Limit dBuV/m	Margin dB	SA reading dBuV	Factor dB	Remark	ANT High cm	Turn Table deg
1	5382.00	46.55	54.00	-7.45	40.52	6.03	Average	---	---
2	5382.00	59.27	74.00	-14.73	53.24	6.03	Peak	---	---
3	7713.30	43.18	54.00	-10.82	32.11	11.07	Average	---	---
4	7713.30	56.11	74.00	-17.89	45.04	11.07	Peak	---	---
5	11570.00	44.38	54.00	-9.62	29.23	15.15	Average	---	---
6	11570.00	57.35	74.00	-16.65	42.20	15.15	Peak	---	---

Note 1: Emission Level (dBuV/m) = SA Reading (dBuV/m) + Factor* (dB)

*Factor includes antenna factor , cable loss and amplifier gain

Note 2: Margin (dB) = Emission level (dBuV/m) – Limit (dBuV/m).

Modulation	11a	Test Freq. (MHz)	5825
Polarization	Horizontal	Test Configuration	3

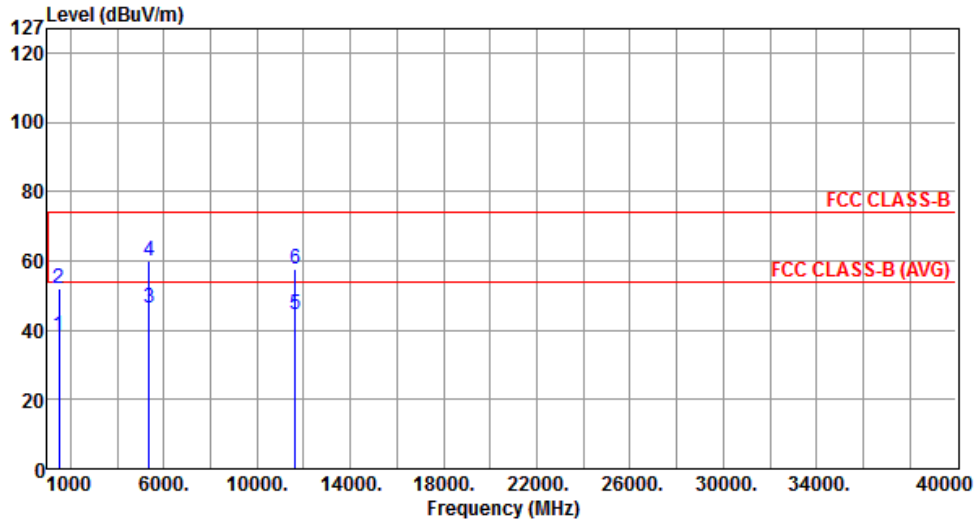

	Freq. MHz	Emission level dBuV/m	Limit dBuV/m	Margin dB	SA reading dBuV	Factor dB	Remark	ANT High cm	Turn Table deg
1	1500.00	38.65	54.00	-15.35	45.12	-6.47	Average	---	---
2	1500.00	51.98	74.00	-22.02	58.45	-6.47	Peak	---	---
3	5367.00	46.48	54.00	-7.52	40.46	6.02	Average	---	---
4	5367.00	60.10	74.00	-13.90	54.08	6.02	Peak	---	---
5	11650.00	44.49	54.00	-9.51	29.38	15.11	Average	---	---
6	11650.00	57.68	74.00	-16.32	42.57	15.11	Peak	---	---

Note 1: Emission Level (dBuV/m) = SA Reading (dBuV/m) + Factor* (dB)

*Factor includes antenna factor , cable loss and amplifier gain

Note 2: Margin (dB) = Emission level (dBuV/m) – Limit (dBuV/m).

Modulation	11a	Test Freq. (MHz)	5825
Polarization	Vertical	Test Configuration	3

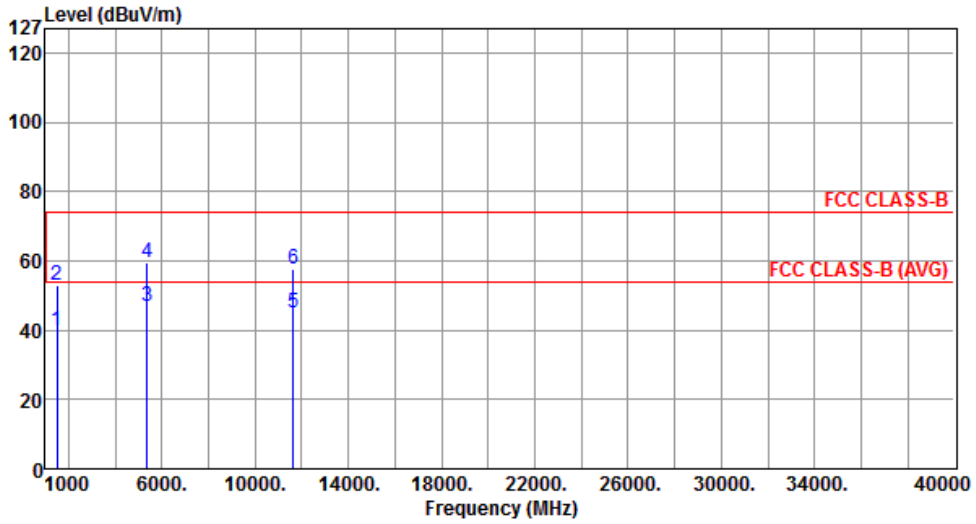

	Freq. MHz	Emission level dBuV/m	Limit dBuV/m	Margin dB	SA reading dBuV	Factor dB	Remark	ANT High cm	Turn Table deg
1	1500.00	39.60	54.00	-14.40	46.07	-6.47	Average	---	---
2	1500.00	53.09	74.00	-20.91	59.56	-6.47	Peak	---	---
3	5367.00	46.89	54.00	-7.11	40.87	6.02	Average	---	---
4	5367.00	59.62	74.00	-14.38	53.60	6.02	Peak	---	---
5	11650.00	44.84	54.00	-9.16	29.73	15.11	Average	---	---
6	11650.00	57.72	74.00	-16.28	42.61	15.11	Peak	---	---

Note 1: Emission Level (dBuV/m) = SA Reading (dBuV/m) + Factor* (dB)

*Factor includes antenna factor , cable loss and amplifier gain

Note 2: Margin (dB) = Emission level (dBuV/m) – Limit (dBuV/m).

3.5.10 Transmitter Radiated Unwanted Emissions (Above 1GHz) for VHT20

Modulation	VHT20	Test Freq. (MHz)	5745
Polarization	Horizontal	Test Configuration	3

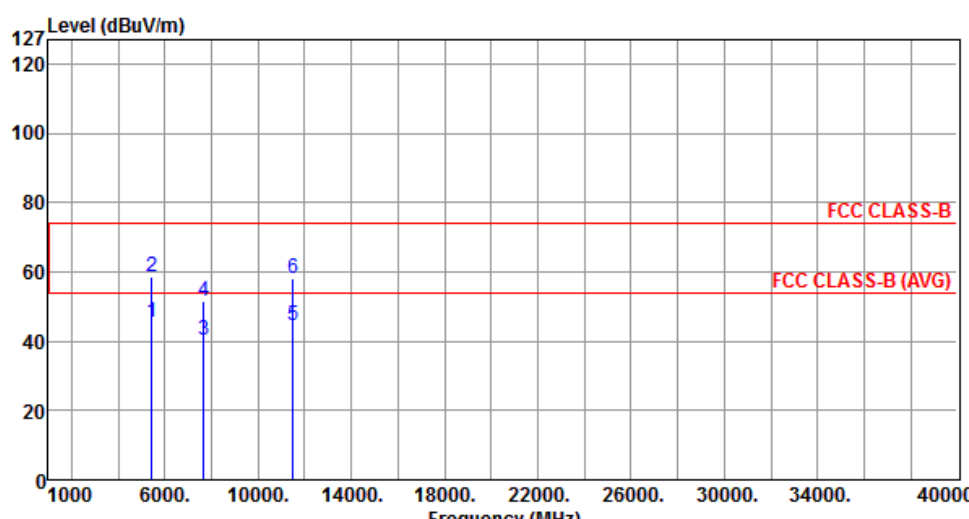

	Freq. MHz	Emission level dBUV/m	Limit dBUV/m	Margin dB	SA reading dBUV	Factor dB	Remark	ANT High cm	Turn Table deg
1	5432.00	45.69	54.00	-8.31	39.61	6.08	Average	---	---
2	5432.00	58.66	74.00	-15.34	52.58	6.08	Peak	---	---
3	7660.00	40.08	54.00	-13.92	28.97	11.11	Average	---	---
4	7660.00	51.67	74.00	-22.33	40.56	11.11	Peak	---	---
5	11490.00	44.75	54.00	-9.25	29.55	15.20	Average	---	---
6	11490.00	58.18	74.00	-15.82	42.98	15.20	Peak	---	---

Note 1: Emission Level (dBUV/m) = SA Reading (dBUV/m) + Factor* (dB)
*Factor includes antenna factor , cable loss and amplifier gain
Note 2: Margin (dB) = Emission level (dBUV/m) – Limit (dBUV/m).

Modulation	VHT20	Test Freq. (MHz)	5745
Polarization	Vertical	Test Configuration	3

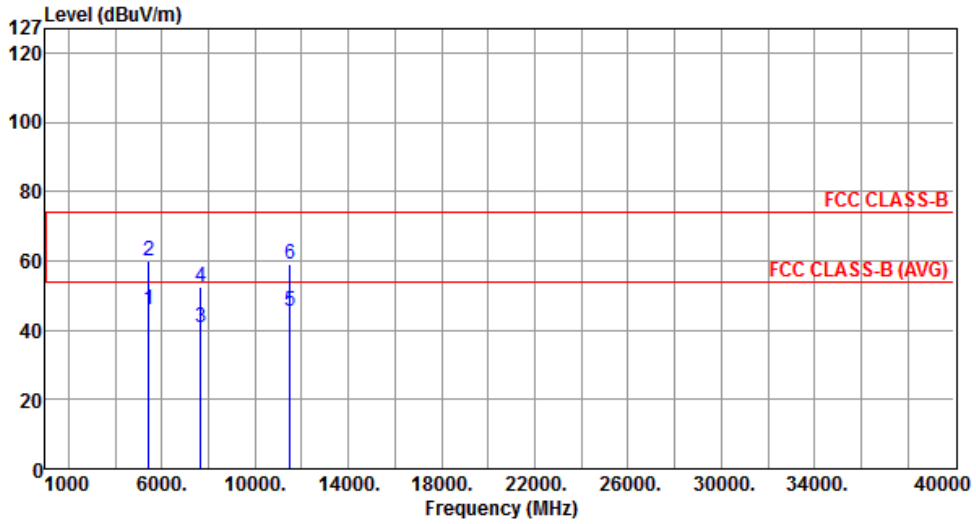

	Freq. MHz	Emission level dBuV/m	Limit dBuV/m	Margin dB	SA reading dBuV	Factor dB	Remark	ANT High cm	Turn Table deg
1	5432.00	45.99	54.00	-8.01	39.91	6.08	Average	---	---
2	5432.00	59.87	74.00	-14.13	53.79	6.08	Peak	---	---
3	7660.00	40.63	54.00	-13.37	29.52	11.11	Average	---	---
4	7660.00	52.35	74.00	-21.65	41.24	11.11	Peak	---	---
5	11490.00	45.24	54.00	-8.76	30.04	15.20	Average	---	---
6	11490.00	59.07	74.00	-14.93	43.87	15.20	Peak	---	---

Note 1: Emission Level (dBuV/m) = SA Reading (dBuV/m) + Factor* (dB)

*Factor includes antenna factor , cable loss and amplifier gain

Note 2: Margin (dB) = Emission level (dBuV/m) – Limit (dBuV/m).

Modulation	VHT20	Test Freq. (MHz)	5785
Polarization	Horizontal	Test Configuration	3

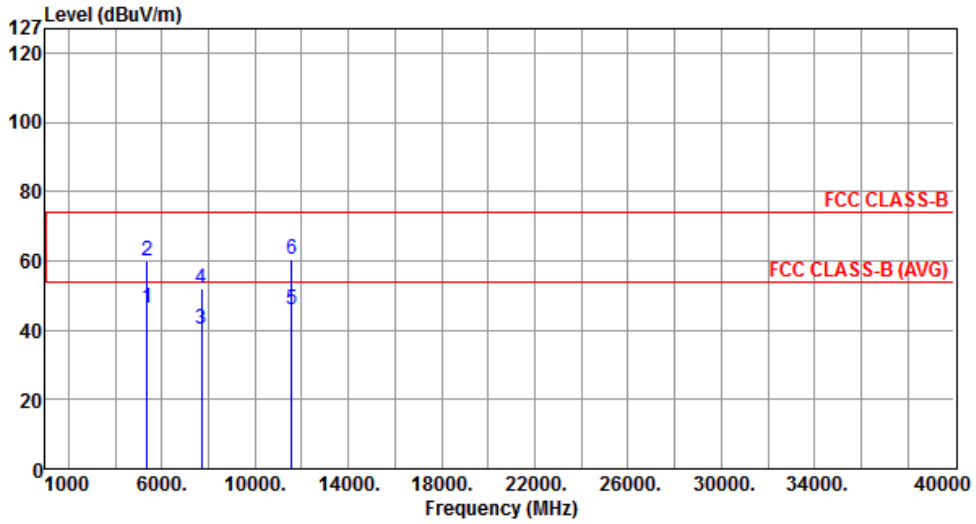

	Freq. MHz	Emission level dBuV/m	Limit dBuV/m	Margin dB	SA reading dBuV	Factor dB	Remark	ANT High cm	Turn Table deg
1	5382.00	46.24	54.00	-7.76	40.21	6.03	Average	---	---
2	5382.00	59.91	74.00	-14.09	53.88	6.03	Peak	---	---
3	7713.33	40.29	54.00	-13.71	29.22	11.07	Average	---	---
4	7713.33	52.02	74.00	-21.98	40.95	11.07	Peak	---	---
5	11570.00	46.08	54.00	-7.92	30.93	15.15	Average	---	---
6	11570.00	60.25	74.00	-13.75	45.10	15.15	Peak	---	---

Note 1: Emission Level (dBuV/m) = SA Reading (dBuV/m) + Factor* (dB)

*Factor includes antenna factor , cable loss and amplifier gain

Note 2: Margin (dB) = Emission level (dBuV/m) – Limit (dBuV/m).

Modulation	VHT20	Test Freq. (MHz)	5785
Polarization	Vertical	Test Configuration	3

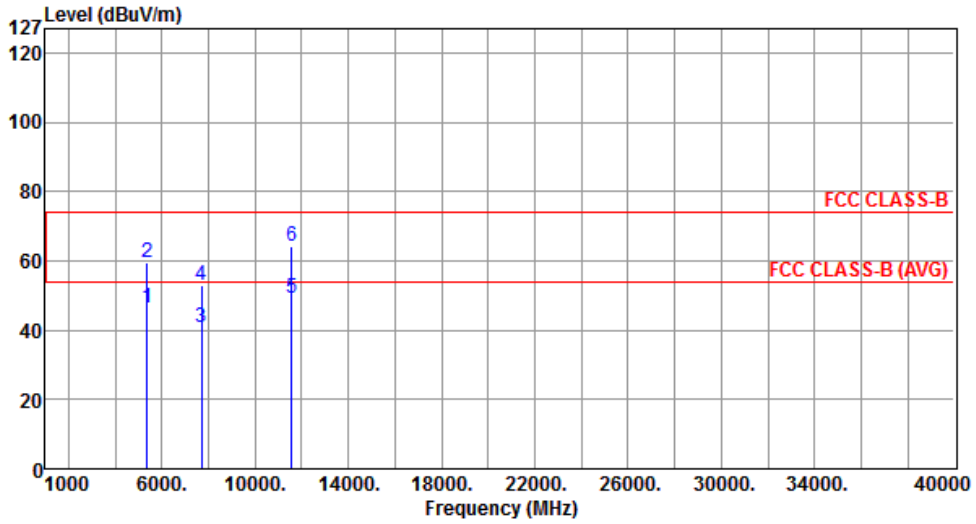

	Freq. MHz	Emission level dBuV/m	Limit dBuV/m	Margin dB	SA reading dBuV	Factor dB	Remark	ANT High cm	Turn Table deg
1	5382.00	46.56	54.00	-7.44	40.53	6.03	Average	---	---
2	5382.00	59.62	74.00	-14.38	53.59	6.03	Peak	---	---
3	7713.33	40.80	54.00	-13.20	29.73	11.07	Average	---	---
4	7713.33	52.73	74.00	-21.27	41.66	11.07	Peak	---	---
5	11570.00	49.07	54.00	-4.93	33.92	15.15	Average	---	---
6	11570.00	64.12	74.00	-9.88	48.97	15.15	Peak	---	---

Note 1: Emission Level (dBuV/m) = SA Reading (dBuV/m) + Factor* (dB)

*Factor includes antenna factor , cable loss and amplifier gain

Note 2: Margin (dB) = Emission level (dBuV/m) – Limit (dBuV/m).

Modulation	VHT20	Test Freq. (MHz)	5825
Polarization	Horizontal	Test Configuration	3

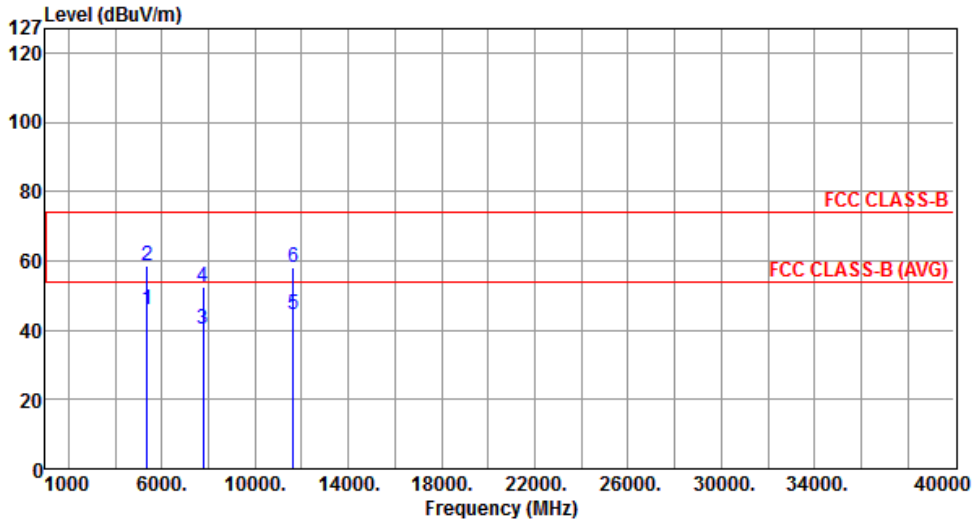

	Freq. MHz	Emission level dBuV/m	Limit dBuV/m	Margin dB	SA reading dBuV	Factor dB	Remark	ANT High cm	Turn Table deg
1	5367.00	46.03	54.00	-7.97	40.01	6.02	Average	---	---
2	5367.00	58.79	74.00	-15.21	52.77	6.02	Peak	---	---
3	7766.66	40.39	54.00	-13.61	29.35	11.04	Average	---	---
4	7766.66	52.41	74.00	-21.59	41.37	11.04	Peak	---	---
5	11650.00	44.75	54.00	-9.25	29.64	15.11	Average	---	---
6	11650.00	58.27	74.00	-15.73	43.16	15.11	Peak	---	---

Note 1: Emission Level (dBuV/m) = SA Reading (dBuV/m) + Factor* (dB)

*Factor includes antenna factor , cable loss and amplifier gain

Note 2: Margin (dB) = Emission level (dBuV/m) – Limit (dBuV/m).

Modulation	VHT20	Test Freq. (MHz)	5825
Polarization	Vertical	Test Configuration	3

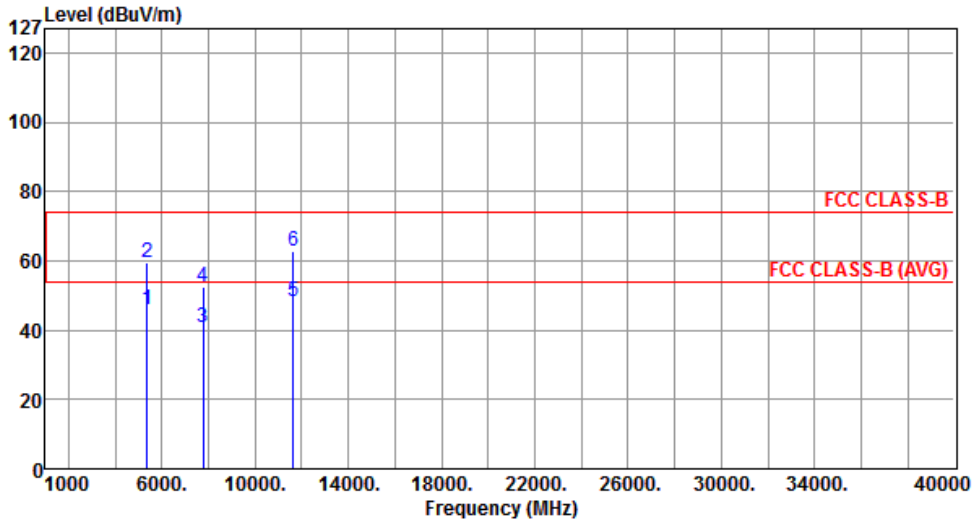

	Freq. MHz	Emission level dBuV/m	Limit dBuV/m	Margin dB	SA reading dBuV	Factor dB	Remark	ANT High cm	Turn Table deg
1	5367.00	45.87	54.00	-8.13	39.85	6.02	Average	---	---
2	5367.00	59.33	74.00	-14.67	53.31	6.02	Peak	---	---
3	7766.66	40.62	54.00	-13.38	29.58	11.04	Average	---	---
4	7766.66	52.31	74.00	-21.69	41.27	11.04	Peak	---	---
5	11650.00	48.49	54.00	-5.51	33.38	15.11	Average	---	---
6	11650.00	62.66	74.00	-11.34	47.55	15.11	Peak	---	---

Note 1: Emission Level (dBuV/m) = SA Reading (dBuV/m) + Factor* (dB)

*Factor includes antenna factor , cable loss and amplifier gain

Note 2: Margin (dB) = Emission level (dBuV/m) – Limit (dBuV/m).

3.5.11 Transmitter Radiated Unwanted Emissions (Above 1GHz) for VHT40

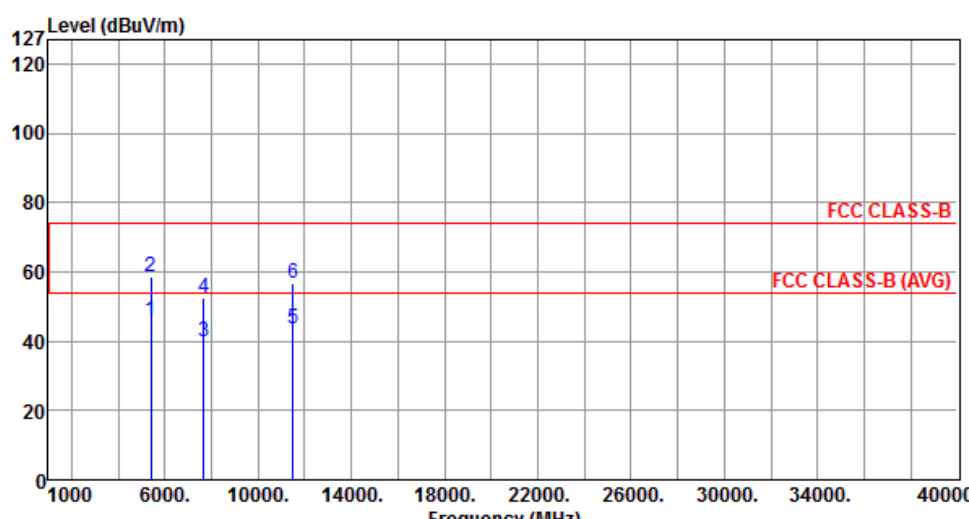
Modulation	VHT40	Test Freq. (MHz)	5755																																																																						
Polarization	Horizontal	Test Configuration	3																																																																						
																																																																									
	<table border="1"> <thead> <tr> <th>Freq.</th> <th>Emission level</th> <th>Limit</th> <th>Margin</th> <th>SA reading</th> <th>Factor</th> <th>Remark</th> <th>ANT High</th> <th>Turn Table</th> </tr> <tr> <th>MHz</th> <th>dBuV/m</th> <th>dBuV/m</th> <th>dB</th> <th>dBuV</th> <th>dB</th> <th></th> <th>cm</th> <th>deg</th> </tr> </thead> <tbody> <tr> <td>1</td> <td>5387.00</td> <td>45.92</td> <td>54.00</td> <td>-8.08</td> <td>39.89</td> <td>6.03</td> <td>Average</td> <td>---</td> </tr> <tr> <td>2</td> <td>5387.00</td> <td>58.70</td> <td>74.00</td> <td>-15.30</td> <td>52.67</td> <td>6.03</td> <td>Peak</td> <td>---</td> </tr> <tr> <td>3</td> <td>7673.33</td> <td>39.92</td> <td>54.00</td> <td>-14.08</td> <td>28.82</td> <td>11.10</td> <td>Average</td> <td>---</td> </tr> <tr> <td>4</td> <td>7673.33</td> <td>52.38</td> <td>74.00</td> <td>-21.62</td> <td>41.28</td> <td>11.10</td> <td>Peak</td> <td>---</td> </tr> <tr> <td>5</td> <td>11510.00</td> <td>43.64</td> <td>54.00</td> <td>-10.36</td> <td>28.46</td> <td>15.18</td> <td>Average</td> <td>---</td> </tr> <tr> <td>6</td> <td>11510.00</td> <td>56.71</td> <td>74.00</td> <td>-17.29</td> <td>41.53</td> <td>15.18</td> <td>Peak</td> <td>---</td> </tr> </tbody> </table>	Freq.	Emission level	Limit	Margin	SA reading	Factor	Remark	ANT High	Turn Table	MHz	dBuV/m	dBuV/m	dB	dBuV	dB		cm	deg	1	5387.00	45.92	54.00	-8.08	39.89	6.03	Average	---	2	5387.00	58.70	74.00	-15.30	52.67	6.03	Peak	---	3	7673.33	39.92	54.00	-14.08	28.82	11.10	Average	---	4	7673.33	52.38	74.00	-21.62	41.28	11.10	Peak	---	5	11510.00	43.64	54.00	-10.36	28.46	15.18	Average	---	6	11510.00	56.71	74.00	-17.29	41.53	15.18	Peak	---
Freq.	Emission level	Limit	Margin	SA reading	Factor	Remark	ANT High	Turn Table																																																																	
MHz	dBuV/m	dBuV/m	dB	dBuV	dB		cm	deg																																																																	
1	5387.00	45.92	54.00	-8.08	39.89	6.03	Average	---																																																																	
2	5387.00	58.70	74.00	-15.30	52.67	6.03	Peak	---																																																																	
3	7673.33	39.92	54.00	-14.08	28.82	11.10	Average	---																																																																	
4	7673.33	52.38	74.00	-21.62	41.28	11.10	Peak	---																																																																	
5	11510.00	43.64	54.00	-10.36	28.46	15.18	Average	---																																																																	
6	11510.00	56.71	74.00	-17.29	41.53	15.18	Peak	---																																																																	
<p>Note 1: Emission Level (dBuV/m) = SA Reading (dBuV/m) + Factor* (dB) *Factor includes antenna factor , cable loss and amplifier gain Note 2: Margin (dB) = Emission level (dBuV/m) – Limit (dBuV/m).</p>																																																																									

Modulation	VHT40	Test Freq. (MHz)	5755
Polarization	Vertical	Test Configuration	3

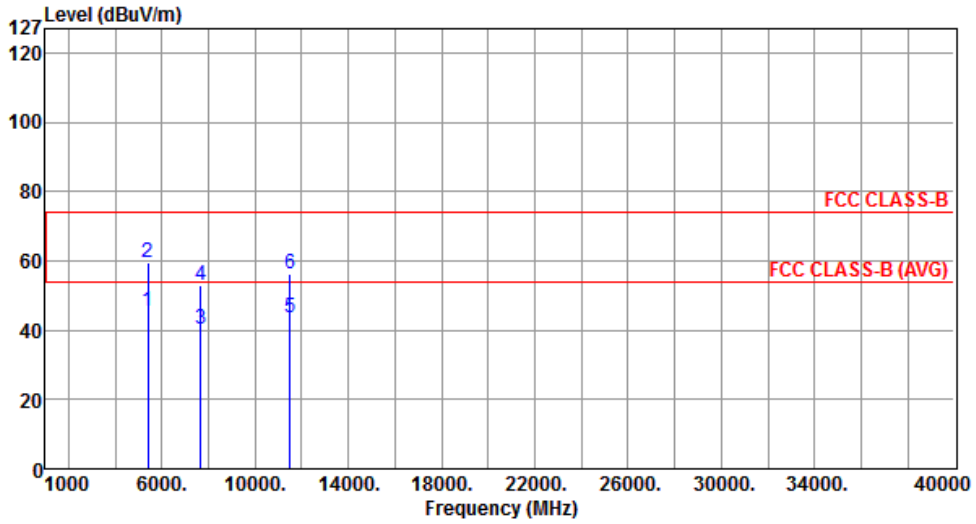

	Freq. MHz	Emission level dBuV/m	Limit dBuV/m	Margin dB	SA reading dBuV	Factor dB	Remark	ANT High cm	Turn Table deg
1	5387.00	45.60	54.00	-8.40	39.57	6.03	Average	---	---
2	5387.00	59.63	74.00	-14.37	53.60	6.03	Peak	---	---
3	7673.33	40.38	54.00	-13.62	29.28	11.10	Average	---	---
4	7673.33	53.07	74.00	-20.93	41.97	11.10	Peak	---	---
5	11510.00	43.57	54.00	-10.43	28.39	15.18	Average	---	---
6	11510.00	56.22	74.00	-17.78	41.04	15.18	Peak	---	---

Note 1: Emission Level (dBuV/m) = SA Reading (dBuV/m) + Factor* (dB)

*Factor includes antenna factor , cable loss and amplifier gain

Note 2: Margin (dB) = Emission level (dBuV/m) – Limit (dBuV/m).

Modulation	VHT40	Test Freq. (MHz)	5795
Polarization	Horizontal	Test Configuration	3

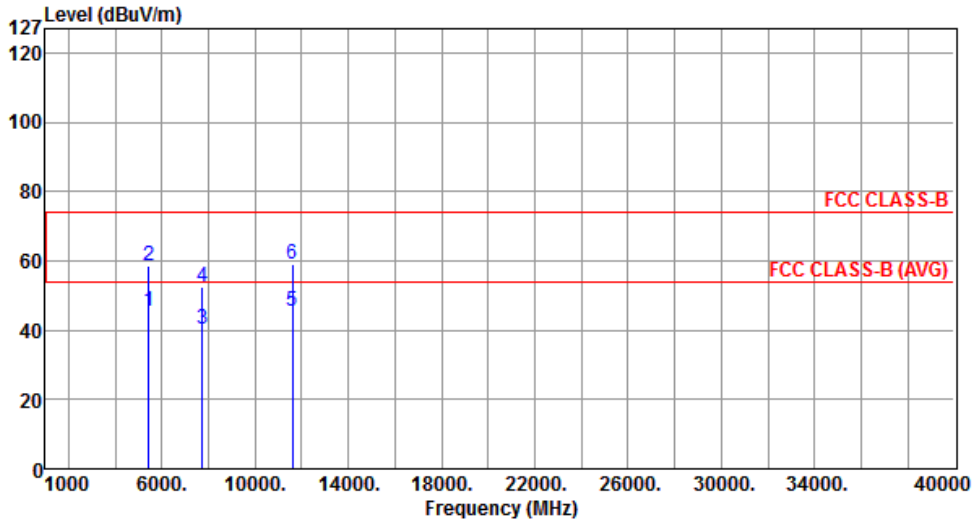

	Freq. MHz	Emission level dBuV/m	Limit dBuV/m	Margin dB	SA reading dBuV	Factor dB	Remark	ANT High cm	Turn Table deg
1	5420.00	45.52	54.00	-8.48	39.45	6.07	Average	---	---
2	5420.00	58.55	74.00	-15.45	52.48	6.07	Peak	---	---
3	7726.66	40.41	54.00	-13.59	29.35	11.06	Average	---	---
4	7726.66	52.30	74.00	-21.70	41.24	11.06	Peak	---	---
5	11590.00	45.55	54.00	-8.45	30.41	15.14	Average	---	---
6	11590.00	59.05	74.00	-14.95	43.91	15.14	Peak	---	---

Note 1: Emission Level (dBuV/m) = SA Reading (dBuV/m) + Factor* (dB)

*Factor includes antenna factor , cable loss and amplifier gain

Note 2: Margin (dB) = Emission level (dBuV/m) – Limit (dBuV/m).

Modulation	VHT40	Test Freq. (MHz)	5795
Polarization	Vertical	Test Configuration	3

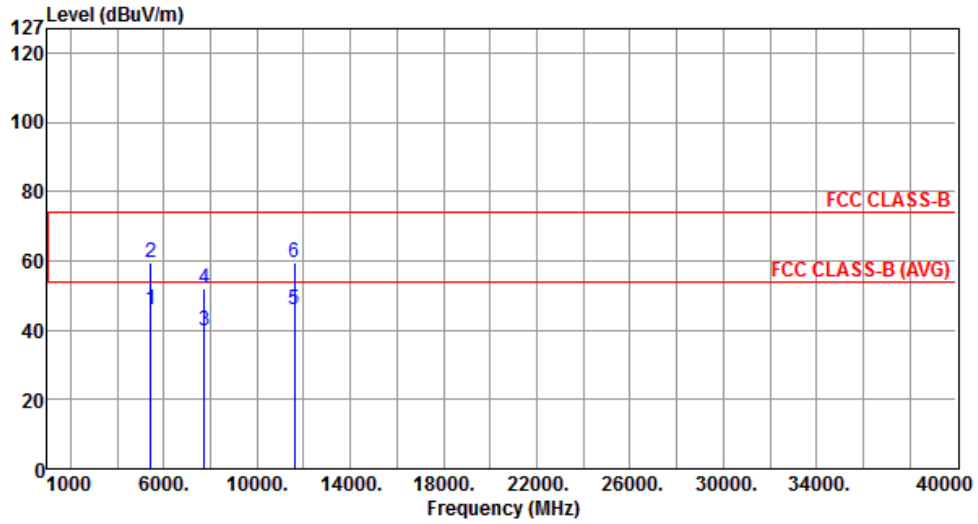

	Freq. MHz	Emission level dBuV/m	Limit dBuV/m	Margin dB	SA reading dBuV	Factor dB	Remark	ANT High cm	Turn Table deg
1	5420.00	45.94	54.00	-8.06	39.87	6.07	Average	---	---
2	5420.00	59.30	74.00	-14.70	53.23	6.07	Peak	---	---
3	7726.66	39.73	54.00	-14.27	28.67	11.06	Average	---	---
4	7726.66	52.12	74.00	-21.88	41.06	11.06	Peak	---	---
5	11590.00	46.04	54.00	-7.96	30.90	15.14	Average	---	---
6	11590.00	59.38	74.00	-14.62	44.24	15.14	Peak	---	---

Note 1: Emission Level (dBuV/m) = SA Reading (dBuV/m) + Factor* (dB)

*Factor includes antenna factor , cable loss and amplifier gain

Note 2: Margin (dB) = Emission level (dBuV/m) – Limit (dBuV/m).

3.5.12 Transmitter Radiated Unwanted Emissions (Above 1GHz) for VHT80

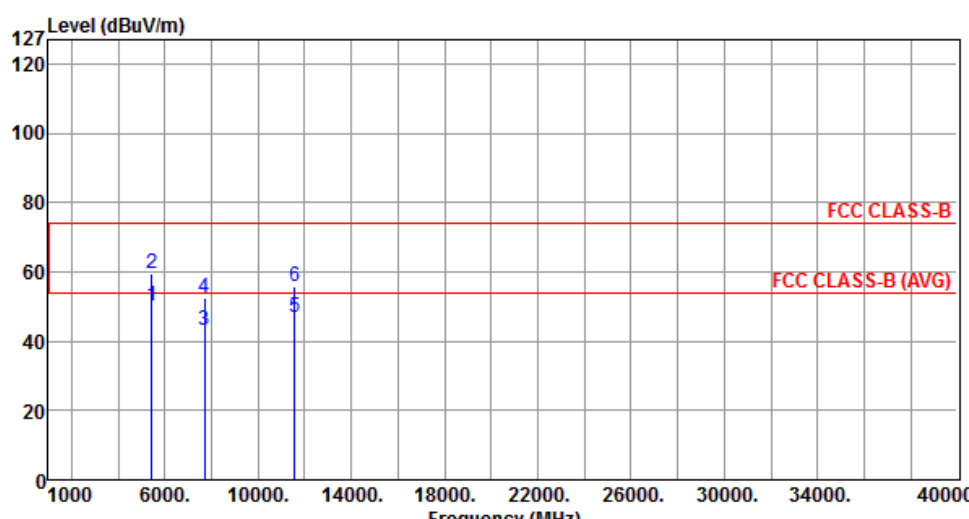
Modulation	VHT80	Test Freq. (MHz)	5775																																																																													
Polarization	Horizontal	Test Configuration	3																																																																													
																																																																																
	<table border="1"> <thead> <tr> <th>Freq.</th> <th>Emission level</th> <th>Limit</th> <th>Margin</th> <th>SA reading</th> <th>Factor</th> <th>Remark</th> <th>ANT High</th> <th>Turn Table</th> </tr> <tr> <th>MHz</th> <th>dBuV/m</th> <th>dBuV/m</th> <th>dB</th> <th>dBuV</th> <th>dB</th> <th></th> <th>cm</th> <th>deg</th> </tr> </thead> <tbody> <tr> <td>1</td> <td>5451.00</td> <td>50.26</td> <td>54.00</td> <td>-3.74</td> <td>44.15</td> <td>6.11</td> <td>Average</td> <td>---</td> </tr> <tr> <td>2</td> <td>5451.00</td> <td>59.49</td> <td>74.00</td> <td>-14.51</td> <td>53.38</td> <td>6.11</td> <td>Peak</td> <td>---</td> </tr> <tr> <td>3</td> <td>7700.00</td> <td>43.30</td> <td>54.00</td> <td>-10.70</td> <td>32.22</td> <td>11.08</td> <td>Average</td> <td>---</td> </tr> <tr> <td>4</td> <td>7700.00</td> <td>52.70</td> <td>74.00</td> <td>-21.30</td> <td>41.62</td> <td>11.08</td> <td>Peak</td> <td>---</td> </tr> <tr> <td>5</td> <td>11550.00</td> <td>46.66</td> <td>54.00</td> <td>-7.34</td> <td>31.50</td> <td>15.16</td> <td>Average</td> <td>---</td> </tr> <tr> <td>6</td> <td>11550.00</td> <td>55.90</td> <td>74.00</td> <td>-18.10</td> <td>40.74</td> <td>15.16</td> <td>Peak</td> <td>---</td> </tr> </tbody> </table>	Freq.	Emission level	Limit	Margin	SA reading	Factor	Remark	ANT High	Turn Table	MHz	dBuV/m	dBuV/m	dB	dBuV	dB		cm	deg	1	5451.00	50.26	54.00	-3.74	44.15	6.11	Average	---	2	5451.00	59.49	74.00	-14.51	53.38	6.11	Peak	---	3	7700.00	43.30	54.00	-10.70	32.22	11.08	Average	---	4	7700.00	52.70	74.00	-21.30	41.62	11.08	Peak	---	5	11550.00	46.66	54.00	-7.34	31.50	15.16	Average	---	6	11550.00	55.90	74.00	-18.10	40.74	15.16	Peak	---							
Freq.	Emission level	Limit	Margin	SA reading	Factor	Remark	ANT High	Turn Table																																																																								
MHz	dBuV/m	dBuV/m	dB	dBuV	dB		cm	deg																																																																								
1	5451.00	50.26	54.00	-3.74	44.15	6.11	Average	---																																																																								
2	5451.00	59.49	74.00	-14.51	53.38	6.11	Peak	---																																																																								
3	7700.00	43.30	54.00	-10.70	32.22	11.08	Average	---																																																																								
4	7700.00	52.70	74.00	-21.30	41.62	11.08	Peak	---																																																																								
5	11550.00	46.66	54.00	-7.34	31.50	15.16	Average	---																																																																								
6	11550.00	55.90	74.00	-18.10	40.74	15.16	Peak	---																																																																								
<p>Note 1: Emission Level (dBuV/m) = SA Reading (dBuV/m) + Factor* (dB) *Factor includes antenna factor , cable loss and amplifier gain Note 2: Margin (dB) = Emission level (dBuV/m) – Limit (dBuV/m).</p>																																																																																

Modulation	VHT80	Test Freq. (MHz)	5775
Polarization	Vertical	Test Configuration	3

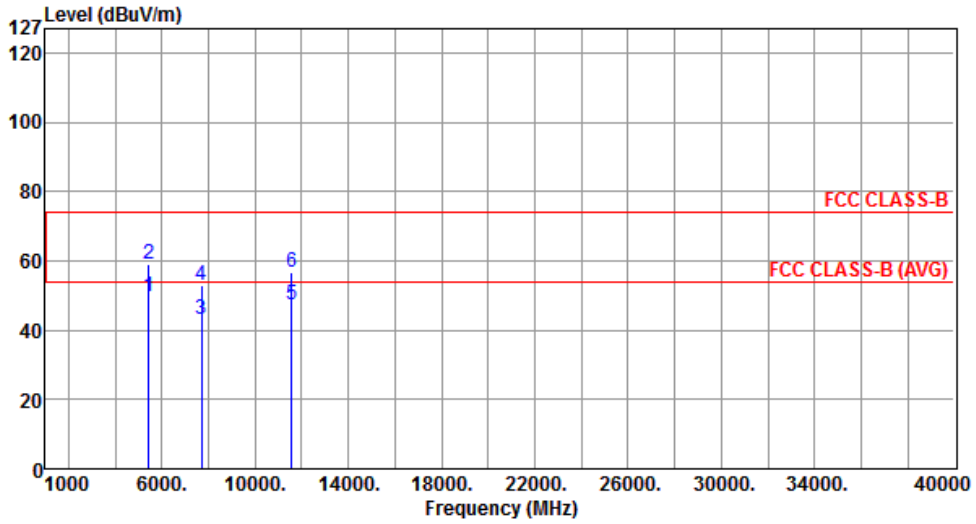

	Freq. MHz	Emission level dBuV/m	Limit dBuV/m	Margin dB	SA reading dBuV	Factor dB	Remark	ANT High cm	Turn Table deg
1	5451.00	49.74	54.00	-4.26	43.63	6.11	Average	---	---
2	5451.00	58.98	74.00	-15.02	52.87	6.11	Peak	---	---
3	7700.00	42.88	54.00	-11.12	31.80	11.08	Average	---	---
4	7700.00	52.72	74.00	-21.28	41.64	11.08	Peak	---	---
5	11550.00	47.13	54.00	-6.87	31.97	15.16	Average	---	---
6	11550.00	56.68	74.00	-17.32	41.52	15.16	Peak	---	---

Note 1: Emission Level (dBuV/m) = SA Reading (dBuV/m) + Factor* (dB)

*Factor includes antenna factor , cable loss and amplifier gain

Note 2: Margin (dB) = Emission level (dBuV/m) – Limit (dBuV/m).

3.6 Unwanted Emissions into Non-Restricted Frequency Bands

3.6.1 Limit of Unwanted Emissions into Non-Restricted Frequency Bands

The peak power in any 100 kHz bandwidth outside of the authorized frequency band shall be attenuated by at least 30 dB relative to the maximum in-band peak PSD level in 100 kHz.

3.6.2 Test Procedures

Reference Level Measurement

1. Set the RBW = 100 kHz, VBW = 300 kHz, Detector = peak.
2. Set Sweep time = auto couple, Trace mode = max hold.
3. Allow trace to fully stabilize.
4. Use the peak marker function to determine the maximum amplitude level.

Unwanted Emissions Level Measurement

1. Set RBW=100kHz, VBW = 300kHz , Detector = Peak, Sweep time = Auto
2. Trace = max hold , Allow Trace to fully stabilize
3. Scan Frequency range is up to 40GHz
4. Use the peak marker function to determine the maximum amplitude level

3.6.3 Test Setup

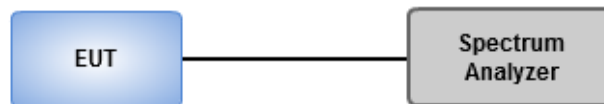

3.6.4 Test Result of Emissions in non-restricted frequency bands

This test item is performed on each TX output individually without summing or adding $10 \log(N_{ANT})$ since measurements are made relative to the in-band emissions on the individual outputs. Only worst test result of each operating mode is presented.

3.6.5 Unwanted Emissions into Non-Restricted Frequency Bands

Legacy/MIMO (CDD) Non-beamforming mode - Test Configuration 1 / 802.11a

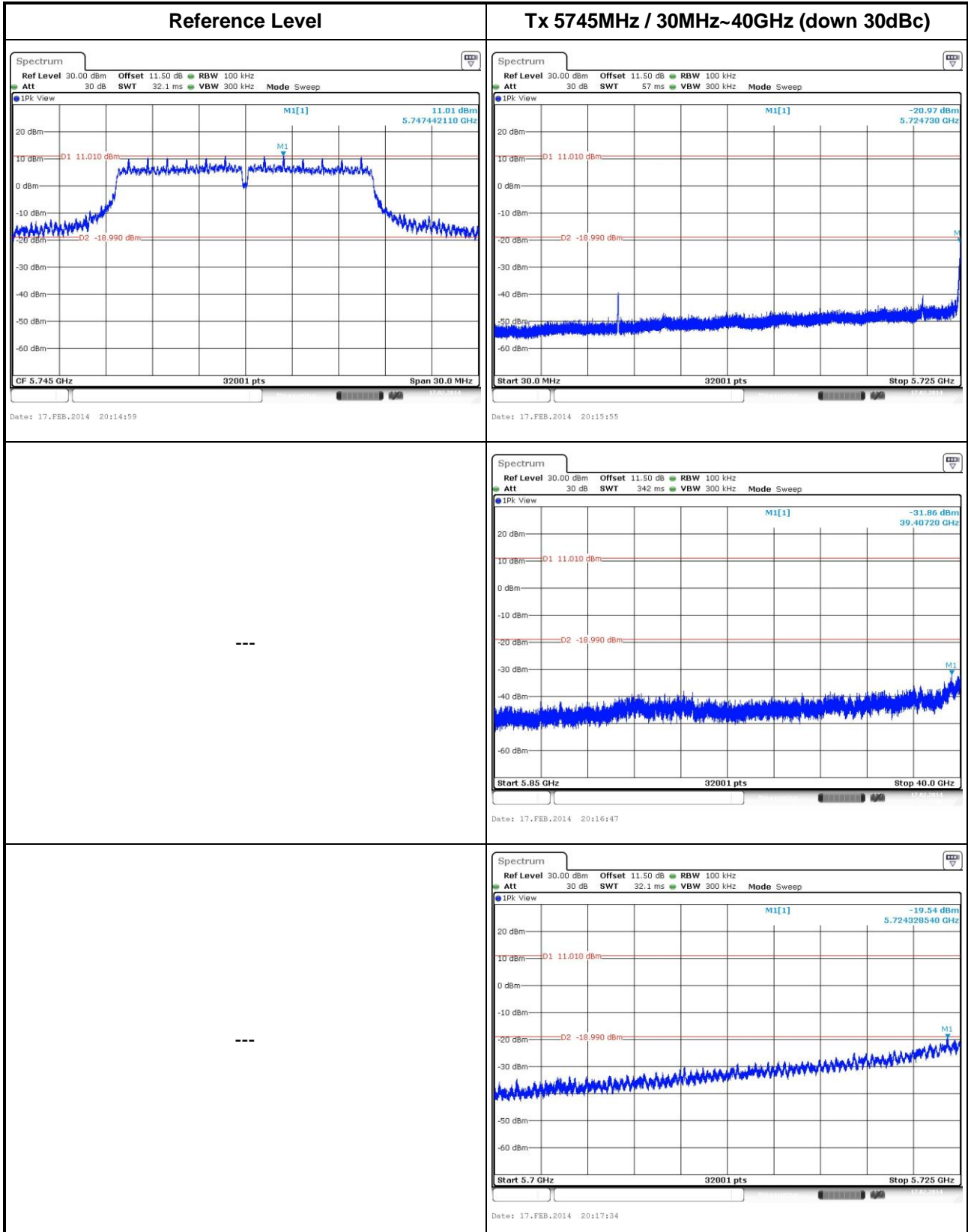

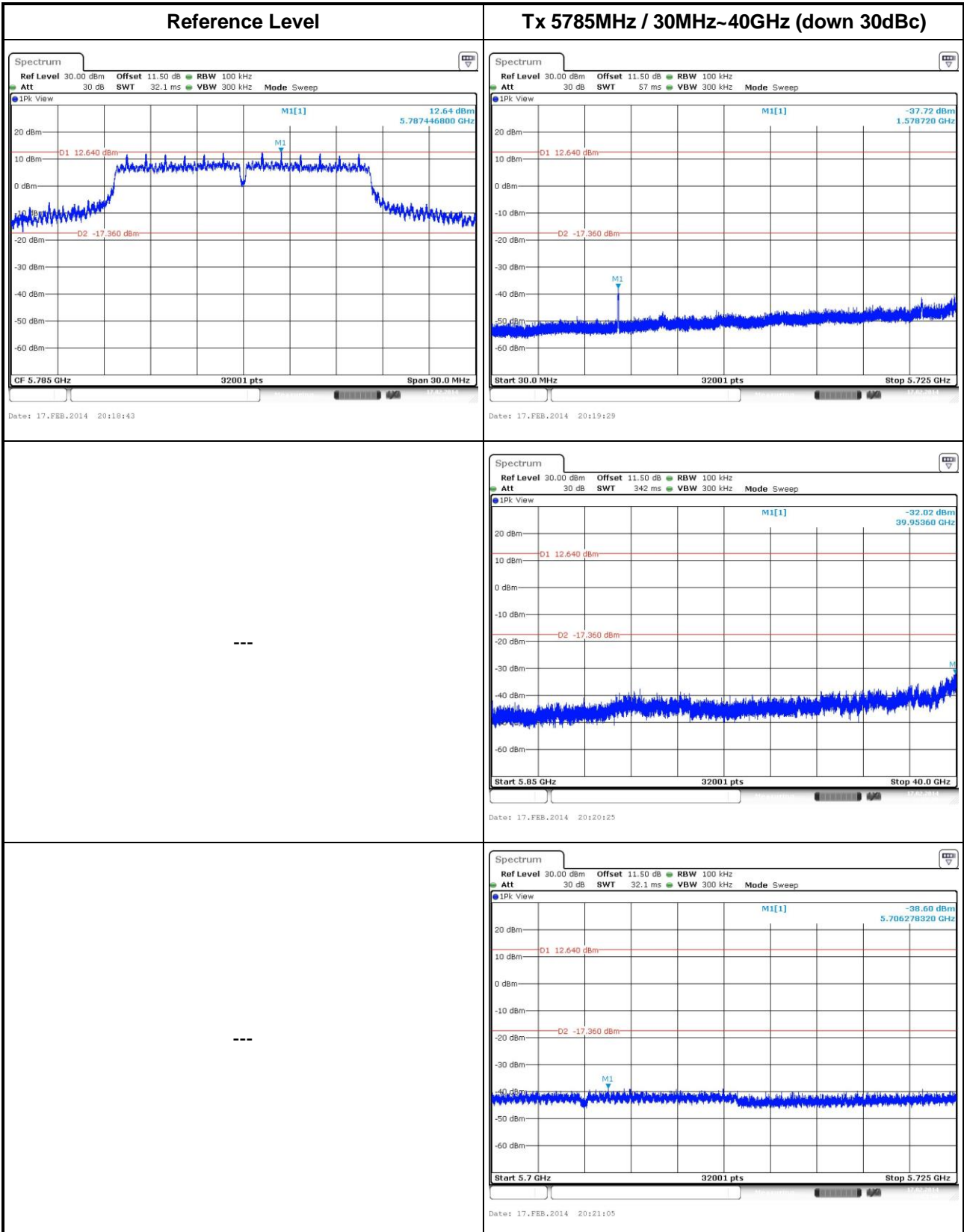

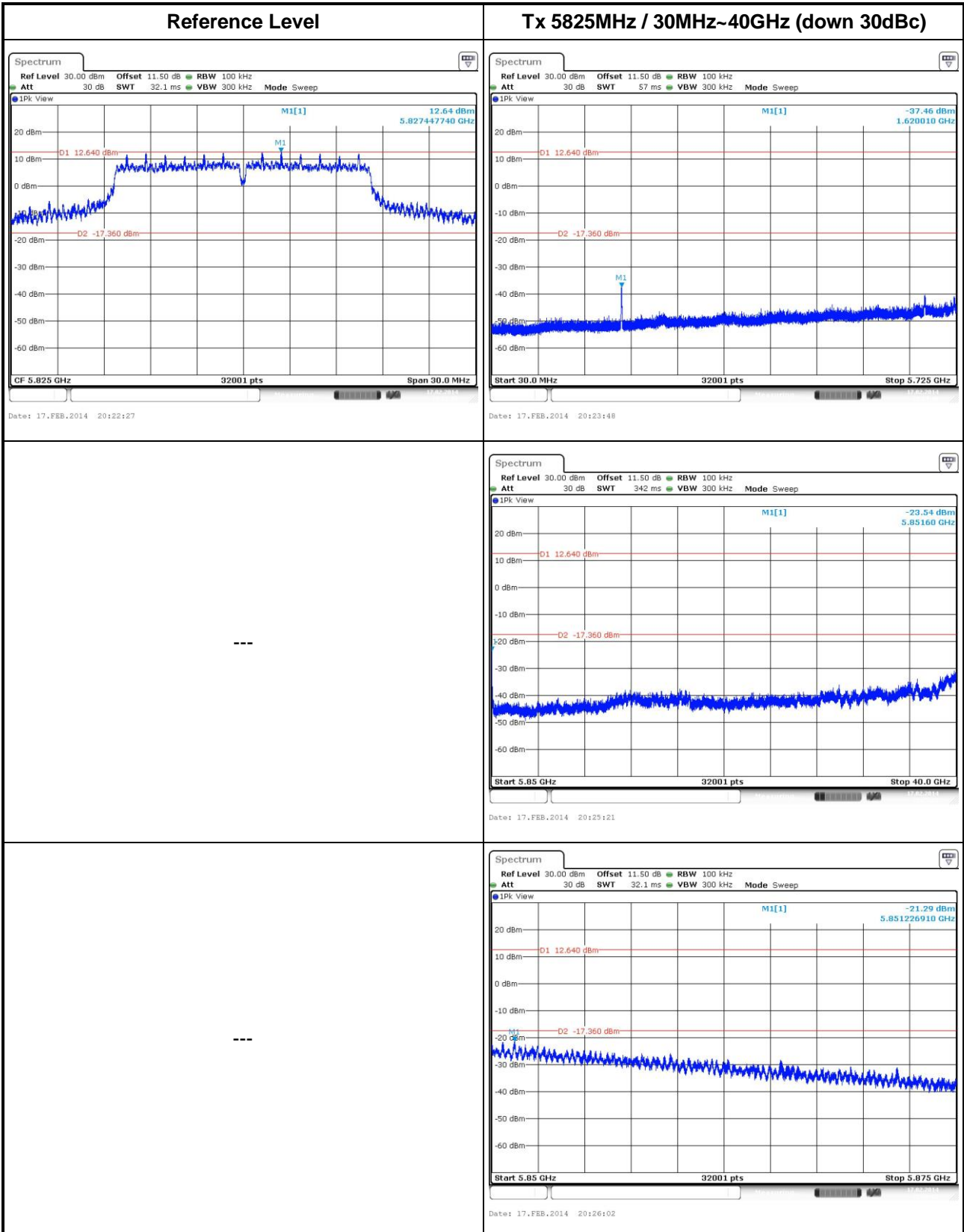

802.11n VHT20

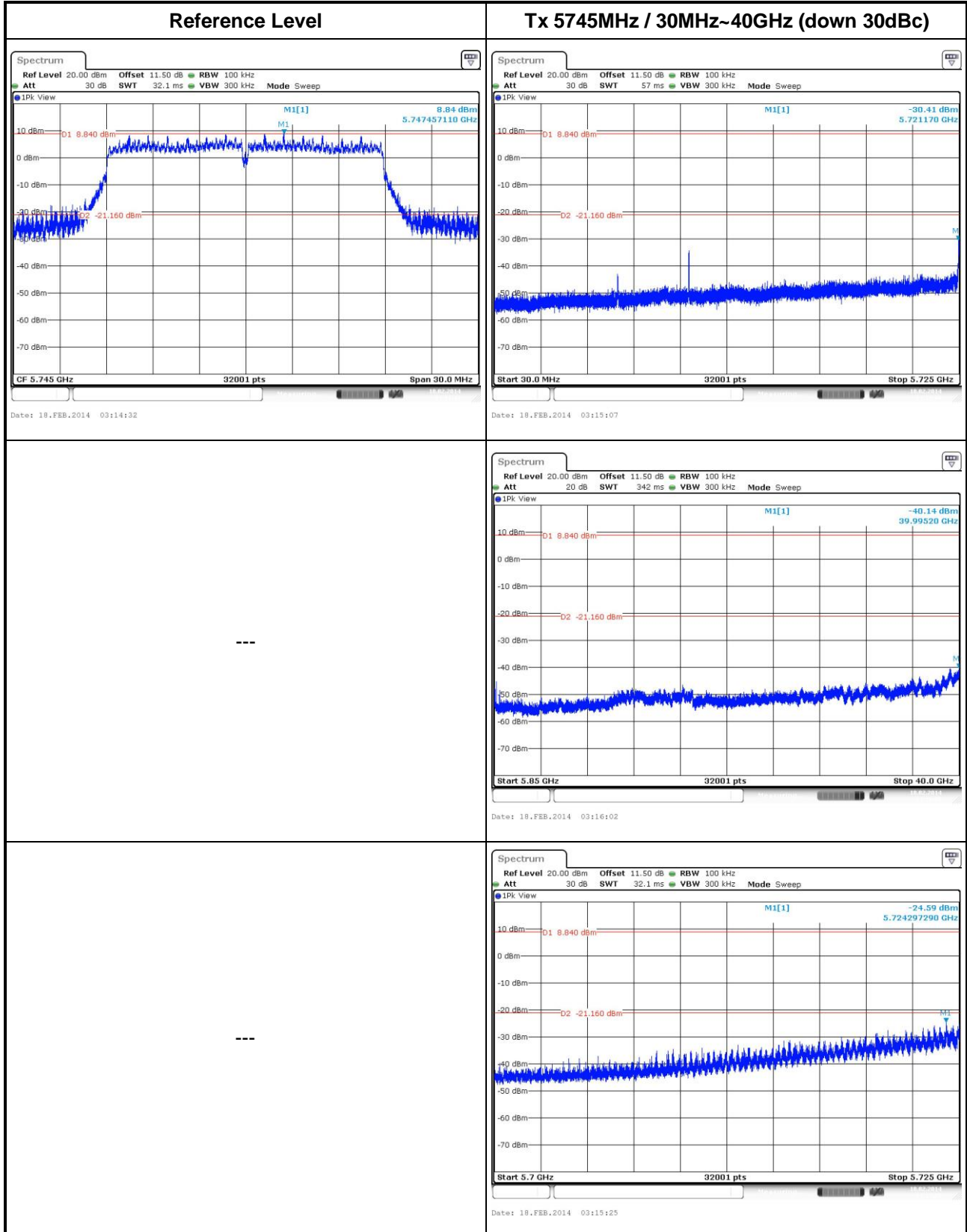

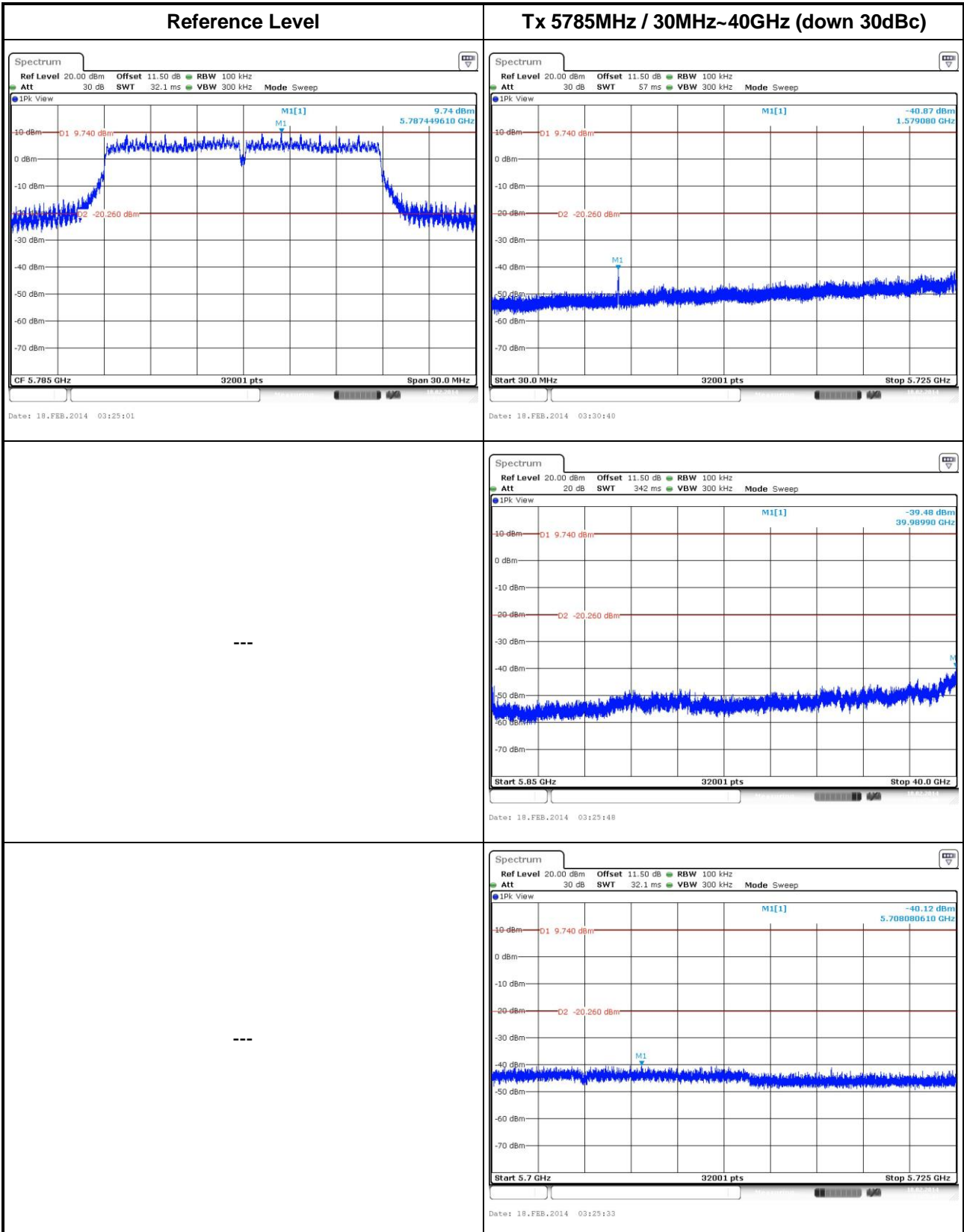

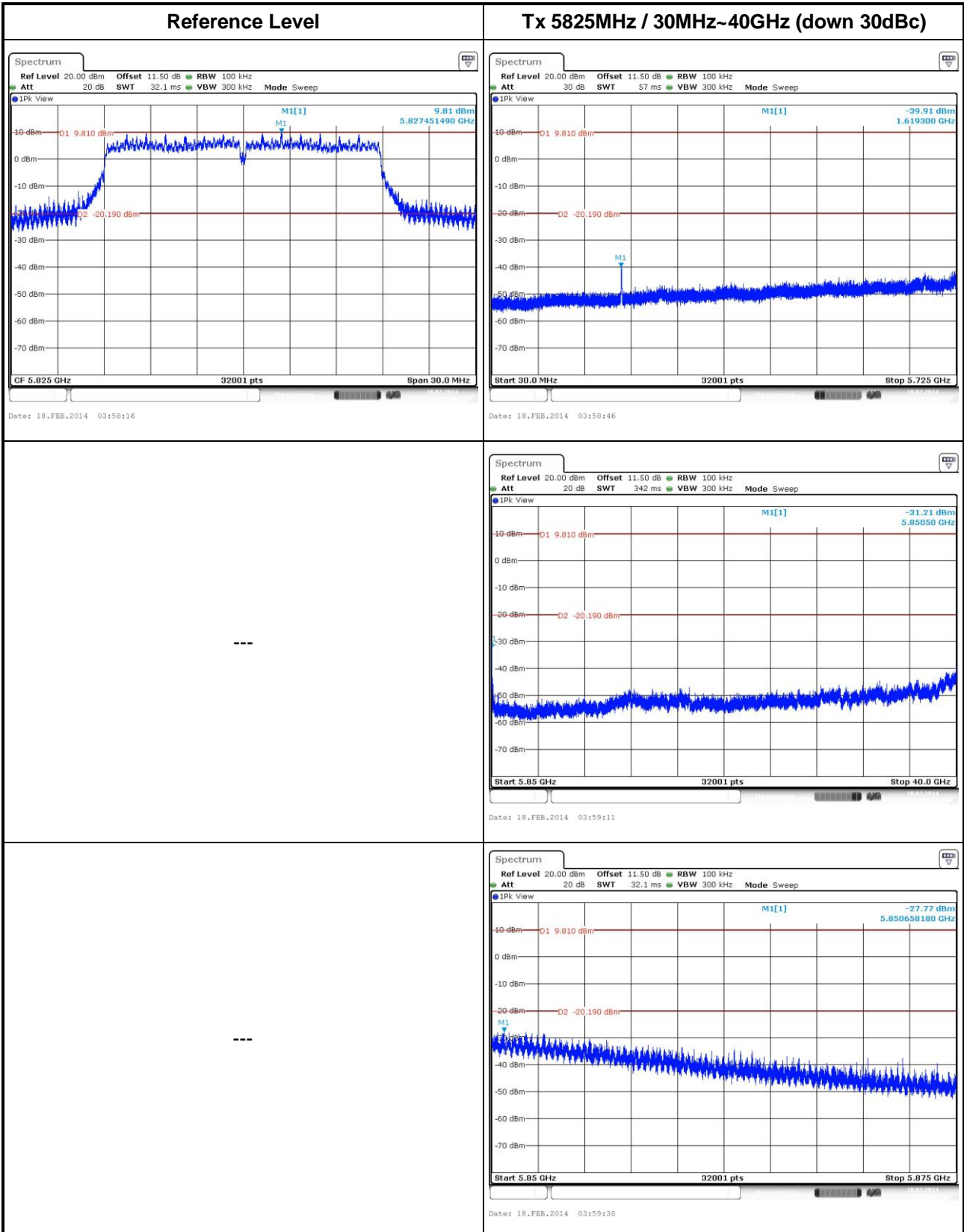

802.11n VHT40

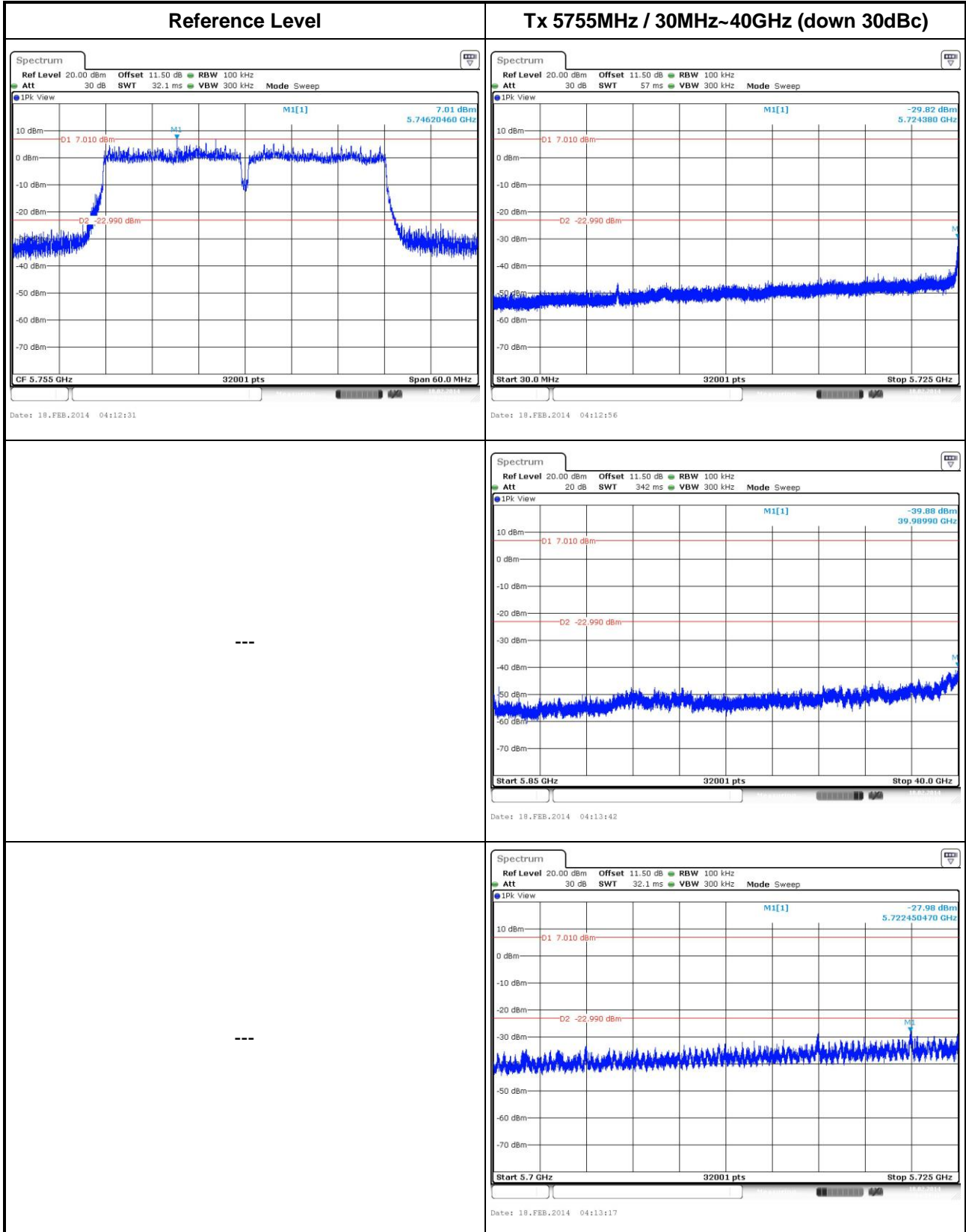

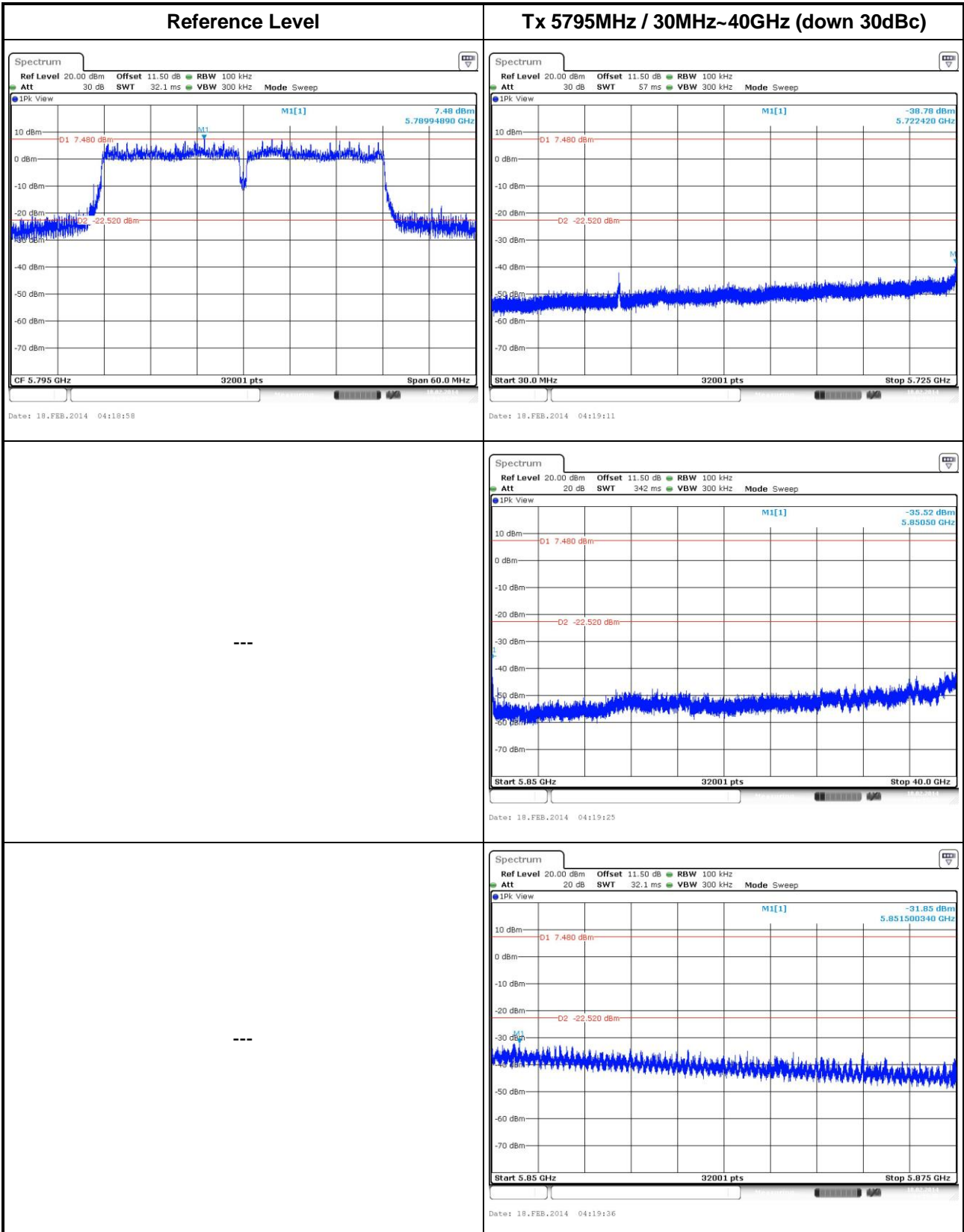

802.11n VHT80

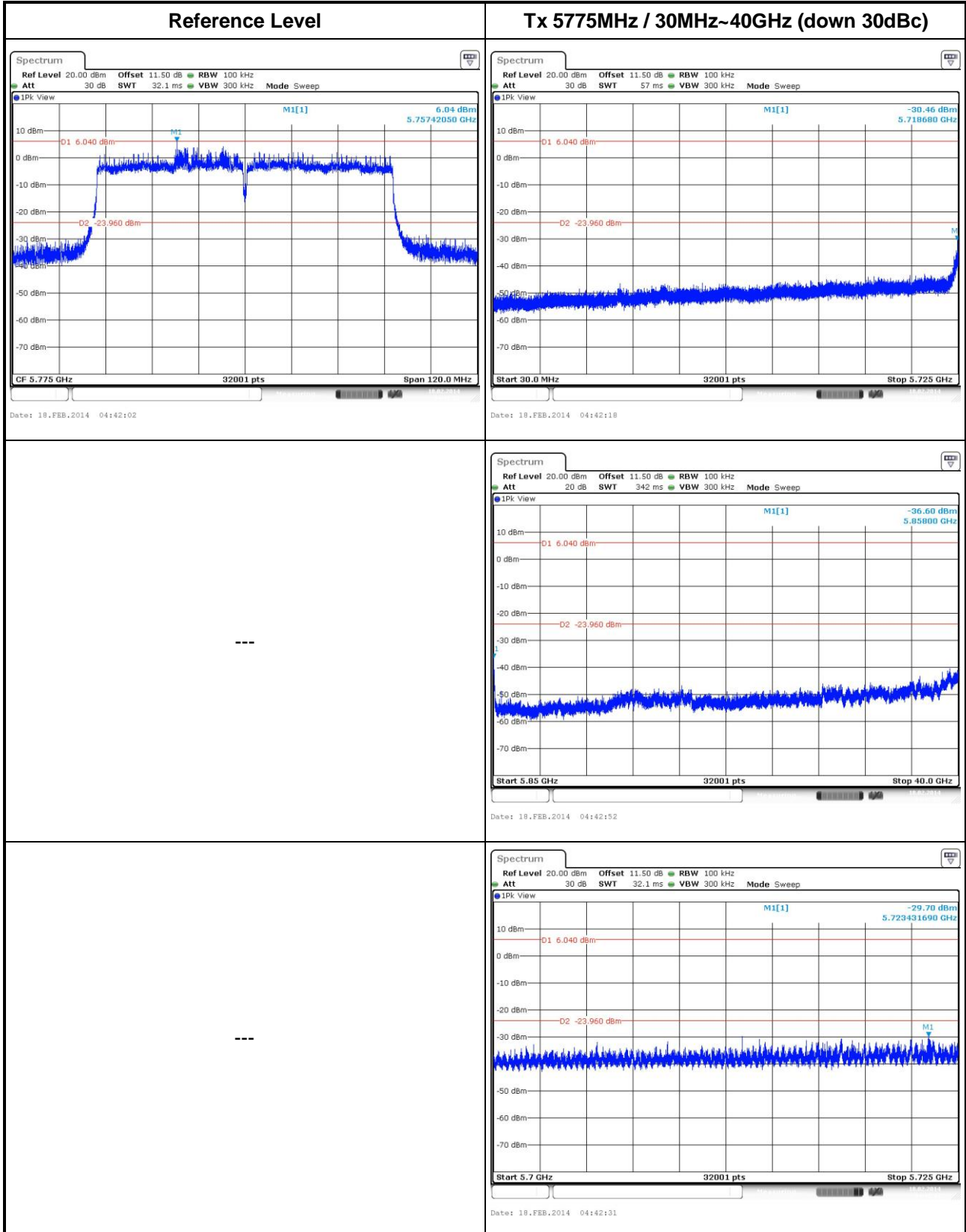

Legacy/MIMO (CDD) beamforming mode - Test Configuration 3 / 802.11a

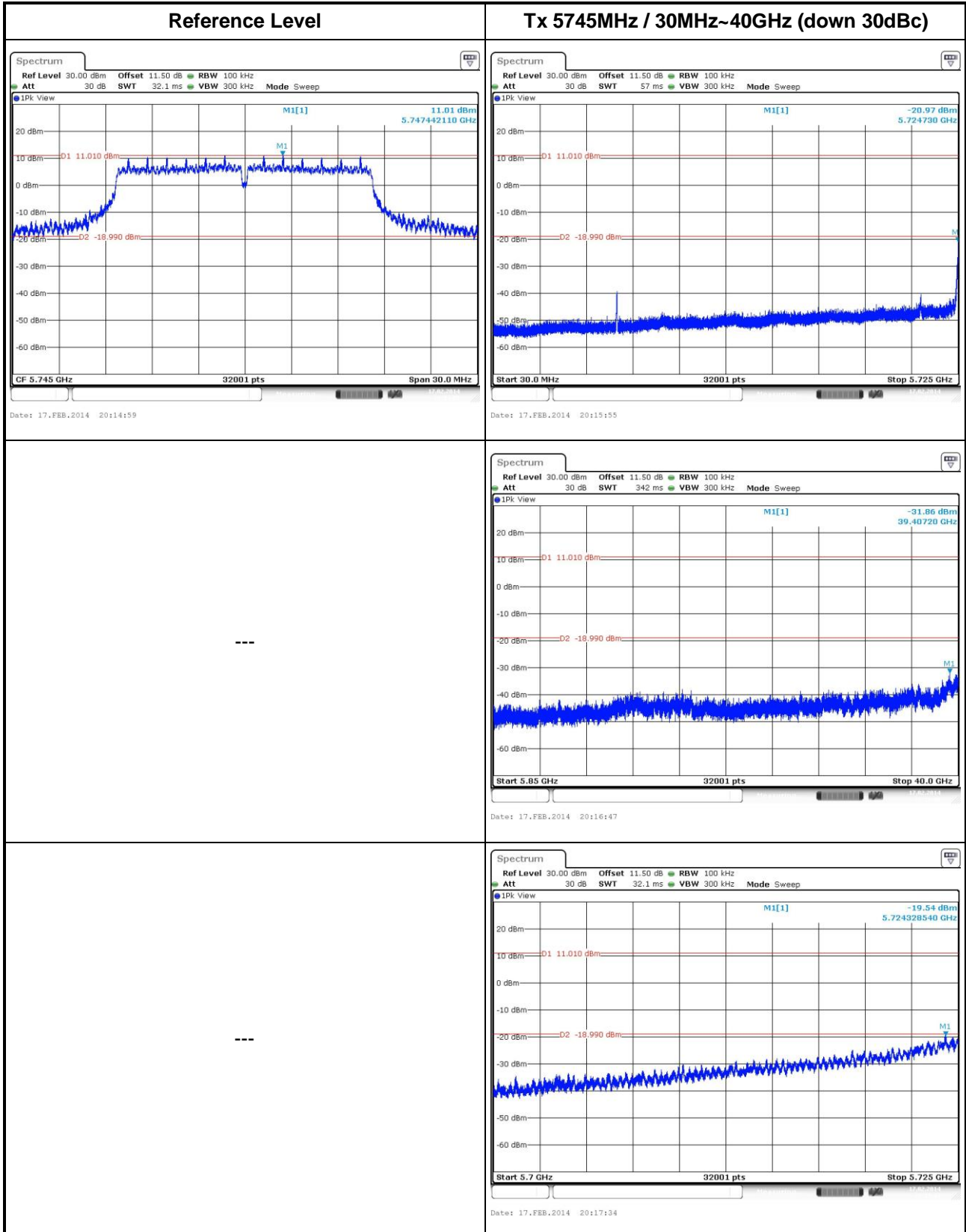

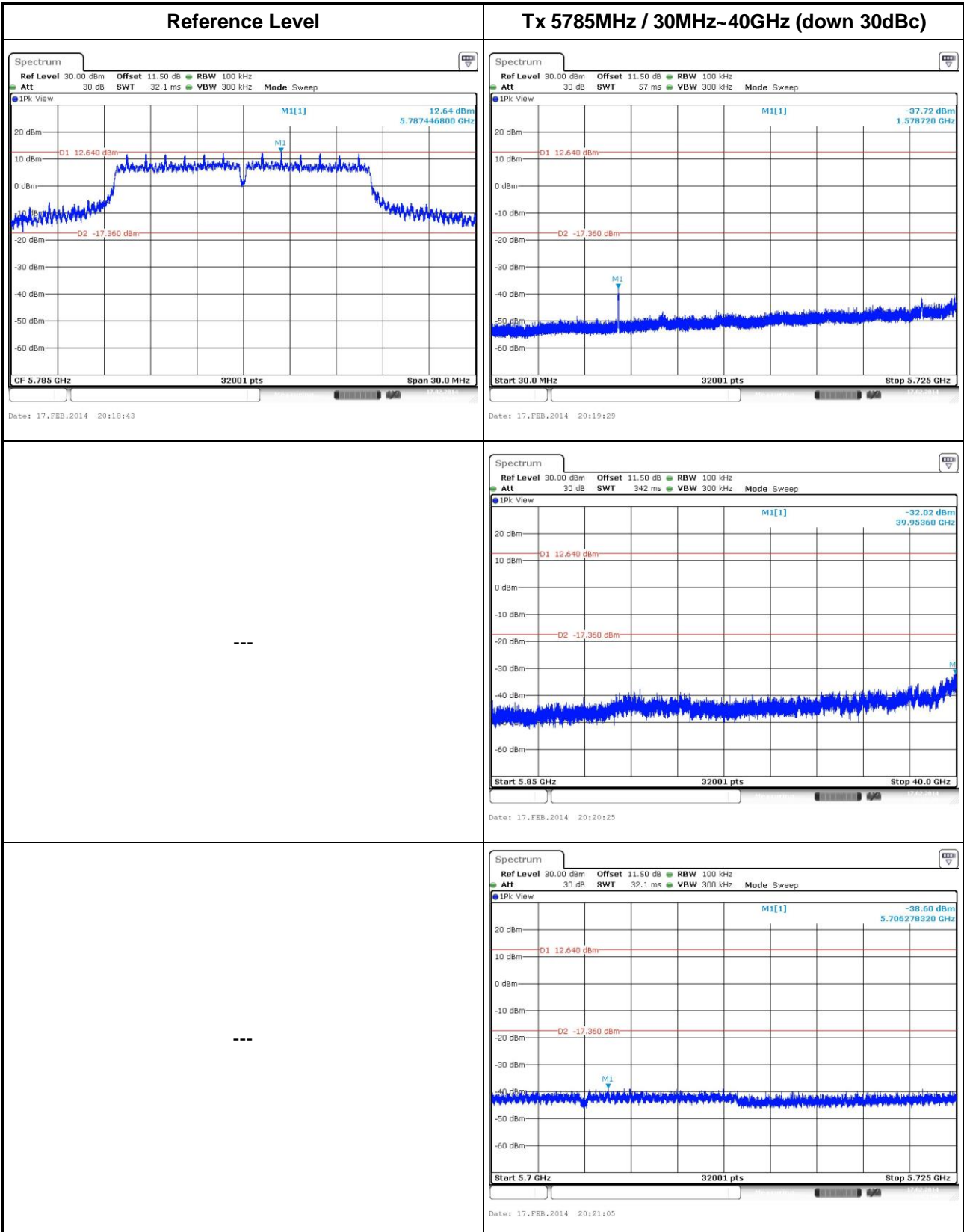

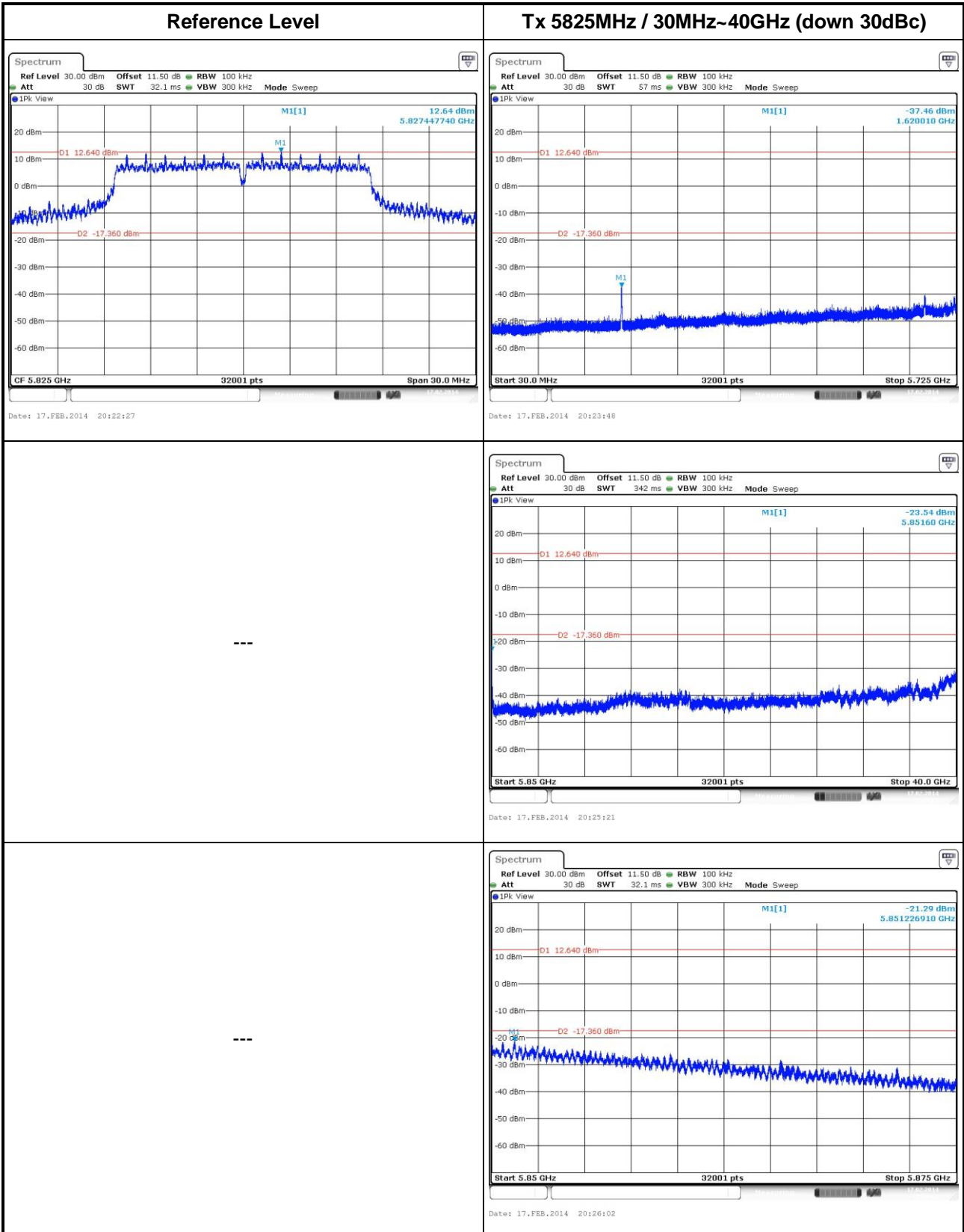

802.11n VHT20

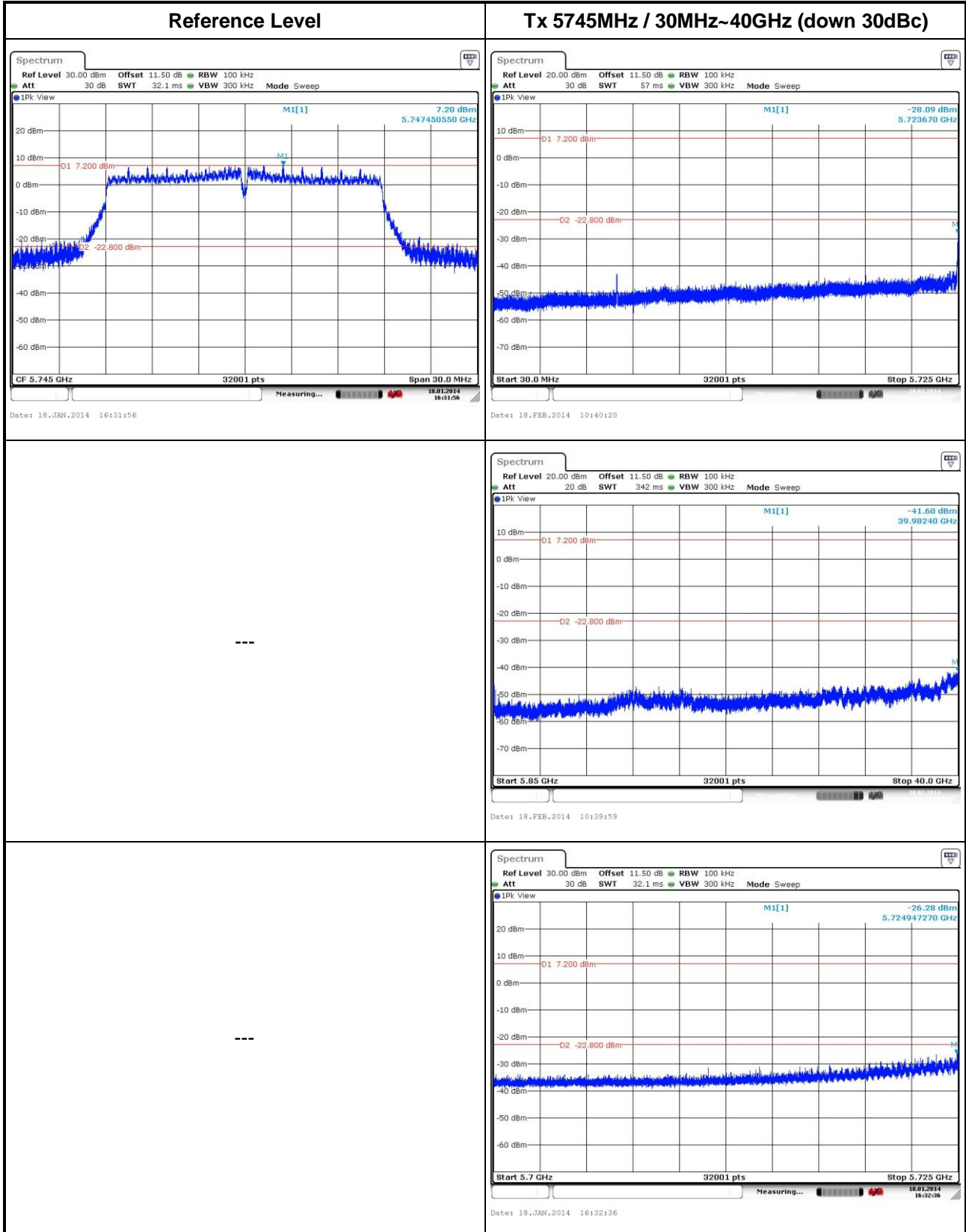

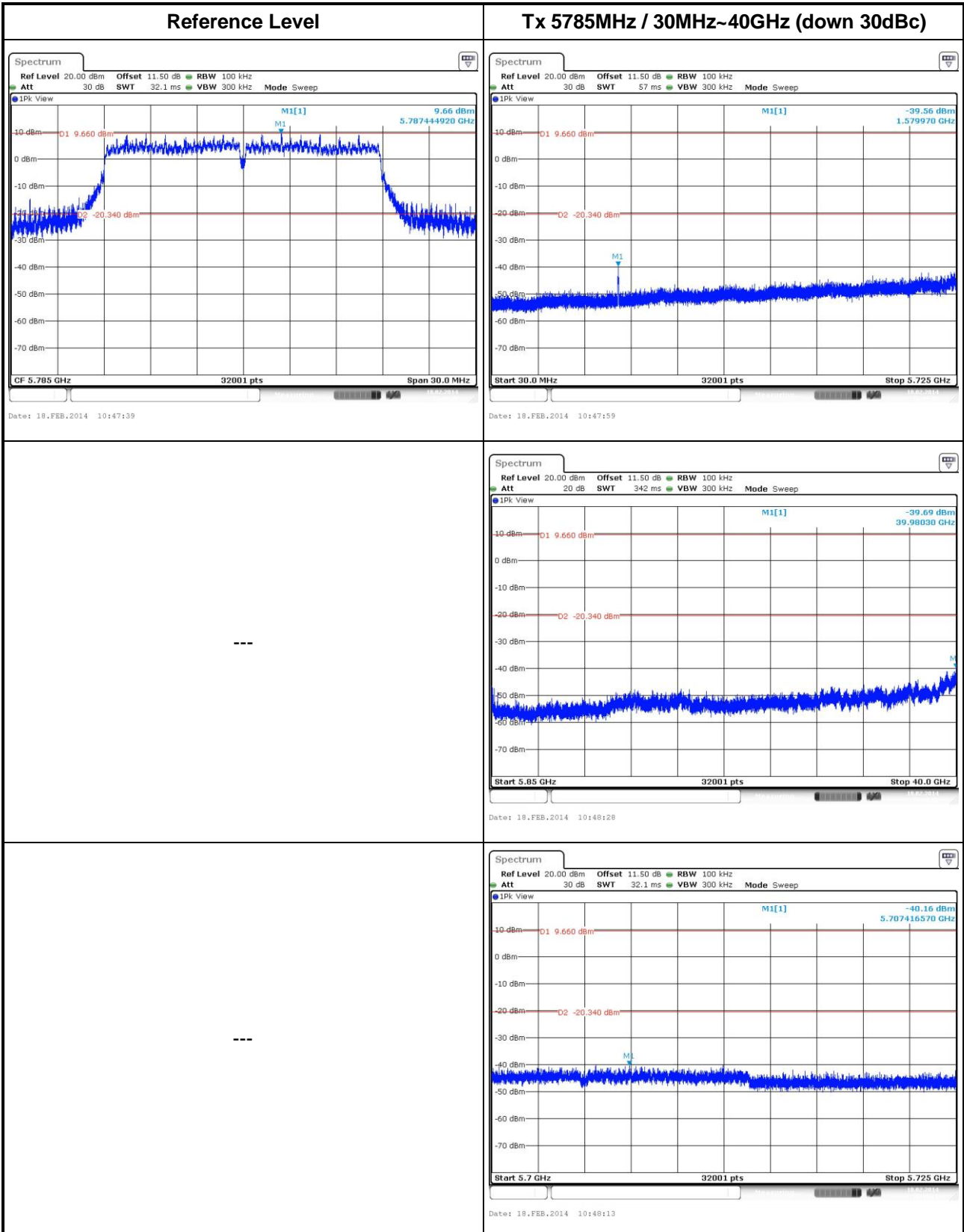

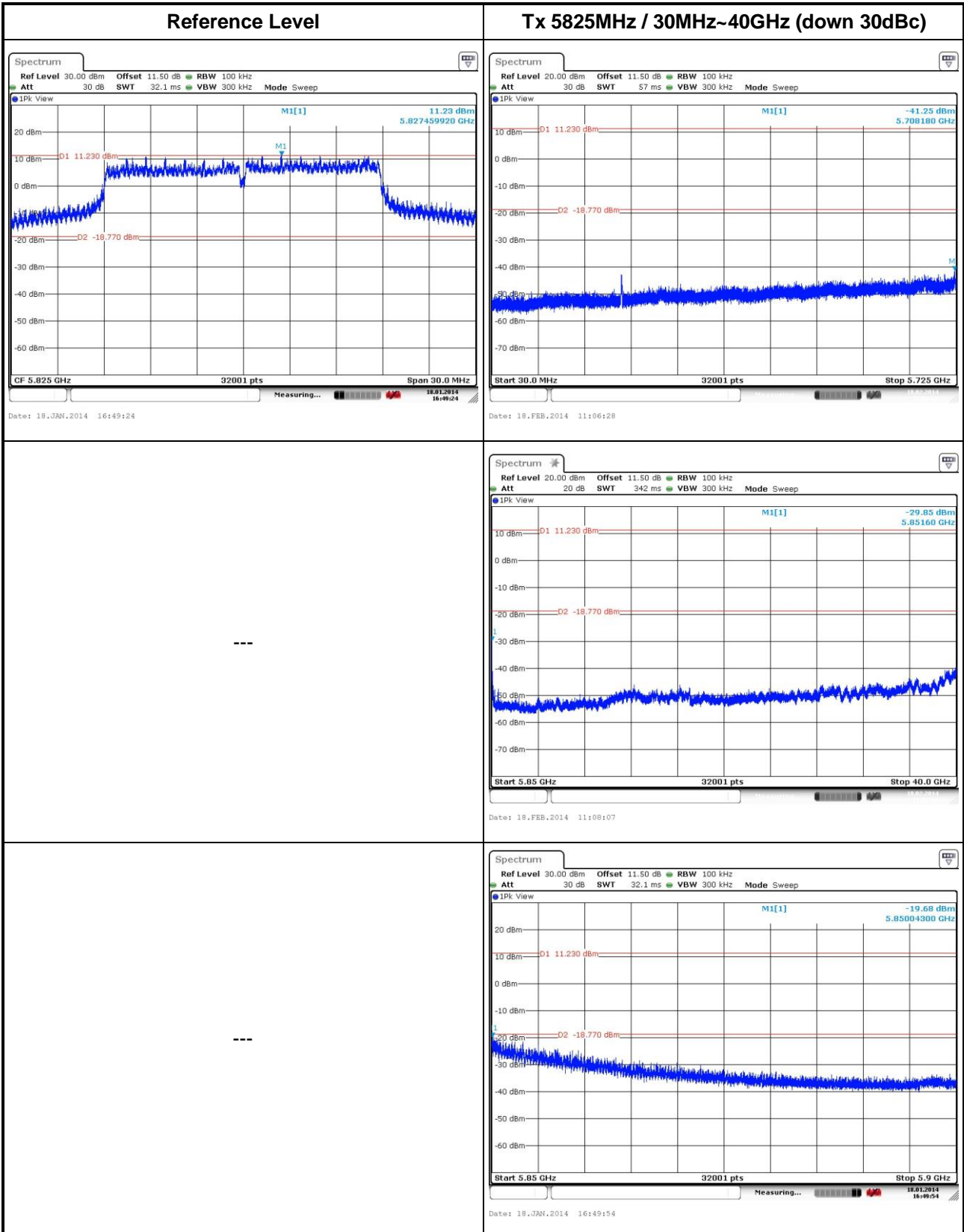

802.11n VHT40

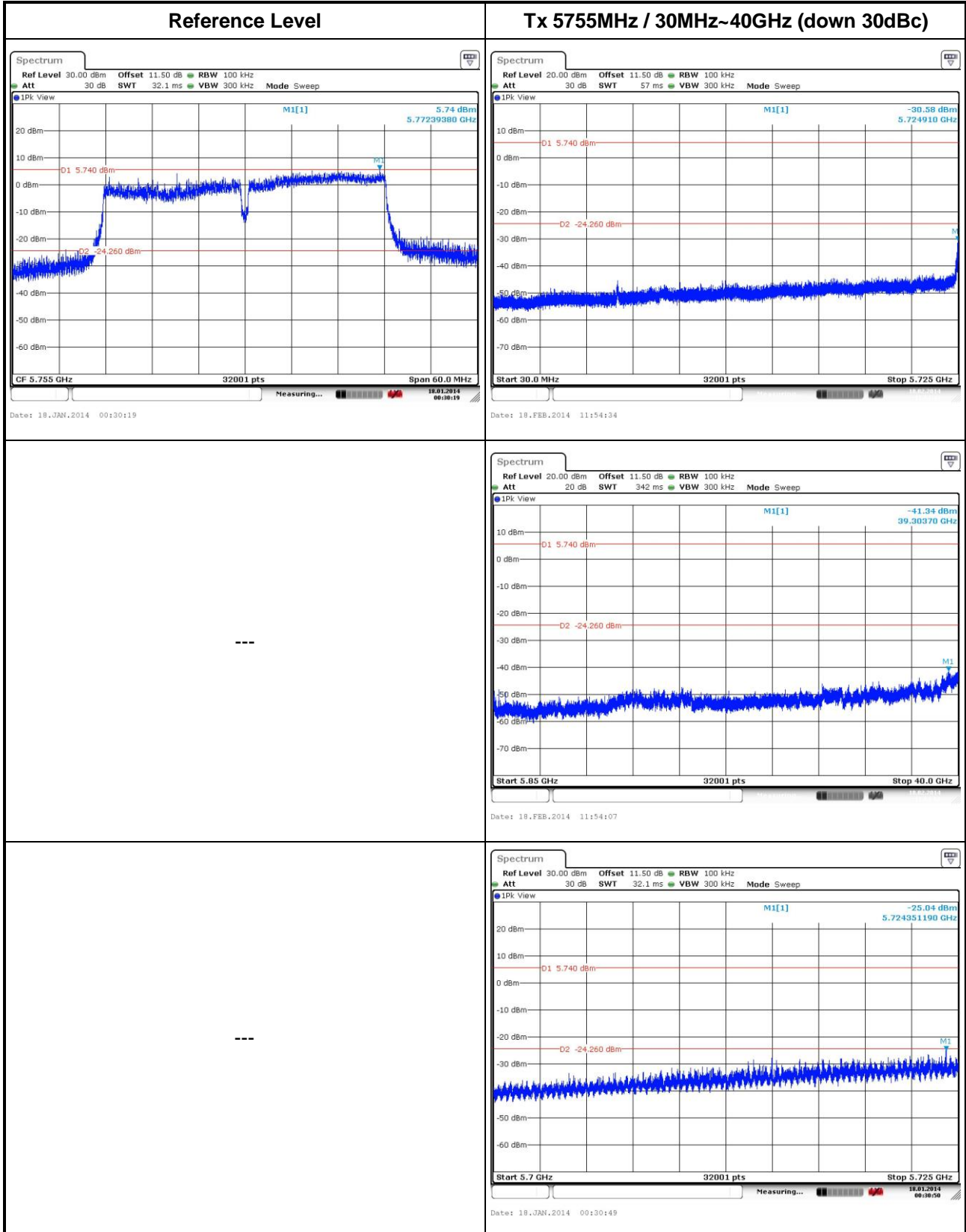

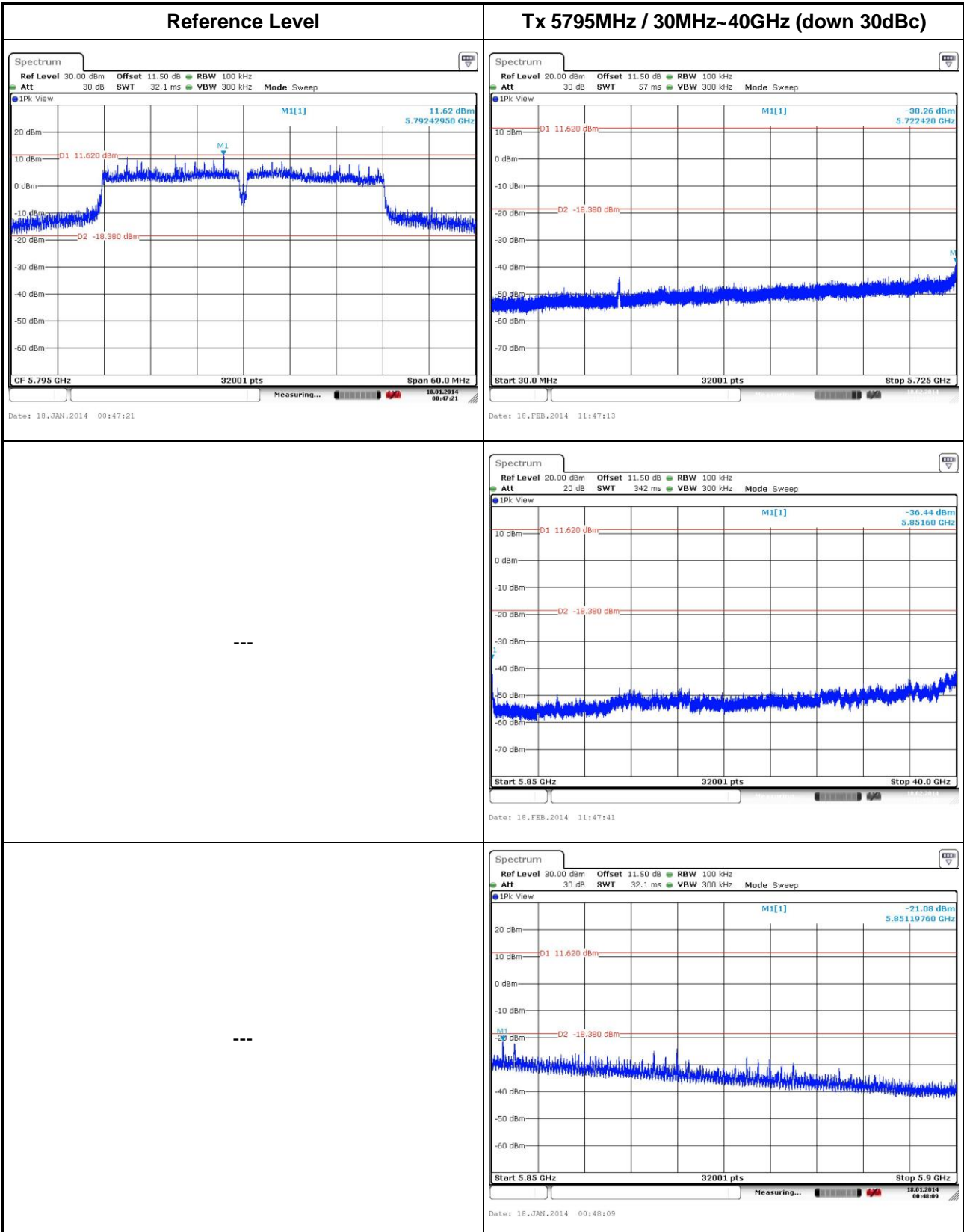

802.11n VHT80

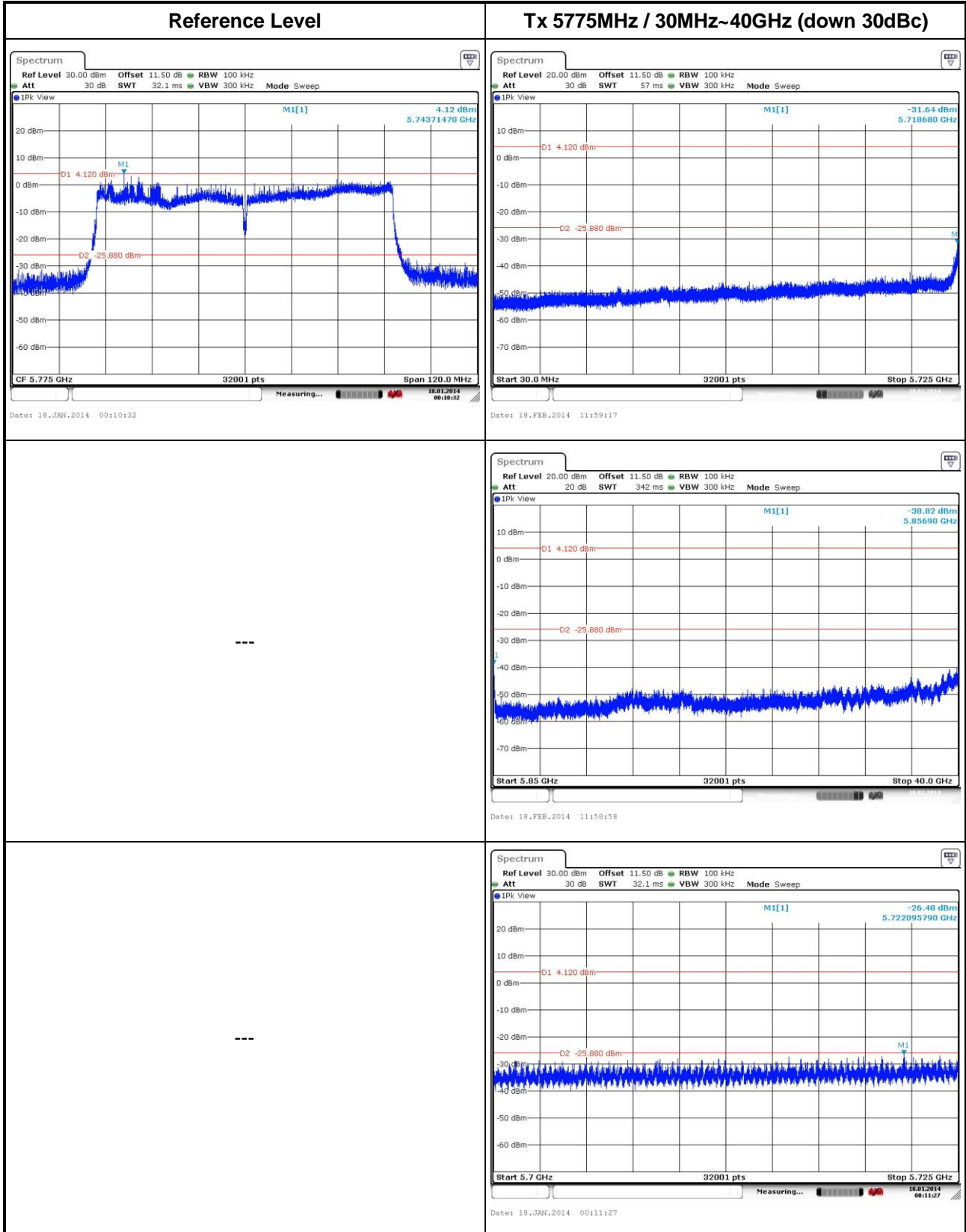

4 Test laboratory information

Established in 2012, ICC provides foremost EMC & RF Testing and advisory consultation services by our skilled engineers and technicians. Our services employ a wide variety of advanced edge test equipment and one of the widest certification extents in the business.

International Certification Corp, it is our definitive objective is to institute long term, trust-based associations with our clients. The expectation we set up with our clients is based on outstanding service, practical expertise and devotion to a certified value structure. Our passion is to grant our clients with best EMC / RF services by oriented knowledgeable and accommodating staff.

Our Test sites are located at Linkou District and Kwei Shan Hsiang. Location map can be found on our website <http://www.icertifi.com.tw>.

Linkou

Tel: 886-2-2601-1640

No. 30-2, Ding Fwu Tsuen, Lin Kou District, New Taipei City, Taiwan, R.O.C.

Kwei Shan

Tel: 886-3-271-8666

No. 3-1, Lane 6, Wen San 3rd St., Kwei Shan Hsiang, Tao Yuan Hsien 333, Taiwan, R.O.C.

If you have any suggestion, please feel free to contact us as below information

Tel: 886-3-271-8666

Fax: 886-3-318-0155

Email: ICC_Service@icertifi.com.tw

==END==