



# FCC Test Report

Equipment : Access Point  
Brand Name : Aerohive  
Model No. : AP150W  
FCC ID : WBV-AP150W  
Standard : 47 CFR FCC Part 15.407  
Operating Band : 5150 MHz – 5250 MHz  
5725 MHz – 5850 MHz  
Applicant : Aerohive Networks Inc.  
1011 McCarthy Blvd, Milpitas, CA 95035  
Manufacturer : Aerohive Networks Inc.  
1011 McCarthy Blvd, Milpitas, CA 95035  
Function :  Outdoor;  Indoor;  Fixed P2P  
 Client

The product sample received on Jun. 13, 2017 and completely tested on Jul. 28, 2017. We, SPORTON, would like to declare that the tested sample has been evaluated in accordance with the procedures given in ANSI C63.10-2013 and shown compliance with the applicable technical standards.

The test results in this report apply exclusively to the tested model / sample. Without written approval of SPORTON INTERNATIONAL INC., the test report shall not be reproduced except in full.

  
Cliff Chang  
SPORTON INTERNATIONAL INC.





# Table of Contents

- 1 GENERAL DESCRIPTION .....5**
- 1.1 Information.....5
- 1.2 Testing Applied Standards .....8
- 1.3 Testing Location Information .....8
- 1.4 Measurement Uncertainty .....8
- 2 TEST CONFIGURATION OF EUT .....9**
- 2.1 Test Channel Mode .....9
- 2.2 The Worst Case Measurement Configuration .....11
- 2.3 EUT Operation during Test .....13
- 2.4 Accessories .....13
- 2.5 Support Equipment.....14
- 2.6 Test Setup Diagram .....15
- 3 TRANSMITTER TEST RESULT .....19**
- 3.1 AC Power-line Conducted Emissions .....19
- 3.2 Emission Bandwidth .....21
- 3.3 Maximum Conducted Output Power .....22
- 3.4 Peak Power Spectral Density.....24
- 3.5 Unwanted Emissions.....27
- 3.6 Frequency Stability.....31
- 4 TEST EQUIPMENT AND CALIBRATION DATA .....32**

**APPENDIX A. TEST RESULTS OF AC POWER-LINE CONDUCTED EMISSIONS**

**APPENDIX B. TEST RESULTS OF EMISSION BANDWIDTH**

**APPENDIX C. TEST RESULTS OF MAXIMUM CONDUCTED OUTPUT POWER**

**APPENDIX D. TEST RESULTS OF PEAK POWER SPECTRAL DENSITY**

**APPENDIX E. TEST RESULTS OF UNWANTED EMISSIONS**

**APPENDIX F. TEST RESULTS OF FREQUENCY STABILITY**

**APPENDIX G. TEST RESULTS OF RADIATED EMISSION CO-LOCATION**

**APPENDIX H. TEST PHOTOS**

**PHOTOGRAPHS OF EUT V01**



## Summary of Test Result

| Conformance Test Specifications |                  |                                   |          |
|---------------------------------|------------------|-----------------------------------|----------|
| Report Clause                   | Ref. Std. Clause | Description                       | Result   |
| 1.1.2                           | 15.203           | Antenna Requirement               | Complied |
| 3.1                             | 15.207           | AC Power-line Conducted Emissions | Complied |
| 3.2                             | 15.407(a)        | Emission Bandwidth                | Complied |
| 3.3                             | 15.407(a)        | Maximum Conducted Output Power    | Complied |
| 3.4                             | 15.407(a)        | Peak Power Spectral Density       | Complied |
| 3.5                             | 15.407(b)        | Unwanted Emissions                | Complied |
| 3.6                             | 15.407(g)        | Frequency Stability               | Complied |





# 1 General Description

## 1.1 Information

### 1.1.1 RF General Information

| Frequency Range (MHz) | IEEE Std. 802.11        | Ch. Frequency (MHz) | Channel Number |
|-----------------------|-------------------------|---------------------|----------------|
| 5150-5250             | a, n (HT20), ac (VHT20) | 5180-5240           | 36-48 [4]      |
| 5725-5850             |                         | 5745-5825           | 149-165 [5]    |
| 5150-5250             | n (HT40), ac (VHT40)    | 5190-5230           | 38-46 [2]      |
| 5725-5850             |                         | 5755-5795           | 151-159 [2]    |
| 5150-5250             | ac (VHT80)              | 5210                | 42 [1]         |
| 5725-5850             |                         | 5775                | 155 [1]        |

| Band          | Mode              | BWch (MHz) | Nant |
|---------------|-------------------|------------|------|
| 5.15-5.25GHz  | 802.11a           | 20         | 3TX  |
| 5.15-5.25GHz  | 802.11n HT20      | 20         | 3TX  |
| 5.15-5.25GHz  | 802.11n HT20-BF   | 20         | 3TX  |
| 5.15-5.25GHz  | 802.11ac VHT20    | 20         | 3TX  |
| 5.15-5.25GHz  | 802.11ac VHT20-BF | 20         | 3TX  |
| 5.15-5.25GHz  | 802.11n HT40      | 40         | 3TX  |
| 5.15-5.25GHz  | 802.11n HT40-BF   | 40         | 3TX  |
| 5.15-5.25GHz  | 802.11ac VHT40    | 40         | 3TX  |
| 5.15-5.25GHz  | 802.11ac VHT40-BF | 40         | 3TX  |
| 5.15-5.25GHz  | 802.11ac VHT80    | 80         | 3TX  |
| 5.15-5.25GHz  | 802.11ac VHT80-BF | 80         | 3TX  |
| 5.725-5.85GHz | 802.11a           | 20         | 3TX  |
| 5.725-5.85GHz | 802.11n HT20      | 20         | 3TX  |
| 5.725-5.85GHz | 802.11n HT20-BF   | 20         | 3TX  |
| 5.725-5.85GHz | 802.11ac VHT20    | 20         | 3TX  |
| 5.725-5.85GHz | 802.11ac VHT20-BF | 20         | 3TX  |
| 5.725-5.85GHz | 802.11n HT40      | 40         | 3TX  |
| 5.725-5.85GHz | 802.11n HT40-BF   | 40         | 3TX  |
| 5.725-5.85GHz | 802.11ac VHT40    | 40         | 3TX  |
| 5.725-5.85GHz | 802.11ac VHT40-BF | 40         | 3TX  |
| 5.725-5.85GHz | 802.11ac VHT80    | 80         | 3TX  |
| 5.725-5.85GHz | 802.11ac VHT80-BF | 80         | 3TX  |



Note:

- ♦ 11a, HT20 and HT40 use a combination of OFDM-BPSK, QPSK, 16QAM, 64QAM modulation.
- ♦ VHT20, VHT40, VHT80 use a combination of OFDM-BPSK, QPSK, 16QAM, 64QAM, 256QAM modulation.
- ♦ BWch is the nominal channel bandwidth.
- ♦ Nss-Min is the minimum number of spatial streams.
- ♦ Nant is the number of outputs. e.g., 2(2,3) means have 2 outputs for port 2 and port 3. 2 means have 2 outputs for port 1 and port 2.

1.1.2 Antenna Information

| Ant. | Brand | P/N          | Antenna Type | Connector | Gain (dBi) |      |
|------|-------|--------------|--------------|-----------|------------|------|
|      |       |              |              |           | 2.4G       | 5G   |
| 1    | WNC   | 95XKAA15.GCY | PCB Antenna  | I-PEX     | 2.33       | 5.88 |
| 2    | WNC   | 95XKAA15.GCZ | PCB Antenna  | I-PEX     | 3.45       | 5.86 |
| 3    | WNC   | 95XKAA15.GC1 | PCB Antenna  | I-PEX     | 3.63       | 5.86 |

Note: The EUT has three antennas.

<For 2.4GHz WLAN Function>

For IEEE 802.11b/g/n/ac mode (2TX, 2RX):

Ant. 2 connect to port 1 and Ant. 3 connect to port 2

Ant. 2 and Ant. 3 could transmit/receive simultaneously.

<For 5GHz WLAN Function>

For IEEE 802.11a/n/ac mode (3TX, 3RX):

Ant. 1 connect to port 1, Ant. 2 connect to port 2 and Ant. 3 connect to port 3

Ant. 1, Ant. 2 and Ant. 3 could transmit/receive simultaneously.

<For Bluetooth Function>

For bluetooth mode (1TX, 1RX):

Ant. 1 connect to port 1

Only Ant. 1 can be used as transmitting/receiving antenna.



1.1.3 Mode Test Duty Cycle

| Mode              | DC    | DCF(dB) | T(s)     | VBW(Hz) ≥ 1/T |
|-------------------|-------|---------|----------|---------------|
| 802.11a           | 0.876 | 0.575   | 2.065m   | 1k            |
| 802.11ac VHT20    | 0.927 | 0.329   | 1.929m   | 1k            |
| 802.11ac VHT20-BF | 0.933 | 0.301   | 3.848m   | 300           |
| 802.11ac VHT40    | 0.868 | 0.615   | 946u     | 3k            |
| 802.11ac VHT40-BF | 0.902 | 0.448   | 4.618m   | 300           |
| 802.11ac VHT80    | 0.812 | 0.904   | 454.667u | 3k            |
| 802.11ac VHT80-BF | 0.868 | 0.615   | 5.11m    | 300           |

1.1.4 EUT Operational Condition

|                      |  |  |  |
|----------------------|--|--|--|
| EUT Power Type       | From Power Adapter or PoE  |  |  |
| Beamforming Function | <input checked="" type="checkbox"/> With beamforming for 802.11n/ac. | <input type="checkbox"/> Without beamforming |  |



## 1.2 Testing Applied Standards

According to the specifications of the manufacturer, the EUT must comply with the requirements of the following standards:

- ◆ 47 CFR FCC Part 15
- ◆ ANSI C63.10-2013
- ◆ FCC KDB 789033 D02 v01r04
- ◆ FCC KDB 644545 D03 v01
- ◆ FCC KDB 662911 D01 v02r01

## 1.3 Testing Location Information

| Testing Location                    |        |   |
|-------------------------------------|--------|---|
| <input type="checkbox"/>            | HWA YA | ADD : No. 52, Hwa Ya 1st Rd., Kwei-Shan Hsiang, Tao Yuan Hsien, Taiwan, R.O.C.<br>TEL : 886-3-327-3456 FAX : 886-3-318-0055   |
| <input checked="" type="checkbox"/> | JHUBEI | ADD : No.8, Lane 724, Bo-ai St., Jhubei City, HsinChu County 302, Taiwan, R.O.C.<br>TEL : 886-3-656-9065 FAX : 886-3-656-9085 |

| Test Condition            | Test Site No. | Test Engineer                       | Test Environment | Test Date                     |
|---------------------------|---------------|-------------------------------------|------------------|-------------------------------|
| RF Conducted              | TH01-CB       | Eddie Weng                          | 23°C / 55%       | Jun. 24, 2017                 |
| Radiated (For below 1GHz) | 03CH01-CB     | Welson Chen & Nyle Chang & Peter Wu | 22°C / 54%       | Jul. 19, 2017                 |
| Radiated (For above 1GHz) | 03CH01-CB     | Welson Chen & Nyle Chang & Peter Wu | 22°C / 54%       | Jun. 16, 2017 ~ Jul. 20, 2017 |
| AC Conduction             | CO01-CB       | Howard Lin                          | 22°C / 54%       | Jul. 28, 2017                 |

Test site Designation No. TW0006 with FCC  
Test site registered number IC 4086D with Industry Canada.

## 1.4 Measurement Uncertainty

ISO/IEC 17025 requires that an estimate of the measurement uncertainties associated with the emissions test results be included in the report. The measurement uncertainties given below are based on a 95% confidence level (based on a coverage factor (k=2))

| Test Items                           | Uncertainty            | Remark                   |
|--------------------------------------|------------------------|--------------------------|
| Conducted Emission (150kHz ~ 30MHz)  | 3.2 dB                 | Confidence levels of 95% |
| Radiated Emission (30MHz ~ 1,000MHz) | 3.6 dB                 | Confidence levels of 95% |
| Radiated Emission (1GHz ~ 18GHz)     | 3.7 dB                 | Confidence levels of 95% |
| Radiated Emission (18GHz ~ 40GHz)    | 3.5 dB                 | Confidence levels of 95% |
| Conducted Emission                   | 1.7 dB                 | Confidence levels of 95% |
| Output Power Measurement             | 1.33 dB                | Confidence levels of 95% |
| Power Density Measurement            | 1.27 dB                | Confidence levels of 95% |
| Bandwidth Measurement                | 9.74 x10 <sup>-8</sup> | Confidence levels of 95% |
| Frequency Stability                  | 6.06 x10 <sup>-8</sup> | Confidence levels of 95% |





## 2 Test Configuration of EUT

### 2.1 Test Channel Mode

| Mode                              | Power Setting |
|-----------------------------------|---------------|
| 802.11a_(6Mbps)_3TX               | -             |
| 5180MHz                           | 66            |
| 5200MHz                           | 79            |
| 5240MHz                           | 70            |
| 5745MHz                           | 86            |
| 5785MHz                           | 86            |
| 5825MHz                           | 86            |
| 802.11ac VHT20_Nss1,(MCS0)_3TX    | -             |
| 5180MHz                           | 63            |
| 5200MHz                           | 78            |
| 5240MHz                           | 70            |
| 5745MHz                           | 86            |
| 5785MHz                           | 86            |
| 5825MHz                           | 86            |
| 802.11ac VHT40_Nss1,(MCS0)_3TX    | -             |
| 5190MHz                           | 48            |
| 5230MHz                           | 69            |
| 5755MHz                           | 78            |
| 5795MHz                           | 78            |
| 802.11ac VHT80_Nss1,(MCS0)_3TX    | -             |
| 5210MHz                           | 51            |
| 5775MHz                           | 67            |
| 802.11ac VHT20-BF_Nss1,(MCS0)_3TX | -             |
| 5180MHz                           | 70            |
| 5200MHz                           | 78            |
| 5240MHz                           | 70            |
| 5745MHz                           | 80            |
| 5785MHz                           | 80            |
| 5825MHz                           | 79            |
| 802.11ac VHT40-BF_Nss1,(MCS0)_3TX | -             |
| 5190MHz                           | 50            |
| 5230MHz                           | 69            |
| 5755MHz                           | 76            |



| Mode                              | Power Setting |
|-----------------------------------|---------------|
| 5795MHz                           | 78            |
| 802.11ac VHT80-BF_Nss1,(MCS0)_3TX | -             |
| 5210MHz                           | 49            |
| 5775MHz                           | 64            |

Note:

- ♦ VHT20/VHT40 covers HT20/HT40, due to same modulation. The power setting for 802.11n HT20 and HT40 are the same or lower than 802.11ac VHT20 and VHT40.
- ♦ There are two modes of EUT for 802.11n/ac in 2.4GHz/5GHz. One is beamforming mode, and the other is non-beamforming mode. Both modes have been tested and recorded in this test report.

## 2.2 The Worst Case Measurement Configuration

| The Worst Case Mode for Following Conformance Tests |  |
|---|--|
| <b>Tests Item</b>                                   | AC power-line conducted emissions                        |
| <b>Condition</b>                                    | AC power-line conducted measurement for line and neutral |
| <b>Operating Mode</b>                               | Normal Link  |
| 1   | EUT + Adapter  |

| The Worst Case Mode for Following Conformance Tests |  |
|---|--|
| <b>Tests Item</b>                                   | Emission Bandwidth<br>Maximum Conducted Output Power<br>Peak Power Spectral Density<br>Frequency Stability |
| <b>Test Condition</b>                               | Conducted measurement at transmit chains   |

| The Worst Case Mode for Following Conformance Tests                           |   |
|---|---|
| <b>Tests Item</b>   | Unwanted Emissions  |
| <b>Test Condition</b>   | Radiated measurement<br>If EUT consist of multiple antenna assembly (multiple antenna are used in EUT regardless of spatial multiplexing MIMO configuration), the radiated test should be performed with highest antenna gain of each antenna type. |
| <b>Operating Mode &lt; 1GHz</b>   | Normal Link   |
| 1   | Normal Link - EUT in Y axis + Adapter   |
| 2   | Normal Link - EUT in Y axis + PoE 1   |
| 3   | Normal Link - EUT in Y axis + PoE 2   |
| For operating mode 1 is the worst case and it was record in this test report. |   |
| <b>Operating Mode &gt; 1GHz</b>   | CTX   |
| 1   | EUT in Y axis   |

| The Worst Case Mode for Following Conformance Tests    |  |
|--|--|
| <b>Tests Item</b>                                      | Simultaneous Transmission Analysis - Radiated Emission Co-location |
| <b>Test Condition</b>                                  | Radiated measurement   |
| <b>Operating Mode</b>                                  | Normal Link  |
| 1  | WLAN 2.4GHz+WLAN 5GHz+Bluetooth                                    |
| Refer to Appendix G for Radiated Emission Co-location. |  |



| The Worst Case Mode for Following Conformance Tests                                |   |
|--|---|
| Tests Item   | Simultaneous Transmission Analysis - Co-location RF Exposure Evaluation |
| Operating Mode   |   |
| 1  | WLAN 2.4GHz+WLAN 5GHz+Bluetooth   |
| Refer to Sporton Test Report No.: FA761315 for Co-location RF Exposure Evaluation. |   |

Note 1: The EUT can only be used at Y axis position.

Note 2: The defines from manufacturer, "console port" without any function, and it was performed test at the load.

Note 3: PoE and Adapter information as below:

The EUT was powered by PoE or Adapter, and the PoE and Adapter was for measurement only, would not be marketed.

| Support Unit | Brand     | Model           |
|--------------|-----------|-----------------|
| Adapter      | CUI INC   | SWI36-48-N      |
| PoE 1        | Microsemi | PD-3501G/AC     |
| PoE 2        | Microsemi | PD-9001GR/AT/AC |



## **2.3 EUT Operation during Test**

For CTX Mode:

non-beamforming mode:

The EUT was programmed to be in continuously transmitting mode.

beamforming mode:

For Conducted Mode:

The EUT was programmed to be in continuously transmitting mode.

For Radiated Mode:

During the test, the following programs under WIN XP were executed.

The program was executed as follows:

1. During the test, the EUT operation to normal function.
2. Executed command fixed test channel under Telnet.
3. Executed "Lantest.exe" to link with the remote workstation to transmit and receive packet by WLAN module and transmit duty cycle no less than 98%.

For Normal Link:

During the test, the EUT operation to normal function.

## **2.4 Accessories**

Wall-mounted rack\*1



## 2.5 Support Equipment

For Test Site No: CO01-CB

| Support Equipment |            |            |            |        |
|-------------------|------------|------------|------------|--------|
| No.               | Equipment  | Brand Name | Model Name | FCC ID |
| 1                 | NB*5       | DELL       | E6430      | DoC    |
| 2                 | PoE Loader | Leader     | PFS-4010   | DoC    |
| 3                 | Adapter    | CUI INC    | SWI36-48-N | DoC    |

For Test Site No: 03CH01-CB (below 1GHz)

| Support Equipment |            |            |            |        |
|-------------------|------------|------------|------------|--------|
| No.               | Equipment  | Brand Name | Model Name | FCC ID |
| 1                 | NB*4       | DELL       | E4300      | DoC    |
| 2                 | NB         | Apple      | Mac Book   | DoC    |
| 3                 | PoE Loader | WNC        | M1         | DoC    |
| 4                 | Adapter    | CUI INC    | SWI36-48-N | DoC    |

For Test Site No: 03CH01-CB (above 1GHz)

For non-beamforming mode

| Support Equipment |           |             |             |        |
|-------------------|-----------|-------------|-------------|--------|
| No.               | Equipment | Brand Name  | Model Name  | FCC ID |
| 1                 | NB        | DELL        | E4300       | DoC    |
| 2                 | PoE 1     | Power Dsine | PD-3501G/AC | DoC    |

For beamforming mode

| Support Equipment |              |             |             |              |
|-------------------|--------------|-------------|-------------|--------------|
| No.               | Equipment    | Brand Name  | Model Name  | FCC ID       |
| 1                 | NB*2         | DELL        | E4300       | DoC          |
| 2                 | PoE 1        | Power Dsine | PD-3501G/AC | DoC          |
| 3                 | WLAN module  | Broadcom    | BCM943162ZP | QDS-BRCM1075 |
| 4                 | Test fixture | N/A         | N/A         | N/A          |

For Test Site No: TH01-CB

| Support Equipment |           |            |                 |        |
|-------------------|-----------|------------|-----------------|--------|
| No.               | Equipment | Brand Name | Model Name      | FCC ID |
| 1                 | NB        | DELL       | E4300           | DoC    |
| 2                 | PoE 2     | Microsemi  | PD-9001GR/AT/AC | DoC    |

## 2.6 Test Setup Diagram

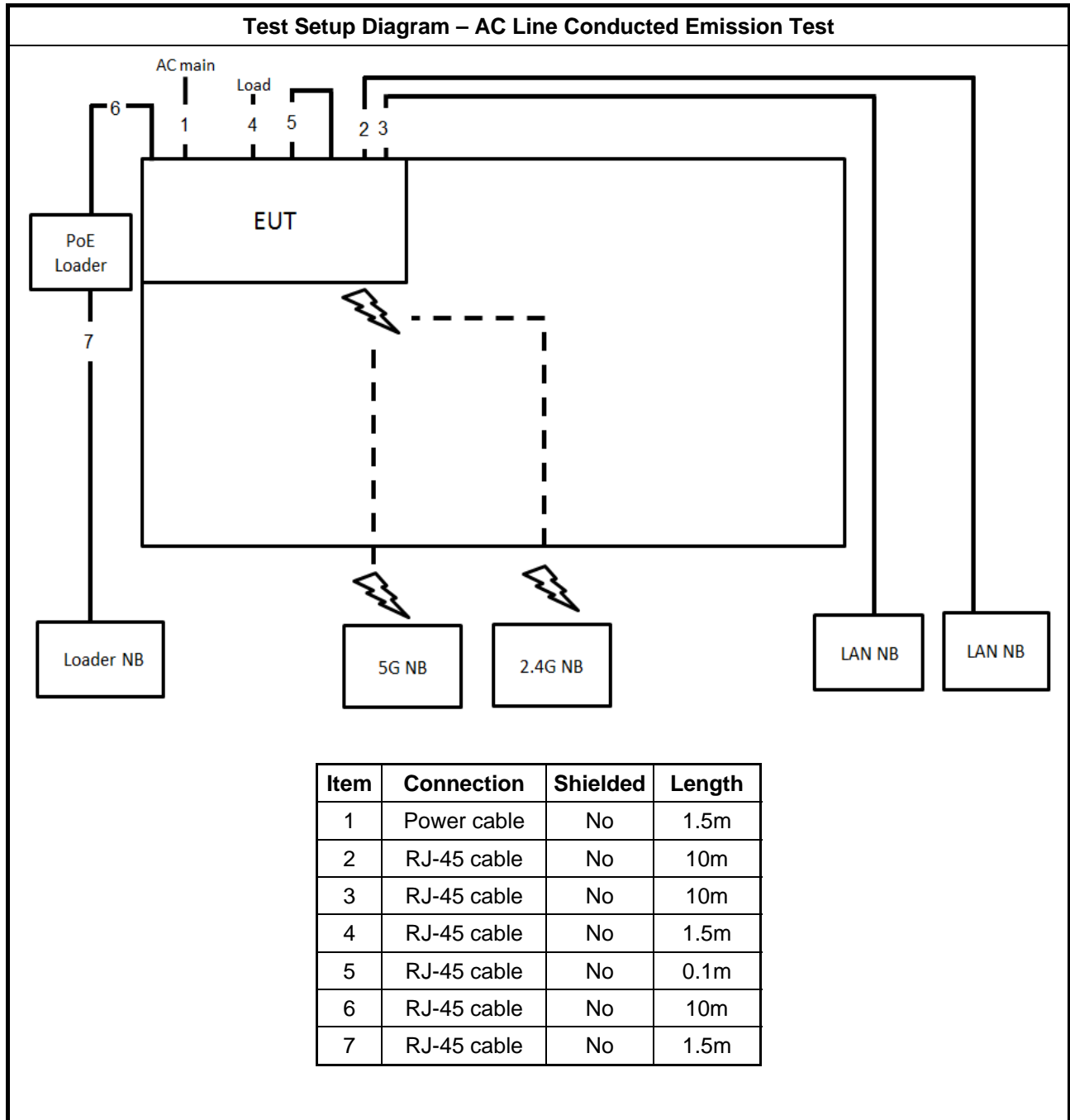

Test Setup Diagram - Radiated Test < 1GHz

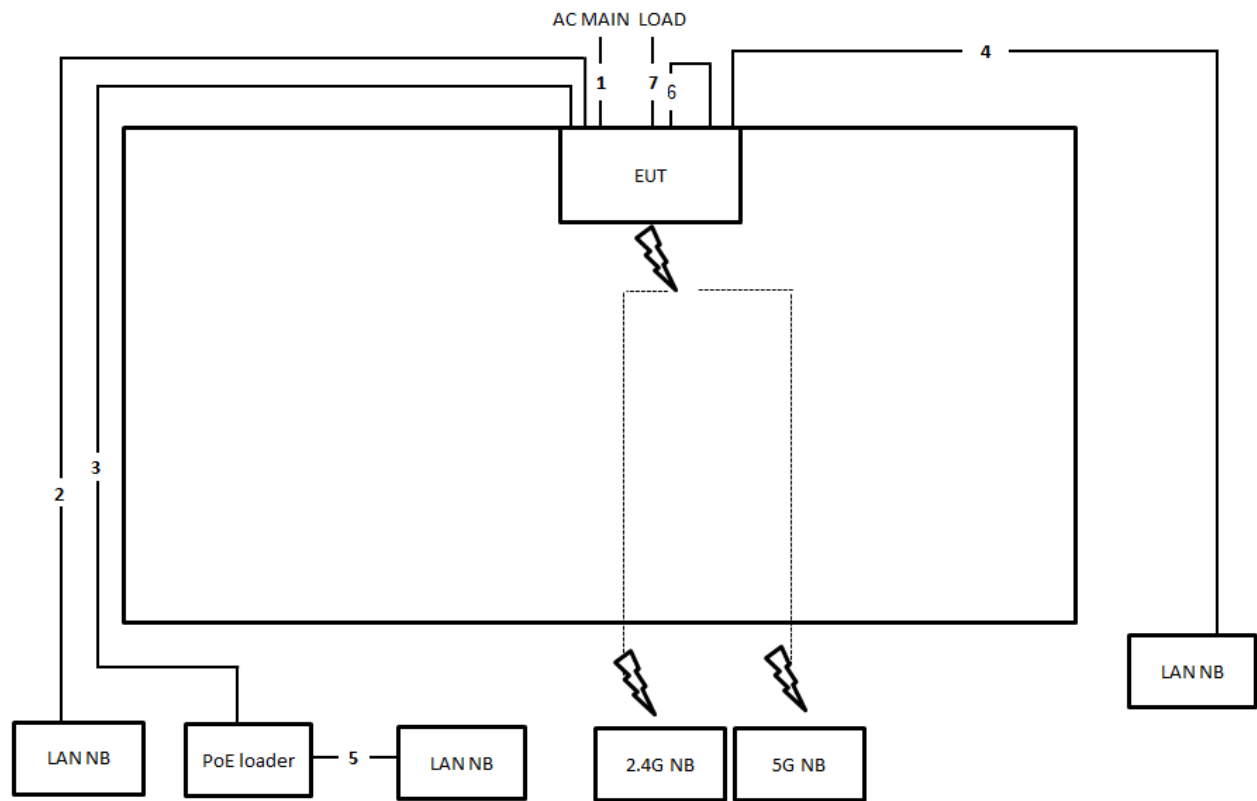

| Item | Connection  | Shielded | Length |
|------|-------------|----------|--------|
| 1    | Power cable | No       | 1.5m   |
| 2    | RJ-45 cable | No       | 10m    |
| 3    | RJ-45 cable | No       | 10m    |
| 4    | RJ-45 cable | No       | 10m    |
| 5    | Power cable | No       | 1.5m   |
| 6    | RJ-45 cable | No       | 0.1m   |
| 7    | RJ-45 cable | No       | 1.5m   |



Test Setup Diagram - Radiated Test > 1GHz / For non-beamforming mode

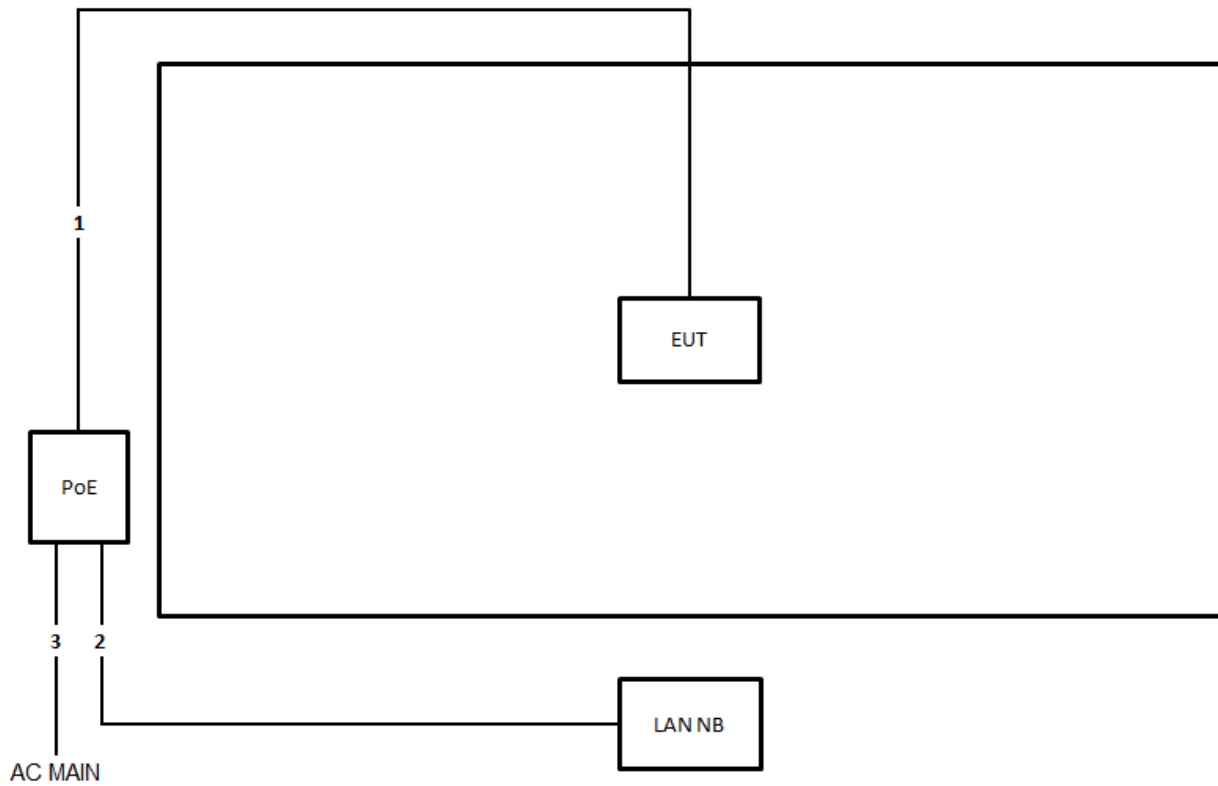

| Item | Connection  | Shielded | Length |
|------|-------------|----------|--------|
| 1    | RJ-45 cable | No       | 10     |
| 2    | RJ-45 cable | No       | 1.5    |
| 3    | Power cable | No       | 1.8    |

Test Setup Diagram - Radiated Test > 1GHz / For beamforming mode

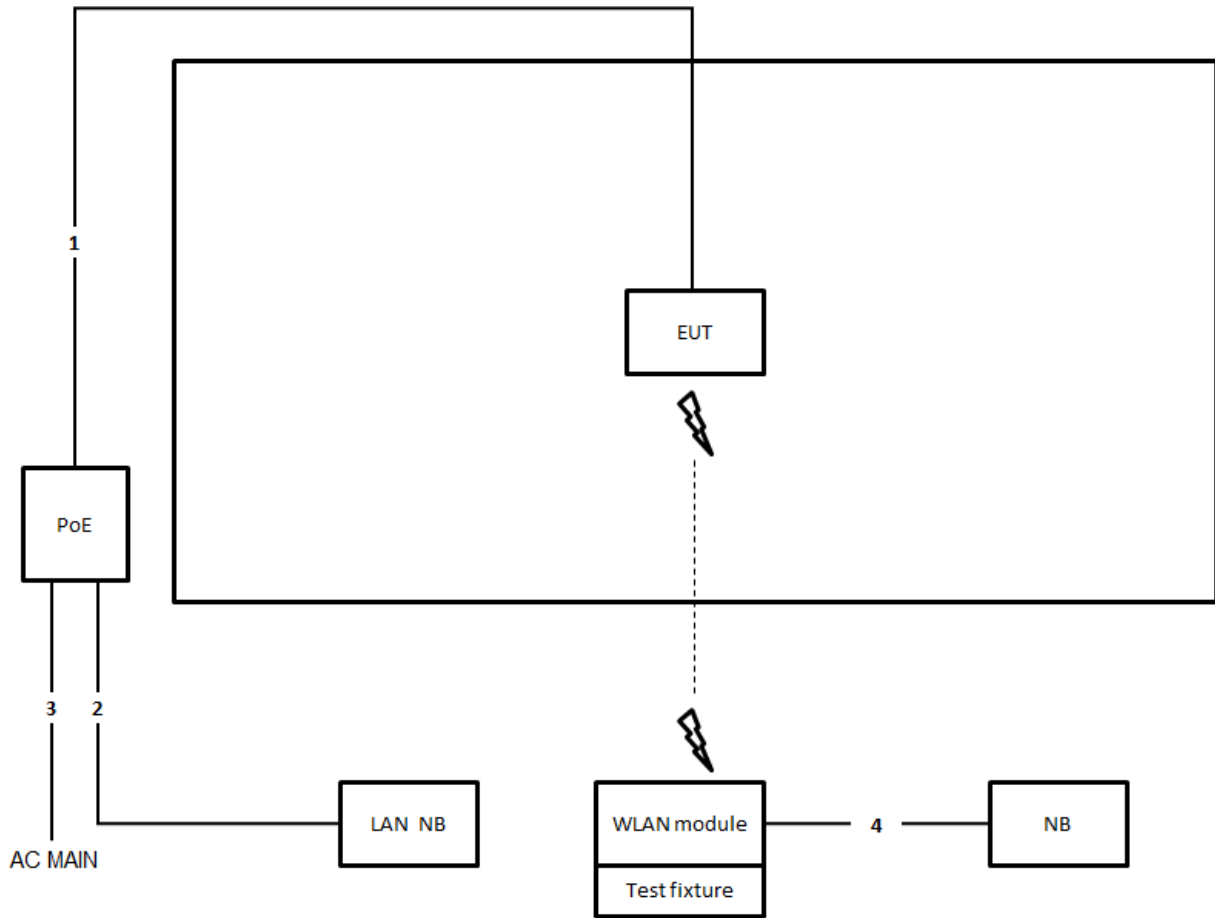

| Item | Connection  | Shielded | Length |
|------|-------------|----------|--------|
| 1    | RJ-45 cable | No       | 10     |
| 2    | RJ-45 cable | No       | 1.5    |
| 3    | Power cable | No       | 1.8    |
| 4    | RJ-45 cable | No       | 1.5    |

### 3 Transmitter Test Result

#### 3.1 AC Power-line Conducted Emissions

##### 3.1.1 AC Power-line Conducted Emissions Limit

| AC Power-line Conducted Emissions Limit |            |           |
|---|------------|-----------|
| Frequency Emission (MHz)                | Quasi-Peak | Average   |
| 0.15-0.5                                | 66 - 56 *  | 56 - 46 * |
| 0.5-5                                   | 56         | 46        |
| 5-30                                    | 60         | 50        |

Note 1: \* Decreases with the logarithm of the frequency.

##### 3.1.2 Measuring Instruments

Refer a test equipment and calibration data table in this test report.

##### 3.1.3 Test Procedures

| Test Method  |
|--|
| <input checked="" type="checkbox"/> Refer as ANSI C63.10-2013, clause 6.2 for AC power-line conducted emissions. |

##### 3.1.4 Test Setup

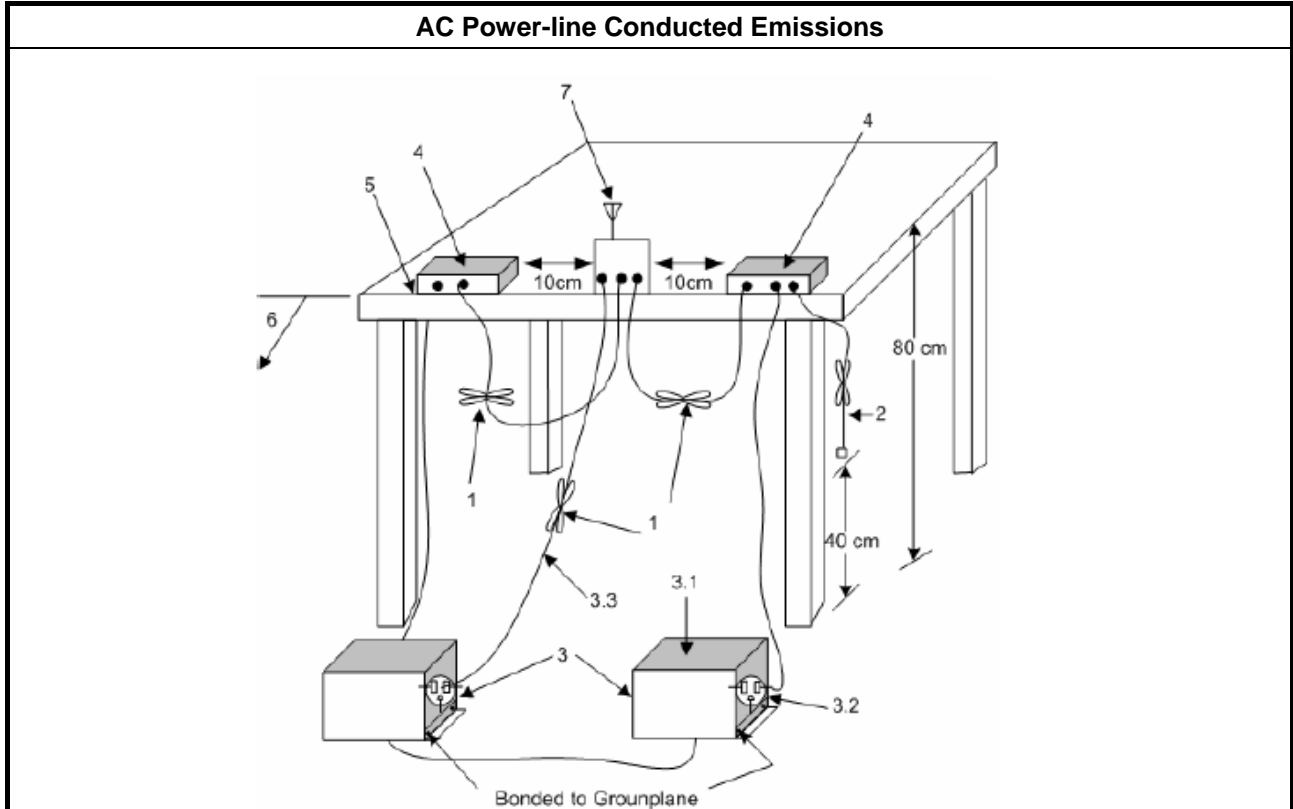



### **3.1.5 Test Result of AC Power-line Conducted Emissions**

Refer as Appendix A

### 3.2 Emission Bandwidth

#### 3.2.1 Emission Bandwidth Limit

| Emission Bandwidth Limit            |   |
|-------------------------------------|---|
| <b>UNII Devices</b>                 |   |
| <input checked="" type="checkbox"/> | For the 5.15-5.25 GHz band, N/A   |
| <input type="checkbox"/>            | For the 5.25-5.35 GHz band, the maximum conducted output power shall not exceed the lesser of 250 mW or 11 dBm + 10 log B, where B is the 26 dB emission bandwidth in MHz.            |
| <input type="checkbox"/>            | For the 5.47-5.725 GHz band, the maximum conducted output power shall not exceed the lesser of 250 mW or 11 dBm + 10 log B, where B is the 26 dB emission bandwidth in MHz.           |
| <input checked="" type="checkbox"/> | For the 5.725-5.85 GHz band, 6 dB emission bandwidth $\geq$ 500kHz.   |
| <b>LE-LAN Devices</b>               |   |
| <input type="checkbox"/>            | For the band 5.15-5.25 GHz, the maximum e.i.r.p. shall not exceed 200 mW or 10 + 10 log B, dBm, whichever power is less. B is the 99% emission bandwidth in MHz.                      |
| <input type="checkbox"/>            | For the 5.25-5.35 GHz band, the maximum e.i.r.p. shall not exceed 1.0 W or 17 + 10 log B, dBm, whichever power is less. B is the 99% emission bandwidth in MHz                        |
| <input type="checkbox"/>            | For the 5.47-5.6 GHz band and 5.65-5.725 GHz band, the maximum e.i.r.p. shall not exceed 1.0 W or 17 + 10 log B, dBm, whichever power is less. B is the 99% emission bandwidth in MHz |
| <input type="checkbox"/>            | For the 5.725-5.85 GHz band, 6 dB emission bandwidth $\geq$ 500kHz.   |

#### 3.2.2 Measuring Instruments

Refer a test equipment and calibration data table in this test report.

#### 3.2.3 Test Procedures

| Test Method  |   |
|--|---|
| <ul style="list-style-type: none"> <li>▪ For the emission bandwidth shall be measured using one of the options below:</li> </ul> |   |
| <input checked="" type="checkbox"/>  | Refer as FCC KDB 789033, clause C for EBW and clause D for OBW measurement. |
| <input type="checkbox"/>   | Refer as ANSI C63.10, clause 6.9.1 for occupied bandwidth testing.          |
| <input checked="" type="checkbox"/>  | Refer as IC RSS-Gen, clause 4.6 for bandwidth testing.                      |

#### 3.2.4 Test Setup

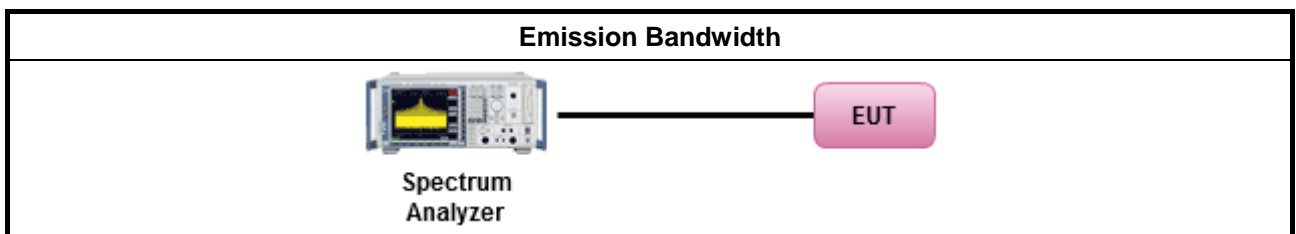

#### 3.2.5 Test Result of Emission Bandwidth

Refer as Appendix B



### 3.3 Maximum Conducted Output Power

#### 3.3.1 Maximum Conducted Output Power Limit

| Maximum Conducted Output Power Limit   |  |
|--|--|
| <b>UNII Devices</b>  |  |
| <input checked="" type="checkbox"/> For the 5.15-5.25 GHz band:  |  |
|  | <ul style="list-style-type: none"> <li>▪ Outdoor AP: the maximum conducted output power (<math>P_{Out}</math>) shall not exceed the lesser of 1 W. If <math>G_{TX} &gt; 6</math> dBi, then <math>P_{Out} = 30 - (G_{TX} - 6)</math>. e.i.r.p. at any elevation angle above 30 degrees <math>\leq 125</math>mW [21dBm]</li> <li>▪ Indoor AP: the maximum conducted output power (<math>P_{Out}</math>) shall not exceed the lesser of 1 W. If <math>G_{TX} &gt; 6</math> dBi, then <math>P_{Out} = 30 - (G_{TX} - 6)</math></li> <li>▪ Point-to-point AP: the maximum conducted output power (<math>P_{Out}</math>) shall not exceed the lesser of 1 W. If <math>G_{TX} &gt; 23</math> dBi, then <math>P_{Out} = 30 - (G_{TX} - 23)</math>.</li> <li>▪ Mobile or Portable Client: the maximum conducted output power (<math>P_{Out}</math>) shall not exceed the lesser of 250 mW. If <math>G_{TX} &gt; 6</math> dBi, then <math>P_{Out} = 24 - (G_{TX} - 6)</math>.</li> </ul> |
| <input type="checkbox"/> For the 5.25-5.35 GHz band, the maximum conducted output power ( $P_{Out}$ ) shall not exceed the lesser of 250 mW or 11 dBm + 10 log B, where B is the 26 dB emission bandwidth in MHz. If $G_{TX} > 6$ dBi, then $P_{Out} = 24 - (G_{TX} - 6)$ .  |  |
| <input type="checkbox"/> For the 5.47-5.725 GHz band, the maximum conducted output power ( $P_{Out}$ ) shall not exceed the lesser of 250 mW or 11 dBm + 10 log B, where B is the 26 dB emission bandwidth in MHz. If $G_{TX} > 6$ dBi, then $P_{Out} = 24 - (G_{TX} - 6)$ . |  |
| <input checked="" type="checkbox"/> For the 5.725-5.85 GHz band:   |  |
|  | <ul style="list-style-type: none"> <li>▪ Point-to-multipoint systems (P2M): the maximum conducted output power (<math>P_{Out}</math>) shall not exceed the lesser of 1 W. If <math>G_{TX} &gt; 6</math> dBi, then <math>P_{Out} = 30 - (G_{TX} - 6)</math>.</li> <li>▪ Point-to-point systems (P2P): the maximum conducted output power (<math>P_{Out}</math>) shall not exceed the lesser of 1 W.</li> </ul>  |
| <b>LE-LAN Devices</b>  |  |
| <input type="checkbox"/> For the 5.15-5.25 GHz band, the maximum e.i.r.p. shall not exceed 200 mW or 10 + 10 log B, dBm, whichever power is less. B is the 99% emission bandwidth in MHz.  |  |
| <input type="checkbox"/> For the 5.25-5.35 GHz band, the maximum e.i.r.p. shall not exceed 1.0 W or 17 + 10 log B, dBm, whichever power is less. B is the 99% emission bandwidth in MHz  |  |
| <input type="checkbox"/> For the 5.47-5.6 GHz band and 5.65-5.725 GHz band, the maximum e.i.r.p. shall not exceed 1.0 W or 17 + 10 log B, dBm, whichever power is less. B is the 99% emission bandwidth in MHz   |  |
| <input type="checkbox"/> For the 5.725-5.85 GHz band:  |  |
|  | <ul style="list-style-type: none"> <li>▪ Point-to-multipoint systems (P2M): the maximum conducted output power (<math>P_{Out}</math>) shall not exceed the lesser of 1 W. If <math>G_{TX} &gt; 6</math> dBi, then <math>P_{Out} = 30 - (G_{TX} - 6)</math>.</li> <li>▪ Point-to-point systems (P2P): the maximum conducted output power (<math>P_{Out}</math>) shall not exceed the lesser of 1 W.</li> </ul>  |
| $P_{Out}$ = maximum conducted output power in dBm,<br>$G_{TX}$ = the maximum transmitting antenna directional gain in dBi.   |  |

### 3.3.2 Measuring Instruments

Refer a test equipment and calibration data table in this test report.

### 3.3.3 Test Procedures

| Test Method  |  |
|--|--|
| <ul style="list-style-type: none"> <li>Maximum Conducted Output Power</li> </ul>   |  |
| Average over on/off periods with duty factor   |  |
| <input type="checkbox"/>   | Refer as FCC KDB 789033, clause E Method SA-2 (spectral trace averaging).                |
| <input type="checkbox"/>   | Refer as FCC KDB 789033, clause E Method SA-2 Alt. (RMS detection with slow sweep speed) |
| Wideband RF power meter and average over on/off periods with duty factor   |  |
| <input checked="" type="checkbox"/>  | Refer as FCC KDB 789033, clause E Method PM-G (using an RF average power meter).         |
| <ul style="list-style-type: none"> <li>For conducted measurement.</li> </ul>   |  |
| <ul style="list-style-type: none"> <li>If the EUT supports multiple transmit chains using options given below:<br/>Refer as FCC KDB 662911, In-band power measurements. Using the measure-and-sum approach, measured all transmit ports individually. Sum the power (in linear power units e.g., mW) of all ports for each individual sample and save them.</li> </ul> |  |
| <ul style="list-style-type: none"> <li>If multiple transmit chains, EIRP calculation could be following as methods:<br/> <math>P_{total} = P_1 + P_2 + \dots + P_n</math><br/>                     (calculated in linear unit [mW] and transfer to log unit [dBm])<br/> <math>EIRP_{total} = P_{total} + DG</math> </li> </ul>   |  |

### 3.3.4 Test Setup

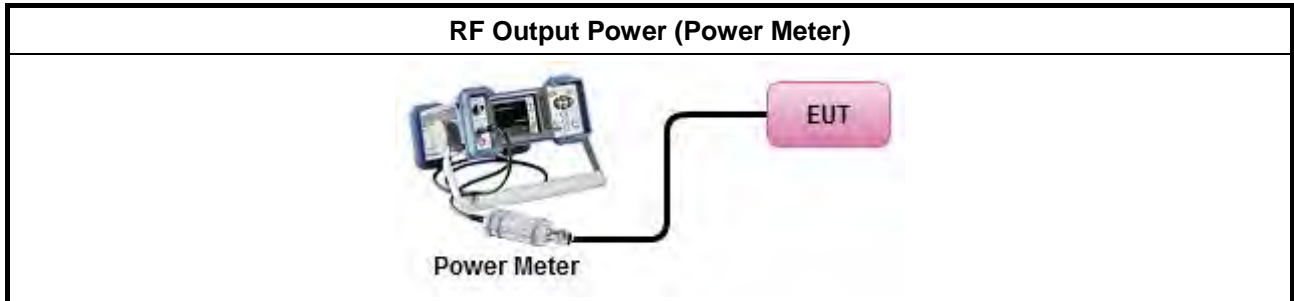

### 3.3.5 Test Result of Maximum Conducted Output Power

Refer as Appendix C



### 3.4 Peak Power Spectral Density

#### 3.4.1 Peak Power Spectral Density Limit

| Peak Power Spectral Density Limit  |  |
|--|--|
| <b>UNII Devices</b>  |  |
| <input checked="" type="checkbox"/> For the 5.15-5.25 GHz band:  |  |
| <input type="checkbox"/>   | <ul style="list-style-type: none"> <li>▪ Outdoor AP: the peak power spectral density (PPSD) shall not exceed the lesser of 17dBm/MHz. If <math>G_{TX} &gt; 6</math> dBi, then <math>P_{Out} = 17 - (G_{TX} - 6)</math>.</li> <li>▪ Indoor AP: the peak power spectral density (PPSD) shall not exceed the lesser of 17dBm/MHz. If <math>G_{TX} &gt; 6</math> dBi, then <math>P_{Out} = 17 - (G_{TX} - 6)</math>.</li> <li>▪ Point-to-point AP: the peak power spectral density (PPSD) shall not exceed the lesser of 17dBm/MHz. If <math>G_{TX} &gt; 23</math> dBi, then <math>P_{Out} = 17 - (G_{TX} - 23)</math>.</li> <li>▪ Mobile or Portable Client: the peak power spectral density (PPSD) <math>\leq 11</math> dBm/MHz. If <math>G_{TX} &gt; 6</math> dBi, then <math>PPSD = 11 - (G_{TX} - 6)</math>.</li> </ul> |
| <input type="checkbox"/> For the 5.25-5.35 GHz band, the peak power spectral density (PPSD) $\leq 11$ dBm/MHz. If $G_{TX} > 6$ dBi, then $PPSD = 11 - (G_{TX} - 6)$ .  |  |
| <input type="checkbox"/> For the 5.47-5.725 GHz band, the peak power spectral density (PPSD) $\leq 11$ dBm/MHz. If $G_{TX} > 6$ dBi, then $PPSD = 11 - (G_{TX} - 6)$ .   |  |
| <input checked="" type="checkbox"/> For the 5.725-5.85 GHz band:   |  |
| <input type="checkbox"/>   | <ul style="list-style-type: none"> <li>▪ Point-to-multipoint systems (P2M): the peak power spectral density (PPSD) <math>\leq 30</math> dBm/500kHz. If <math>G_{TX} &gt; 6</math> dBi, then <math>PPSD = 30 - (G_{TX} - 6)</math>.</li> <li>▪ Point-to-point systems (P2P): the peak power spectral density (PPSD) <math>\leq 30</math> dBm/500kHz.</li> </ul>   |
| <b>LE-LAN Devices</b>  |  |
| <input type="checkbox"/> For the 5.15-5.25 GHz band, the peak power spectral density (PPSD) $\leq 4$ dBm/MHz and the e.i.r.p. peak power spectral density (PPSD) $\leq 10$ dBm/MHz.  |  |
| <input type="checkbox"/> For the 5.25-5.35 GHz band, the peak power spectral density (PPSD) $\leq 11$ dBm/MHz and the e.i.r.p. peak power spectral density (PPSD) $\leq 17$ dBm/MHz.   |  |
| <input type="checkbox"/>   | <ul style="list-style-type: none"> <li>▪ e.i.r.p. greater than 200 mW shall comply with the following e.i.r.p. at different elevations, where <math>\theta</math> is the angle above the local horizontal plane (of the Earth) as shown below:<br/> -13 dBW/MHz for <math>0^\circ \leq \theta &lt; 8^\circ</math> ; -13 - 0.716 (<math>\theta-8</math>) dBW/MHz for <math>8^\circ \leq \theta &lt; 40^\circ</math><br/> -35.9 - 1.22 (<math>\theta-40</math>) dBW/MHz for <math>40^\circ \leq \theta \leq 45^\circ</math> ; -42 dBW/MHz for <math>\theta &gt; 45^\circ</math></li> </ul>   |
| <input type="checkbox"/> For the 5.47-5.6 GHz band and 5.65-5.725 GHz band, the peak power spectral density (PPSD) $\leq 11$ dBm/MHz and the e.i.r.p. peak power spectral density (PPSD) $\leq 17$ dBm/MHz.  |  |
| <input type="checkbox"/> For the 5.725-5.85 GHz band:  |  |
| <input type="checkbox"/>   | <ul style="list-style-type: none"> <li>▪ Point-to-multipoint systems (P2M): the peak power spectral density (PPSD) <math>\leq 30</math> dBm/500kHz. If <math>G_{TX} &gt; 6</math> dBi, then <math>PPSD = 30 - (G_{TX} - 6)</math>.</li> <li>▪ Point-to-point systems (P2P): the peak power spectral density (PPSD) <math>\leq 30</math> dBm/500kHz.</li> </ul>   |
| <p><b>PPSD</b> = peak power spectral density that he same method as used to determine the conducted output power shall be used to determine the power spectral density. And power spectral density in dBm/MHz</p> <p><b>G<sub>TX</sub></b> = the maximum transmitting antenna directional gain in dBi.</p> |  |





### 3.4.2 Measuring Instruments

Refer a test equipment and calibration data table in this test report.

### 3.4.3 Test Procedures

| Test Method   |   |
|---|---|
| <ul style="list-style-type: none"> <li>▪ Peak power spectral density procedures that the same method as used to determine the conducted output power shall be used to determine the peak power spectral density and use the peak search function on the spectrum analyzer to find the peak of the spectrum. For the peak power spectral density shall be measured using below options:</li> </ul> |   |
| <input type="checkbox"/>  | Refer as FCC KDB 789033, F)5) power spectral density can be measured using resolution bandwidths < 1 MHz provided that the results are integrated over 1 MHz bandwidth  |
| [duty cycle ≥ 98% or external video / power trigger]  |   |
| <input checked="" type="checkbox"/>   | Refer as FCC KDB 789033, clause E Method SA-1 (spectral trace averaging).   |
| <input type="checkbox"/>  | Refer as FCC KDB 789033, clause E Method SA-1 Alt. (RMS detection with slow sweep speed)  |
| duty cycle < 98% and average over on/off periods with duty factor   |   |
| <input checked="" type="checkbox"/>   | Refer as FCC KDB 789033, clause E Method SA-2 (spectral trace averaging).   |
| <input type="checkbox"/>  | Refer as FCC KDB 789033, clause E Method SA-2 Alt. (RMS detection with slow sweep speed)  |
| <ul style="list-style-type: none"> <li>▪ For conducted measurement.</li> </ul>  |   |
| <ul style="list-style-type: none"> <li>▪ If the EUT supports multiple transmit chains using options given below:</li> </ul>   |   |
| <input checked="" type="checkbox"/>   | Option 1: Measure and sum the spectra across the outputs. Refer as FCC KDB 662911, In-band power spectral density (PSD). Sample all transmit ports simultaneously using a spectrum analyzer for each transmit port. Where the trace bin-by-bin of each transmit port summing can be performed. (i.e., in the first spectral bin of output 1 is summed with that in the first spectral bin of output 2 and that from the first spectral bin of output 3, and so on up to the NTX output to obtain the value for the first frequency bin of the summed spectrum.) Add up the amplitude (power) values for the different transmit chains and use this as the new data trace. |
| <input type="checkbox"/>  | Option 2: Measure and sum spectral maxima across the outputs. With this technique, spectra are measured at each output of the device at the required resolution bandwidth. The maximum value (peak) of each spectrum is determined. These maximum values are then summed mathematically in linear power units across the outputs. These operations shall be performed separately over frequency spans that have different out-of-band or spurious emission limits,  |
| <input type="checkbox"/>  | Option 3: Measure and add 10 log(N) dB, where N is the number of transmit chains. Refer as FCC KDB 662911, In-band power spectral density (PSD). Performed at each transmit chains and each transmit chains shall be compared with the limit have been reduced with 10 log(N). Or each transmit chains shall be add 10 log(N) to compared with the limit.   |
| <ul style="list-style-type: none"> <li>▪ If multiple transmit chains, EIRP PPSD calculation could be following as methods:<br/> <math display="block">PPSD_{total} = PPSD_1 + PPSD_2 + \dots + PPSD_n</math>                     (calculated in linear unit [mW] and transfer to log unit [dBm])<br/> <math display="block">EIRP_{total} = PPSD_{total} + DG</math> </li> </ul>                   |   |

### 3.4.4 Test Setup

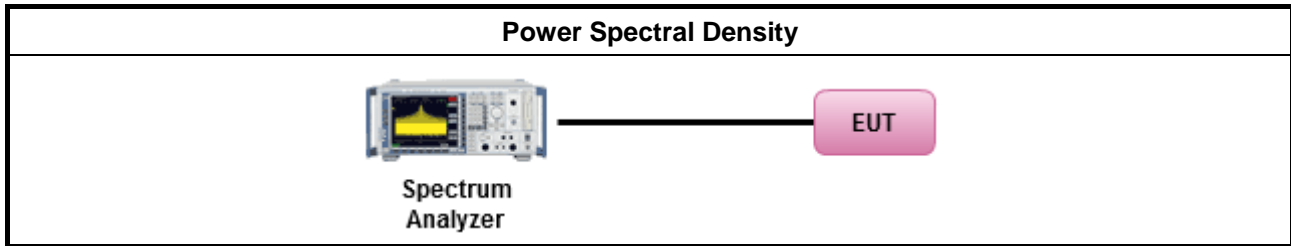

### 3.4.5 Test Result of Peak Power Spectral Density

Refer as Appendix D



### 3.5 Unwanted Emissions

#### 3.5.1 Transmitter Radiated Unwanted Emissions Limit

| Unwanted emissions below 1 GHz and restricted band emissions above 1GHz limit |                       |                         |                      |
|---|-----------------------|-------------------------|----------------------|
| Frequency Range (MHz)   | Field Strength (uV/m) | Field Strength (dBuV/m) | Measure Distance (m) |
| 0.009~0.490   | 2400/F(kHz)           | 48.5 - 13.8             | 300                  |
| 0.490~1.705   | 24000/F(kHz)          | 33.8 - 23               | 30                   |
| 1.705~30.0  | 30                    | 29                      | 30                   |
| 30~88   | 100                   | 40                      | 3                    |
| 88~216  | 150                   | 43.5                    | 3                    |
| 216~960   | 200                   | 46                      | 3                    |
| Above 960   | 500                   | 54                      | 3                    |

Note 1: Test distance for frequencies at or above 30 MHz, measurements may be performed at a distance other than the limit distance provided they are not performed in the near field and the emissions to be measured can be detected by the measurement equipment. When performing measurements at a distance other than that specified, the results shall be extrapolated to the specified distance using an extrapolation factor of 20 dB/decade (inverse of linear distance for field-strength measurements, inverse of linear distance-squared for power-density measurements).

Note 2: Test distance for frequencies at below 30 MHz, measurements may be performed at a distance closer than the EUT limit distance; however, an attempt should be made to avoid making measurements in the near field. When performing measurements below 30 MHz at a closer distance than the limit distance, the results shall be extrapolated to the specified distance by either making measurements at a minimum of two or more distances on at least one radial to determine the proper extrapolation factor or by using the square of an inverse linear distance extrapolation factor (40 dB/decade). The test report shall specify the extrapolation method used to determine compliance of the EUT.

| Un-restricted band emissions above 1GHz Limit |   |
|---|---|
| Operating Band                                | Limit   |
| 5.15 - 5.25 GHz                               | e.i.r.p. -27 dBm [68.2 dBuV/m@3m]   |
| 5.25 - 5.35 GHz                               | e.i.r.p. -27 dBm [68.2 dBuV/m@3m]   |
| 5.47 - 5.725 GHz                              | e.i.r.p. -27 dBm [68.2 dBuV/m@3m]   |
| 5.725 - 5.85 GHz                              | all emissions shall be limited to a level of -27 dBm/MHz at 75 MHz or more above or below the band edge increasing linearly to 10 dBm/MHz at 25 MHz above or below the band edge, and from 25 MHz above or below the band edge increasing linearly to a level of 15.6 dBm/MHz at 5 MHz above or below the band edge, and from 5 MHz above or below the band edge increasing linearly to a level of 27 dBm/MHz at the band edge. |

Note 1: Measurements may be performed at a distance other than the limit distance provided they are not performed in the near field and the emissions to be measured can be detected by the measurement equipment. When performing measurements at a distance other than that specified, the results shall be extrapolated to the specified distance using an extrapolation factor of 20 dB/decade (inverse of linear distance for field-strength measurements, inverse of linear distance-squared for power-density measurements).



### 3.5.2 Measuring Instruments

Refer a test equipment and calibration data table in this test report.

### 3.5.3 Test Procedures

| Test Method |  |
|-------------|--|
|             | <ul style="list-style-type: none"> <li>▪ Measurements may be performed at a distance other than the limit distance provided they are not performed in the near field and the emissions to be measured can be detected by the measurement equipment. Measurements shall not be performed at a distance greater than 30 m for frequencies above 30 MHz, unless it can be further demonstrated that measurements at a distance of 30 m or less are impractical. When performing measurements at a distance other than that specified, the results shall be extrapolated to the specified distance using an extrapolation factor of 20 dB/decade (inverse of linear distance for field-strength measurements, inverse of linear distance-squared for power-density measurements).</li> </ul> |
|             | <ul style="list-style-type: none"> <li>▪ The average emission levels shall be measured in [duty cycle <math>\geq</math> 98 or duty factor].</li> </ul>   |
|             | <ul style="list-style-type: none"> <li>▪ For the transmitter unwanted emissions shall be measured using following options below:</li> </ul>  |
|             | <ul style="list-style-type: none"> <li>▪ Refer as FCC KDB 789033, clause H)2) for unwanted emissions into non-restricted bands.</li> </ul>   |
|             | <ul style="list-style-type: none"> <li>▪ Refer as FCC KDB 789033, clause H)1) for unwanted emissions into restricted bands.</li> </ul>   |
|             | <ul style="list-style-type: none"> <li><input type="checkbox"/> Refer as FCC KDB 789033, H)6) Method AD (Trace Averaging).</li> <li><input checked="" type="checkbox"/> Refer as FCC KDB 789033, H)6) Method VB (Reduced VBW).</li> <li><input type="checkbox"/> Refer as ANSI C63.10, clause 4.2.3.2.3 (Reduced VBW). VBW <math>\geq</math> 1/T, where T is pulse time.</li> <li><input type="checkbox"/> Refer as ANSI C63.10, clause 4.2.3.2.4 average value of pulsed emissions.</li> <li><input checked="" type="checkbox"/> Refer as FCC KDB 789033, clause H)5) measurement procedure peak limit.</li> <li><input type="checkbox"/> Refer as ANSI C63.10, clause 4.2.3.2.2 measurement procedure peak limit.</li> </ul>   |
|             | <ul style="list-style-type: none"> <li>▪ For radiated measurement.</li> </ul>  |
|             | <ul style="list-style-type: none"> <li>▪ Refer as ANSI C63.10, clause 6.4 for radiated emissions below 30 MHz and test distance is 3m.</li> <li>▪ Refer as ANSI C63.10, clause 6.5 for radiated emissions 30 MHz to 1 GHz and test distance is 3m.</li> <li>▪ Refer as ANSI C63.10, clause 6.6 for radiated emissions above 1GHz.</li> </ul>   |
|             | <ul style="list-style-type: none"> <li>▪ The any unwanted emissions level shall not exceed the fundamental emission level.</li> </ul>  |
|             | <ul style="list-style-type: none"> <li>▪ All amplitude of spurious emissions that are attenuated by more than 20 dB below the permissible value has no need to be reported.</li> </ul>   |

### 3.5.4 Test Setup

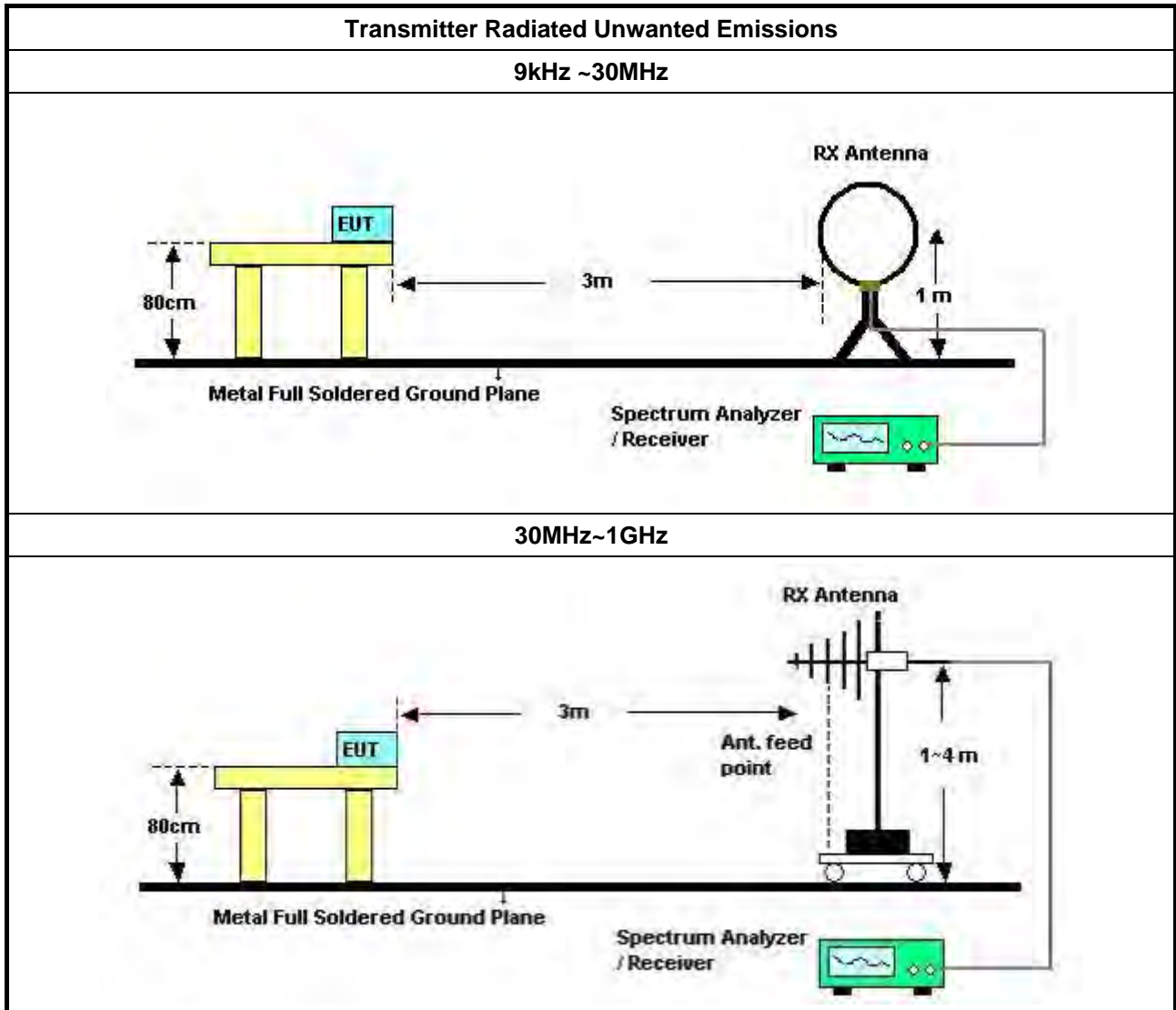

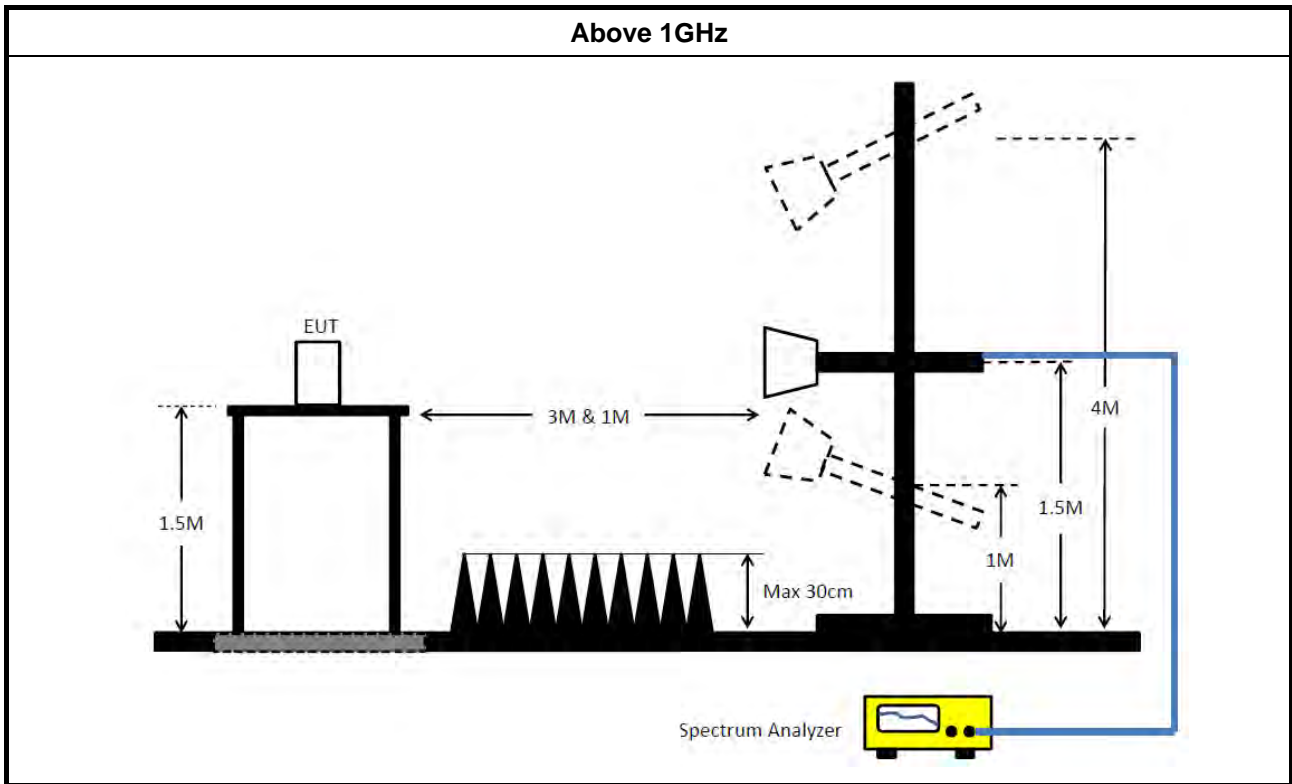

### 3.5.5 Transmitter Unwanted Emissions (Below 30MHz)

All amplitude of spurious emissions that are attenuated by more than 20 dB below the permissible value has no need to be reported.

### 3.5.6 Test Result of Transmitter Unwanted Emissions

Refer as Appendix E

### 3.6 Frequency Stability

#### 3.6.1 Frequency Stability Limit

| Frequency Stability Limit  |
|--|
| <b>UNII Devices</b>  |
| <ul style="list-style-type: none"> <li>In-band emission is maintained within the band of operation under all conditions of normal operation as specified in the user's manual.</li> </ul>                          |
| <b>LE-LAN Devices</b>  |
| <ul style="list-style-type: none"> <li>N/A</li> </ul>  |
| <b>IEEE Std. 802.11</b>  |
| <ul style="list-style-type: none"> <li>The transmitter center frequency tolerance shall be <math>\pm 20</math> ppm maximum for the 5 GHz band and <math>\pm 25</math> ppm maximum for the 2.4 GHz band.</li> </ul> |

#### 3.6.2 Measuring Instruments

Refer a test equipment and calibration data table in this test report.

#### 3.6.3 Test Procedures

| Test Method  |
|--|
| <ul style="list-style-type: none"> <li>Refer as ANSI C63.10, clause 6.8 for frequency stability tests</li> </ul> |
| <ul style="list-style-type: none"> <li>Frequency stability with respect to ambient temperature</li> </ul>        |
| <ul style="list-style-type: none"> <li>Frequency stability when varying supply voltage</li> </ul>                |
| <ul style="list-style-type: none"> <li>Extreme temperature is 0°C~40°C.</li> </ul>                               |

#### 3.6.4 Test Setup

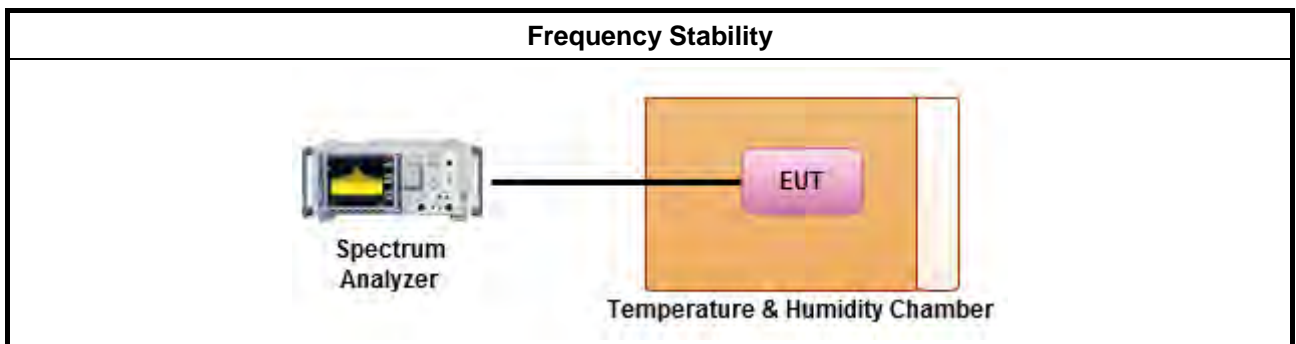

#### 3.6.5 Test Result of Frequency Stability

Refer as Appendix F



## 4 Test Equipment and Calibration Data

| Instrument                        | Manufacturer | Model No.        | Serial No.     | Characteristics | Calibration Date | Remark                |
|-----------------------------------|--------------|------------------|----------------|-----------------|------------------|-----------------------|
| EMI Receiver                      | Agilent      | N9038A           | My52260123     | 9kHz ~ 8.45GHz  | Jan. 23, 2017    | Conduction (CO01-CB)  |
| LISN                              | F.C.C.       | FCC-LISN-50-16-2 | 04083          | 150kHz ~ 100MHz | Dec. 14, 2016    | Conduction (CO01-CB)  |
| LISN                              | Schwarzbeck  | NSLK 8127        | 8127647        | 9kHz ~ 30MHz    | Dec. 21, 2016    | Conduction (CO01-CB)  |
| COND Cable                        | Woken        | Cable            | 01             | 150kHz ~ 30MHz  | May 23, 2017     | Conduction (CO01-CB)  |
| Software                          | Audix        | E3               | 6.120210n      | -               | N.C.R.           | Conduction (CO01-CB)  |
| BILOG ANTENNA with 6dB Attenuator | TESEQ & EMCI | CBL6112D&N-6-06  | 37880&AT-N0609 | 20MHz ~ 2GHz    | Aug. 30, 2016    | Radiation (03CH01-CB) |
| Loop Antenna                      | Teseq        | HLA 6120         | 24155          | 9kHz - 30 MHz   | Mar. 16, 2016*   | Radiation (03CH01-CB) |
| Horn Antenna                      | EMCO         | 3115             | 00075790       | 750MHz ~ 18GHz  | Nov. 10, 2016    | Radiation (03CH01-CB) |
| Horn Antenna                      | Schwarzbeck  | BBHA 9170        | BBHA9170252    | 15GHz ~ 40GHz   | Jul. 25, 2016    | Radiation (03CH01-CB) |
| Horn Antenna                      | Schwarzbeck  | BBHA 9170        | BBHA9170252    | 15GHz ~ 40GHz   | Jul. 05, 2017    | Radiation (03CH01-CB) |
| Pre-Amplifier                     | EMCI         | EMC330N          | 980332         | 20MHz ~ 3GHz    | May 02, 2017     | Radiation (03CH01-CB) |
| Pre-Amplifier                     | Agilent      | 8449B            | 3008A02310     | 1GHz ~ 26.5GHz  | Jan. 16, 2017    | Radiation (03CH01-CB) |
| Pre-Amplifier                     | MITEQ        | TTA1840-35-HG    | 1864479        | 18GHz ~ 40GHz   | Jun. 28, 2016    | Radiation (03CH01-CB) |
| Pre-Amplifier                     | MITEQ        | TTA1840-35-HG    | 1864479        | 18GHz ~ 40GHz   | Jul. 10, 2017    | Radiation (03CH01-CB) |
| Spectrum Analyzer                 | R&S          | FSP40            | 100056         | 9kHz ~ 40GHz    | Nov. 22, 2016    | Radiation (03CH01-CB) |
| EMI Test                          | R&S          | ESCS             | 100355         | 9kHz ~ 2.75GHz  | May 06, 2017     | Radiation (03CH01-CB) |
| RF Cable-low                      | Woken        | Low Cable-16+17  | N/A            | 30 MHz ~ 1 GHz  | Oct. 24, 2016    | Radiation (03CH01-CB) |
| RF Cable-high                     | Woken        | High Cable-16    | N/A            | 1 GHz ~ 18 GHz  | Oct. 24, 2016    | Radiation (03CH01-CB) |
| RF Cable-high                     | Woken        | High Cable-16+17 | N/A            | 1 GHz ~ 18 GHz  | Oct. 24, 2016    | Radiation (03CH01-CB) |





| Instrument                 | Manufacturer | Model No.        | Serial No.    | Characteristics  | Calibration Date | Remark                |
|----------------------------|--------------|------------------|---------------|------------------|------------------|-----------------------|
| RF Cable-high              | Woken        | High Cable-40G#1 | N/A           | 18GHz ~ 40 GHz   | Oct. 24, 2016    | Radiation (03CH01-CB) |
| RF Cable-high              | Woken        | High Cable-40G#2 | N/A           | 18GHz ~ 40 GHz   | Oct. 24, 2016    | Radiation (03CH01-CB) |
| Test Software              | Audix        | E3               | 6.2009-I0-7   | N/A              | N/A              | Radiation (03CH01-CB) |
| Spectrum analyzer          | R&S          | FSV40            | 100979        | 9kHz~40GHz       | Dec. 26, 2016    | Conducted (TH01-CB)   |
| Temp. and Humidity Chamber | Ten Billion  | TTH-D3SP         | TBN-931011    | -30~100 degree   | Jun. 02, 2017    | Conducted (TH01-CB)   |
| RF Cable-high              | Woken        | RG402            | High Cable-6  | 1 GHz – 26.5 GHz | Oct. 24, 2016    | Conducted (TH01-CB)   |
| RF Cable-high              | Woken        | RG402            | High Cable-7  | 1 GHz –26.5 GHz  | Oct. 24, 2016    | Conducted (TH01-CB)   |
| RF Cable-high              | Woken        | RG402            | High Cable-8  | 1 GHz –26.5 GHz  | Oct. 24, 2016    | Conducted (TH01-CB)   |
| RF Cable-high              | Woken        | RG402            | High Cable-9  | 1 GHz –26.5 GHz  | Oct. 24, 2016    | Conducted (TH01-CB)   |
| RF Cable-high              | Woken        | RG402            | High Cable-10 | 1 GHz –26.5 GHz  | Oct. 24, 2016    | Conducted (TH01-CB)   |
| Power Sensor               | Agilent      | U2021XA          | MY53410001    | 50MHz~18GHz      | Nov. 22, 2016    | Conducted (TH01-CB)   |

Note: Calibration Interval of instruments listed above is one year.

“\*\*” Calibration Interval of instruments listed above is two years.

N.C.R. means Non-Calibration required.



# AC Power-line Conducted Emissions Result

Appendix A

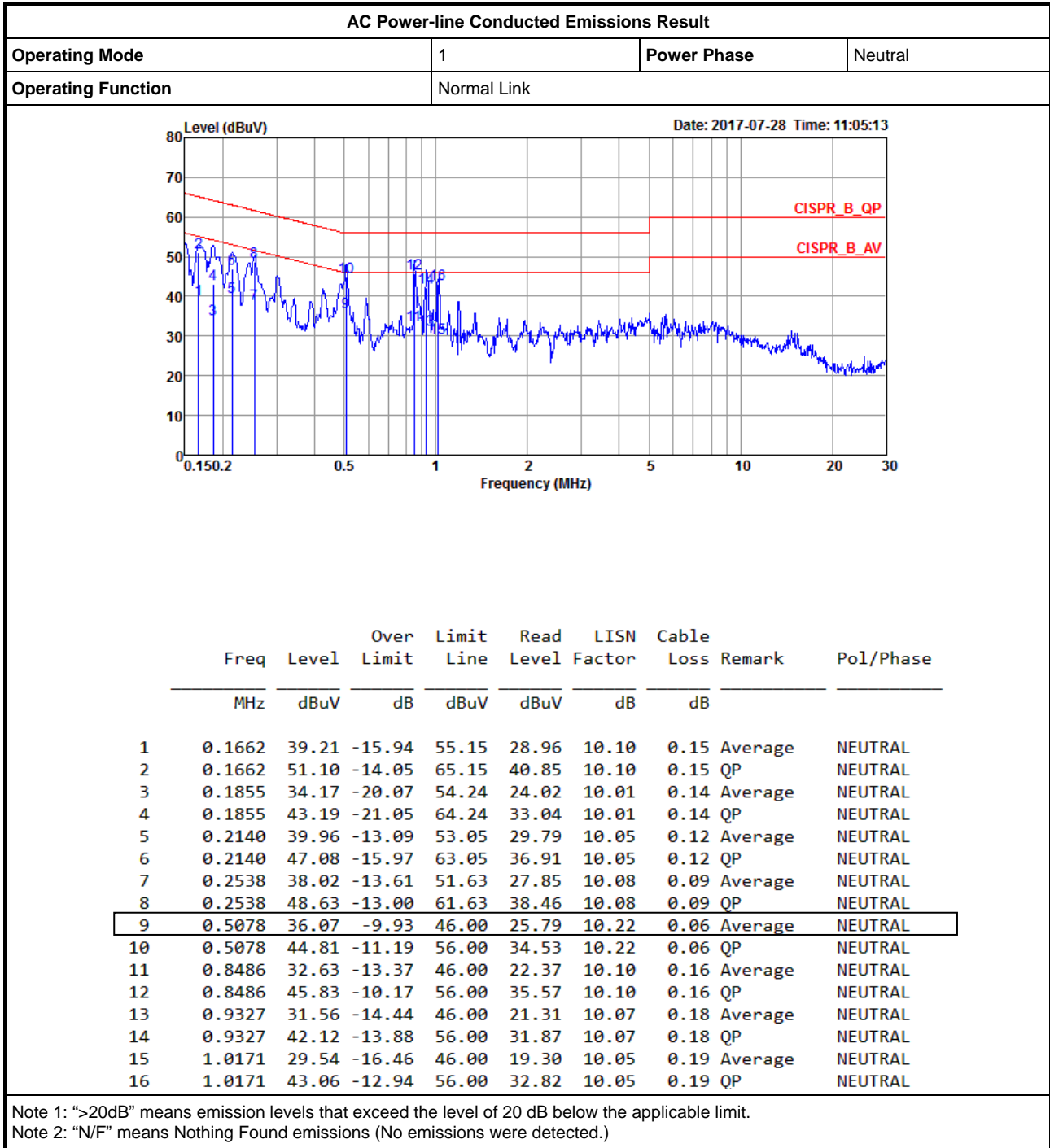



# AC Power-line Conducted Emissions Result

Appendix A

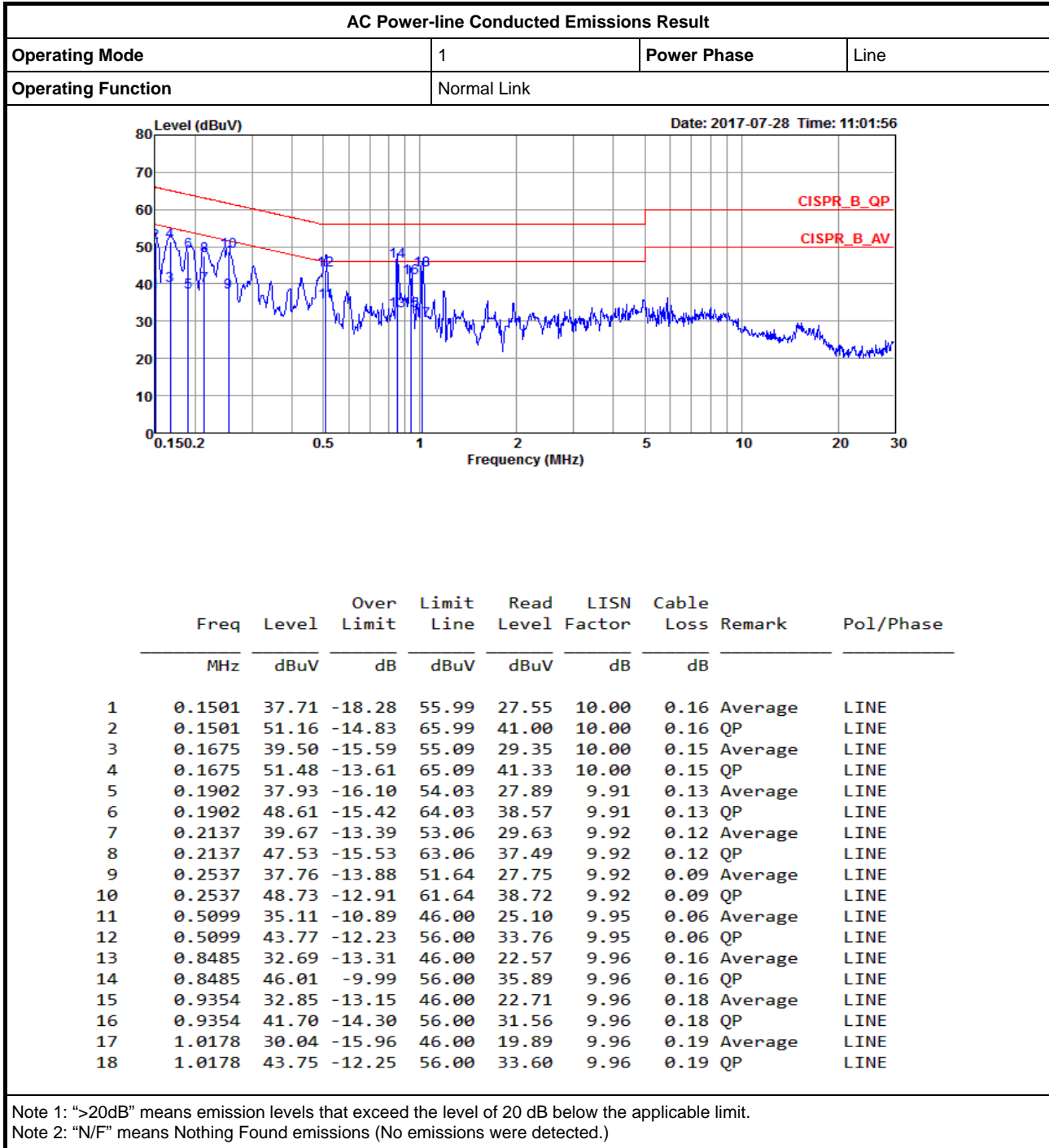



**Summary**

| Mode                              | Max-N dB<br>(Hz) | Max-OBW<br>(Hz) | ITU-Code | Min-N dB<br>(Hz) | Min-OBW<br>(Hz) |
|-----------------------------------|------------------|-----------------|----------|------------------|-----------------|
| 802.11a_(6Mbps)_3TX               | -                | -               | -        | -                | -               |
| 5.15-5.25GHz                      | 47.65M           | 29.46M          | 29M5D1D  | 31.55M           | 16.667M         |
| 5.725-5.85GHz                     | 16.375M          | 37.781M         | 37M8D1D  | 16.3M            | 34.733M         |
| 802.11ac VHT20_Nss1,(MCS0)_3TX    | -                | -               | -        | -                | -               |
| 5.15-5.25GHz                      | 49.975M          | 30.96M          | 31M0D1D  | 32.4M            | 17.791M         |
| 5.725-5.85GHz                     | 17.625M          | 39.505M         | 39M5D1D  | 17.275M          | 36.557M         |
| 802.11ac VHT40_Nss1,(MCS0)_3TX    | -                | -               | -        | -                | -               |
| 5.15-5.25GHz                      | 88.75M           | 38.881M         | 38M9D1D  | 39.75M           | 36.232M         |
| 5.725-5.85GHz                     | 36.35M           | 55.172M         | 55M2D1D  | 36.1M            | 36.557M         |
| 802.11ac VHT80_Nss1,(MCS0)_3TX    | -                | -               | -        | -                | -               |
| 5.15-5.25GHz                      | 93.6M            | 75.162M         | 75M2D1D  | 80.7M            | 74.963M         |
| 5.725-5.85GHz                     | 76.3M            | 76.462M         | 76M5D1D  | 75.3M            | 75.962M         |
| 802.11ac VHT20-BF_Nss1,(MCS0)_3TX | -                | -               | -        | -                | -               |
| 5.15-5.25GHz                      | 50M              | 32.409M         | 32M4D1D  | 38.2M            | 18.041M         |
| 5.725-5.85GHz                     | 17.6M            | 33.308M         | 33M3D1D  | 17.275M          | 19.815M         |
| 802.11ac VHT40-BF_Nss1,(MCS0)_3TX | -                | -               | -        | -                | -               |
| 5.15-5.25GHz                      | 93.3M            | 38.131M         | 38M1D1D  | 43.25M           | 36.282M         |
| 5.725-5.85GHz                     | 36.3M            | 76.312M         | 76M3D1D  | 35.85M           | 36.732M         |
| 802.11ac VHT80-BF_Nss1,(MCS0)_3TX | -                | -               | -        | -                | -               |
| 5.15-5.25GHz                      | 107M             | 75.162M         | 75M2D1D  | 80.8M            | 74.763M         |
| 5.725-5.85GHz                     | 76.3M            | 76.262M         | 76M3D1D  | 75.8M            | 75.862M         |

**Max-N dB** = Maximum 6dB down bandwidth for 5.725-5.85GHz band / Maximum 26dB down bandwidth for other band;

**Max-OBW** = Maximum 99% occupied bandwidth;

**Min-N dB** = Minimum 6dB down bandwidth for 5.725-5.85GHz band / Maximum 26dB down bandwidth for other band;

**Min-OBW** = Minimum 99% occupied bandwidth;



**Result**

| Mode                              | Result | Limit (Hz) | Port 1-N dB (Hz) | Port 1-OBW (Hz) | Port 2-N dB (Hz) | Port 2-OBW (Hz) | Port 3-N dB (Hz) | Port 3-OBW (Hz) |
|-----------------------------------|--------|------------|------------------|-----------------|------------------|-----------------|------------------|-----------------|
| 802.11a_(6Mbps)_3TX               | -      | -          | -                | -               | -                | -               | -                | -               |
| 5180MHz                           | Pass   | Inf        | 38.7M            | 17.316M         | 31.55M           | 16.667M         | 34.25M           | 16.792M         |
| 5200MHz                           | Pass   | Inf        | 47.65M           | 29.46M          | 41.875M          | 21.714M         | 43.675M          | 26.037M         |
| 5240MHz                           | Pass   | Inf        | 41.5M            | 18.216M         | 37.275M          | 16.992M         | 36.9M            | 17.441M         |
| 5745MHz                           | Pass   | 500k       | 16.325M          | 35.382M         | 16.325M          | 37.106M         | 16.3M            | 35.282M         |
| 5785MHz                           | Pass   | 500k       | 16.35M           | 34.733M         | 16.325M          | 37.706M         | 16.375M          | 35.782M         |
| 5825MHz                           | Pass   | 500k       | 16.3M            | 35.907M         | 16.3M            | 37.781M         | 16.3M            | 36.557M         |
| 802.11ac VHT20_Nss1,(MCS0)_3TX    | -      | -          | -                | -               | -                | -               | -                | -               |
| 5180MHz                           | Pass   | Inf        | 40.55M           | 18.041M         | 33.55M           | 17.791M         | 32.4M            | 17.891M         |
| 5200MHz                           | Pass   | Inf        | 49.975M          | 30.96M          | 44.175M          | 21.689M         | 46.625M          | 25.237M         |
| 5240MHz                           | Pass   | Inf        | 43.575M          | 19.54M          | 37.8M            | 18.091M         | 41.95M           | 18.541M         |
| 5745MHz                           | Pass   | 500k       | 17.6M            | 36.982M         | 17.625M          | 38.231M         | 17.575M          | 37.206M         |
| 5785MHz                           | Pass   | 500k       | 17.6M            | 36.557M         | 17.525M          | 39.505M         | 17.275M          | 37.656M         |
| 5825MHz                           | Pass   | 500k       | 17.525M          | 37.431M         | 17.6M            | 39.005M         | 17.525M          | 37.681M         |
| 802.11ac VHT40_Nss1,(MCS0)_3TX    | -      | -          | -                | -               | -                | -               | -                | -               |
| 5190MHz                           | Pass   | Inf        | 63.75M           | 36.282M         | 39.75M           | 36.332M         | 41.35M           | 36.232M         |
| 5230MHz                           | Pass   | Inf        | 88.75M           | 38.881M         | 81.3M            | 36.632M         | 88.05M           | 36.832M         |
| 5755MHz                           | Pass   | 500k       | 36.35M           | 37.281M         | 36.25M           | 47.226M         | 36.3M            | 54.873M         |
| 5795MHz                           | Pass   | 500k       | 36.35M           | 37.031M         | 36.1M            | 48.326M         | 36.35M           | 55.172M         |
| 802.11ac VHT80_Nss1,(MCS0)_3TX    | -      | -          | -                | -               | -                | -               | -                | -               |
| 5210MHz                           | Pass   | Inf        | 91.1M            | 75.162M         | 93.6M            | 74.963M         | 80.7M            | 75.062M         |
| 5775MHz                           | Pass   | 500k       | 75.3M            | 75.962M         | 76.3M            | 76.462M         | 76.3M            | 76.162M         |
| 802.11ac VHT20-BF_Nss1,(MCS0)_3TX | -      | -          | -                | -               | -                | -               | -                | -               |
| 5180MHz                           | Pass   | Inf        | 45.475M          | 20.015M         | 39.775M          | 18.041M         | 40.35M           | 18.366M         |
| 5200MHz                           | Pass   | Inf        | 50M              | 32.409M         | 44.375M          | 22.014M         | 46.375M          | 25.112M         |
| 5240MHz                           | Pass   | Inf        | 43.45M           | 19.465M         | 38.2M            | 18.091M         | 40.975M          | 18.316M         |
| 5745MHz                           | Pass   | 500k       | 17.55M           | 19.815M         | 17.525M          | 26.912M         | 17.575M          | 26.412M         |
| 5785MHz                           | Pass   | 500k       | 17.525M          | 19.79M          | 17.6M            | 28.311M         | 17.55M           | 27.636M         |
| 5825MHz                           | Pass   | 500k       | 17.275M          | 20.215M         | 17.525M          | 33.308M         | 17.525M          | 31.734M         |
| 802.11ac VHT40-BF_Nss1,(MCS0)_3TX | -      | -          | -                | -               | -                | -               | -                | -               |
| 5190MHz                           | Pass   | Inf        | 67.7M            | 36.282M         | 43.25M           | 36.282M         | 44.65M           | 36.282M         |
| 5230MHz                           | Pass   | Inf        | 93.3M            | 38.131M         | 81.95M           | 36.582M         | 85.35M           | 36.932M         |
| 5755MHz                           | Pass   | 500k       | 36.3M            | 36.732M         | 36.3M            | 41.829M         | 36M              | 47.826M         |
| 5795MHz                           | Pass   | 500k       | 35.85M           | 37.381M         | 36.3M            | 52.724M         | 36.3M            | 76.312M         |
| 802.11ac VHT80-BF_Nss1,(MCS0)_3TX | -      | -          | -                | -               | -                | -               | -                | -               |
| 5210MHz                           | Pass   | Inf        | 107M             | 75.162M         | 81.3M            | 74.963M         | 80.8M            | 74.763M         |
| 5775MHz                           | Pass   | 500k       | 75.8M            | 75.862M         | 75.8M            | 76.262M         | 76.3M            | 76.062M         |

**Port X-N dB** = Port X 6dB down bandwidth for 5.725-5.85GHz band / 26dB down bandwidth for other band

**Port X-OBW** = Port X 99% occupied bandwidth;

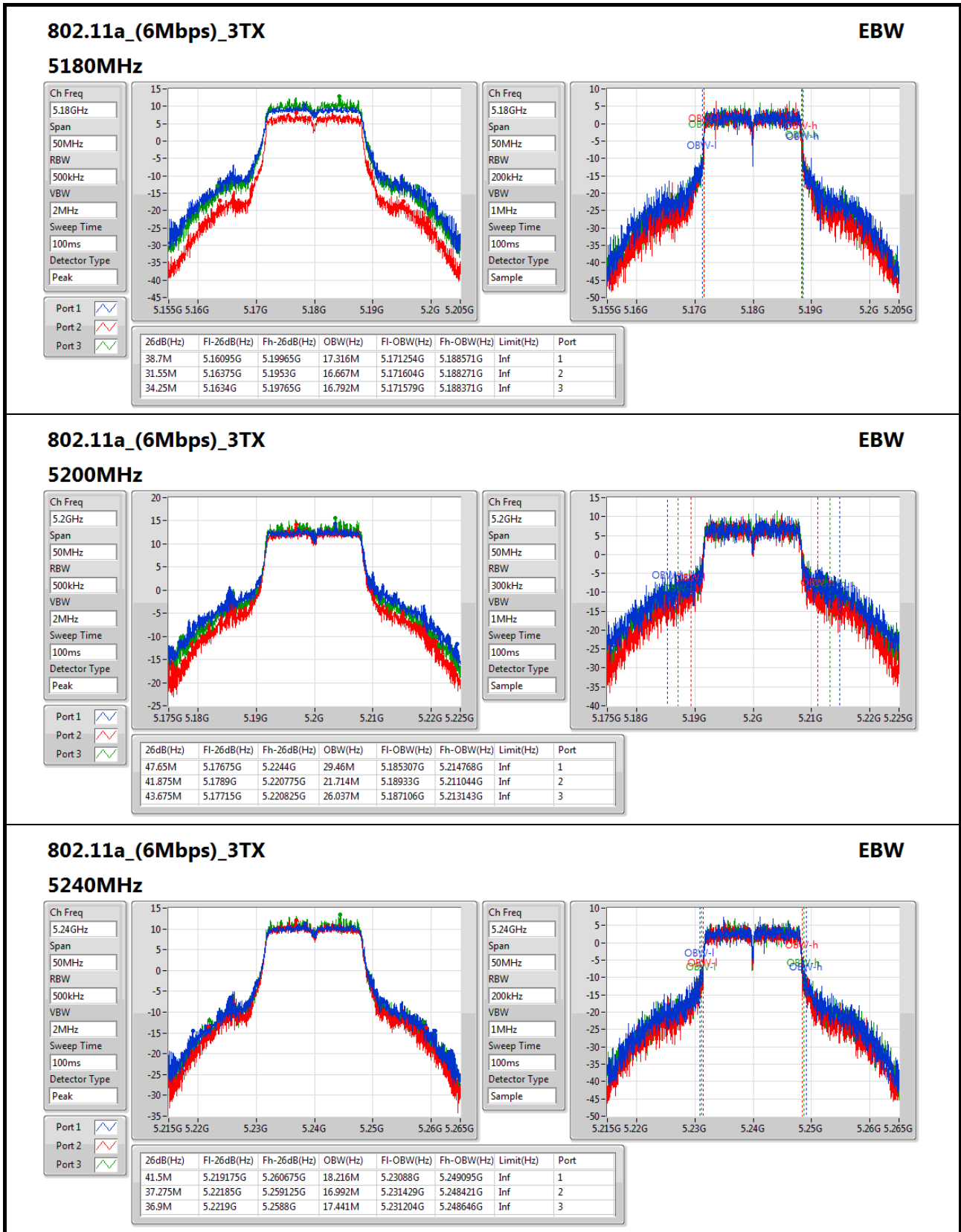

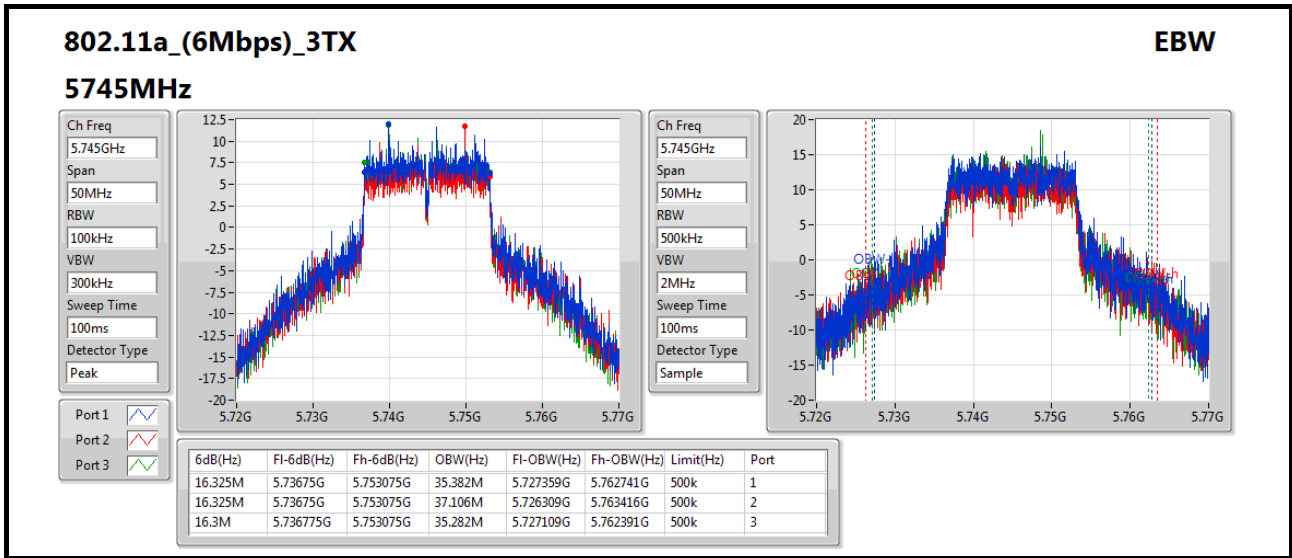

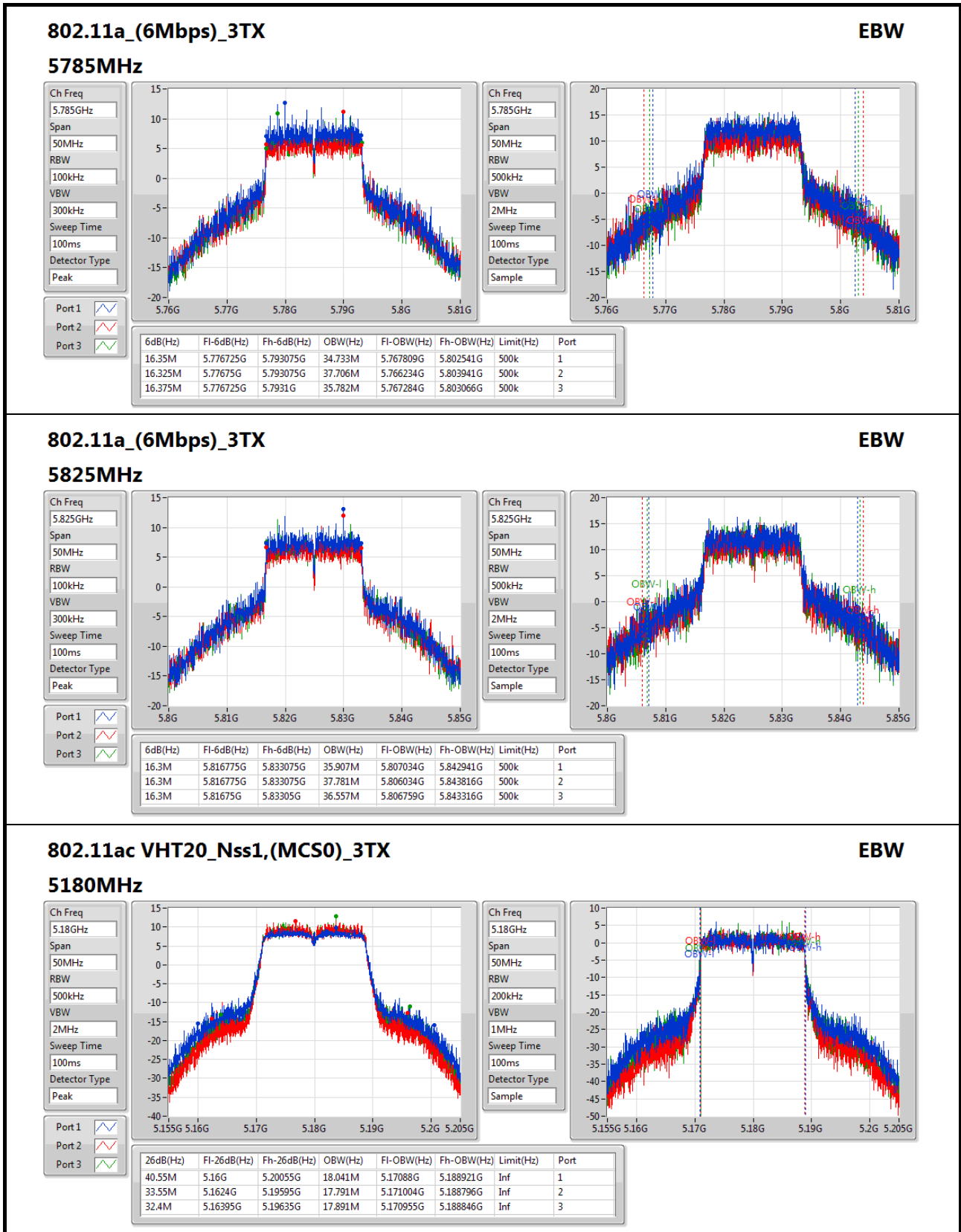



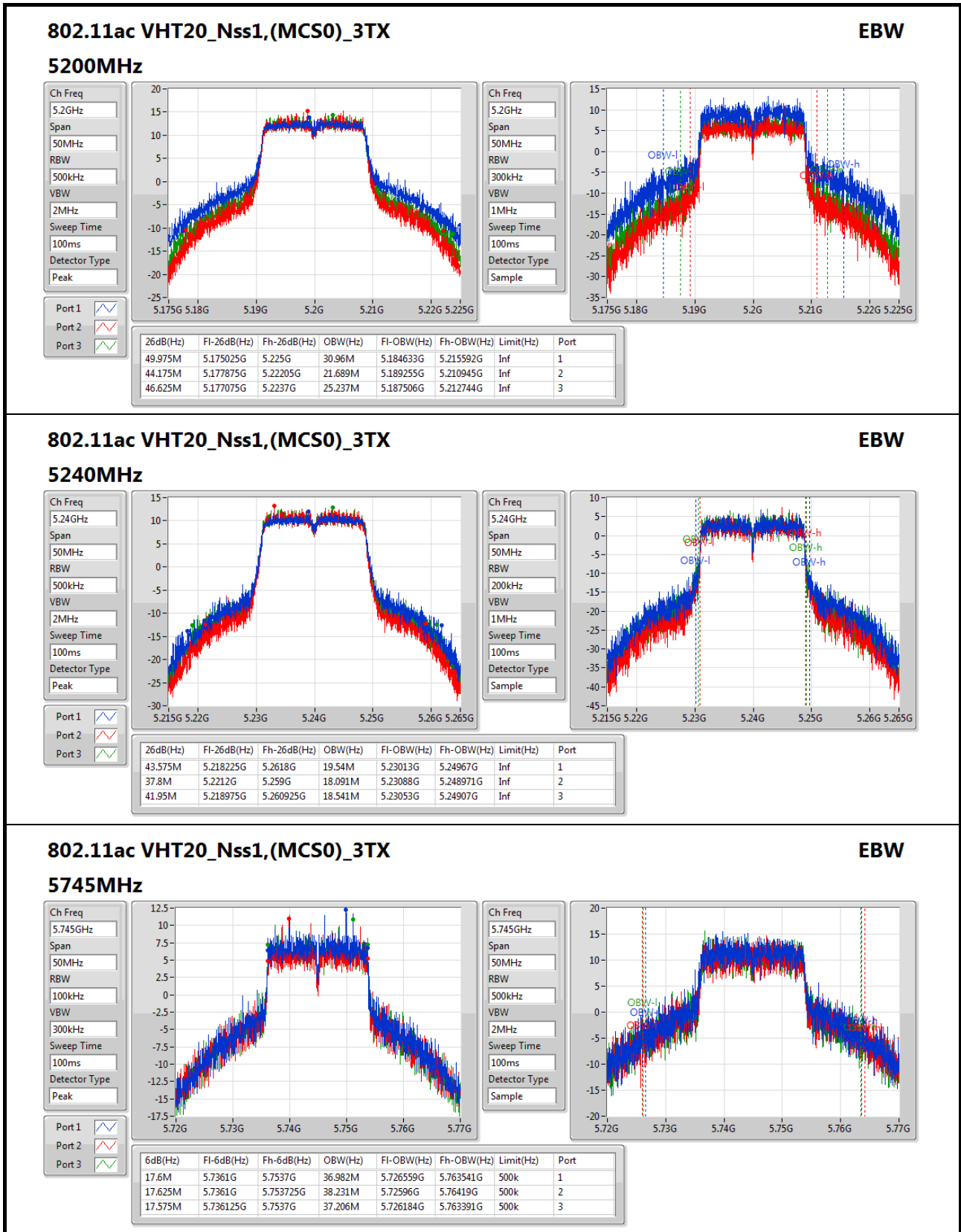

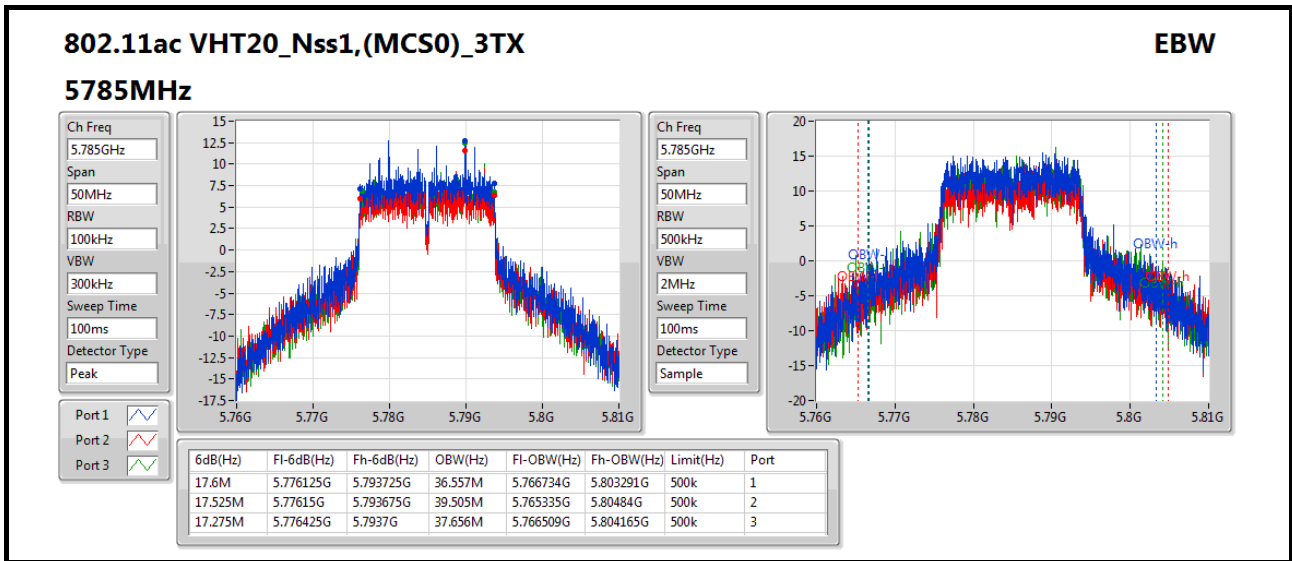

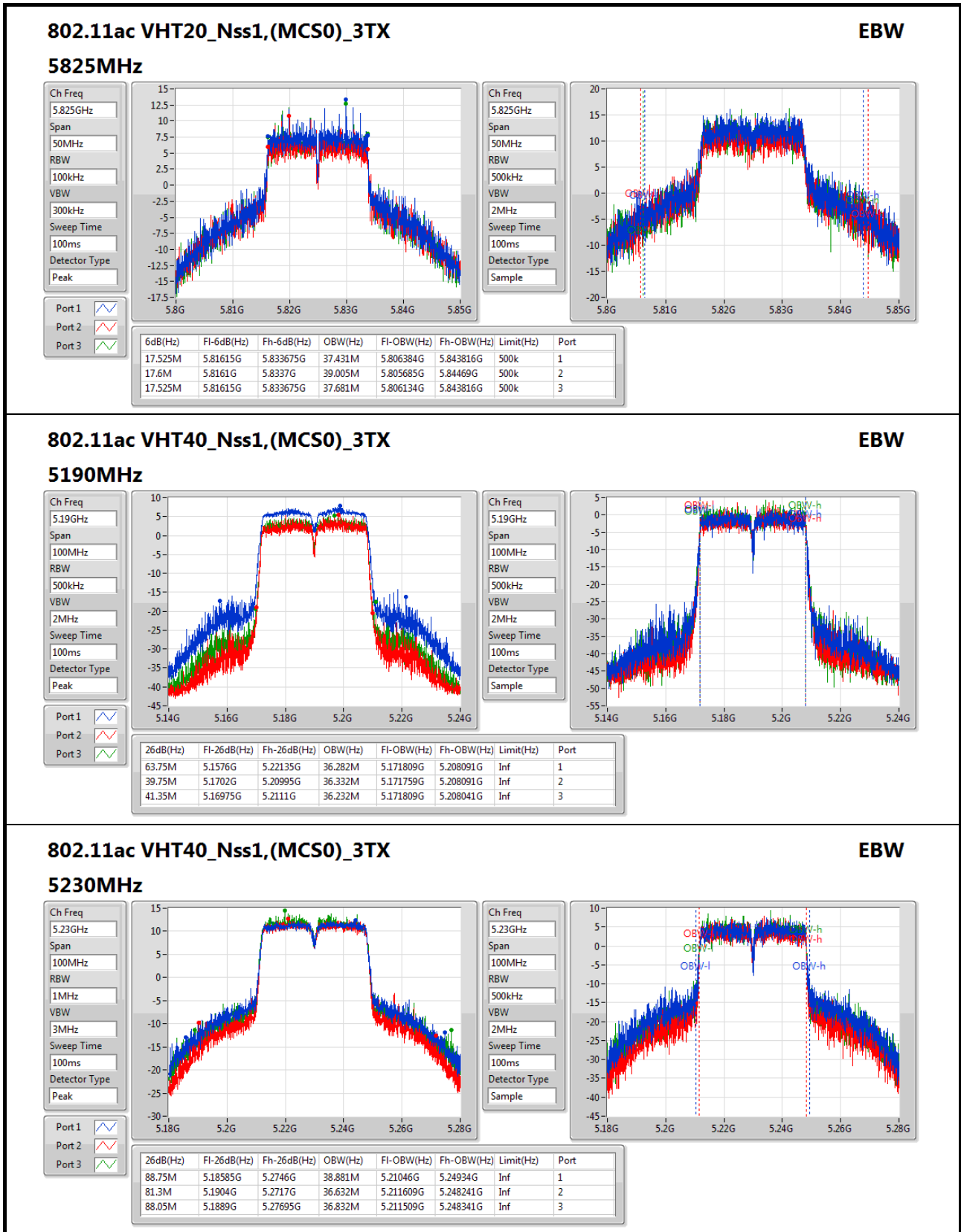

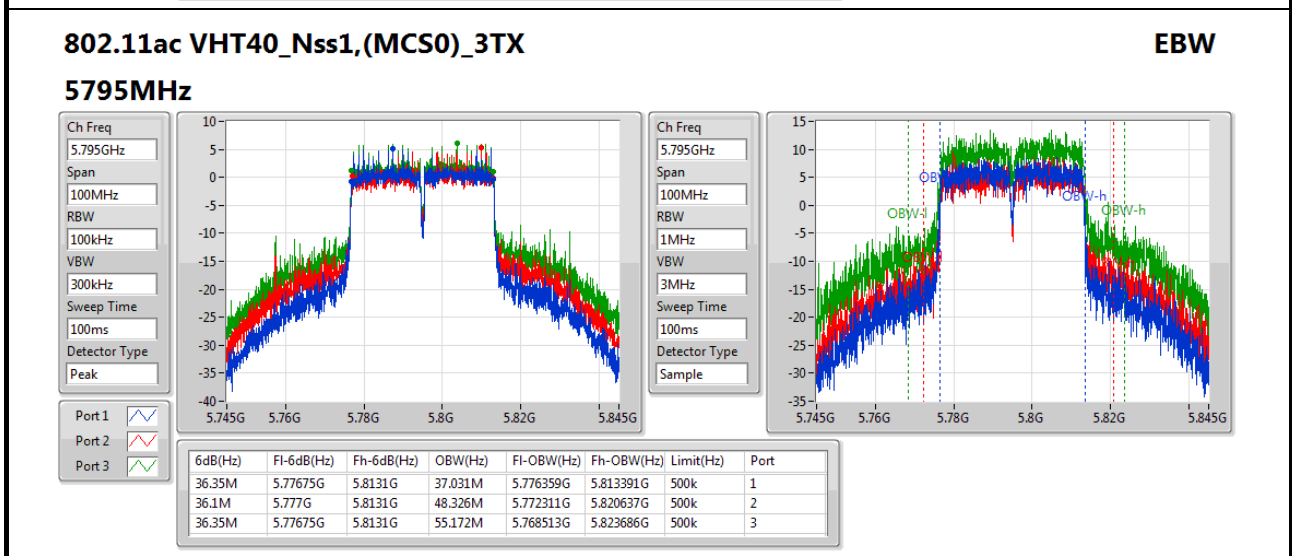
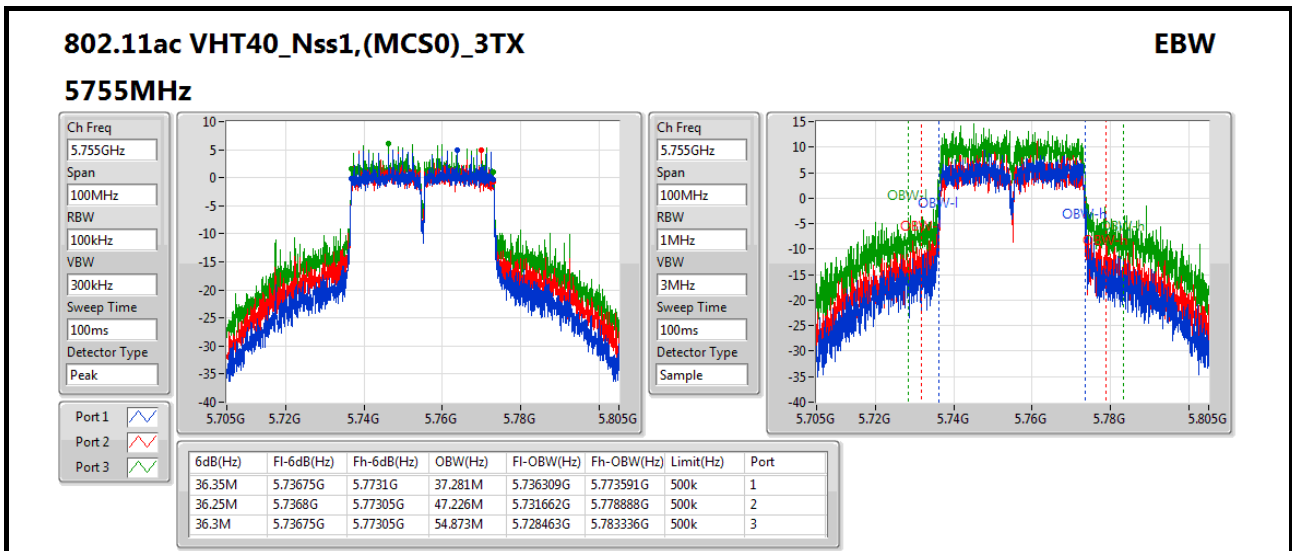

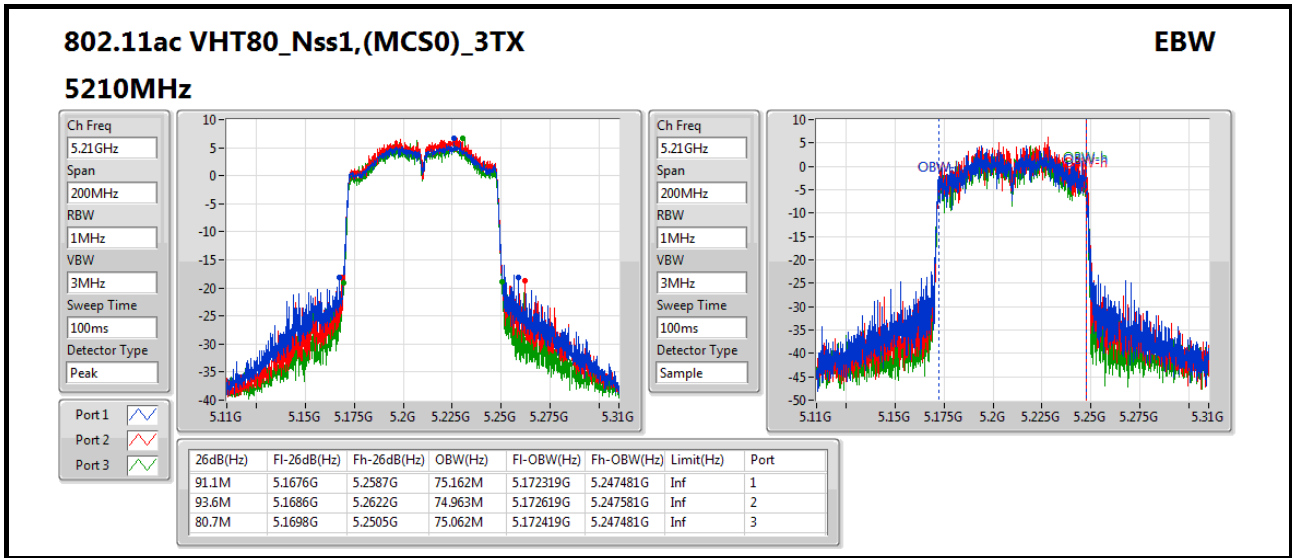

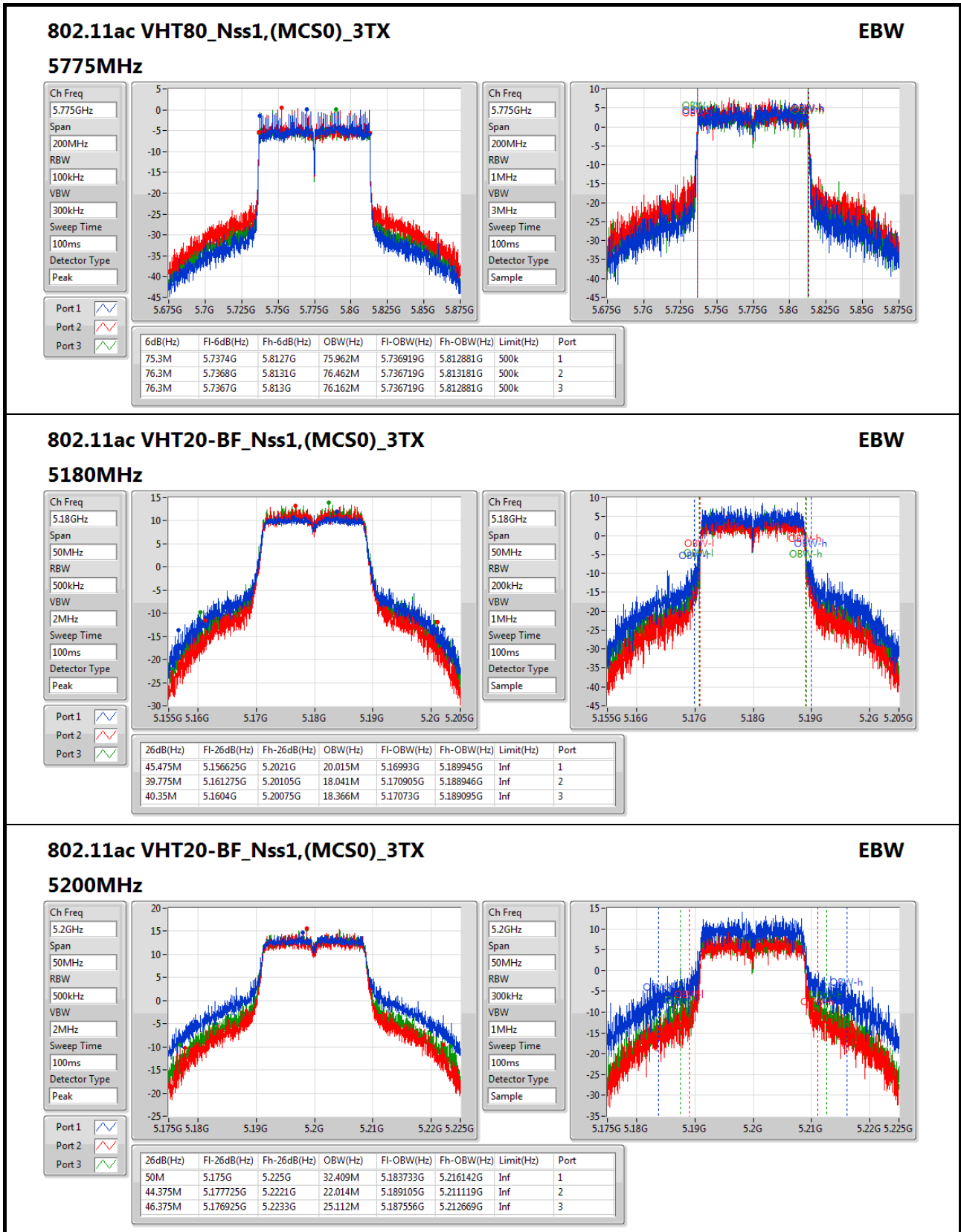

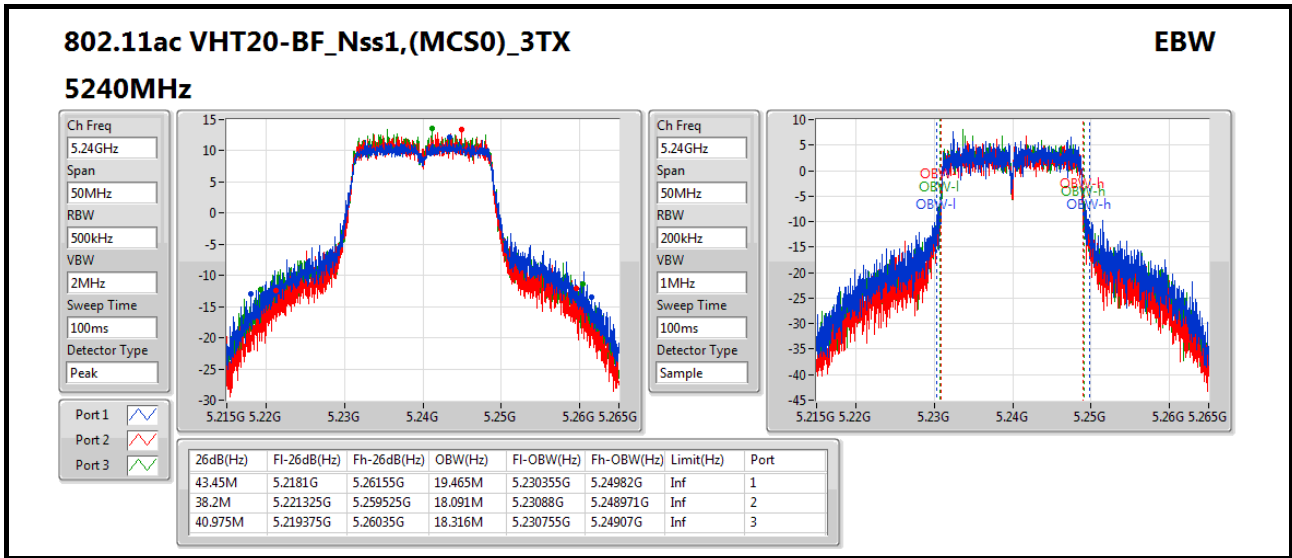

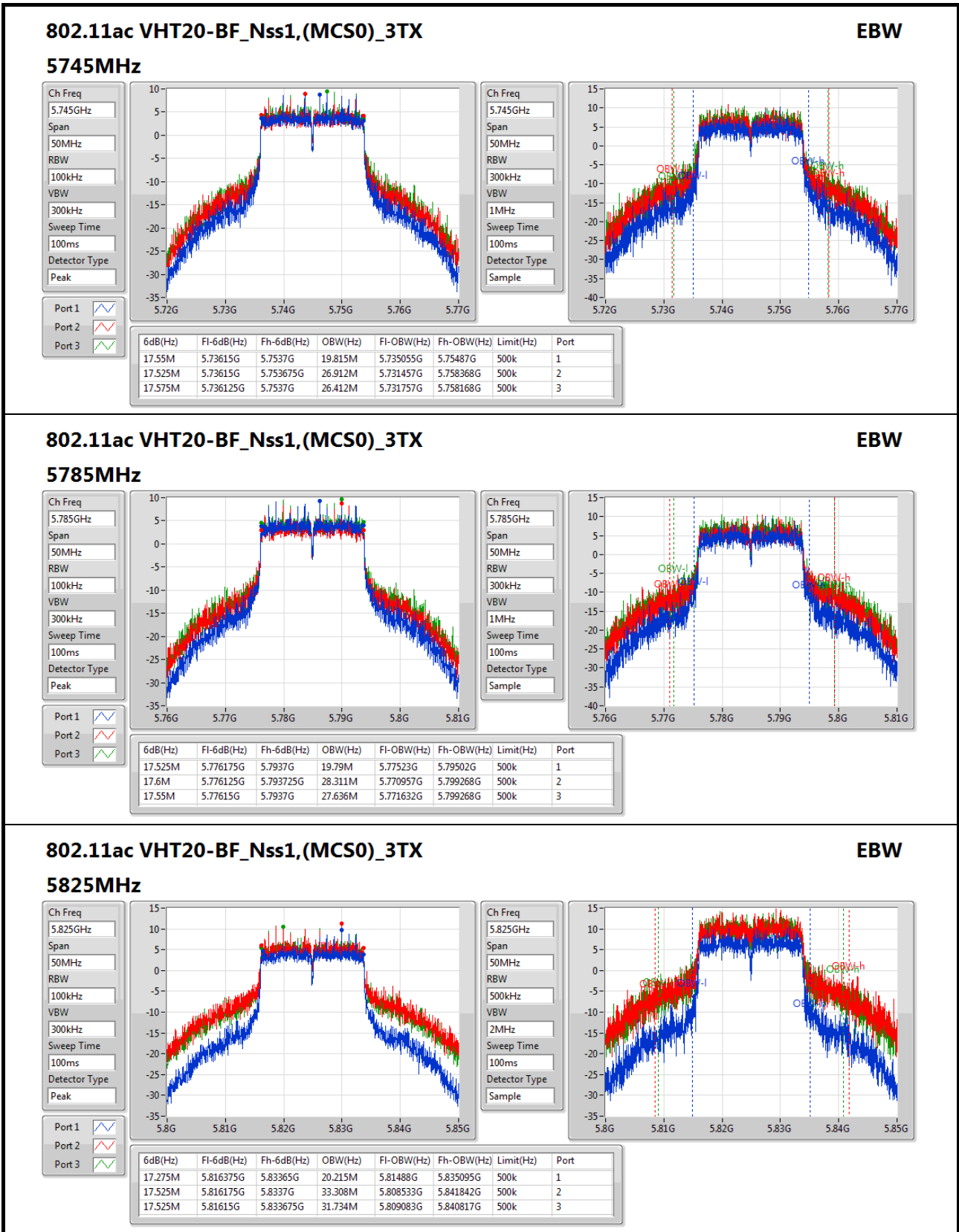



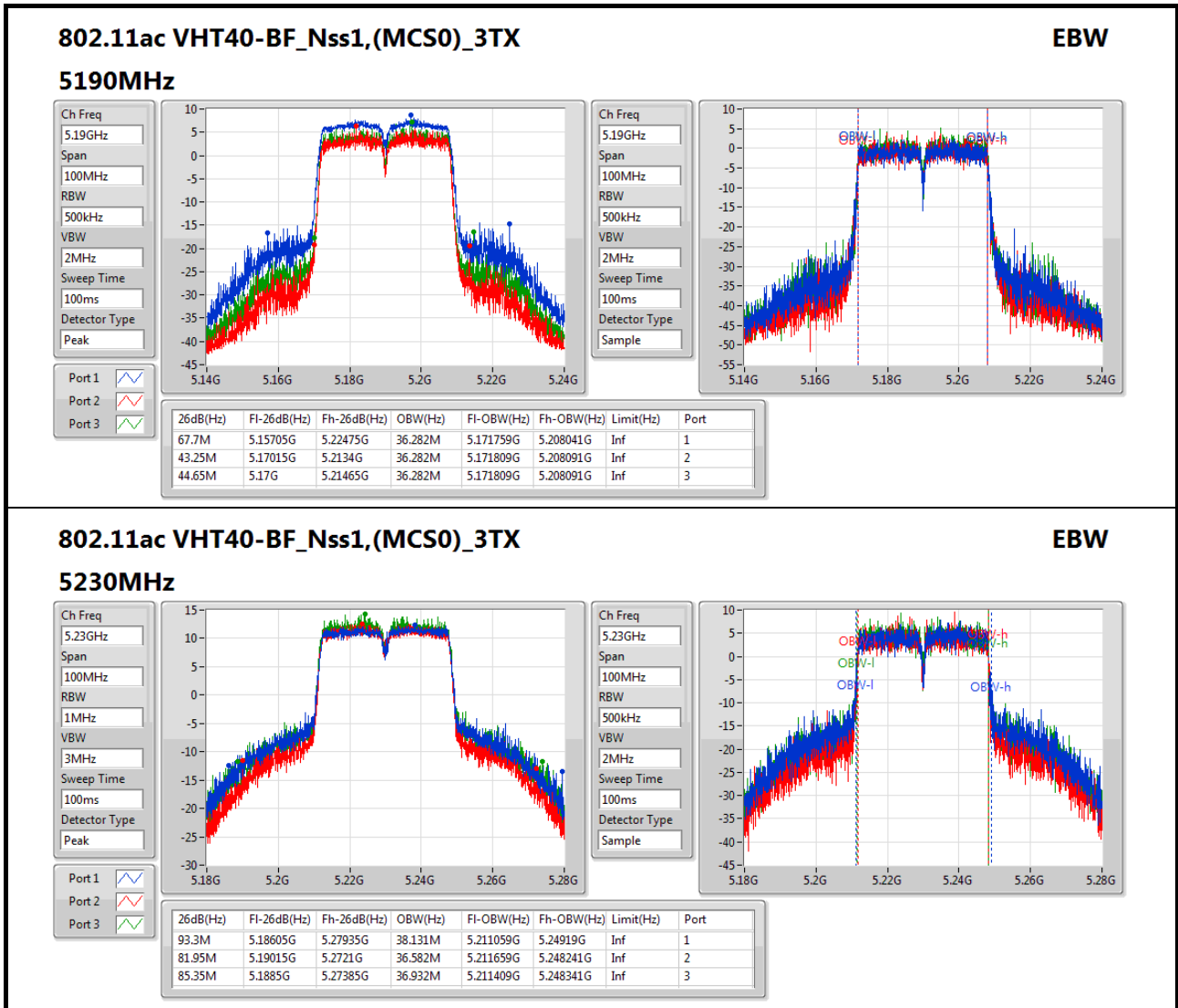

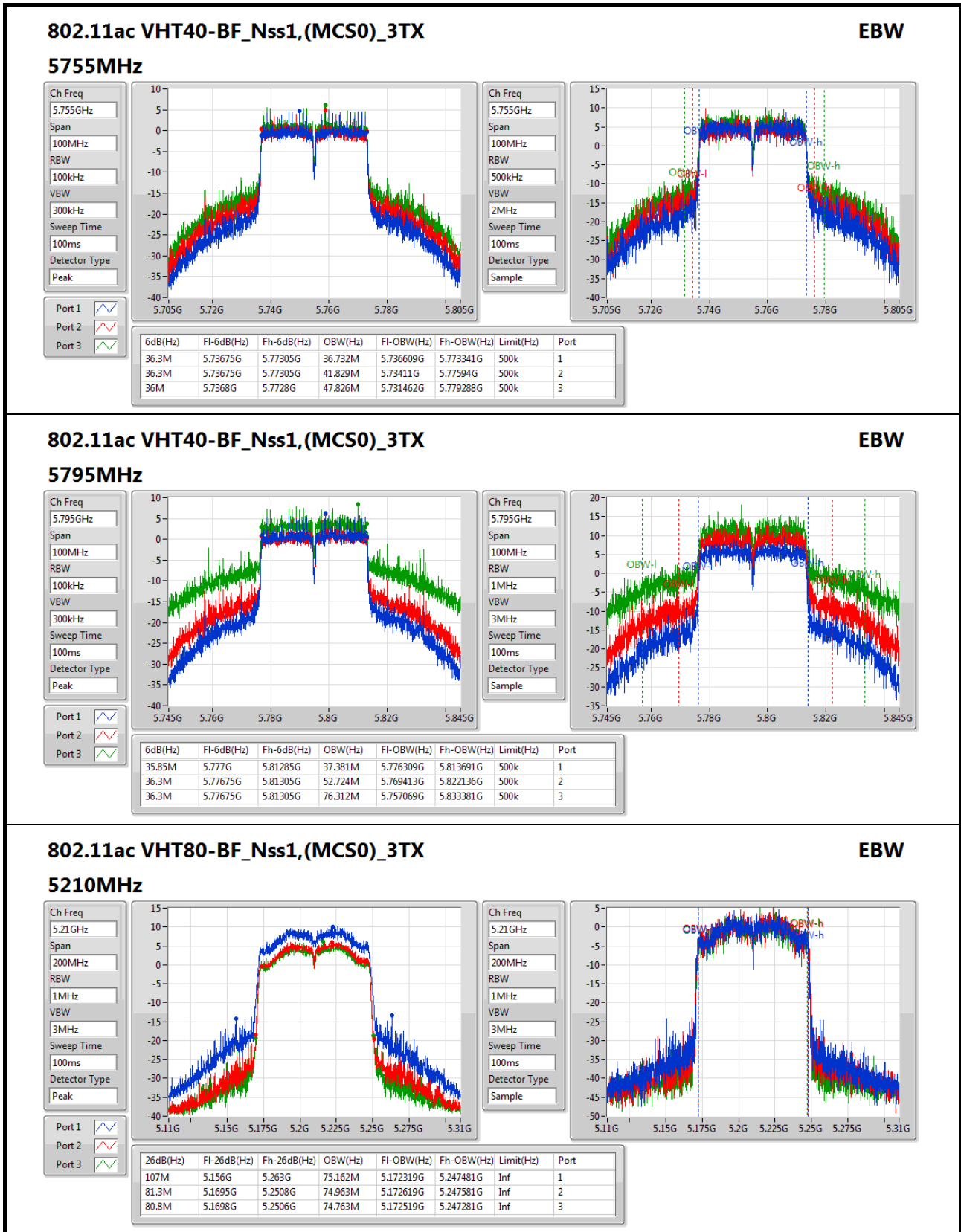

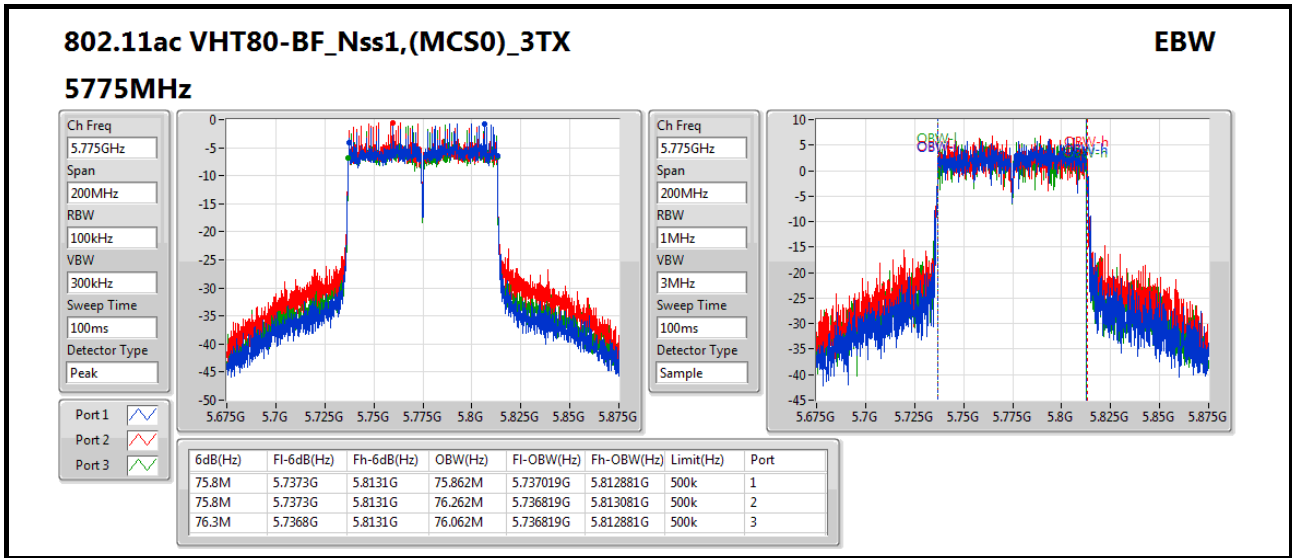



**Summary**

| Mode                              | Total Power (dBm) | Total Power (W) | EIRP (dBm) | EIRP (W) |
|-----------------------------------|-------------------|-----------------|------------|----------|
| 802.11a_(6Mbps)_3TX               | -                 | -               | -          | -        |
| 5.15-5.25GHz                      | 25.04             | 0.31915         | 30.92      | 1.23595  |
| 5.725-5.85GHz                     | 27.34             | 0.54200         | 33.22      | 2.09894  |
| 802.11ac VHT20_Nss1,(MCS0)_3TX    | -                 | -               | -          | -        |
| 5.15-5.25GHz                      | 24.72             | 0.29648         | 30.60      | 1.14815  |
| 5.725-5.85GHz                     | 27.35             | 0.54325         | 33.23      | 2.10378  |
| 802.11ac VHT40_Nss1,(MCS0)_3TX    | -                 | -               | -          | -        |
| 5.15-5.25GHz                      | 23.05             | 0.20184         | 28.93      | 0.78163  |
| 5.725-5.85GHz                     | 24.69             | 0.29444         | 30.57      | 1.14025  |
| 802.11ac VHT80_Nss1,(MCS0)_3TX    | -                 | -               | -          | -        |
| 5.15-5.25GHz                      | 18.46             | 0.07015         | 24.34      | 0.27164  |
| 5.725-5.85GHz                     | 21.77             | 0.15031         | 27.65      | 0.58210  |
| 802.11ac VHT20-BF_Nss1,(MCS0)_3TX | -                 | -               | -          | -        |
| 5.15-5.25GHz                      | 25.14             | 0.32659         | 35.78      | 3.78443  |
| 5.725-5.85GHz                     | 25.05             | 0.31989         | 35.69      | 3.70681  |
| 802.11ac VHT40-BF_Nss1,(MCS0)_3TX | -                 | -               | -          | -        |
| 5.15-5.25GHz                      | 23.07             | 0.20277         | 33.71      | 2.34963  |
| 5.725-5.85GHz                     | 24.65             | 0.29174         | 35.29      | 3.38065  |
| 802.11ac VHT80-BF_Nss1,(MCS0)_3TX | -                 | -               | -          | -        |
| 5.15-5.25GHz                      | 17.95             | 0.06237         | 28.59      | 0.72277  |
| 5.725-5.85GHz                     | 21.04             | 0.12706         | 31.67      | 1.46893  |



**Result**

| Mode                              | Result | DG    | Port 1 | Port 2 | Port 3 | Total Power | Power Limit |
|-----------------------------------|--------|-------|--------|--------|--------|-------------|-------------|
|                                   |        | (dBi) | (dBm)  | (dBm)  | (dBm)  | (dBm)       | (dBm)       |
| 802.11a_(6Mbps)_3TX               | -      | -     | -      | -      | -      | -           | -           |
| 5180MHz                           | Pass   | 5.88  | 17.02  | 16.96  | 17.31  | 21.87       | 30.00       |
| 5200MHz                           | Pass   | 5.88  | 20.24  | 19.98  | 20.56  | 25.04       | 30.00       |
| 5240MHz                           | Pass   | 5.88  | 17.71  | 17.71  | 18.09  | 22.61       | 30.00       |
| 5745MHz                           | Pass   | 5.88  | 22.57  | 21.61  | 22.21  | 26.92       | 30.00       |
| 5785MHz                           | Pass   | 5.88  | 22.99  | 21.30  | 21.82  | 26.87       | 30.00       |
| 5825MHz                           | Pass   | 5.88  | 23.28  | 21.95  | 22.36  | 27.34       | 30.00       |
| 802.11ac VHT20_Nss1,(MCS0)_3TX    | -      | -     | -      | -      | -      | -           | -           |
| 5180MHz                           | Pass   | 5.88  | 16.28  | 16.20  | 16.52  | 21.11       | 30.00       |
| 5200MHz                           | Pass   | 5.88  | 20.14  | 19.60  | 20.10  | 24.72       | 30.00       |
| 5240MHz                           | Pass   | 5.88  | 18.32  | 17.75  | 18.19  | 22.86       | 30.00       |
| 5745MHz                           | Pass   | 5.88  | 22.91  | 21.72  | 22.32  | 27.11       | 30.00       |
| 5785MHz                           | Pass   | 5.88  | 23.13  | 21.42  | 22.03  | 27.02       | 30.00       |
| 5825MHz                           | Pass   | 5.88  | 23.30  | 21.88  | 22.43  | 27.35       | 30.00       |
| 802.11ac VHT40_Nss1,(MCS0)_3TX    | -      | -     | -      | -      | -      | -           | -           |
| 5190MHz                           | Pass   | 5.88  | 13.02  | 12.77  | 13.57  | 17.90       | 30.00       |
| 5230MHz                           | Pass   | 5.88  | 18.28  | 17.88  | 18.63  | 23.05       | 30.00       |
| 5755MHz                           | Pass   | 5.88  | 19.33  | 19.16  | 20.44  | 24.45       | 30.00       |
| 5795MHz                           | Pass   | 5.88  | 19.75  | 19.23  | 20.66  | 24.69       | 30.00       |
| 802.11ac VHT80_Nss1,(MCS0)_3TX    | -      | -     | -      | -      | -      | -           | -           |
| 5210MHz                           | Pass   | 5.88  | 13.77  | 14.04  | 13.21  | 18.46       | 30.00       |
| 5775MHz                           | Pass   | 5.88  | 17.02  | 17.04  | 16.95  | 21.77       | 30.00       |
| 802.11ac VHT20-BF_Nss1,(MCS0)_3TX | -      | -     | -      | -      | -      | -           | -           |
| 5180MHz                           | Pass   | 10.64 | 18.25  | 18.09  | 18.65  | 23.11       | 25.36       |
| 5200MHz                           | Pass   | 10.64 | 20.74  | 19.96  | 20.37  | 25.14       | 25.36       |
| 5240MHz                           | Pass   | 10.64 | 18.26  | 17.58  | 18.30  | 22.83       | 25.36       |
| 5745MHz                           | Pass   | 10.64 | 19.79  | 20.26  | 20.74  | 25.05       | 25.36       |
| 5785MHz                           | Pass   | 10.64 | 20.30  | 19.52  | 20.14  | 24.77       | 25.36       |
| 5825MHz                           | Pass   | 10.64 | 20.00  | 19.86  | 20.22  | 24.80       | 25.36       |
| 802.11ac VHT40-BF_Nss1,(MCS0)_3TX | -      | -     | -      | -      | -      | -           | -           |
| 5190MHz                           | Pass   | 10.64 | 13.74  | 13.32  | 14.34  | 18.59       | 25.36       |
| 5230MHz                           | Pass   | 10.64 | 18.26  | 17.91  | 18.69  | 23.07       | 25.36       |
| 5755MHz                           | Pass   | 10.64 | 18.82  | 18.54  | 19.76  | 23.84       | 25.36       |
| 5795MHz                           | Pass   | 10.64 | 19.78  | 19.30  | 20.48  | 24.65       | 25.36       |
| 802.11ac VHT80-BF_Nss1,(MCS0)_3TX | -      | -     | -      | -      | -      | -           | -           |
| 5210MHz                           | Pass   | 10.64 | 13.26  | 13.49  | 12.75  | 17.95       | 25.36       |
| 5775MHz                           | Pass   | 10.64 | 16.27  | 16.26  | 16.27  | 21.04       | 25.36       |

**DG = Directional Gain; Port X = Port X output power**



Summary

| Mode                              | PD<br>(dBm/RBW) | EIRP PD<br>(dBm/RBW) |
|-----------------------------------|-----------------|----------------------|
| 802.11a_(6Mbps)_3TX               | -               | -                    |
| 5.15-5.25GHz                      | 12.29           | 22.93                |
| 5.725-5.85GHz                     | 12.81           | 23.45                |
| 802.11ac VHT20_Nss1,(MCS0)_3TX    | -               | -                    |
| 5.15-5.25GHz                      | 11.68           | 22.32                |
| 5.725-5.85GHz                     | 12.41           | 23.05                |
| 802.11ac VHT40_Nss1,(MCS0)_3TX    | -               | -                    |
| 5.15-5.25GHz                      | 7.28            | 17.92                |
| 5.725-5.85GHz                     | 7.56            | 18.20                |
| 802.11ac VHT80_Nss1,(MCS0)_3TX    | -               | -                    |
| 5.15-5.25GHz                      | 1.01            | 11.65                |
| 5.725-5.85GHz                     | 2.46            | 13.10                |
| 802.11ac VHT20-BF_Nss1,(MCS0)_3TX | -               | -                    |
| 5.15-5.25GHz                      | 12.02           | 22.66                |
| 5.725-5.85GHz                     | 11.03           | 21.67                |
| 802.11ac VHT40-BF_Nss1,(MCS0)_3TX | -               | -                    |
| 5.15-5.25GHz                      | 7.24            | 17.87                |
| 5.725-5.85GHz                     | 8.25            | 18.89                |
| 802.11ac VHT80-BF_Nss1,(MCS0)_3TX | -               | -                    |
| 5.15-5.25GHz                      | 0.30            | 10.94                |
| 5.725-5.85GHz                     | 1.03            | 11.67                |

RBW = 500kHz for 5.725-5.85GHz band / 1MHz for other band;



Result

| Mode                              | Result | DG<br>(dBi) | Port 1<br>(dBm/RBW) | Port 2<br>(dBm/RBW) | Port 3<br>(dBm/RBW) | PD<br>(dBm/RBW) | PD Limit<br>(dBm/RBW) |
|-----------------------------------|--------|-------------|---------------------|---------------------|---------------------|-----------------|-----------------------|
| 802.11a_(6Mbps)_3TX               | -      | -           | -                   | -                   | -                   | -               | -                     |
| 5180MHz                           | Pass   | 10.64       | 4.61                | 4.47                | 5.00                | 9.38            | 12.36                 |
| 5200MHz                           | Pass   | 10.64       | 7.61                | 7.33                | 8.01                | 12.29           | 12.36                 |
| 5240MHz                           | Pass   | 10.64       | 5.71                | 5.24                | 5.80                | 10.28           | 12.36                 |
| 5745MHz                           | Pass   | 10.64       | 8.51                | 7.33                | 8.14                | 12.57           | 25.36                 |
| 5785MHz                           | Pass   | 10.64       | 8.79                | 7.13                | 7.95                | 12.65           | 25.36                 |
| 5825MHz                           | Pass   | 10.64       | 8.82                | 7.43                | 7.98                | 12.81           | 25.36                 |
| 802.11ac VHT20_Nss1,(MCS0)_3TX    | -      | -           | -                   | -                   | -                   | -               | -                     |
| 5180MHz                           | Pass   | 10.64       | 3.36                | 3.36                | 3.80                | 8.24            | 12.36                 |
| 5200MHz                           | Pass   | 10.64       | 7.14                | 6.67                | 7.15                | 11.68           | 12.36                 |
| 5240MHz                           | Pass   | 10.64       | 5.32                | 4.79                | 5.16                | 9.77            | 12.36                 |
| 5745MHz                           | Pass   | 10.64       | 8.12                | 7.00                | 7.57                | 12.21           | 25.36                 |
| 5785MHz                           | Pass   | 10.64       | 8.41                | 6.70                | 7.33                | 12.23           | 25.36                 |
| 5825MHz                           | Pass   | 10.64       | 8.43                | 7.04                | 7.59                | 12.41           | 25.36                 |
| 802.11ac VHT40_Nss1,(MCS0)_3TX    | -      | -           | -                   | -                   | -                   | -               | -                     |
| 5190MHz                           | Pass   | 10.64       | -2.60               | -2.78               | -2.07               | 2.24            | 12.36                 |
| 5230MHz                           | Pass   | 10.64       | 2.65                | 2.23                | 3.02                | 7.28            | 12.36                 |
| 5755MHz                           | Pass   | 10.64       | 2.30                | 2.19                | 3.44                | 7.33            | 25.36                 |
| 5795MHz                           | Pass   | 10.64       | 2.80                | 2.11                | 3.54                | 7.56            | 25.36                 |
| 802.11ac VHT80_Nss1,(MCS0)_3TX    | -      | -           | -                   | -                   | -                   | -               | -                     |
| 5210MHz                           | Pass   | 10.64       | -3.70               | -3.27               | -4.08               | 1.01            | 12.36                 |
| 5775MHz                           | Pass   | 10.64       | -2.43               | -2.82               | -2.87               | 1.83            | 25.36                 |
| 802.11ac VHT20-BF_Nss1,(MCS0)_3TX | -      | -           | -                   | -                   | -                   | -               | -                     |
| 5180MHz                           | Pass   | 10.64       | 5.13                | 5.27                | 5.63                | 10.06           | 12.36                 |
| 5200MHz                           | Pass   | 10.64       | 7.68                | 6.93                | 7.27                | 12.02           | 12.36                 |
| 5240MHz                           | Pass   | 10.64       | 5.55                | 4.83                | 5.33                | 9.90            | 12.36                 |
| 5745MHz                           | Pass   | 10.64       | 5.30                | 5.50                | 6.10                | 10.28           | 25.36                 |
| 5785MHz                           | Pass   | 10.64       | 5.68                | 5.04                | 5.86                | 10.26           | 25.36                 |
| 5825MHz                           | Pass   | 10.64       | 5.78                | 6.47                | 6.84                | 11.03           | 25.36                 |
| 802.11ac VHT40-BF_Nss1,(MCS0)_3TX | -      | -           | -                   | -                   | -                   | -               | -                     |
| 5190MHz                           | Pass   | 10.64       | -1.91               | -2.21               | -1.45               | 2.87            | 12.36                 |
| 5230MHz                           | Pass   | 10.64       | 2.62                | 2.15                | 2.88                | 7.24            | 12.36                 |
| 5755MHz                           | Pass   | 10.64       | 1.71                | 1.69                | 2.78                | 6.63            | 25.36                 |
| 5795MHz                           | Pass   | 10.64       | 2.79                | 2.39                | 5.04                | 8.25            | 25.36                 |
| 802.11ac VHT80-BF_Nss1,(MCS0)_3TX | -      | -           | -                   | -                   | -                   | -               | -                     |
| 5210MHz                           | Pass   | 10.64       | -4.51               | -3.92               | -4.78               | 0.30            | 12.36                 |
| 5775MHz                           | Pass   | 10.64       | -3.45               | -3.65               | -3.79               | 1.03            | 25.36                 |

DG = Directional Gain; RBW = 500kHz for 5.725-5.85GHz band / 1MHz for other band;

PD = trace bin-by-bin of each transmits port summing can be performed maximum power density; Port X = Port X power density;

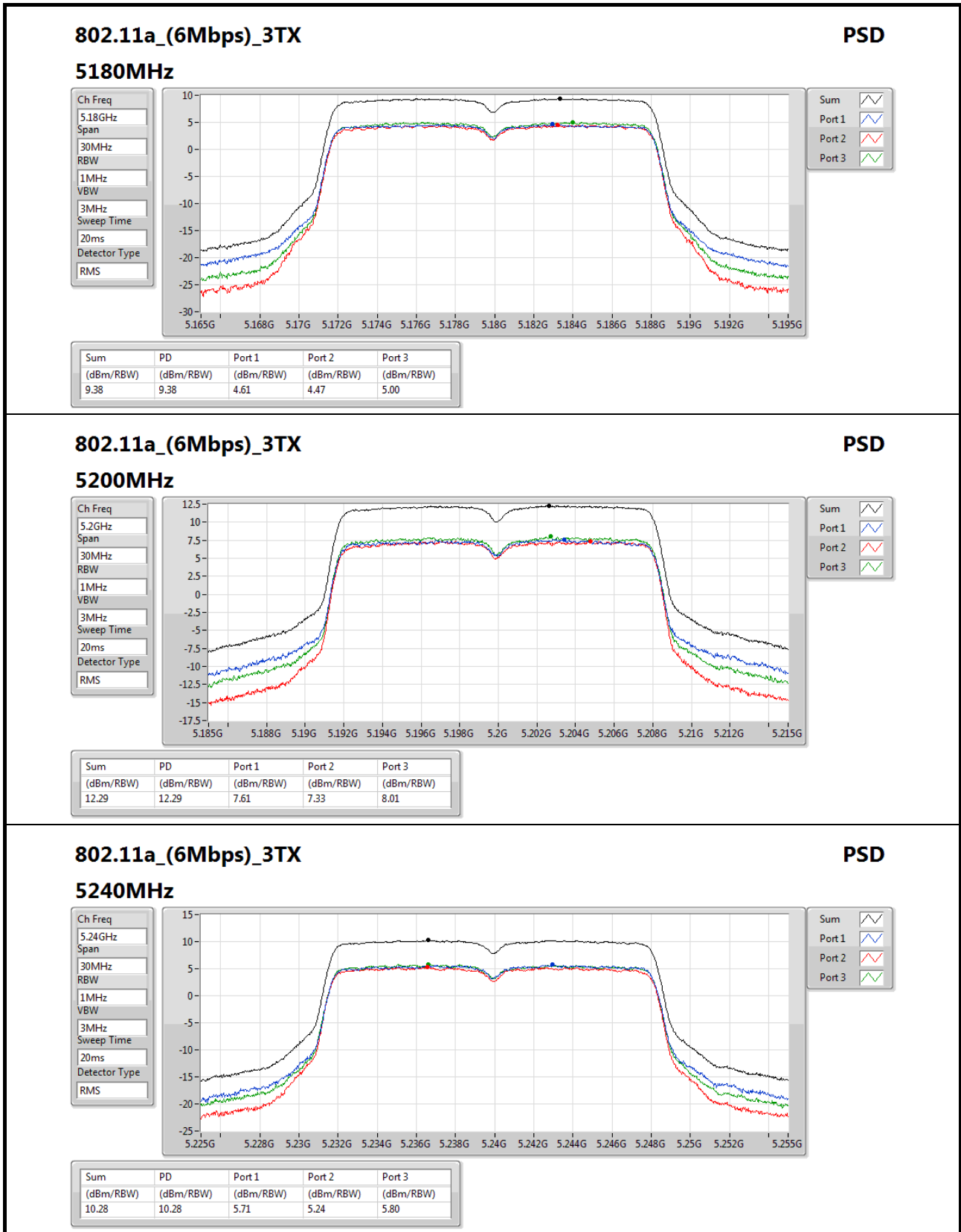
**802.11a\_(6Mbps)\_3TX**
**PSD**

**5240MHz**

Ch Freq  
5.24GHz

Span  
30MHz

RBW  
1MHz

VBW  
3MHz

Sweep Time  
20ms

Detector Type  
RMS

Sum

Port 1

Port 2

Port 3

| Sum       | PD        | Port 1    | Port 2    | Port 3    |
|-----------|-----------|-----------|-----------|-----------|
| (dBm/RBW) | (dBm/RBW) | (dBm/RBW) | (dBm/RBW) | (dBm/RBW) |
| 10.28     | 10.28     | 5.71      | 5.24      | 5.80      |



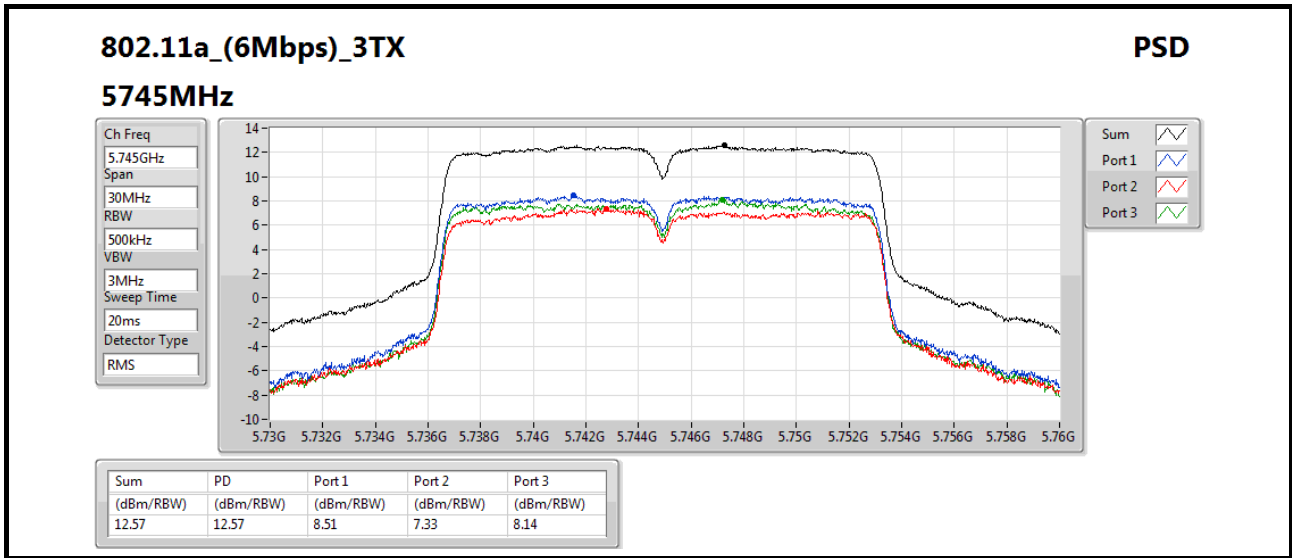

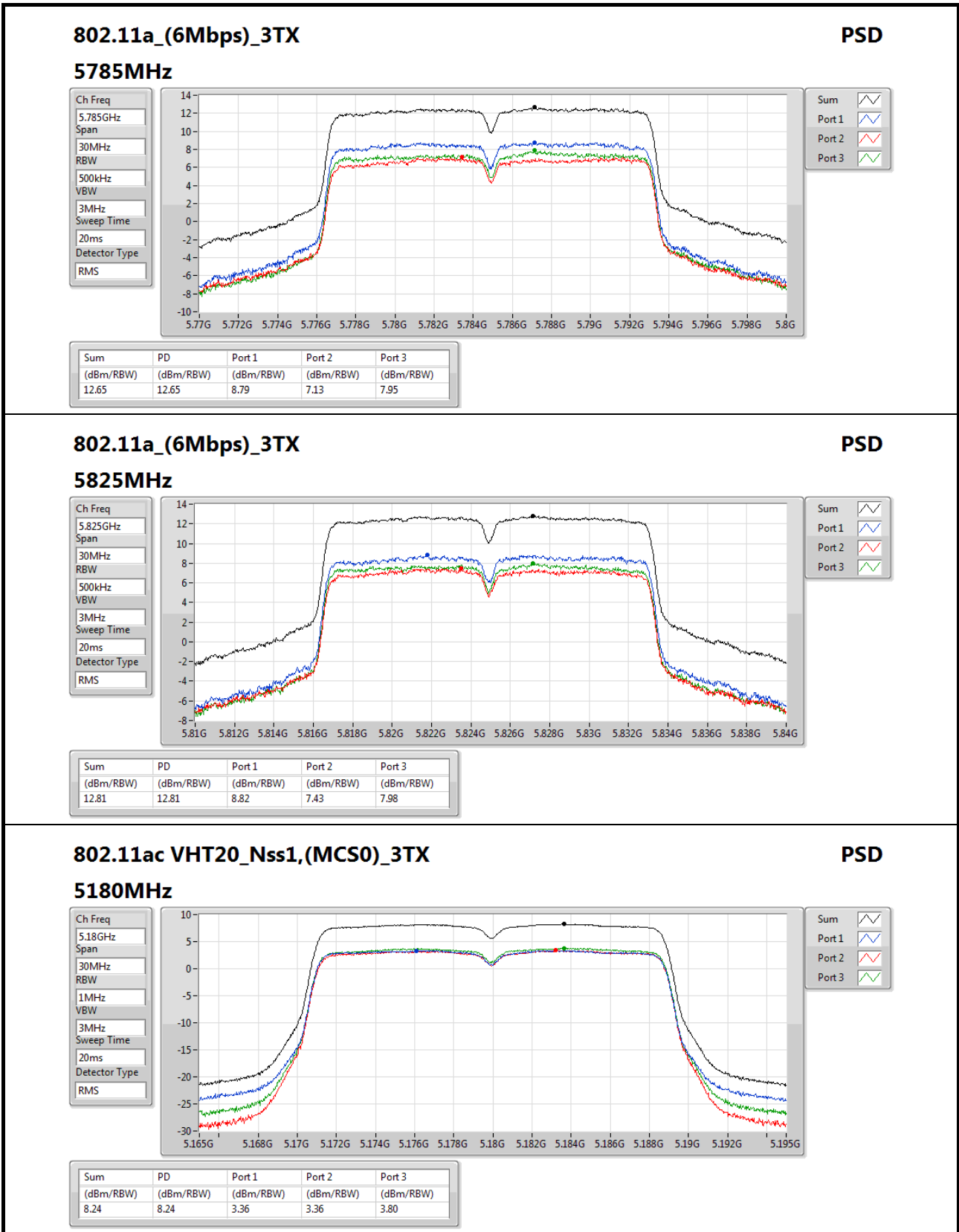

### 802.11ac VHT20\_Nss1,(MCS0)\_3TX

#### 5180MHz

### PSD

Ch Freq  
5.18GHz

Span  
30MHz

RBW  
1MHz

VBW  
3MHz

Sweep Time  
20ms

Detector Type  
RMS

Sum

Port 1

Port 2

Port 3

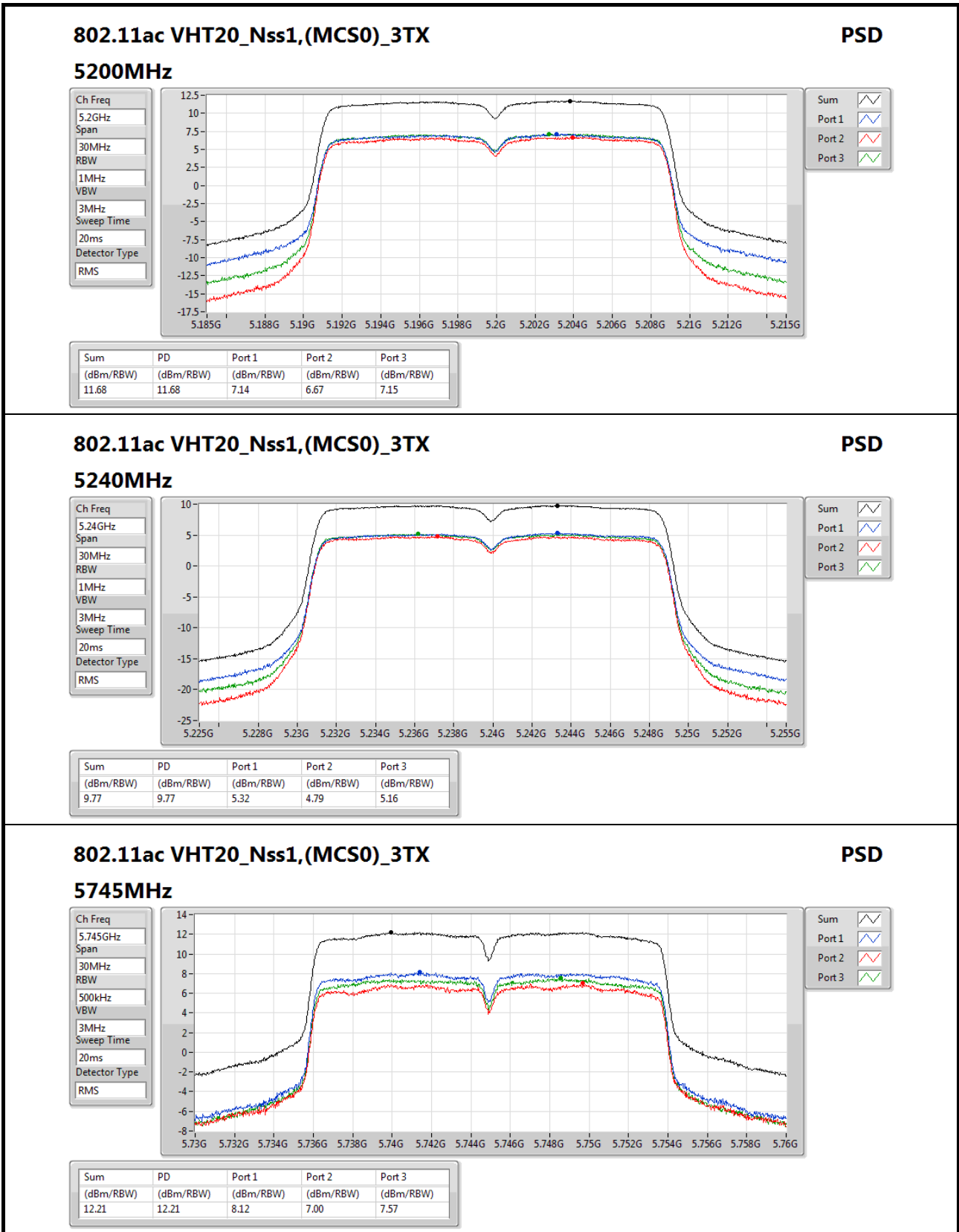

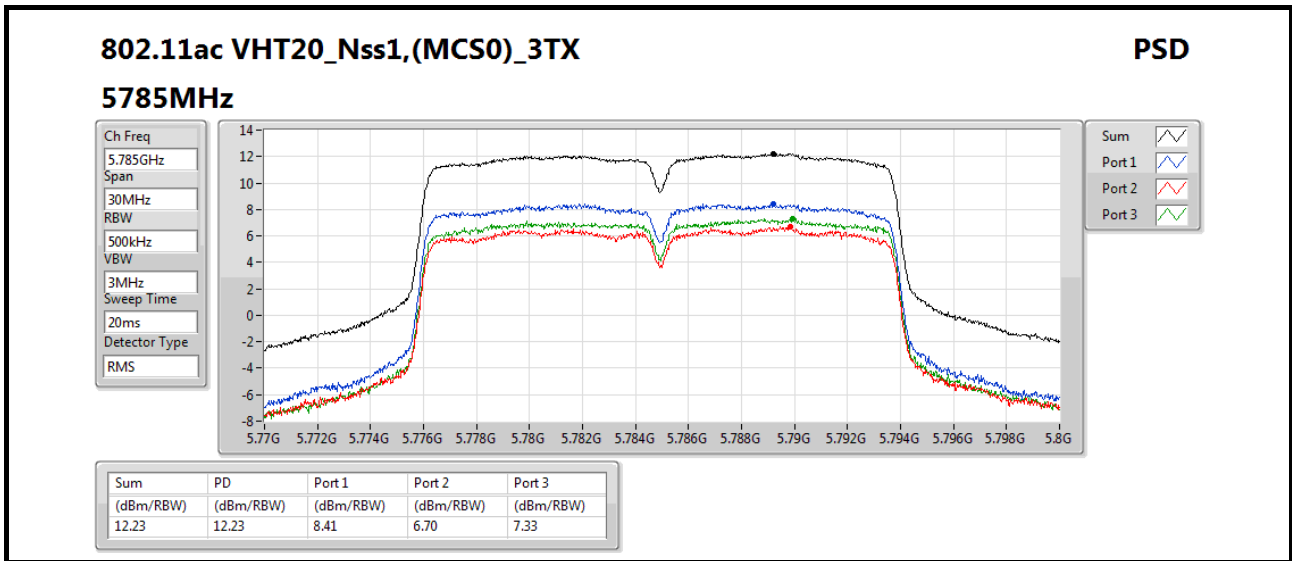

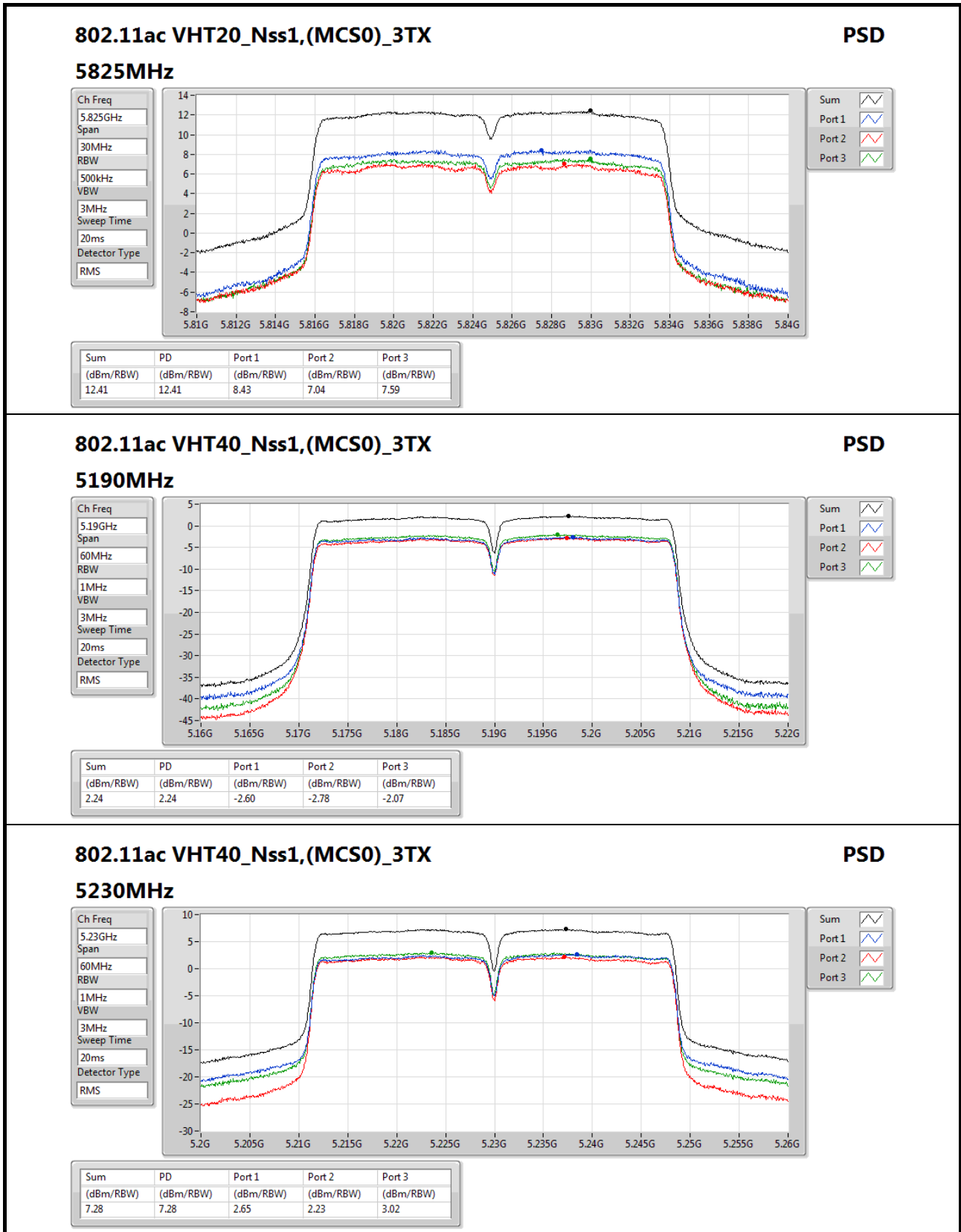

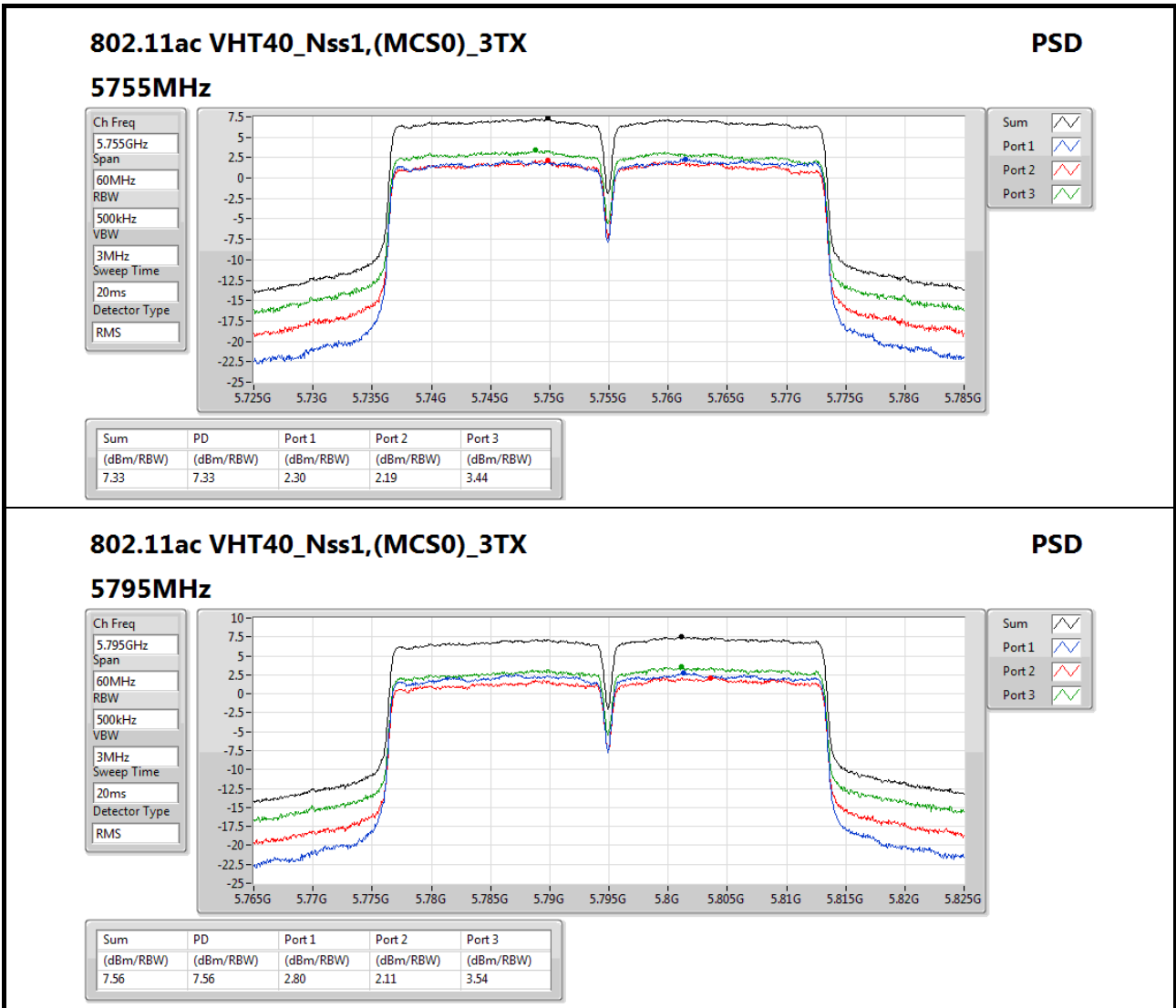

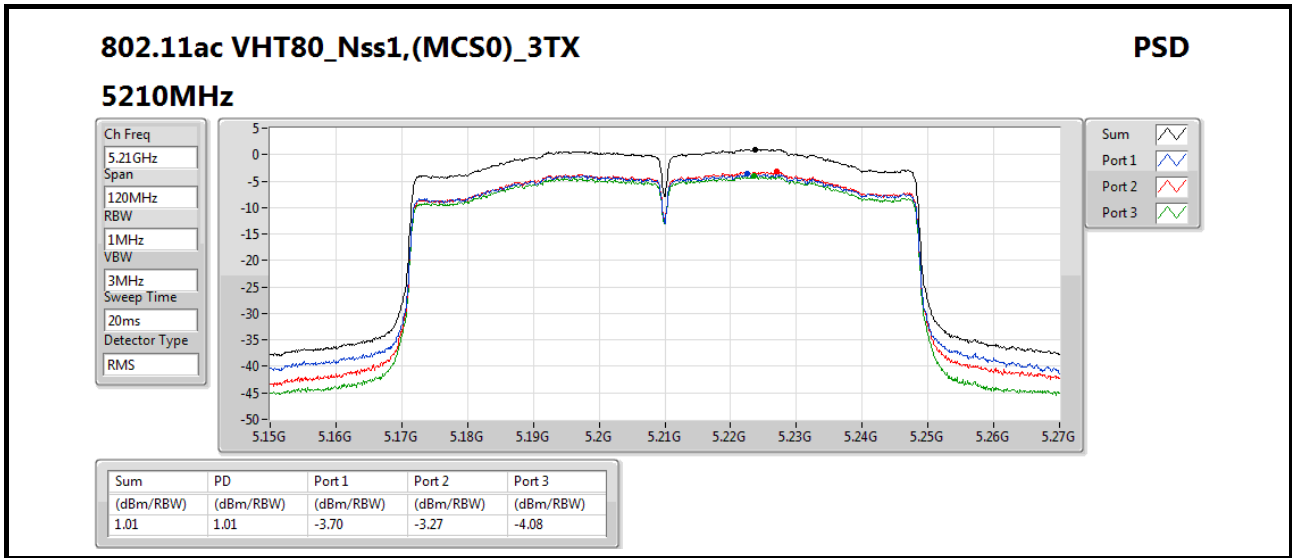

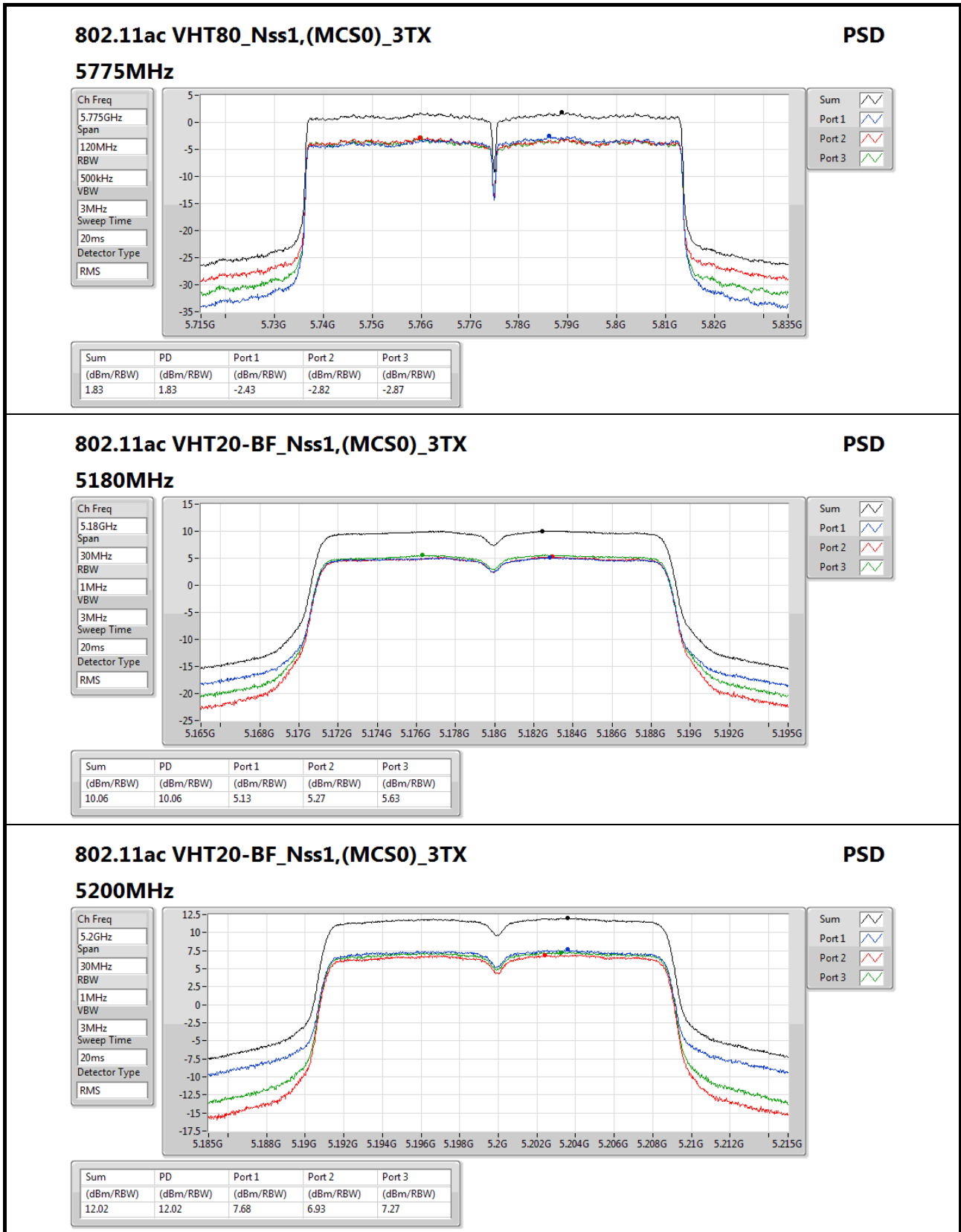



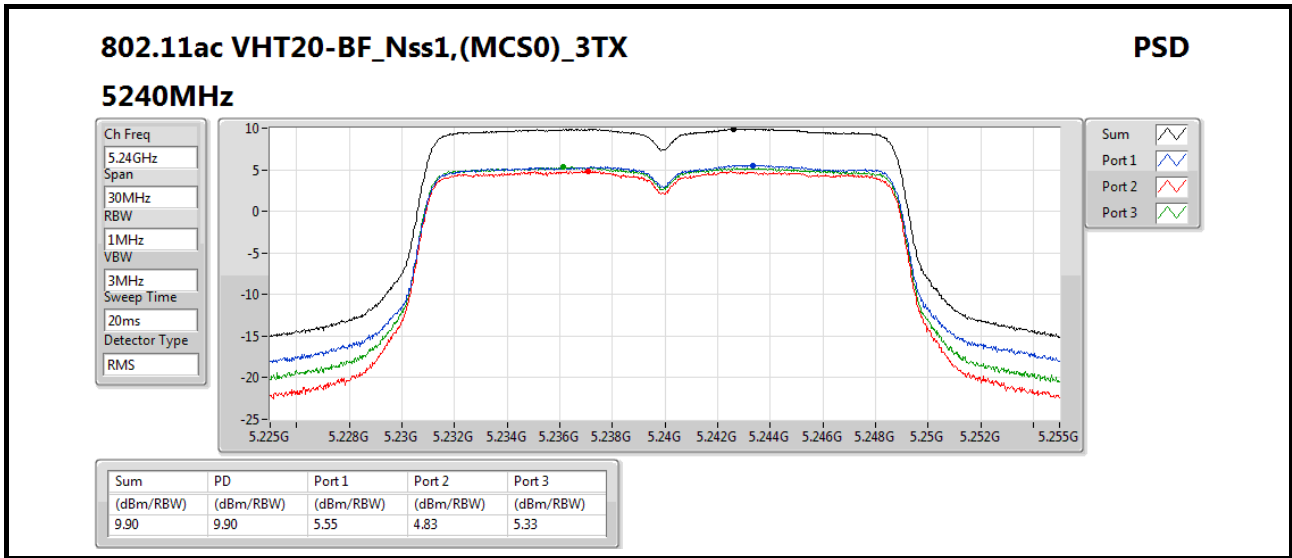

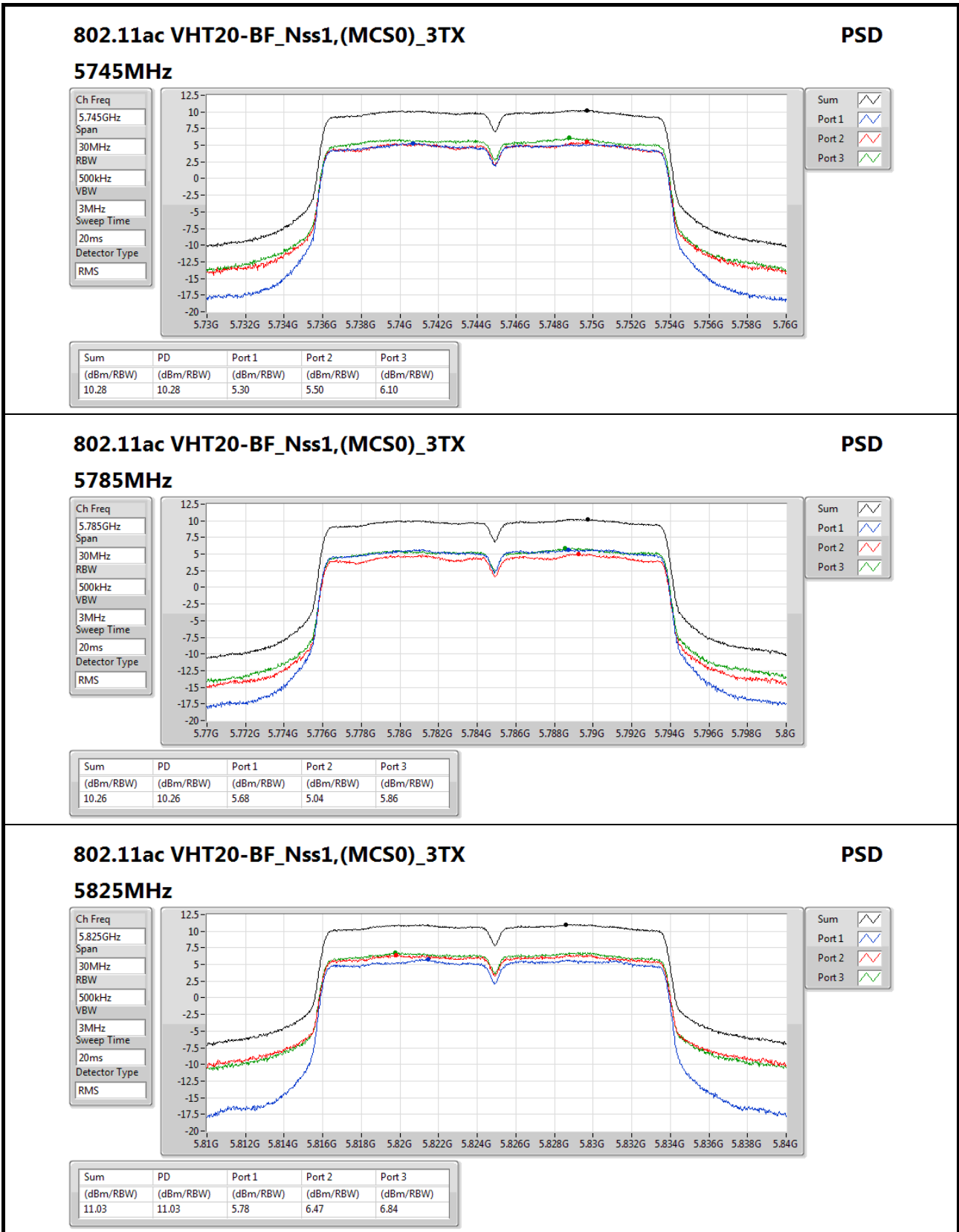



802.11ac VHT40-BF\_Nss1,(MCS0)\_3TX

PSD

5190MHz

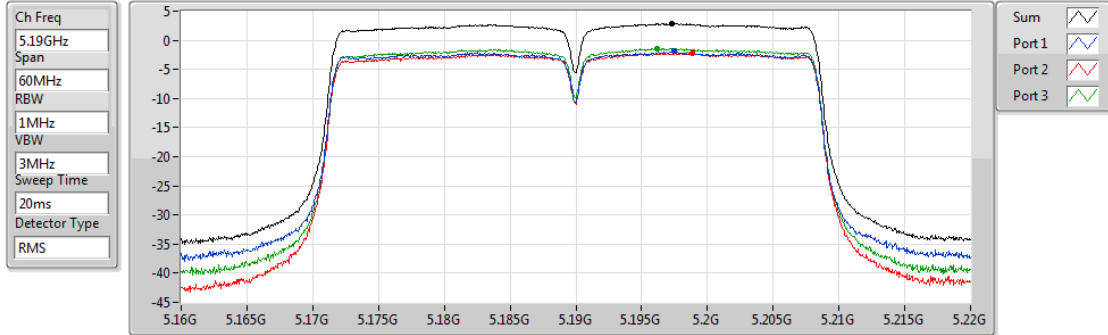

| Sum       | PD        | Port 1    | Port 2    | Port 3    |
|-----------|-----------|-----------|-----------|-----------|
| (dBm/RBW) | (dBm/RBW) | (dBm/RBW) | (dBm/RBW) | (dBm/RBW) |
| 2.87      | 2.87      | -1.91     | -2.21     | -1.45     |

802.11ac VHT40-BF\_Nss1,(MCS0)\_3TX

PSD

5230MHz

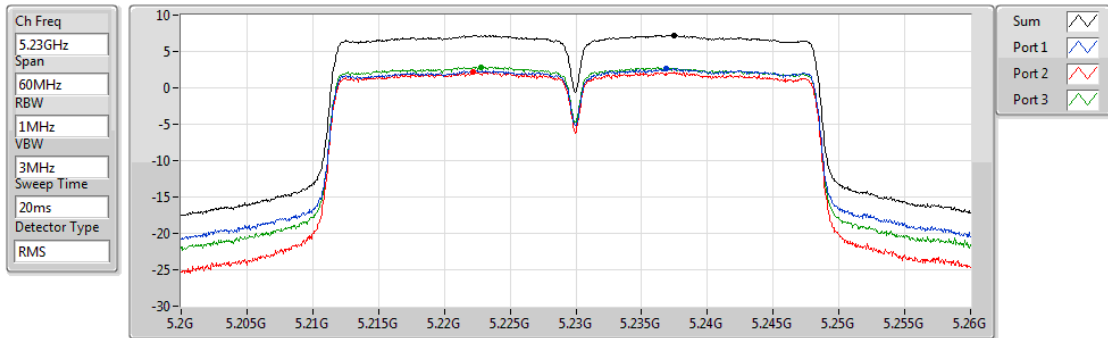

| Sum       | PD        | Port 1    | Port 2    | Port 3    |
|-----------|-----------|-----------|-----------|-----------|
| (dBm/RBW) | (dBm/RBW) | (dBm/RBW) | (dBm/RBW) | (dBm/RBW) |
| 7.24      | 7.24      | 2.62      | 2.15      | 2.88      |

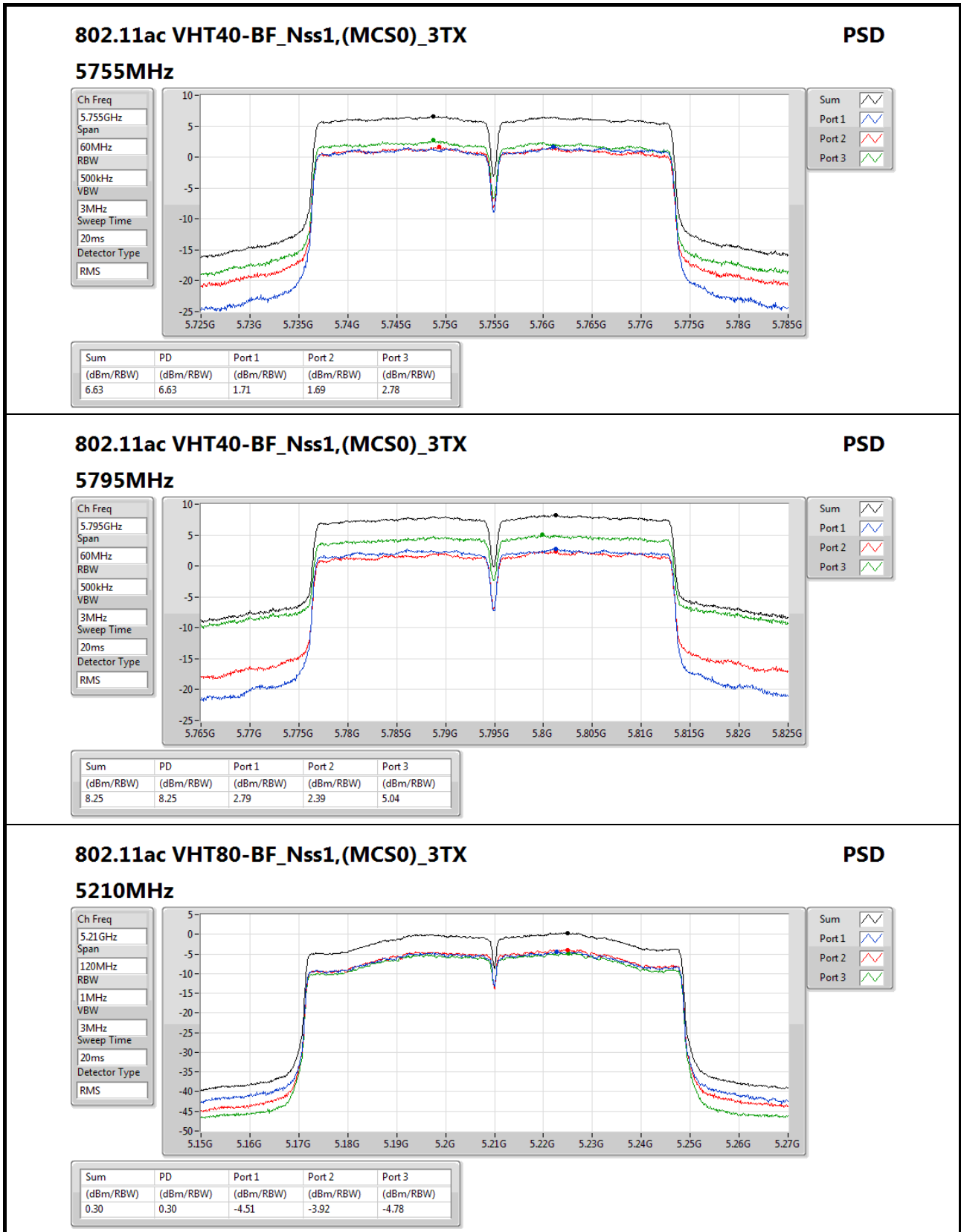

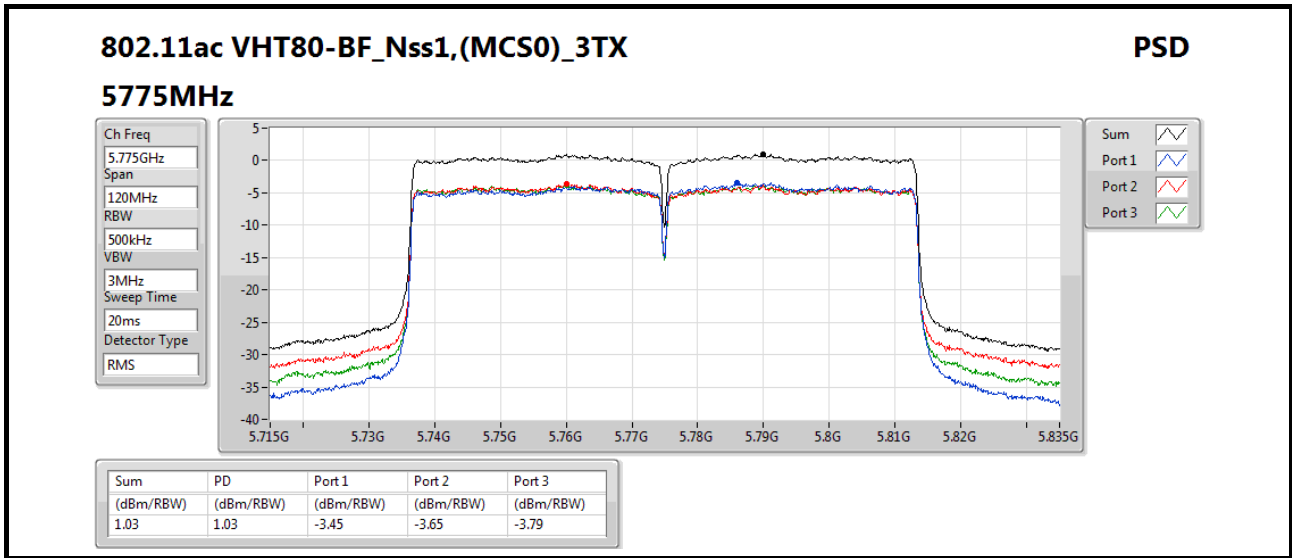



# RSE below 1GHz Result

Appendix E.1

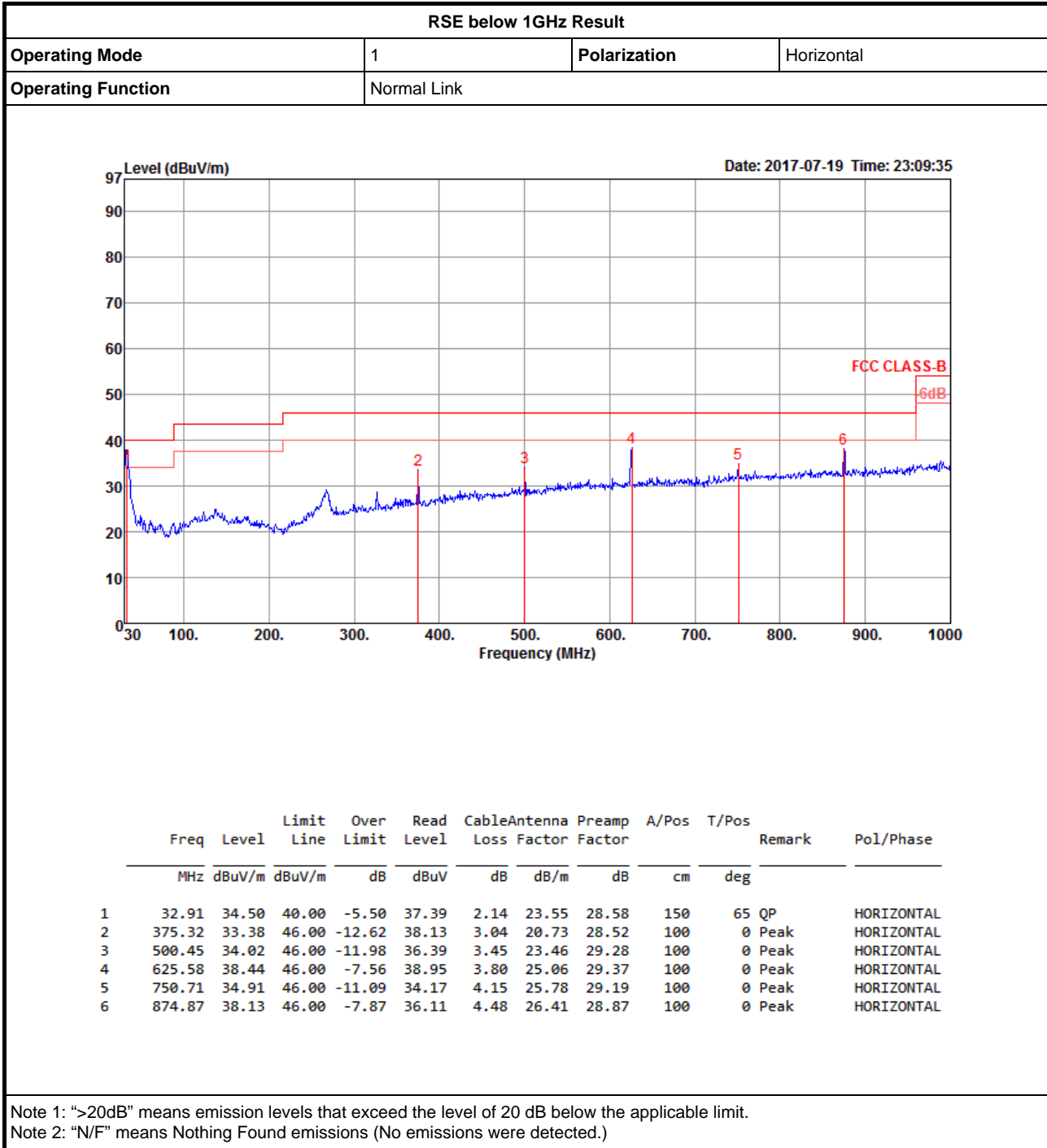



# RSE below 1GHz Result

Appendix E.1

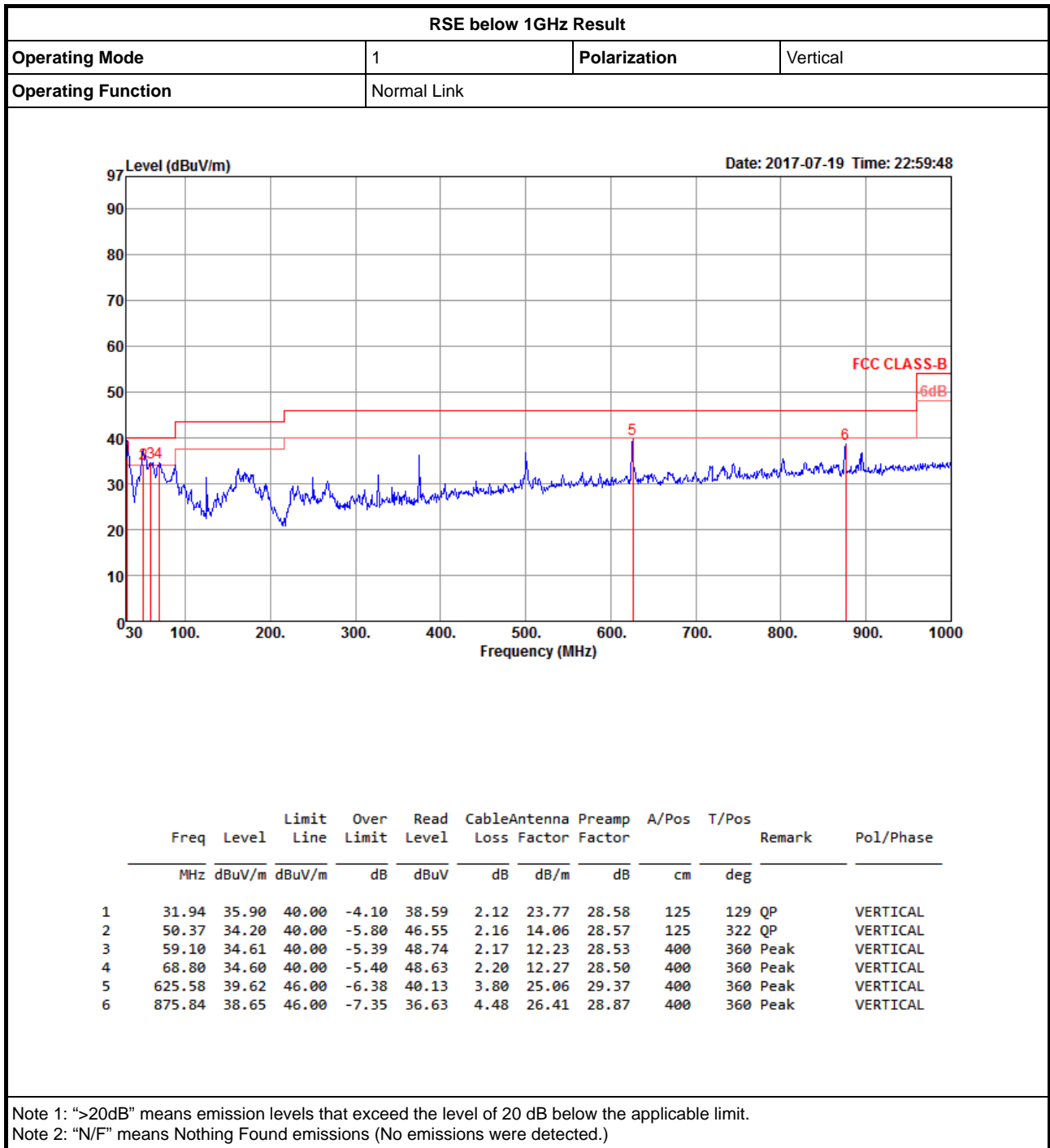



Summary

| Mode                              | Result | Type | Freq (Hz) | Level (dBuV/m) | Limit (dBuV/m) | Margin (dB) | Factor (dB) | Dist (m) | Pol. (H/V) | Azimuth (°) | Height (m) | Comments |
|-----------------------------------|--------|------|-----------|----------------|----------------|-------------|-------------|----------|------------|-------------|------------|----------|
| 802.11ac VHT20-BF_Nss1,(MCS0)_3TX | -      | -    | -         | -              | -              | -           | -           | -        | -          | -           | -          | -        |
| 5.725-5.85GHz                     | Pass   | PK   | 5.9362G   | 68.19          | 68.20          | -0.01       | 8.85        | 3        | V          | 342         | 1.56       | -        |



### 802.11a\_(6Mbps)\_3TX

### 5180MHz\_TX

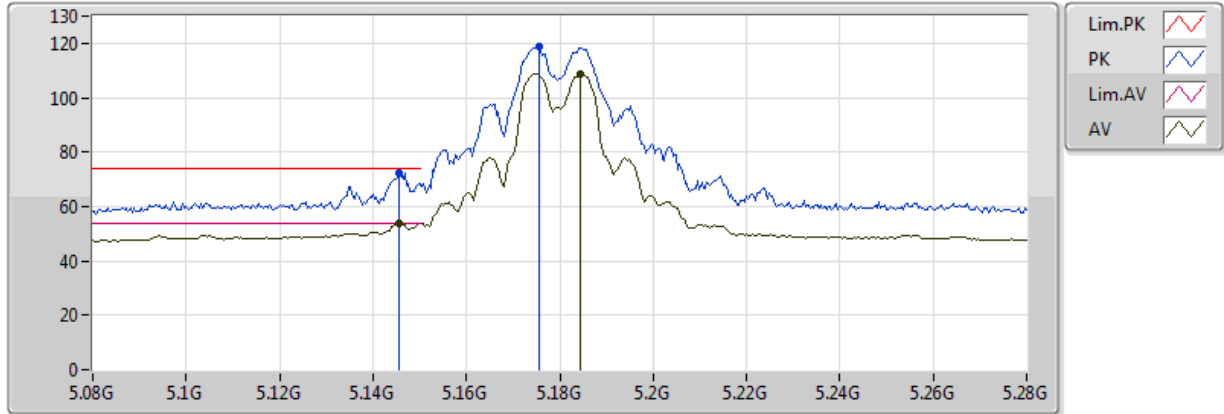

20170616  
EUT\_Y\_3TX  
Setting 66  
02-W-3-10  
FSU

| Type | Freq(Hz) | Level(dBuV/m) | Limit(dBuV/m) | Margin(dB) | Factor(dB) | Dist(m) | Pol.(H/V) | Azimuth(°) | Height(m) | Comments |
|------|----------|---------------|---------------|------------|------------|---------|-----------|------------|-----------|----------|
| AV   | 5.1456G  | 53.85         | 54.00         | -0.15      | 9.02       | 3       | V         | 1          | 2.43      | -        |
| AV   | 5.1844G  | 108.71        | Inf           | -Inf       | 9.12       | 3       | V         | 1          | 2.43      | -        |
| PK   | 5.1456G  | 72.47         | 74.00         | -1.53      | 9.02       | 3       | V         | 1          | 2.43      | -        |
| PK   | 5.1756G  | 118.70        | Inf           | -Inf       | 9.10       | 3       | V         | 1          | 2.43      | -        |

### 802.11a\_(6Mbps)\_3TX

### 5180MHz\_TX

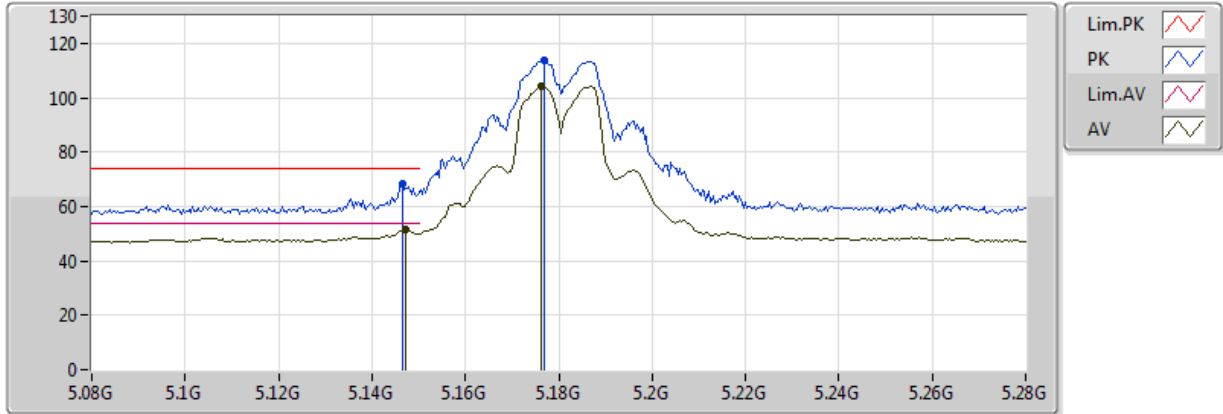

20170616  
EUT\_Y\_3TX  
Setting 66  
02-W-3-10  
FSU

| Type | Freq(Hz) | Level(dBuV/m) | Limit(dBuV/m) | Margin(dB) | Factor(dB) | Dist(m) | Pol.(H/V) | Azimuth(°) | Height(m) | Comments |
|------|----------|---------------|---------------|------------|------------|---------|-----------|------------|-----------|----------|
| AV   | 5.1472G  | 51.28         | 54.00         | -2.72      | 9.03       | 3       | H         | 4          | 1.72      | -        |
| AV   | 5.1764G  | 104.28        | Inf           | -Inf       | 9.10       | 3       | H         | 4          | 1.72      | -        |
| PK   | 5.1464G  | 68.33         | 74.00         | -5.67      | 9.03       | 3       | H         | 4          | 1.72      | -        |
| PK   | 5.1768G  | 113.67        | Inf           | -Inf       | 9.10       | 3       | H         | 4          | 1.72      | -        |

### 802.11a\_(6Mbps)\_3TX

### 5180MHz\_TX

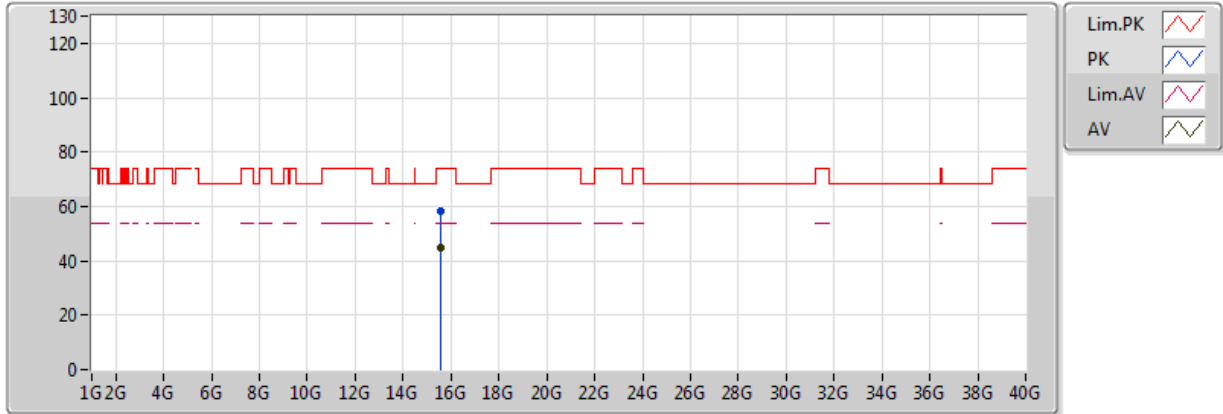

20170616  
EUT\_Y\_3TX  
Setting 66  
02-W-3  
FSU

| Type | Freq(Hz)   | Level(dBuV/m) | Limit(dBuV/m) | Margin(dB) | Factor(dB) | Dist(m) | Pol.(H/V) | Azimuth(°) | Height(m) | Comments |
|------|------------|---------------|---------------|------------|------------|---------|-----------|------------|-----------|----------|
| AV   | 15.542784G | 44.83         | 54.00         | -9.17      | 18.02      | 3       | V         | 24         | 1.02      | -        |
| PK   | 15.54246G  | 58.12         | 74.00         | -15.88     | 18.02      | 3       | V         | 24         | 1.02      | -        |



### 802.11a\_(6Mbps)\_3TX

### 5180MHz\_TX

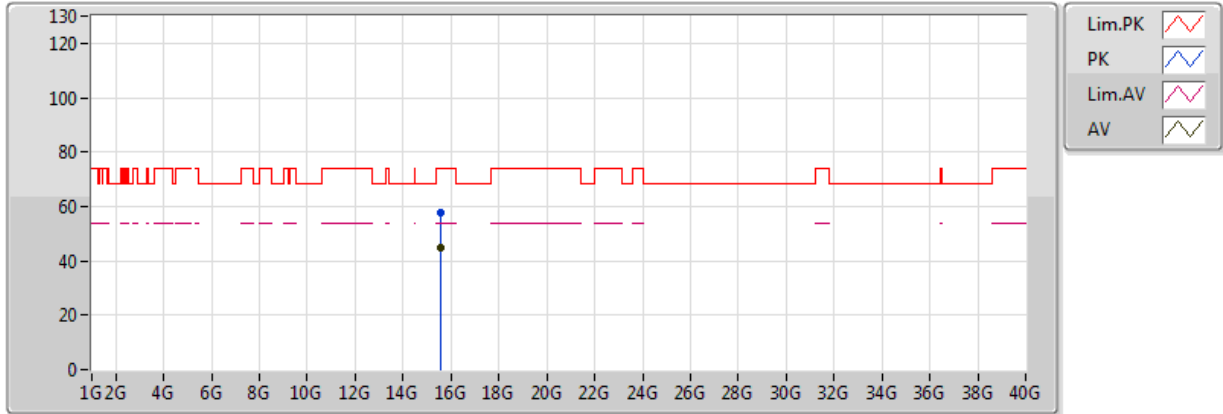

20170616  
EUT\_Y\_3TX  
Setting 66  
02-W-3  
FSU

| Type | Freq(Hz)   | Level(dBuV/m) | Limit(dBuV/m) | Margin(dB) | Factor(dB) | Dist(m) | Pol.(H/V) | Azimuth(°) | Height(m) | Comments |
|------|------------|---------------|---------------|------------|------------|---------|-----------|------------|-----------|----------|
| AV   | 15.539952G | 44.56         | 54.00         | -9.44      | 18.03      | 3       | H         | 164        | 1.57      | -        |
| PK   | 15.539484G | 57.93         | 74.00         | -16.07     | 18.03      | 3       | H         | 164        | 1.57      | -        |

### 802.11a\_(6Mbps)\_3TX

### 5200MHz\_TX

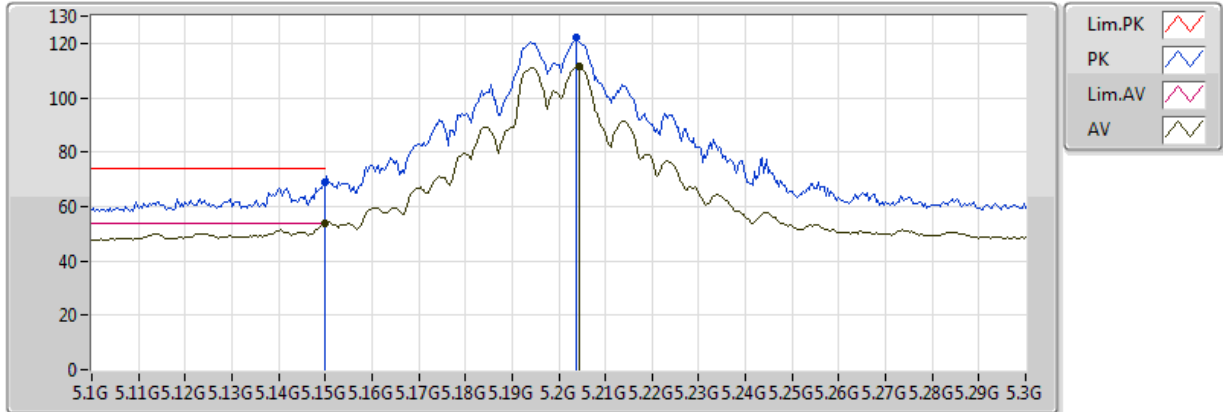

20170616  
EUT\_Y\_3TX  
Setting 79  
02-W-3-10  
FSU

| Type | Freq(Hz)  | Level(dBuV/m) | Limit(dBuV/m) | Margin(dB) | Factor(dB) | Dist(m) | Pol.(H/V) | Azimuth(°) | Height(m) | Comments |
|------|-----------|---------------|---------------|------------|------------|---------|-----------|------------|-----------|----------|
| AV   | 5.149995G | 53.98         | 54.00         | -0.02      | 9.03       | 3       | V         | 1          | 2.75      | -        |
| AV   | 5.2044G   | 111.49        | Inf           | -Inf       | 9.17       | 3       | V         | 1          | 2.75      | -        |
| PK   | 5.149995G | 69.12         | 74.00         | -4.88      | 9.03       | 3       | V         | 1          | 2.75      | -        |
| PK   | 5.2036G   | 122.21        | Inf           | -Inf       | 9.17       | 3       | V         | 1          | 2.75      | -        |

### 802.11a\_(6Mbps)\_3TX

### 5200MHz\_TX

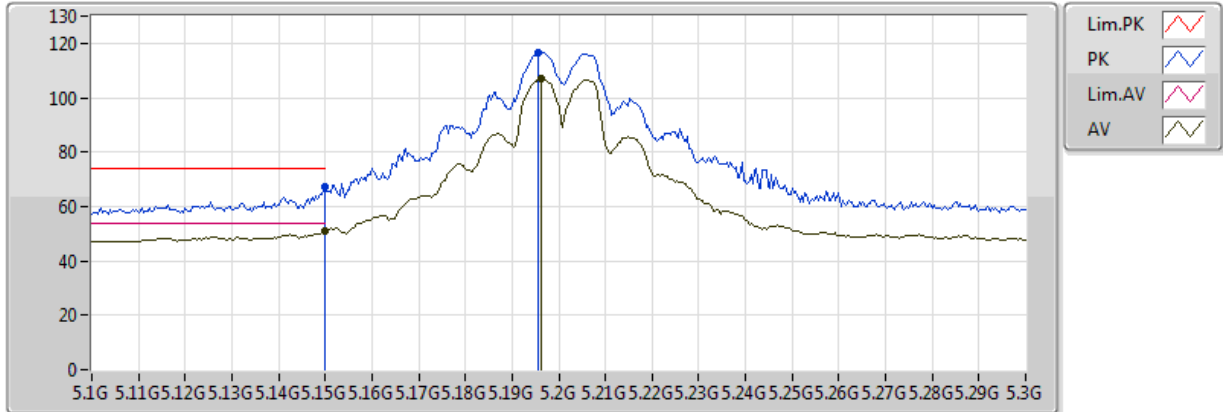

20170616  
EUT\_Y\_3TX  
Setting 79  
02-W-3-10  
FSU

| Type | Freq(Hz)  | Level(dBuV/m) | Limit(dBuV/m) | Margin(dB) | Factor(dB) | Dist(m) | Pol.(H/V) | Azimuth(°) | Height(m) | Comments |
|------|-----------|---------------|---------------|------------|------------|---------|-----------|------------|-----------|----------|
| AV   | 5.149995G | 50.92         | 54.00         | -3.08      | 9.03       | 3       | H         | 1          | 1.81      | -        |
| AV   | 5.1964G   | 107.19        | Inf           | -Inf       | 9.15       | 3       | H         | 1          | 1.81      | -        |
| PK   | 5.149995G | 67.31         | 74.00         | -6.69      | 9.03       | 3       | H         | 1          | 1.81      | -        |
| PK   | 5.1956G   | 116.69        | Inf           | -Inf       | 9.15       | 3       | H         | 1          | 1.81      | -        |



### 802.11a\_(6Mbps)\_3TX

### 5200MHz\_TX

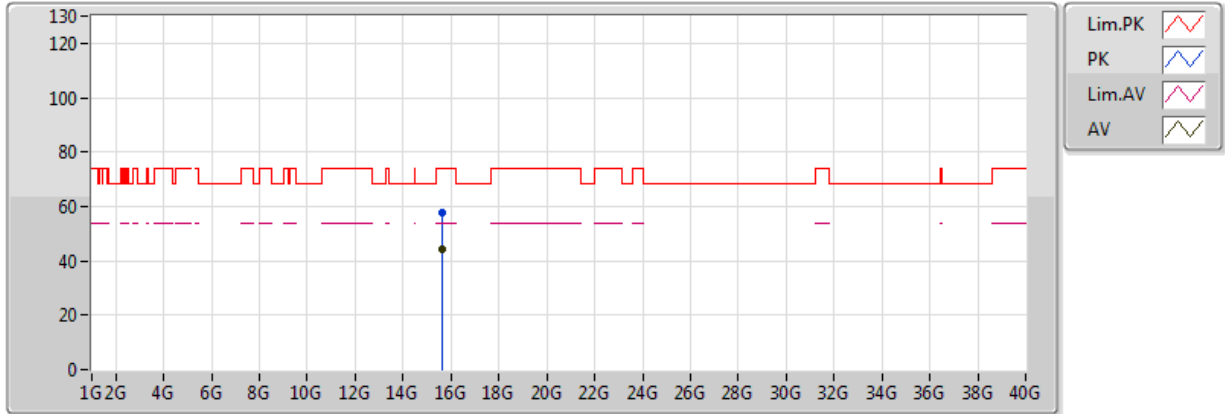

20170616  
EUT\_Y\_3TX  
Setting 79  
02-W-3  
FSU

| Type | Freq(Hz)  | Level(dBuV/m) | Limit(dBuV/m) | Margin(dB) | Factor(dB) | Dist(m) | Pol.(H/V) | Azimuth(°) | Height(m) | Comments |
|------|-----------|---------------|---------------|------------|------------|---------|-----------|------------|-----------|----------|
| AV   | 15.60157G | 44.42         | 54.00         | -9.58      | 17.89      | 3       | V         | 287        | 1.29      | -        |
| PK   | 15.60187G | 57.89         | 74.00         | -16.11     | 17.89      | 3       | V         | 287        | 1.29      | -        |

### 802.11a\_(6Mbps)\_3TX

### 5200MHz\_TX

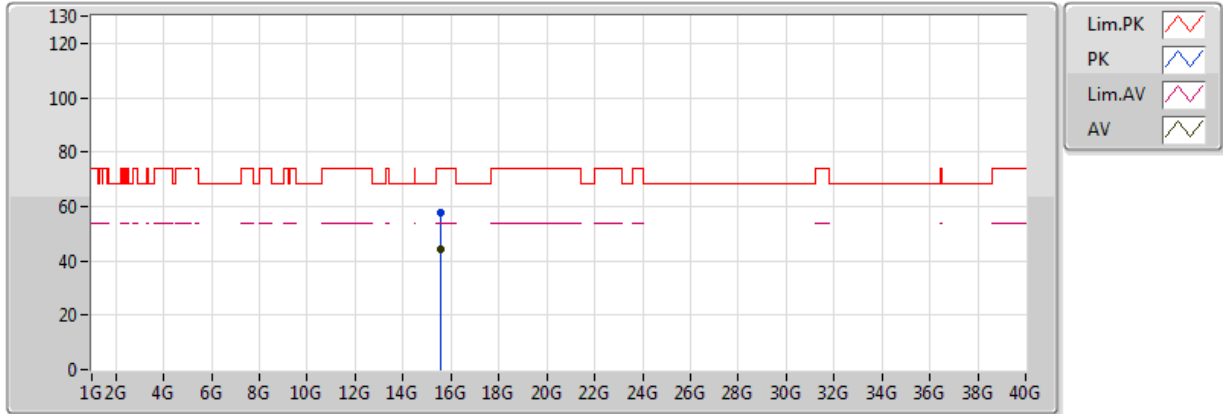

20170616  
EUT\_Y\_3TX  
Setting 79  
02-W-3  
FSU

| Type | Freq(Hz)   | Level(dBuV/m) | Limit(dBuV/m) | Margin(dB) | Factor(dB) | Dist(m) | Pol.(H/V) | Azimuth(°) | Height(m) | Comments |
|------|------------|---------------|---------------|------------|------------|---------|-----------|------------|-----------|----------|
| AV   | 15.599984G | 44.39         | 54.00         | -9.61      | 17.90      | 3       | H         | 222        | 1.47      | -        |
| PK   | 15.600472G | 57.64         | 74.00         | -16.36     | 17.90      | 3       | H         | 222        | 1.47      | -        |



### 802.11a\_(6Mbps)\_3TX

### 5240MHz\_TX

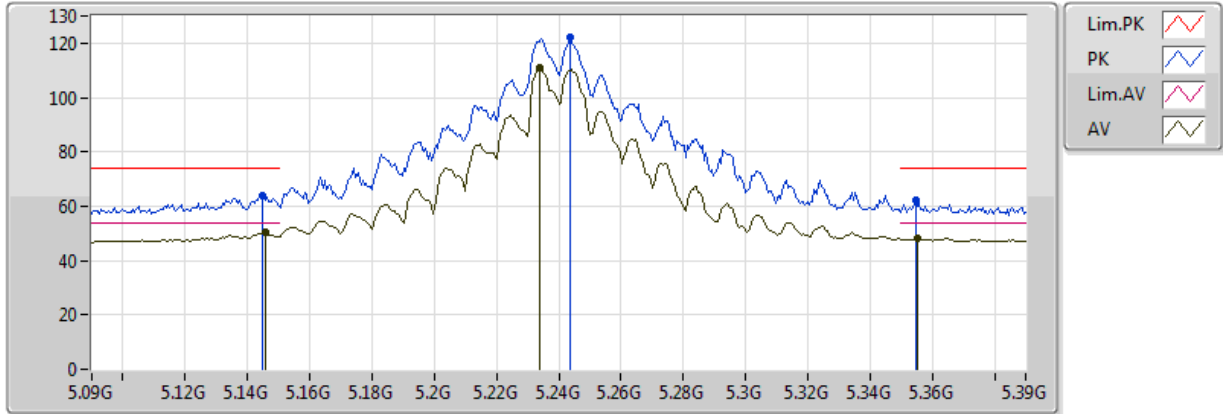

20170616  
 EUT Y\_3TX  
 Setting 120(Max setting)  
 02-W-3-10  
 FSU

| Type | Freq(Hz) | Level(dBuV/m) | Limit(dBuV/m) | Margin(dB) | Factor(dB) | Dist(m) | Pol.(H/V) | Azimuth(°) | Height(m) | Comments |
|------|----------|---------------|---------------|------------|------------|---------|-----------|------------|-----------|----------|
| AV   | 5.1458G  | 50.19         | 54.00         | -3.81      | 9.02       | 3       | V         | 333        | 1.10      | -        |
| AV   | 5.234G   | 110.75        | Inf           | -Inf       | 9.22       | 3       | V         | 333        | 1.10      | -        |
| AV   | 5.3552G  | 48.30         | 54.00         | -5.70      | 9.44       | 3       | V         | 333        | 1.10      | -        |
| PK   | 5.1446G  | 63.95         | 74.00         | -10.05     | 9.02       | 3       | V         | 333        | 1.10      | -        |
| PK   | 5.2436G  | 122.37        | Inf           | -Inf       | 9.24       | 3       | V         | 333        | 1.10      | -        |
| PK   | 5.3546G  | 62.12         | 74.00         | -11.88     | 9.44       | 3       | V         | 333        | 1.10      | -        |

### 802.11a\_(6Mbps)\_3TX

### 5240MHz\_TX

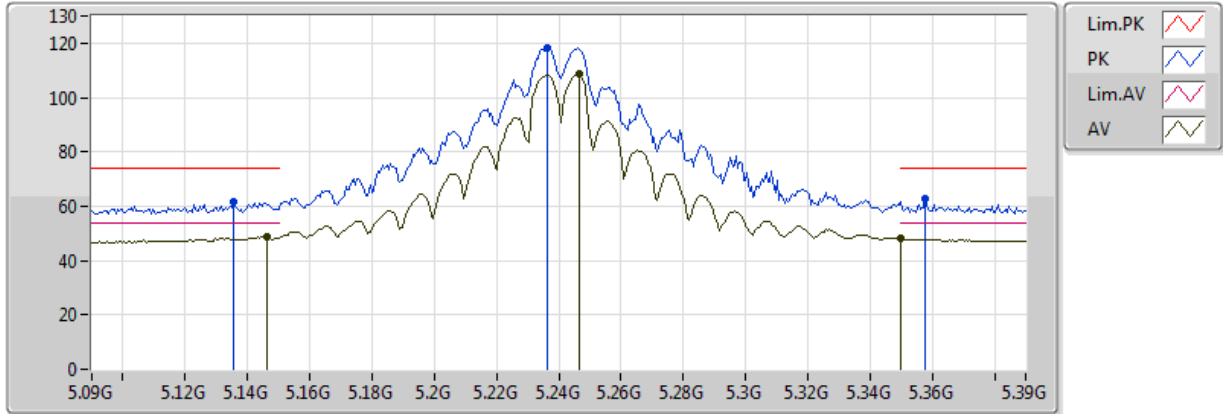

20170616  
 EUT\_Y\_3TX  
 Setting 120(Max setting)  
 02-W-3-10  
 FSU

| Type | Freq(Hz)  | Level(dBuV/m) | Limit(dBuV/m) | Margin(dB) | Factor(dB) | Dist(m) | Pol.(H/V) | Azimuth(°) | Height(m) | Comments |
|------|-----------|---------------|---------------|------------|------------|---------|-----------|------------|-----------|----------|
| AV   | 5.1464G   | 48.86         | 54.00         | -5.14      | 9.03       | 3       | H         | 7          | 1.91      | -        |
| AV   | 5.2466G   | 108.43        | Inf           | -Inf       | 9.25       | 3       | H         | 7          | 1.91      | -        |
| AV   | 5.350005G | 48.01         | 54.00         | -5.99      | 9.44       | 3       | H         | 7          | 1.91      | -        |
| PK   | 5.1356G   | 61.67         | 74.00         | -12.33     | 9.00       | 3       | H         | 7          | 1.91      | -        |
| PK   | 5.2364G   | 118.51        | Inf           | -Inf       | 9.23       | 3       | H         | 7          | 1.91      | -        |
| PK   | 5.3576G   | 62.57         | 74.00         | -11.43     | 9.45       | 3       | H         | 7          | 1.91      | -        |

### 802.11a\_(6Mbps)\_3TX

### 5240MHz\_TX

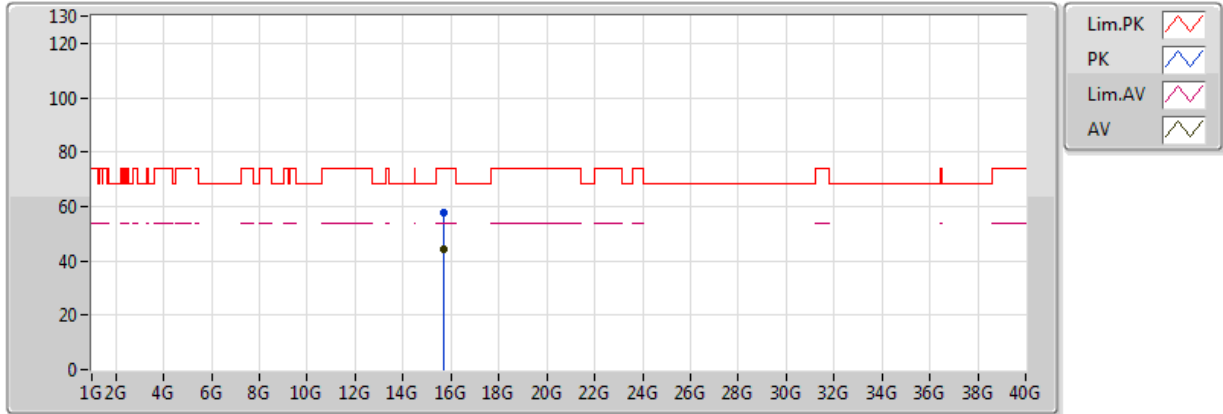

20170616  
 EUT\_Y\_3TX  
 Setting 120(Max setting)  
 02-W-3  
 FSU

| Type | Freq(Hz)  | Level(dBuV/m) | Limit(dBuV/m) | Margin(dB) | Factor(dB) | Dist(m) | Pol.(H/V) | Azimuth(°) | Height(m) | Comments |
|------|-----------|---------------|---------------|------------|------------|---------|-----------|------------|-----------|----------|
| AV   | 15.72388G | 44.48         | 54.00         | -9.52      | 17.63      | 3       | V         | 354        | 1.73      | -        |
| PK   | 15.71846G | 57.87         | 74.00         | -16.13     | 17.64      | 3       | V         | 354        | 1.73      | -        |

### 802.11a\_(6Mbps)\_3TX

### 5240MHz\_TX

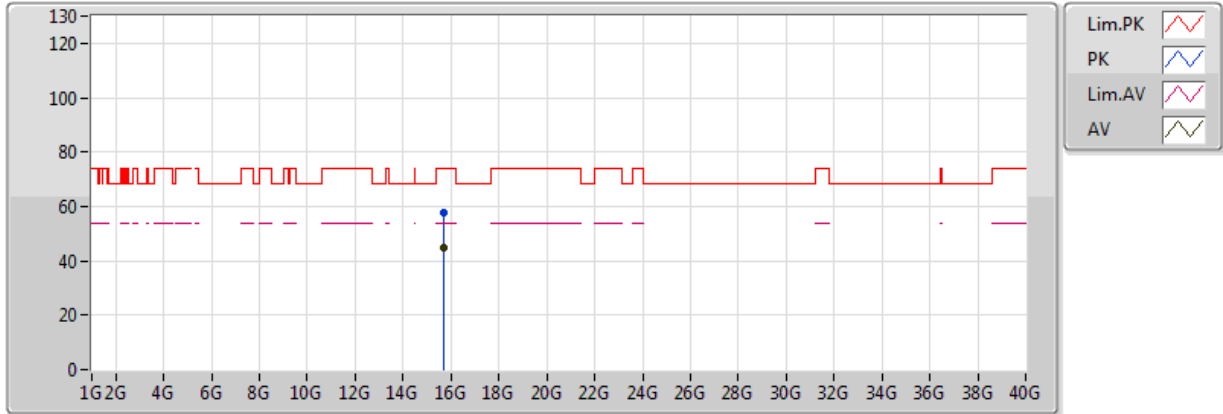

20170616  
 EUT\_Y\_3TX  
 Setting 120(Max setting)  
 02-W-3  
 FSU

| Type | Freq(Hz)   | Level(dBuV/m) | Limit(dBuV/m) | Margin(dB) | Factor(dB) | Dist(m) | Pol.(H/V) | Azimuth(°) | Height(m) | Comments |
|------|------------|---------------|---------------|------------|------------|---------|-----------|------------|-----------|----------|
| AV   | 15.719788G | 44.57         | 54.00         | -9.43      | 17.64      | 3       | H         | 242        | 1.64      | -        |
| PK   | 15.719504G | 57.80         | 74.00         | -16.20     | 17.64      | 3       | H         | 242        | 1.64      | -        |

### 802.11a\_(6Mbps)\_3TX

### 5745MHz\_TX

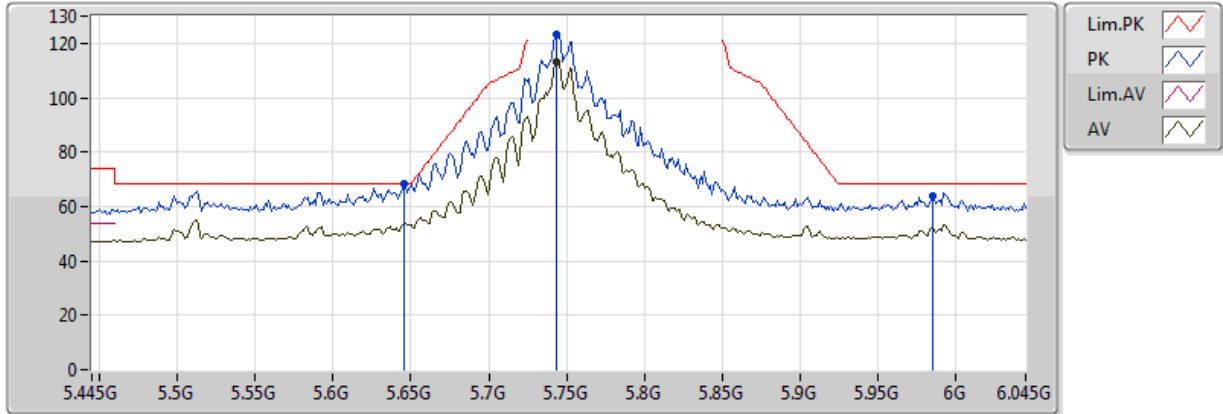

20170616  
EUT\_Y\_3TX  
Setting 110  
02-W-3-10  
FSU

| Type | Freq(Hz) | Level(dBuV/m) | Limit(dBuV/m) | Margin(dB) | Factor(dB) | Dist(m) | Pol.(H/V) | Azimuth(°) | Height(m) | Comments |
|------|----------|---------------|---------------|------------|------------|---------|-----------|------------|-----------|----------|
| AV   | 5.7438G  | 113.06        | Inf           | -Inf       | 9.91       | 3       | V         | 355        | 1.26      | -        |
| PK   | 5.6454G  | 68.09         | 68.20         | -0.11      | 9.89       | 3       | V         | 355        | 1.26      | -        |
| PK   | 5.7438G  | 123.42        | Inf           | -Inf       | 9.91       | 3       | V         | 355        | 1.26      | -        |
| PK   | 5.985G   | 63.64         | 68.20         | -4.56      | 10.18      | 3       | V         | 355        | 1.26      | -        |

### 802.11a\_(6Mbps)\_3TX

### 5745MHz\_TX

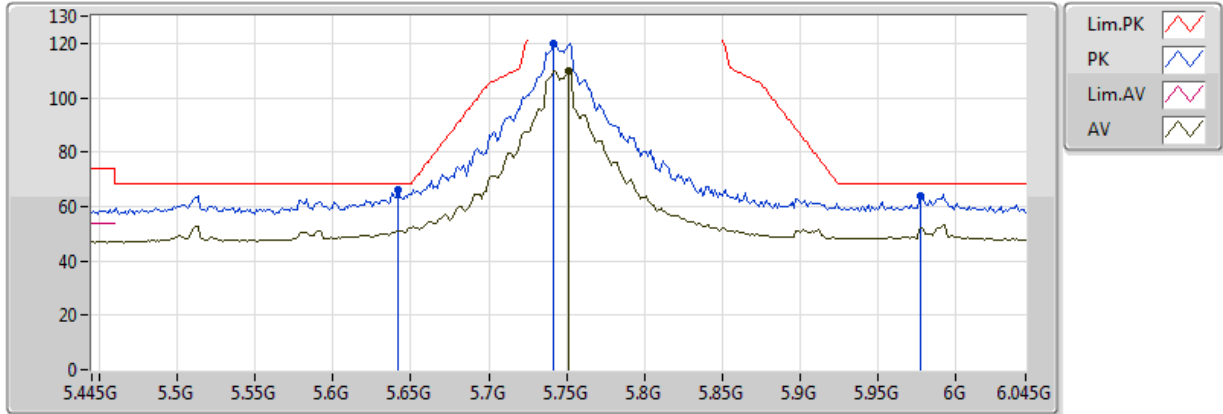

20170616  
EUT\_Y\_3TX  
Setting 110  
02-W-3-10  
FSU

| Type | Freq(Hz) | Level(dBuV/m) | Limit(dBuV/m) | Margin(dB) | Factor(dB) | Dist(m) | Pol.(H/V) | Azimuth(°) | Height(m) | Comments |
|------|----------|---------------|---------------|------------|------------|---------|-----------|------------|-----------|----------|
| AV   | 5.751G   | 109.91        | Inf           | -Inf       | 9.91       | 3       | H         | 3          | 1.00      | -        |
| PK   | 5.6418G  | 66.09         | 68.20         | -2.11      | 9.89       | 3       | H         | 3          | 1.00      | -        |
| PK   | 5.7414G  | 119.80        | Inf           | -Inf       | 9.91       | 3       | H         | 3          | 1.00      | -        |
| PK   | 5.9778G  | 63.92         | 68.20         | -4.28      | 10.17      | 3       | H         | 3          | 1.00      | -        |

### 802.11a\_(6Mbps)\_3TX

### 5745MHz\_TX

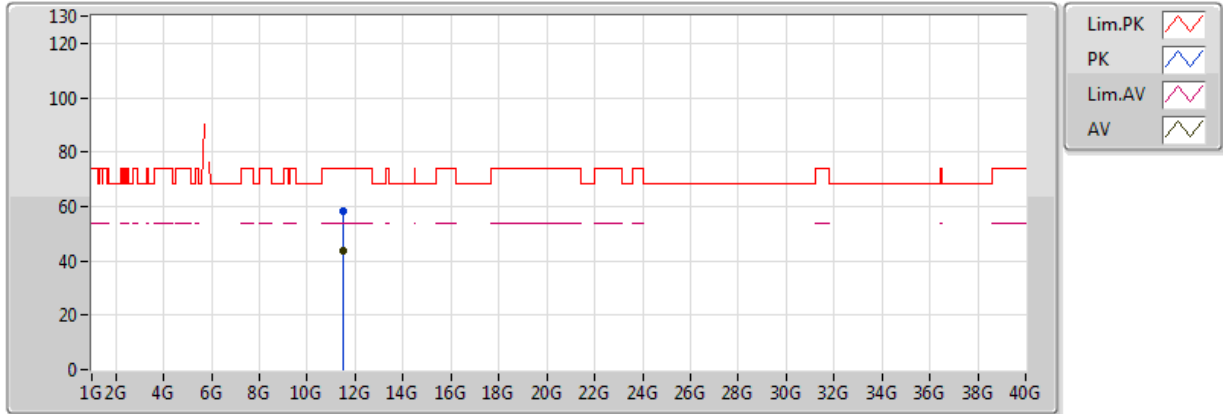

20170616  
EUT\_Y\_3TX  
Setting 110  
02-W-3  
FSU

| Type | Freq(Hz)  | Level(dBuV/m) | Limit(dBuV/m) | Margin(dB) | Factor(dB) | Dist(m) | Pol.(H/V) | Azimuth(°) | Height(m) | Comments |
|------|-----------|---------------|---------------|------------|------------|---------|-----------|------------|-----------|----------|
| AV   | 11.49316G | 43.68         | 54.00         | -10.32     | 16.37      | 3       | V         | 323        | 1.15      | -        |
| PK   | 11.49436G | 58.20         | 74.00         | -15.80     | 16.37      | 3       | V         | 323        | 1.15      | -        |

### 802.11a\_(6Mbps)\_3TX

### 5745MHz\_TX

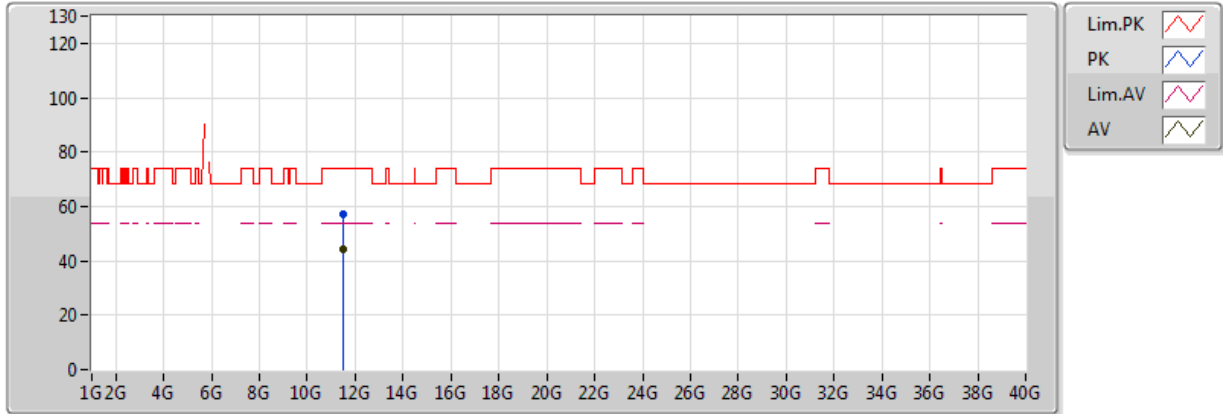

20170616  
EUT\_Y\_3TX  
Setting 110  
02-W-3  
FSU

| Type | Freq(Hz)  | Level(dBuV/m) | Limit(dBuV/m) | Margin(dB) | Factor(dB) | Dist(m) | Pol.(H/V) | Azimuth(°) | Height(m) | Comments |
|------|-----------|---------------|---------------|------------|------------|---------|-----------|------------|-----------|----------|
| AV   | 11.49282G | 44.08         | 54.00         | -9.92      | 16.37      | 3       | H         | 141        | 1.73      | -        |
| PK   | 11.48898G | 57.42         | 74.00         | -16.58     | 16.36      | 3       | H         | 141        | 1.73      | -        |



### 802.11a\_(6Mbps)\_3TX

### 5785MHz\_TX

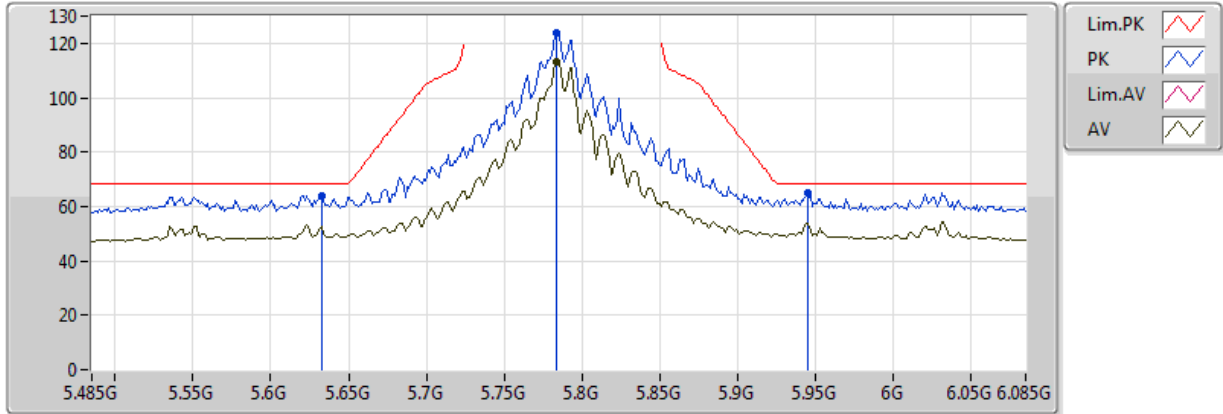

20170616  
 EUT\_Y\_3TX  
 Setting 120(Max setting)  
 02-W-3-10  
 FSU

| Type | Freq(Hz) | Level(dBuV/m) | Limit(dBuV/m) | Margin(dB) | Factor(dB) | Dist(m) | Pol.(H/V) | Azimuth(°) | Height(m) | Comments |
|------|----------|---------------|---------------|------------|------------|---------|-----------|------------|-----------|----------|
| AV   | 5.7838G  | 113.24        | Inf           | -Inf       | 9.92       | 3       | V         | 357        | 1.21      | -        |
| PK   | 5.6326G  | 63.90         | 68.20         | -4.30      | 9.89       | 3       | V         | 357        | 1.21      | -        |
| PK   | 5.7838G  | 124.03        | Inf           | -Inf       | 9.92       | 3       | V         | 357        | 1.21      | -        |
| PK   | 5.9446G  | 65.09         | 68.20         | -3.11      | 10.12      | 3       | V         | 357        | 1.21      | -        |

### 802.11a\_(6Mbps)\_3TX

### 5785MHz\_TX

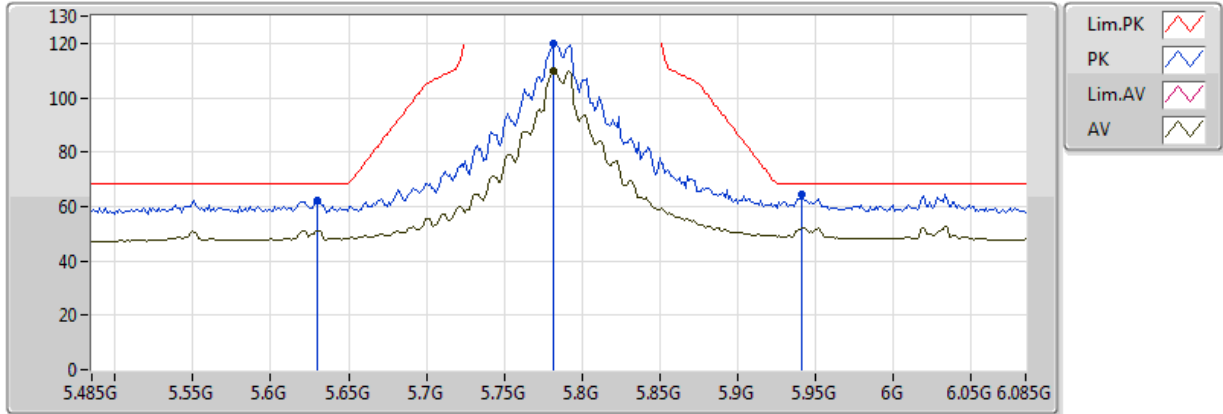

20170616  
 EUT\_Y\_3TX  
 Setting 120(Max setting)  
 02-W-3-10  
 FSU

| Type | Freq(Hz) | Level(dBuV/m) | Limit(dBuV/m) | Margin(dB) | Factor(dB) | Dist(m) | Pol.(H/V) | Azimuth(°) | Height(m) | Comments |
|------|----------|---------------|---------------|------------|------------|---------|-----------|------------|-----------|----------|
| AV   | 5.7814G  | 109.86        | Inf           | -Inf       | 9.92       | 3       | H         | 23         | 1.05      | -        |
| PK   | 5.6302G  | 62.26         | 68.20         | -5.94      | 9.89       | 3       | H         | 23         | 1.05      | -        |
| PK   | 5.7814G  | 119.87        | Inf           | -Inf       | 9.92       | 3       | H         | 23         | 1.05      | -        |
| PK   | 5.941G   | 64.69         | 68.20         | -3.51      | 10.12      | 3       | H         | 23         | 1.05      | -        |

### 802.11a\_(6Mbps)\_3TX

### 5785MHz\_TX

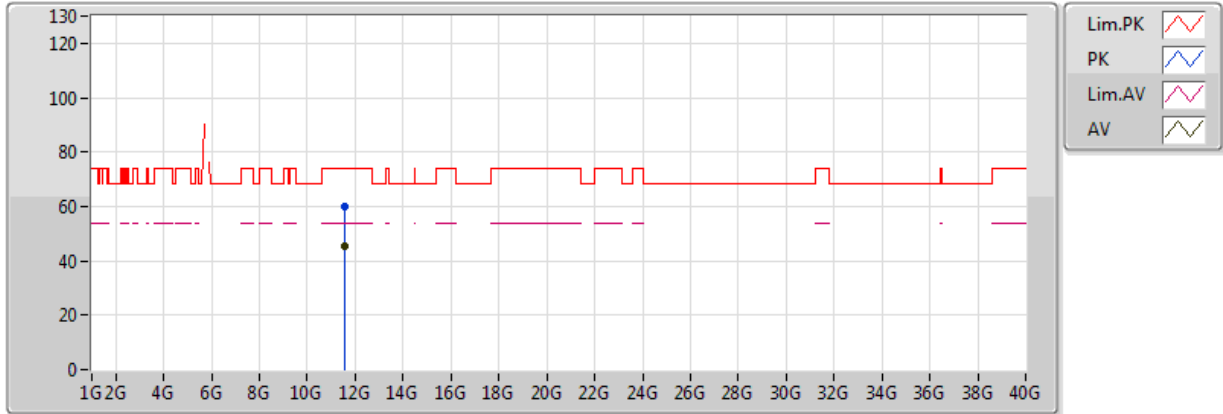

20170616  
 EUT Y\_3TX  
 Setting 120(Max setting)  
 02-W-3  
 FSU

| Type | Freq(Hz)  | Level(dBuV/m) | Limit(dBuV/m) | Margin(dB) | Factor(dB) | Dist(m) | Pol.(H/V) | Azimuth(°) | Height(m) | Comments |
|------|-----------|---------------|---------------|------------|------------|---------|-----------|------------|-----------|----------|
| AV   | 11.57236G | 45.43         | 54.00         | -8.57      | 16.45      | 3       | V         | 334        | 3.00      | -        |
| PK   | 11.57324G | 59.95         | 74.00         | -14.05     | 16.45      | 3       | V         | 334        | 3.00      | -        |

### 802.11a\_(6Mbps)\_3TX

### 5785MHz\_TX

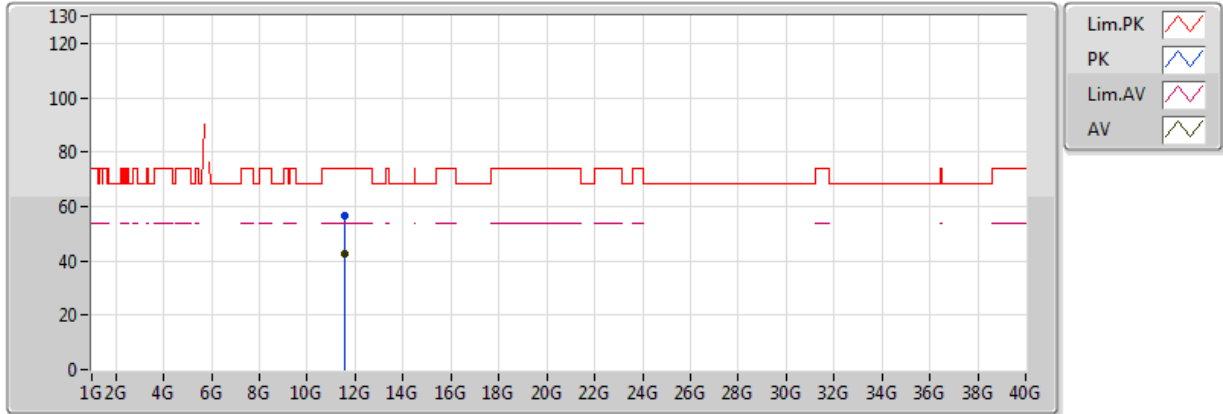

20170616  
 EUT\_Y\_3TX  
 Setting 120(Max setting)  
 02-W-3  
 FSU

| Type | Freq(Hz)  | Level(dBuV/m) | Limit(dBuV/m) | Margin(dB) | Factor(dB) | Dist(m) | Pol.(H/V) | Azimuth(°) | Height(m) | Comments |
|------|-----------|---------------|---------------|------------|------------|---------|-----------|------------|-----------|----------|
| AV   | 11.57078G | 42.84         | 54.00         | -11.16     | 16.45      | 3       | H         | 299        | 2.21      | -        |
| PK   | 11.5697G  | 56.72         | 74.00         | -17.28     | 16.45      | 3       | H         | 299        | 2.21      | -        |

### 802.11a\_(6Mbps)\_3TX

### 5825MHz\_TX

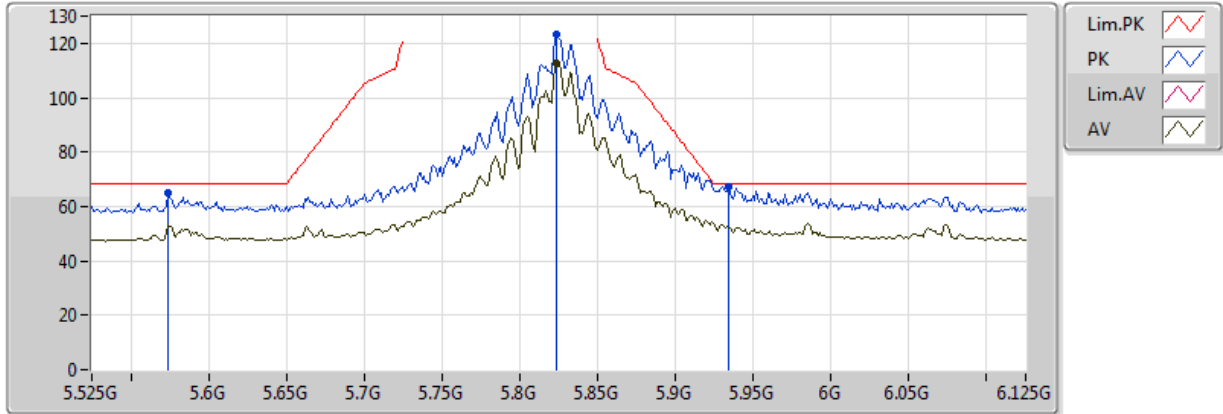

20170616  
 EUT\_Y\_3TX  
 Setting 120(Max setting)  
 02-W-3-10  
 FSU

| Type | Freq(Hz) | Level(dBuV/m) | Limit(dBuV/m) | Margin(dB) | Factor(dB) | Dist(m) | Pol.(H/V) | Azimuth(°) | Height(m) | Comments |
|------|----------|---------------|---------------|------------|------------|---------|-----------|------------|-----------|----------|
| AV   | 5.8238G  | 112.90        | Inf           | -Inf       | 9.95       | 3       | V         | 358        | 1.10      | -        |
| PK   | 5.5742G  | 64.85         | 68.20         | -3.35      | 9.86       | 3       | V         | 358        | 1.10      | -        |
| PK   | 5.8238G  | 123.11        | Inf           | -Inf       | 9.95       | 3       | V         | 358        | 1.10      | -        |
| PK   | 5.9342G  | 67.36         | 68.20         | -0.84      | 10.11      | 3       | V         | 358        | 1.10      | -        |

### 802.11a\_(6Mbps)\_3TX

### 5825MHz\_TX

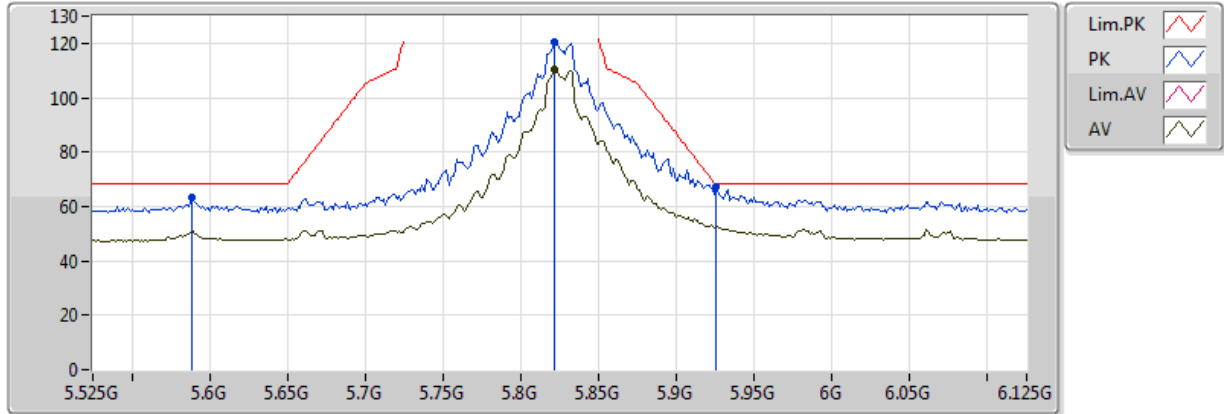

20170616  
 EUT\_Y\_3TX  
 Setting 120(Max setting)  
 02-W-3-10  
 FSU

| Type | Freq(Hz) | Level(dBuV/m) | Limit(dBuV/m) | Margin(dB) | Factor(dB) | Dist(m) | Pol.(H/V) | Azimuth(°) | Height(m) | Comments |
|------|----------|---------------|---------------|------------|------------|---------|-----------|------------|-----------|----------|
| AV   | 5.8214G  | 110.18        | Inf           | -Inf       | 9.95       | 3       | H         | 18         | 1.00      | -        |
| PK   | 5.5886G  | 63.25         | 68.20         | -4.95      | 9.87       | 3       | H         | 18         | 1.00      | -        |
| PK   | 5.8214G  | 120.24        | Inf           | -Inf       | 9.95       | 3       | H         | 18         | 1.00      | -        |
| PK   | 5.9258G  | 67.13         | 68.20         | -1.07      | 10.10      | 3       | H         | 18         | 1.00      | -        |

### 802.11a\_(6Mbps)\_3TX

### 5825MHz\_TX

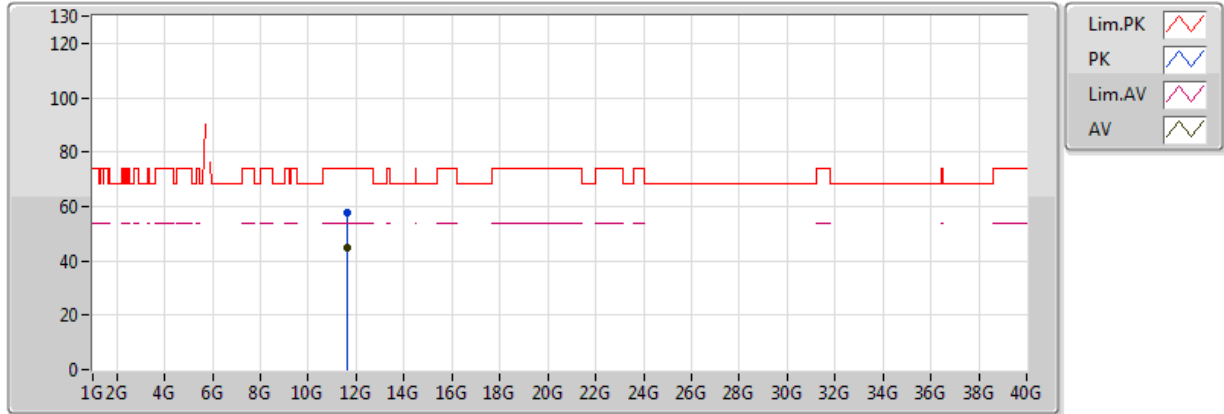

20170616  
 EUT\_Y\_3TX  
 Setting 120(Max setting)  
 02-W-3  
 FSU

| Type | Freq(Hz)  | Level(dBuV/m) | Limit(dBuV/m) | Margin(dB) | Factor(dB) | Dist(m) | Pol.(H/V) | Azimuth(°) | Height(m) | Comments |
|------|-----------|---------------|---------------|------------|------------|---------|-----------|------------|-----------|----------|
| AV   | 11.65204G | 44.73         | 54.00         | -9.27      | 16.54      | 3       | V         | 55         | 2.11      | -        |
| PK   | 11.65027G | 57.68         | 74.00         | -16.32     | 16.54      | 3       | V         | 55         | 2.11      | -        |

### 802.11a\_(6Mbps)\_3TX

### 5825MHz\_TX

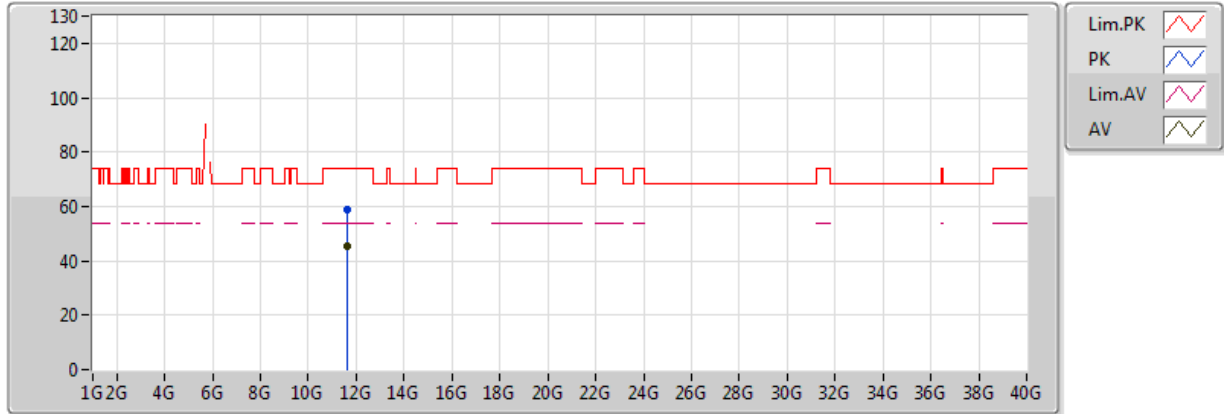

20170616  
 EUT\_Y\_3TX  
 Setting 120(Max setting)  
 02-W-3  
 FSU

| Type | Freq(Hz)  | Level(dBuV/m) | Limit(dBuV/m) | Margin(dB) | Factor(dB) | Dist(m) | Pol.(H/V) | Azimuth(°) | Height(m) | Comments |
|------|-----------|---------------|---------------|------------|------------|---------|-----------|------------|-----------|----------|
| AV   | 11.65173G | 45.54         | 54.00         | -8.46      | 16.54      | 3       | H         | 119        | 2.07      | -        |
| PK   | 11.65136G | 58.66         | 74.00         | -15.34     | 16.54      | 3       | H         | 119        | 2.07      | -        |



### 802.11ac VHT20\_Nss1,(MCS0)\_3TX

### 5180MHz\_TX

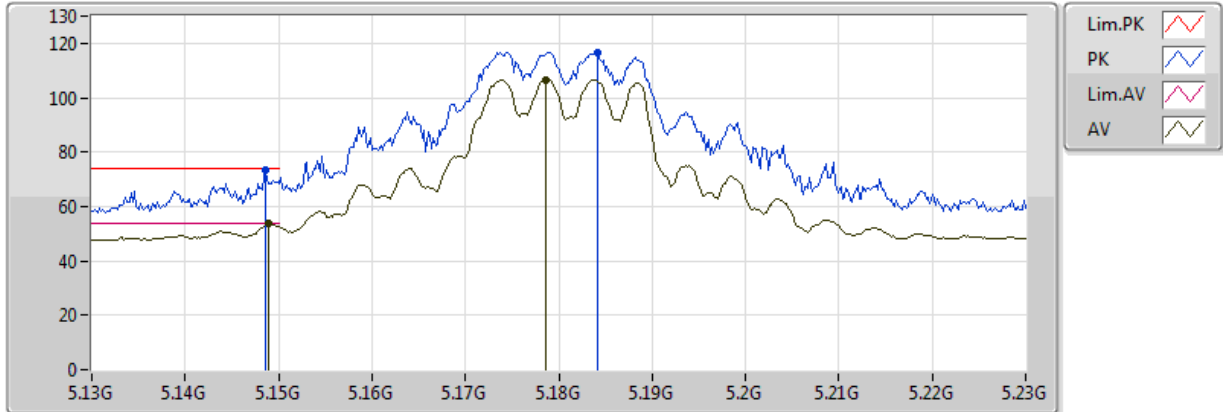

20170617  
EUT Y\_3TX  
Setting 63  
02-W-3-10  
FSU

| Type | Freq(Hz) | Level(dBuV/m) | Limit(dBuV/m) | Margin(dB) | Factor(dB) | Dist(m) | Pol.(H/V) | Azimuth(°) | Height(m) | Comments |
|------|----------|---------------|---------------|------------|------------|---------|-----------|------------|-----------|----------|
| AV   | 5.149G   | 53.80         | 54.00         | -0.20      | 9.03       | 3       | V         | 359        | 2.66      | -        |
| AV   | 5.1786G  | 106.53        | Inf           | -Inf       | 9.11       | 3       | V         | 359        | 2.66      | -        |
| PK   | 5.1486G  | 73.46         | 74.00         | -0.54      | 9.03       | 3       | V         | 359        | 2.66      | -        |
| PK   | 5.1842G  | 116.62        | Inf           | -Inf       | 9.12       | 3       | V         | 359        | 2.66      | -        |

### 802.11ac VHT20\_Nss1,(MCS0)\_3TX

### 5180MHz\_TX

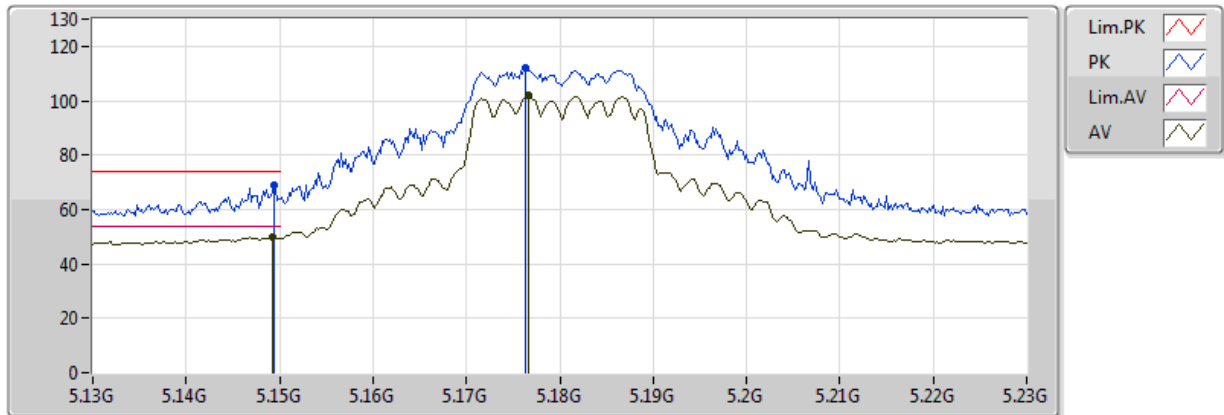

20170617  
EUT\_Y\_3TX  
Setting 63  
02-W-3-10  
FSU

| Type | Freq(Hz) | Level(dBuV/m) | Limit(dBuV/m) | Margin(dB) | Factor(dB) | Dist(m) | Pol.(H/V) | Azimuth(°) | Height(m) | Comments |
|------|----------|---------------|---------------|------------|------------|---------|-----------|------------|-----------|----------|
| AV   | 5.1492G  | 50.12         | 54.00         | -3.88      | 9.03       | 3       | H         | 1          | 1.50      | -        |
| AV   | 5.1766G  | 102.05        | Inf           | -Inf       | 9.10       | 3       | H         | 1          | 1.50      | -        |
| PK   | 5.1494G  | 69.06         | 74.00         | -4.94      | 9.03       | 3       | H         | 1          | 1.50      | -        |
| PK   | 5.1764G  | 112.04        | Inf           | -Inf       | 9.10       | 3       | H         | 1          | 1.50      | -        |

### 802.11ac VHT20\_Nss1,(MCS0)\_3TX

### 5180MHz\_TX

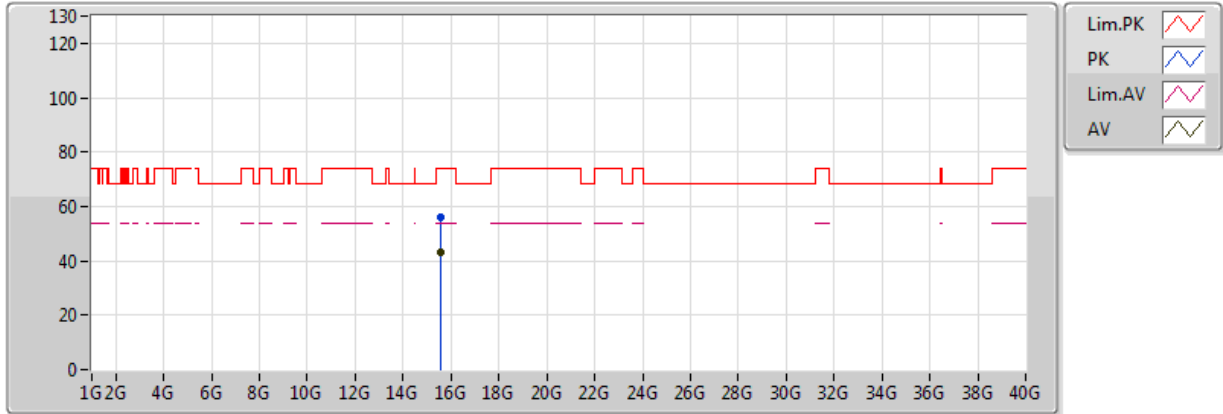

20170617  
EUT\_Y\_3TX  
Setting 63  
02-W-3  
FSU

| Type | Freq(Hz)  | Level(dBuV/m) | Limit(dBuV/m) | Margin(dB) | Factor(dB) | Dist(m) | Pol.(H/V) | Azimuth(°) | Height(m) | Comments |
|------|-----------|---------------|---------------|------------|------------|---------|-----------|------------|-----------|----------|
| AV   | 15.53909G | 43.07         | 54.00         | -10.93     | 18.03      | 3       | V         | 99         | 1.69      | -        |
| PK   | 15.54055G | 56.19         | 74.00         | -17.81     | 18.03      | 3       | V         | 99         | 1.69      | -        |

### 802.11ac VHT20\_Nss1,(MCS0)\_3TX

### 5180MHz\_TX

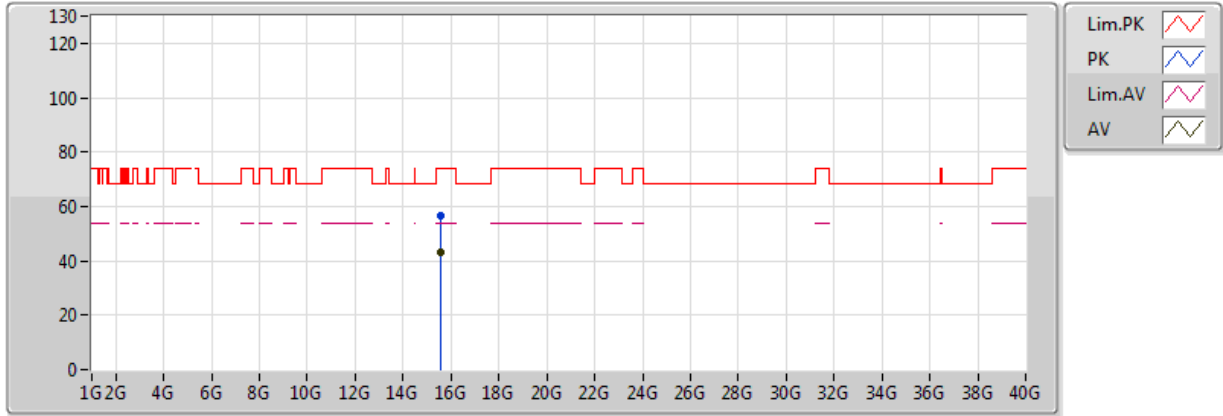

20170617  
EUT\_Y\_3TX  
Setting 63  
02-W-3  
FSU

| Type | Freq(Hz)  | Level(dBuV/m) | Limit(dBuV/m) | Margin(dB) | Factor(dB) | Dist(m) | Pol.(H/V) | Azimuth(°) | Height(m) | Comments |
|------|-----------|---------------|---------------|------------|------------|---------|-----------|------------|-----------|----------|
| AV   | 15.54057G | 43.24         | 54.00         | -10.76     | 18.03      | 3       | H         | 203        | 2.18      | -        |
| PK   | 15.53947G | 56.65         | 74.00         | -17.35     | 18.03      | 3       | H         | 203        | 2.18      | -        |

### 802.11ac VHT20\_Nss1,(MCS0)\_3TX

### 5200MHz\_TX

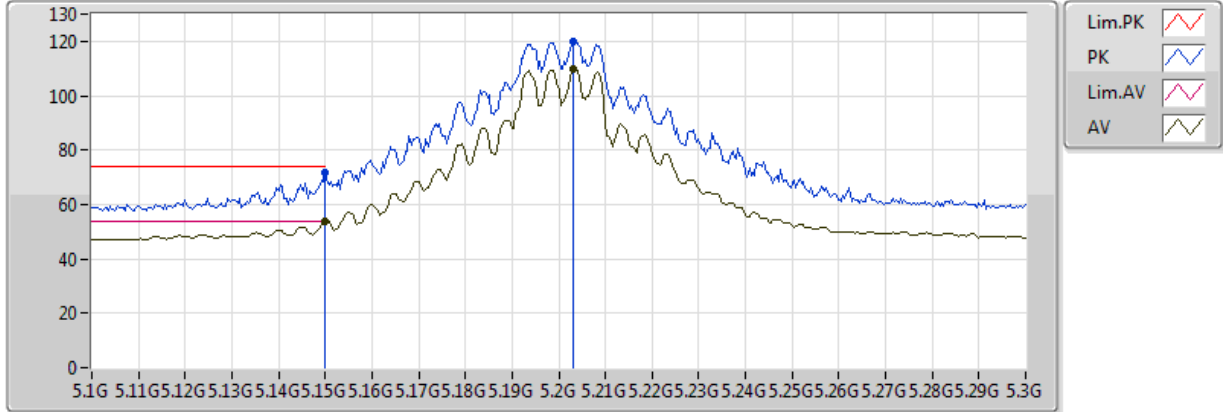

20170617  
 EUT\_Y\_3TX  
 Setting 78  
 02-W-3-10  
 FSU

| Type | Freq(Hz)  | Level(dBuV/m) | Limit(dBuV/m) | Margin(dB) | Factor(dB) | Dist(m) | Pol.(H/V) | Azimuth(°) | Height(m) | Comments |
|------|-----------|---------------|---------------|------------|------------|---------|-----------|------------|-----------|----------|
| AV   | 5.149995G | 53.97         | 54.00         | -0.03      | 9.03       | 3       | V         | 1          | 2.64      | -        |
| AV   | 5.2032G   | 109.78        | Inf           | -Inf       | 9.17       | 3       | V         | 1          | 2.64      | -        |
| PK   | 5.149995G | 71.87         | 74.00         | -2.13      | 9.03       | 3       | V         | 1          | 2.64      | -        |
| PK   | 5.2032G   | 120.02        | Inf           | -Inf       | 9.17       | 3       | V         | 1          | 2.64      | -        |

### 802.11ac VHT20\_Nss1,(MCS0)\_3TX

### 5200MHz\_TX

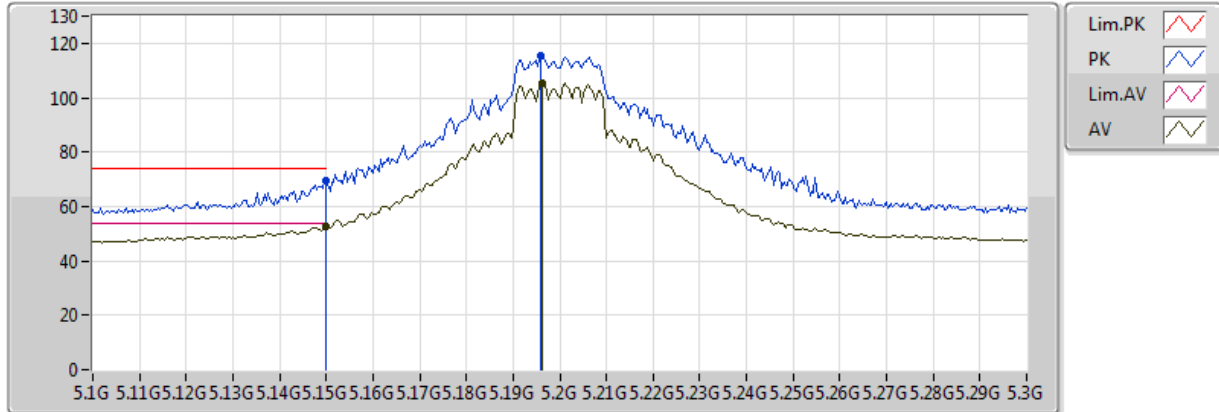

20170617  
EUT\_Y\_3TX  
Setting 78  
02-W-3-10  
FSU

| Type | Freq(Hz)  | Level(dBuV/m) | Limit(dBuV/m) | Margin(dB) | Factor(dB) | Dist(m) | Pol.(H/V) | Azimuth(°) | Height(m) | Comments |
|------|-----------|---------------|---------------|------------|------------|---------|-----------|------------|-----------|----------|
| AV   | 5.149995G | 52.55         | 54.00         | -1.45      | 9.03       | 3       | H         | 11         | 1.57      | -        |
| AV   | 5.1964G   | 105.31        | Inf           | -Inf       | 9.15       | 3       | H         | 11         | 1.57      | -        |
| PK   | 5.149995G | 69.46         | 74.00         | -4.54      | 9.03       | 3       | H         | 11         | 1.57      | -        |
| PK   | 5.196G    | 115.23        | Inf           | -Inf       | 9.15       | 3       | H         | 11         | 1.57      | -        |

### 802.11ac VHT20\_Nss1,(MCS0)\_3TX

### 5200MHz\_TX

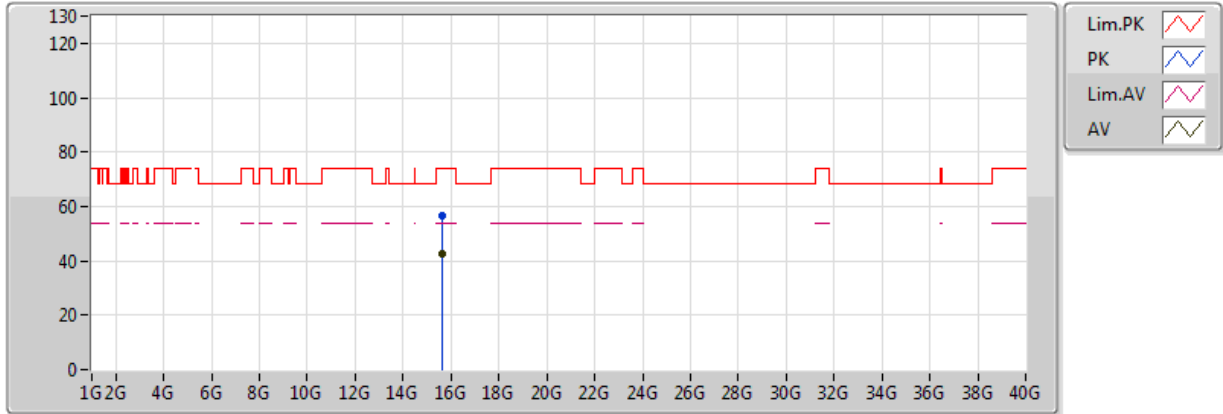

20170617  
EUT\_Y\_3TX  
Setting 78  
02-W-3  
FSU

| Type | Freq(Hz)  | Level(dBuV/m) | Limit(dBuV/m) | Margin(dB) | Factor(dB) | Dist(m) | Pol.(H/V) | Azimuth(°) | Height(m) | Comments |
|------|-----------|---------------|---------------|------------|------------|---------|-----------|------------|-----------|----------|
| AV   | 15.6018G  | 42.82         | 54.00         | -11.18     | 17.89      | 3       | V         | 214        | 1.92      | -        |
| PK   | 15.60155G | 56.52         | 74.00         | -17.48     | 17.89      | 3       | V         | 214        | 1.92      | -        |

### 802.11ac VHT20\_Nss1,(MCS0)\_3TX

### 5200MHz\_TX

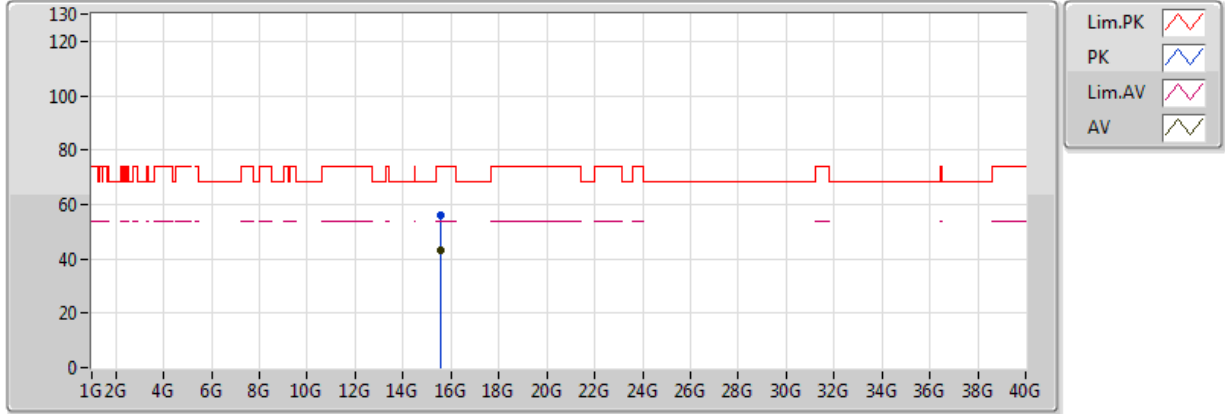

20170617  
EUT\_Y\_3TX  
Setting 78  
02-W-3  
FSU

| Type | Freq(Hz)  | Level(dBuV/m) | Limit(dBuV/m) | Margin(dB) | Factor(dB) | Dist(m) | Pol.(H/V) | Azimuth(°) | Height(m) | Comments |
|------|-----------|---------------|---------------|------------|------------|---------|-----------|------------|-----------|----------|
| AV   | 15.59884G | 42.98         | 54.00         | -11.02     | 17.90      | 3       | H         | 263        | 2.47      | -        |
| PK   | 15.59838G | 55.81         | 74.00         | -18.19     | 17.90      | 3       | H         | 263        | 2.47      | -        |



### 802.11ac VHT20\_Nss1,(MCS0)\_3TX

### 5240MHz\_TX

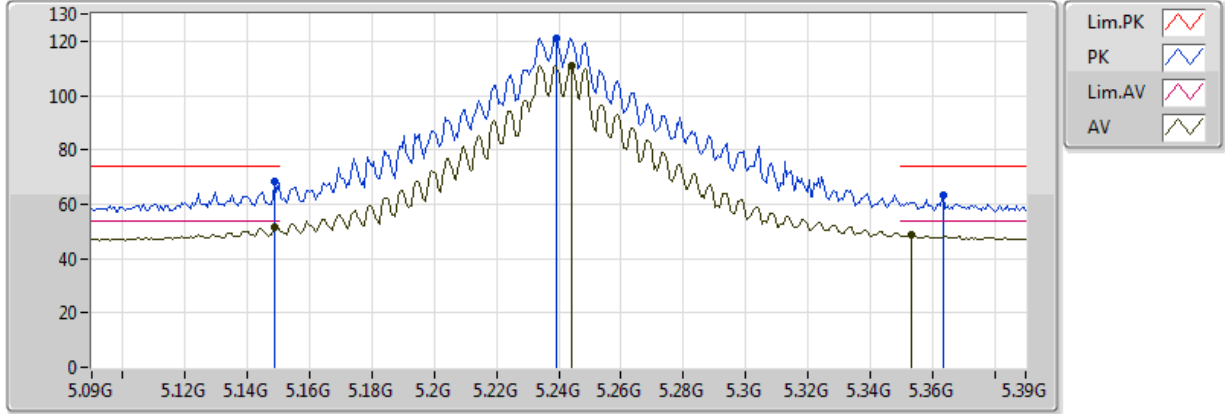

20170617  
 EUT Y\_3TX  
 Setting 120(Max setting)  
 02-W-3-10  
 FSU

| Type | Freq(Hz) | Level(dBuV/m) | Limit(dBuV/m) | Margin(dB) | Factor(dB) | Dist(m) | Pol.(H/V) | Azimuth(°) | Height(m) | Comments |
|------|----------|---------------|---------------|------------|------------|---------|-----------|------------|-----------|----------|
| AV   | 5.1488G  | 51.40         | 54.00         | -2.60      | 9.03       | 3       | V         | 358        | 2.73      | -        |
| AV   | 5.2442G  | 111.12        | Inf           | -Inf       | 9.24       | 3       | V         | 358        | 2.73      | -        |
| AV   | 5.3534G  | 48.98         | 54.00         | -5.02      | 9.44       | 3       | V         | 358        | 2.73      | -        |
| PK   | 5.1488G  | 68.11         | 74.00         | -5.89      | 9.03       | 3       | V         | 358        | 2.73      | -        |
| PK   | 5.2394G  | 121.27        | Inf           | -Inf       | 9.23       | 3       | V         | 358        | 2.73      | -        |
| PK   | 5.3636G  | 63.19         | 74.00         | -10.81     | 9.46       | 3       | V         | 358        | 2.73      | -        |

### 802.11ac VHT20\_Nss1,(MCS0)\_3TX

### 5240MHz\_TX

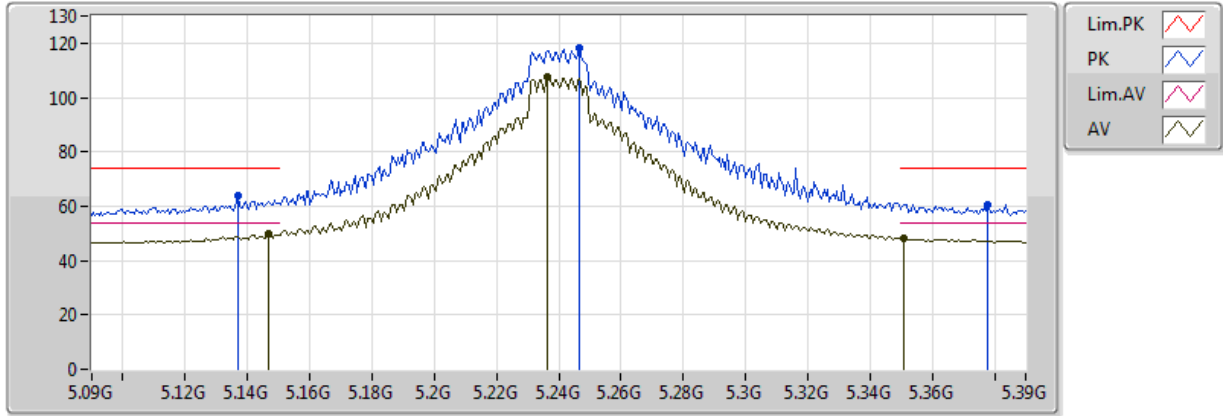

20170617  
 EUT\_Y\_3TX  
 Setting 120(Max setting)  
 02-W-3-10  
 FSU

| Type | Freq(Hz) | Level(dBuV/m) | Limit(dBuV/m) | Margin(dB) | Factor(dB) | Dist(m) | Pol.(H/V) | Azimuth(°) | Height(m) | Comments |
|------|----------|---------------|---------------|------------|------------|---------|-----------|------------|-----------|----------|
| AV   | 5.147G   | 49.68         | 54.00         | -4.32      | 9.03       | 3       | H         | 4          | 1.53      | -        |
| AV   | 5.2364G  | 107.55        | Inf           | -Inf       | 9.23       | 3       | H         | 4          | 1.53      | -        |
| AV   | 5.351G   | 48.18         | 54.00         | -5.82      | 9.44       | 3       | H         | 4          | 1.53      | -        |
| PK   | 5.1368G  | 63.92         | 74.00         | -10.08     | 9.00       | 3       | H         | 4          | 1.53      | -        |
| PK   | 5.2466G  | 118.24        | Inf           | -Inf       | 9.25       | 3       | H         | 4          | 1.53      | -        |
| PK   | 5.378G   | 60.50         | 74.00         | -13.50     | 9.48       | 3       | H         | 4          | 1.53      | -        |

### 802.11ac VHT20\_Nss1,(MCS0)\_3TX

### 5240MHz\_TX

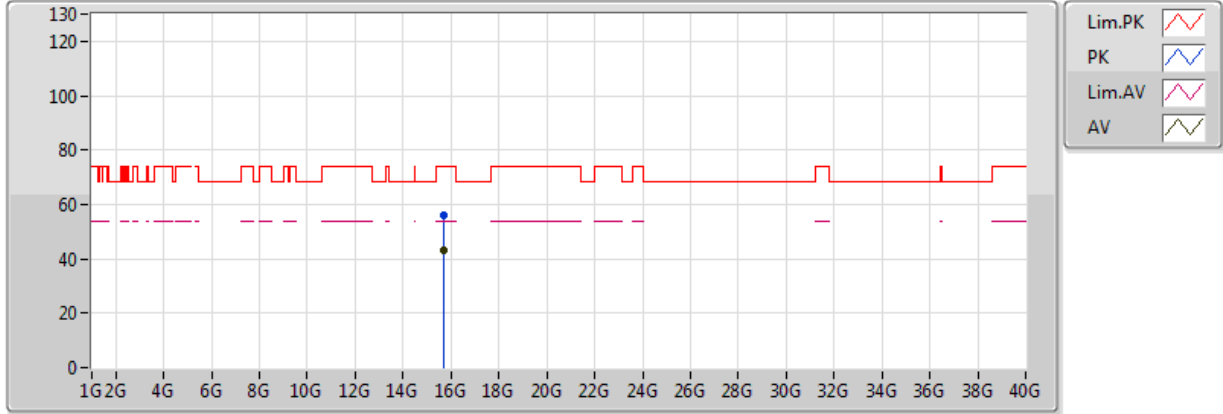

20170617  
 EUT\_Y\_3TX  
 Setting 120(Max setting)  
 02-W-3  
 FSU

| Type | Freq(Hz)  | Level(dBuV/m) | Limit(dBuV/m) | Margin(dB) | Factor(dB) | Dist(m) | Pol.(H/V) | Azimuth(°) | Height(m) | Comments |
|------|-----------|---------------|---------------|------------|------------|---------|-----------|------------|-----------|----------|
| AV   | 15.71824G | 42.94         | 54.00         | -11.06     | 17.64      | 3       | V         | 334        | 2.29      | -        |
| PK   | 15.71853G | 56.09         | 74.00         | -17.91     | 17.64      | 3       | V         | 334        | 2.29      | -        |

### 802.11ac VHT20\_Nss1,(MCS0)\_3TX

### 5240MHz\_TX

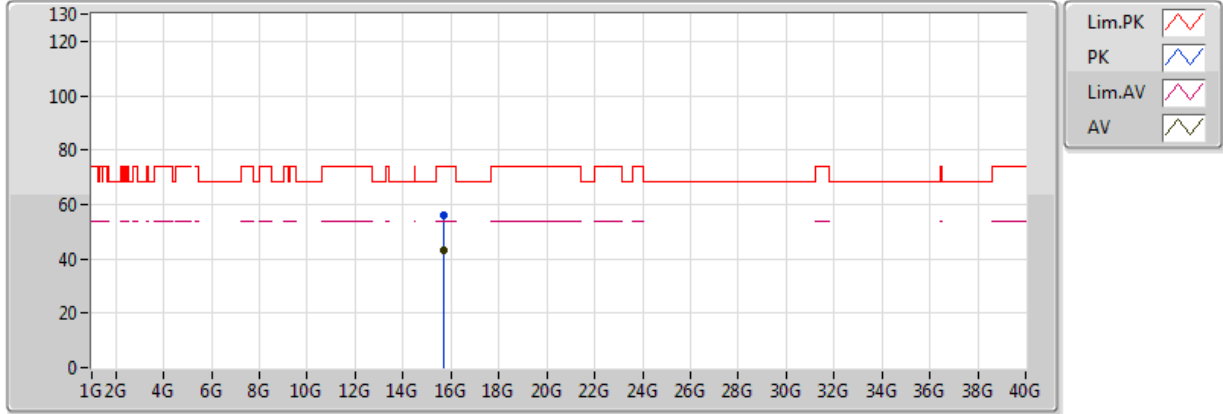

20170617  
 EUT\_Y\_3TX  
 Setting 120(Max setting)  
 02-W-3  
 FSU

| Type | Freq(Hz)  | Level(dBuV/m) | Limit(dBuV/m) | Margin(dB) | Factor(dB) | Dist(m) | Pol.(H/V) | Azimuth(°) | Height(m) | Comments |
|------|-----------|---------------|---------------|------------|------------|---------|-----------|------------|-----------|----------|
| AV   | 15.72225G | 43.18         | 54.00         | -10.82     | 17.63      | 3       | H         | 356        | 1.93      | -        |
| PK   | 15.72103G | 56.28         | 74.00         | -17.72     | 17.64      | 3       | H         | 356        | 1.93      | -        |

### 802.11ac VHT20\_Nss1,(MCS0)\_3TX

### 5745MHz\_TX

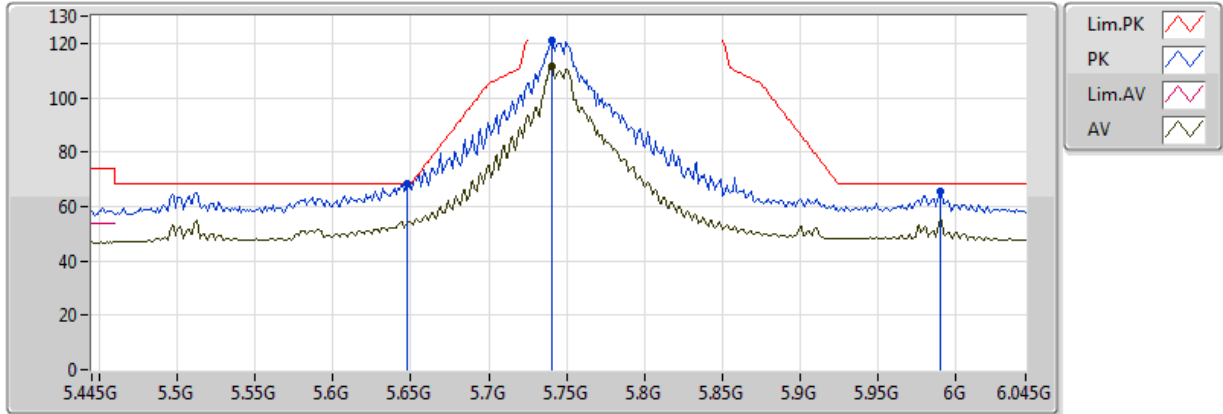

20170617  
EUT\_Y\_3TX  
Setting 105  
02-W-3-10  
FSU

| Type | Freq(Hz) | Level(dBuV/m) | Limit(dBuV/m) | Margin(dB) | Factor(dB) | Dist(m) | Pol.(H/V) | Azimuth(°) | Height(m) | Comments |
|------|----------|---------------|---------------|------------|------------|---------|-----------|------------|-----------|----------|
| AV   | 5.7402G  | 111.32        | Inf           | -Inf       | 9.91       | 3       | V         | 358        | 1.01      | -        |
| PK   | 5.6478G  | 68.17         | 68.20         | -0.03      | 9.89       | 3       | V         | 358        | 1.01      | -        |
| PK   | 5.7402G  | 120.92        | Inf           | -Inf       | 9.91       | 3       | V         | 358        | 1.01      | -        |
| PK   | 5.9898G  | 65.35         | 68.20         | -2.85      | 10.19      | 3       | V         | 358        | 1.01      | -        |

### 802.11ac VHT20\_Nss1,(MCS0)\_3TX

### 5745MHz\_TX

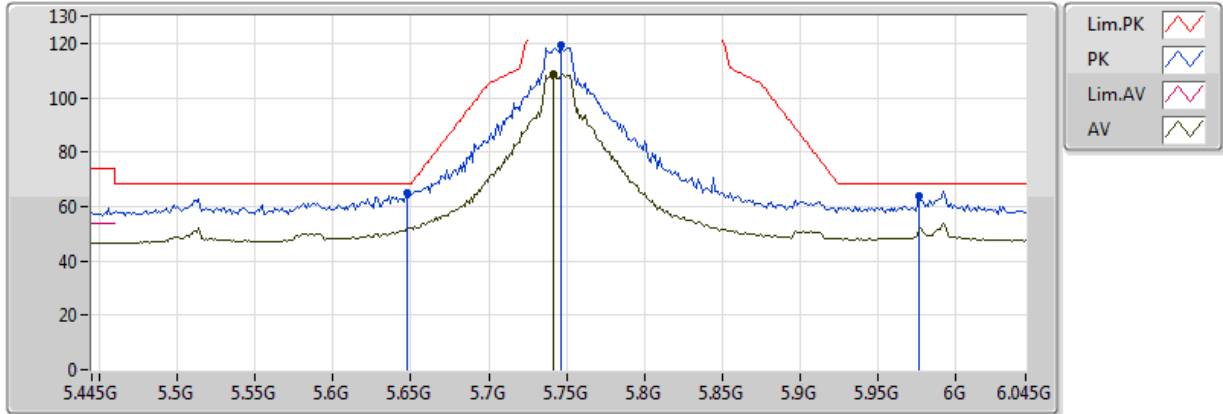

20170617  
EUT\_Y\_3TX  
Setting 105  
02-W-3-10  
FSU

| Type | Freq(Hz) | Level(dBuV/m) | Limit(dBuV/m) | Margin(dB) | Factor(dB) | Dist(m) | Pol.(H/V) | Azimuth(°) | Height(m) | Comments |
|------|----------|---------------|---------------|------------|------------|---------|-----------|------------|-----------|----------|
| AV   | 5.7414G  | 108.76        | Inf           | -Inf       | 9.91       | 3       | H         | 16         | 1.00      | -        |
| PK   | 5.6478G  | 64.80         | 68.20         | -3.40      | 9.89       | 3       | H         | 16         | 1.00      | -        |
| PK   | 5.7462G  | 119.33        | Inf           | -Inf       | 9.91       | 3       | H         | 16         | 1.00      | -        |
| PK   | 5.9766G  | 63.78         | 68.20         | -4.42      | 10.17      | 3       | H         | 16         | 1.00      | -        |

### 802.11ac VHT20\_Nss1,(MCS0)\_3TX

### 5745MHz\_TX

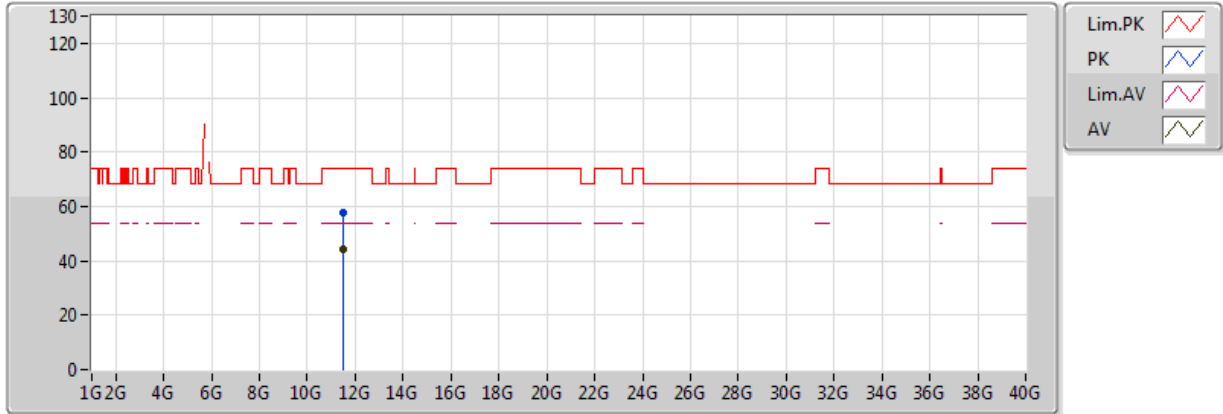

20170617  
EUT\_Y\_3TX  
Setting 105  
02-W-3  
FSU

| Type | Freq(Hz)  | Level(dBuV/m) | Limit(dBuV/m) | Margin(dB) | Factor(dB) | Dist(m) | Pol.(H/V) | Azimuth(°) | Height(m) | Comments |
|------|-----------|---------------|---------------|------------|------------|---------|-----------|------------|-----------|----------|
| AV   | 11.48854G | 44.02         | 54.00         | -9.98      | 16.36      | 3       | V         | 337        | 2.98      | -        |
| PK   | 11.48849G | 57.46         | 74.00         | -16.54     | 16.36      | 3       | V         | 337        | 2.98      | -        |

### 802.11ac VHT20\_Nss1,(MCS0)\_3TX

### 5745MHz\_TX

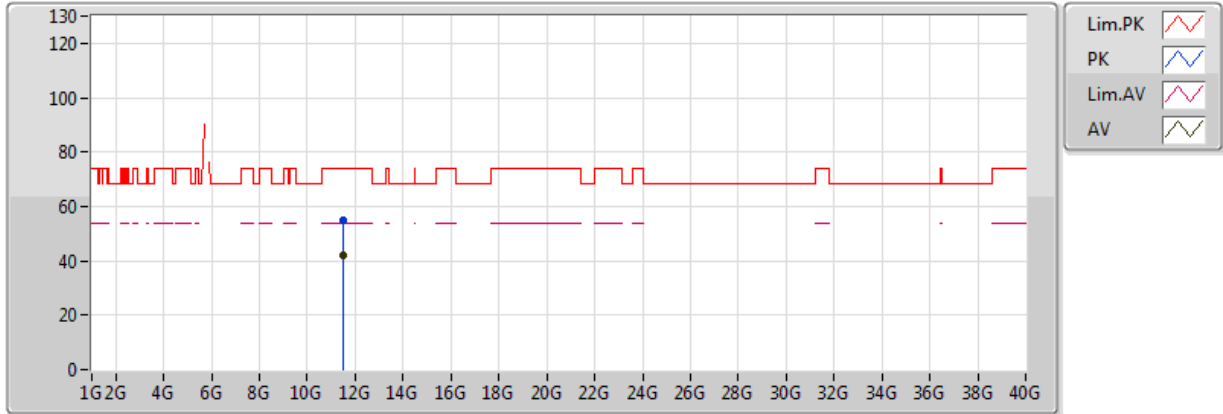

20170617  
EUT\_Y\_3TX  
Setting 105  
02-W-3  
FSU

| Type | Freq(Hz)  | Level(dBuV/m) | Limit(dBuV/m) | Margin(dB) | Factor(dB) | Dist(m) | Pol.(H/V) | Azimuth(°) | Height(m) | Comments |
|------|-----------|---------------|---------------|------------|------------|---------|-----------|------------|-----------|----------|
| AV   | 11.48897G | 42.10         | 54.00         | -11.90     | 16.36      | 3       | H         | 149        | 1.11      | -        |
| PK   | 11.49198G | 55.18         | 74.00         | -18.82     | 16.37      | 3       | H         | 149        | 1.11      | -        |



### 802.11ac VHT20\_Nss1,(MCS0)\_3TX

### 5785MHz\_TX

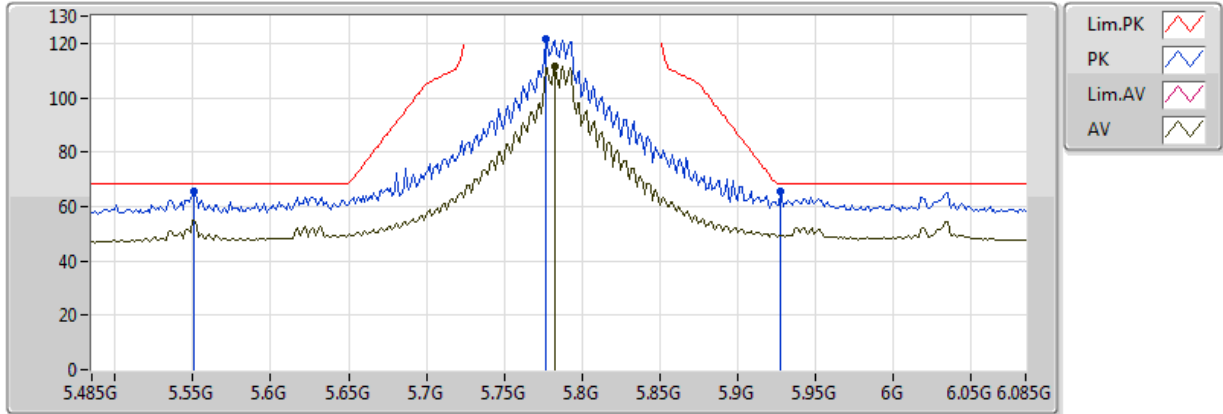

20170617  
 EUT\_Y\_3TX  
 Setting 120(Max setting)  
 02-W-3-10  
 FSU

| Type | Freq(Hz) | Level(dBuV/m) | Limit(dBuV/m) | Margin(dB) | Factor(dB) | Dist(m) | Pol.(H/V) | Azimuth(°) | Height(m) | Comments |
|------|----------|---------------|---------------|------------|------------|---------|-----------|------------|-----------|----------|
| AV   | 5.7826G  | 111.47        | Inf           | -Inf       | 9.92       | 3       | V         | 359        | 1.30      | -        |
| PK   | 5.551G   | 65.29         | 68.20         | -2.91      | 9.84       | 3       | V         | 359        | 1.30      | -        |
| PK   | 5.7766G  | 121.35        | Inf           | -Inf       | 9.92       | 3       | V         | 359        | 1.30      | -        |
| PK   | 5.9278G  | 65.41         | 68.20         | -2.79      | 10.10      | 3       | V         | 359        | 1.30      | -        |

### 802.11ac VHT20\_Nss1,(MCS0)\_3TX

### 5785MHz\_TX

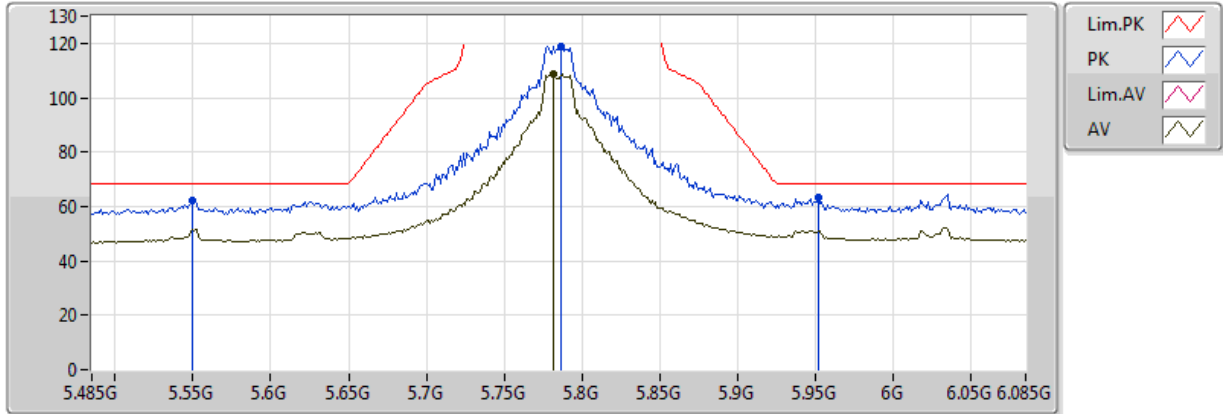

20170617  
 EUT\_Y\_3TX  
 Setting 120(Max setting)  
 02-W-3-10  
 FSU

| Type | Freq(Hz) | Level(dBuV/m) | Limit(dBuV/m) | Margin(dB) | Factor(dB) | Dist(m) | Pol.(H/V) | Azimuth(°) | Height(m) | Comments |
|------|----------|---------------|---------------|------------|------------|---------|-----------|------------|-----------|----------|
| AV   | 5.7814G  | 108.64        | Inf           | -Inf       | 9.92       | 3       | H         | 14         | 1.00      | -        |
| PK   | 5.5498G  | 62.47         | 68.20         | -5.73      | 9.83       | 3       | H         | 14         | 1.00      | -        |
| PK   | 5.7862G  | 118.90        | Inf           | -Inf       | 9.92       | 3       | H         | 14         | 1.00      | -        |
| PK   | 5.9518G  | 63.38         | 68.20         | -4.82      | 10.13      | 3       | H         | 14         | 1.00      | -        |

### 802.11ac VHT20\_Nss1,(MCS0)\_3TX

### 5785MHz\_TX

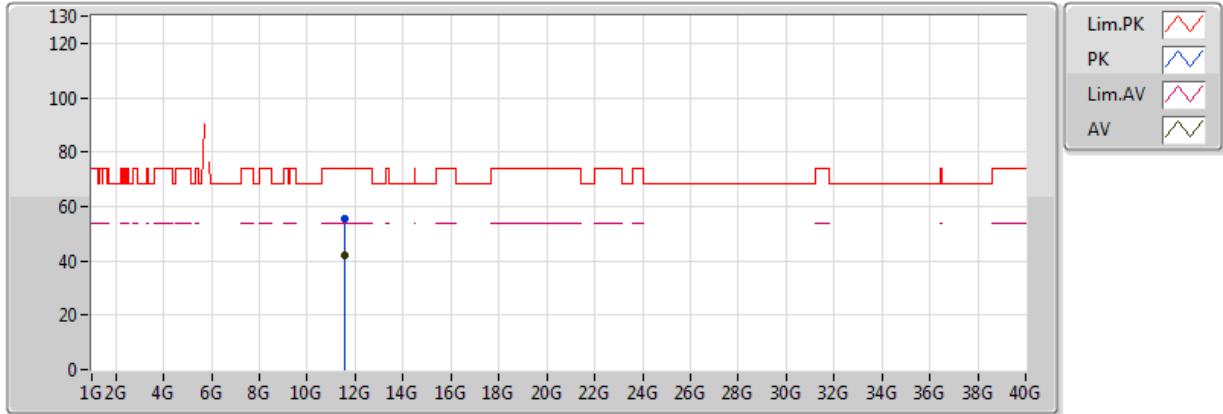

20170617  
 EUT\_Y\_3TX  
 Setting 120(Max setting)  
 02-W-3  
 FSU

| Type | Freq(Hz)  | Level(dBuV/m) | Limit(dBuV/m) | Margin(dB) | Factor(dB) | Dist(m) | Pol.(H/V) | Azimuth(°) | Height(m) | Comments |
|------|-----------|---------------|---------------|------------|------------|---------|-----------|------------|-----------|----------|
| AV   | 11.56761G | 41.98         | 54.00         | -12.02     | 16.45      | 3       | V         | 115        | 1.25      | -        |
| PK   | 11.56877G | 55.58         | 74.00         | -18.42     | 16.45      | 3       | V         | 115        | 1.25      | -        |

### 802.11ac VHT20\_Nss1,(MCS0)\_3TX

### 5785MHz\_TX

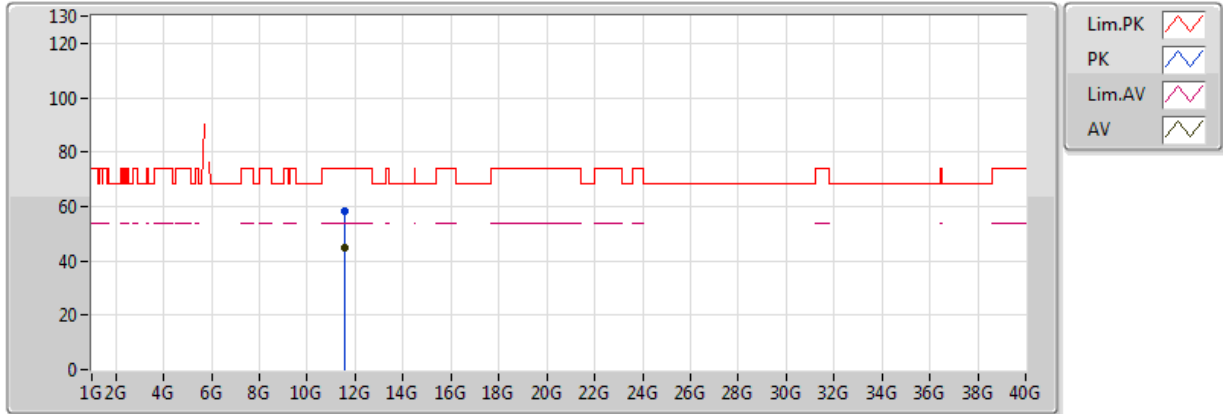

20170617  
 EUT\_Y\_3TX  
 Setting 120(Max setting)  
 02-W-3  
 FSU

| Type | Freq(Hz)  | Level(dBuV/m) | Limit(dBuV/m) | Margin(dB) | Factor(dB) | Dist(m) | Pol.(H/V) | Azimuth(°) | Height(m) | Comments |
|------|-----------|---------------|---------------|------------|------------|---------|-----------|------------|-----------|----------|
| AV   | 11.56832G | 44.57         | 54.00         | -9.43      | 16.45      | 3       | H         | 139        | 1.98      | -        |
| PK   | 11.56816G | 58.17         | 74.00         | -15.83     | 16.45      | 3       | H         | 139        | 1.98      | -        |

### 802.11ac VHT20\_Nss1,(MCS0)\_3TX

### 5825MHz\_TX

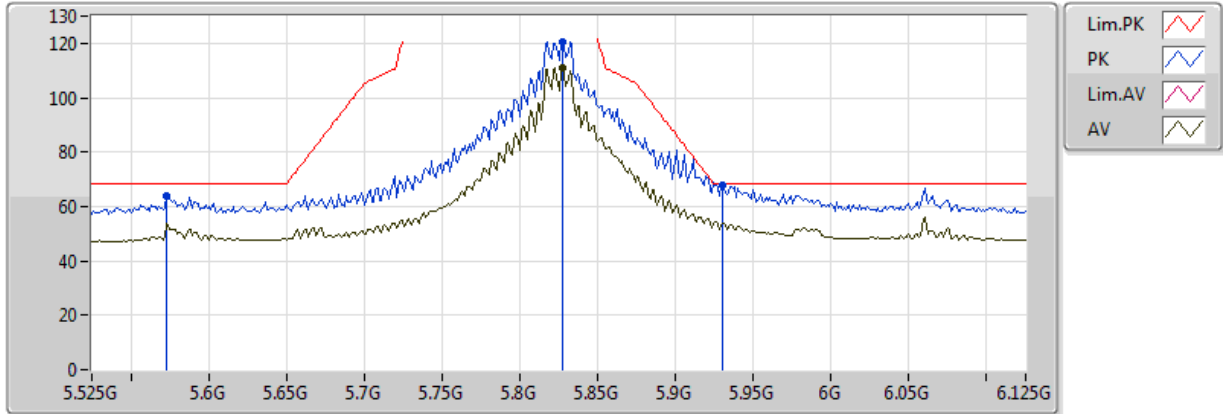

20170617  
EUT\_Y\_3TX  
Setting 108  
02-W-3-10  
FSU

| Type | Freq(Hz) | Level(dBuV/m) | Limit(dBuV/m) | Margin(dB) | Factor(dB) | Dist(m) | Pol.(H/V) | Azimuth(°) | Height(m) | Comments |
|------|----------|---------------|---------------|------------|------------|---------|-----------|------------|-----------|----------|
| AV   | 5.8274G  | 110.91        | Inf           | -Inf       | 9.96       | 3       | V         | 353        | 1.30      | -        |
| PK   | 5.573G   | 63.86         | 68.20         | -4.34      | 9.86       | 3       | V         | 353        | 1.30      | -        |
| PK   | 5.8274G  | 120.70        | Inf           | -Inf       | 9.96       | 3       | V         | 353        | 1.30      | -        |
| PK   | 5.9306G  | 67.87         | 68.20         | -0.33      | 10.10      | 3       | V         | 353        | 1.30      | -        |

### 802.11ac VHT20\_Nss1,(MCS0)\_3TX

### 5825MHz\_TX

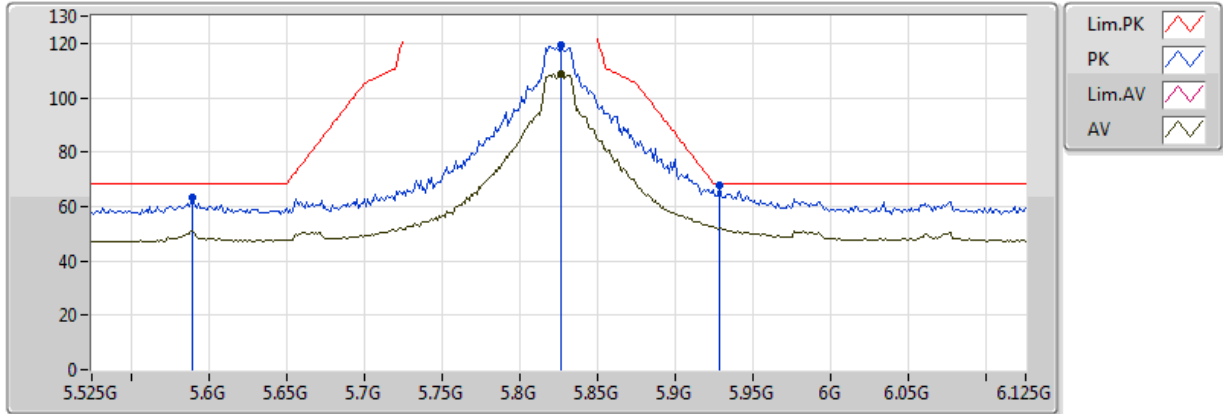

20170617  
EUT\_Y\_3TX  
Setting 108  
02-W-3-10  
FSU

| Type | Freq(Hz) | Level(dBuV/m) | Limit(dBuV/m) | Margin(dB) | Factor(dB) | Dist(m) | Pol.(H/V) | Azimuth(°) | Height(m) | Comments |
|------|----------|---------------|---------------|------------|------------|---------|-----------|------------|-----------|----------|
| AV   | 5.8262G  | 108.66        | Inf           | -Inf       | 9.96       | 3       | H         | 15         | 1.01      | -        |
| PK   | 5.5898G  | 63.25         | 68.20         | -4.95      | 9.87       | 3       | H         | 15         | 1.01      | -        |
| PK   | 5.8262G  | 119.16        | Inf           | -Inf       | 9.96       | 3       | H         | 15         | 1.01      | -        |
| PK   | 5.9282G  | 67.53         | 68.20         | -0.67      | 10.10      | 3       | H         | 15         | 1.01      | -        |

### 802.11ac VHT20\_Nss1,(MCS0)\_3TX

### 5825MHz\_TX

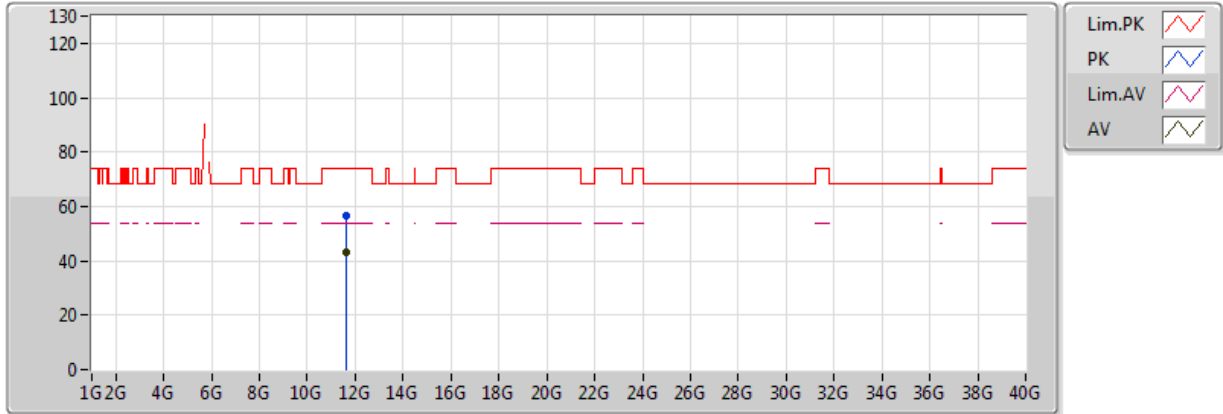

20170617  
EUT\_Y\_3TX  
Setting 108  
02-W-3  
FSU

| Type | Freq(Hz)  | Level(dBuV/m) | Limit(dBuV/m) | Margin(dB) | Factor(dB) | Dist(m) | Pol.(H/V) | Azimuth(°) | Height(m) | Comments |
|------|-----------|---------------|---------------|------------|------------|---------|-----------|------------|-----------|----------|
| AV   | 11.64828G | 43.01         | 54.00         | -10.99     | 16.54      | 3       | V         | 34         | 2.82      | -        |
| PK   | 11.64816G | 56.49         | 74.00         | -17.51     | 16.54      | 3       | V         | 34         | 2.82      | -        |

### 802.11ac VHT20\_Nss1,(MCS0)\_3TX

### 5825MHz\_TX

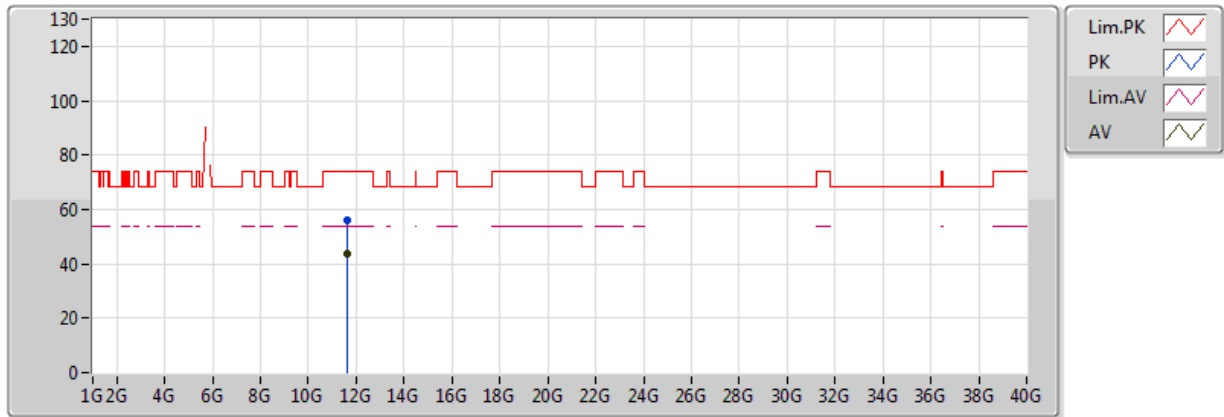

20170617  
EUT\_Y\_3TX  
Setting 108  
02-W-3  
FSU

| Type | Freq(Hz)  | Level(dBuV/m) | Limit(dBuV/m) | Margin(dB) | Factor(dB) | Dist(m) | Pol.(H/V) | Azimuth(°) | Height(m) | Comments |
|------|-----------|---------------|---------------|------------|------------|---------|-----------|------------|-----------|----------|
| AV   | 11.64764G | 43.70         | 54.00         | -10.30     | 16.54      | 3       | H         | 117        | 2.21      | -        |
| PK   | 11.6486G  | 56.29         | 74.00         | -17.71     | 16.54      | 3       | H         | 117        | 2.21      | -        |



### 802.11ac VHT40\_Nss1,(MCS0)\_3TX

### 5190MHz\_TX

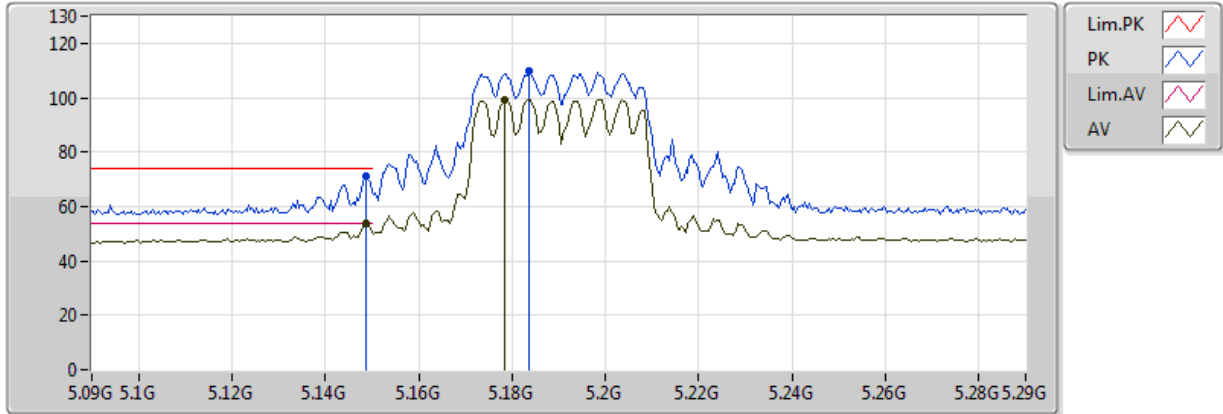

20170617  
EUT\_Y\_3TX  
Setting 48  
02-W-3-10  
FSU

| Type | Freq(Hz) | Level(dBuV/m) | Limit(dBuV/m) | Margin(dB) | Factor(dB) | Dist(m) | Pol.(H/V) | Azimuth(°) | Height(m) | Comments |
|------|----------|---------------|---------------|------------|------------|---------|-----------|------------|-----------|----------|
| AV   | 5.1488G  | 53.88         | 54.00         | -0.12      | 9.03       | 3       | V         | 359        | 2.55      | -        |
| AV   | 5.1784G  | 99.43         | Inf           | -Inf       | 9.11       | 3       | V         | 359        | 2.55      | -        |
| PK   | 5.1488G  | 71.31         | 74.00         | -2.69      | 9.03       | 3       | V         | 359        | 2.55      | -        |
| PK   | 5.1836G  | 109.64        | Inf           | -Inf       | 9.12       | 3       | V         | 359        | 2.55      | -        |

### 802.11ac VHT40\_Nss1,(MCS0)\_3TX

### 5190MHz\_TX

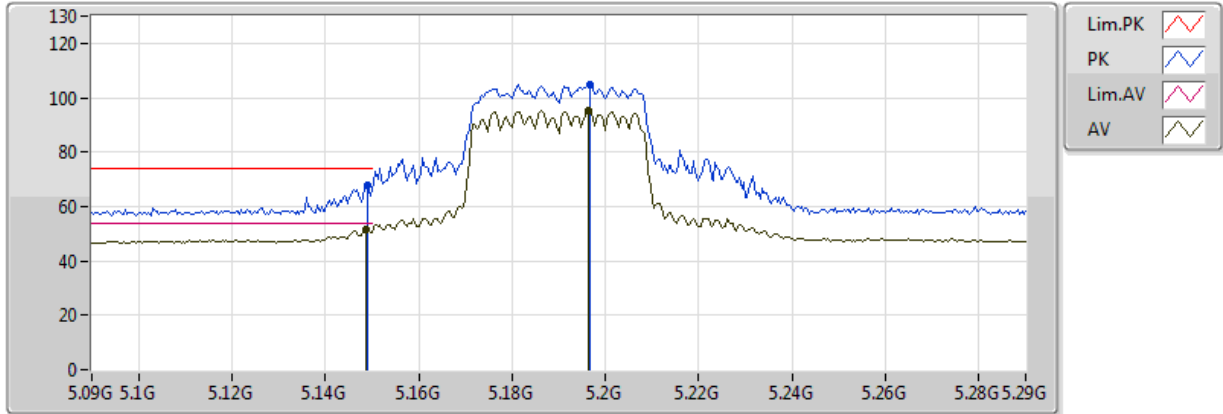

20170617  
EUT\_Y\_3TX  
Setting 48  
02-W-3-10  
FSU

| Type | Freq(Hz) | Level(dBuV/m) | Limit(dBuV/m) | Margin(dB) | Factor(dB) | Dist(m) | Pol.(H/V) | Azimuth(°) | Height(m) | Comments |
|------|----------|---------------|---------------|------------|------------|---------|-----------|------------|-----------|----------|
| AV   | 5.1488G  | 51.50         | 54.00         | -2.50      | 9.03       | 3       | H         | 9          | 1.55      | -        |
| AV   | 5.1964G  | 95.53         | Inf           | -Inf       | 9.15       | 3       | H         | 9          | 1.55      | -        |
| PK   | 5.1492G  | 67.89         | 74.00         | -6.11      | 9.03       | 3       | H         | 9          | 1.55      | -        |
| PK   | 5.1968G  | 104.70        | Inf           | -Inf       | 9.15       | 3       | H         | 9          | 1.55      | -        |

### 802.11ac VHT40\_Nss1,(MCS0)\_3TX

### 5190MHz\_TX

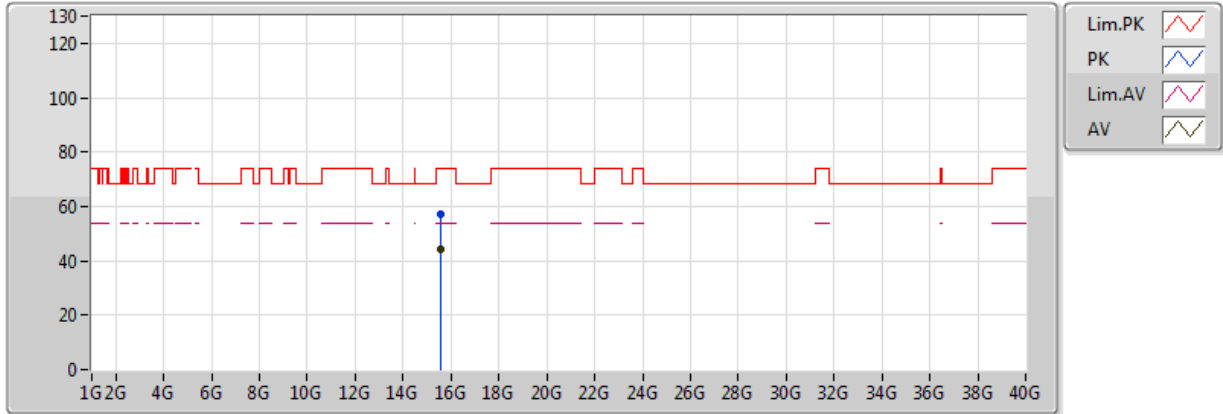

20170617  
EUT\_Y\_3TX  
Setting 48  
02-W-3  
FSU

| Type | Freq(Hz)  | Level(dBuV/m) | Limit(dBuV/m) | Margin(dB) | Factor(dB) | Dist(m) | Pol.(H/V) | Azimuth(°) | Height(m) | Comments |
|------|-----------|---------------|---------------|------------|------------|---------|-----------|------------|-----------|----------|
| AV   | 15.56834G | 44.15         | 54.00         | -9.85      | 17.97      | 3       | V         | 171        | 2.20      | -        |
| PK   | 15.5708G  | 57.00         | 74.00         | -17.00     | 17.96      | 3       | V         | 171        | 2.20      | -        |

### 802.11ac VHT40\_Nss1,(MCS0)\_3TX

### 5190MHz\_TX

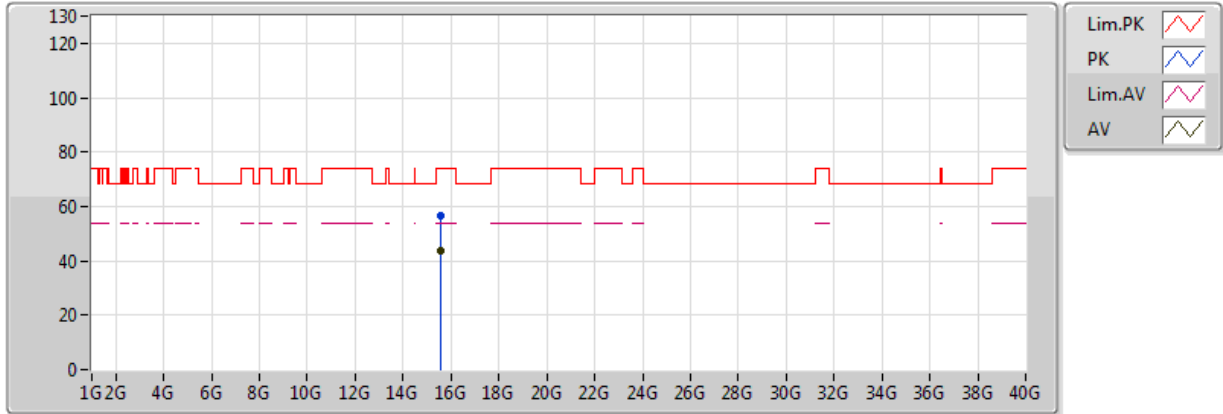

20170617  
EUT\_Y\_3TX  
Setting 48  
02-W-3  
FSU

| Type | Freq(Hz)  | Level(dBuV/m) | Limit(dBuV/m) | Margin(dB) | Factor(dB) | Dist(m) | Pol.(H/V) | Azimuth(°) | Height(m) | Comments |
|------|-----------|---------------|---------------|------------|------------|---------|-----------|------------|-----------|----------|
| AV   | 15.5675G  | 43.96         | 54.00         | -10.04     | 17.97      | 3       | H         | 284        | 2.20      | -        |
| PK   | 15.57233G | 56.86         | 74.00         | -17.14     | 17.96      | 3       | H         | 284        | 2.20      | -        |

### 802.11ac VHT40\_Nss1,(MCS0)\_3TX

### 5230MHz\_TX

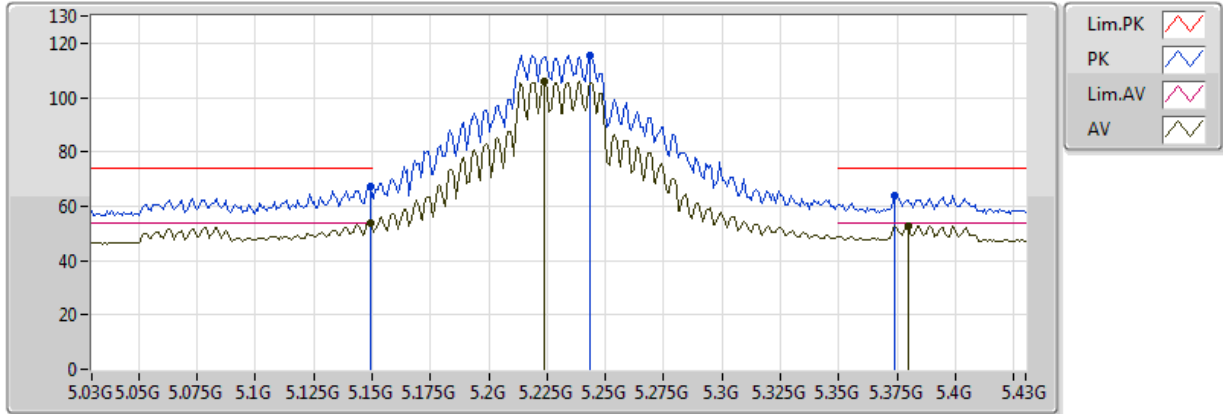

20170617  
EUT Y\_3TX  
Setting 74  
02-W-3-10  
FSU

| Type | Freq(Hz) | Level(dBuV/m) | Limit(dBuV/m) | Margin(dB) | Factor(dB) | Dist(m) | Pol.(H/V) | Azimuth(°) | Height(m) | Comments |
|------|----------|---------------|---------------|------------|------------|---------|-----------|------------|-----------|----------|
| AV   | 5.1492G  | 53.85         | 54.00         | -0.15      | 9.03       | 3       | V         | 360        | 2.75      | -        |
| AV   | 5.2236G  | 105.85        | Inf           | -Inf       | 9.20       | 3       | V         | 360        | 2.75      | -        |
| AV   | 5.3796G  | 52.86         | 54.00         | -1.14      | 9.49       | 3       | V         | 360        | 2.75      | -        |
| PK   | 5.1492G  | 66.99         | 74.00         | -7.01      | 9.03       | 3       | V         | 360        | 2.75      | -        |
| PK   | 5.2436G  | 115.54        | Inf           | -Inf       | 9.24       | 3       | V         | 360        | 2.75      | -        |
| PK   | 5.374G   | 63.89         | 74.00         | -10.11     | 9.48       | 3       | V         | 360        | 2.75      | -        |

### 802.11ac VHT40\_Nss1,(MCS0)\_3TX

### 5230MHz\_TX

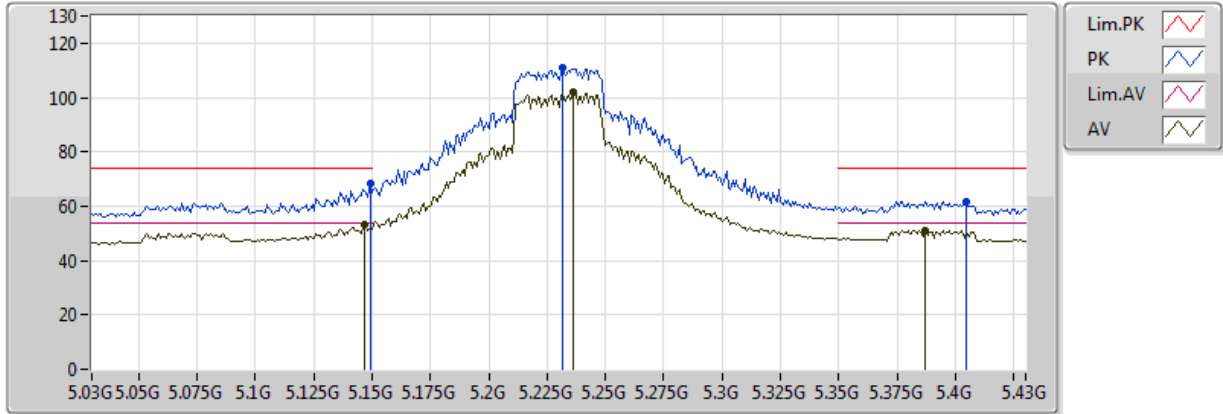

20170617  
EUT Y\_3TX  
Setting 74  
02-W-3-10  
FSU

| Type | Freq(Hz) | Level(dBuV/m) | Limit(dBuV/m) | Margin(dB) | Factor(dB) | Dist(m) | Pol.(H/V) | Azimuth(°) | Height(m) | Comments |
|------|----------|---------------|---------------|------------|------------|---------|-----------|------------|-----------|----------|
| AV   | 5.1468G  | 53.05         | 54.00         | -0.95      | 9.03       | 3       | H         | 6          | 1.72      | -        |
| AV   | 5.2364G  | 101.72        | Inf           | -Inf       | 9.23       | 3       | H         | 6          | 1.72      | -        |
| AV   | 5.3868G  | 51.18         | 54.00         | -2.82      | 9.50       | 3       | H         | 6          | 1.72      | -        |
| PK   | 5.1492G  | 68.34         | 74.00         | -5.66      | 9.03       | 3       | H         | 6          | 1.72      | -        |
| PK   | 5.2316G  | 111.04        | Inf           | -Inf       | 9.22       | 3       | H         | 6          | 1.72      | -        |
| PK   | 5.4044G  | 61.49         | 74.00         | -12.51     | 9.53       | 3       | H         | 6          | 1.72      | -        |

### 802.11ac VHT40\_Nss1,(MCS0)\_3TX

### 5230MHz\_TX

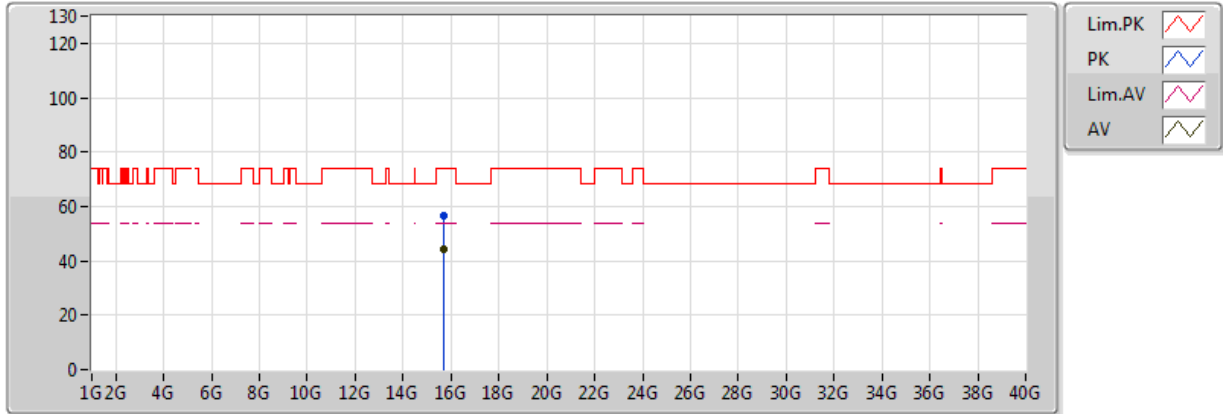

20170617  
EUT\_Y\_3TX  
Setting 74  
02-W-3  
FSU

| Type | Freq(Hz)  | Level(dBuV/m) | Limit(dBuV/m) | Margin(dB) | Factor(dB) | Dist(m) | Pol.(H/V) | Azimuth(°) | Height(m) | Comments |
|------|-----------|---------------|---------------|------------|------------|---------|-----------|------------|-----------|----------|
| AV   | 15.68829G | 44.05         | 54.00         | -9.95      | 17.71      | 3       | V         | 26         | 1.27      | -        |
| PK   | 15.6925G  | 56.83         | 74.00         | -17.17     | 17.70      | 3       | V         | 26         | 1.27      | -        |

### 802.11ac VHT40\_Nss1,(MCS0)\_3TX

### 5230MHz\_TX

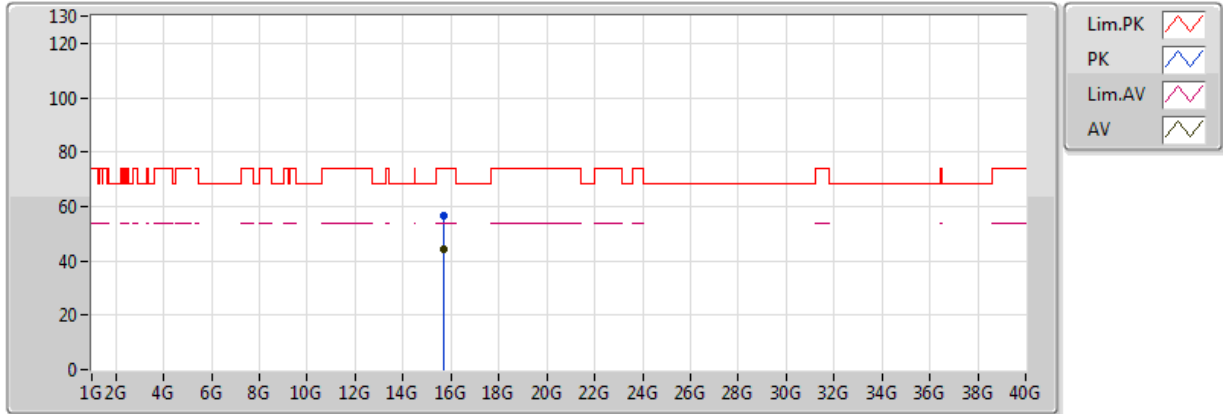

20170617  
EUT\_Y\_3TX  
Setting 74  
02-W-3  
FSU

| Type | Freq(Hz)  | Level(dBuV/m) | Limit(dBuV/m) | Margin(dB) | Factor(dB) | Dist(m) | Pol.(H/V) | Azimuth(°) | Height(m) | Comments |
|------|-----------|---------------|---------------|------------|------------|---------|-----------|------------|-----------|----------|
| AV   | 15.68917G | 44.23         | 54.00         | -9.77      | 17.70      | 3       | H         | 171        | 2.07      | -        |
| PK   | 15.69085G | 56.63         | 74.00         | -17.37     | 17.70      | 3       | H         | 171        | 2.07      | -        |



### 802.11ac VHT40\_Nss1,(MCS0)\_3TX

### 5755MHz\_TX

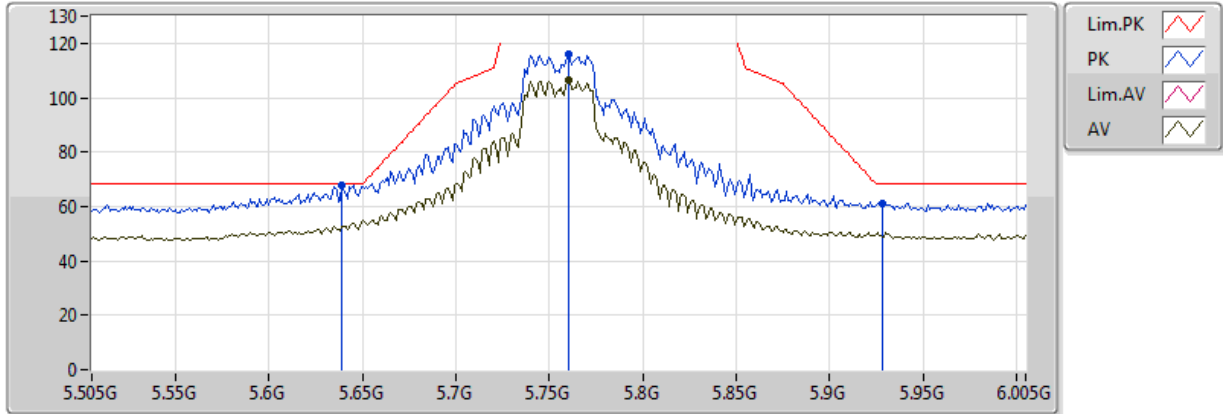

20170617  
 EUT\_Y\_3TX  
 Setting 78  
 02-W-3-10  
 FSU

| Type | Freq(Hz) | Level(dBuV/m) | Limit(dBuV/m) | Margin(dB) | Factor(dB) | Dist(m) | Pol.(H/V) | Azimuth(°) | Height(m) | Comments |
|------|----------|---------------|---------------|------------|------------|---------|-----------|------------|-----------|----------|
| AV   | 5.76G    | 106.55        | Inf           | -Inf       | 9.91       | 3       | V         | 358        | 1.01      | -        |
| PK   | 5.639G   | 68.00         | 68.20         | -0.20      | 9.89       | 3       | V         | 358        | 1.01      | -        |
| PK   | 5.76G    | 115.99        | Inf           | -Inf       | 9.91       | 3       | V         | 358        | 1.01      | -        |
| PK   | 5.928G   | 61.26         | 68.20         | -6.94      | 10.10      | 3       | V         | 358        | 1.01      | -        |

### 802.11ac VHT40\_Nss1,(MCS0)\_3TX

### 5755MHz\_TX

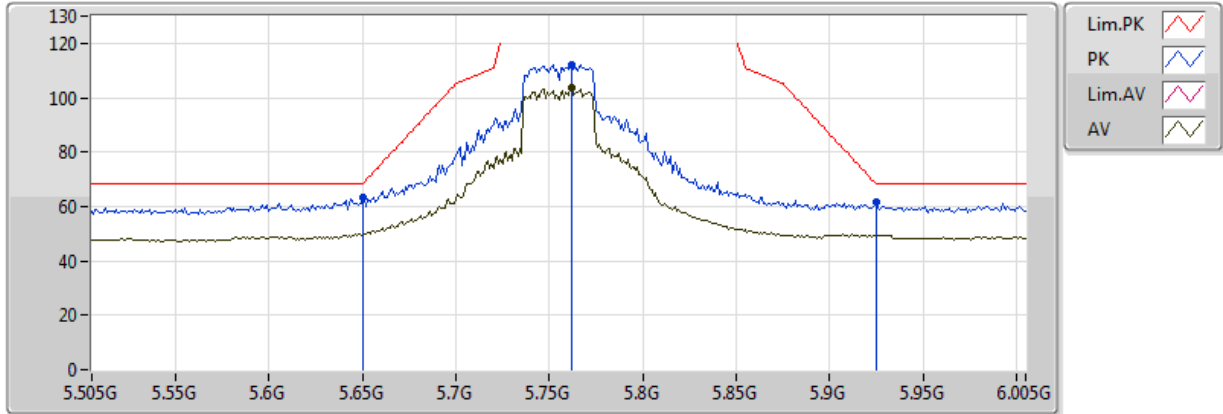

20170617  
EUT\_Y\_3TX  
Setting 78  
02-W-3-10  
FSU

| Type | Freq(Hz) | Level(dBuV/m) | Limit(dBuV/m) | Margin(dB) | Factor(dB) | Dist(m) | Pol.(H/V) | Azimuth(°) | Height(m) | Comments |
|------|----------|---------------|---------------|------------|------------|---------|-----------|------------|-----------|----------|
| AV   | 5.762G   | 103.64        | Inf           | -Inf       | 9.91       | 3       | H         | 24         | 1.04      | -        |
| PK   | 5.65G    | 63.43         | 68.20         | -4.77      | 9.89       | 3       | H         | 24         | 1.04      | -        |
| PK   | 5.762G   | 112.00        | Inf           | -Inf       | 9.91       | 3       | H         | 24         | 1.04      | -        |
| PK   | 5.925G   | 61.49         | 68.20         | -6.71      | 10.09      | 3       | H         | 24         | 1.04      | -        |

### 802.11ac VHT40\_Nss1,(MCS0)\_3TX

### 5755MHz\_TX

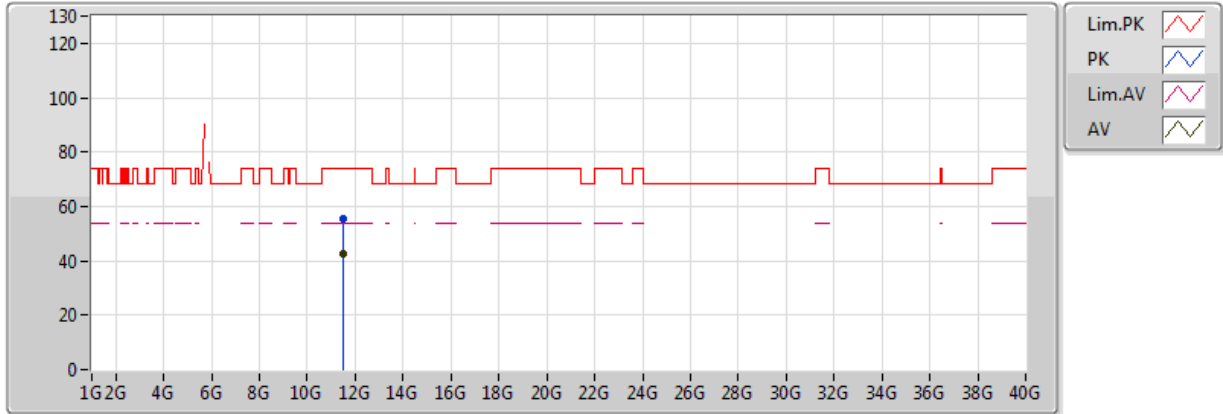

20170617  
EUT\_Y\_3TX  
Setting 78  
02-W-3  
FSU

| Type | Freq(Hz)  | Level(dBuV/m) | Limit(dBuV/m) | Margin(dB) | Factor(dB) | Dist(m) | Pol.(H/V) | Azimuth(°) | Height(m) | Comments |
|------|-----------|---------------|---------------|------------|------------|---------|-----------|------------|-----------|----------|
| AV   | 11.51248G | 42.82         | 54.00         | -11.18     | 16.39      | 3       | V         | 59         | 1.36      | -        |
| PK   | 11.51202G | 55.61         | 74.00         | -18.39     | 16.39      | 3       | V         | 59         | 1.36      | -        |

### 802.11ac VHT40\_Nss1,(MCS0)\_3TX

### 5755MHz\_TX

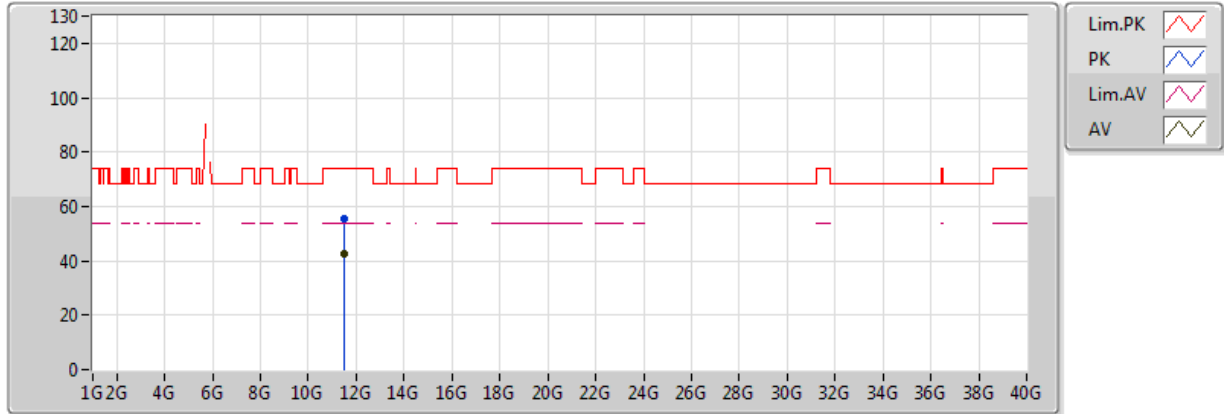

20170617  
EUT\_Y\_3TX  
Setting 78  
02-W-3  
FSU

| Type | Freq(Hz)  | Level(dBuV/m) | Limit(dBuV/m) | Margin(dB) | Factor(dB) | Dist(m) | Pol.(H/V) | Azimuth(°) | Height(m) | Comments |
|------|-----------|---------------|---------------|------------|------------|---------|-----------|------------|-----------|----------|
| AV   | 11.50772G | 42.80         | 54.00         | -11.20     | 16.38      | 3       | H         | 171        | 2.06      | -        |
| PK   | 11.50915G | 55.31         | 74.00         | -18.69     | 16.38      | 3       | H         | 171        | 2.06      | -        |

### 802.11ac VHT40\_Nss1,(MCS0)\_3TX

### 5795MHz\_TX

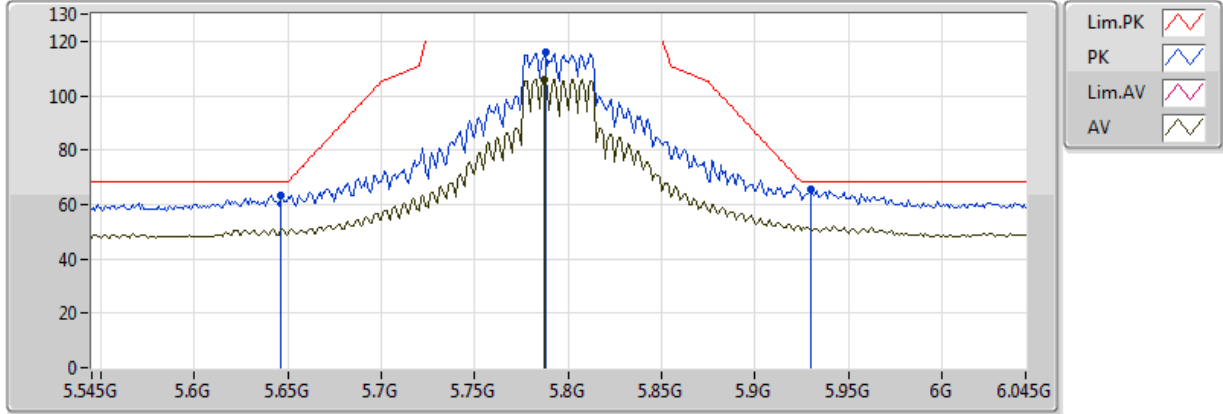

20170617  
 EUT\_Y\_3TX  
 Setting 78(79 Fail)  
 02-W-3-10  
 FSU

| Type | Freq(Hz) | Level(dBuV/m) | Limit(dBuV/m) | Margin(dB) | Factor(dB) | Dist(m) | Pol.(H/V) | Azimuth(°) | Height(m) | Comments |
|------|----------|---------------|---------------|------------|------------|---------|-----------|------------|-----------|----------|
| AV   | 5.787G   | 106.02        | Inf           | -Inf       | 9.92       | 3       | V         | 354        | 1.48      | -        |
| PK   | 5.646G   | 63.21         | 68.20         | -4.99      | 9.89       | 3       | V         | 354        | 1.48      | -        |
| PK   | 5.788G   | 115.73        | Inf           | -Inf       | 9.92       | 3       | V         | 354        | 1.48      | -        |
| PK   | 5.93G    | 65.59         | 68.20         | -2.61      | 10.10      | 3       | V         | 354        | 1.48      | -        |

### 802.11ac VHT40\_Nss1,(MCS0)\_3TX

### 5795MHz\_TX

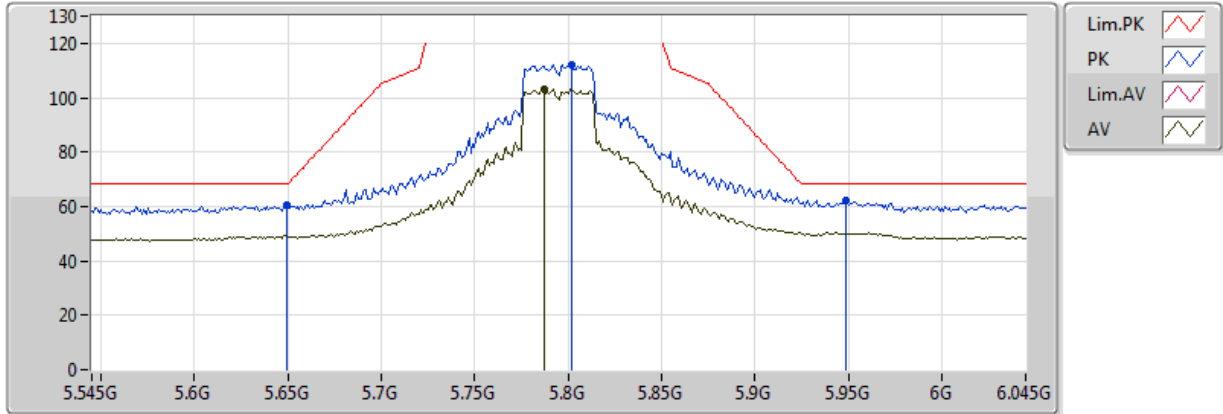

20170617  
 EUT\_Y\_3TX  
 Setting 78(79 Fail)  
 02-W-3-10  
 FSU

| Type | Freq(Hz) | Level(dBuV/m) | Limit(dBuV/m) | Margin(dB) | Factor(dB) | Dist(m) | Pol.(H/V) | Azimuth(°) | Height(m) | Comments |
|------|----------|---------------|---------------|------------|------------|---------|-----------|------------|-----------|----------|
| AV   | 5.787G   | 103.11        | Inf           | -Inf       | 9.92       | 3       | H         | 14         | 1.01      | -        |
| PK   | 5.649G   | 60.73         | 68.20         | -7.47      | 9.89       | 3       | H         | 14         | 1.01      | -        |
| PK   | 5.802G   | 112.12        | Inf           | -Inf       | 9.92       | 3       | H         | 14         | 1.01      | -        |
| PK   | 5.949G   | 62.29         | 68.20         | -5.91      | 10.13      | 3       | H         | 14         | 1.01      | -        |

### 802.11ac VHT40\_Nss1,(MCS0)\_3TX

### 5795MHz\_TX

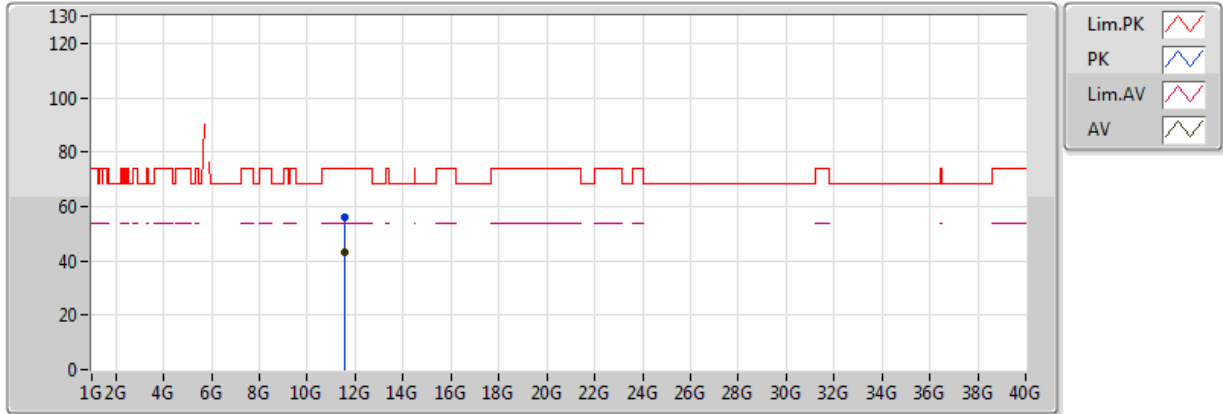

20170617  
 EUT\_Y\_3TX  
 Setting 78(79 Fail)  
 02-W-3  
 FSU

| Type | Freq(Hz)  | Level(dBuV/m) | Limit(dBuV/m) | Margin(dB) | Factor(dB) | Dist(m) | Pol.(H/V) | Azimuth(°) | Height(m) | Comments |
|------|-----------|---------------|---------------|------------|------------|---------|-----------|------------|-----------|----------|
| AV   | 11.58764G | 43.17         | 54.00         | -10.83     | 16.47      | 3       | V         | 319        | 1.65      | -        |
| PK   | 11.58938G | 56.06         | 74.00         | -17.94     | 16.47      | 3       | V         | 319        | 1.65      | -        |

### 802.11ac VHT40\_Nss1,(MCS0)\_3TX

### 5795MHz\_TX

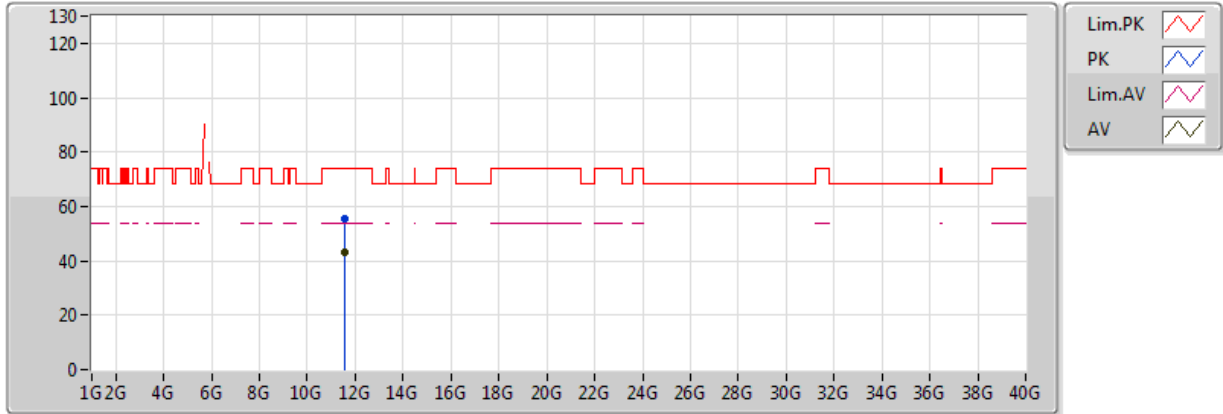

20170617  
 EUT\_Y\_3TX  
 Setting 78(79 Fail)  
 02-W-3  
 FSU

| Type | Freq(Hz)  | Level(dBuV/m) | Limit(dBuV/m) | Margin(dB) | Factor(dB) | Dist(m) | Pol.(H/V) | Azimuth(°) | Height(m) | Comments |
|------|-----------|---------------|---------------|------------|------------|---------|-----------|------------|-----------|----------|
| AV   | 11.58788G | 43.09         | 54.00         | -10.91     | 16.47      | 3       | H         | 249        | 1.71      | -        |
| PK   | 11.58779G | 55.39         | 74.00         | -18.61     | 16.47      | 3       | H         | 249        | 1.71      | -        |



### 802.11ac VHT80\_Nss1,(MCS0)\_3TX

### 5210MHz\_TX

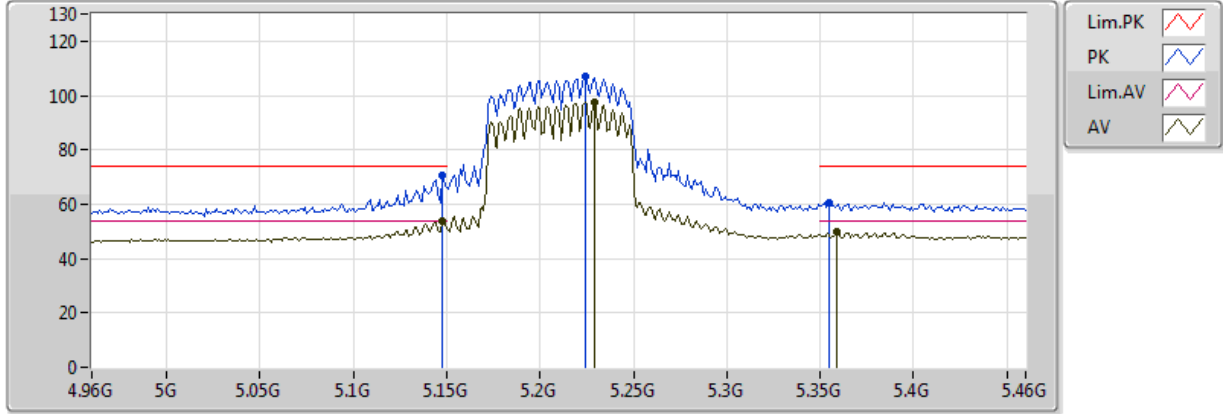

20170617  
EUT\_Y\_3TX  
Setting 51  
02-W-3-10  
FSU

| Type | Freq(Hz) | Level(dBuV/m) | Limit(dBuV/m) | Margin(dB) | Factor(dB) | Dist(m) | Pol.(H/V) | Azimuth(°) | Height(m) | Comments |
|------|----------|---------------|---------------|------------|------------|---------|-----------|------------|-----------|----------|
| AV   | 5.148G   | 53.98         | 54.00         | -0.02      | 9.03       | 3       | V         | 358        | 2.74      | -        |
| AV   | 5.229G   | 97.39         | Inf           | -Inf       | 9.22       | 3       | V         | 358        | 2.74      | -        |
| AV   | 5.359G   | 49.67         | 54.00         | -4.33      | 9.45       | 3       | V         | 358        | 2.74      | -        |
| PK   | 5.148G   | 70.64         | 74.00         | -3.36      | 9.03       | 3       | V         | 358        | 2.74      | -        |
| PK   | 5.224G   | 107.00        | Inf           | -Inf       | 9.21       | 3       | V         | 358        | 2.74      | -        |
| PK   | 5.355G   | 60.76         | 74.00         | -13.24     | 9.44       | 3       | V         | 358        | 2.74      | -        |

### 802.11ac VHT80\_Nss1,(MCS0)\_3TX

### 5210MHz\_TX

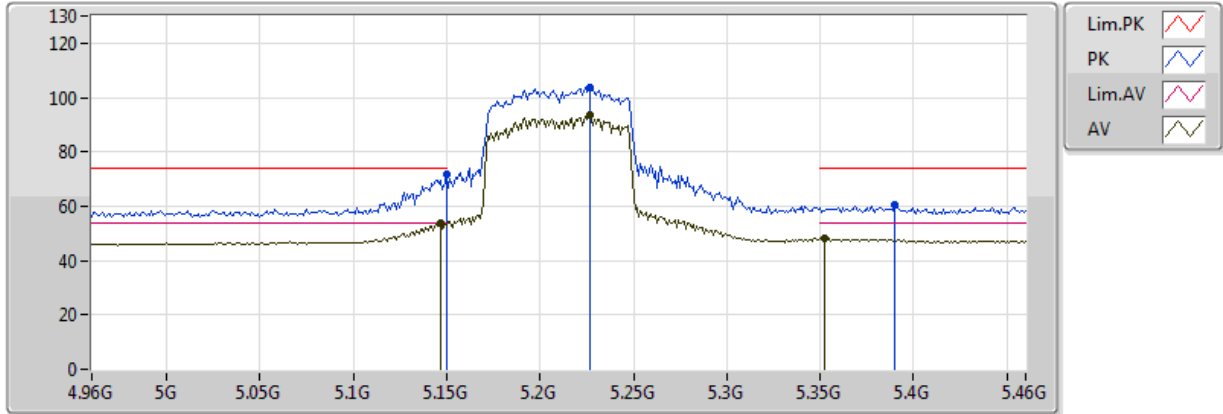

20170617  
EUT\_Y\_3TX  
Setting 51  
02-W-3-10  
FSU

| Type | Freq(Hz)  | Level(dBuV/m) | Limit(dBuV/m) | Margin(dB) | Factor(dB) | Dist(m) | Pol.(H/V) | Azimuth(°) | Height(m) | Comments |
|------|-----------|---------------|---------------|------------|------------|---------|-----------|------------|-----------|----------|
| AV   | 5.147G    | 53.75         | 54.00         | -0.25      | 9.03       | 3       | H         | 6          | 1.43      | -        |
| AV   | 5.227G    | 93.42         | Inf           | -Inf       | 9.21       | 3       | H         | 6          | 1.43      | -        |
| AV   | 5.352G    | 48.16         | 54.00         | -5.84      | 9.44       | 3       | H         | 6          | 1.43      | -        |
| PK   | 5.149995G | 71.99         | 74.00         | -2.01      | 9.03       | 3       | H         | 6          | 1.43      | -        |
| PK   | 5.227G    | 103.72        | Inf           | -Inf       | 9.21       | 3       | H         | 6          | 1.43      | -        |
| PK   | 5.39G     | 60.29         | 74.00         | -13.71     | 9.50       | 3       | H         | 6          | 1.43      | -        |

### 802.11ac VHT80\_Nss1,(MCS0)\_3TX

### 5210MHz\_TX

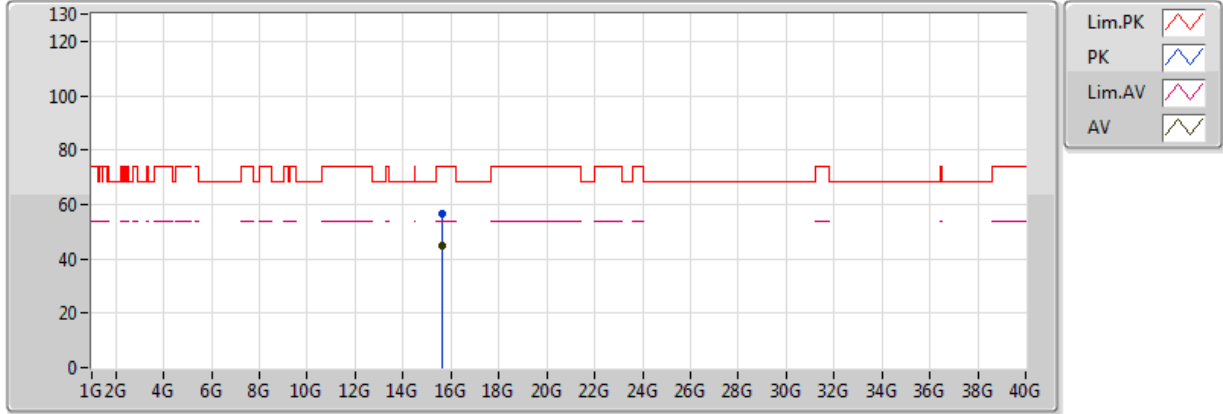

20170617  
EUT\_Y\_3TX  
Setting 51  
02-W-3  
FSU

| Type | Freq(Hz)  | Level(dBuV/m) | Limit(dBuV/m) | Margin(dB) | Factor(dB) | Dist(m) | Pol.(H/V) | Azimuth(°) | Height(m) | Comments |
|------|-----------|---------------|---------------|------------|------------|---------|-----------|------------|-----------|----------|
| AV   | 15.6318G  | 44.84         | 54.00         | -9.16      | 17.83      | 3       | V         | 122        | 1.12      | -        |
| PK   | 15.62841G | 56.85         | 74.00         | -17.15     | 17.84      | 3       | V         | 122        | 1.12      | -        |

### 802.11ac VHT80\_Nss1,(MCS0)\_3TX

### 5210MHz\_TX

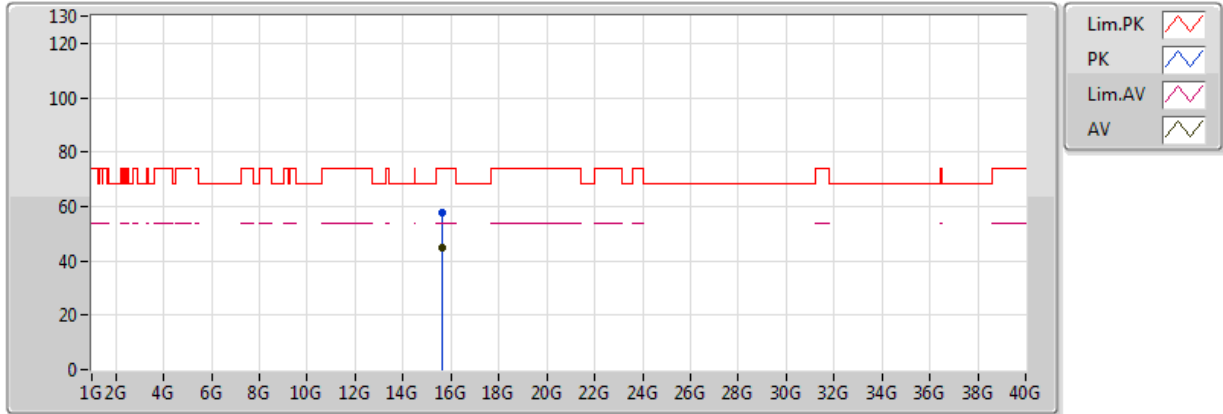

20170617  
EUT\_Y\_3TX  
Setting 51  
02-W-3  
FSU

| Type | Freq(Hz)  | Level(dBuV/m) | Limit(dBuV/m) | Margin(dB) | Factor(dB) | Dist(m) | Pol.(H/V) | Azimuth(°) | Height(m) | Comments |
|------|-----------|---------------|---------------|------------|------------|---------|-----------|------------|-----------|----------|
| AV   | 15.63098G | 44.66         | 54.00         | -9.34      | 17.83      | 3       | H         | 213        | 2.02      | -        |
| PK   | 15.63131G | 57.53         | 74.00         | -16.47     | 17.83      | 3       | H         | 213        | 2.02      | -        |

### 802.11ac VHT80\_Nss1,(MCS0)\_3TX

### 5775MHz\_TX

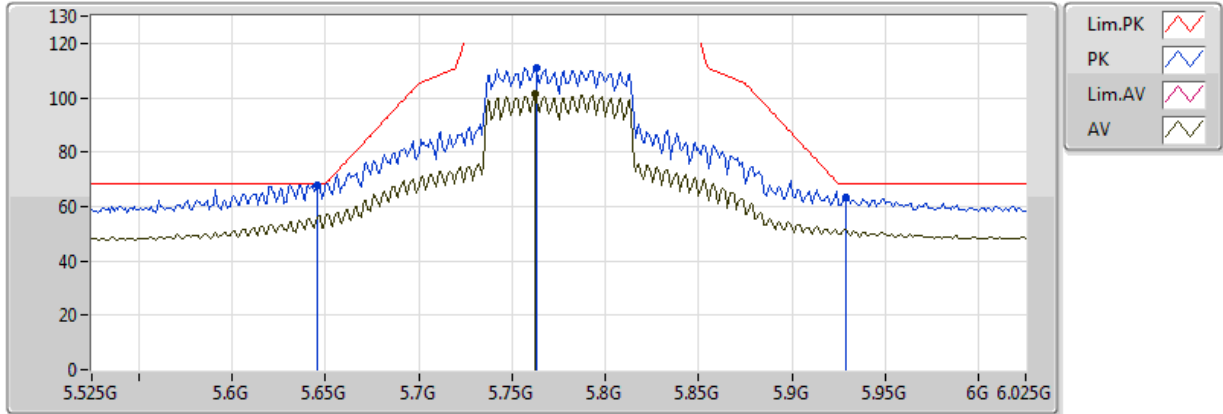

20170617  
EUT\_Y\_3TX  
Setting 67  
02-W-3-10  
FSU

| Type | Freq(Hz) | Level(dBuV/m) | Limit(dBuV/m) | Margin(dB) | Factor(dB) | Dist(m) | Pol.(H/V) | Azimuth(°) | Height(m) | Comments |
|------|----------|---------------|---------------|------------|------------|---------|-----------|------------|-----------|----------|
| AV   | 5.762G   | 101.29        | Inf           | -Inf       | 9.91       | 3       | V         | 352        | 1.26      | -        |
| PK   | 5.646G   | 68.03         | 68.20         | -0.17      | 9.89       | 3       | V         | 352        | 1.26      | -        |
| PK   | 5.763G   | 111.06        | Inf           | -Inf       | 9.91       | 3       | V         | 352        | 1.26      | -        |
| PK   | 5.929G   | 63.53         | 68.20         | -4.67      | 10.10      | 3       | V         | 352        | 1.26      | -        |

### 802.11ac VHT80\_Nss1,(MCS0)\_3TX

### 5775MHz\_TX

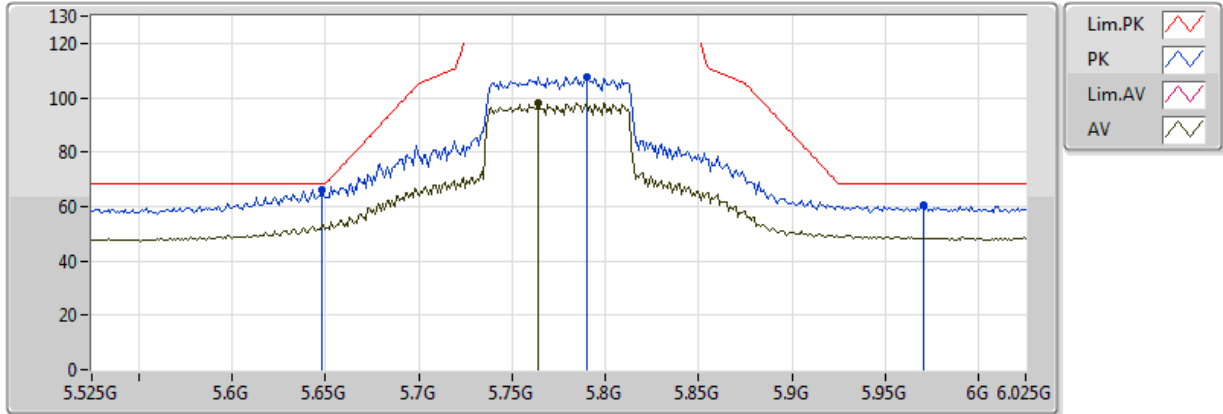

20170617  
EUT\_Y\_3TX  
Setting 67  
02-W-3-10  
FSU

| Type | Freq(Hz) | Level(dBuV/m) | Limit(dBuV/m) | Margin(dB) | Factor(dB) | Dist(m) | Pol.(H/V) | Azimuth(°) | Height(m) | Comments |
|------|----------|---------------|---------------|------------|------------|---------|-----------|------------|-----------|----------|
| AV   | 5.764G   | 97.98         | Inf           | -Inf       | 9.91       | 3       | H         | 6          | 2.27      | -        |
| PK   | 5.648G   | 66.01         | 68.20         | -2.19      | 9.89       | 3       | H         | 6          | 2.27      | -        |
| PK   | 5.79G    | 107.60        | Inf           | -Inf       | 9.92       | 3       | H         | 6          | 2.27      | -        |
| PK   | 5.97G    | 60.29         | 68.20         | -7.91      | 10.16      | 3       | H         | 6          | 2.27      | -        |

### 802.11ac VHT80\_Nss1,(MCS0)\_3TX

### 5775MHz\_TX

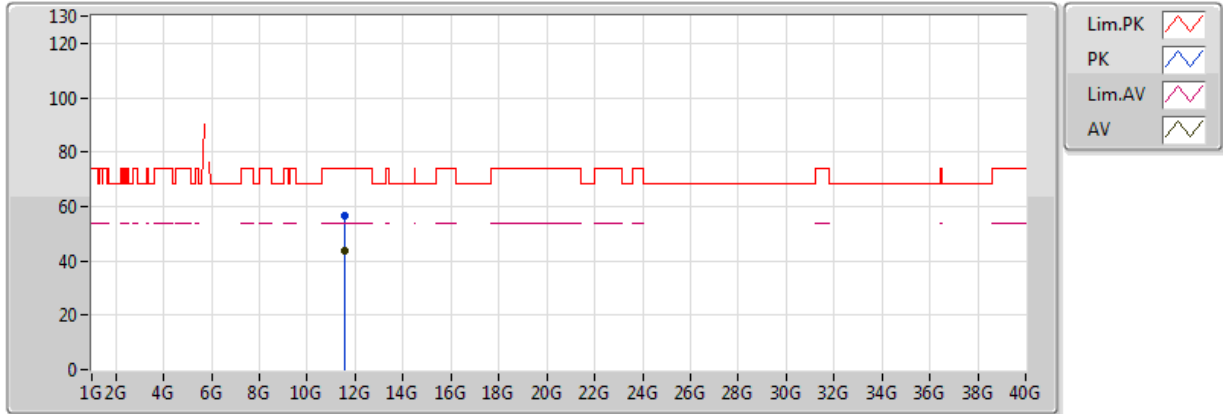

20170617  
EUT\_Y\_3TX  
Setting 67  
02-W-3  
FSU

| Type | Freq(Hz)  | Level(dBuV/m) | Limit(dBuV/m) | Margin(dB) | Factor(dB) | Dist(m) | Pol.(H/V) | Azimuth(°) | Height(m) | Comments |
|------|-----------|---------------|---------------|------------|------------|---------|-----------|------------|-----------|----------|
| AV   | 11.55132G | 43.44         | 54.00         | -10.56     | 16.43      | 3       | V         | 240        | 1.82      | -        |
| PK   | 11.55232G | 56.32         | 74.00         | -17.68     | 16.43      | 3       | V         | 240        | 1.82      | -        |

### 802.11ac VHT80\_Nss1,(MCS0)\_3TX

### 5775MHz\_TX

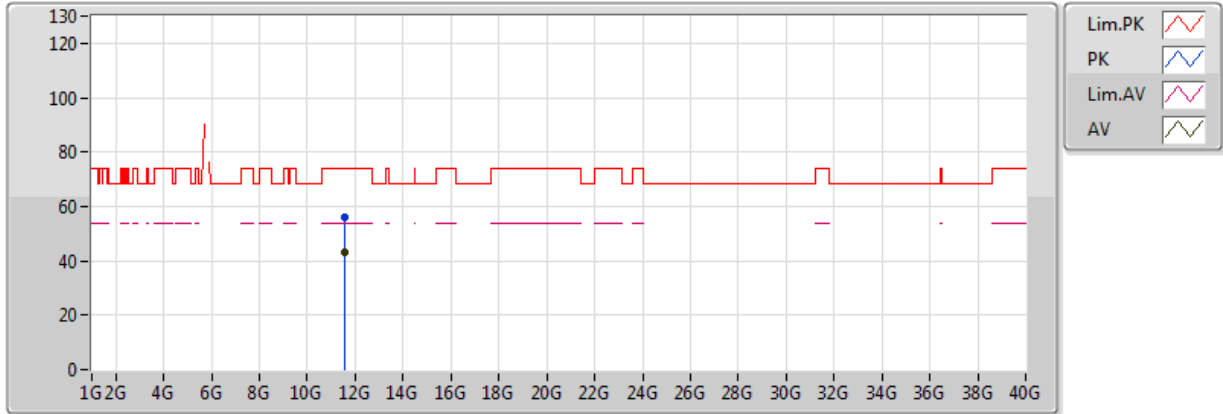

20170617  
EUT\_Y\_3TX  
Setting 67  
02-W-3  
FSU

| Type | Freq(Hz) | Level(dBuV/m) | Limit(dBuV/m) | Margin(dB) | Factor(dB) | Dist(m) | Pol.(H/V) | Azimuth(°) | Height(m) | Comments |
|------|----------|---------------|---------------|------------|------------|---------|-----------|------------|-----------|----------|
| AV   | 11.5515G | 43.00         | 54.00         | -11.00     | 16.43      | 3       | H         | 138        | 1.66      | -        |
| PK   | 11.5506G | 55.82         | 74.00         | -18.18     | 16.43      | 3       | H         | 138        | 1.66      | -        |



### 802.11ac VHT20-BF\_Nss1,(MCS0)\_3TX

### 5180MHz\_TX

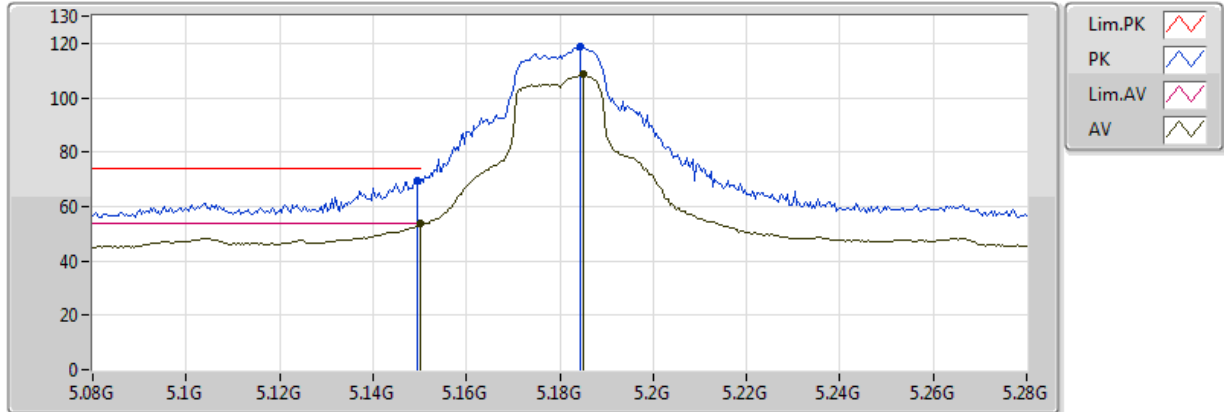

20170620  
EUT\_Y\_3TX  
Setting 70  
01-M-0-10  
FSP

| Type | Freq(Hz)  | Level(dBuV/m) | Limit(dBuV/m) | Margin(dB) | Factor(dB) | Dist(m) | Pol.(H/V) | Azimuth(°) | Height(m) | Comments |
|------|-----------|---------------|---------------|------------|------------|---------|-----------|------------|-----------|----------|
| AV   | 5.149995G | 53.90         | 54.00         | -0.10      | 4.27       | 3       | V         | 329        | 1.01      | -        |
| AV   | 5.1852G   | 108.71        | Inf           | -Inf       | 4.35       | 3       | V         | 329        | 1.01      | -        |
| PK   | 5.1496G   | 69.72         | 74.00         | -4.28      | 4.27       | 3       | V         | 329        | 1.01      | -        |
| PK   | 5.1844G   | 118.64        | Inf           | -Inf       | 4.35       | 3       | V         | 329        | 1.01      | -        |

### 802.11ac VHT20-BF\_Nss1,(MCS0)\_3TX

### 5180MHz\_TX

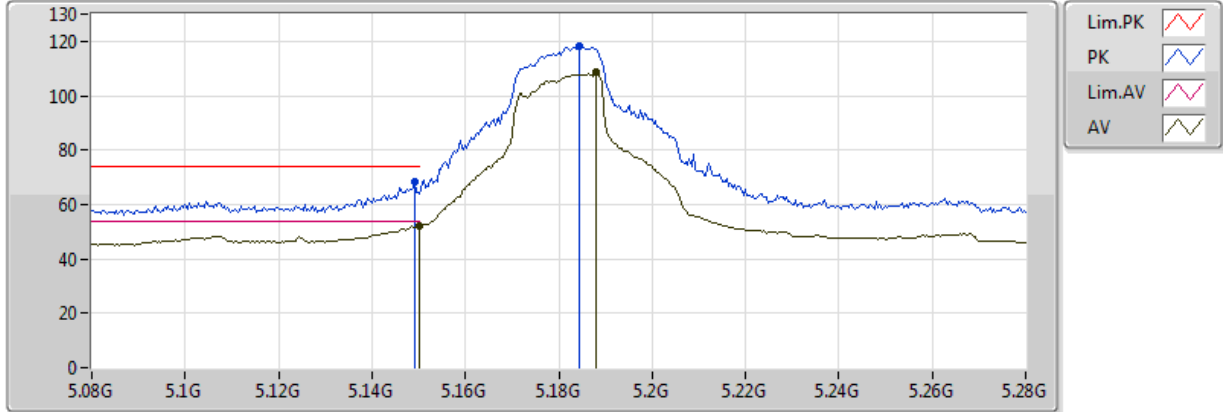

20170620  
EUT\_Y\_3TX  
Setting 70  
01-M-0-10  
FSP

| Type | Freq(Hz)  | Level(dBuV/m) | Limit(dBuV/m) | Margin(dB) | Factor(dB) | Dist(m) | Pol.(H/V) | Azimuth(°) | Height(m) | Comments |
|------|-----------|---------------|---------------|------------|------------|---------|-----------|------------|-----------|----------|
| AV   | 5.149995G | 52.19         | 54.00         | -1.81      | 4.27       | 3       | H         | 4          | 1.42      | -        |
| AV   | 5.188G    | 108.47        | Inf           | -Inf       | 4.35       | 3       | H         | 4          | 1.42      | -        |
| PK   | 5.1492G   | 68.46         | 74.00         | -5.54      | 4.27       | 3       | H         | 4          | 1.42      | -        |
| PK   | 5.1844G   | 118.32        | Inf           | -Inf       | 4.35       | 3       | H         | 4          | 1.42      | -        |

### 802.11ac VHT20-BF\_Nss1,(MCS0)\_3TX

### 5180MHz\_TX

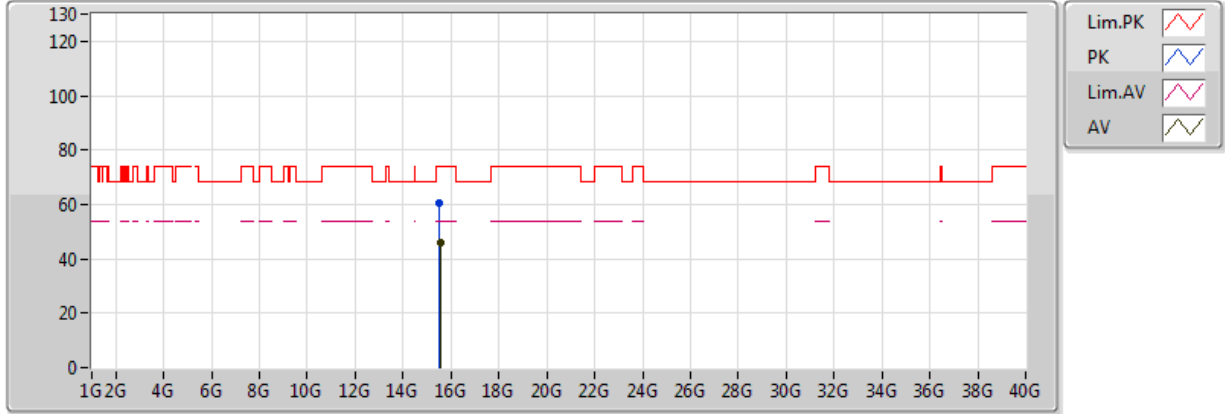

20170621  
 EUT\_Y\_3TX  
 Setting 70  
 05-P-2  
 FSP(100142)

| Type | Freq(Hz)  | Level(dBuV/m) | Limit(dBuV/m) | Margin(dB) | Factor(dB) | Dist(m) | Pol.(H/V) | Azimuth(°) | Height(m) | Comments |
|------|-----------|---------------|---------------|------------|------------|---------|-----------|------------|-----------|----------|
| AV   | 15.53956G | 46.14         | 54.00         | -7.86      | 19.07      | 3       | V         | 198        | 1.74      | -        |
| PK   | 15.53672G | 60.26         | 74.00         | -13.74     | 19.08      | 3       | V         | 198        | 1.74      | -        |

### 802.11ac VHT20-BF\_Nss1,(MCS0)\_3TX

### 5180MHz\_TX

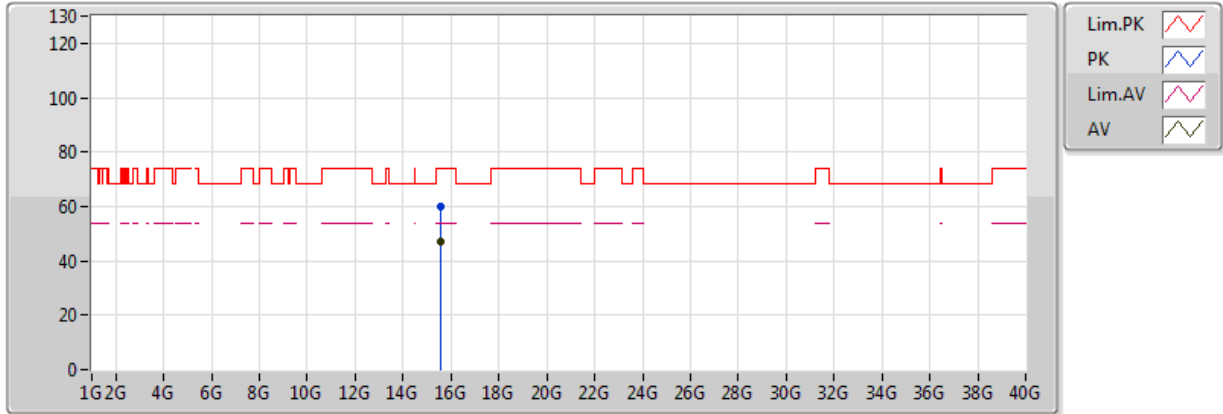

20170621  
EUT\_Y\_3TX  
Setting 70  
05-P-2  
FSP(100142)

| Type | Freq(Hz)  | Level(dBuV/m) | Limit(dBuV/m) | Margin(dB) | Factor(dB) | Dist(m) | Pol.(H/V) | Azimuth(°) | Height(m) | Comments |
|------|-----------|---------------|---------------|------------|------------|---------|-----------|------------|-----------|----------|
| AV   | 15.53834G | 47.18         | 54.00         | -6.82      | 19.07      | 3       | H         | 194        | 2.28      | -        |
| PK   | 15.54064G | 60.10         | 74.00         | -13.90     | 19.06      | 3       | H         | 194        | 2.28      | -        |

### 802.11ac VHT20-BF\_Nss1,(MCS0)\_3TX

### 5200MHz\_TX

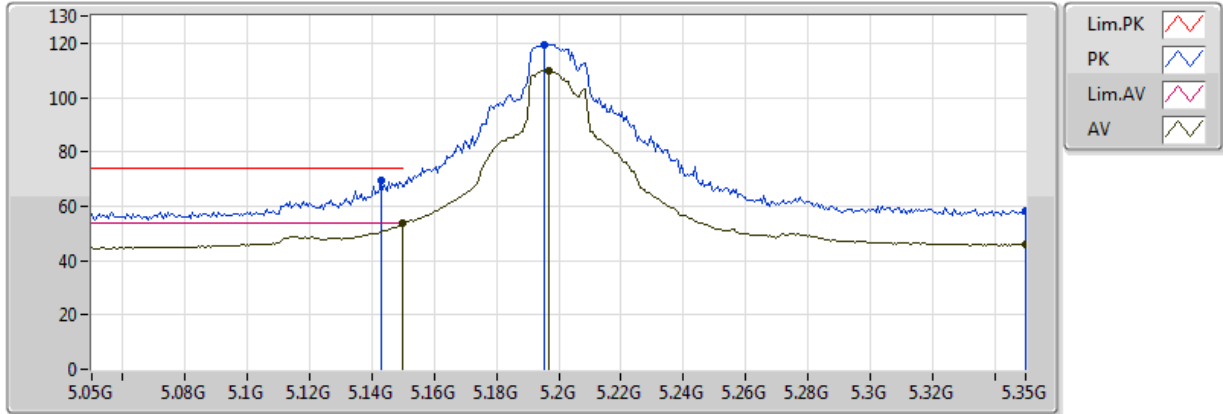

20170620  
EUT Y\_3TX  
Setting 78  
01-M-0-10  
FSP

| Type | Freq(Hz)  | Level(dBuV/m) | Limit(dBuV/m) | Margin(dB) | Factor(dB) | Dist(m) | Pol.(H/V) | Azimuth(°) | Height(m) | Comments |
|------|-----------|---------------|---------------|------------|------------|---------|-----------|------------|-----------|----------|
| AV   | 5.149995G | 53.73         | 54.00         | -0.27      | 4.27       | 3       | V         | 334        | 1.35      | -        |
| AV   | 5.197G    | 109.95        | Inf           | -Inf       | 4.37       | 3       | V         | 334        | 1.35      | -        |
| AV   | 5.35G     | 45.70         | Inf           | -Inf       | 4.68       | 3       | V         | 334        | 1.35      | -        |
| PK   | 5.143G    | 69.47         | 74.00         | -4.53      | 4.25       | 3       | V         | 334        | 1.35      | -        |
| PK   | 5.1952G   | 119.52        | Inf           | -Inf       | 4.37       | 3       | V         | 334        | 1.35      | -        |
| PK   | 5.35G     | 58.02         | Inf           | -Inf       | 4.68       | 3       | V         | 334        | 1.35      | -        |

### 802.11ac VHT20-BF\_Nss1,(MCS0)\_3TX

### 5200MHz\_TX

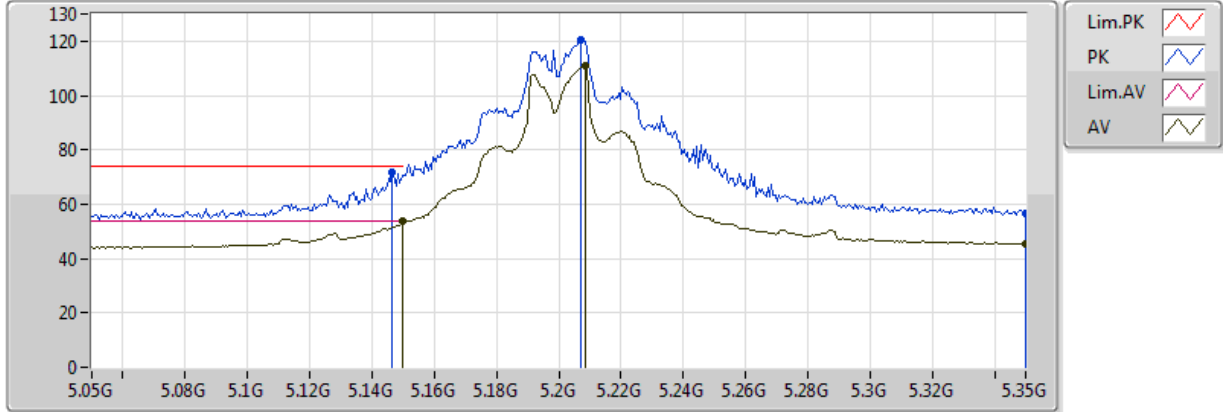

20170620  
EUT Y\_3TX  
Setting 78  
01-M-0-10  
FSP

| Type | Freq(Hz)  | Level(dBuV/m) | Limit(dBuV/m) | Margin(dB) | Factor(dB) | Dist(m) | Pol.(H/V) | Azimuth(°) | Height(m) | Comments |
|------|-----------|---------------|---------------|------------|------------|---------|-----------|------------|-----------|----------|
| AV   | 5.149995G | 53.96         | 54.00         | -0.04      | 4.27       | 3       | H         | 355        | 1.44      | -        |
| AV   | 5.2084G   | 111.03        | Inf           | -Inf       | 4.40       | 3       | H         | 355        | 1.44      | -        |
| AV   | 5.35G     | 45.53         | Inf           | -Inf       | 4.68       | 3       | H         | 355        | 1.44      | -        |
| PK   | 5.1466G   | 71.73         | 74.00         | -2.27      | 4.26       | 3       | H         | 355        | 1.44      | -        |
| PK   | 5.2072G   | 120.49        | Inf           | -Inf       | 4.40       | 3       | H         | 355        | 1.44      | -        |
| PK   | 5.35G     | 56.44         | Inf           | -Inf       | 4.68       | 3       | H         | 355        | 1.44      | -        |

### 802.11ac VHT20-BF\_Nss1,(MCS0)\_3TX

### 5200MHz\_TX

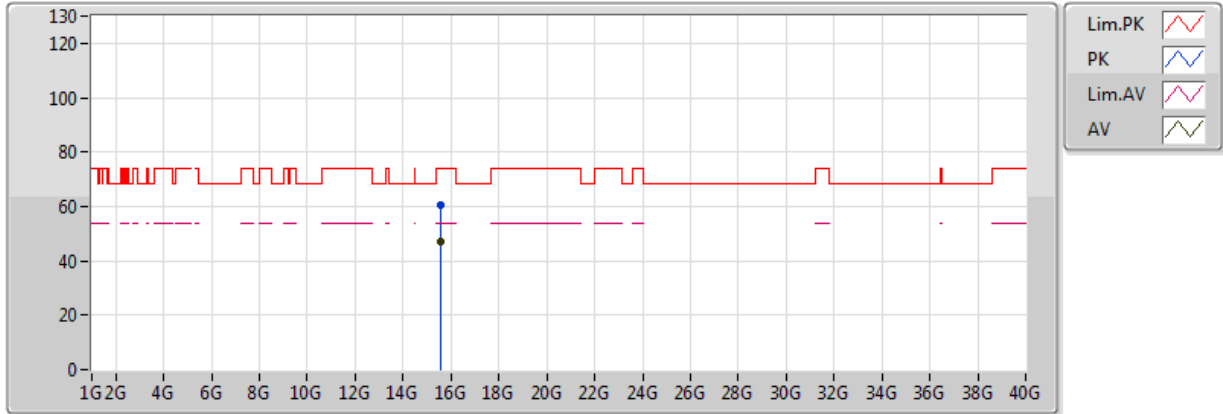

20170621  
 EUT\_Y\_3TX  
 Setting 78  
 05-P-2  
 FSP(100142)

| Type | Freq(Hz)  | Level(dBuV/m) | Limit(dBuV/m) | Margin(dB) | Factor(dB) | Dist(m) | Pol.(H/V) | Azimuth(°) | Height(m) | Comments |
|------|-----------|---------------|---------------|------------|------------|---------|-----------|------------|-----------|----------|
| AV   | 15.59948G | 46.94         | 54.00         | -7.06      | 18.88      | 3       | V         | 270        | 2.44      | -        |
| PK   | 15.598G   | 60.68         | 74.00         | -13.32     | 18.88      | 3       | V         | 270        | 2.44      | -        |

### 802.11ac VHT20-BF\_Nss1,(MCS0)\_3TX

### 5200MHz\_TX

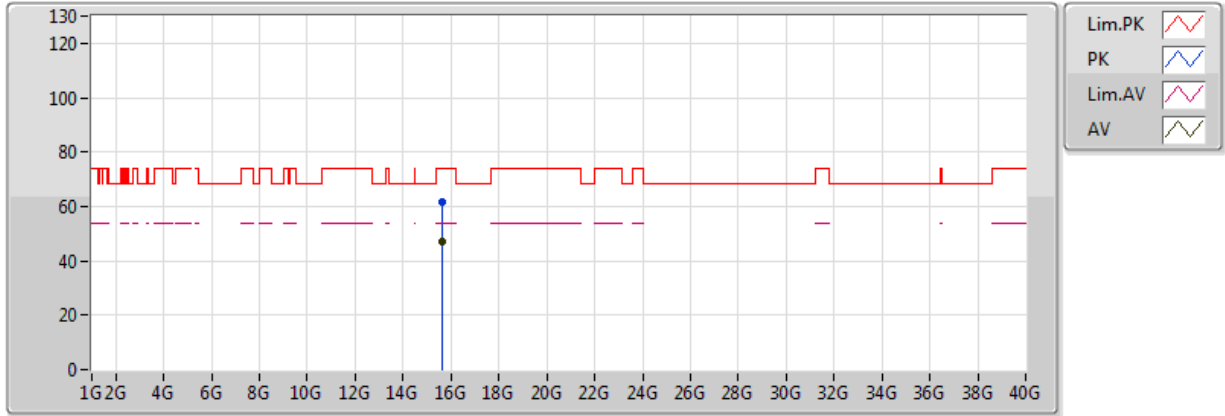

20170621  
EUT\_Y\_3TX  
Setting 78  
05-P-2  
FSP(100142)

| Type | Freq(Hz)  | Level(dBuV/m) | Limit(dBuV/m) | Margin(dB) | Factor(dB) | Dist(m) | Pol.(H/V) | Azimuth(°) | Height(m) | Comments |
|------|-----------|---------------|---------------|------------|------------|---------|-----------|------------|-----------|----------|
| AV   | 15.60408G | 46.86         | 54.00         | -7.14      | 18.87      | 3       | H         | 86         | 2.12      | -        |
| PK   | 15.60352G | 61.36         | 74.00         | -12.64     | 18.87      | 3       | H         | 86         | 2.12      | -        |



### 802.11ac VHT20-BF\_Nss1,(MCS0)\_3TX

### 5240MHz\_TX

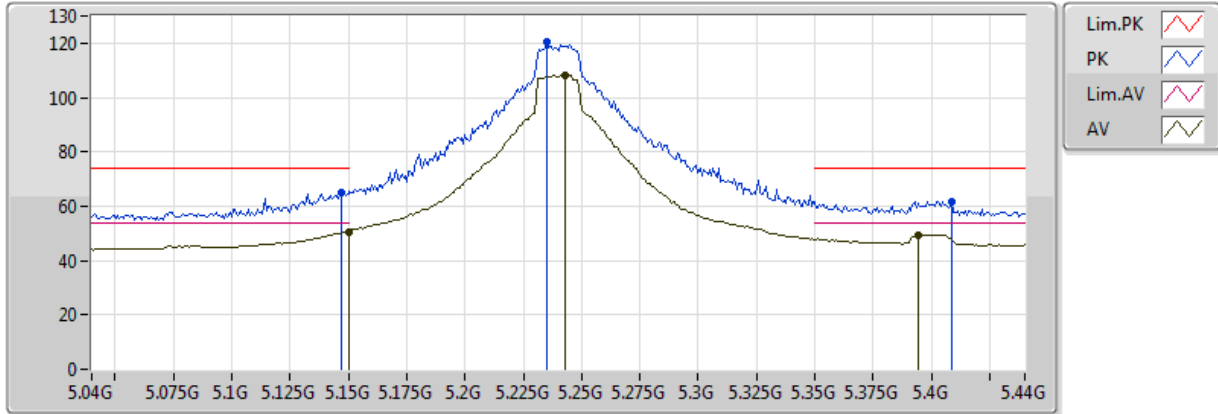

20170620  
EUT Y\_3TX  
Setting 120  
01-M-0-10  
FSP

| Type | Freq(Hz)  | Level(dBuV/m) | Limit(dBuV/m) | Margin(dB) | Factor(dB) | Dist(m) | Pol.(H/V) | Azimuth(°) | Height(m) | Comments |
|------|-----------|---------------|---------------|------------|------------|---------|-----------|------------|-----------|----------|
| AV   | 5.149995G | 50.51         | 54.00         | -3.49      | 4.27       | 3       | V         | 0          | 2.53      | -        |
| AV   | 5.2432G   | 108.40        | Inf           | -Inf       | 4.47       | 3       | V         | 0          | 2.53      | -        |
| AV   | 5.3944G   | 49.38         | 54.00         | -4.62      | 4.76       | 3       | V         | 0          | 2.53      | -        |
| PK   | 5.1472G   | 65.04         | 74.00         | -8.96      | 4.26       | 3       | V         | 0          | 2.53      | -        |
| PK   | 5.2352G   | 120.36        | Inf           | -Inf       | 4.45       | 3       | V         | 0          | 2.53      | -        |
| PK   | 5.4088G   | 61.68         | 74.00         | -12.32     | 4.79       | 3       | V         | 0          | 2.53      | -        |

### 802.11ac VHT20-BF\_Nss1,(MCS0)\_3TX 5240MHz\_TX

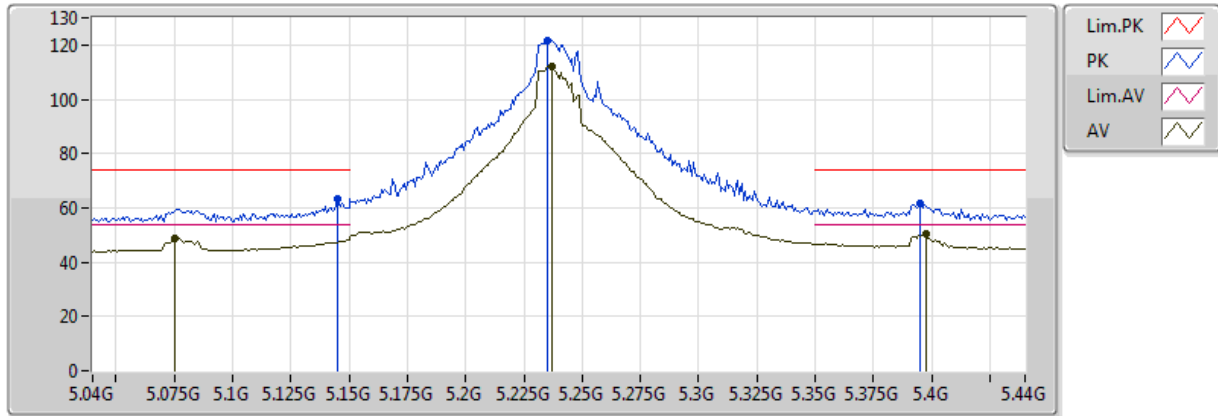

20170620  
EUT\_Y\_3TX  
Setting 120  
01-M-0-10  
FSP

| Type | Freq(Hz) | Level(dBuV/m) | Limit(dBuV/m) | Margin(dB) | Factor(dB) | Dist(m) | Pol.(H/V) | Azimuth(°) | Height(m) | Comments |
|------|----------|---------------|---------------|------------|------------|---------|-----------|------------|-----------|----------|
| AV   | 5.0752G  | 48.61         | 54.00         | -5.39      | 4.10       | 3       | H         | 360        | 1.41      | -        |
| AV   | 5.2368G  | 112.25        | Inf           | -Inf       | 4.46       | 3       | H         | 360        | 1.41      | -        |
| AV   | 5.3976G  | 50.20         | 54.00         | -3.80      | 4.77       | 3       | H         | 360        | 1.41      | -        |
| PK   | 5.1448G  | 63.05         | 74.00         | -10.95     | 4.26       | 3       | H         | 360        | 1.41      | -        |
| PK   | 5.2352G  | 121.73        | Inf           | -Inf       | 4.45       | 3       | H         | 360        | 1.41      | -        |
| PK   | 5.3952G  | 61.80         | 74.00         | -12.20     | 4.76       | 3       | H         | 360        | 1.41      | -        |

### 802.11ac VHT20-BF\_Nss1,(MCS0)\_3TX

### 5240MHz\_TX

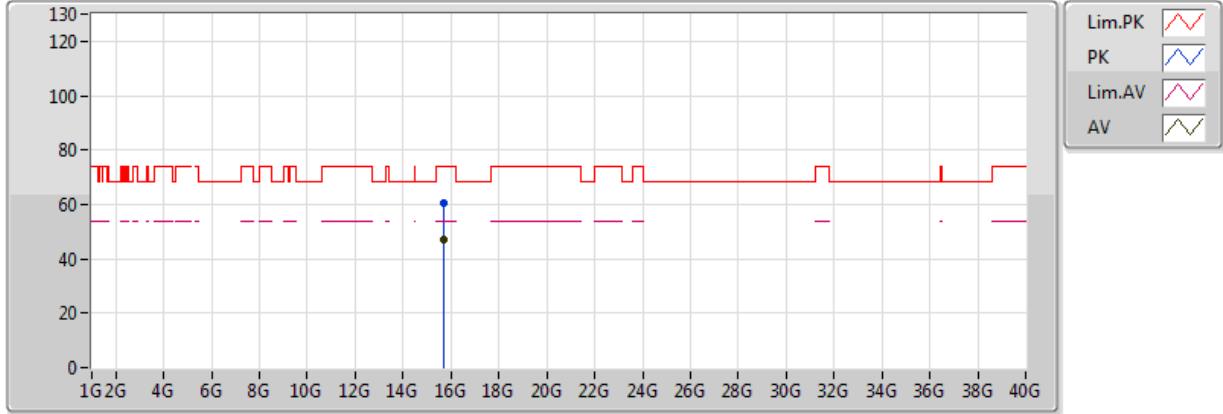

20170621  
 EUT\_Y\_3TX  
 Setting 120  
 05-P-2  
 FSP(100142)

| Type | Freq(Hz)  | Level(dBuV/m) | Limit(dBuV/m) | Margin(dB) | Factor(dB) | Dist(m) | Pol.(H/V) | Azimuth(°) | Height(m) | Comments |
|------|-----------|---------------|---------------|------------|------------|---------|-----------|------------|-----------|----------|
| AV   | 15.71642G | 47.07         | 54.00         | -6.93      | 18.51      | 3       | V         | 22         | 2.42      | -        |
| PK   | 15.71948G | 60.25         | 74.00         | -13.75     | 18.51      | 3       | V         | 22         | 2.42      | -        |

### 802.11ac VHT20-BF\_Nss1,(MCS0)\_3TX

### 5240MHz\_TX

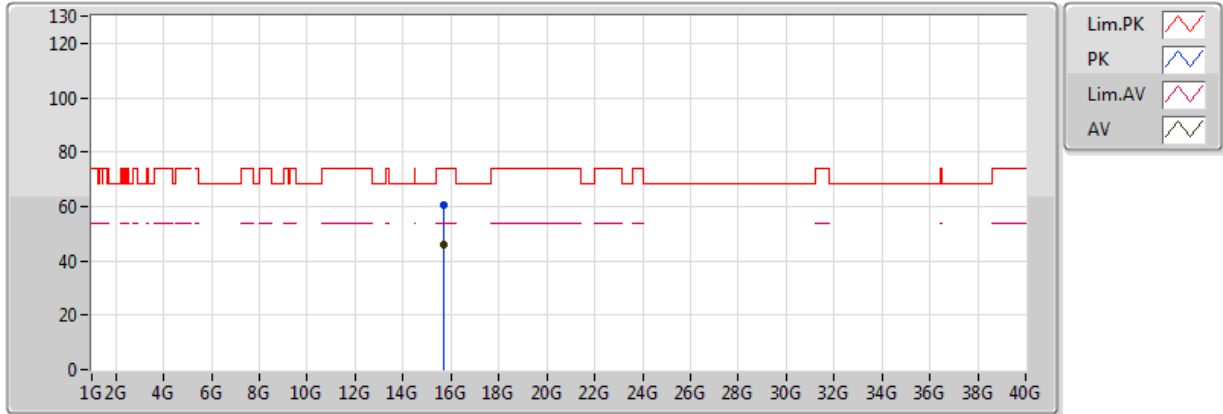

20170621  
EUT\_Y\_3TX  
Setting 120  
05-P-2  
FSP(100142)

| Type | Freq(Hz)  | Level(dBuV/m) | Limit(dBuV/m) | Margin(dB) | Factor(dB) | Dist(m) | Pol.(H/V) | Azimuth(°) | Height(m) | Comments |
|------|-----------|---------------|---------------|------------|------------|---------|-----------|------------|-----------|----------|
| AV   | 15.72012G | 46.01         | 54.00         | -7.99      | 18.50      | 3       | H         | 76         | 1.51      | -        |
| PK   | 15.72112G | 60.24         | 74.00         | -13.76     | 18.50      | 3       | H         | 76         | 1.51      | -        |

### 802.11ac VHT20-BF\_Nss1,(MCS0)\_3TX

### 5745MHz\_TX

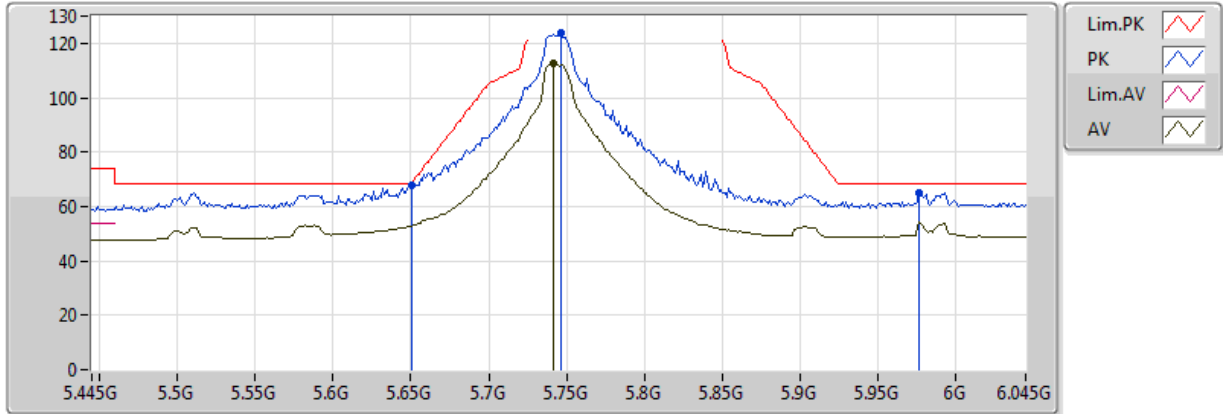

20170621  
EUT\_Y\_3TX  
Setting 90  
05-P-2-10  
FSP(100142)

| Type | Freq(Hz) | Level(dBuV/m) | Limit(dBuV/m) | Margin(dB) | Factor(dB) | Dist(m) | Pol.(H/V) | Azimuth(°) | Height(m) | Comments |
|------|----------|---------------|---------------|------------|------------|---------|-----------|------------|-----------|----------|
| AV   | 5.7414G  | 112.54        | Inf           | -Inf       | 8.39       | 3       | V         | 351        | 1.19      | -        |
| PK   | 5.6502G  | 67.93         | 68.35         | -0.42      | 8.22       | 3       | V         | 351        | 1.19      | -        |
| PK   | 5.7462G  | 123.86        | Inf           | -Inf       | 8.40       | 3       | V         | 351        | 1.19      | -        |
| PK   | 5.9766G  | 64.85         | 68.20         | -3.35      | 8.95       | 3       | V         | 351        | 1.19      | -        |

### 802.11ac VHT20-BF\_Nss1,(MCS0)\_3TX

### 5745MHz\_TX

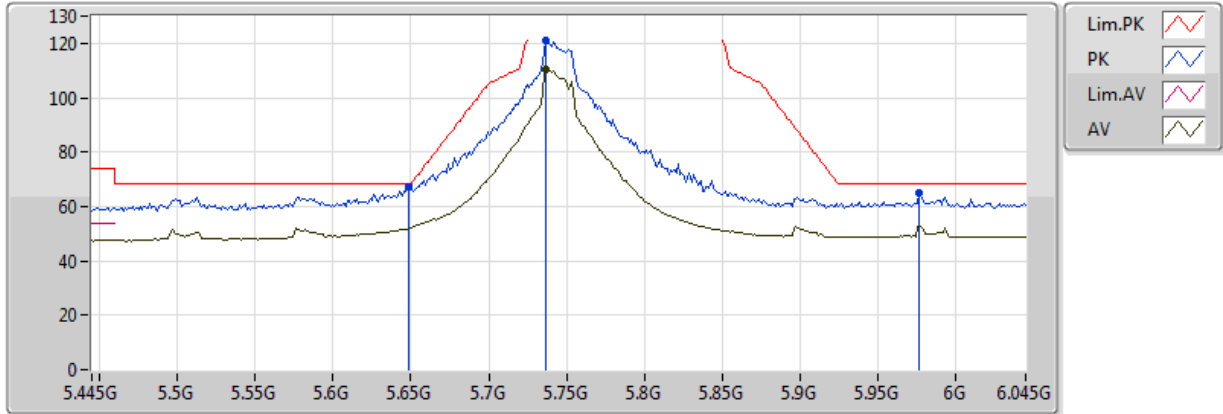

20170621  
 EUT\_Y\_3TX  
 Setting 90  
 05-P-2-10  
 FSP(100142)

| Type | Freq(Hz) | Level(dBuV/m) | Limit(dBuV/m) | Margin(dB) | Factor(dB) | Dist(m) | Pol.(H/V) | Azimuth(°) | Height(m) | Comments |
|------|----------|---------------|---------------|------------|------------|---------|-----------|------------|-----------|----------|
| AV   | 5.7366G  | 110.62        | Inf           | -Inf       | 8.38       | 3       | H         | 357        | 1.02      | -        |
| PK   | 5.649G   | 67.07         | 68.20         | -1.13      | 8.22       | 3       | H         | 357        | 1.02      | -        |
| PK   | 5.7366G  | 121.17        | Inf           | -Inf       | 8.38       | 3       | H         | 357        | 1.02      | -        |
| PK   | 5.9766G  | 65.01         | 68.20         | -3.19      | 8.95       | 3       | H         | 357        | 1.02      | -        |

### 802.11ac VHT20-BF\_Nss1,(MCS0)\_3TX

### 5745MHz\_TX

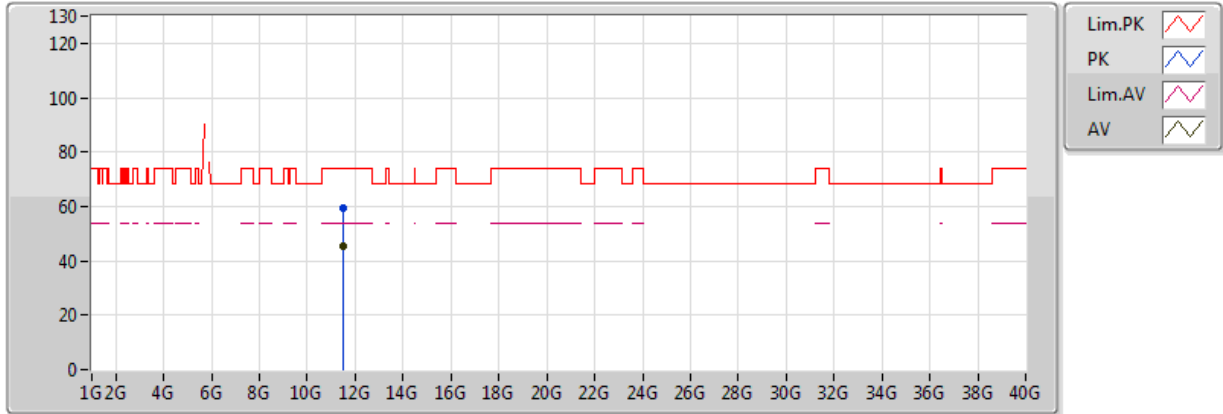

20170621  
 EUT\_Y\_3TX  
 Setting 90  
 05-P-2  
 FSP(100142)

| Type | Freq(Hz)  | Level(dBuV/m) | Limit(dBuV/m) | Margin(dB) | Factor(dB) | Dist(m) | Pol.(H/V) | Azimuth(°) | Height(m) | Comments |
|------|-----------|---------------|---------------|------------|------------|---------|-----------|------------|-----------|----------|
| AV   | 11.49434G | 45.31         | 54.00         | -8.69      | 17.99      | 3       | V         | 26         | 2.06      | -        |
| PK   | 11.48832G | 59.34         | 74.00         | -14.66     | 18.00      | 3       | V         | 26         | 2.06      | -        |

### 802.11ac VHT20-BF\_Nss1,(MCS0)\_3TX

### 5745MHz\_TX

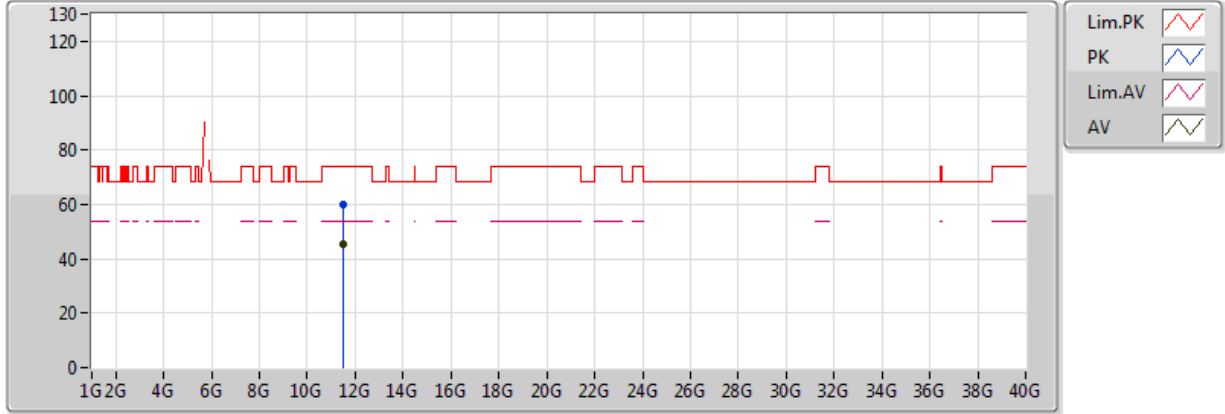

20170621  
 EUT\_Y\_3TX  
 Setting 90  
 05-P-2  
 FSP(100142)

| Type | Freq(Hz)  | Level(dBuV/m) | Limit(dBuV/m) | Margin(dB) | Factor(dB) | Dist(m) | Pol.(H/V) | Azimuth(°) | Height(m) | Comments |
|------|-----------|---------------|---------------|------------|------------|---------|-----------|------------|-----------|----------|
| AV   | 11.48944G | 45.37         | 54.00         | -8.63      | 18.00      | 3       | H         | 42         | 2.07      | -        |
| PK   | 11.48666G | 59.80         | 74.00         | -14.20     | 18.00      | 3       | H         | 42         | 2.07      | -        |



### 802.11ac VHT20-BF\_Nss1,(MCS0)\_3TX

### 5785MHz\_TX

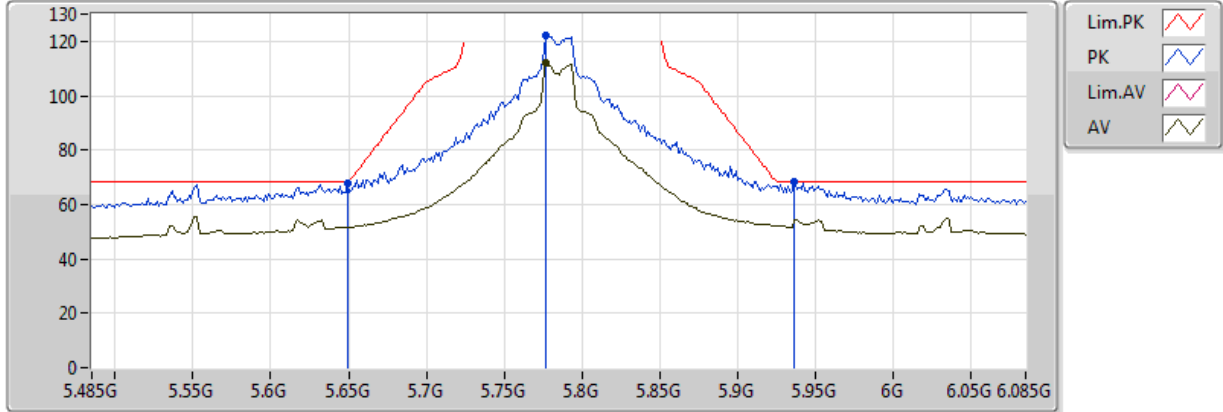

20170621  
EUT\_Y\_3TX  
Setting 90  
05-P-2-10  
FSP(100142)

| Type | Freq(Hz) | Level(dBuV/m) | Limit(dBuV/m) | Margin(dB) | Factor(dB) | Dist(m) | Pol.(H/V) | Azimuth(°) | Height(m) | Comments |
|------|----------|---------------|---------------|------------|------------|---------|-----------|------------|-----------|----------|
| AV   | 5.7766G  | 112.01        | Inf           | -Inf       | 8.46       | 3       | V         | 342        | 1.56      | -        |
| PK   | 5.6494G  | 67.84         | 68.20         | -0.36      | 8.22       | 3       | V         | 342        | 1.56      | -        |
| PK   | 5.7766G  | 122.15        | Inf           | -Inf       | 8.46       | 3       | V         | 342        | 1.56      | -        |
| PK   | 5.9362G  | 68.19         | 68.20         | -0.01      | 8.85       | 3       | V         | 342        | 1.56      | -        |

### 802.11ac VHT20-BF\_Nss1,(MCS0)\_3TX

### 5785MHz\_TX

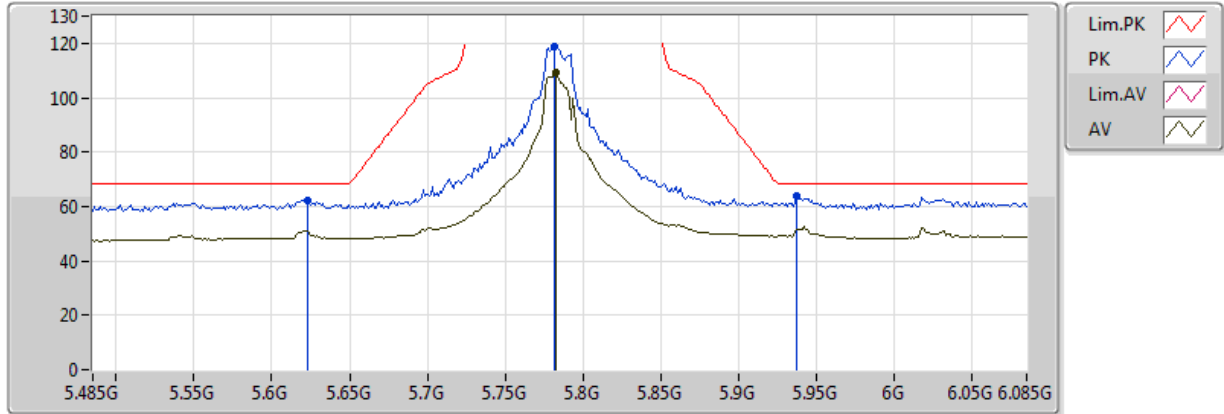

20170621  
 EUT\_Y\_3TX  
 Setting 90  
 05-P-2-10  
 FSP(100142)

| Type | Freq(Hz) | Level(dBuV/m) | Limit(dBuV/m) | Margin(dB) | Factor(dB) | Dist(m) | Pol.(H/V) | Azimuth(°) | Height(m) | Comments |
|------|----------|---------------|---------------|------------|------------|---------|-----------|------------|-----------|----------|
| AV   | 5.7826G  | 109.31        | Inf           | -Inf       | 8.47       | 3       | H         | 2          | 1.01      | -        |
| PK   | 5.623G   | 62.40         | 68.20         | -5.80      | 8.17       | 3       | H         | 2          | 1.01      | -        |
| PK   | 5.7814G  | 118.82        | Inf           | -Inf       | 8.46       | 3       | H         | 2          | 1.01      | -        |
| PK   | 5.9374G  | 64.07         | 68.20         | -4.13      | 8.85       | 3       | H         | 2          | 1.01      | -        |

### 802.11ac VHT20-BF\_Nss1,(MCS0)\_3TX

### 5785MHz\_TX

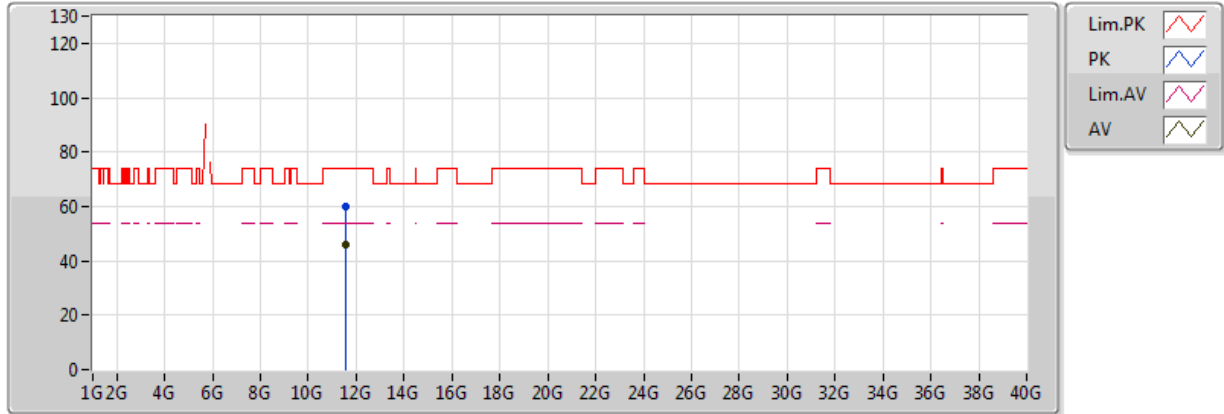

20170621  
 EUT\_Y\_3TX  
 Setting 90  
 05-P-2  
 FSP(100142)

| Type | Freq(Hz)  | Level(dBuV/m) | Limit(dBuV/m) | Margin(dB) | Factor(dB) | Dist(m) | Pol.(H/V) | Azimuth(°) | Height(m) | Comments |
|------|-----------|---------------|---------------|------------|------------|---------|-----------|------------|-----------|----------|
| AV   | 11.57046G | 45.85         | 54.00         | -8.15      | 17.90      | 3       | V         | 107        | 1.95      | -        |
| PK   | 11.57086G | 59.80         | 74.00         | -14.20     | 17.90      | 3       | V         | 107        | 1.95      | -        |

### 802.11ac VHT20-BF\_Nss1,(MCS0)\_3TX

### 5785MHz\_TX

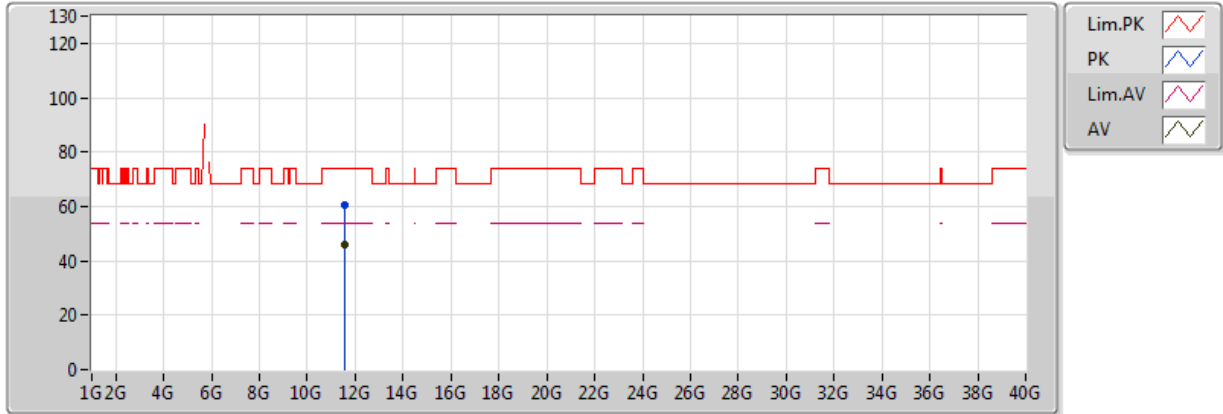

20170621  
 EUT\_Y\_3TX  
 Setting 90  
 05-P-2  
 FSP(100142)

| Type | Freq(Hz)  | Level(dBuV/m) | Limit(dBuV/m) | Margin(dB) | Factor(dB) | Dist(m) | Pol.(H/V) | Azimuth(°) | Height(m) | Comments |
|------|-----------|---------------|---------------|------------|------------|---------|-----------|------------|-----------|----------|
| AV   | 11.57332G | 45.88         | 54.00         | -8.12      | 17.90      | 3       | H         | 85         | 2.40      | -        |
| PK   | 11.56742G | 60.77         | 74.00         | -13.23     | 17.91      | 3       | H         | 85         | 2.40      | -        |

### 802.11ac VHT20-BF\_Nss1,(MCS0)\_3TX

### 5825MHz\_TX

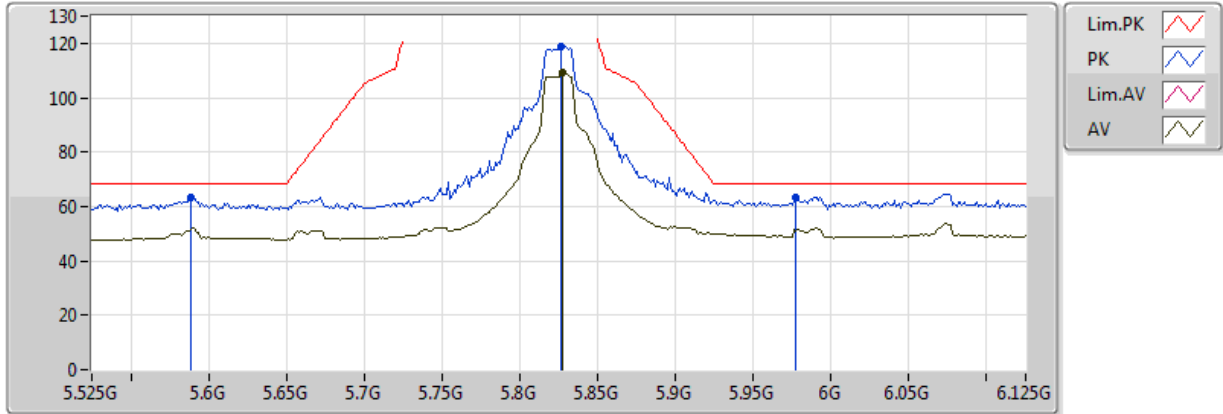

20170621  
 EUT\_Y\_3TX  
 Setting 80 ( 81 over 4 )  
 05-P-2-10  
 FSP(100142)

| Type | Freq(Hz) | Level(dBuV/m) | Limit(dBuV/m) | Margin(dB) | Factor(dB) | Dist(m) | Pol.(H/V) | Azimuth(°) | Height(m) | Comments |
|------|----------|---------------|---------------|------------|------------|---------|-----------|------------|-----------|----------|
| AV   | 5.8274G  | 109.01        | Inf           | -Inf       | 8.57       | 3       | V         | 340        | 1.67      | -        |
| PK   | 5.5886G  | 63.47         | 68.20         | -4.73      | 8.10       | 3       | V         | 340        | 1.67      | -        |
| PK   | 5.8262G  | 118.77        | Inf           | -Inf       | 8.57       | 3       | V         | 340        | 1.67      | -        |
| PK   | 5.9774G  | 63.32         | 68.20         | -4.88      | 8.95       | 3       | V         | 340        | 1.67      | -        |

### 802.11ac VHT20-BF\_Nss1,(MCS0)\_3TX

### 5825MHz\_TX

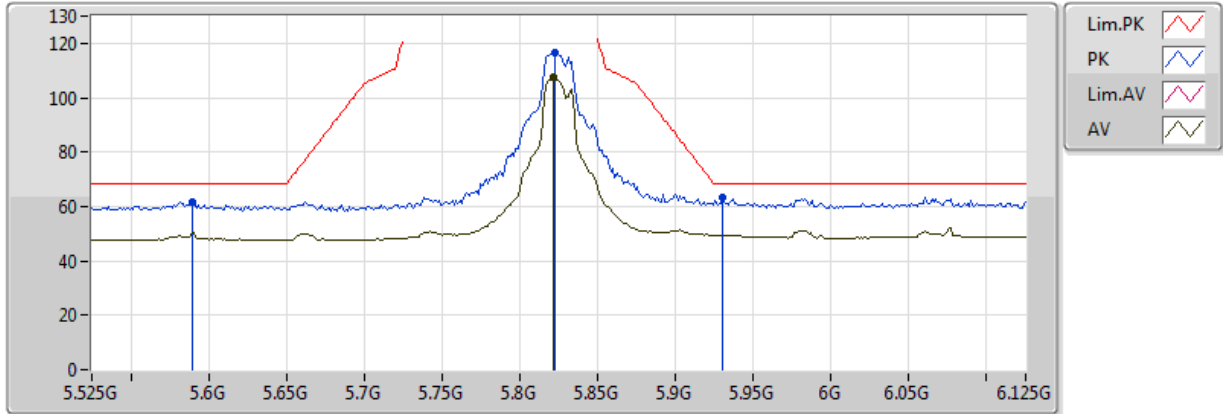

20170621  
EUT\_Y\_3TX  
Setting 80  
05-P-2-10  
FSP(100142)

| Type | Freq(Hz) | Level(dBuV/m) | Limit(dBuV/m) | Margin(dB) | Factor(dB) | Dist(m) | Pol.(H/V) | Azimuth(°) | Height(m) | Comments |
|------|----------|---------------|---------------|------------|------------|---------|-----------|------------|-----------|----------|
| AV   | 5.8214G  | 107.34        | Inf           | -Inf       | 8.56       | 3       | H         | 16         | 1.01      | -        |
| PK   | 5.5898G  | 61.86         | 68.20         | -6.34      | 8.11       | 3       | H         | 16         | 1.01      | -        |
| PK   | 5.8226G  | 116.72        | Inf           | -Inf       | 8.56       | 3       | H         | 16         | 1.01      | -        |
| PK   | 5.9306G  | 63.07         | 68.20         | -5.13      | 8.84       | 3       | H         | 16         | 1.01      | -        |

### 802.11ac VHT20-BF\_Nss1,(MCS0)\_3TX

### 5825MHz\_TX

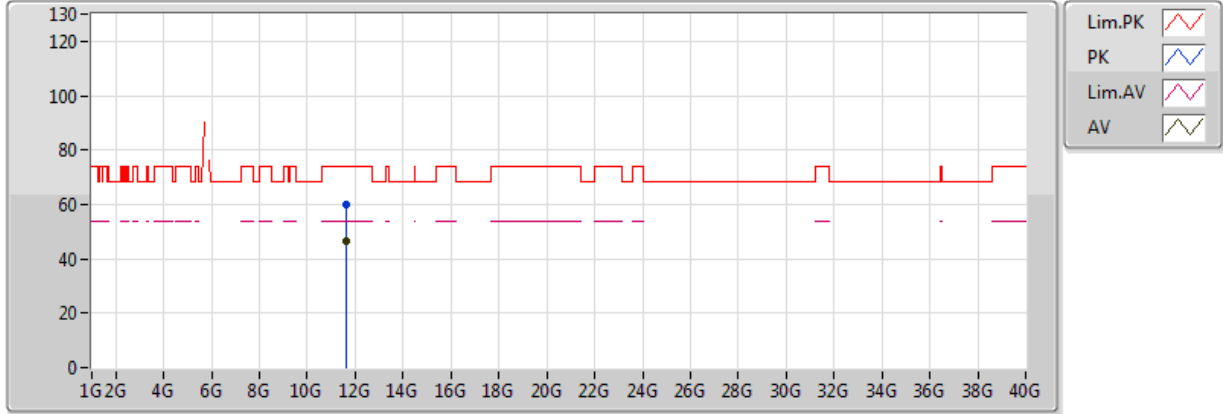

20170621  
 EUT\_Y\_3TX  
 Setting 80  
 05-P-2  
 FSP(100142)

| Type | Freq(Hz)  | Level(dBuV/m) | Limit(dBuV/m) | Margin(dB) | Factor(dB) | Dist(m) | Pol.(H/V) | Azimuth(°) | Height(m) | Comments |
|------|-----------|---------------|---------------|------------|------------|---------|-----------|------------|-----------|----------|
| AV   | 11.65336G | 46.35         | 54.00         | -7.65      | 17.81      | 3       | V         | 17         | 1.57      | -        |
| PK   | 11.64554G | 59.84         | 74.00         | -14.16     | 17.81      | 3       | V         | 17         | 1.57      | -        |

### 802.11ac VHT20-BF\_Nss1,(MCS0)\_3TX

### 5825MHz\_TX

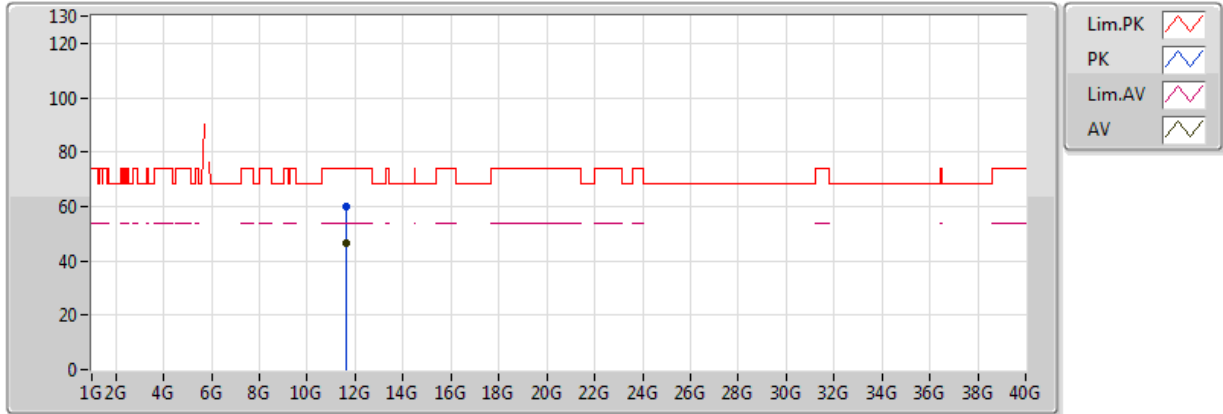

20170621  
EUT\_Y\_3TX  
Setting 80  
05-P-2  
FSP(100142)

| Type | Freq(Hz)  | Level(dBuV/m) | Limit(dBuV/m) | Margin(dB) | Factor(dB) | Dist(m) | Pol.(H/V) | Azimuth(°) | Height(m) | Comments |
|------|-----------|---------------|---------------|------------|------------|---------|-----------|------------|-----------|----------|
| AV   | 11.65364G | 46.45         | 54.00         | -7.55      | 17.81      | 3       | H         | 255        | 1.45      | -        |
| PK   | 11.65288G | 59.97         | 74.00         | -14.03     | 17.81      | 3       | H         | 255        | 1.45      | -        |



### 802.11ac VHT40-BF\_Nss1,(MCS0)\_3TX

### 5190MHz\_TX

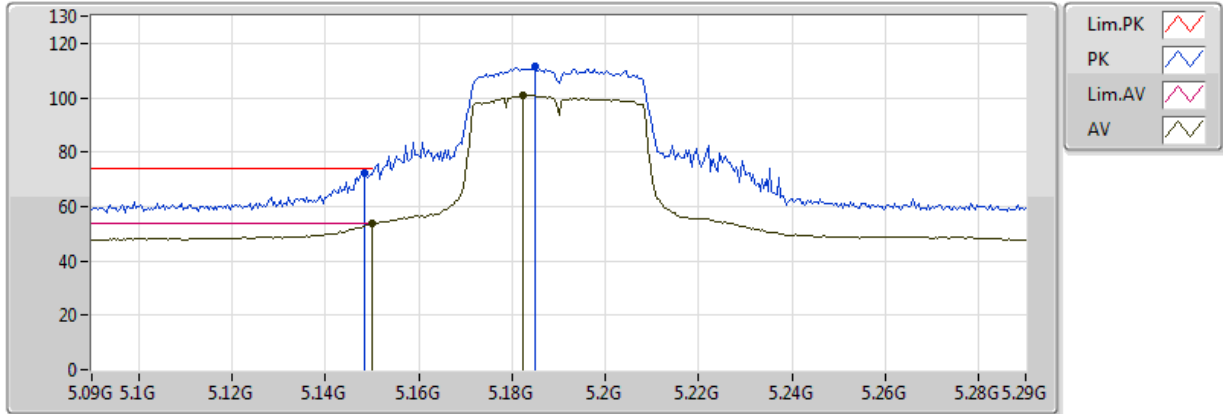

20170620  
EUT\_Y\_3TX  
Setting 50  
05-N-2-10  
FSP

| Type | Freq(Hz)  | Level(dBuV/m) | Limit(dBuV/m) | Margin(dB) | Factor(dB) | Dist(m) | Pol.(H/V) | Azimuth(°) | Height(m) | Comments |
|------|-----------|---------------|---------------|------------|------------|---------|-----------|------------|-----------|----------|
| AV   | 5.149995G | 53.75         | 54.00         | -0.25      | 7.33       | 3       | V         | 0          | 1.76      | -        |
| AV   | 5.1824G   | 100.81        | Inf           | -Inf       | 7.39       | 3       | V         | 0          | 1.76      | -        |
| PK   | 5.1484G   | 72.15         | 74.00         | -1.85      | 7.33       | 3       | V         | 0          | 1.76      | -        |
| PK   | 5.1848G   | 111.45        | Inf           | -Inf       | 7.39       | 3       | V         | 0          | 1.76      | -        |

**802.11ac VHT40-BF\_Nss1,(MCS0)\_3TX**

**5190MHz\_TX**

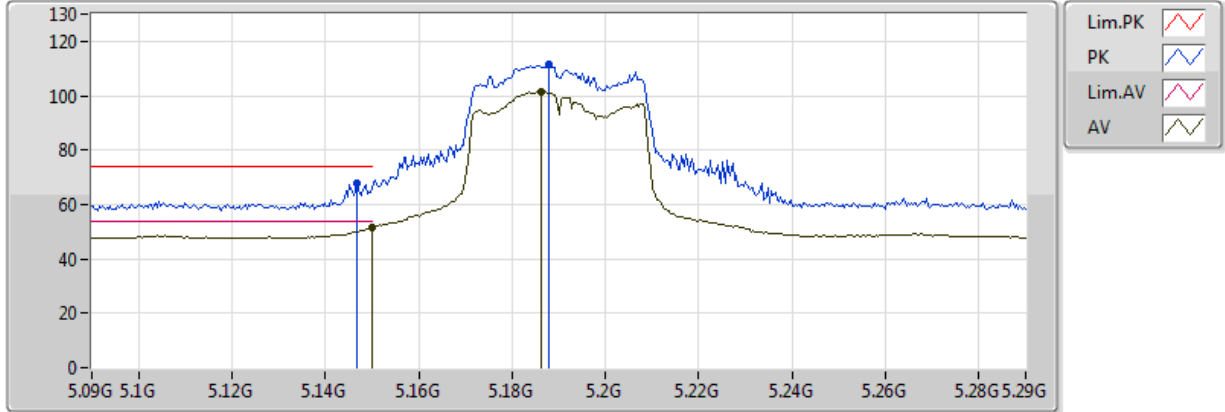

20170620  
EUT\_Y\_3TX  
Setting 50  
05-N-2-10  
FSP

| Type | Freq(Hz)  | Level(dBuV/m) | Limit(dBuV/m) | Margin(dB) | Factor(dB) | Dist(m) | Pol.(H/V) | Azimuth(°) | Height(m) | Comments |
|------|-----------|---------------|---------------|------------|------------|---------|-----------|------------|-----------|----------|
| AV   | 5.149995G | 51.60         | 54.00         | -2.40      | 7.33       | 3       | H         | 6          | 2.02      | -        |
| AV   | 5.1864G   | 101.48        | Inf           | -Inf       | 7.40       | 3       | H         | 6          | 2.02      | -        |
| PK   | 5.1468G   | 67.73         | 74.00         | -6.27      | 7.33       | 3       | H         | 6          | 2.02      | -        |
| PK   | 5.188G    | 111.57        | Inf           | -Inf       | 7.40       | 3       | H         | 6          | 2.02      | -        |

### 802.11ac VHT40-BF\_Nss1,(MCS0)\_3TX

### 5190MHz\_TX

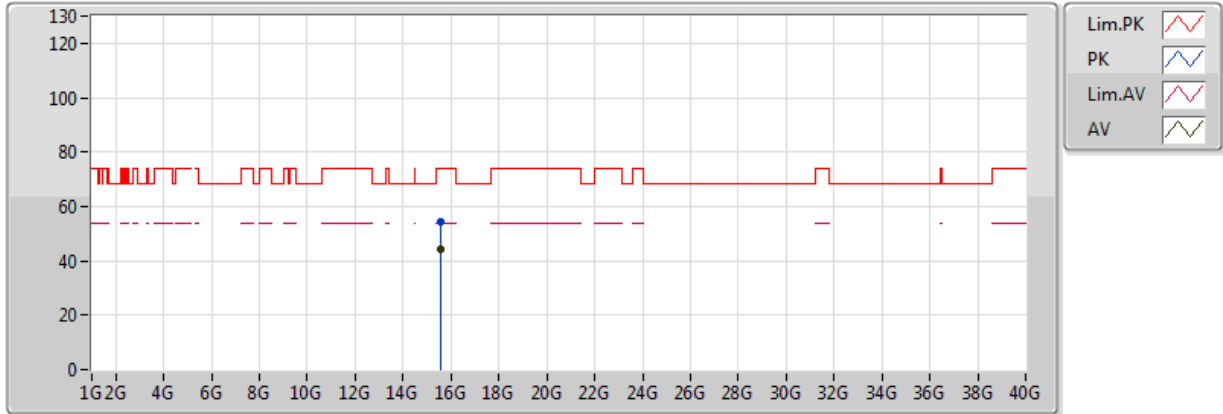

20170620  
EUT\_Y\_3TX  
Setting 50  
05-N-2  
FSP

| Type | Freq(Hz) | Level(dBuV/m) | Limit(dBuV/m) | Margin(dB) | Factor(dB) | Dist(m) | Pol.(H/V) | Azimuth(°) | Height(m) | Comments |
|------|----------|---------------|---------------|------------|------------|---------|-----------|------------|-----------|----------|
| AV   | 15.57G   | 44.11         | 54.00         | -9.89      | 18.97      | 3       | V         | 293        | 1.61      | -        |
| PK   | 15.5659G | 54.23         | 74.00         | -19.77     | 18.98      | 3       | V         | 293        | 1.61      | -        |

### 802.11ac VHT40-BF\_Nss1,(MCS0)\_3TX

### 5190MHz\_TX

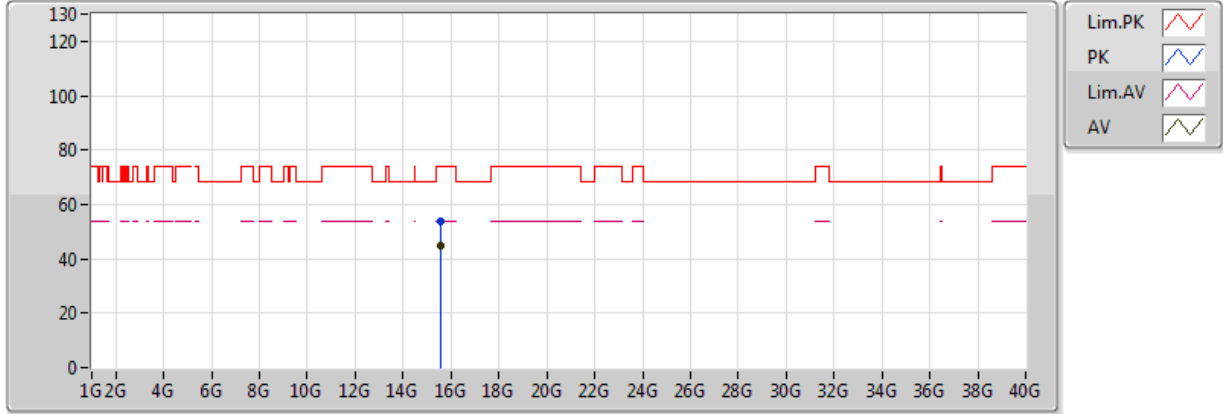

20170620  
EUT\_Y\_3TX  
Setting 50  
05-N-2  
FSP

| Type | Freq(Hz)  | Level(dBuV/m) | Limit(dBuV/m) | Margin(dB) | Factor(dB) | Dist(m) | Pol.(H/V) | Azimuth(°) | Height(m) | Comments |
|------|-----------|---------------|---------------|------------|------------|---------|-----------|------------|-----------|----------|
| AV   | 15.57306G | 44.66         | 54.00         | -9.34      | 18.96      | 3       | H         | 333        | 1.61      | -        |
| PK   | 15.56608G | 53.68         | 74.00         | -20.32     | 18.98      | 3       | H         | 333        | 1.61      | -        |

### 802.11ac VHT40-BF\_Nss1,(MCS0)\_3TX

### 5230MHz\_TX

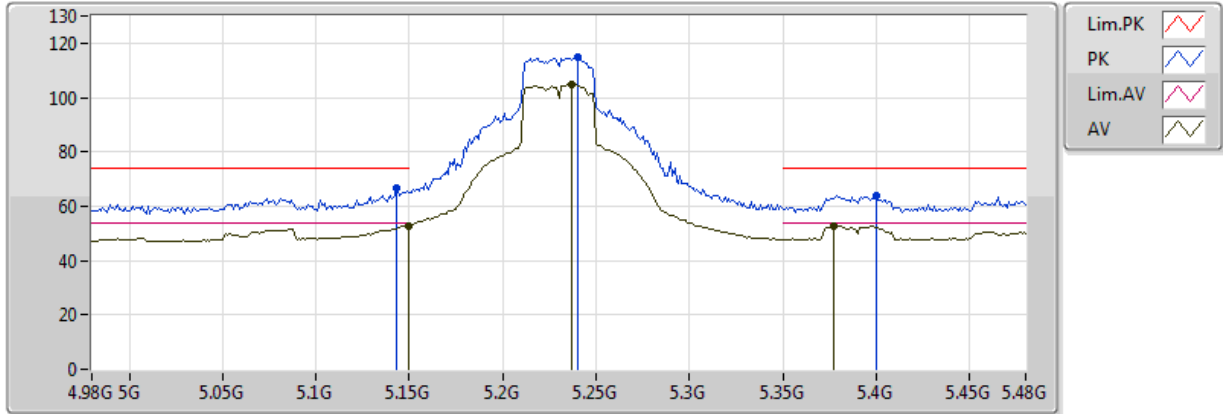

20170620  
EUT Y\_3TX  
Setting 71  
05-N-2-10  
FSP

| Type | Freq(Hz)  | Level(dBuV/m) | Limit(dBuV/m) | Margin(dB) | Factor(dB) | Dist(m) | Pol.(H/V) | Azimuth(°) | Height(m) | Comments |
|------|-----------|---------------|---------------|------------|------------|---------|-----------|------------|-----------|----------|
| AV   | 5.149995G | 52.82         | 54.00         | -1.18      | 7.33       | 3       | V         | 335        | 1.50      | -        |
| AV   | 5.237G    | 105.00        | Inf           | -Inf       | 7.48       | 3       | V         | 335        | 1.50      | -        |
| AV   | 5.377G    | 52.82         | 54.00         | -1.18      | 7.71       | 3       | V         | 335        | 1.50      | -        |
| PK   | 5.143G    | 66.53         | 74.00         | -7.47      | 7.32       | 3       | V         | 335        | 1.50      | -        |
| PK   | 5.24G     | 114.76        | Inf           | -Inf       | 7.49       | 3       | V         | 335        | 1.50      | -        |
| PK   | 5.4G      | 63.93         | 74.00         | -10.07     | 7.75       | 3       | V         | 335        | 1.50      | -        |

### 802.11ac VHT40-BF\_Nss1,(MCS0)\_3TX

### 5230MHz\_TX

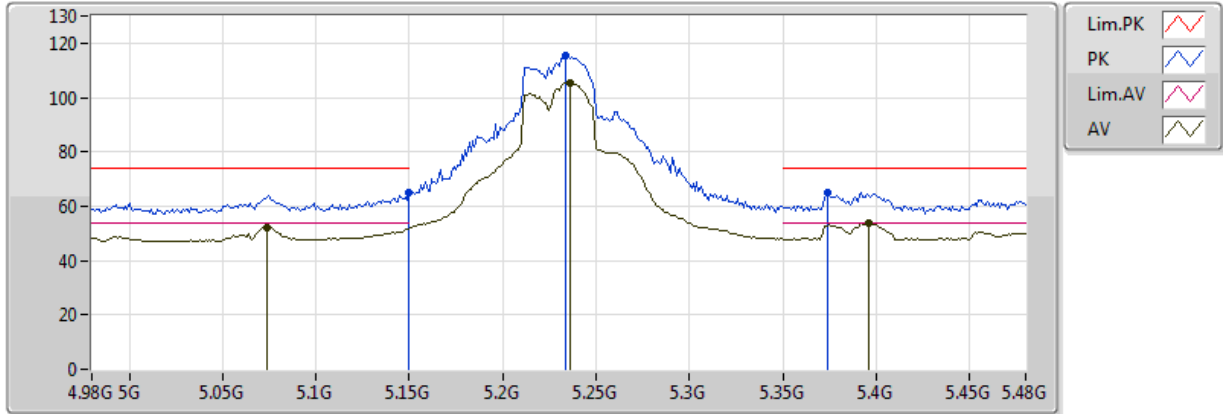

20170620  
EUT\_Y\_3TX  
Setting 71  
05-N-2-10  
FSP

| Type | Freq(Hz)  | Level(dBuV/m) | Limit(dBuV/m) | Margin(dB) | Factor(dB) | Dist(m) | Pol.(H/V) | Azimuth(°) | Height(m) | Comments |
|------|-----------|---------------|---------------|------------|------------|---------|-----------|------------|-----------|----------|
| AV   | 5.074G    | 52.11         | 54.00         | -1.89      | 7.20       | 3       | H         | 7          | 2.05      | -        |
| AV   | 5.236G    | 105.61        | Inf           | -Inf       | 7.48       | 3       | H         | 7          | 2.05      | -        |
| AV   | 5.396G    | 53.88         | 54.00         | -0.12      | 7.74       | 3       | H         | 7          | 2.05      | -        |
| PK   | 5.149995G | 65.05         | 74.00         | -8.95      | 7.33       | 3       | H         | 7          | 2.05      | -        |
| PK   | 5.234G    | 115.20        | Inf           | -Inf       | 7.48       | 3       | H         | 7          | 2.05      | -        |
| PK   | 5.374G    | 64.85         | 74.00         | -9.15      | 7.71       | 3       | H         | 7          | 2.05      | -        |

### 802.11ac VHT40-BF\_Nss1,(MCS0)\_3TX

### 5230MHz\_TX

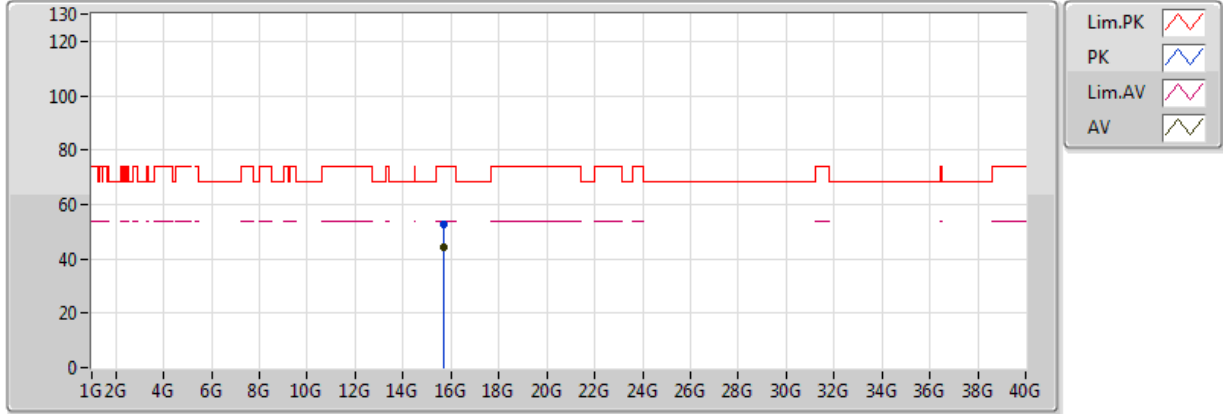

20170620  
EUT\_Y\_3TX  
Setting 71  
05-N-2  
FSP

| Type | Freq(Hz)  | Level(dBuV/m) | Limit(dBuV/m) | Margin(dB) | Factor(dB) | Dist(m) | Pol.(H/V) | Azimuth(°) | Height(m) | Comments |
|------|-----------|---------------|---------------|------------|------------|---------|-----------|------------|-----------|----------|
| AV   | 15.68128G | 44.54         | 54.00         | -9.46      | 18.62      | 3       | V         | 176        | 2.46      | -        |
| PK   | 15.68288G | 52.77         | 74.00         | -21.23     | 18.62      | 3       | V         | 176        | 2.46      | -        |

### 802.11ac VHT40-BF\_Nss1,(MCS0)\_3TX

### 5230MHz\_TX

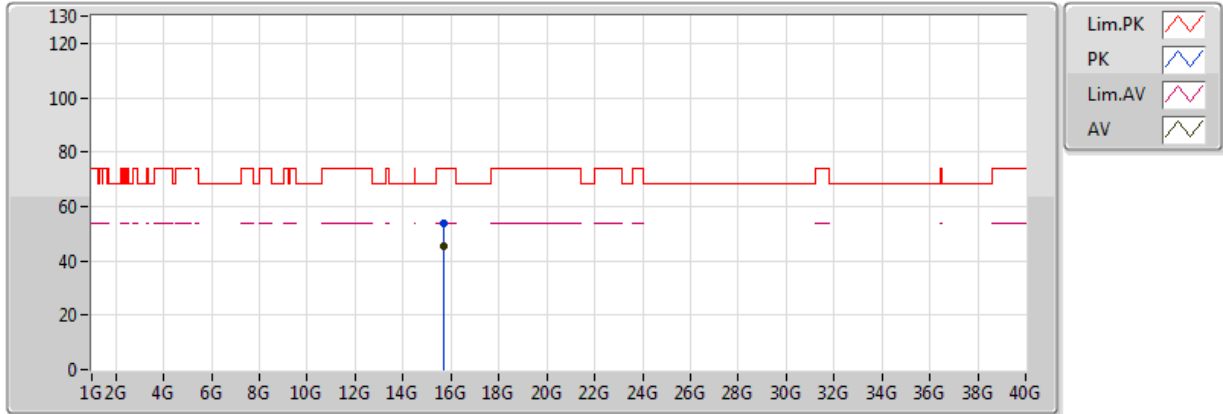

20170620  
EUT\_Y\_3TX  
Setting 71  
05-N-2  
FSP

| Type | Freq(Hz) | Level(dBuV/m) | Limit(dBuV/m) | Margin(dB) | Factor(dB) | Dist(m) | Pol.(H/V) | Azimuth(°) | Height(m) | Comments |
|------|----------|---------------|---------------|------------|------------|---------|-----------|------------|-----------|----------|
| AV   | 15.681G  | 45.59         | 54.00         | -8.41      | 18.63      | 3       | H         | 116        | 1.63      | -        |
| PK   | 15.698G  | 53.61         | 74.00         | -20.39     | 18.57      | 3       | H         | 116        | 1.63      | -        |



### 802.11ac VHT40-BF\_Nss1,(MCS0)\_3TX

### 5755MHz\_TX

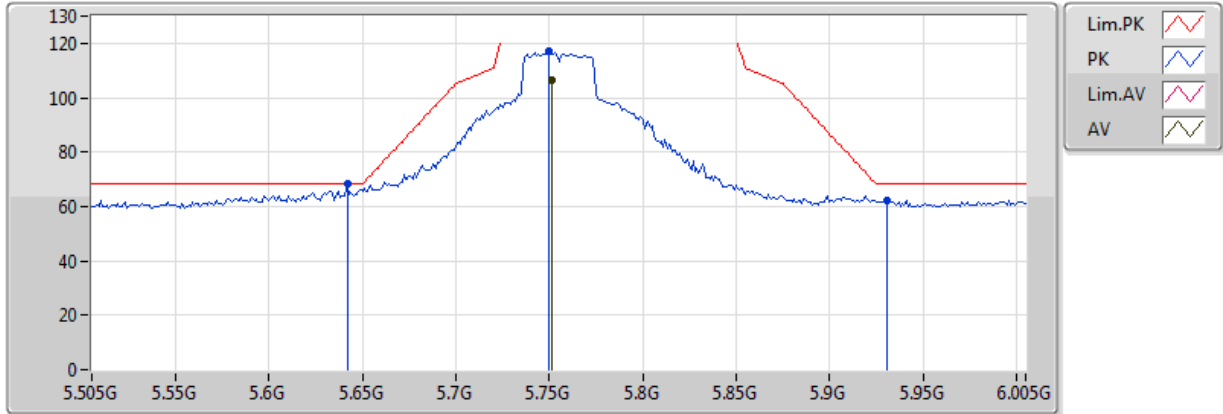

20170620  
EUT\_Y\_3TX  
Setting 76  
05-N-2-10  
FSP

| Type | Freq(Hz) | Level(dBuV/m) | Limit(dBuV/m) | Margin(dB) | Factor(dB) | Dist(m) | Pol.(H/V) | Azimuth(°) | Height(m) | Comments |
|------|----------|---------------|---------------|------------|------------|---------|-----------|------------|-----------|----------|
| AV   | 5.751G   | 106.44        | Inf           | -Inf       | 8.41       | 3       | V         | 348        | 1.66      | -        |
| PK   | 5.642G   | 68.12         | 68.20         | -0.08      | 8.21       | 3       | V         | 348        | 1.66      | -        |
| PK   | 5.75G    | 117.21        | Inf           | -Inf       | 8.41       | 3       | V         | 348        | 1.66      | -        |
| PK   | 5.931G   | 62.33         | 68.20         | -5.87      | 8.84       | 3       | V         | 348        | 1.66      | -        |

### 802.11ac VHT40-BF\_Nss1,(MCS0)\_3TX

### 5755MHz\_TX

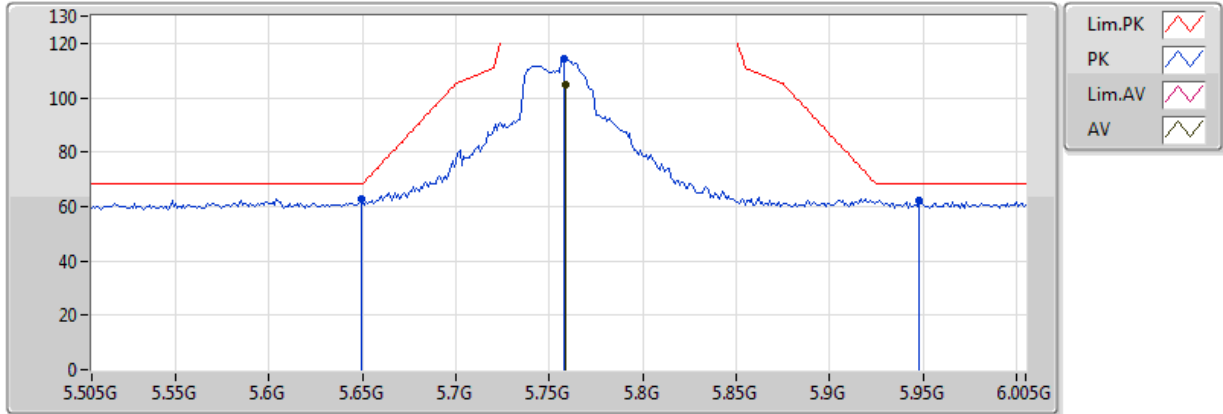

20170620  
EUT\_Y\_3TX  
Setting 76  
05-N-2-10  
FSP

| Type | Freq(Hz) | Level(dBuV/m) | Limit(dBuV/m) | Margin(dB) | Factor(dB) | Dist(m) | Pol.(H/V) | Azimuth(°) | Height(m) | Comments |
|------|----------|---------------|---------------|------------|------------|---------|-----------|------------|-----------|----------|
| AV   | 5.759G   | 105.00        | Inf           | -Inf       | 8.42       | 3       | H         | 9          | 1.04      | -        |
| PK   | 5.649G   | 62.72         | 68.20         | -5.48      | 8.22       | 3       | H         | 9          | 1.04      | -        |
| PK   | 5.758G   | 114.54        | Inf           | -Inf       | 8.42       | 3       | H         | 9          | 1.04      | -        |
| PK   | 5.948G   | 62.07         | 68.20         | -6.13      | 8.88       | 3       | H         | 9          | 1.04      | -        |

### 802.11ac VHT40-BF\_Nss1,(MCS0)\_3TX

### 5755MHz\_TX

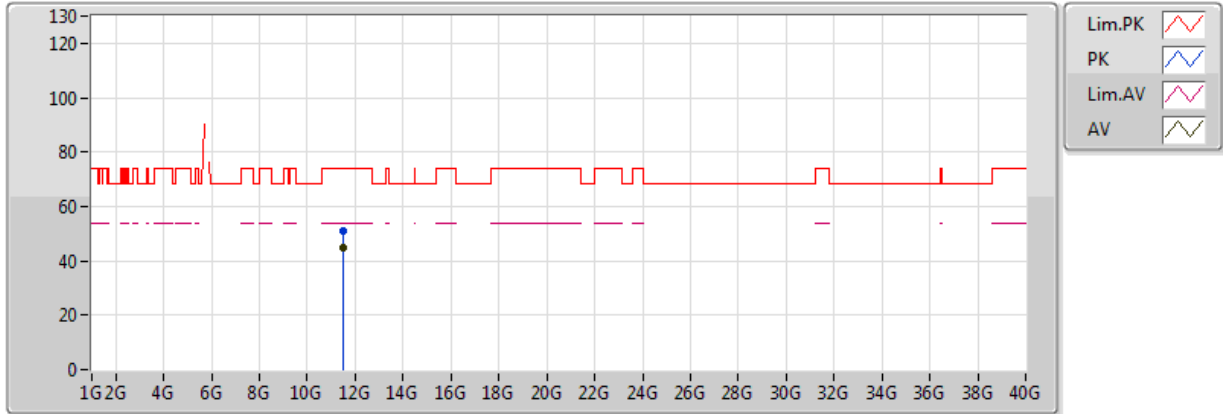

20170620  
EUT\_Y\_3TX  
Setting 76  
05-N-2  
FSP

| Type | Freq(Hz)  | Level(dBuV/m) | Limit(dBuV/m) | Margin(dB) | Factor(dB) | Dist(m) | Pol.(H/V) | Azimuth(°) | Height(m) | Comments |
|------|-----------|---------------|---------------|------------|------------|---------|-----------|------------|-----------|----------|
| AV   | 11.52212G | 44.56         | 54.00         | -9.44      | 17.96      | 3       | V         | 225        | 2.34      | -        |
| PK   | 11.49584G | 51.18         | 74.00         | -22.82     | 17.99      | 3       | V         | 225        | 2.34      | -        |

### 802.11ac VHT40-BF\_Nss1,(MCS0)\_3TX

### 5755MHz\_TX

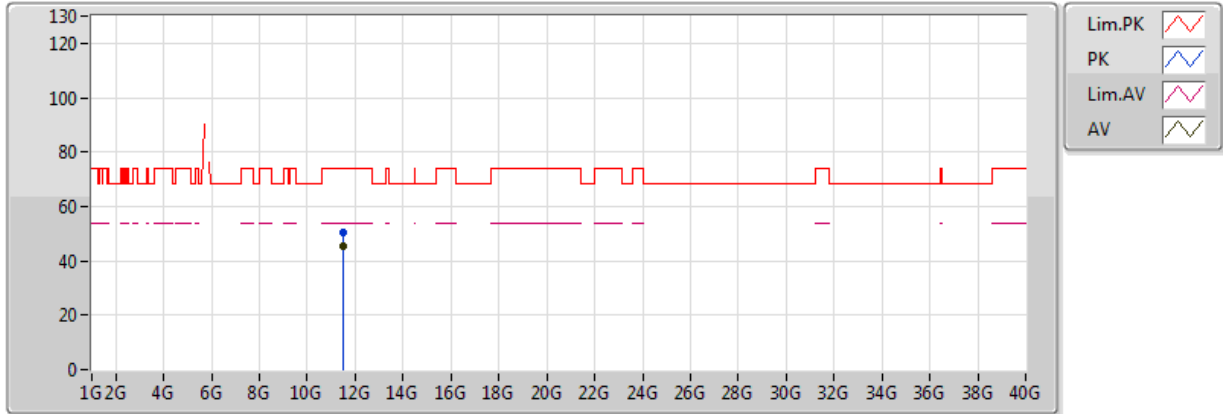

20170620  
EUT\_Y\_3TX  
Setting 76  
05-N-2  
FSP

| Type | Freq(Hz)  | Level(dBuV/m) | Limit(dBuV/m) | Margin(dB) | Factor(dB) | Dist(m) | Pol.(H/V) | Azimuth(°) | Height(m) | Comments |
|------|-----------|---------------|---------------|------------|------------|---------|-----------|------------|-----------|----------|
| AV   | 11.52404G | 45.22         | 54.00         | -8.78      | 17.96      | 3       | H         | 161        | 1.53      | -        |
| PK   | 11.51732G | 50.48         | 74.00         | -23.52     | 17.96      | 3       | H         | 161        | 1.53      | -        |

### 802.11ac VHT40-BF\_Nss1,(MCS0)\_3TX

### 5795MHz\_TX

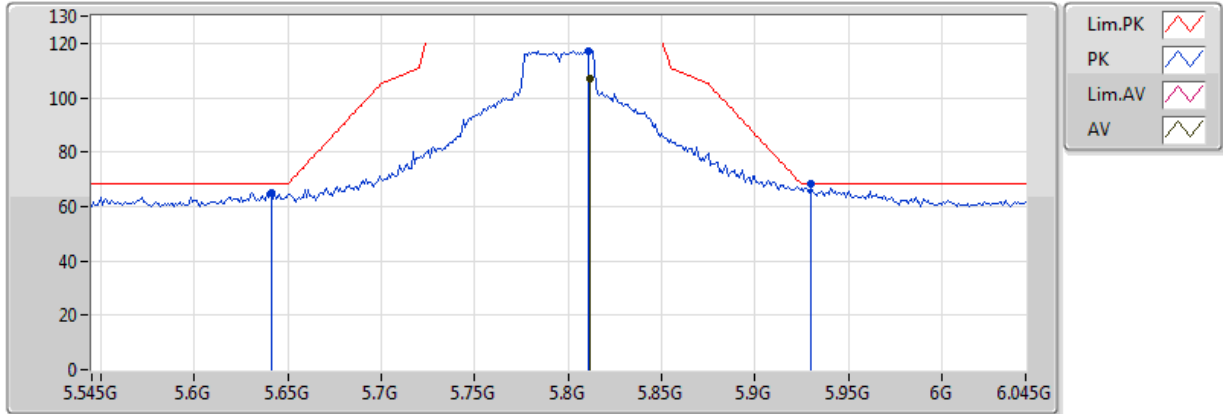

20170620  
EUT\_Y\_3TX  
Setting 79  
05-N-2-10  
FSP

| Type | Freq(Hz) | Level(dBuV/m) | Limit(dBuV/m) | Margin(dB) | Factor(dB) | Dist(m) | Pol.(H/V) | Azimuth(°) | Height(m) | Comments |
|------|----------|---------------|---------------|------------|------------|---------|-----------|------------|-----------|----------|
| AV   | 5.812G   | 107.30        | Inf           | -Inf       | 8.53       | 3       | V         | 346        | 1.55      | -        |
| PK   | 5.641G   | 65.06         | 68.20         | -3.14      | 8.20       | 3       | V         | 346        | 1.55      | -        |
| PK   | 5.811G   | 117.12        | Inf           | -Inf       | 8.53       | 3       | V         | 346        | 1.55      | -        |
| PK   | 5.93G    | 68.10         | 68.20         | -0.10      | 8.84       | 3       | V         | 346        | 1.55      | -        |

### 802.11ac VHT40-BF\_Nss1,(MCS0)\_3TX

### 5795MHz\_TX

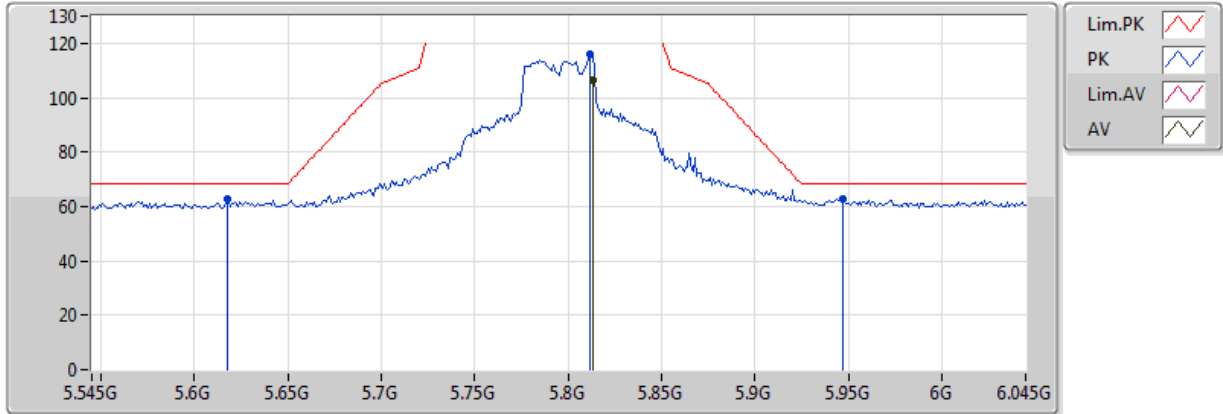

20170620  
EUT\_Y\_3TX  
Setting 79  
05-N-2-10  
FSP

| Type | Freq(Hz) | Level(dBuV/m) | Limit(dBuV/m) | Margin(dB) | Factor(dB) | Dist(m) | Pol.(H/V) | Azimuth(°) | Height(m) | Comments |
|------|----------|---------------|---------------|------------|------------|---------|-----------|------------|-----------|----------|
| AV   | 5.813G   | 106.57        | Inf           | -Inf       | 8.53       | 3       | H         | 8          | 1.10      | -        |
| PK   | 5.618G   | 62.85         | 68.20         | -5.35      | 8.16       | 3       | H         | 8          | 1.10      | -        |
| PK   | 5.812G   | 116.10        | Inf           | -Inf       | 8.53       | 3       | H         | 8          | 1.10      | -        |
| PK   | 5.947G   | 62.78         | 68.20         | -5.42      | 8.88       | 3       | H         | 8          | 1.10      | -        |

### 802.11ac VHT40-BF\_Nss1,(MCS0)\_3TX

### 5795MHz\_TX

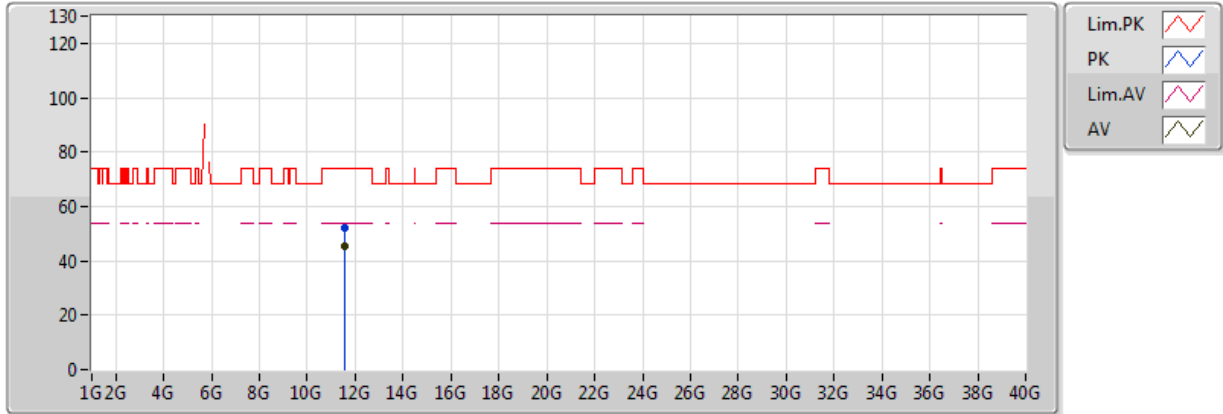

20170620  
EUT\_Y\_3TX  
Setting 79  
05-N-2  
FSP

| Type | Freq(Hz)  | Level(dBuV/m) | Limit(dBuV/m) | Margin(dB) | Factor(dB) | Dist(m) | Pol.(H/V) | Azimuth(°) | Height(m) | Comments |
|------|-----------|---------------|---------------|------------|------------|---------|-----------|------------|-----------|----------|
| AV   | 11.58046G | 45.15         | 54.00         | -8.85      | 17.89      | 3       | V         | 32         | 1.31      | -        |
| PK   | 11.58022G | 52.02         | 74.00         | -21.98     | 17.89      | 3       | V         | 32         | 1.31      | -        |

### 802.11ac VHT40-BF\_Nss1,(MCS0)\_3TX

### 5795MHz\_TX

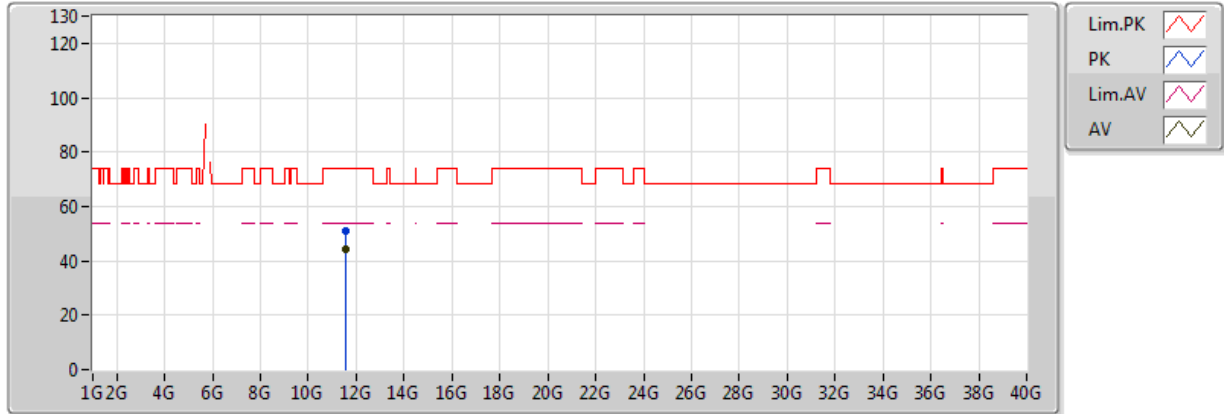

20170620  
EUT\_Y\_3TX  
Setting 79  
05-N-2  
FSP

| Type | Freq(Hz)  | Level(dBuV/m) | Limit(dBuV/m) | Margin(dB) | Factor(dB) | Dist(m) | Pol.(H/V) | Azimuth(°) | Height(m) | Comments |
|------|-----------|---------------|---------------|------------|------------|---------|-----------|------------|-----------|----------|
| AV   | 11.59024G | 44.15         | 54.00         | -9.85      | 17.88      | 3       | H         | 151        | 1.33      | -        |
| PK   | 11.58196G | 51.25         | 74.00         | -22.75     | 17.89      | 3       | H         | 151        | 1.33      | -        |



### 802.11ac VHT80-BF\_Nss1,(MCS0)\_3TX

### 5210MHz\_TX

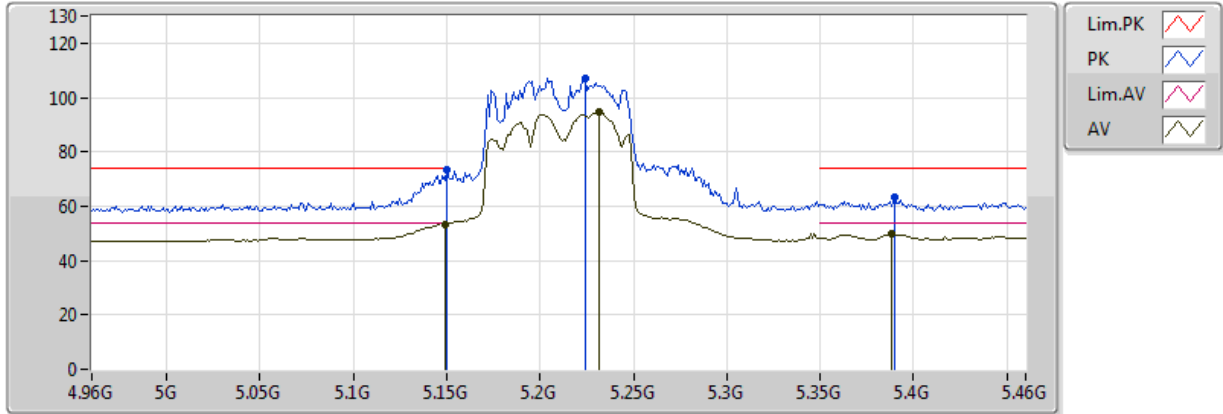

20170620  
EUT\_Y\_3TX  
Setting 49  
05-N-2-10  
FSP

| Type | Freq(Hz)  | Level(dBuV/m) | Limit(dBuV/m) | Margin(dB) | Factor(dB) | Dist(m) | Pol.(H/V) | Azimuth(°) | Height(m) | Comments |
|------|-----------|---------------|---------------|------------|------------|---------|-----------|------------|-----------|----------|
| AV   | 5.149G    | 53.           | 54.00         | -0.14      | 7.33       | 3       | V         | 0          | 2.66      | -        |
| AV   | 5.232G    | 94.47         | Inf           | -Inf       | 7.47       | 3       | V         | 0          | 2.66      | -        |
| AV   | 5.388G    | 49.75         | 54.00         | -4.25      | 7.73       | 3       | V         | 0          | 2.66      | -        |
| PK   | 5.149995G | 73.39         | 74.00         | -0.61      | 7.33       | 3       | V         | 0          | 2.66      | -        |
| PK   | 5.224G    | 107.16        | Inf           | -Inf       | 7.46       | 3       | V         | 0          | 2.66      | -        |
| PK   | 5.39G     | 63.45         | 74.00         | -10.55     | 7.73       | 3       | V         | 0          | 2.66      | -        |

### 802.11ac VHT80-BF\_Nss1,(MCS0)\_3TX

### 5210MHz\_TX

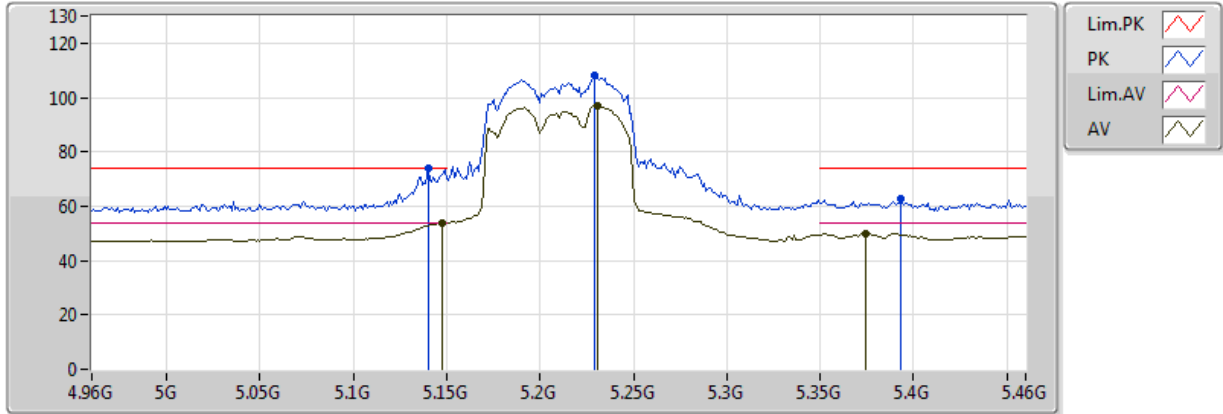

20170620  
EUT\_Y\_3TX  
Setting 49  
05-N-2-10  
FSP

| Type | Freq(Hz) | Level(dBuV/m) | Limit(dBuV/m) | Margin(dB) | Factor(dB) | Dist(m) | Pol.(H/V) | Azimuth(°) | Height(m) | Comments |
|------|----------|---------------|---------------|------------|------------|---------|-----------|------------|-----------|----------|
| AV   | 5.148G   | 53.97         | 54.00         | -0.03      | 7.33       | 3       | H         | 7          | 2.04      | -        |
| AV   | 5.231G   | 97.16         | Inf           | -Inf       | 7.47       | 3       | H         | 7          | 2.04      | -        |
| AV   | 5.374G   | 49.92         | 54.00         | -4.08      | 7.71       | 3       | H         | 7          | 2.04      | -        |
| PK   | 5.14G    | 73.96         | 74.00         | -0.04      | 7.32       | 3       | H         | 7          | 2.04      | -        |
| PK   | 5.229G   | 107.96        | Inf           | -Inf       | 7.47       | 3       | H         | 7          | 2.04      | -        |
| PK   | 5.393G   | 62.86         | 74.00         | -11.14     | 7.74       | 3       | H         | 7          | 2.04      | -        |

### 802.11ac VHT80-BF\_Nss1,(MCS0)\_3TX

### 5210MHz\_TX

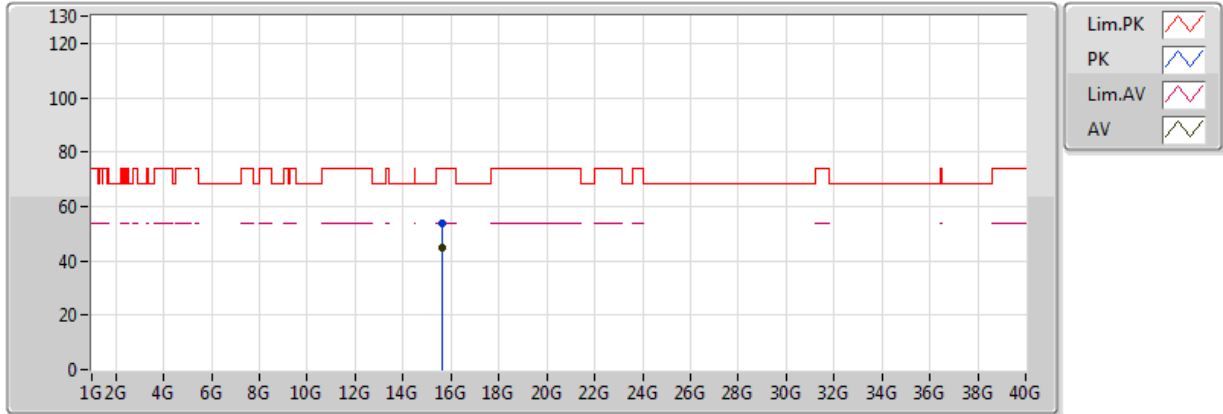

20170620  
EUT\_Y\_3TX  
Setting 49  
05-N-2  
FSP

| Type | Freq(Hz)  | Level(dBuV/m) | Limit(dBuV/m) | Margin(dB) | Factor(dB) | Dist(m) | Pol.(H/V) | Azimuth(°) | Height(m) | Comments |
|------|-----------|---------------|---------------|------------|------------|---------|-----------|------------|-----------|----------|
| AV   | 15.63114G | 44.96         | 54.00         | -9.04      | 18.78      | 3       | V         | 211        | 1.18      | -        |
| PK   | 15.61728G | 53.61         | 74.00         | -20.39     | 18.82      | 3       | V         | 211        | 1.18      | -        |

### 802.11ac VHT80-BF\_Nss1,(MCS0)\_3TX

### 5210MHz\_TX

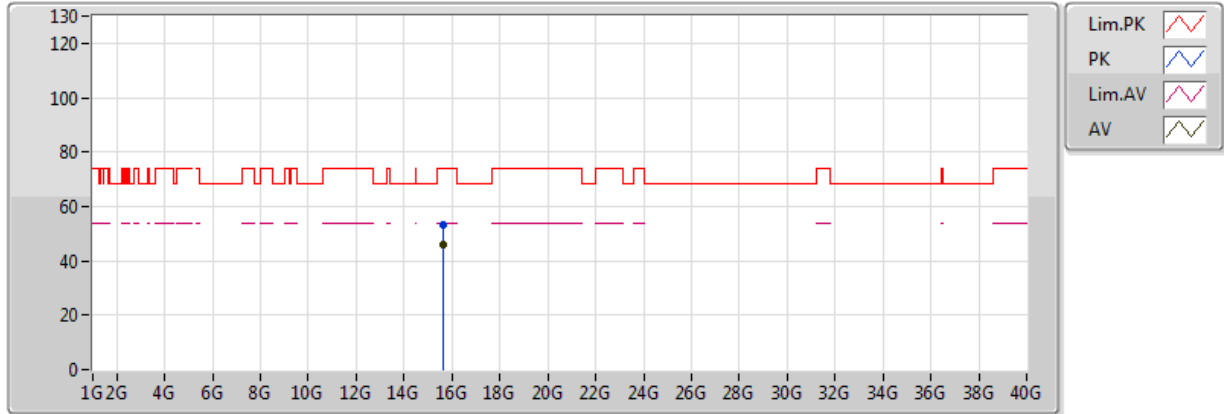

20170620  
EUT\_Y\_3TX  
Setting 49  
05-N-2  
FSP

| Type | Freq(Hz)  | Level(dBuV/m) | Limit(dBuV/m) | Margin(dB) | Factor(dB) | Dist(m) | Pol.(H/V) | Azimuth(°) | Height(m) | Comments |
|------|-----------|---------------|---------------|------------|------------|---------|-----------|------------|-----------|----------|
| AV   | 15.64158G | 45.95         | 54.00         | -8.05      | 18.75      | 3       | H         | 33         | 1.99      | -        |
| PK   | 15.6279G  | 53.07         | 74.00         | -20.93     | 18.79      | 3       | H         | 33         | 1.99      | -        |

### 802.11ac VHT80-BF\_Nss1,(MCS0)\_3TX

### 5775MHz\_TX

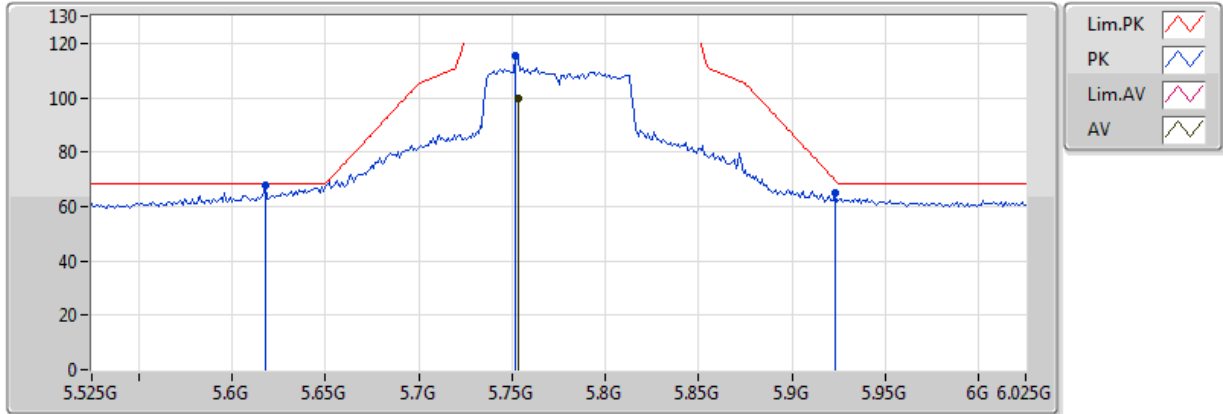

20170620  
EUT\_Y\_3TX  
Setting 64  
05-N-2-10  
FSP

| Type | Freq(Hz) | Level(dBuV/m) | Limit(dBuV/m) | Margin(dB) | Factor(dB) | Dist(m) | Pol.(H/V) | Azimuth(°) | Height(m) | Comments |
|------|----------|---------------|---------------|------------|------------|---------|-----------|------------|-----------|----------|
| AV   | 5.753G   | 99.74         | Inf           | -Inf       | 8.41       | 3       | V         | 0          | 1.70      | -        |
| PK   | 5.618G   | 67.97         | 68.20         | -0.23      | 8.16       | 3       | V         | 0          | 1.70      | -        |
| PK   | 5.752G   | 115.42        | Inf           | -Inf       | 8.41       | 3       | V         | 0          | 1.70      | -        |
| PK   | 5.923G   | 64.83         | 69.68         | -4.85      | 8.82       | 3       | V         | 0          | 1.70      | -        |

### 802.11ac VHT80-BF\_Nss1,(MCS0)\_3TX

### 5775MHz\_TX

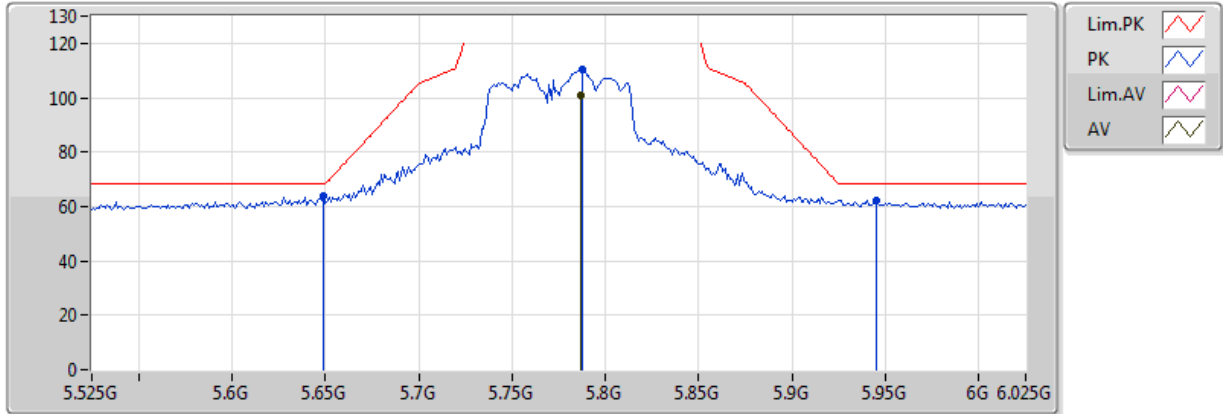

20170620  
EUT\_Y\_3TX  
Setting 64  
05-N-2-10  
FSP

| Type | Freq(Hz) | Level(dBuV/m) | Limit(dBuV/m) | Margin(dB) | Factor(dB) | Dist(m) | Pol.(H/V) | Azimuth(°) | Height(m) | Comments |
|------|----------|---------------|---------------|------------|------------|---------|-----------|------------|-----------|----------|
| AV   | 5.787G   | 100.71        | Inf           | -Inf       | 8.48       | 3       | H         | 8          | 1.05      | -        |
| PK   | 5.649G   | 63.85         | 68.20         | -4.35      | 8.22       | 3       | H         | 8          | 1.05      | -        |
| PK   | 5.788G   | 110.57        | Inf           | -Inf       | 8.48       | 3       | H         | 8          | 1.05      | -        |
| PK   | 5.945G   | 62.21         | 68.20         | -5.99      | 8.87       | 3       | H         | 8          | 1.05      | -        |

### 802.11ac VHT80-BF\_Nss1,(MCS0)\_3TX

### 5775MHz\_TX

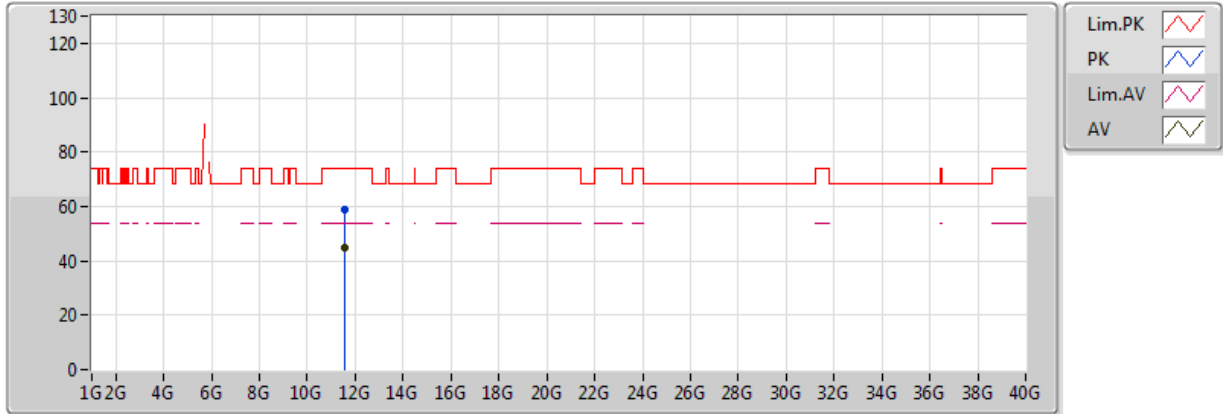

20170620  
EUT\_Y\_3TX  
Setting 64  
05-N-2  
FSP

| Type | Freq(Hz)  | Level(dBuV/m) | Limit(dBuV/m) | Margin(dB) | Factor(dB) | Dist(m) | Pol.(H/V) | Azimuth(°) | Height(m) | Comments |
|------|-----------|---------------|---------------|------------|------------|---------|-----------|------------|-----------|----------|
| AV   | 11.55896G | 44.97         | 54.00         | -9.03      | 17.92      | 3       | V         | 89         | 1.49      | -        |
| PK   | 11.54072G | 58.74         | 74.00         | -15.26     | 17.94      | 3       | V         | 89         | 1.49      | -        |

### 802.11ac VHT80-BF\_Nss1,(MCS0)\_3TX

### 5775MHz\_TX

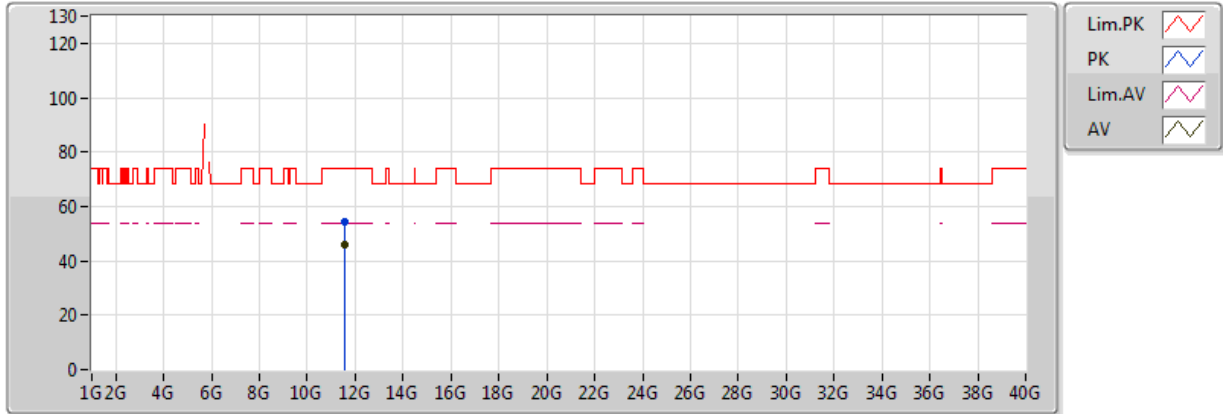

20170620  
EUT\_Y\_3TX  
Setting 64  
05-N-2  
FSP

| Type | Freq(Hz)  | Level(dBuV/m) | Limit(dBuV/m) | Margin(dB) | Factor(dB) | Dist(m) | Pol.(H/V) | Azimuth(°) | Height(m) | Comments |
|------|-----------|---------------|---------------|------------|------------|---------|-----------|------------|-----------|----------|
| AV   | 11.55296G | 45.67         | 54.00         | -8.33      | 17.92      | 3       | H         | 154        | 1.12      | -        |
| PK   | 11.54412G | 54.15         | 74.00         | -19.85     | 17.93      | 3       | H         | 154        | 1.12      | -        |





Mode: 20 MHz / Ant. 2

**Voltage vs. Frequency Stability**

| Voltage<br>(V)       | Measurement Frequency (MHz) |           |           |           |
|----------------------|-----------------------------|-----------|-----------|-----------|
|                      | 5200 MHz                    |           |           |           |
|                      | 0 Minute                    | 2 Minute  | 5 Minute  | 10 Minute |
| 126.50               | 5199.9636                   | 5199.9631 | 5199.9626 | 5199.9624 |
| 110.00               | 5199.9635                   | 5199.9630 | 5199.9629 | 5199.9620 |
| 93.50                | 5199.9632                   | 5199.9626 | 5199.9622 | 5199.9617 |
| Max. Deviation (MHz) | 0.0368                      | 0.0374    | 0.0378    | 0.0383    |
| Max. Deviation (ppm) | 7.08                        | 7.19      | 7.27      | 7.37      |
| Result               | Pass                        |           |           |           |

**Temperature vs. Frequency Stability**

| Temperature<br>(°C)  | Measurement Frequency (MHz) |           |           |           |
|----------------------|-----------------------------|-----------|-----------|-----------|
|                      | 5200 MHz                    |           |           |           |
|                      | 0 Minute                    | 2 Minute  | 5 Minute  | 10 Minute |
| 0                    | 5199.9598                   | 5199.9597 | 5199.9589 | 5199.9584 |
| 10                   | 5199.9618                   | 5199.9611 | 5199.9605 | 5199.9601 |
| 20                   | 5199.9635                   | 5199.9632 | 5199.9622 | 5199.9614 |
| 30                   | 5199.9958                   | 5199.9950 | 5199.9948 | 5199.9947 |
| 40                   | 5199.9959                   | 5199.9953 | 5199.9948 | 5199.9944 |
| Max. Deviation (MHz) | 0.0421                      | 0.0431    | 0.0434    | 0.0435    |
| Max. Deviation (ppm) | 8.10                        | 8.29      | 8.35      | 8.37      |
| Result               | Pass                        |           |           |           |

**Voltage vs. Frequency Stability**

| Voltage<br>(V)       | Measurement Frequency (MHz) |           |           |           |
|----------------------|-----------------------------|-----------|-----------|-----------|
|                      | 5785 MHz                    |           |           |           |
|                      | 0 Minute                    | 2 Minute  | 5 Minute  | 10 Minute |
| 126.50               | 5784.9638                   | 5784.9630 | 5784.9626 | 5784.9624 |
| 110.00               | 5784.9635                   | 5784.9631 | 5784.9622 | 5784.9612 |
| 93.50                | 5784.9632                   | 5784.9626 | 5784.9623 | 5784.9615 |
| Max. Deviation (MHz) | 0.0368                      | 0.0374    | 0.0378    | 0.0388    |
| Max. Deviation (ppm) | 6.36                        | 6.46      | 6.53      | 6.71      |
| Result               | Pass                        |           |           |           |

**Temperature vs. Frequency Stability**

| Temperature<br>(°C)  | Measurement Frequency (MHz) |           |           |           |
|----------------------|-----------------------------|-----------|-----------|-----------|
|                      | 5785 MHz                    |           |           |           |
|                      | 0 Minute                    | 2 Minute  | 5 Minute  | 10 Minute |
| 0                    | 5784.9621                   | 5784.9617 | 5784.9613 | 5784.9606 |
| 10                   | 5784.9629                   | 5784.9628 | 5784.9623 | 5784.9618 |
| 20                   | 5784.9635                   | 5784.9630 | 5784.9624 | 5784.9619 |
| 30                   | 5784.9958                   | 5784.9951 | 5784.9942 | 5784.9937 |
| 40                   | 5784.9960                   | 5784.9958 | 5784.9953 | 5784.9945 |
| Max. Deviation (MHz) | 0.0420                      | 0.0426    | 0.0430    | 0.0436    |
| Max. Deviation (ppm) | 7.26                        | 7.36      | 7.43      | 7.54      |
| Result               | Pass                        |           |           |           |



Mode: 40 MHz / Ant. 2

**Voltage vs. Frequency Stability**

| Voltage<br>(V)       | Measurement Frequency (MHz) |           |           |           |
|----------------------|-----------------------------|-----------|-----------|-----------|
|                      | 5190 MHz                    |           |           |           |
|                      | 0 Minute                    | 2 Minute  | 5 Minute  | 10 Minute |
| 126.50               | 5189.9639                   | 5189.9630 | 5189.9620 | 5189.9616 |
| 110.00               | 5189.9635                   | 5189.9629 | 5189.9624 | 5189.9621 |
| 93.50                | 5189.9632                   | 5189.9625 | 5189.9621 | 5189.9619 |
| Max. Deviation (MHz) | 0.0368                      | 0.0375    | 0.0380    | 0.0384    |
| Max. Deviation (ppm) | 7.09                        | 7.23      | 7.32      | 7.40      |
| Result               | Pass                        |           |           |           |

**Temperature vs. Frequency Stability**

| Temperature<br>(°C)  | Measurement Frequency (MHz) |           |           |           |
|----------------------|-----------------------------|-----------|-----------|-----------|
|                      | 5190 MHz                    |           |           |           |
|                      | 0 Minute                    | 2 Minute  | 5 Minute  | 10 Minute |
| 0                    | 5189.9609                   | 5189.9608 | 5189.9607 | 5189.9603 |
| 10                   | 5189.9619                   | 5189.9616 | 5189.9609 | 5189.9602 |
| 20                   | 5189.9635                   | 5189.9628 | 5189.9623 | 5189.9617 |
| 30                   | 5189.9958                   | 5189.9955 | 5189.9952 | 5189.9948 |
| 40                   | 5189.9976                   | 5189.9968 | 5189.9963 | 5189.9958 |
| Max. Deviation (MHz) | 0.0431                      | 0.0435    | 0.0438    | 0.0445    |
| Max. Deviation (ppm) | 8.30                        | 8.38      | 8.44      | 8.57      |
| Result               | Pass                        |           |           |           |

**Voltage vs. Frequency Stability**

| Voltage<br>(V)       | Measurement Frequency (MHz) |           |           |           |
|----------------------|-----------------------------|-----------|-----------|-----------|
|                      | 5755 MHz                    |           |           |           |
|                      | 0 Minute                    | 2 Minute  | 5 Minute  | 10 Minute |
| 126.50               | 5754.9638                   | 5754.9634 | 5754.9624 | 5754.9619 |
| 110.00               | 5754.9635                   | 5754.9627 | 5754.9624 | 5754.9617 |
| 93.50                | 5754.9628                   | 5754.9625 | 5754.9615 | 5754.9612 |
| Max. Deviation (MHz) | 0.0372                      | 0.0375    | 0.0385    | 0.0388    |
| Max. Deviation (ppm) | 6.46                        | 6.52      | 6.69      | 6.74      |
| Result               | Pass                        |           |           |           |

**Temperature vs. Frequency Stability**

| Temperature<br>(°C)  | Measurement Frequency (MHz) |           |           |           |
|----------------------|-----------------------------|-----------|-----------|-----------|
|                      | 5755 MHz                    |           |           |           |
|                      | 0 Minute                    | 2 Minute  | 5 Minute  | 10 Minute |
| 0                    | 5754.9615                   | 5754.9610 | 5754.9604 | 5754.9596 |
| 10                   | 5754.9621                   | 5754.9616 | 5754.9607 | 5754.9602 |
| 20                   | 5754.9635                   | 5754.9633 | 5754.9631 | 5754.9623 |
| 30                   | 5754.9958                   | 5754.9956 | 5754.9951 | 5754.9942 |
| 40                   | 5754.9966                   | 5754.9965 | 5754.9956 | 5754.9951 |
| Max. Deviation (MHz) | 0.0432                      | 0.0439    | 0.0448    | 0.0454    |
| Max. Deviation (ppm) | 7.51                        | 7.63      | 7.78      | 7.89      |
| Result               | Pass                        |           |           |           |



Mode: 80 MHz / Ant. 2

**Voltage vs. Frequency Stability**

| Voltage<br>(V)       | Measurement Frequency (MHz) |           |           |           |
|----------------------|-----------------------------|-----------|-----------|-----------|
|                      | 5210 MHz                    |           |           |           |
|                      | 0 Minute                    | 2 Minute  | 5 Minute  | 10 Minute |
| 126.50               | 5209.9643                   | 5209.9638 | 5209.9629 | 5209.9625 |
| 110.00               | 5209.9635                   | 5209.9628 | 5209.9621 | 5209.9618 |
| 93.50                | 5209.9631                   | 5209.9629 | 5209.9622 | 5209.9618 |
| Max. Deviation (MHz) | 0.0369                      | 0.0372    | 0.0379    | 0.0382    |
| Max. Deviation (ppm) | 7.08                        | 7.14      | 7.27      | 7.33      |
| Result               | Pass                        |           |           |           |

**Temperature vs. Frequency Stability**

| Temperature<br>(°C)  | Measurement Frequency (MHz) |           |           |           |
|----------------------|-----------------------------|-----------|-----------|-----------|
|                      | 5210 MHz                    |           |           |           |
|                      | 0 Minute                    | 2 Minute  | 5 Minute  | 10 Minute |
| 0                    | 5209.9599                   | 5209.9594 | 5209.9584 | 5209.9575 |
| 10                   | 5209.9616                   | 5209.9610 | 5209.9609 | 5209.9606 |
| 20                   | 5209.9635                   | 5209.9631 | 5209.9621 | 5209.9620 |
| 30                   | 5209.9958                   | 5209.9953 | 5209.9945 | 5209.9944 |
| 40                   | 5209.9978                   | 5209.9975 | 5209.9965 | 5209.9961 |
| Max. Deviation (MHz) | 0.0423                      | 0.0429    | 0.0435    | 0.0438    |
| Max. Deviation (ppm) | 8.12                        | 8.23      | 8.35      | 8.41      |
| Result               | Pass                        |           |           |           |

**Voltage vs. Frequency Stability**

| Voltage<br>(V)       | Measurement Frequency (MHz) |           |           |           |
|----------------------|-----------------------------|-----------|-----------|-----------|
|                      | 5775 MHz                    |           |           |           |
|                      | 0 Minute                    | 2 Minute  | 5 Minute  | 10 Minute |
| 126.50               | 5774.9637                   | 5774.9633 | 5774.9629 | 5774.9620 |
| 110.00               | 5774.9635                   | 5774.9634 | 5774.9628 | 5774.9626 |
| 93.50                | 5774.9632                   | 5774.9629 | 5774.9621 | 5774.9617 |
| Max. Deviation (MHz) | 0.0368                      | 0.0371    | 0.0379    | 0.0383    |
| Max. Deviation (ppm) | 6.37                        | 6.42      | 6.56      | 6.63      |
| Result               | Pass                        |           |           |           |

**Temperature vs. Frequency Stability**

| Temperature<br>(°C)  | Measurement Frequency (MHz) |           |           |           |
|----------------------|-----------------------------|-----------|-----------|-----------|
|                      | 5775 MHz                    |           |           |           |
|                      | 0 Minute                    | 2 Minute  | 5 Minute  | 10 Minute |
| 0                    | 5774.9604                   | 5774.9603 | 5774.9598 | 5774.9596 |
| 10                   | 5774.9615                   | 5774.9605 | 5774.9600 | 5774.9593 |
| 20                   | 5774.9635                   | 5774.9627 | 5774.9622 | 5774.9616 |
| 30                   | 5774.9958                   | 5774.9951 | 5774.9944 | 5774.9938 |
| 40                   | 5774.9976                   | 5774.9974 | 5774.9970 | 5774.9965 |
| Max. Deviation (MHz) | 0.0416                      | 0.0422    | 0.0430    | 0.0440    |
| Max. Deviation (ppm) | 7.20                        | 7.31      | 7.45      | 7.62      |
| Result               | Pass                        |           |           |           |



# RSE Co-location Result

Appendix G

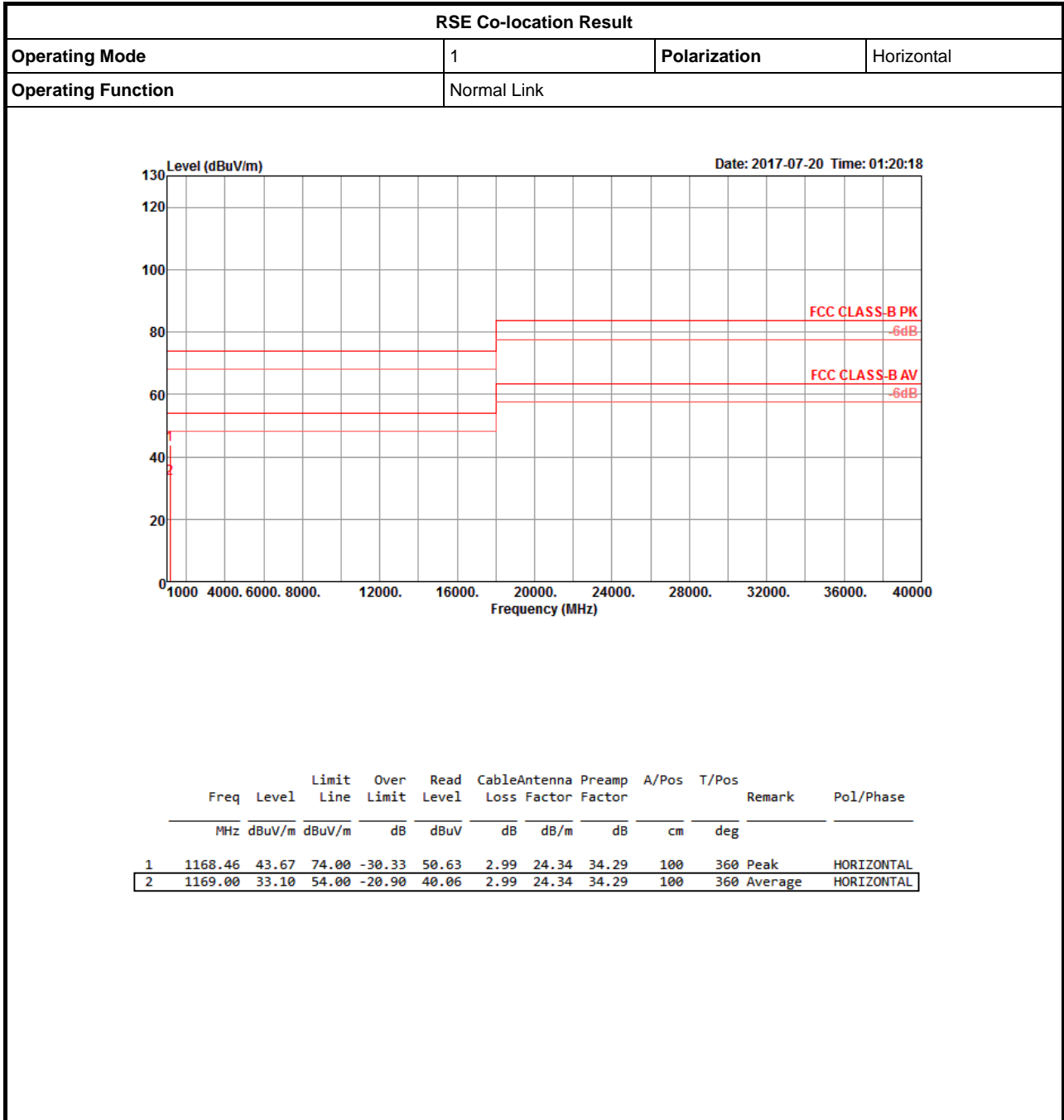



RSE Co-location Result

Appendix G

