



FCC REPORT

Applicant: BTI Wireless

Address of Applicant: 6185 Phyllis Dr. Unit D Cypress California 90630 United States

Equipment Under Test (EUT)

Product Name: mBSC-CM RUM

Model No.: mBSC2100E-005-RUCM11, mBSC2100E-005-RUCM12

FCC ID: WBKMBSCAWS3RUM

Applicable standards: FCC CFR Title 47 Part 2:2014
FCC CFR Title 47 Part27 Subpart C:2014

Date of sample receipt: October 18 2015

Date of Test: October 18-30 2015

Date of report issued: November 05 2015

Test Result : PASS *

* In the configuration tested, the EUT complied with the standards specified above.

Authorized Signature:

Robinson Lo
Laboratory Manager

This report details the results of the testing carried out on one sample. The results contained in this test report do not relate to other samples of the same product and does not permit the use of the GTS product certification mark. The manufacturer should ensure that all products in series production are in conformity with the product sample detailed in this report.

This report may only be reproduced and distributed in full. If the product in this report is used in any configuration other than that detailed in the report, the manufacturer must ensure the new system complies with all relevant standards.

Any mention of GTS or testing done by GTS in connection with, distribution or use of the product described in this report must be approved by GTS in writing.

This document cannot be reproduced except in full, without prior written approval of the Company. Any unauthorized alteration, forgery or falsification of the content or appearance of this document is unlawful and offenders may be prosecuted to the fullest extent of the law. Unless otherwise stated the results shown in this test report refer only to the sample(s) tested and such sample(s) are retained for 90 days only

2 Version

Version No.	Date	Description
00	November 05 2015	Original

Prepared By:

Edward. Pan

Date:

November 05 2015

Project Engineer

Check By:

Frank. Yan

Date:

November 05 2015

Reviewer

3 Contents

	Page
1 COVER PAGE	1
2 VERSION	2
3 CONTENTS	3
4 TEST SUMMARY	5
5 GENERAL INFORMATION	6
5.1 CLIENT INFORMATION	6
5.2 GENERAL DESCRIPTION OF EUT	6
5.3 RELATED SUBMITTAL(S) / GRANT (S)	7
5.4 TEST METHODOLOGY	7
5.5 TEST FACILITY	7
5.6 TEST LOCATION	7
5.7 TEST INSTRUMENTS LIST	8
6 TEST CONFIGURATION AND CONDITIONS	9
6.1 EUT CONFIGURATION	9
6.2 CONFIGURATION OF TESTED SYSTEM	10
6.3 TEST ENVIRONMENTS	12
6.4 TEST SIGNAL	12
6.5 TEST FREQUENCY SELECTION	13
6.6 DESCRIPTION OF TEST MODES	15
7 RF POWER OUTPUT MEASUREMENT	16
7.1 STANDARD APPLICABLE	16
7.2 TEST SETUP	16
7.3 MEASUREMENT PROCEDURE	16
7.4 TEST RESULT	17
7.5 PEAK TO AVERAGE RATIO	19
8 MEASURING THE EUT AGC THRESHOLD	20
8.1 STANDARD APPLICABLE	20
8.2 TEST SETUP	20
8.3 TEST PROCEDURE	20
8.4 TEST RESULT	20
9 PASSBAND GAIN AND 99% OCCUPIED BANDWIDTH	22
9.1 STANDARD APPLICABLE	22
9.2 TEST SETUP	22
9.3 TEST PROCEDURE	22
9.4 TEST RESULT	22
10 OUT OF BAND EMISSION AT ANTENNA TERMINALS	41
10.1 STANDARD APPLICABLE	41
10.2 TEST SETUP	41
10.3 MEASUREMENT PROCEDURE	41
10.4 MEASUREMENT RESULT	41

10.4.1	Spurious emission	41
10.4.2	Band edge emission	90
11	INTERMODULATION.....	96
11.1	STANDARD APPLICABLE	96
11.2	TEST SETUP	96
11.3	MEASUREMENT PROCEDURE.....	96
11.4	TEST RESULT	96
12	FIELD STRENGTH OF SPURIOUS RADIATION MEASUREMENT	141
12.1	STANDARD APPLICABLE	141
12.2	EUT SETUP (BLOCK DIAGRAM OF CONFIGURATION).....	141
12.3	MEASUREMENT PROCEDURE.....	141
12.4	MEASUREMENT DATA.....	142
13	FREQUENCY STABILITY.....	148
13.1	STANDARD APPLICABLE	148
13.2	TEST SETUP	148
13.3	TEST PROCEDURE.....	148
13.4	TEST RESULT	149
14	OUT-OF-BAND REJECTION.....	151
14.1	STANDARD APPLICABLE	151
14.2	TEST SETUP	151
14.3	TEST PROCEDURE.....	151
14.4	TEST RESULT	151
15	AC POWER LINE CONDUCTED EMISSION TEST.....	152
15.1	STANDARD APPLICABLE	152
15.2	TEST SETUP	152
15.3	TEST PROCEDURE.....	152
15.4	MEASUREMENT RESULT.....	152
16	TEST SETUP PHOTO.....	157
17	EUT CONSTRUCTIONAL DETAILS	159

4 Test Summary

Test Item	Test Description	Result
Maximum Permissible exposure(MPE)	§ 1.1307(b)(1), § 2.1091	PASS* (Please refer to MPE Report)
RF Output Power	§ 2.1046; § 27.50(h)	PASS
Modulation Characteristics	§ 2.1047	N/A*
Passband Gain and 99% Occupied Bandwidth	§ 2.1049 ; § 27.53(m)	PASS
Spurious Emissions at Antenna Terminal	§ 2.1051; § 27.53(m)	PASS
Intermodulation	§ 2.1051; § 27.53(m)	PASS
Field Strength of Spurious Radiation	§ 2.1053; § 27.53(m)	PASS
Out of band emission, Band Edge	§ 27.53(m)	PASS
Frequency stability vs. temperature Frequency stability vs. voltage	§ 2.1055; § 27.54	PASS
Measuring the EUT AGC threshold	---	PASS
Out-of-Band Rejection	---	PASS
AC Power Line Conducted Emission Test	§ 15.207	PASS

Remark:

N/A*: Not application

5 General Information

5.1 Client Information

Applicant:	BTI Wireless
Address of Applicant:	6185 Phyllis Dr. Unit D Cypress California 90630 United States
Manufacturer:	Bravo Tech, Inc.
Address of Manufacturer:	6185 Phyllis Dr. Unit D Cypress California 90630 United States
Factory:	BTI Wireless(ShenZhen)Co.,Ltd.
Address of Factory:	No. 8 Building, The 3rd Zone, Tangtou Industrial Park Shiyan, Baoan District, Shenzhen, China

5.2 General Description of EUT

Product Name:	mBSC-CM RUM	
Model No.:	mBSC2100E-005-RUCM11, mBSC2100E-005-RUCM12	
Power supply:	RPM: Input: AC 120V/60Hz RUM: DC 28V, 3A Max RTM: Input DC 28V / 2.2A Normal test voltage: AC 120V/60Hz	
Operating Temperature:	-20°C to + 55°C	
Operating Humidity:	up to 95%	
Technical Parameter:		
Frequency Range	Downlink	2110MHz~2180MHz
	Uplink	1710MHz~1780MHz
Operating Bandwidth	70MHz	
Multiple Carrier Supported	LTE: 1 carrier WCDMA: 4carrier	
Channel Spacing(s) / Bandwidth(s)	LTE: 1.4MHz; 3MHz; 5MHz; 10MHz; 15MHz; 20MHz WCDMA: 5MHz.	
Maximun RF Output Power	Downlink: 37.75dBm Uplink: 5.23dBm	
Max Gain	Downlink: 54.26dB; Uplink: 62.34dB	
Type of modulation and Designator	LTE(W7D), WCDMA(F9W);	
Antenna Type	External antenna (N female)	
Antenna Gain	Maximum permissible antenna gain is 16dBi.	

5.3 Related Submittal(s) / Grant (s)

Title 47 Part 2	General Requirements and Information for the Certification of Radio Apparatus
Title 47 Part 27	MISCELLANEOUS WIRELESS COMMUNICATIONS SERVICES

5.4 Test Methodology

Title 47 Part 2	General Requirements and Information for the Certification of Radio Apparatus
Title 47 Part 20	COMMERCIAL MOBILE SERVICES
Title 47 Part 27	MISCELLANEOUS WIRELESS COMMUNICATIONS SERVICES
ANSI C63.4: 2014	Methods of Measurement of Radio-Noise Emissions from Low Voltage Electrical and Electronic Equipment in the Range of 9 kHz to 40 GHz
KDB	AMPLIFIER, BOOSTER, AND REPEATER REMINDER SHEET
KDB 935210	D01 Signal Booster Definitions v02; D02 Signal Booster Certification v03 D03 Signal Booster Measurements v03 D04 Signal Booster Provider Specific v01r01 D05 Indus Booster Basic Meas v01

5.5 Test Facility

<p>The test facility is recognized, certified, or accredited by the following organizations:</p> <ul style="list-style-type: none"> ● FCC —Registration No.: 600491 Global United Technology Services Co., Ltd., Shenzhen EMC Laboratory has been registered and fully described in a report filed with the (FCC) Federal Communications Commission. The acceptance letter from the FCC is maintained in files. Registration 600491, June 28, 2013. ● Industry Canada (IC) The 3m Semi-anechoic chamber of China Certification & Inspection Services Co., Ltd. has been Registered by Certification and Engineering Bureau of Industry Canada for radio equipment testing with Registration No.: 9079A-2, June 26, 2013.
--

5.6 Test Location

All tests were performed at:
Global United Technology Services Co., Ltd. Address: Room 301-309, 3th Floor, Block A, Huafeng Jinyuan Business Building, No. 300 Laodong Industrial Zone, Xixiang Road, Baoan District, Shenzhen 518102 Tel: 0755-27798480 Fax: 0755-27798960

5.7 Test Instruments list

Item	Test Equipment	Manufacturer	Model No.	Inventory No.	Cal.Date (dd-mm-yy)	Cal.Due date (dd-mm-yy)
1	3m Semi- Anechoic Chamber	ZhongYu Electron	9.2(L)*6.2(W)* 6.4(H)	GTS250	Mar. 27 2015	Mar. 26 2020
2	Control Room	ZhongYu Electron	6.2(L)*2.5(W)* 2.4(H)	GTS251	N/A	N/A
3	EMI Test Receiver	Rohde & Schwarz	ESU26	GTS203	Jun. 29, 2015	Jun. 28, 2016
4	BiConiLog Antenna	SCHWARZBECK MESS-ELEKTRONIK	VULB9163	GTS214	Feb. 21 2015	Feb. 20 2016
5	Double -ridged waveguide horn	SCHWARZBECK MESS-ELEKTRONIK	9120D-829	GTS208	June 25 2015	June 24 2016
6	EMI Test Software	AUDIX	E3	N/A	N/A	N/A
7	Coaxial Cable	GTS	N/A	GTS213	Mar. 27 2015	Mar. 26 2016
8	Coaxial Cable	GTS	N/A	GTS211	Mar. 27 2015	Mar. 26 2016
9	Coaxial cable	GTS	N/A	GTS210	Mar. 27 2015	Mar. 26 2016
10	Coaxial Cable	GTS	N/A	GTS212	Mar. 27 2015	Mar. 26 2016
11	Amplifier(100KHz-5GHz)	HP	8347A	GTS204	Jun. 29, 2015	Jun. 28, 2016
12	Amplifier(2GHz-20GHz)	HP	8349B	GTS206	Jun. 29, 2015	Jun. 28, 2016
13	Amplifier (18-26GHz)	Rohde & Schwarz	AFS33-18002 650-30-8P-44	GTS218	June 25 2015	June 24 2016
14	Shielding Room	ZhongYu Electron	7.0(L)x3.0(W)x3.0(H)	GTS264	Sep. 05 2015	Sep. 04 2017
15	EMI Test Receiver	Rohde & Schwarz	ESCS30	GTS223	Jun. 29, 2015	Jun. 28, 2016
16	10dB Pulse Limita	Rohde & Schwarz	N/A	GTS224	Jun. 29, 2015	Jun. 28, 2016
17	LISN	SCHWARZBECK MESS-ELEKTRONIK	NSLK 8127	GTS226	Jun. 29, 2015	Jun. 28, 2016
18	Temp. Humidity/Barometer	Oregon Scientific	BA-888	GTS248	May 08 2015	May 07 2017
19	Spectrum Analyzer	Agilent	E4440A	GTS 536	Oct.19 2015	Oct.18 2016
20	Spectrum Analyzer	Agilent	E4445A	MY41000047	Sept. 09 2015	Sept. 08 2017
21	Splitter	Agilent	11636B	GTS237	May 08 2015	May 07 2017
22	Signal Generator	Rohde & Schwarz	SML03	GTS236	May 08 2015	May 07 2017
23	Signal Generator	AEROFLEX	IFR3414	341300/019	Sept. 09 2015	Sept. 08 2016
24	Power Meter	Giga-tronics	8541C	1831177	Sept. 09 2015	Sept. 08 2016
25	Power Sensor	Giga-tronics	80601A	1831785	Sept. 09 2015	Sept. 08 2016
26	Power Attenuator	BTI	30dB/250W	040706090	Sept. 09 2015	Sept. 08 2016
27	Power Attenuator	BTI	20dB	040706089	Sept. 09 2015	Sept. 08 2016
28	Power Attenuator	BTI	10dB	040706088	Sept. 09 2015	Sept. 08 2016
29	Signal Generator	Agilent	E4438C	MY45093111	Oct.19 2015	Oct.18 2016
30	Signal Generator	Agilent	4432B	GB40051373	May 08 2015	May 07 2016

6 TEST CONFIGURATION AND CONDITIONS

6.1 EUT Configuration

This MBSC2100-005-RUCM11 is the Remote Unit on BTI CM system. This remote unit supports 2100MHz band with the air standard LTE and WCDMA. The unit consists of Duplexer, PA and CPU board. This product is designed to operate in an outdoor or indoor environment. The output power of the RUM at Antenna interface port is average 37.75dBm for Downlink path with Convection Cooling.

For details, refer to technical document and the user manual.

6.2 Configuration of Tested System

(A) RF Output Power, Occupied Bandwidth, Spurious Emissions at Antenna Terminal, Band Edge, Test Set-UP

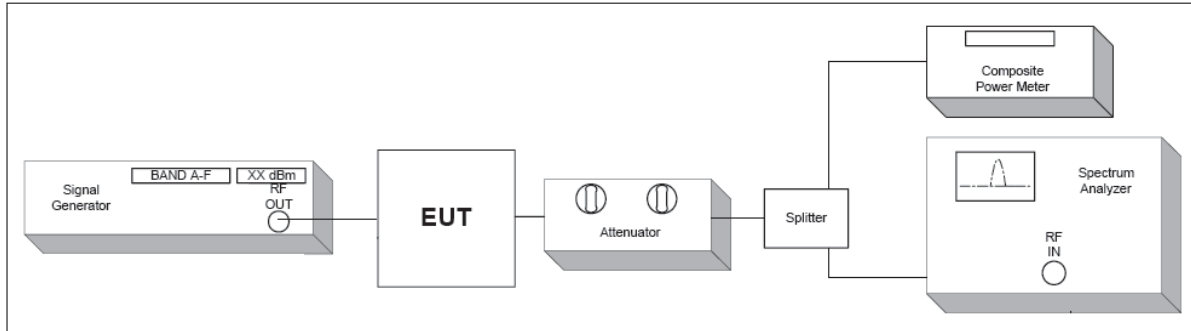

(B) Intermodulation Test Set-UP

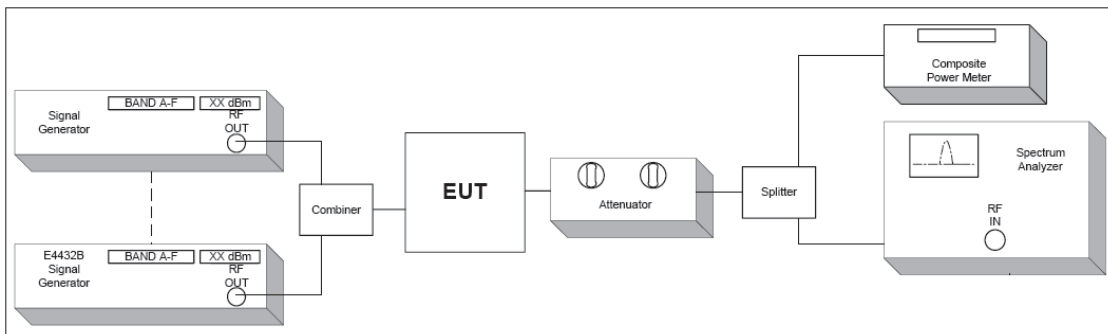

(C) Frequency stability Test Set-UP

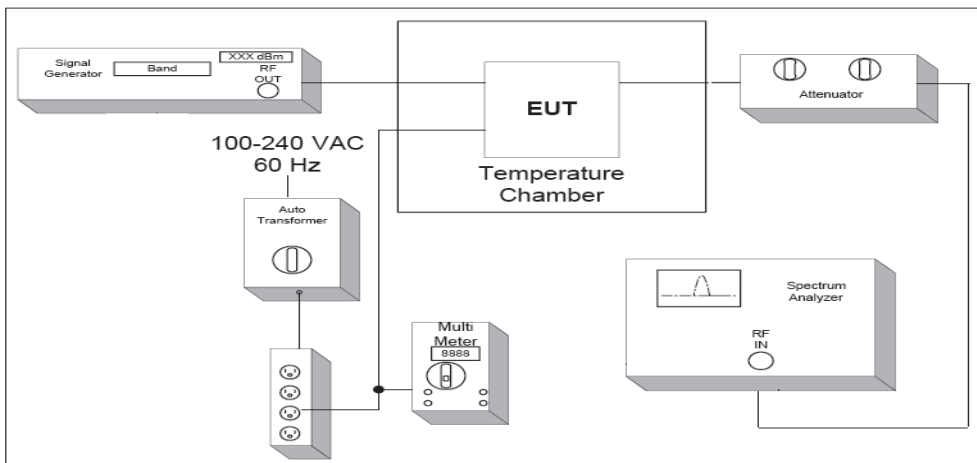

(D) Radiated Emission Test Set-Up, Frequency below 1000MHz

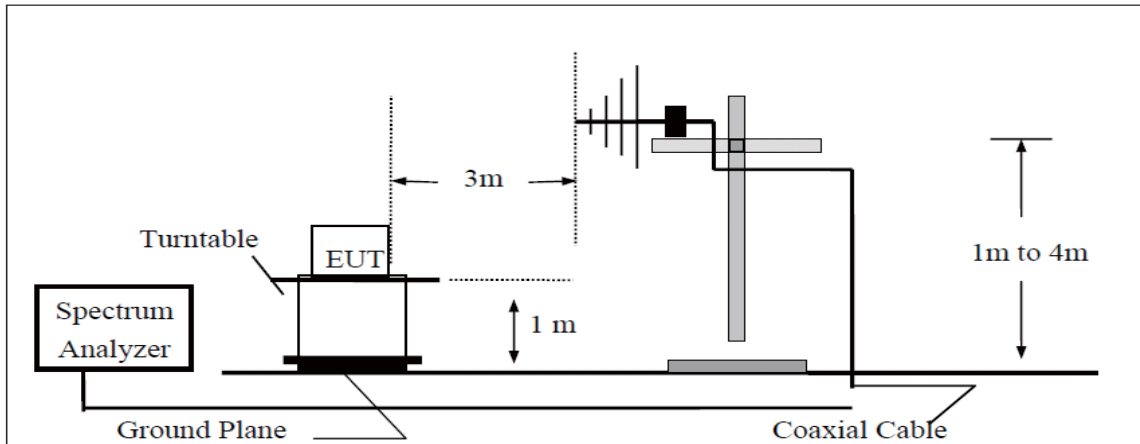

(E) Radiated Emission Test Set-UP Frequency over 1 GHz

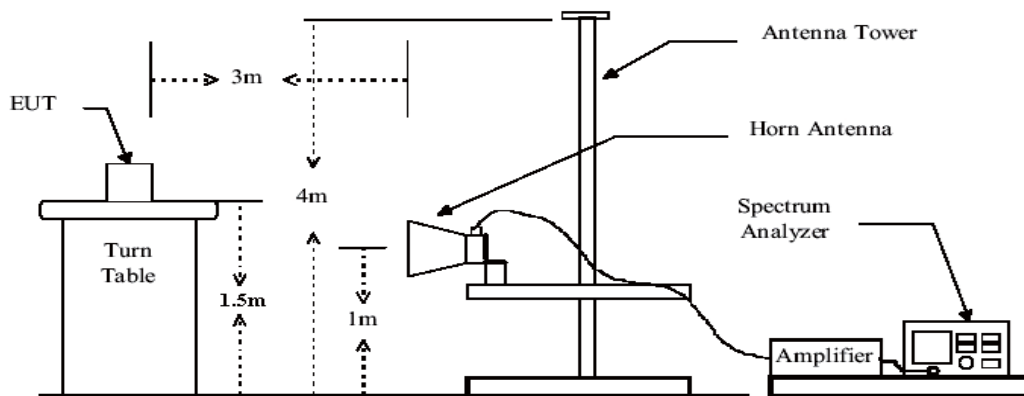

(F) Substituted Method Test Set-UP

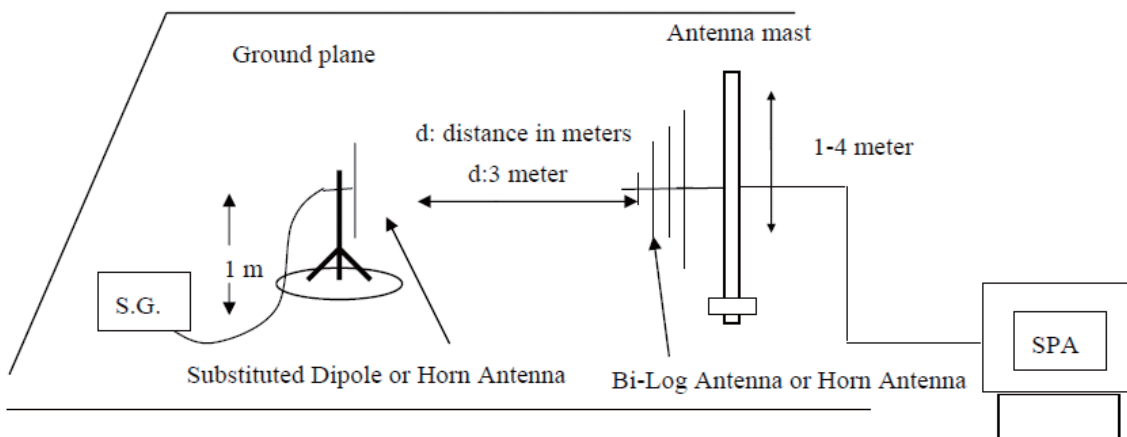

6.3 Test Environments

Condition	Minimum value	Maximum value
Barometric pressure	86 kPa	106 kPa
Temperature	15°C	30°C
Relative Humidity	20 %	75 %
Power supply range	±5% of rated voltages	
Normal Test Condition	(1). Temperature: +15 °C to +30 °C; (2). voltage is 120V AC.	
Extreme Test Conditions:	(1). Temperatures: -20°C to +55°C. (2). Voltages: 102V AC to 138V AC.	

6.4 Test signal

1: Test signal LTE:

Signal waveform according to Test Model 1.1, E-TM1.1, clause 6.1.1.1-1, table 6.1.1.1-1 of standard specification 3GPP TS 36.141 V9.3.0 (2010-03).

2: Test signal WCDMA

Signal waveform according to Test Model 1 of standard specification 3GPP TS25.141. Signal modulated with a combination of PCCPCH, SCCPCH and Dedicated Physical Channels specified as test model 1 64 DPCH.

3: Test signal CW

N/A

6.5 Test frequency selection

Downlink:

Operating Mode(TX)	Channels No.	Channels frequency (MHz)		
	Multi- Carriers	Low Ch.	Mid Ch.	High Ch.
LTE 1.4MHz Bandwidth	Single Carrier	2110.70	2145.00	2779.30
LTE 3MHz Bandwidth	Single Carrier	2111.50	2145.00	2778.50
LTE 5MHz Bandwidth	Single Carrier	2112.50	2145.00	2777.50
LTE 10MHz Bandwidth	Single Carrier	2115.00	2145.00	2775.00
LTE 15MHz Bandwidth	Single Carrier	2117.50	2145.00	2772.50
LTE 20MHz Bandwidth	Single Carrier	2120.00	2145.00	2770.00
WCDMA	Single Carrier	2112.40	2145.00	2777.60
	Two Carrier	2114.80	2145.00	2775.20
	Three Carrier	2117.20	2145.00	2772.80
	Four Carrier	2119.60	2145.00	2770.40

Uplink:

Operating Mode(TX)	Channels No.	Channels frequency (MHz)		
	Multi- Carriers	Low Ch.	Mid Ch.	High Ch.
LTE 1.4MHz Bandwidth	Single Carrier	1710.70	1745.00	1779.30
LTE 3MHz Bandwidth	Single Carrier	1711.50	1745.00	1778.50
LTE 5MHz Bandwidth	Single Carrier	1712.50	1745.00	1777.50
LTE 10MHz Bandwidth	Single Carrier	1715.00	1745.00	1775.00
LTE 15MHz Bandwidth	Single Carrier	1717.50	1745.00	1772.50
LTE 20MHz Bandwidth	Single Carrier	1720.00	1745.00	1770.00
WCDMA	Single Carrier	1712.40	1745.00	1777.60
	Two Carrier	1714.80	1745.00	1775.20
	Three Carrier	1717.20	1745.00	1772.80
	Four Carrier	1719.60	1745.00	1770.40

6.6 DESCRIPTION OF TEST MODES

Test mode	Detail description of the test mode
Downlink	Downlink (Low channel; middle channel; high channel)
Uplink	Uplink (Low channel; middle channel; high channel)
Multi-carrier	Single Carrier
Multi-bandwidth	LTE: 1.4MHz; 3MHz; 5MHz; 10MHz; 15MHz; 20MHz. WCDMA: 5MHz
Modulation type	LTE, WCDMA

Remark:

- 1: The EUT was powered by 120VAC.
- 2: The EUT was configured for maximum gain and maximum output power. The input power was the maximum declared by the manufacturer. This is to ensure that the equipment is operating in the linear output range.
- 3: Signal generator was used to provide the input signals to the EUT. Tests were performed with LTE and WCDMA signal input and multi-carrier signal mode input.
- 4: Pre-test all test modes as above, only the worst case and typical mode is listed in report.
- 5: All testing is end-to-end (input to host through to output from remote, and vice-versa)

7 RF POWER OUTPUT MEASUREMENT

7.1 Standard Applicable

According to FCC § 2.1046 and § 27.53(h).

7.2 Test setup

Please refer the section §6.2 Configuration of Tested System.

7.3 Measurement Procedure

1. The output from the EUT t signal shall be increased, antenna connector was connected to the power meter.
2. The level of RF input until the maximum output power per channel, declared by client, is reached.
3. The RF output power was measured at low, middle and high channel with LTE and WCDMA signal.

7.4 Test Result

Downlink:

Test mode	Carrier Conf.	Channel	Average Power (dBm)	Average Power (W)	RF Output Power(W/MHz)	Result
LTE	LTE 1.4MHz Bandwidth	Low	37.58	5.73	4.09	Compliant
		Middle	37.75	5.96	4.26	Compliant
		High	37.64	5.81	4.15	Compliant
	LTE 3MHz Bandwidth	Low	37.67	5.85	1.95	Compliant
		Middle	37.71	5.90	1.97	Compliant
		High	37.60	5.75	1.92	Compliant
	LTE 5MHz Bandwidth	Low	37.51	5.64	1.13	Compliant
		Middle	37.67	5.85	1.17	Compliant
		High	37.62	5.78	1.16	Compliant
	LTE 10MHz Bandwidth	Low	37.52	5.65	0.57	Compliant
		Middle	37.64	5.81	0.58	Compliant
		High	37.59	5.74	0.57	Compliant
	LTE 15MHz Bandwidth	Low	37.67	5.85	0.39	Compliant
		Middle	37.70	5.89	0.39	Compliant
		High	37.62	5.78	0.39	Compliant
	LTE 20MHz Bandwidth	Low	37.57	5.71	0.29	Compliant
		Middle	37.61	5.77	0.29	Compliant
		High	37.53	5.66	0.28	Compliant
WCDMA	Single Carrier	Low	37.61	5.77	1.15	Compliant
		Middle	37.72	5.92	1.18	Compliant
		High	37.65	5.82	1.16	Compliant
	Two Carrier	Low	37.51	5.64	0.56	Compliant
		Middle	37.60	5.75	0.58	Compliant
		High	37.54	5.68	0.57	Compliant
	Three Carrier	Low	37.46	5.57	0.37	Compliant
		Middle	37.51	5.64	0.38	Compliant
		High	37.43	5.53	0.37	Compliant
	Four Carrier	Low	37.36	5.45	0.27	Compliant
		Middle	37.44	5.55	0.28	Compliant
		High	37.38	5.47	0.27	Compliant

Uplink:

Test mode	Carrier Conf.	Channel	Average Power (dBm)	Average Power (W)	RF Output Power(W/MHz)	Result
LTE	LTE 1.4MHz Bandwidth	Low	4.92	0.0031	0.00221	Compliant
		Middle	5.23	0.0033	0.00236	Compliant
		High	4.88	0.0031	0.00221	Compliant
	LTE 3MHz Bandwidth	Low	4.89	0.0031	0.00103	Compliant
		Middle	5.19	0.0033	0.00110	Compliant
		High	4.93	0.0031	0.00103	Compliant
	LTE 5MHz Bandwidth	Low	4.95	0.0031	0.00062	Compliant
		Middle	5.15	0.0033	0.00066	Compliant
		High	5.02	0.0032	0.00064	Compliant
	LTE 10MHz Bandwidth	Low	4.97	0.0031	0.00031	Compliant
		Middle	5.20	0.0033	0.00033	Compliant
		High	5.03	0.0032	0.00032	Compliant
	LTE 15MHz Bandwidth	Low	4.87	0.0031	0.00021	Compliant
		Middle	5.13	0.0033	0.00022	Compliant
		High	5.08	0.0032	0.00021	Compliant
	LTE 20MHz Bandwidth	Low	4.87	0.0031	0.00016	Compliant
		Middle	5.07	0.0032	0.00016	Compliant
		High	4.97	0.0031	0.00016	Compliant
WCDMA	Single Carrier	Low	5.01	0.0032	0.00064	Compliant
		Middle	5.16	0.0033	0.00066	Compliant
		High	4.97	0.0031	0.00062	Compliant
	Two Carrier	Low	4.96	0.0031	0.00031	Compliant
		Middle	5.13	0.0033	0.00033	Compliant
		High	4.95	0.0031	0.00031	Compliant
	Three Carrier	Low	4.91	0.0031	0.00021	Compliant
		Middle	5.04	0.0032	0.00021	Compliant
		High	4.87	0.0031	0.00021	Compliant
	Four Carrier	Low	4.85	0.0031	0.00016	Compliant
		Middle	4.96	0.0031	0.00016	Compliant
		High	4.79	0.0030	0.00015	Compliant

7.5 Peak to Average Ratio

Downlink:

Test mode	Carrier Conf.	Peak to Average Ratio (dB)			Limit (dB)	Result
		Low Ch.	Middle Ch.	High Ch.		
LTE	1.4MHz	8.69	8.57	8.43	13	Compliant
	3MHz	8.46	8.55	8.39	13	Compliant
	5MHz	8.68	8.75	8.41	13	Compliant
	10MHz	8.51	8.25	8.27	13	Compliant
	15MHz	8.43	8.66	8.71	13	Compliant
	20MHz	8.62	8.45	8.58	13	Compliant
WCDMA	Single Carrier	4.62	4.55	4.65	13	Compliant
	Two Carrier	4.28	4.75	4.45	13	Compliant
	Three Carrier	4.58	4.67	4.31	13	Compliant
	Four Carrier	4.67	4.25	4.63	13	Compliant

Uplink:

Test mode	Carrier Conf.	Peak to Average Ratio (dB)			Limit (dB)	Result
		Low Ch.	Middle Ch.	High Ch.		
LTE	1.4MHz	7.95	8.68	8.38	13	Compliant
	3MHz	8.24	7.46	8.57	13	Compliant
	5MHz	8.24	8.82	8.25	13	Compliant
	10MHz	8.29	8.68	8.17	13	Compliant
	15MHz	8.64	8.71	8.28	13	Compliant
	20MHz	8.45	8.65	8.39	13	Compliant
WCDMA	Single Carrier	4.53	4.37	4.46	13	Compliant
	Two Carrier	4.47	4.52	4.52	13	Compliant
	Three Carrier	4.38	4.27	4.22	13	Compliant
	Four Carrier	4.62	4.56	4.38	13	Compliant

8 MEASURING THE EUT AGC THRESHOLD

8.1 Standard Applicable

Please refer the section §3.2 8 MEASURING THE EUT AGC THRESHOLD of D05 Indus Booster Basic Meas v01

8.2 Test setup

Please refer the section §6.2 Configuration of Tested System.

8.3 Test Procedure

Please refer the section §3.2 8 MEASURING THE EUT AGC THRESHOLD of D05 Indus Booster Basic Meas v01

8.4 Test Result

Downlink:

Test mode	Carrier Conf.	AGC threshold level (dB)			Result
		Low Ch.	Middle Ch.	High Ch.	
LTE	1.4MHz	39.32	39.47	39.51	Compliant
	3MHz	39.33	39.54	39.48	Compliant
	5MHz	39.50	39.56	39.55	Compliant
	10MHz	39.46	39.57	39.61	Compliant
	15MHz	39.60	39.57	39.46	Compliant
	20MHz	39.45	39.51	39.48	Compliant
WCDMA	Single Carrier	39.55	39.46	39.57	Compliant
	Two Carrier	39.56	39.61	39.64	Compliant
	Three Carrier	39.48	39.62	39.55	Compliant
	Four Carrier	39.45	39.56	39.50	Compliant

Uplink:

Test mode	Carrier Conf.	AGC threshold level (dB)			Result
		Low Ch.	Middle Ch.	High Ch.	
LTE	1.4MHz	5.34	5.26	5.46	Compliant
	3MHz	5.45	5.48	5.47	Compliant
	5MHz	5.53	5.49	5.55	Compliant
	10MHz	5.53	5.61	5.49	Compliant
	15MHz	5.38	5.45	5.53	Compliant
	20MHz	5.49	5.38	5.48	Compliant
WCDMA	Single Carrier	5.61	5.57	5.51	Compliant
	Two Carrier	5.49	5.57	5.47	Compliant
	Three Carrier	5.61	5.62	5.53	Compliant
	Four Carrier	5.51	5.66	5.68	Compliant

9 PASSBAND GAIN AND 99% OCCUPIED BANDWIDTH

9.1 Standard Applicable

According to FCC § 2.1049 , § 27.53(m)

9.2 Test setup

Please refer the section §6.2 Configuration of Tested System.

9.3 Test Procedure

1. The EUT RF output port was connected to spectrum analyzer.
2. The level of RF input signal shall be increased, until the maximum output power per channel, declared by client, is reached.
3. The spectrum analyzer was setup to measure the Occupied Bandwidth (defined as the 99% Power Bandwidth).
4. The Occupied Bandwidth was measured at the input and output ports of the EUT at low, middle and high channel of each type of modulation and each type of carrier signal.

Spectrum analyzer settings:

Detector: RMS.

RBW= 1% to 5 % of the anticipated OBW

VBW \geq 3*RBW Sweep: Auto

9.4 Test Result

Pass band Gain

Downlink:

Test mode	Carrier Conf.	Channel	Passband Gain (dB)	Nominal Gain (dB)	Result
LTE	LTE 1.4MHz Bandwidth	Low	54.05	54±0.5dB	Compliant
		Middle	54.26		Compliant
		High	53.98		Compliant
	LTE 3MHz Bandwidth	Low	54.01		Compliant
		Middle	54.15		Compliant
		High	53.69		Compliant
	LTE 5MHz Bandwidth	Low	54.03		Compliant
		Middle	54.18		Compliant
		High	54.07		Compliant
	LTE 10MHz Bandwidth	Low	54.13		Compliant
		Middle	54.19		Compliant
		High	54.09		Compliant
	LTE 15MHz Bandwidth	Low	53.99		Compliant
		Middle	54.16		Compliant
		High	53.96		Compliant
	LTE 20MHz Bandwidth	Low	54.03		Compliant
		Middle	54.13		Compliant
		High	54.00		Compliant
WCDMA	Single Carrier	Low	54.05	Compliant	
		Middle	54.21	Compliant	
		High	53.93	Compliant	
	Two Carrier	Low	54.03	Compliant	
		Middle	54.20	Compliant	
		High	54.14	Compliant	
	Three Carrier	Low	54.15	Compliant	
		Middle	54.24	Compliant	
		High	54.12	Compliant	
	Four Carrier	Low	54.17	Compliant	
		Middle	54.21	Compliant	
		High	54.15	Compliant	

Uplink:

Test mode	Carrier Conf.	Channel	Passband Gain (dB)	Nominal Gain (dB)	Result	
LTE	LTE 1.4MHz Bandwidth	Low	62.13	62±0.5dB	Compliant	
		Middle	62.34		Compliant	
		High	62.27		Compliant	
	LTE 3MHz Bandwidth	Low	61.93		Compliant	
		Middle	62.24		Compliant	
		High	62.09		Compliant	
	LTE 5MHz Bandwidth	Low	61.76		Compliant	
		Middle	61.85		Compliant	
		High	61.91		Compliant	
	LTE 10MHz Bandwidth	Low	62.12		Compliant	
		Middle	62.19		Compliant	
		High	62.15		Compliant	
	LTE 15MHz Bandwidth	Low	62.21		Compliant	
		Middle	62.30		Compliant	
		High	62.12		Compliant	
	LTE 20MHz Bandwidth	Low	61.99		Compliant	
		Middle	62.08		Compliant	
		High	62.14		Compliant	
	WCDMA	Single Carrier	Low		62.01	Compliant
			Middle		62.12	Compliant
			High		62.23	Compliant
		Two Carrier	Low		62.07	Compliant
			Middle		62.24	Compliant
			High		62.10	Compliant
Three Carrier		Low	62.01	Compliant		
		Middle	62.16	Compliant		
		High	62.19	Compliant		
Four Carrier		Low	62.20	Compliant		
		Middle	62.31	Compliant		
		High	62.24	Compliant		

Input/output Bandwidth Comparison

Downlink:

Input/output Bandwidth Comparison for LTE 1.4MHz Bandwidth

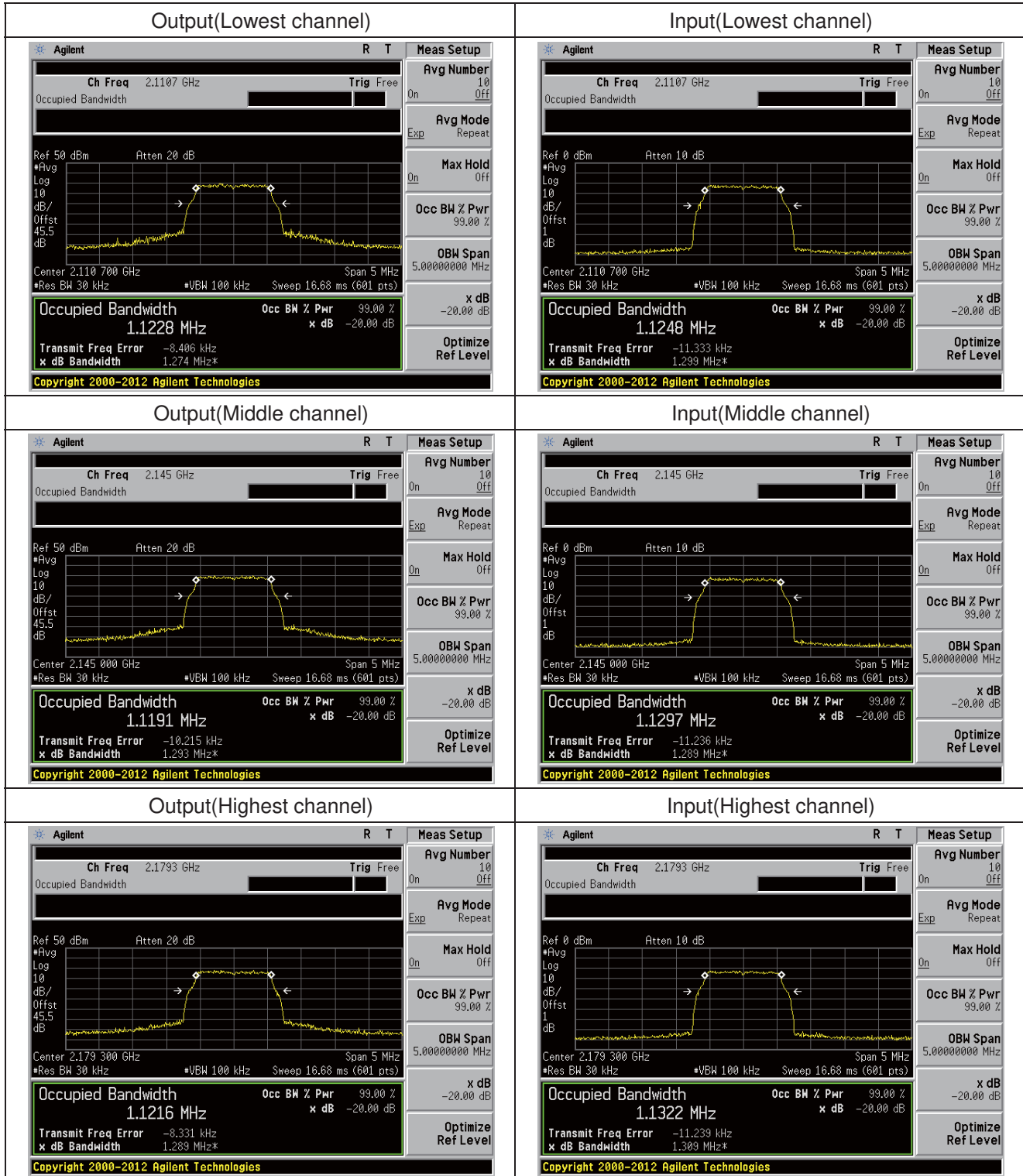

Input/output Bandwidth Comparison for LTE 3MHz Bandwidth

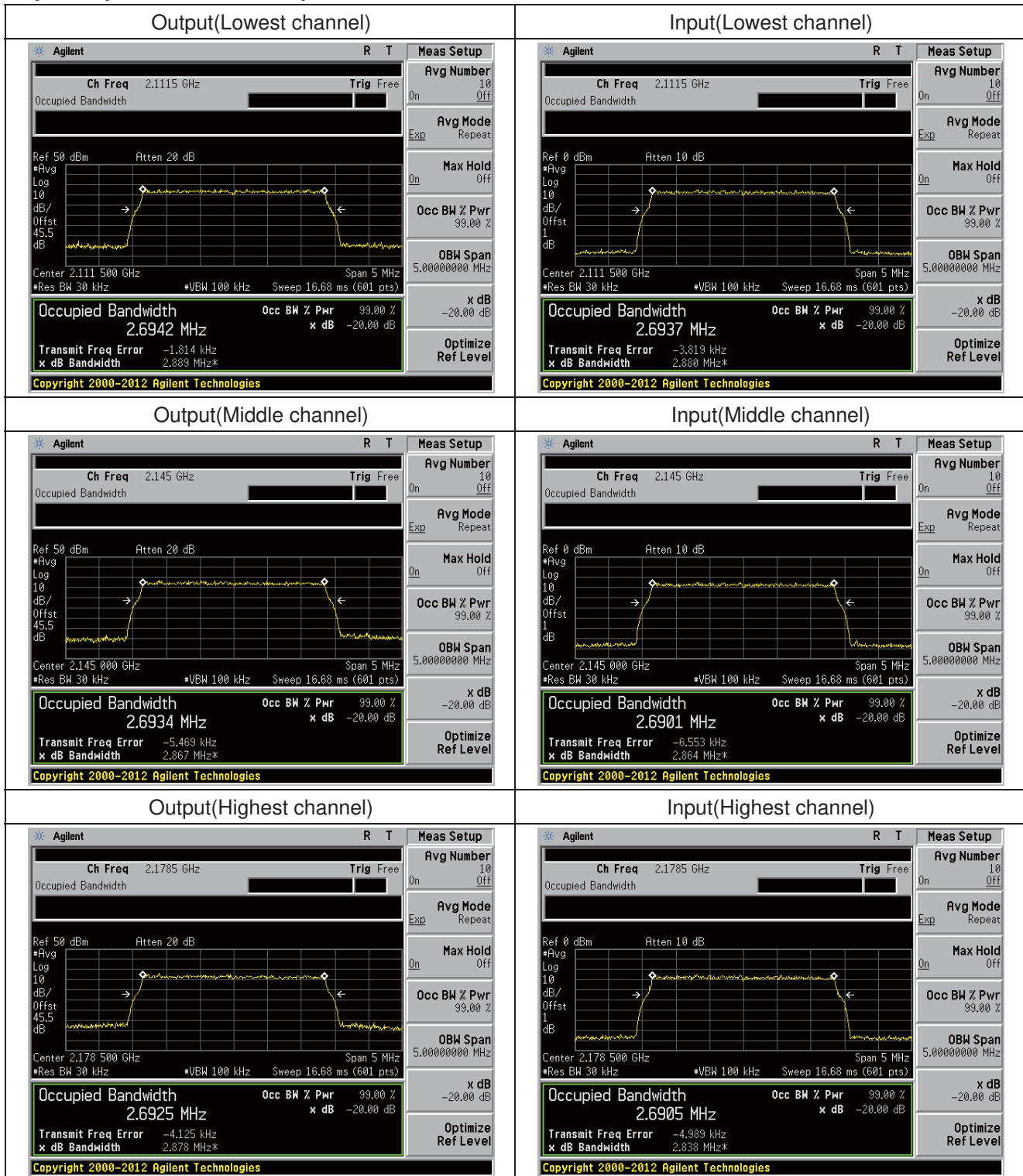

Input/output Bandwidth Comparison for LTE 5MHz Bandwidth

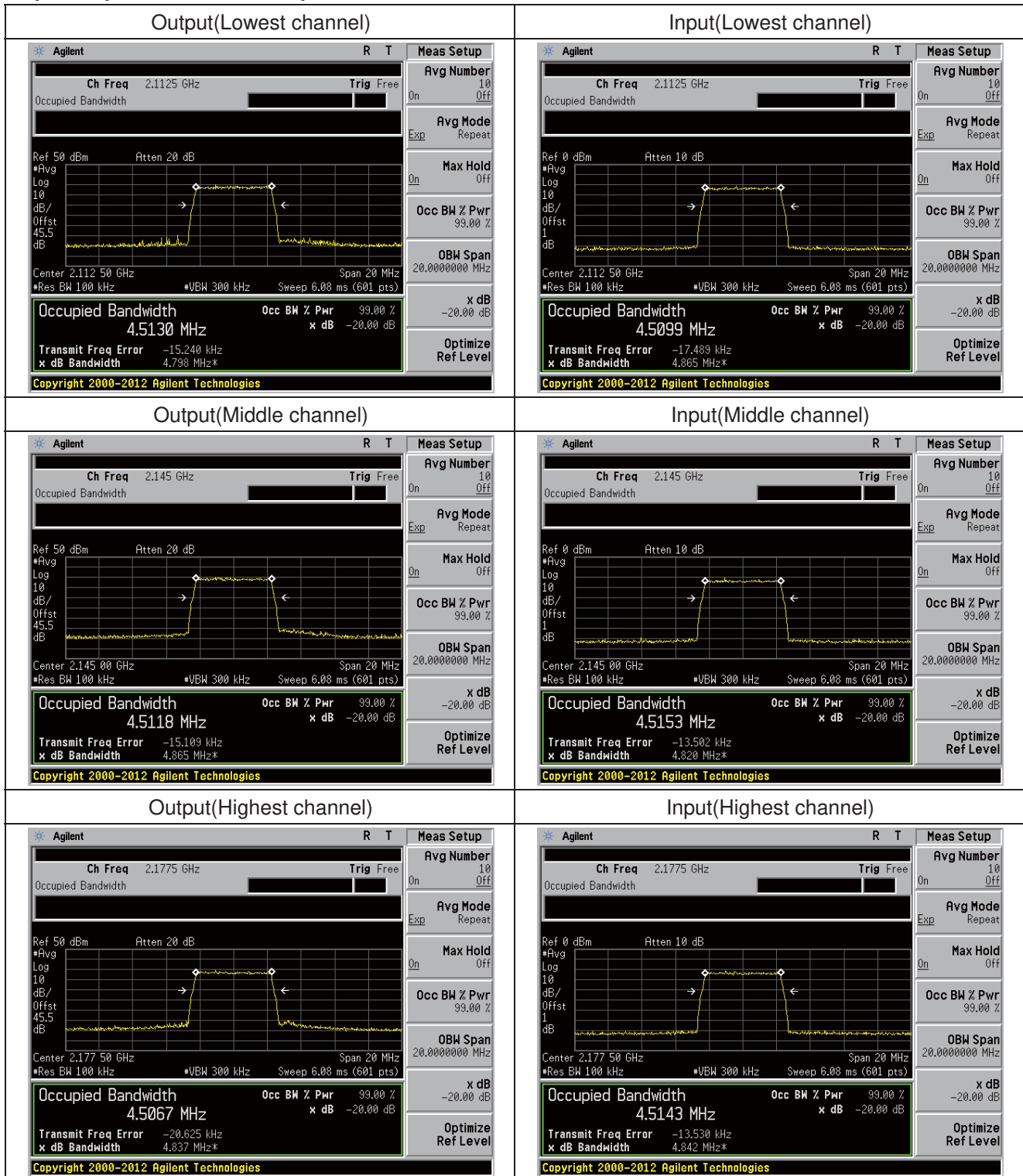

Input/output Bandwidth Comparison for LTE 10MHz Bandwidth

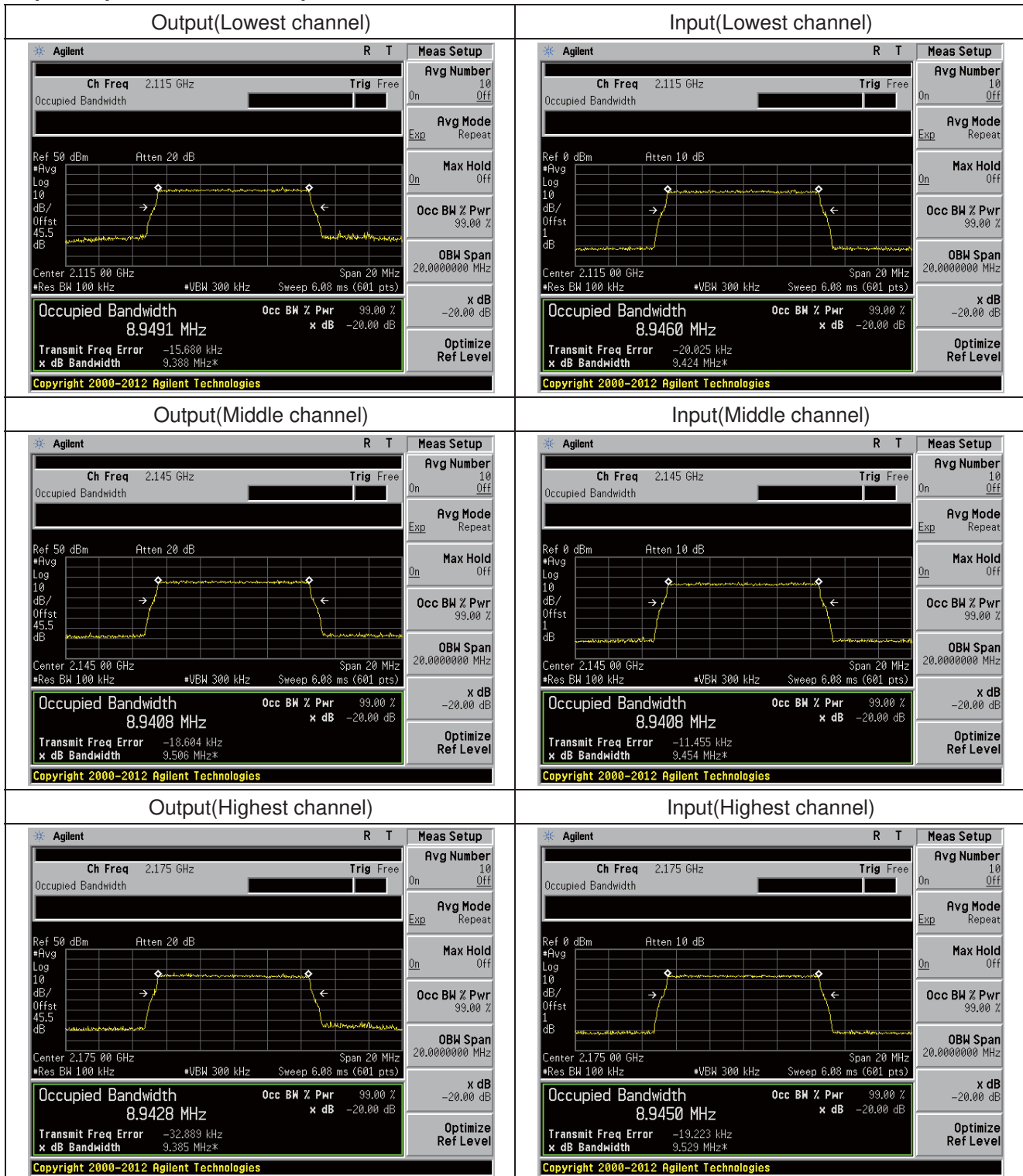

Input/output Bandwidth Comparison for LTE 15MHz Bandwidth

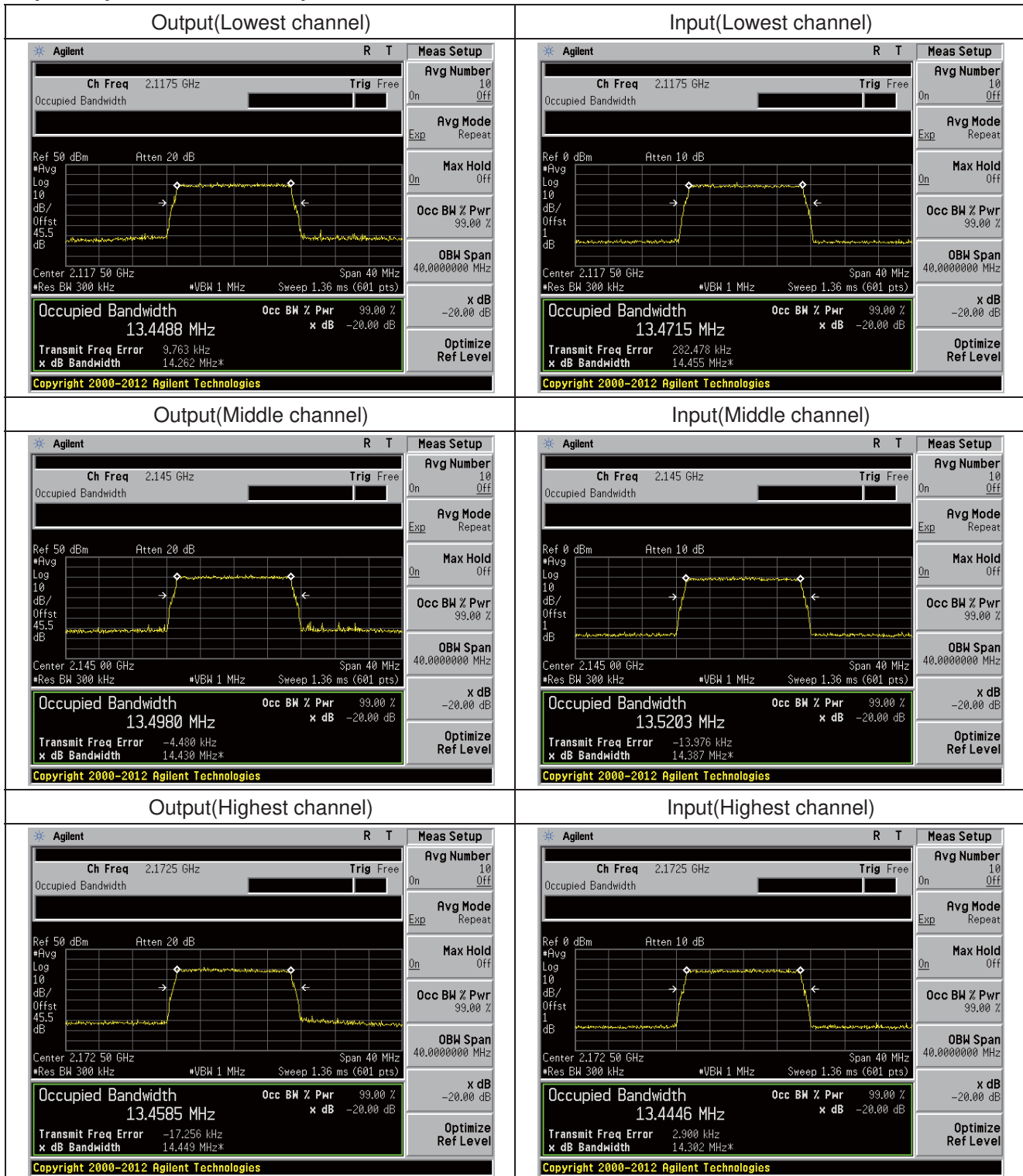

Input/output Bandwidth Comparison for LTE 20MHz Bandwidth

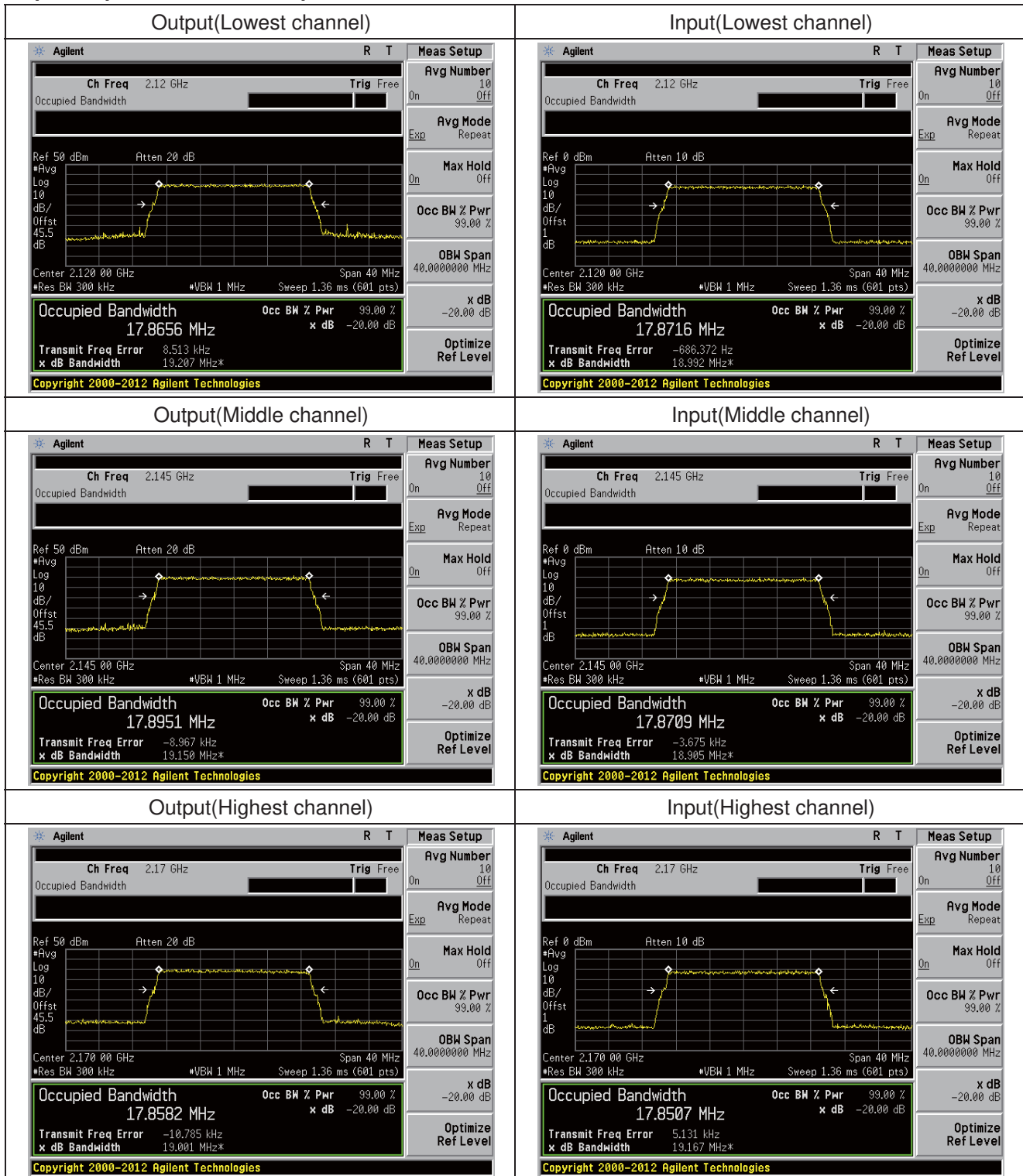

Input/output Bandwidth Comparison for WCDMA Single Carrier

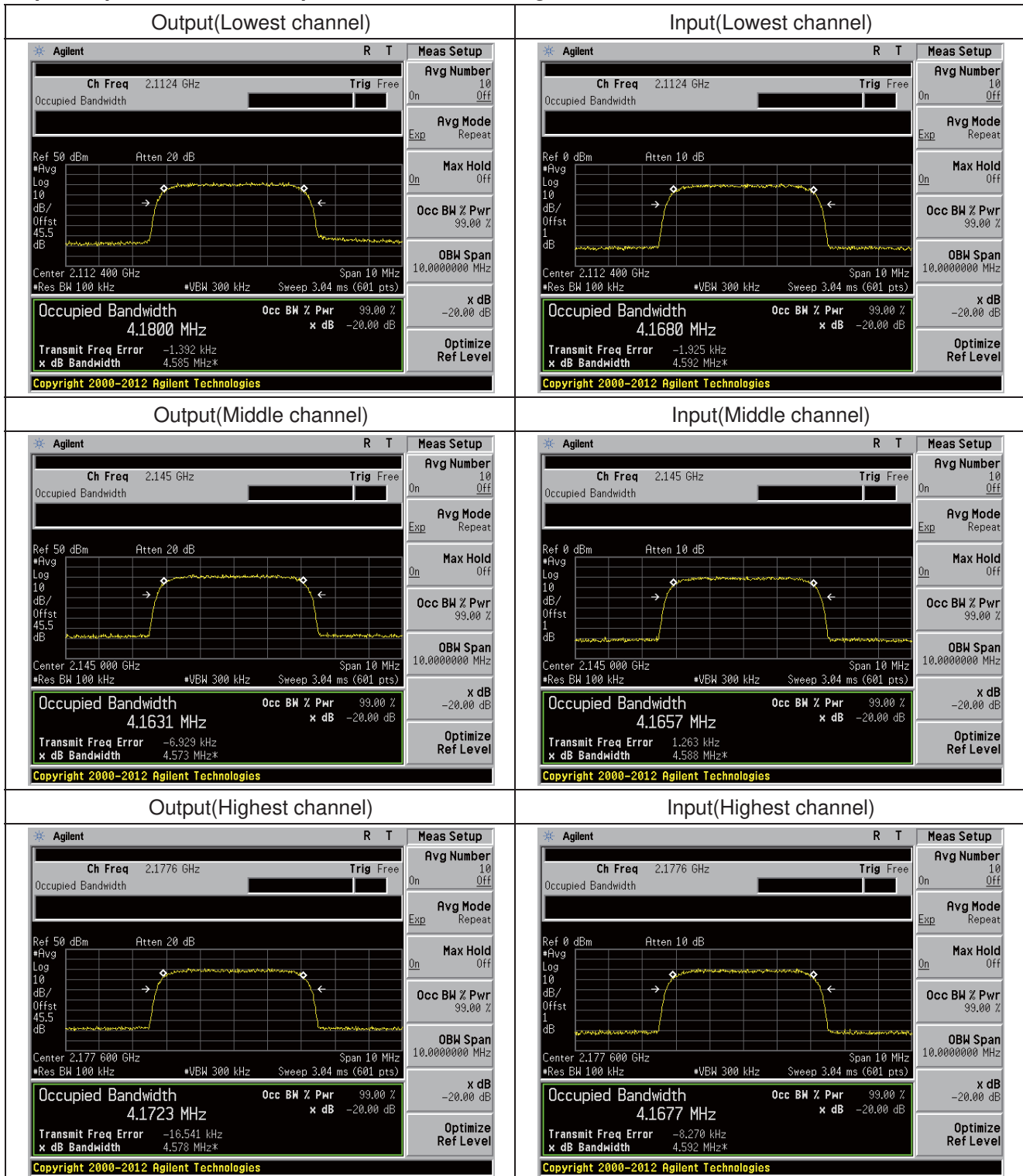

Input/output Bandwidth Comparison for WCDMA Four Carrier

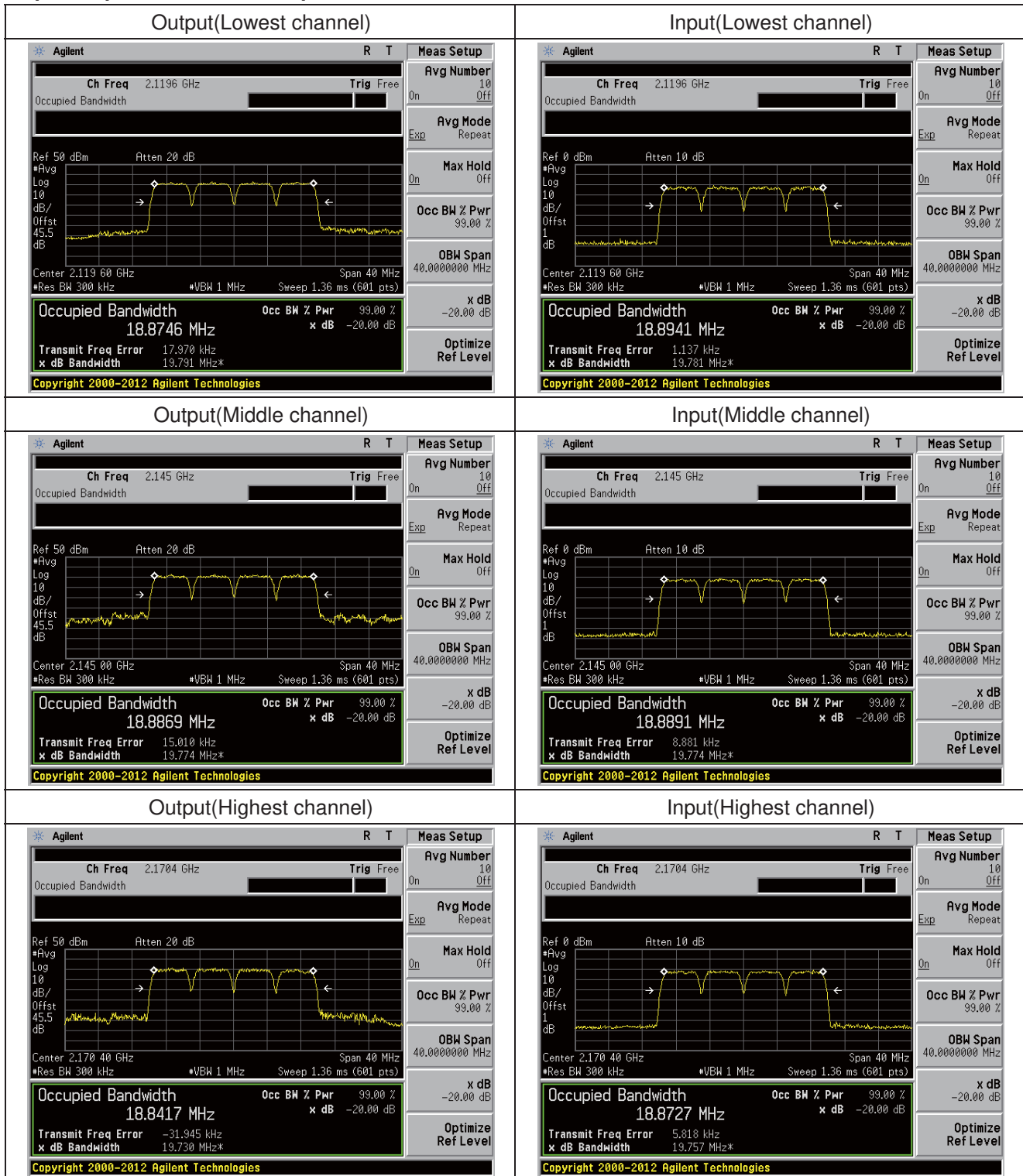

Uplink:

Input/output Bandwidth Comparison for LTE 1.4MHz Bandwidth

Output(Lowest channel)	Input(Lowest channel)
<p>Agilent R T Meas Setup</p> <p>Ch Freq 1.7107 GHz Trig Free</p> <p>Occupied Bandwidth</p> <p>Ref 20 dBm Atten 20 dB</p> <p>#Avg Log 10 dB/Offst 15.5 dB</p> <p>Center 1.710 700 GHz Span 5 MHz</p> <p>#Res BW 30 kHz #VBW 100 kHz Sweep 16.68 ms (601 pts)</p> <p>Occupied Bandwidth 1.1056 MHz</p> <p>Occ BW % Pwr 99.00 %</p> <p>x dB -20.00 dB</p> <p>Transmit Freq Error -2.236 kHz</p> <p>x dB Bandwidth 1.245 MHz*</p> <p>Copyright 2000-2012 Agilent Technologies</p>	<p>Agilent R T Meas Setup</p> <p>Ch Freq 1.7107 GHz Trig Free</p> <p>Occupied Bandwidth</p> <p>Ref -20 dBm #Atten 0 dB</p> <p>#Avg Log 10 dB/Offst 1 dB</p> <p>Center 1.710 700 GHz Span 5 MHz</p> <p>#Res BW 30 kHz #VBW 100 kHz Sweep 16.68 ms (601 pts)</p> <p>Occupied Bandwidth 1.1066 MHz</p> <p>Occ BW % Pwr 99.00 %</p> <p>x dB -20.00 dB</p> <p>Transmit Freq Error -2.206 kHz</p> <p>x dB Bandwidth 1.205 MHz*</p> <p>Copyright 2000-2012 Agilent Technologies</p>
Output(Middle channel)	Input(Middle channel)
<p>Agilent R T Meas Setup</p> <p>Ch Freq 1.745 GHz Trig Free</p> <p>Occupied Bandwidth</p> <p>Ref 20 dBm Atten 20 dB</p> <p>#Avg Log 10 dB/Offst 15.5 dB</p> <p>Center 1.745 000 GHz Span 5 MHz</p> <p>#Res BW 30 kHz #VBW 100 kHz Sweep 16.68 ms (601 pts)</p> <p>Occupied Bandwidth 1.1051 MHz</p> <p>Occ BW % Pwr 99.00 %</p> <p>x dB -20.00 dB</p> <p>Transmit Freq Error -5.869 kHz</p> <p>x dB Bandwidth 1.257 MHz*</p> <p>Copyright 2000-2012 Agilent Technologies</p>	<p>Agilent R T Meas Setup</p> <p>Ch Freq 1.745 GHz Trig Free</p> <p>Occupied Bandwidth</p> <p>Ref -20 dBm #Atten 0 dB</p> <p>#Avg Log 10 dB/Offst 1 dB</p> <p>Center 1.745 000 GHz Span 5 MHz</p> <p>#Res BW 30 kHz #VBW 100 kHz Sweep 16.68 ms (601 pts)</p> <p>Occupied Bandwidth 1.1061 MHz</p> <p>Occ BW % Pwr 99.00 %</p> <p>x dB -20.00 dB</p> <p>Transmit Freq Error -5.069 kHz</p> <p>x dB Bandwidth 1.250 MHz*</p> <p>Copyright 2000-2012 Agilent Technologies</p>
Output(Highest channel)	Input(Highest channel)
<p>Agilent R T Meas Setup</p> <p>Ch Freq 1.7793 GHz Trig Free</p> <p>Occupied Bandwidth</p> <p>Ref 20 dBm Atten 20 dB</p> <p>#Avg Log 10 dB/Offst 15.5 dB</p> <p>Center 1.779 300 GHz Span 5 MHz</p> <p>#Res BW 30 kHz #VBW 100 kHz Sweep 16.68 ms (601 pts)</p> <p>Occupied Bandwidth 1.1103 MHz</p> <p>Occ BW % Pwr 99.00 %</p> <p>x dB -20.00 dB</p> <p>Transmit Freq Error -6.070 kHz</p> <p>x dB Bandwidth 1.238 MHz*</p> <p>Copyright 2000-2012 Agilent Technologies</p>	<p>Agilent R T Meas Setup</p> <p>Ch Freq 1.7793 GHz Trig Free</p> <p>Occupied Bandwidth</p> <p>Ref -20 dBm #Atten 0 dB</p> <p>#Avg Log 10 dB/Offst 1 dB</p> <p>Center 1.779 300 GHz Span 5 MHz</p> <p>#Res BW 30 kHz #VBW 100 kHz Sweep 16.68 ms (601 pts)</p> <p>Occupied Bandwidth 1.1106 MHz</p> <p>Occ BW % Pwr 99.00 %</p> <p>x dB -20.00 dB</p> <p>Transmit Freq Error -6.072 kHz</p> <p>x dB Bandwidth 1.200 MHz*</p> <p>Copyright 2000-2012 Agilent Technologies</p>

Input/output Bandwidth Comparison for LTE 3MHz Bandwidth

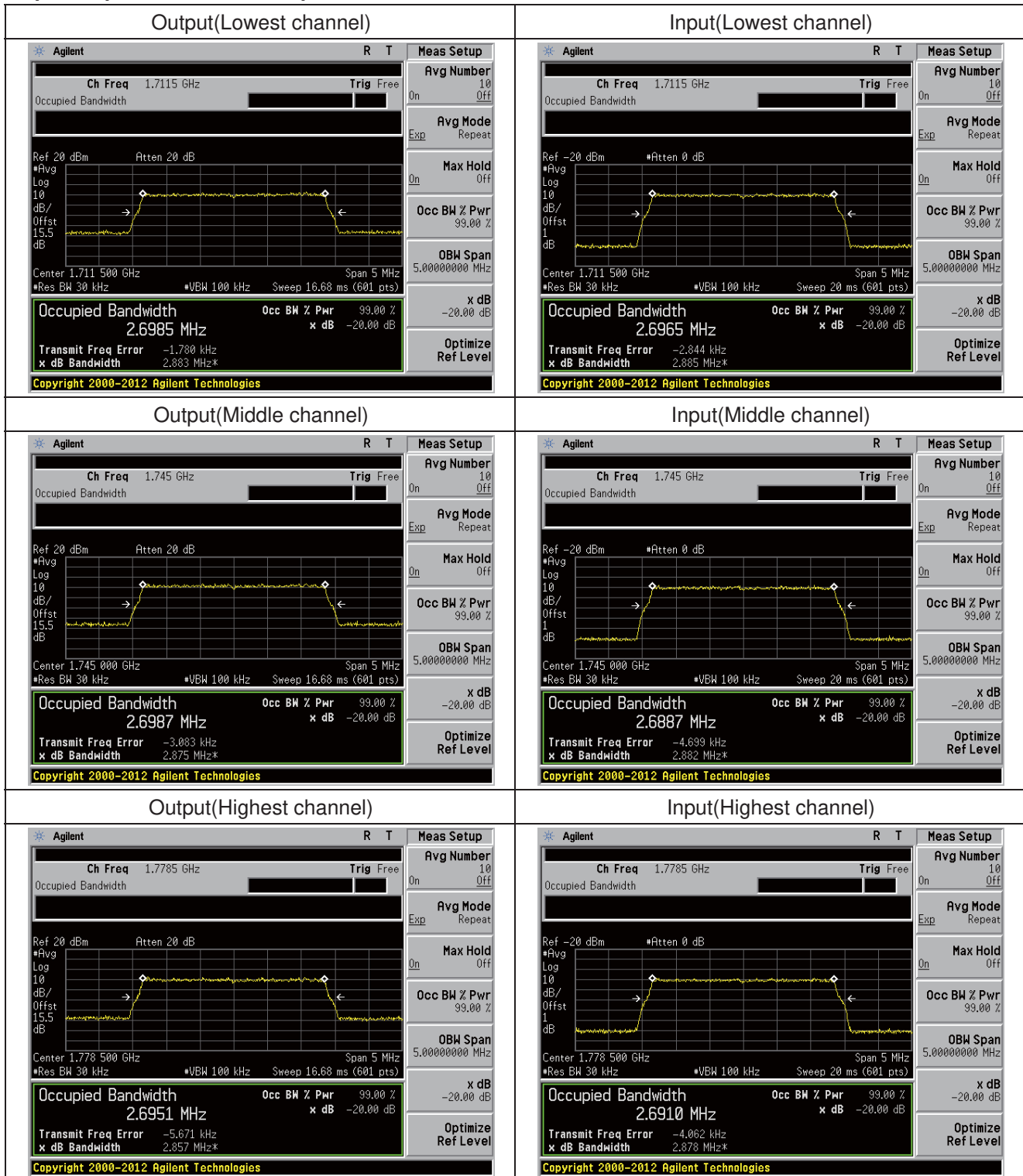

Input/output Bandwidth Comparison for LTE 5MHz Bandwidth

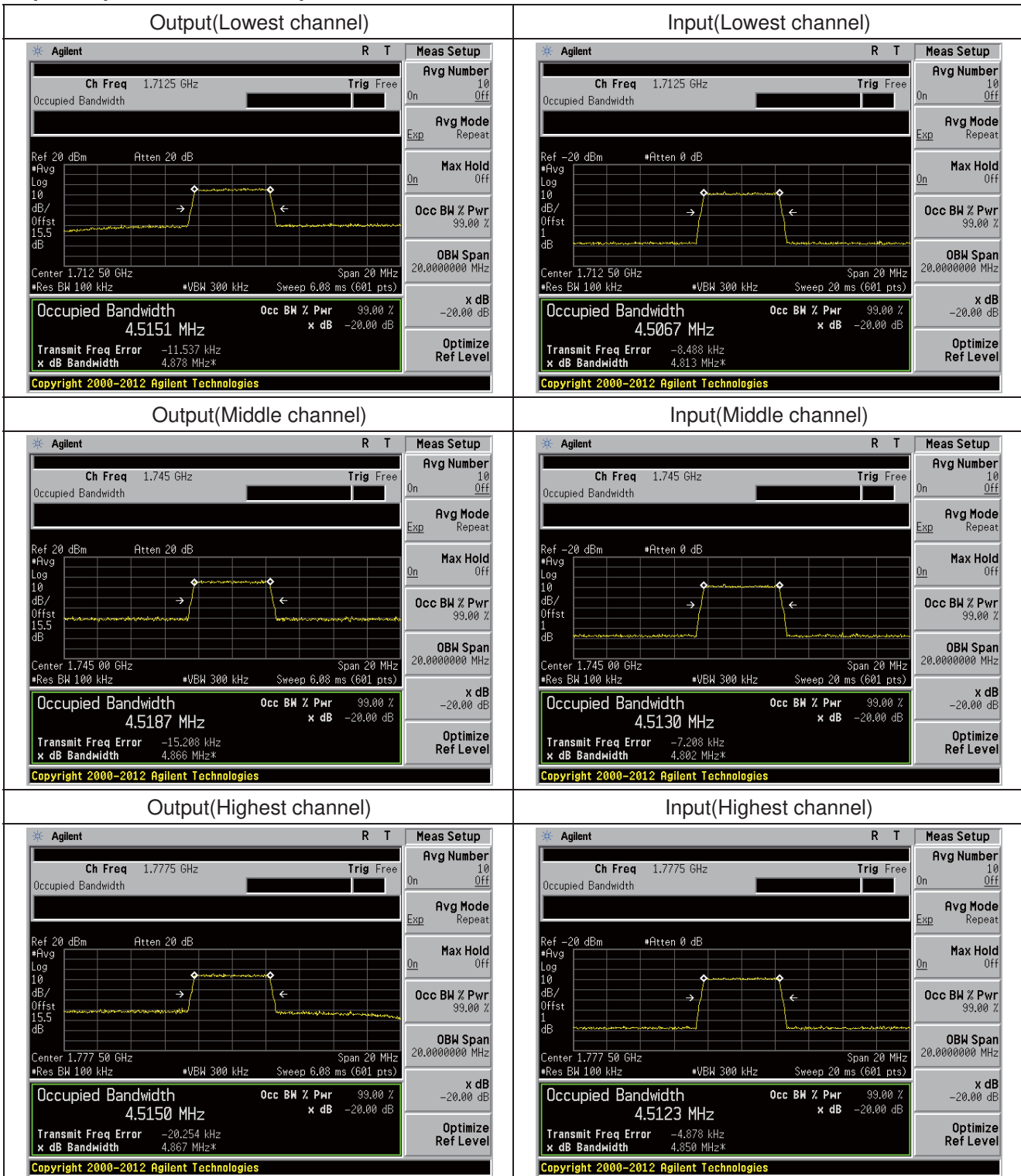

Input/output Bandwidth Comparison for LTE 10MHz Bandwidth

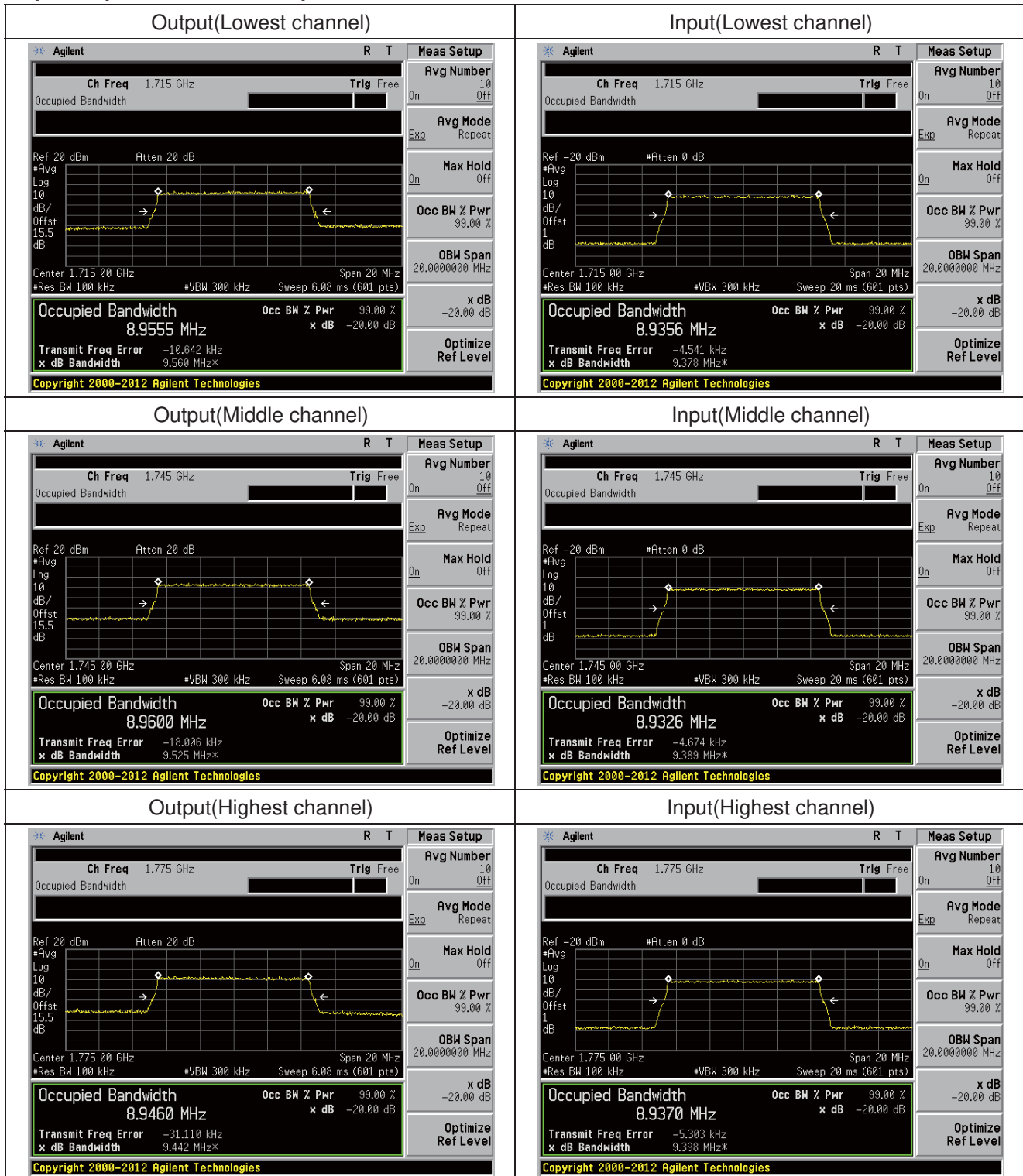

Input/output Bandwidth Comparison for LTE 15MHz Bandwidth

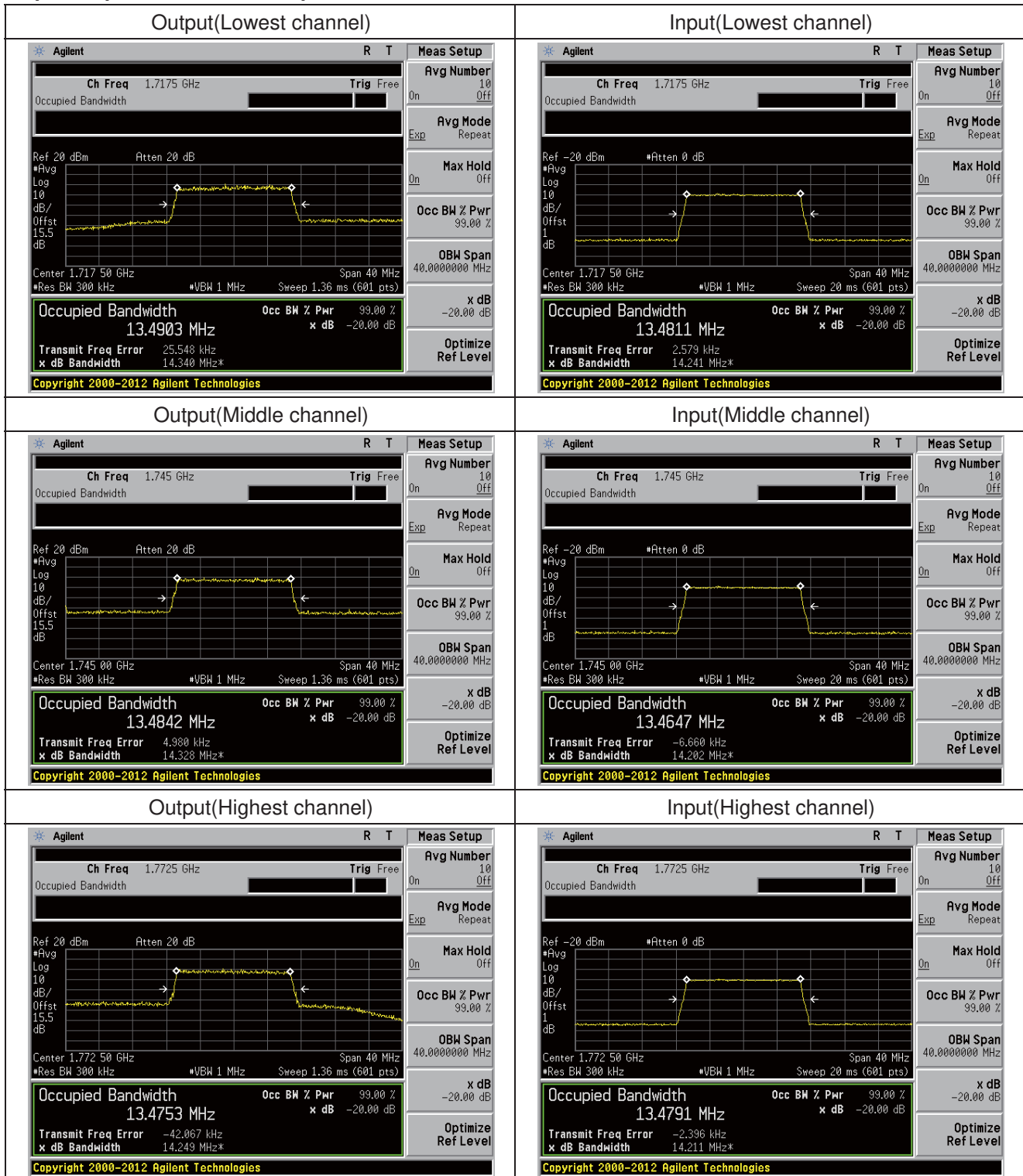

Input/output Bandwidth Comparison for LTE 20MHz Bandwidth

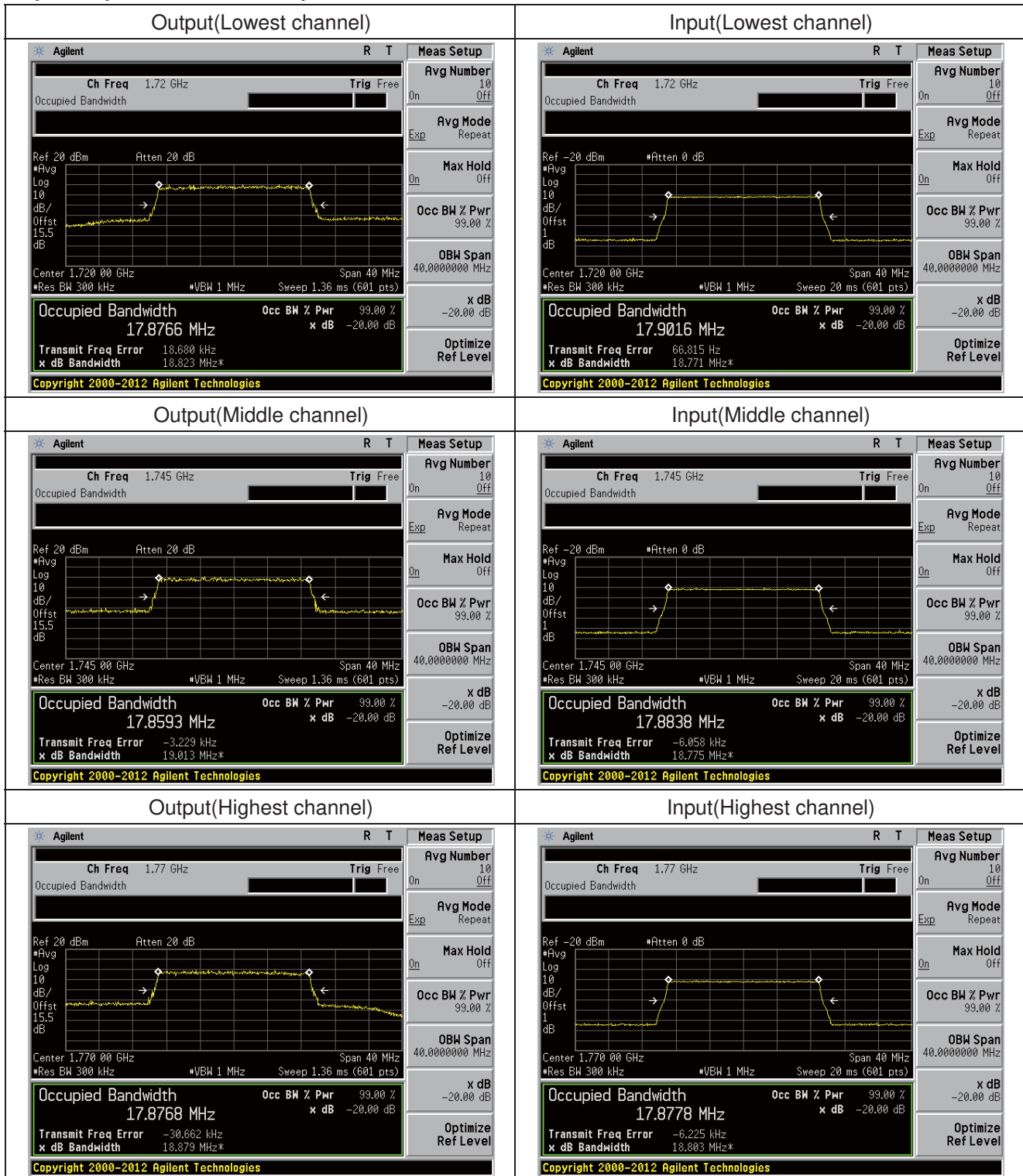

Input/output Bandwidth Comparison for WCDMA Single Carrier

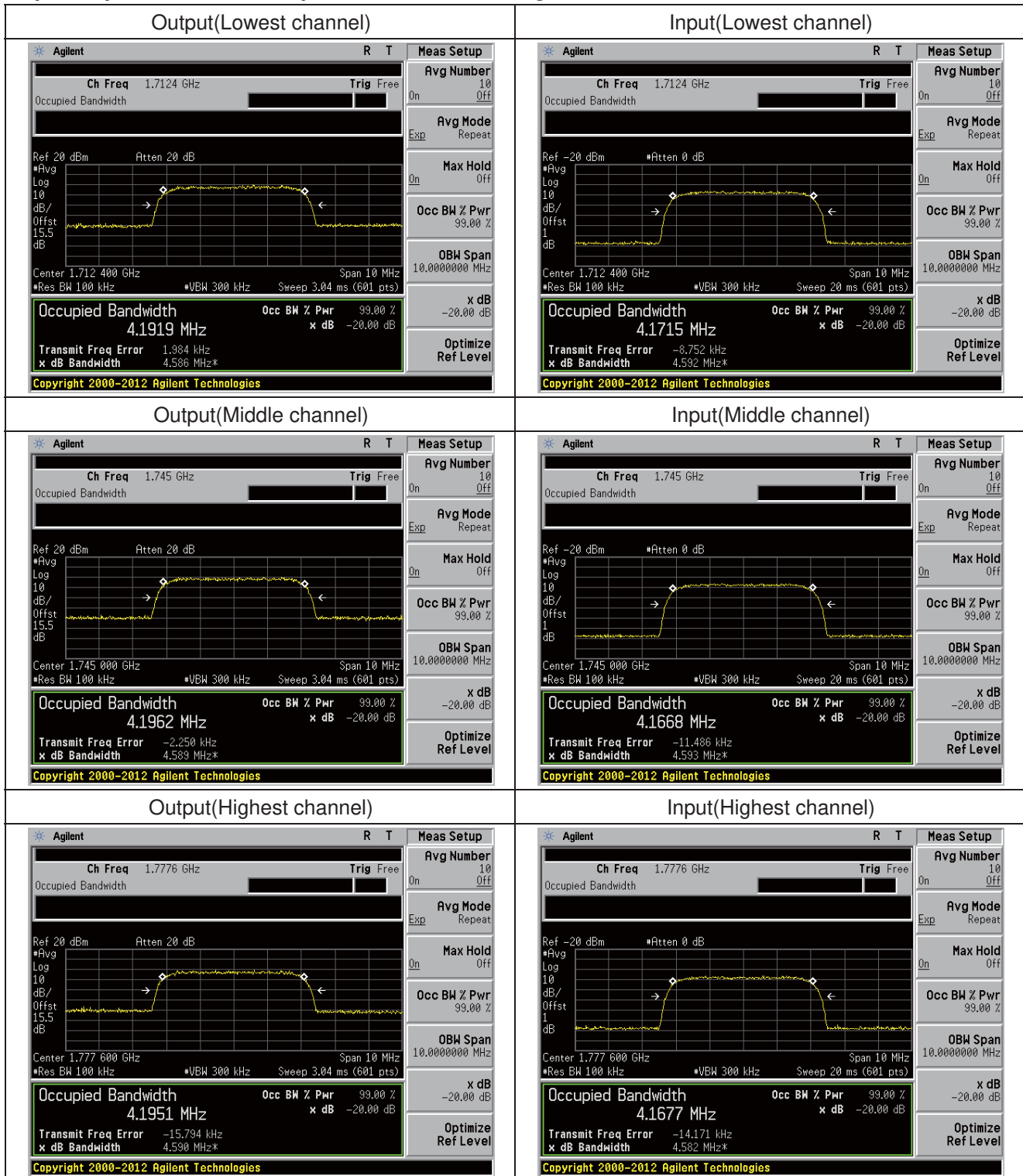

Input/output Bandwidth Comparison for WCDMA Four Carrier

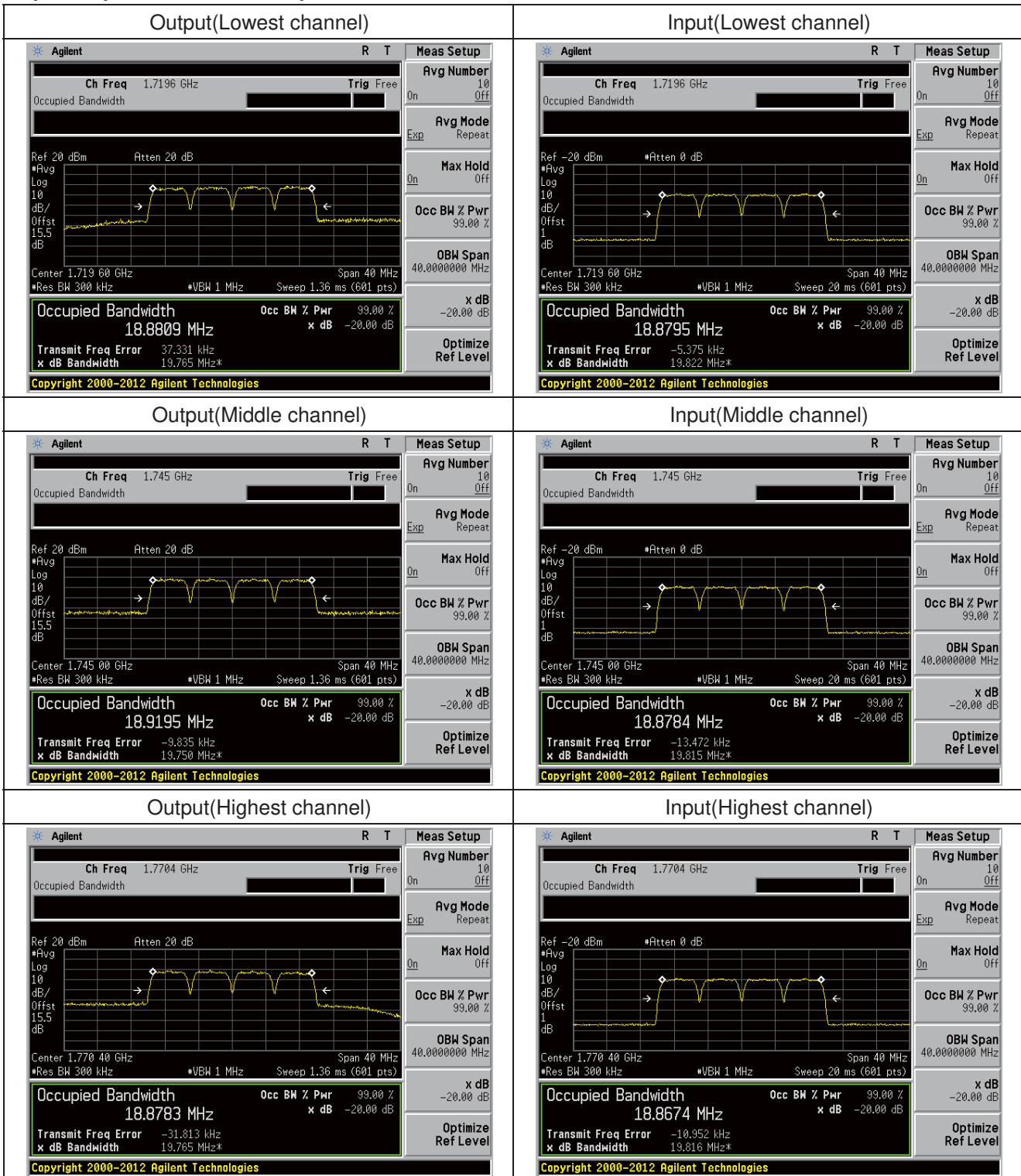

10 OUT OF BAND EMISSION AT ANTENNA TERMINALS

10.1 Standard Applicable

According to FCC § 2.1051 and § 27.53(m)

10.2 Test setup

Please refer the section §6.2 Configuration of Tested System.

10.3 Measurement Procedure

The out of band emissions were measured directly from the EUT antenna output with a spectrum analyzer from 30 MHz to the 10th harmonic of the highest carrier frequency. Test signals used is LTE and WCDMA. The different signals were input one at a time to the EUT. Tests was performed with LTE and WCDMA signal input.

Band edge compliance is also demonstrated using a LTE and WCDMA signal at the upper and lower limits of the band.

1. The EUT RF output port was connected to spectrum analyzer.
2. The level of RF input signal shall be increased, until the maximum output power per channel, declared by client, is reached.
3. The spurious emissions at antenna were measured at the RF output port of the EUT at middle channel of each type of modulation.

Spectrum analyzer settings:

Detector: RMS.

> 1 MHz from Band Edge

Below 1G: RBW=100kHz; VBW=300KHz; Above 1G: RBW=1 MHz ; VBW \geq RBW

< 1 MHz from Band Edge

RBW=3 kHz; VBW \geq RBW

10.4 Measurement Result

10.4.1 Spurious emission

Downlink:

Spurious emission of LTE 1.4MHz Bandwidth

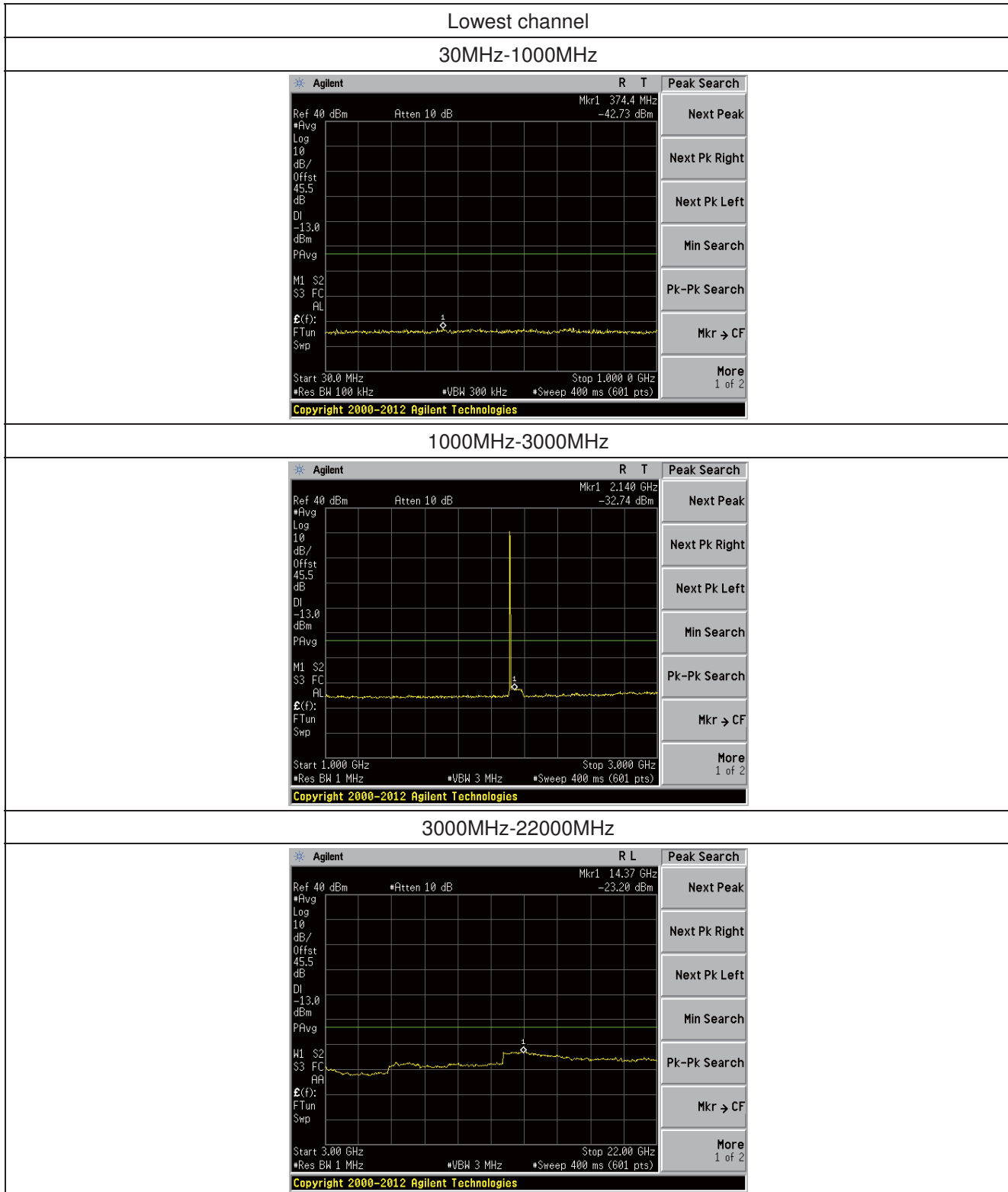

Middle channel

30MHz-1000MHz

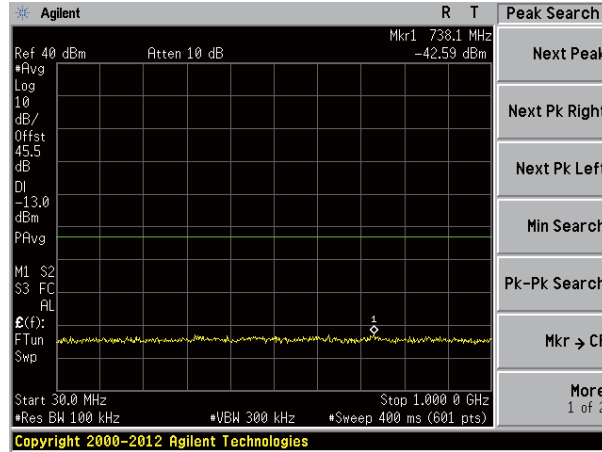

1000MHz-3000MHz

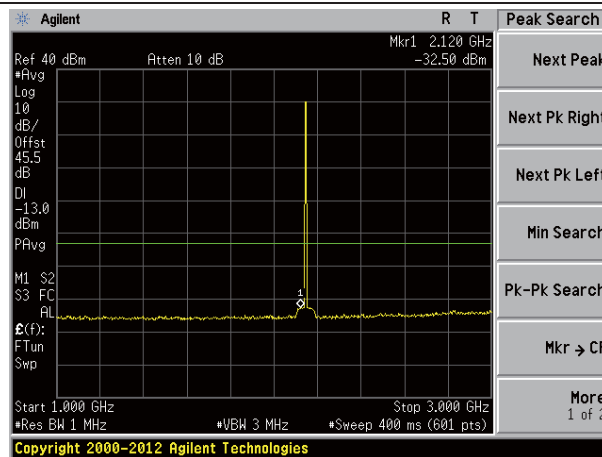

3000MHz-22000MHz

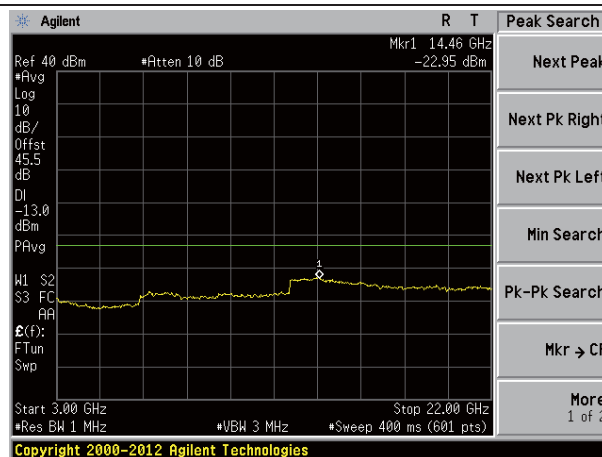

Highest channel

30MHz-1000MHz

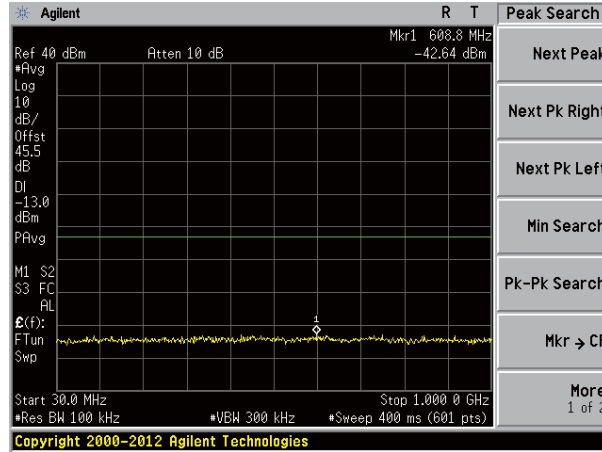

1000MHz-3000MHz

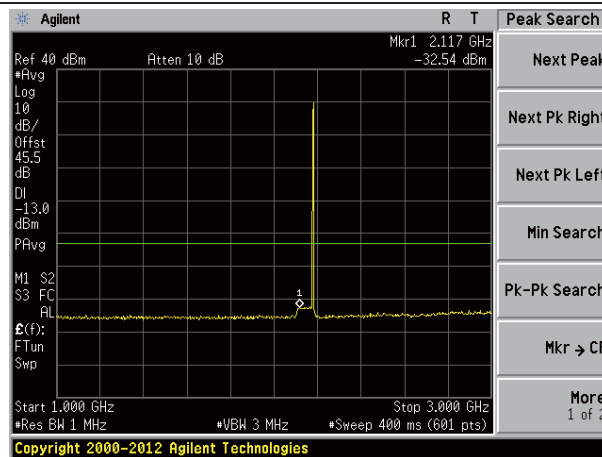

3000MHz-22000MHz

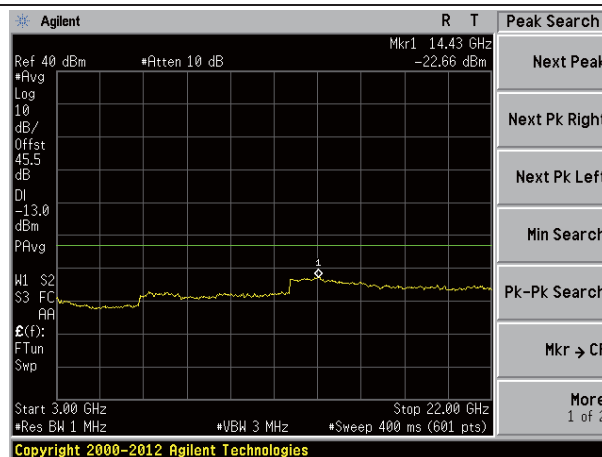

Spurious emission of LTE 3MHz Bandwidth

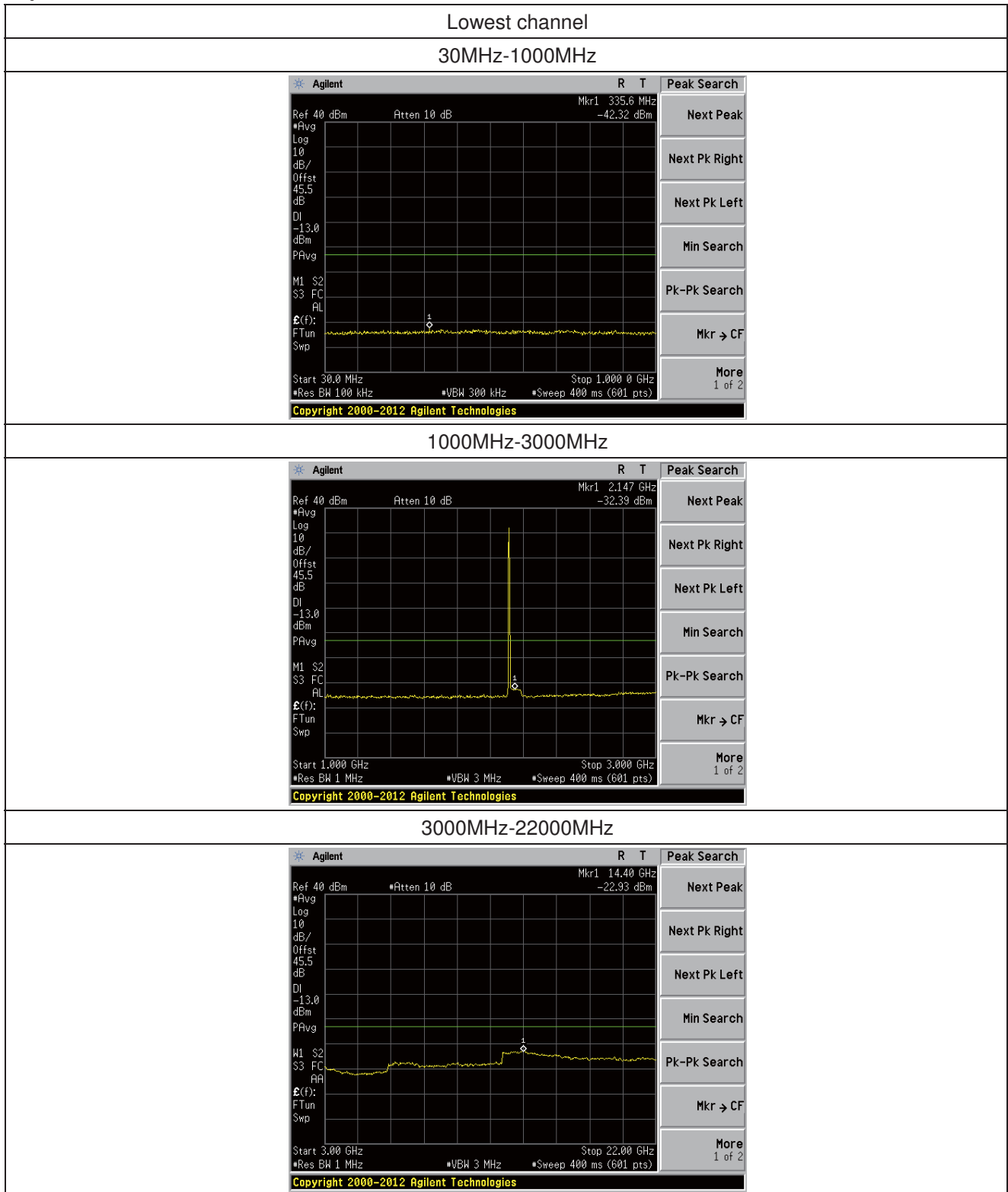

Middle channel

30MHz-1000MHz

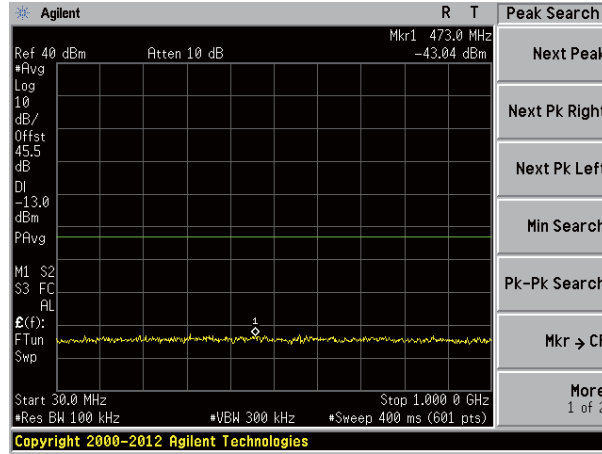

1000MHz-3000MHz

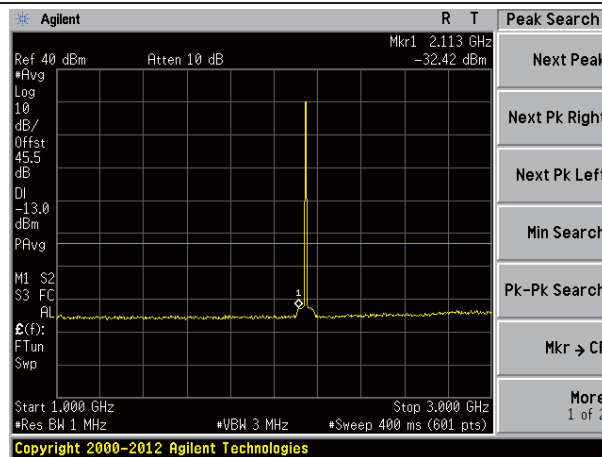

3000MHz-22000MHz

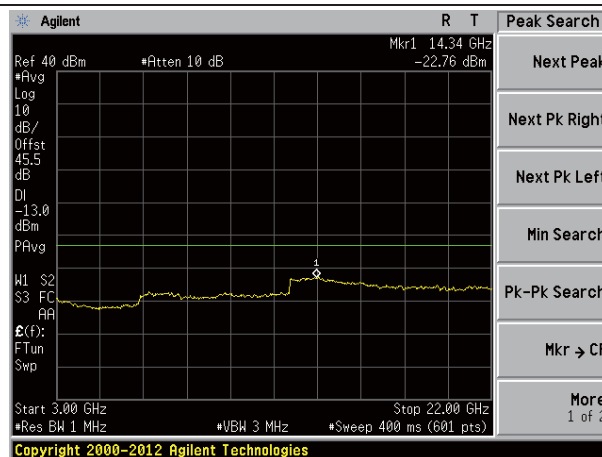

Highest channel

30MHz-1000MHz

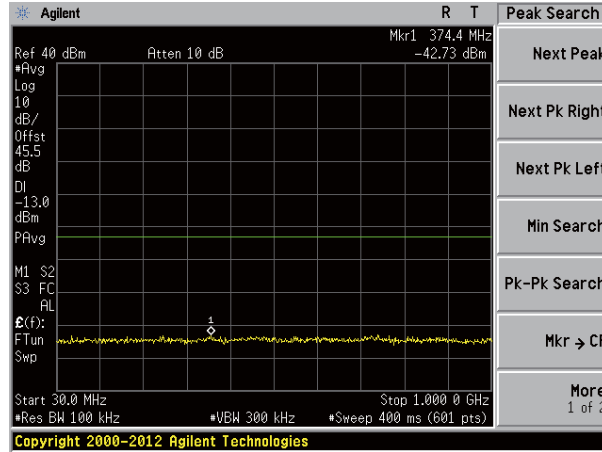

1000MHz-3000MHz

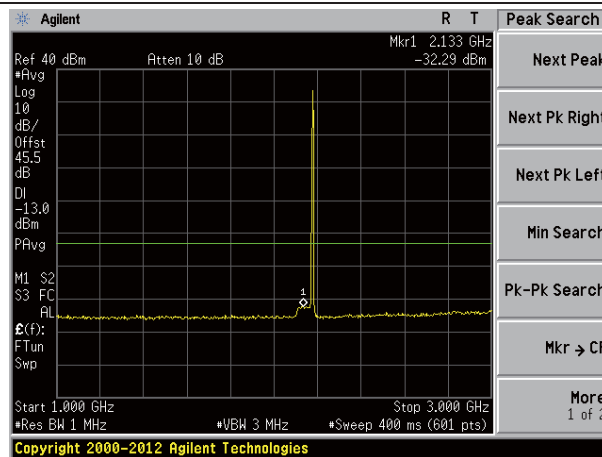

3000MHz-22000MHz

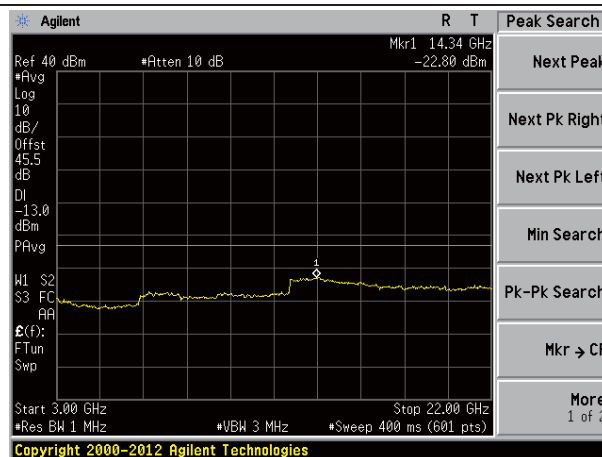

Spurious emission of LTE 5MHz Bandwidth

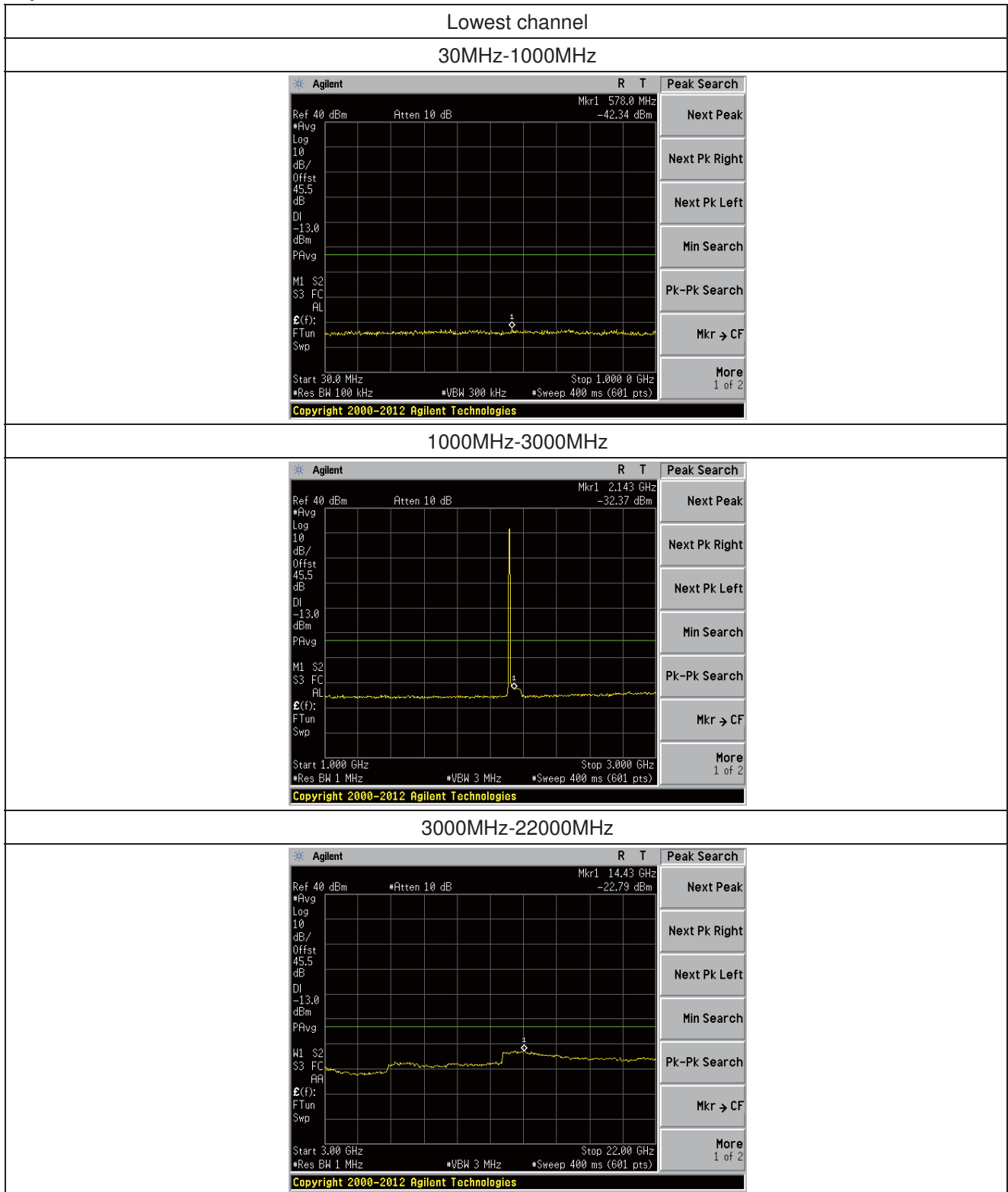

Middle channel

30MHz-1000MHz

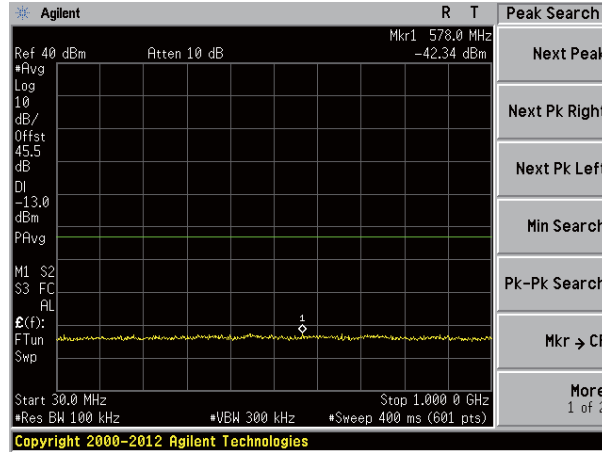

1000MHz-3000MHz

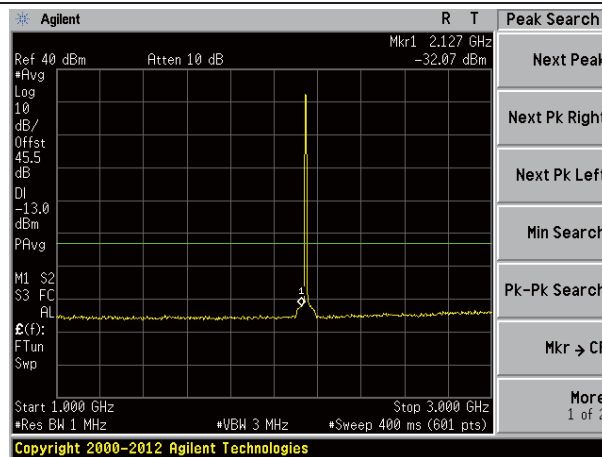

3000MHz-22000MHz

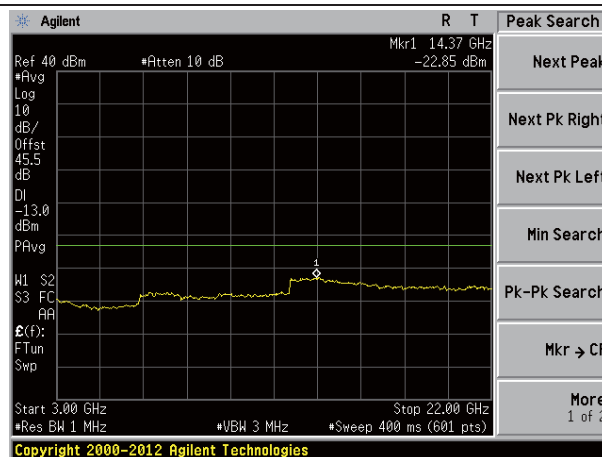

Highest channel

30MHz-1000MHz

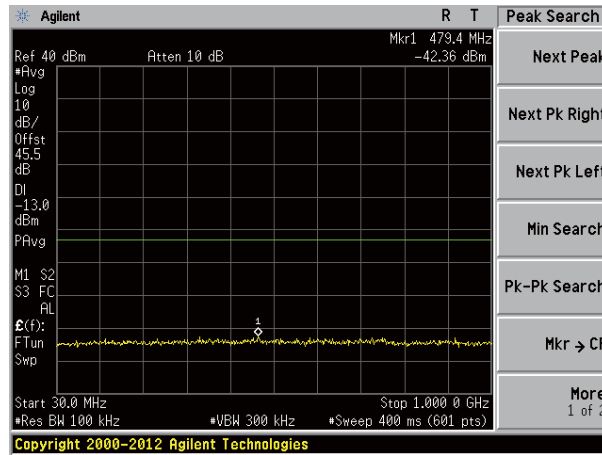

1000MHz-3000MHz

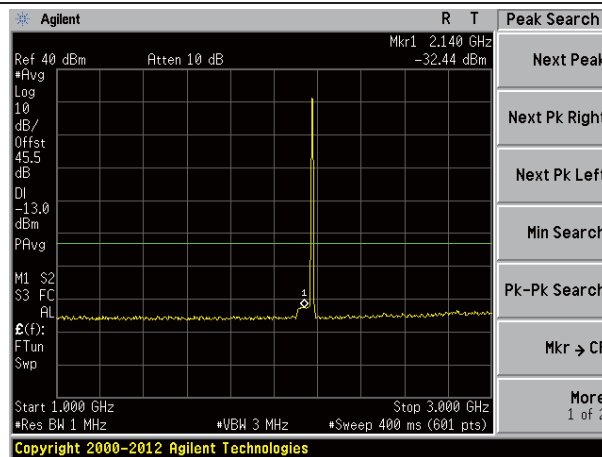

3000MHz-22000MHz

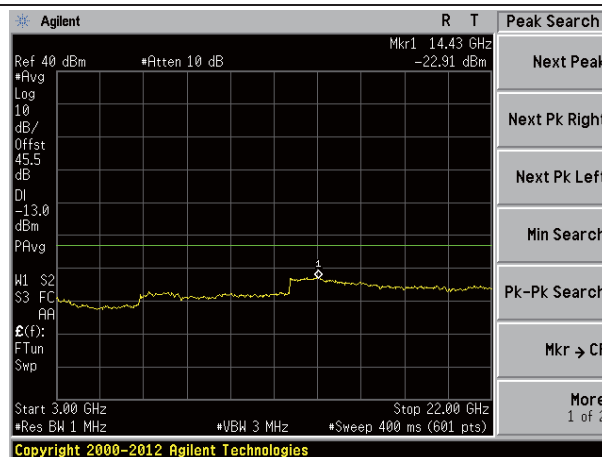

Spurious emission of LTE 10MHz Bandwidth

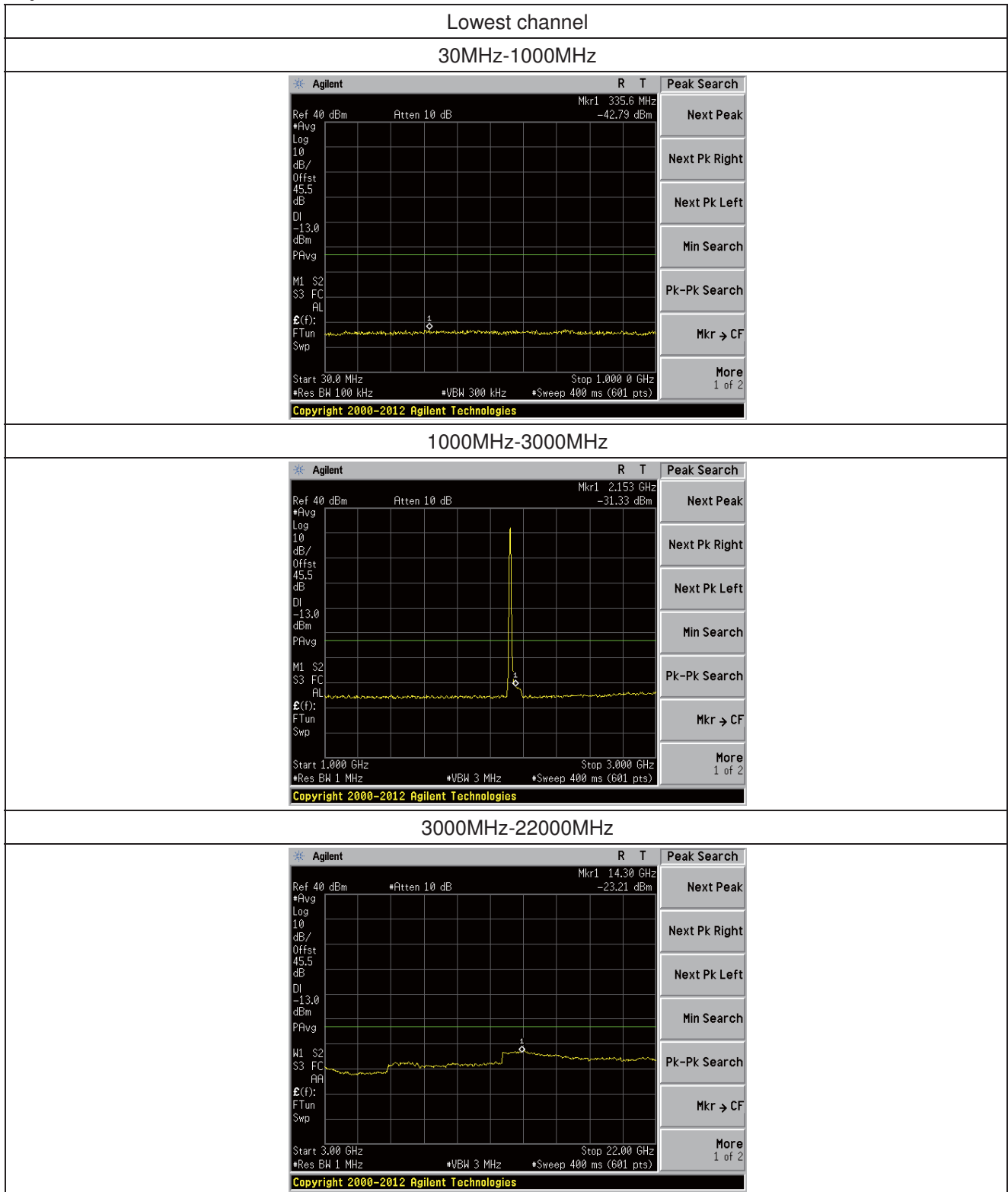

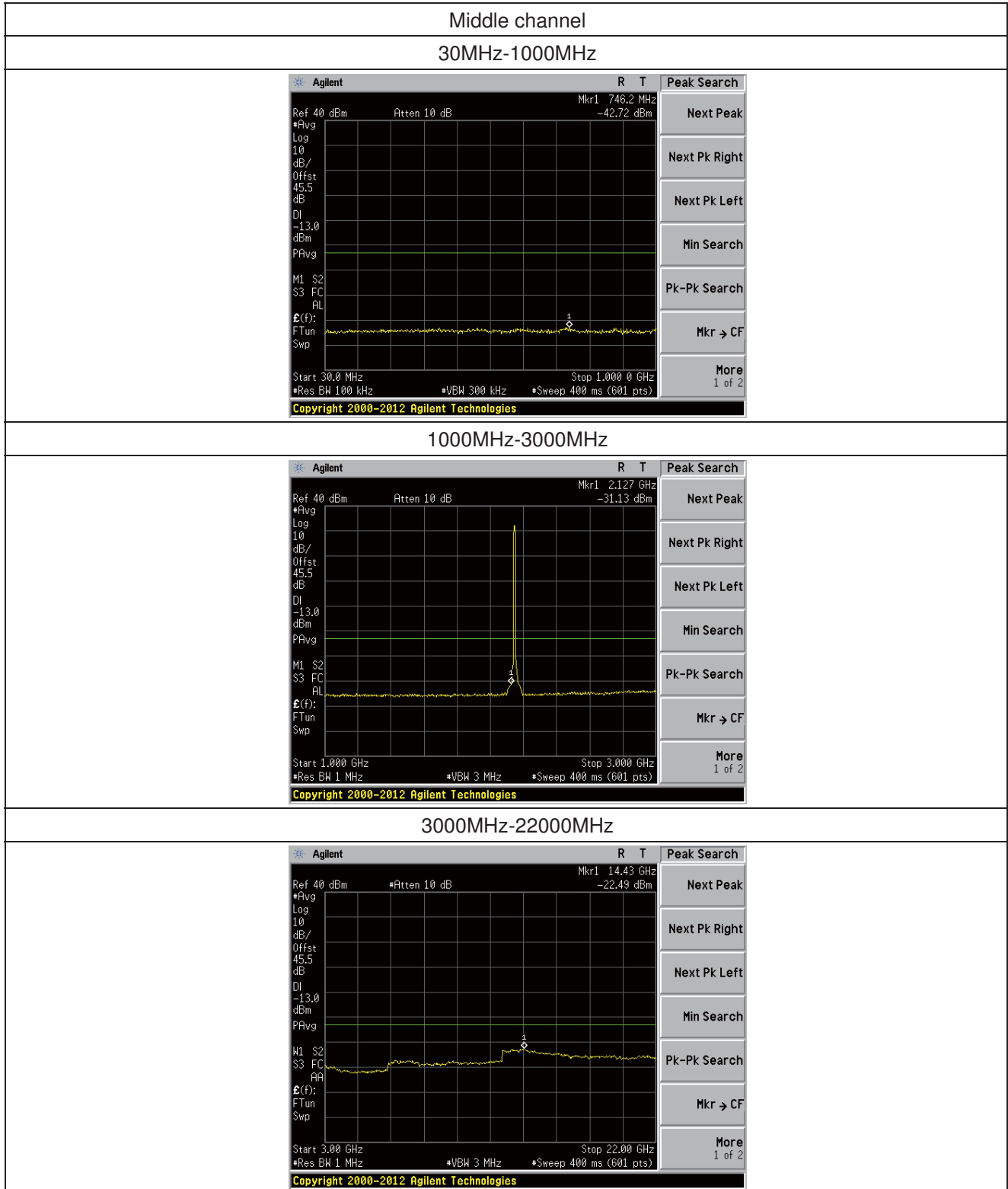

Highest channel

30MHz-1000MHz

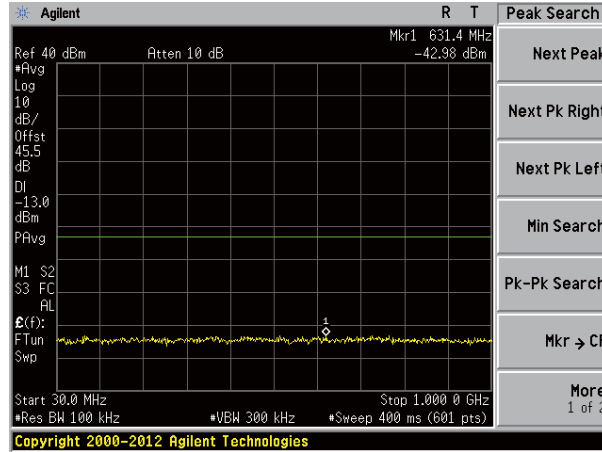

1000MHz-3000MHz

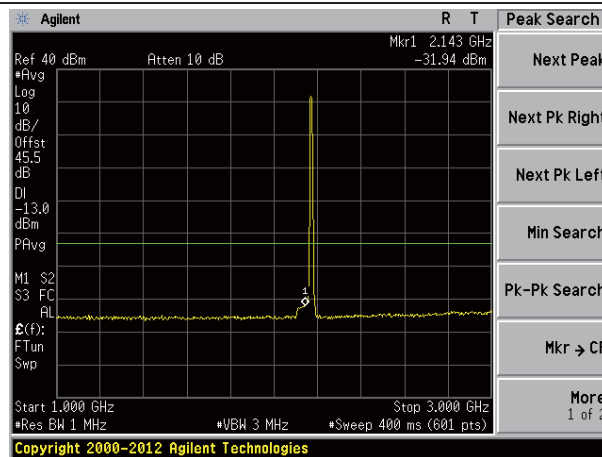

3000MHz-22000MHz

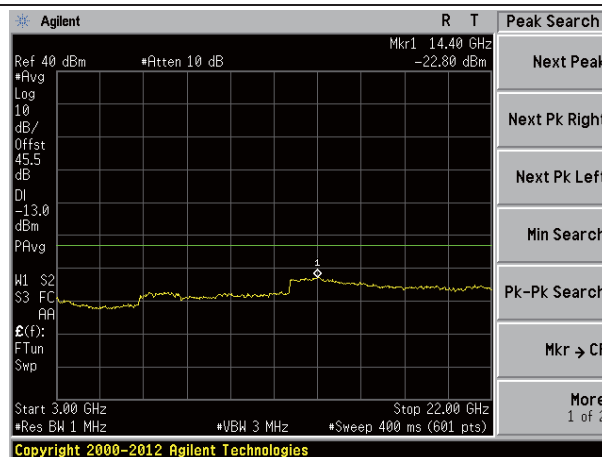

Spurious emission of LTE 15MHz Bandwidth

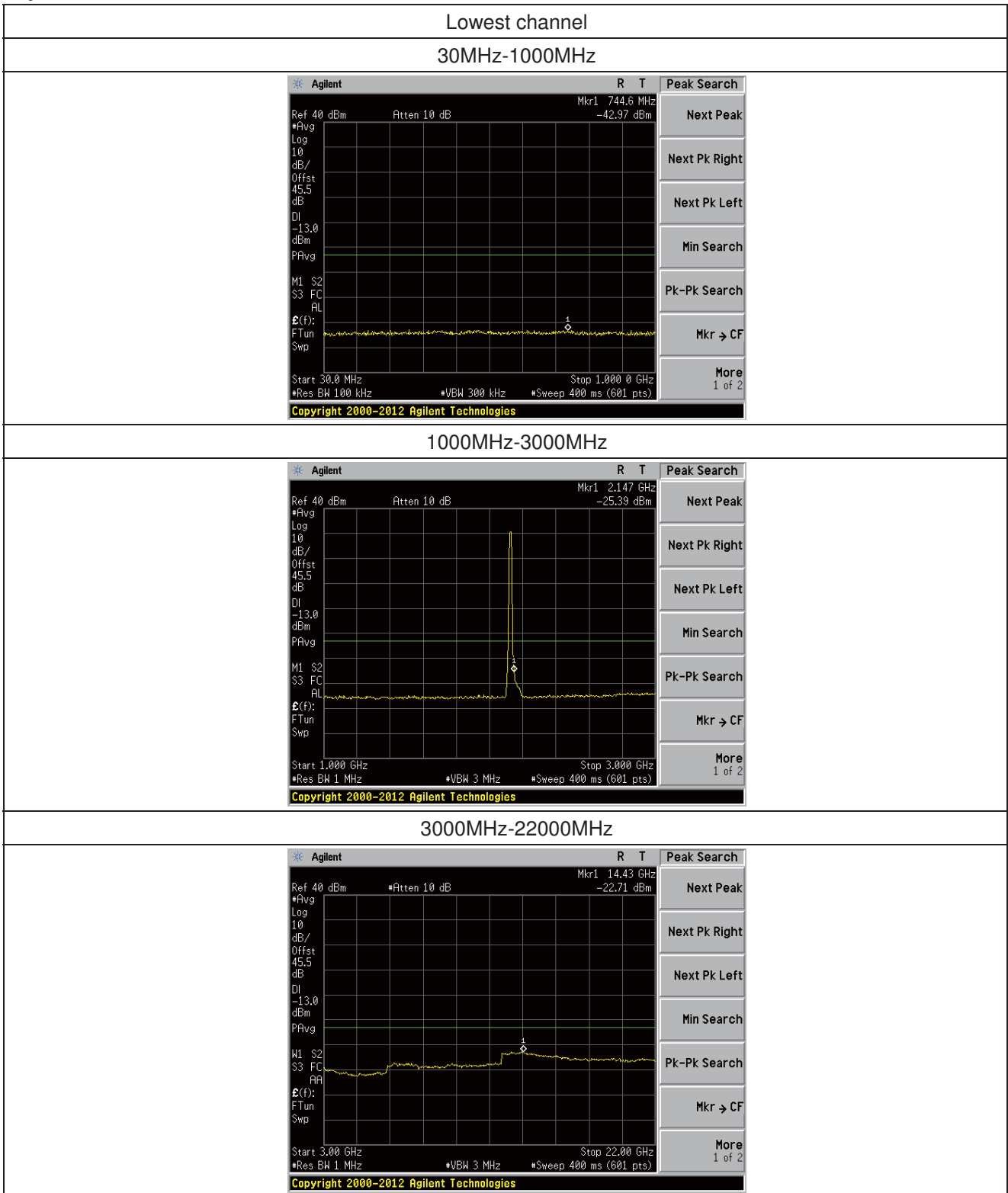

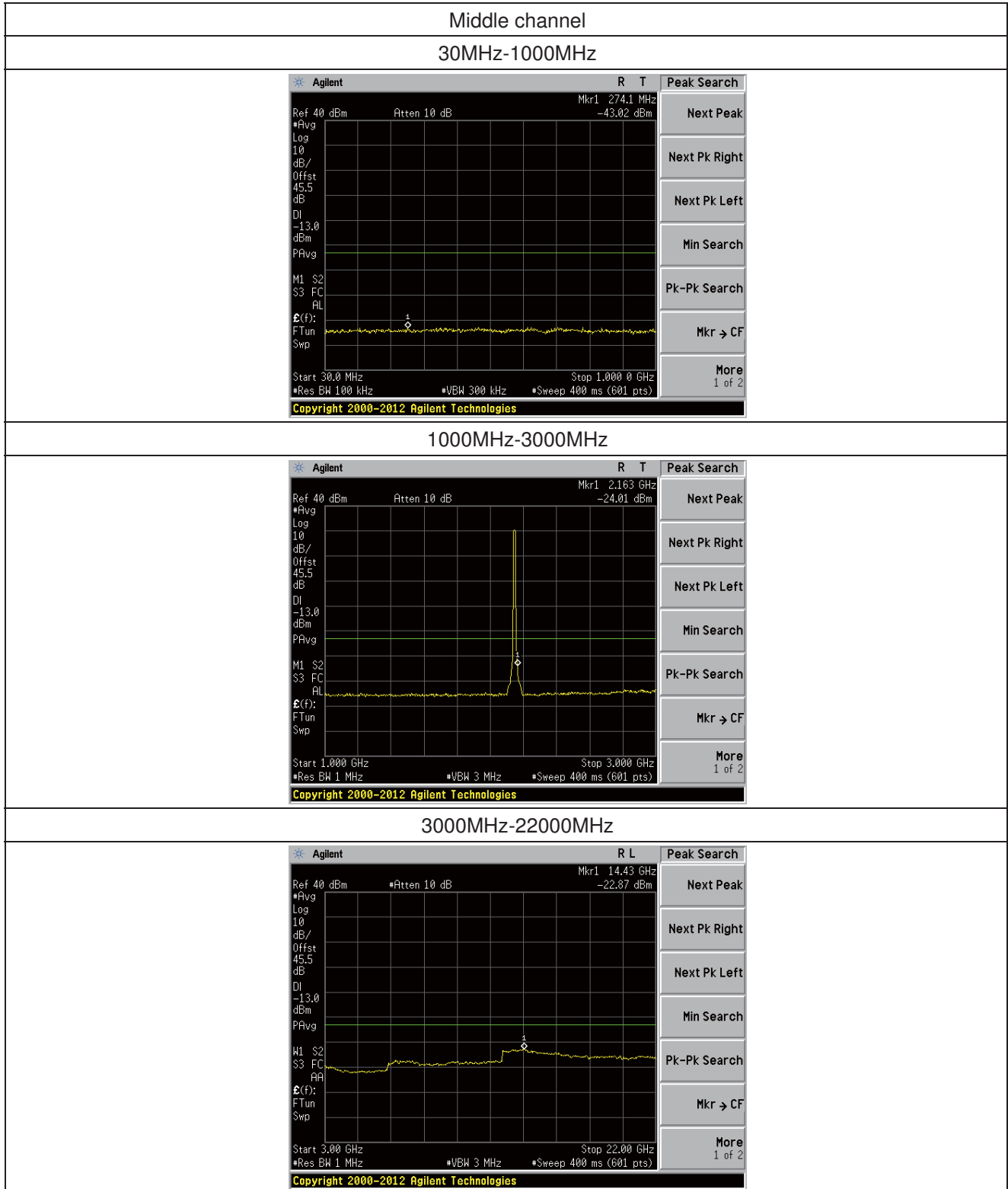

Highest channel

30MHz-1000MHz

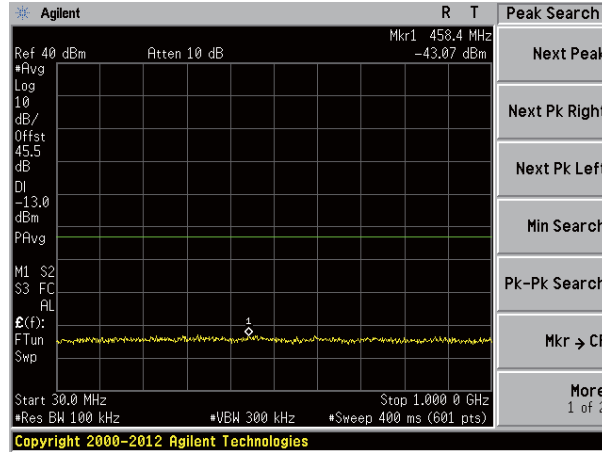

1000MHz-3000MHz

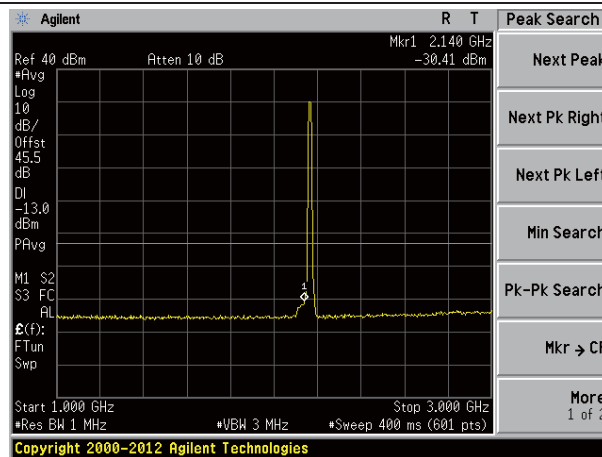

3000MHz-22000MHz

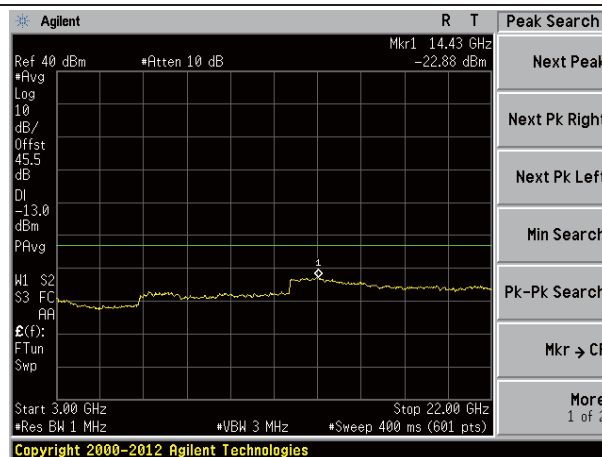

Spurious emission of LTE 20MHz Bandwidth

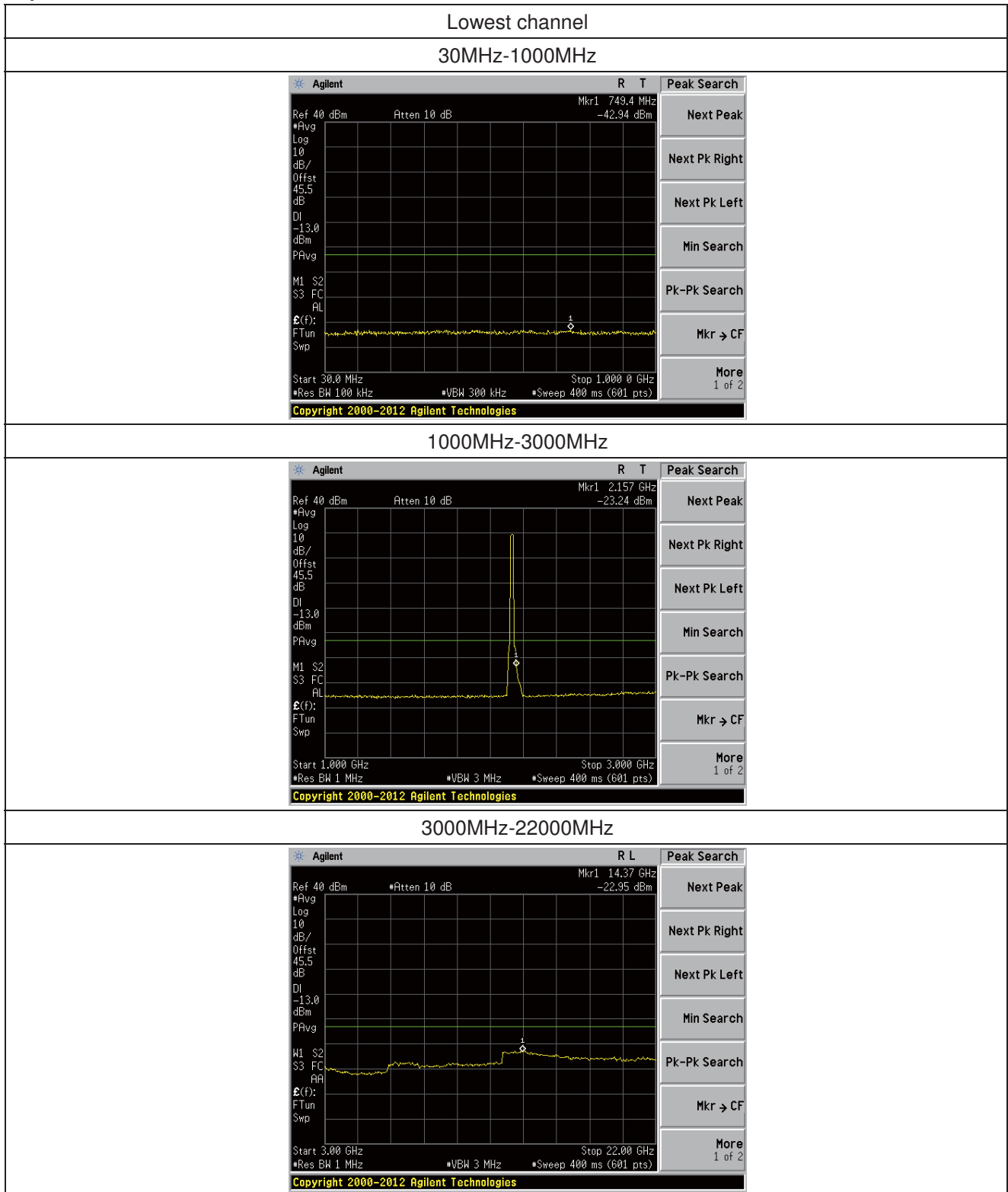

Middle channel

30MHz-1000MHz

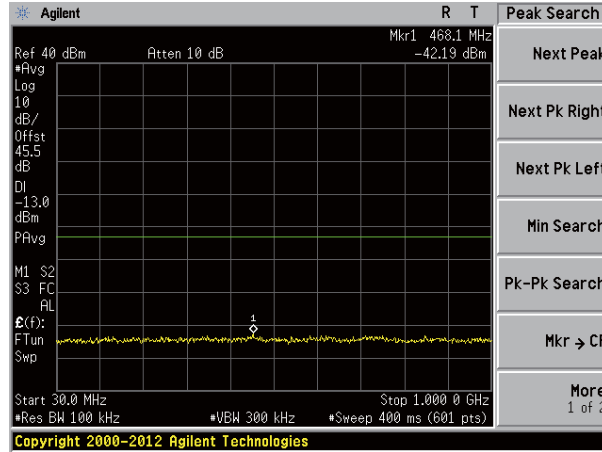

1000MHz-3000MHz

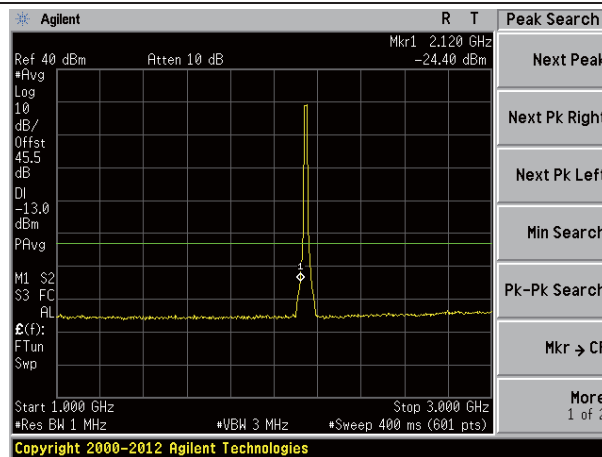

3000MHz-22000MHz

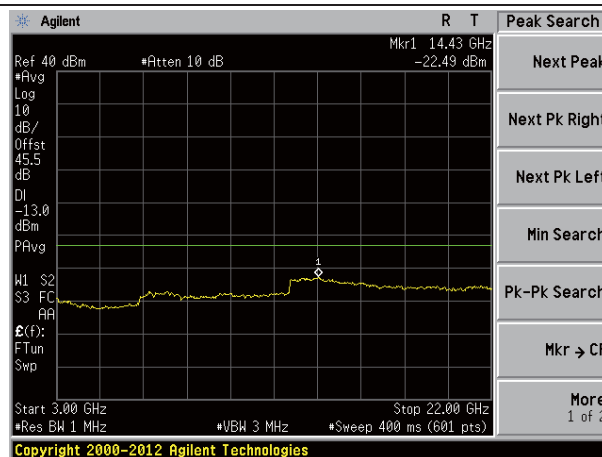

Highest channel

30MHz-1000MHz

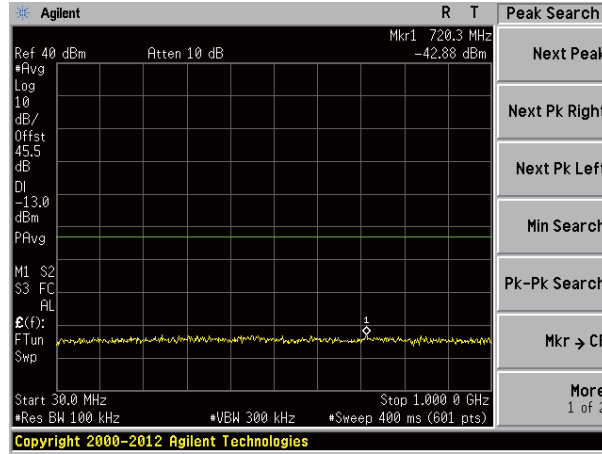

1000MHz-3000MHz

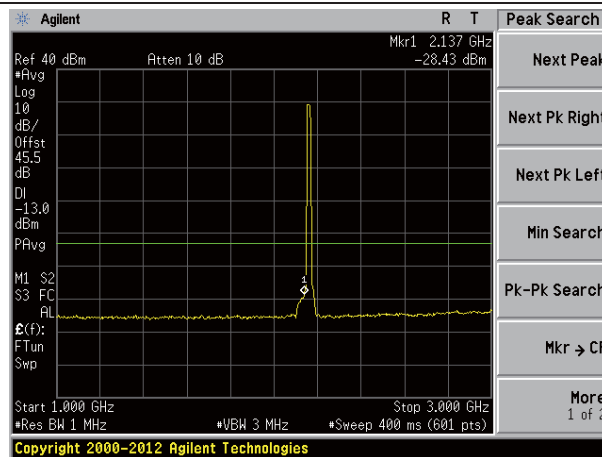

3000MHz-22000MHz

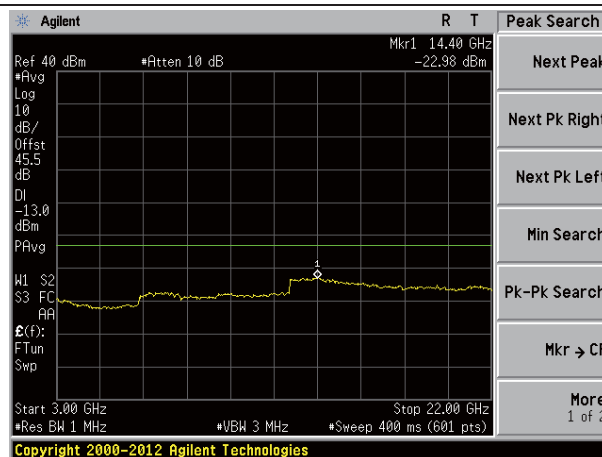

Spurious emission of WCDMA Single Carrier

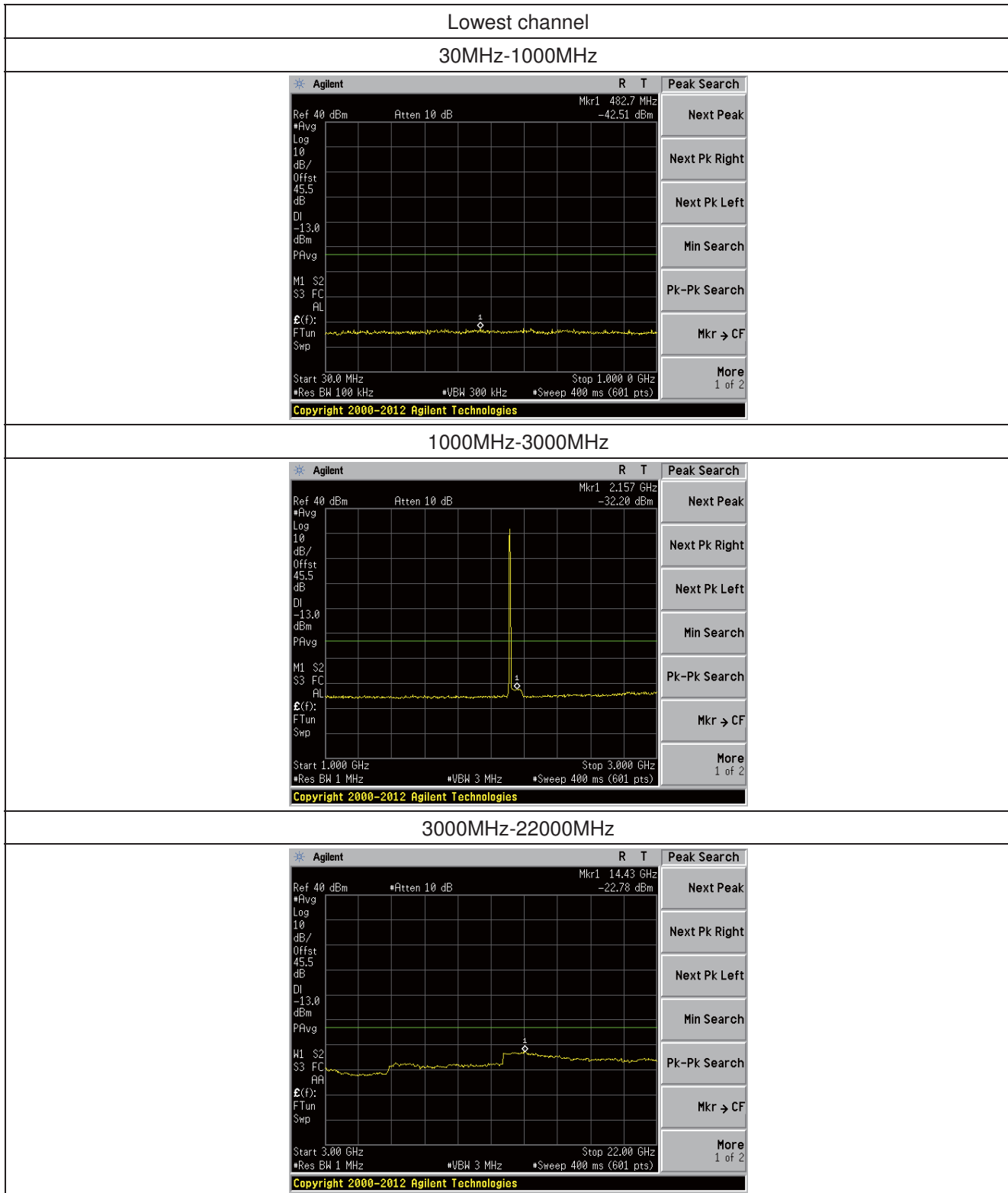

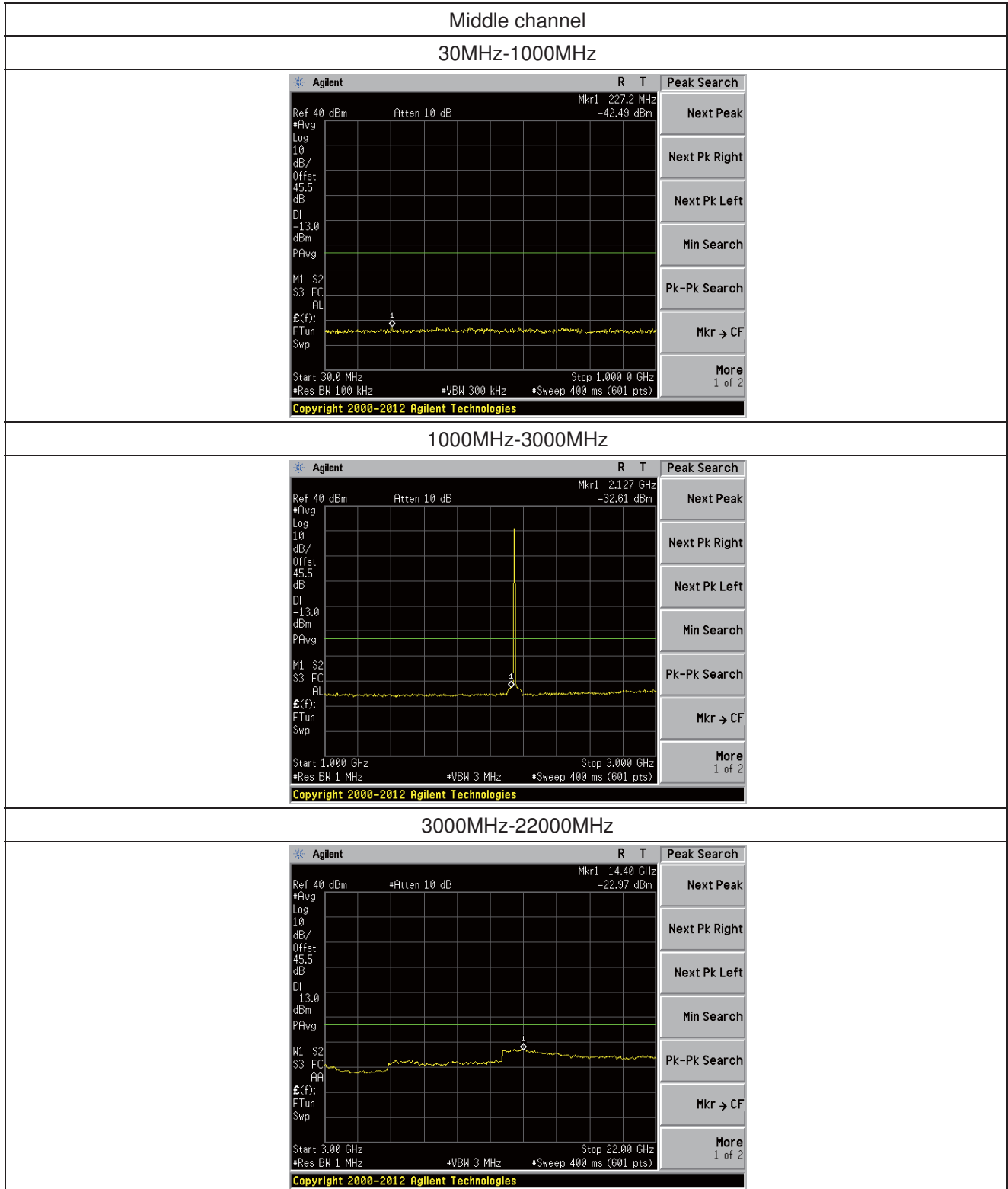

Highest channel

30MHz-1000MHz

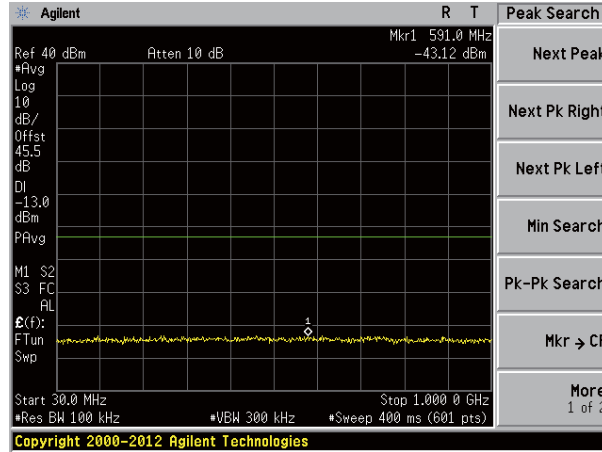

1000MHz-3000MHz

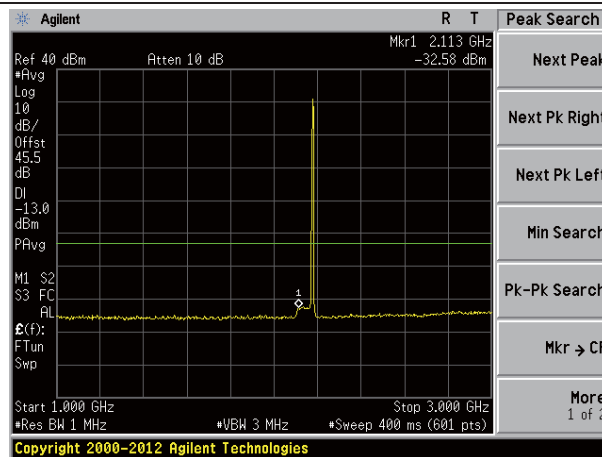

3000MHz-22000MHz

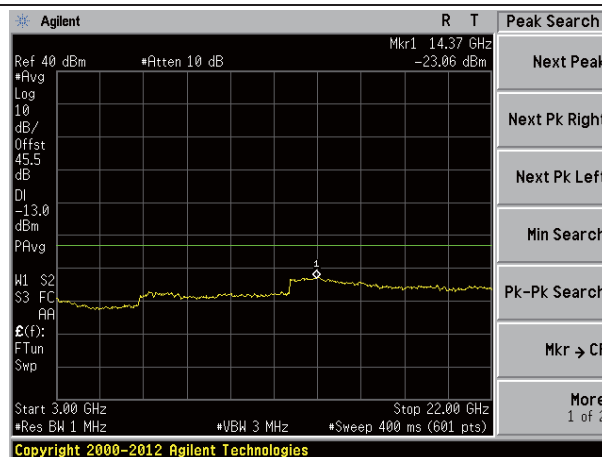

Spurious emission of WCDMA Four Carrier

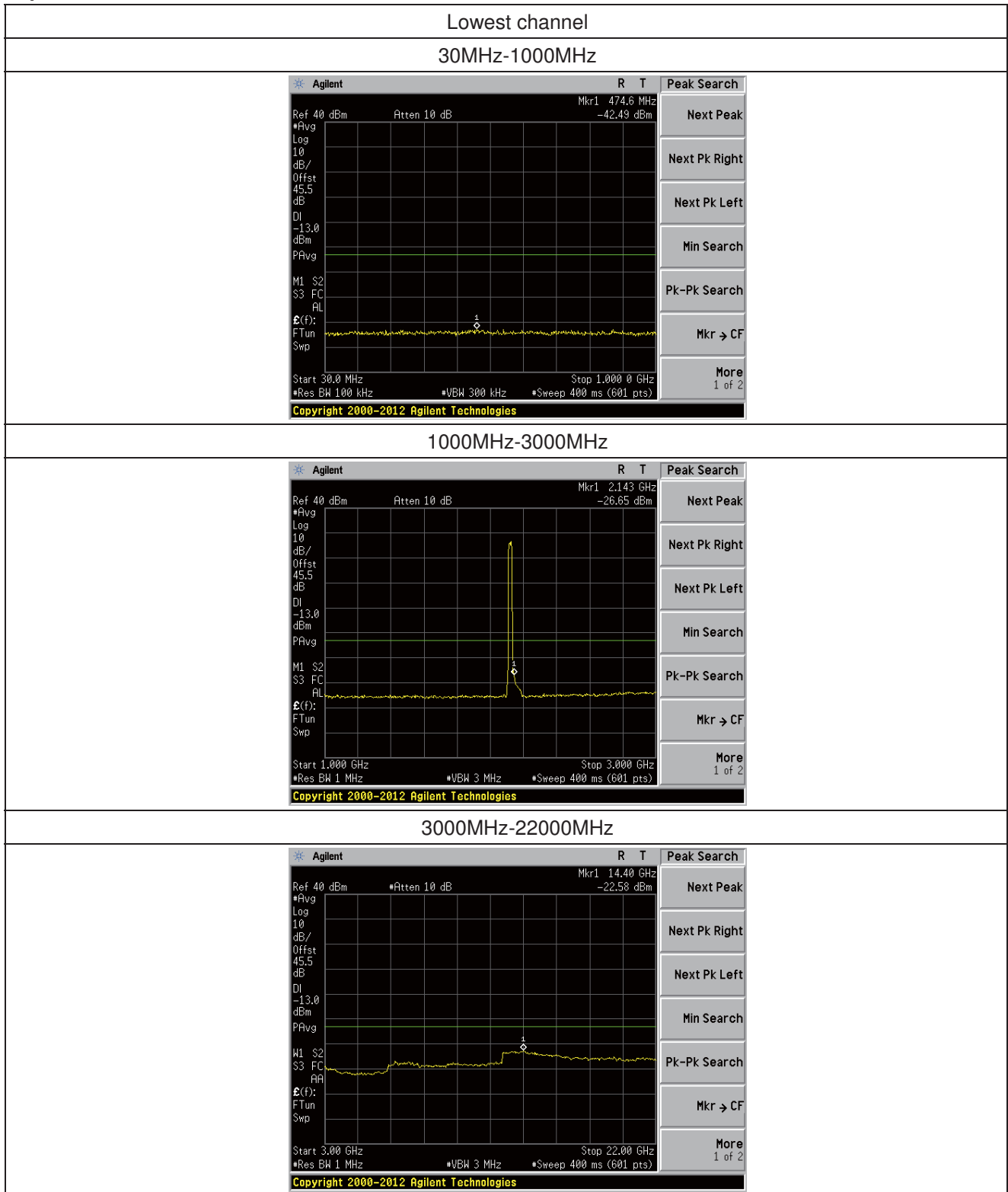

Middle channel

30MHz-1000MHz

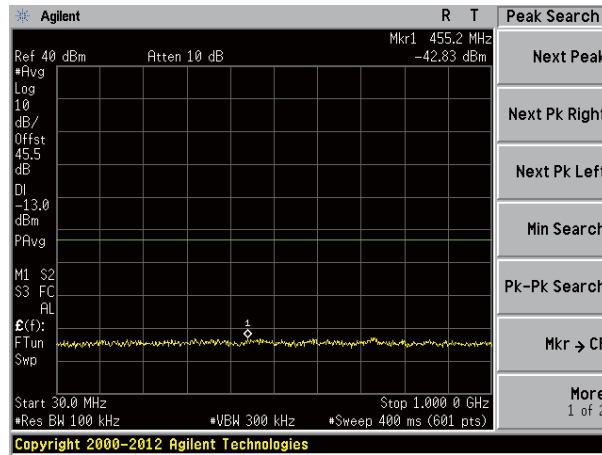

1000MHz-3000MHz

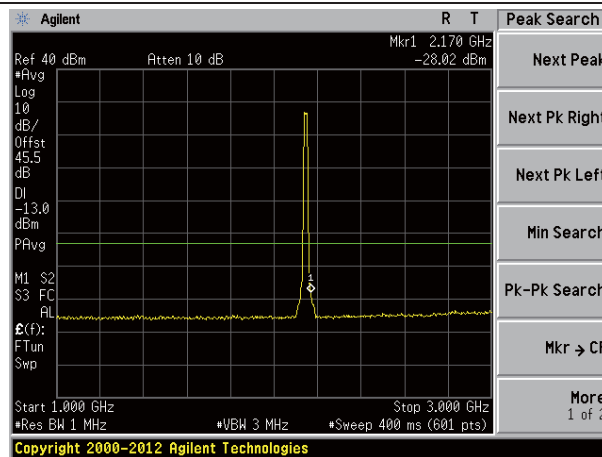

3000MHz-22000MHz

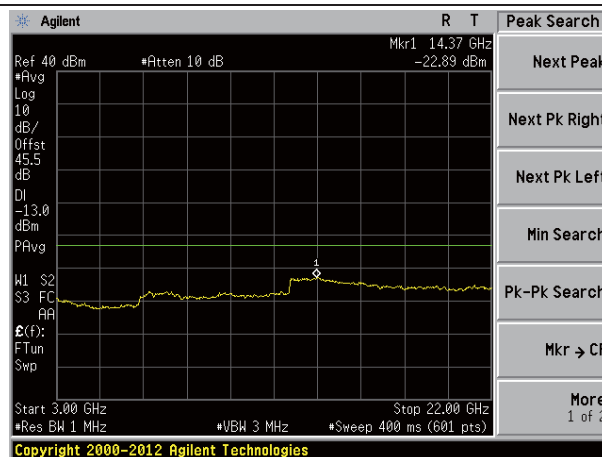

Highest channel

30MHz-1000MHz

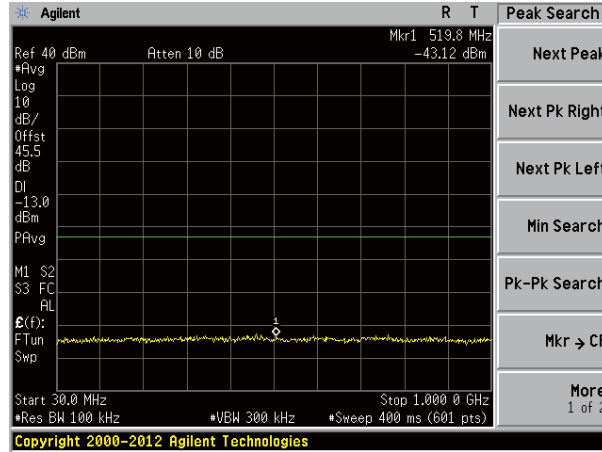

1000MHz-3000MHz

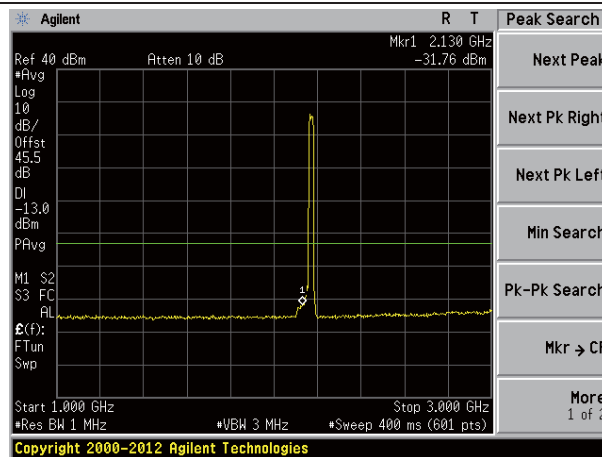

3000MHz-22000MHz

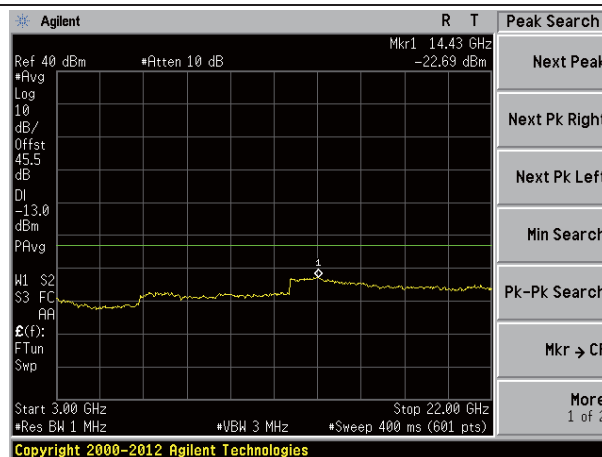

Uplink:

Spurious emission of LTE 1.4MHz Bandwidth



Middle channel

30MHz-1000MHz

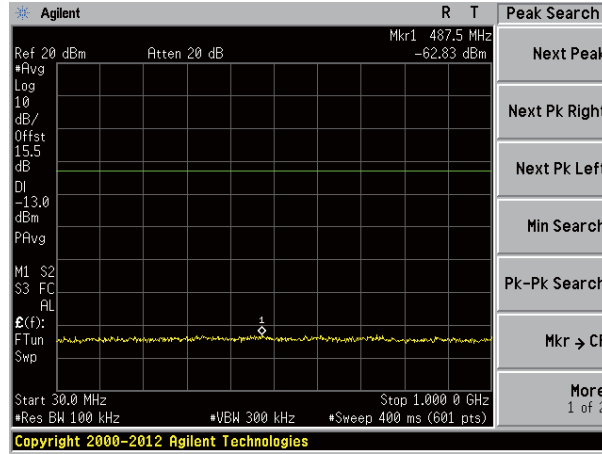

1000MHz-3000MHz

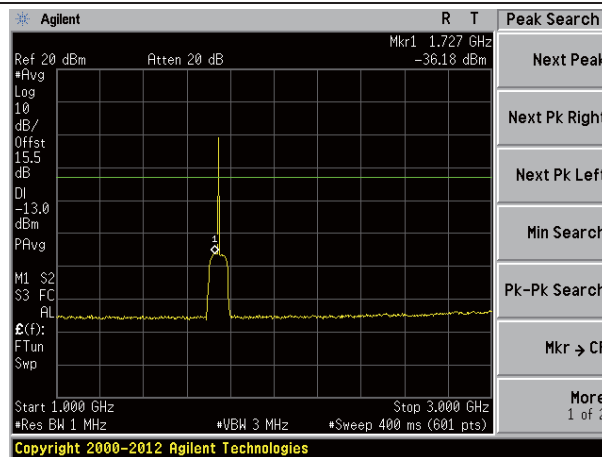

3000MHz-18000MHz

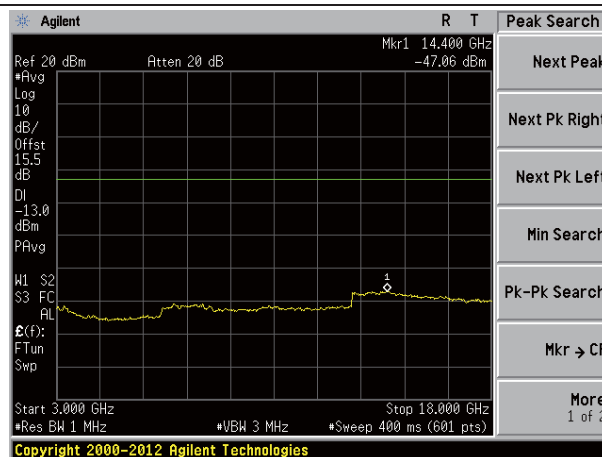

Highest channel

30MHz-1000MHz

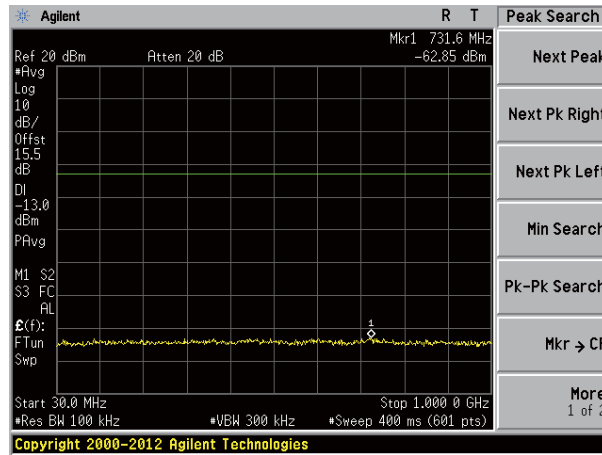

1000MHz-3000MHz

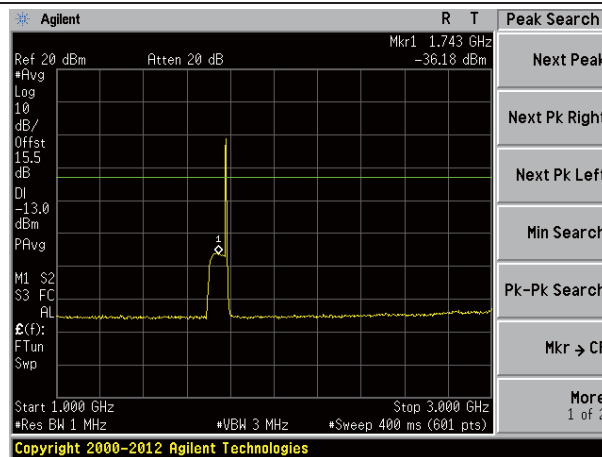

3000MHz-22000MHz

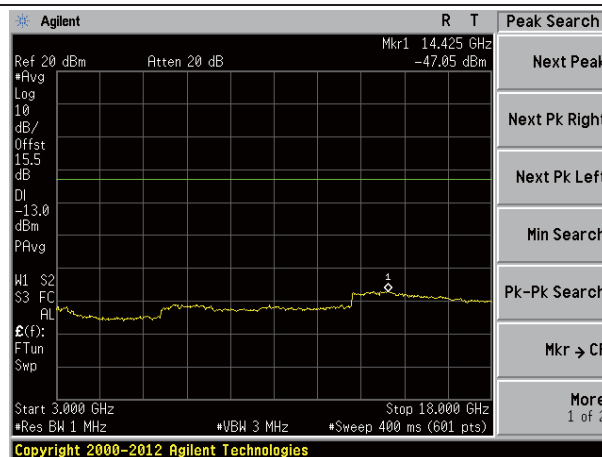

Spurious emission of LTE 3MHz Bandwidth

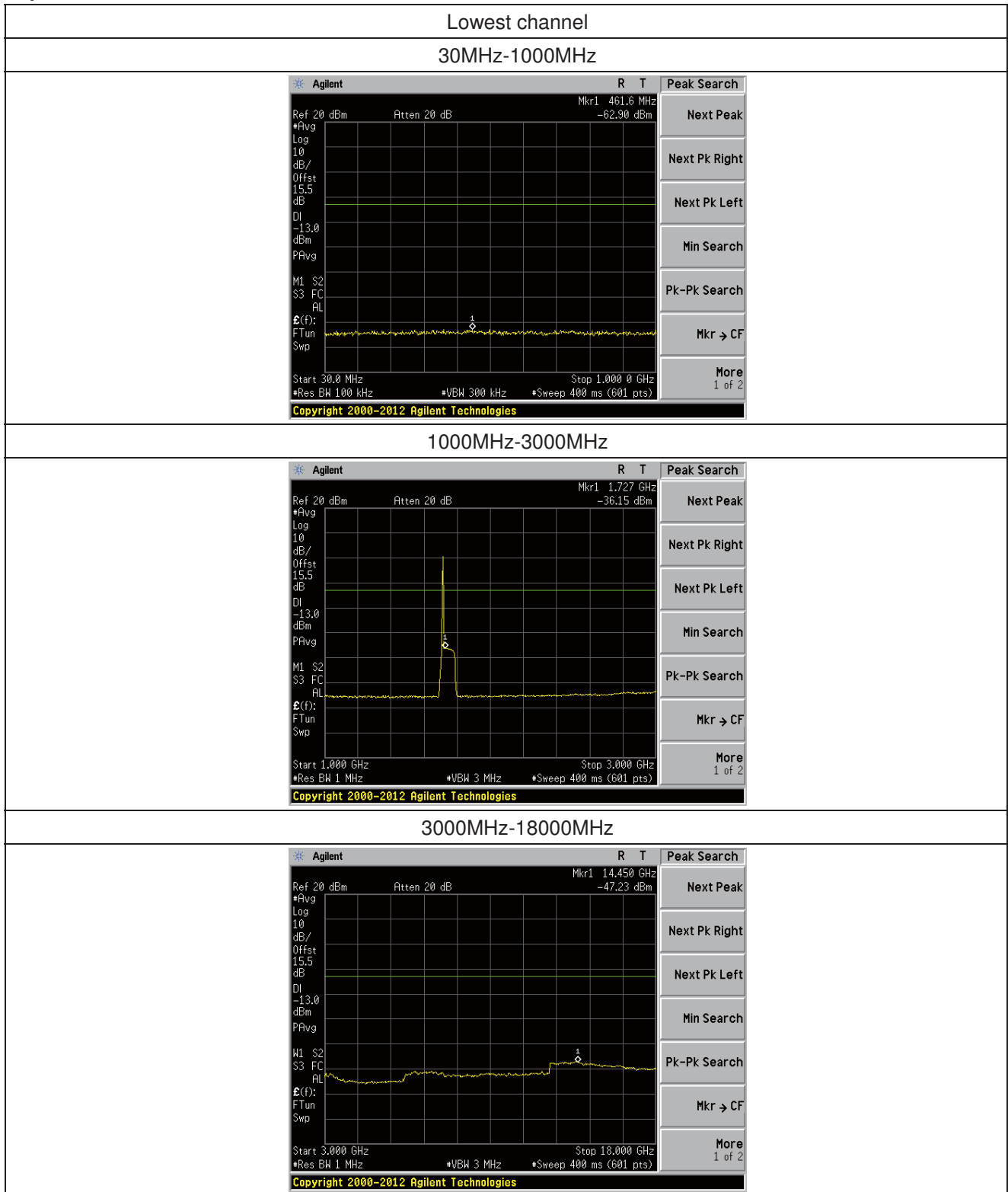

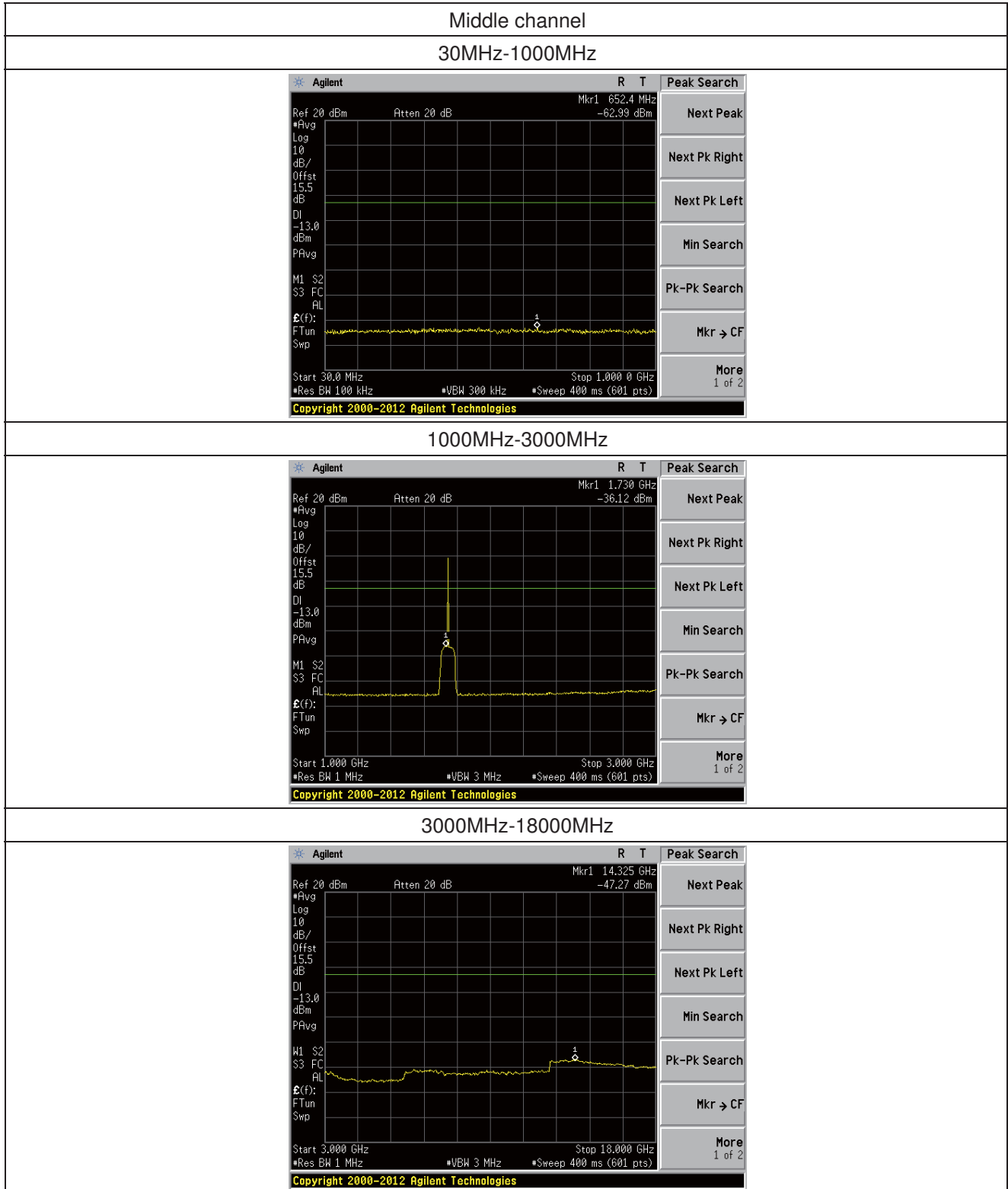

Highest channel

30MHz-1000MHz

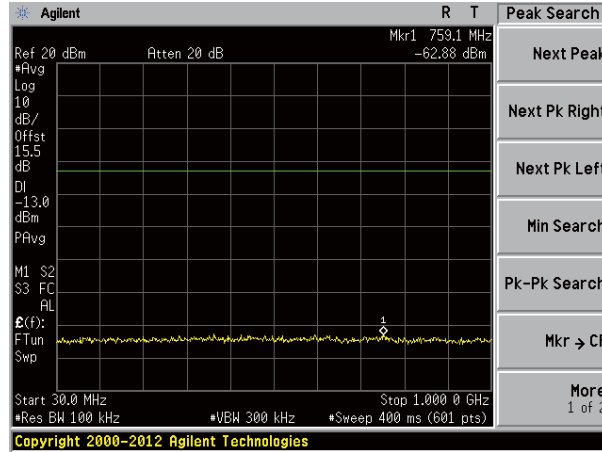

1000MHz-3000MHz

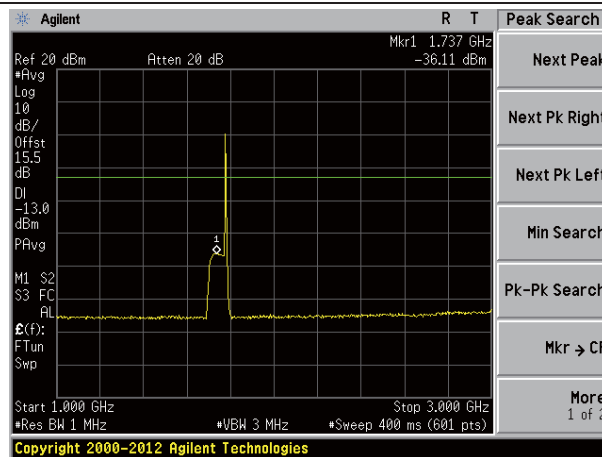

3000MHz-18000MHz

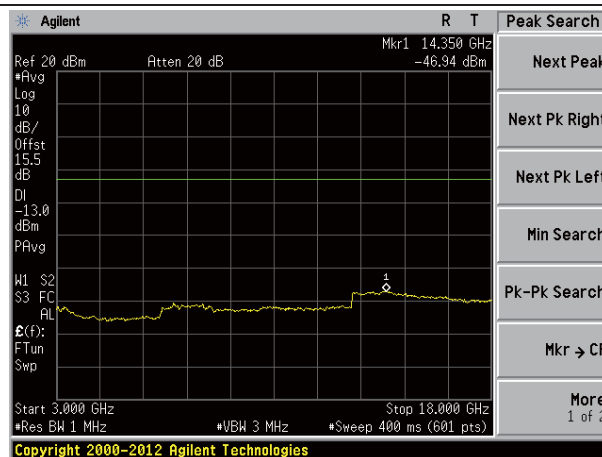

Spurious emission of LTE 5MHz Bandwidth

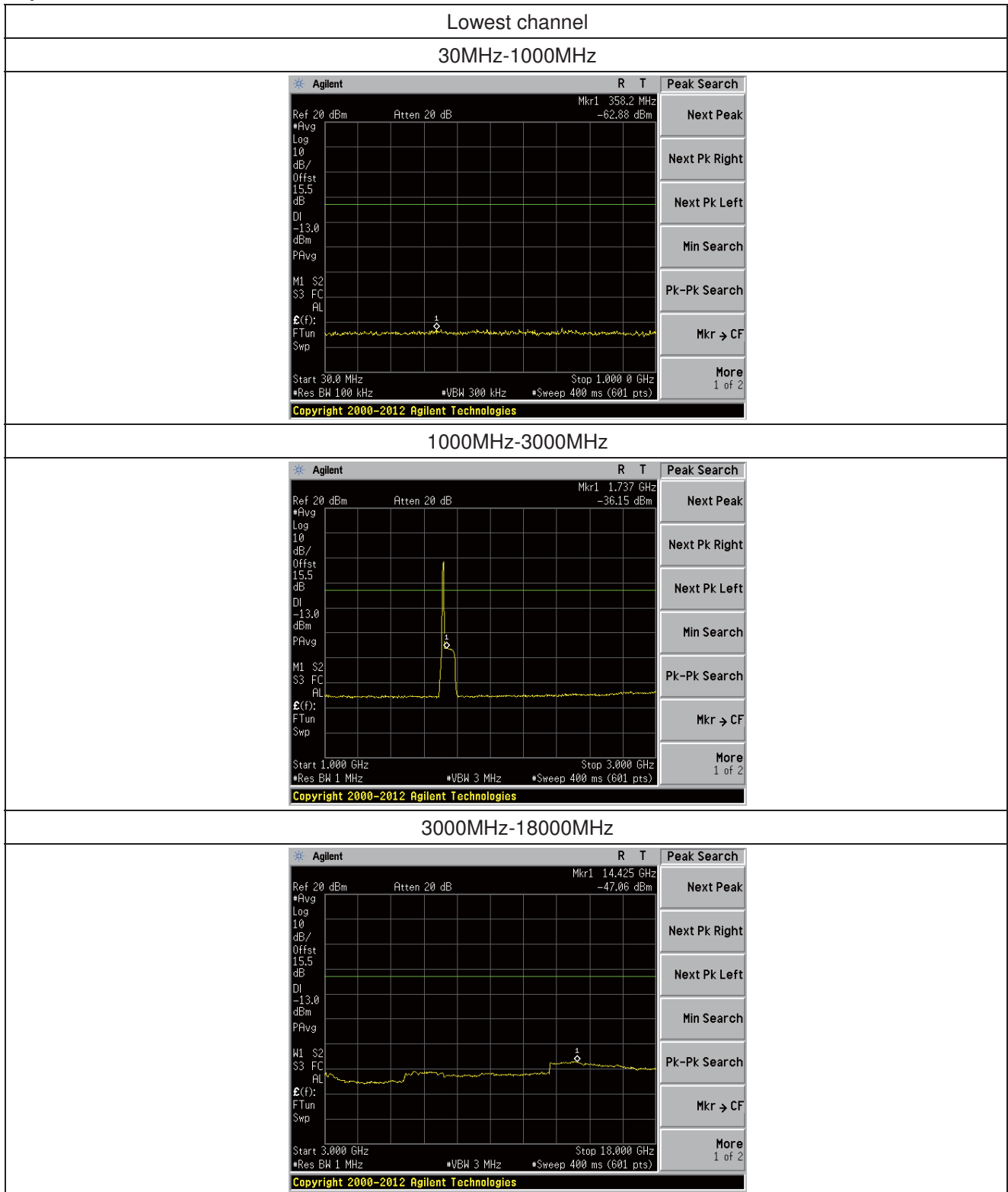

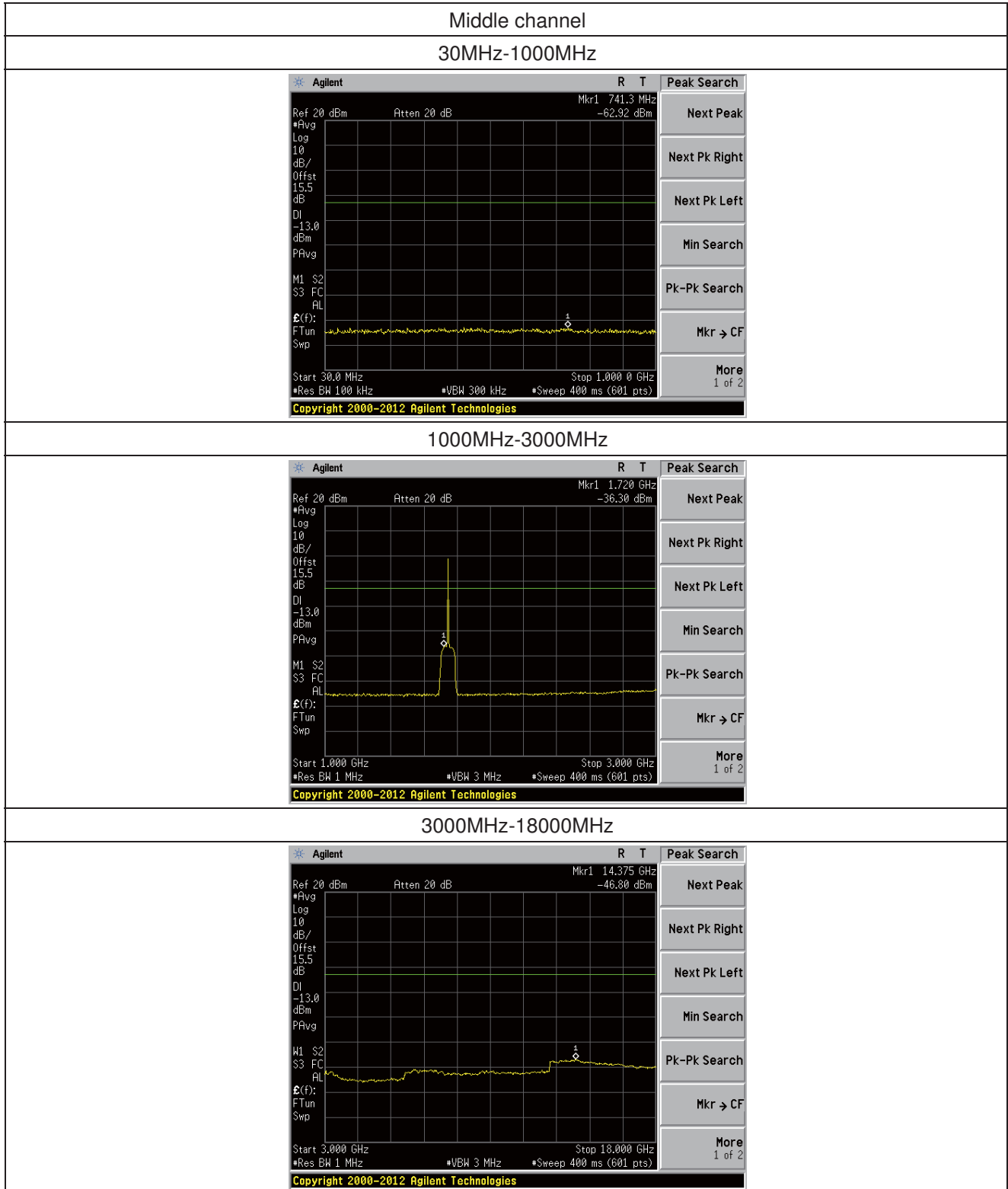

Highest channel

30MHz-1000MHz

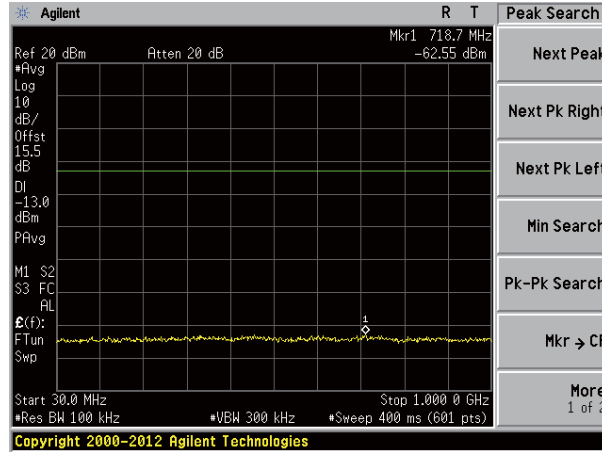

1000MHz-3000MHz

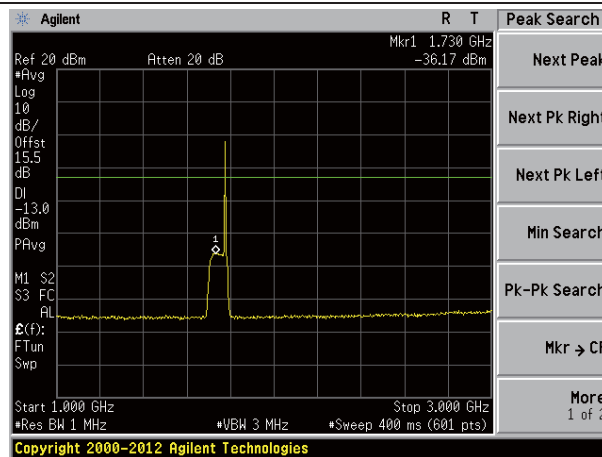

3000MHz-18000MHz

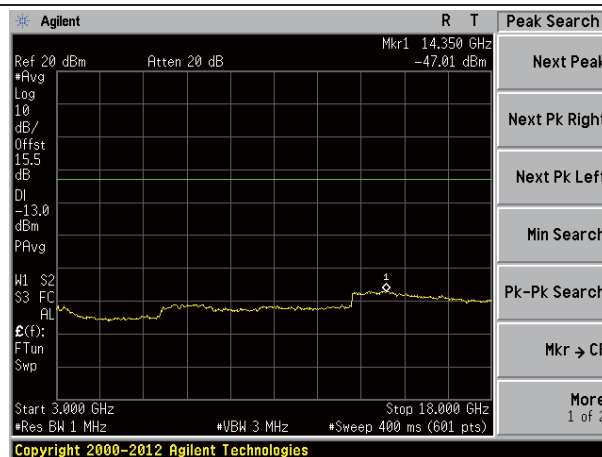

Spurious emission of LTE 10MHz Bandwidth

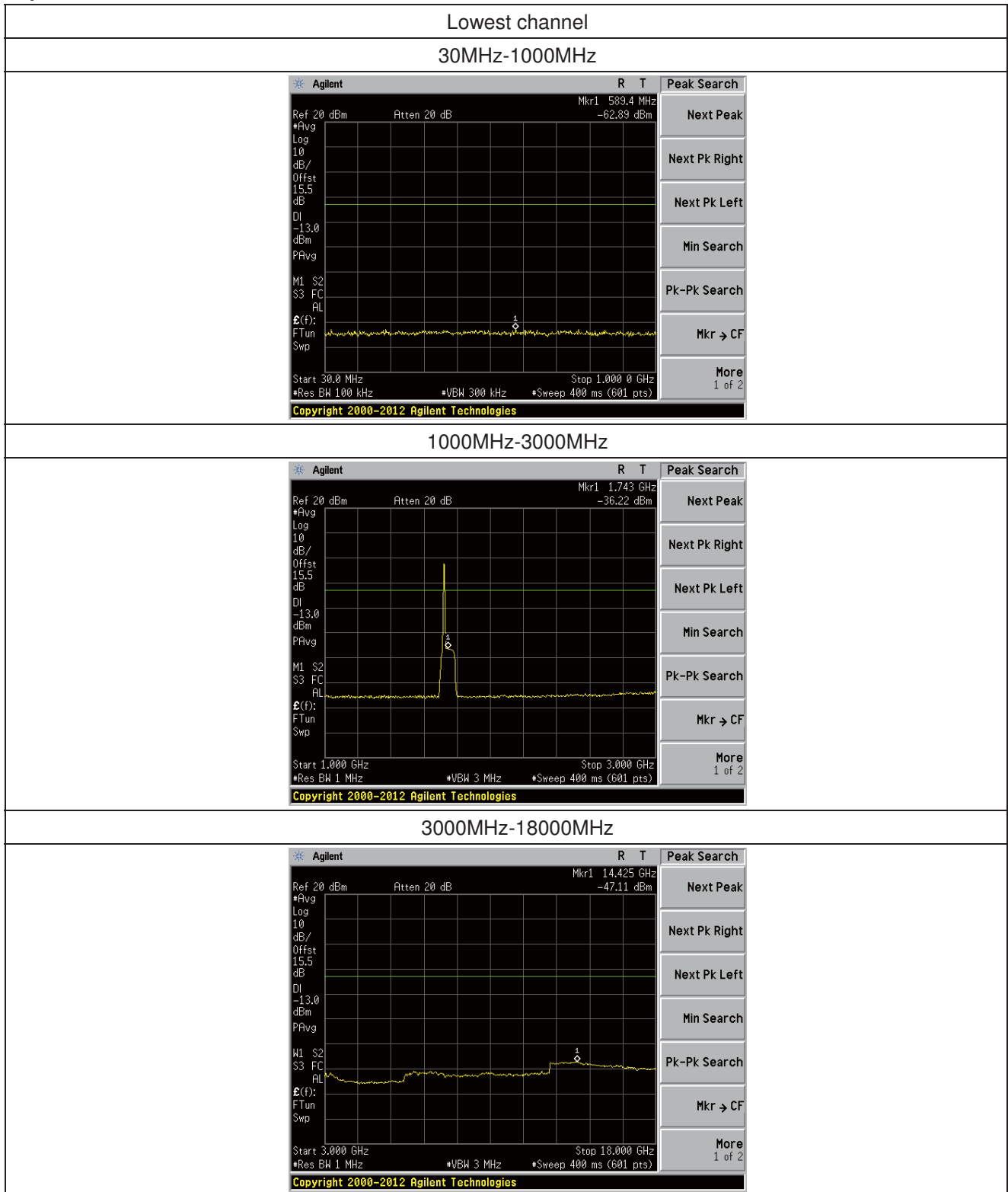

Middle channel

30MHz-1000MHz

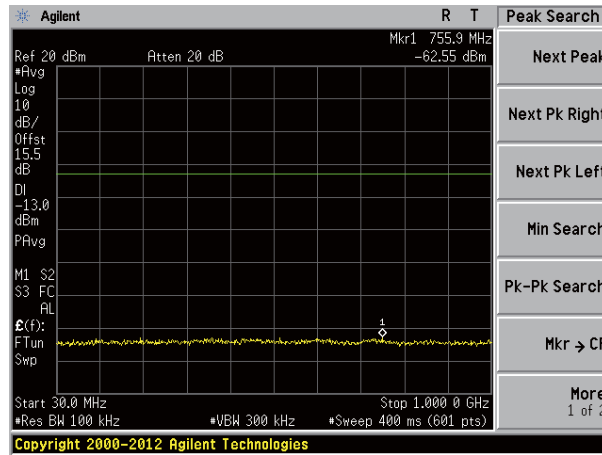

1000MHz-3000MHz

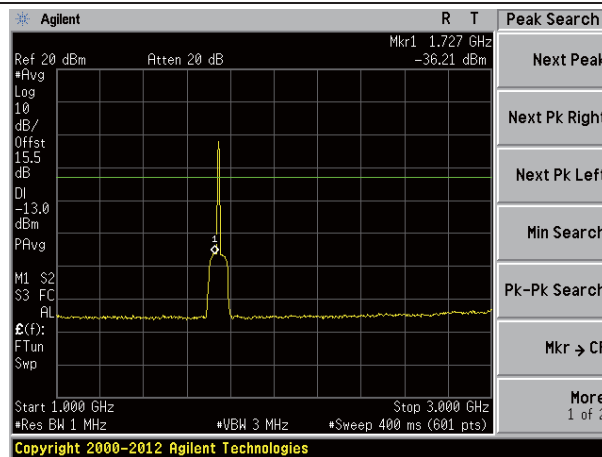

3000MHz-18000MHz

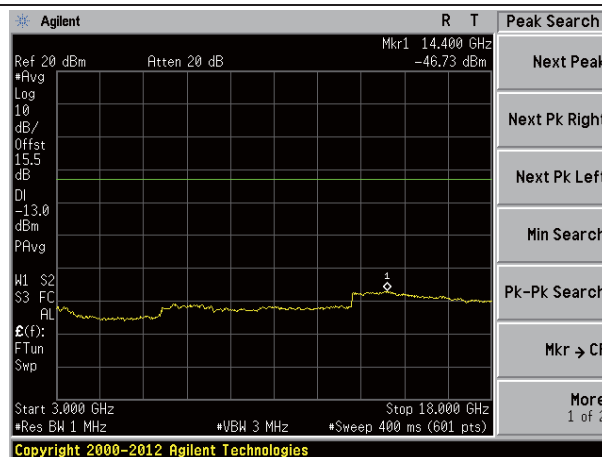

Highest channel

30MHz-1000MHz

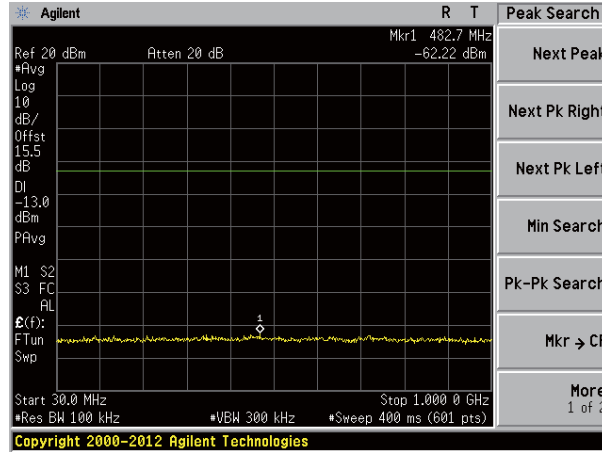

1000MHz-3000MHz

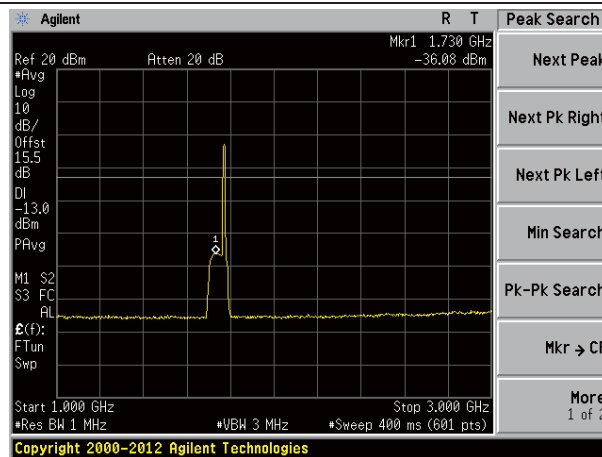

3000MHz-18000MHz

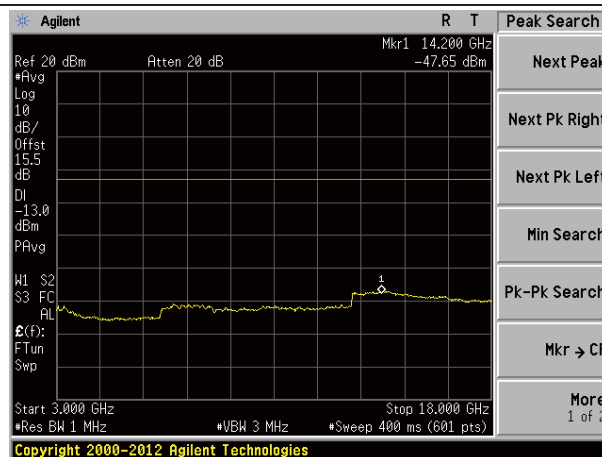

Spurious emission of LTE 15MHz Bandwidth

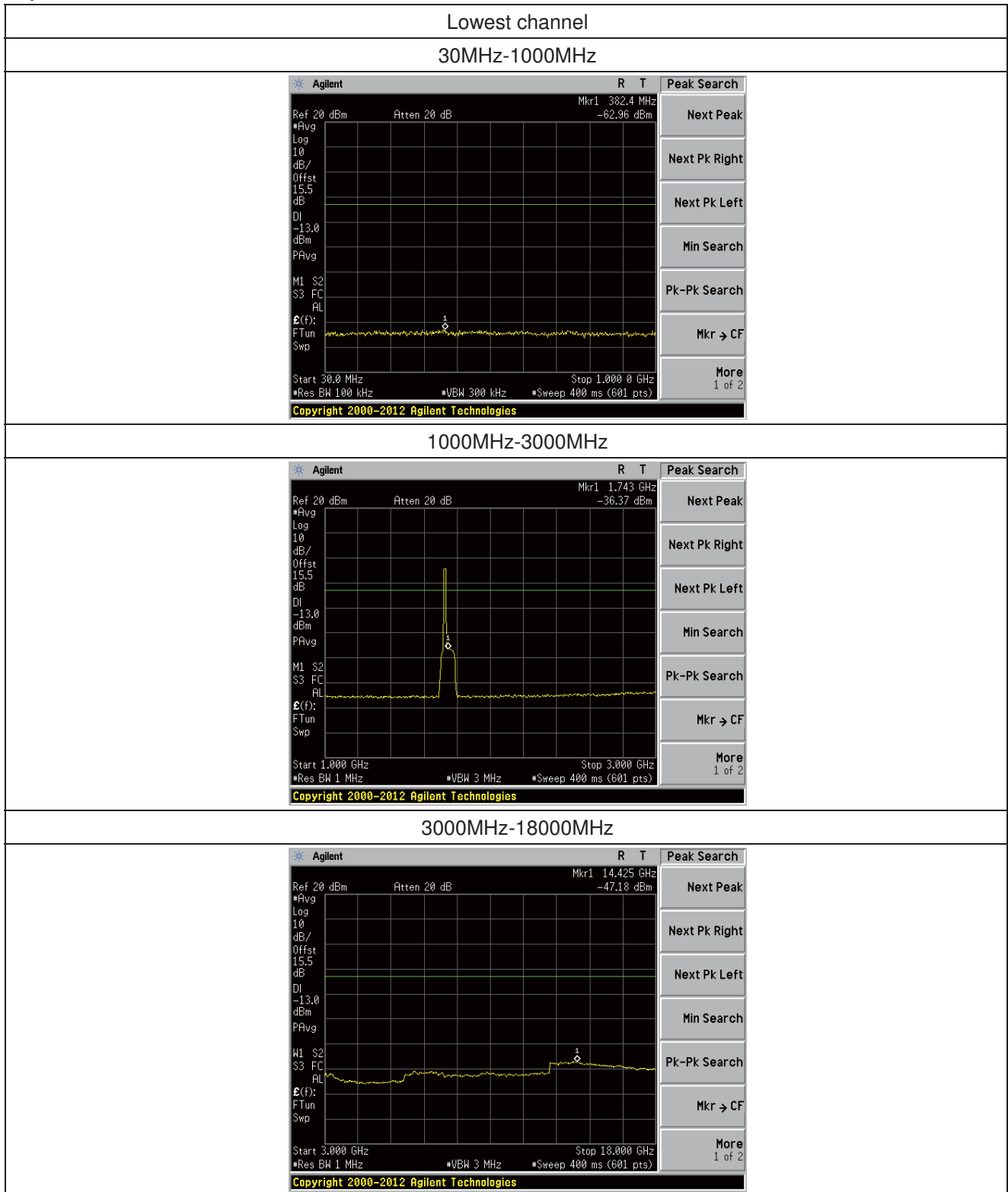

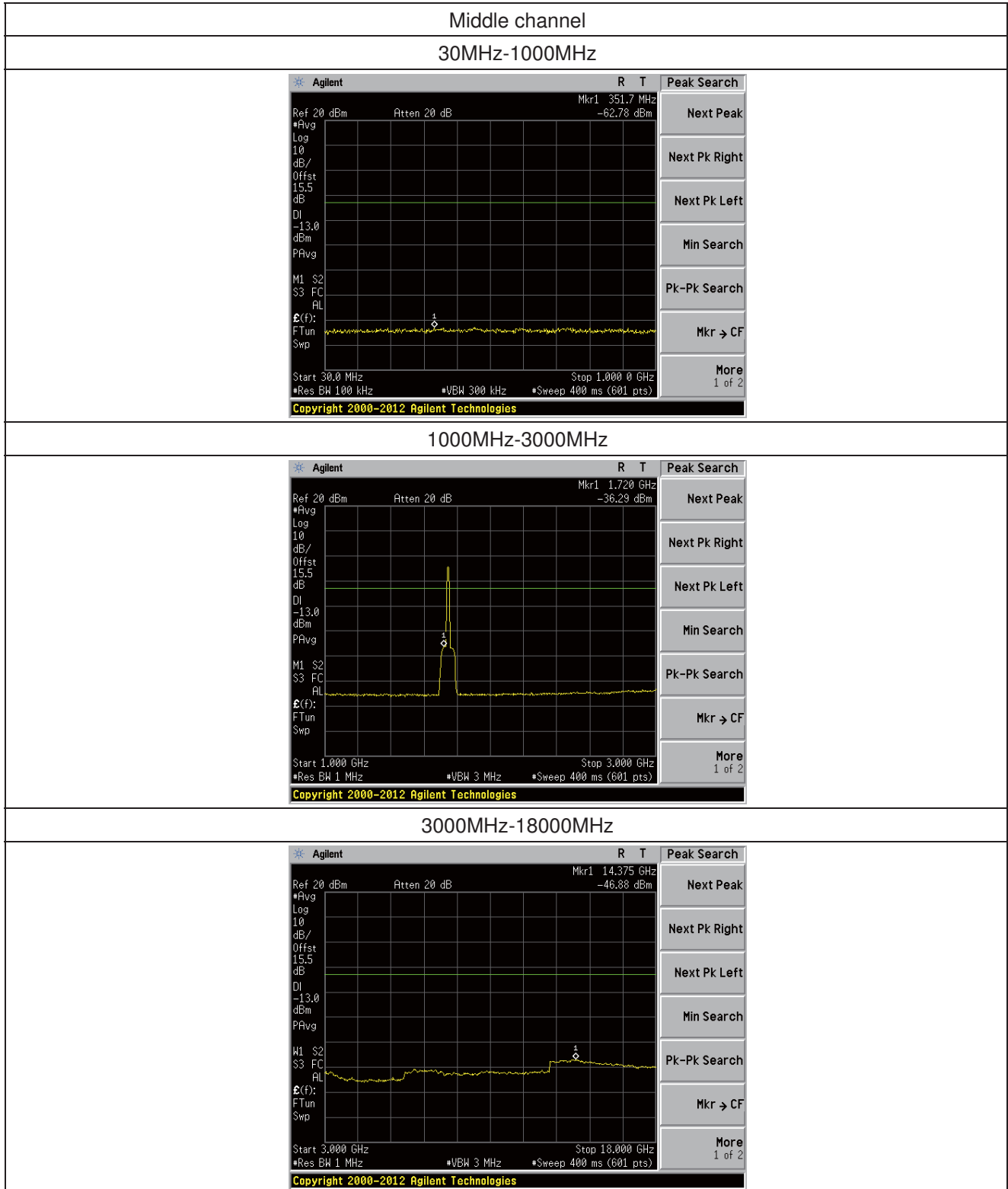

Highest channel

30MHz-1000MHz

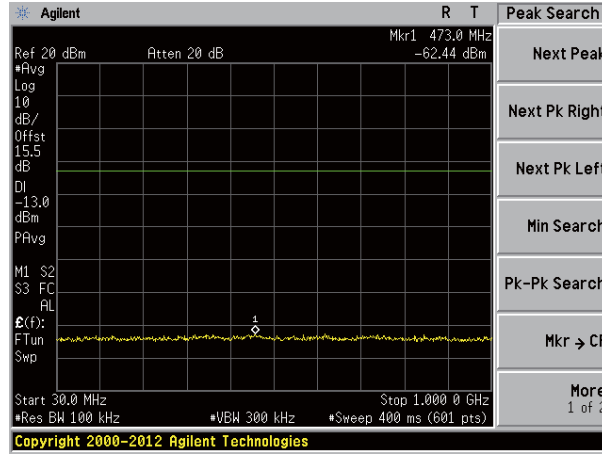

1000MHz-3000MHz

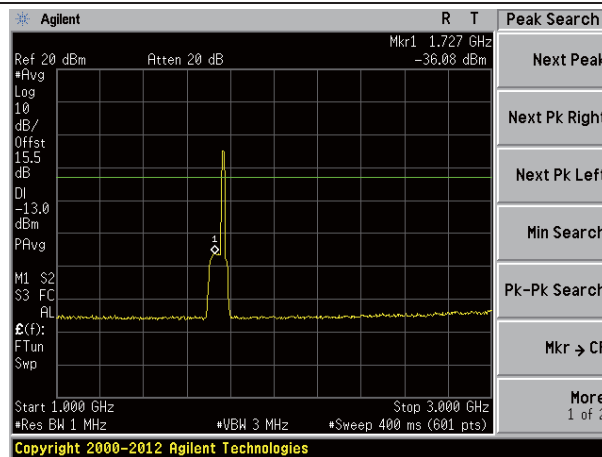

3000MHz-18000MHz

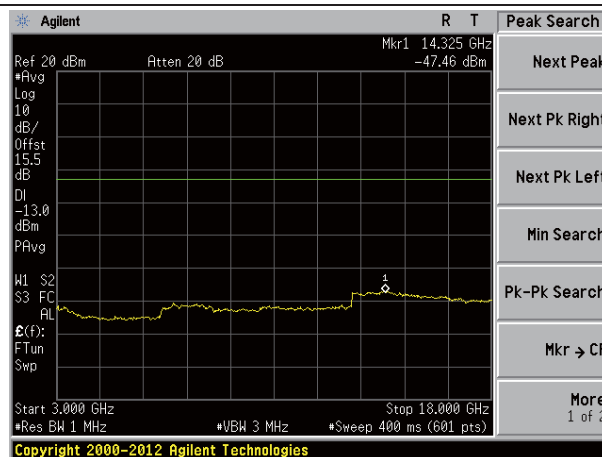

Spurious emission of LTE 20MHz Bandwidth

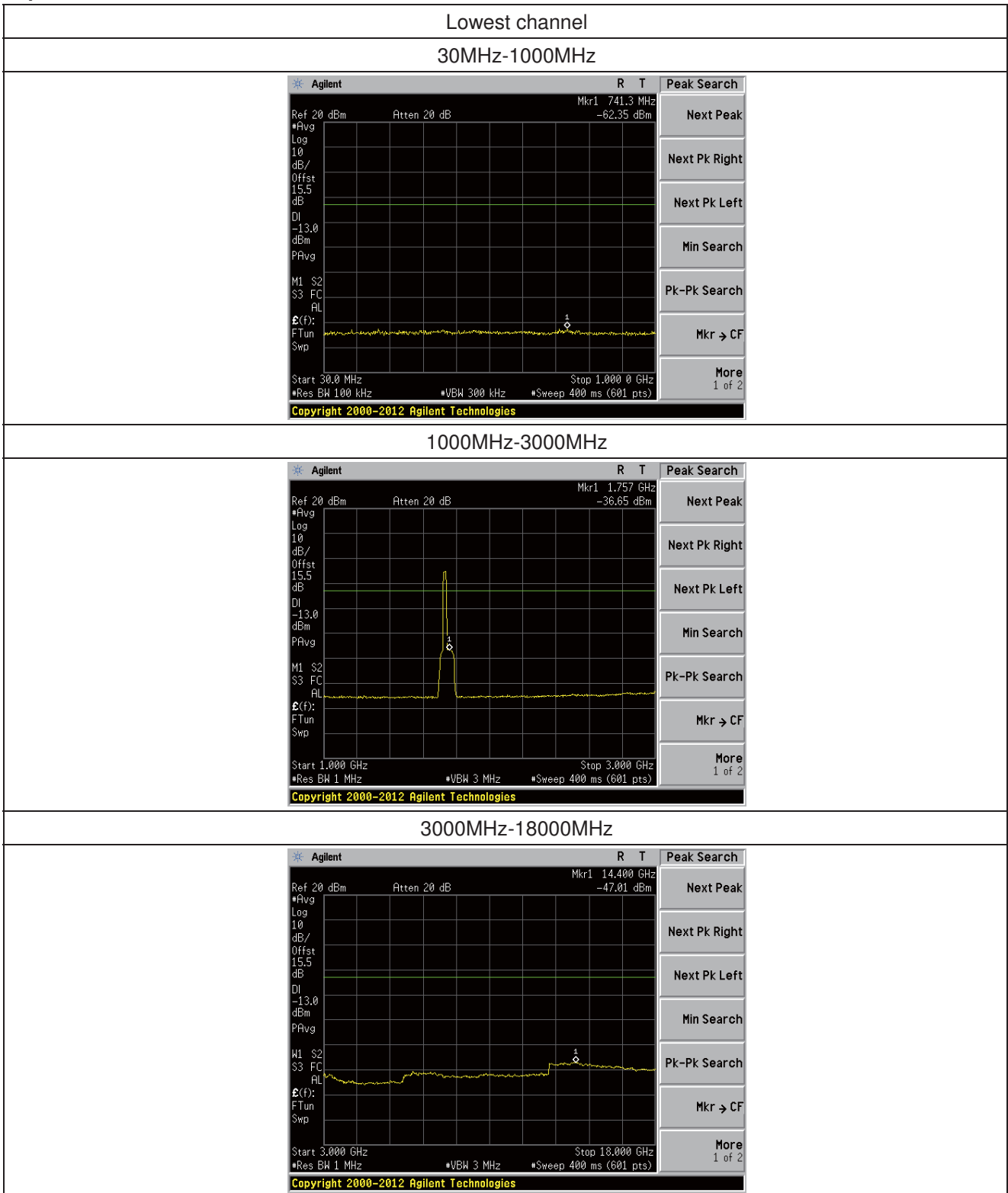

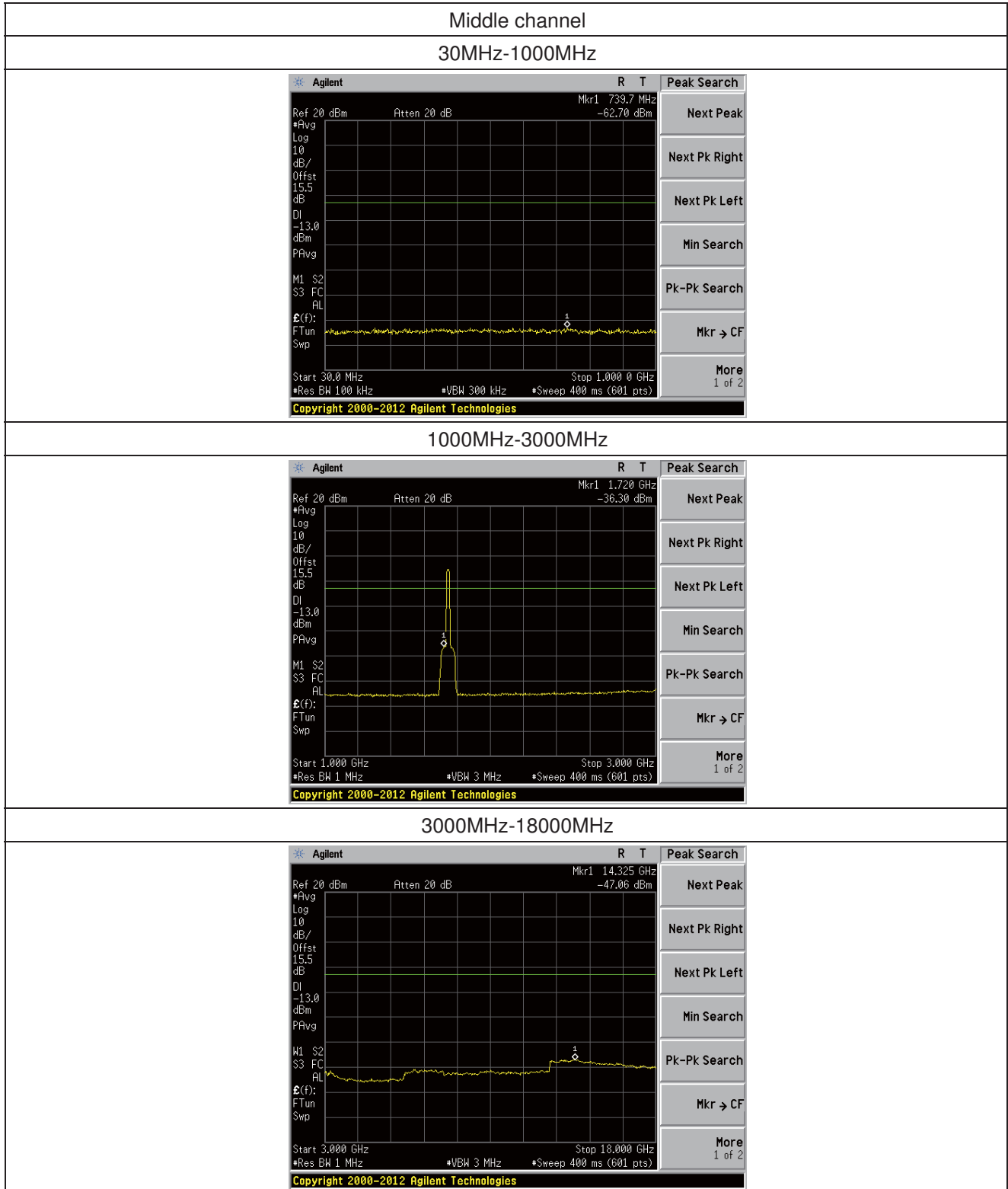

Highest channel

30MHz-1000MHz

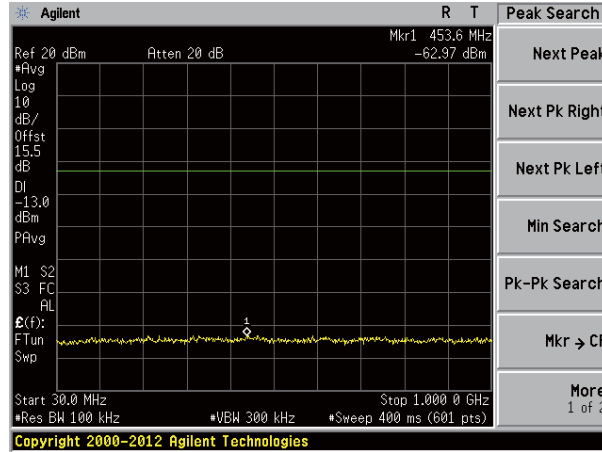

1000MHz-3000MHz

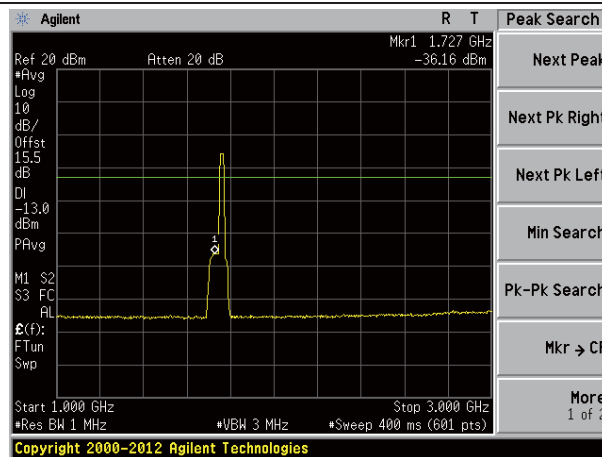

3000MHz-18000MHz

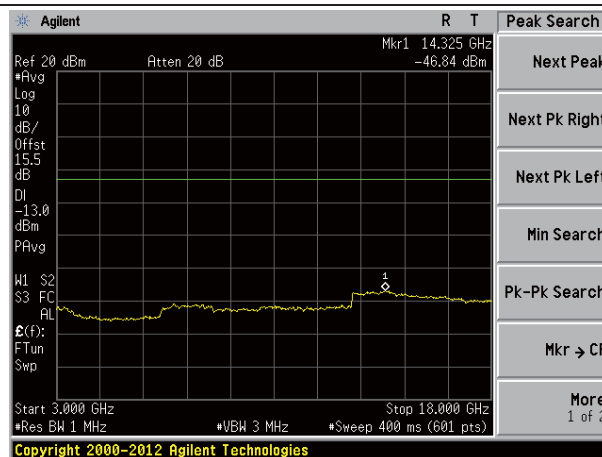

Spurious emission of WCDMA Single Carrier

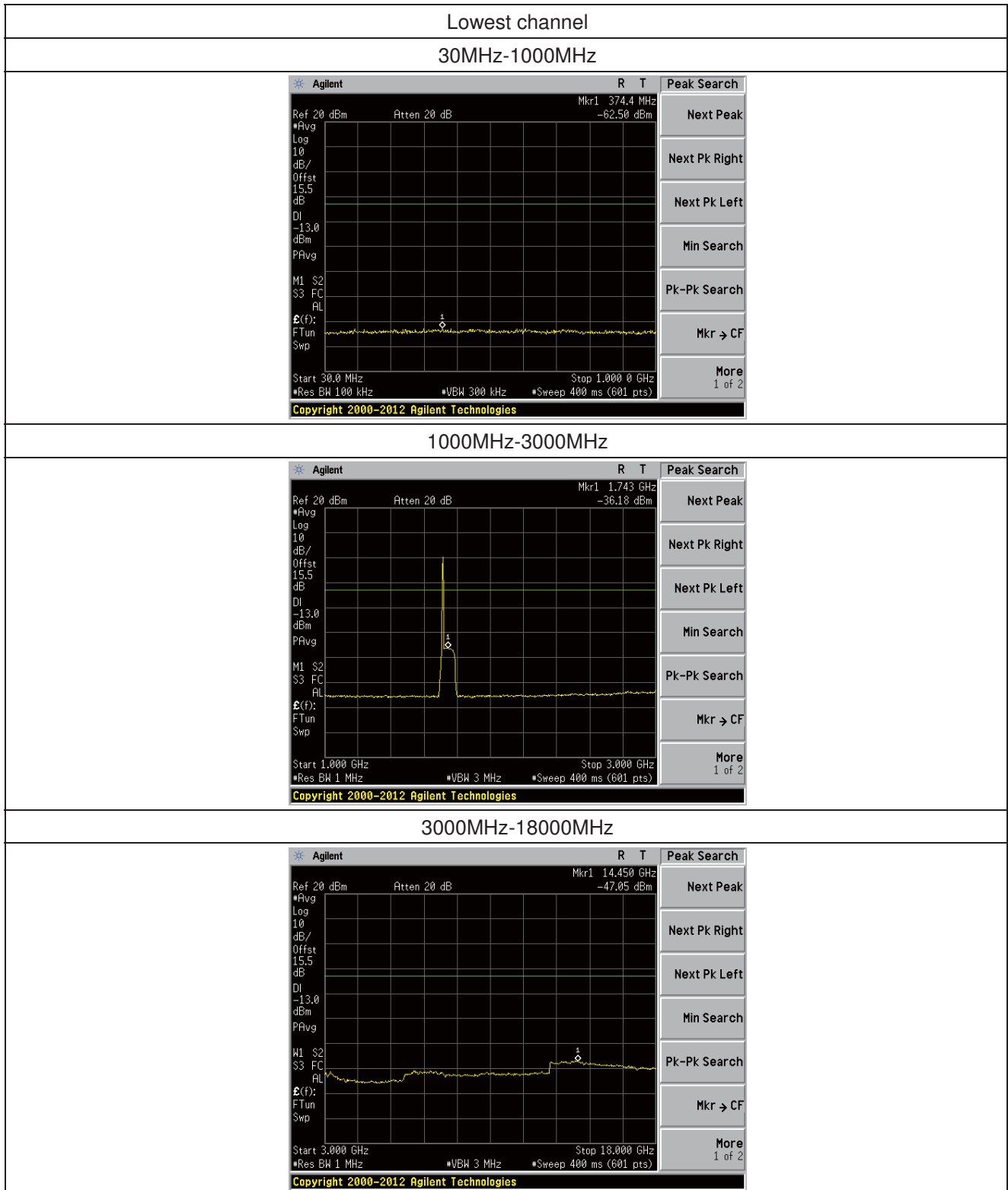

Middle channel

30MHz-1000MHz

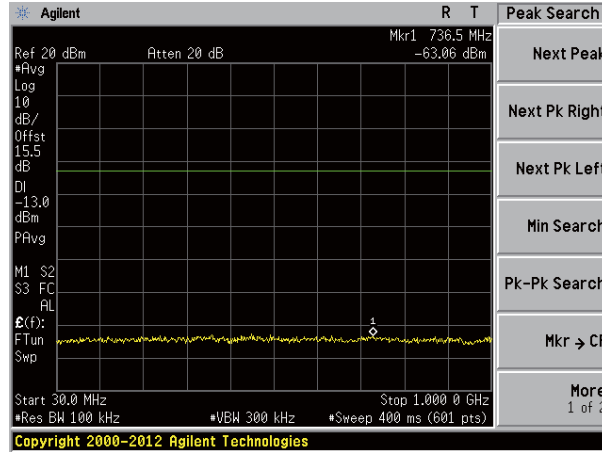

1000MHz-3000MHz

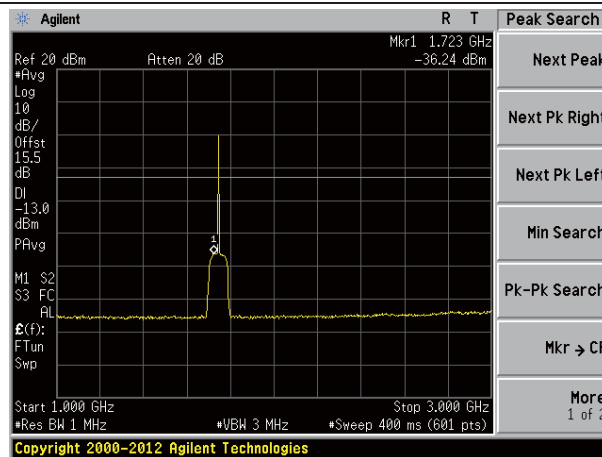

3000MHz-18000MHz

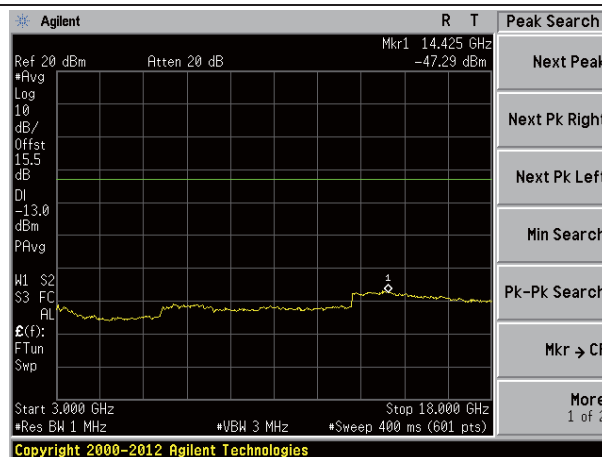

Highest channel

30MHz-1000MHz

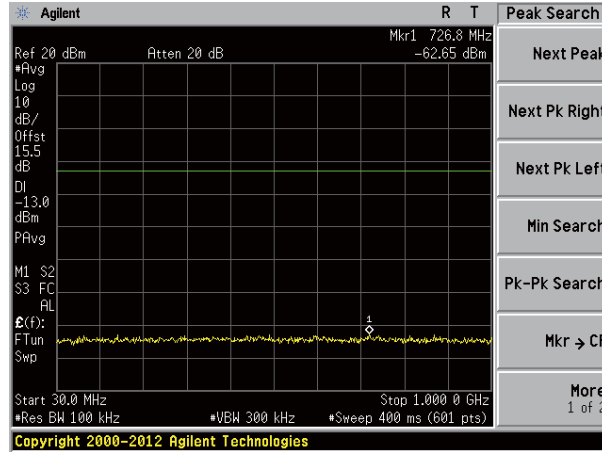

1000MHz-3000MHz

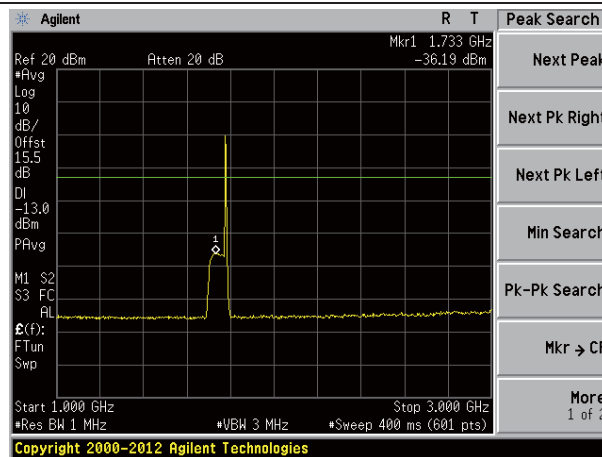

3000MHz-18000MHz

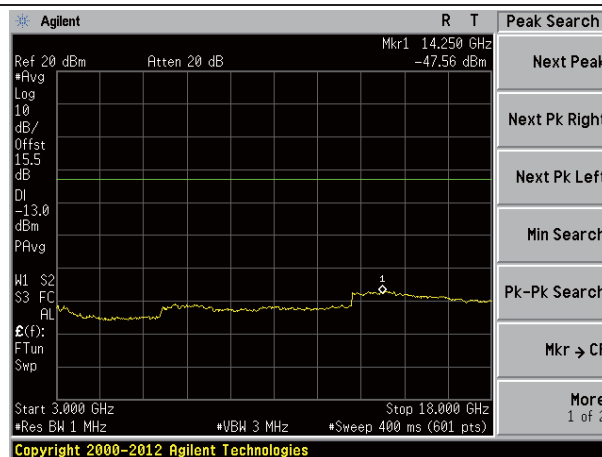

Spurious emission of WCDMA Four Carrier

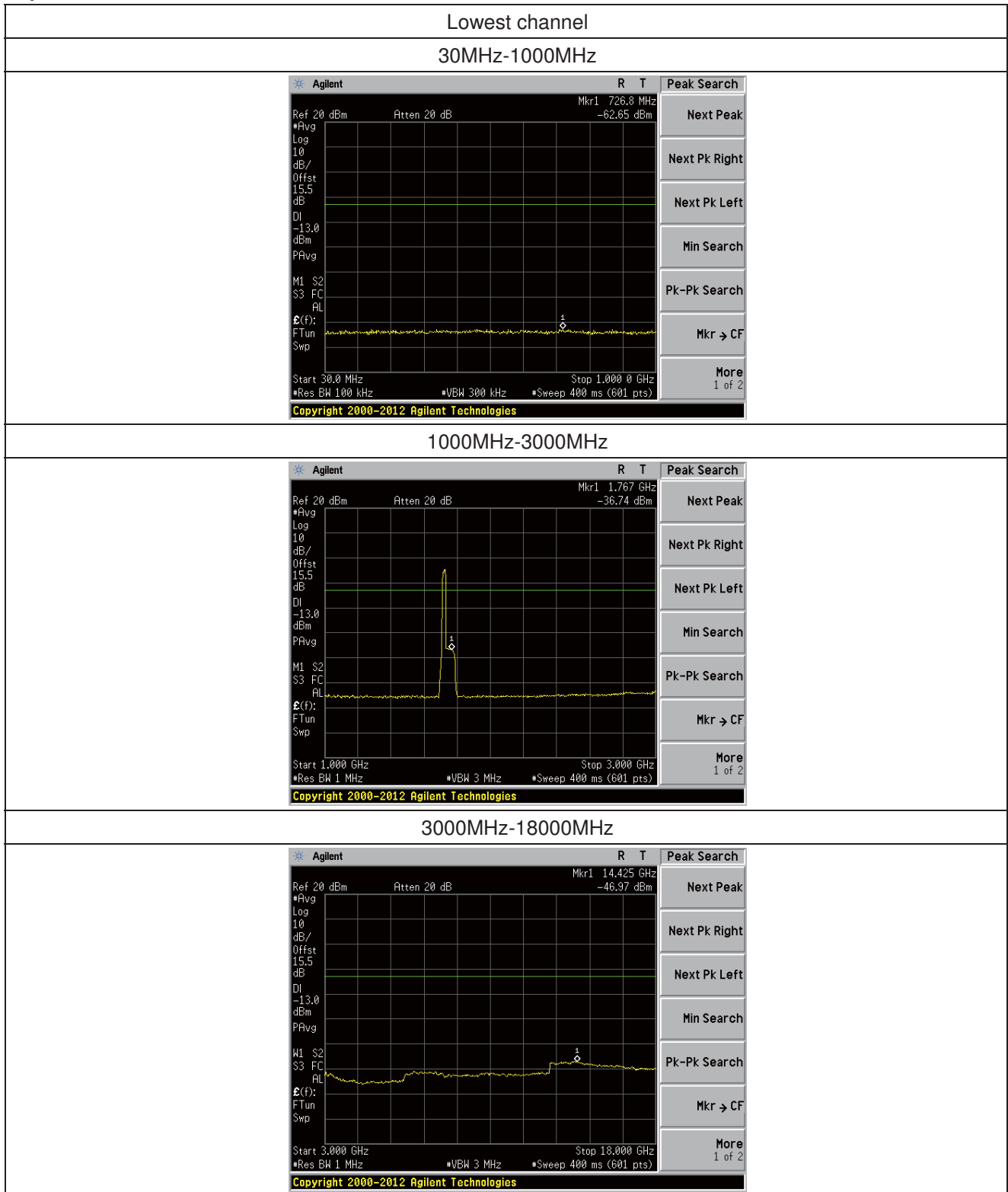

Middle channel

30MHz-1000MHz

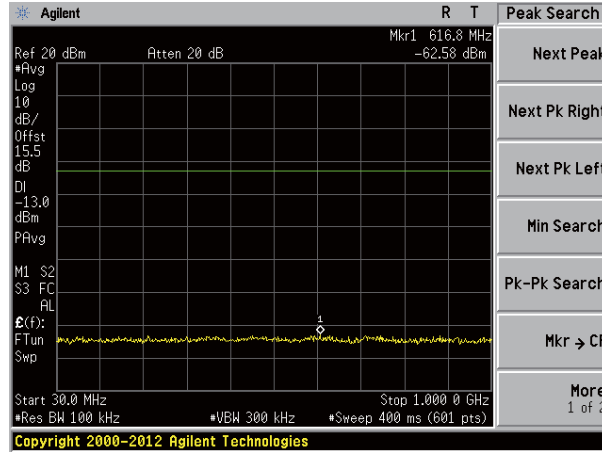

1000MHz-3000MHz

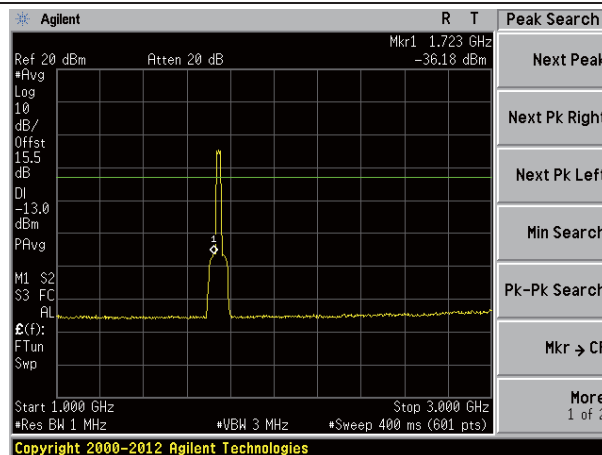

3000MHz-18000MHz

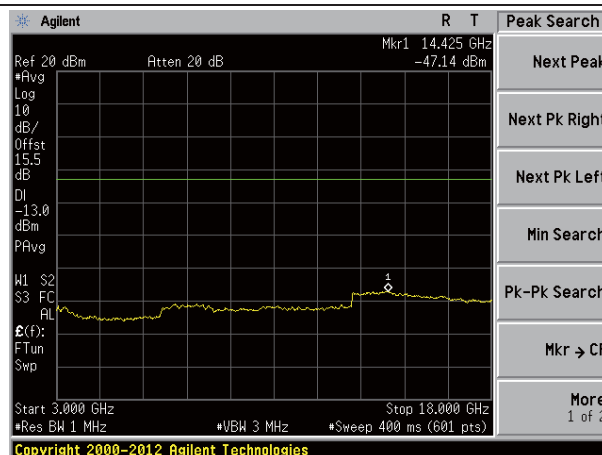

Highest channel

30MHz-1000MHz

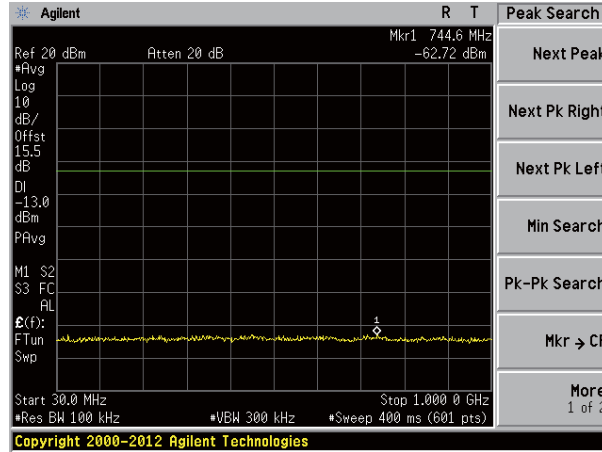

1000MHz-3000MHz

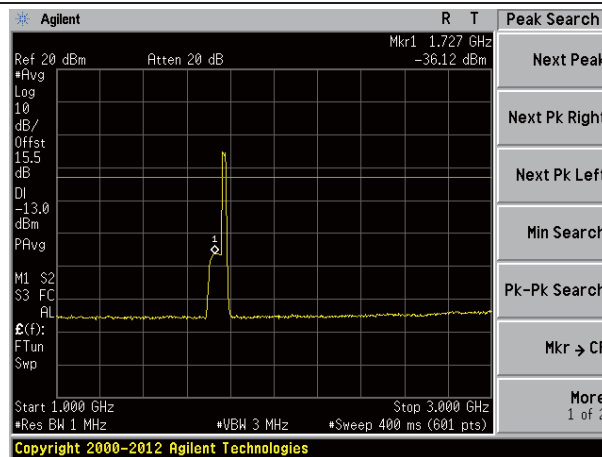

3000MHz-18000MHz

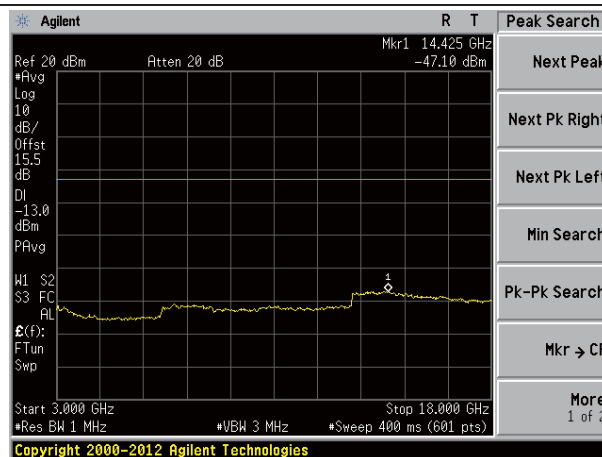

10.4.2 Band edge emission

Downlink:

Band edge of LTE 1.4MHz Bandwidth

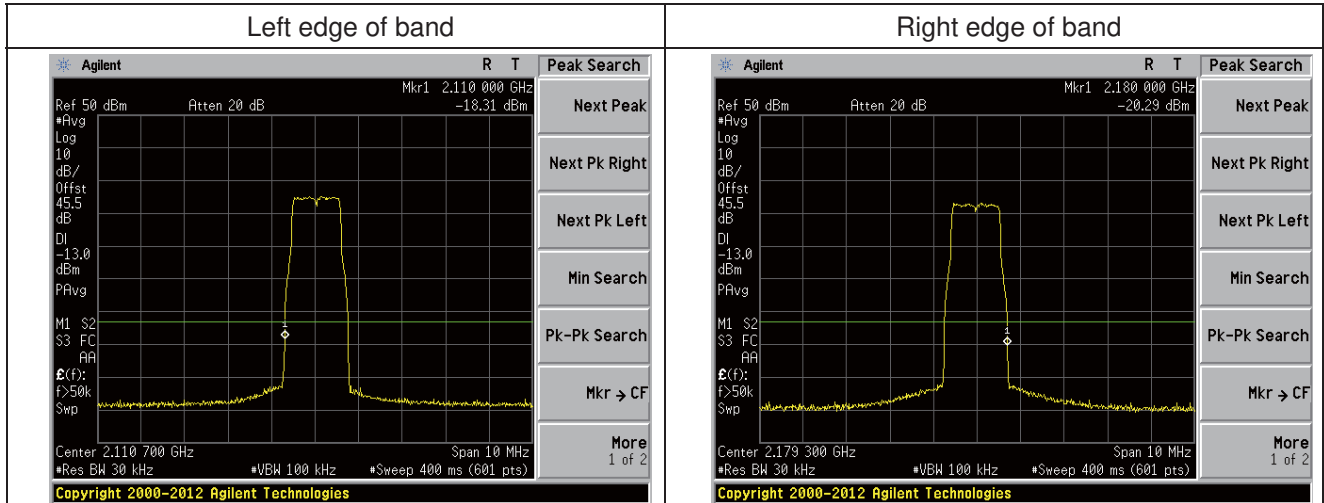

Band edge of LTE 3MHz Bandwidth

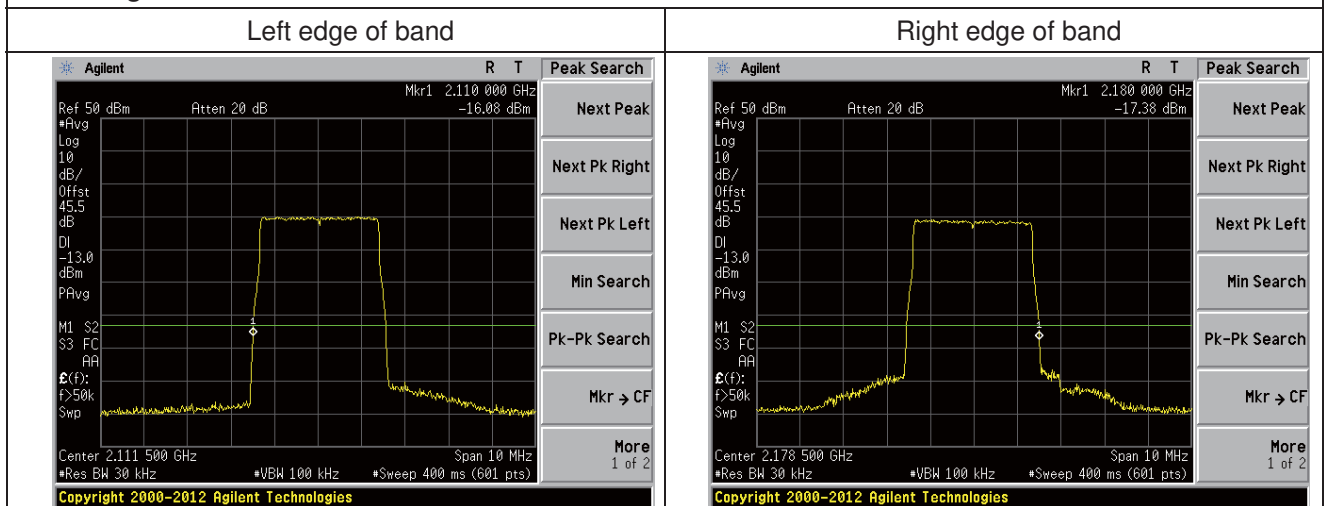

Band edge of LTE 5MHz Bandwidth

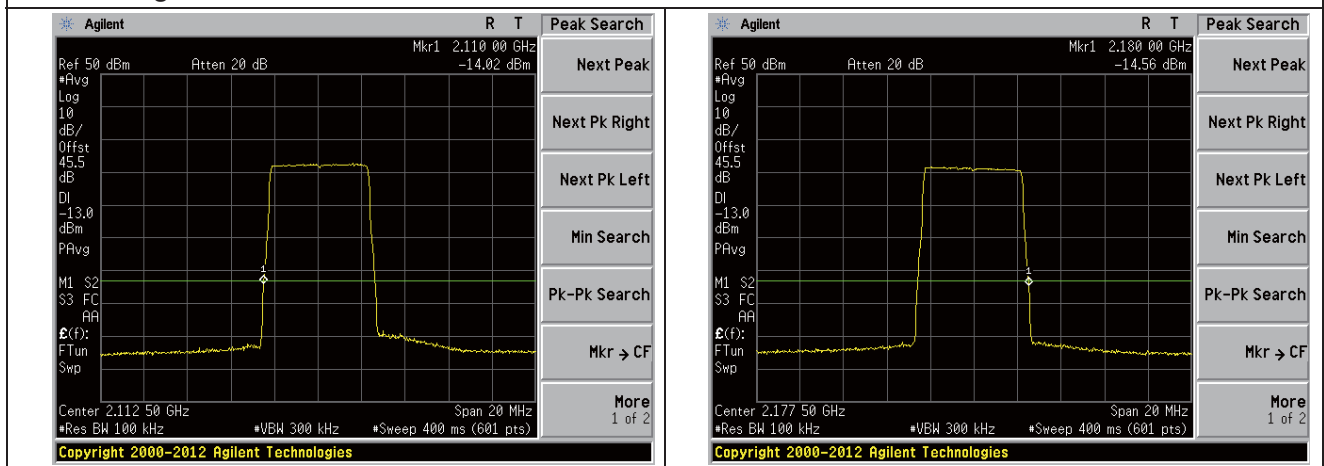

Band edge of LTE 10MHz Bandwidth

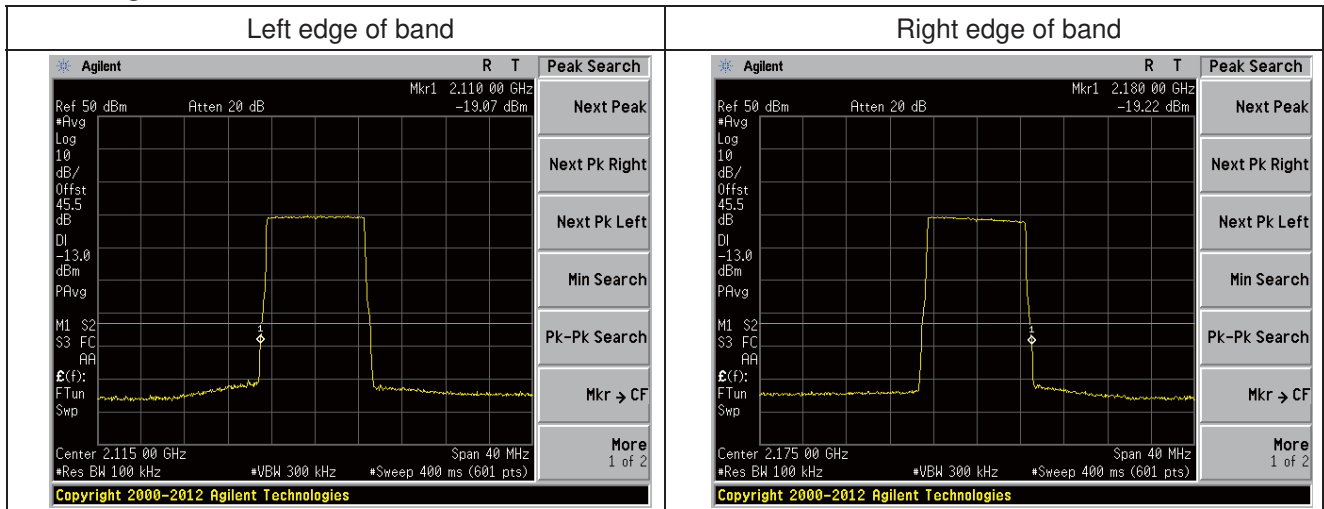

Band edge of LTE 15MHz Bandwidth

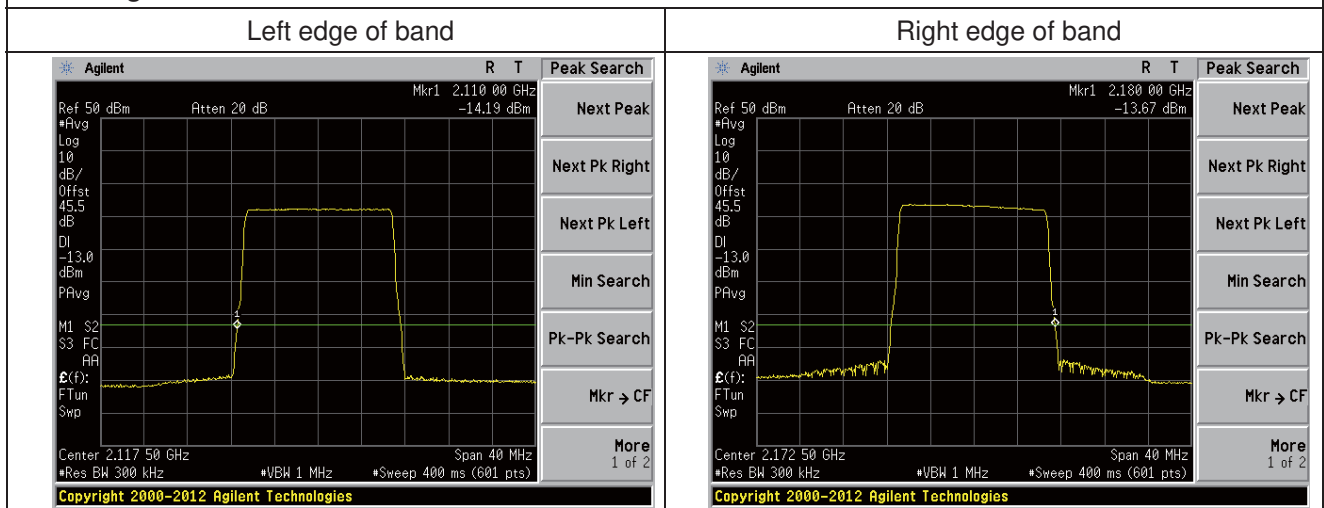

Band edge of LTE 20MHz Bandwidth

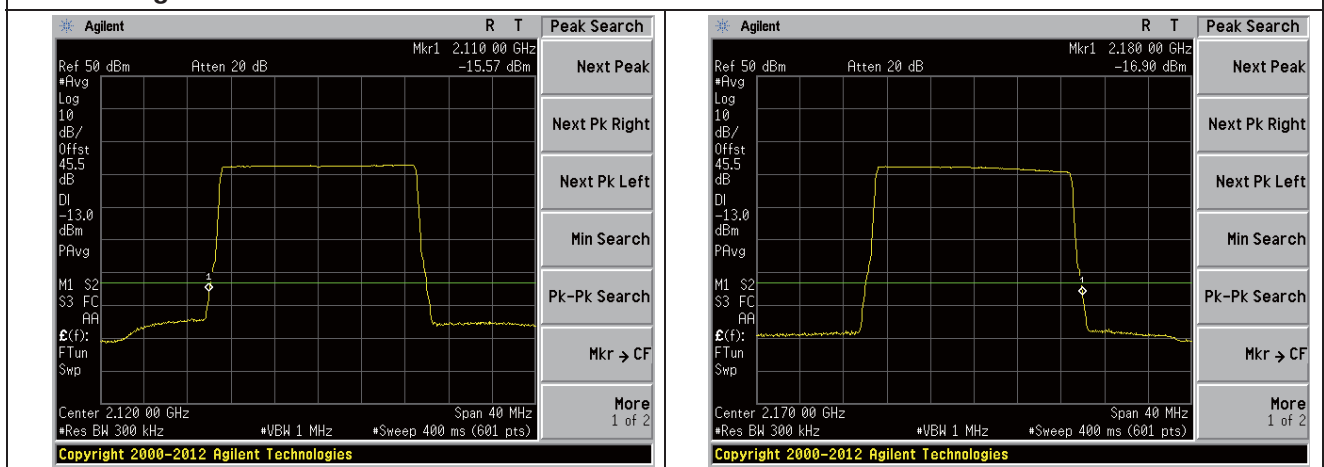

Band edge of WCDMA Single Carrier

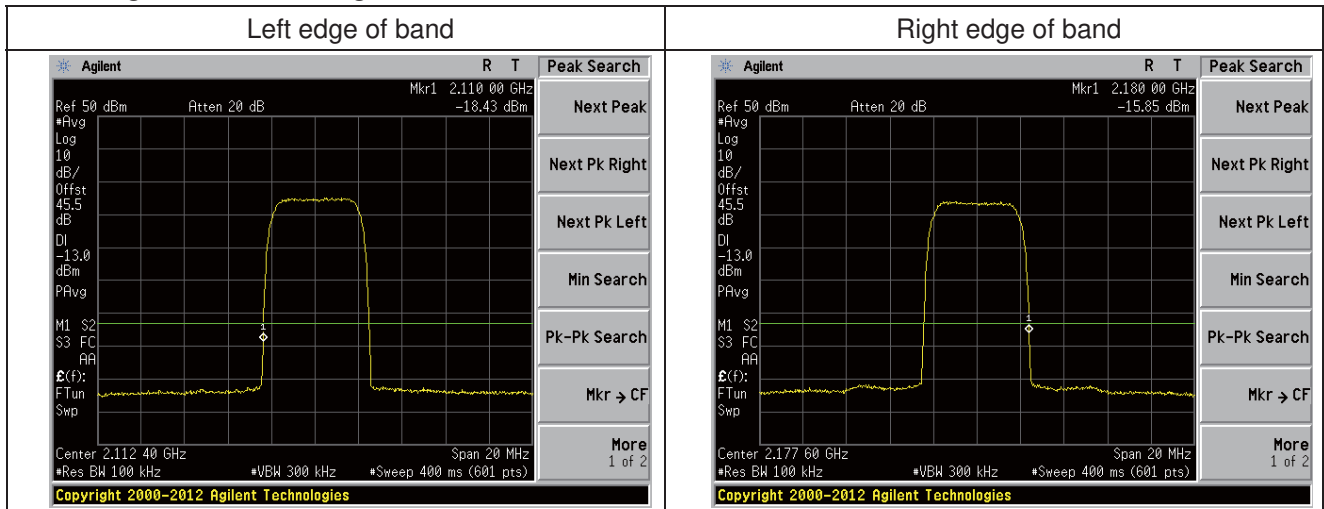

Band edge of WCDMA Four Carrier

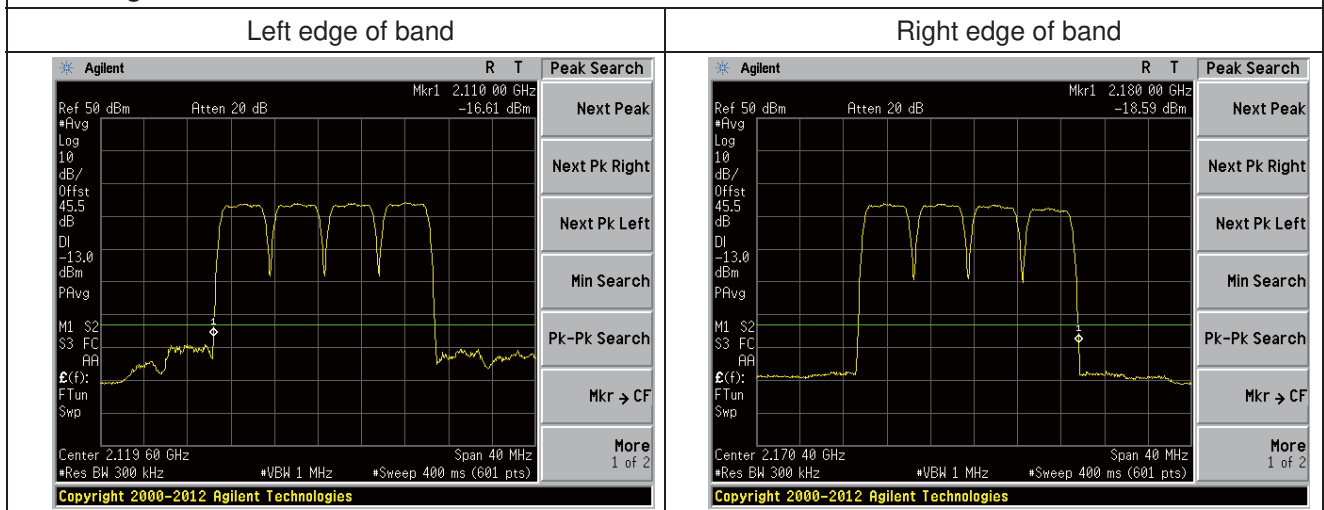

Uplink:

Band edge of LTE 1.4MHz Bandwidth

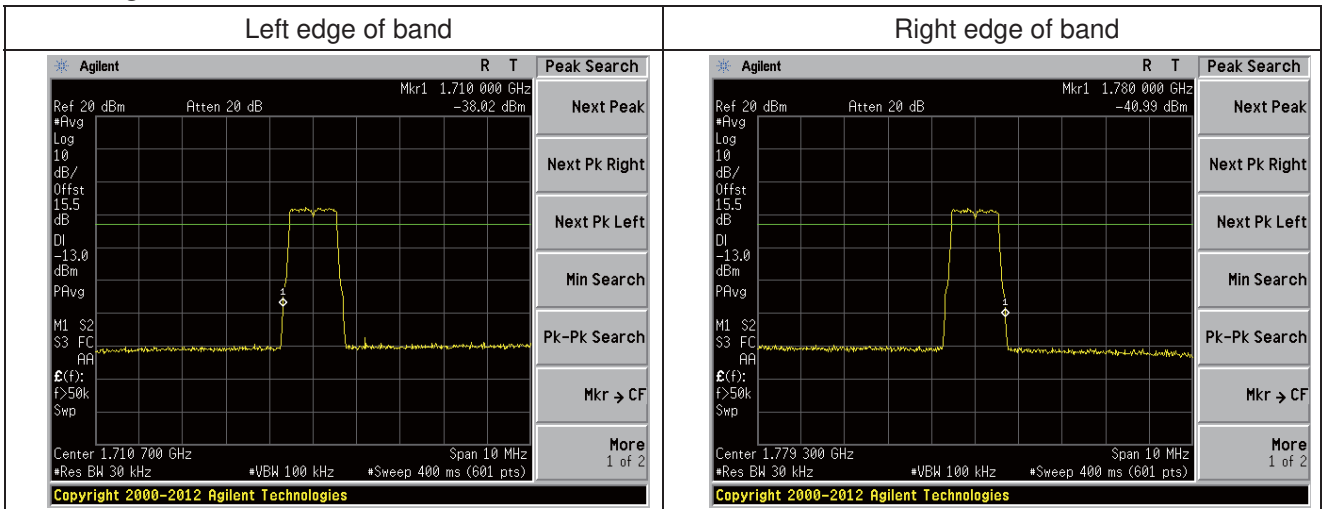

Band edge of LTE 3MHz Bandwidth

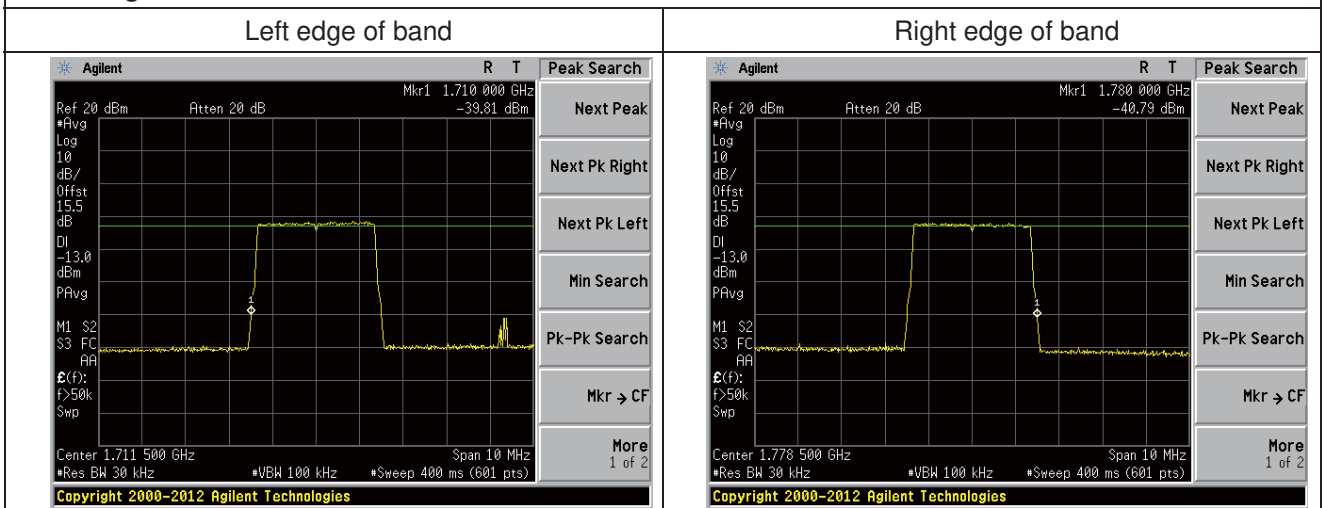

Band edge of LTE 5MHz Bandwidth

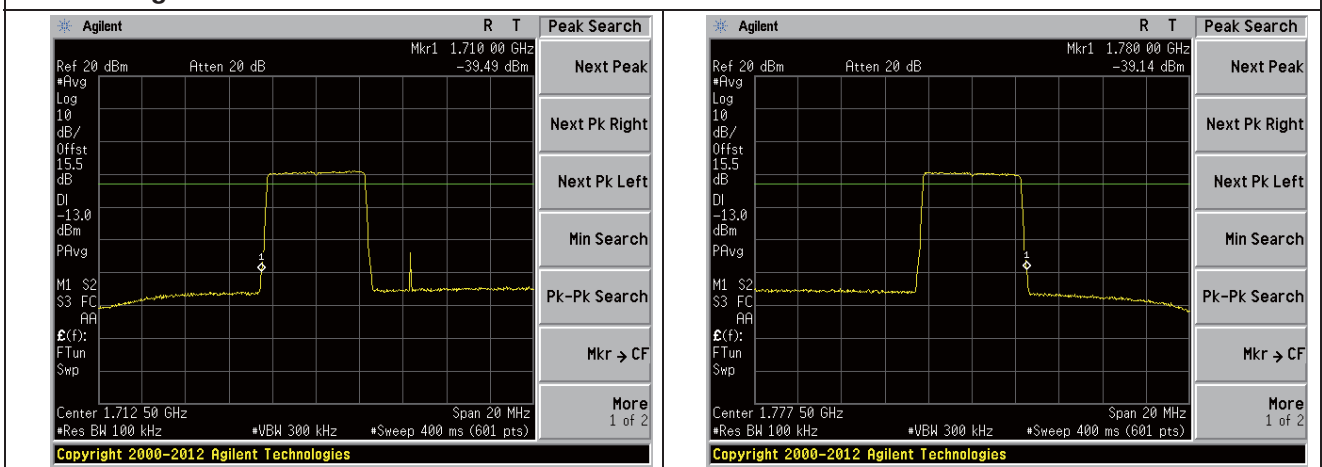

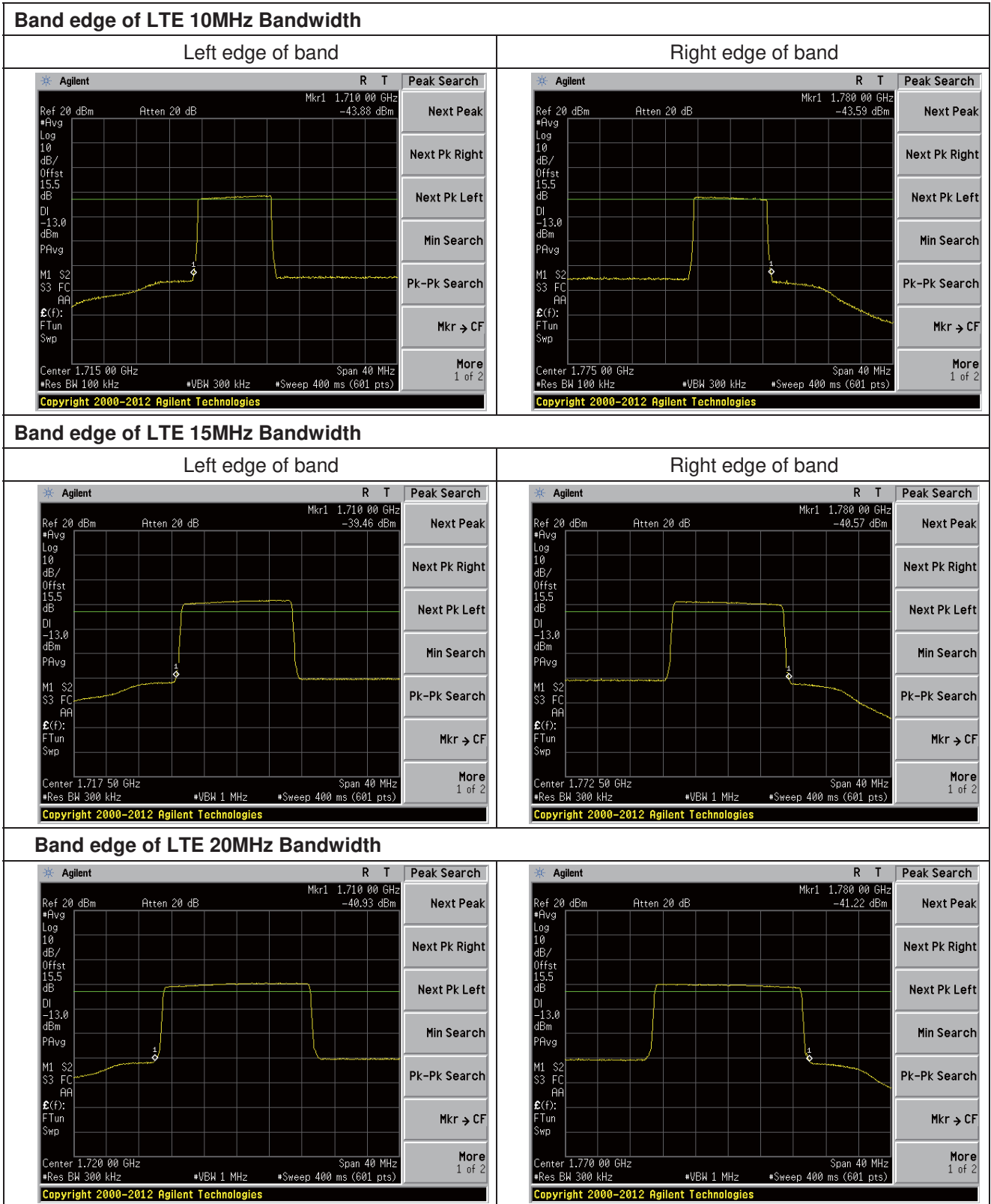

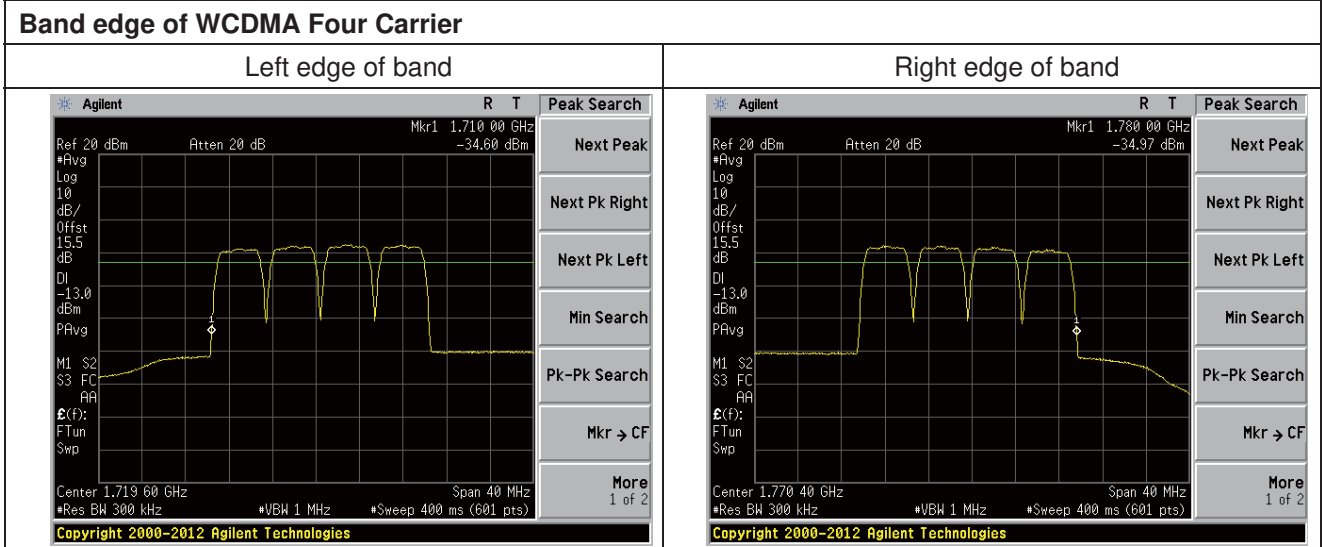
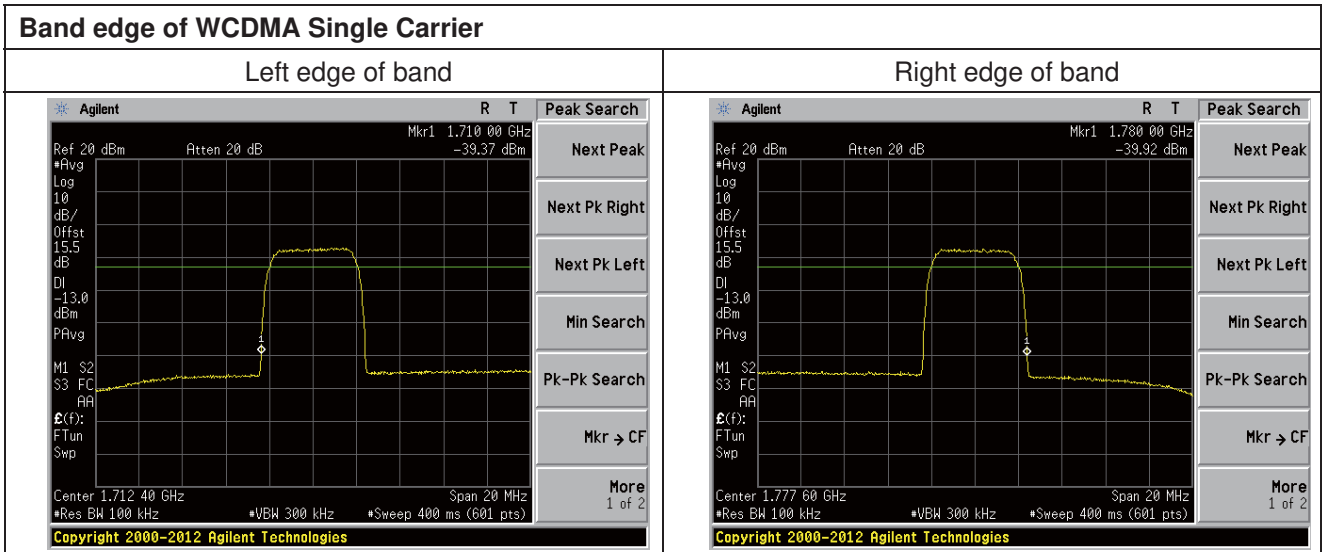

11 INTERMODULATION

11.1 Standard Applicable

According to FCC § 2.1051 and § 27.53(m)

11.2 Test setup

Please refer the section §6.2 Configuration of Tested System.

11.3 Measurement Procedure

1. The EUT RF output port was connected to spectrum analyzer. The EUT shall be set to maximum gain and maximum rated output power per channel.
2. Two continuous sinusoidal RF signals shall be fed to the input antenna port of the repeater using a combining device. The two channels near each other should be separated by at least one operating channel width.
3. The spurious emissions at antenna were measured at the RF output port of the EUT.
4. The modulation types tested is LTE and WCDMA.

Spectrum analyzer settings:

Detector: RMS.

Intermodulation:

RBW= 1% to 5 % of the anticipated OBW ; VBW \geq 3*RBW

Spurious emissions:

Below 1G: RBW=100kHz; Above 1G: RBW=1 MHz ; VBW \geq RBW

11.4 Test Result

Passed.

Downlink:

Intermodulation of LTE 1.4MHz Bandwidth

Intermodulation - Low part of band

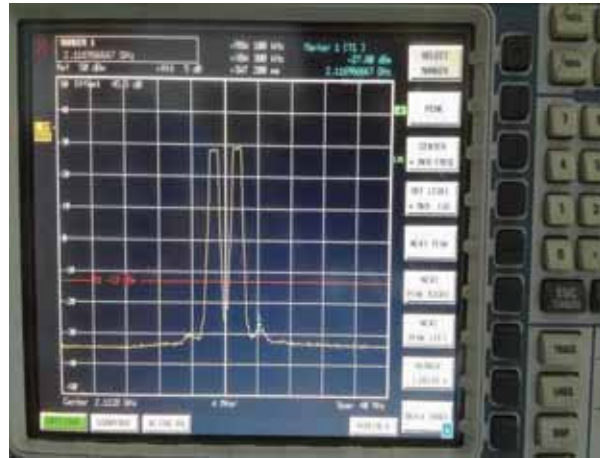

30MHz-1000MHz spurious emissions



1000MHz-3000MHz spurious emissions



3000MHz-22000MHz spurious emissions

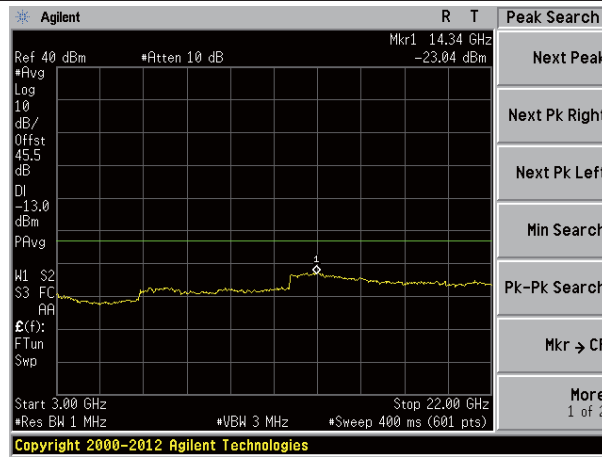

Intermodulation - High part of band



30MHz-1000MHz spurious emissions



1000MHz-3000MHz spurious emissions

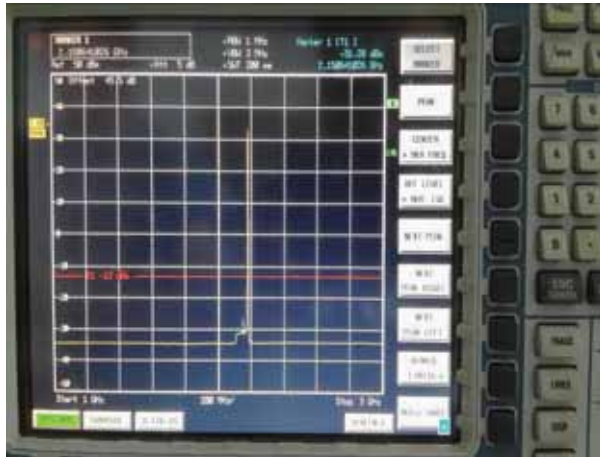

3000MHz-22000MHz spurious emissions

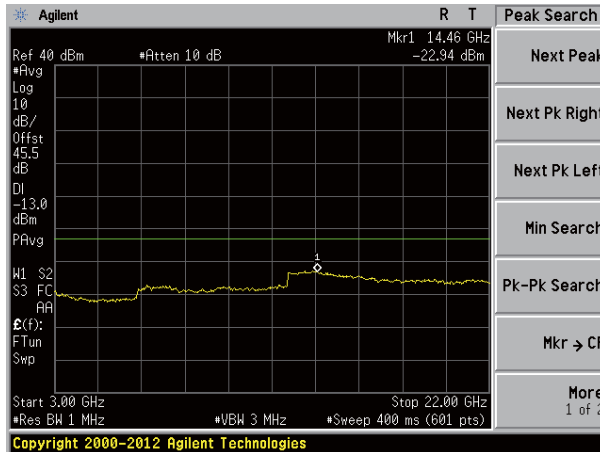

Intermodulation of LTE 3MHz Bandwidth

Intermodulation - Low part of band

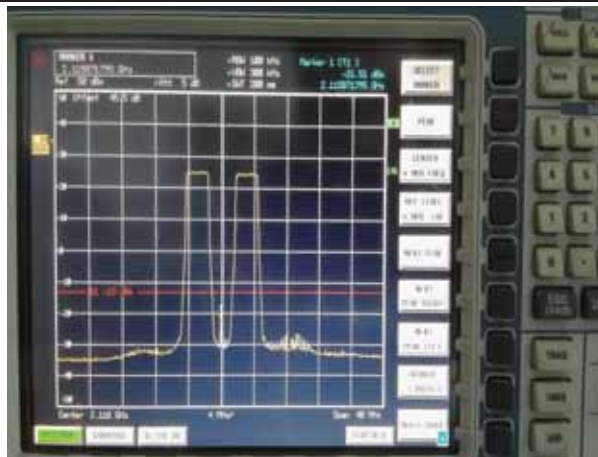

30MHz-1000MHz spurious emissions

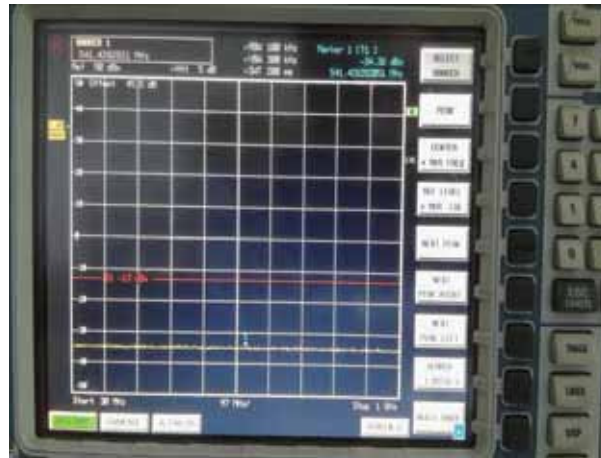

1000MHz-3000MHz spurious emissions

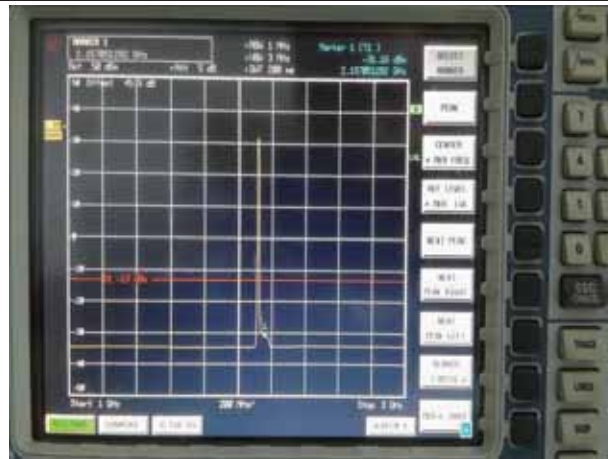

3000MHz-22000MHz spurious emissions

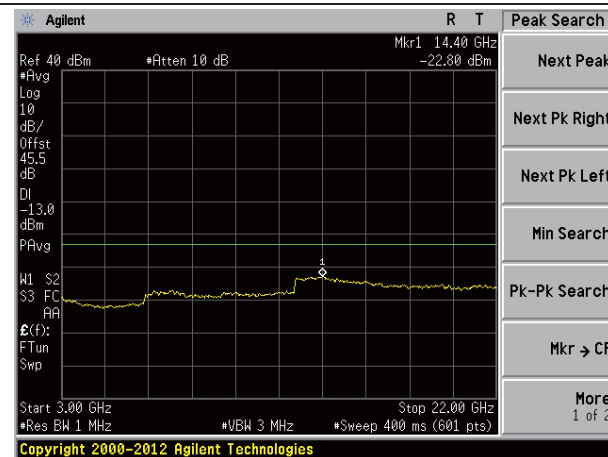

Intermodulation - High part of band



30MHz-1000MHz spurious emissions

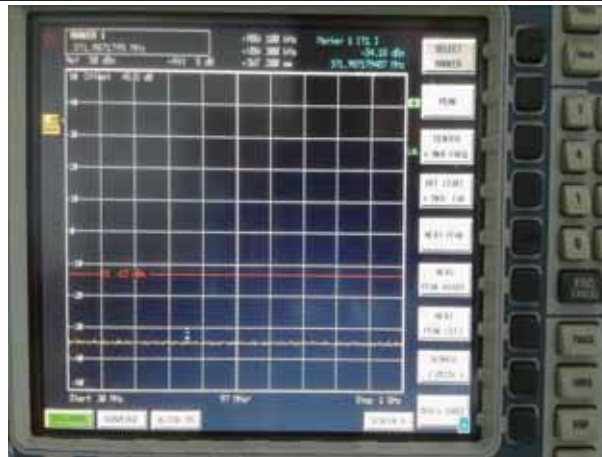

1000MHz-3000MHz spurious emissions

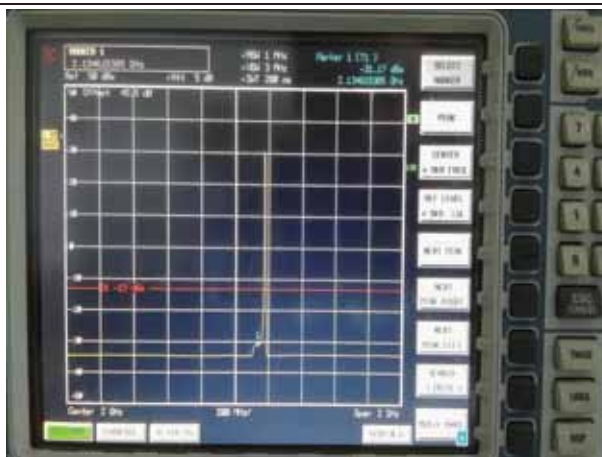

3000MHz-22000MHz spurious emissions

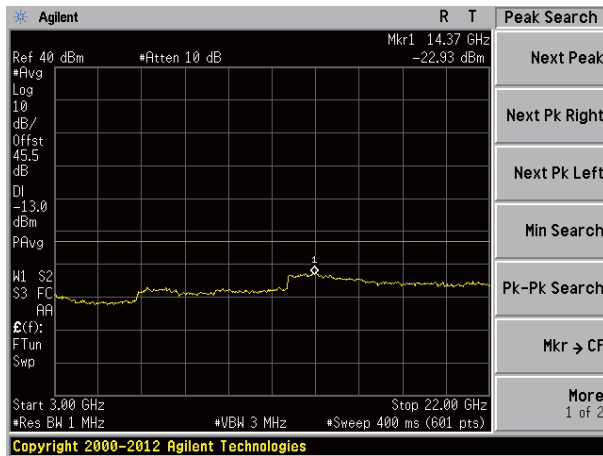

Intermodulation of LTE 5MHz Bandwidth

Intermodulation - Low part of band



30MHz-100MHz spurious emissions



1000MHz-3000MHz spurious emissions



3000MHz-22000MHz spurious emissions

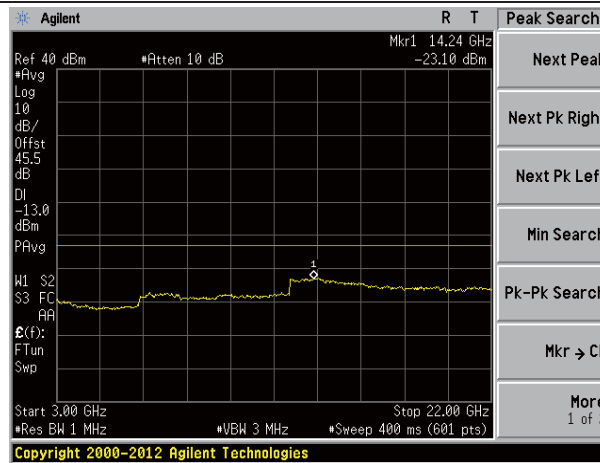

Intermodulation - High part of band



30MHz-1000MHz spurious emissions



1000MHz-10000MHz spurious emissions

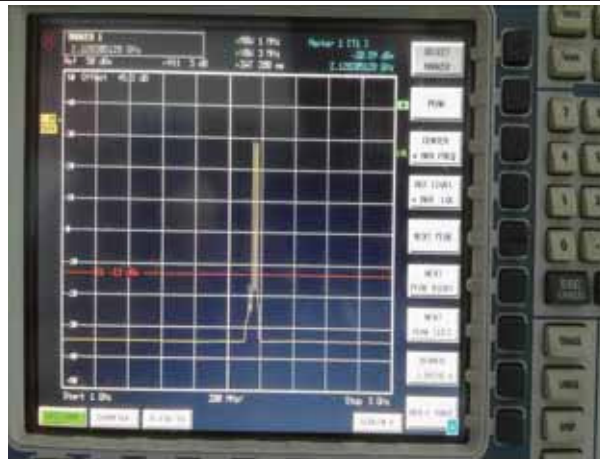

3000MHz-22000MHz spurious emissions

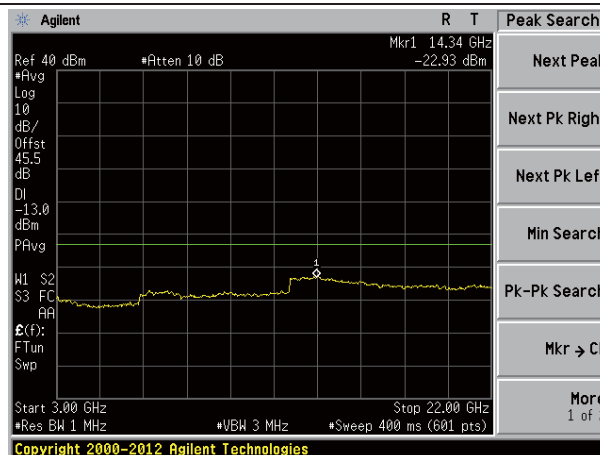

Intermodulation of LTE 10MHz Bandwidth

Intermodulation - Low part of band

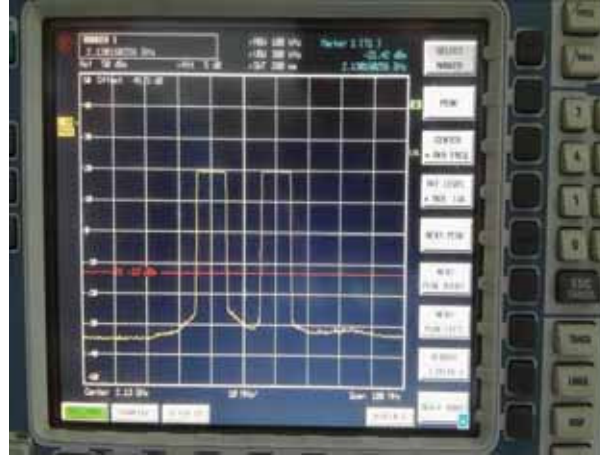

30MHz-1000MHz spurious emissions



1000MHz-3000MHz spurious emissions

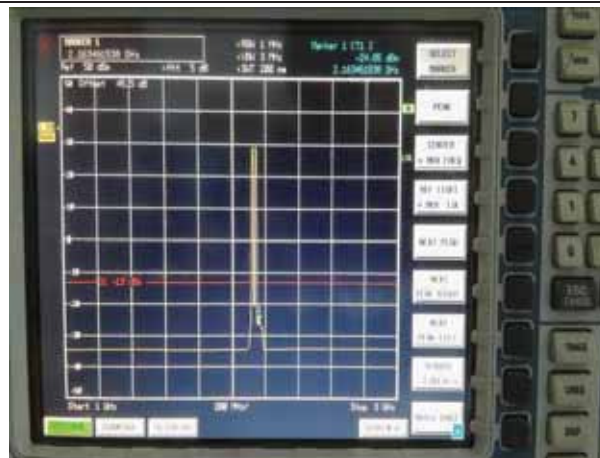

3000MHz-22000MHz spurious emissions

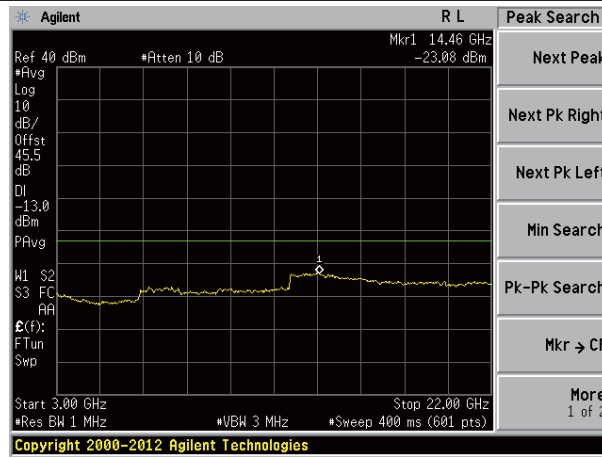

Intermodulation - High part of band



30MHz-1000MHz spurious emissions



1000MHz-3000MHz spurious emissions

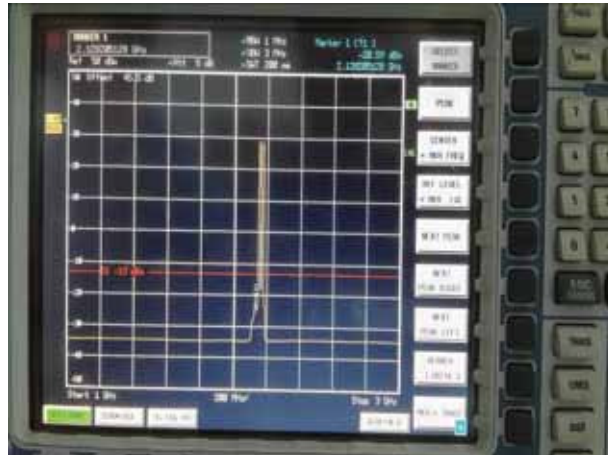

3000MHz-22000MHz spurious emissions

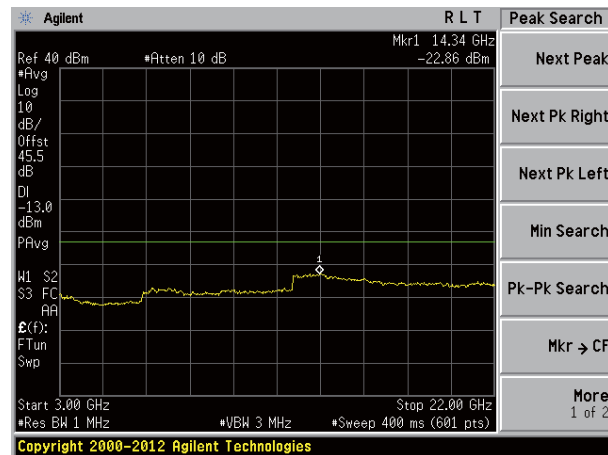

Intermodulation of LTE 15MHz Bandwidth

Intermodulation - Low part of band



30MHz-1000MHz spurious emissions



1000MHz-3000MHz spurious emissions



3000MHz-22000MHz spurious emissions

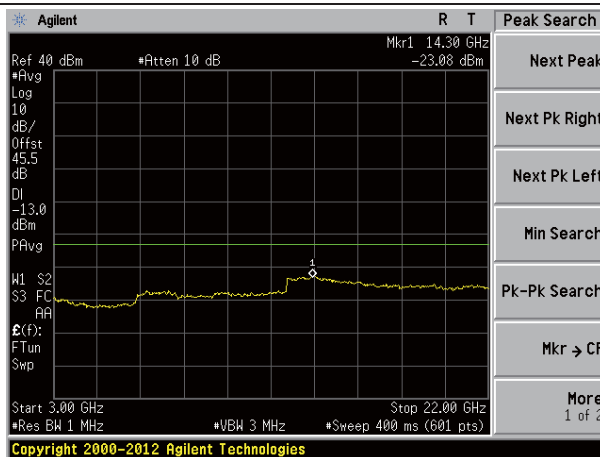

Intermodulation - High part of band



30MHz-1000MHz spurious emissions



1000MHz-3000MHz spurious emissions



3000MHz-22000MHz spurious emissions

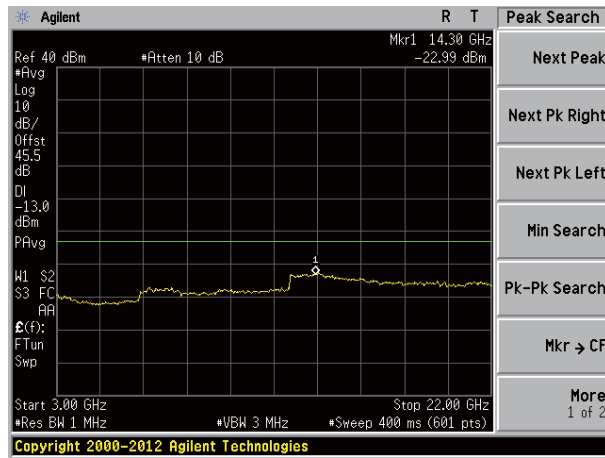

Intermodulation of LTE 20MHz Bandwidth

Intermodulation - Low part of band



30MHz-100MHz spurious emissions



1000MHz-3000MHz spurious emissions



3000MHz-22000MHz spurious emissions

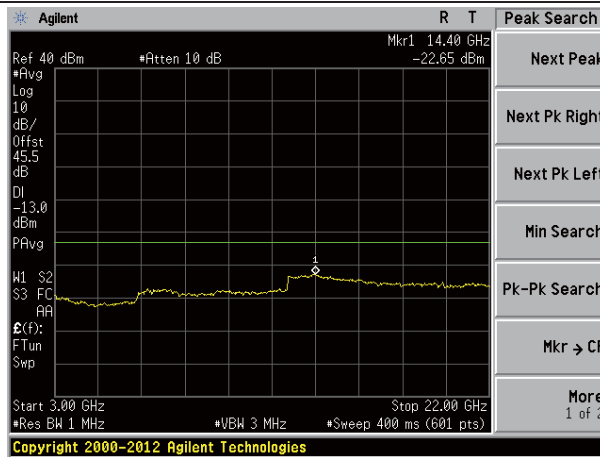

Intermodulation - High part of band



30MHz-1000MHz spurious emissions



1000MHz-3000MHz spurious emissions



3000MHz-22000MHz spurious emissions

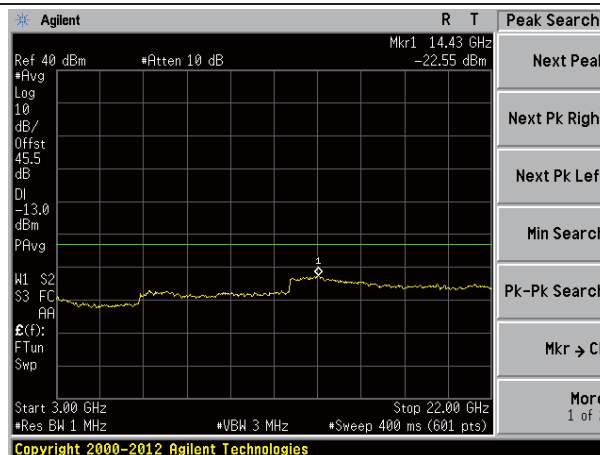

Intermodulation of WCDMA Single Carrier

Intermodulation - Low part of band

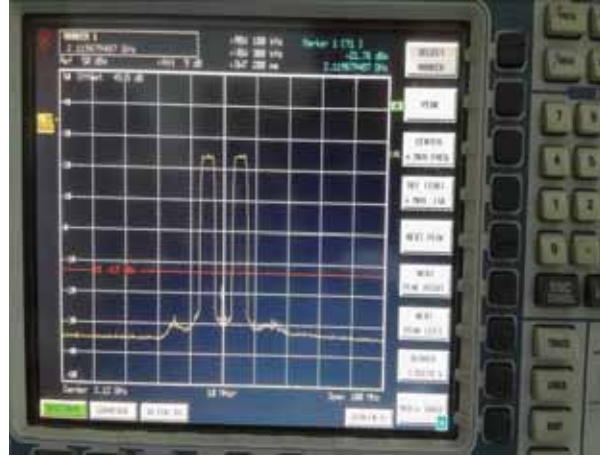

30MHz-1000MHz spurious emissions



1000MHz-3000MHz spurious emissions



3000MHz-22000MHz spurious emissions

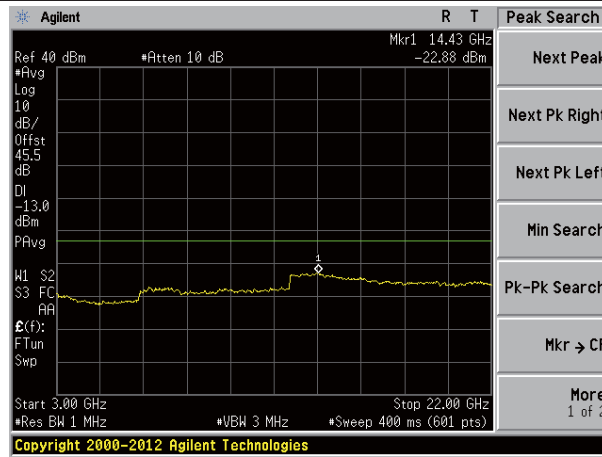

Intermodulation - High part of band

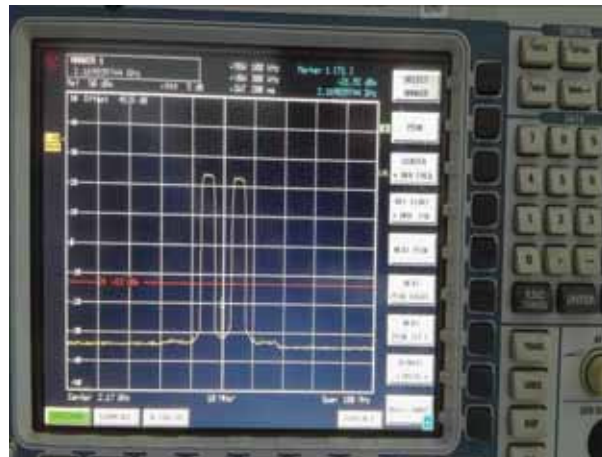

30MHz-1000MHz spurious emissions



1000MHz-3000MHz spurious emissions

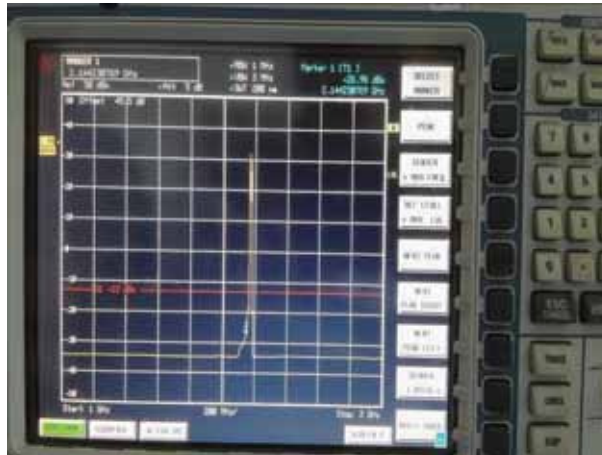

3000MHz-22000MHz spurious emissions

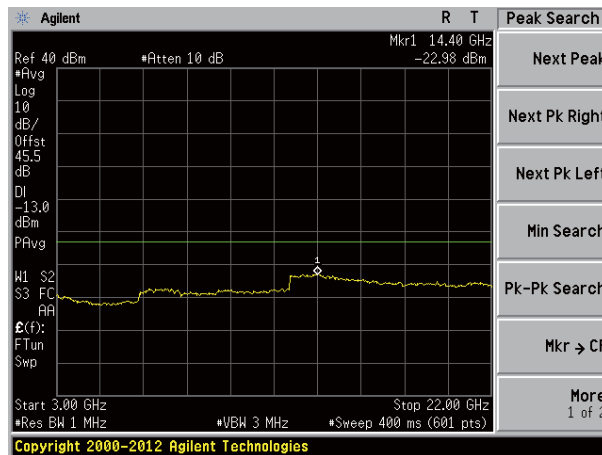

Intermodulation of WCDMA Four Carrier

Intermodulation - Low part of band



30MHz-1000MHz spurious emissions



1000MHz-3000MHz spurious emissions



3000MHz-22000MHz spurious emissions

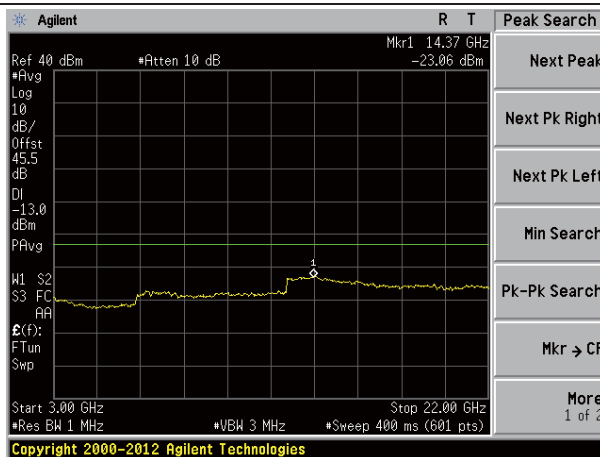

Intermodulation - High part of band



30MHz-1000MHz spurious emissions



1000MHz-3000MHz spurious emissions



3000MHz-22000MHz spurious emissions

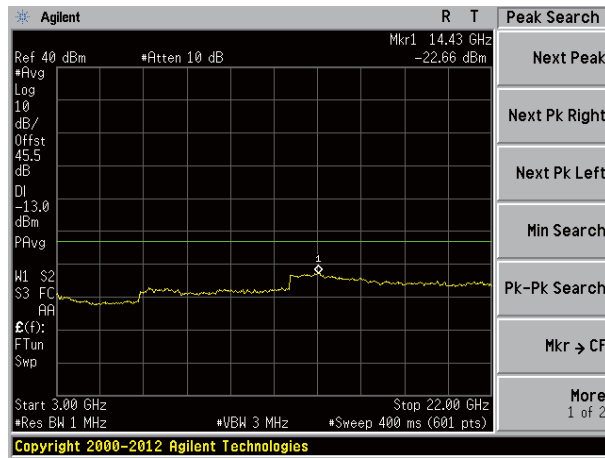

Uplink:

Intermodulation of LTE 1.4MHz Bandwidth

Intermodulation - Low part of band



30MHz-1000MHz spurious emissions



1000MHz-3000MHz spurious emissions



3000MHz-18000MHz spurious emissions

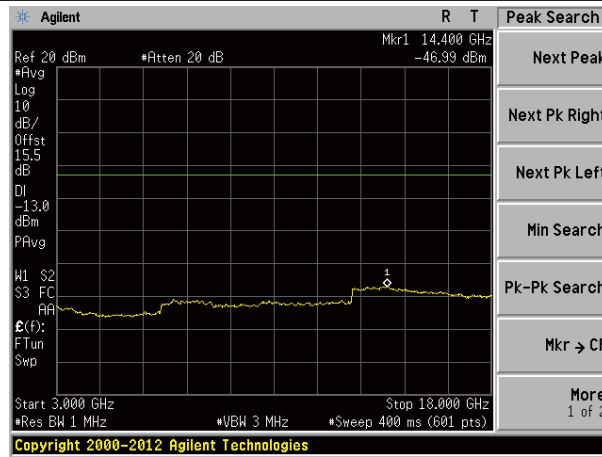

Intermodulation - High part of band



30MHz-1000MHz spurious emissions



1000MHz-3000MHz spurious emissions



3000MHz-18000MHz spurious emissions

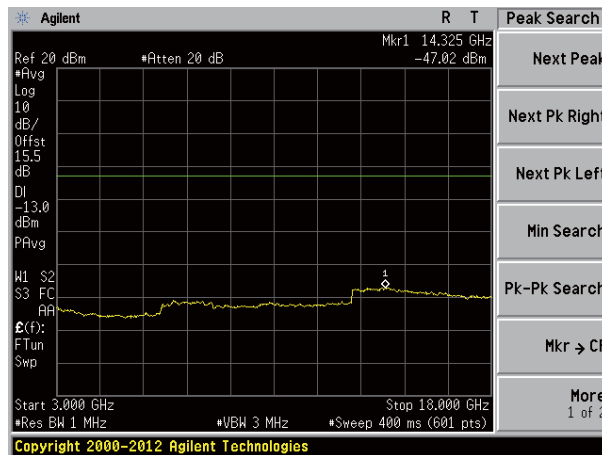

Intermodulation of LTE 3MHz Bandwidth

Intermodulation - Low part of band

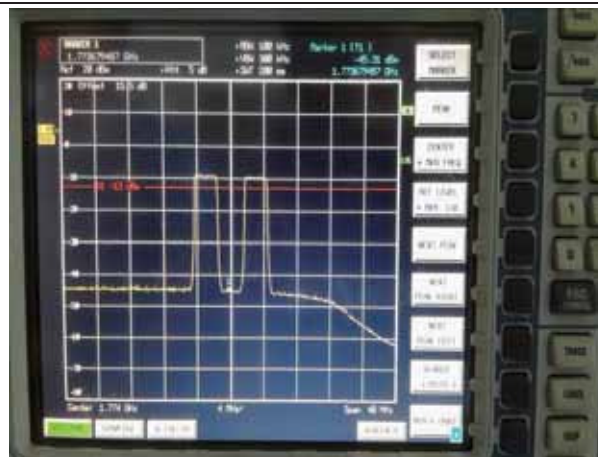

30MHz-1000MHz spurious emissions



1000MHz-3000MHz spurious emissions



3000MHz-18000MHz spurious emissions

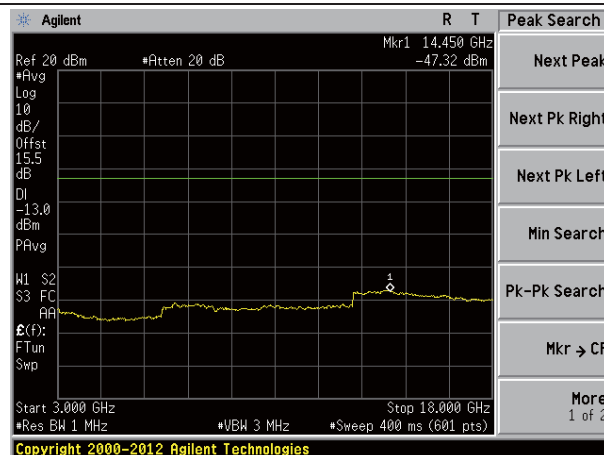

Intermodulation - High part of band



30MHz-1000MHz spurious emissions



1000MHz-3000MHz spurious emissions



3000MHz-18000MHz spurious emissions

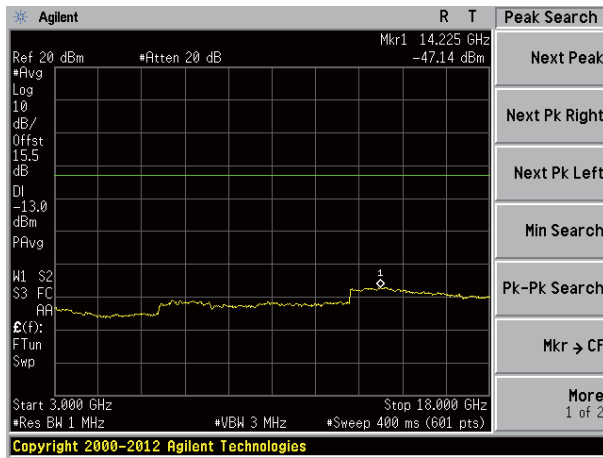

Intermodulation of LTE 5MHz Bandwidth

Intermodulation - Low part of band



30MHz-100MHz spurious emissions



1000MHz-3000MHz spurious emissions



3000MHz-18000MHz spurious emissions

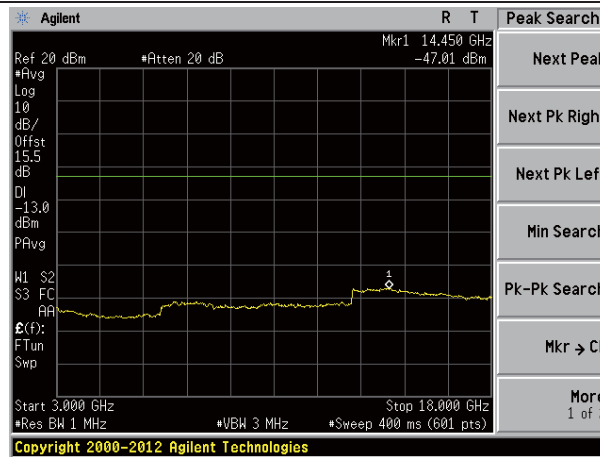

Intermodulation - High part of band



30MHz-1000MHz spurious emissions



1000MHz-10000MHz spurious emissions

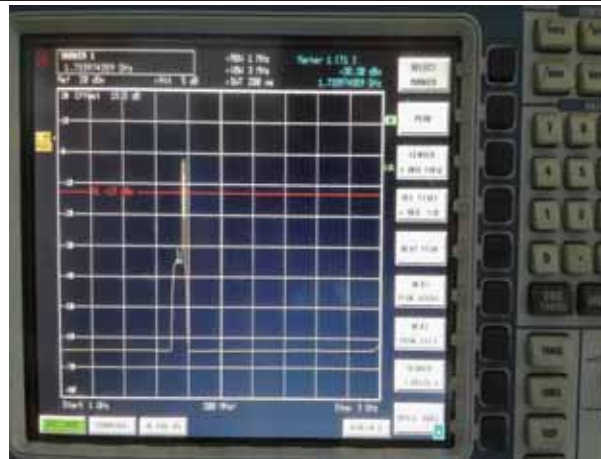

3000MHz-18000MHz spurious emissions

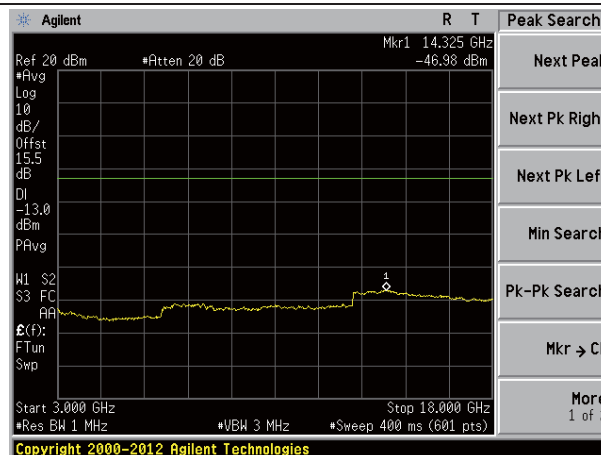

Intermodulation of LTE 10MHz Bandwidth

Intermodulation - Low part of band



30MHz-1000MHz spurious emissions

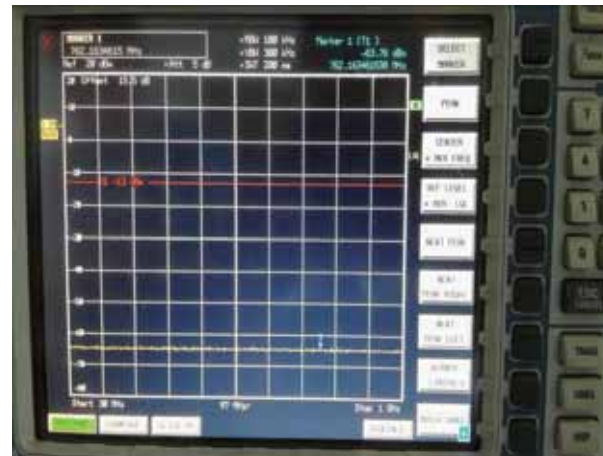

1000MHz-3000MHz spurious emissions



3000MHz-18000MHz spurious emissions

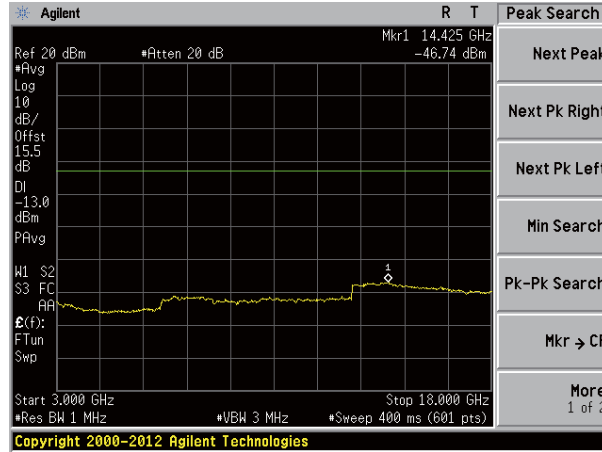

Intermodulation - High part of band

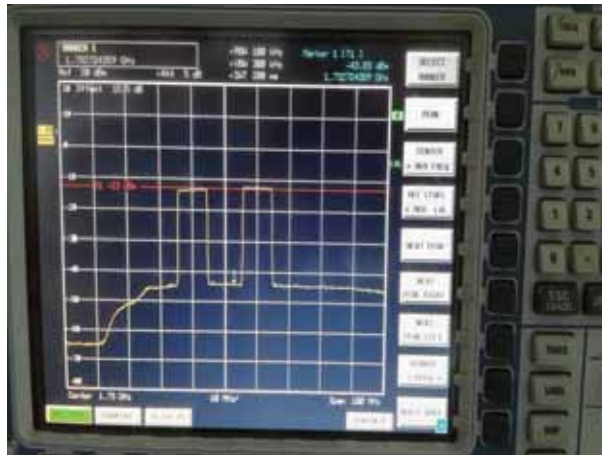

30MHz-1000MHz spurious emissions



1000MHz-3000MHz spurious emissions

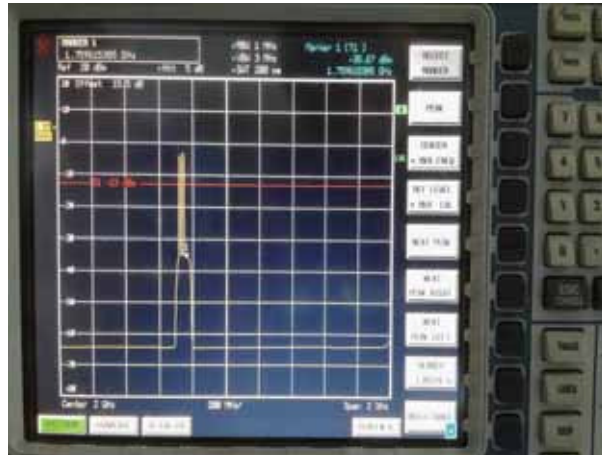

3000MHz-18000MHz spurious emissions

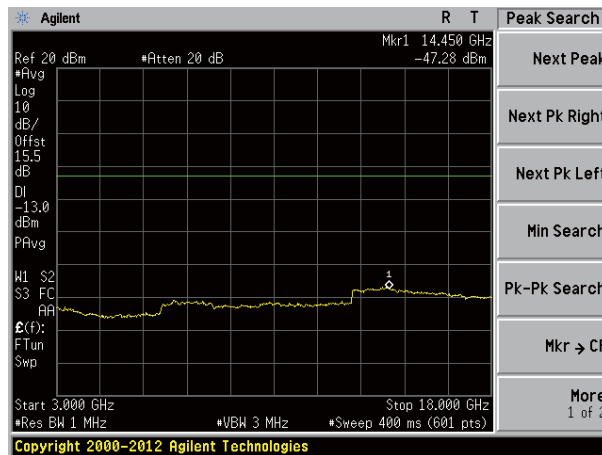

Intermodulation of LTE 15MHz Bandwidth

Intermodulation - Low part of band



30MHz-1000MHz spurious emissions



1000MHz-3000MHz spurious emissions



3000MHz-18000MHz spurious emissions

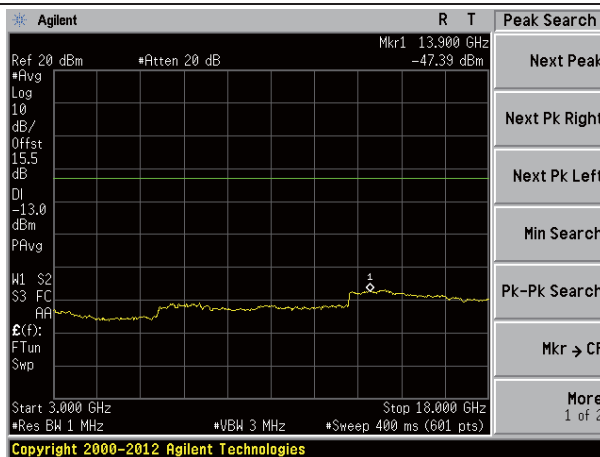

Intermodulation - High part of band

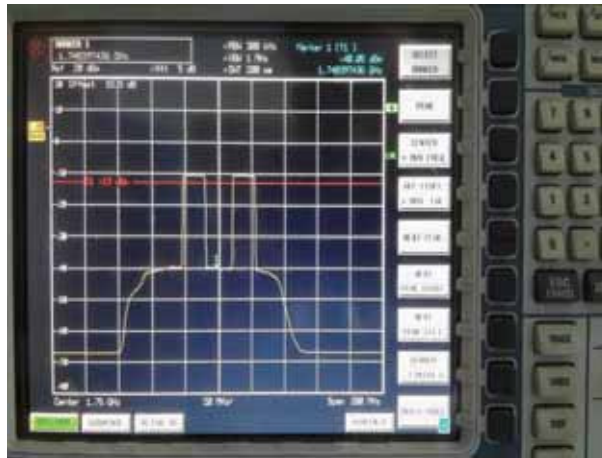

30MHz-1000MHz spurious emissions

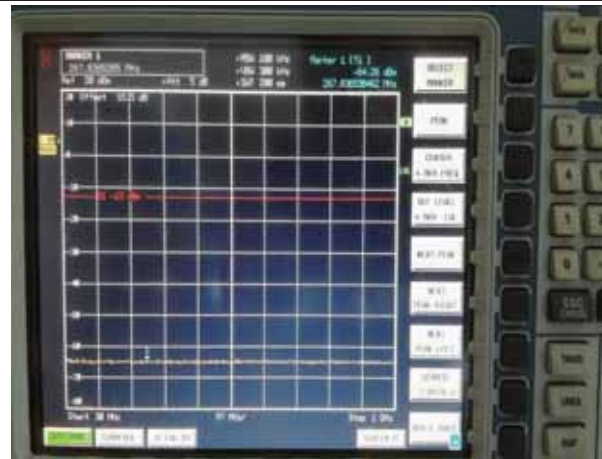

1000MHz-3000MHz spurious emissions

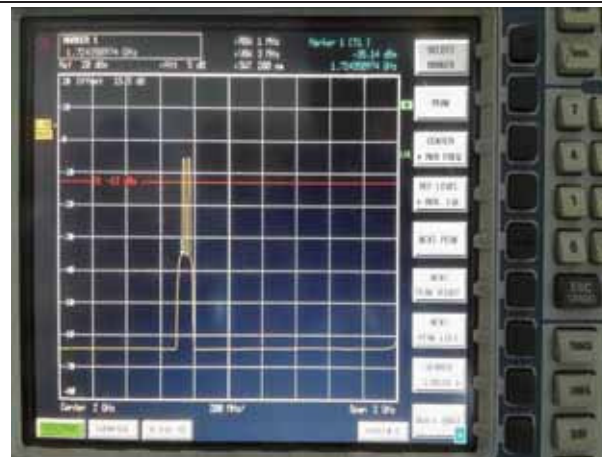

3000MHz-18000MHz spurious emissions

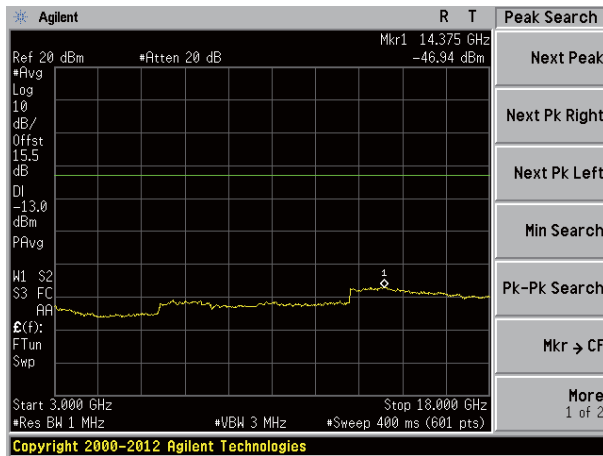

Intermodulation of LTE 20MHz Bandwidth

Intermodulation - Low part of band

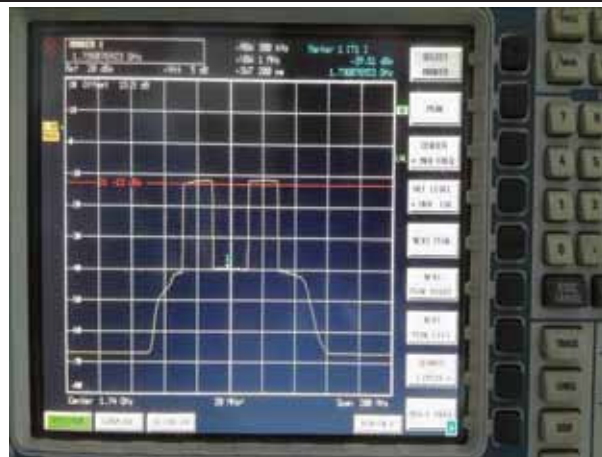

30MHz-1000MHz spurious emissions



1000MHz-3000MHz spurious emissions



3000MHz-18000MHz spurious emissions

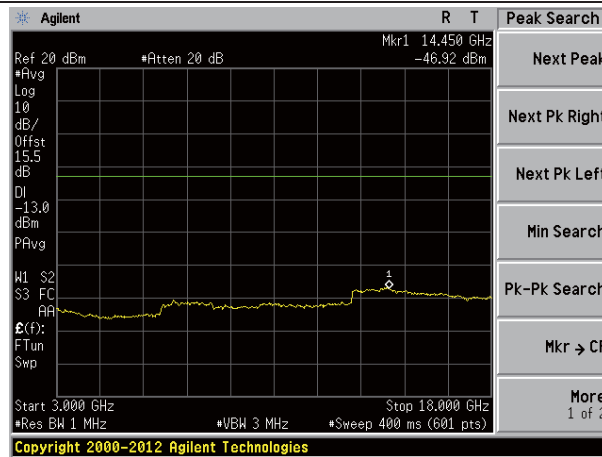

Intermodulation - High part of band



30MHz-1000MHz spurious emissions

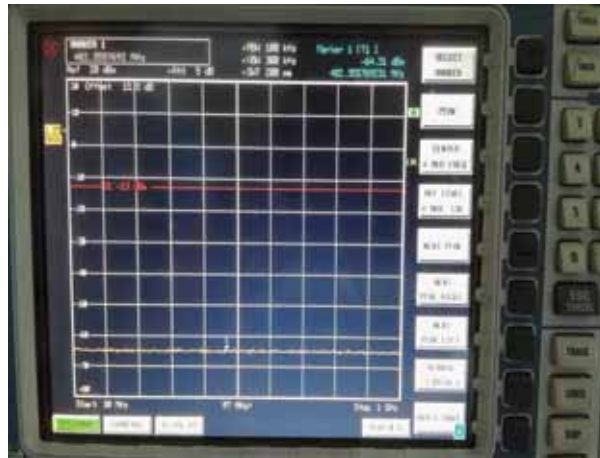

1000MHz-3000MHz spurious emissions



3000MHz-18000MHz spurious emissions

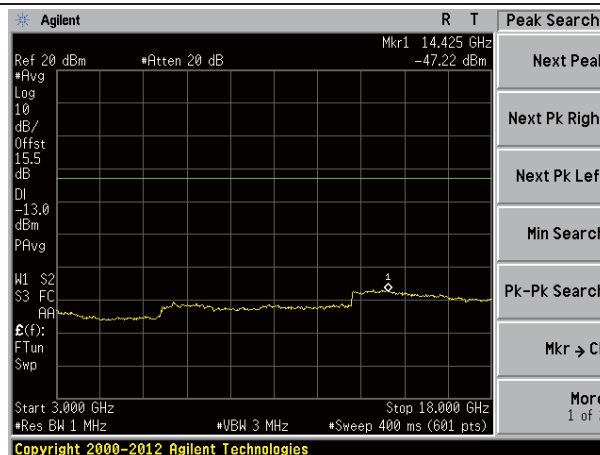

Intermodulation of WCDMA Single Carrier

Intermodulation - Low part of band



30MHz-1000MHz spurious emissions

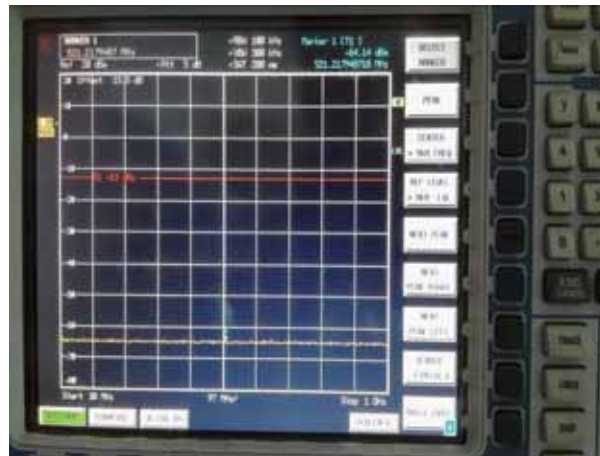

1000MHz-3000MHz spurious emissions

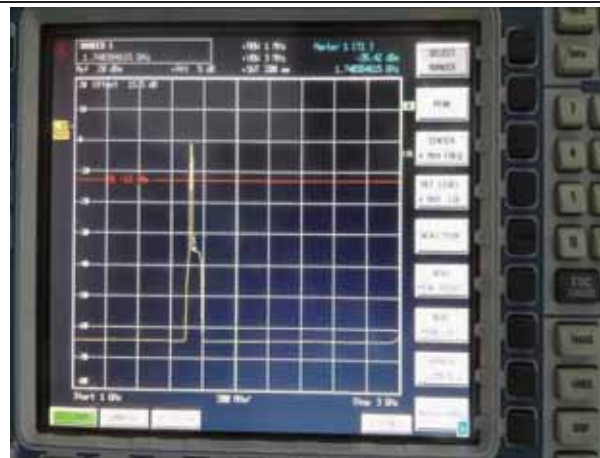

3000MHz-18000MHz spurious emissions

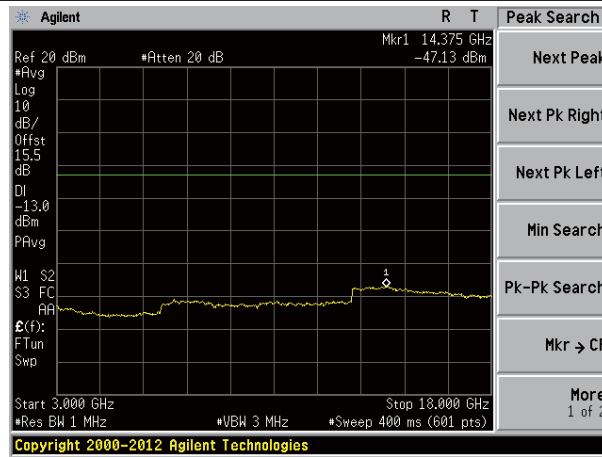

Intermodulation - High part of band



30MHz-1000MHz spurious emissions



1000MHz-3000MHz spurious emissions



3000MHz-18000MHz spurious emissions

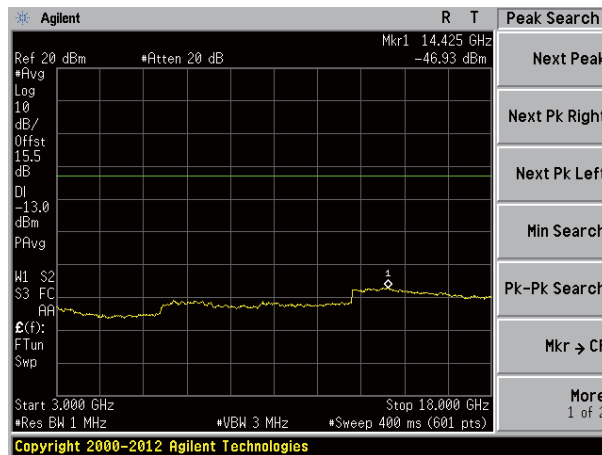

Intermodulation of WCDMA Four Carrier

Intermodulation - Low part of band



30MHz-1000MHz spurious emissions



1000MHz-3000MHz spurious emissions

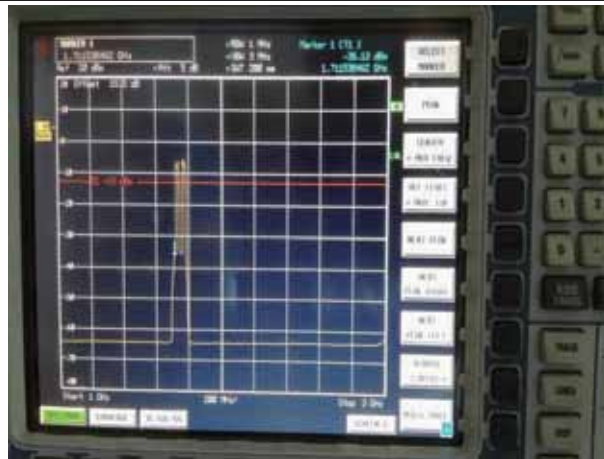

3000MHz-18000MHz spurious emissions

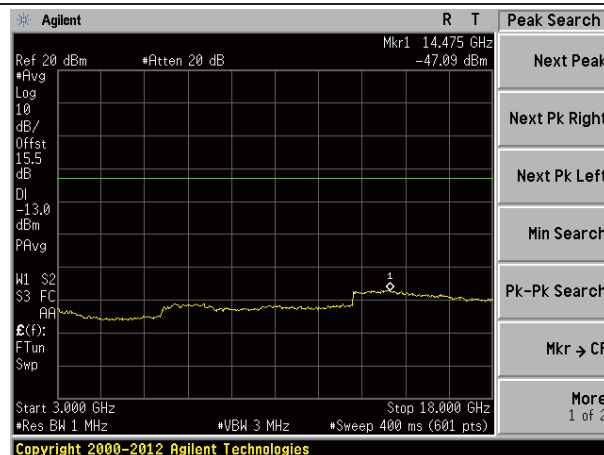

Intermodulation - High part of band



30MHz-1000MHz spurious emissions



1000MHz-3000MHz spurious emissions



3000MHz-18000MHz spurious emissions

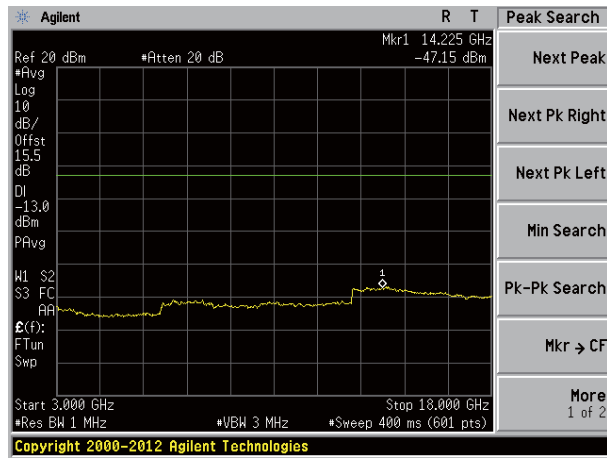

12 FIELD STRENGTH OF SPURIOUS RADIATION MEASUREMENT

12.1 Standard Applicable

According to FCC § 2.1053 and § 27.53(m)

12.2 EUT Setup (Block Diagram of Configuration)

Please refer the section §6.2 Configuration of Tested System.

12.3 Measurement Procedure

1. The EUT RF output port was connected to 50 ohm RF load.
2. The EUT input port was connected to signal generator and was setup to transmit maximum power.
3. The measurement antenna was placed at a distance of 3 meters from the EUT.
4. During the tests, the antenna height and polarization as well as EUT azimuth were varied in order to identify the maximum level of emissions from EUT.
5. The frequency range up to 10-th harmonic of each of the three fundamental frequencies (low, middle and high channels) was investigated. The worst case of emissions was reported.
6. For spurious emissions attenuation, the substitution method was used.
7. The EUT was substituted by a reference antenna (half-wave dipole – below 1 GHz, or Horn antenna – above 1 GHz), connected to a signal generator.
8. The signal generator output level was adjusted to obtain the same reading as from EUT. The EIRP at the spurious emissions frequency was calculated as follows:
$$\text{EIRP} = \text{S.G. output (dBm)} + \text{Antenna Gain(dBi)} - \text{Cable Loss (dB)}$$
9. The antenna substitution method is used to determine the equivalent radiated power at spurious frequencies. The spurious emissions are measured at a distance of 3 meters. The EUT is then replaced with a reference substitution antenna with a known gain referenced to a dipole. This antenna is fed with a signal at the spurious frequency. The level of the signal is adjusted to repeat the previously measured level. The resulting eirp is the signal level fed to the reference antenna corrected for gain referenced to an isotropic dipole
10. From KDB (AMPLIFIER, BOOSTER, AND REPEATER REMINDER SHEET): Radiated spurs (enclosure) – Use of CW signal (low, mid. and high freq.) is acceptable rather than all modulations.
11. The maximum RFI field strength was determined during the measurement by rotating the turntable (± 180 degrees) and varying the height of the receive antenna ($h = 1 \dots 4$ m) as like defined in ANSI C63.4. A measurement receiver has been used with a RBW 120 kHz up to 1 GHz and 1 MHz above 1 GHz. Steps with during pre measurement was half the RBW.
12. Both, the Fully Anechoic Chamber (FAC) and the Semi Anechoic Chamber (SAC) fulfil the requirements of ANSI C63.4 and CISPR 16-1-4 with regards to NSA and SVSWR.

12.4 Measurement data

Downlink mode

Test mode:	Below 1G		Test channel:	Lowest channel
Frequency (MHz)	Spurious Emission		Limit (dBm)	Result
	Polarization	Level (dBm)		
32.63	Vertical	-36.31	-13.00	Pass
39.02	V	-31.88		
52.21	V	-41.13		
90.86	V	-41.54		
152.66	V	---		
225.31	V	---		
32.18	Horizontal	-54.90	-13.00	Pass
39.02	H	-49.47		
52.76	H	-50.31		
91.82	H	-51.90		
130.38	H	---		
216.78	H	---		
Test mode:	Above 1G		Test channel:	Lowest channel
Frequency (MHz)	Spurious Emission		Limit (dBm)	Result
	Polarization	Level (dBm)		
2358.00	Vertical	-53.43	-13.00	Pass
3865.00	V	-51.25		
5719.00	V	-52.37		
7634.00	V	---		
8827.00	V	---		
1527.00	Horizontal	-56.38	-13.00	Pass
3869.00	H	-55.21		
5328.00	H	-53.19		
6651.00	H	---		
8418.00	H	---		

Test mode:	Below 1G		Test channel:	Middle channel
Frequency (MHz)	Spurious Emission		Limit (dBm)	Result
	Polarization	Level (dBm)		
30.32	Vertical	-37.81	-13.00	Pass
43.51	V	-37.73		
52.76	V	-34.55		
93.44	V	-41.22		
130.84	V	---		
198.59	V	---		
32.86	Horizontal	-54.95	-13.00	Pass
42.90	H	-52.36		
88.34	H	-53.67		
118.60	H	-46.51		
212.27	H	---		
256.52	H	---		
Test mode:	Above 1G		Test channel:	Middle channel
Frequency (MHz)	Spurious Emission		Limit (dBm)	Result
	Polarization	Level (dBm)		
2518.00	Vertical	-53.95	-13.00	Pass
3427.00	V	-52.35		
5675.00	V	-52.72		
8251.00	V	---		
9357.00	V	---		
1255.00	Horizontal	-56.31	-13.00	Pass
4236.00	H	-55.47		
5527.00	H	-53.29		
6938.00	H	---		
8421.00	H	---		

Test mode:	Below 1G		Test channel:	Highest channel
Frequency (MHz)	Spurious Emission		Limit (dBm)	Result
	Polarization	Level (dBm)		
32.98	Vertical	-36.19	-13.00	Pass
38.21	V	-32.50		
53.88	V	-38.84		
96.44	V	-42.86		
158.67	V	---		
178.13	V	---		
34.52	Horizontal	-57.14	-13.00	Pass
37.95	H	-48.07		
53.88	H	-51.42		
84.41	H	-54.15		
127.67	H	---		
162.61	H	---		
Test mode:	Above 1G		Test channel:	Highest channel
Frequency (MHz)	Spurious Emission		Limit (dBm)	Result
	Polarization	Level (dBm)		
1671.00	Vertical	-54.38	-13.00	Pass
2957.00	V	-54.21		
5520.00	V	-53.39		
7469.00	V	---		
9157.00	V	---		
2371.00	Horizontal	-56.29	-13.00	Pass
3922.00	H	-55.51		
5365.00	H	-53.42		
6847.00	H	---		
8839.00	H	---		

Remark:

1. Remark"---" means that the emission level is too low to be measured
2. 10GHz-22GHz: No substitution measurement has been performed, because there were no emissions detected during the pre measurement other than noise.

Uplink mode

Test mode:	Below 1G		Test channel:	Lowest channel
Frequency (MHz)	Spurious Emission		Limit (dBm)	Result
	Polarization	Level (dBm)		
30.42	Vertical	-38.77	-13.00	Pass
38.21	V	-32.50		
44.90	V	-37.97		
91.82	V	-41.67		
148.44	V	---		
223.73	V	---		
32.07	Horizontal	-53.13	-13.00	Pass
38.89	H	-51.32		
52.76	H	-50.31		
87.73	H	-53.67		
129.92	H	---		
218.31	H	---		
Test mode:	Above 1G		Test channel:	Lowest channel
Frequency (MHz)	Spurious Emission		Limit (dBm)	Result
	Polarization	Level (dBm)		
1845.00	Vertical	-57.88	-13.00	Pass
3524.00	V	-56.61		
5718.00	V	-56.52		
7654.00	V	---		
8869.00	V	---		
2854.00	Horizontal	-56.64	-13.00	Pass
3916.00	H	-56.38		
5718.00	H	-55.97		
7251.00	H	---		
9258.00	H	---		

Test mode:	Below 1G		Test channel:	Middle channel
Frequency (MHz)	Spurious Emission		Limit (dBm)	Result
	Polarization	Level (dBm)		
32.63	Vertical	-36.31	-13.00	Pass
43.81	V	-37.70		
89.59	V	-42.35		
131.76	V	-42.54		
178.13	V	---		
252.95	V	---		
43.05	Horizontal	-52.04	-13.00	Pass
53.88	H	-51.42		
81.78	H	-55.15		
119.44	H	-46.30		
166.65	H	---		
264.75	H	---		
Test mode:	Above 1G		Test channel:	Middle channel
Frequency (MHz)	Spurious Emission		Limit (dBm)	Result
	Polarization	Level (dBm)		
1725.00	Vertical	-57.22	-13.00	Pass
3695.00	V	-56.47		
5247.00	V	-56.39		
7613.00	V	---		
8694.00	V	---		
2135.00	Horizontal	-57.38	-13.00	Pass
3957.00	H	-57.17		
5174.00	H	-55.57		
7251.00	H	---		
8807.00	H	---		

Test mode:	Below 1G		Test channel:	Highest channel
Frequency (MHz)	Spurious Emission		Limit (dBm)	Result
	Polarization	Level (dBm)		
33.68	Vertical	-37.77	-13.00	Pass
42.75	V	-37.88		
53.69	V	-41.53		
95.43	V	-42.41		
157.56	V	---		
217.54	V	---		
37.81	Horizontal	-55.21	-13.00	Pass
52.03	H	-57.83		
100.93	H	-52.84		
142.32	H	-42.17		
212.27	H	---		
298.27	H	---		
Test mode:	Above 1G		Test channel:	Highest channel
Frequency (MHz)	Spurious Emission		Limit (dBm)	Result
	Polarization	Level (dBm)		
1541.00	Vertical	-57.47	-13.00	Pass
3471.00	V	-56.88		
5509.00	V	-56.23		
7385.00	V	---		
8836.00	V	---		
2381.00	Horizontal	-57.14	-13.00	Pass
3716.00	H	-57.85		
5277.00	H	-56.05		
6860.00	H	---		
8528.00	H	---		

Remark:

1. Remark"---" means that the emission level is too low to be measured
2. 10GHz-18GHz: No substitution measurement has been performed, because there were no emissions detected during the pre measurement other than noise.

13 FREQUENCY STABILITY

13.1 Standard Applicable

According to FCC § 2.1055 and § 27.54

13.2 Test setup

Please refer the section §6.2 Configuration of Tested System.

13.3 Test Procedure

1. The EUT was placed inside the temperature chamber.
2. The RF output port was connected to a spectrum analyzer.
3. The level of RF input signal shall be increased, until the maximum output power per channel, declared by client, is reached.
4. After the temperature stabilized for approximately 20 min, the transmitting frequency was measured by the spectrum analyzer and recorded.
5. At room temperature, the frequency was measured when EUT was powered with the nominal voltage and with 85% and 115% of the nominal voltage.

13.4 Test Result

Passed.

Downlink:

WCDMA mode					
Reference Frequency: Middle channel=2145.00MHz					
Voltage with nominal Voltage	Power Supplied (VAC)	Temperature (°C)	Frequency Error (Hz)	Frequency Error (ppm)	Result
100%	120V	-40	18	0.0084	Passed
100%		-30	15	0.0070	Passed
100%		-20	13	0.0061	Passed
100%		-10	10	0.0047	Passed
100%		0	7	0.0033	Passed
100%		10	11	0.0051	Passed
100%		20	13	0.0061	Passed
100%		30	11	0.0051	Passed
100%		40	16	0.0075	Passed
100%		50	18	0.0084	Passed
100%		55	18	0.0084	Passed
85%	102V	20	14	0.0065	Passed
115%	138V	20	12	0.0056	Passed

Remark: EUT is specified for outdoor use with temperature range of -40° to +55° C, and was tested with its range.

Uplink:

WCDMAmode					
Reference Frequency: Middle channel=1745.00MHz					
Voltage with nominal Voltage	Power Supplied (VAC)	Temperature (°C)	Frequency Error (Hz)	Frequency Error (ppm)	Result
100%	120V	-40	17	0.0097	Passed
100%		-30	15	0.0086	Passed
100%		-20	12	0.0069	Passed
100%		-10	6	0.0034	Passed
100%		0	8	0.0046	Passed
100%		10	11	0.0063	Passed
100%		20	10	0.0057	Passed
100%		30	13	0.0074	Passed
100%		40	17	0.0097	Passed
100%		50	16	0.0092	Passed
100%		55	17	0.0097	Passed
85%		102V	20	13	0.0074
115%	138V	20	12	0.0069	Passed

Remark: EUT is specified for outdoor use with temperature range of -40° to +55° C, and was tested with its range.

14 OUT-OF-BAND REJECTION

14.1 Standard Applicable

According to KDB (AMPLIFIER, BOOSTER, AND REPEATER REMINDER SHEET):

Out of Band Rejection – Test for rejection of out of band signals. Filter freq. response plots are acceptable.

14.2 Test setup

Please refer the section §6.2 Configuration of Tested System.

14.3 Test Procedure

1. The EUT RF output port was connected to spectrum analyzer.
2. The level of RF input signal shall be increased, until the maximum output power per channel, declared by client, is reached.
3. A continuous sinusoidal RF signal shall be fed successively at frequency offsets 100 MHz from the edges of the relevant MS or BTS transmit frequency band into the relevant input port of the repeater.
4. The RF output curve was recorded by spectrum analyzer.

14.4 Test Result

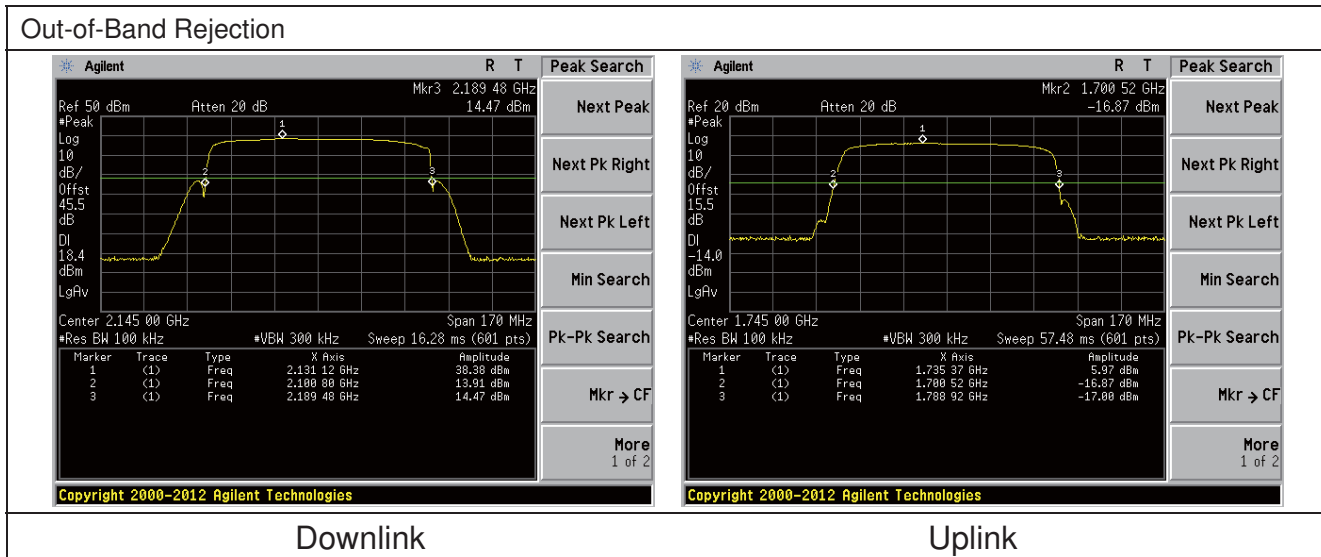

15 AC POWER LINE CONDUCTED EMISSION TEST

15.1 Standard Applicable

According to FCC §15.207. The emission value for frequency within 150KHz to 30MHz shall not Exceed criteria of below chart.

Frequency range (MHz)	Limits dB(uV)	
	Quasi-peak	Average
0.15 to 0.50	79	66
0.50 to 30	73	60

Note

- 1.The lower limit shall apply at the transition frequencies
- 2.The limit decreases linearly with the logarithm of the frequency in the range 0.15 MHz to 0.50 MHz.

15.2 Test setup

1. The conducted emission tests were performed in the test site, using the setup in accordance with the ANSI C63.4-2014.
2. The EUT was plug-in DC power adaptor and was placed on the center of the back edge on the test table. The peripherals like earphone was placed on the side of the EUT. The rear of the EUT and peripherals were placed flushed with the rear of the tabletop.
3. The Power adaptor was connected with 120VAC/60Hz power source.

15.3 Test Procedure

1. The EUT was placed on a table which is 0.8m above ground plane.
2. Maximum procedure was performed on the six highest emissions to ensure EUT compliance.
3. Repeat above procedures until all frequency measured were complete.

15.4 Measurement Result

Downlink:

Line:

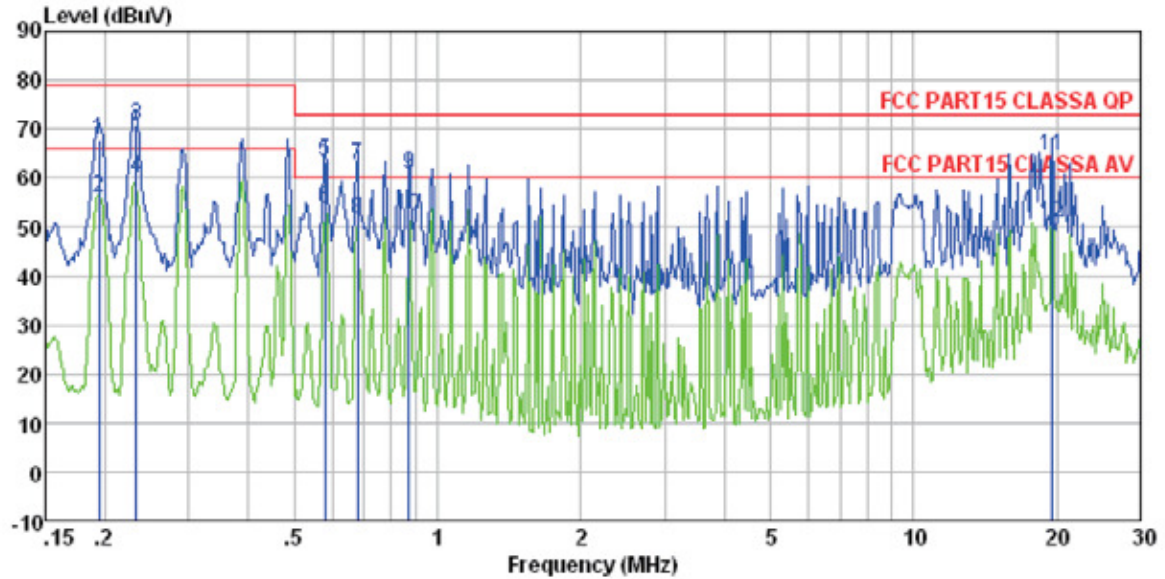

Condition : FCC PART15 CLASSA QP LISN-2013 LINE
 Job No. : 2039RF
 Test mode : Downlink mode
 Test Engineer: Edward

	Freq	Read Level	LISN Factor	Cable Loss	Level	Limit Line	Over Limit	Remark
	MHz	dBuV	dB	dB	dBuV	dBuV	dB	
1	0.194	67.45	0.14	0.13	67.72	79.00	-11.28	QP
2	0.194	55.85	0.14	0.13	56.12	66.00	-9.88	Average
3	0.233	70.49	0.12	0.12	70.73	79.00	-8.27	QP
4	0.233	59.92	0.12	0.12	60.16	66.00	-5.84	Average
5	0.579	63.24	0.13	0.12	63.49	73.00	-9.51	QP
6	0.579	53.55	0.13	0.12	53.80	60.00	-6.20	Average
7	0.679	62.45	0.14	0.13	62.72	73.00	-10.28	QP
8	0.679	51.29	0.14	0.13	51.56	60.00	-8.44	Average
9	0.871	60.55	0.14	0.13	60.82	73.00	-12.18	QP
10	0.871	51.96	0.14	0.13	52.23	60.00	-7.77	Average
11	19.532	63.65	0.58	0.22	64.45	73.00	-8.55	QP
12	19.532	50.24	0.58	0.22	51.04	60.00	-8.96	Average

Neutral:

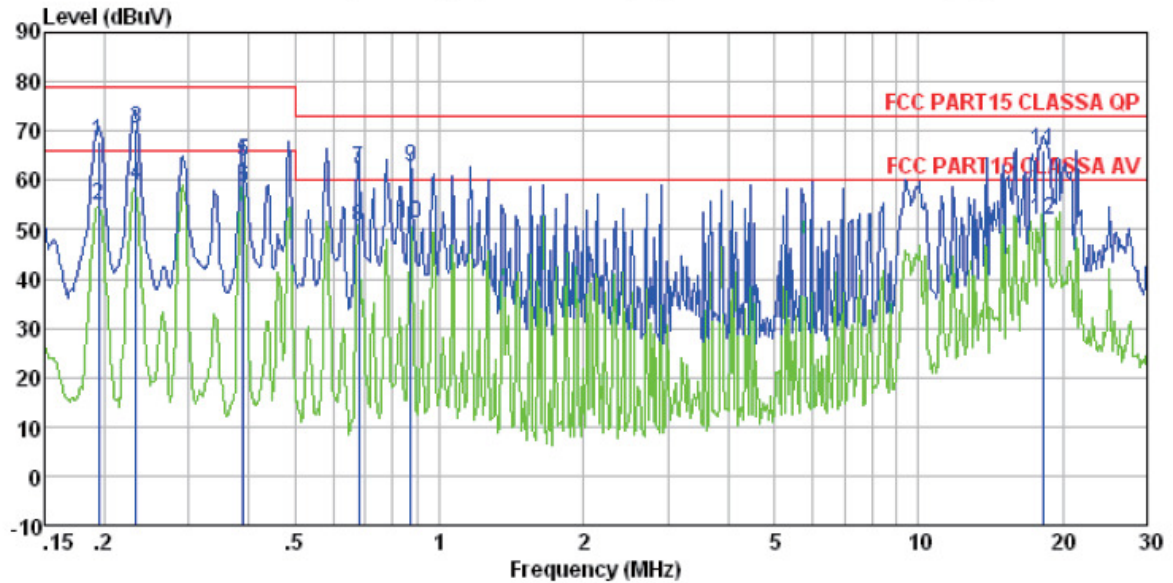

Condition : FCC PART15 CLASSA QP LISN-2013 NEUTRAL
 Job No. : 2039RF
 Test mode : Downlink mode
 Test Engineer: Edward

	Freq	Read Level	LISN Factor	Cable Loss	Level	Limit Line	Over Limit	Remark
	MHz	dBuV	dB	dB	dBuV	dBuV	dB	
1	0.194	67.54	0.07	0.13	67.74	79.00	-11.26	QP
2	0.194	54.76	0.07	0.13	54.96	66.00	-11.04	Average
3	0.233	70.22	0.06	0.12	70.40	79.00	-8.60	QP
4	0.233	58.83	0.06	0.12	59.01	66.00	-6.99	Average
5	0.389	63.49	0.06	0.11	63.66	79.00	-15.34	QP
6	0.389	58.55	0.06	0.11	58.72	66.00	-7.28	Average
7	0.679	62.19	0.07	0.13	62.39	73.00	-10.61	QP
8	0.679	50.32	0.07	0.13	50.52	60.00	-9.48	Average
9	0.871	62.35	0.07	0.13	62.55	73.00	-10.45	QP
10	0.871	51.09	0.07	0.13	51.29	60.00	-8.71	Average
11	18.232	65.54	0.42	0.22	66.18	73.00	-6.82	QP
12	18.232	51.24	0.42	0.22	51.88	60.00	-8.12	Average

Uplink:

Line:

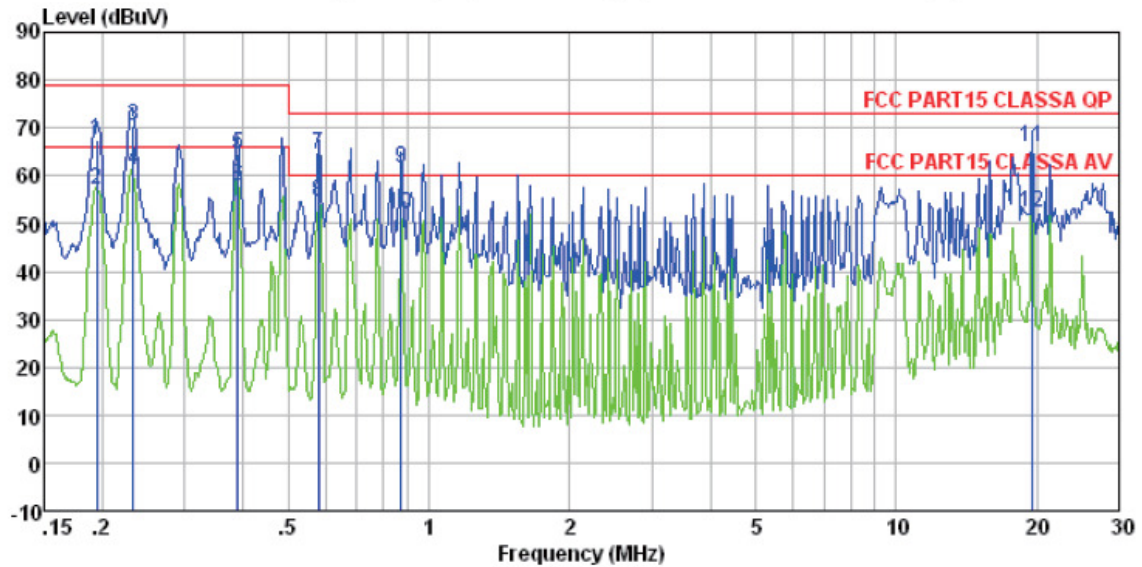

Condition : FCC PART15 CLASS A QP LISN-2013 LINE
 Job No. : 2039RF
 Test mode : Uplink mode
 Test Engineer: Edward

	Freq	Read Level	LISN Factor	Cable Loss	Level	Limit Line	Over Limit	Remark
	MHz	dBuV	dB	dB	dBuV	dBuV	dB	
1	0.194	67.38	0.14	0.13	67.65	79.00	-11.35	QP
2	0.194	56.87	0.14	0.13	57.14	66.00	-8.86	Average
3	0.233	70.32	0.12	0.12	70.56	79.00	-8.44	QP
4	0.233	60.95	0.12	0.12	61.19	66.00	-4.81	Average
5	0.389	64.30	0.11	0.11	64.52	79.00	-14.48	QP
6	0.389	57.84	0.11	0.11	58.06	66.00	-7.94	Average
7	0.579	64.21	0.13	0.12	64.46	73.00	-8.54	QP
8	0.579	54.37	0.13	0.12	54.62	60.00	-5.38	Average
9	0.871	61.36	0.14	0.13	61.63	73.00	-11.37	QP
10	0.871	51.68	0.14	0.13	51.95	60.00	-8.05	Average
11	19.532	65.25	0.58	0.22	66.05	73.00	-6.95	QP
12	19.532	51.42	0.58	0.22	52.22	60.00	-7.78	Average

Neutral:

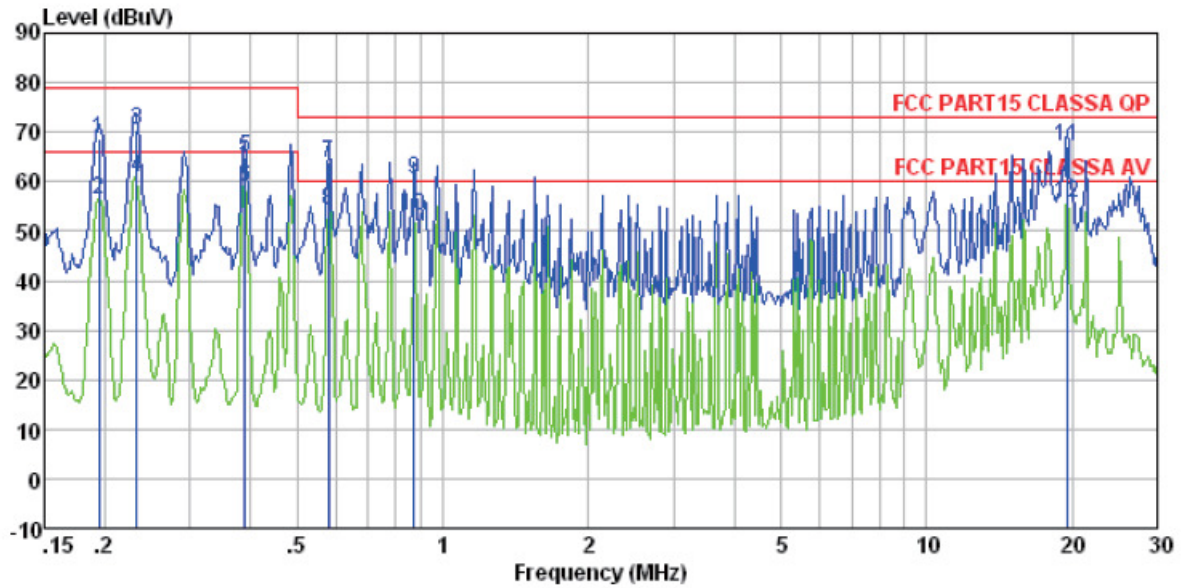

Condition : FCC PART15 CLASSA QP LISN-2013 NEUTRAL
 Job No. : 2039RF
 Test mode : Uplink mode
 Test Engineer: Edward

	Freq	Read Level	LISN Factor	Cable Loss	Level	Limit Line	Over Limit	Remark
	MHz	dBuV	dB	dB	dBuV	dBuV	dB	
1	0.194	68.35	0.07	0.13	68.55	79.00	-10.45	QP
2	0.194	56.18	0.07	0.13	56.38	66.00	-9.62	Average
3	0.233	70.22	0.06	0.12	70.40	79.00	-8.60	QP
4	0.233	60.72	0.06	0.12	60.90	66.00	-5.10	Average
5	0.389	64.57	0.06	0.11	64.74	79.00	-14.26	QP
6	0.389	58.66	0.06	0.11	58.83	66.00	-7.17	Average
7	0.579	63.45	0.07	0.12	63.64	73.00	-9.36	QP
8	0.579	53.95	0.07	0.12	54.14	60.00	-5.86	Average
9	0.871	60.22	0.07	0.13	60.42	73.00	-12.58	QP
10	0.871	52.76	0.07	0.13	52.96	60.00	-7.04	Average
11	19.532	66.55	0.50	0.22	67.27	73.00	-5.73	QP
12	19.532	54.90	0.50	0.22	55.62	60.00	-4.38	Average

16 Test Setup Photo

Radiated Emission

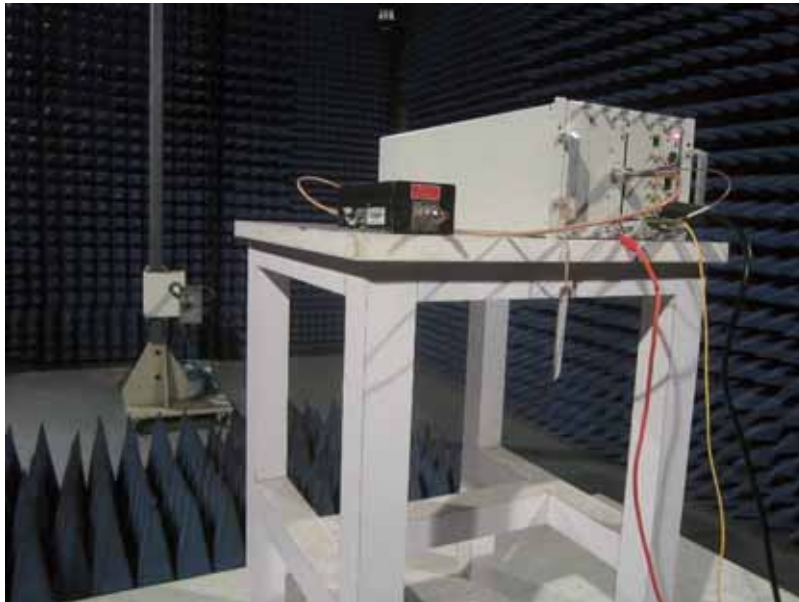
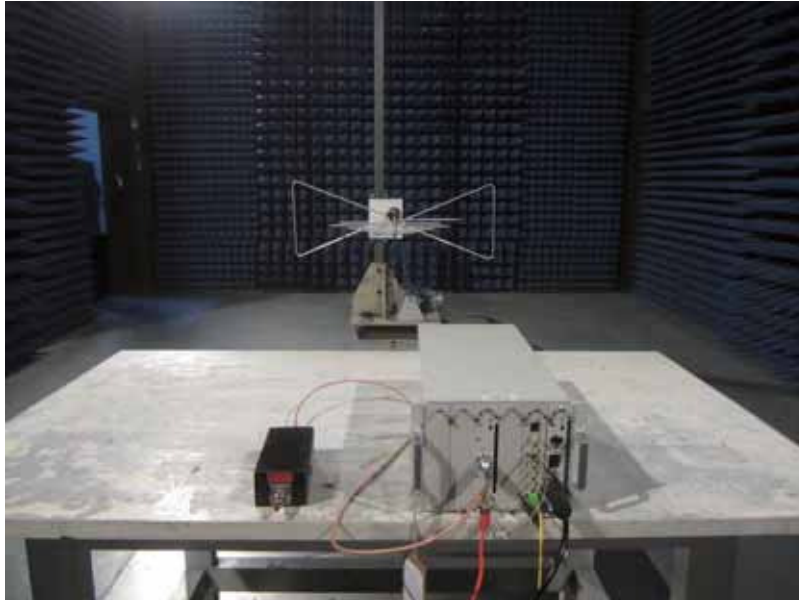

Conducted Emission



17 EUT Constructional Details

RUM- Front view



RUM- Rear view



RUM- Top view



RUM- Bottom view

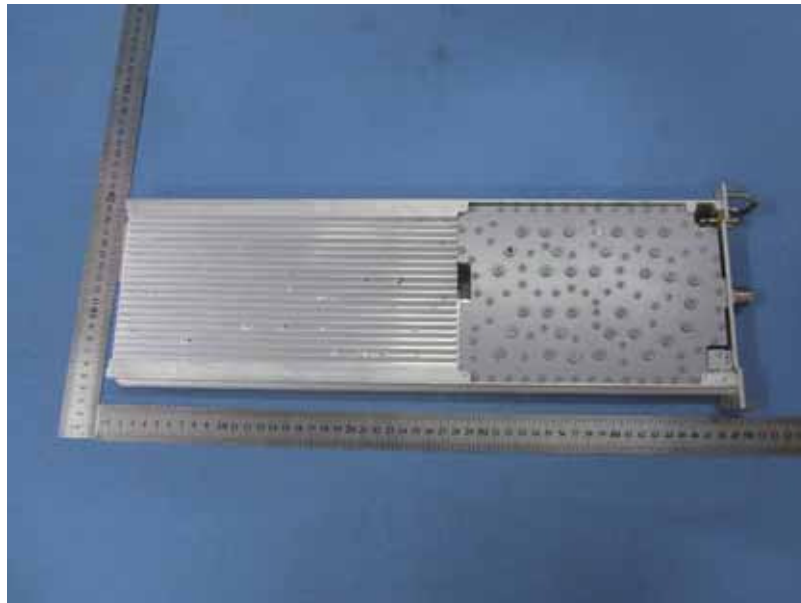

RUM- Left view



RUM- Right view

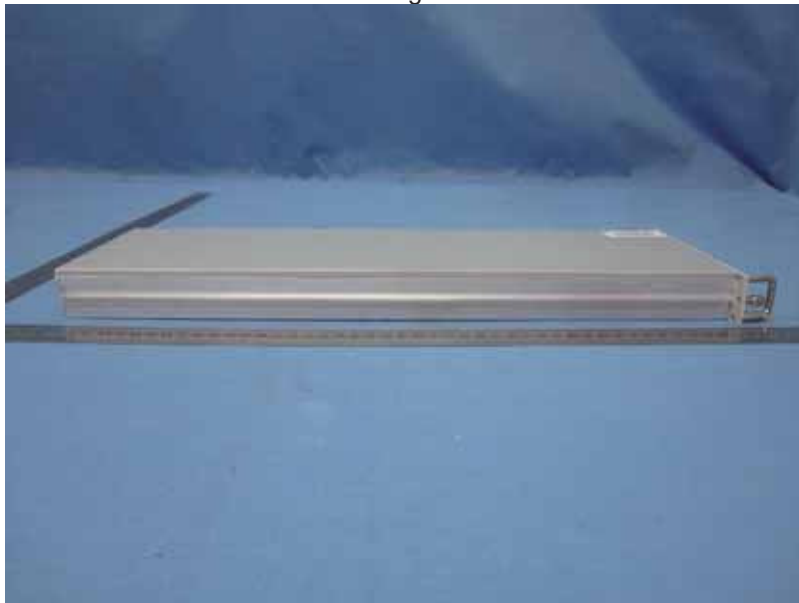

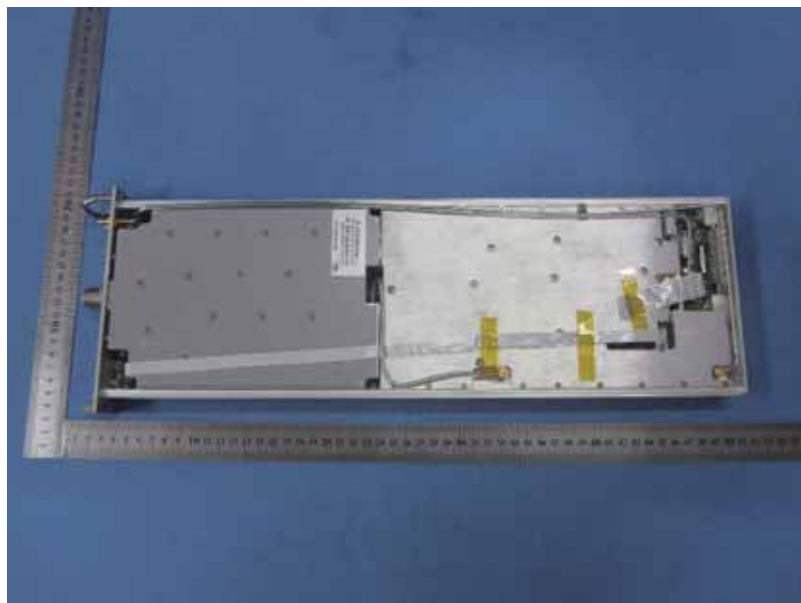
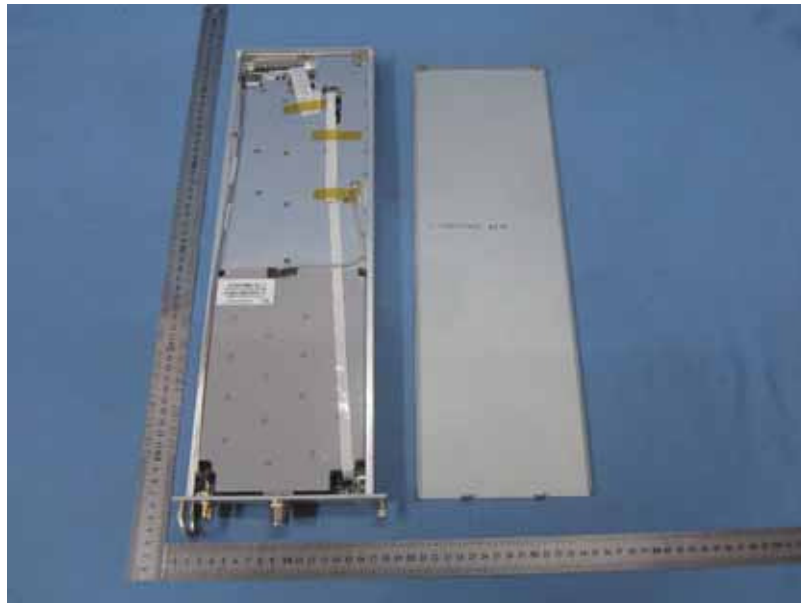





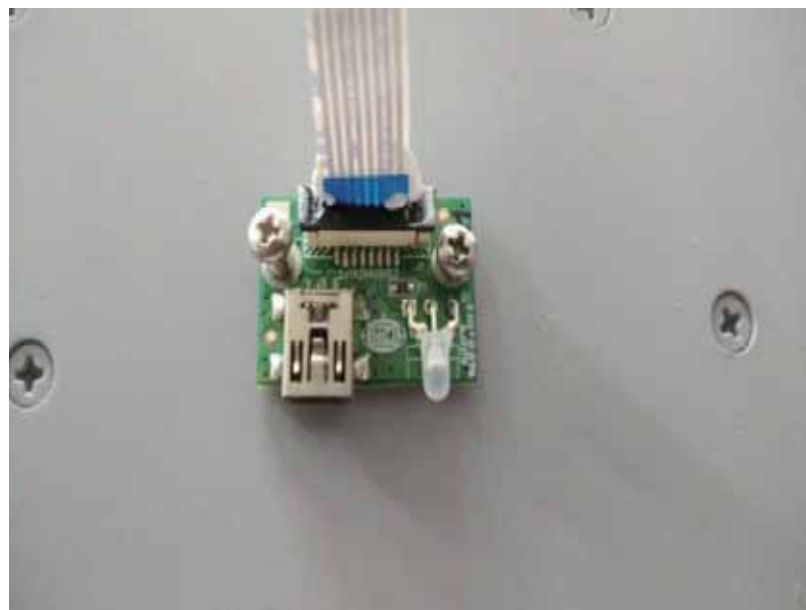
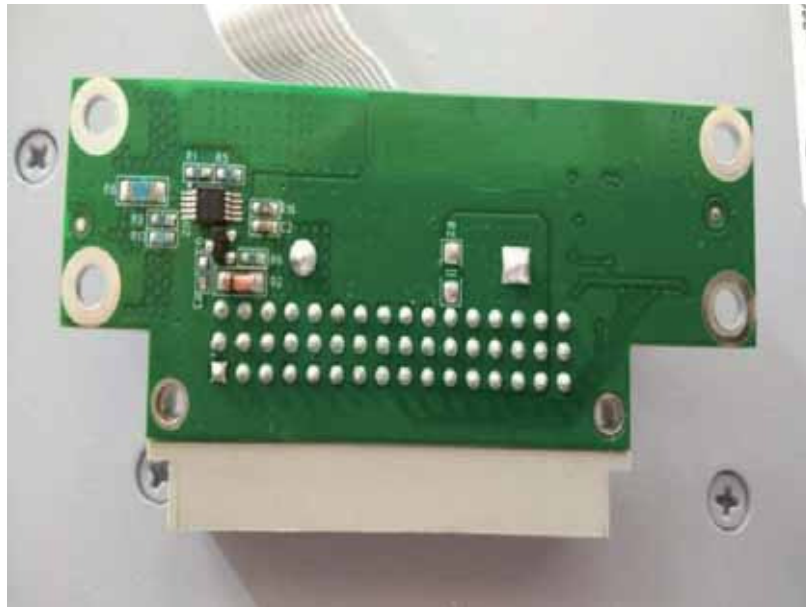

-----end-----