



# FCC REPORT

**Applicant:** BTI Wireless

**Address of Applicant:** 6185 Phyllis Drive #D Cypress California 90630 United States

**Equipment Under Test (EUT)**

Product Name: mBSC-C RU

Model No.: mBSC2100E-040-RUC11, mBSC2100E-040-RUC12, mBSC2100E-020-RUC11, mBSC2100E-020-RUC12

Trade Mark: 

**FCC ID:** WBKMBSCAWS3RUC

**Applicable standards:** FCC CFR Title 47 Part 2:2014  
FCC CFR Title 47 Part27 Subpart C:2014

**Date of sample receipt:** December 01 2015

**Date of Test:** December 01-10 2015

**Date of report issued:** December 10 2015

**Test Result :** PASS \*

\* In the configuration tested, the EUT complied with the standards specified above.

Authorized Signature:



**Robinson Lo**  
Laboratory Manager

This report details the results of the testing carried out on one sample. The results contained in this test report do not relate to other samples of the same product and does not permit the use of the GTS product certification mark. The manufacturer should ensure that all products in series production are in conformity with the product sample detailed in this report.

This report may only be reproduced and distributed in full. If the product in this report is used in any configuration other than that detailed in the report, the manufacturer must ensure the new system complies with all relevant standards.

Any mention of GTS or testing done by GTS in connection with, distribution or use of the product described in this report must be approved by GTS in writing.

This document cannot be reproduced except in full, without prior written approval of the Company. Any unauthorized alteration, forgery or falsification of the content or appearance of this document is unlawful and offenders may be prosecuted to the fullest extent of the law. Unless otherwise stated the results shown in this test report refer only to the sample(s) tested and such sample(s) are retained for 90 days only

## 2 Version

Version No.	Date	Description
00	December 10 2015	Original

Prepared By:

*Edward. Pan*

Date:

December 10 2015

Project Engineer

Check By:

*Frank. yan*

Date:

December 10 2015

Reviewer

### 3 Contents

	Page
<b>1 COVER PAGE</b> .....	<b>1</b>
<b>2 VERSION</b> .....	<b>2</b>
<b>3 CONTENTS</b> .....	<b>3</b>
<b>4 TEST SUMMARY</b> .....	<b>5</b>
<b>5 GENERAL INFORMATION</b> .....	<b>6</b>
5.1 CLIENT INFORMATION .....	6
5.2 GENERAL DESCRIPTION OF EUT .....	6
5.3 RELATED SUBMITTAL(S) / GRANT (S) .....	7
5.4 TEST METHODOLOGY .....	7
5.5 TEST FACILITY .....	7
5.6 TEST LOCATION .....	7
5.7 TEST INSTRUMENTS LIST .....	8
<b>6 TEST CONFIGURATION AND CONDITIONS</b> .....	<b>9</b>
6.1 EUT CONFIGURATION .....	9
6.2 CONFIGURATION OF TESTED SYSTEM .....	10
6.3 TEST ENVIRONMENTS .....	12
6.4 TEST SIGNAL .....	12
6.5 TEST FREQUENCY SELECTION .....	13
6.6 DESCRIPTION OF TEST MODES .....	15
<b>7 RF POWER OUTPUT MEASUREMENT</b> .....	<b>16</b>
7.1 STANDARD APPLICABLE .....	16
7.2 TEST SETUP .....	16
7.3 MEASUREMENT PROCEDURE .....	16
7.4 TEST RESULT .....	17
7.5 PEAK TO AVERAGE RATIO .....	21
<b>8 MEASURING THE EUT AGC THRESHOLD</b> .....	<b>22</b>
8.1 STANDARD APPLICABLE .....	22
8.2 TEST SETUP .....	22
8.3 TEST PROCEDURE .....	22
8.4 TEST RESULT .....	22
<b>9 PASSBAND GAIN AND 99% OCCUPIED BANDWIDTH</b> .....	<b>24</b>
9.1 STANDARD APPLICABLE .....	24
9.2 TEST SETUP .....	24
9.3 TEST PROCEDURE .....	24
9.4 TEST RESULT .....	24
<b>10 OUT OF BAND EMISSION AT ANTENNA TERMINALS</b> .....	<b>43</b>
10.1 STANDARD APPLICABLE .....	43
10.2 TEST SETUP .....	43
10.3 MEASUREMENT PROCEDURE .....	43
10.4 MEASUREMENT RESULT .....	43

10.4.1	Spurious emission .....	43
10.4.2	Band edge emission .....	92
<b>11</b>	<b>INTERMODULATION.....</b>	<b>98</b>
11.1	STANDARD APPLICABLE .....	98
11.2	TEST SETUP .....	98
11.3	MEASUREMENT PROCEDURE.....	98
11.4	TEST RESULT .....	98
<b>12</b>	<b>FIELD STRENGTH OF SPURIOUS RADIATION MEASUREMENT .....</b>	<b>143</b>
12.1	STANDARD APPLICABLE .....	143
12.2	EUT SETUP (BLOCK DIAGRAM OF CONFIGURATION).....	143
12.3	MEASUREMENT PROCEDURE.....	143
12.4	MEASUREMENT DATA.....	144
<b>13</b>	<b>FREQUENCY STABILITY.....</b>	<b>150</b>
13.1	STANDARD APPLICABLE .....	150
13.2	TEST SETUP .....	150
13.3	TEST PROCEDURE.....	150
13.4	TEST RESULT .....	151
<b>14</b>	<b>OUT-OF-BAND REJECTION.....</b>	<b>153</b>
14.1	STANDARD APPLICABLE .....	153
14.2	TEST SETUP .....	153
14.3	TEST PROCEDURE.....	153
14.4	TEST RESULT .....	153
<b>15</b>	<b>AC POWER LINE CONDUCTED EMISSION TEST.....</b>	<b>154</b>
15.1	STANDARD APPLICABLE .....	154
15.2	TEST SETUP .....	154
15.3	TEST PROCEDURE.....	154
15.4	MEASUREMENT RESULT.....	154
<b>16</b>	<b>TEST SETUP PHOTO.....</b>	<b>159</b>
<b>17</b>	<b>EUT CONSTRUCTIONAL DETAILS .....</b>	<b>161</b>

## 4 Test Summary

Test Item	Test Description	Result
Maximum Permissible exposure(MPE)	§ 1.1307(b)(1), § 2.1091	PASS* (Please refer to MPE Report)
RF Output Power	§ 2.1046; § 27.50(h)	PASS
Modulation Characteristics	§ 2.1047	N/A*
Measuring The EUT AGC Threshold	---	PASS
Passband Gain and 99% Occupied Bandwidth	§ 2.1049 ; § 27.53(m)	PASS
Spurious Emissions at Antenna Terminal	§ 2.1051; § 27.53(m)	PASS
Intermodulation	§ 2.1051; § 27.53(m)	PASS
Field Strength of Spurious Radiation	§ 2.1053; § 27.53(m)	PASS
Out of band emission, Band Edge	§ 27.53(m)	PASS
Frequency stability vs. temperature Frequency stability vs. voltage	§ 2.1055; § 27.54	PASS
Out-of-Band Rejection	---	PASS
AC Power Line Conducted Emission Test	§ 15.207	PASS

Remark:

N/A\*: Not application

## 5 General Information

### 5.1 Client Information

Applicant:	BTI Wireless
Address of Applicant:	6185 Phyllis Drive #D Cypress California 90630 United States
Manufacturer:	BTI Wireless
Address of Manufacturer:	6185 Phyllis Drive #D Cypress California 90630 United States
Factory:	BTI Wireless(ShenZhen)Co.,Ltd.
Address of Factory:	No. 8 Building, The 3rd Zone, Tangtou Industrial Park Shiyan, Baoan District, Shenzhen, China

### 5.2 General Description of EUT

Product Name:	mBSC-C RU	
Model No.:	mBSC2100E-040-RUC11, mBSC2100E-040-RUC12, mBSC2100E-020-RUC11, mBSC2100E-020-RUC12	
Power supply:	RPM: Input: AC 120V/60Hz RUM: DC 28V, 3A Max RTM: Input DC 28V / 2.2A Normal test voltage: AC 120V/60Hz	
Operating Temperature:	-20°C to + 55°C	
Operating Humidity:	up to 95%	
<b>Technical Parameter:</b>		
Frequency Range	Downlink	2110MHz~2180MHz
	Uplink	1710MHz~1780MHz
Operating Bandwidth	70MHz	
Multiple Carrier Supported	LTE: 1 carrier WCDMA: 4carrier	
Channel Spacing(s) / Bandwidth(s)	LTE: 1.4MHz; 3MHz; 5MHz; 10MHz; 15MHz; 20MHz WCDMA: 5MHz.	
Maximun RF Output Power	Downlink: 46.11dBm(For 40W); 43.19dBm(For 20W); Uplink: 15.34dBm(For 40W); 15.28dBm(For 20W);	
Max Gain	Downlink: 62.38dB; Uplink: 62.36dB	
Type of modulation and Designator	LTE(W7D), WCDMA(F9W);	
Antenna Type	External antenna (N female)	
Antenna Gain	Maximum permissible antenna gain is 17dBi.	

### 5.3 Related Submittal(s) / Grant (s)

Title 47 Part 2	General Requirements and Information for the Certification of Radio Apparatus
Title 47 Part 27	MISCELLANEOUS WIRELESS COMMUNICATIONS SERVICES

### 5.4 Test Methodology

Title 47 Part 2	General Requirements and Information for the Certification of Radio Apparatus
Title 47 Part 20	COMMERCIAL MOBILE SERVICES
Title 47 Part 27	MISCELLANEOUS WIRELESS COMMUNICATIONS SERVICES
ANSI C63.4: 2014	Methods of Measurement of Radio-Noise Emissions from Low Voltage Electrical and Electronic Equipment in the Range of 9 kHz to 40 GHz
KDB	AMPLIFIER, BOOSTER, AND REPEATER REMINDER SHEET
KDB 935210	D01 Signal Booster Definitions v02; D02 Signal Booster Certification v03 D03 Signal Booster Measurements v03 D04 Signal Booster Provider Specific v01r01 D05 Indus Booster Basic Meas v01

### 5.5 Test Facility

<p>The test facility is recognized, certified, or accredited by the following organizations:</p> <ul style="list-style-type: none"> <li>● FCC —Registration No.: 600491 Global United Technology Services Co., Ltd., Shenzhen EMC Laboratory has been registered and fully described in a report filed with the (FCC) Federal Communications Commission. The acceptance letter from the FCC is maintained in files. Registration 600491, June 28, 2013.</li> <li>● Industry Canada (IC) The 3m Semi-anechoic chamber of China Certification &amp; Inspection Services Co., Ltd. has been Registered by Certification and Engineering Bureau of Industry Canada for radio equipment testing with Registration No.: 9079A-2, June 26, 2013.</li> </ul>
--

### 5.6 Test Location

All tests were performed at:
Global United Technology Services Co., Ltd. Address: No. 301-309, 3/F., Jinyuan Business Building, No.2, Laodong Industrial Zone, Xixiang Road, Baoan District, Shenzhen, Guangdong, China Tel: 0755-27798480 Fax: 0755-27798960

## 5.7 Test Instruments list

Item	Test Equipment	Manufacturer	Model No.	Inventory No.	Cal.Date (dd-mm-yy)	Cal.Due date (dd-mm-yy)
1	3m Semi- Anechoic Chamber	ZhongYu Electron	9.2(L)*6.2(W)* 6.4(H)	GTS250	Mar. 27 2015	Mar. 26 2020
2	Control Room	ZhongYu Electron	6.2(L)*2.5(W)* 2.4(H)	GTS251	N/A	N/A
3	EMI Test Receiver	Rohde & Schwarz	ESU26	GTS203	Jun. 29, 2015	Jun. 28, 2016
4	BiConiLog Antenna	SCHWARZBECK MESS-ELEKTRONIK	VULB9163	GTS214	Feb. 21 2015	Feb. 20 2016
5	Double -ridged waveguide horn	SCHWARZBECK MESS-ELEKTRONIK	9120D-829	GTS208	June 25 2015	June 24 2016
6	EMI Test Software	AUDIX	E3	N/A	N/A	N/A
7	Coaxial Cable	GTS	N/A	GTS213	Mar. 27 2015	Mar. 26 2016
8	Coaxial Cable	GTS	N/A	GTS211	Mar. 27 2015	Mar. 26 2016
9	Coaxial cable	GTS	N/A	GTS210	Mar. 27 2015	Mar. 26 2016
10	Coaxial Cable	GTS	N/A	GTS212	Mar. 27 2015	Mar. 26 2016
11	Amplifier(100KHz-5GHz)	HP	8347A	GTS204	Jun. 29, 2015	Jun. 28, 2016
12	Amplifier(2GHz-20GHz)	HP	8349B	GTS206	Jun. 29, 2015	Jun. 28, 2016
13	Amplifier (18-26GHz)	Rohde & Schwarz	AFS33-18002 650-30-8P-44	GTS218	June 25 2015	June 24 2016
14	Shielding Room	ZhongYu Electron	7.0(L)x3.0(W)x3.0(H)	GTS264	Sep. 05 2015	Sep. 04 2017
15	EMI Test Receiver	Rohde & Schwarz	ESCS30	GTS223	Jun. 29, 2015	Jun. 28, 2016
16	10dB Pulse Limita	Rohde & Schwarz	N/A	GTS224	Jun. 29, 2015	Jun. 28, 2016
17	LISN	SCHWARZBECK MESS-ELEKTRONIK	NSLK 8127	GTS226	Jun. 29, 2015	Jun. 28, 2016
18	Temp. Humidity/Barometer	Oregon Scientific	BA-888	GTS248	May 08 2015	May 07 2017
19	Spectrum Analyzer	Agilent	E4440A	GTS 536	Oct.19 2015	Oct.18 2016
20	Spectrum Analyzer	Agilent	E4445A	MY41000047	Sept. 09 2015	Sept. 08 2017
21	Splitter	Agilent	11636B	GTS237	May 08 2015	May 07 2017
22	Signal Generator	Rohde & Schwarz	SML03	GTS236	May 08 2015	May 07 2017
23	Signal Generator	AEROFLEX	IFR3414	341300/019	Sept. 09 2015	Sept. 08 2016
24	Power Meter	Giga-tronics	8541C	1831177	Sept. 09 2015	Sept. 08 2016
25	Power Sensor	Giga-tronics	80601A	1831785	Sept. 09 2015	Sept. 08 2016
26	Power Attenuator	BTI	30dB/250W	040706090	Sept. 09 2015	Sept. 08 2016
27	Power Attenuator	BTI	20dB	040706089	Sept. 09 2015	Sept. 08 2016
28	Power Attenuator	BTI	10dB	040706088	Sept. 09 2015	Sept. 08 2016
29	Signal Generator	Agilent	E4438C	MY45093111	Oct.19 2015	Oct.18 2016
30	Signal Generator	Agilent	4432B	GB40051373	May 08 2015	May 07 2016



## 6 TEST CONFIGURATION AND CONDITIONS

### 6.1 EUT Configuration

This MBSC2100-040-RUC13 and MBSC2100-020-RUC13 are the Remote Unit on BTI CM system. This remote unit supports 2100MHz band with the air standard LTE and WCDMA. The unit consists of Duplexer, PA and CPU board. This product is designed to operate in an outdoor or indoor environment. The output power of the RUM at Antenna interface port is average 46.11dBm(for 40W) and 43.19dBm(for 20W) for Downlink path with Convection Cooling.

For details, refer to technical document and the user manual.

## 6.2 Configuration of Tested System

(A) RF Output Power, Occupied Bandwidth, Spurious Emissions at Antenna Terminal, Band Edge, Test Set-UP

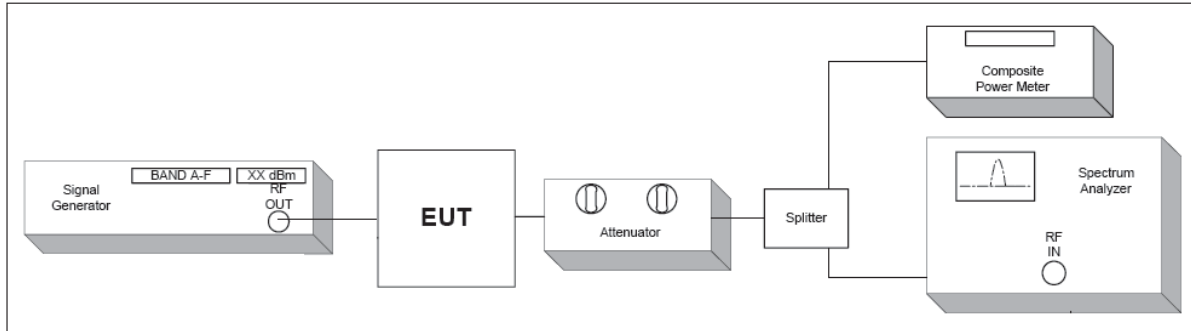

(B) Intermodulation Test Set-UP

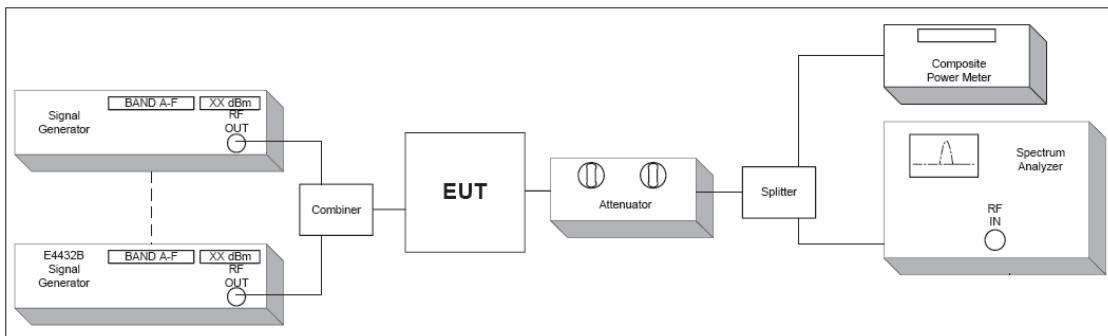

(C) Frequency stability Test Set-UP

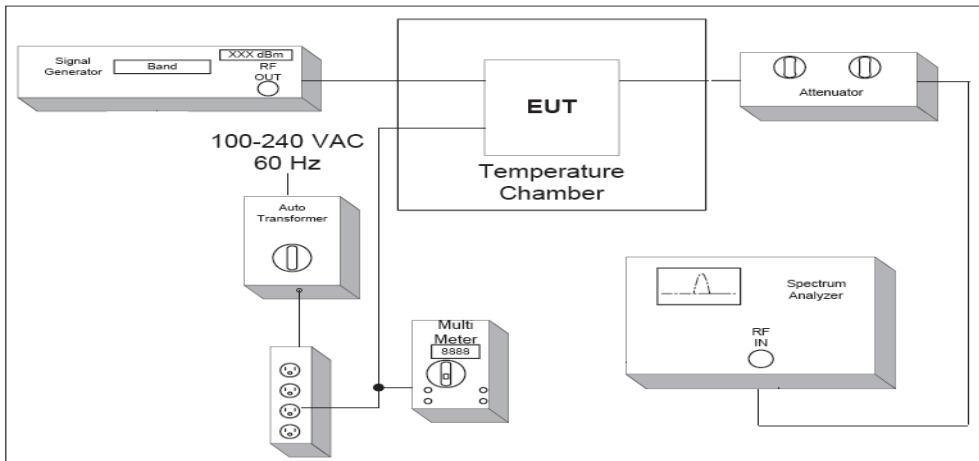

(D) Radiated Emission Test Set-Up, Frequency below 1000MHz

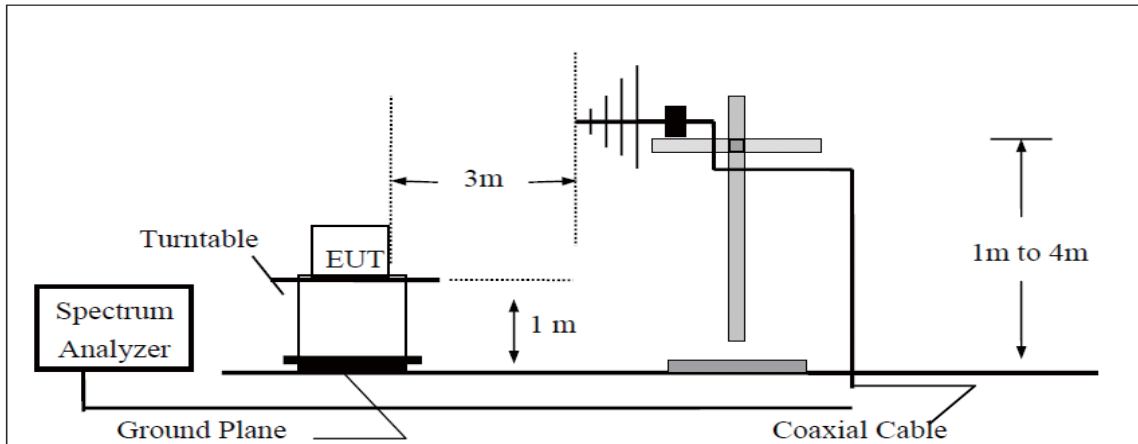

(E) Radiated Emission Test Set-UP Frequency over 1 GHz

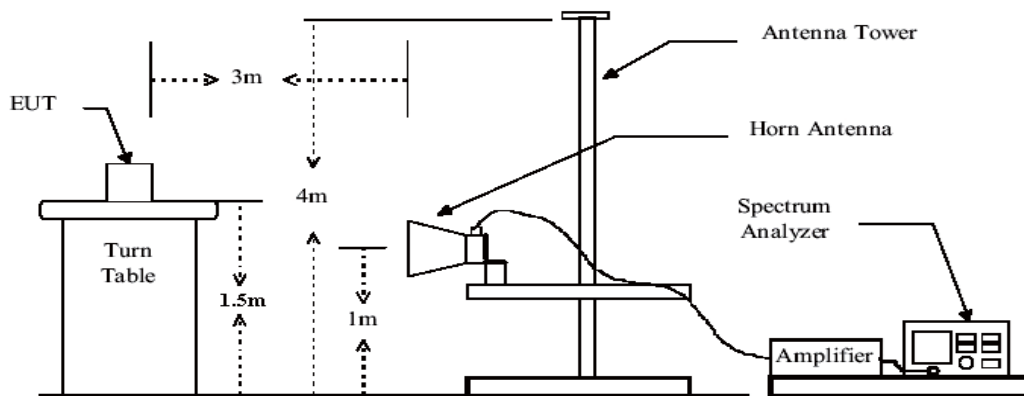

(F) Substituted Method Test Set-UP

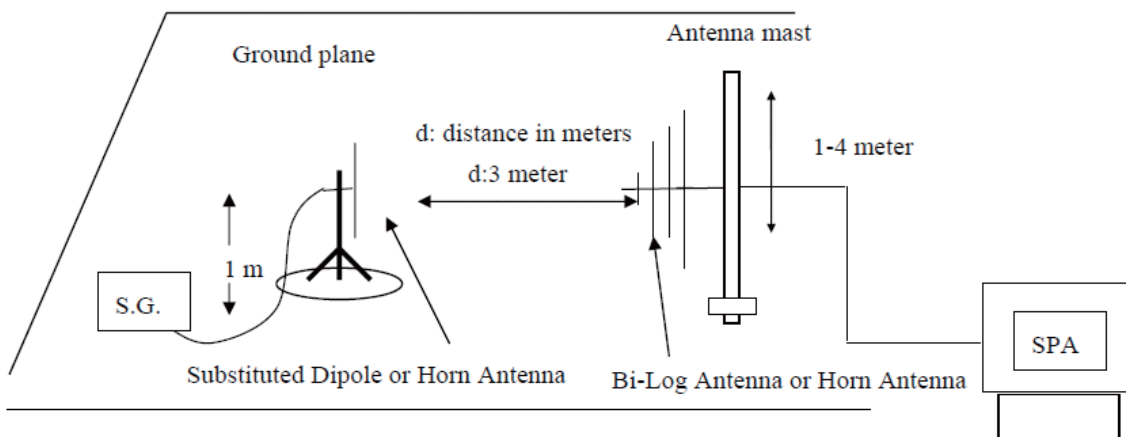

### 6.3 Test Environments

Condition	Minimum value	Maximum value
Barometric pressure	86 kPa	106 kPa
Temperature	15°C	30°C
Relative Humidity	20 %	75 %
Power supply range	±5% of rated voltages	
Normal Test Condition	(1). Temperature: +15 °C to +30 °C; (2). voltage is 120V AC.	
Extreme Test Conditions:	(1). Temperatures: -20°C to +55°C. (2). Voltages: 102V AC to 138V AC.	

### 6.4 Test signal

1: Test signal LTE:

Signal waveform according to Test Model 1.1, E-TM1.1, clause 6.1.1.1-1, table 6.1.1.1-1 of standard specification 3GPP TS 36.141 V9.3.0 (2010-03).

2: Test signal WCDMA

Signal waveform according to Test Model 1 of standard specification 3GPP TS25.141. Signal modulated with a combination of PCCPCH, SCCPCH and Dedicated Physical Channels specified as test model 1 64 DPCH.

3: Test signal CW

N/A

## 6.5 Test frequency selection

Downlink:

Operating Mode(TX)	Channels No.	Channels frequency (MHz)		
	Multi- Carriers	Low Ch.	Mid Ch.	High Ch.
<b>LTE</b> <b>1.4MHz Bandwidth</b>	Single Carrier	2110.70	2145.00	2179.30
<b>LTE</b> <b>3MHz Bandwidth</b>	Single Carrier	2111.50	2145.00	2178.50
<b>LTE</b> <b>5MHz Bandwidth</b>	Single Carrier	2112.50	2145.00	2177.50
<b>LTE</b> <b>10MHz Bandwidth</b>	Single Carrier	2115.00	2145.00	2175.00
<b>LTE</b> <b>15MHz Bandwidth</b>	Single Carrier	2117.50	2145.00	2172.50
<b>LTE</b> <b>20MHz Bandwidth</b>	Single Carrier	2120.00	2145.00	2170.00
<b>WCDMA</b>	Single Carrier	2112.40	2145.00	2177.60
	Two Carrier	2114.80	2145.00	2175.20
	Three Carrier	2117.20	2145.00	2172.80
	Four Carrier	2119.60	2145.00	2170.40

Uplink:

Operating Mode(TX)	Channels No.	Channels frequency (MHz)		
	Multi- Carriers	Low Ch.	Mid Ch.	High Ch.
<b>LTE</b> <b>1.4MHz Bandwidth</b>	Single Carrier	1710.70	1745.00	1779.30
<b>LTE</b> <b>3MHz Bandwidth</b>	Single Carrier	1711.50	1745.00	1778.50
<b>LTE</b> <b>5MHz Bandwidth</b>	Single Carrier	1712.50	1745.00	1777.50
<b>LTE</b> <b>10MHz Bandwidth</b>	Single Carrier	1715.00	1745.00	1775.00
<b>LTE</b> <b>15MHz Bandwidth</b>	Single Carrier	1717.50	1745.00	1772.50
<b>LTE</b> <b>20MHz Bandwidth</b>	Single Carrier	1720.00	1745.00	1770.00
<b>WCDMA</b>	Single Carrier	1712.40	1745.00	1777.60
	Two Carrier	1714.80	1745.00	1775.20
	Three Carrier	1717.20	1745.00	1772.80
	Four Carrier	1719.60	1745.00	1770.40

## 6.6 DESCRIPTION OF TEST MODES

Test mode	Detail description of the test mode
Downlink	Downlink (Low channel; middle channel; high channel)
Uplink	Uplink (Low channel; middle channel; high channel)
Multi-carrier	Single Carrier
Multi-bandwidth	LTE: 1.4MHz; 3MHz; 5MHz; 10MHz; 15MHz; 20MHz. WCDMA: 5MHz
Modulation type	LTE, WCDMA

Remark:

- 1: The EUT was powered by 120VAC.
- 2: The EUT was configured for maximum gain and maximum output power. The input power was the maximum declared by the manufacturer. This is to ensure that the equipment is operating in the linear output range.
- 3: Signal generator was used to provide the input signals to the EUT. Tests were performed with LTE and WCDMA signal input and multi-carrier signal mode input.
- 4: Pre-test all test modes as above, only the worst case and typical mode is listed in report.
- 5: All testing is end-to-end (input to host through to output from remote, and vice-versa)

## **7 RF POWER OUTPUT MEASUREMENT**

### **7.1 Standard Applicable**

According to FCC § 2.1046 and § 27.53(h).

### **7.2 Test setup**

Please refer the section §6.2 Configuration of Tested System.

### **7.3 Measurement Procedure**

1. The output from the EUT t signal shall be increased, antenna connector was connected to the power meter.
2. The level of RF input until the maximum output power per channel, declared by client, is reached.
3. The RF output power was measured at low, middle and high channel with LTE and WCDMA signal.



## 7.4 Test Result

### 40W

Downlink:

Test mode	Carrier Conf.	Channel	Average Power (dBm)	Average Power (W)	RF Output Power(W/MHz)	Result	
LTE	LTE 1.4MHz Bandwidth	Low	45.97	39.54	28.24	Compliant	
		Middle	46.11	40.83	29.16	Compliant	
		High	46.06	40.36	28.83	Compliant	
	LTE 3MHz Bandwidth	Low	46.02	39.99	13.33	Compliant	
		Middle	46.09	40.64	13.55	Compliant	
		High	46.08	40.55	13.52	Compliant	
	LTE 5MHz Bandwidth	Low	46.03	40.09	8.02	Compliant	
		Middle	46.05	40.27	8.05	Compliant	
		High	46.06	40.36	8.07	Compliant	
	LTE 10MHz Bandwidth	Low	45.93	39.17	3.92	Compliant	
		Middle	46.03	40.09	4.01	Compliant	
		High	45.94	39.26	3.93	Compliant	
	LTE 15MHz Bandwidth	Low	45.98	39.63	2.64	Compliant	
		Middle	46.06	40.36	2.69	Compliant	
		High	46.02	39.99	2.67	Compliant	
	LTE 20MHz Bandwidth	Low	45.99	39.72	1.99	Compliant	
		Middle	46.08	40.55	2.03	Compliant	
		High	45.96	39.45	1.97	Compliant	
	WCDMA	Single Carrier	Low	45.94	39.26	7.85	Compliant
			Middle	46.09	40.64	8.13	Compliant
			High	45.97	39.54	7.91	Compliant
		Two Carrier	Low	46.01	39.90	3.99	Compliant
			Middle	46.10	40.74	4.07	Compliant
			High	45.96	39.45	3.95	Compliant
Three Carrier		Low	46.01	39.90	2.66	Compliant	
		Middle	46.07	40.46	2.70	Compliant	
		High	46.03	40.09	2.67	Compliant	
Four Carrier		Low	45.99	39.72	1.99	Compliant	
		Middle	46.07	40.46	2.02	Compliant	
		High	46.04	40.18	2.01	Compliant	

Uplink:

Test mode	Carrier Conf.	Channel	Average Power (dBm)	Average Power (W)	RF Output Power(W/MHz)	Result
LTE	LTE 1.4MHz Bandwidth	Low	15.13	0.0326	0.0233	Compliant
		Middle	15.34	0.0342	0.0244	Compliant
		High	15.25	0.0335	0.0239	Compliant
	LTE 3MHz Bandwidth	Low	15.01	0.0317	0.0106	Compliant
		Middle	15.24	0.0334	0.0111	Compliant
		High	15.21	0.0332	0.0111	Compliant
	LTE 5MHz Bandwidth	Low	15.03	0.0318	0.0064	Compliant
		Middle	15.16	0.0328	0.0066	Compliant
		High	15.25	0.0335	0.0067	Compliant
	LTE 10MHz Bandwidth	Low	15.12	0.0325	0.0033	Compliant
		Middle	15.25	0.0335	0.0034	Compliant
		High	15.02	0.0318	0.0032	Compliant
	LTE 15MHz Bandwidth	Low	14.97	0.0314	0.0021	Compliant
		Middle	15.04	0.0319	0.0021	Compliant
		High	14.95	0.0313	0.0021	Compliant
LTE 20MHz Bandwidth	Low	14.89	0.0308	0.0015	Compliant	
	Middle	14.97	0.0314	0.0016	Compliant	
	High	14.87	0.0307	0.0015	Compliant	
WCDMA	Single Carrier	Low	15.06	0.0321	0.0064	Compliant
		Middle	15.21	0.0332	0.0066	Compliant
		High	15.08	0.0322	0.0064	Compliant
	Two Carrier	Low	15.02	0.0318	0.0032	Compliant
		Middle	15.13	0.0326	0.0033	Compliant
		High	15.00	0.0316	0.0032	Compliant
	Three Carrier	Low	14.92	0.0310	0.0021	Compliant
		Middle	15.02	0.0318	0.0021	Compliant
		High	14.85	0.0305	0.0020	Compliant
	Four Carrier	Low	14.79	0.0301	0.0015	Compliant
		Middle	14.96	0.0313	0.0016	Compliant
		High	14.91	0.0310	0.0016	Compliant

**20W**

Downlink:

Test mode	Carrier Conf.	Channel	Average Power (dBm)	Average Power (W)	RF Output Power(W/MHz)	Result
LTE	LTE 1.4MHz Bandwidth	Low	43.03	20.09	14.35	Compliant
		Middle	43.19	20.84	14.89	Compliant
		High	43.13	20.56	14.69	Compliant
	LTE 3MHz Bandwidth	Low	43.04	20.14	6.71	Compliant
		Middle	43.15	20.65	6.88	Compliant
		High	43.12	20.51	6.84	Compliant
	LTE 5MHz Bandwidth	Low	43.01	20.00	4.00	Compliant
		Middle	43.14	20.61	4.12	Compliant
		High	43.08	20.32	4.06	Compliant
	LTE 10MHz Bandwidth	Low	43.00	19.95	2.00	Compliant
		Middle	43.09	20.37	2.04	Compliant
		High	43.03	20.09	2.01	Compliant
	LTE 15MHz Bandwidth	Low	42.97	19.82	1.32	Compliant
		Middle	43.06	20.23	1.35	Compliant
		High	42.91	19.54	1.30	Compliant
	LTE 20MHz Bandwidth	Low	42.89	19.45	0.97	Compliant
		Middle	42.96	19.77	0.99	Compliant
		High	42.89	19.45	0.97	Compliant
WCDMA	Single Carrier	Low	43.06	20.23	4.05	Compliant
		Middle	43.15	20.65	4.13	Compliant
		High	43.03	20.09	4.02	Compliant
	Two Carrier	Low	42.98	19.86	1.99	Compliant
		Middle	43.07	20.28	2.03	Compliant
		High	43.03	20.09	2.01	Compliant
	Three Carrier	Low	42.96	19.77	1.32	Compliant
		Middle	43.00	19.95	1.33	Compliant
		High	42.90	19.50	1.30	Compliant
	Four Carrier	Low	42.89	19.45	0.97	Compliant
		Middle	42.95	19.72	0.99	Compliant
		High	42.86	19.32	0.97	Compliant

Uplink:

Test mode	Carrier Conf.	Channel	Average Power (dBm)	Average Power (W)	RF Output Power(W/MHz)	Result
LTE	LTE 1.4MHz Bandwidth	Low	15.16	0.0328	0.0234	Compliant
		Middle	15.28	0.0337	0.0241	Compliant
		High	15.20	0.0331	0.0236	Compliant
	LTE 3MHz Bandwidth	Low	15.03	0.0318	0.0106	Compliant
		Middle	15.21	0.0332	0.0111	Compliant
		High	15.18	0.0330	0.0110	Compliant
	LTE 5MHz Bandwidth	Low	15.02	0.0318	0.0064	Compliant
		Middle	15.15	0.0327	0.0065	Compliant
		High	15.04	0.0319	0.0064	Compliant
	LTE 10MHz Bandwidth	Low	15.13	0.0326	0.0033	Compliant
		Middle	15.20	0.0331	0.0033	Compliant
		High	15.01	0.0317	0.0032	Compliant
	LTE 15MHz Bandwidth	Low	14.95	0.0313	0.0021	Compliant
		Middle	15.06	0.0321	0.0021	Compliant
		High	14.93	0.0311	0.0021	Compliant
	LTE 20MHz Bandwidth	Low	14.88	0.0308	0.0015	Compliant
		Middle	14.99	0.0316	0.0016	Compliant
		High	14.86	0.0306	0.0015	Compliant
WCDMA	Single Carrier	Low	15.02	0.0318	0.0064	Compliant
		Middle	15.14	0.0327	0.0065	Compliant
		High	15.04	0.0319	0.0064	Compliant
	Two Carrier	Low	15.01	0.0317	0.0032	Compliant
		Middle	15.15	0.0327	0.0033	Compliant
		High	15.02	0.0318	0.0032	Compliant
	Three Carrier	Low	14.96	0.0313	0.0021	Compliant
		Middle	15.05	0.0320	0.0021	Compliant
		High	14.83	0.0304	0.0020	Compliant
	Four Carrier	Low	14.78	0.0301	0.0015	Compliant
		Middle	14.97	0.0314	0.0016	Compliant
		High	14.96	0.0313	0.0016	Compliant

## 7.5 Peak to Average Ratio

Downlink:

Test mode	Carrier Conf.	Peak to Average Ratio (dB)			Limit (dB)	Result
		Low Ch.	Middle Ch.	High Ch.		
LTE	1.4MHz	8.69	8.57	8.43	13	Compliant
	3MHz	8.46	8.55	8.39	13	Compliant
	5MHz	8.68	8.75	8.41	13	Compliant
	10MHz	8.51	8.25	8.27	13	Compliant
	15MHz	8.43	8.66	8.71	13	Compliant
	20MHz	8.62	8.45	8.58	13	Compliant
WCDMA	Single Carrier	4.62	4.55	4.65	13	Compliant
	Two Carrier	4.28	4.75	4.45	13	Compliant
	Three Carrier	4.58	4.67	4.31	13	Compliant
	Four Carrier	4.67	4.25	4.63	13	Compliant

Uplink:

Test mode	Carrier Conf.	Peak to Average Ratio (dB)			Limit (dB)	Result
		Low Ch.	Middle Ch.	High Ch.		
LTE	1.4MHz	7.95	8.68	8.38	13	Compliant
	3MHz	8.24	7.46	8.57	13	Compliant
	5MHz	8.24	8.82	8.25	13	Compliant
	10MHz	8.29	8.68	8.17	13	Compliant
	15MHz	8.64	8.71	8.28	13	Compliant
	20MHz	8.45	8.65	8.39	13	Compliant
WCDMA	Single Carrier	4.53	4.37	4.46	13	Compliant
	Two Carrier	4.47	4.52	4.52	13	Compliant
	Three Carrier	4.38	4.27	4.22	13	Compliant
	Four Carrier	4.62	4.56	4.38	13	Compliant

## **8 MEASURING THE EUT AGC THRESHOLD**

### **8.1 Standard Applicable**

Please refer the section §3.2 8 MEASURING THE EUT AGC THRESHOLD of D05 Indus Booster Basic Meas v01

### **8.2 Test setup**

Please refer the section §6.2 Configuration of Tested System.

### **8.3 Test Procedure**

Please refer the section §3.2 8 MEASURING THE EUT AGC THRESHOLD of D05 Indus Booster Basic Meas v01

### **8.4 Test Result**

Downlink:

Test mode	Carrier Conf.	AGC threshold level (dB)			Result
		Low Ch.	Middle Ch.	High Ch.	
LTE	1.4MHz	46.89	47.28	47.12	Compliant
	3MHz	46.97	47.28	47.17	Compliant
	5MHz	46.56	47.05	46.75	Compliant
	10MHz	46.85	47.22	47.12	Compliant
	15MHz	46.92	47.08	47.11	Compliant
	20MHz	46.77	47.16	47.15	Compliant
WCDMA	Single Carrier	46.85	47.10	46.75	Compliant
	Two Carrier	46.79	47.21	46.55	Compliant
	Three Carrier	46.89	47.18	46.80	Compliant
	Four Carrier	46.81	47.26	46.93	Compliant

Uplink:

Test mode	Carrier Conf.	AGC threshold level (dB)			Result
		Low Ch.	Middle Ch.	High Ch.	
LTE	1.4MHz	16.21	16.85	16.54	Compliant
	3MHz	16.27	16.77	16.39	Compliant
	5MHz	16.34	16.75	16.33	Compliant
	10MHz	16.42	16.86	16.38	Compliant
	15MHz	16.35	16.71	16.27	Compliant
	20MHz	16.27	16.53	16.24	Compliant
WCDMA	Single Carrier	16.11	16.69	16.20	Compliant
	Two Carrier	16.25	16.55	16.19	Compliant
	Three Carrier	16.37	16.75	16.21	Compliant
	Four Carrier	16.42	16.82	16.22	Compliant

## 9 PASSBAND GAIN AND 99% OCCUPIED BANDWIDTH

### 9.1 Standard Applicable

According to FCC § 2.1049 , § 27.53(m)

### 9.2 Test setup

Please refer the section §6.2 Configuration of Tested System.

### 9.3 Test Procedure

1. The EUT RF output port was connected to spectrum analyzer.
2. The level of RF input signal shall be increased, until the maximum output power per channel, declared by client, is reached.
3. The spectrum analyzer was setup to measure the Occupied Bandwidth (defined as the 99% Power Bandwidth).
4. The Occupied Bandwidth was measured at the input and output ports of the EUT at low, middle and high channel of each type of modulation and each type of carrier signal.

Spectrum analyzer settings:

Detector: RMS.

RBW= 1% to 5 % of the anticipated OBW

VBW $\geq$ 3\*RBW Sweep: Auto

### 9.4 Test Result



### Pass band Gain

Downlink:

Test mode	Carrier Conf.	Channel	Passband Gain (dB)	Nominal Gain (dB)	Result
LTE	LTE 1.4MHz Bandwidth	Low	62.24	62±0.5dB	Compliant
		Middle	62.38		Compliant
		High	62.19		Compliant
	LTE 3MHz Bandwidth	Low	62.26		Compliant
		Middle	62.35		Compliant
		High	62.16		Compliant
	LTE 5MHz Bandwidth	Low	62.12		Compliant
		Middle	62.29		Compliant
		High	62.32		Compliant
	LTE 10MHz Bandwidth	Low	62.15		Compliant
		Middle	62.25		Compliant
		High	62.12		Compliant
	LTE 15MHz Bandwidth	Low	62.20		Compliant
		Middle	62.26		Compliant
		High	62.13		Compliant
	LTE 20MHz Bandwidth	Low	62.11		Compliant
		Middle	62.23		Compliant
		High	62.05		Compliant
WCDMA	Single Carrier	Low	62.29	Compliant	
		Middle	62.36	Compliant	
		High	62.25	Compliant	
	Two Carrier	Low	62.24	Compliant	
		Middle	62.33	Compliant	
		High	62.15	Compliant	
	Three Carrier	Low	62.21	Compliant	
		Middle	62.20	Compliant	
		High	62.05	Compliant	
	Four Carrier	Low	62.12	Compliant	
		Middle	62.15	Compliant	
		High	62.04	Compliant	

Uplink:

Test mode	Carrier Conf.	Channel	Passband Gain (dB)	Nominal Gain (dB)	Result	
LTE	LTE 1.4MHz Bandwidth	Low	62.25	62±0.5dB	Compliant	
		Middle	62.36		Compliant	
		High	62.23		Compliant	
	LTE 3MHz Bandwidth	Low	61.99		Compliant	
		Middle	62.21		Compliant	
		High	62.07		Compliant	
	LTE 5MHz Bandwidth	Low	61.89		Compliant	
		Middle	61.97		Compliant	
		High	61.93		Compliant	
	LTE 10MHz Bandwidth	Low	62.10		Compliant	
		Middle	62.16		Compliant	
		High	62.04		Compliant	
	LTE 15MHz Bandwidth	Low	62.11		Compliant	
		Middle	62.32		Compliant	
		High	62.14		Compliant	
	LTE 20MHz Bandwidth	Low	61.91		Compliant	
		Middle	62.02		Compliant	
		High	62.19		Compliant	
	WCDMA	Single Carrier	Low		62.03	Compliant
			Middle		62.15	Compliant
			High		62.14	Compliant
		Two Carrier	Low		62.05	Compliant
			Middle		62.21	Compliant
			High		62.17	Compliant
Three Carrier		Low	62.02	Compliant		
		Middle	62.15	Compliant		
		High	62.10	Compliant		
Four Carrier		Low	62.23	Compliant		
		Middle	62.31	Compliant		
		High	62.26	Compliant		

## Input/output Bandwidth Comparison

Downlink:

### Input/output Bandwidth Comparison for LTE 1.4MHz Bandwidth

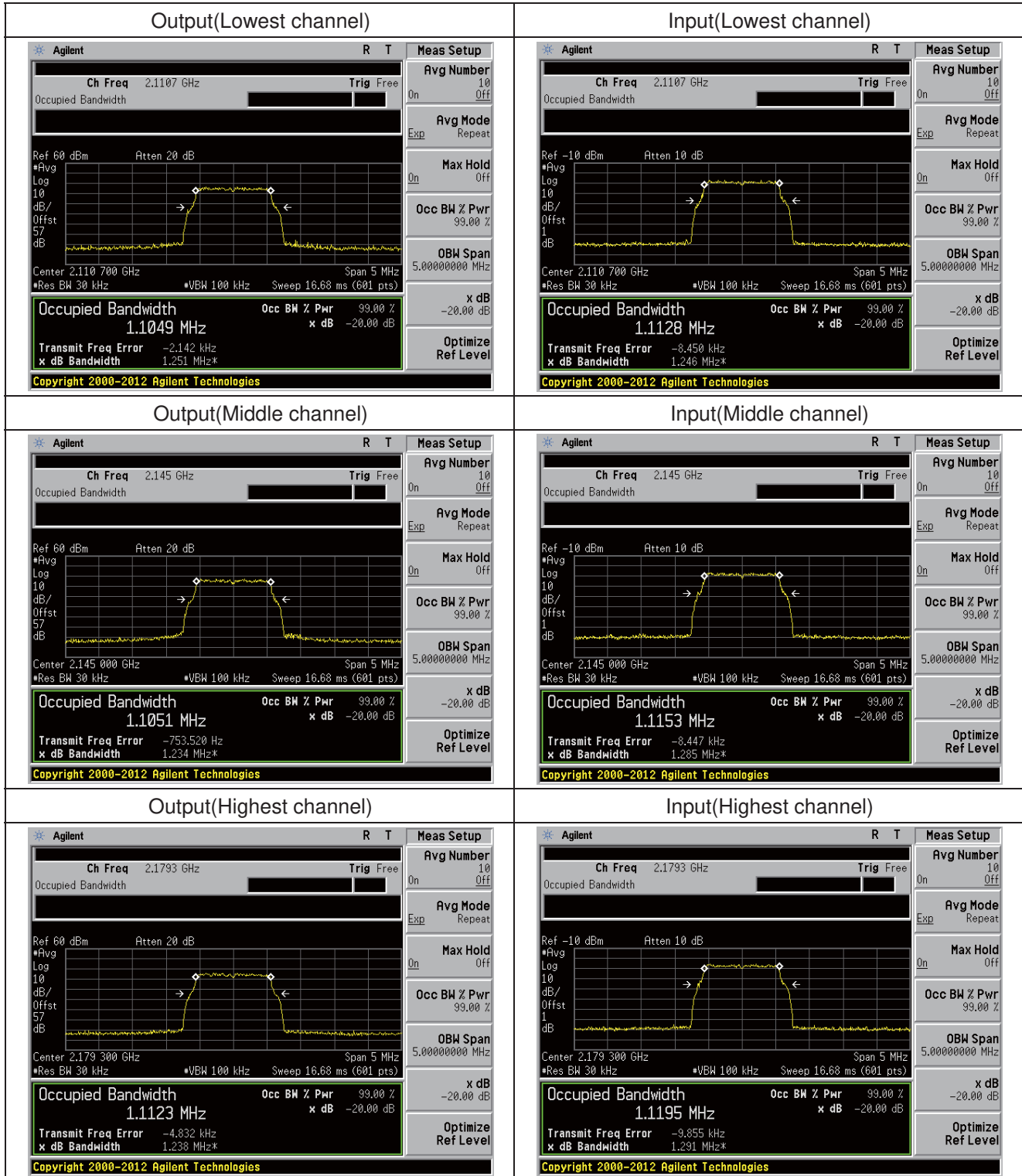

## Input/output Bandwidth Comparison for LTE 3MHz Bandwidth

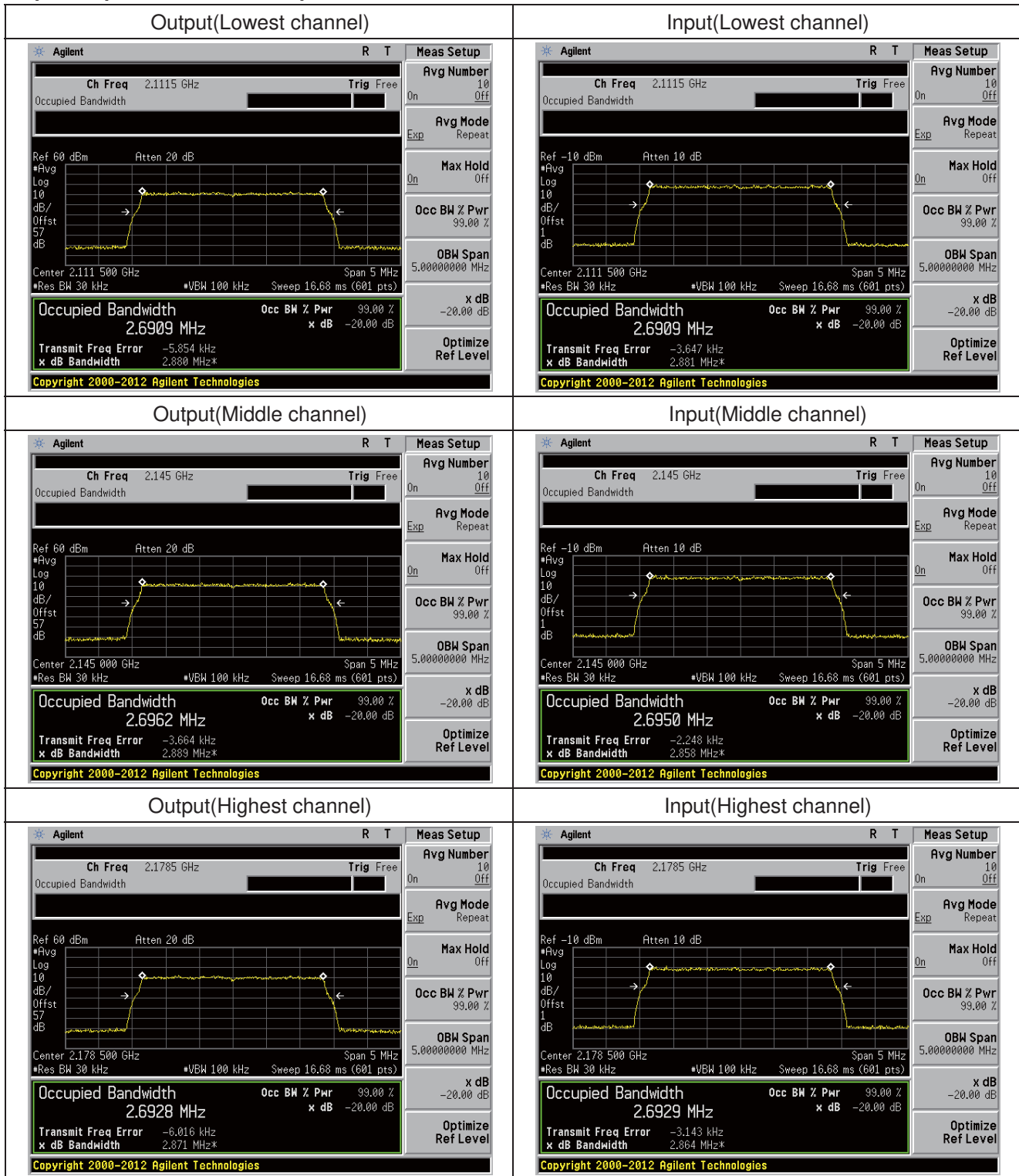

## Input/output Bandwidth Comparison for LTE 5MHz Bandwidth

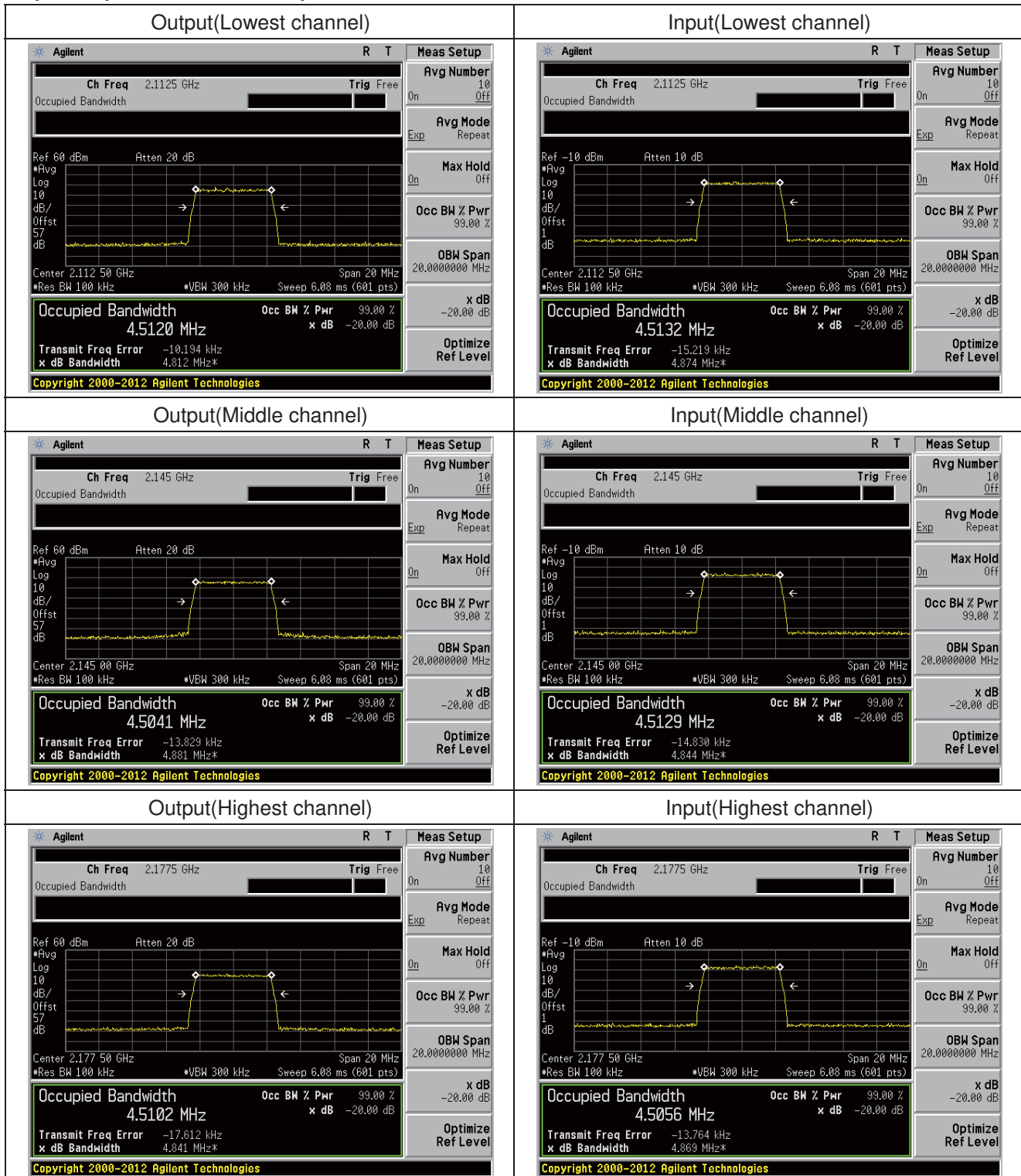

## Input/output Bandwidth Comparison for LTE 10MHz Bandwidth

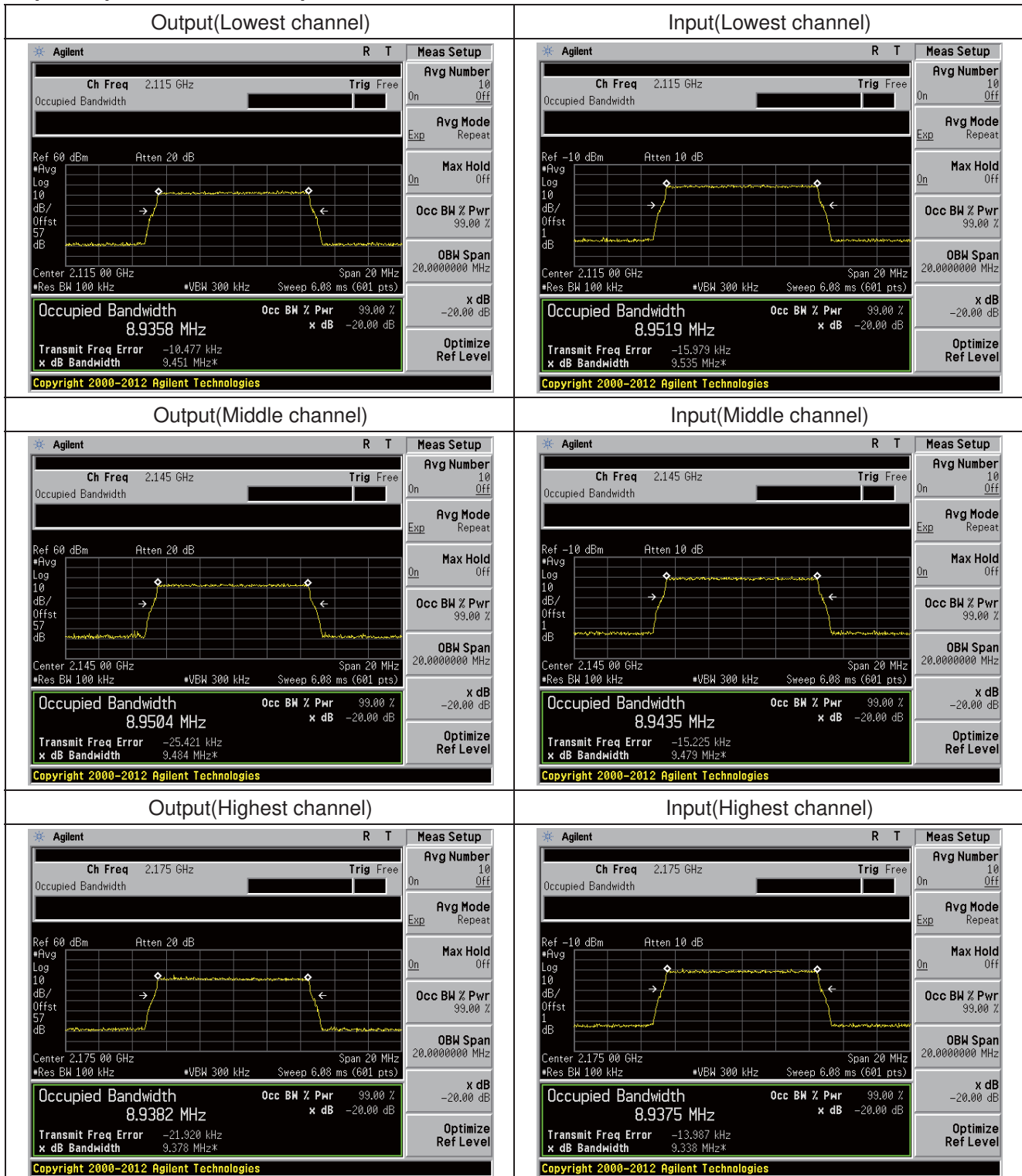

## Input/output Bandwidth Comparison for LTE 15MHz Bandwidth

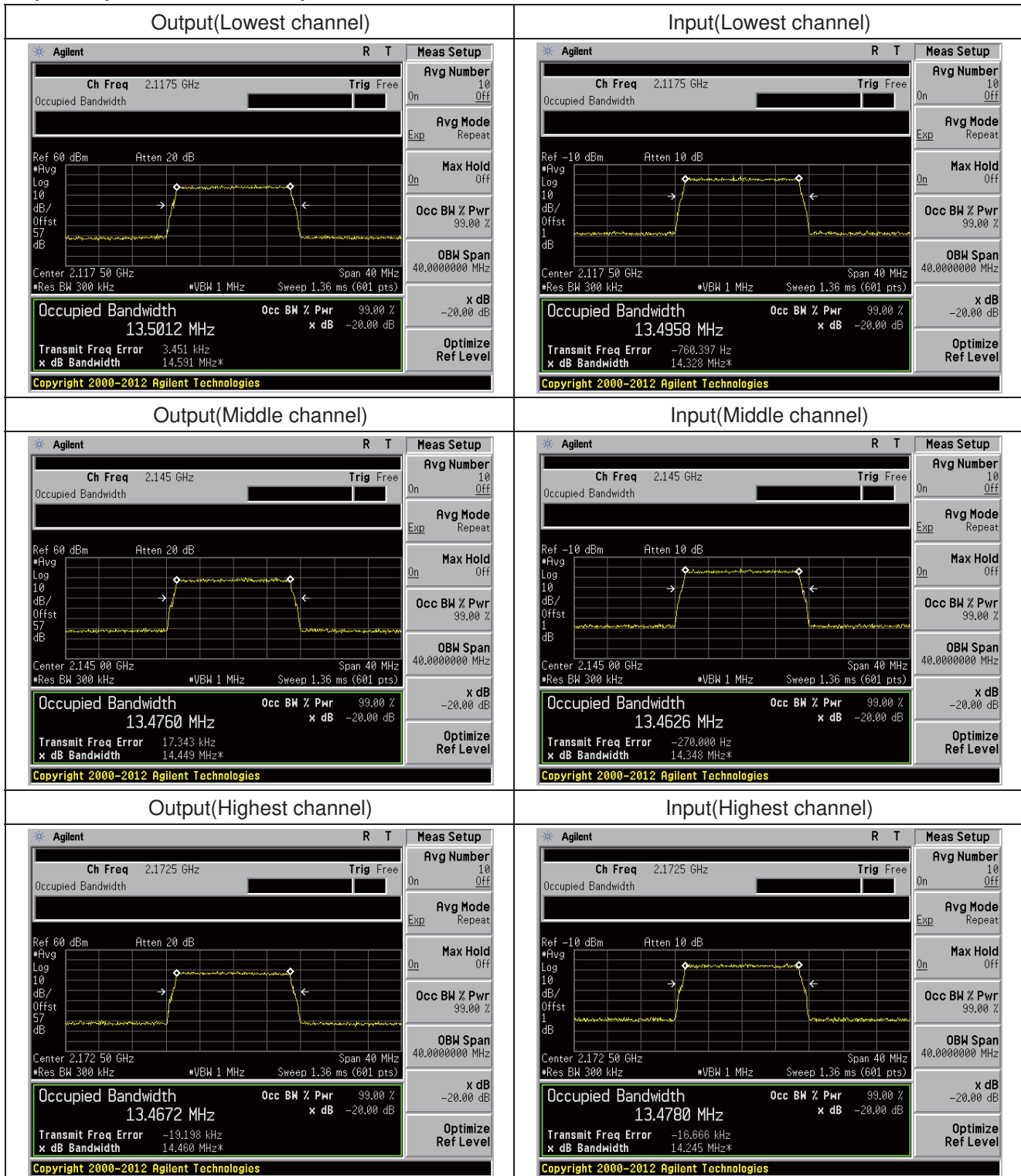



## Input/output Bandwidth Comparison for LTE 20MHz Bandwidth

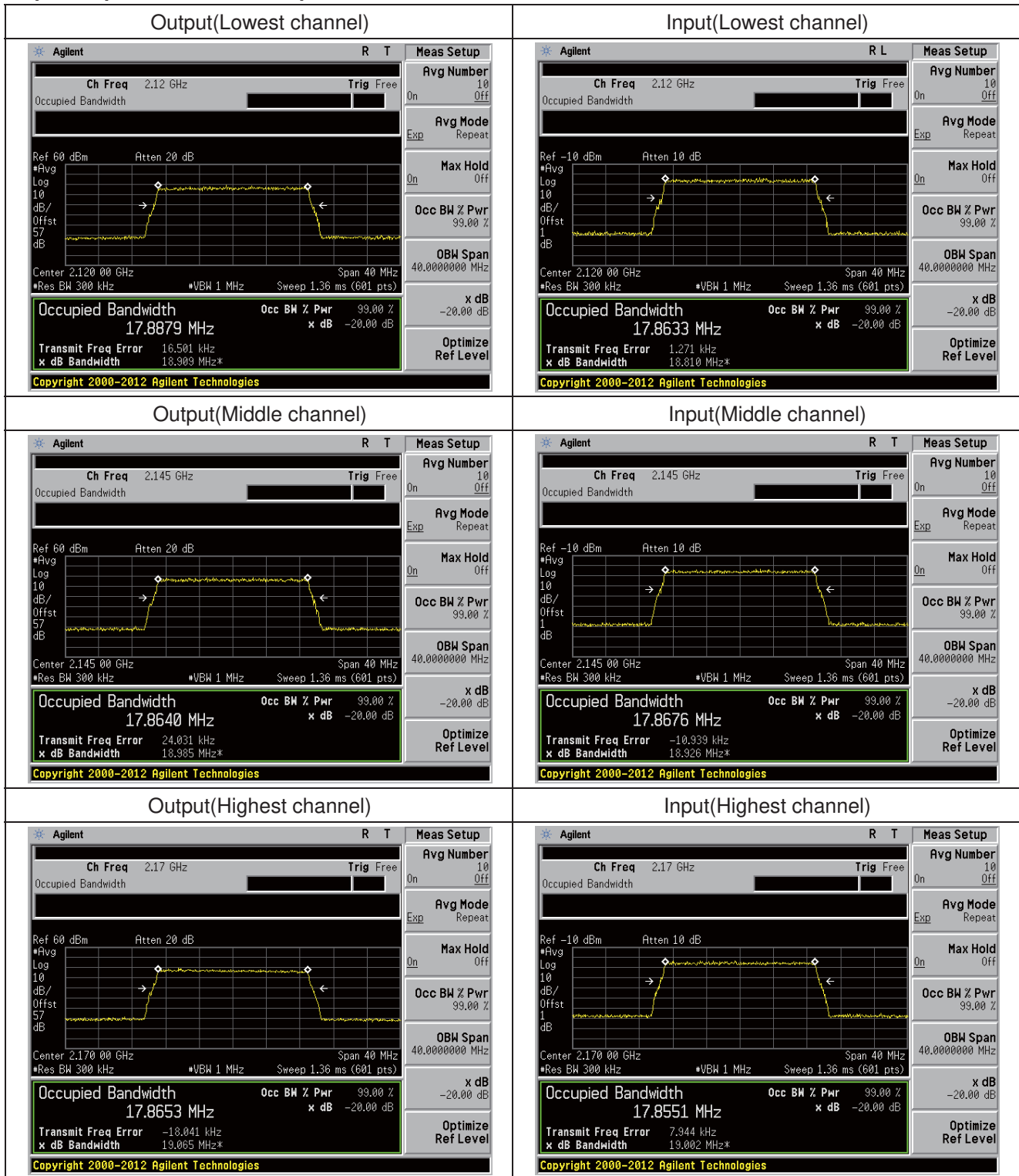



## Input/output Bandwidth Comparison for WCDMA Single Carrier

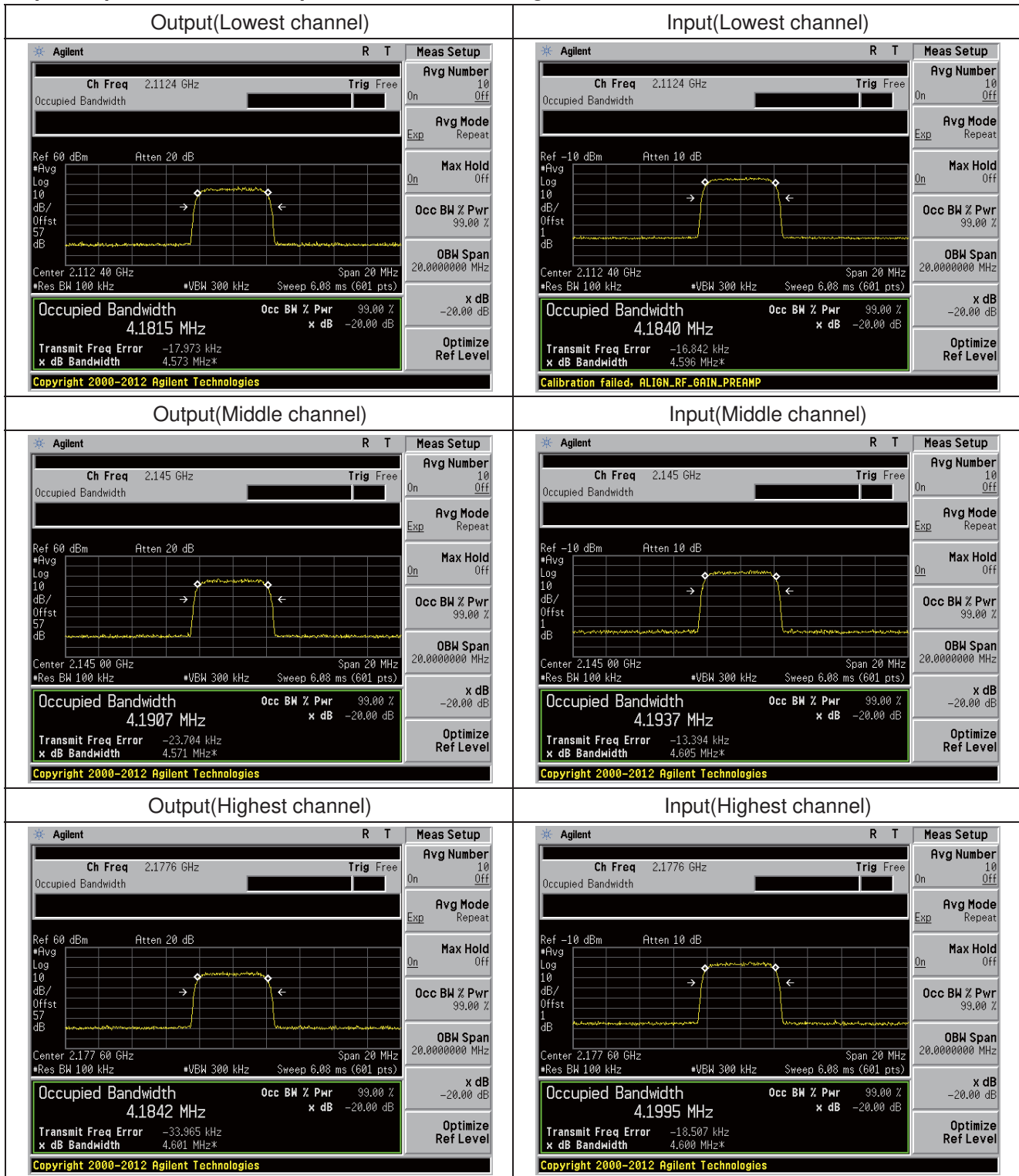

## Input/output Bandwidth Comparison for WCDMA Four Carrier

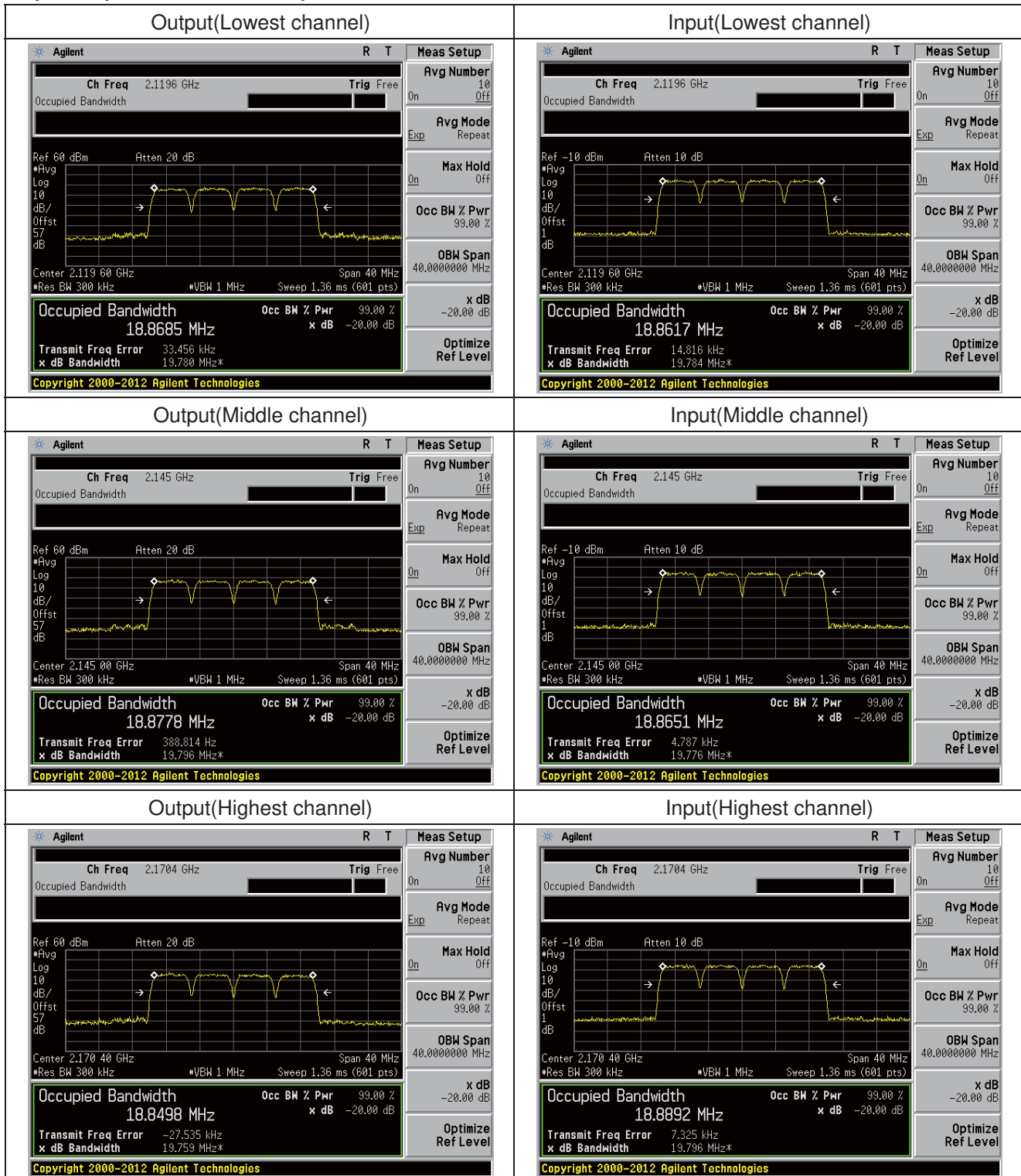

Uplink:

## Input/output Bandwidth Comparison for LTE 1.4MHz Bandwidth

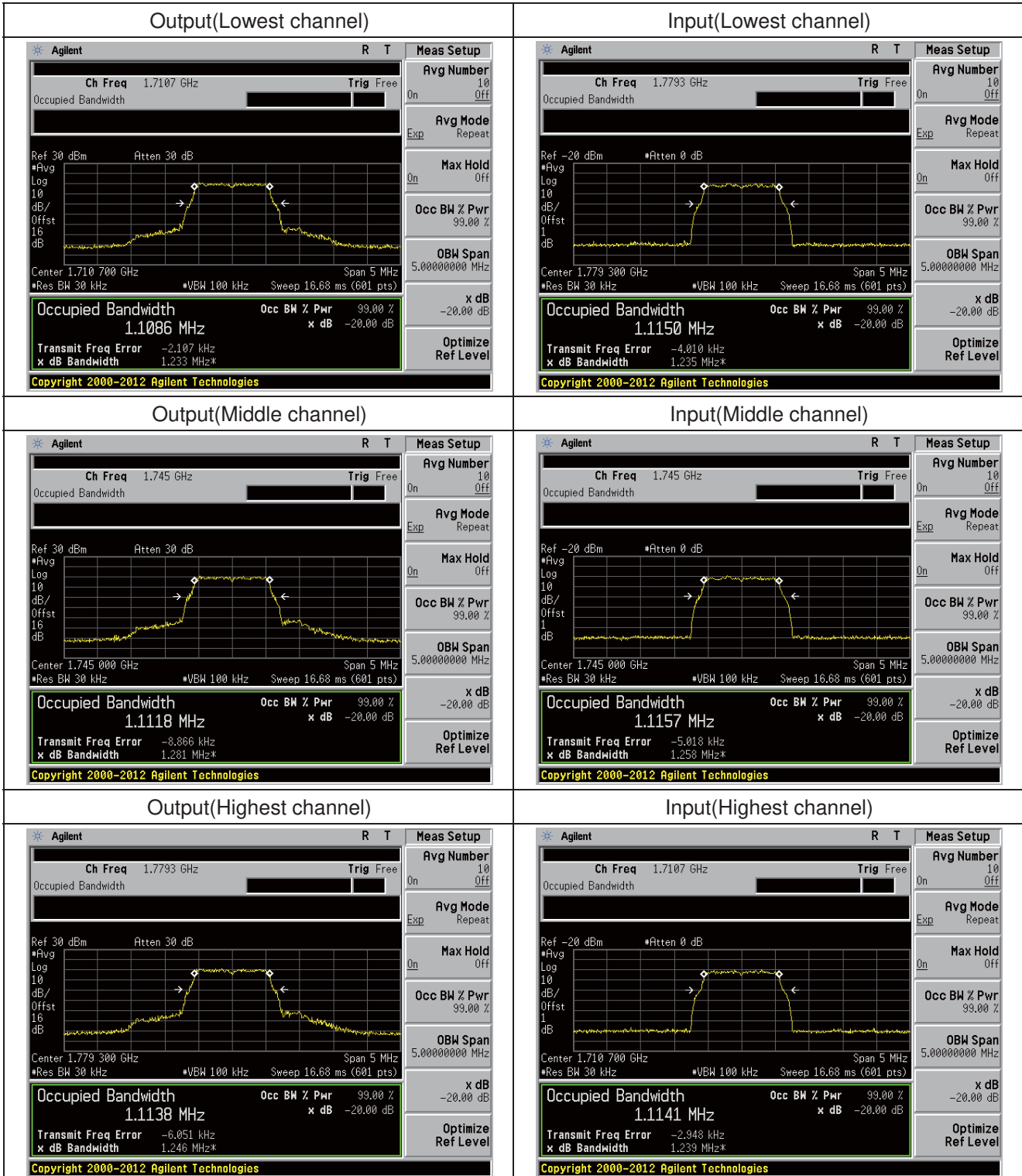

## Input/output Bandwidth Comparison for LTE 3MHz Bandwidth

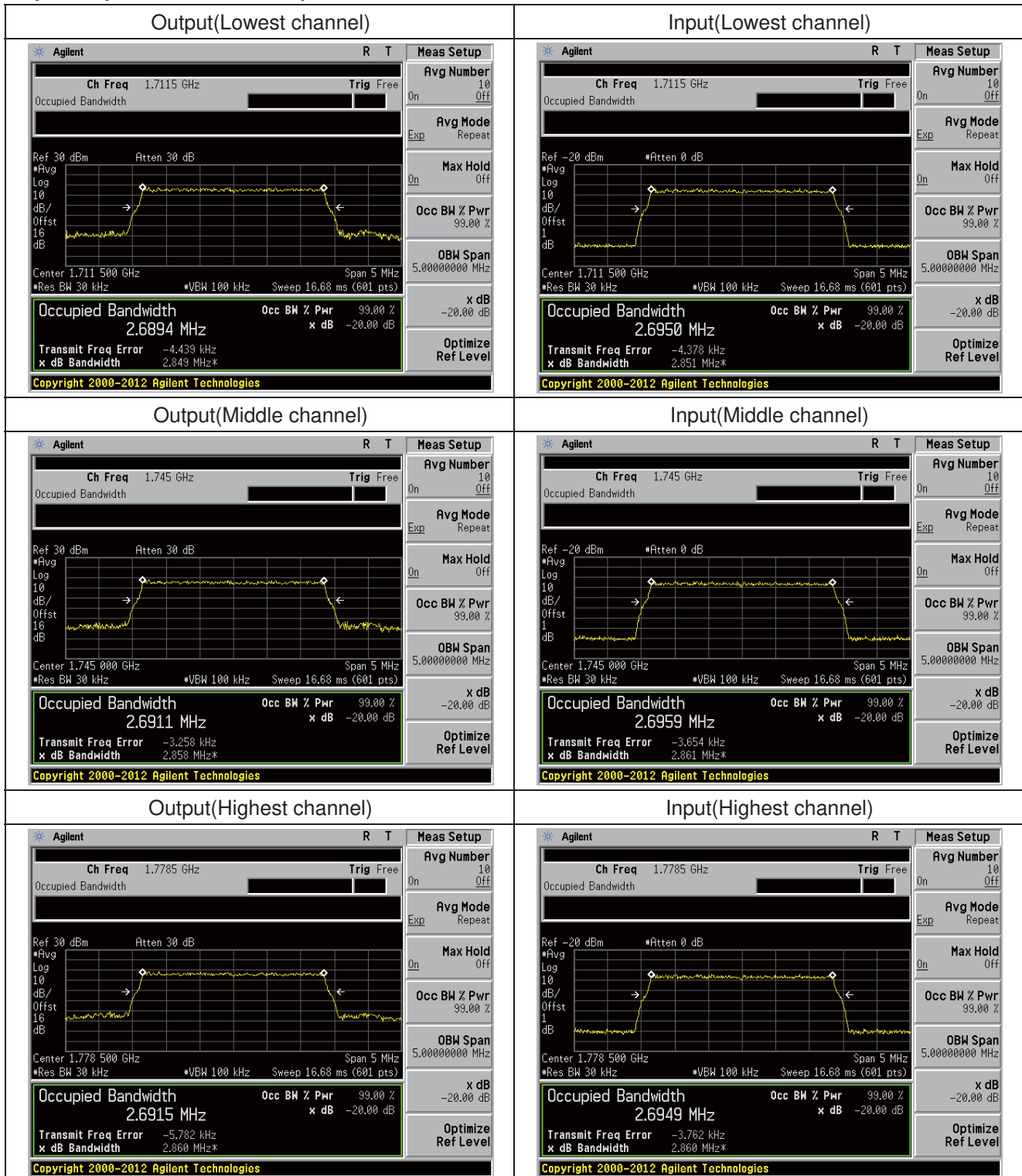

## Input/output Bandwidth Comparison for LTE 5MHz Bandwidth

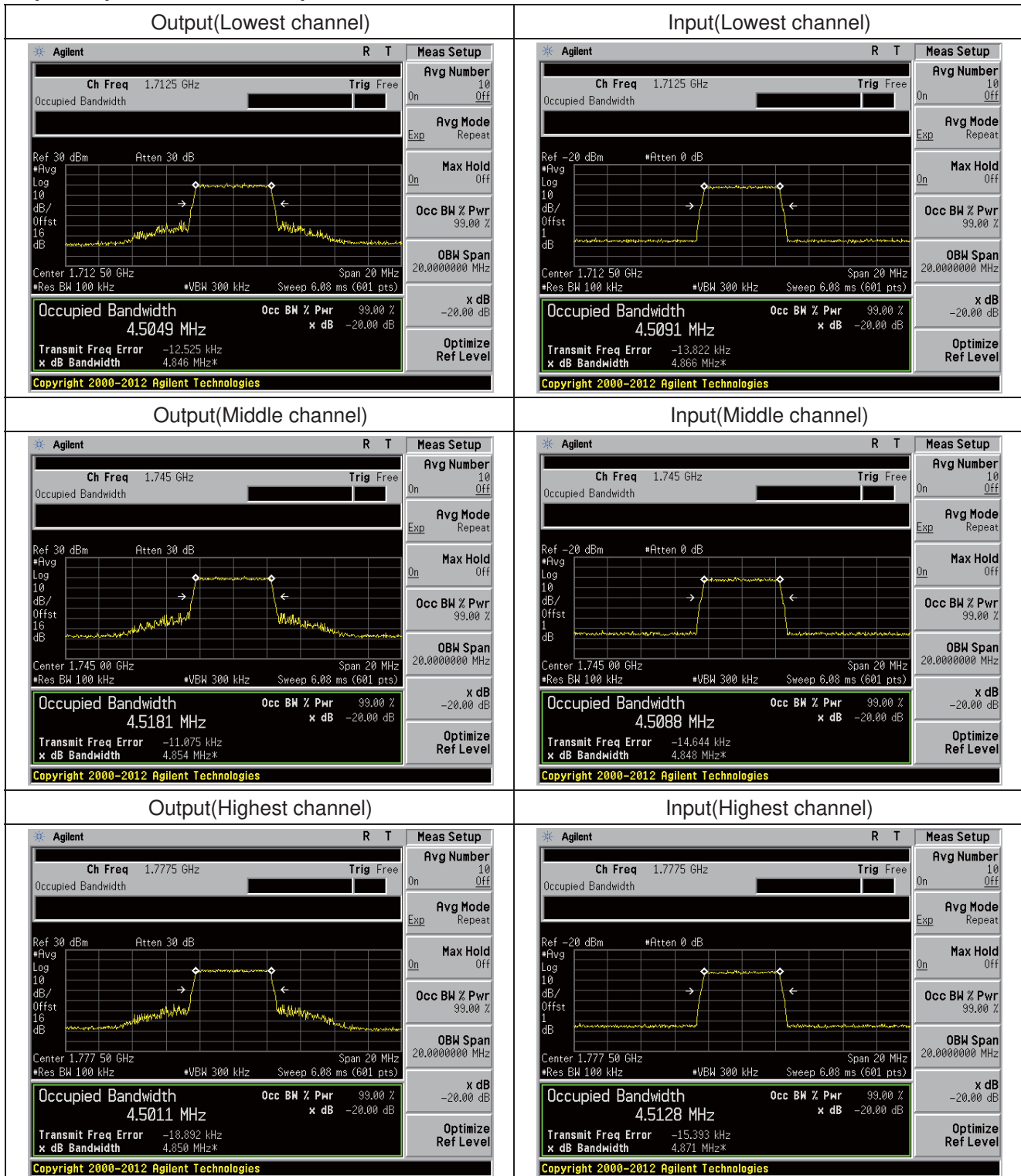

## Input/output Bandwidth Comparison for LTE 10MHz Bandwidth

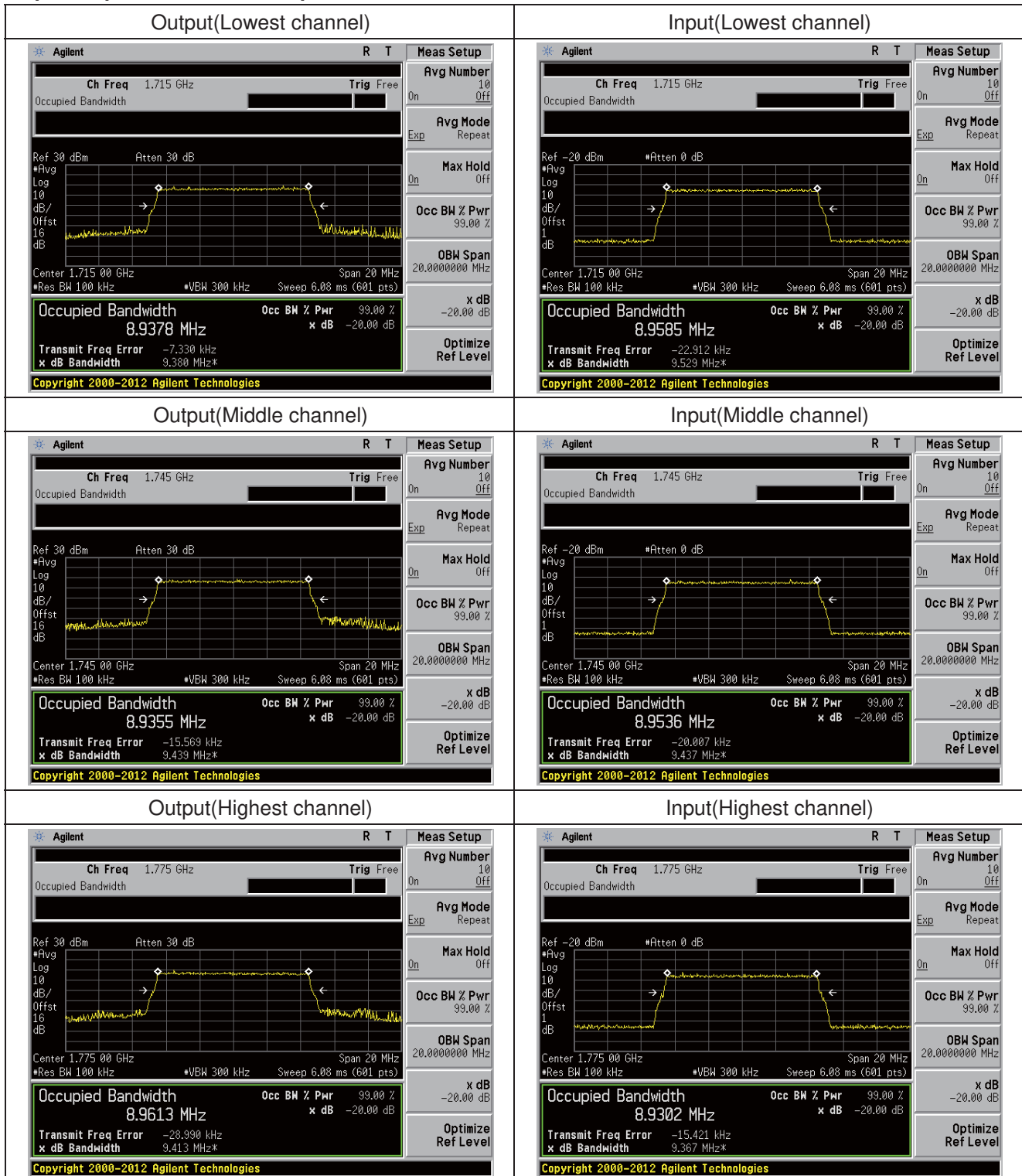

## Input/output Bandwidth Comparison for LTE 15MHz Bandwidth

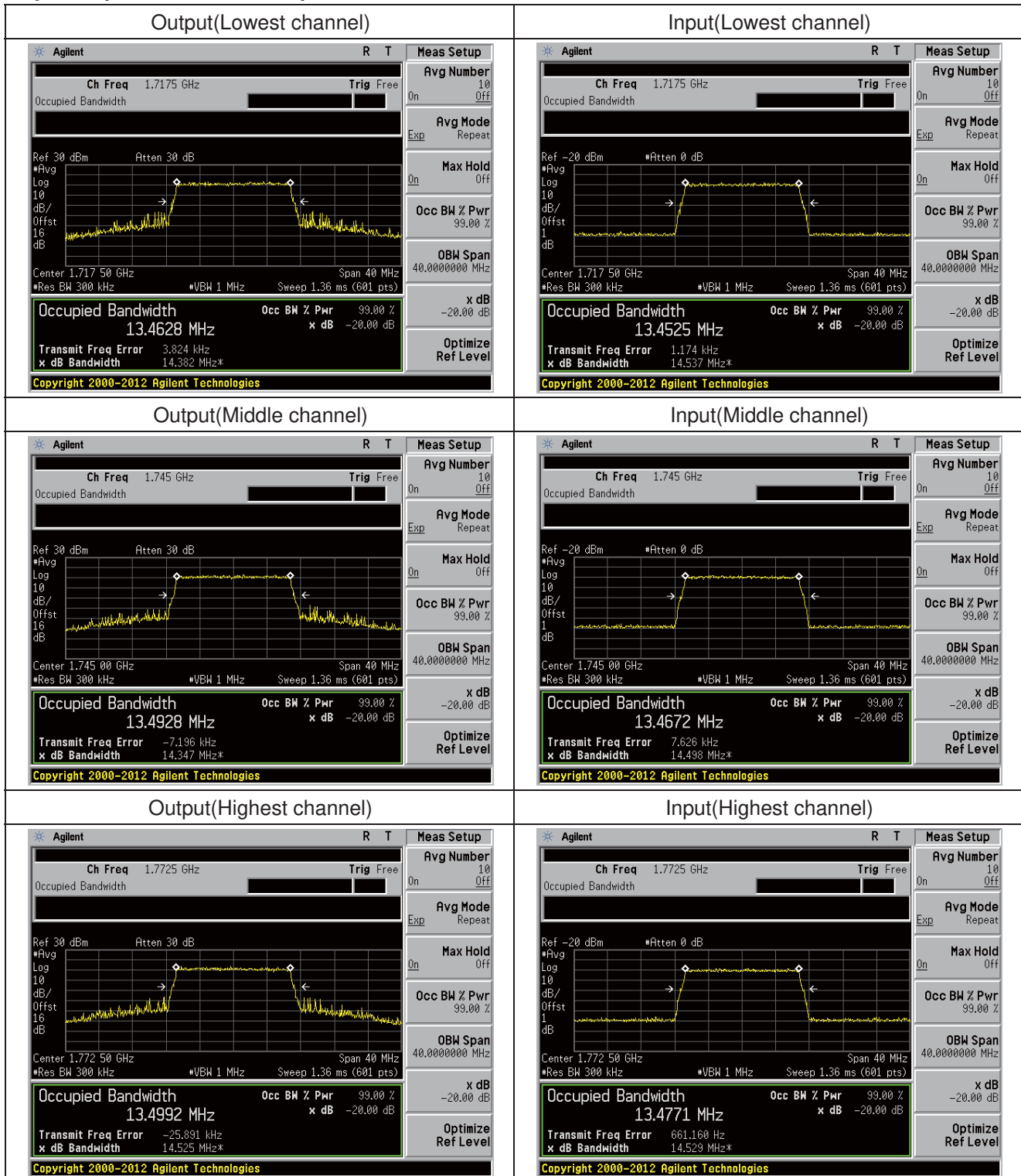



## Input/output Bandwidth Comparison for LTE 20MHz Bandwidth

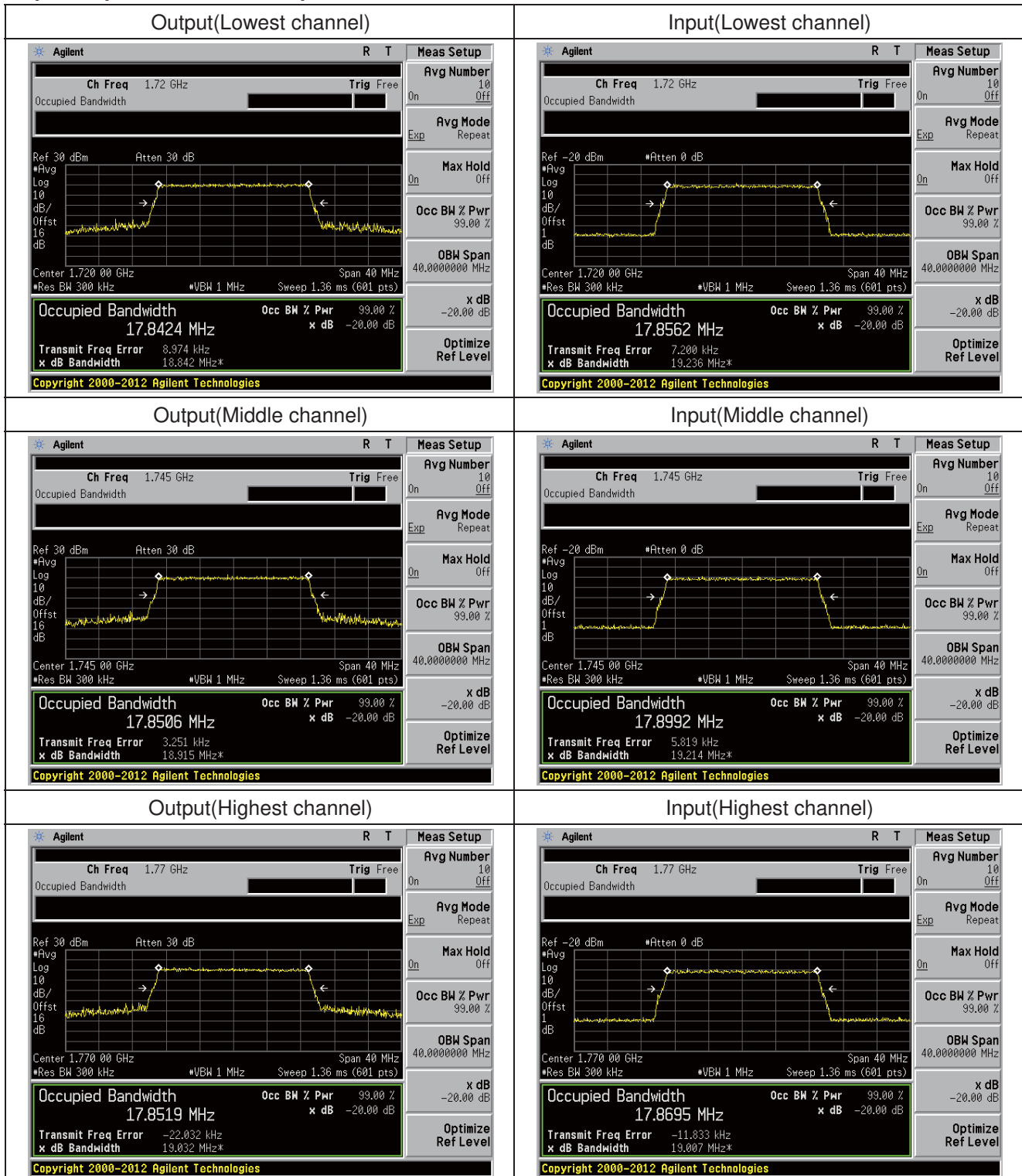



## Input/output Bandwidth Comparison for WCDMA Single Carrier

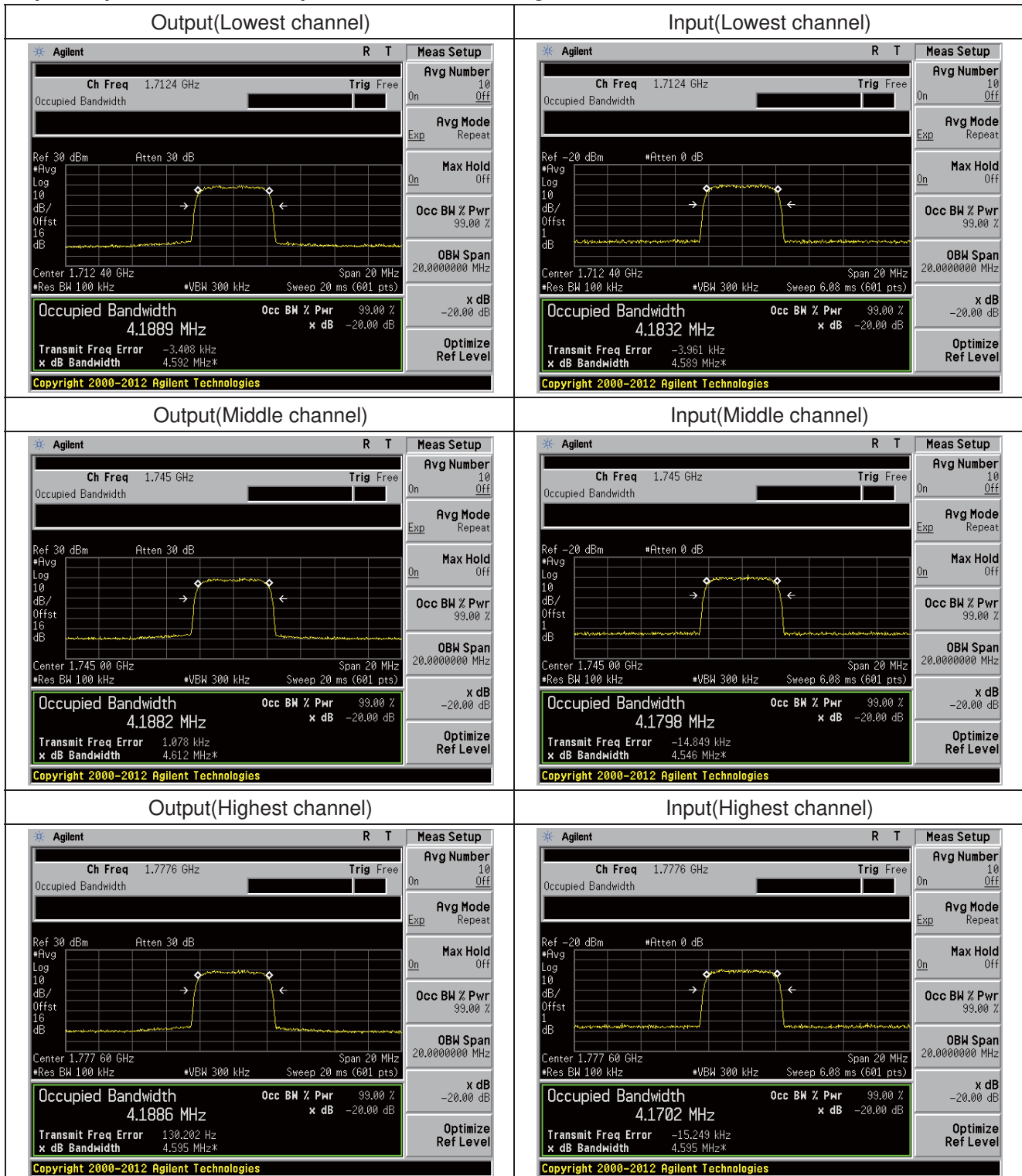

## Input/output Bandwidth Comparison for WCDMA Four Carrier

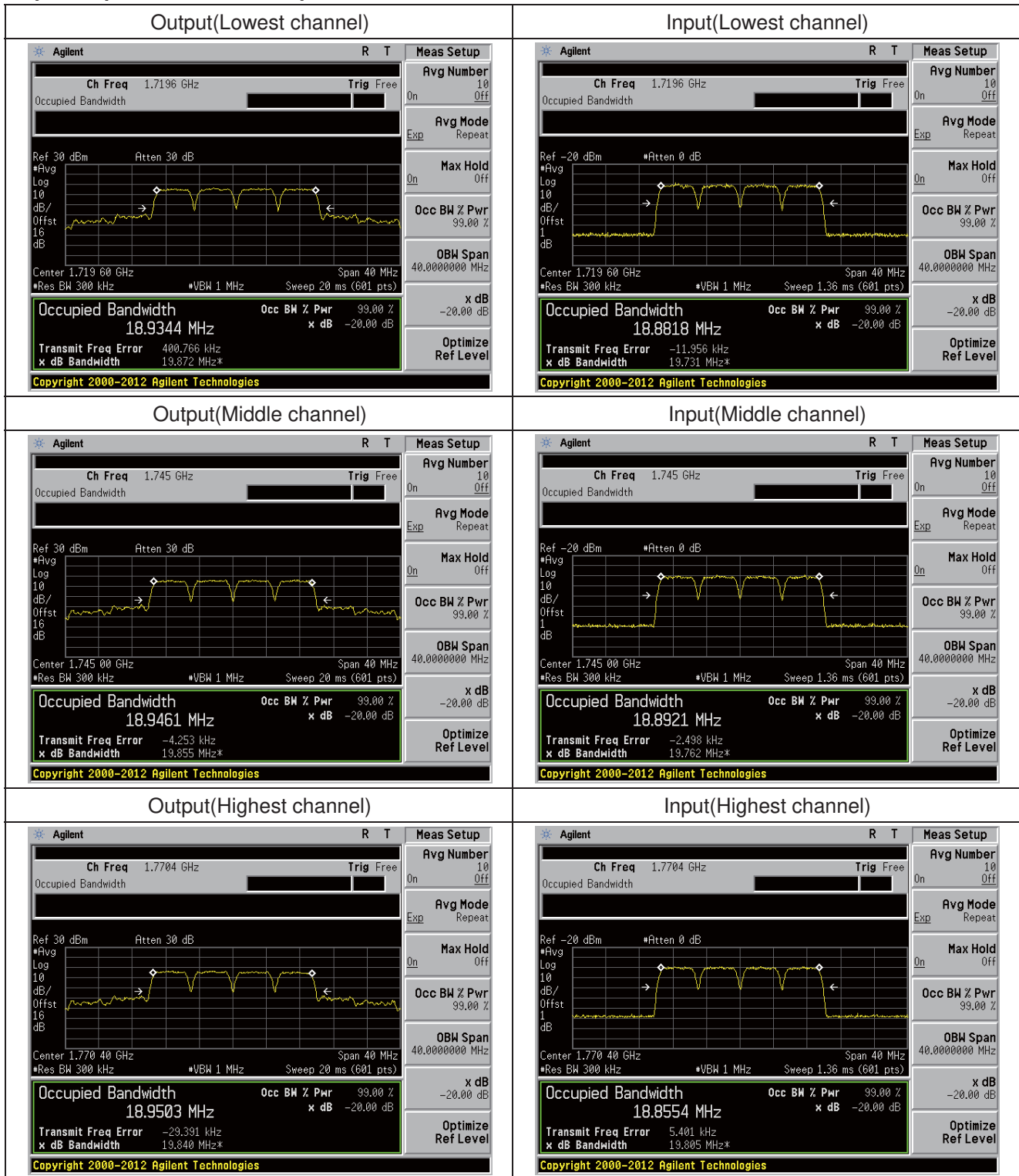

## 10 OUT OF BAND EMISSION AT ANTENNA TERMINALS

### 10.1 Standard Applicable

According to FCC § 2.1051 and § 27.53(m)

### 10.2 Test setup

Please refer the section §6.2 Configuration of Tested System.

### 10.3 Measurement Procedure

The out of band emissions were measured directly from the EUT antenna output with a spectrum analyzer from 30 MHz to the 10th harmonic of the highest carrier frequency. Test signals used is LTE and WCDMA. The different signals were input one at a time to the EUT. Tests was performed with LTE and WCDMA signal input.

Band edge compliance is also demonstrated using a LTE and WCDMA signal at the upper and lower limits of the band.

1. The EUT RF output port was connected to spectrum analyzer.
2. The level of RF input signal shall be increased, until the maximum output power per channel, declared by client, is reached.
3. The spurious emissions at antenna were measured at the RF output port of the EUT at middle channel of each type of modulation.

Spectrum analyzer settings:

Detector: RMS.

> 1 MHz from Band Edge

Below 1G: RBW=100kHz; VBW=300KHz; Above 1G: RBW=1 MHz ; VBW≥ RBW

< 1 MHz from Band Edge

RBW=3 kHz; VBW≥ RBW

### 10.4 Measurement Result

#### 10.4.1 Spurious emission

Downlink:

## Spurious emission of LTE 1.4MHz Bandwidth



Middle channel

30MHz-1000MHz

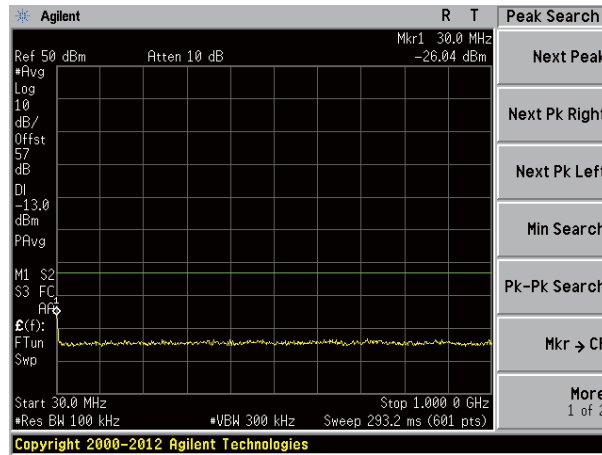

1000MHz-3000MHz

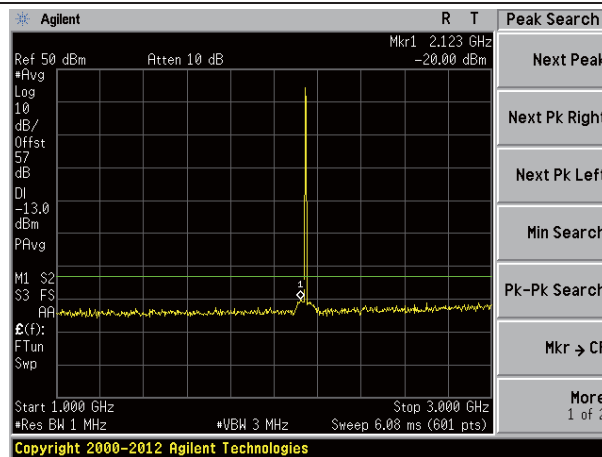

3000MHz-22000MHz

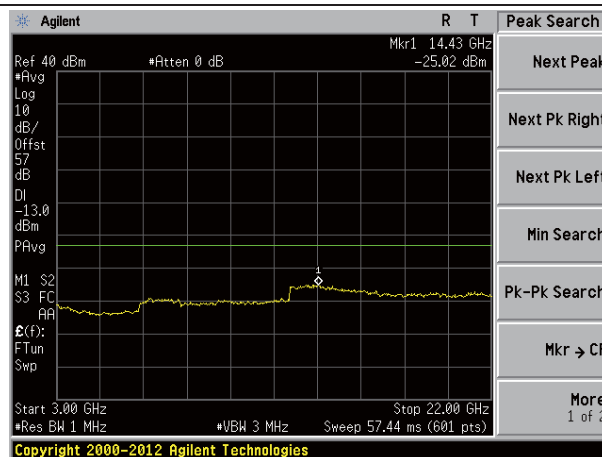

### Highest channel

#### 30MHz-1000MHz

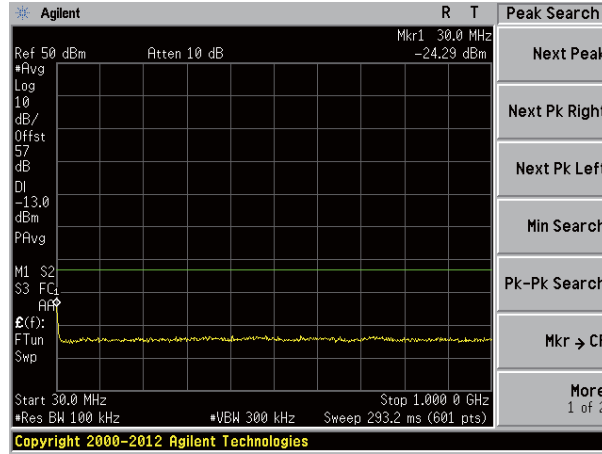

#### 1000MHz-3000MHz

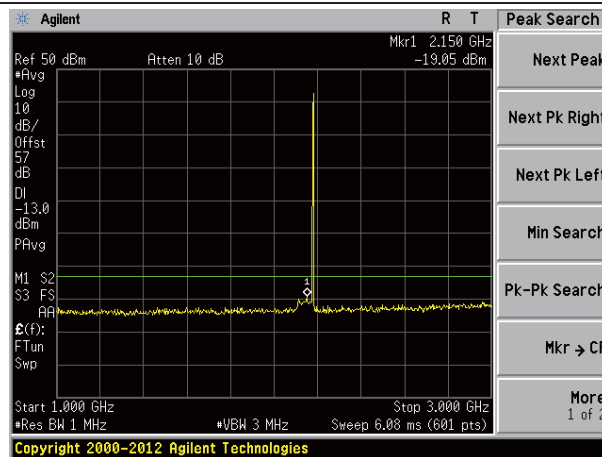

#### 3000MHz-22000MHz

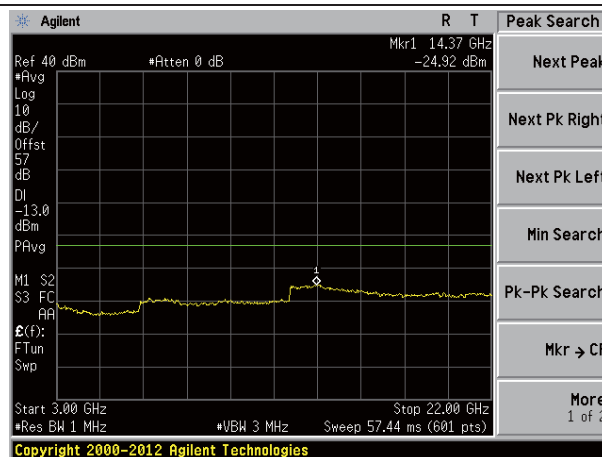

## Spurious emission of LTE 3MHz Bandwidth

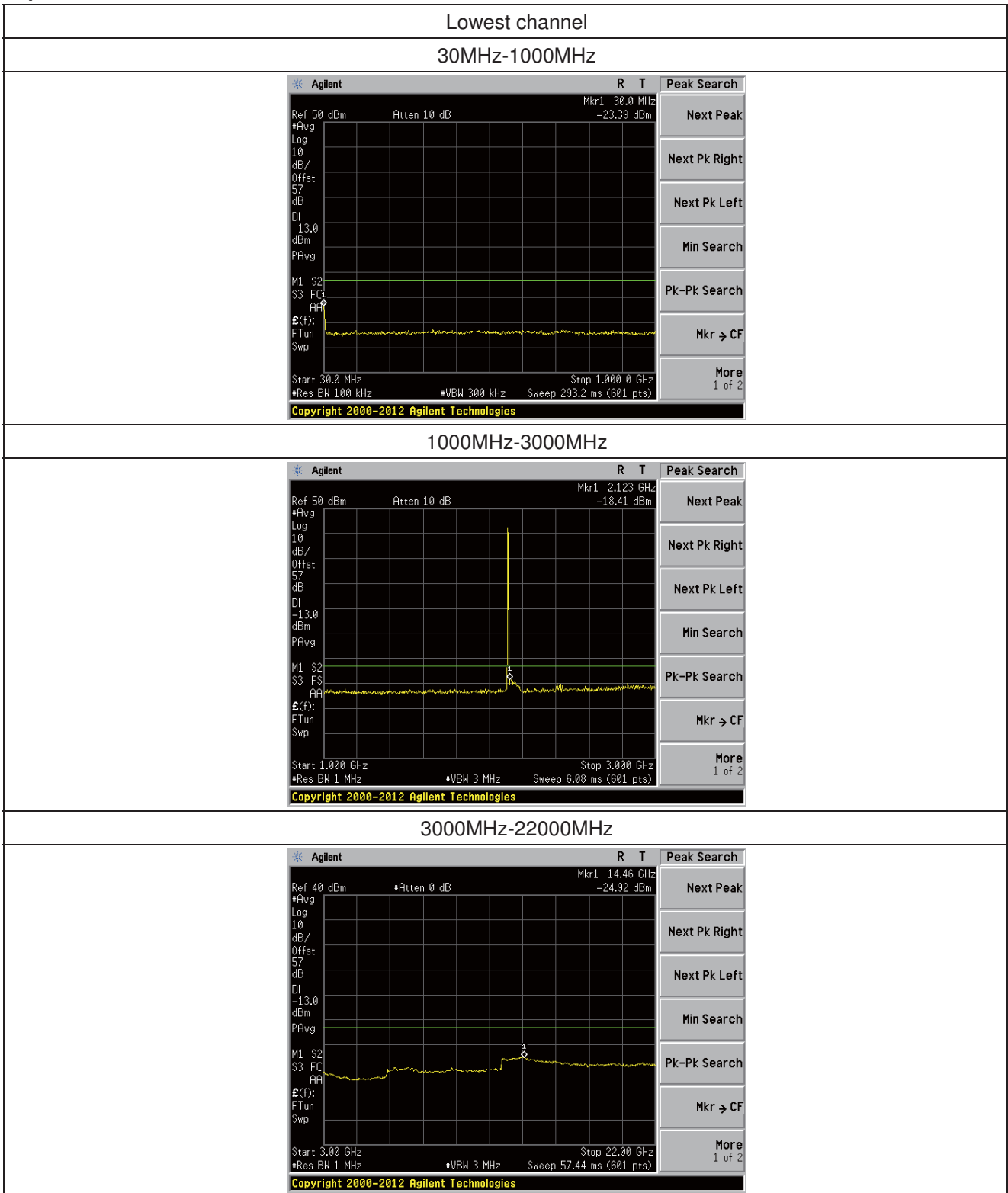

Middle channel

30MHz-1000MHz

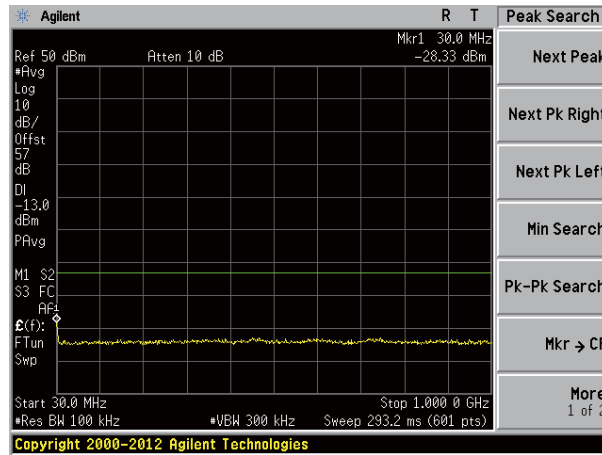

1000MHz-3000MHz

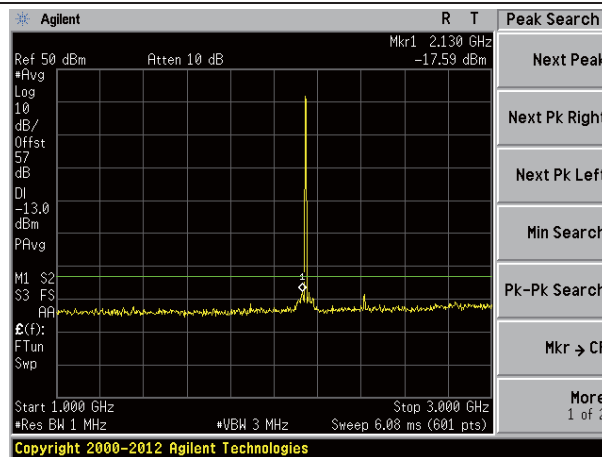

3000MHz-22000MHz

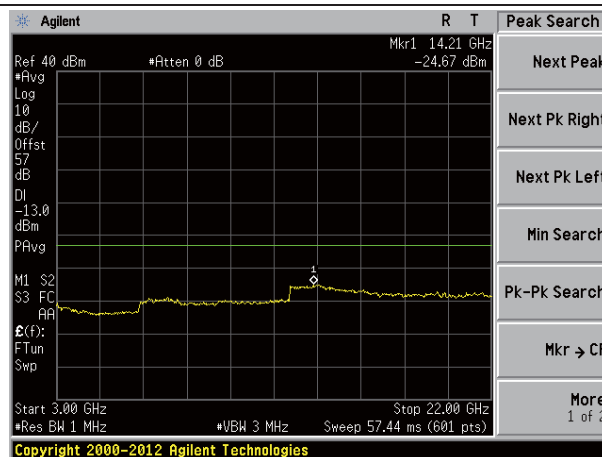



Highest channel

30MHz-1000MHz

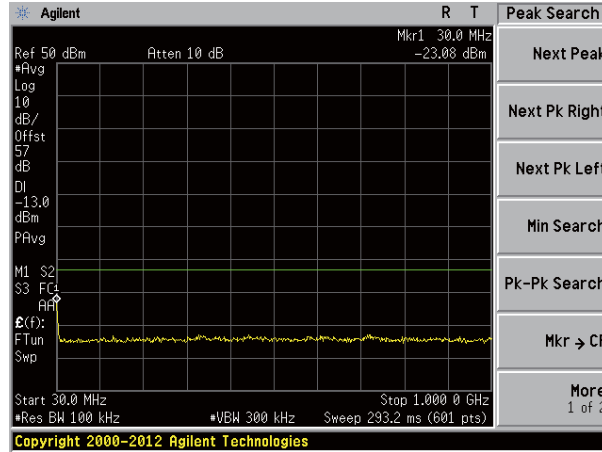

1000MHz-3000MHz

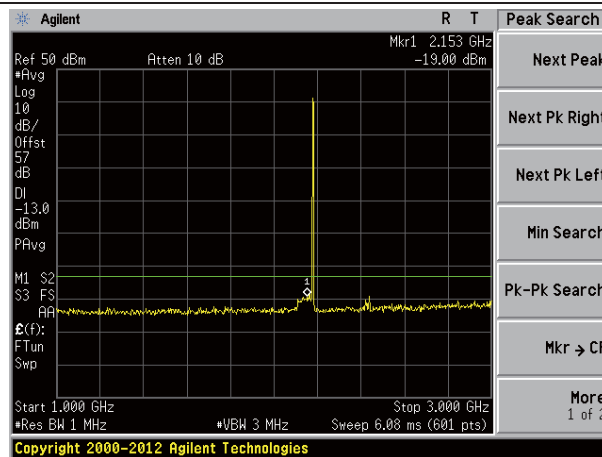

3000MHz-22000MHz

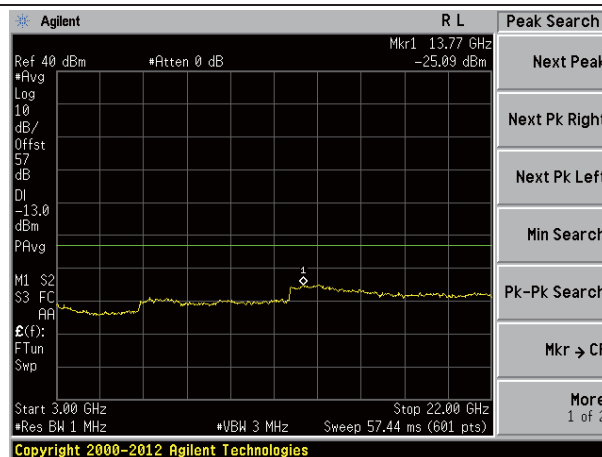

## Spurious emission of LTE 5MHz Bandwidth

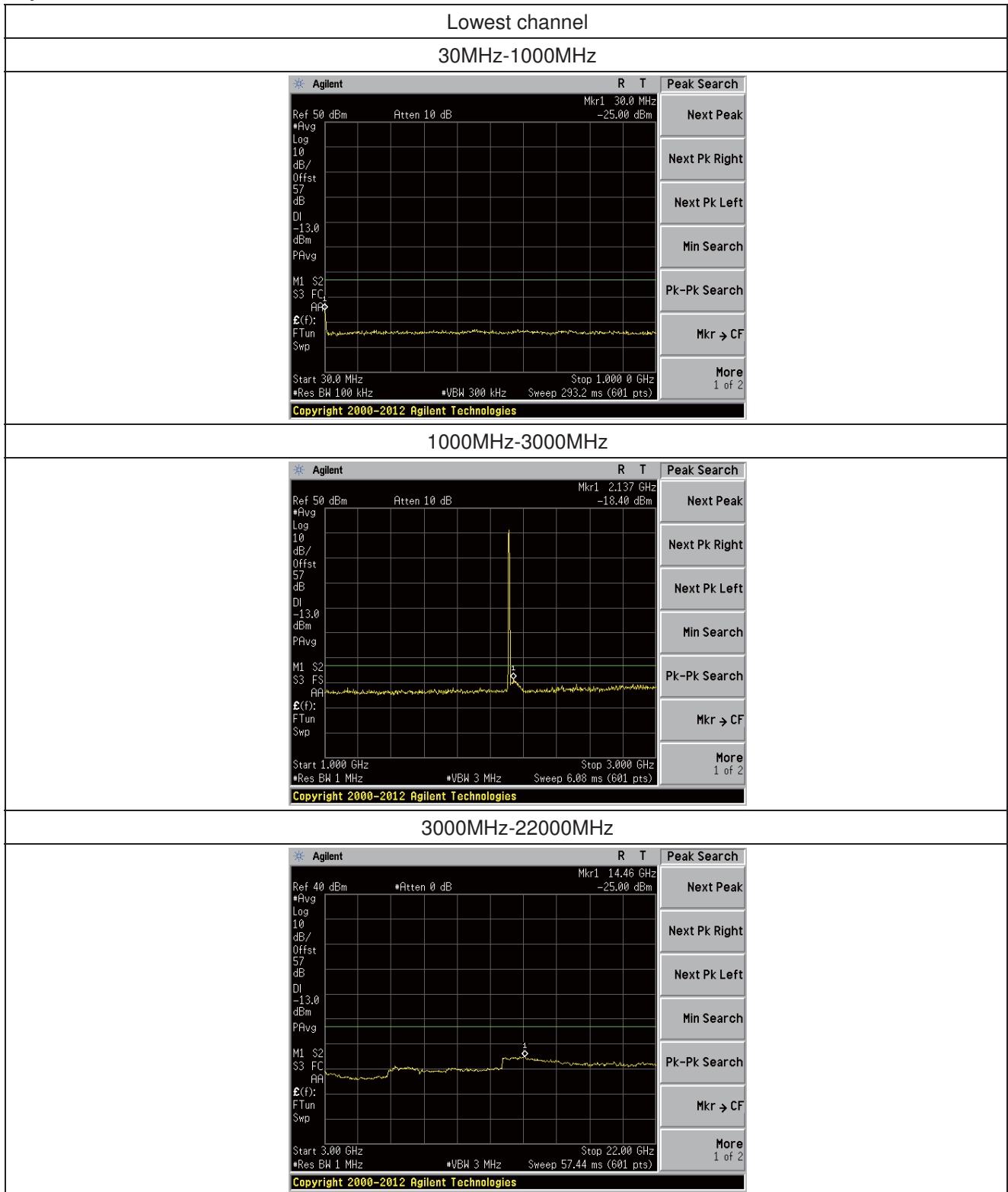

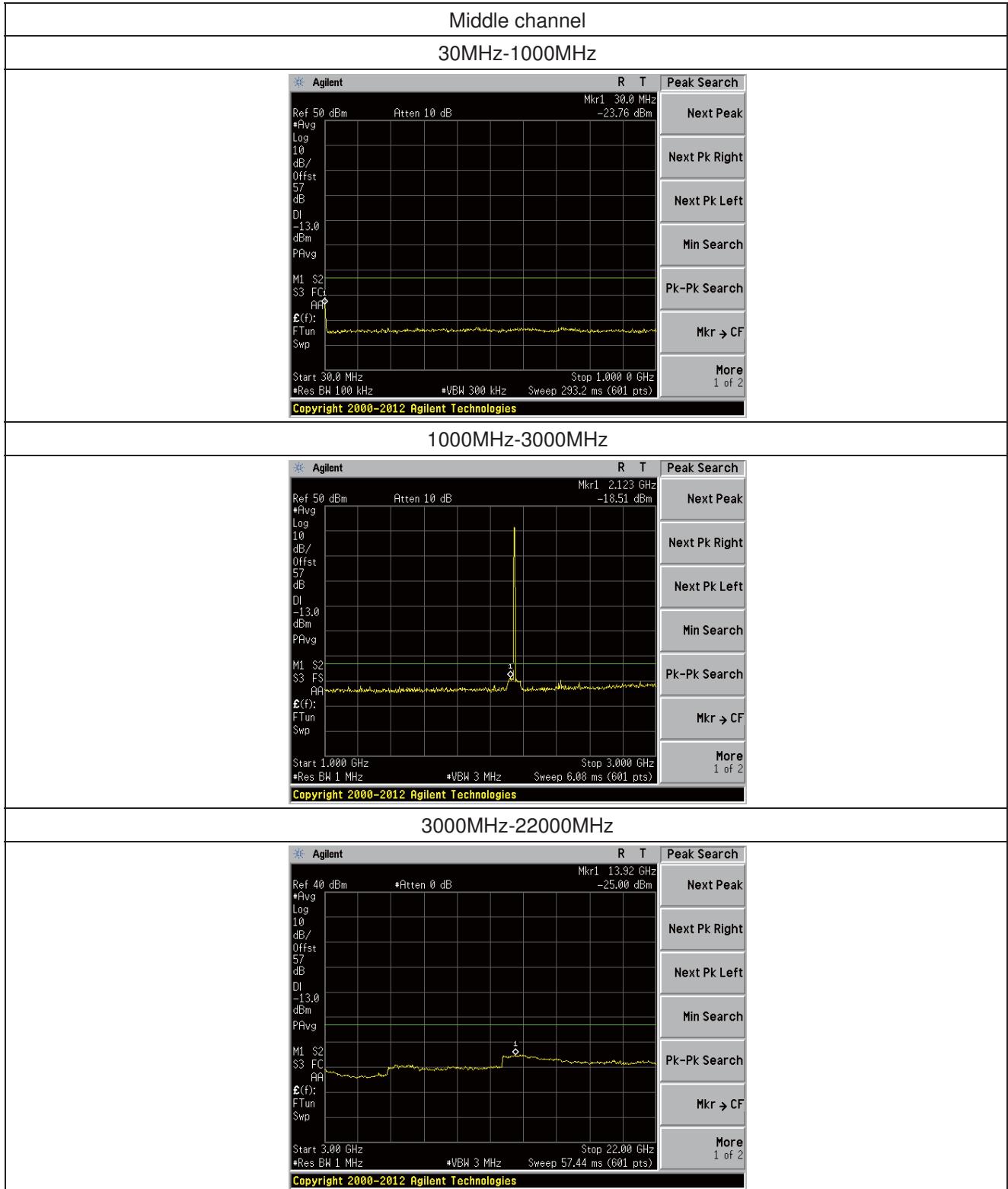

### Highest channel

#### 30MHz-1000MHz

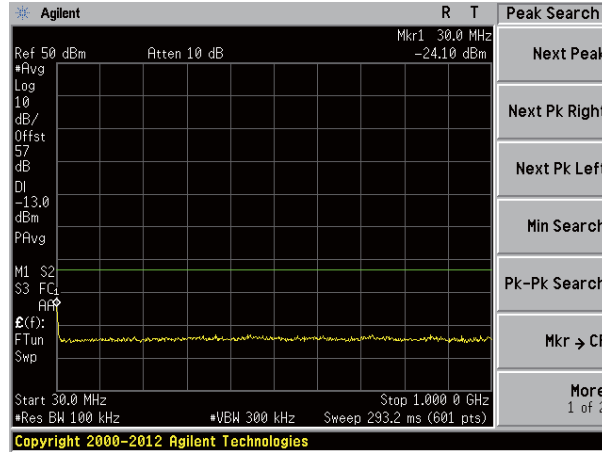

#### 1000MHz-3000MHz

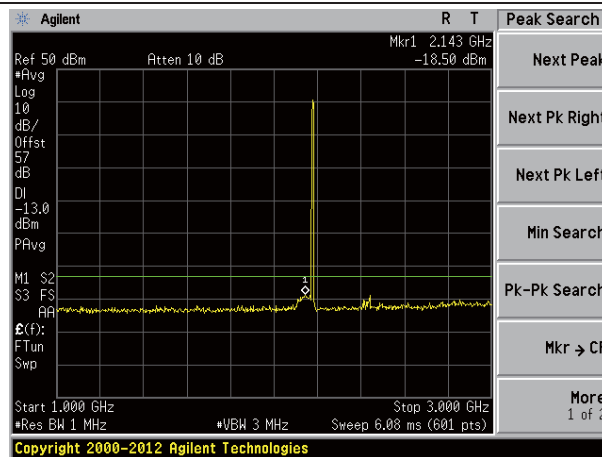

#### 3000MHz-22000MHz

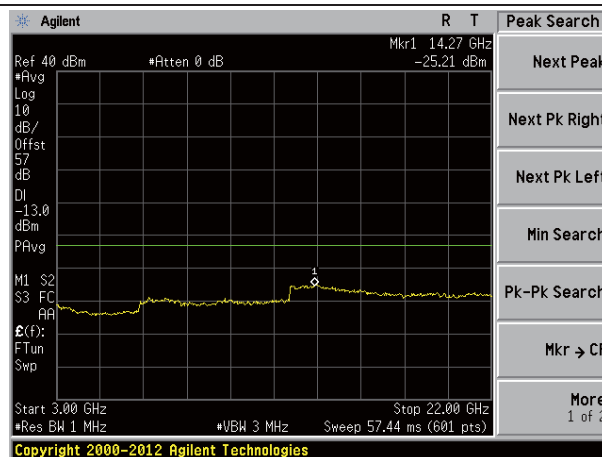

## Spurious emission of LTE 10MHz Bandwidth

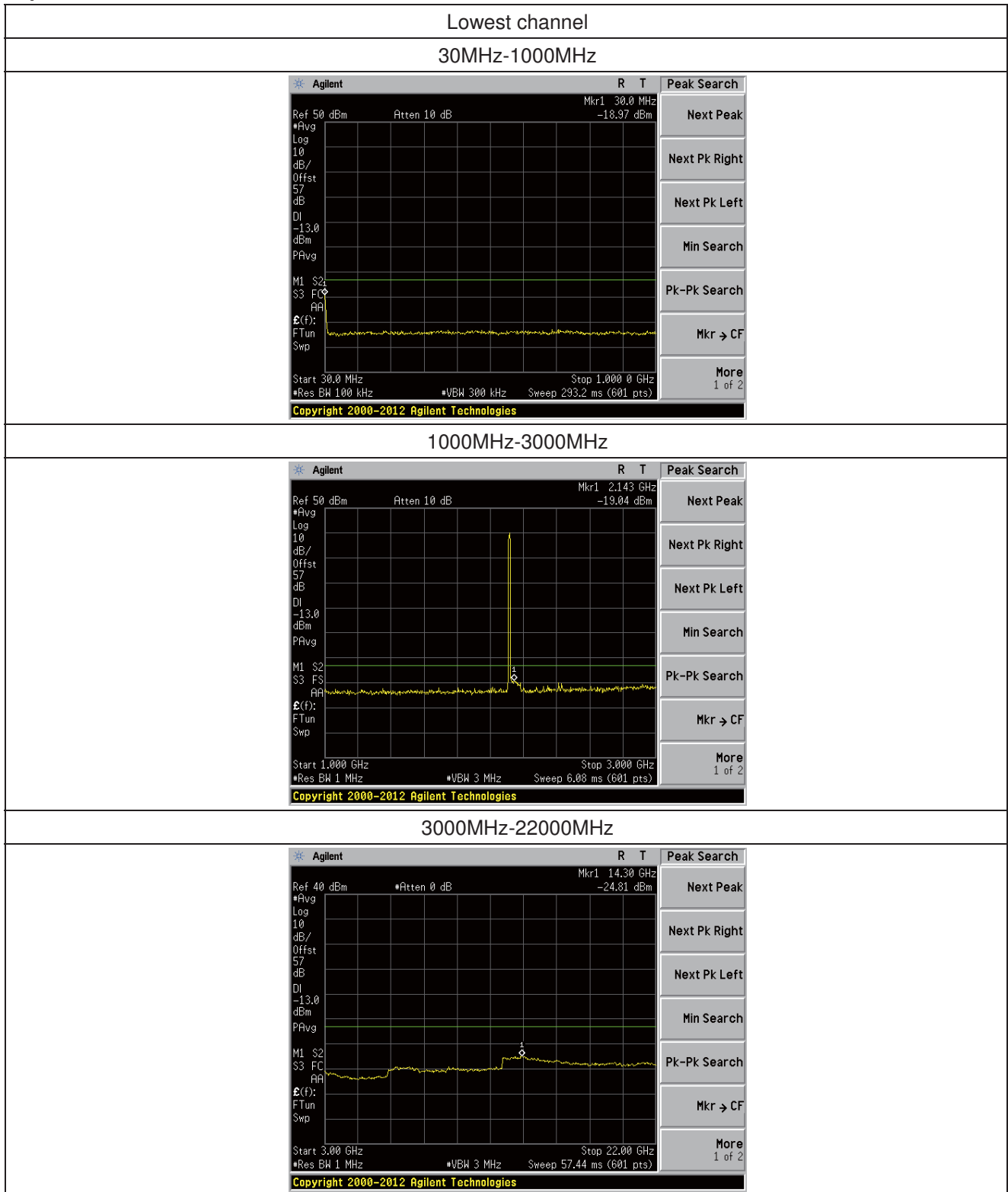

Middle channel

30MHz-1000MHz

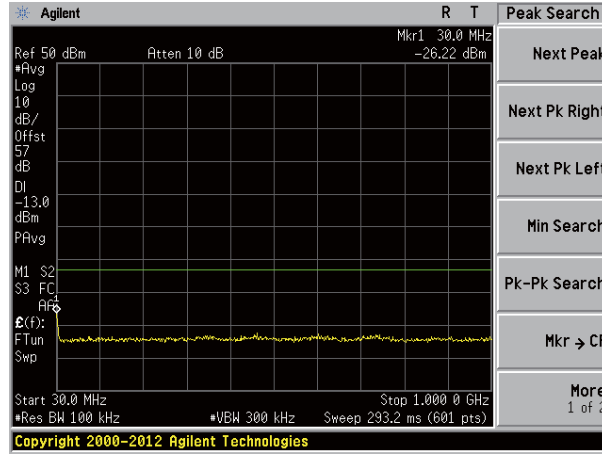

1000MHz-3000MHz

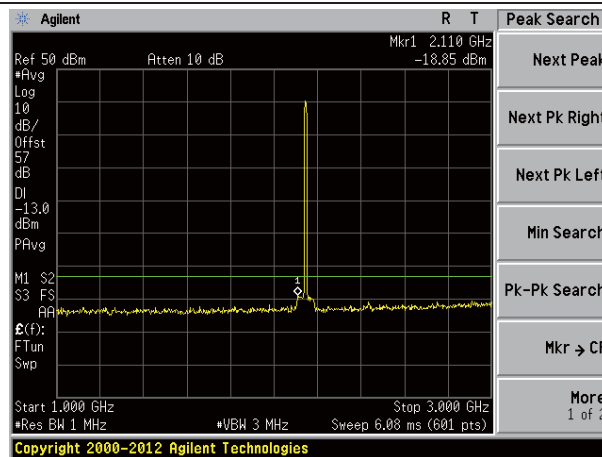

3000MHz-22000MHz

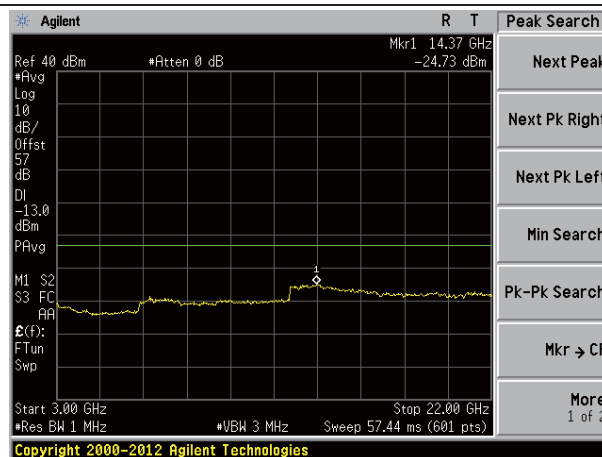

### Highest channel

#### 30MHz-1000MHz

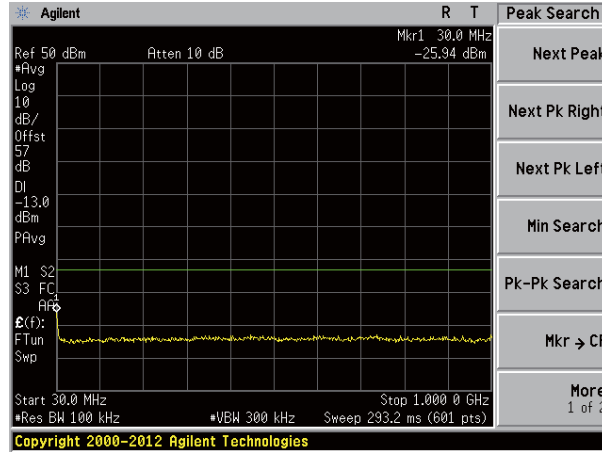

#### 1000MHz-3000MHz

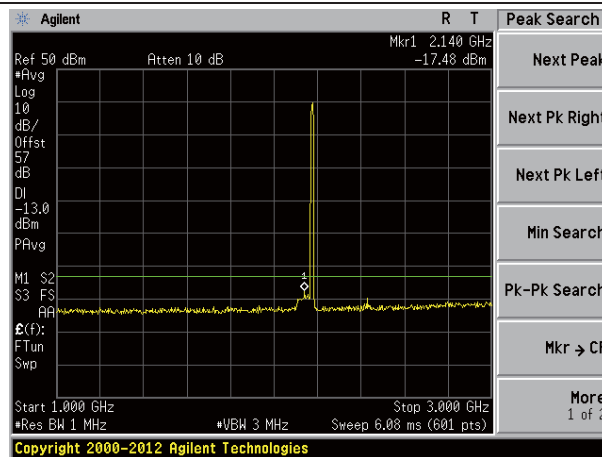

#### 3000MHz-22000MHz

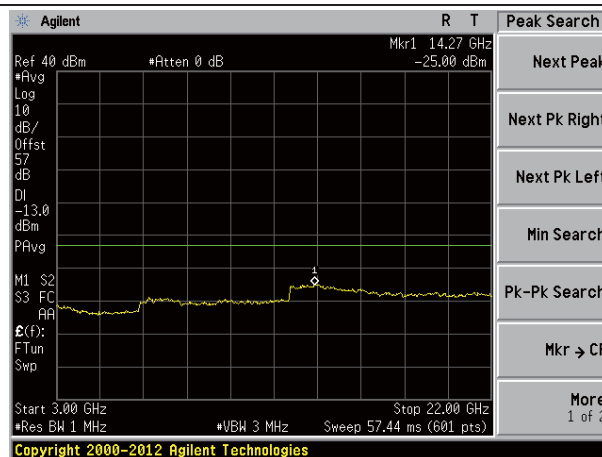

## Spurious emission of LTE 15MHz Bandwidth

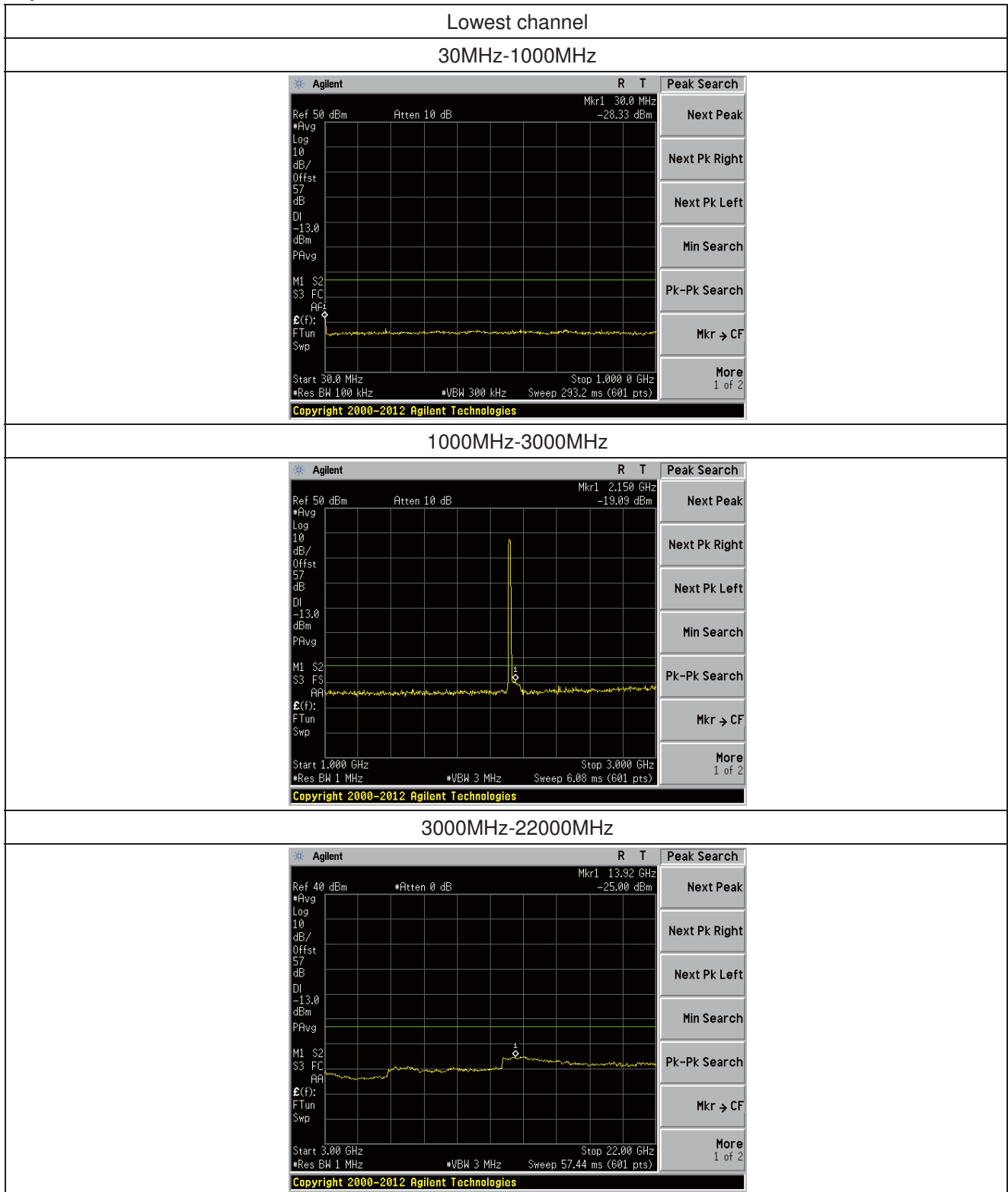



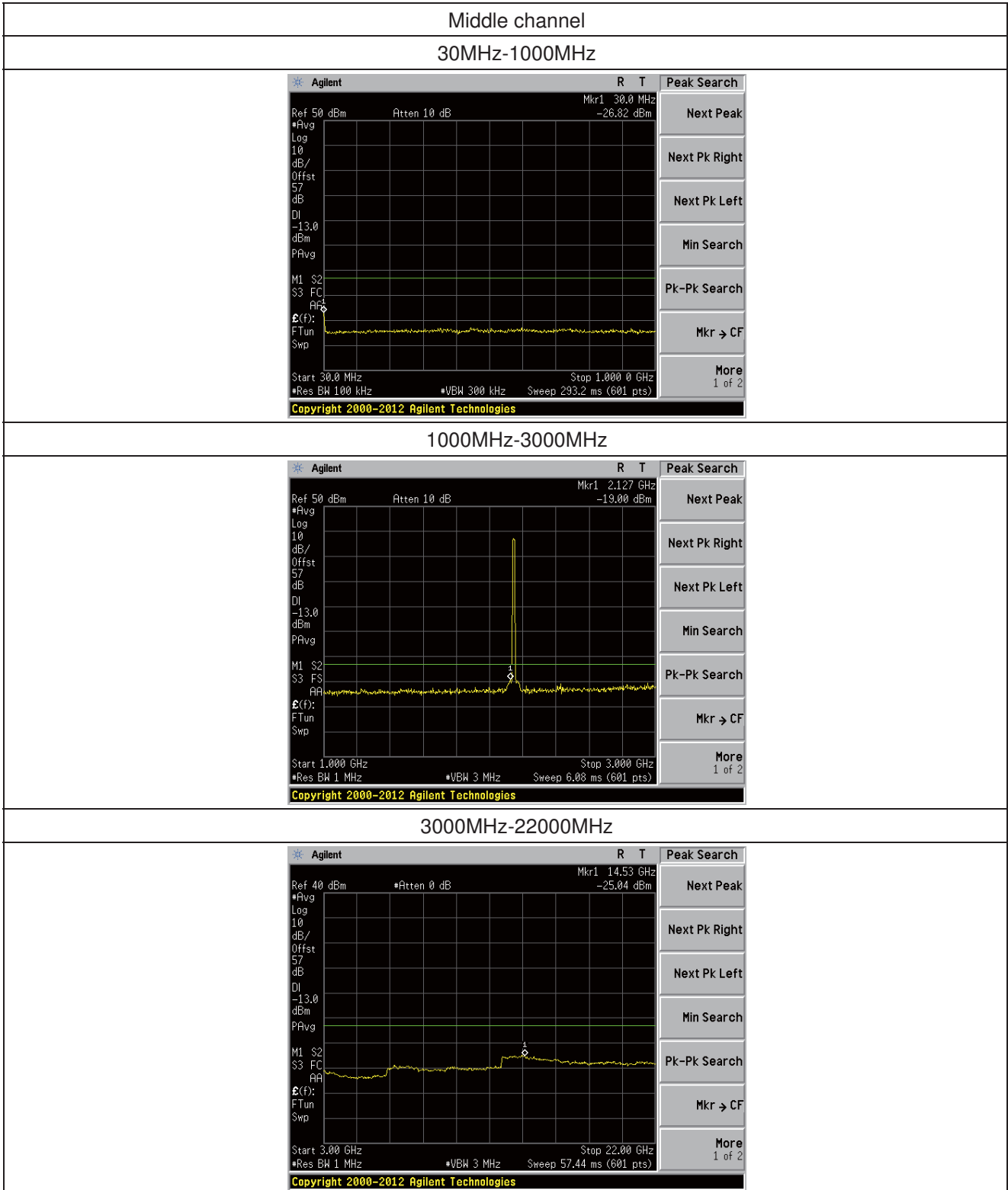

### Highest channel

#### 30MHz-1000MHz

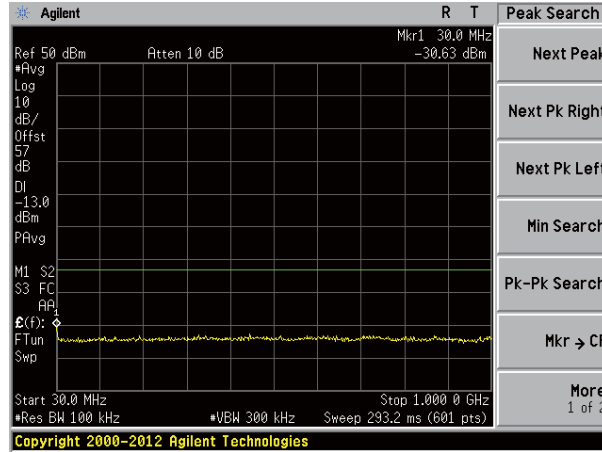

#### 1000MHz-3000MHz

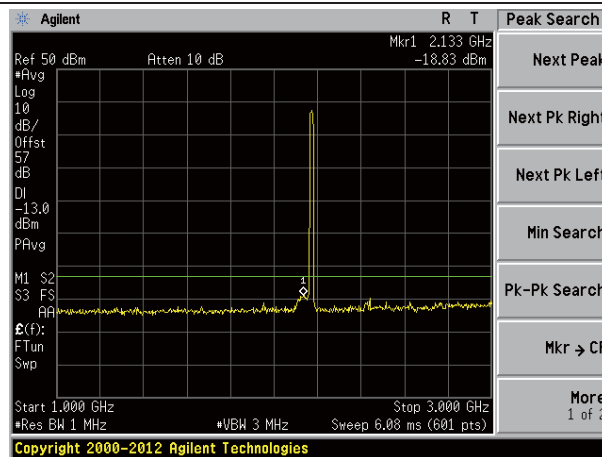

#### 3000MHz-22000MHz

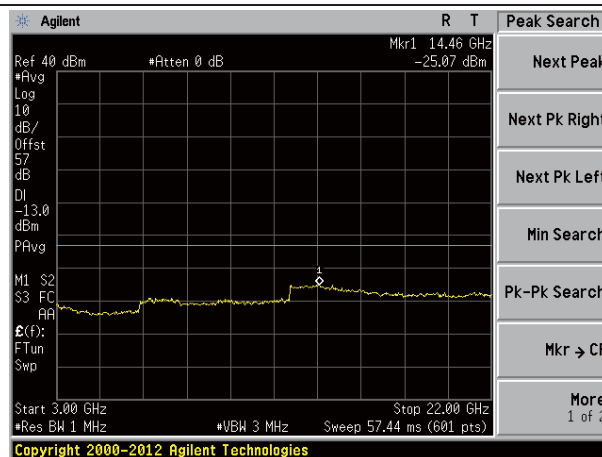

## Spurious emission of LTE 20MHz Bandwidth

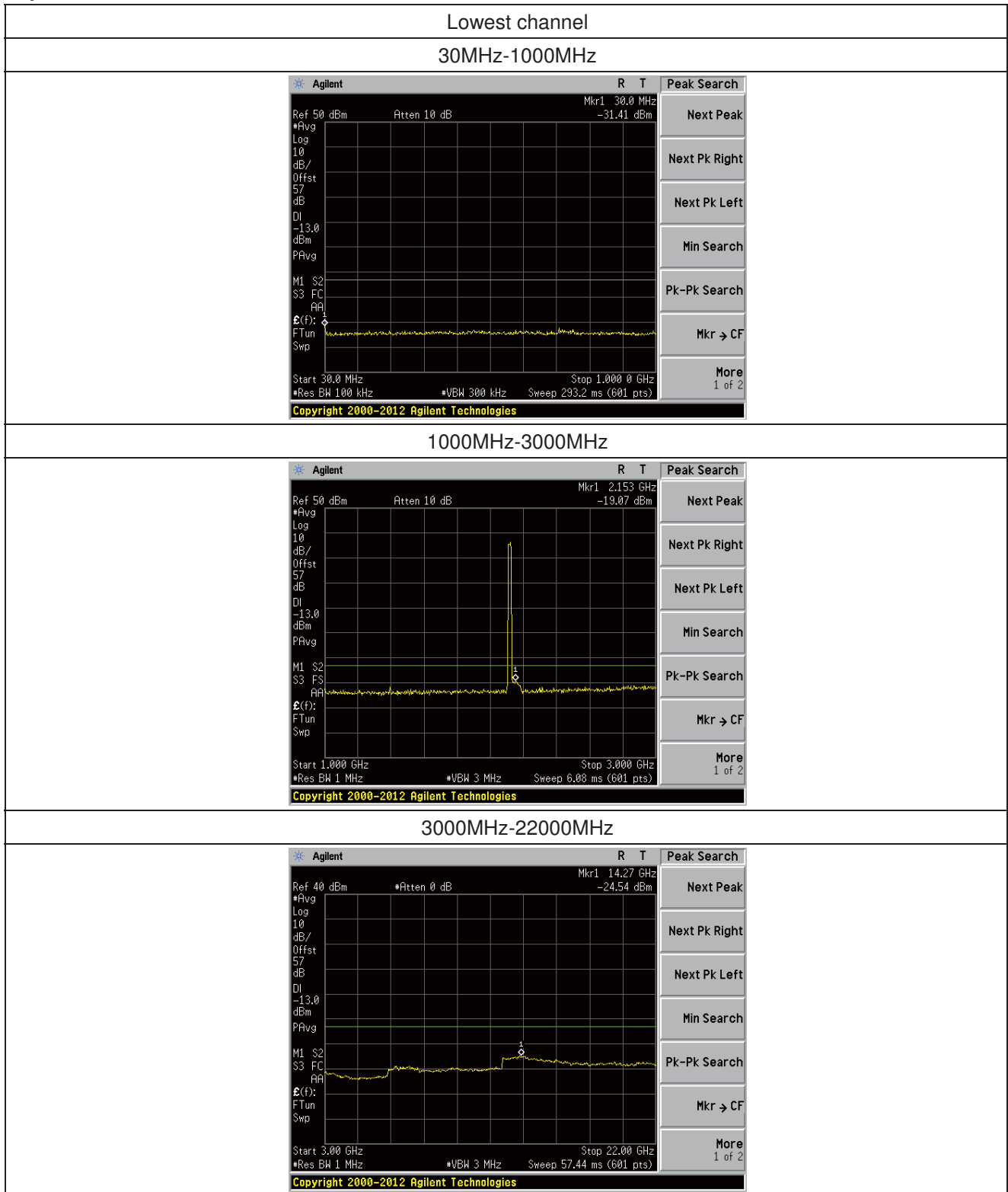

Middle channel

30MHz-1000MHz

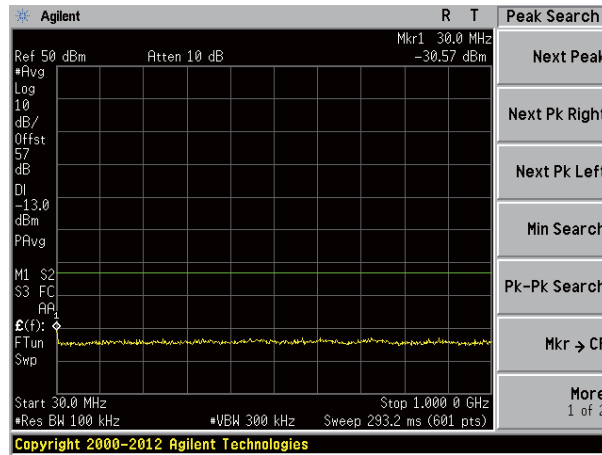

1000MHz-3000MHz

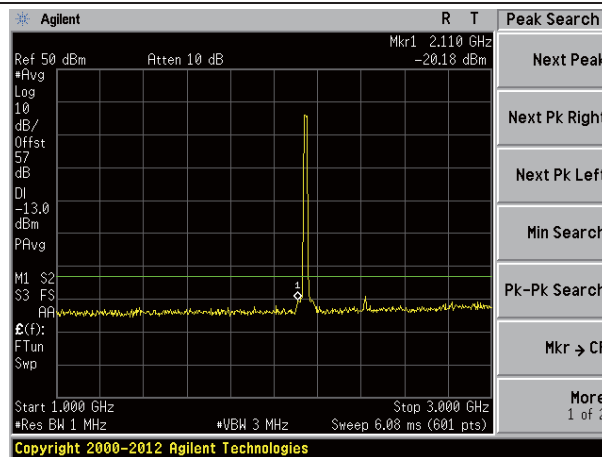

3000MHz-22000MHz

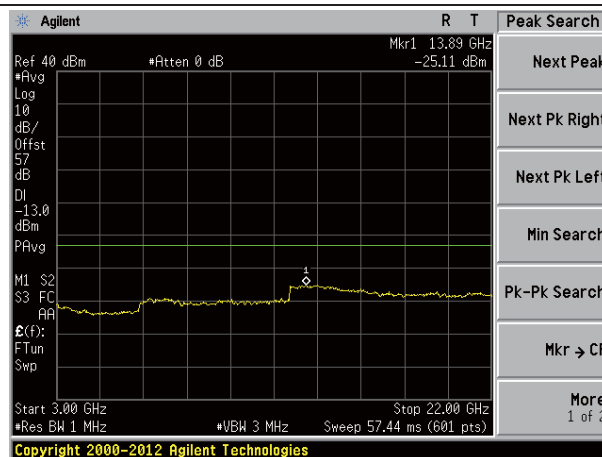

### Highest channel

#### 30MHz-1000MHz

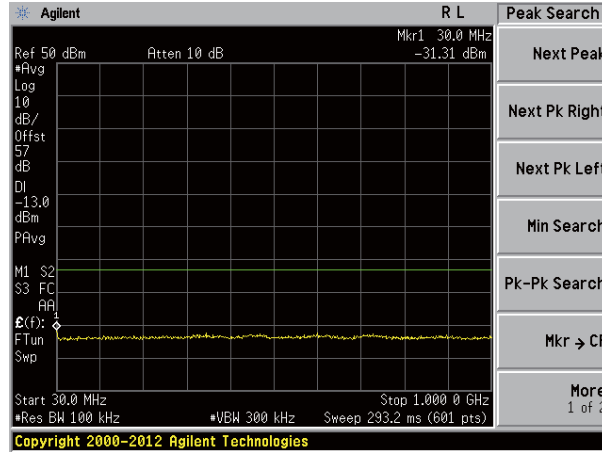

#### 1000MHz-3000MHz

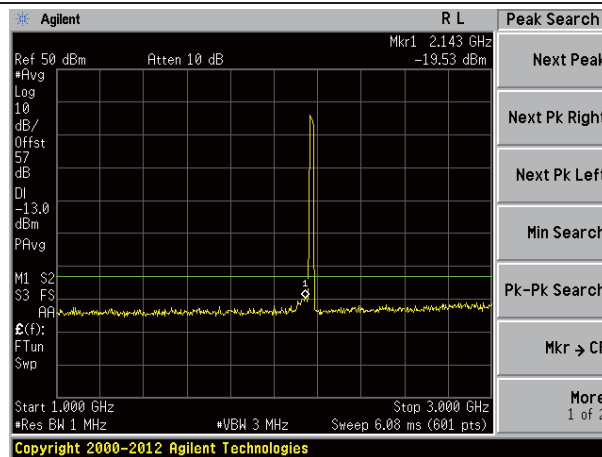

#### 3000MHz-22000MHz

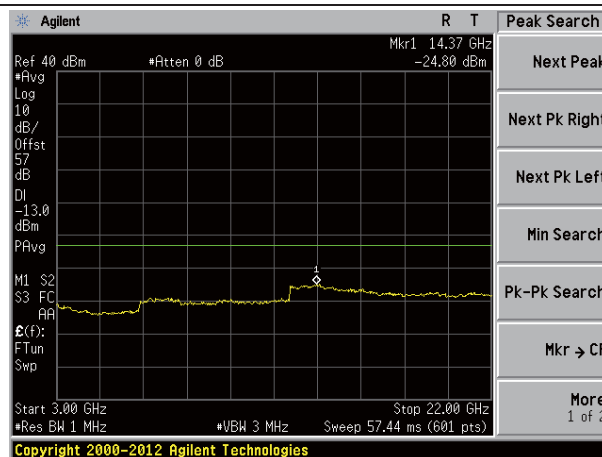

## Spurious emission of WCDMA Single Carrier

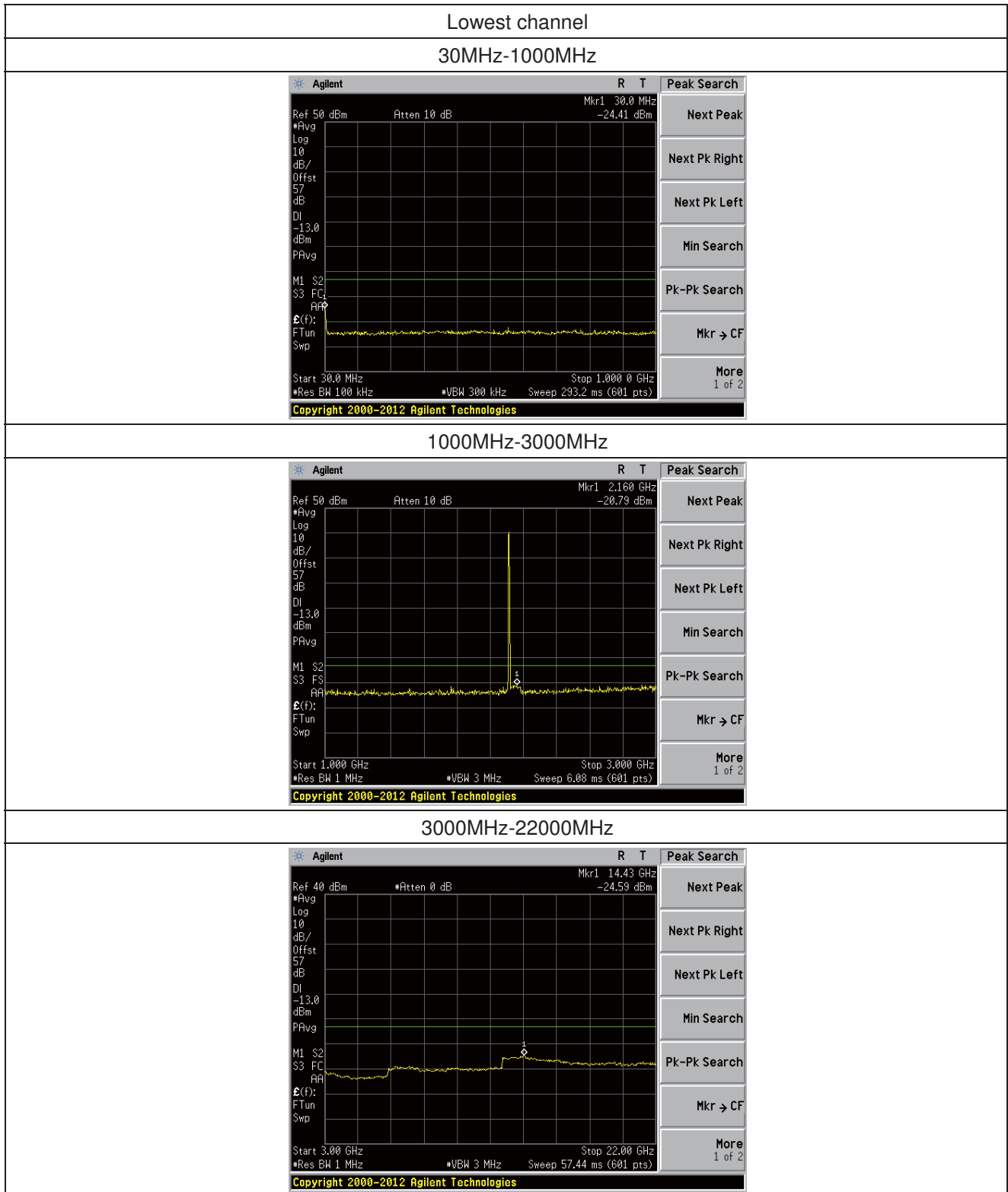

Middle channel

30MHz-1000MHz

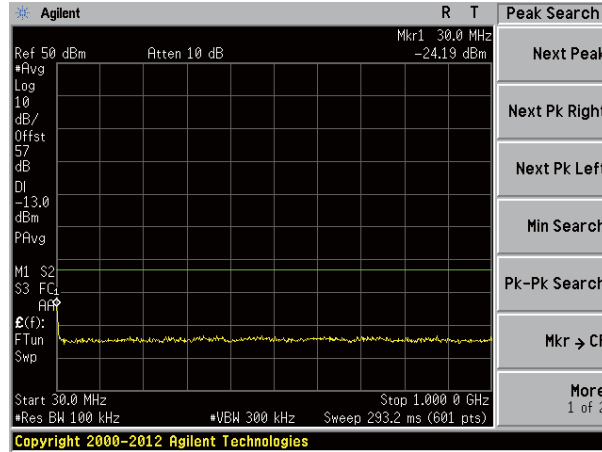

1000MHz-3000MHz

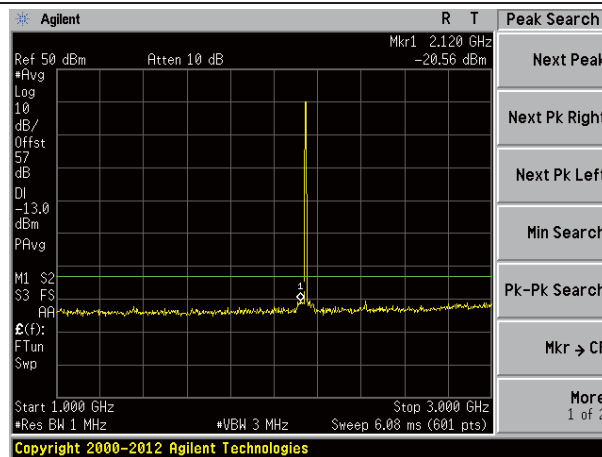

3000MHz-22000MHz

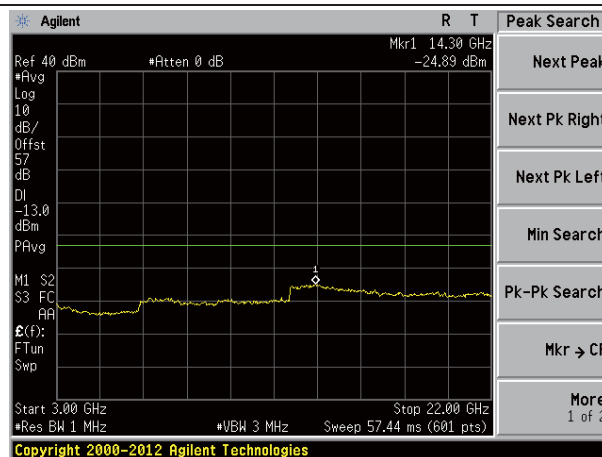

### Highest channel

#### 30MHz-1000MHz

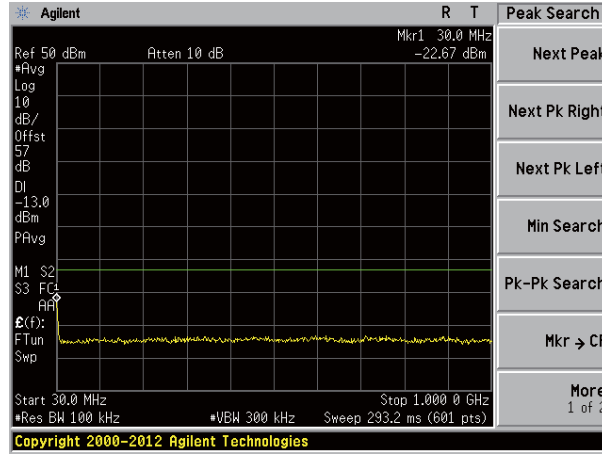

#### 1000MHz-3000MHz

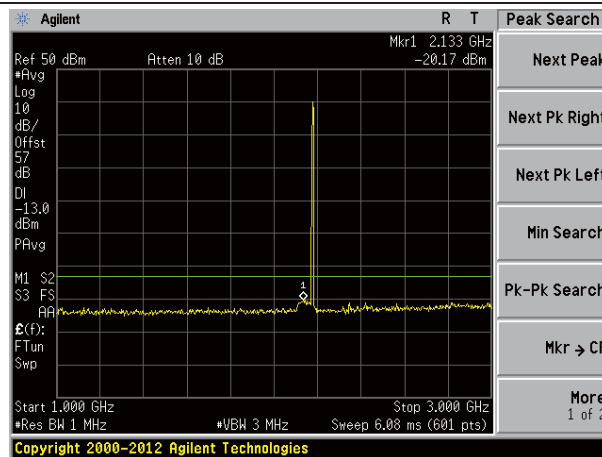

#### 3000MHz-22000MHz

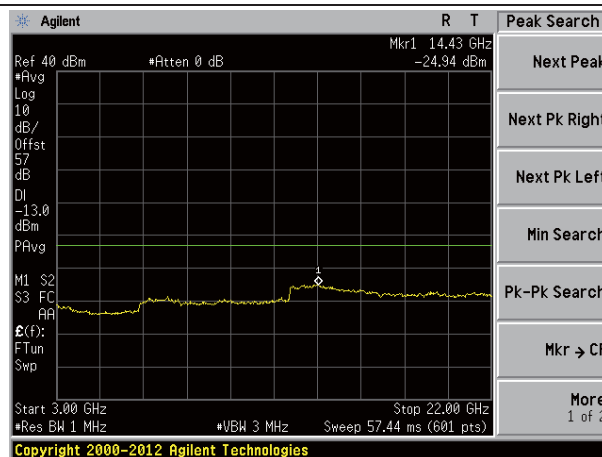



## Spurious emission of WCDMA Four Carrier

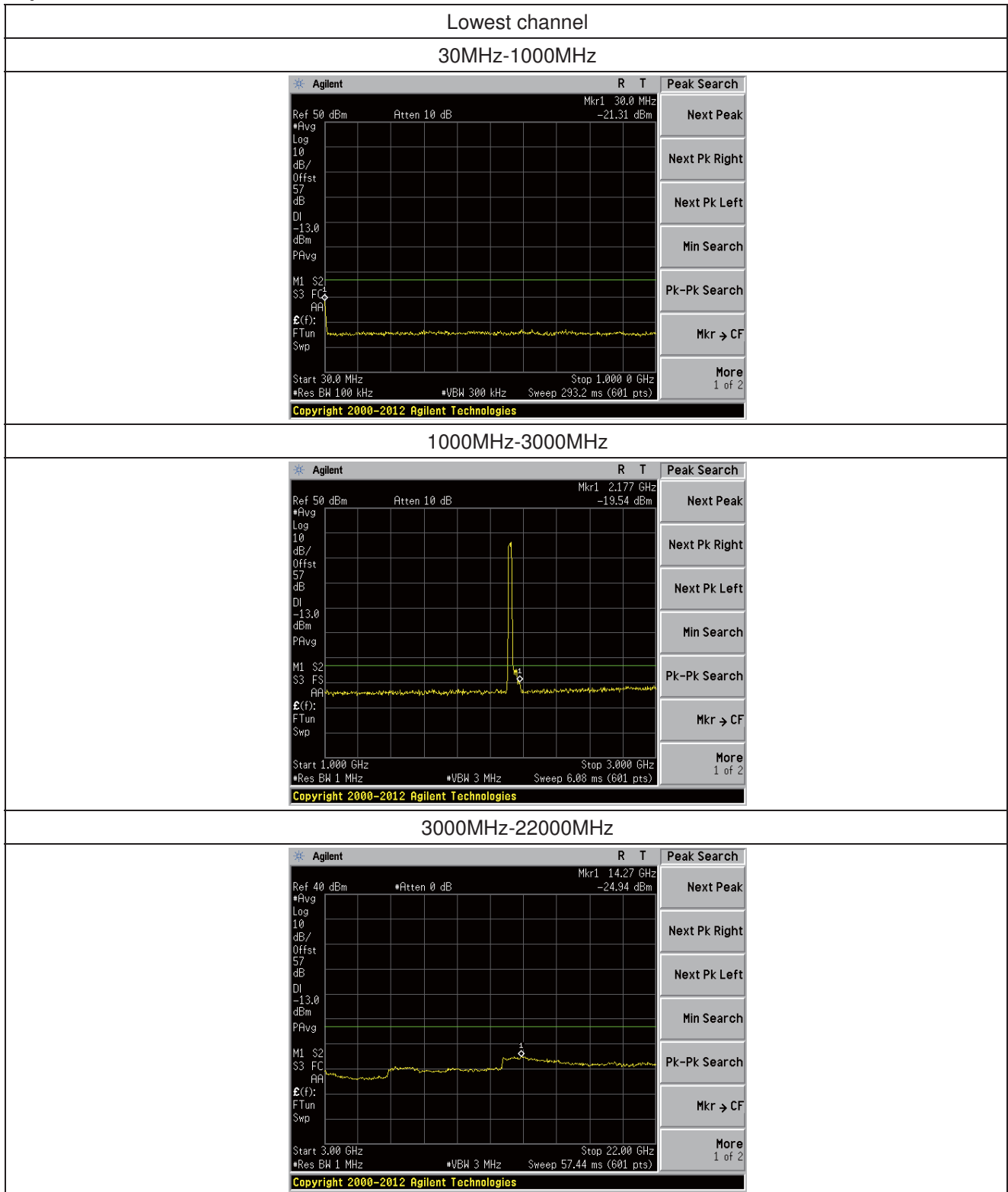

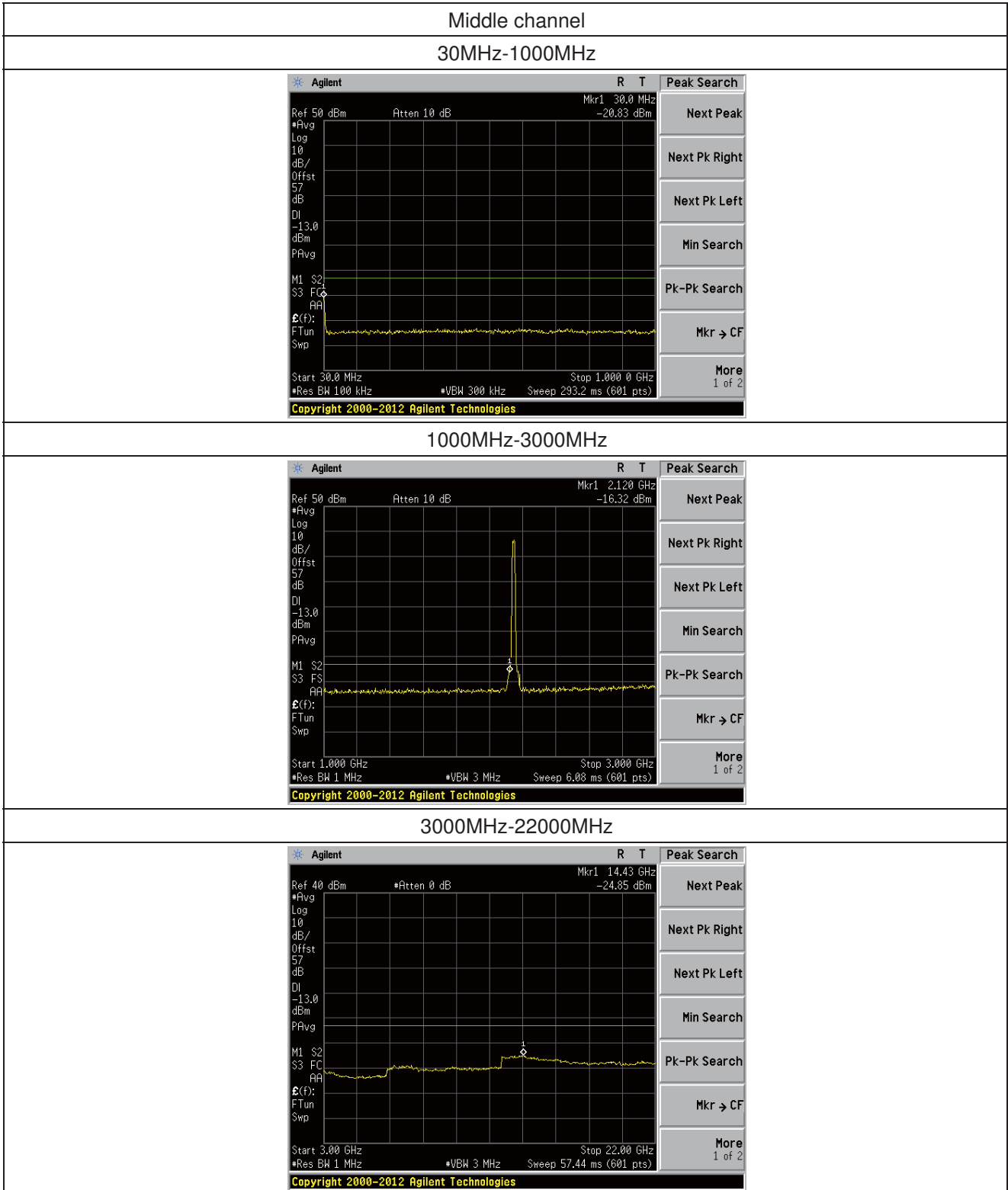

### Highest channel

#### 30MHz-1000MHz

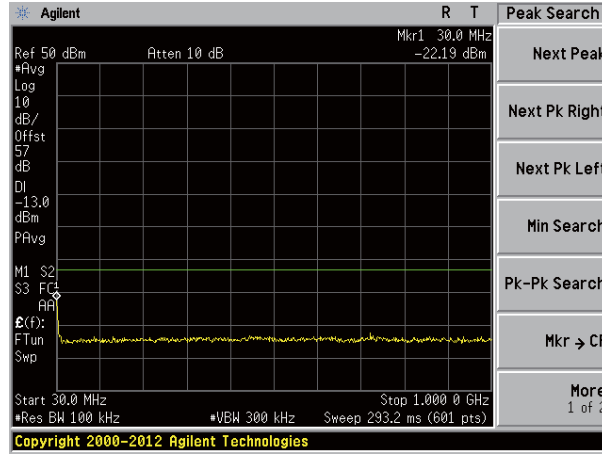

#### 1000MHz-3000MHz

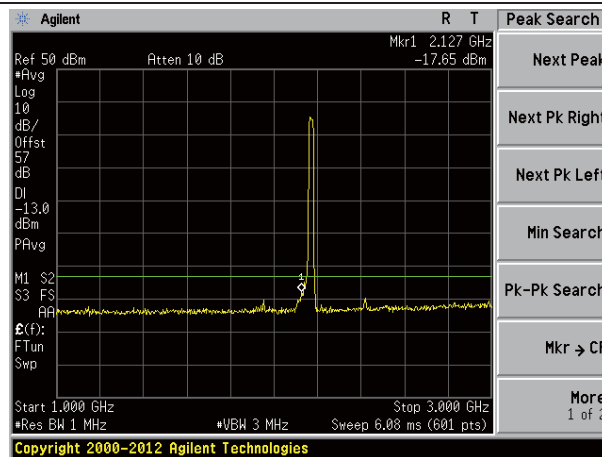

#### 3000MHz-22000MHz

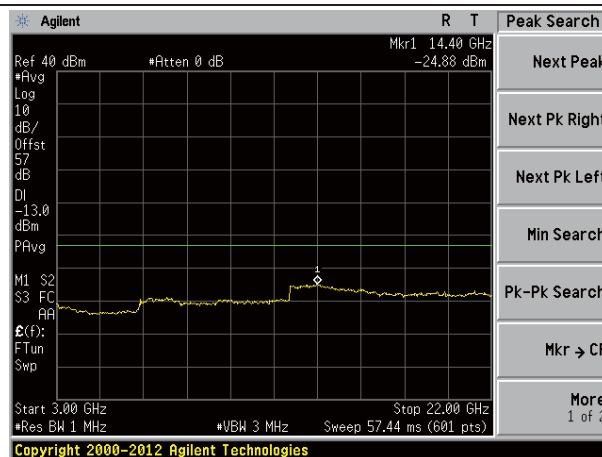

Uplink:

## Spurious emission of LTE 1.4MHz Bandwidth

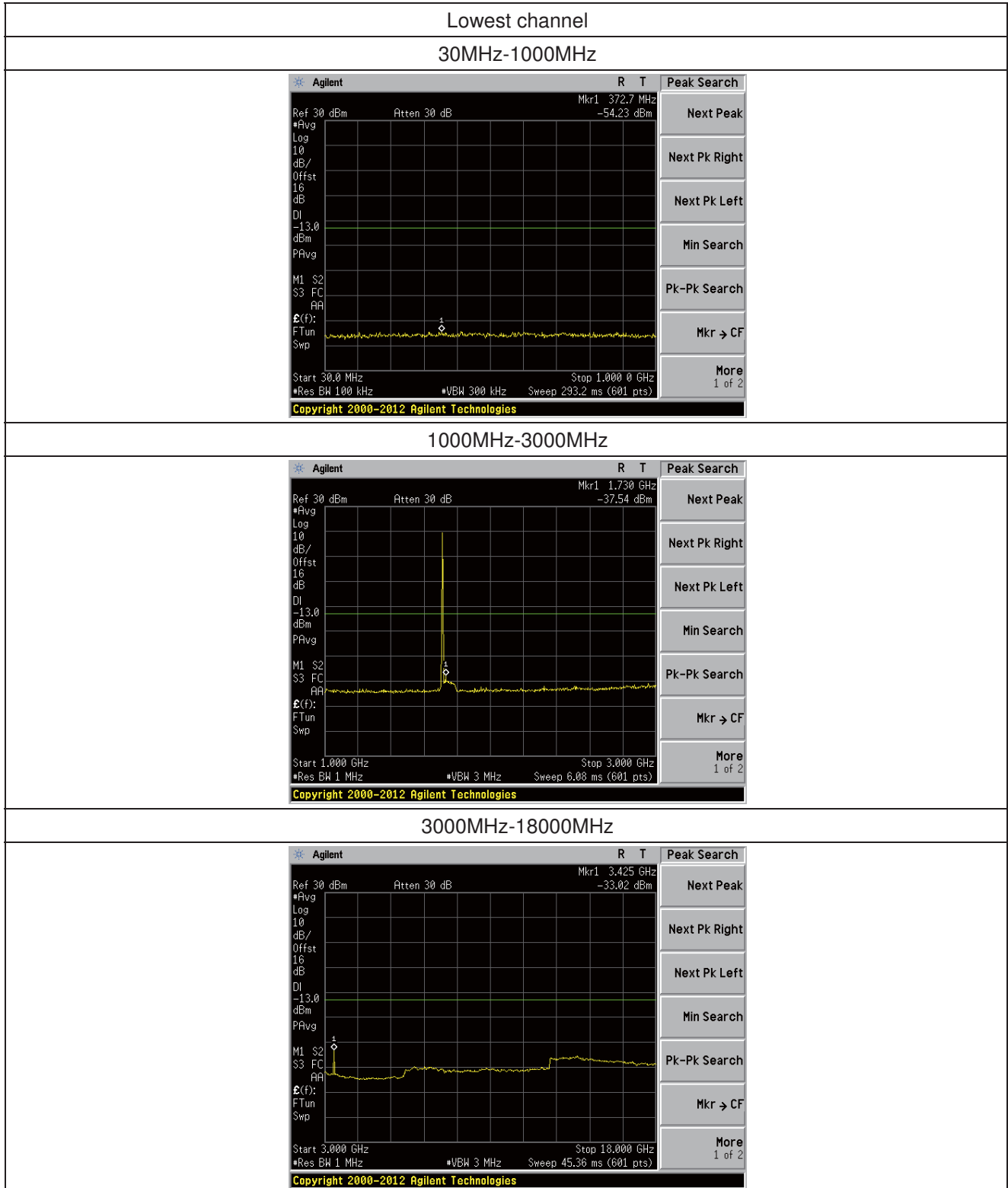

Middle channel

30MHz-1000MHz

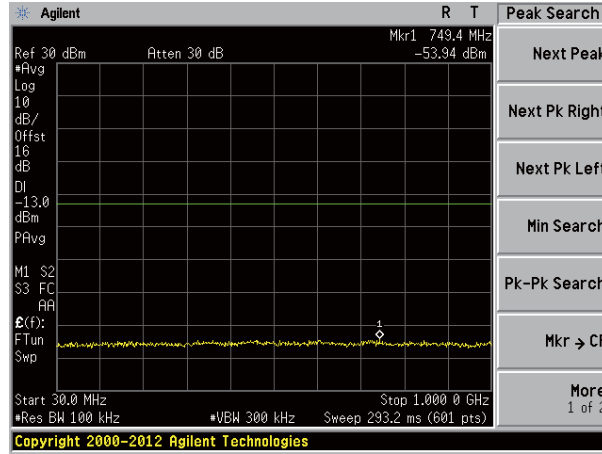

1000MHz-3000MHz

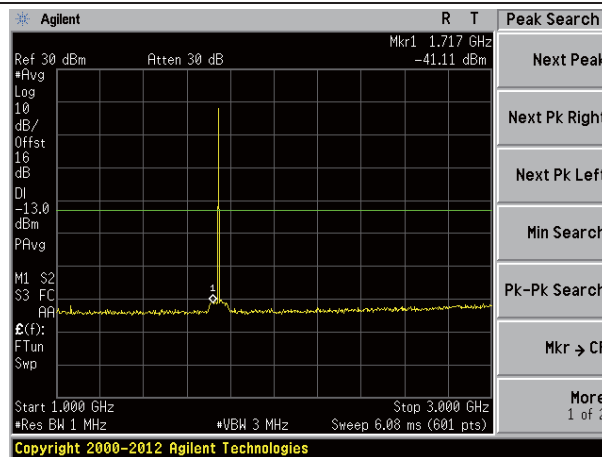

3000MHz-18000MHz

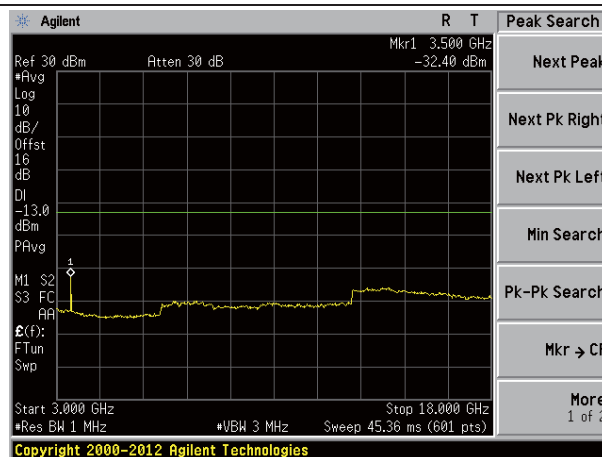

### Highest channel

#### 30MHz-1000MHz

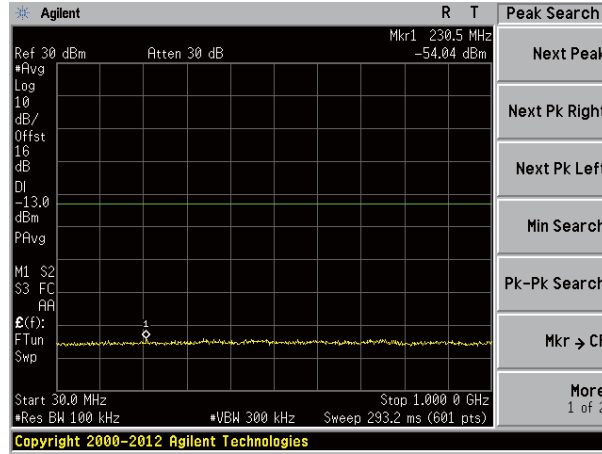

#### 1000MHz-3000MHz

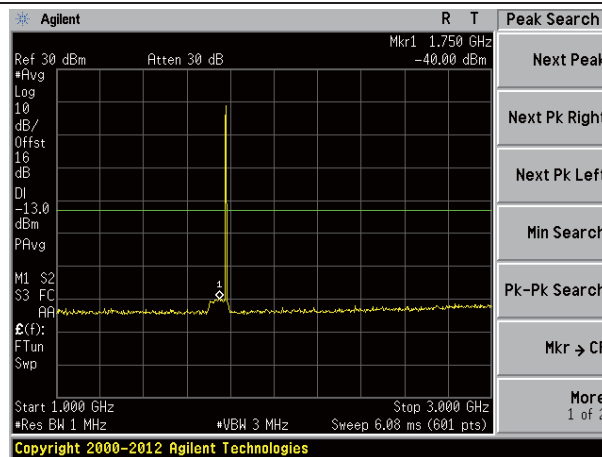

#### 3000MHz-22000MHz

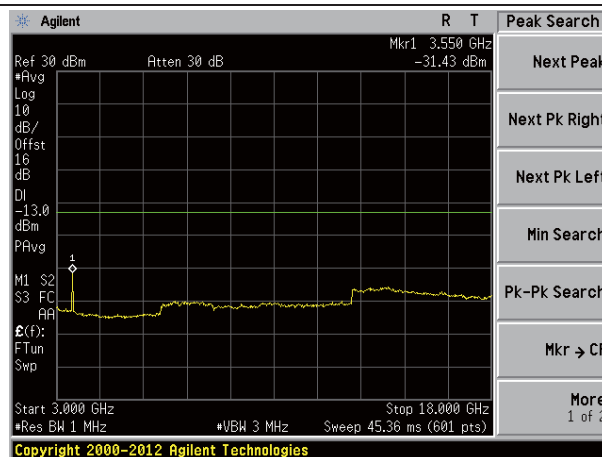

## Spurious emission of LTE 3MHz Bandwidth

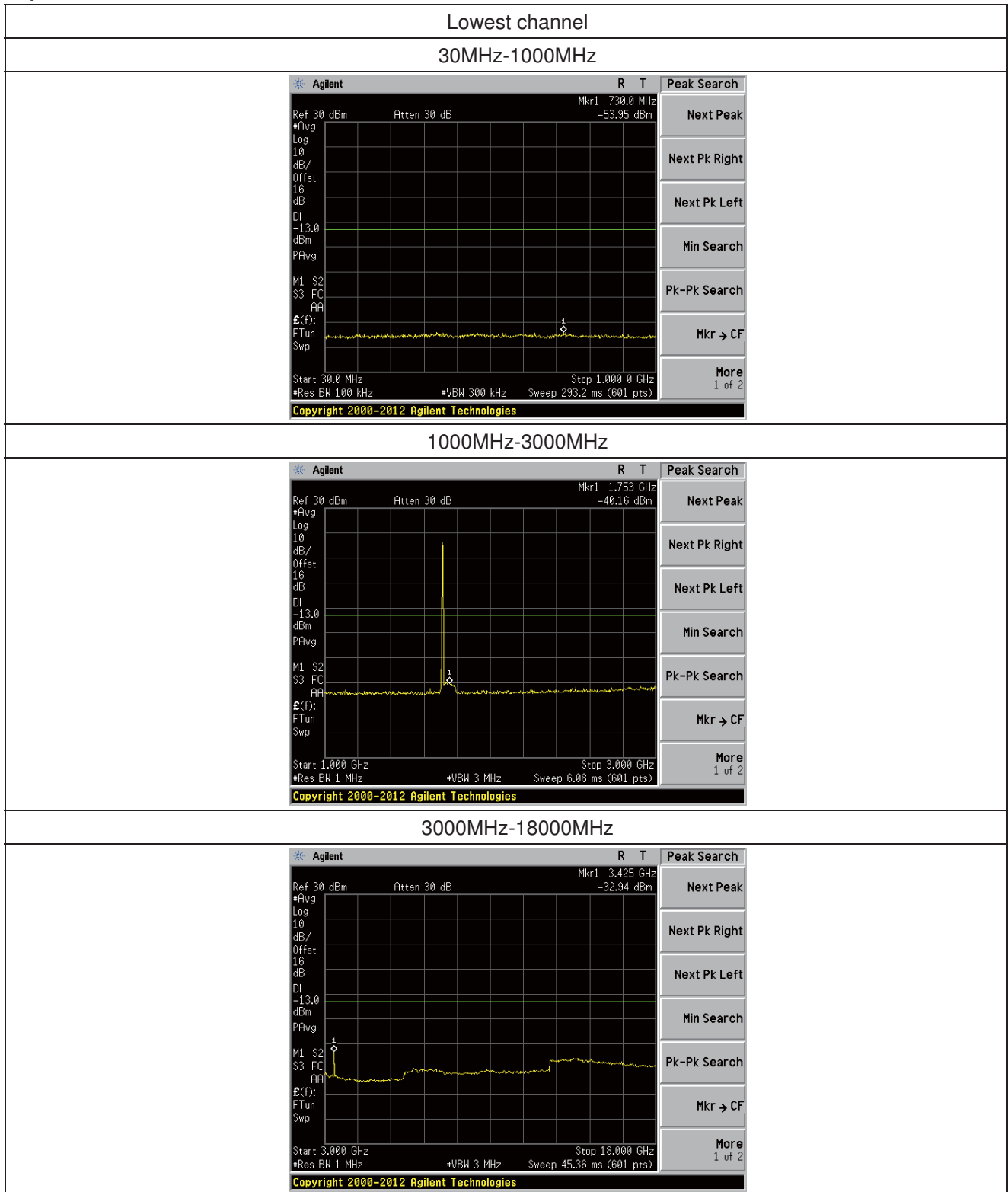

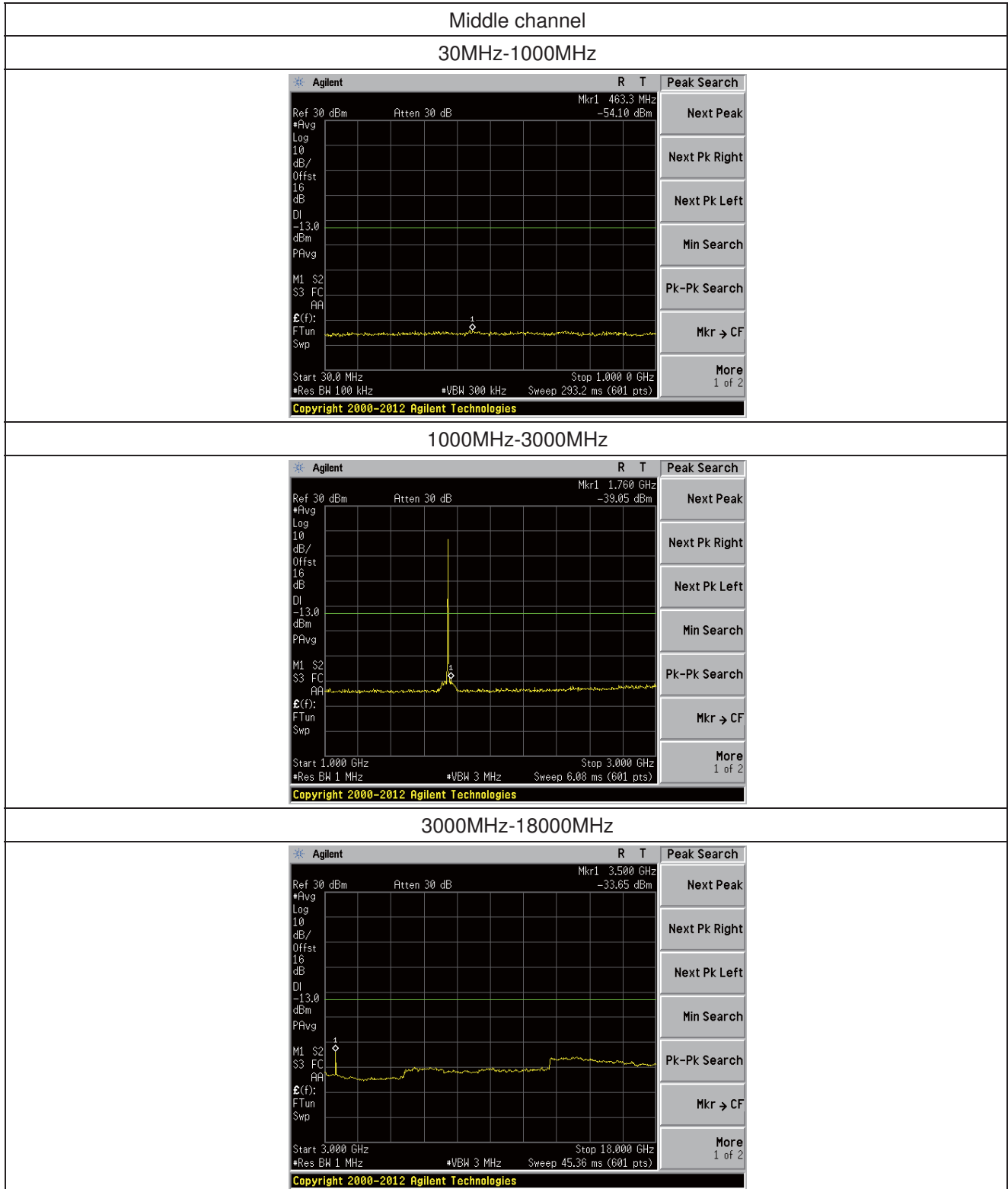



### Highest channel

#### 30MHz-1000MHz

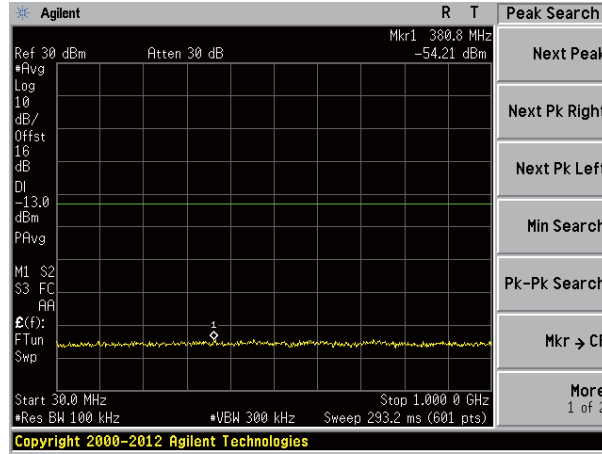

#### 1000MHz-3000MHz

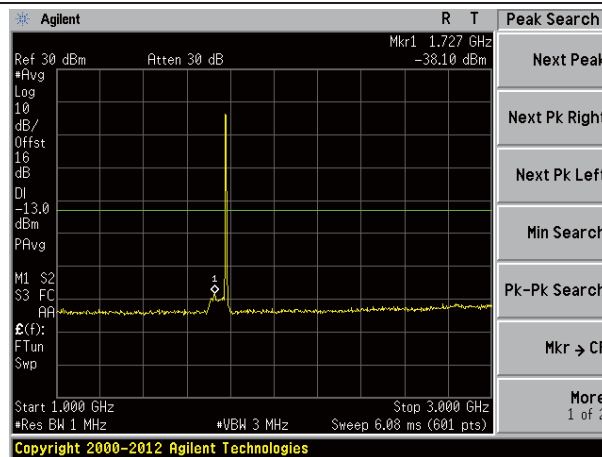

#### 3000MHz-18000MHz

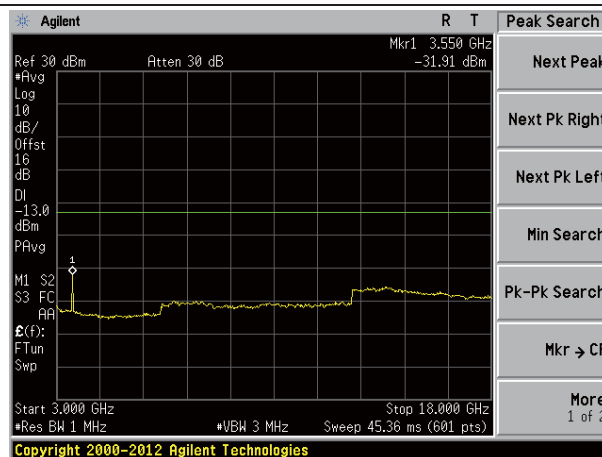

## Spurious emission of LTE 5MHz Bandwidth

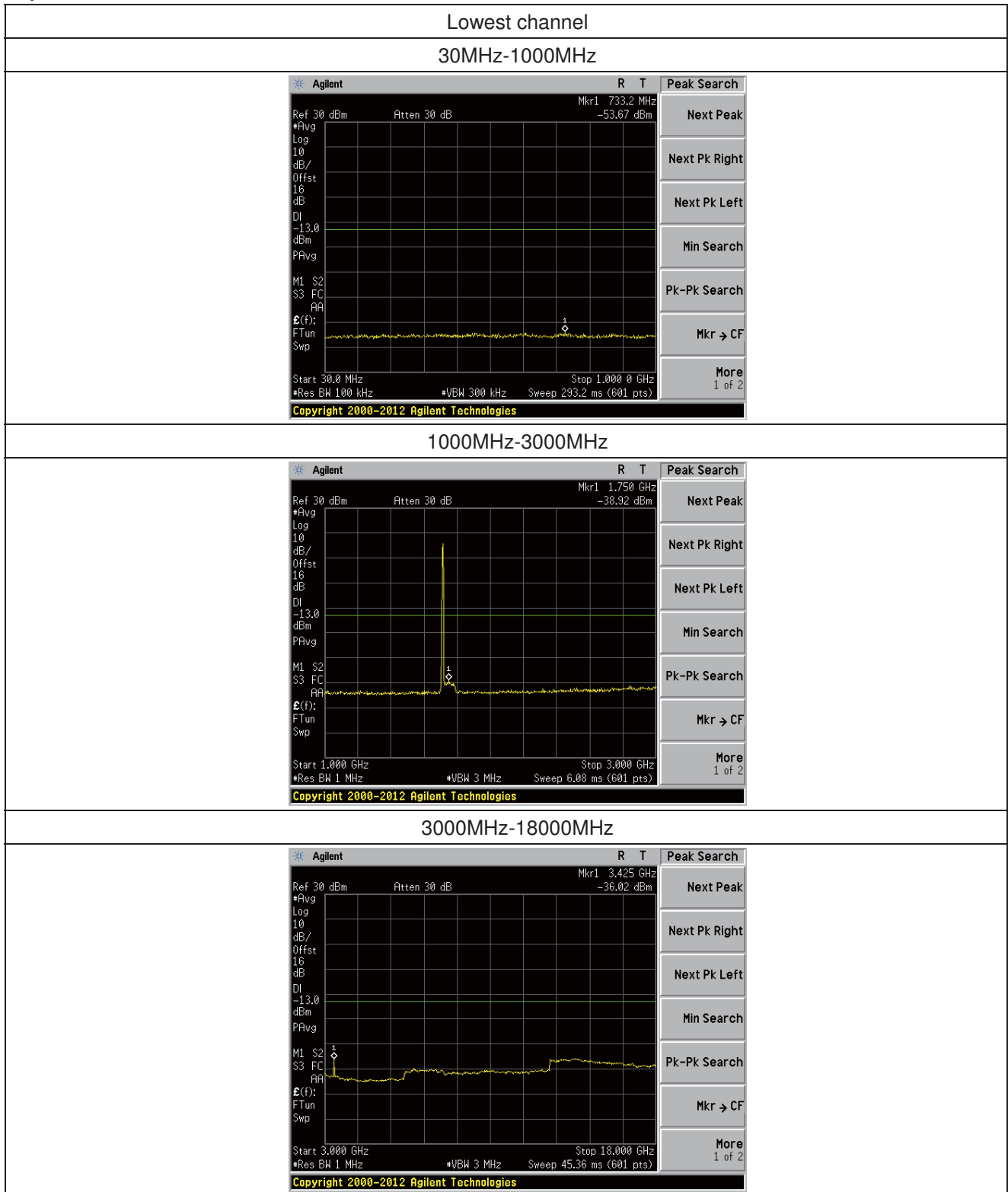

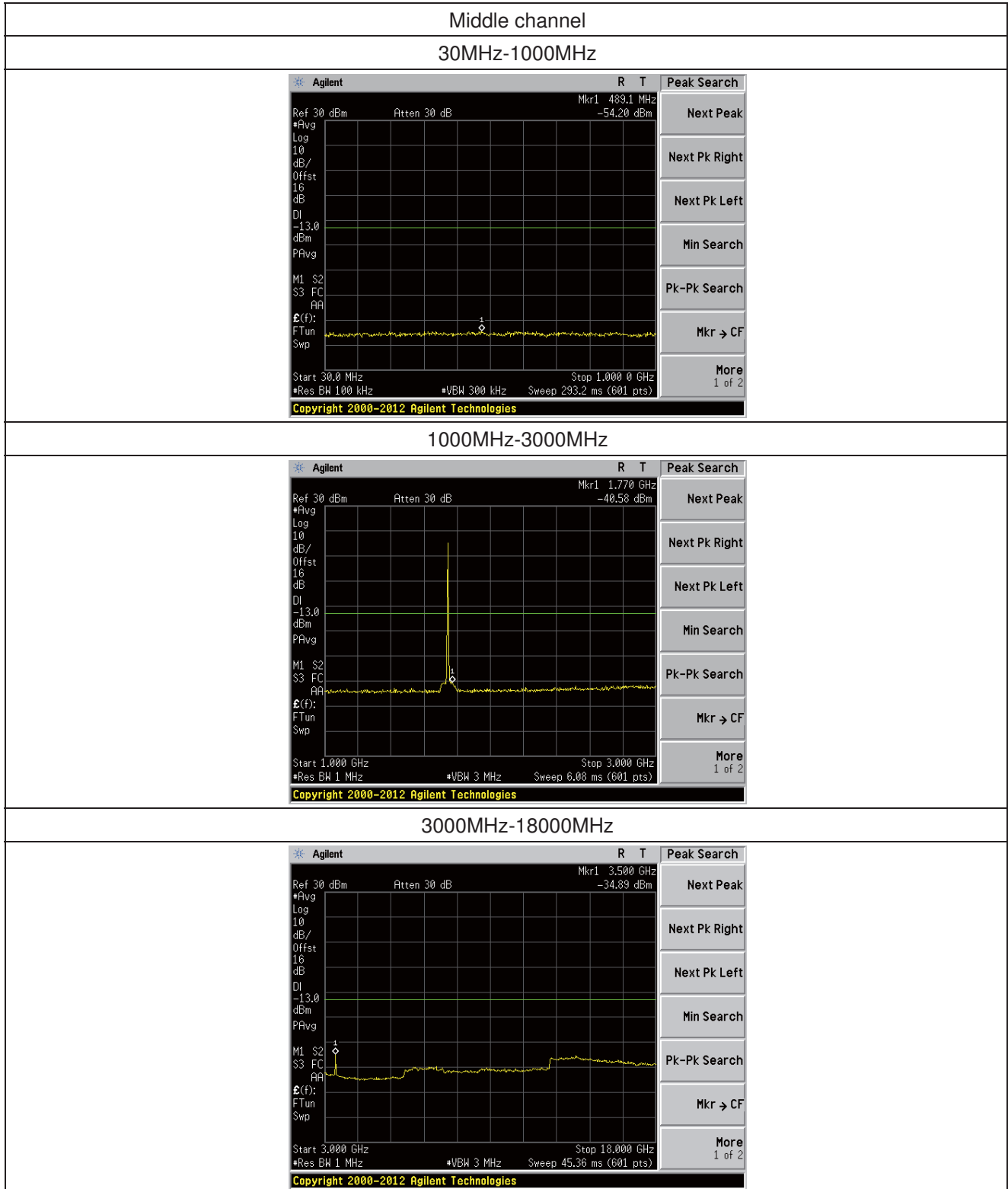

### Highest channel

#### 30MHz-1000MHz

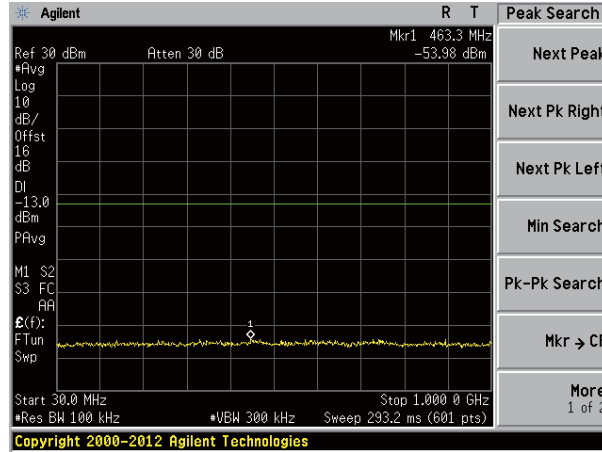

#### 1000MHz-3000MHz

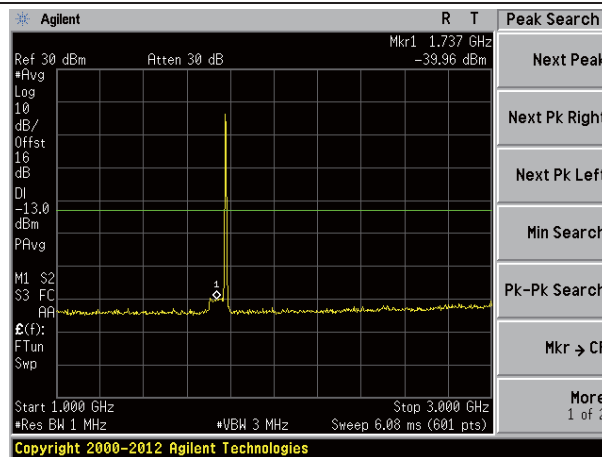

#### 3000MHz-18000MHz

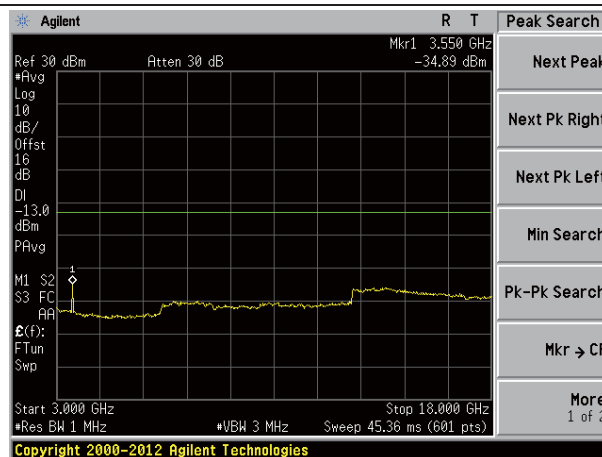

## Spurious emission of LTE 10MHz Bandwidth

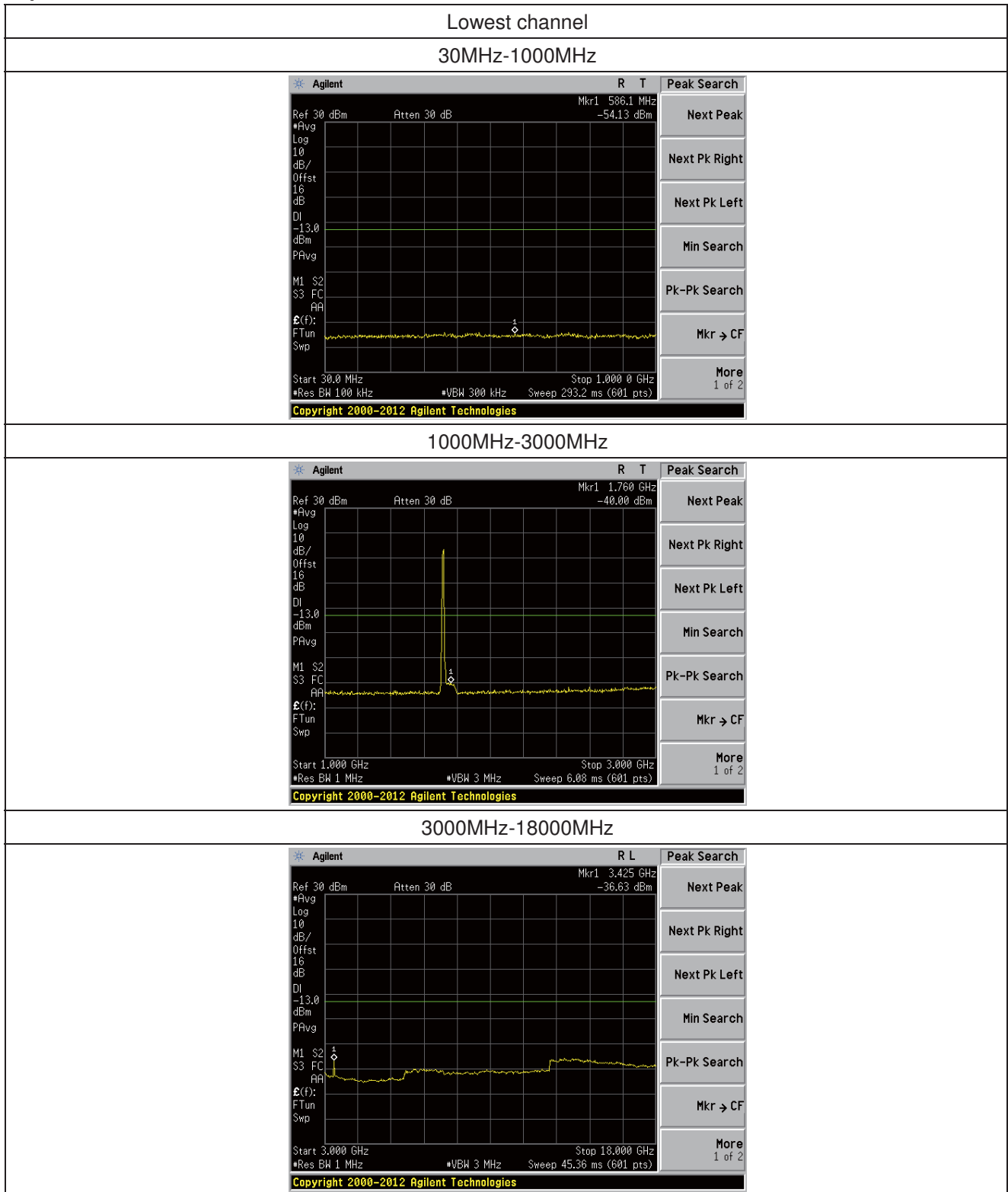

Middle channel

30MHz-1000MHz

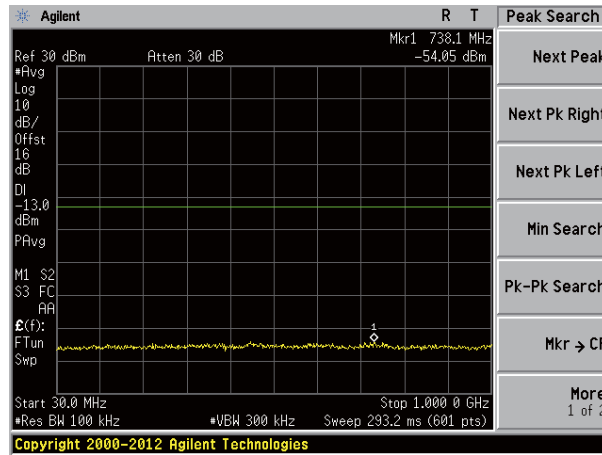

1000MHz-3000MHz

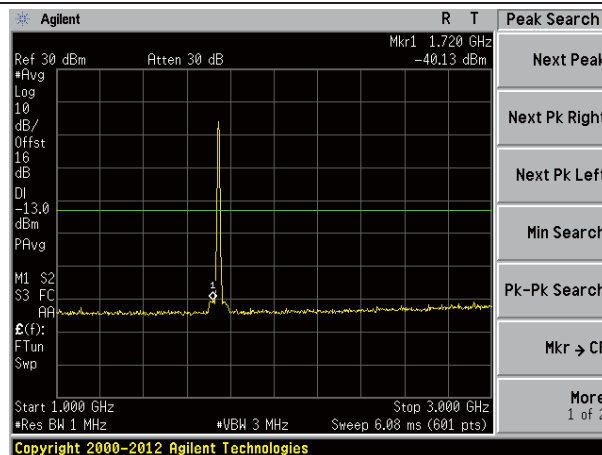

3000MHz-18000MHz

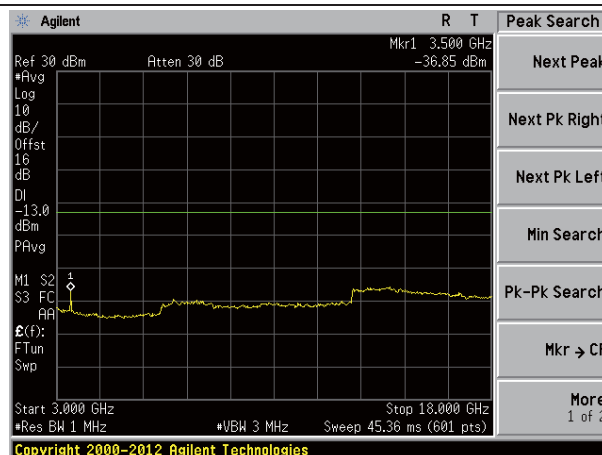

### Highest channel

#### 30MHz-1000MHz

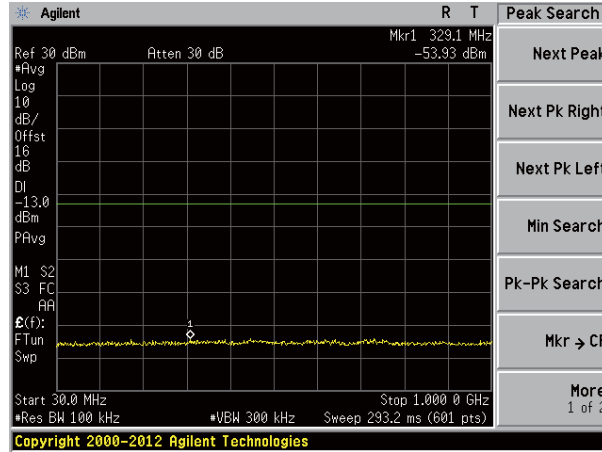

#### 1000MHz-3000MHz

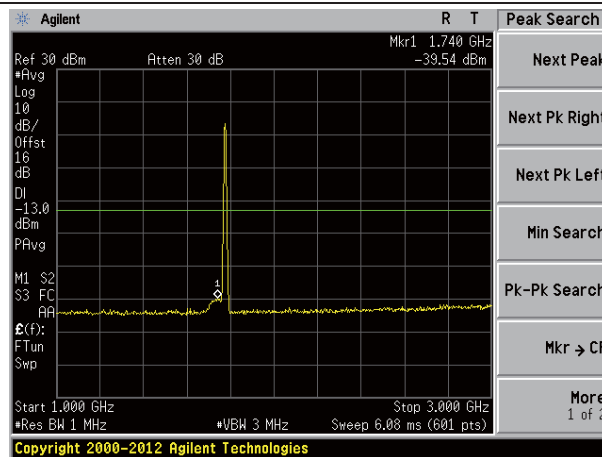

#### 3000MHz-18000MHz

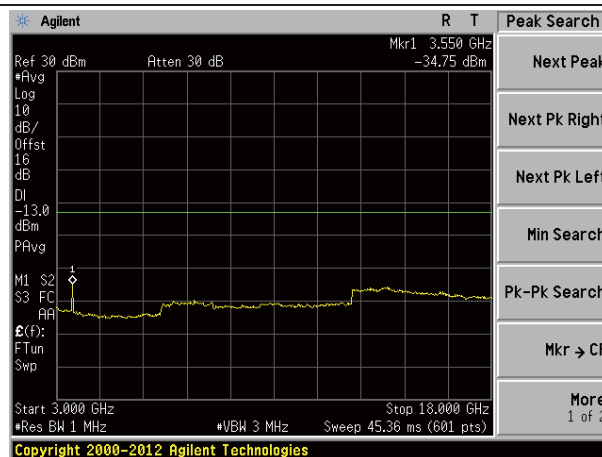

## Spurious emission of LTE 15MHz Bandwidth

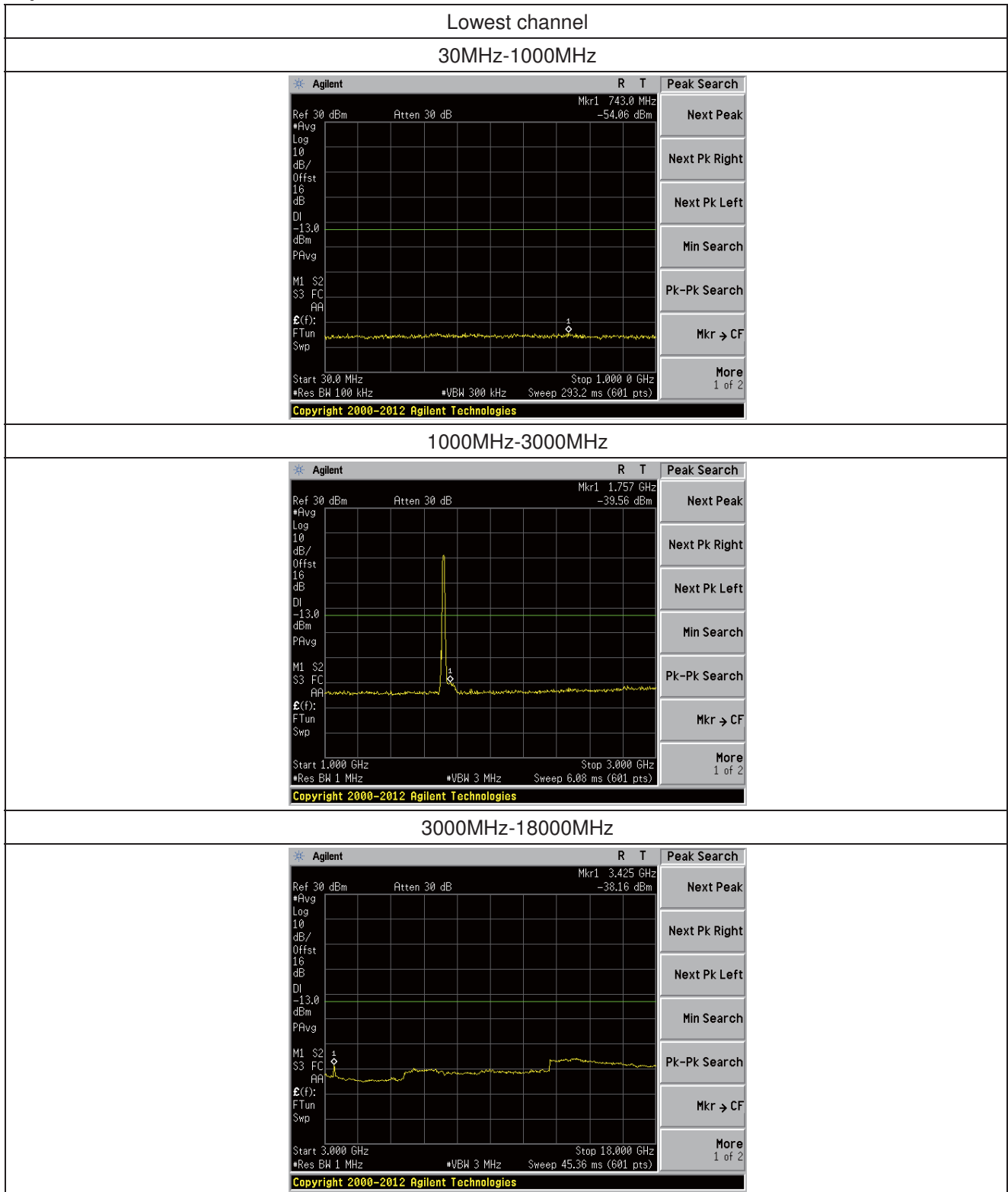



Middle channel

30MHz-1000MHz

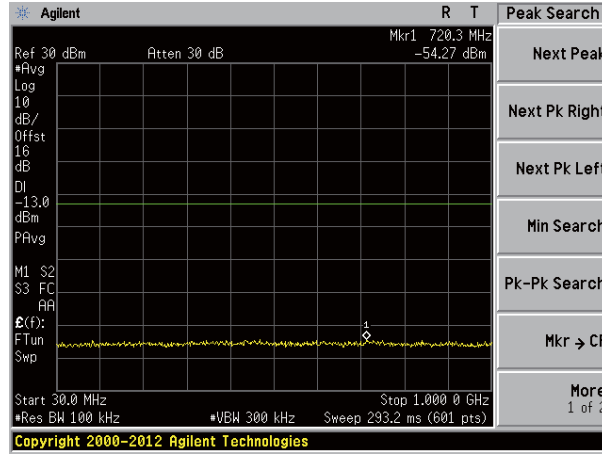

1000MHz-3000MHz

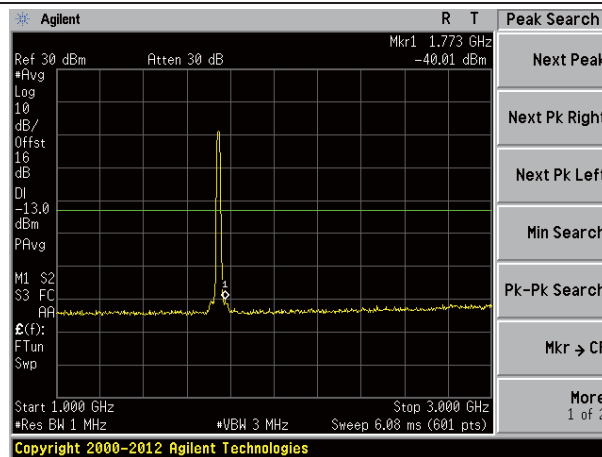

3000MHz-18000MHz

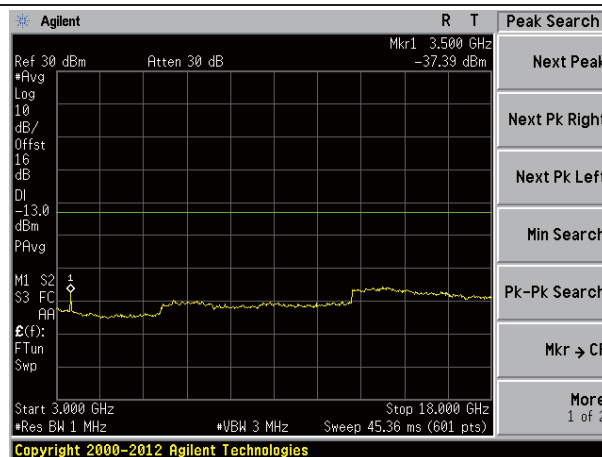

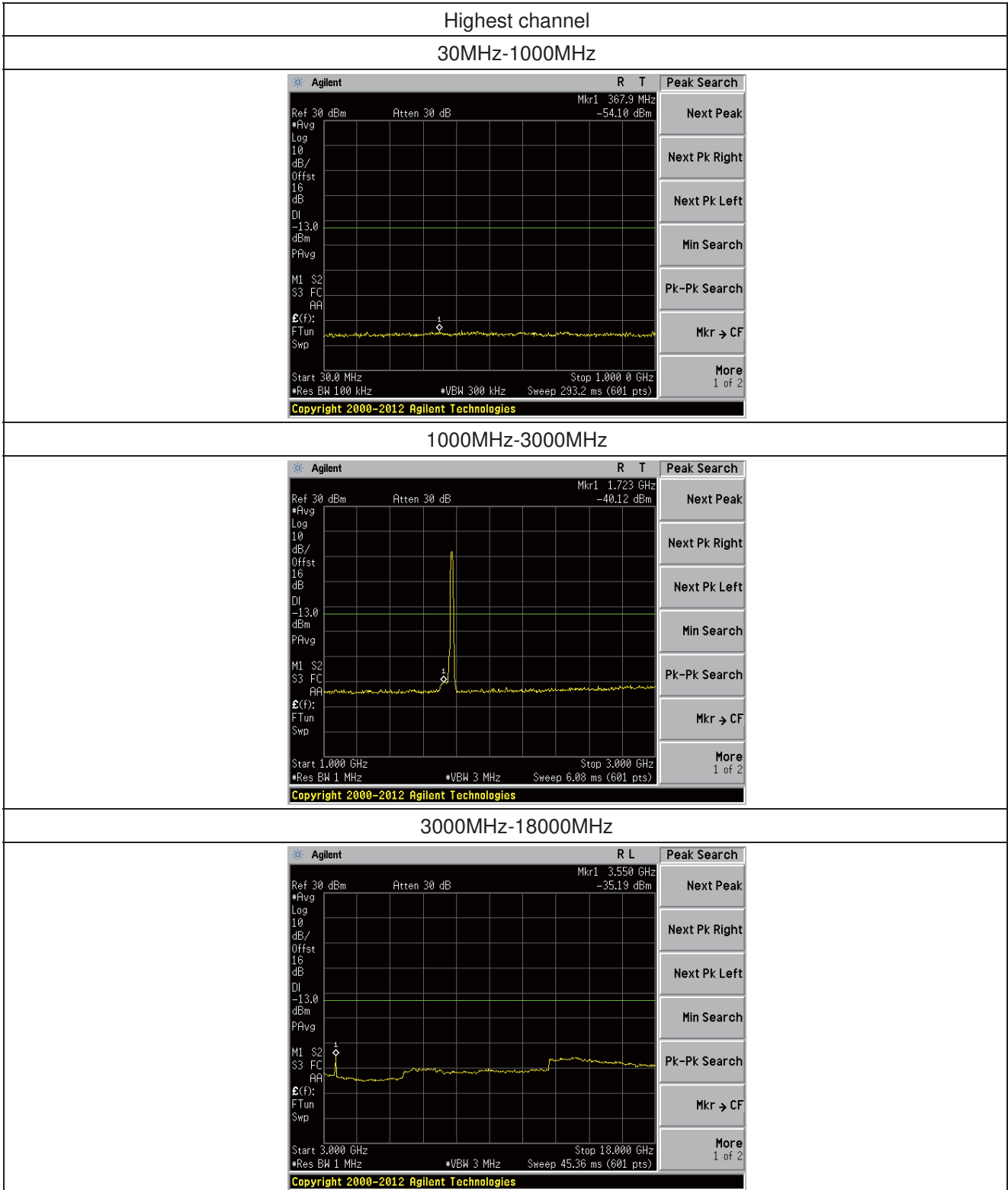

## Spurious emission of LTE 20MHz Bandwidth

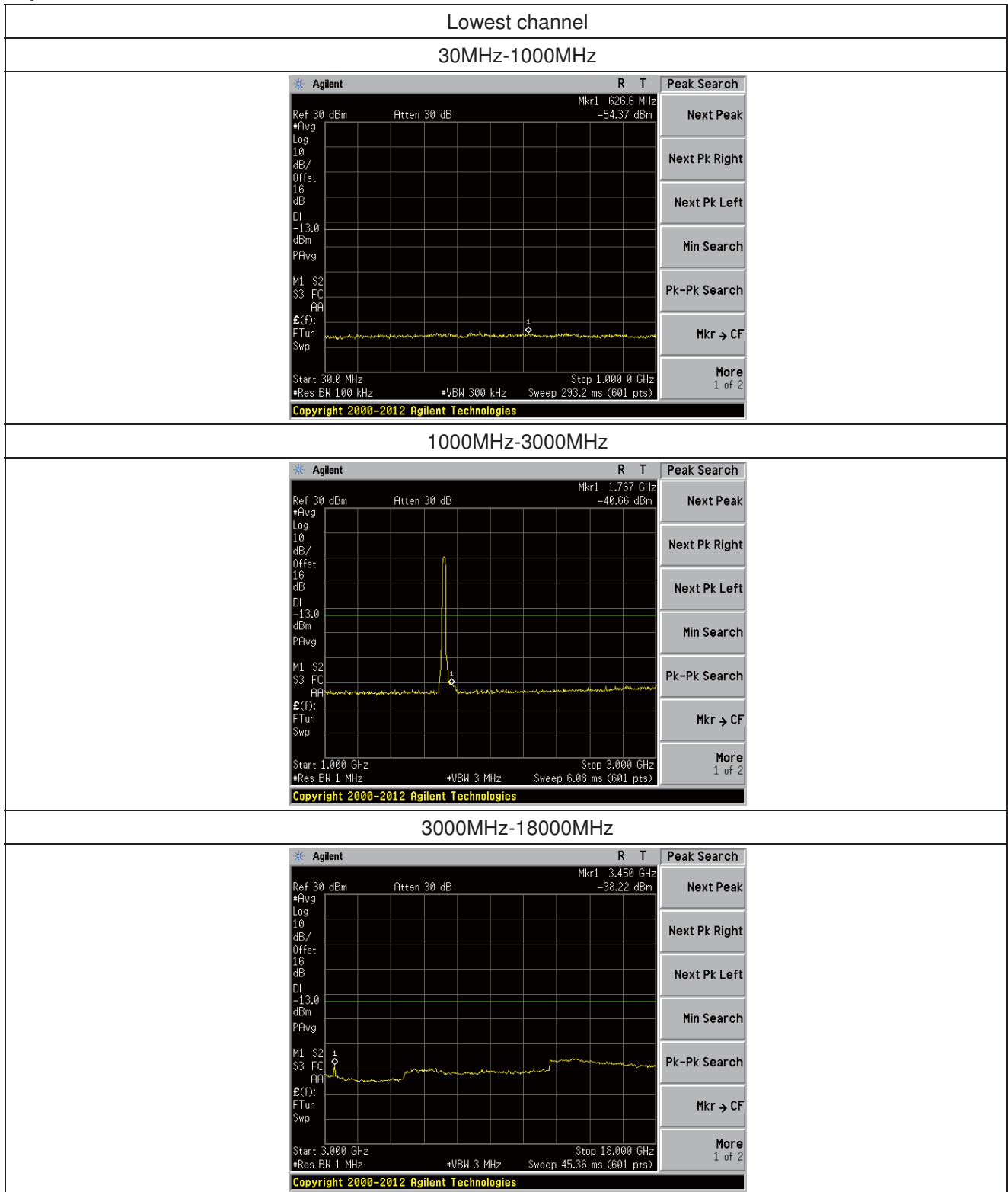

Middle channel

30MHz-1000MHz

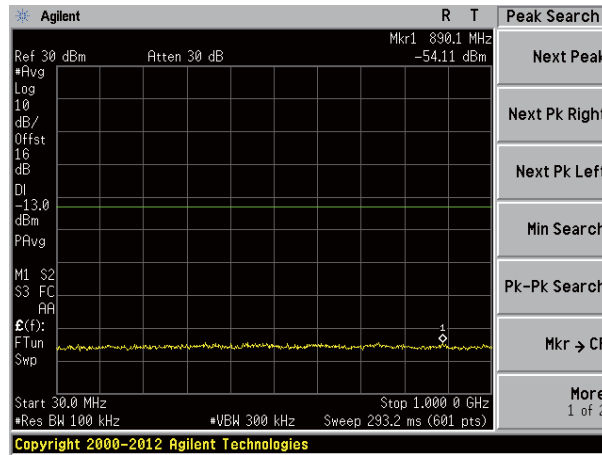

1000MHz-3000MHz

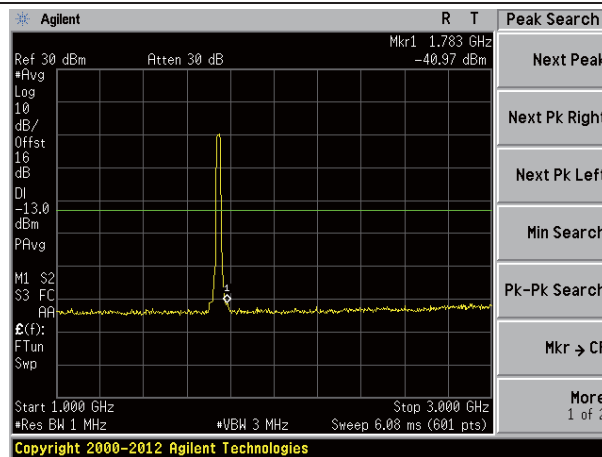

3000MHz-18000MHz

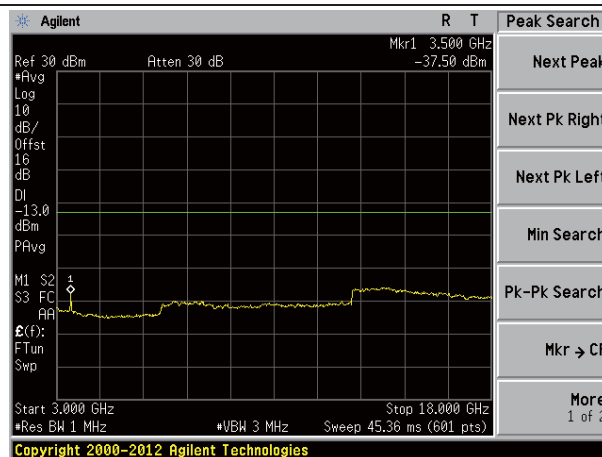

### Highest channel

#### 30MHz-1000MHz

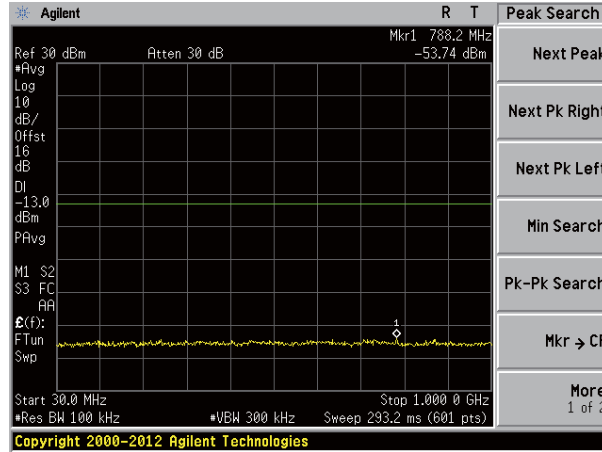

#### 1000MHz-3000MHz

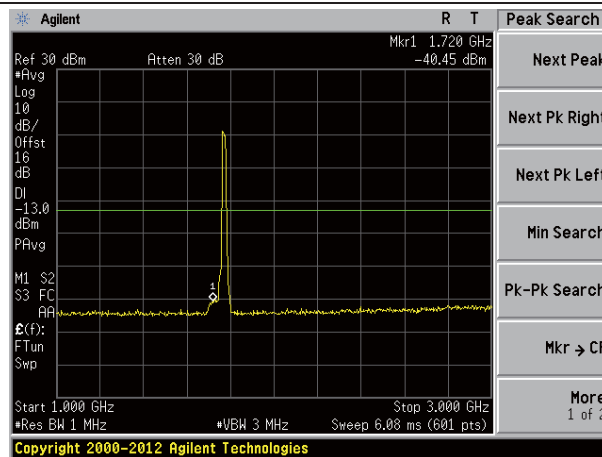

#### 3000MHz-18000MHz

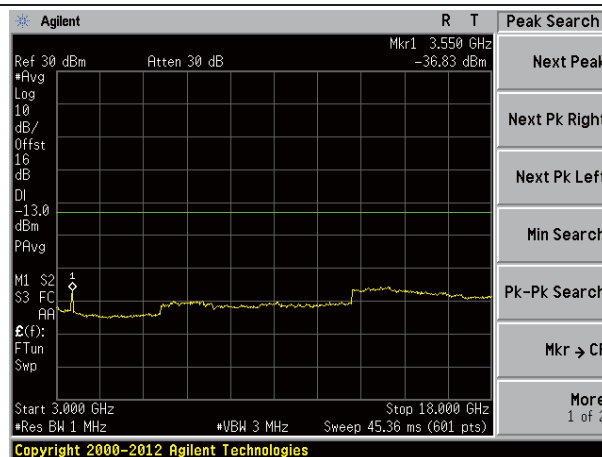

## Spurious emission of WCDMA Single Carrier



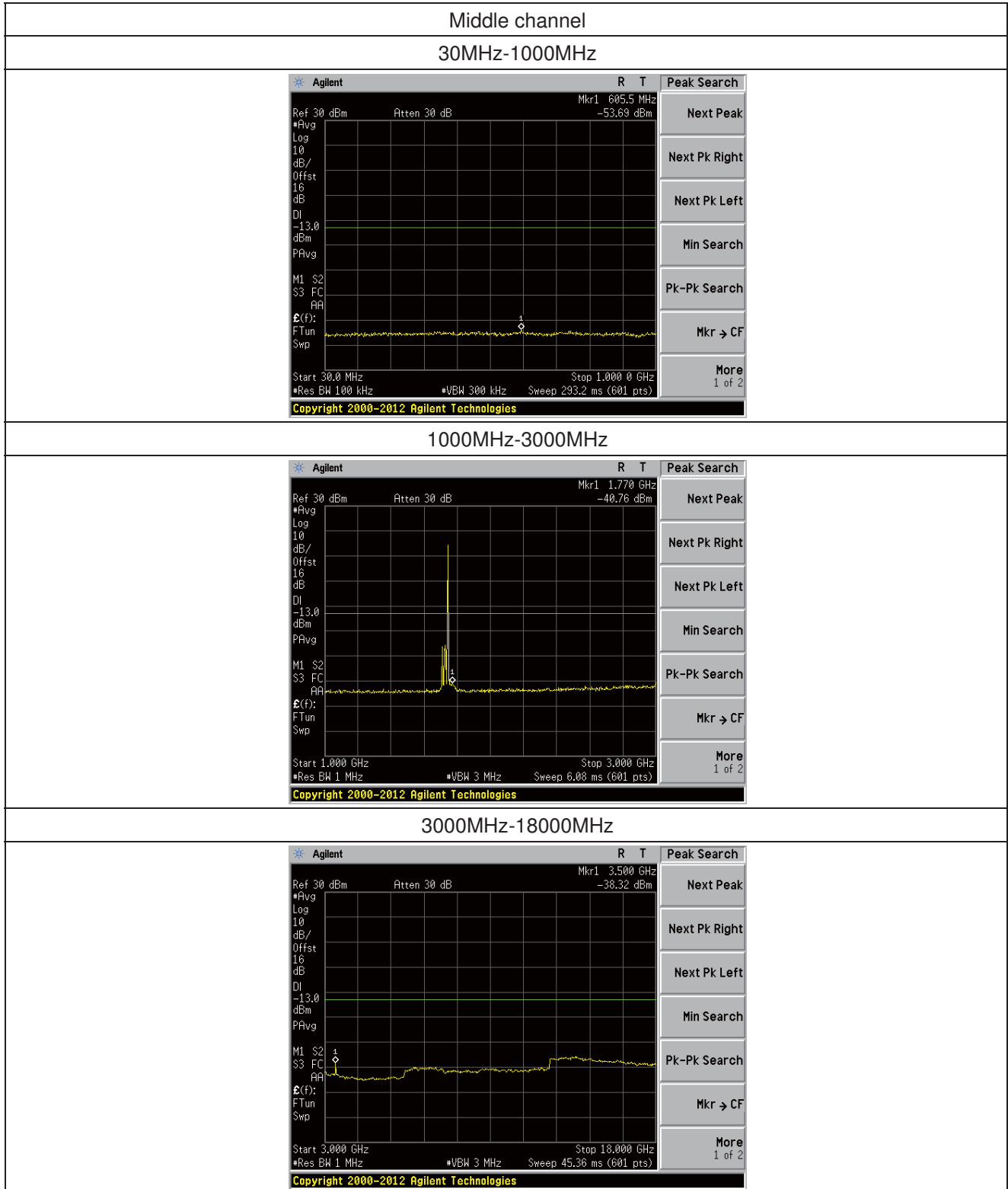

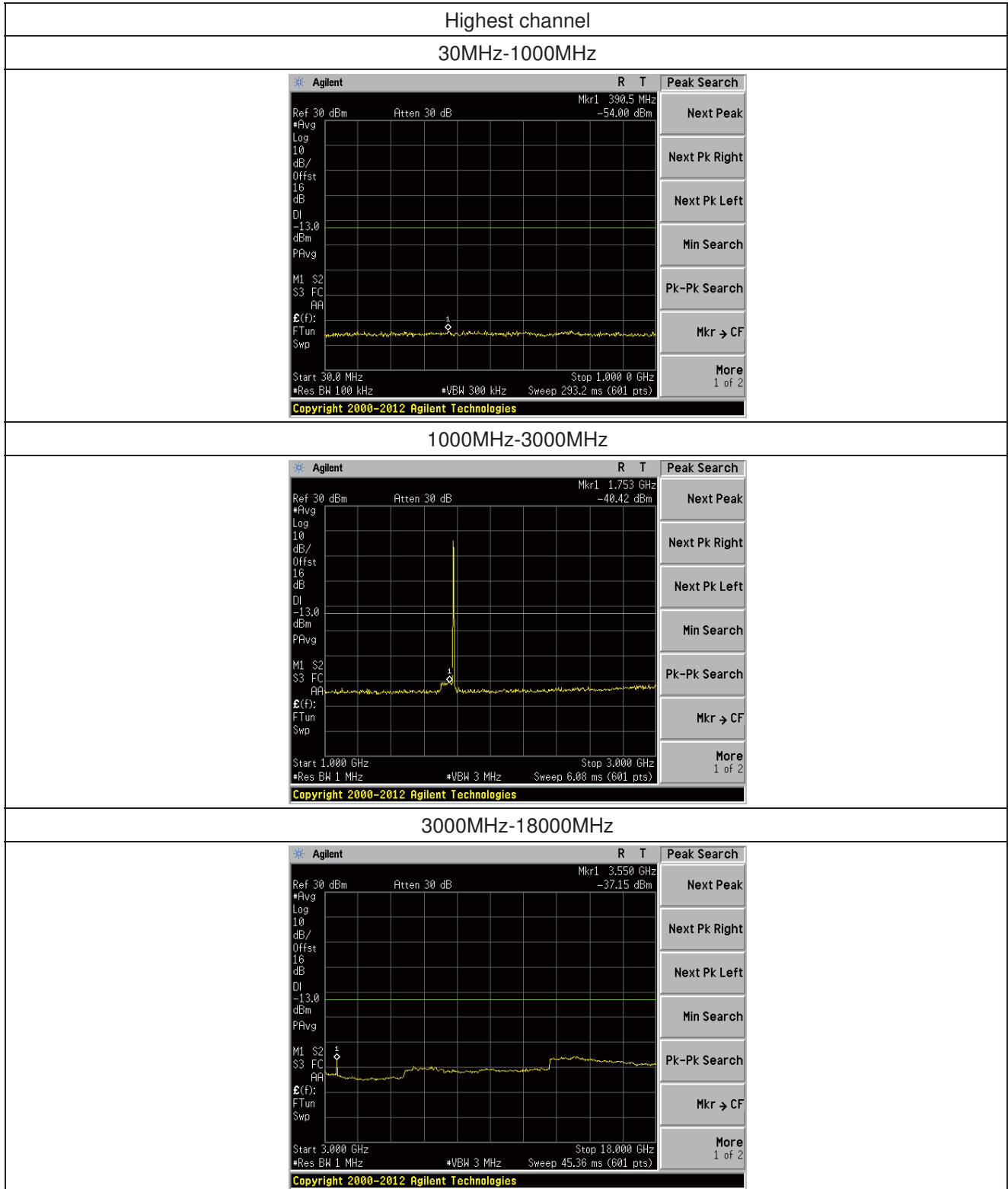



## Spurious emission of WCDMA Four Carrier

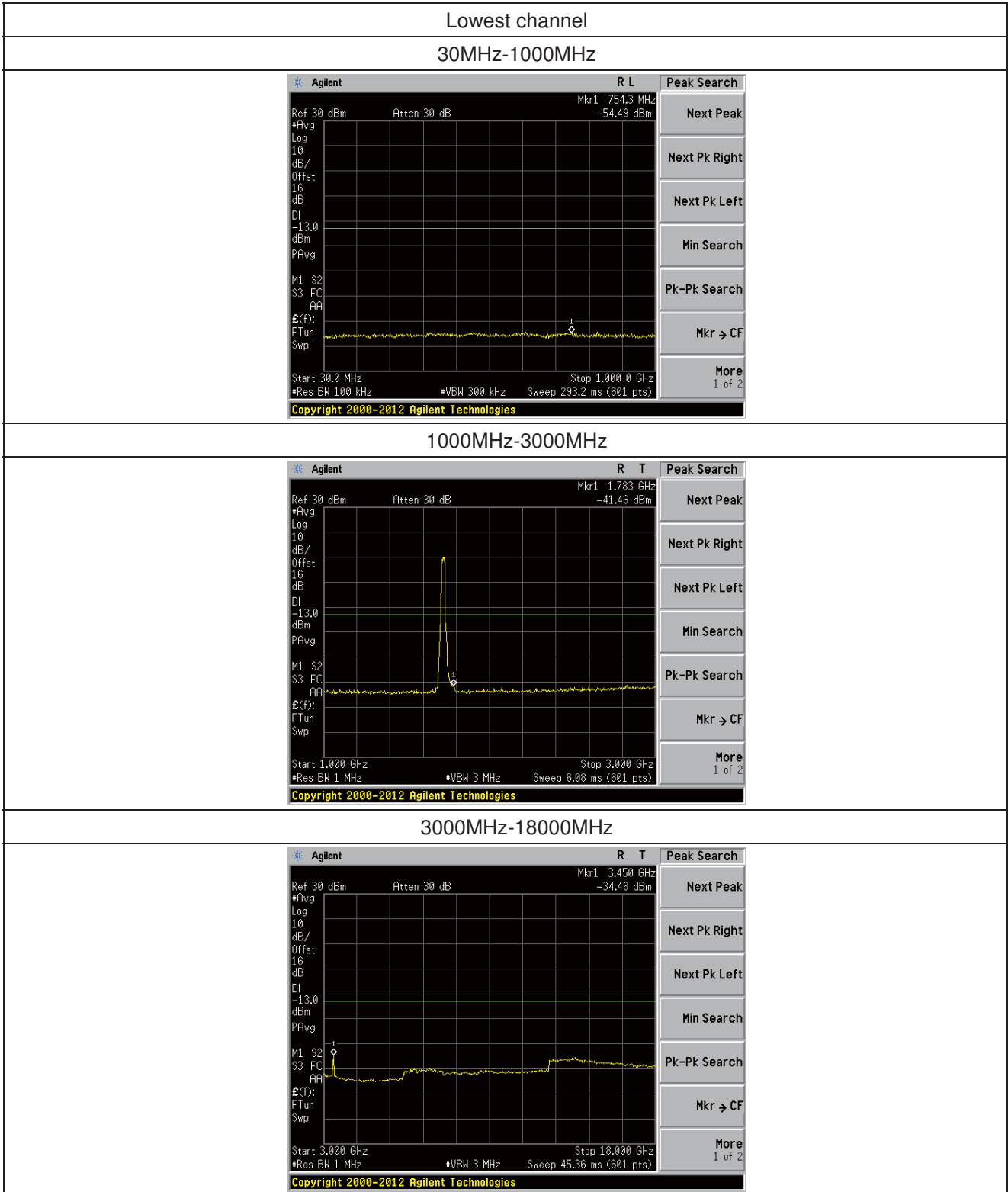

Middle channel

30MHz-1000MHz

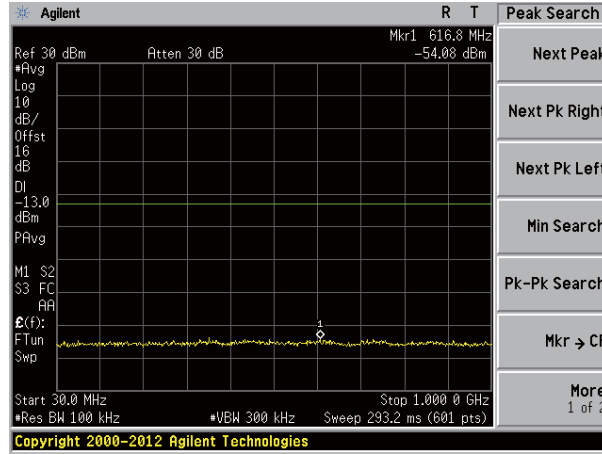

1000MHz-3000MHz

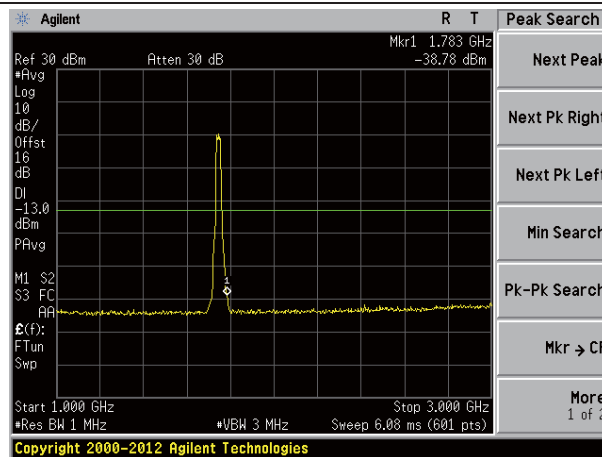

3000MHz-18000MHz

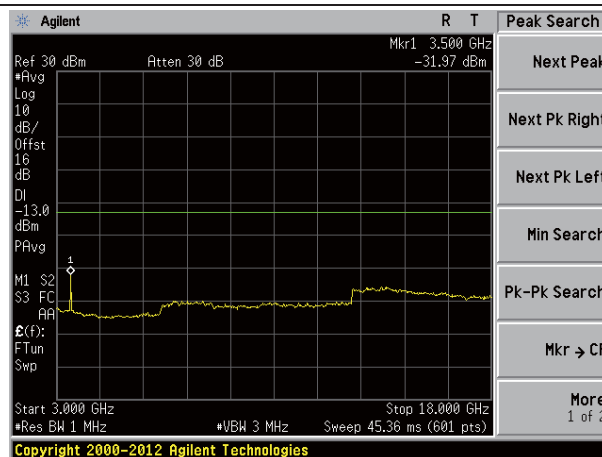

### Highest channel

#### 30MHz-1000MHz

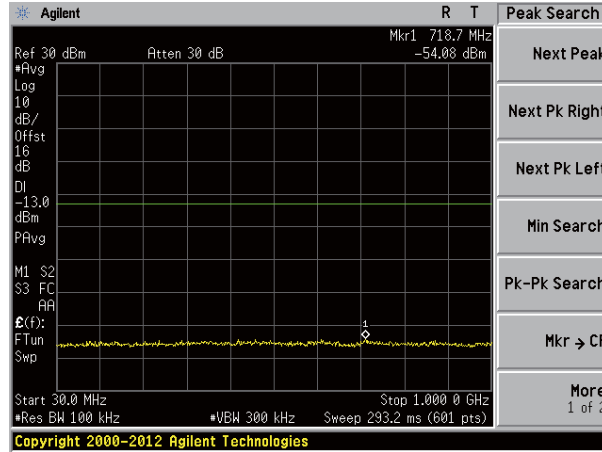

#### 1000MHz-3000MHz

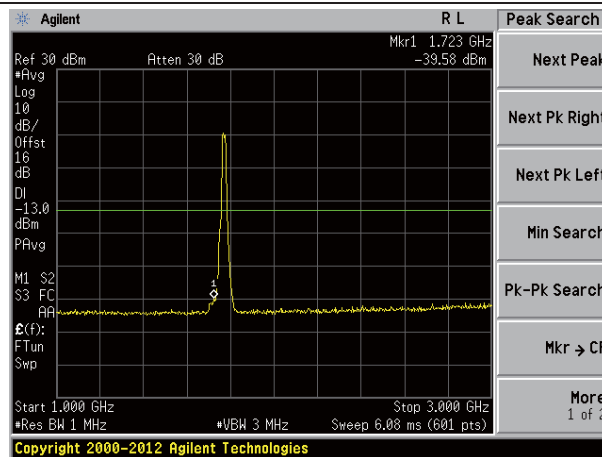

#### 3000MHz-18000MHz

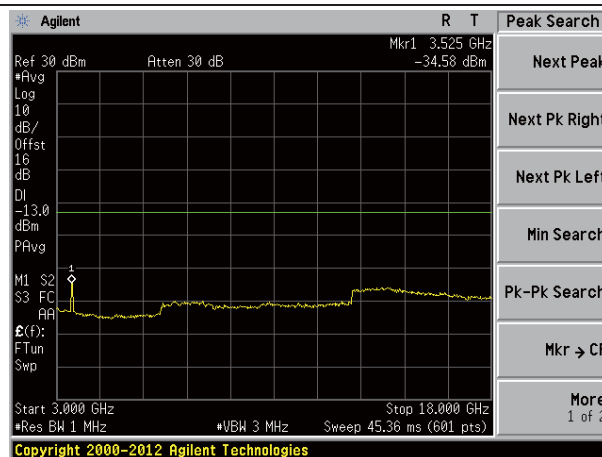

## 10.4.2 Band edge emission

Downlink:

### Band edge of LTE 1.4MHz Bandwidth

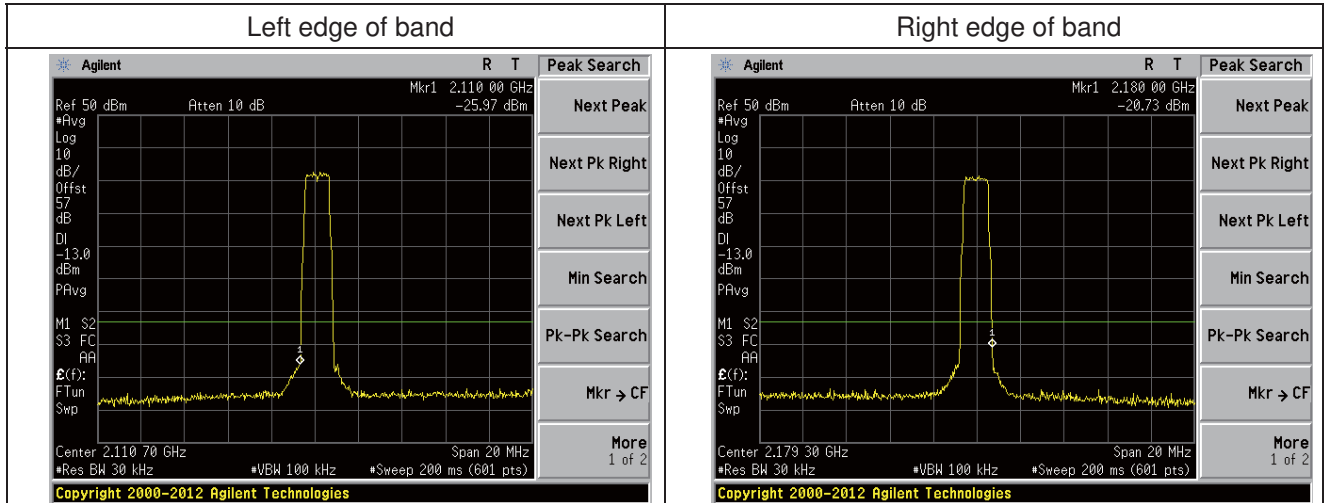

### Band edge of LTE 3MHz Bandwidth

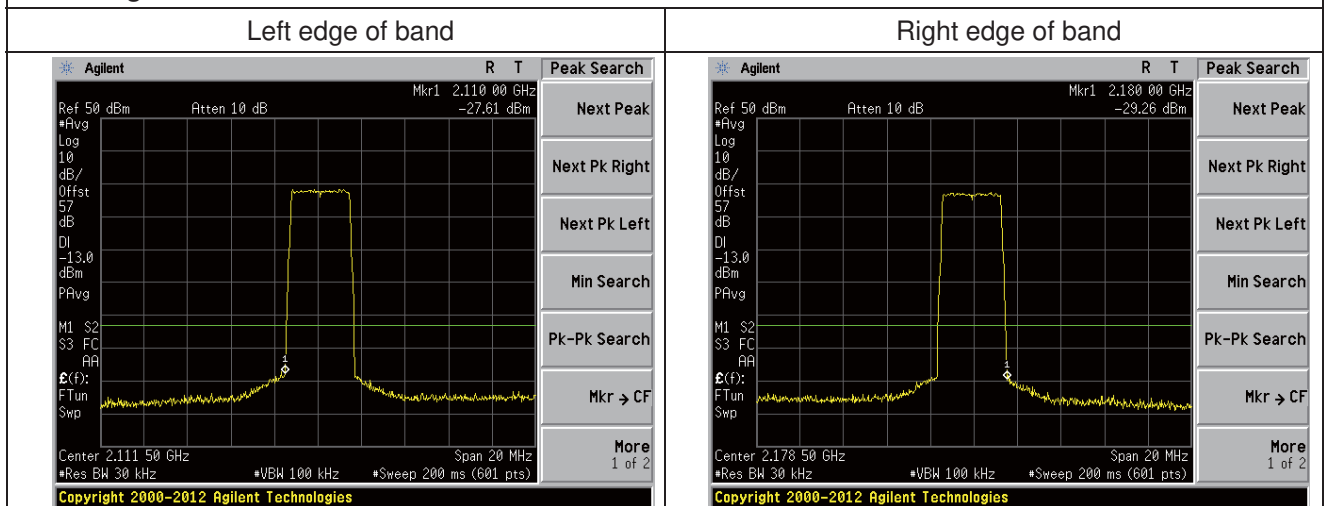

### Band edge of LTE 5MHz Bandwidth

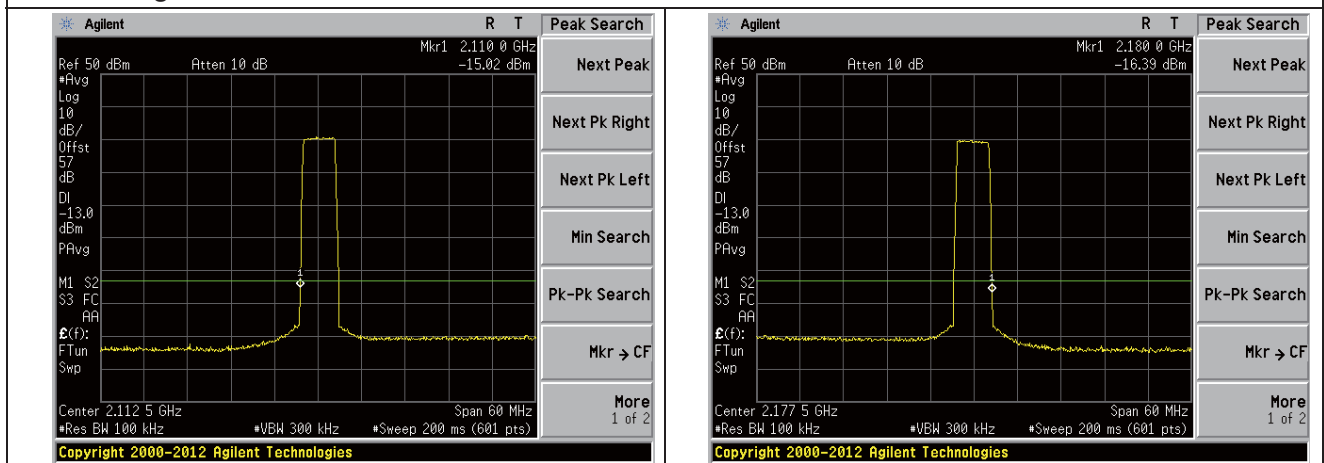

## Band edge of LTE 10MHz Bandwidth

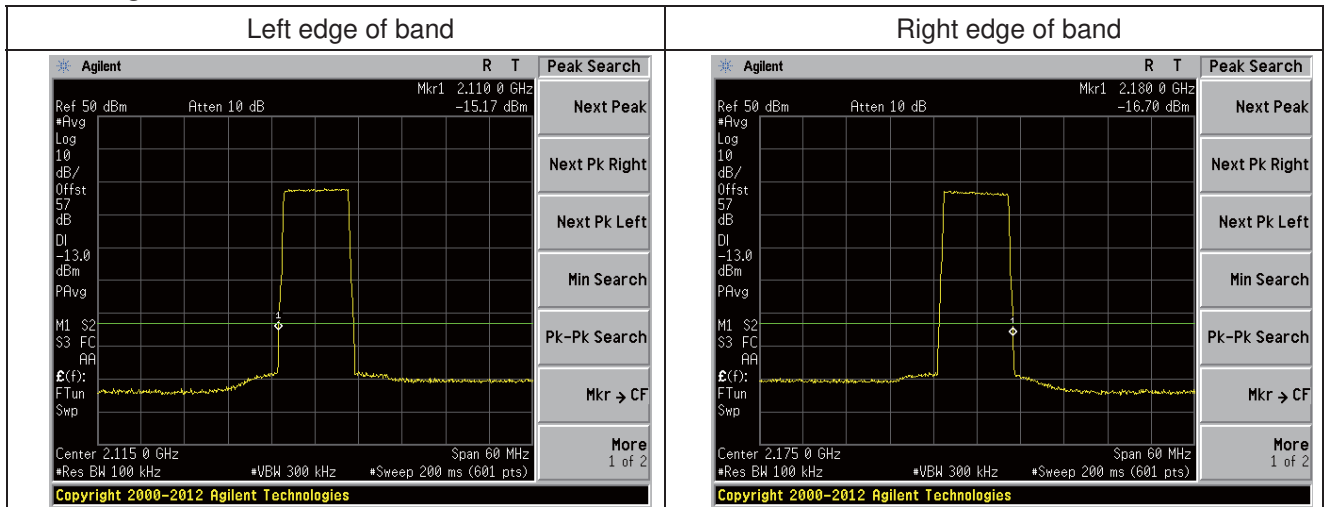

## Band edge of LTE 15MHz Bandwidth

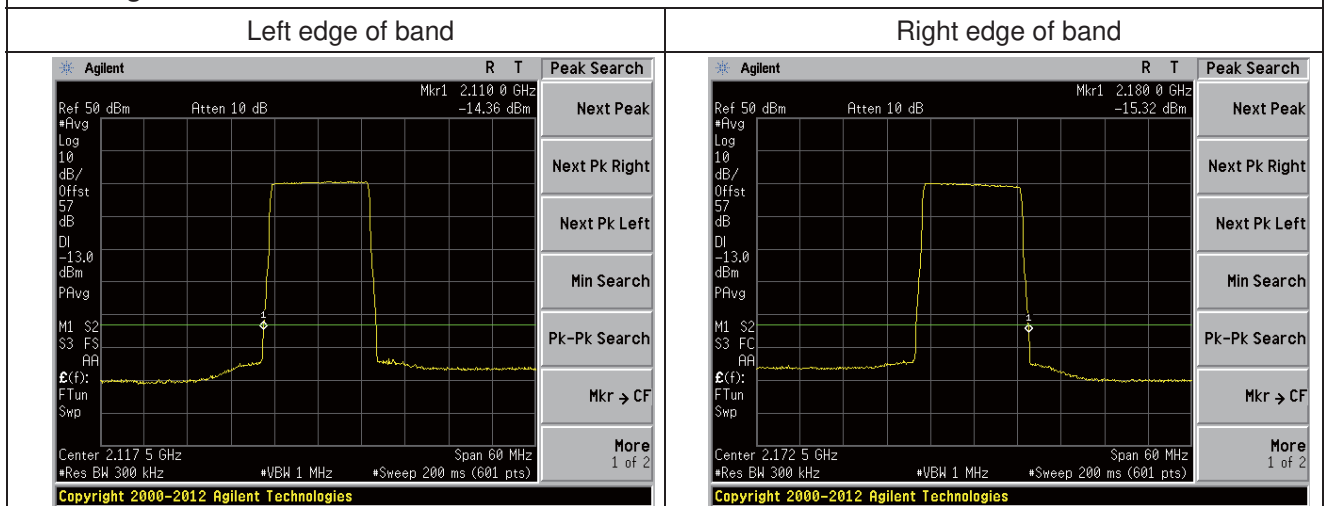

## Band edge of LTE 20MHz Bandwidth

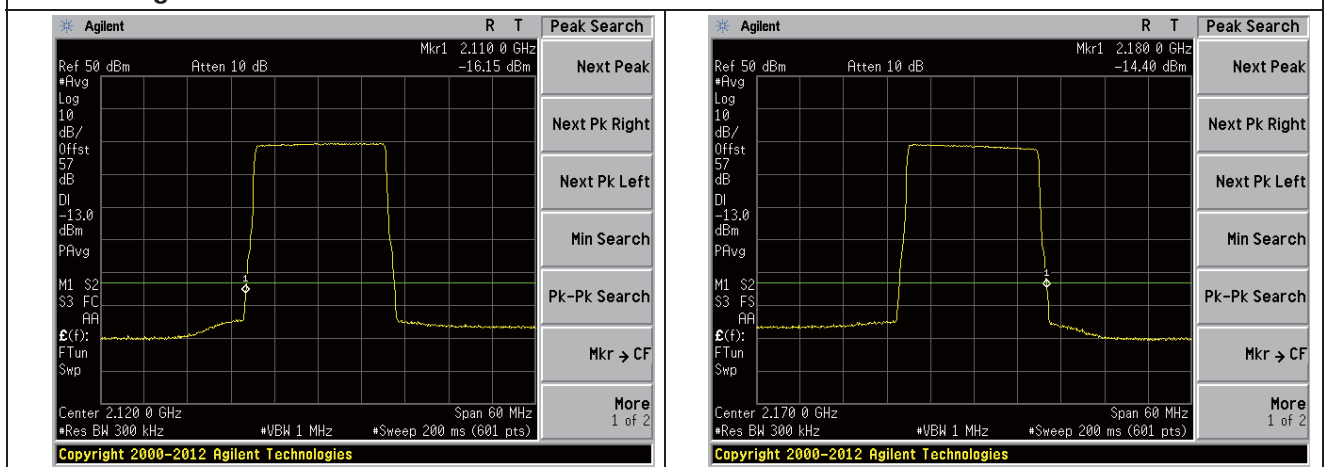

## Band edge of WCDMA Single Carrier

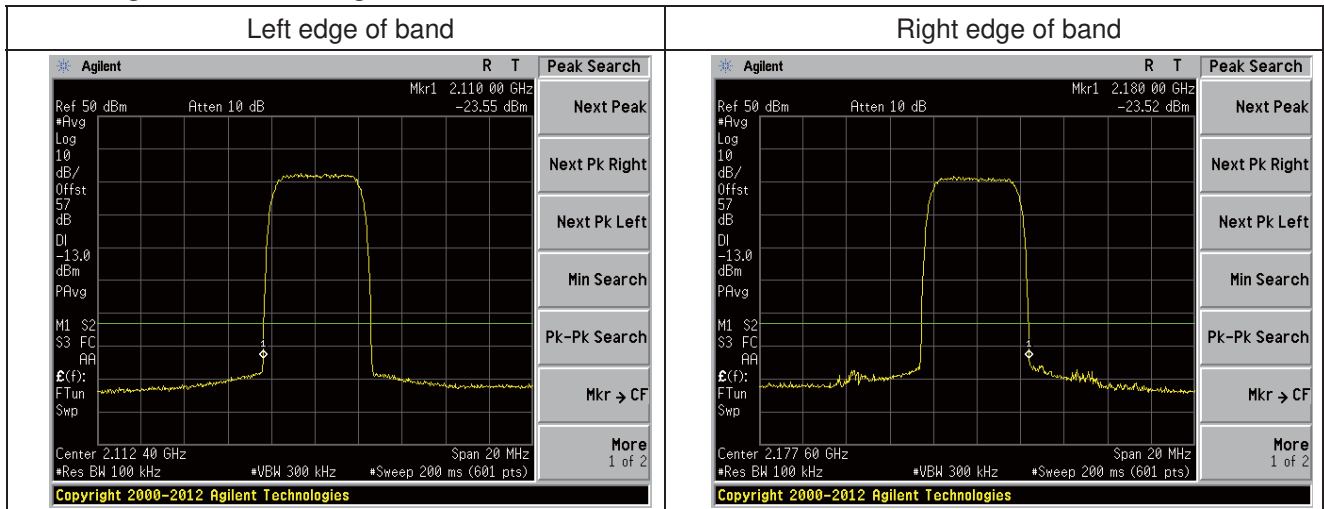

## Band edge of WCDMA Four Carrier

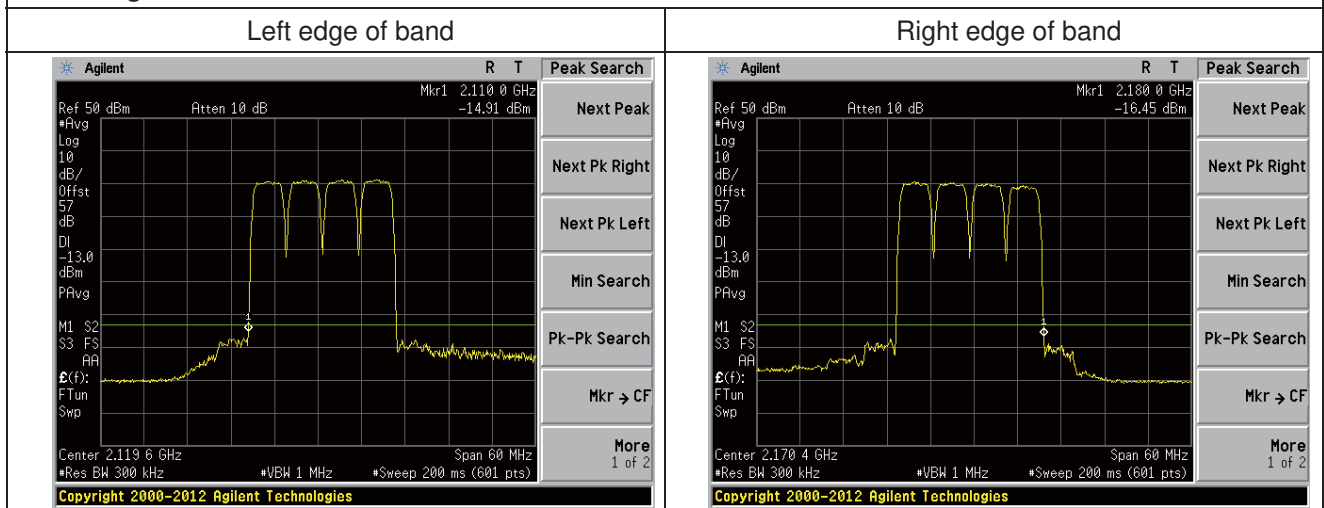

Uplink:

### Band edge of LTE 1.4MHz Bandwidth

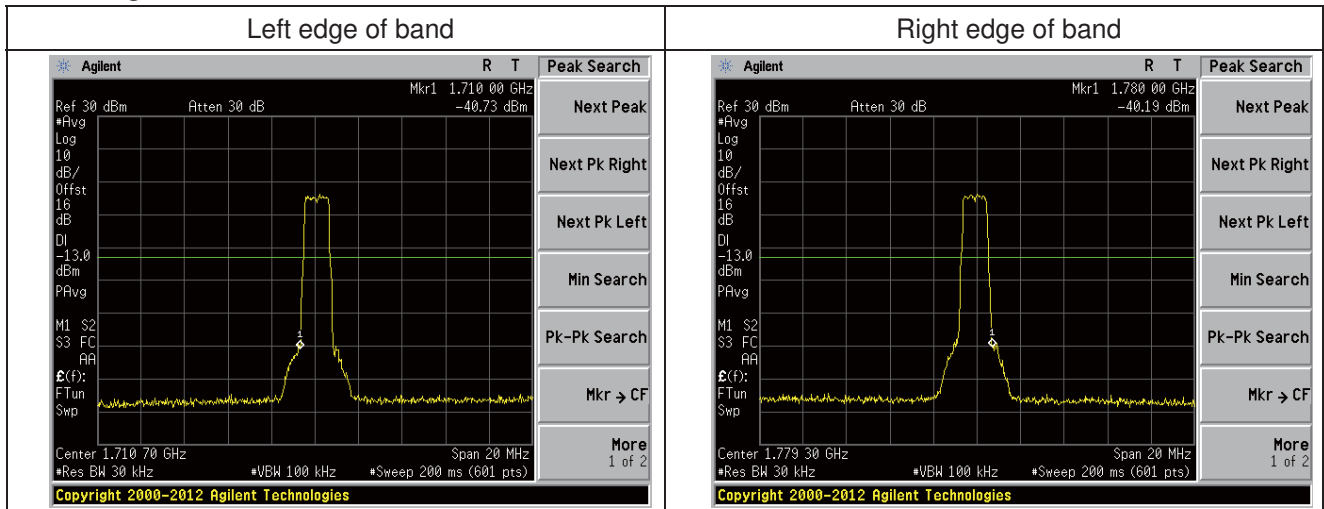

### Band edge of LTE 3MHz Bandwidth

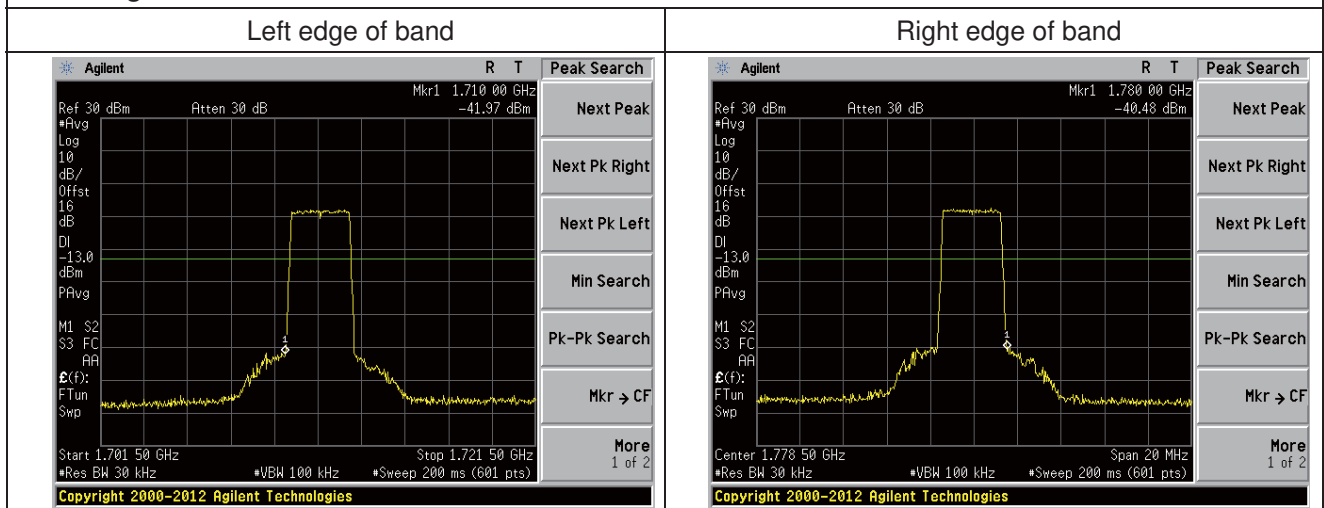

### Band edge of LTE 5MHz Bandwidth

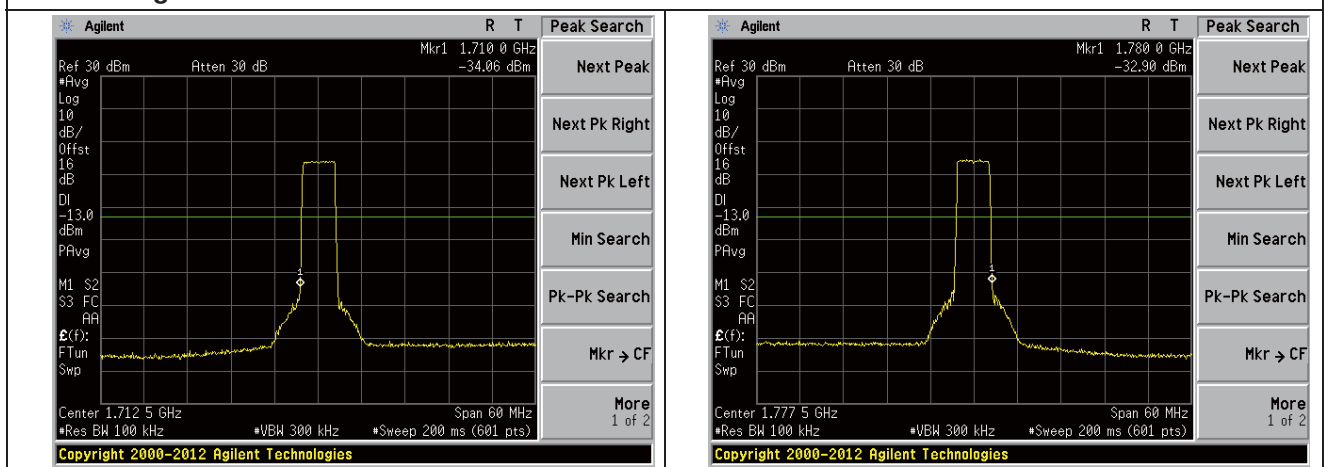

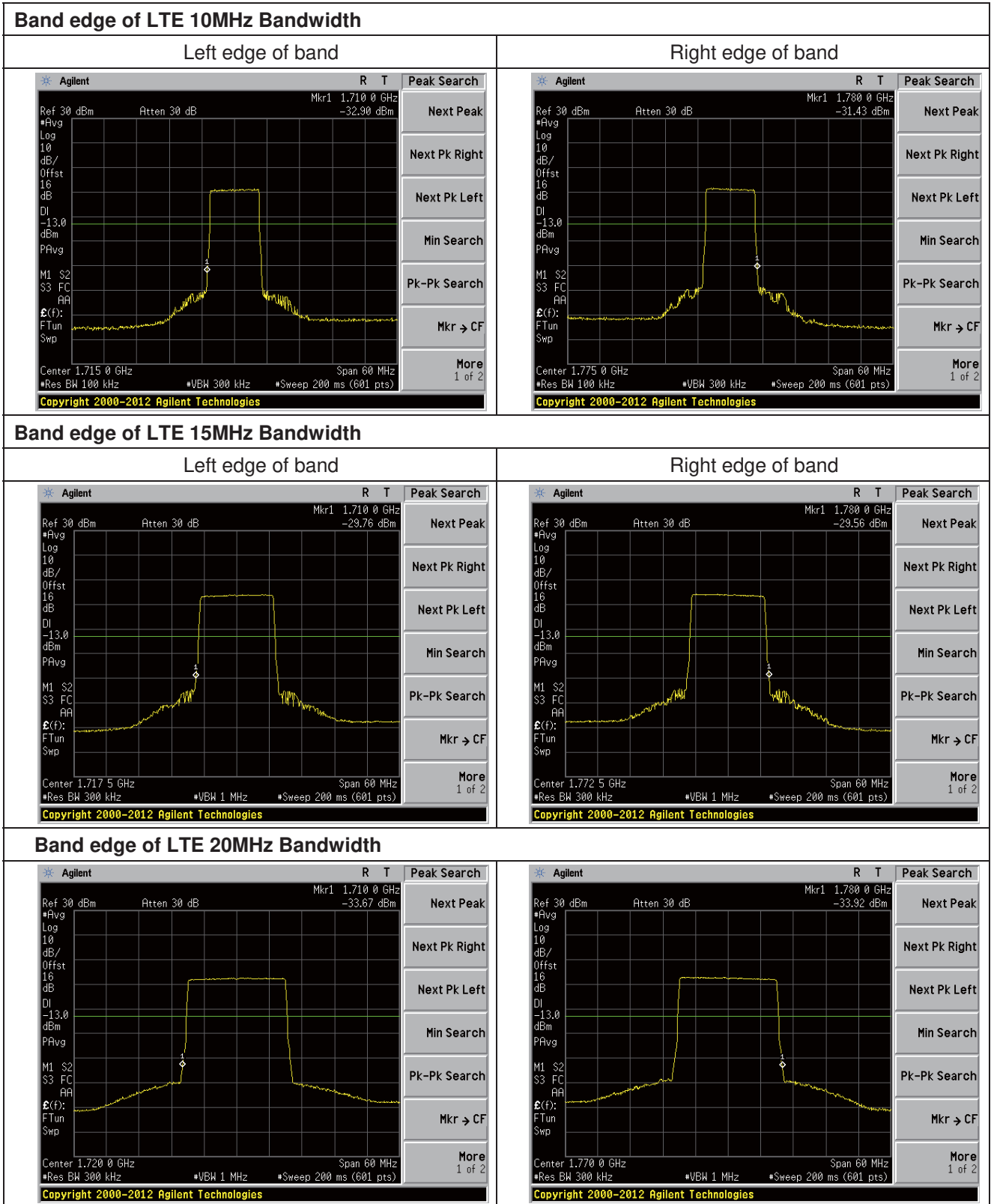



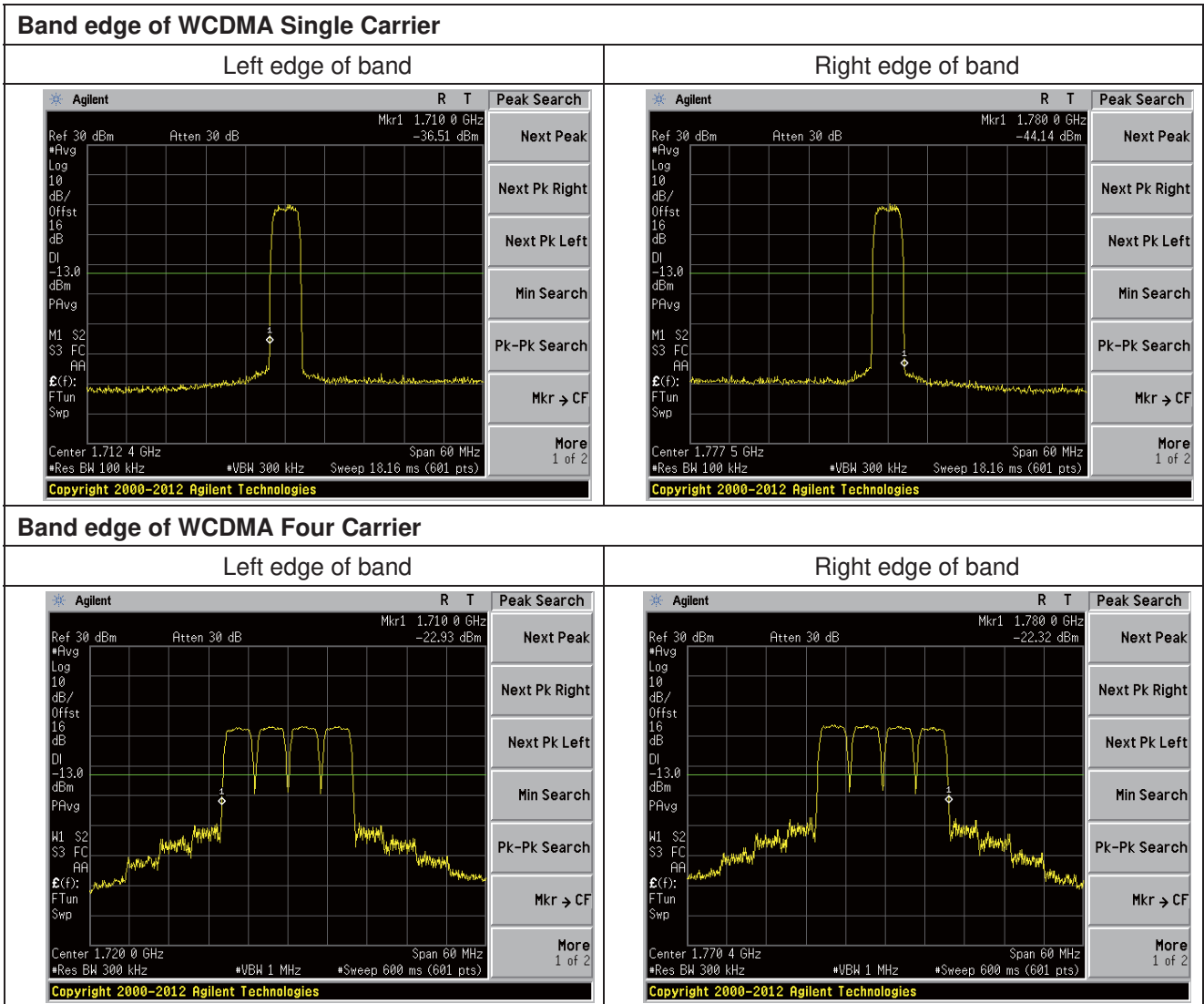

## 11 INTERMODULATION

### 11.1 Standard Applicable

According to FCC § 2.1051 and § 27.53(m)

### 11.2 Test setup

Please refer the section §6.2 Configuration of Tested System.

### 11.3 Measurement Procedure

1. The EUT RF output port was connected to spectrum analyzer. The EUT shall be set to maximum gain and maximum rated output power per channel.
2. Two continuous sinusoidal RF signals shall be fed to the input antenna port of the repeater using a combining device. The two channels near each other should be separated by at least one operating channel width.
3. The spurious emissions at antenna were measured at the RF output port of the EUT.
4. The modulation types tested is LTE and WCDMA.

Spectrum analyzer settings:

Detector: RMS.

Intermodulation:

RBW= 1% to 5 % of the anticipated OBW ; VBW $\geq$  3\*RBW

Spurious emissions:

Below 1G: RBW=100kHz; Above 1G: RBW=1 MHz ; VBW $\geq$  RBW

### 11.4 Test Result

**Passed.**

Downlink:

## Intermodulation of LTE 1.4MHz Bandwidth

Intermodulation - Low part of band

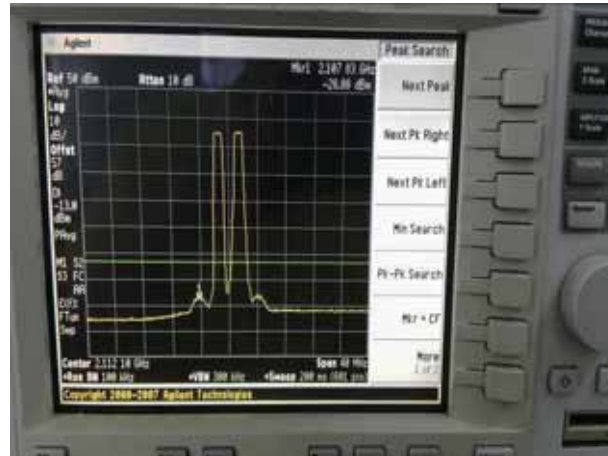

30MHz-1000MHz spurious emissions

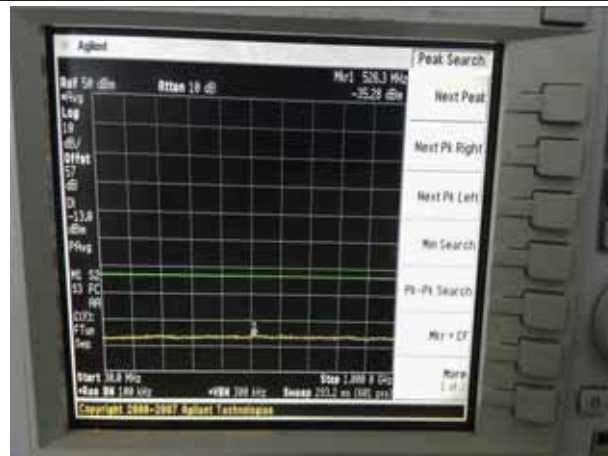

1000MHz-3000MHz spurious emissions



### 3000MHz-22000MHz spurious emissions

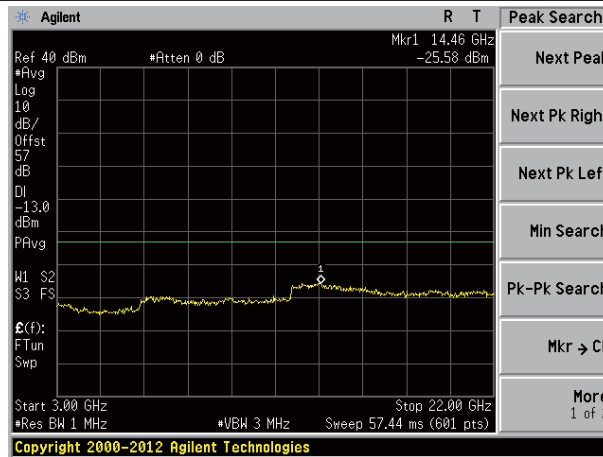

### Intermodulation - High part of band



### 30MHz-1000MHz spurious emissions

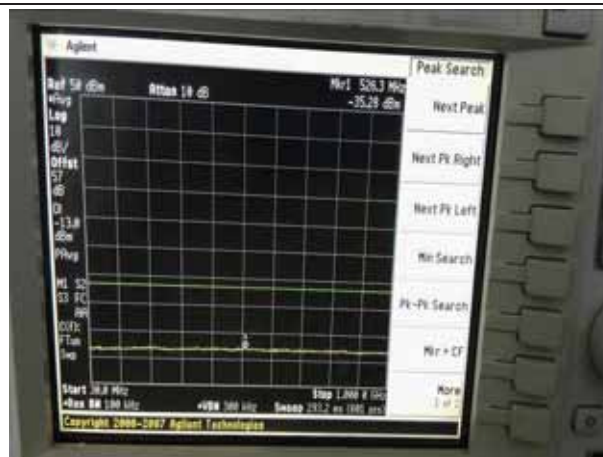

### 1000MHz-3000MHz spurious emissions



### 3000MHz-22000MHz spurious emissions

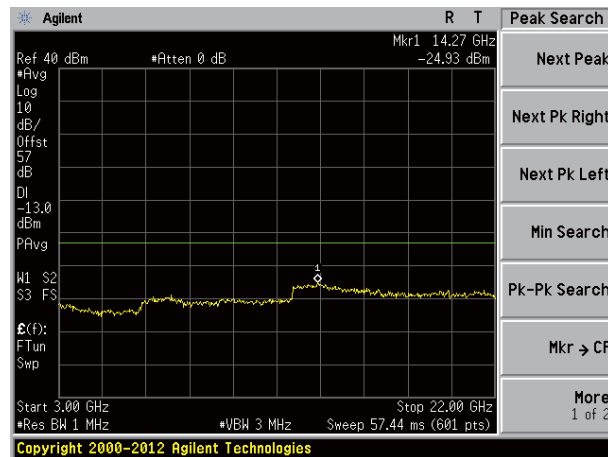

### Intermodulation of LTE 3MHz Bandwidth

#### Intermodulation - Low part of band



30MHz-1000MHz spurious emissions

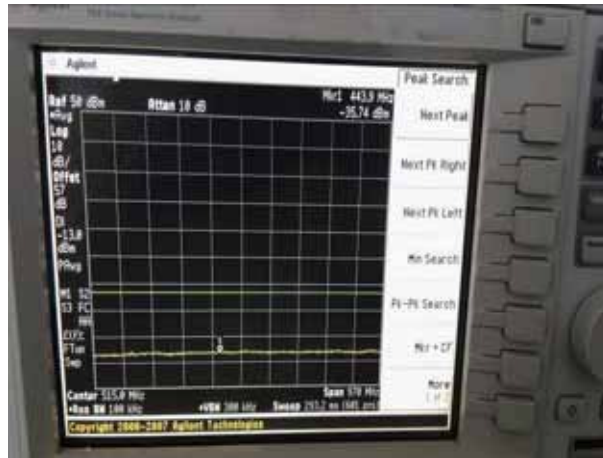

1000MHz-3000MHz spurious emissions

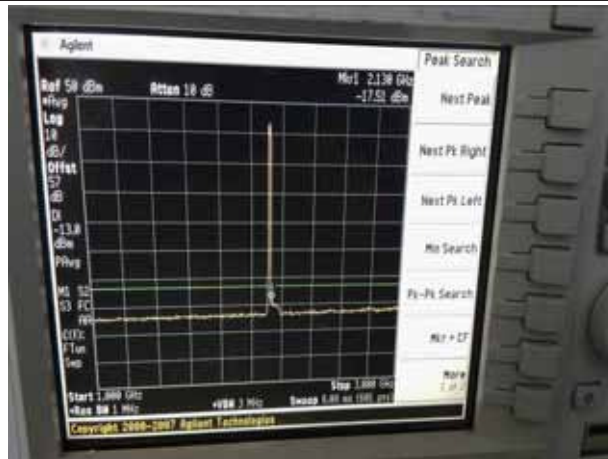

3000MHz-22000MHz spurious emissions

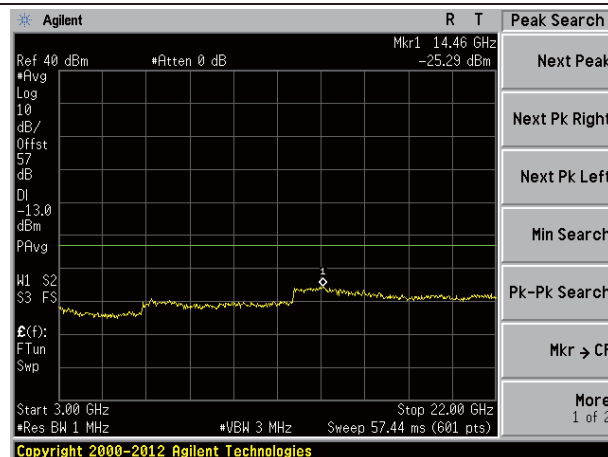



Intermodulation - High part of band



30MHz-100MHz spurious emissions

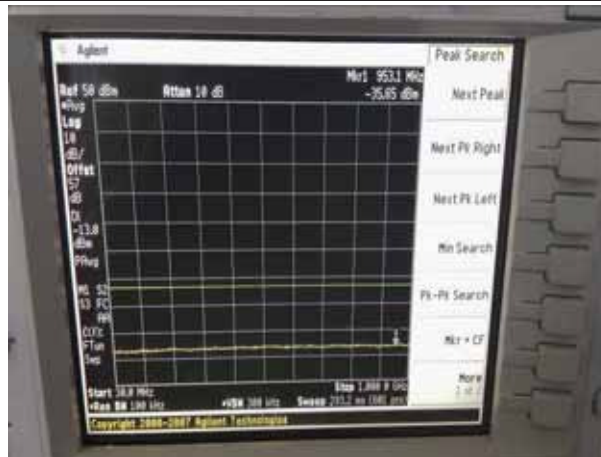

1000MHz-3000MHz spurious emissions

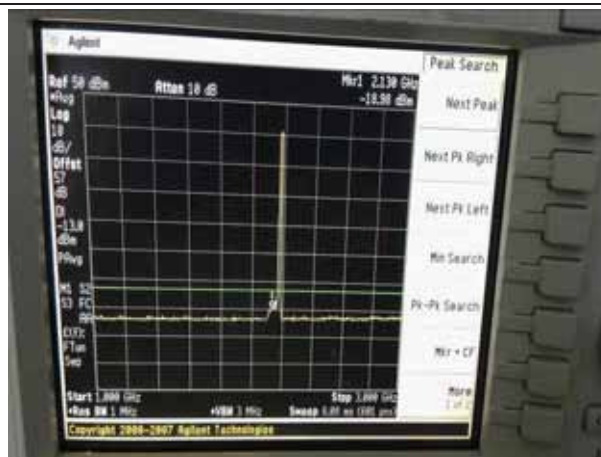

### 3000MHz-22000MHz spurious emissions

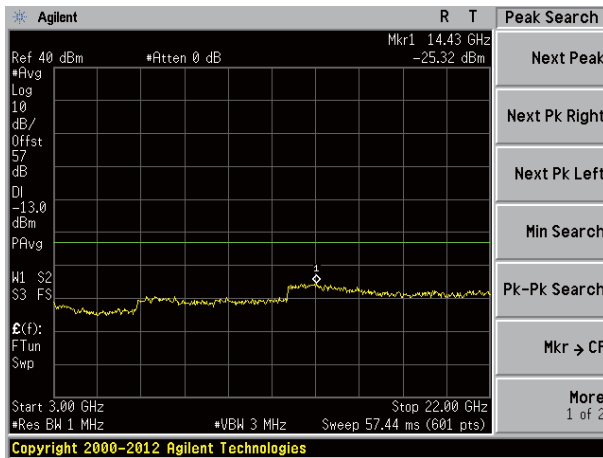

### Intermodulation of LTE 5MHz Bandwidth

#### Intermodulation - Low part of band

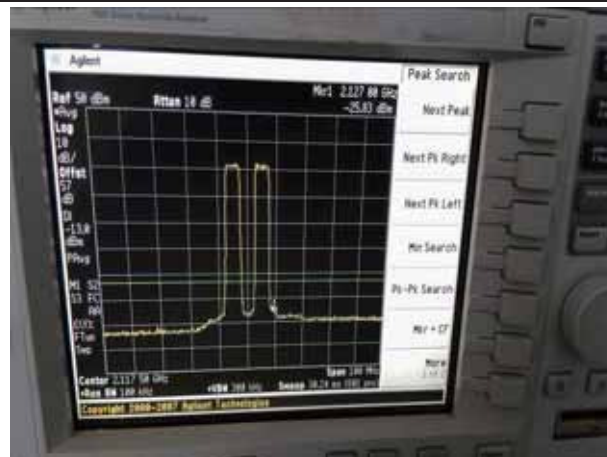

#### 30MHz-100MHz spurious emissions

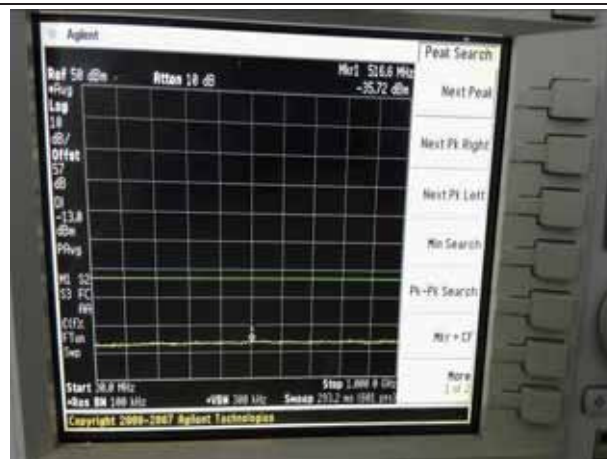



1000MHz-3000MHz spurious emissions

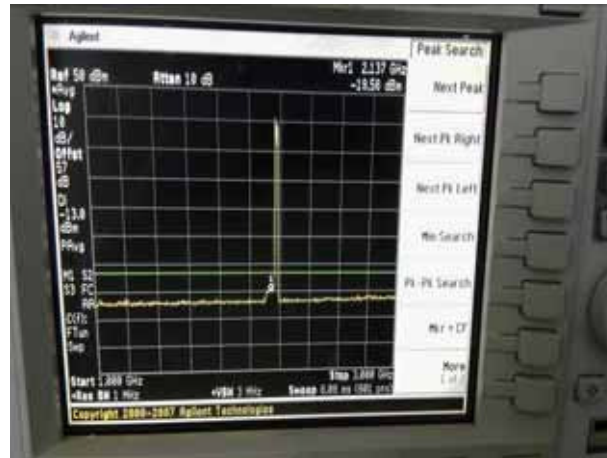

3000MHz-22000MHz spurious emissions

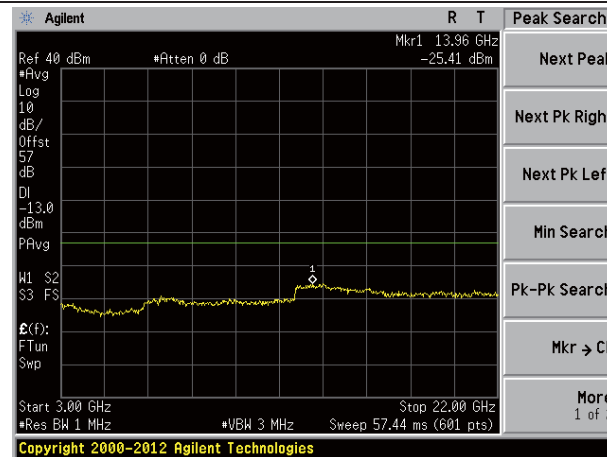

Intermodulation - High part of band



### 30MHz-1000MHz spurious emissions

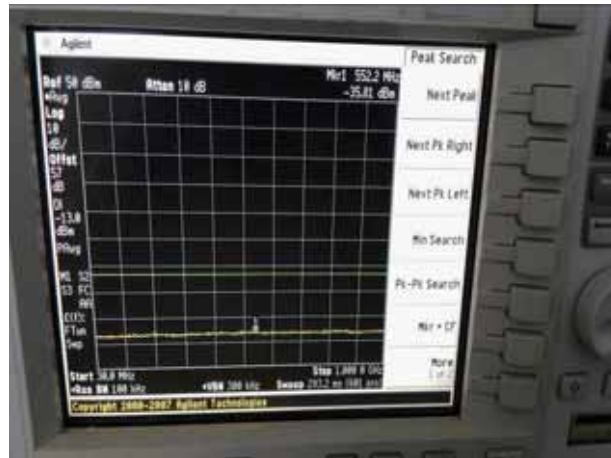

### 1000MHz-10000MHz spurious emissions

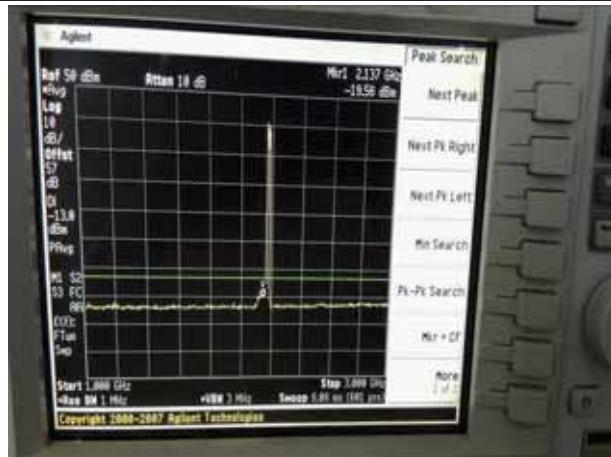

### 3000MHz-22000MHz spurious emissions

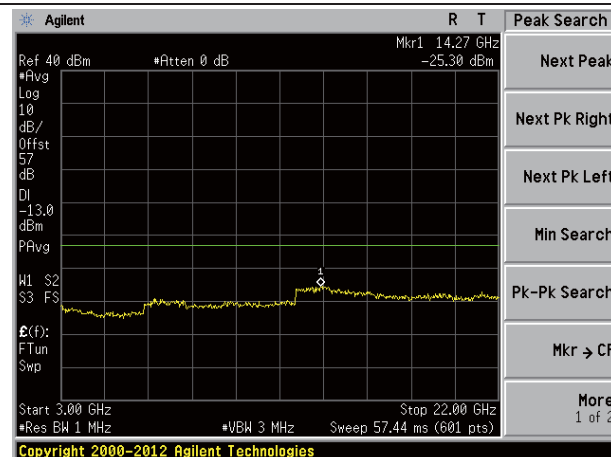

## Intermodulation of LTE 10MHz Bandwidth

Intermodulation - Low part of band

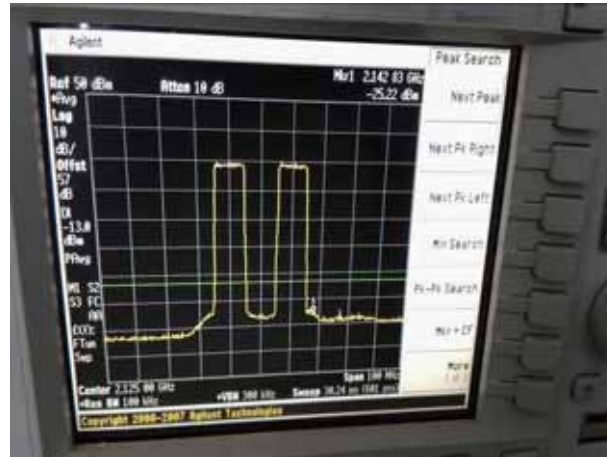

30MHz-1000MHz spurious emissions

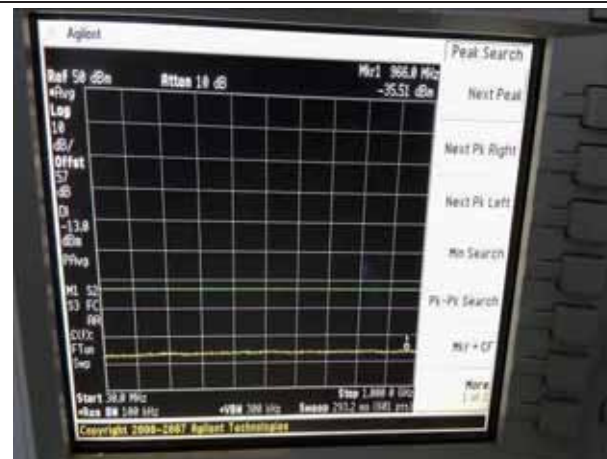

1000MHz-3000MHz spurious emissions



### 3000MHz-22000MHz spurious emissions

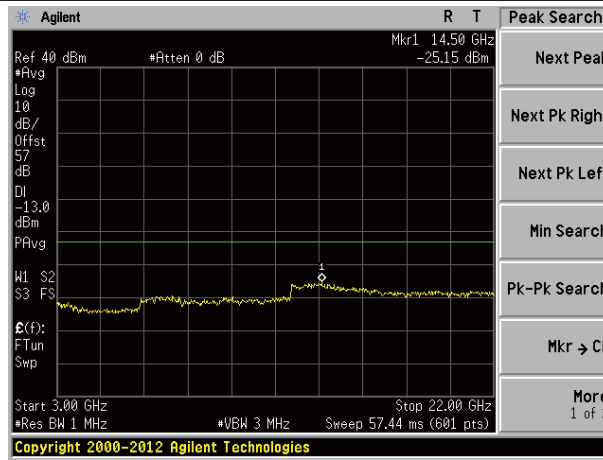

### Intermodulation - High part of band

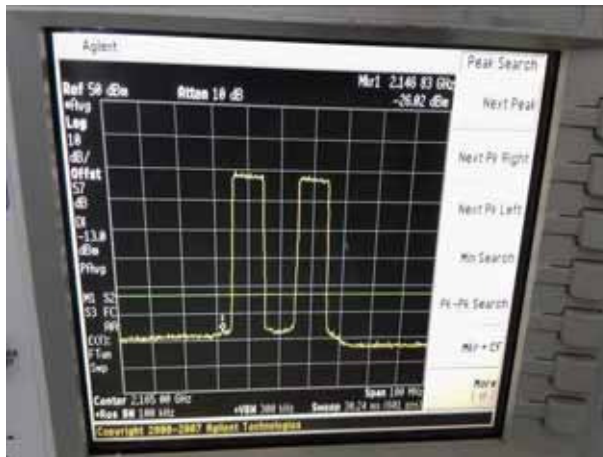

### 30MHz-1000MHz spurious emissions

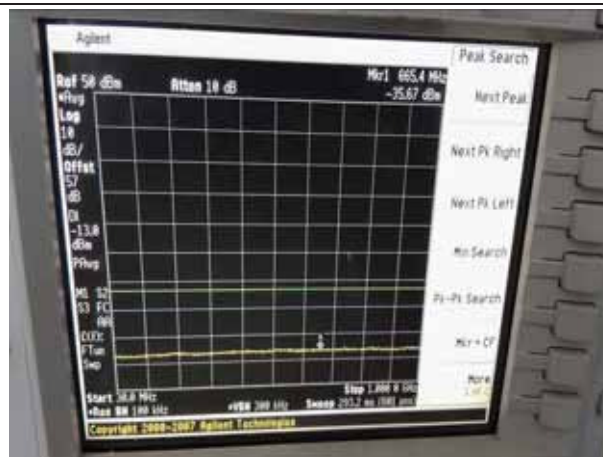

### 1000MHz-3000MHz spurious emissions

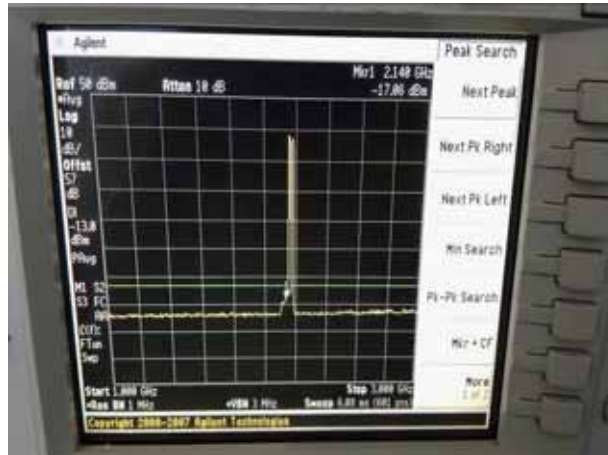

### 3000MHz-22000MHz spurious emissions

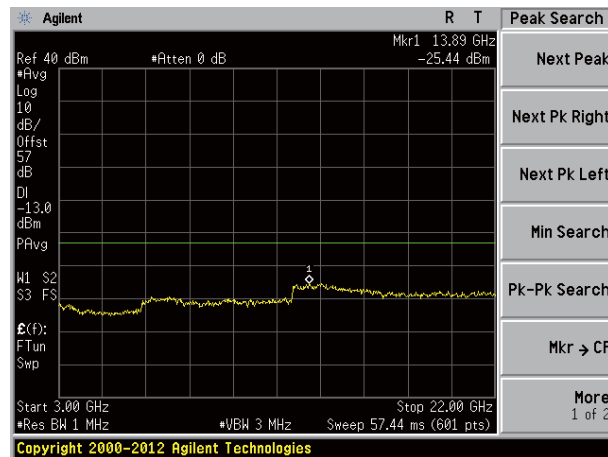

### Intermodulation of LTE 15MHz Bandwidth

#### Intermodulation - Low part of band

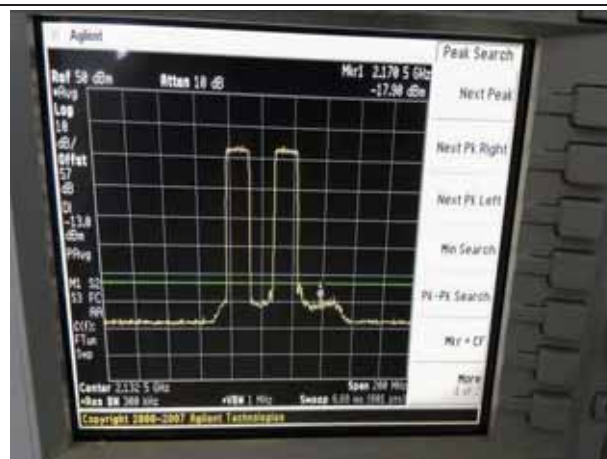



30MHz-1000MHz spurious emissions

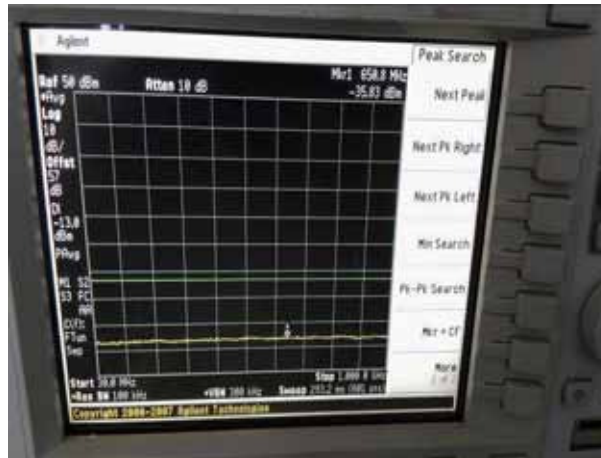

1000MHz-3000MHz spurious emissions



3000MHz-22000MHz spurious emissions

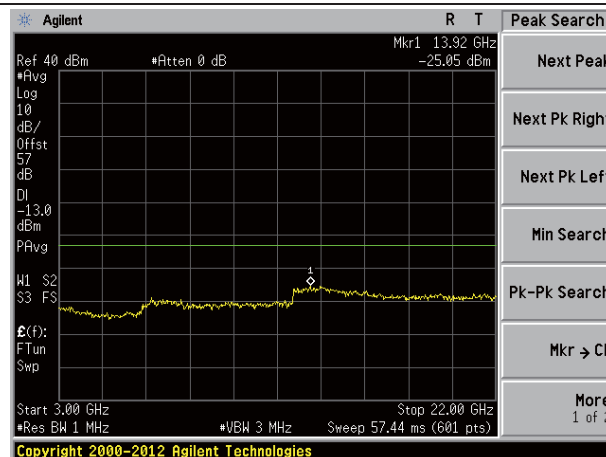

Intermodulation - High part of band

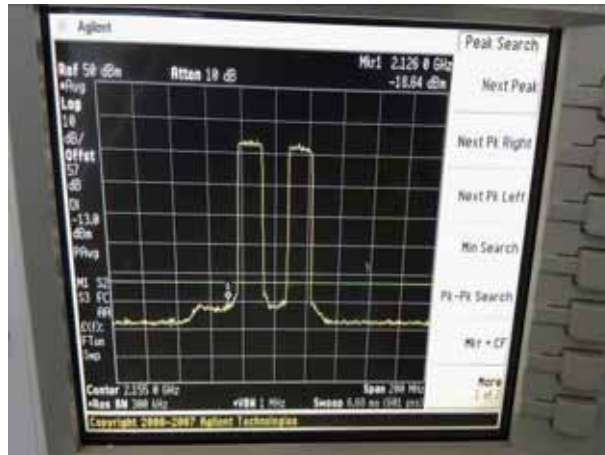

30MHz-1000MHz spurious emissions

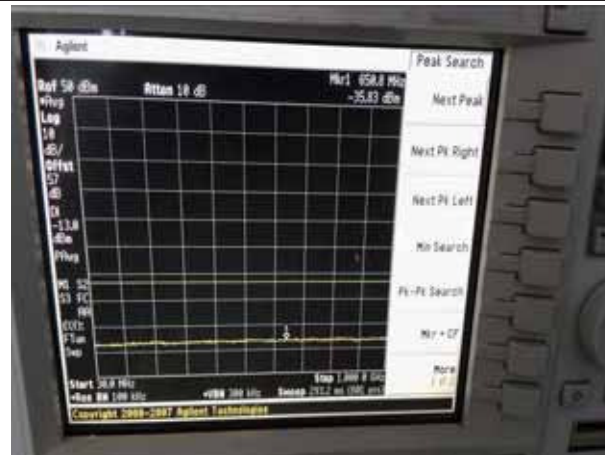

1000MHz-3000MHz spurious emissions

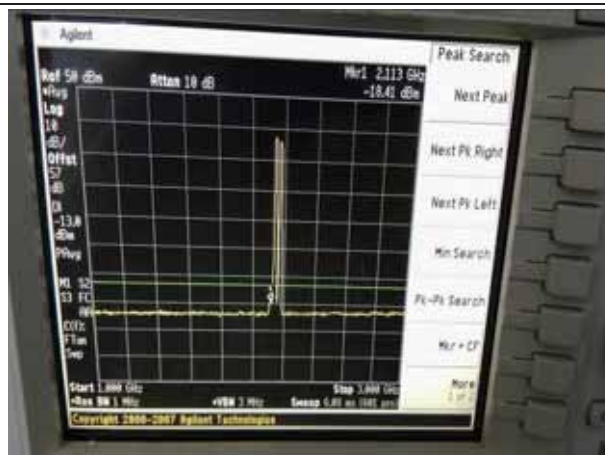

### 3000MHz-22000MHz spurious emissions

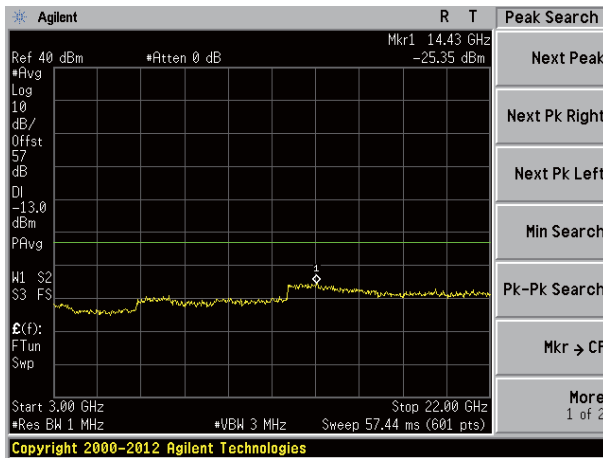

### Intermodulation of LTE 20MHz Bandwidth

#### Intermodulation - Low part of band



#### 30MHz-1000MHz spurious emissions

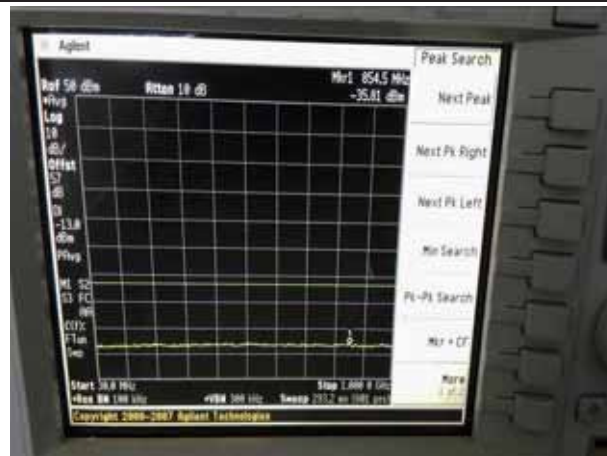



1000MHz-3000MHz spurious emissions



3000MHz-22000MHz spurious emissions

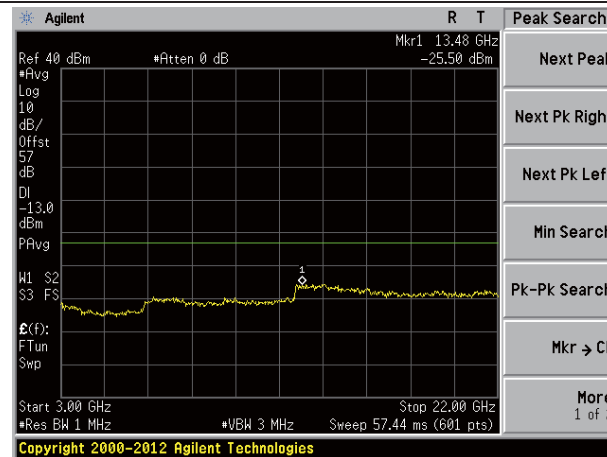

Intermodulation - High part of band

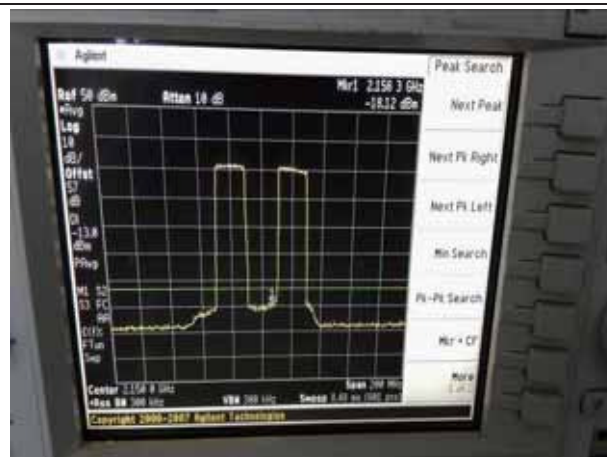

30MHz-1000MHz spurious emissions

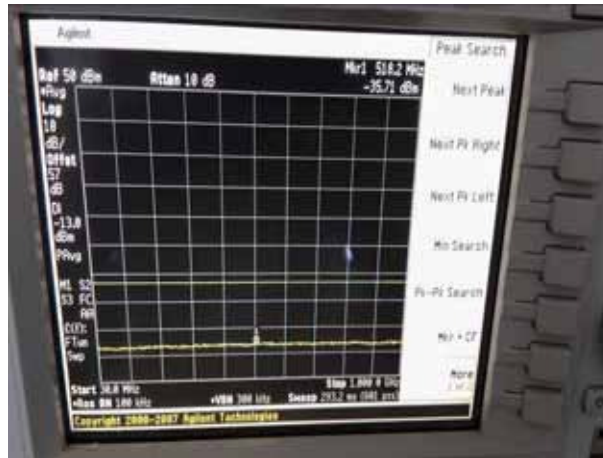

1000MHz-3000MHz spurious emissions

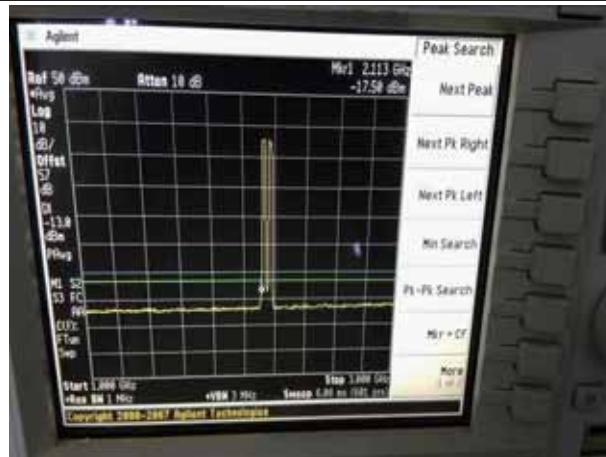

3000MHz-22000MHz spurious emissions

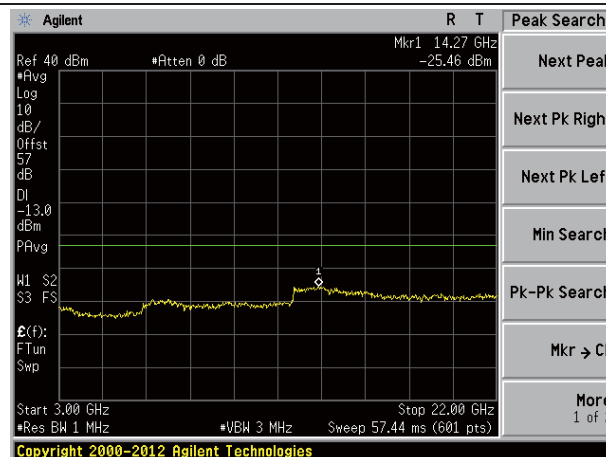

## Intermodulation of WCDMA Single Carrier

Intermodulation - Low part of band

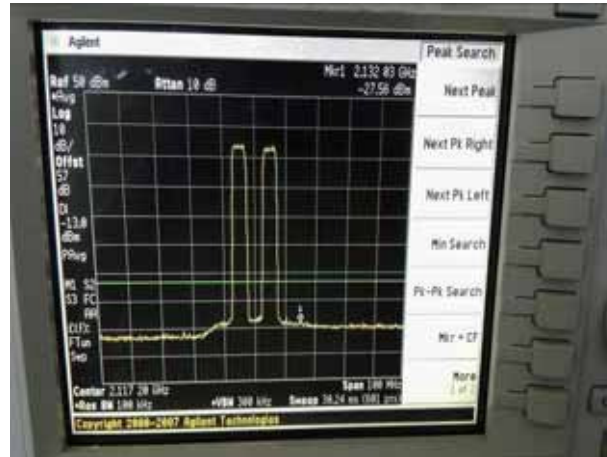

30MHz-1000MHz spurious emissions

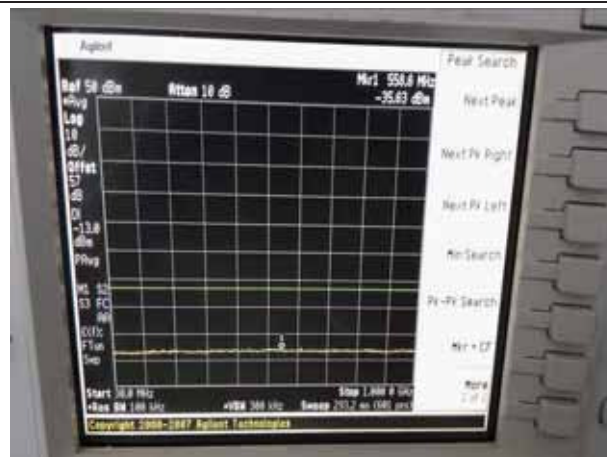

1000MHz-3000MHz spurious emissions

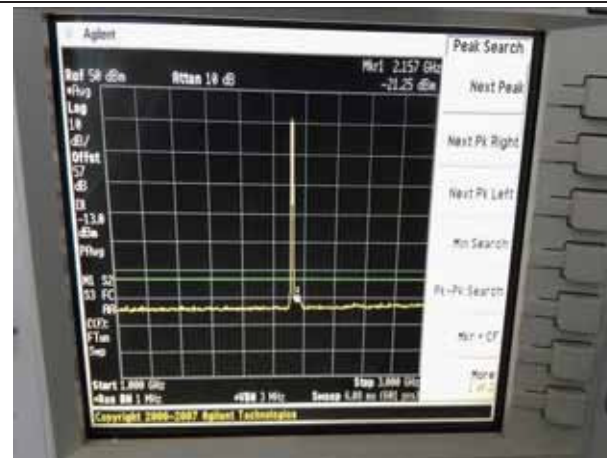

### 3000MHz-22000MHz spurious emissions

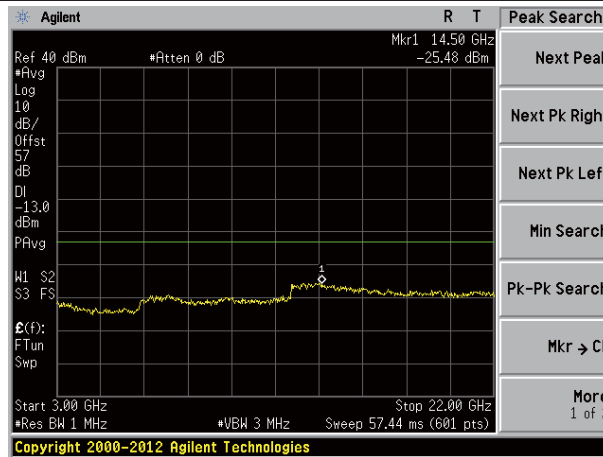

### Intermodulation - High part of band

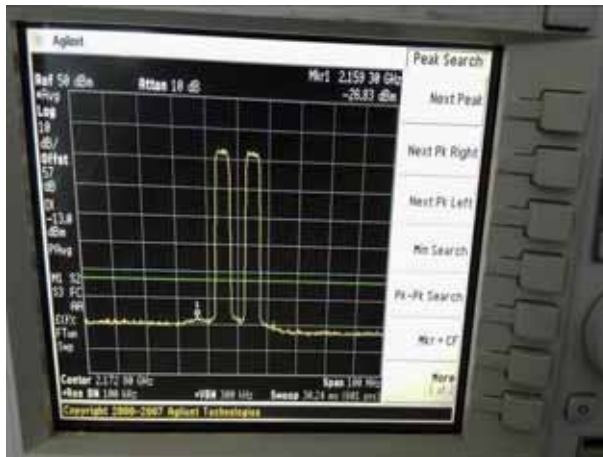

### 30MHz-1000MHz spurious emissions

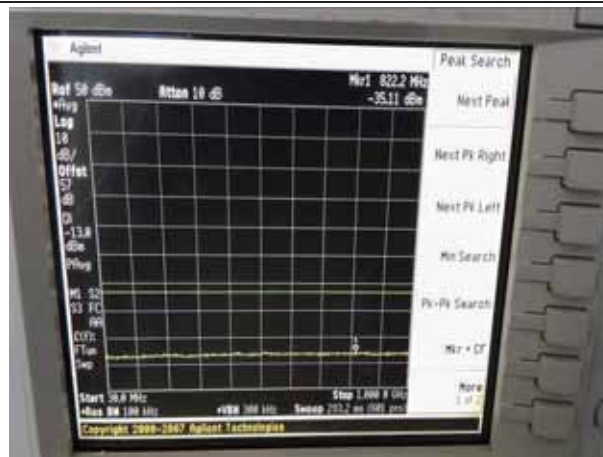

### 1000MHz-3000MHz spurious emissions

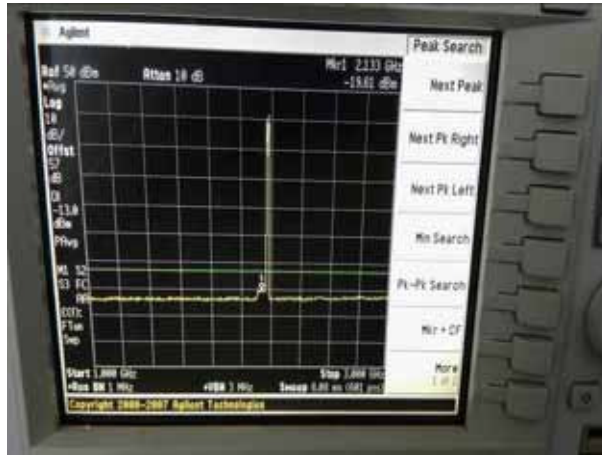

### 3000MHz-22000MHz spurious emissions

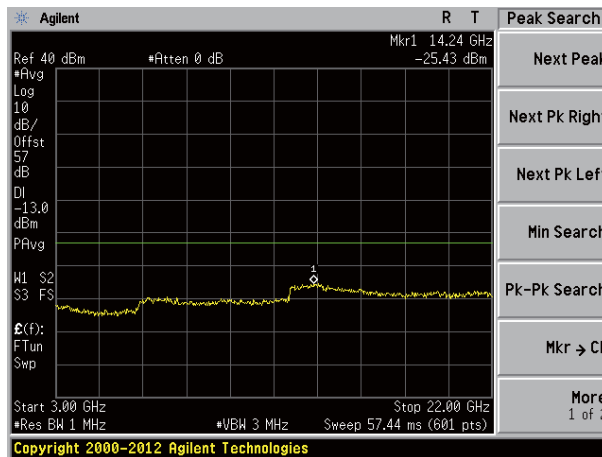

### Intermodulation of WCDMA Four Carrier

#### Intermodulation - Low part of band

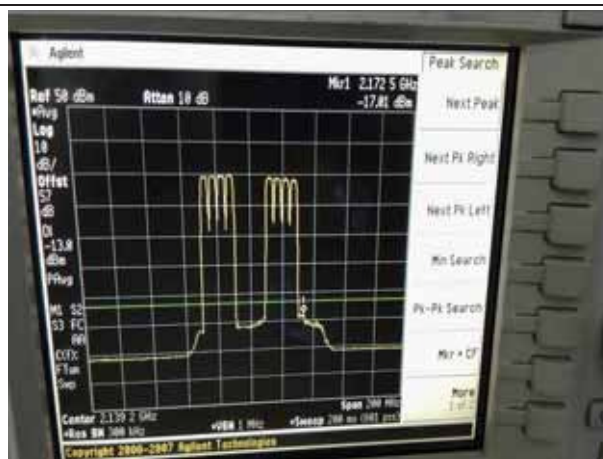



### 30MHz-1000MHz spurious emissions

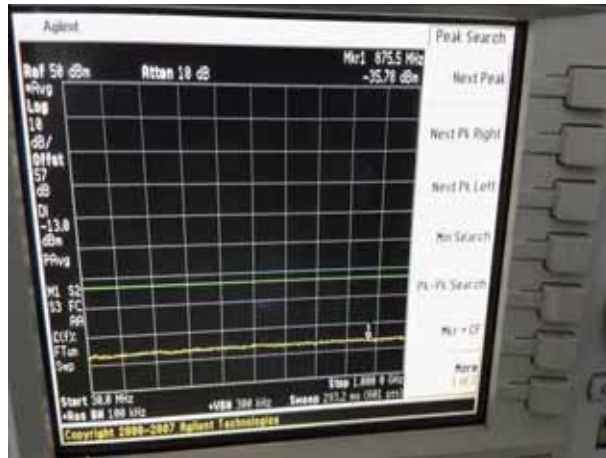

### 1000MHz-3000MHz spurious emissions

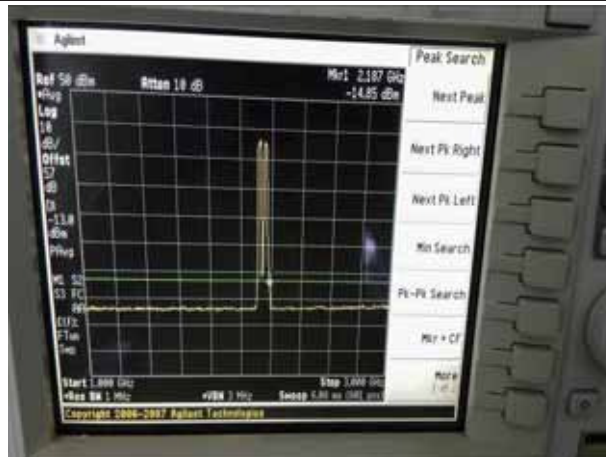

### 3000MHz-22000MHz spurious emissions

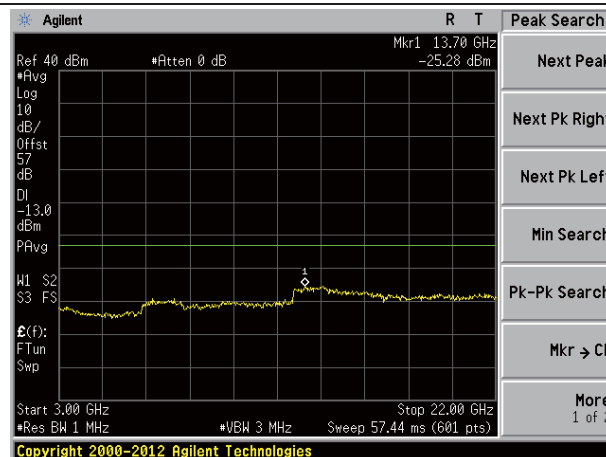

Intermodulation - High part of band

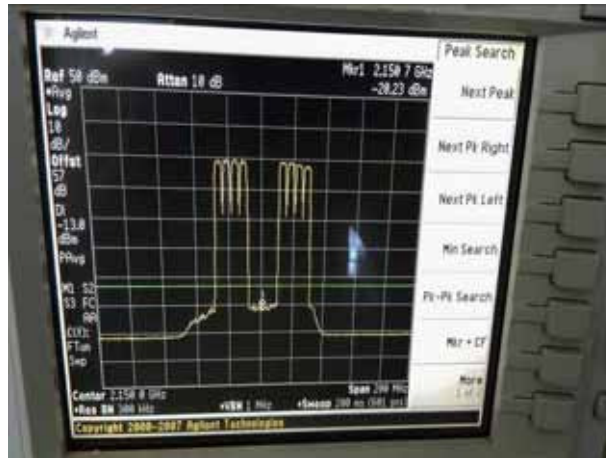

30MHz-1000MHz spurious emissions

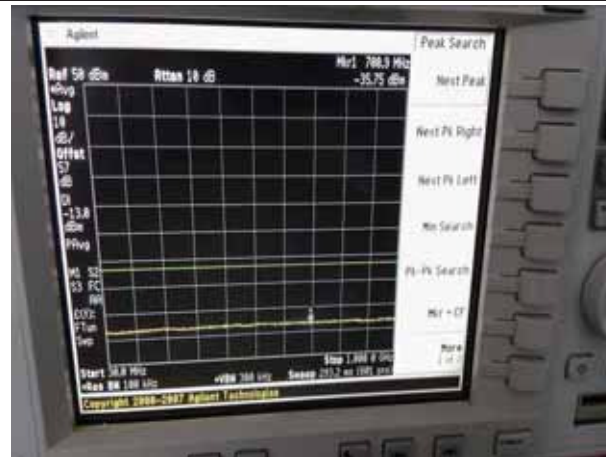

1000MHz-3000MHz spurious emissions

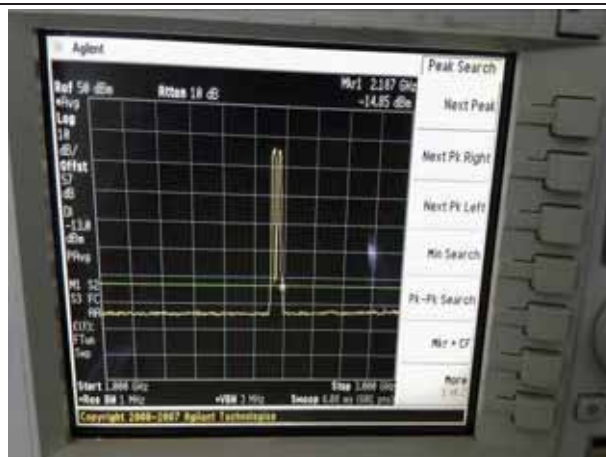

### 3000MHz-22000MHz spurious emissions

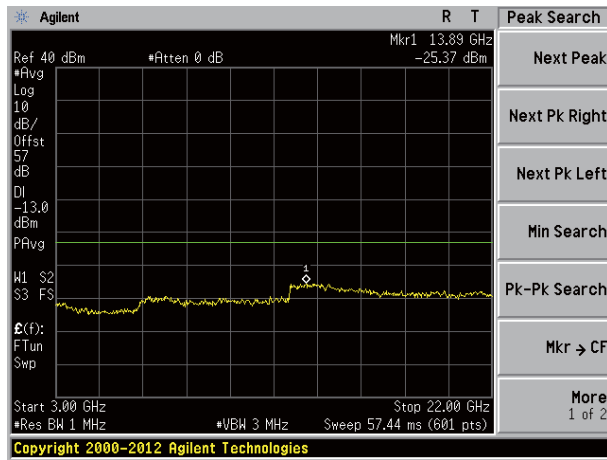



Uplink:

## Intermodulation of LTE 1.4MHz Bandwidth

Intermodulation - Low part of band

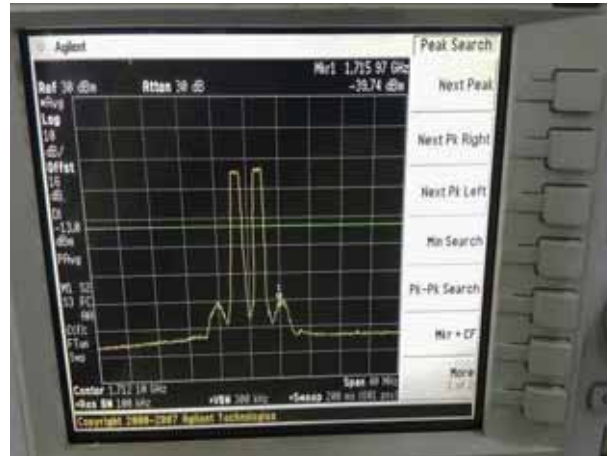

30MHz-1000MHz spurious emissions

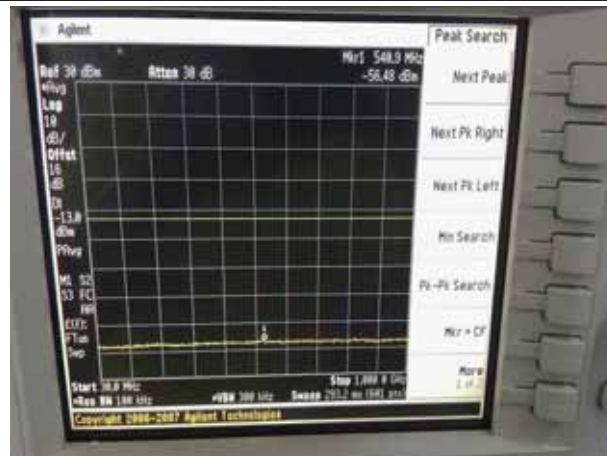

1000MHz-3000MHz spurious emissions

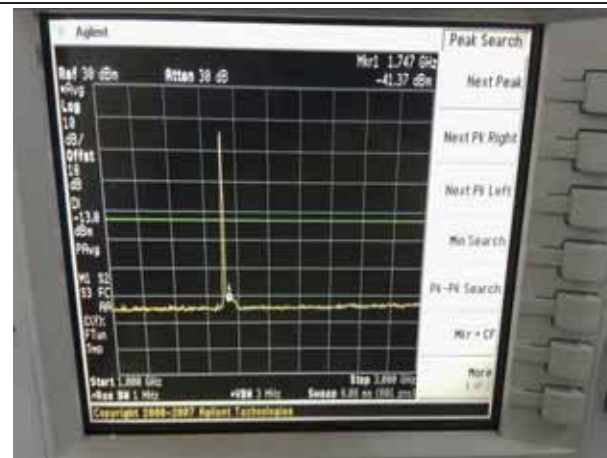

### 3000MHz-18000MHz spurious emissions

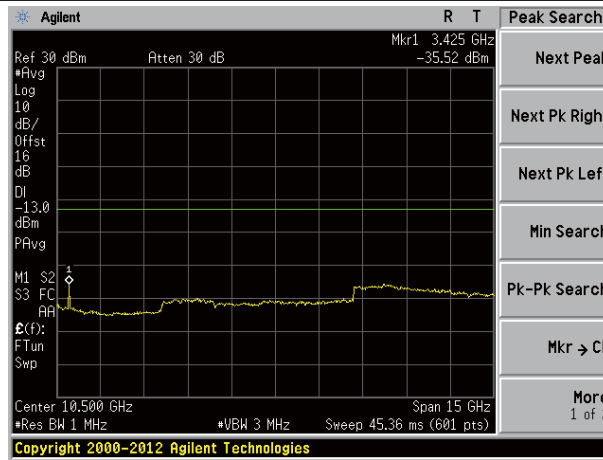

### Intermodulation - High part of band



### 30MHz-1000MHz spurious emissions



### 1000MHz-3000MHz spurious emissions

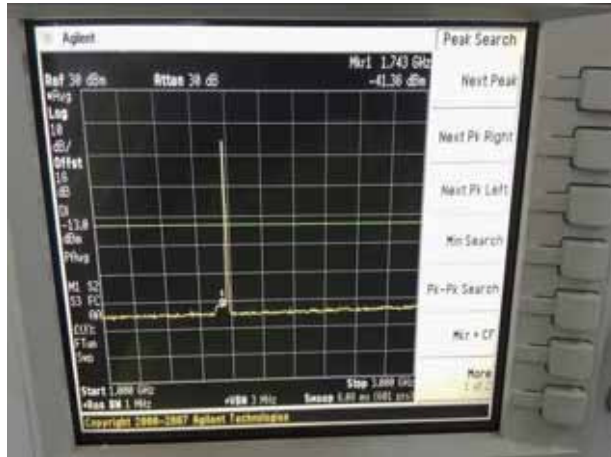

### 3000MHz-18000MHz spurious emissions

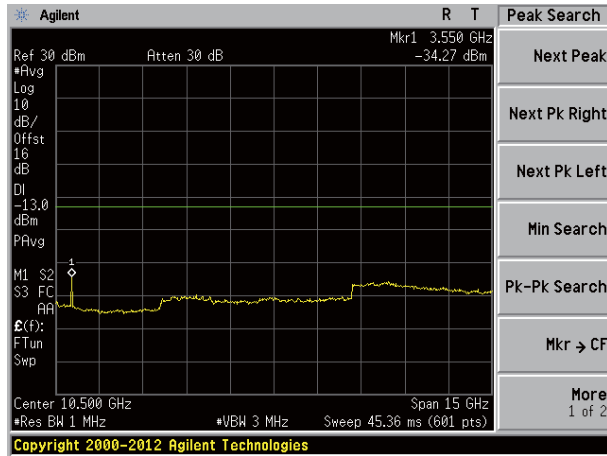

### Intermodulation of LTE 3MHz Bandwidth

#### Intermodulation - Low part of band

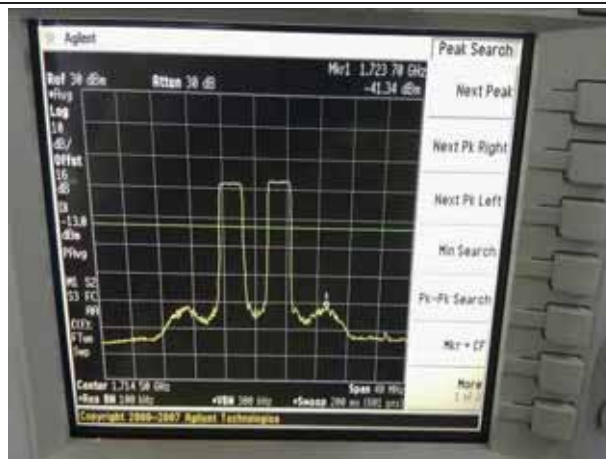

30MHz-1000MHz spurious emissions

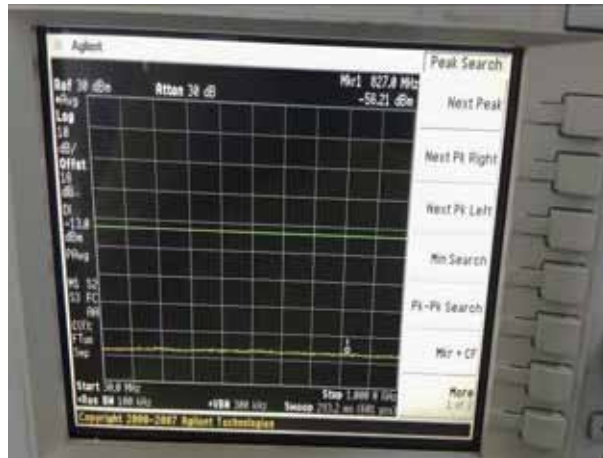

1000MHz-3000MHz spurious emissions

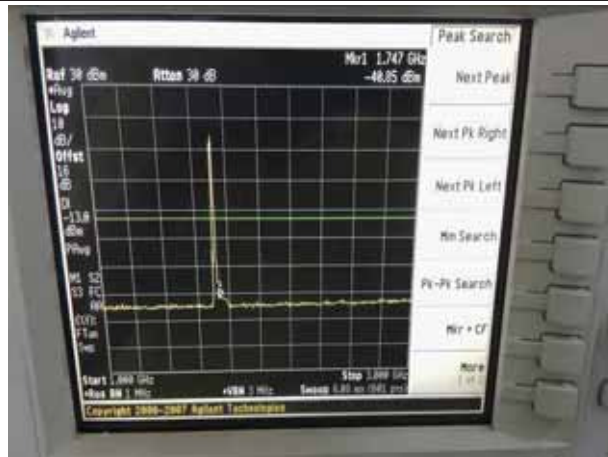

3000MHz-18000MHz spurious emissions

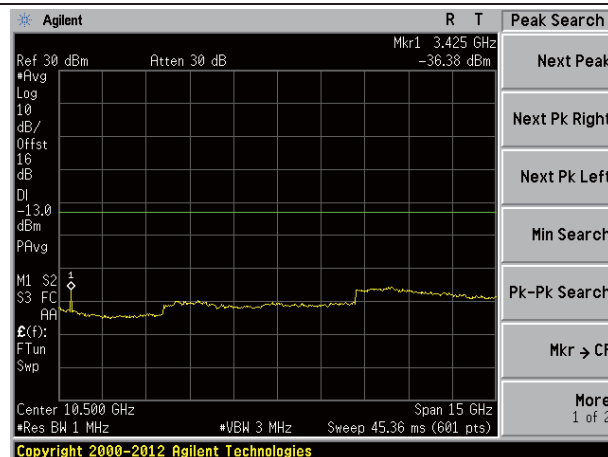

### Intermodulation - High part of band

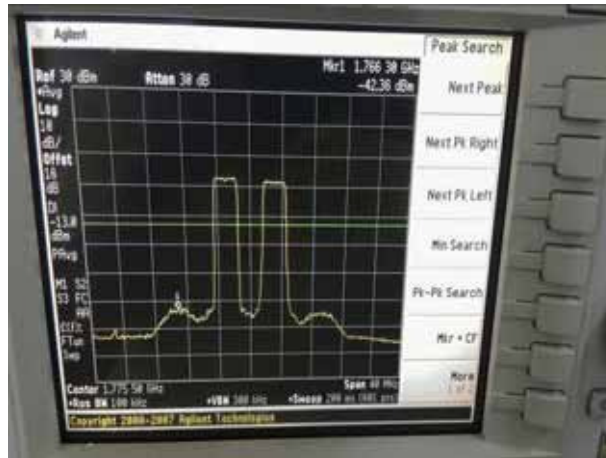

### 30MHz-100MHz spurious emissions

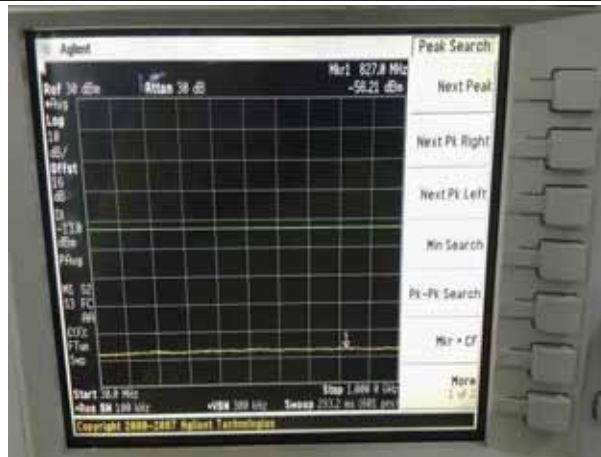

### 1000MHz-3000MHz spurious emissions

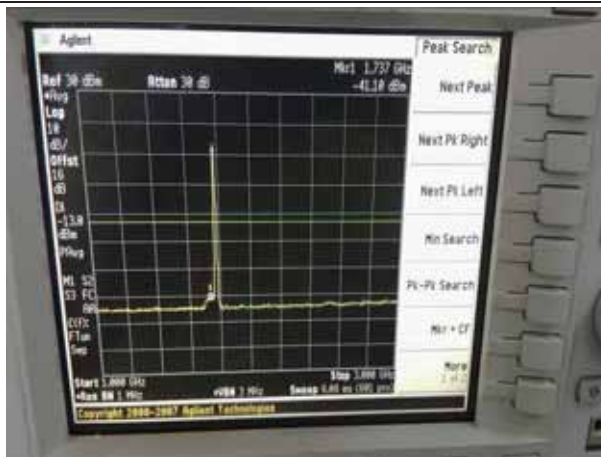



### 3000MHz-18000MHz spurious emissions

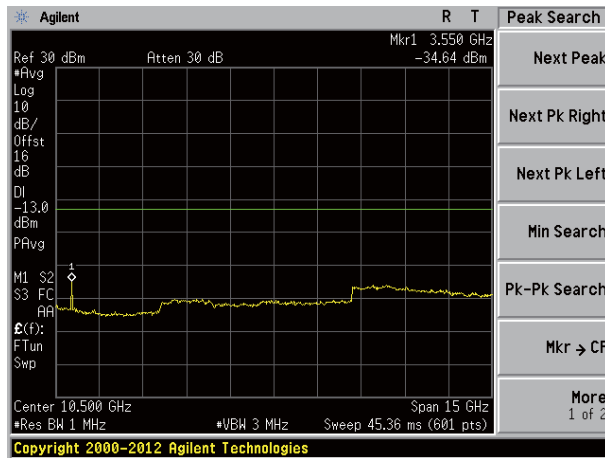

### Intermodulation of LTE 5MHz Bandwidth

#### Intermodulation - Low part of band

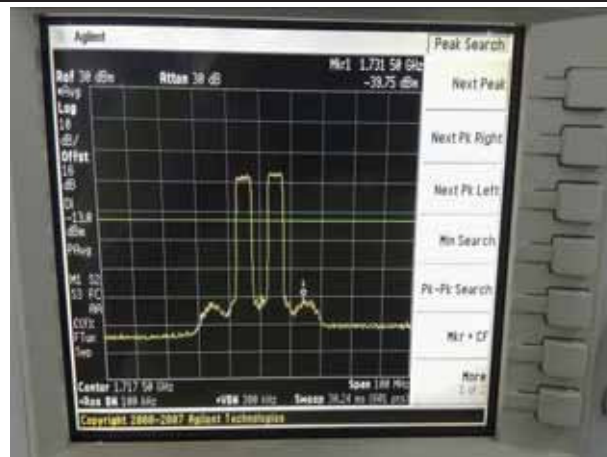

#### 30MHz-1000MHz spurious emissions

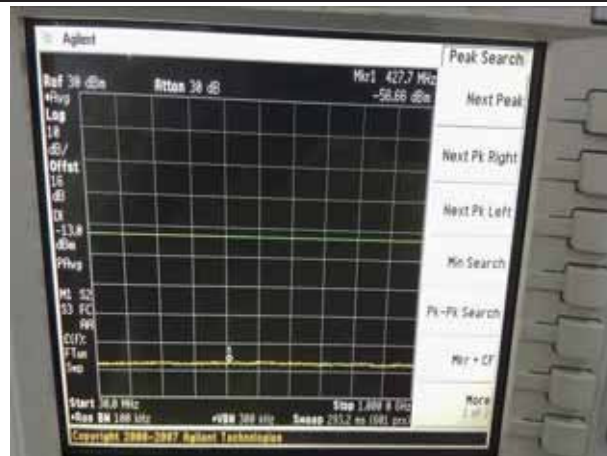

### 1000MHz-3000MHz spurious emissions

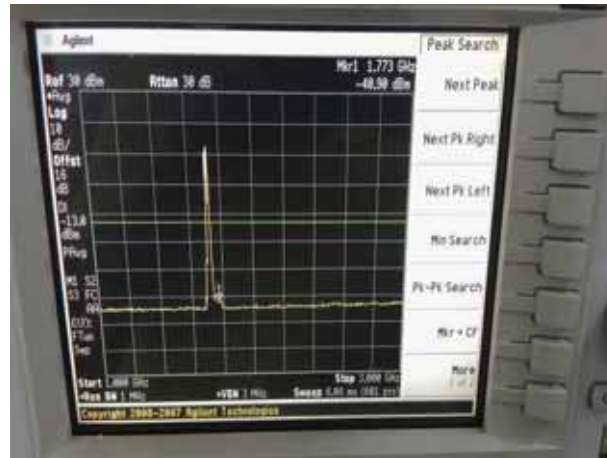

### 3000MHz-18000MHz spurious emissions

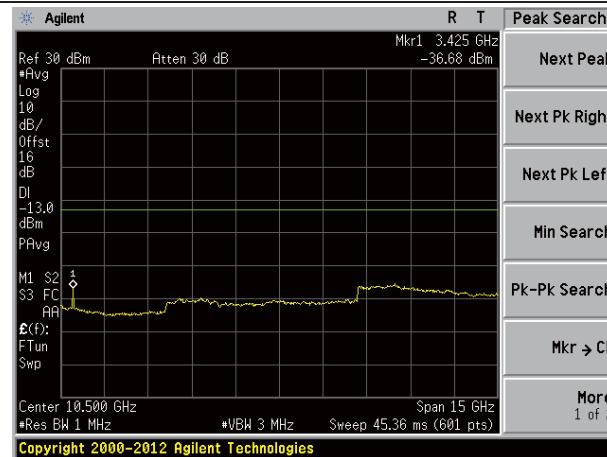

### Intermodulation - High part of band

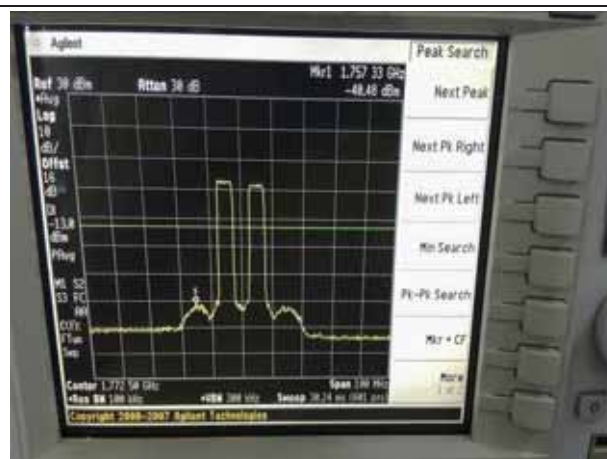

### 30MHz-1000MHz spurious emissions

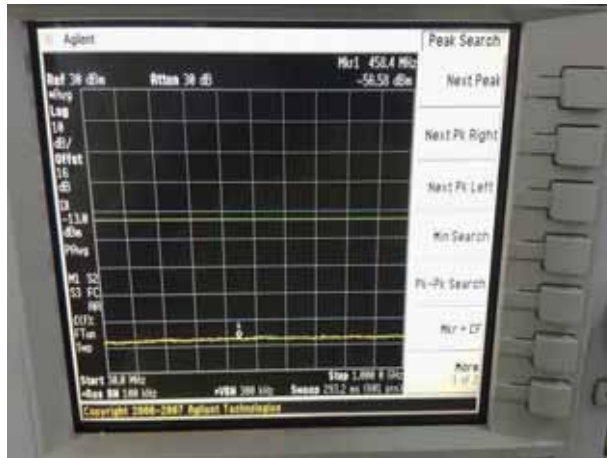

### 1000MHz-10000MHz spurious emissions

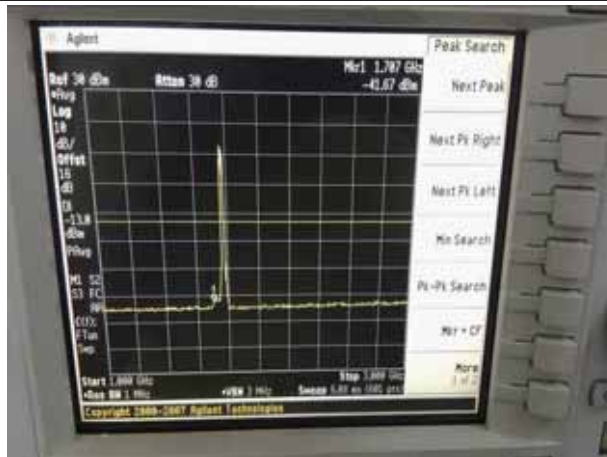

### 3000MHz-18000MHz spurious emissions

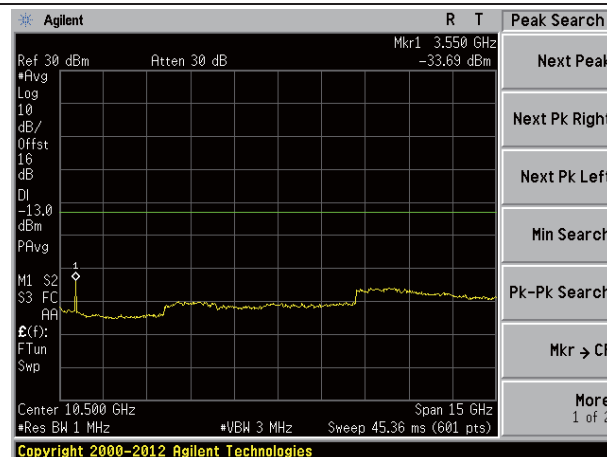



## Intermodulation of LTE 10MHz Bandwidth

Intermodulation - Low part of band

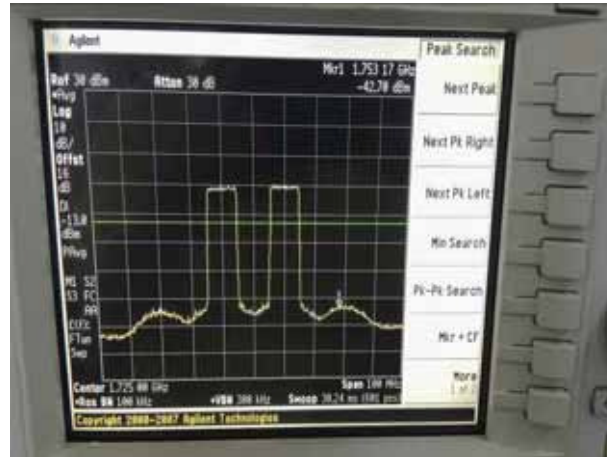

30MHz-1000MHz spurious emissions



1000MHz-3000MHz spurious emissions

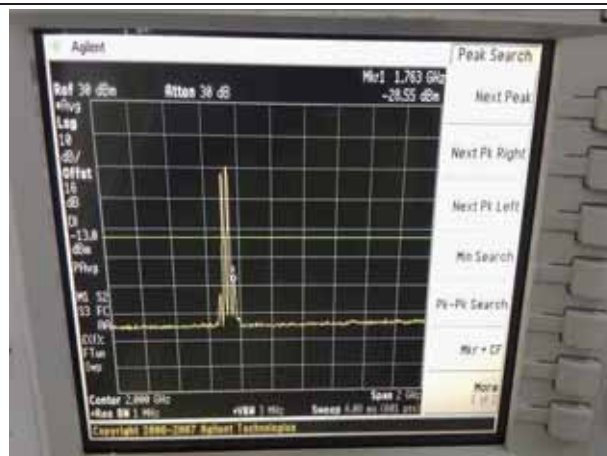

### 3000MHz-18000MHz spurious emissions

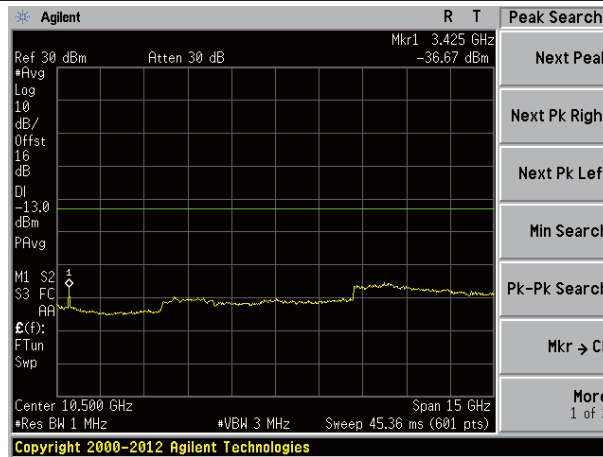

### Intermodulation - High part of band

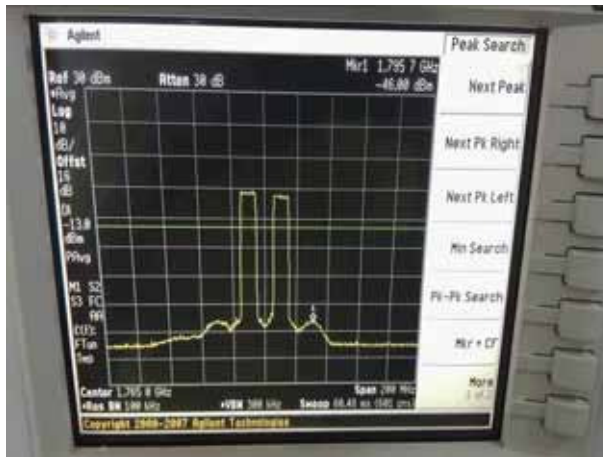

### 30MHz-1000MHz spurious emissions

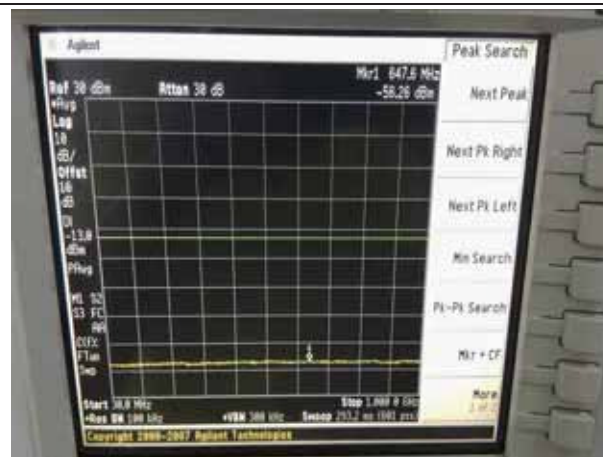

### 1000MHz-3000MHz spurious emissions

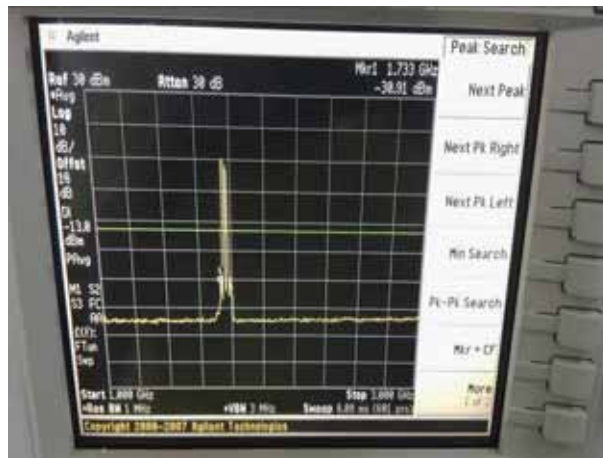

### 3000MHz-18000MHz spurious emissions

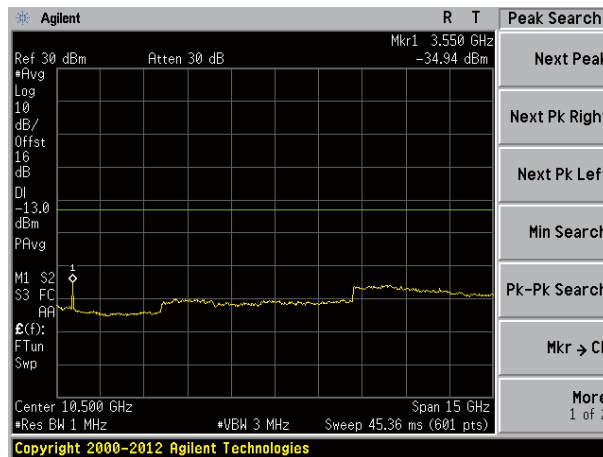

### Intermodulation of LTE 15MHz Bandwidth

#### Intermodulation - Low part of band

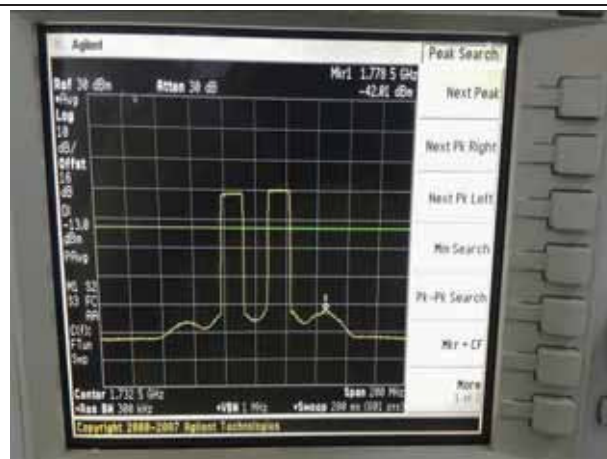

30MHz-1000MHz spurious emissions

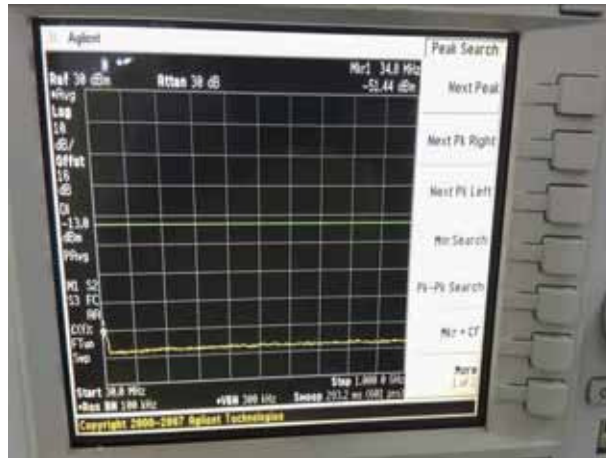

1000MHz-3000MHz spurious emissions



3000MHz-18000MHz spurious emissions

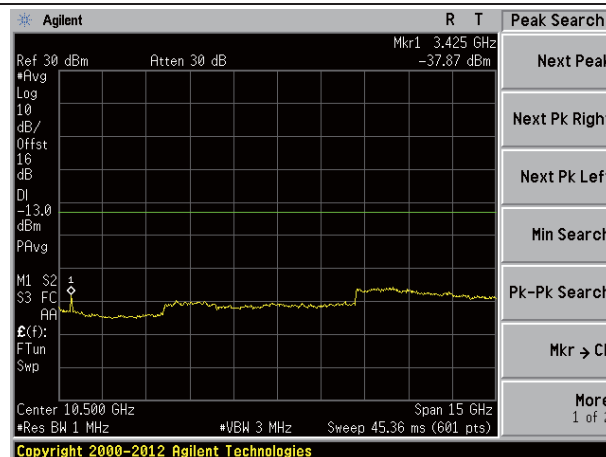

### Intermodulation - High part of band

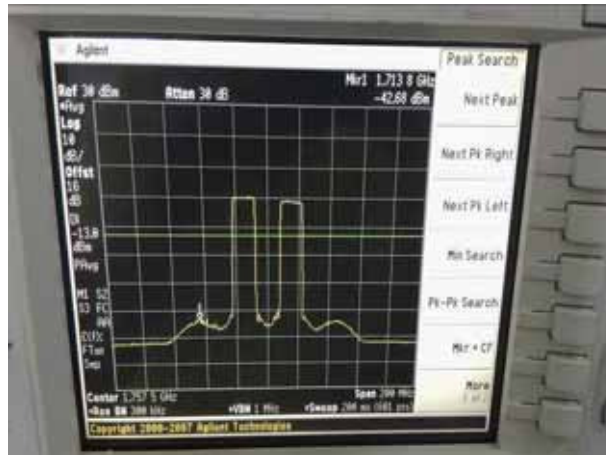

### 30MHz-1000MHz spurious emissions

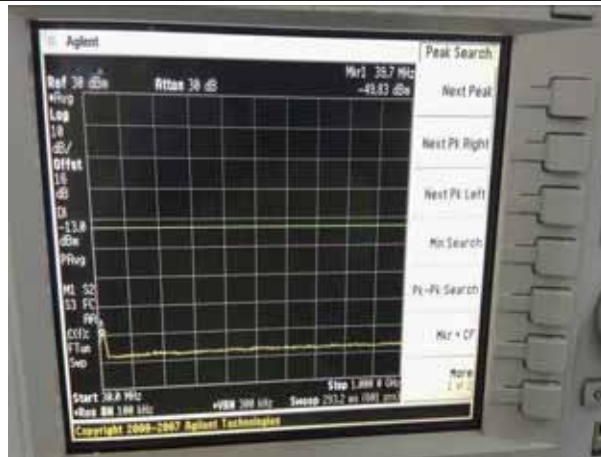

### 1000MHz-3000MHz spurious emissions

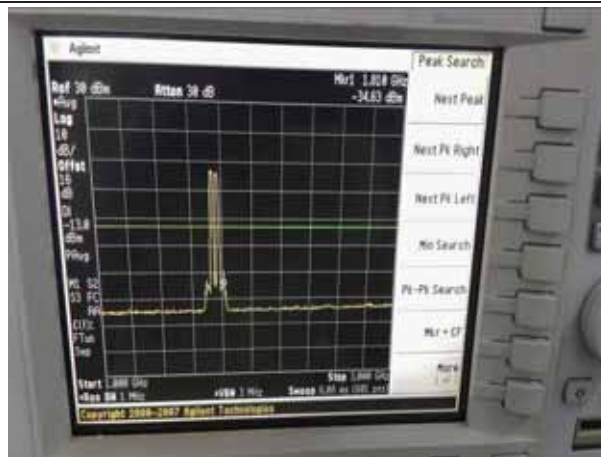



### 3000MHz-18000MHz spurious emissions

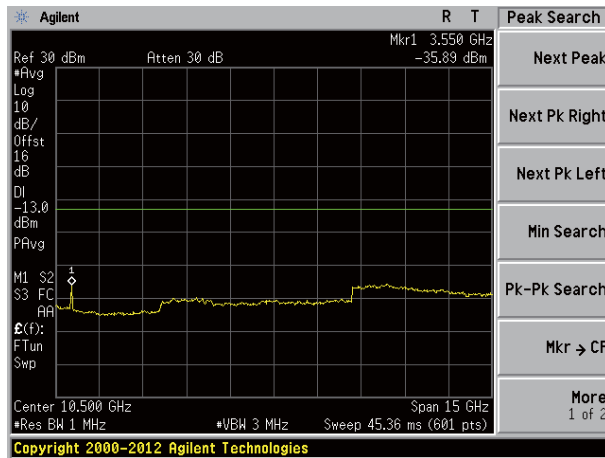

### Intermodulation of LTE 20MHz Bandwidth

#### Intermodulation - Low part of band



#### 30MHz-1000MHz spurious emissions

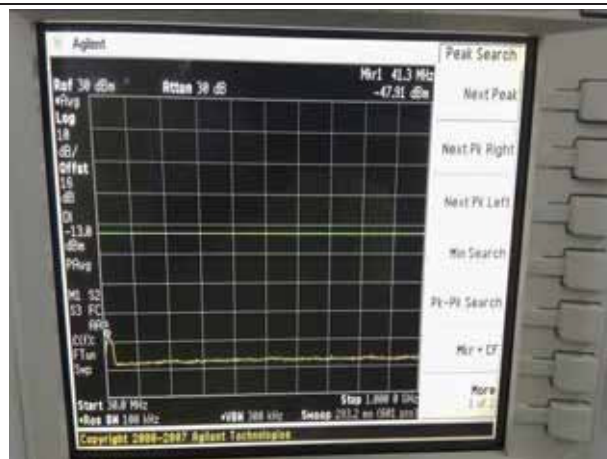

### 1000MHz-3000MHz spurious emissions



### 3000MHz-18000MHz spurious emissions

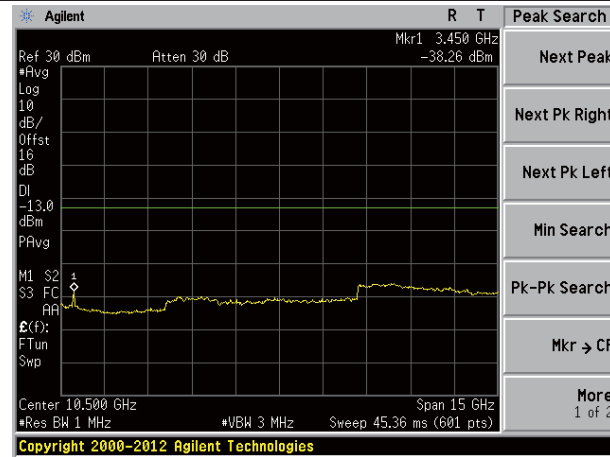

### Intermodulation - High part of band



### 30MHz-1000MHz spurious emissions

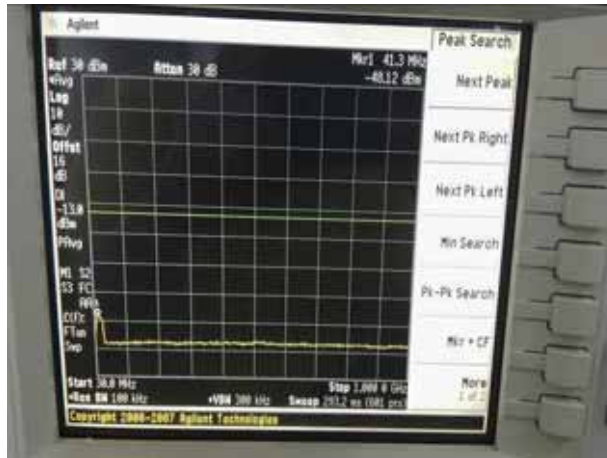

### 1000MHz-3000MHz spurious emissions



### 3000MHz-18000MHz spurious emissions

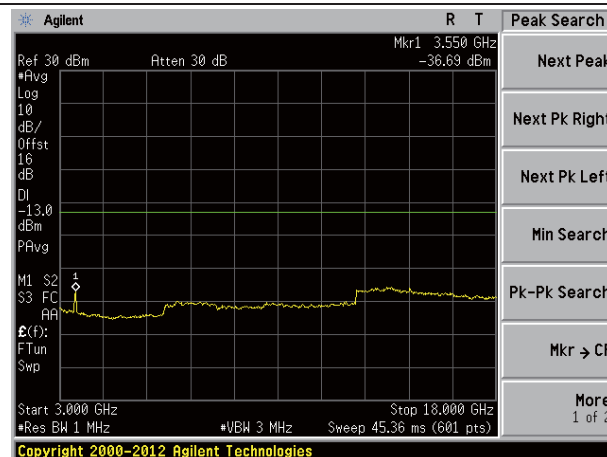



## Intermodulation of WCDMA Single Carrier

Intermodulation - Low part of band

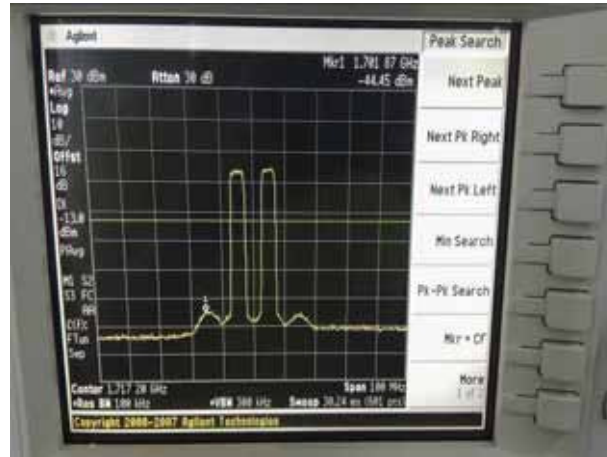

30MHz-1000MHz spurious emissions

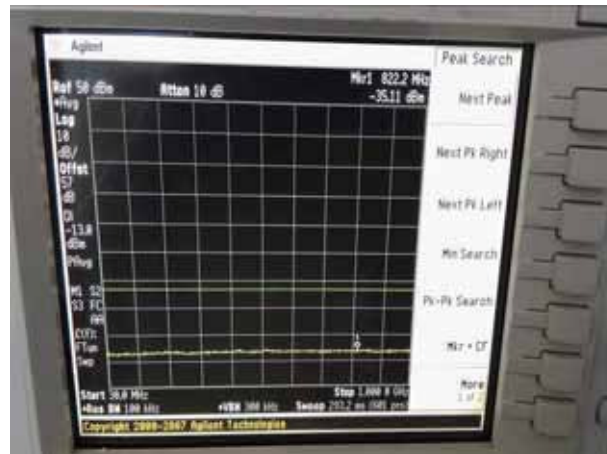

1000MHz-3000MHz spurious emissions

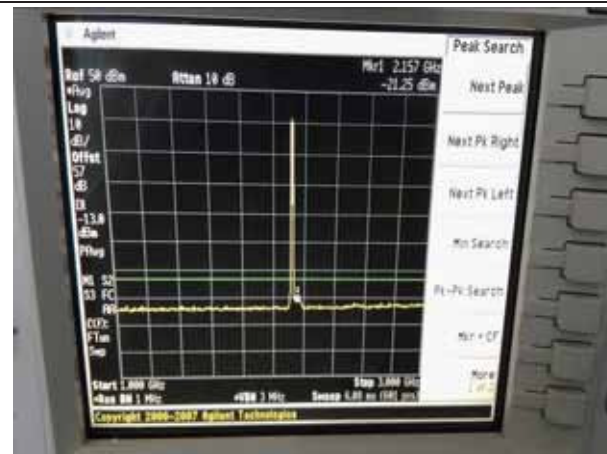

### 3000MHz-18000MHz spurious emissions

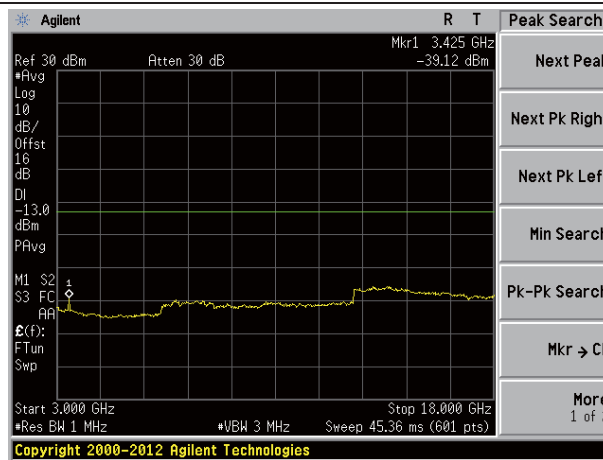

### Intermodulation - High part of band

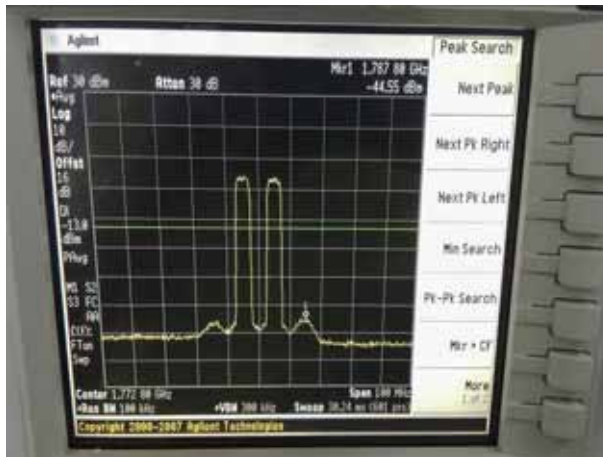

### 30MHz-1000MHz spurious emissions

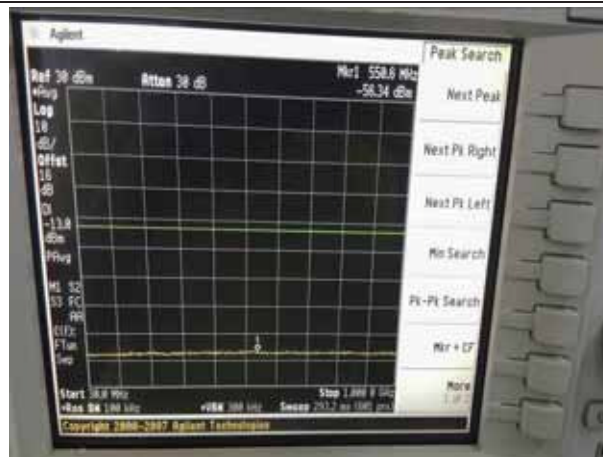

### 1000MHz-3000MHz spurious emissions

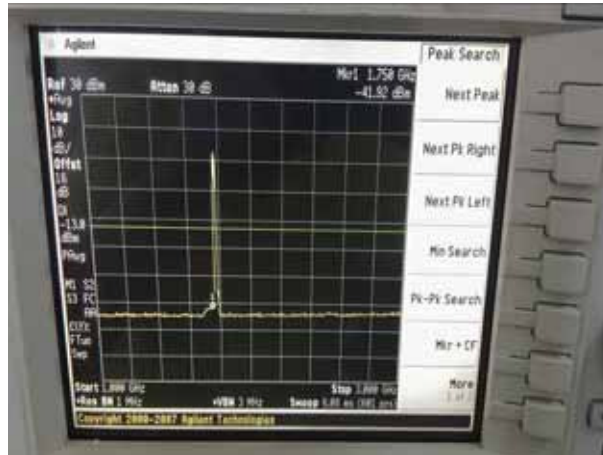

### 3000MHz-18000MHz spurious emissions

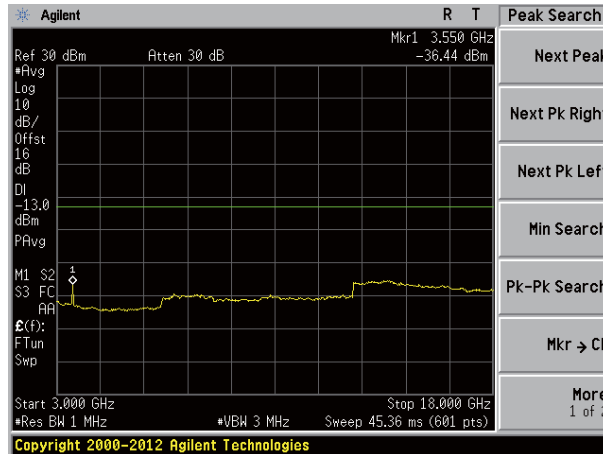

### Intermodulation of WCDMA Four Carrier

#### Intermodulation - Low part of band



### 30MHz-1000MHz spurious emissions

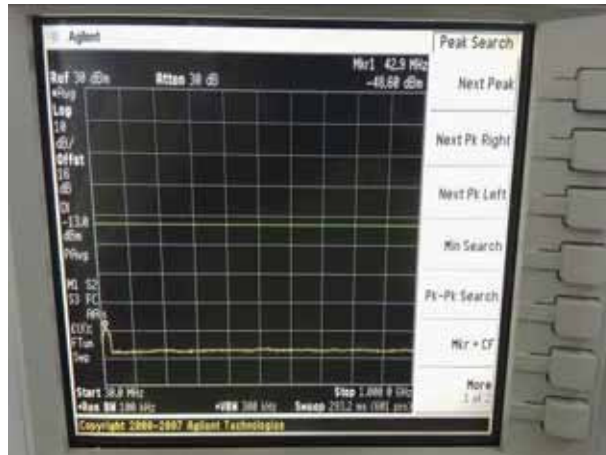

### 1000MHz-3000MHz spurious emissions



### 3000MHz-18000MHz spurious emissions

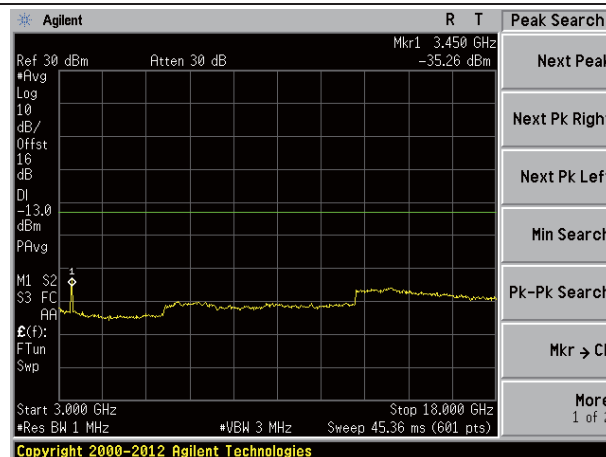

Intermodulation - High part of band



30MHz-1000MHz spurious emissions

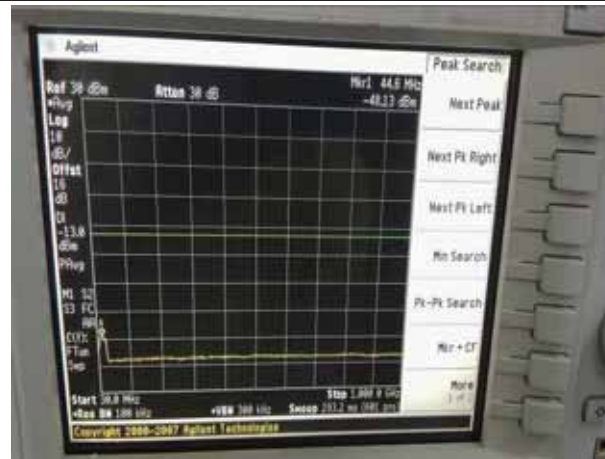

1000MHz-3000MHz spurious emissions



### 3000MHz-18000MHz spurious emissions

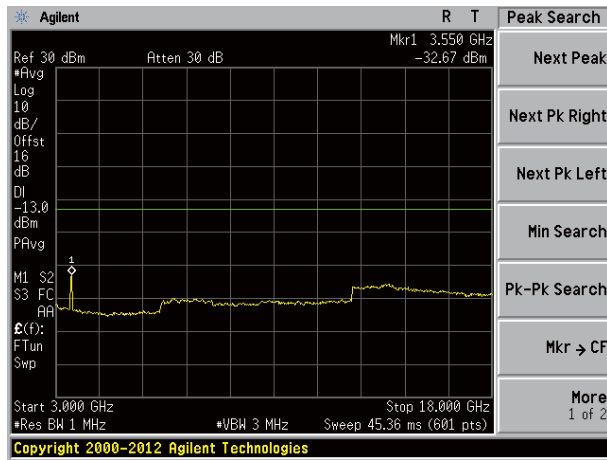



## 12 FIELD STRENGTH OF SPURIOUS RADIATION MEASUREMENT

### 12.1 Standard Applicable

According to FCC § 2.1053 and § 27.53(m)

### 12.2 EUT Setup (Block Diagram of Configuration)

Please refer the section §6.2 Configuration of Tested System.

### 12.3 Measurement Procedure

1. The EUT RF output port was connected to 50 ohm RF load.
2. The EUT input port was connected to signal generator and was setup to transmit maximum power.
3. The measurement antenna was placed at a distance of 3 meters from the EUT.
4. During the tests, the antenna height and polarization as well as EUT azimuth were varied in order to identify the maximum level of emissions from EUT.
5. The frequency range up to 10-th harmonic of each of the three fundamental frequencies (low, middle and high channels) was investigated. The worst case of emissions was reported.
6. For spurious emissions attenuation, the substitution method was used.
7. The EUT was substituted by a reference antenna (half-wave dipole – below 1 GHz, or Horn antenna – above 1 GHz), connected to a signal generator.
8. The signal generator output level was adjusted to obtain the same reading as from EUT. The EIRP at the spurious emissions frequency was calculated as follows:  
$$\text{EIRP} = \text{S.G. output (dBm)} + \text{Antenna Gain(dBi)} - \text{Cable Loss (dB)}$$
9. The antenna substitution method is used to determine the equivalent radiated power at spurious frequencies. The spurious emissions are measured at a distance of 3 meters. The EUT is then replaced with a reference substitution antenna with a known gain referenced to a dipole. This antenna is fed with a signal at the spurious frequency. The level of the signal is adjusted to repeat the previously measured level. The resulting eirp is the signal level fed to the reference antenna corrected for gain referenced to an isotropic dipole
10. From KDB (AMPLIFIER, BOOSTER, AND REPEATER REMINDER SHEET): Radiated spurs (enclosure) – Use of CW signal (low, mid. and high freq.) is acceptable rather than all modulations.
11. The maximum RFI field strength was determined during the measurement by rotating the turntable ( $\pm 180$  degrees) and varying the height of the receive antenna ( $h = 1 \dots 4$  m) as like defined in ANSI C63.4. A measurement receiver has been used with a RBW 120 kHz up to 1 GHz and 1 MHz above 1 GHz. Steps with during pre measurement was half the RBW.
12. Both, the Fully Anechoic Chamber (FAC) and the Semi Anechoic Chamber (SAC) fulfil the requirements of ANSI C63.4 and CISPR 16-1-4 with regards to NSA and SVSWR.

## 12.4 Measurement data

Downlink mode

Test mode:	Below 1G		Test channel:	Lowest channel
Frequency (MHz)	Spurious Emission		Limit (dBm)	Result
	Polarization	Level (dBm)		
30.00	Vertical	-34.08	-13.00	Pass
49.53	V	-35.25		
80.08	V	-47.76		
106.39	V	-54.27		
150.01	V	---		
183.84	V	---		
50.76	Horizontal	-48.64	-13.00	Pass
79.52	H	-48.30		
91.18	H	-51.71		
207.85	H	-59.86		
360.45	H	---		
480.53	H	---		
Test mode:	Above 1G		Test channel:	Lowest channel
Frequency (MHz)	Spurious Emission		Limit (dBm)	Result
	Polarization	Level (dBm)		
1171.00	Vertical	-57.24	-13.00	Pass
2890.00	V	-56.43		
4348.00	V	-54.22		
6184.00	V	---		
7975.00	V	---		
1225.00	Horizontal	-58.21	-13.00	Pass
2773.00	H	-55.78		
4141.00	H	-54.64		
5806.00	H	---		
7624.00	H	---		



Test mode:	Below 1G		Test channel:	Middle channel
Frequency (MHz)	Spurious Emission		Limit (dBm)	Result
	Polarization	Level (dBm)		
31.84	Vertical	-37.86	-13.00	Pass
50.59	V	-35.92		
73.36	V	-48.38		
90.22	V	-52.59		
144.84	V	---		
169.60	V	---		
55.22	Horizontal	-47.95	-13.00	Pass
80.36	H	-49.15		
103.08	H	-58.11		
199.99	H	-59.89		
261.06	H	---		
349.25	H	---		
Test mode:	Above 1G		Test channel:	Middle channel
Frequency (MHz)	Spurious Emission		Limit (dBm)	Result
	Polarization	Level (dBm)		
2170.00	Vertical	-57.73	-13.00	Pass
3322.00	V	-53.97		
5320.00	V	-54.05		
6706.00	V	---		
8290.00	V	---		
2404.00	Horizontal	-57.87	-13.00	Pass
3457.00	H	-53.45		
4942.00	H	-53.80		
6697.00	H	---		
8119.00	H	---		

Test mode:	Below 1G		Test channel:	Highest channel
Frequency (MHz)	Spurious Emission		Limit (dBm)	Result
	Polarization	Level (dBm)		
30.85	Vertical	-39.03	-13.00	Pass
52.21	V	-37.90		
78.97	V	-49.58		
104.17	V	-57.71		
171.39	V	---		
210.79	V	---		
40.56	Horizontal	-56.80	-13.00	Pass
54.26	H	-49.51		
78.97	H	-49.31		
107.13	H	-59.13		
191.07	H	---		
258.33	H	---		
Test mode:	Above 1G		Test channel:	Highest channel
Frequency (MHz)	Spurious Emission		Limit (dBm)	Result
	Polarization	Level (dBm)		
1369.00	Vertical	-57.68	-13.00	Pass
2692.00	V	-56.18		
3781.00	V	-55.18		
5617.00	V	---		
7075.00	V	---		
2278.00	Horizontal	-58.53	-13.00	Pass
3070.00	H	-54.81		
4321.00	H	-52.95		
5167.00	H	---		
6625.00	H	---		

**Remark:**

1. Remark"---" means that the emission level is too low to be measured
2. 10GHz-22GHz: No substitution measurement has been performed, because there were no emissions detected during the pre measurement other than noise.

Uplink mode

Test mode:	Below 1G		Test channel:	Lowest channel
Frequency (MHz)	Spurious Emission		Limit (dBm)	Result
	Polarization	Level (dBm)		
31.84	Vertical	-35.98	-13.00	Pass
50.06	V	-34.51		
79.80	V	-47.24		
107.13	V	-54.42		
170.20	V	---		
257.42	V	---		
50.41	Horizontal	-48.33	-13.00	Pass
79.24	H	-48.23		
91.18	H	-52.11		
103.08	H	-58.32		
210.05	H	---		
480.53	H	---		
Test mode:	Above 1G		Test channel:	Lowest channel
Frequency (MHz)	Spurious Emission		Limit (dBm)	Result
	Polarization	Level (dBm)		
1279.00	Vertical	-58.07	-13.00	Pass
2422.00	V	-56.36		
3961.00	V	-55.53		
5671.00	V	---		
6805.00	V	---		
1261.00	Horizontal	-57.85		
2881.00	H	-56.44		
4456.00	H	-54.62		
5932.00	H	---		
8020.00	H	---		

Test mode:	Below 1G		Test channel:	Middle channel
Frequency (MHz)	Spurious Emission		Limit (dBm)	Result
	Polarization	Level (dBm)		
30.00	Vertical	-34.55	-13.00	Pass
39.72	V	-43.58		
54.07	V	-37.53		
72.85	V	-47.53		
144.34	V	---		
185.14	V	---		
31.84	Horizontal	-54.99	-13.00	Pass
54.84	H	-49.73		
78.41	H	-49.59		
106.39	H	-58.48		
196.51	H	---		
257.42	H	---		
Test mode:	Above 1G		Test channel:	Middle channel
Frequency (MHz)	Spurious Emission		Limit (dBm)	Result
	Polarization	Level (dBm)		
2278.00	Vertical	-57.58	-13.00	Pass
3052.00	V	-55.33		
4987.00	V	-53.08		
6616.00	V	---		
7516.00	V	---		
2341.00	Horizontal	-57.81		
4303.00	H	-54.30		
5113.00	H	-53.81		
6868.00	H	---		
8758.00	H	---		

Test mode:	Below 1G		Test channel:	Highest channel
Frequency (MHz)	Spurious Emission		Limit (dBm)	Result
	Polarization	Level (dBm)		
32.29	Vertical	-37.74	-13.00	Pass
50.76	V	-35.59		
81.50	V	-50.80		
150.01	V	-55.92		
195.14	V	---		
239.99	V	---		
40.85	Horizontal	-56.95	-13.00	Pass
49.71	H	-49.60		
80.36	H	-48.80		
92.14	H	-54.52		
168.41	H	---		
218.31	H	---		
Test mode:	Above 1G		Test channel:	Highest channel
Frequency (MHz)	Spurious Emission		Limit (dBm)	Result
	Polarization	Level (dBm)		
1819.00	Vertical	-58.66	-13.00	Pass
3529.00	V	-53.86		
5230.00	V	-54.90		
6229.00	V	---		
7651.00	V	---		
1639.00	Horizontal	-58.08		
3457.00	H	-53.45		
4618.00	H	-54.71		
5716.00	H	---		
6661.00	H	---		

Remark:

1. Remark"---" means that the emission level is too low to be measured
2. 10GHz-18GHz: No substitution measurement has been performed, because there were no emissions detected during the pre measurement other than noise.

## 13 FREQUENCY STABILITY

### 13.1 Standard Applicable

According to FCC § 2.1055 and § 27.54

### 13.2 Test setup

Please refer the section §6.2 Configuration of Tested System.

### 13.3 Test Procedure

1. The EUT was placed inside the temperature chamber.
2. The RF output port was connected to a spectrum analyzer.
3. The level of RF input signal shall be increased, until the maximum output power per channel, declared by client, is reached.
4. After the temperature stabilized for approximately 20 min, the transmitting frequency was measured by the spectrum analyzer and recorded.
5. At room temperature, the frequency was measured when EUT was powered with the nominal voltage and with 85% and 115% of the nominal voltage.

## 13.4 Test Result

**Passed.**

Downlink:

WCDMA mode					
Reference Frequency: Middle channel=2145.00MHz					
Voltage with nominal Voltage	Power Supplied (VAC)	Temperature (°C)	Frequency Error (Hz)	Frequency Error (ppm)	Result
100%	120V	-40	19	0.0089	Passed
100%		-30	17	0.0079	Passed
100%		-20	14	0.0065	Passed
100%		-10	11	0.0051	Passed
100%		0	9	0.0042	Passed
100%		10	12	0.0056	Passed
100%		20	13	0.0061	Passed
100%		30	12	0.0056	Passed
100%		40	17	0.0079	Passed
100%		50	19	0.0089	Passed
100%		55	17	0.0079	Passed
85%	102V	20	12	0.0056	Passed
115%	138V	20	13	0.0061	Passed

Remark: EUT is specified for outdoor use with temperature range of -40° to +55° C, and was tested with its range.

Uplink:

WCDMAmode					
Reference Frequency: Middle channel=1745.00MHz					
Voltage with nominal Voltage	Power Supplied (VAC)	Temperature (°C)	Frequency Error (Hz)	Frequency Error (ppm)	Result
100%	120V	-40	18	0.0084	Passed
100%		-30	16	0.0075	Passed
100%		-20	14	0.0065	Passed
100%		-10	9	0.0042	Passed
100%		0	7	0.0033	Passed
100%		10	13	0.0061	Passed
100%		20	15	0.0070	Passed
100%		30	16	0.0075	Passed
100%		40	18	0.0084	Passed
100%		50	19	0.0089	Passed
100%		55	17	0.0079	Passed
85%	102V	20	14	0.0065	Passed
115%	138V	20	15	0.0070	Passed

Remark: EUT is specified for outdoor use with temperature range of -40° to +55° C, and was tested with its range.



## 14 OUT-OF-BAND REJECTION

### 14.1 Standard Applicable

According to KDB (AMPLIFIER, BOOSTER, AND REPEATER REMINDER SHEET):

Out of Band Rejection – Test for rejection of out of band signals. Filter freq. response plots are acceptable.

### 14.2 Test setup

Please refer the section §6.2 Configuration of Tested System.

### 14.3 Test Procedure

1. The EUT RF output port was connected to spectrum analyzer.
2. The level of RF input signal shall be increased, until the maximum output power per channel, declared by client, is reached.
3. A continuous sinusoidal RF signal shall be fed successively at frequency offsets 100 MHz from the edges of the relevant MS or BTS transmit frequency band into the relevant input port of the repeater.
4. The RF output curve was recorded by spectrum analyzer.

### 14.4 Test Result

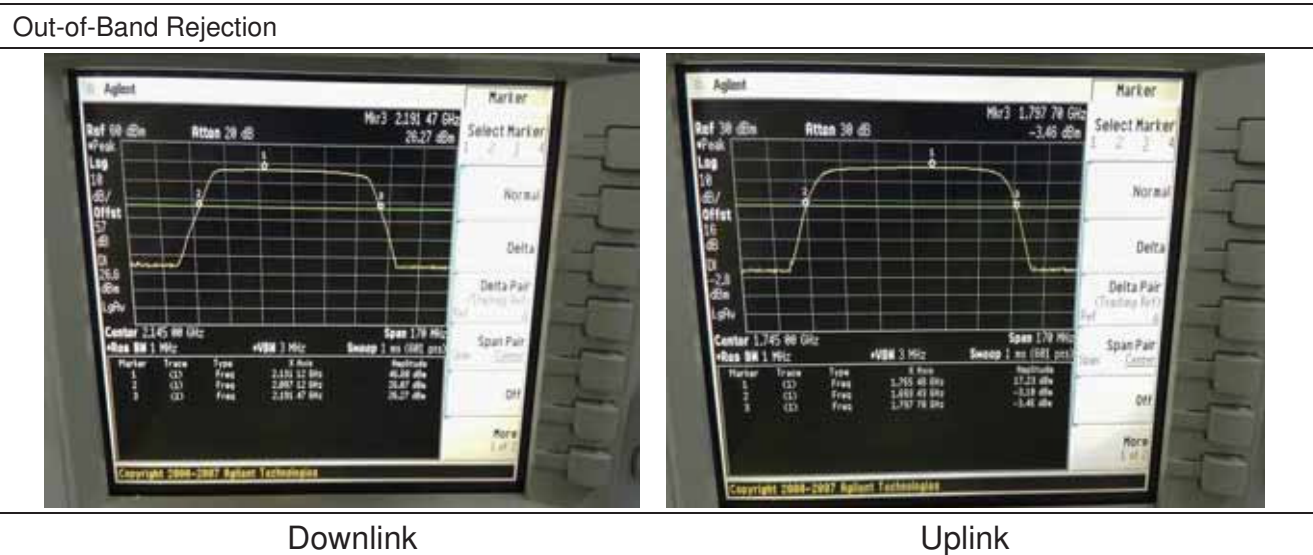

## 15 AC POWER LINE CONDUCTED EMISSION TEST

### 15.1 Standard Applicable

According to FCC §15.207. The emission value for frequency within 150KHz to 30MHz shall not Exceed criteria of below chart.

Frequency range (MHz)	Limits dB(uV)	
	Quasi-peak	Average
0.15 to 0.50	79	66
0.50 to 30	73	60

Note

- 1.The lower limit shall apply at the transition frequencies
- 2.The limit decreases linearly with the logarithm of the frequency in the range 0.15 MHz to 0.50 MHz.

### 15.2 Test setup

1. The conducted emission tests were performed in the test site, using the setup in accordance with the ANSI C63.4-2014.
2. The EUT was plug-in DC power adaptor and was placed on the center of the back edge on the test table. The peripherals like earphone was placed on the side of the EUT. The rear of the EUT and peripherals were placed flushed with the rear of the tabletop.
3. The Power adaptor was connected with 120VAC/60Hz power source.

### 15.3 Test Procedure

1. The EUT was placed on a table which is 0.8m above ground plane.
2. Maximum procedure was performed on the six highest emissions to ensure EUT compliance.
3. Repeat above procedures until all frequency measured were complete.

### 15.4 Measurement Result

Downlink:

Line:

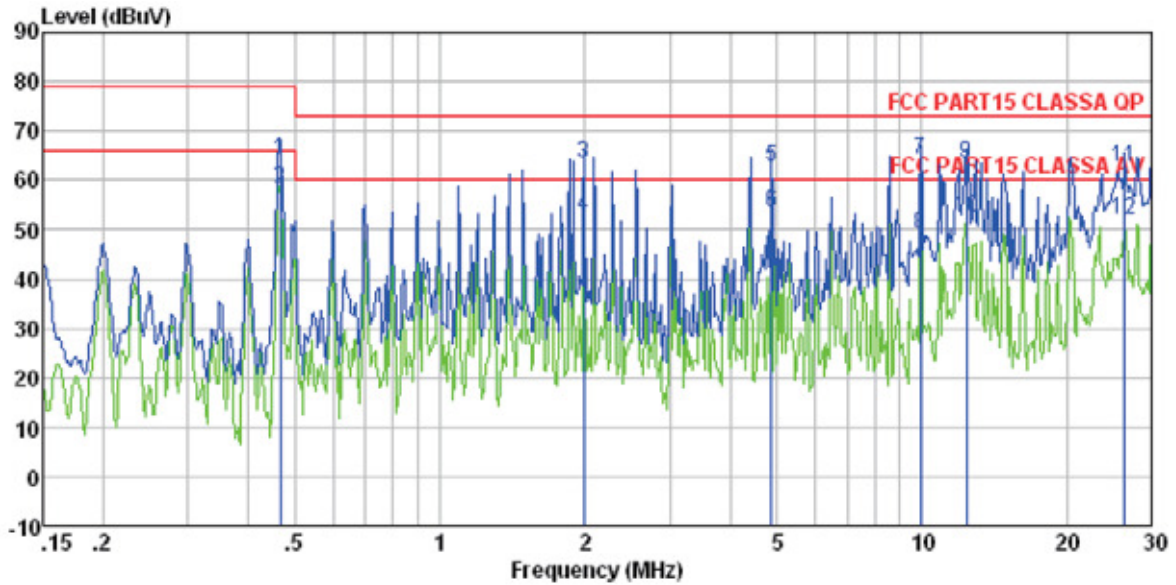

Condition : FCC PART15 CLASSA QP LISN-2013 LINE  
 Job No. : 2196RF  
 Test mode : Downlink mode  
 Test Engineer: Edward

	Freq	Read Level	LISN Factor	Cable Loss	Level	Limit Line	Over Limit	Remark
	MHz	dBuV	dB	dB	dBuV	dBuV	dB	
1	0.466	63.87	0.12	0.11	64.10	79.00	-14.90	QP
2	0.466	57.91	0.12	0.11	58.14	66.00	-7.86	Average
3	1.991	63.32	0.12	0.15	63.59	73.00	-9.41	QP
4	1.991	52.54	0.12	0.15	52.81	60.00	-7.19	Average
5	4.874	62.32	0.21	0.15	62.68	73.00	-10.32	QP
6	4.874	53.13	0.21	0.15	53.49	60.00	-6.51	Average
7	9.966	63.65	0.29	0.19	64.13	73.00	-8.87	QP
8	9.966	48.50	0.29	0.19	48.98	60.00	-11.02	Average
9	12.384	62.84	0.36	0.21	63.41	73.00	-9.59	QP
10	12.384	51.91	0.36	0.21	52.48	60.00	-7.52	Average
11	26.418	61.56	1.05	0.23	62.84	73.00	-10.16	QP
12	26.418	50.54	1.05	0.23	51.82	60.00	-8.18	Average

Neutral:

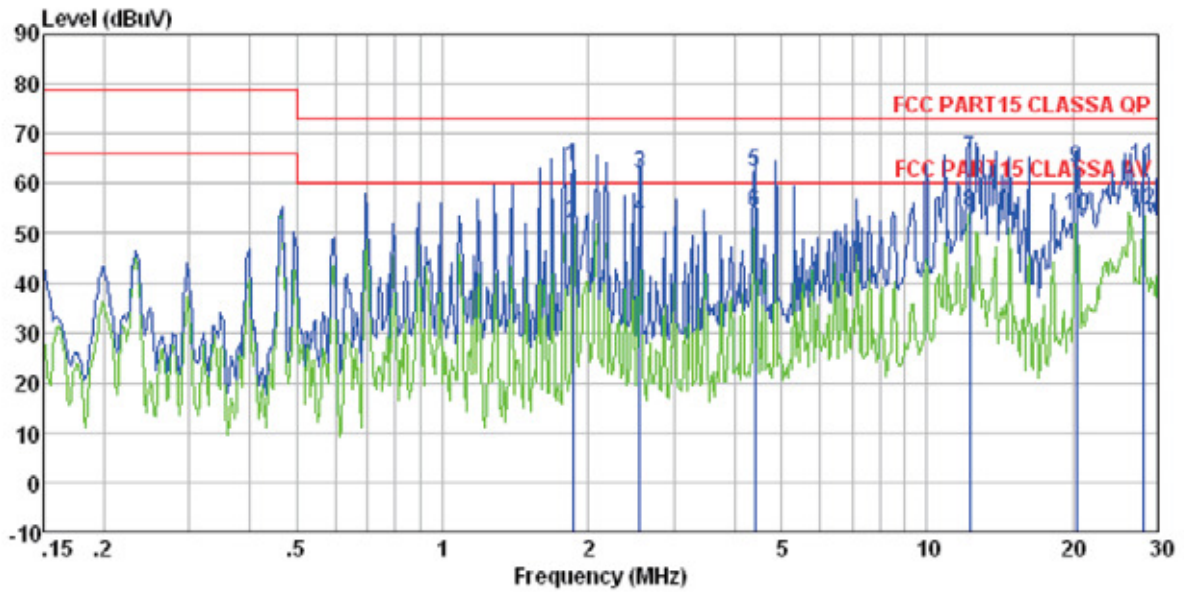

Condition : FCC PART15 CLASS A QP LISN-2013 NEUTRAL  
 Job No. : 2196RF  
 Test mode : Downlink mode  
 Test Engineer: Edward

	Freq	Read Level	LISN Factor	Cable Loss	Level	Limit Line	Over Limit	Remark
	MHz	dBuV	dB	dB	dBuV	dBuV	dB	
1	1.858	63.31	0.09	0.14	63.54	73.00	-9.46	QP
2	1.858	51.63	0.09	0.14	51.86	60.00	-8.14	Average
3	2.554	61.65	0.10	0.15	61.90	73.00	-11.10	QP
4	2.554	52.73	0.10	0.15	52.98	60.00	-7.02	Average
5	4.407	61.89	0.15	0.15	62.19	73.00	-10.81	QP
6	4.407	53.94	0.15	0.15	54.24	60.00	-5.76	Average
7	12.253	64.36	0.32	0.20	64.88	73.00	-8.12	QP
8	12.253	53.63	0.32	0.20	54.15	60.00	-5.85	Average
9	20.377	62.34	0.56	0.22	63.12	73.00	-9.88	QP
10	20.377	52.80	0.56	0.22	53.58	60.00	-6.42	Average
11	28.003	62.35	0.79	0.24	63.38	73.00	-9.62	QP
12	28.003	53.69	0.79	0.24	54.72	60.00	-5.28	Average

Uplink:

Line:

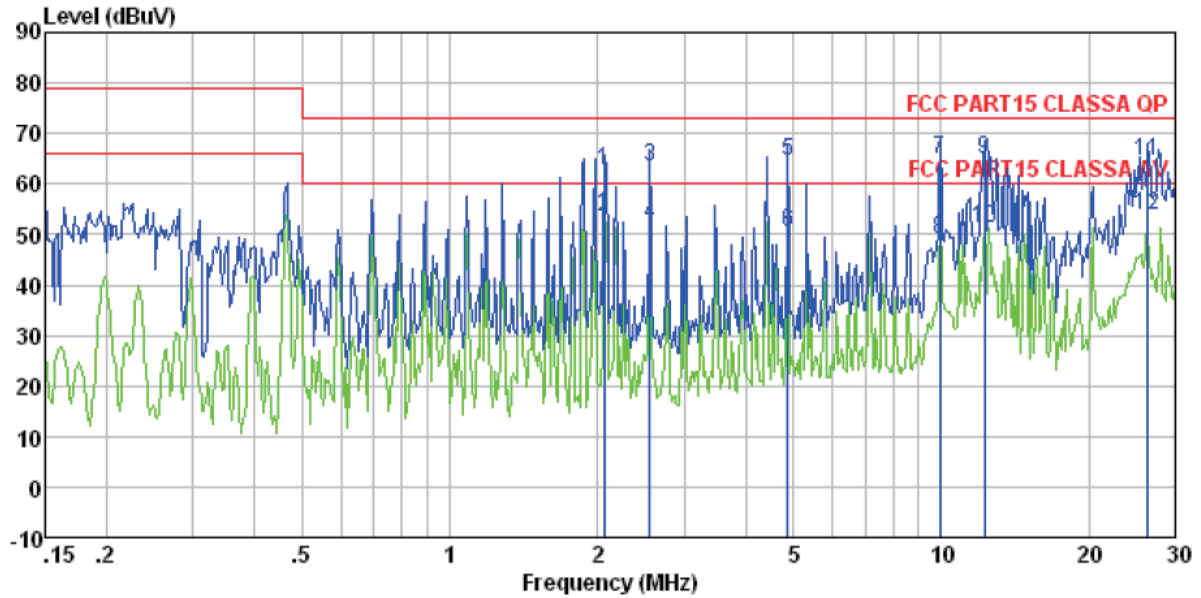

Condition : FCC PART15 CLASSA QP LISN-2013 LINE  
 Job No. : 2196RF  
 Test mode : Uplink mode  
 Test Engineer: Edward

	Read Freq	LISN Level	Cable Factor	Cable Loss	Limit Level	Over Line	Remark
	MHz	dBuV	dB	dB	dBuV	dB	
1	2.066	62.54	0.12	0.15	62.81	73.00	-10.19 QP
2	2.066	53.20	0.12	0.15	53.47	60.00	-6.53 Average
3	2.554	63.16	0.13	0.15	63.44	73.00	-9.56 QP
4	2.554	51.64	0.13	0.15	51.92	60.00	-8.08 Average
5	4.874	64.32	0.21	0.15	64.68	73.00	-8.32 QP
6	4.874	50.31	0.21	0.15	50.67	60.00	-9.33 Average
7	9.966	64.35	0.29	0.19	64.83	73.00	-8.17 QP
8	9.966	48.67	0.29	0.19	49.15	60.00	-10.85 Average
9	12.253	64.26	0.36	0.20	64.82	73.00	-8.18 QP
10	12.253	50.85	0.36	0.20	51.41	60.00	-8.59 Average
11	26.418	63.33	1.05	0.23	64.61	73.00	-8.39 QP
12	26.418	52.68	1.05	0.23	53.96	60.00	-6.04 Average



Neutral:

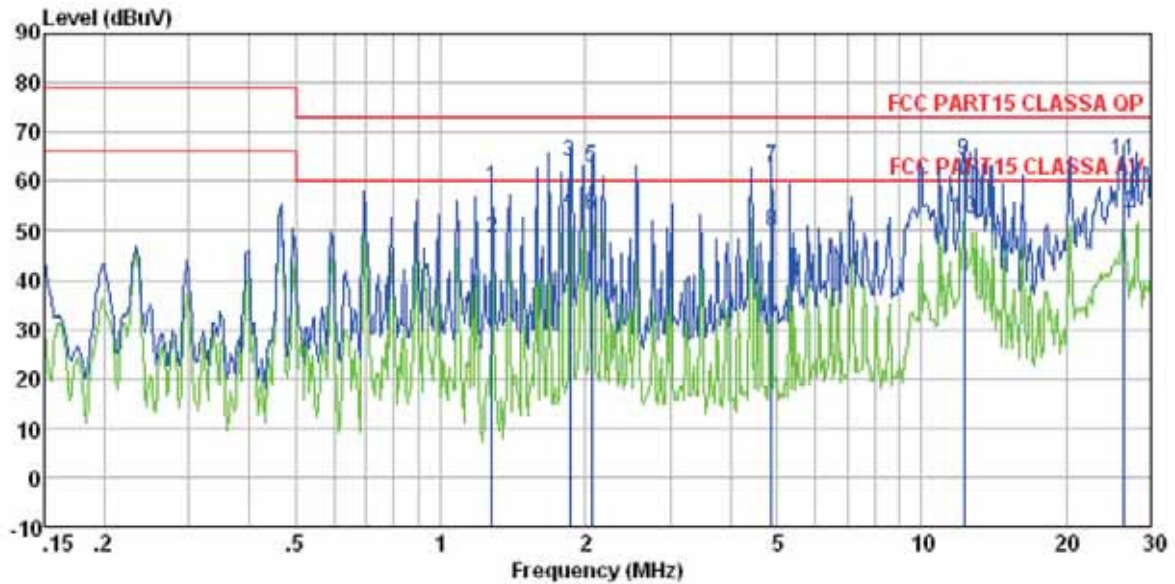

Condition : FCC PART15 CLASS A QP LISN-2013 NEUTRAL  
 Job No. : 2196RF  
 Test mode : Uplink mode  
 Test Engineer: Edward

	Freq	Read Level	LISN Factor	Cable Loss	Level	Limit Line	Over Limit	Remark
	MHz	dBuV	dB	dB	dBuV	dBuV	dB	
1	1.282	58.32	0.09	0.13	58.54	73.00	-14.46	QP
2	1.282	48.23	0.09	0.13	48.45	60.00	-11.55	Average
3	1.858	63.65	0.09	0.14	63.88	73.00	-9.12	QP
4	1.858	53.64	0.09	0.14	53.87	60.00	-6.13	Average
5	2.066	62.34	0.09	0.15	62.58	73.00	-10.42	QP
6	2.066	53.04	0.09	0.15	53.28	60.00	-6.72	Average
7	4.874	62.55	0.15	0.15	62.85	73.00	-10.15	QP
8	4.874	49.40	0.15	0.15	49.70	60.00	-10.30	Average
9	12.253	63.65	0.32	0.20	64.17	73.00	-8.83	QP
10	12.253	51.72	0.32	0.20	52.24	60.00	-7.76	Average
11	26.278	63.06	0.96	0.23	64.25	73.00	-8.75	QP
12	26.278	52.10	0.96	0.23	53.29	60.00	-6.71	Average

## 16 Test Setup Photo

Radiated Emission

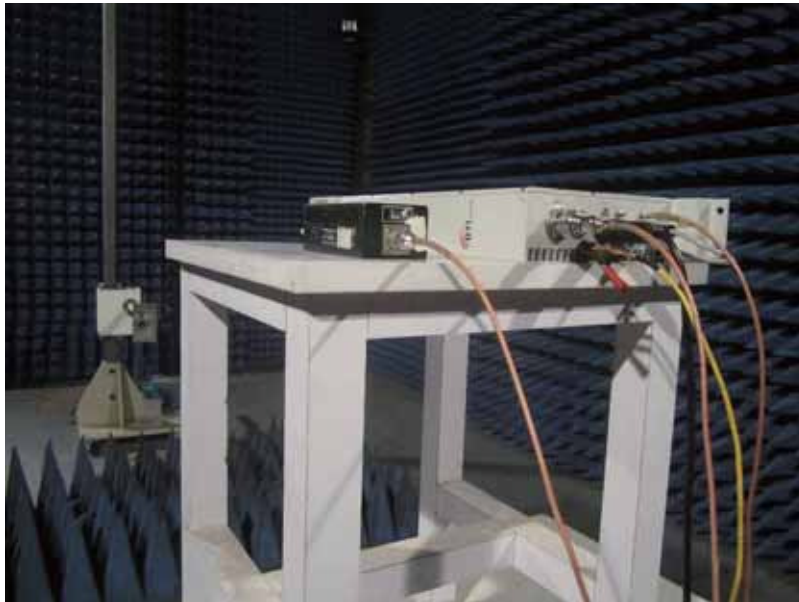
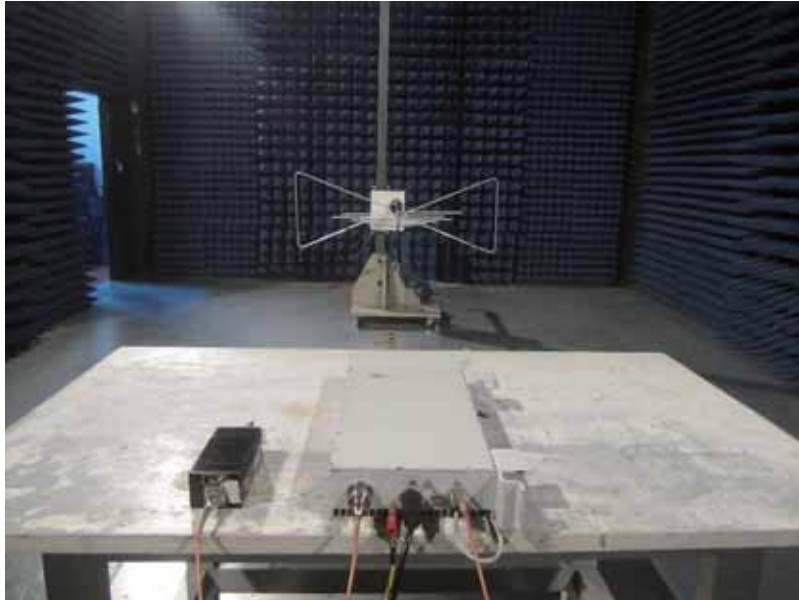

## Conducted Emission





## 17 EUT Constructional Details

RUM- Front view



RUM- Rear view

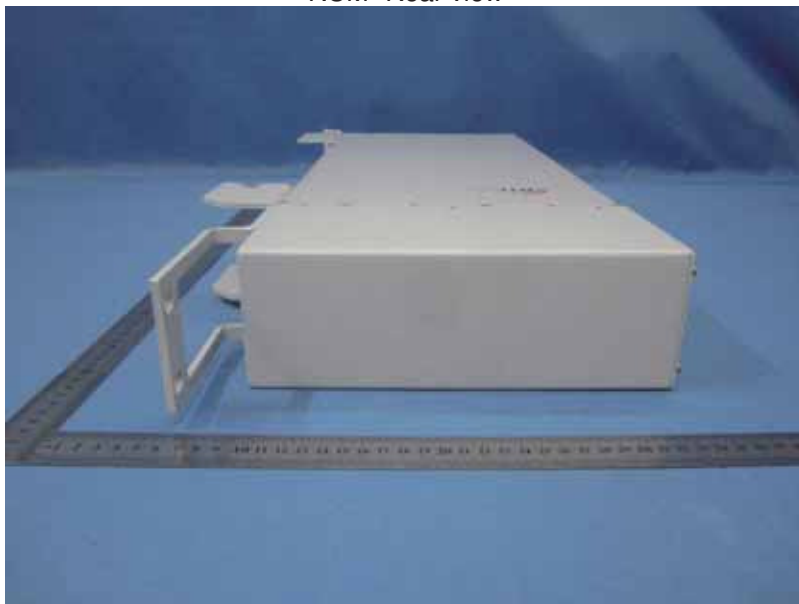

RUM- Top view



RUM- Bottom view

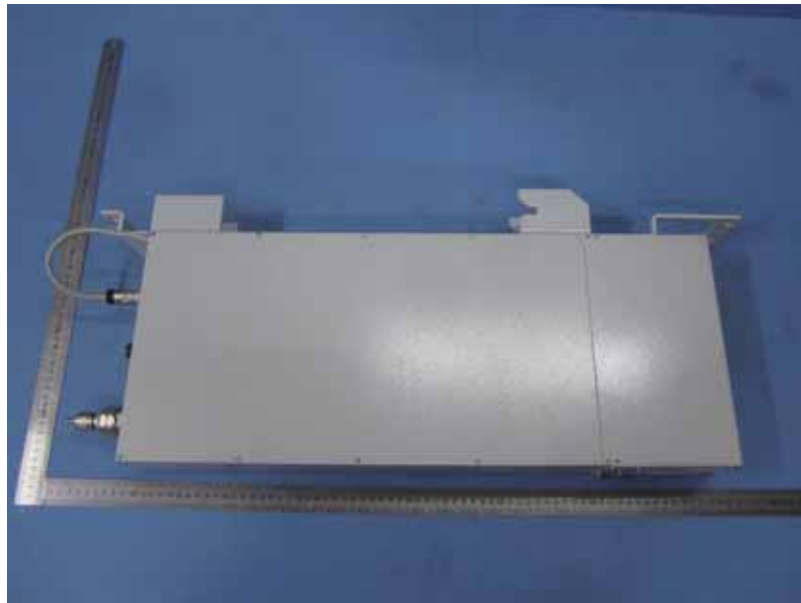

RUM- Left view



RUM- Right view



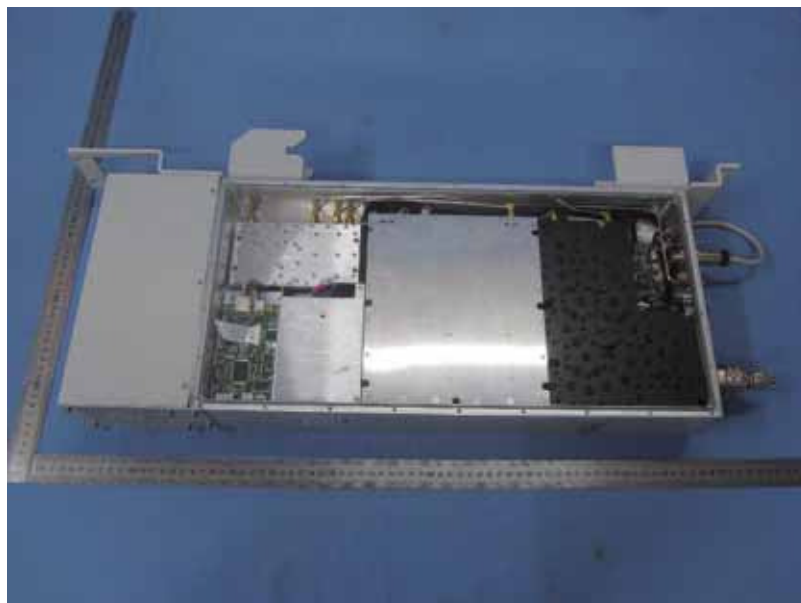







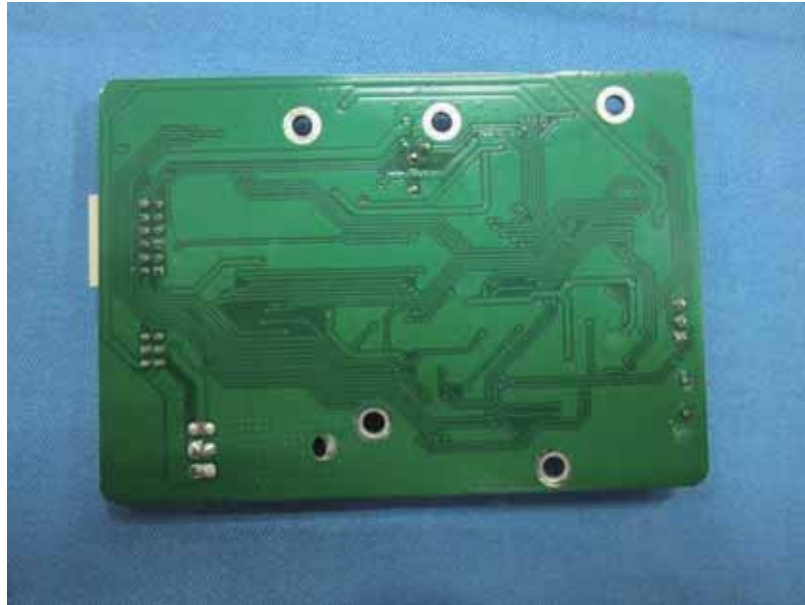





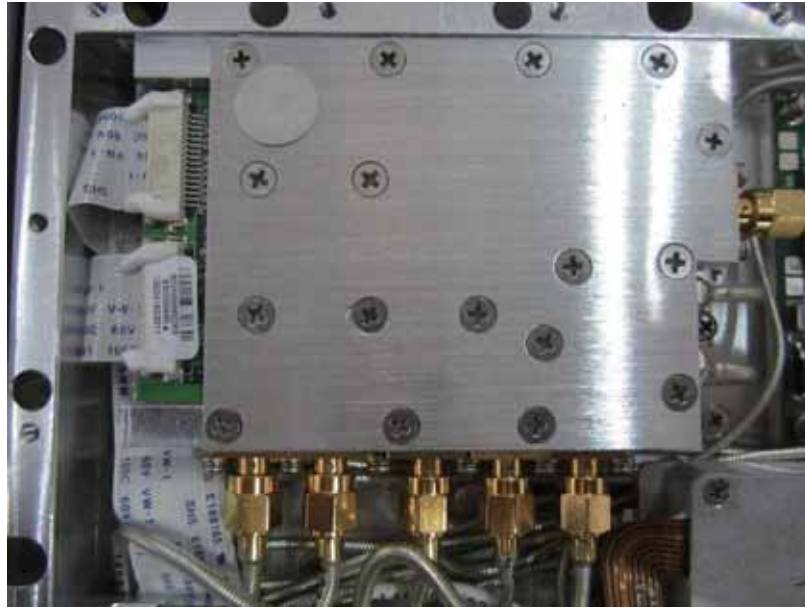



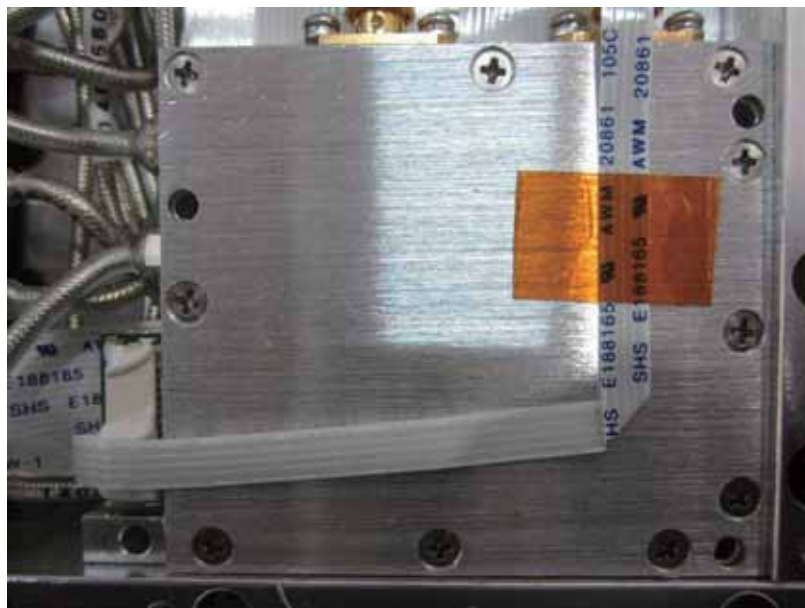
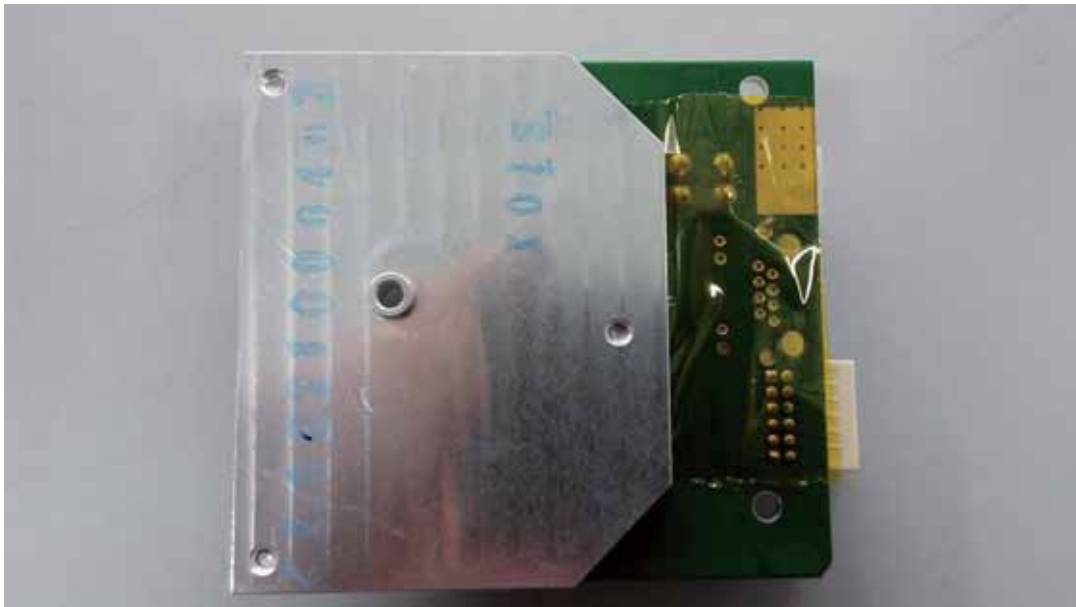









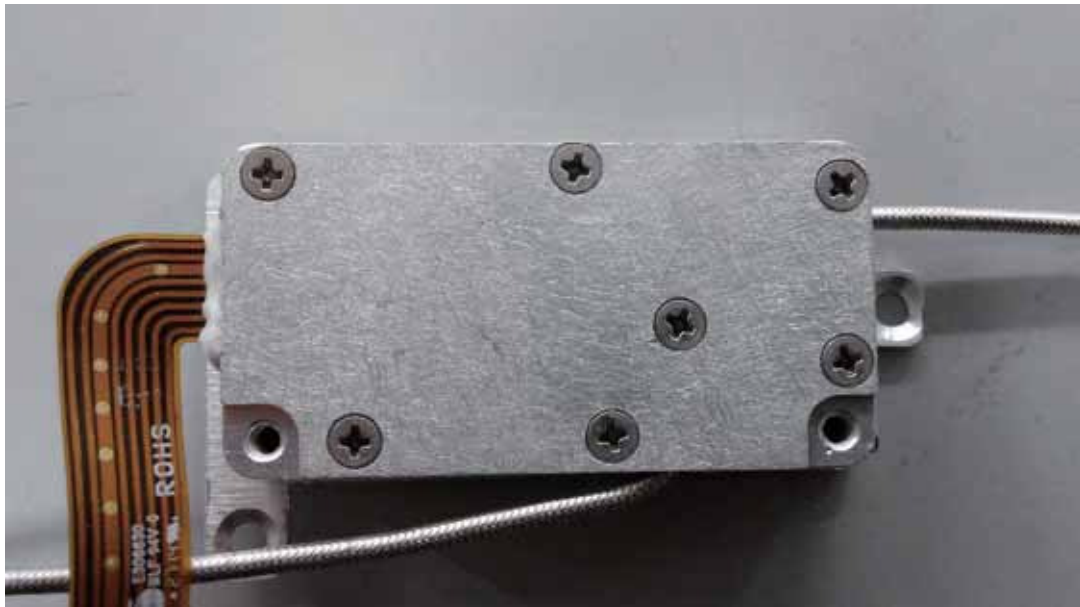









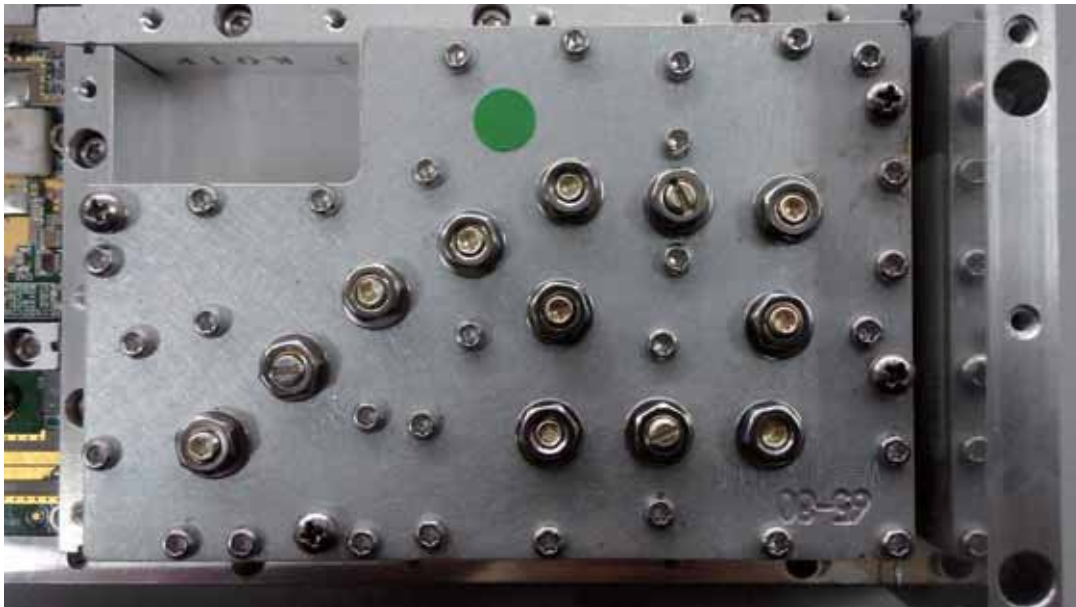



-----end-----