

FCC REPORT

Applicant: Bravo Tech (Shenzhen) Co. Ltd.

Address of Applicant: No. 8 Building, The 3rd Zone, Tangtou Industrial Park Shiyan, Baoan District, Shenzhen, China

Equipment Under Test (EUT)

Product Name: mBSC-C RUM

Model No.: mBSC2500U-005-RUCM11

FCC ID: WBKMBSC25U05RUM

Applicable standards: FCC CFR Title 47 Part 2:2014
FCC CFR Title 47 Part27 Subpart C:2014

Date of sample receipt: January 15, 2015

Date of Test: January 15-26, 2015

Date of report issued: January 26, 2015

Test Result : PASS *

* In the configuration tested, the EUT complied with the standards specified above.

Authorized Signature:



Robinson Lo
Laboratory Manager

This report details the results of the testing carried out on one sample. The results contained in this test report do not relate to other samples of the same product and does not permit the use of the GTS product certification mark. The manufacturer should ensure that all products in series production are in conformity with the product sample detailed in this report.

This report may only be reproduced and distributed in full. If the product in this report is used in any configuration other than that detailed in the report, the manufacturer must ensure the new system complies with all relevant standards.

Any mention of GTS or testing done by GTS in connection with, distribution or use of the product described in this report must be approved by GTS in writing.

This document cannot be reproduced except in full, without prior written approval of the Company. Any unauthorized alteration, forgery or falsification of the content or appearance of this document is unlawful and offenders may be prosecuted to the fullest extent of the law. Unless otherwise stated the results shown in this test report refer only to the sample(s) tested and such sample(s) are retained for 90 days only

2 Version

Version No.	Date	Description
00	January 26, 2015	Original

Prepared By:

Edward. Pan

Date:

January 26, 2015

Project Engineer

Check By:

Frank. Yan

Date:

January 26, 2015

Reviewer

3 Contents

	Page
1 COVER PAGE	1
2 VERSION	2
3 CONTENTS	3
4 TEST SUMMARY	5
5 GENERAL INFORMATION	6
5.1 CLIENT INFORMATION	6
5.2 GENERAL DESCRIPTION OF EUT	6
5.3 RELATED SUBMITTAL(S) / GRANT (S)	7
5.4 TEST METHODOLOGY	7
5.5 TEST FACILITY	7
5.6 TEST LOCATION	7
5.7 TEST INSTRUMENTS LIST	8
6 TEST CONFIGURATION AND CONDITIONS	9
6.1 EUT CONFIGURATION	9
6.2 CONFIGURATION OF TESTED SYSTEM	10
6.3 TEST ENVIRONMENTS	12
6.4 TEST SIGNAL	12
6.5 TEST FREQUENCY SELECTION	13
6.6 DESCRIPTION OF TEST MODES	14
7 RF POWER OUTPUT MEASUREMENT	15
7.1 STANDARD APPLICABLE	15
7.2 TEST SETUP	15
7.3 MEASUREMENT PROCEDURE	15
7.4 TEST RESULT	16
7.5 PEAK TO AVERAGE RATIO	18
8 PASSBAND GAIN AND 99% OCCUPIED BANDWIDTH	19
8.1 STANDARD APPLICABLE	19
8.2 TEST SETUP	19
8.3 TEST PROCEDURE	19
8.4 TEST RESULT	19
9 OUT OF BAND EMISSION AT ANTENNA TERMINALS	34
9.1 STANDARD APPLICABLE	34
9.2 TEST SETUP	34
9.3 MEASUREMENT PROCEDURE	34
9.4 MEASUREMENT RESULT	34
9.4.1 Spurious emission	34
9.4.2 Band edge emission	71
10 INTERMODULATION	75
10.1 STANDARD APPLICABLE	75
10.2 TEST SETUP	75

10.3	MEASUREMENT PROCEDURE.....	75
10.4	TEST RESULT	75
11	FIELD STRENGTH OF SPURIOUS RADIATION MEASUREMENT	108
11.1	STANDARD APPLICABLE	108
11.2	EUT SETUP (BLOCK DIAGRAM OF CONFIGURATION).....	108
11.3	MEASUREMENT PROCEDURE.....	108
11.4	MEASUREMENT DATA.....	109
12	FREQUENCY STABILITY.....	115
12.1	STANDARD APPLICABLE	115
12.2	TEST SETUP	115
12.3	TEST PROCEDURE.....	115
12.4	TEST RESULT	116
13	OUT-OF-BAND REJECTION.....	118
13.1	STANDARD APPLICABLE	118
13.2	TEST SETUP	118
13.3	TEST PROCEDURE.....	118
13.4	TEST RESULT	118
14	AC POWER LINE CONDUCTED EMISSION TEST.....	119
14.1	STANDARD APPLICABLE	119
14.2	TEST SETUP	119
14.3	TEST PROCEDURE.....	119
14.4	MEASUREMENT RESULT.....	119
15	TEST SETUP PHOTO.....	124
16	EUT CONSTRUCTIONAL DETAILS	126

4 Test Summary

Test Item	Test Description	Result
Maximum Permissible exposure(MPE)	§ 1.1307(b)(1), § 2.1091	PASS* (Please refer to MPE Report)
RF Output Power	§ 2.1046; § 27.50(h)	PASS
Modulation Characteristics	§ 2.1047	N/A*
Passband Gain and 99% Occupied Bandwidth	§ 2.1049 ; § 27.53(m)	PASS
Spurious Emissions at Antenna Terminal	§ 2.1051; § 27.53(m)	PASS
Intermodulation	§ 2.1051; § 27.53(m)	PASS
Field Strength of Spurious Radiation	§ 2.1053; § 27.53(m)	PASS
Out of band emission, Band Edge	§ 27.53(m)	PASS
Frequency stability vs. temperature Frequency stability vs. voltage	§ 2.1055; § 27.54	PASS
Out-of-Band Rejection	---	PASS
AC Power Line Conducted Emission Test	§ 15.207	PASS

Remark:

N/A*: Not application

5 General Information

5.1 Client Information

Applicant:	Bravo Tech (Shenzhen) Co. Ltd.
Address of Applicant:	No. 8 Building, The 3rd Zone, Tangtou Industrial Park Shiyan, Baoan District, Shenzhen, China
Manufacturer:	Bravo Tech (Shenzhen) Co. Ltd.
Address of Manufacturer:	No. 8 Building, The 3rd Zone, Tangtou Industrial Park Shiyan, Baoan District, Shenzhen, China
Factory:	BTI Wireless(ShenZhen)Co.,Ltd.
Address of Factory:	No. 8 Building, The 3rd Zone, Tangtou Industrial Park Shiyan, Baoan District, Shenzhen, China

5.2 General Description of EUT

Product Name:	mBSC-C RUM	
Model No.:	MBSC2500U-005-RUCM11	
Power supply:	RPM: Input: AC 120V/60Hz RUM: DC 28V, 3A Max RTM: Input DC 28V / 2.2A Normal test voltage: AC 120V/60Hz	
Operating Temperature:	-20°C to + 55°C	
Operating Humidity:	up to 95%	
Technical Parameter:		
Frequency Range	Downlink	2570MHz~2690MHz
	Uplink	2570MHz~2690MHz
Operating Bandwidth	120MHz	
Multiple Carrier Supported	1	
Channel Spacing(s) / Bandwidth(s)	LTE: 1.4MHz; 3MHz; 5MHz; 10MHz; 15MHz; 20MHz.	
Maximun RF Output Power	Downlink: 37.73dBm Uplink: 4.95dBm	
Max Gain	Downlink: 54±0.5dB; Uplink: 62±0.5dB	
Type of modulation and Designator	LTE(W7D)	
Antenna Type	External antenna (N female)	
Antenna Gain	Maximum permissible antenna gain is 17dBi.	

5.3 Related Submittal(s) / Grant (s)

Title 47 Part 2	General Requirements and Information for the Certification of Radio Apparatus
Title 47 Part 27	MISCELLANEOUS WIRELESS COMMUNICATIONS SERVICES

5.4 Test Methodology

Title 47 Part 2	General Requirements and Information for the Certification of Radio Apparatus
Title 47 Part 20	COMMERCIAL MOBILE SERVICES
Title 47 Part 27	MISCELLANEOUS WIRELESS COMMUNICATIONS SERVICES
ANSI C63.4: 2003	Methods of Measurement of Radio-Noise Emissions from Low Voltage Electrical and Electronic Equipment in the Range of 9 kHz to 40 GHz
KDB	AMPLIFIER, BOOSTER, AND REPEATER REMINDER SHEET
KDB 935210	D01 Signal Booster Definitions v02; D02 Signal Booster Certification v02r01; D03 Signal Booster Measurements v02r01; D04 Signal Booster Provider Specific v01

5.5 Test Facility

<p>The test facility is recognized, certified, or accredited by the following organizations:</p> <ul style="list-style-type: none"> ● CNAS —Registration No.: CNAS L5775 CNAS has accredited Global United Technology Services Co., Ltd. to ISO/IEC 17025 General Requirements for the competence of testing and calibration laboratories (CNAS-CL01 Accreditation Criteria for the Competence of Testing and Calibration Laboratories) for the competence in the field of testing. ● FCC —Registration No.: 600491 Global United Technology Services Co., Ltd., Shenzhen EMC Laboratory has been registered and fully described in a report filed with the (FCC) Federal Communications Commission. The acceptance letter from the FCC is maintained in files. Registration 600491, June 28, 2013. ● Industry Canada (IC) The 3m Semi-anechoic chamber of China Certification & Inspection Services Co., Ltd. has been Registered by Certification and Engineering Bureau of Industry Canada for radio equipment testing with Registration No.: 9079A-2, June 26, 2013.

5.6 Test Location

All tests were performed at:
<p>Global United Technology Services Co., Ltd. Address: 2nd Floor, Block No.2, Laodong Industrial Zone, Xixiang Road Baoan District, Shenzhen, China Tel: 0755-27798480 Fax: 0755-27798960</p>

5.7 Test Instruments list

Item	Test Equipment	Manufacturer	Model No.	Inventory No.	Cal.Date (dd-mm-yy)	Cal.Due date (dd-mm-yy)
1	3m Semi- Anechoic Chamber	ZhongYu Electron	9.2(L)*6.2(W)* 6.4(H)	GTS250	Mar. 29 2013	Mar. 28 2015
2	Control Room	ZhongYu Electron	6.2(L)*2.5(W)* 2.4(H)	GTS251	N/A	N/A
3	EMI Test Receiver	Rohde & Schwarz	ESU26	GTS203	Jul. 01 2014	Jun. 30, 2015
4	BiConiLog Antenna	SCHWARZBECK MESS-ELEKTRONIK	VULB9163	GTS214	Feb. 23 2014	Feb. 22 2015
5	Double -ridged waveguide horn	SCHWARZBECK MESS-ELEKTRONIK	9120D-829	GTS208	June 27 2014	June 26 2015
6	EMI Test Software	AUDIX	E3	N/A	N/A	N/A
7	Coaxial Cable	GTS	N/A	GTS213	Mar. 29 2014	Mar. 28 2015
8	Coaxial Cable	GTS	N/A	GTS211	Mar. 29 2014	Mar. 28 2015
9	Coaxial cable	GTS	N/A	GTS210	Mar. 29 2014	Mar. 28 2015
10	Coaxial Cable	GTS	N/A	GTS212	Mar. 29 2014	Mar. 28 2015
11	Amplifier(100KHz-5GHz)	HP	8347A	GTS204	Jul. 01 2014	Jun. 30, 2015
12	Amplifier(2GHz-20GHz)	HP	8349B	GTS206	Jul. 01 2014	Jun. 30, 2015
13	Amplifier (18-26GHz)	Rohde & Schwarz	AFS33-18002 650-30-8P-44	GTS218	June 27 2014	June 26 2015
14	Shielding Room	ZhongYu Electron	7.0(L)x3.0(W)x3.0(H)	GTS264	Sep. 07 2013	Sep. 06 2015
15	EMI Test Receiver	Rohde & Schwarz	ESCS30	GTS223	Jul. 01 2014	Jun. 30, 2015
16	10dB Pulse Limita	Rohde & Schwarz	N/A	GTS224	Jul. 01 2014	Jun. 30, 2015
17	LISN	SCHWARZBECK MESS-ELEKTRONIK	NSLK 8127	GTS226	Jul. 01 2014	Jun. 30, 2015
18	Temp. Humidity/ Barometer	Oregon Scientific	BA-888	GTS248	May 10 2013	May 09 2015
19	Spectrum Analyzer	Agilent	E4440A	GTS 536	Oct.21 2014	Oct.20 2015
20	Spectrum Analyzer	Agilent	E4445A	MY41000047	Sept. 10 2013	Sept. 01 2015
21	Splitter	Agilent	11636B	GTS237	May 10 2013	May 09 2015
22	Signal Generator	Rohde & Schwarz	SML03	GTS236	May 10 2013	May 09 2015
23	Signal Generator	AEROFLEX	IFR3414	341300/019	Sept. 10 2014	Sept. 10 2015
24	Power Reflection Meter	Rohde & Schwarz	NRT	100540	Sept. 10 2014	Sept. 10 2015
25	Power Sensor	Giga-tronics	80601A	1831785	Sept. 10 2014	Sept. 10 2015
26	Power Attenuator	BTI	30dB/250W	040706090	Sept. 10 2014	Sept. 10 2015
27	Power Attenuator	BTI	20dB	040706089	Sept. 10 2014	Sept. 10 2015
28	Power Attenuator	BTI	10dB	040706088	Sept. 10 2014	Sept. 10 2015
29	Signal Generator	Agilent	E4438C	MY45093111	Oct.21 2014	Oct.20 2015
30	Signal Generator	Agilent	4432B	GB40051373	May 10 2014	May 09 2015

6 TEST CONFIGURATION AND CONDITIONS

6.1 EUT Configuration

This MBSC2500U-005-RUCM11 is the Remote Unit on BTI CM system. This remote unit supports 2500MHz band with the air standard TDD-LTE. The unit consists of Duplexer, PA and CPU board. This product is designed to operate in an outdoor or indoor environment. The output power of the RUM at Antenna interface port is average 38dBm for Downlink path with Convection Cooling.

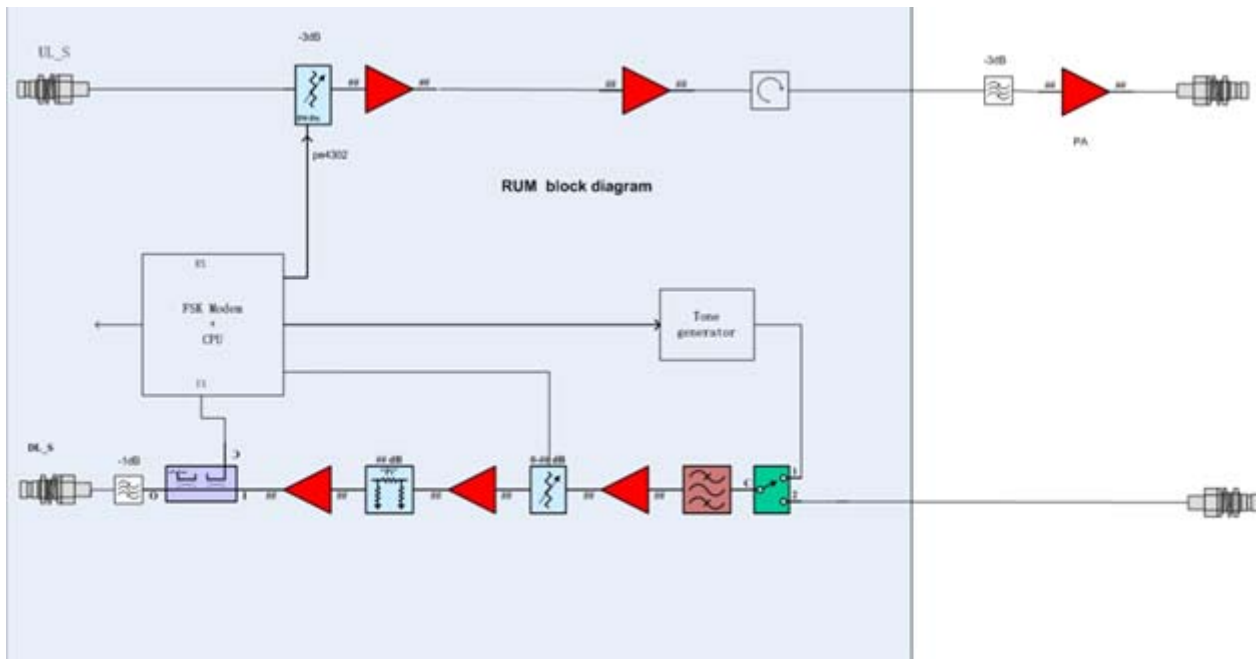
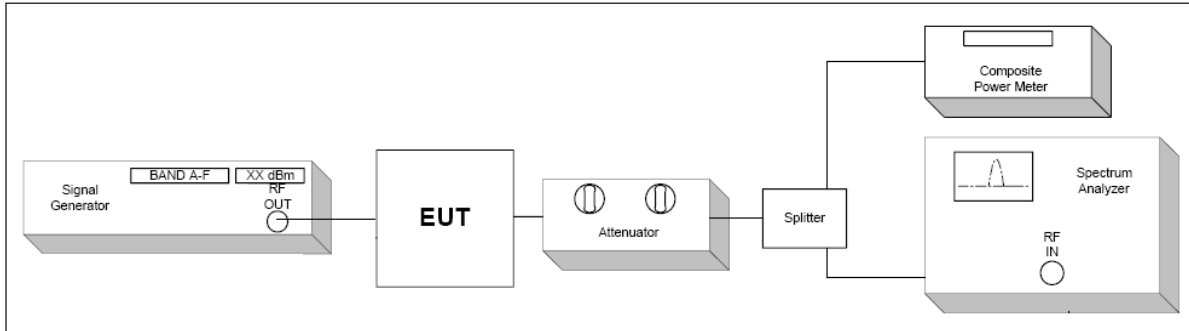

Figure 1: Remote Unit block diagram

For details, refer to technical document and the user manual.

6.2 Configuration of Tested System

(A) RF Output Power, Occupied Bandwidth, Spurious Emissions at Antenna Terminal, Band Edge, Test Set-UP



(B) Intermodulation Test Set-UP

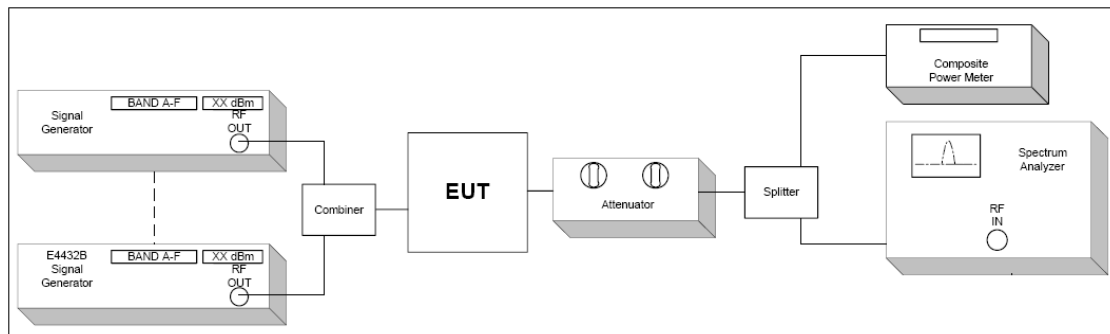

(C) Frequency stability Test Set-UP

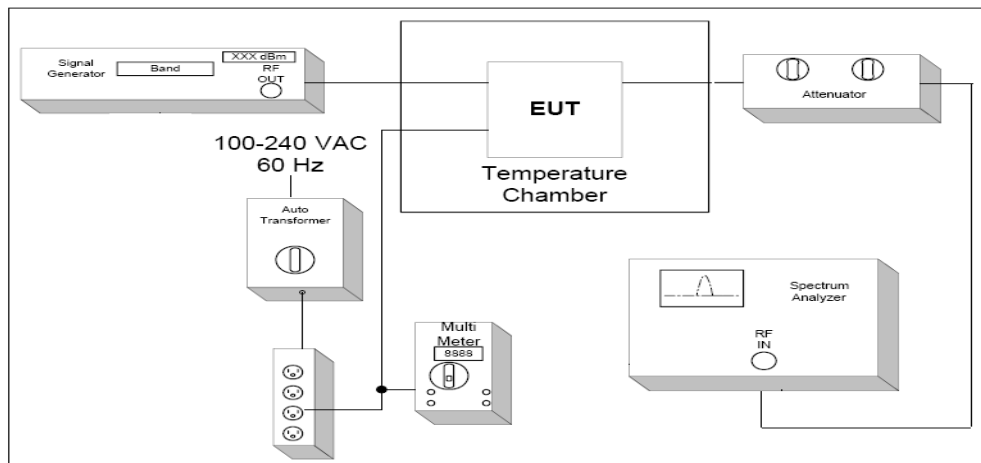

(D) Radiated Emission Test Set-Up, Frequency below 1000MHz

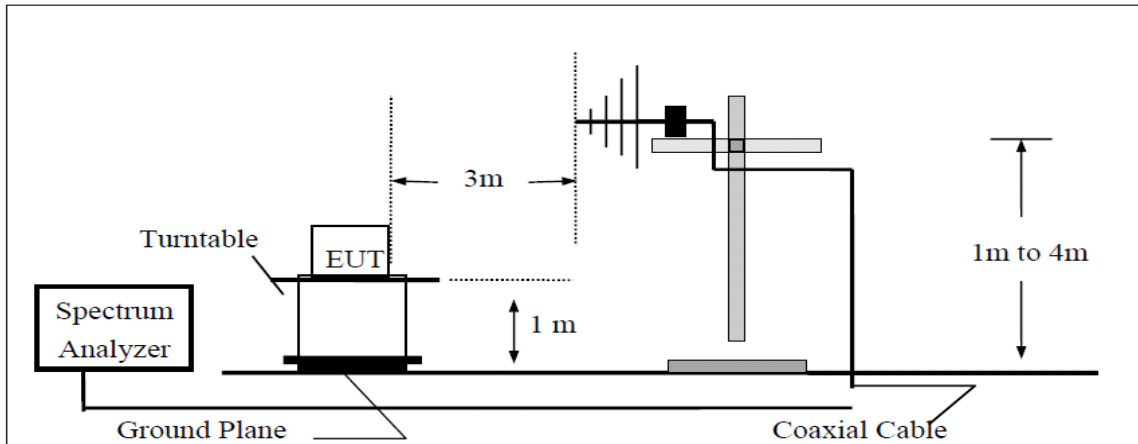

(E) Radiated Emission Test Set-UP Frequency over 1 GHz

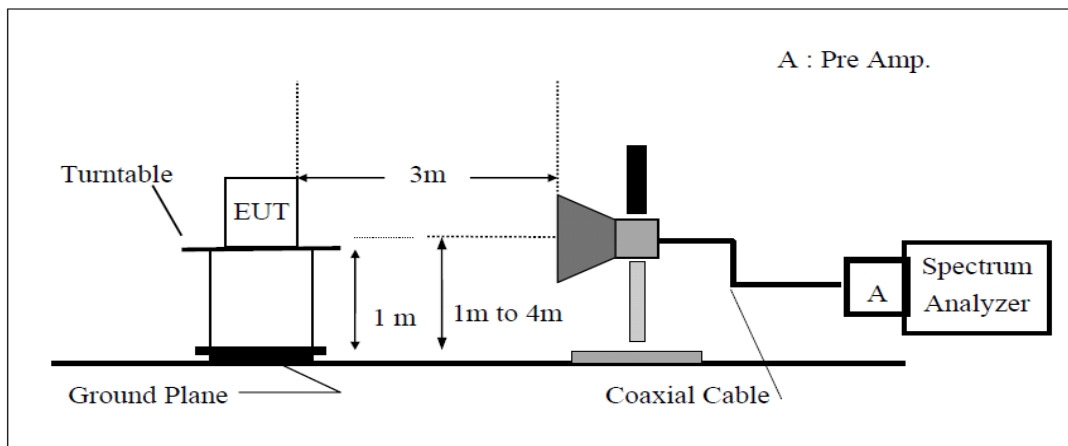

(F) Substituted Method Test Set-UP

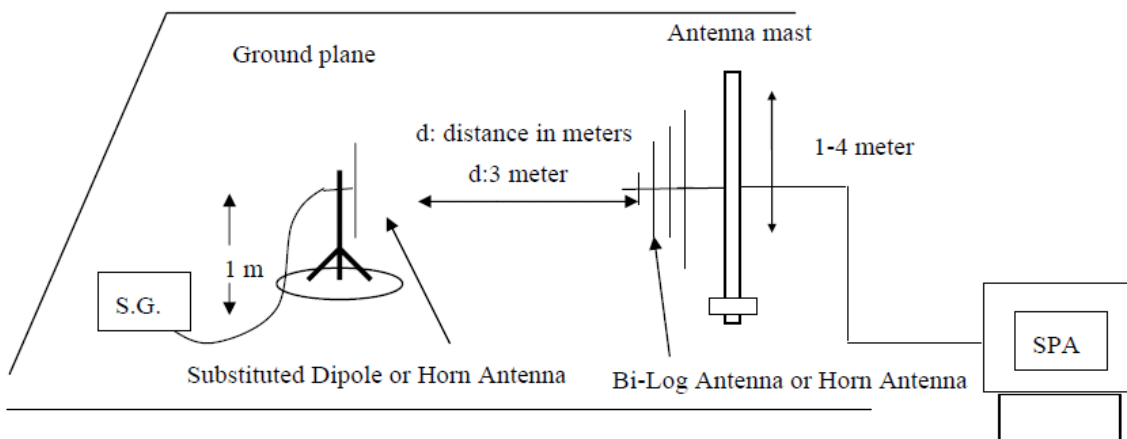

6.3 Test Environments

Condition	Minimum value	Maximum value
Barometric pressure	86 kPa	106 kPa
Temperature	15°C	30°C
Relative Humidity	20 %	75 %
Power supply range	±5% of rated voltages	
Normal Test Condition	(1). Temperature: +15 °C to +30 °C; (2). voltage is 120V AC.	
Extreme Test Conditions:	(1). Temperatures: -20°C to +55°C. (2). Voltages: 102V AC to 138V AC.	

6.4 Test signal

1: Test signal LTE:

Signal waveform according to Test Model 1.1, E-TM1.1, clause 6.1.1.1-1, table 6.1.1.1-1 of standard specification 3GPP TS 36.141 V9.3.0 (2010-03).

2: Test signal CW

N/A

6.5 Test frequency selection

Downlink:

Operating Mode(TX)	Channels No.		Channels frequency (MHz)		
	Multi- Carriers		Low Ch.	Mid Ch.	High Ch.
LTE 1.4MHz Bandwidth	Single Carrier		2570.70	2630.90	2689.30
LTE 3MHz Bandwidth	Single Carrier		2571.50	2631.50	2688.50
LTE 5MHz Bandwidth	Single Carrier		2572.50	2632.50	2687.50
LTE 10MHz Bandwidth	Single Carrier		2575.00	2635.00	2685.00
LTE 15MHz Bandwidth	Single Carrier		2577.50	2637.50	2682.50
LTE 20MHz Bandwidth	Single Carrier		2580.00	2640.00	2680.00

Uplink:

Operating Mode(TX)	Channels No.		Channels frequency (MHz)		
	Multi- Carriers		Low Ch.	Mid Ch.	High Ch.
LTE 1.4MHz Bandwidth	Single Carrier		2570.70	2630.90	2689.30
LTE 3MHz Bandwidth	Single Carrier		2571.50	2631.50	2688.50
LTE 5MHz Bandwidth	Single Carrier		2572.50	2632.50	2687.50
LTE 10MHz Bandwidth	Single Carrier		2575.00	2635.00	2685.00
LTE 15MHz Bandwidth	Single Carrier		2577.50	2637.50	2682.50
LTE 20MHz Bandwidth	Single Carrier		2580.00	2640.00	2680.00

6.6 DESCRIPTION OF TEST MODES

Test mode	Detail description of the test mode
Downlink	Downlink (Low channel; middle channel; high channel)
Uplink	Uplink (Low channel; middle channel; high channel)
Multi-carrier	Single Carrier
Multi-bandwidth	LTE: 1.4MHz; 3MHz; 5MHz; 10MHz; 15MHz; 20MHz.
Modulation type	LTE

Remark:

- 1: The EUT was powered by 120VAC.
- 2: The EUT was configured for maximum gain and maximum output power. The input power was the maximum declared by the manufacturer. This is to ensure that the equipment is operating in the linear output range.
- 3: Signal generator was used to provide the input signals to the EUT. Tests were performed with LTE signal input and multi-carrier signal mode input.
- 4: Pre-test all test modes as above, only the worst case and typical mode is listed in report it.
- 5: All testing is end-to-end (input to host through to output from remote, and vice-versa)

7 RF POWER OUTPUT MEASUREMENT

7.1 Standard Applicable

According to FCC § 2.1046 and § 27.53(h).

7.2 Test setup

Please refer the section §6.2 Configuration of Tested System.

7.3 Measurement Procedure

1. The output from the EUT t signal shall be increased, antenna connector was connected to the power meter.
2. The level of RF input until the maximum output power per channel, declared by client, is reached.
3. The RF output power was measured at low, middle and high channel with LTE signal.

7.4 Test Result

Downlink:

Test mode	Carrier Conf.	Channel	Average Power (dBm)	Average Power (W)	Result
LTE	LTE 1.4MHz Bandwidth	Low	37.45	5.56	Compliant
		Middle	37.69	5.87	Compliant
		High	37.58	5.73	Compliant
	LTE 3MHz Bandwidth	Low	37.63	5.79	Compliant
		Middle	37.59	5.74	Compliant
		High	37.63	5.79	Compliant
	LTE 5MHz Bandwidth	Low	37.49	5.61	Compliant
		Middle	37.73	5.93	Compliant
		High	37.69	5.87	Compliant
	LTE 10MHz Bandwidth	Low	37.57	5.71	Compliant
		Middle	37.68	5.86	Compliant
		High	37.72	5.92	Compliant
	LTE 15MHz Bandwidth	Low	37.71	5.90	Compliant
		Middle	37.55	5.69	Compliant
		High	37.66	5.83	Compliant
	LTE 20MHz Bandwidth	Low	37.72	5.92	Compliant
		Middle	37.59	5.74	Compliant
		High	37.68	5.86	Compliant

Uplink:

Test mode	Carrier Conf.	Channel	Average Power (dBm)	Average Power (W)	Result
LTE	LTE 1.4MHz Bandwidth	Low	4.87	0.0031	Compliant
		Middle	4.95	0.0031	Compliant
		High	4.65	0.0029	Compliant
	LTE 3MHz Bandwidth	Low	4.83	0.0030	Compliant
		Middle	4.89	0.0031	Compliant
		High	4.72	0.0030	Compliant
	LTE 5MHz Bandwidth	Low	4.75	0.0030	Compliant
		Middle	4.91	0.0031	Compliant
		High	4.58	0.0029	Compliant
	LTE 10MHz Bandwidth	Low	4.67	0.0029	Compliant
		Middle	4.90	0.0031	Compliant
		High	4.56	0.0029	Compliant
	LTE 15MHz Bandwidth	Low	4.82	0.0030	Compliant
		Middle	4.89	0.0031	Compliant
		High	4.76	0.0030	Compliant
	LTE 20MHz Bandwidth	Low	4.76	0.0030	Compliant
		Middle	4.67	0.0029	Compliant
		High	4.58	0.0029	Compliant

7.5 Peak to Average Ratio

Downlink:

Test mode	Carrier Conf.	Peak to Average Ratio (dB)			Limit (dB)	Result
		Low Ch.	Middle Ch.	High Ch.		
LTE	1.4MHz	8.85	8.40	8.40	13	Compliant
	3MHz	8.50	8.10	8.30	13	Compliant
	5MHz	8.47	8.90	8.45	13	Compliant
	10MHz	8.20	8.10	8.30	13	Compliant
	15MHz	8.18	8.27	8.15	13	Compliant
	20MHz	8.73	8.20	8.25	13	Compliant

Uplink:

Test mode	Carrier Conf.	Peak to Average Ratio (dB)			Limit (dB)	Result
		Low Ch.	Middle Ch.	High Ch.		
LTE	1.4MHz	7.77	8.90	8.50	13	Compliant
	3MHz	8.04	7.88	8.25	13	Compliant
	5MHz	8.10	8.50	7.98	13	Compliant
	10MHz	8.05	8.67	8.15	13	Compliant
	15MHz	8.00	8.20	8.20	13	Compliant
	20MHz	8.42	8.27	8.27	13	Compliant

8 PASSBAND GAIN AND 99% OCCUPIED BANDWIDTH

8.1 Standard Applicable

According to FCC § 2.1049 , § 27.53(m)

8.2 Test setup

Please refer the section §6.2 Configuration of Tested System.

8.3 Test Procedure

1. The EUT RF output port was connected to spectrum analyzer.
2. The level of RF input signal shall be increased, until the maximum output power per channel, declared by client, is reached.
3. The spectrum analyzer was setup to measure the Occupied Bandwidth (defined as the 99% Power Bandwidth).
4. The Occupied Bandwidth was measured at the input and output ports of the EUT at low, middle and high channel of each type of modulation and each type of carrier signal.

Spectrum analyzer settings:

Detector: RMS.

LTE: RBW= 100 kHz VBW \geq RBW Sweep: Auto

8.4 Test Result

Pass band Gain

Downlink:

Test mode	Carrier Conf.	Channel	Passband Gain (dB)	Nominal Gain (dB)	Result
LTE	LTE 1.4MHz Bandwidth	Low	54.02	54±0.5dB	Compliant
		Middle	53.84		Compliant
		High	53.91		Compliant
	LTE 3MHz Bandwidth	Low	53.97		Compliant
		Middle	54.12		Compliant
		High	53.67		Compliant
	LTE 5MHz Bandwidth	Low	54.06		Compliant
		Middle	54.23		Compliant
		High	54.11		Compliant
	LTE 10MHz Bandwidth	Low	54.12		Compliant
		Middle	54.15		Compliant
		High	54.21		Compliant
	LTE 15MHz Bandwidth	Low	53.88		Compliant
		Middle	53.86		Compliant
		High	53.94		Compliant
	LTE 20MHz Bandwidth	Low	54.07		Compliant
		Middle	54.12		Compliant
		High	54.01		Compliant

Uplink:

Test mode	Carrier Conf.	Channel	Passband Gain (dB)	Nominal Gain (dB)	Result
LTE	LTE 1.4MHz Bandwidth	Low	62.12	62±0.5dB	Compliant
		Middle	62.05		Compliant
		High	62.10		Compliant
	LTE 3MHz Bandwidth	Low	61.95		Compliant
		Middle	62.06		Compliant
		High	62.00		Compliant
	LTE 5MHz Bandwidth	Low	61.86		Compliant
		Middle	61.88		Compliant
		High	61.79		Compliant
	LTE 10MHz Bandwidth	Low	62.03		Compliant
		Middle	62.09		Compliant
		High	62.13		Compliant
	LTE 15MHz Bandwidth	Low	61.76		Compliant
		Middle	62.10		Compliant
		High	61.99		Compliant
	LTE 20MHz Bandwidth	Low	61.86		Compliant
		Middle	62.03		Compliant
		High	61.77		Compliant

Input/output Bandwidth Comparison

Downlink:

Input/output Bandwidth Comparison for LTE 1.4MHz Bandwidth

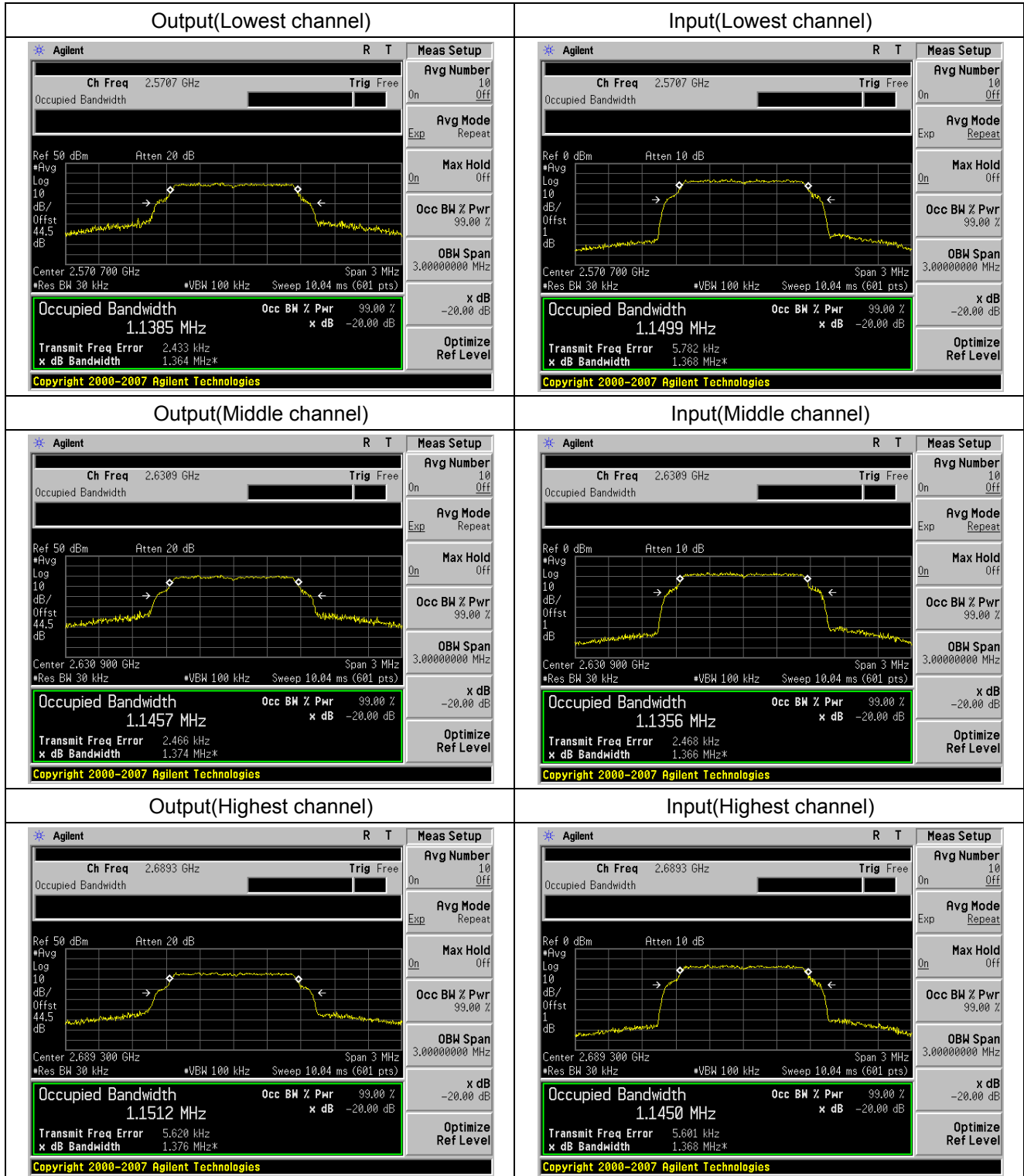

Input/output Bandwidth Comparison for LTE 3MHz Bandwidth

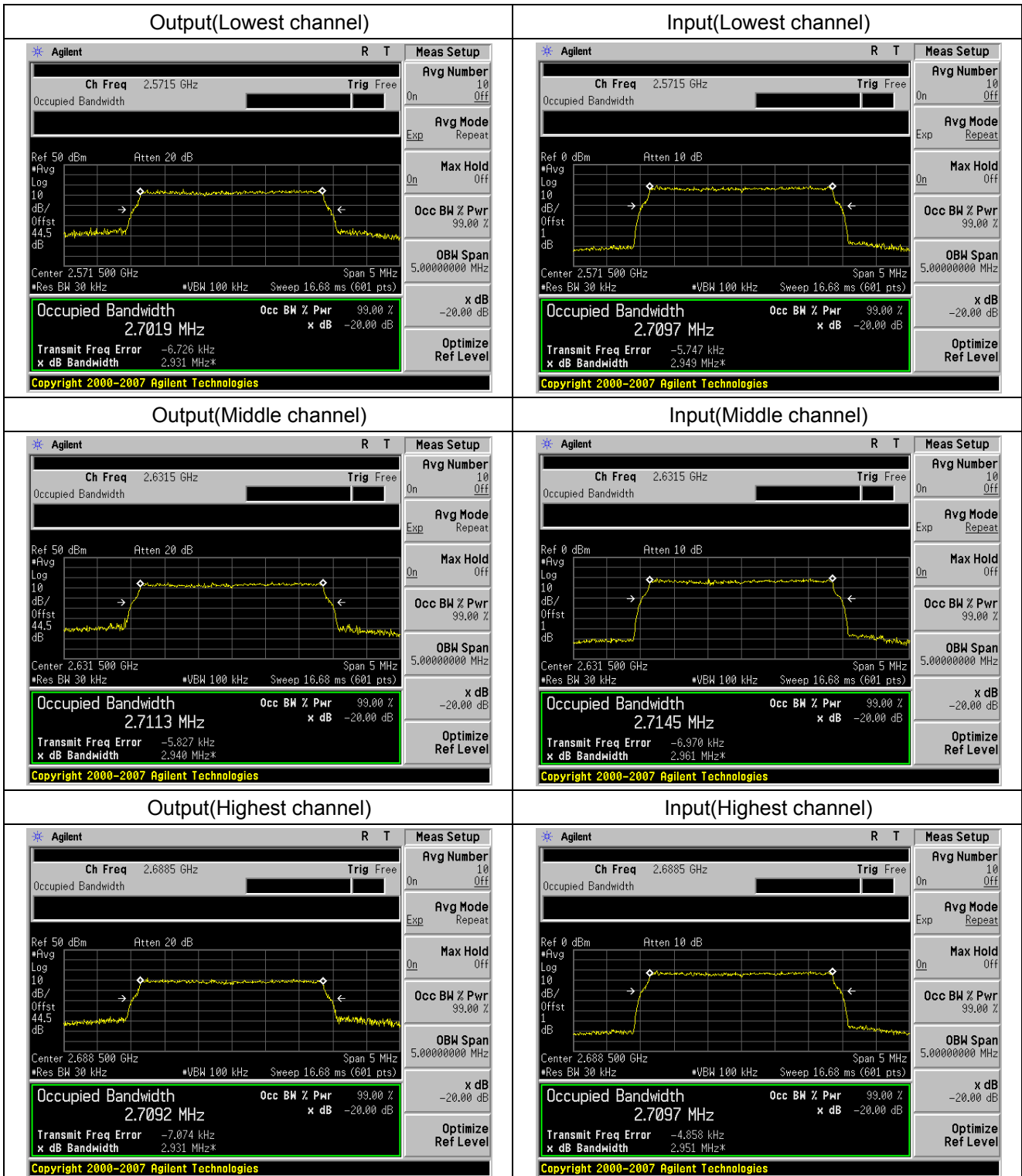

Input/output Bandwidth Comparison for LTE 5MHz Bandwidth

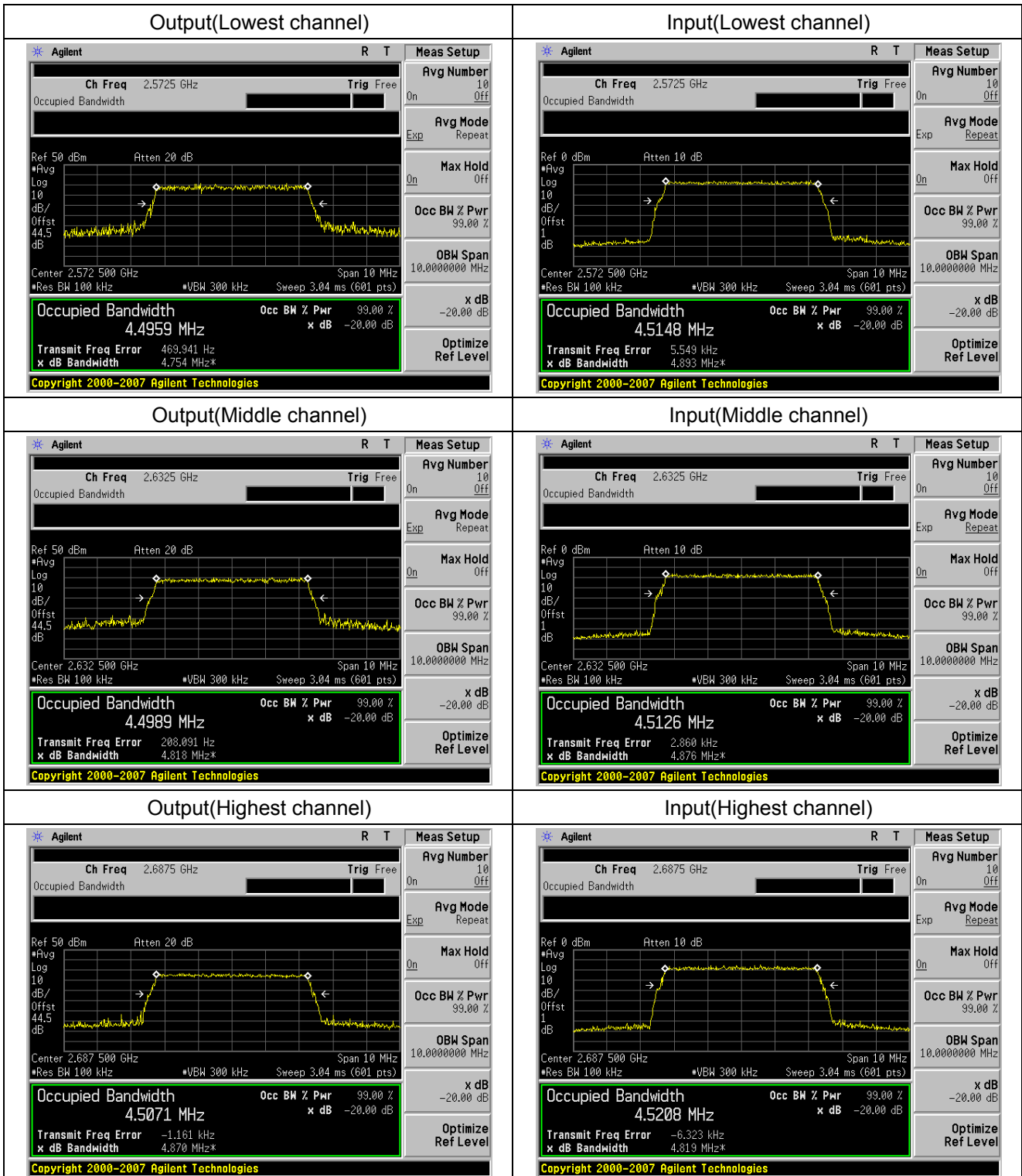

Input/output Bandwidth Comparison for LTE 10MHz Bandwidth

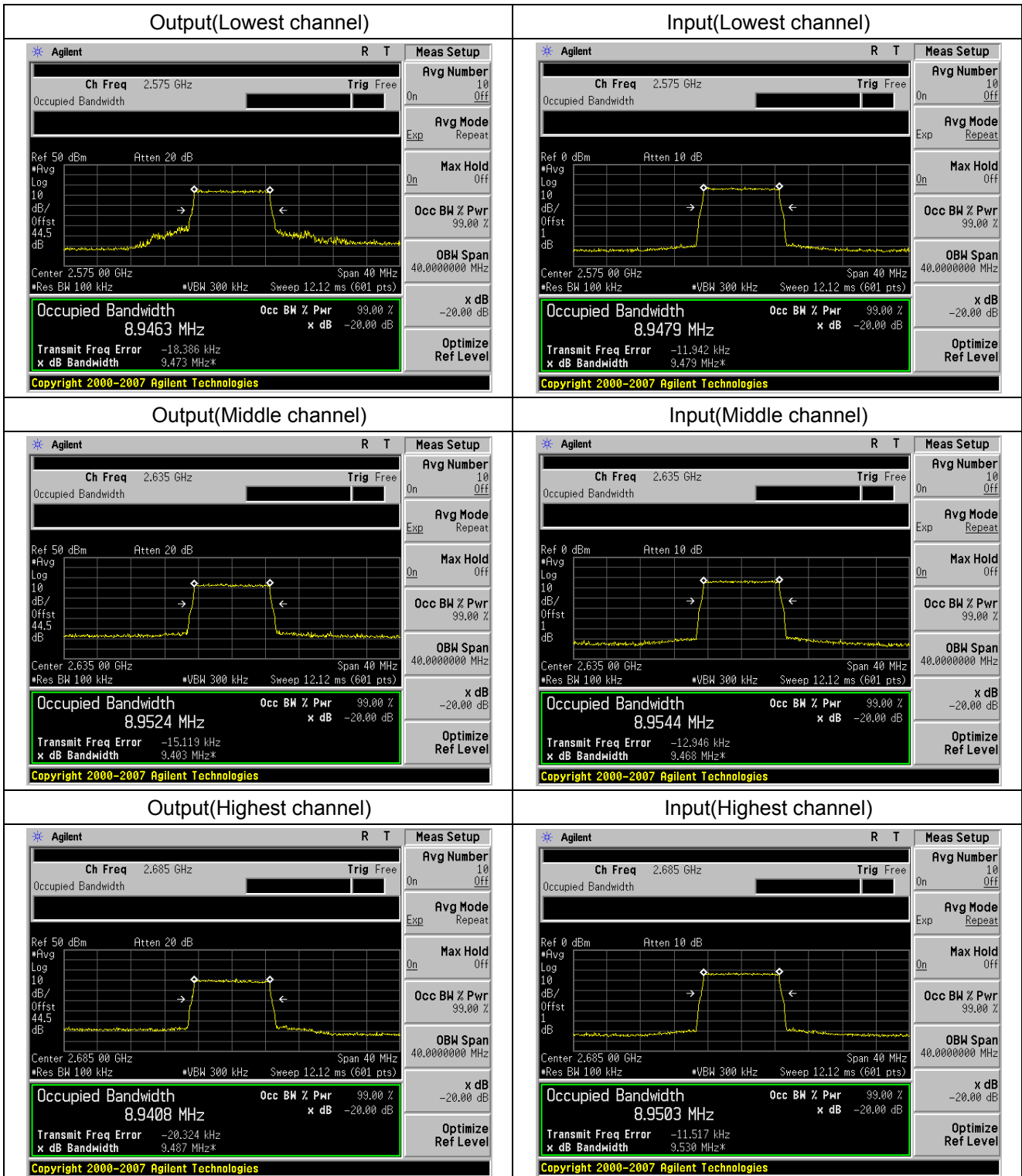

Input/output Bandwidth Comparison for LTE 15MHz Bandwidth

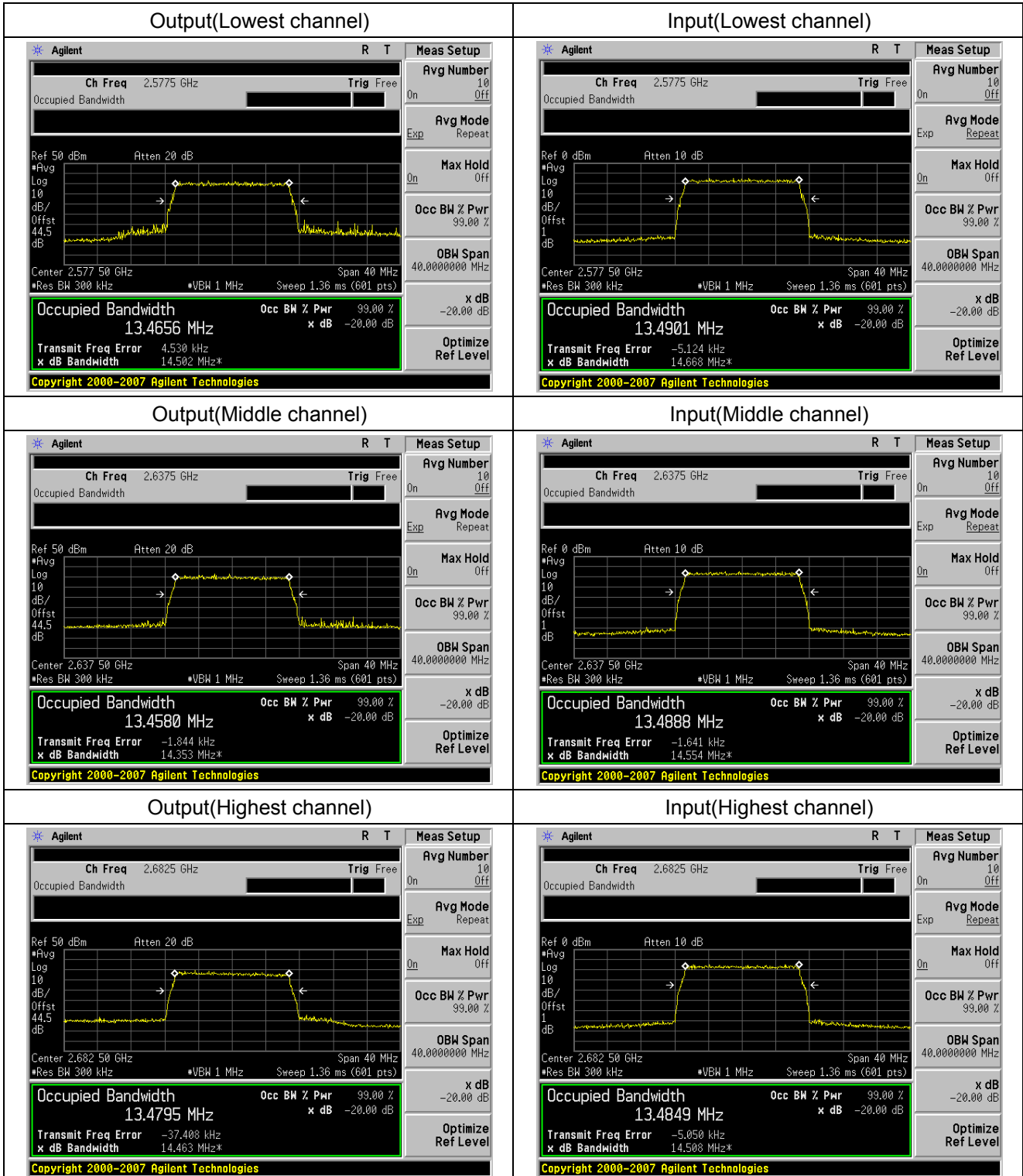

Input/output Bandwidth Comparison for LTE 20MHz Bandwidth

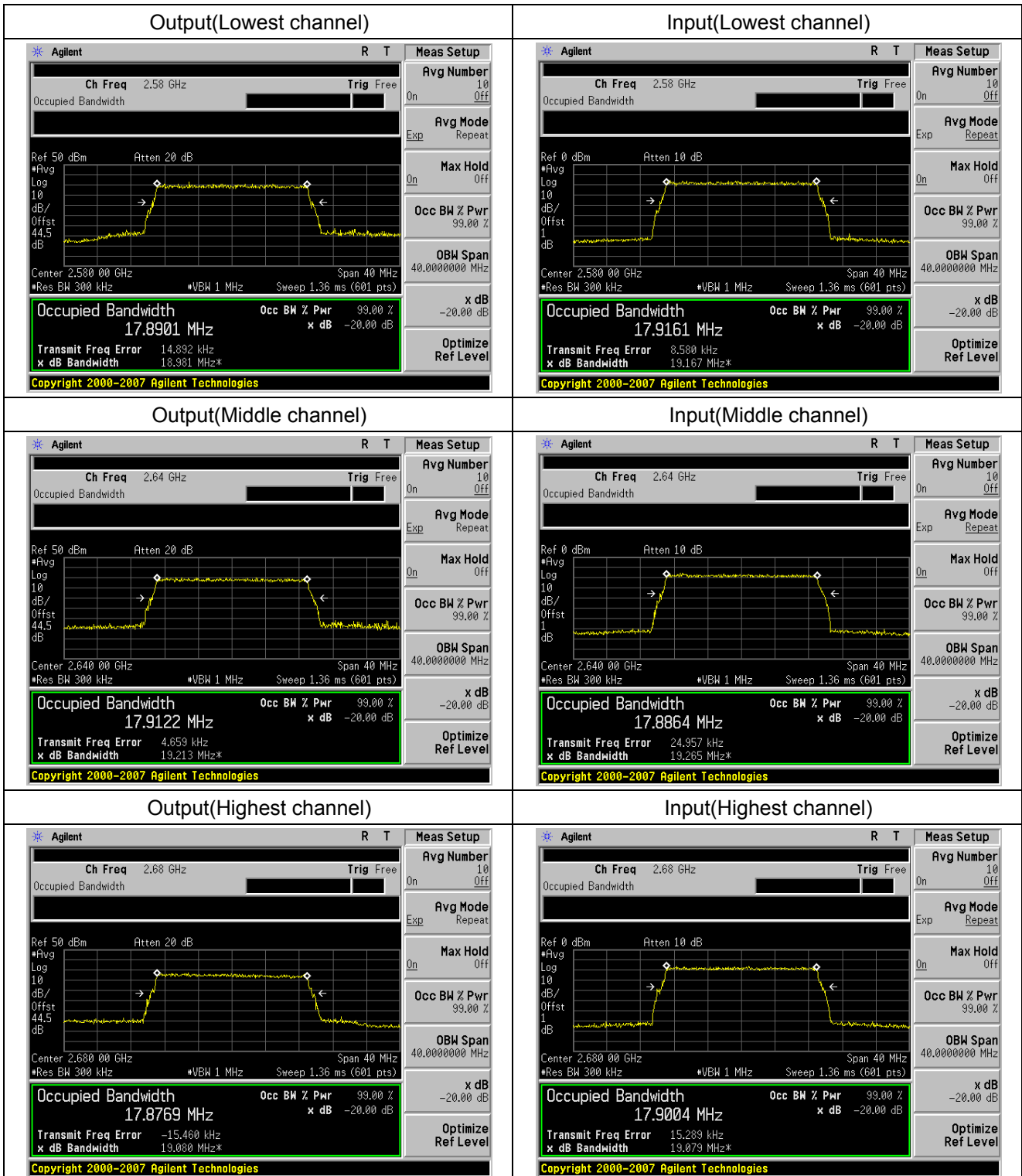

Uplink:

Input/output Bandwidth Comparison for LTE 1.4MHz Bandwidth

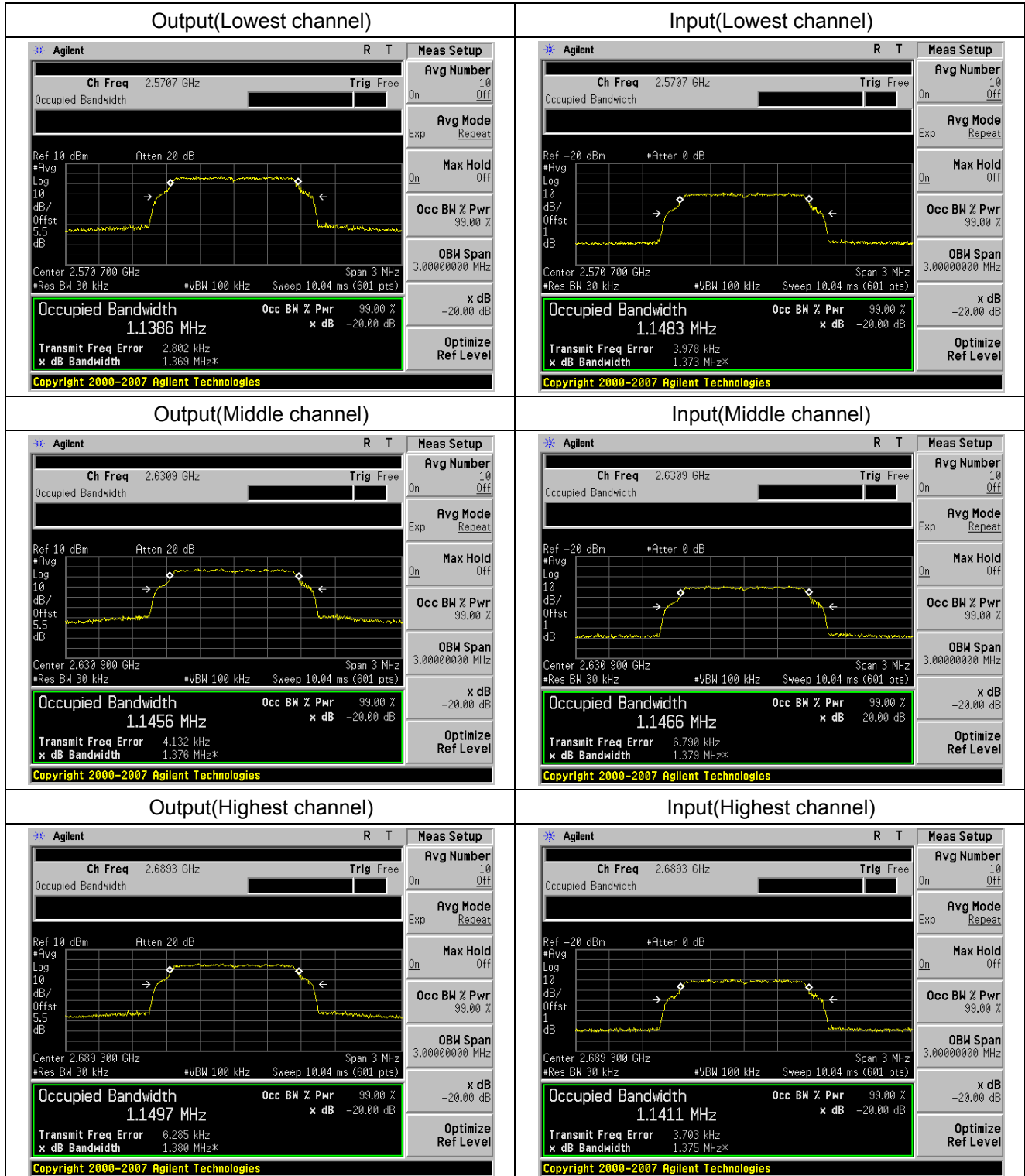

Input/output Bandwidth Comparison for LTE 3MHz Bandwidth

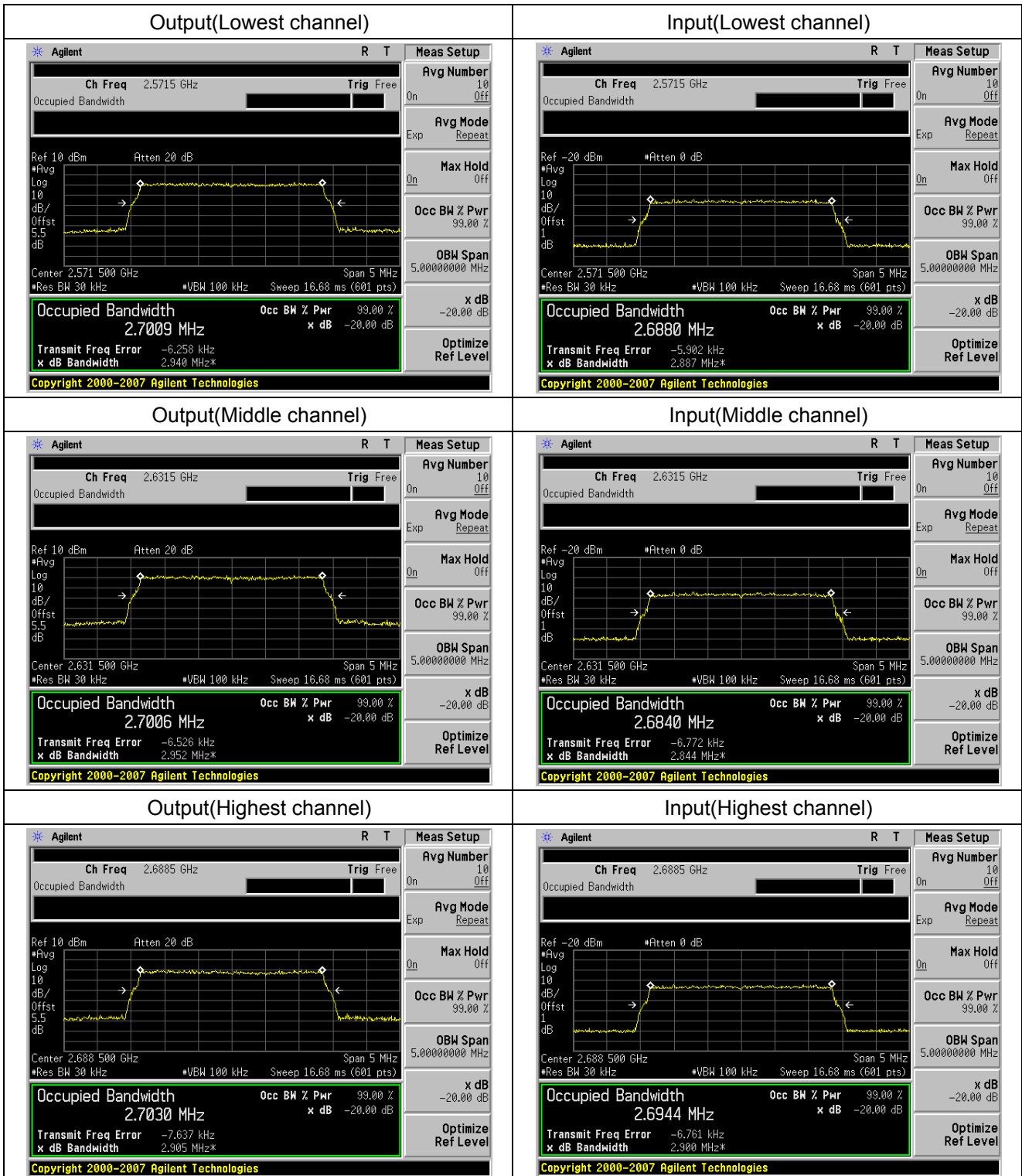

Input/output Bandwidth Comparison for LTE 5MHz Bandwidth

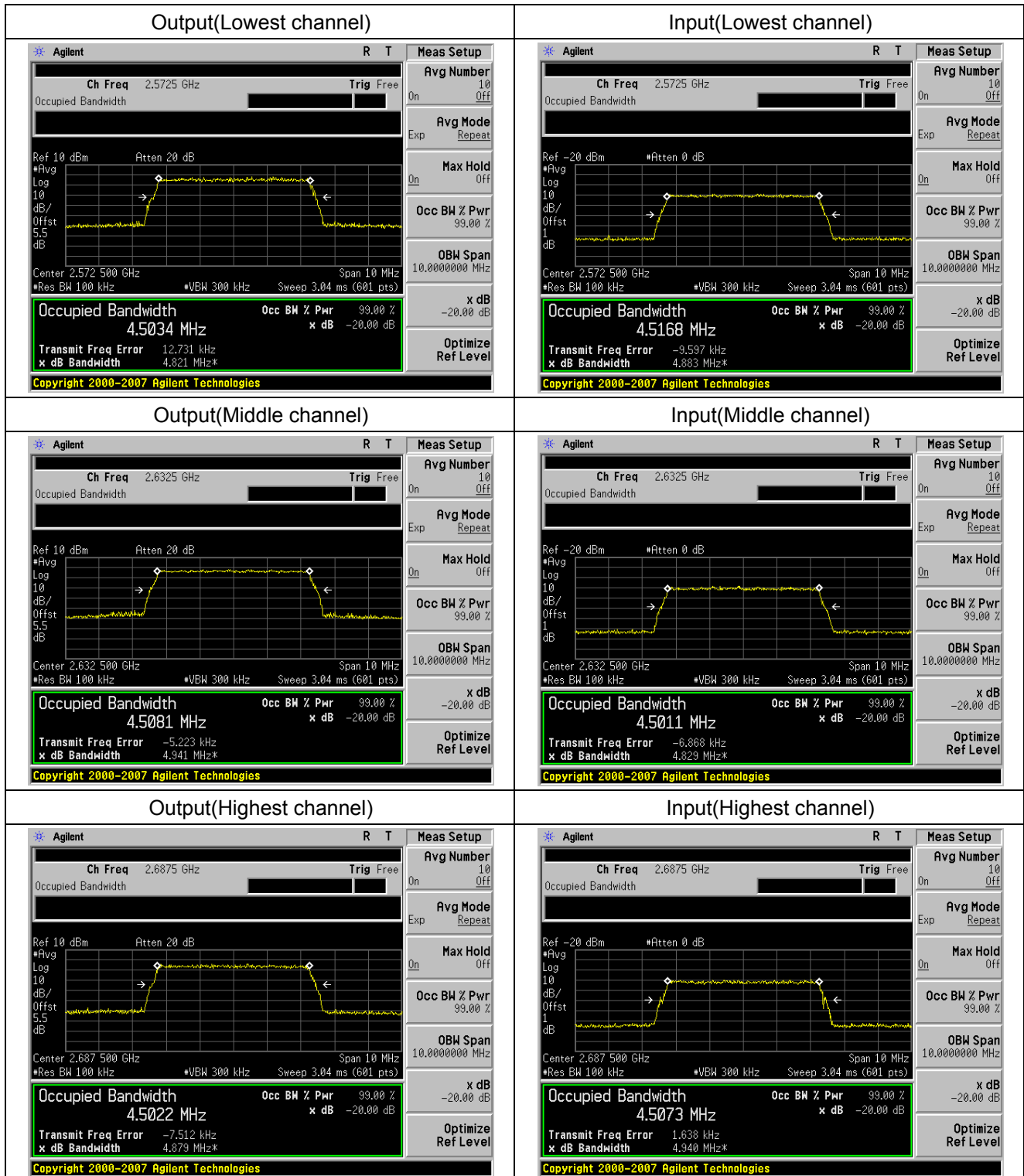

Input/output Bandwidth Comparison for LTE 10MHz Bandwidth

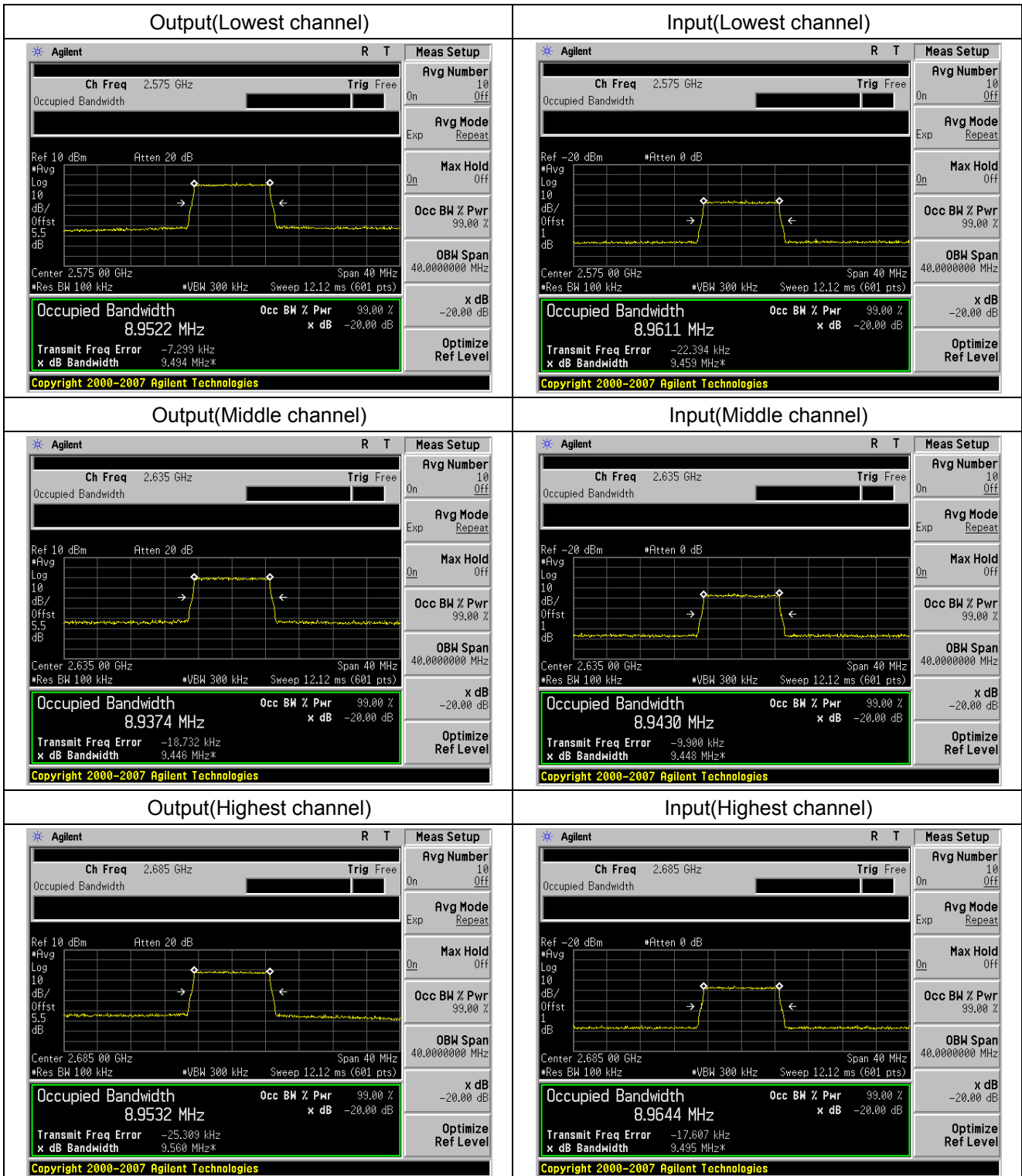

Input/output Bandwidth Comparison for LTE 15MHz Bandwidth

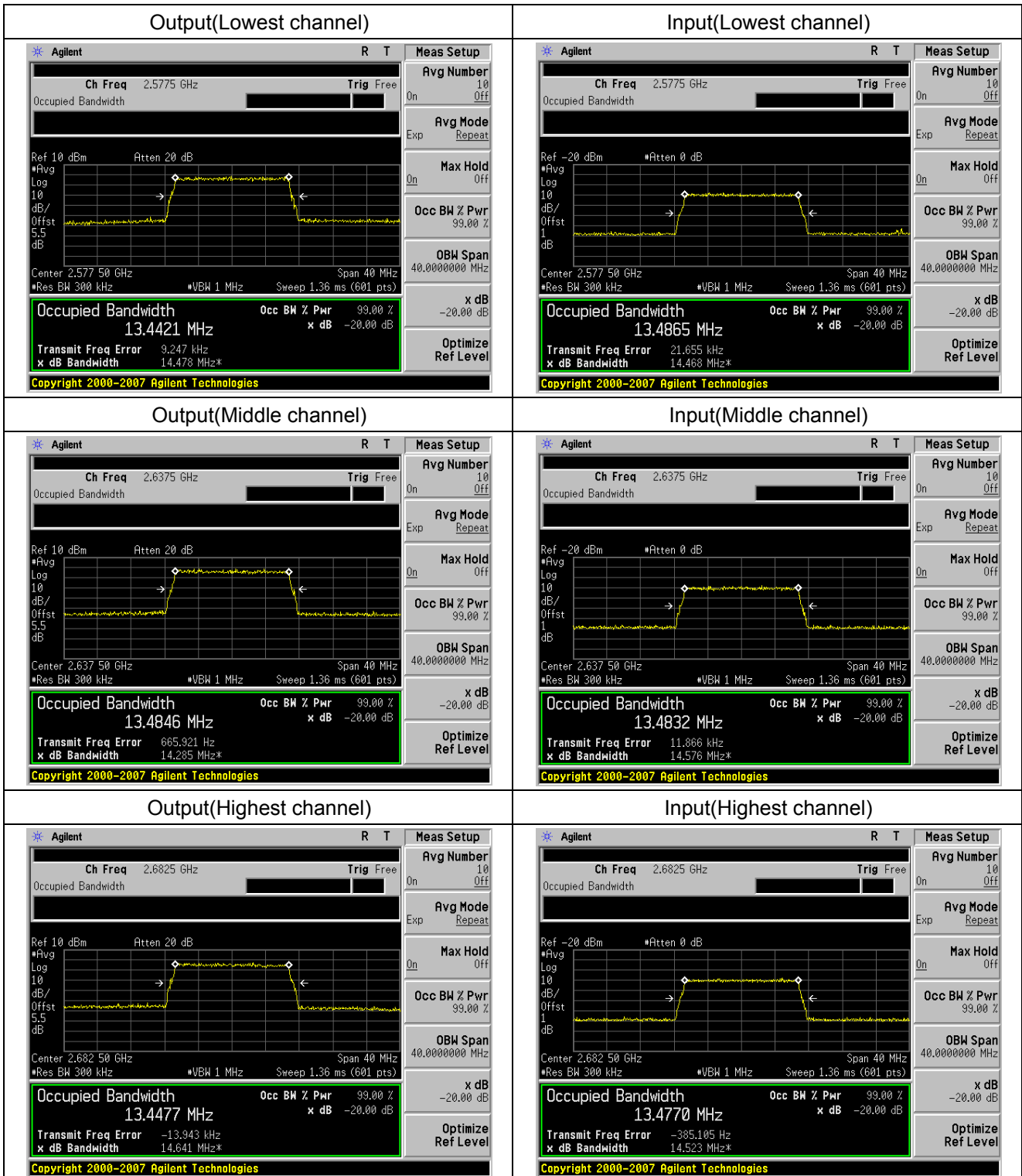

Input/output Bandwidth Comparison for LTE 20MHz Bandwidth

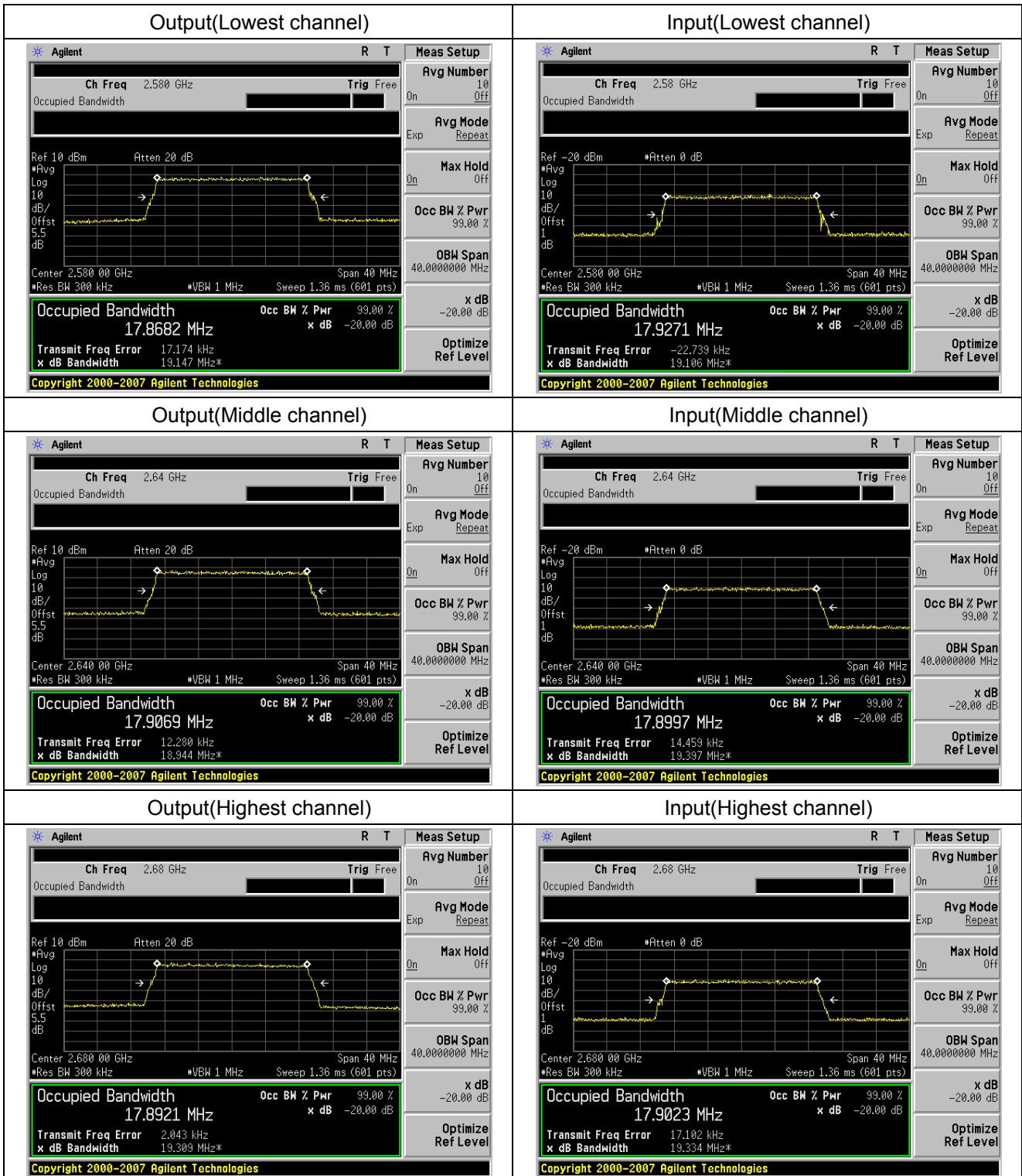

9 OUT OF BAND EMISSION AT ANTENNA TERMINALS

9.1 Standard Applicable

According to FCC § 2.1051 and § 27.53(m)

9.2 Test setup

Please refer the section §6.2 Configuration of Tested System.

9.3 Measurement Procedure

The out of band emissions were measured directly from the EUT antenna output with a spectrum analyzer from 30 MHz to the 10th harmonic of the highest carrier frequency. Test signals used is LTE. The different signals were input one at a time to the EUT. Tests was performed with LTE signal input.

Band edge compliance is also demonstrated using a LTE signal at the upper and lower limits of the band.

1. The EUT RF output port was connected to spectrum analyzer.
2. The level of RF input signal shall be increased, until the maximum output power per channel, declared by client, is reached.
3. The spurious emissions at antenna were measured at the RF output port of the EUT at middle channel of each type of modulation.

Spectrum analyzer settings:

Detector: RMS.

> 1 MHz from Band Edge

Below 1G: RBW=100kHz; VBW=300KHz; Above 1G: RBW=1 MHz ; VBW≥ RBW

< 1 MHz from Band Edge

RBW=3 kHz; VBW≥ RBW

9.4 Measurement Result

9.4.1 Spurious emission

Downlink:

Spurious emission of LTE 1.4MHz Bandwidth

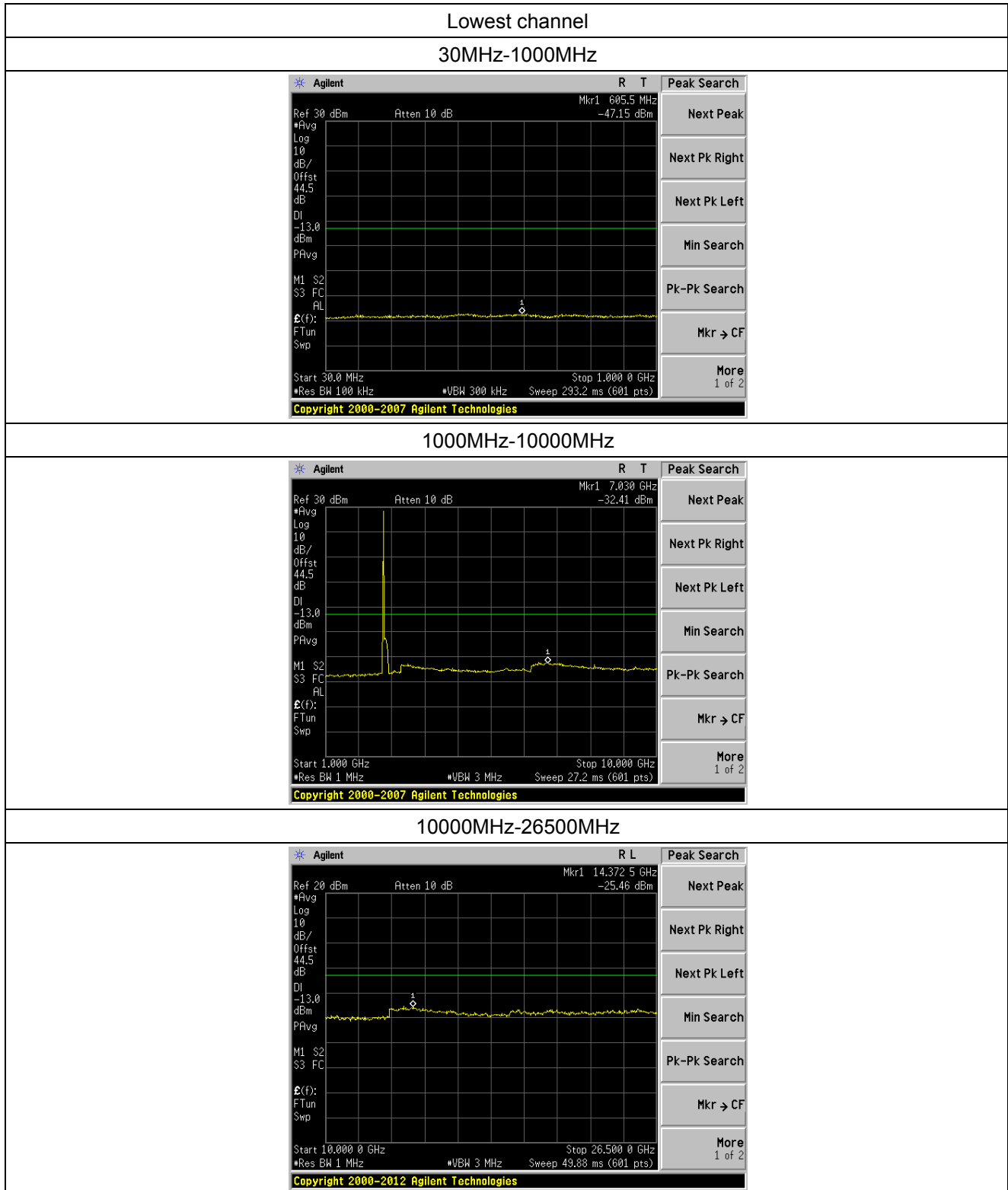

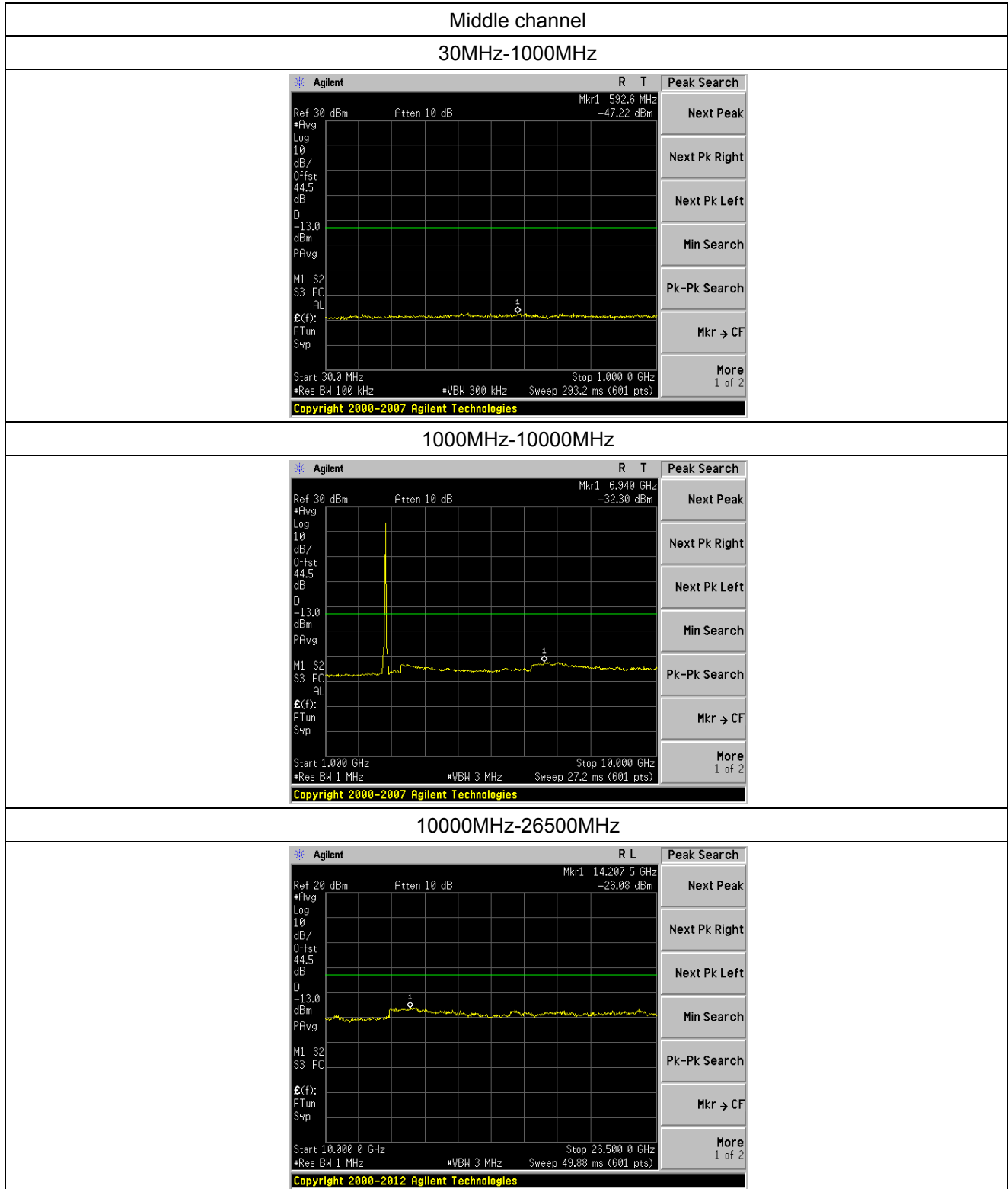

Highest channel

30MHz-1000MHz

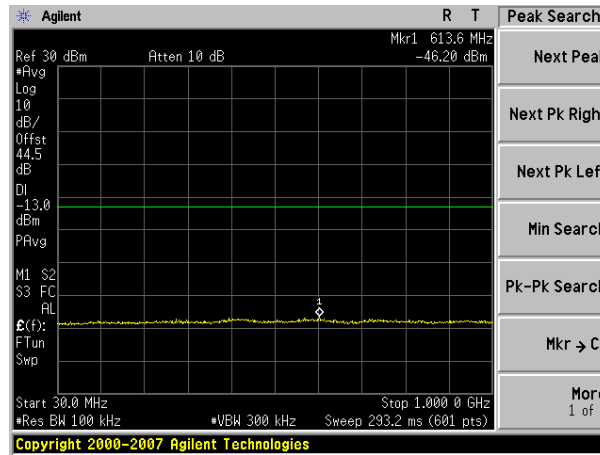

1000MHz-10000MHz

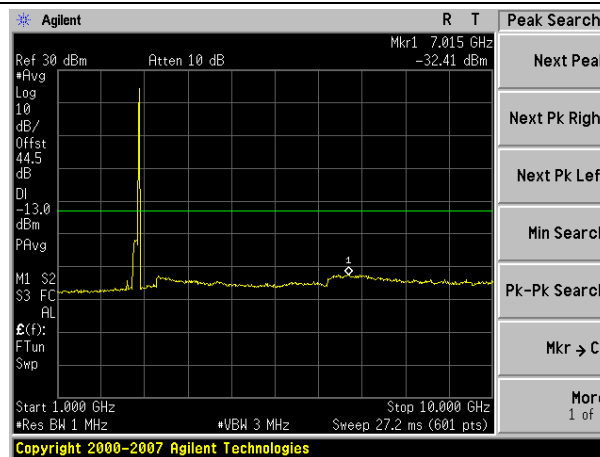

10000MHz-26500MHz

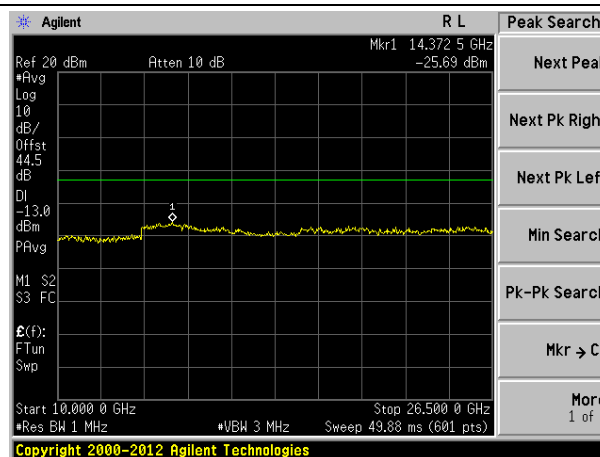

Spurious emission of LTE 3MHz Bandwidth

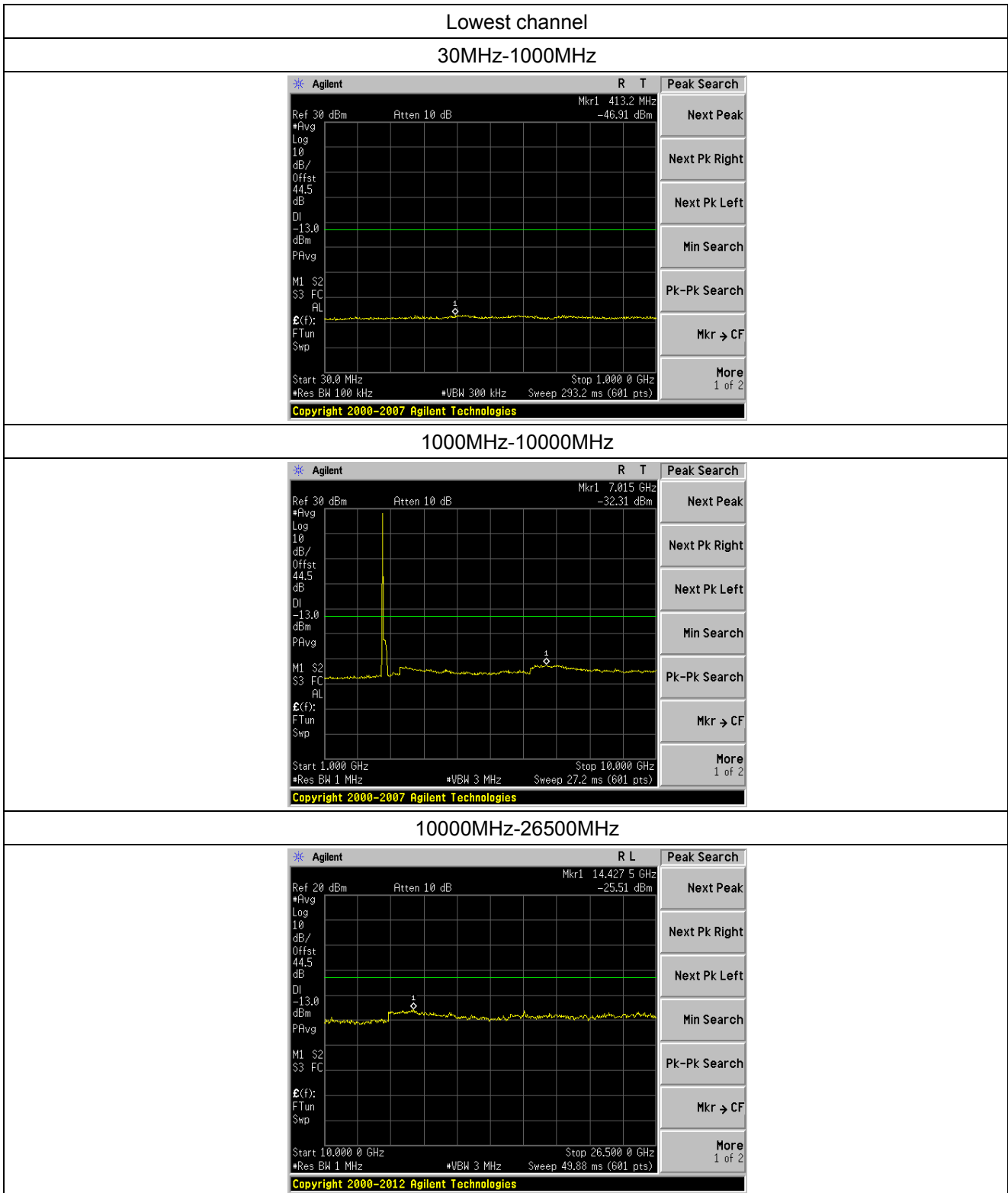

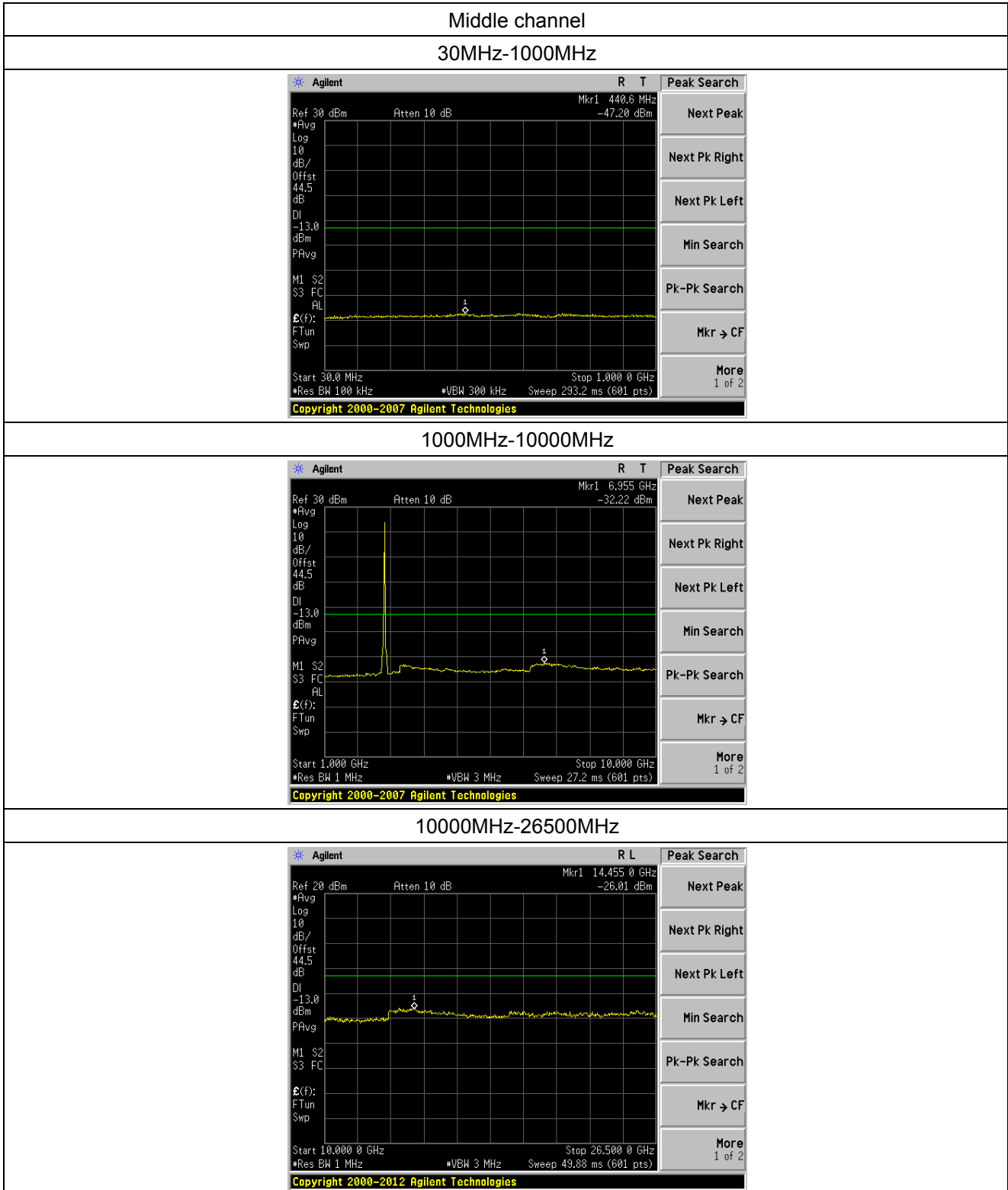

Highest channel

30MHz-1000MHz

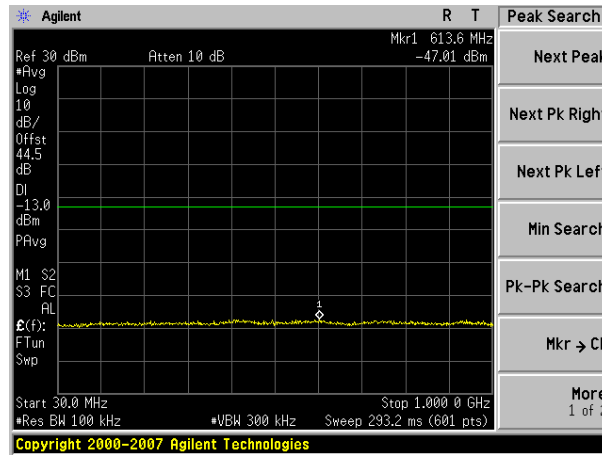

1000MHz-10000MHz

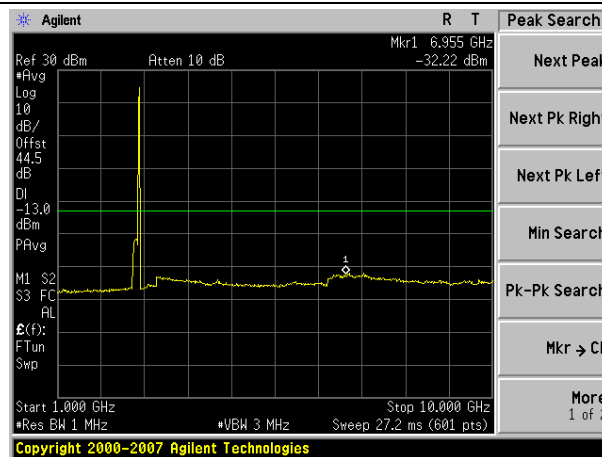

10000MHz-26500MHz

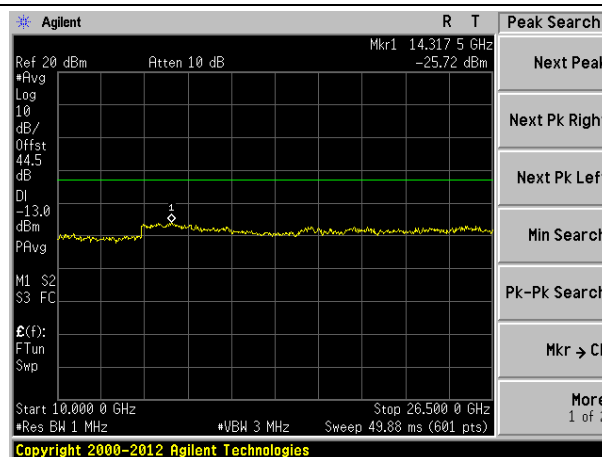

Spurious emission of LTE 5MHz Bandwidth

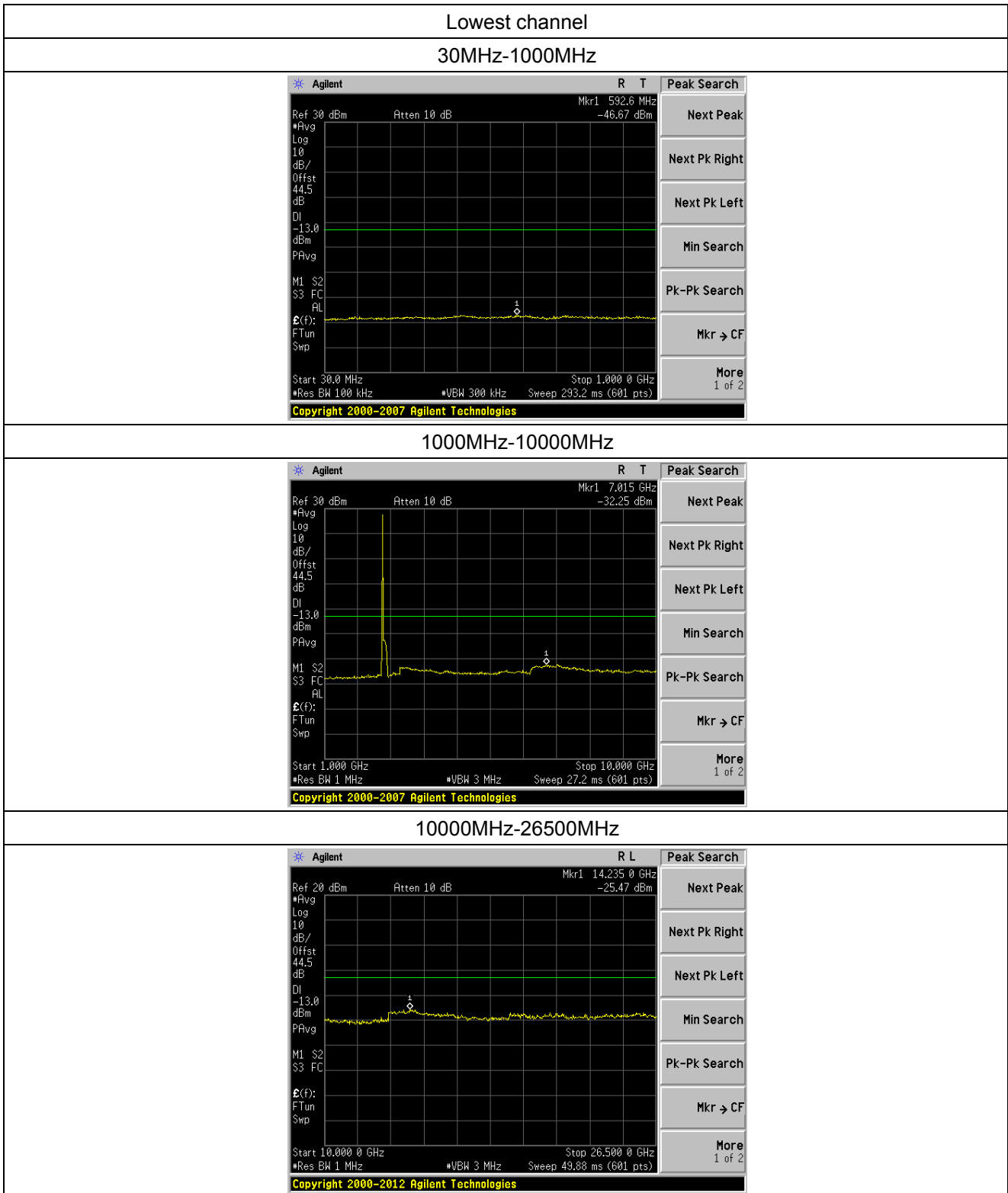

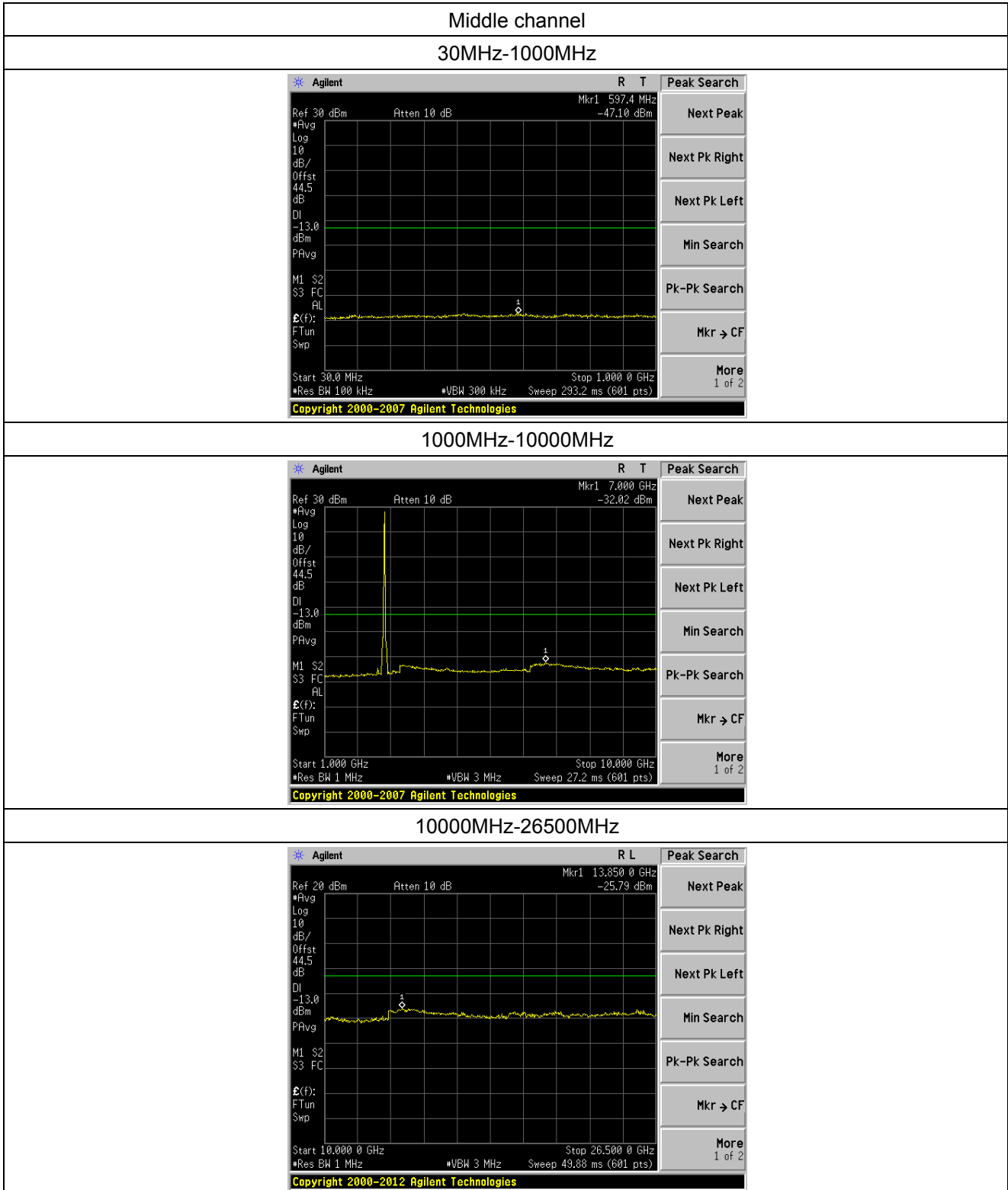

Highest channel

30MHz-1000MHz

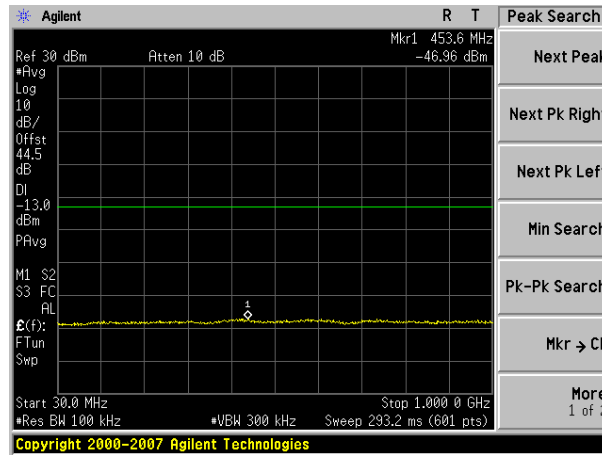

1000MHz-10000MHz

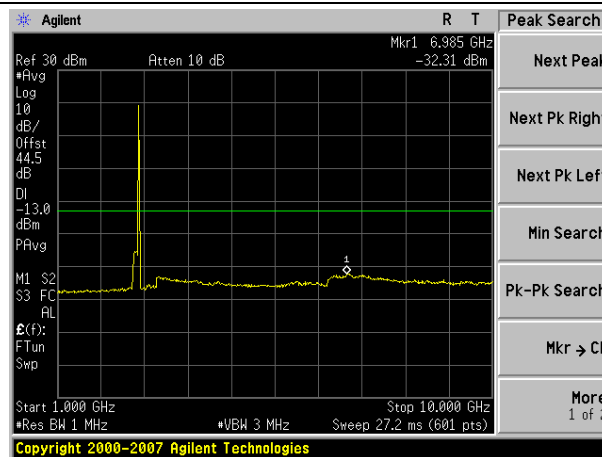

10000MHz-26500MHz

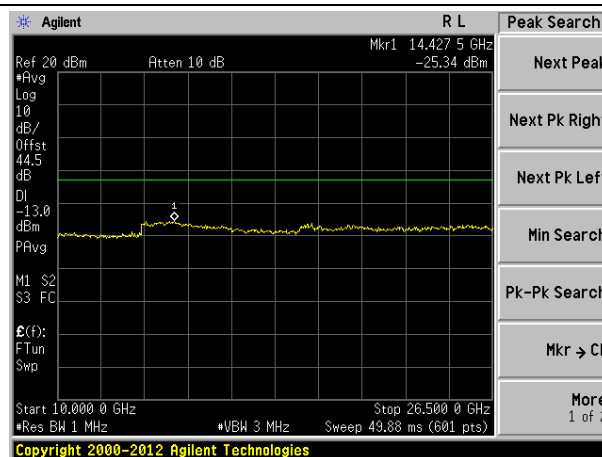

Spurious emission of LTE 10MHz Bandwidth

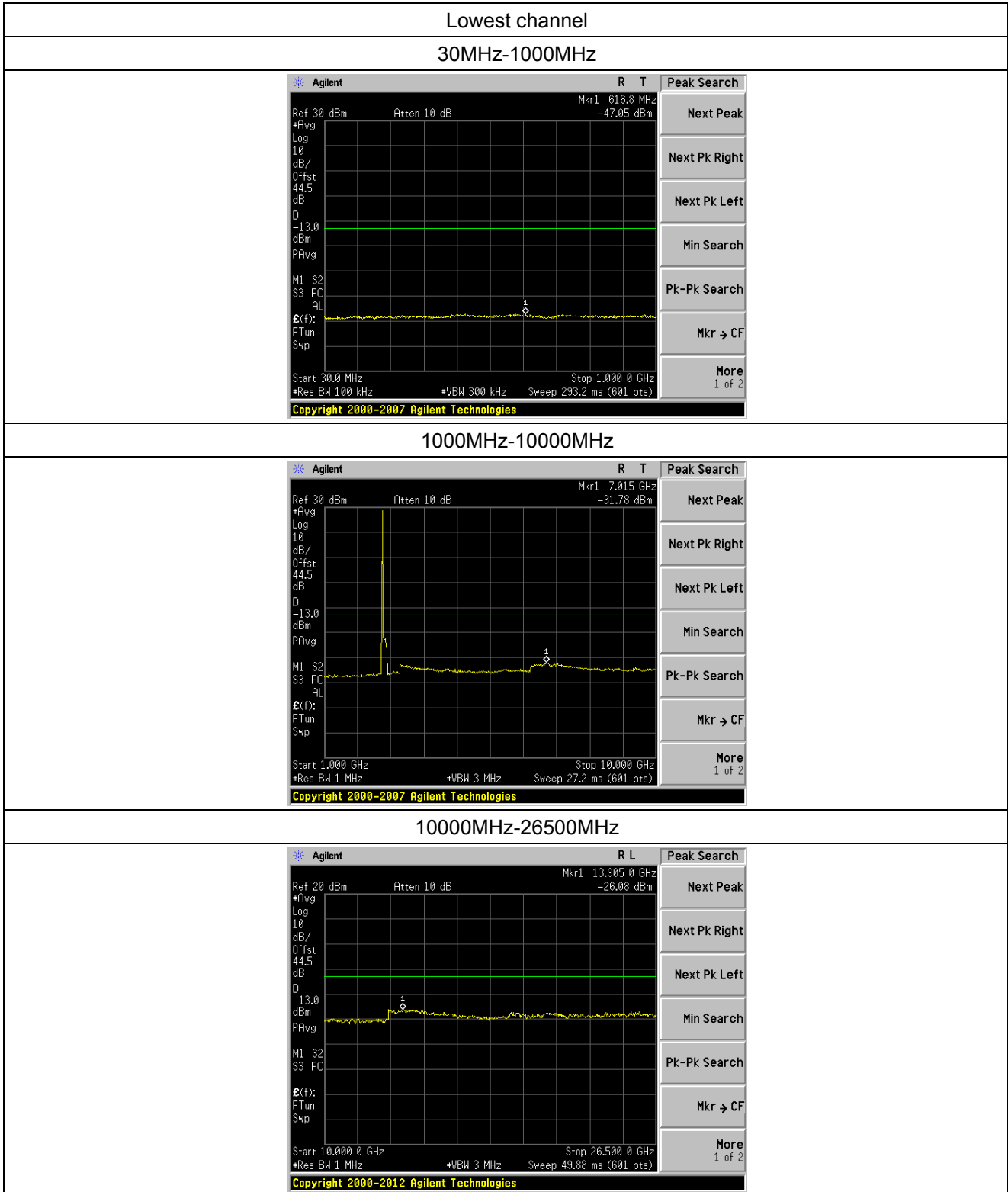

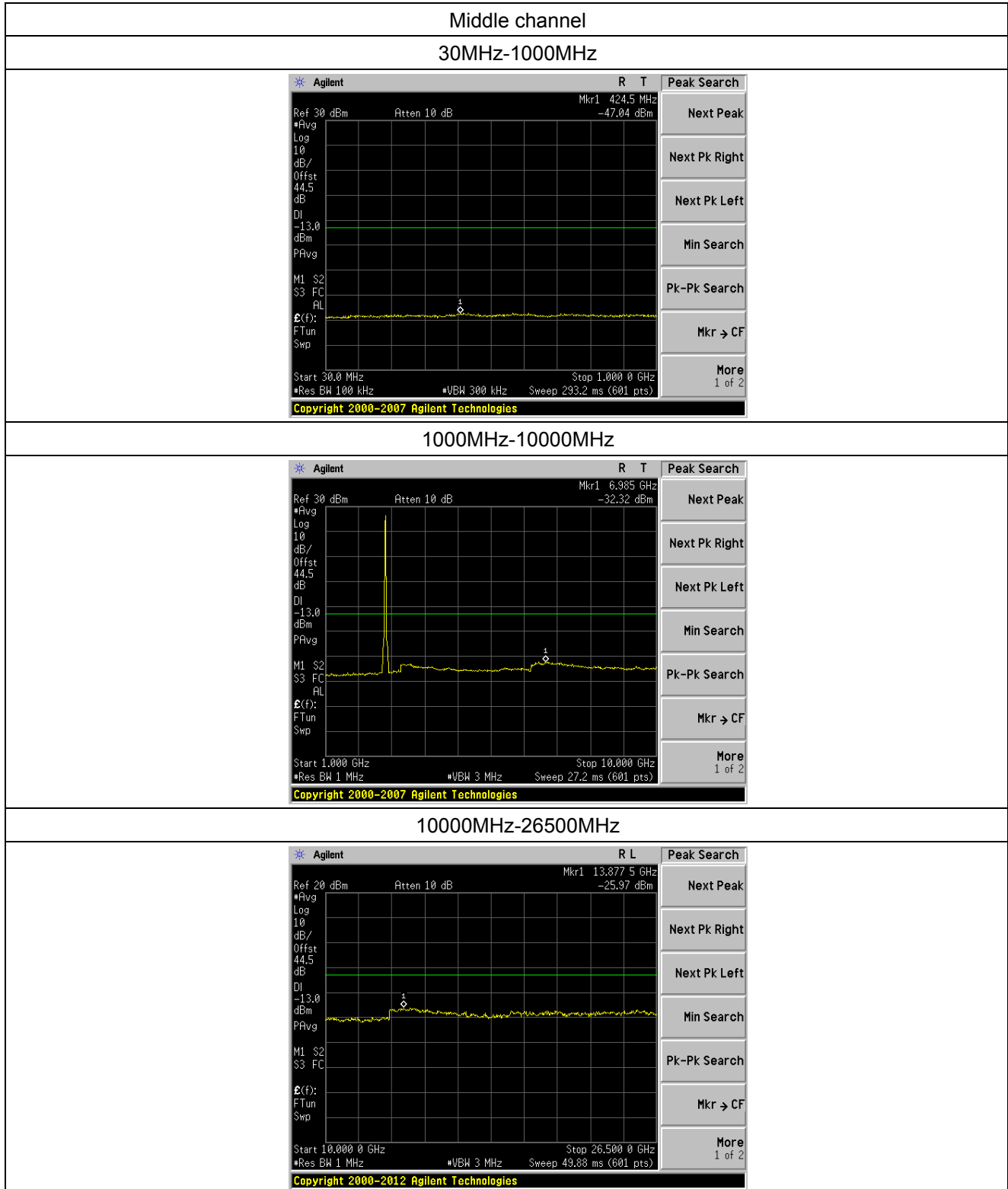

Highest channel

30MHz-1000MHz

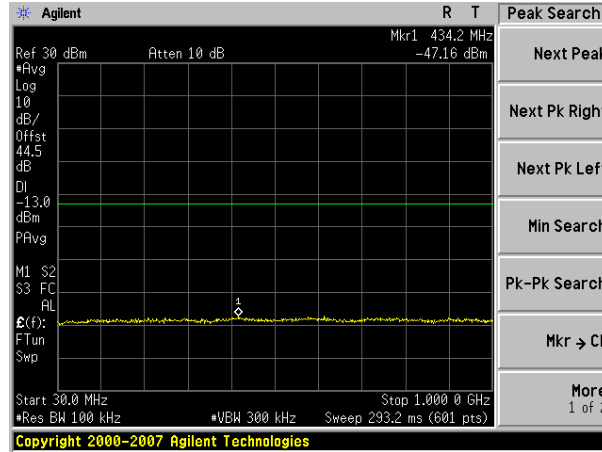

1000MHz-10000MHz

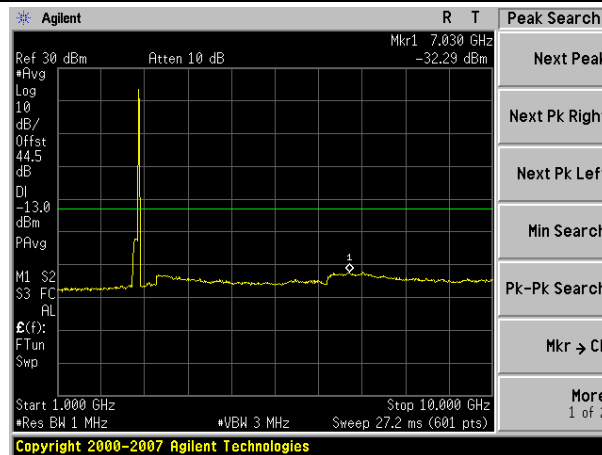

10000MHz-26500MHz

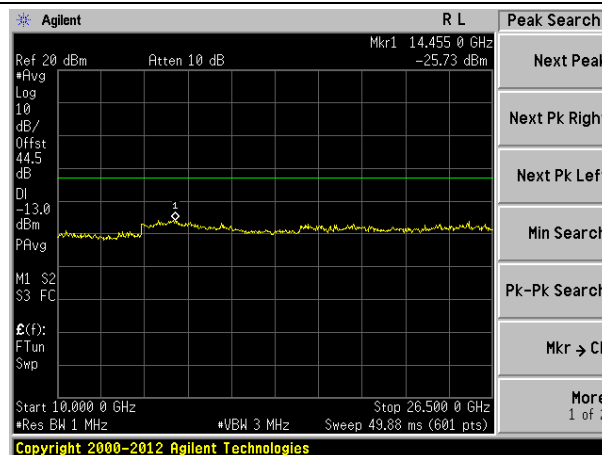

Spurious emission of LTE 15MHz Bandwidth

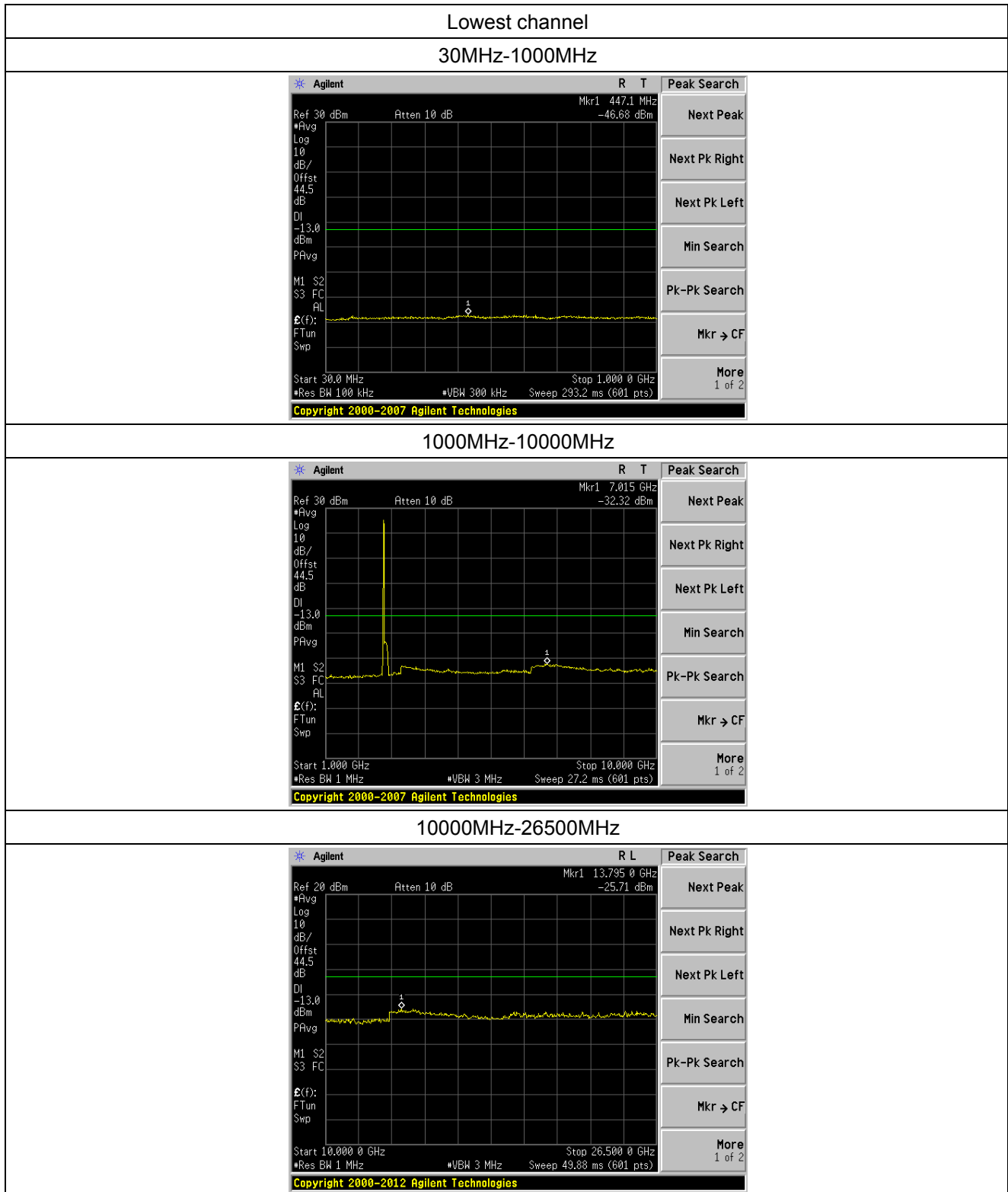

Middle channel

30MHz-1000MHz

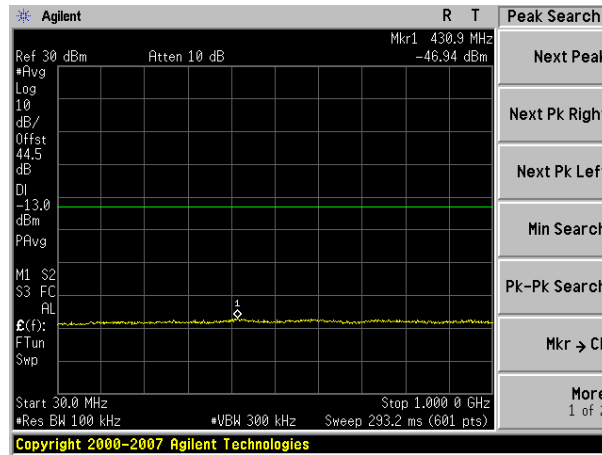

1000MHz-10000MHz

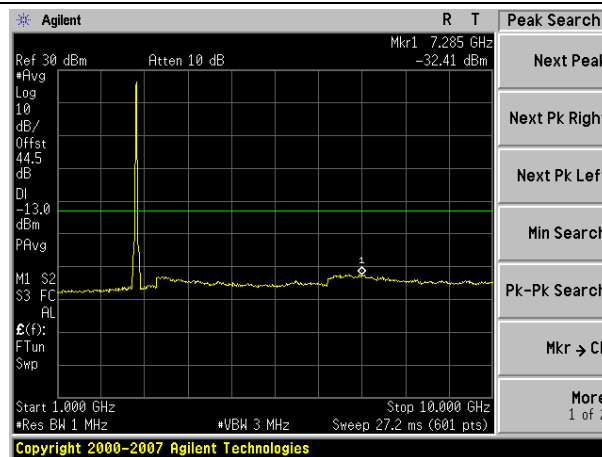

10000MHz-26500MHz

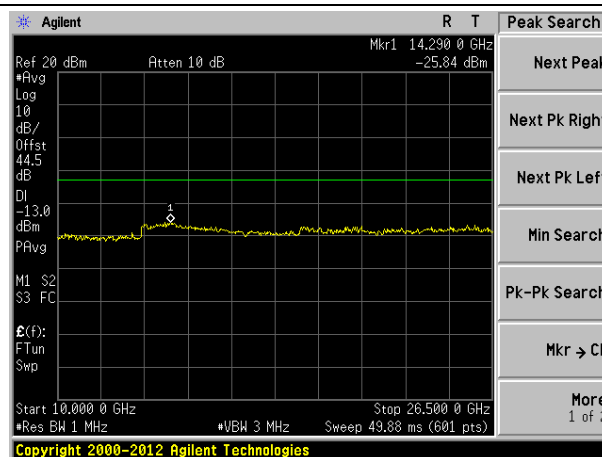

Highest channel

30MHz-1000MHz

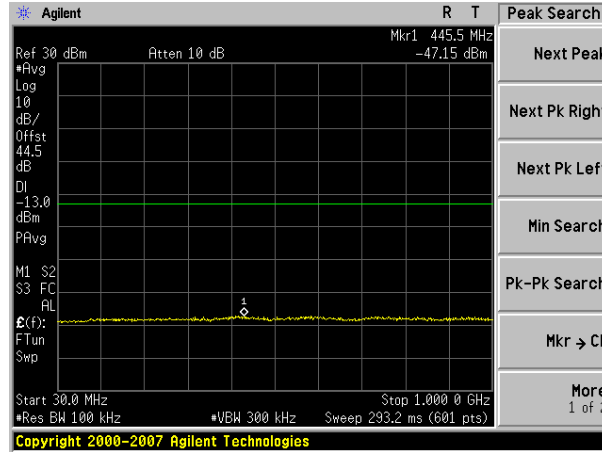

1000MHz-10000MHz

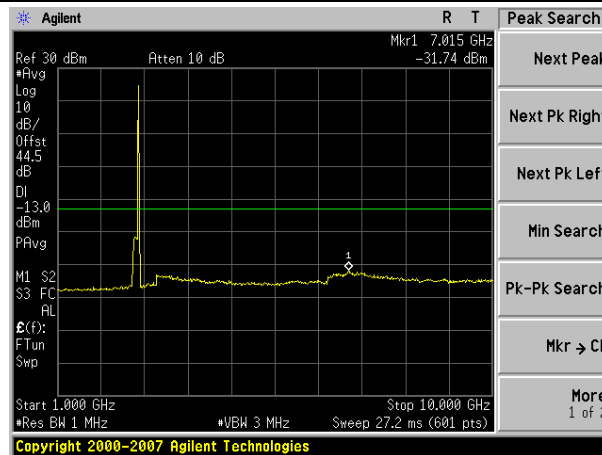

10000MHz-26500MHz

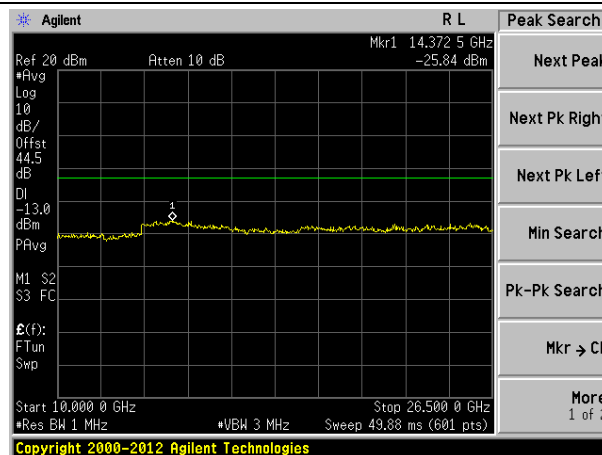

Spurious emission of LTE 20MHz Bandwidth

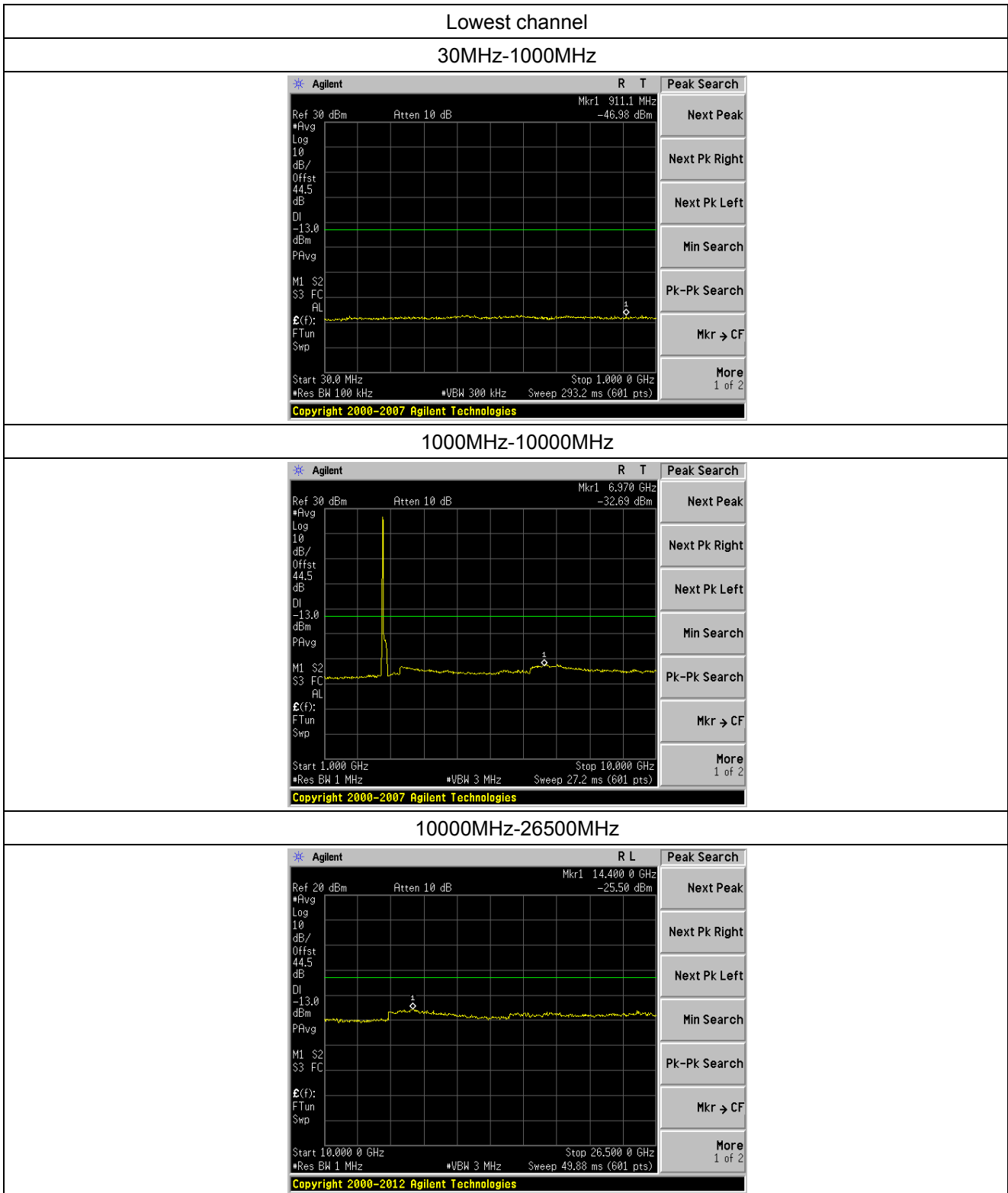

Middle channel

30MHz-1000MHz

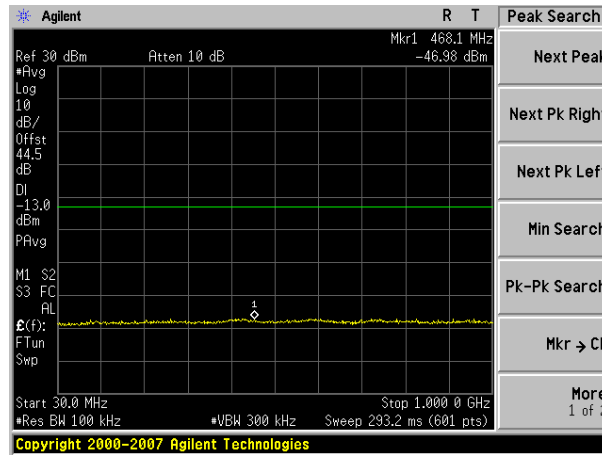

1000MHz-10000MHz

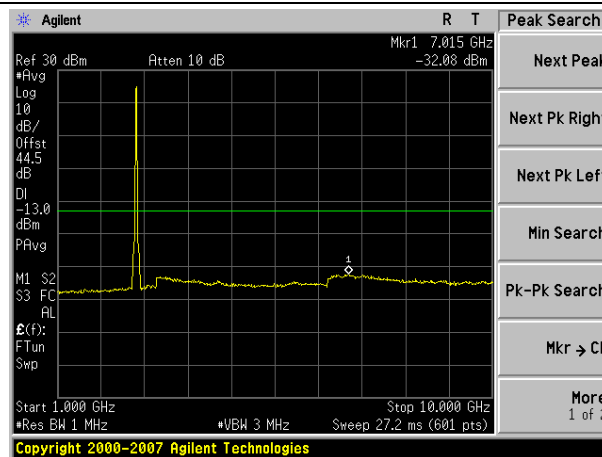

10000MHz-26500MHz

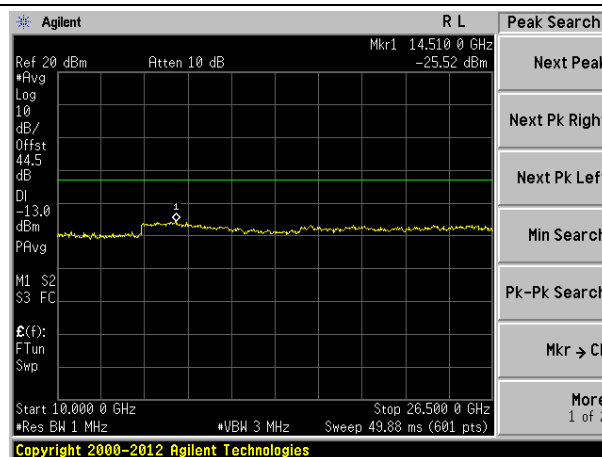

Highest channel

30MHz-1000MHz

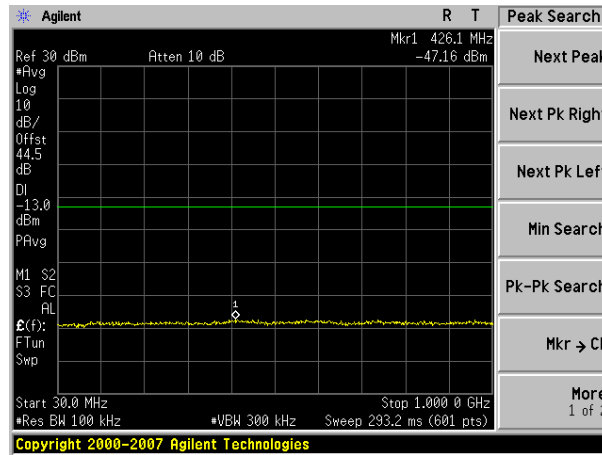

1000MHz-10000MHz

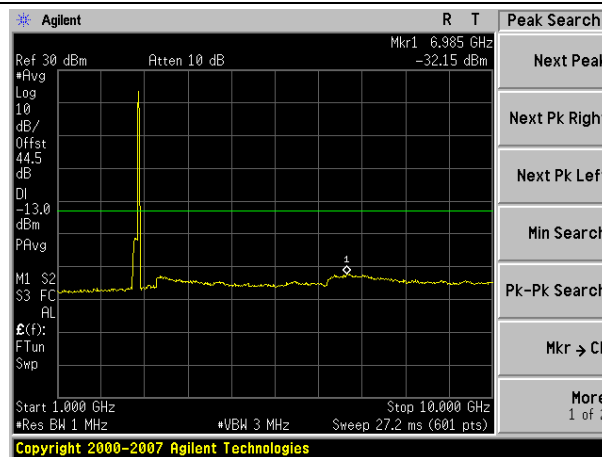

10000MHz-26500MHz

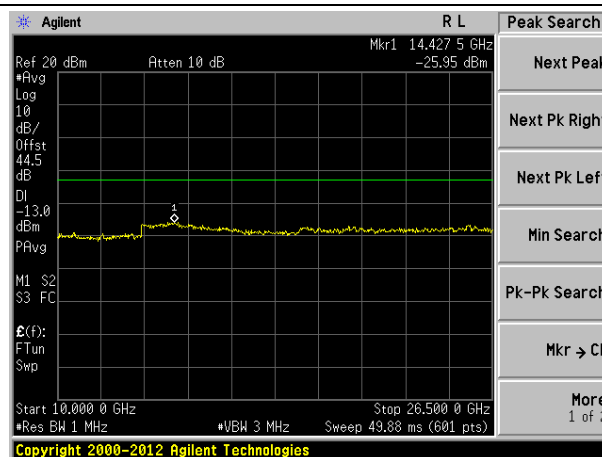

Uplink:

Spurious emission of LTE 1.4MHz Bandwidth

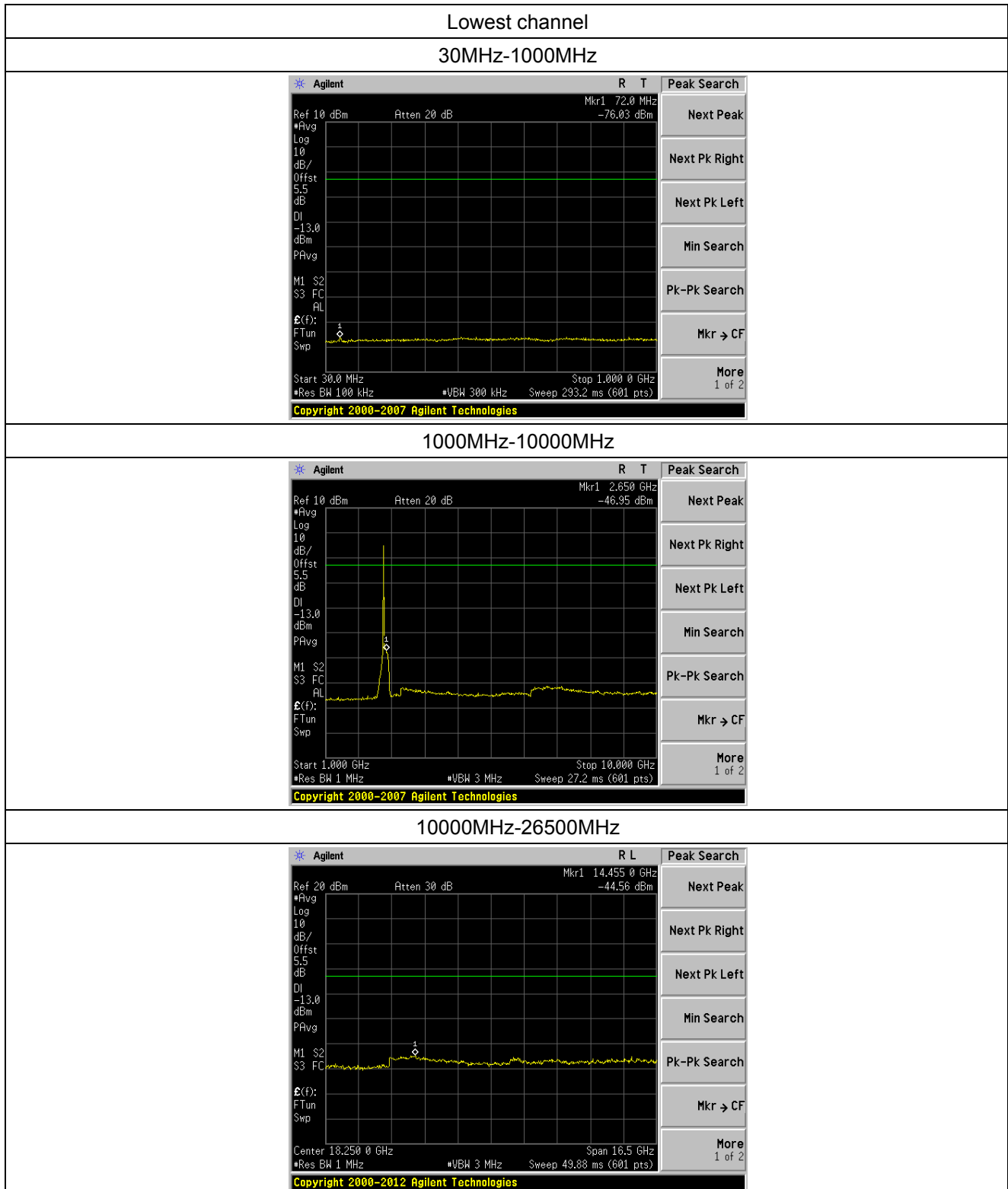

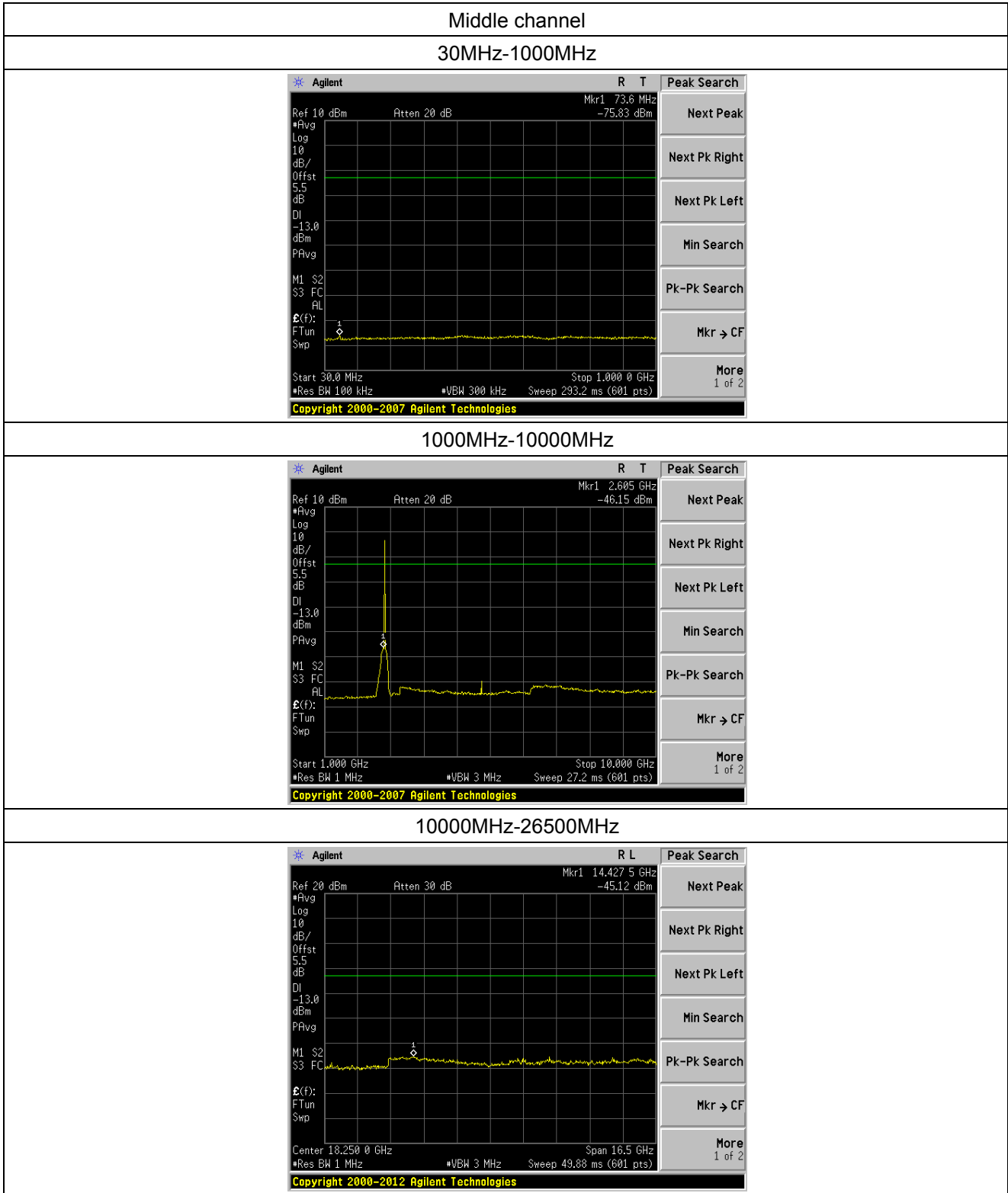

Highest channel

30MHz-1000MHz

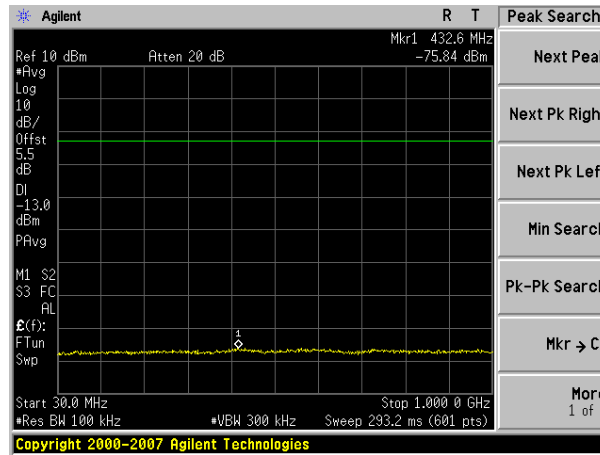

1000MHz-10000MHz

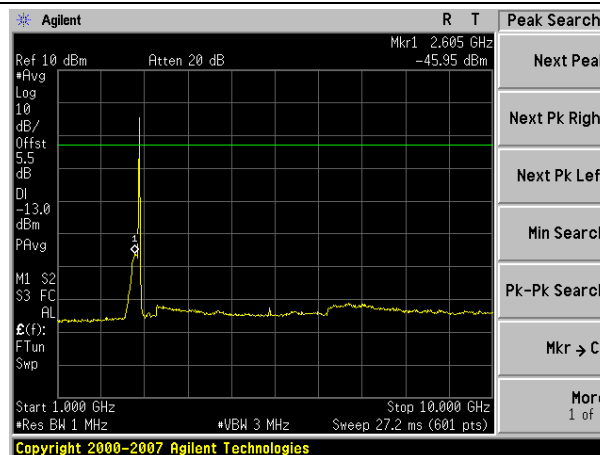

10000MHz-26500MHz

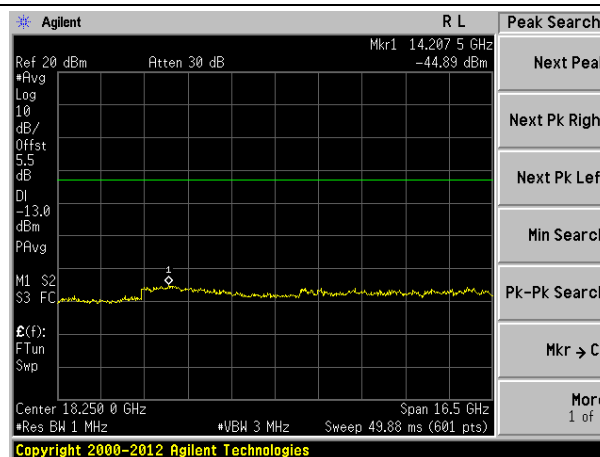

Spurious emission of LTE 3MHz Bandwidth

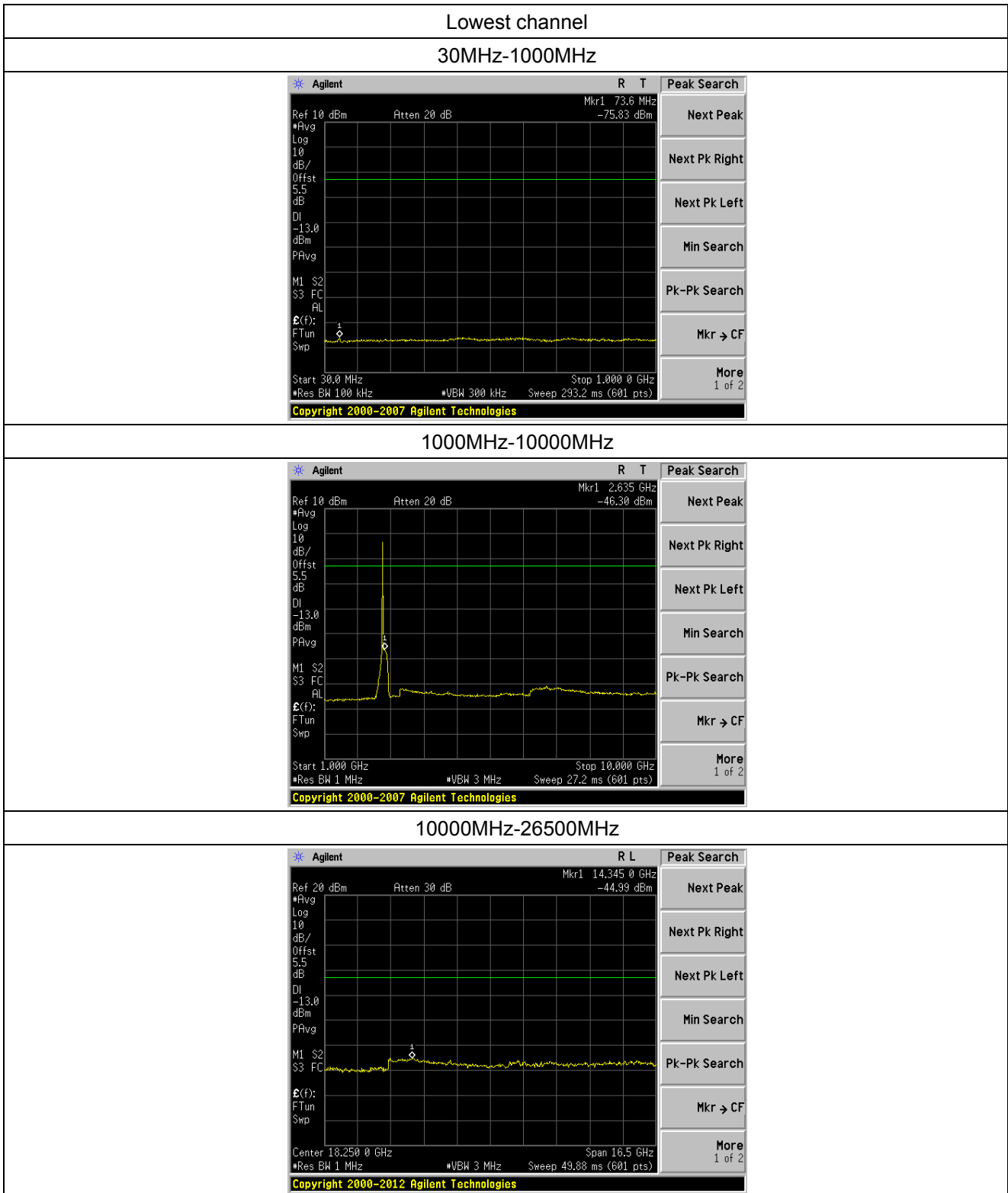

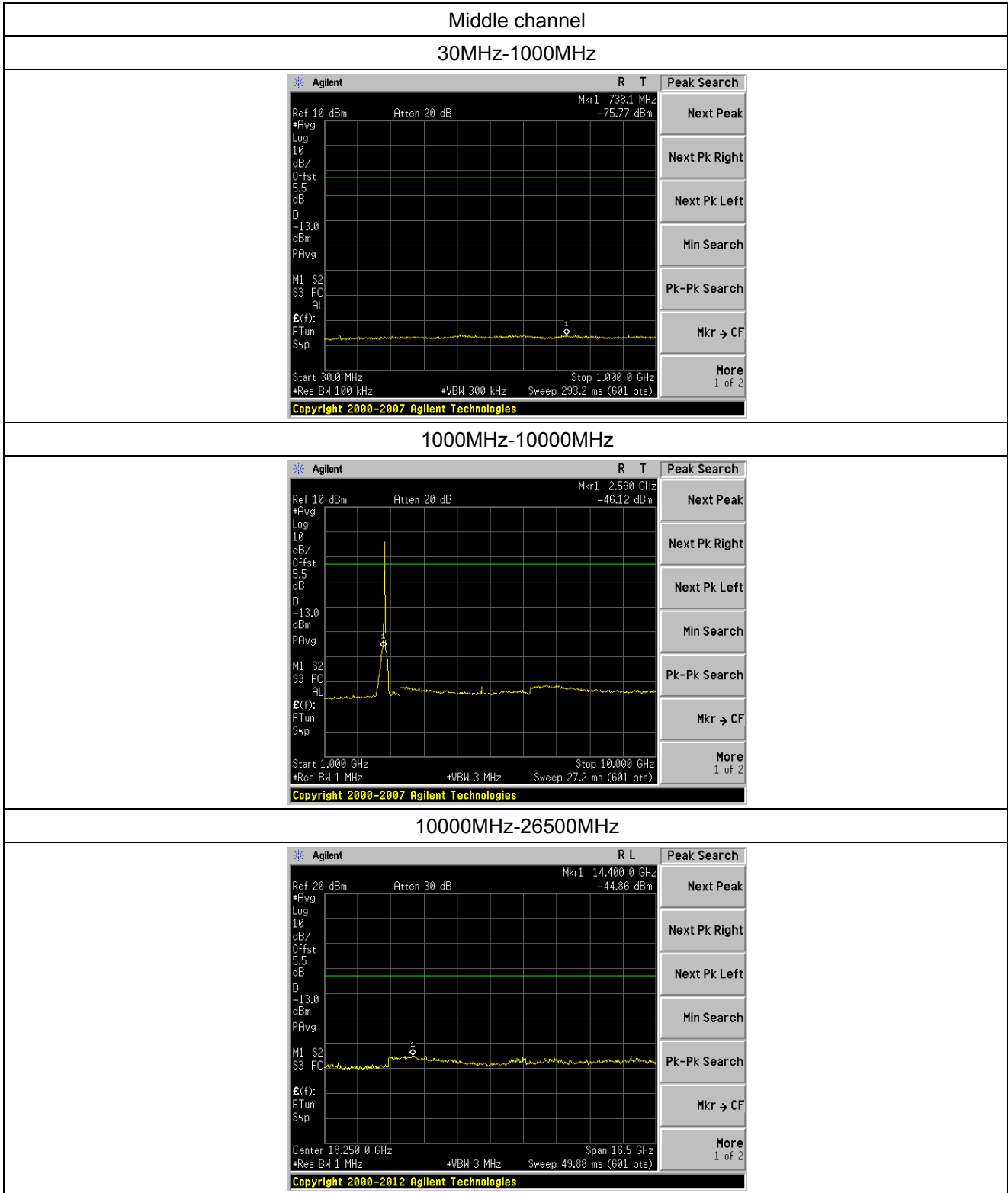

Highest channel

30MHz-1000MHz

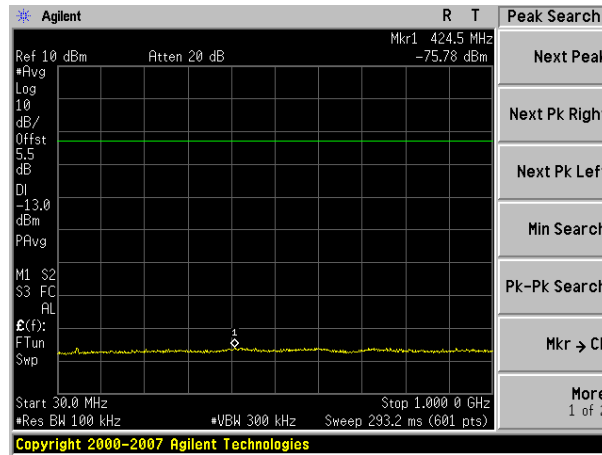

1000MHz-10000MHz

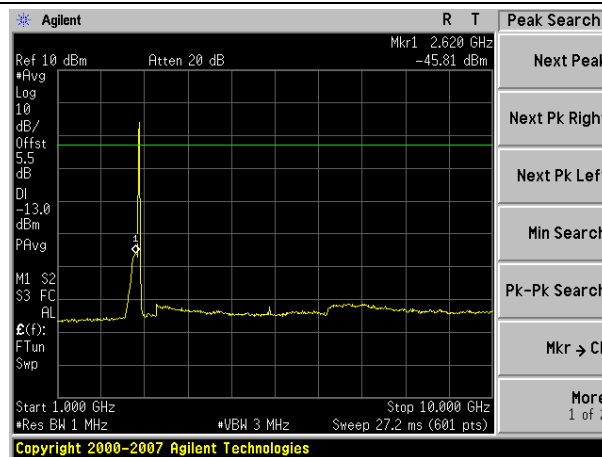

10000MHz-26500MHz

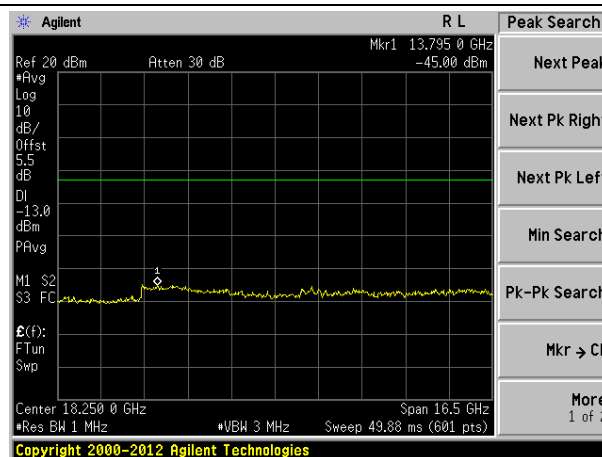

Spurious emission of LTE 5MHz Bandwidth

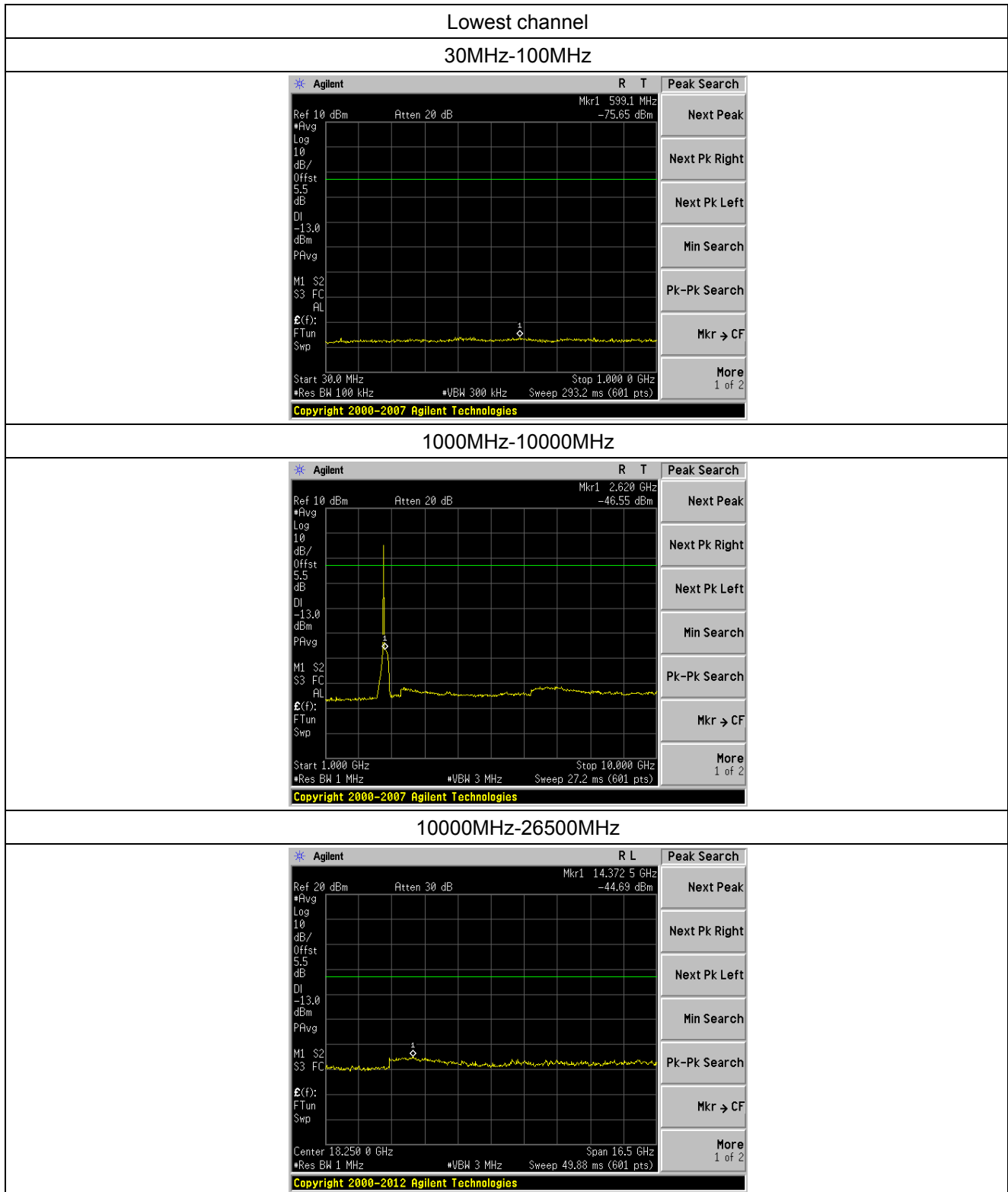

Middle channel

30MHz-1000MHz

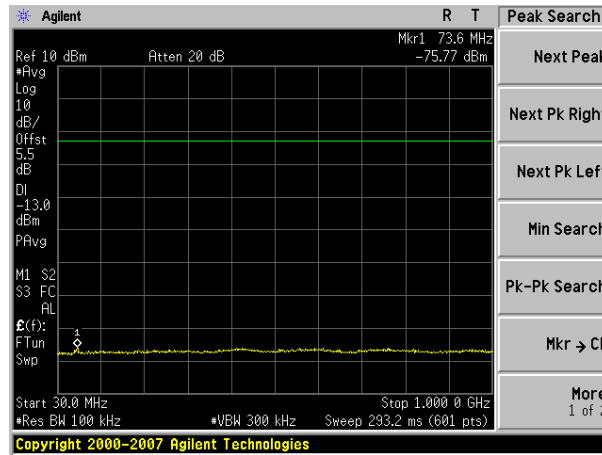

1000MHz-10000MHz

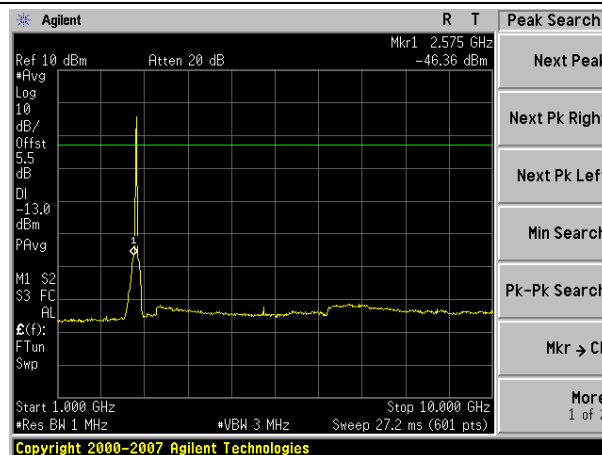

10000MHz-26500MHz

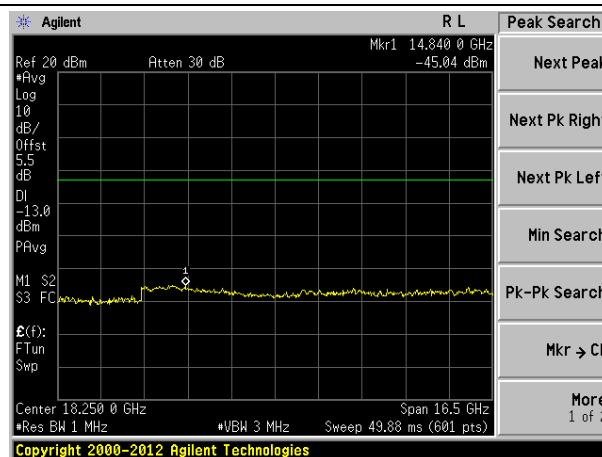

Highest channel

30MHz-1000MHz

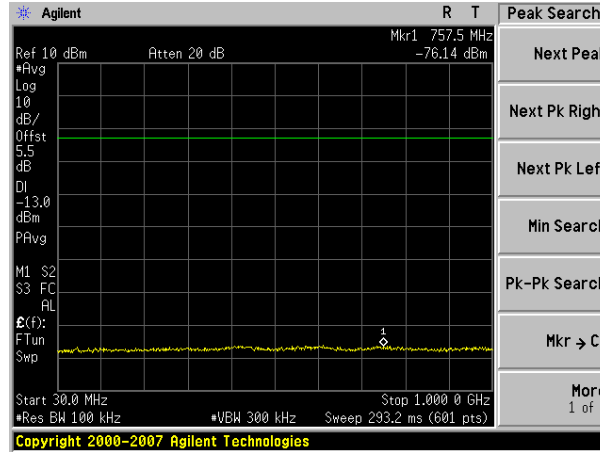

1000MHz-10000MHz

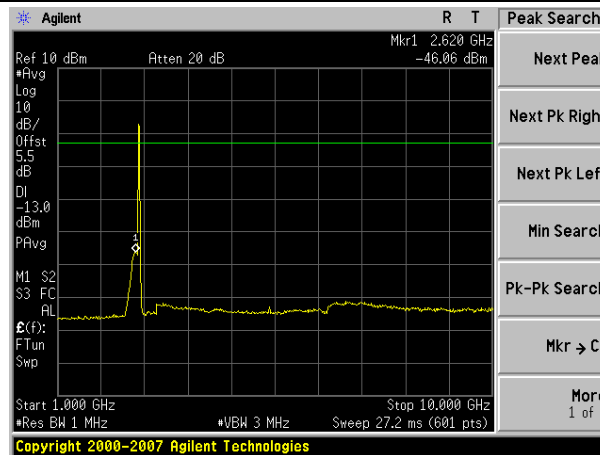

10000MHz-26500MHz

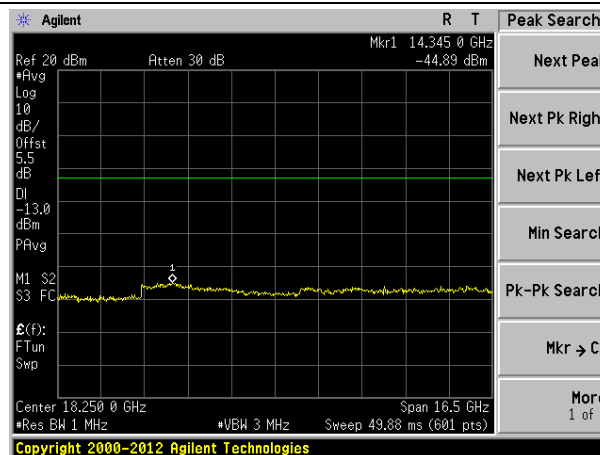

Spurious emission of LTE 10MHz Bandwidth

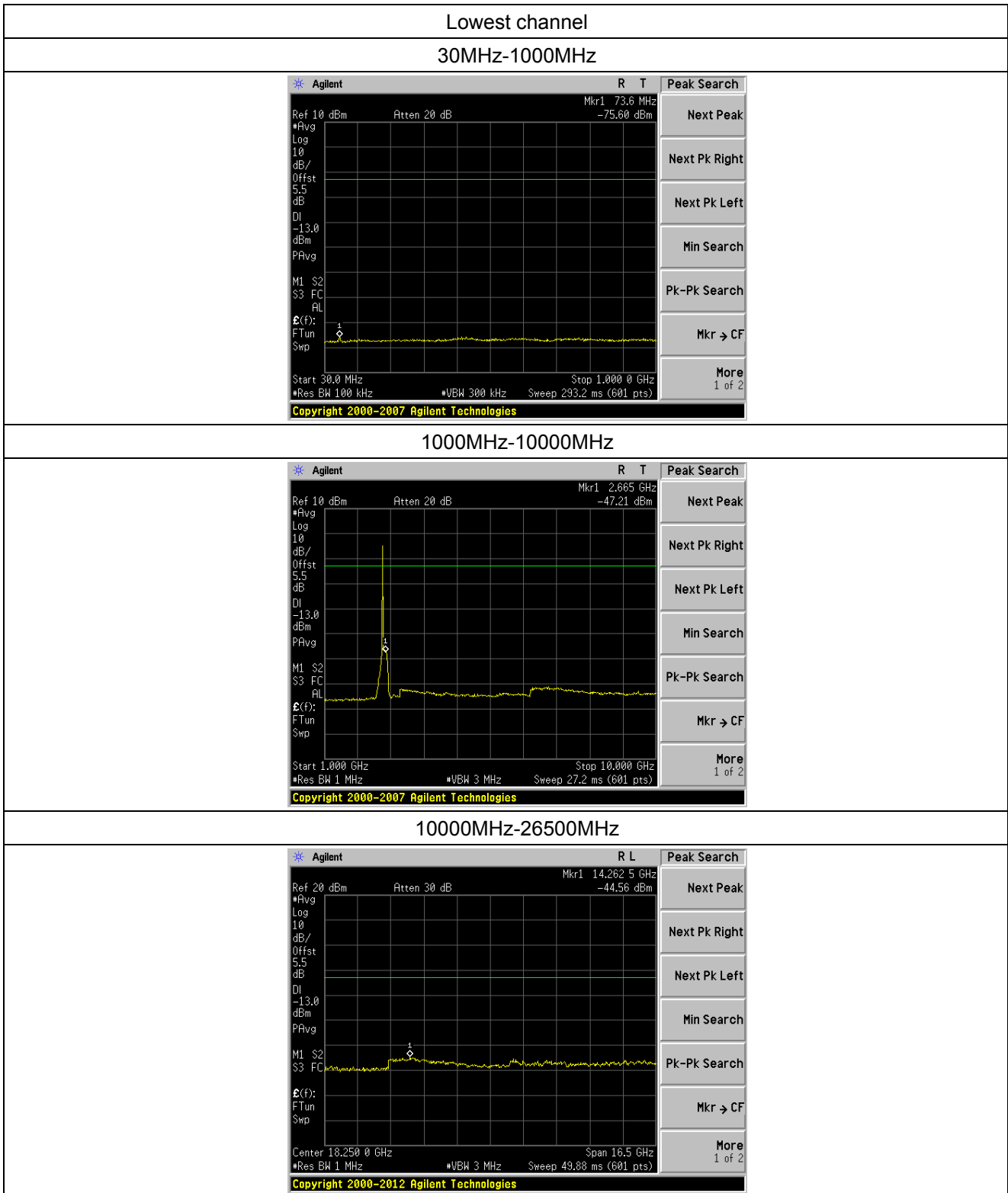

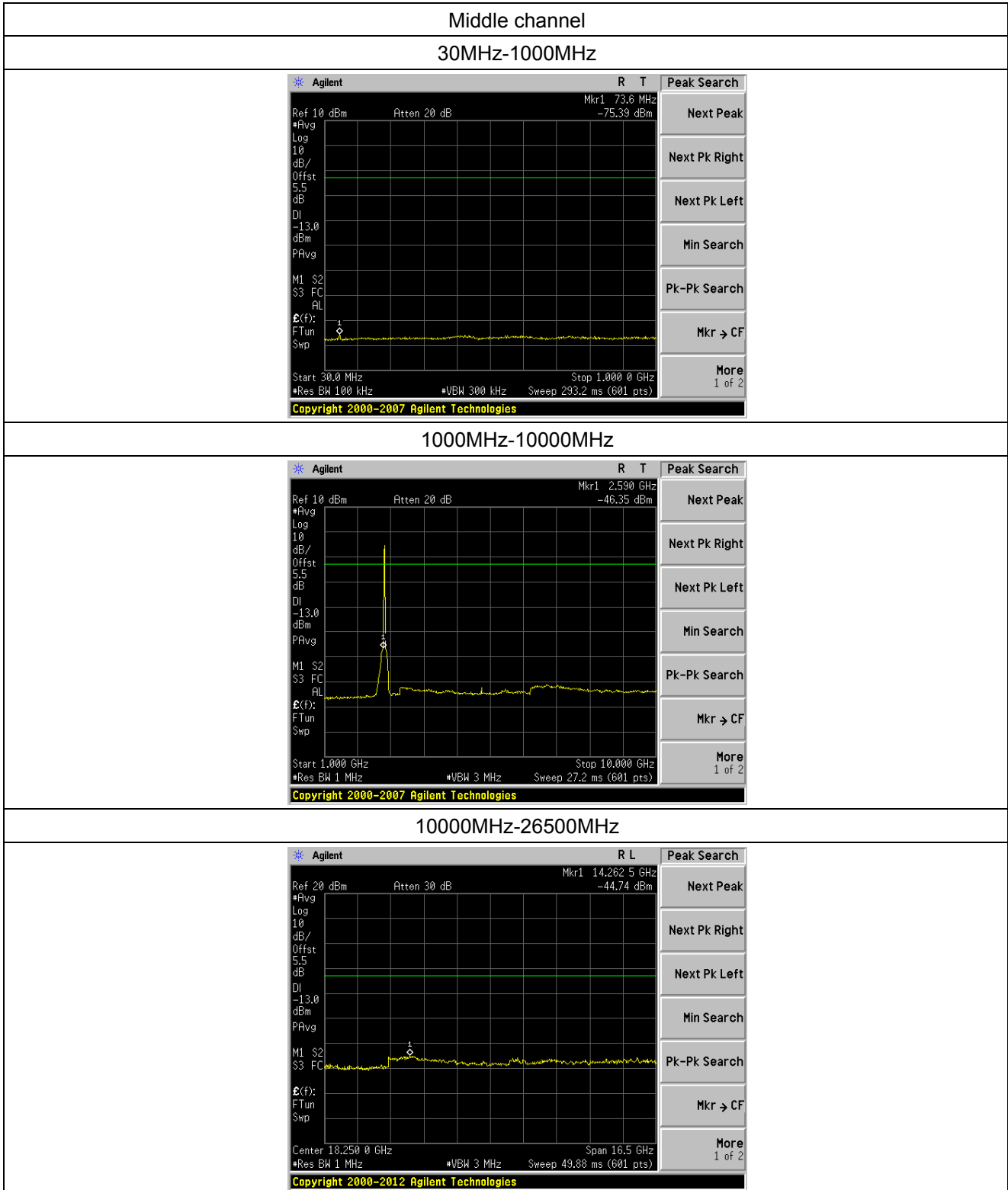

Highest channel

30MHz-1MHz

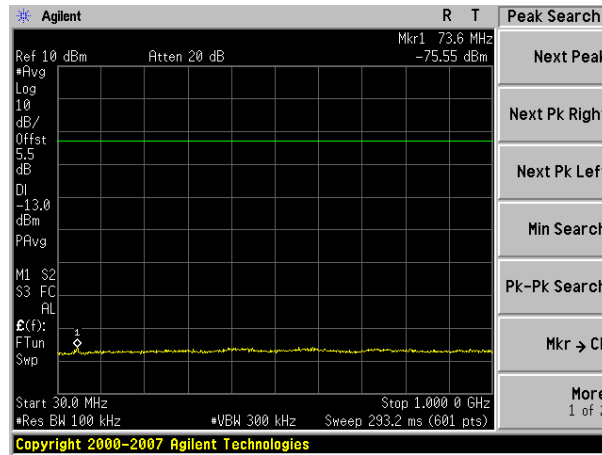

1000MHz-10000MHz

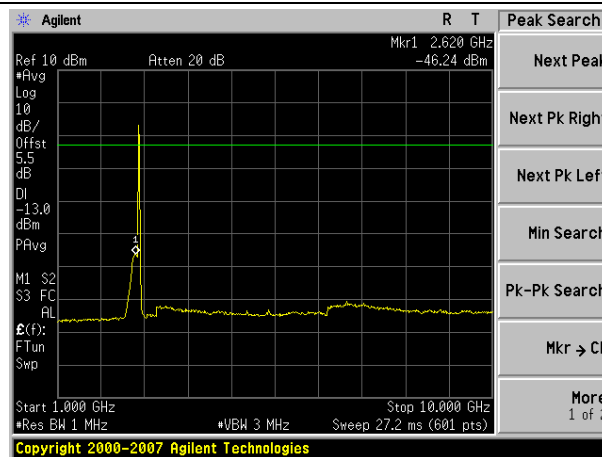

10000MHz-26500MHz

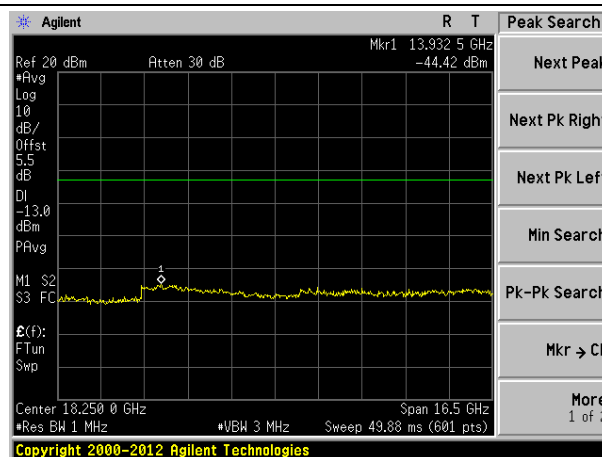

Spurious emission of LTE 15MHz Bandwidth

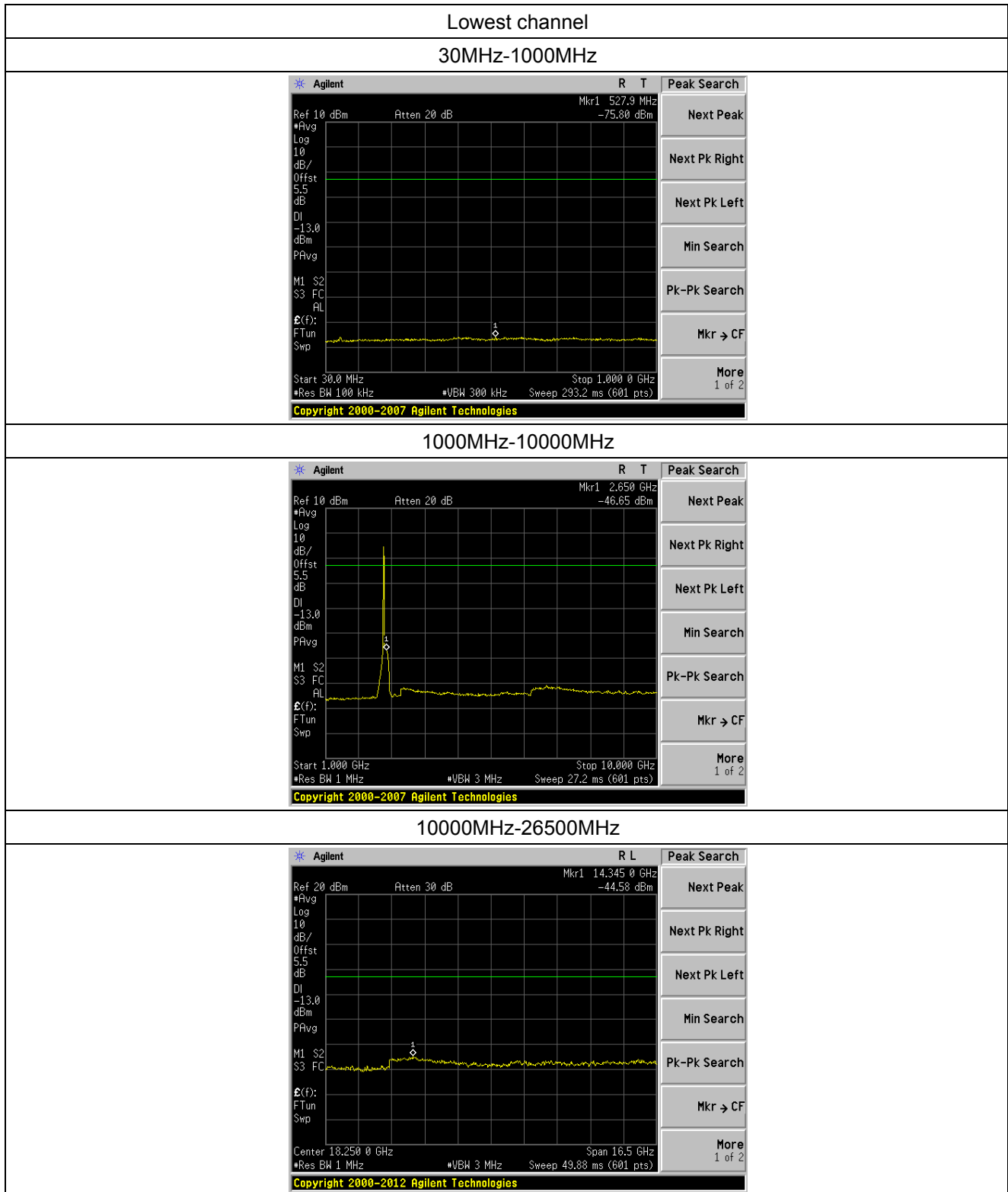

Middle channel

30MHz-1000MHz

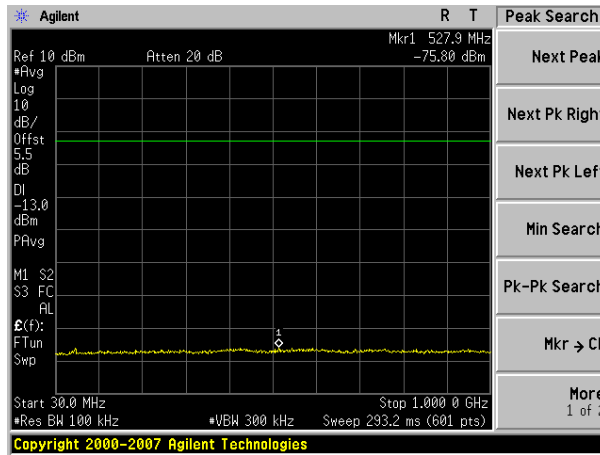

1000MHz-10000MHz

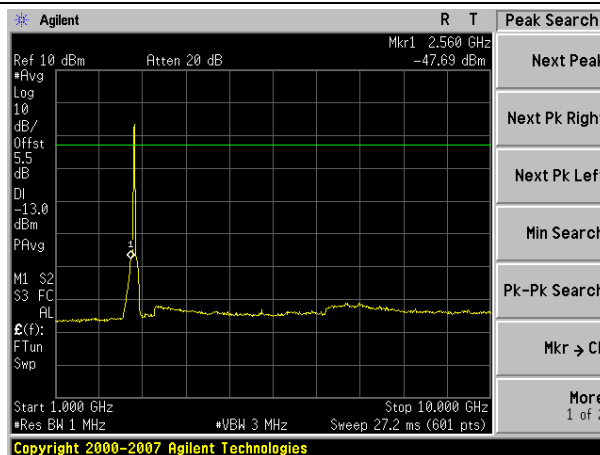

10000MHz-26500MHz

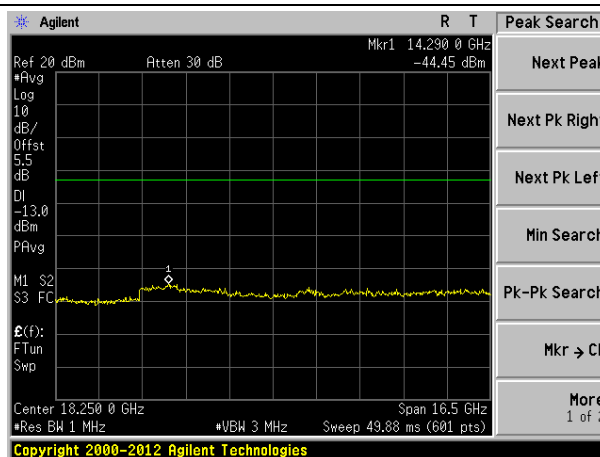

Highest channel

30MHz-1000MHz

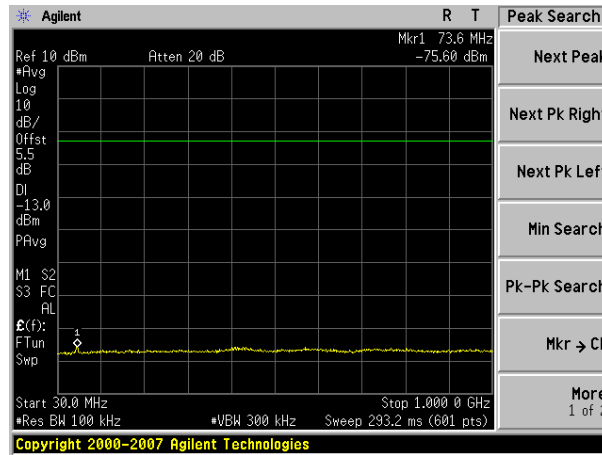

1000MHz-10000MHz

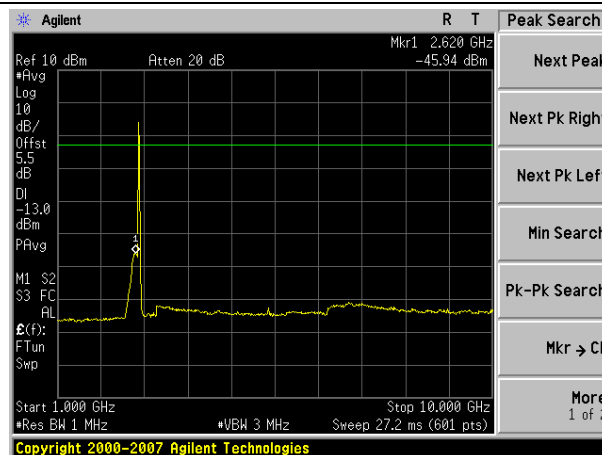

10000MHz-26500MHz

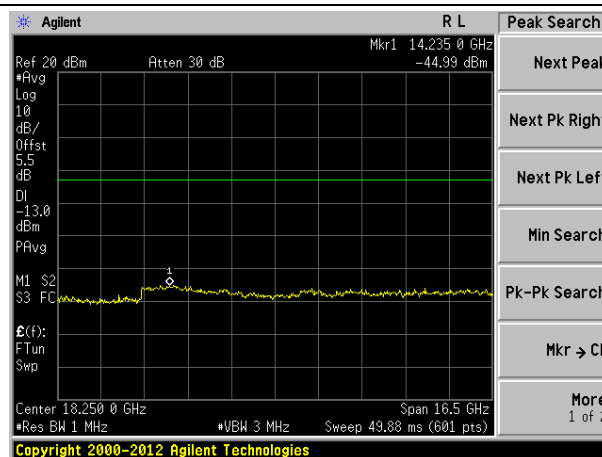

Spurious emission of LTE 20MHz Bandwidth

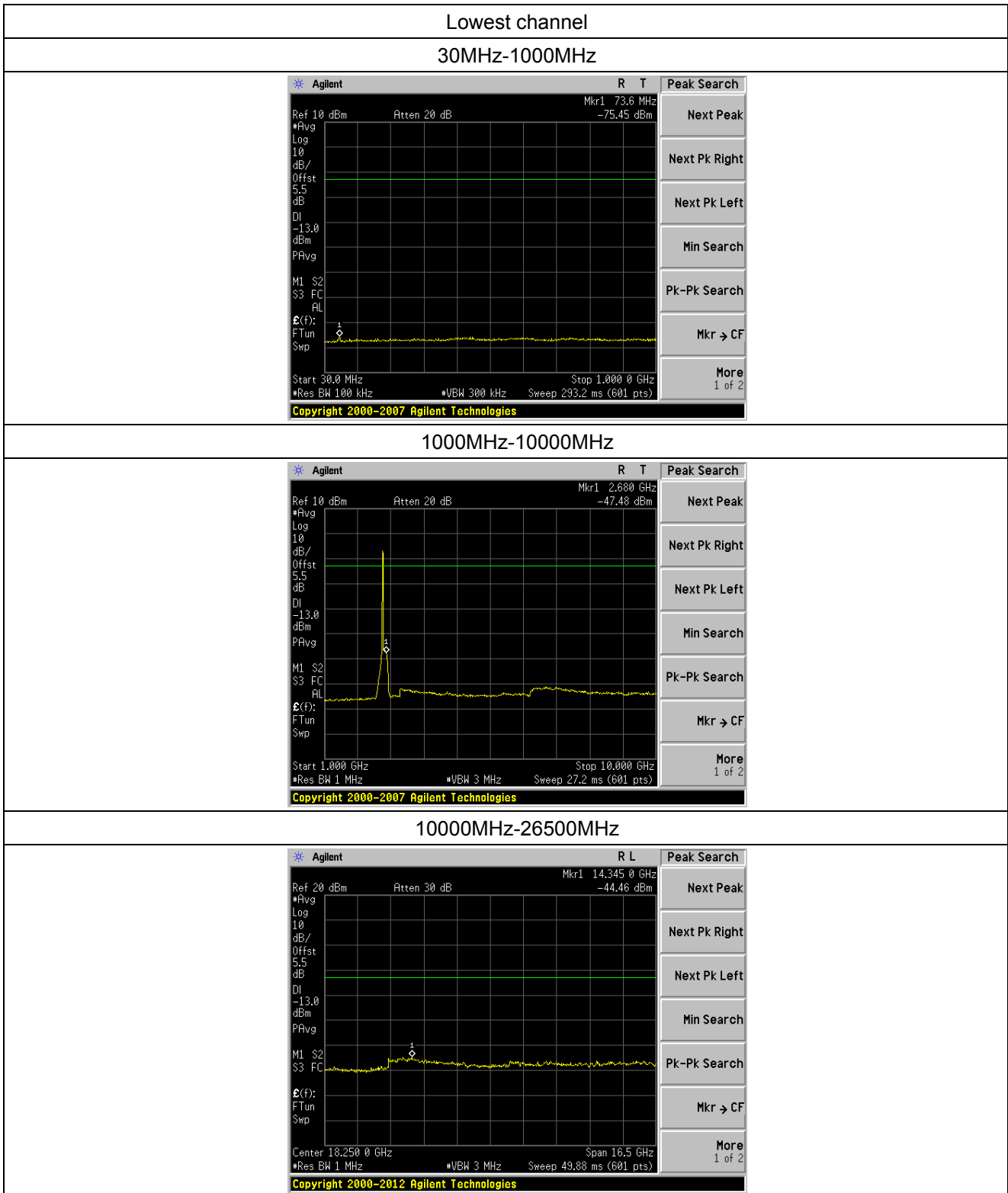

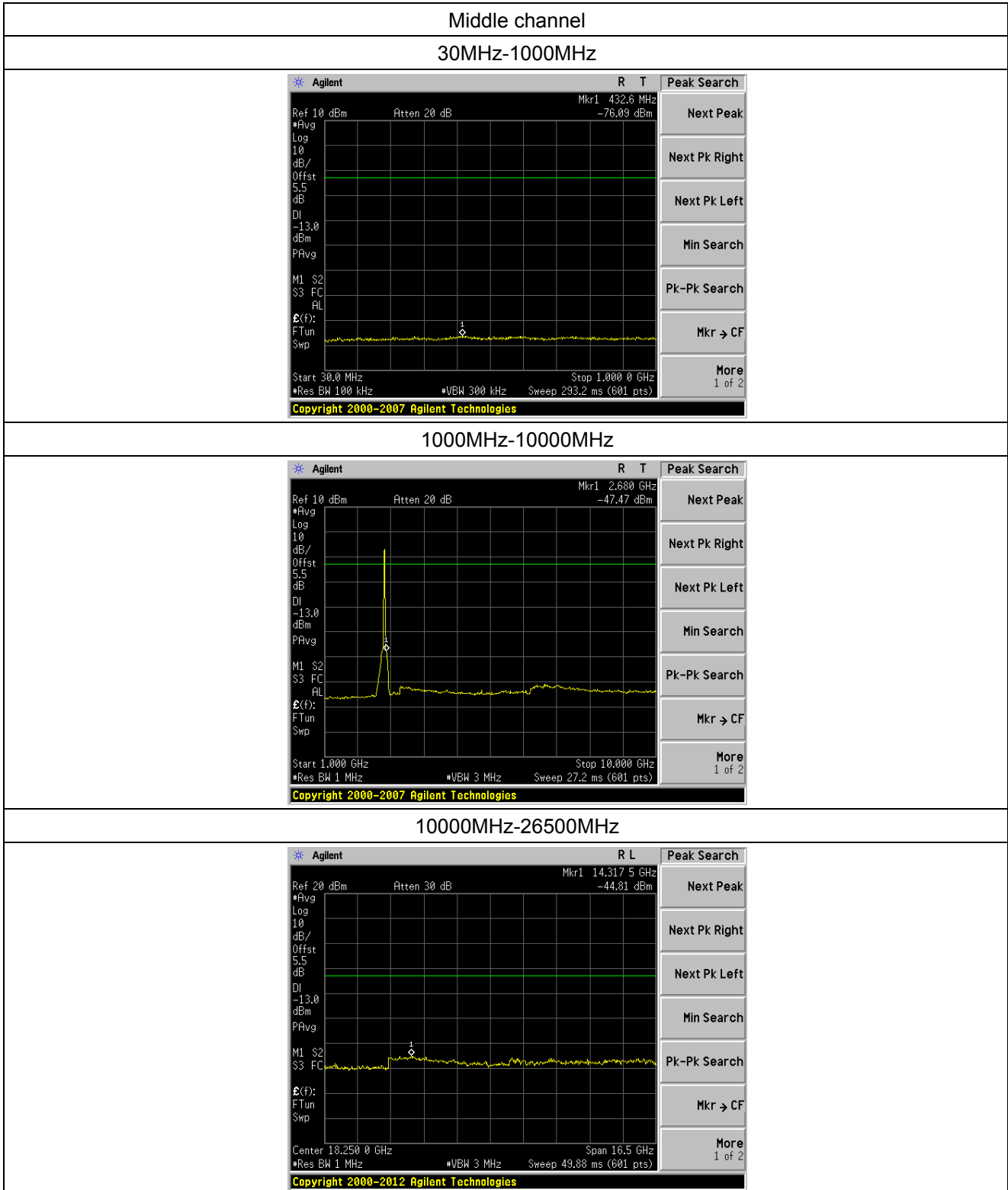

Highest channel

30MHz-1000MHz

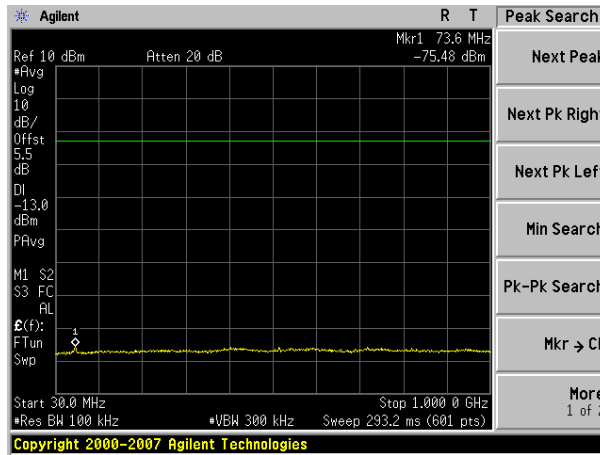

1000MHz-10000MHz

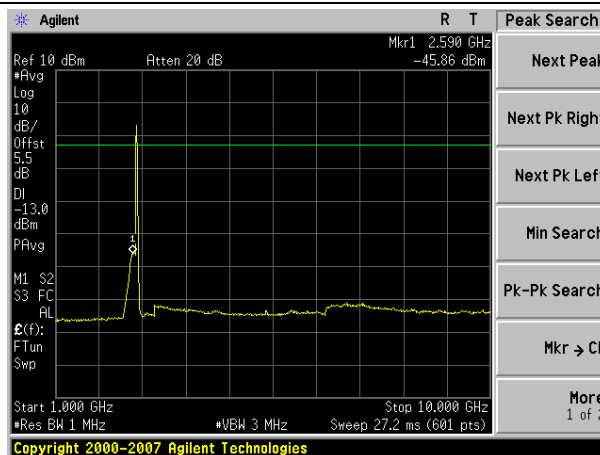

10000MHz-26500MHz

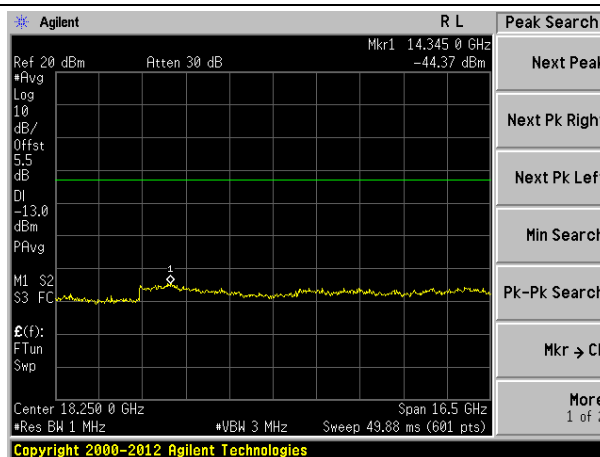

9.4.2 Band edge emission

Downlink:

Band edge of LTE 1.4MHz Bandwidth

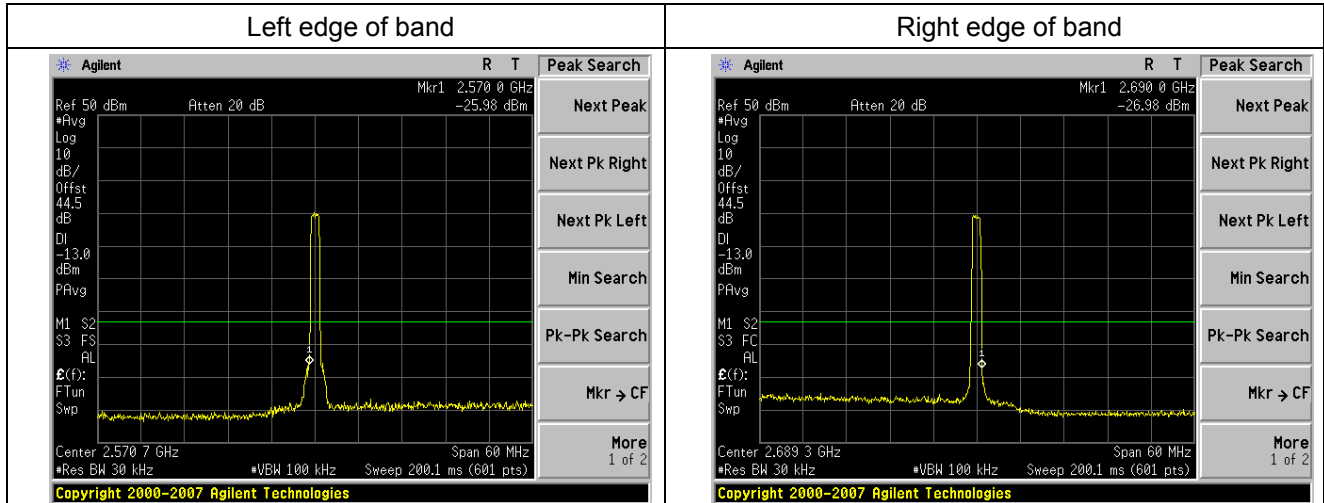

Band edge of LTE 3MHz Bandwidth

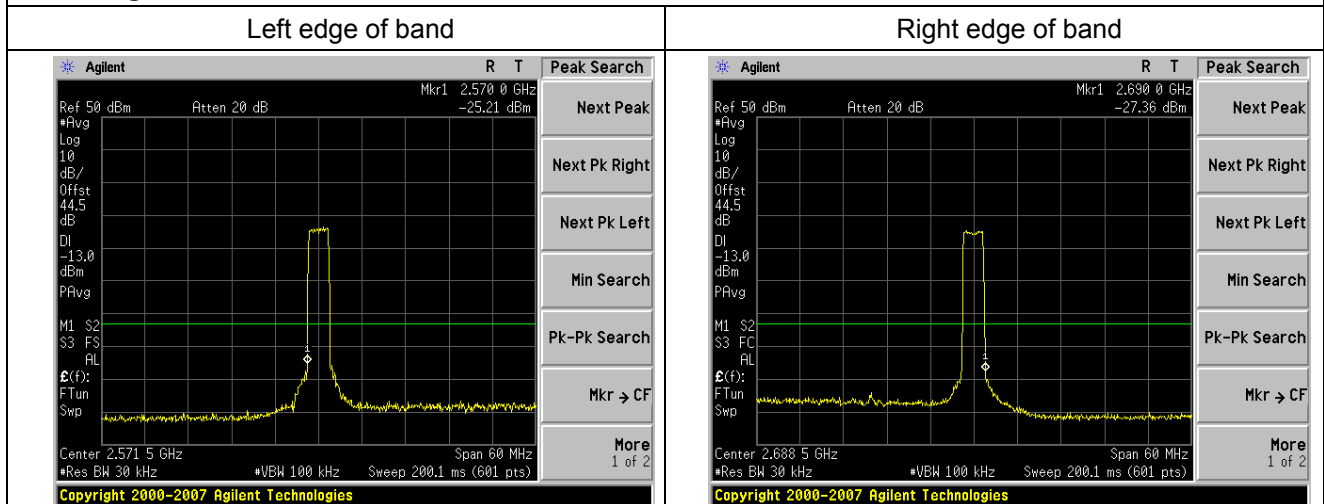

Band edge of LTE 5MHz Bandwidth

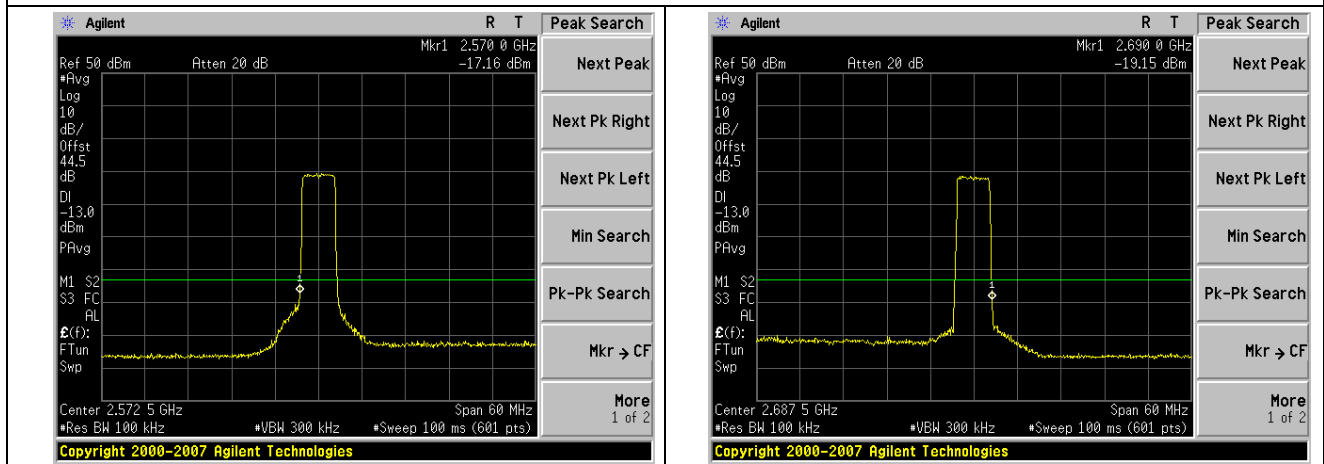

Band edge of LTE 10MHz Bandwidth

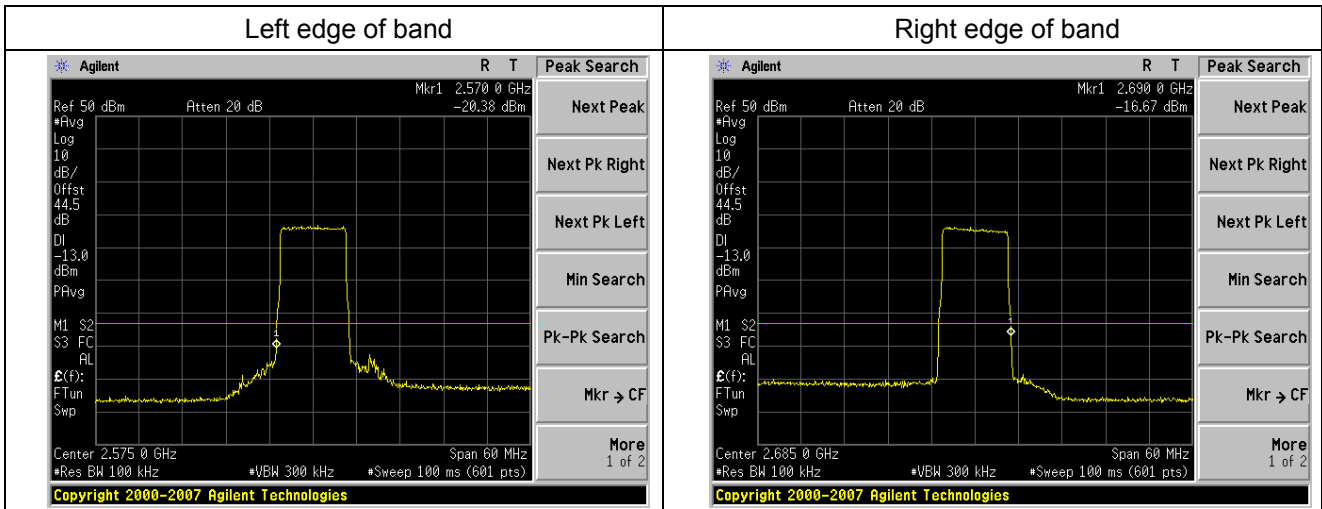

Band edge of LTE 15MHz Bandwidth

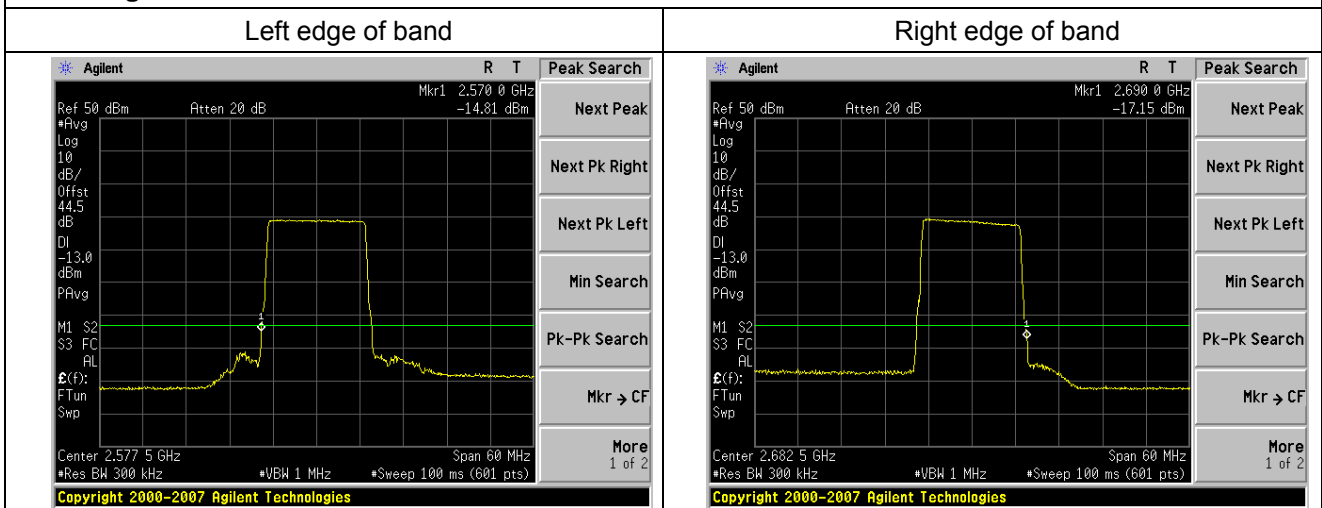

Band edge of LTE 20MHz Bandwidth

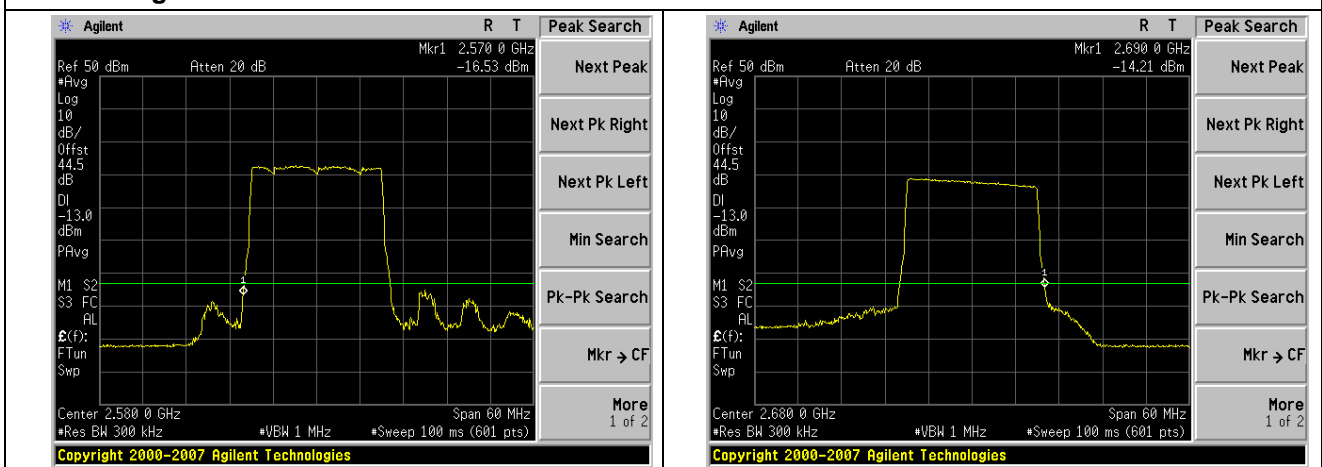

Uplink:

Band edge of LTE 1.4MHz Bandwidth

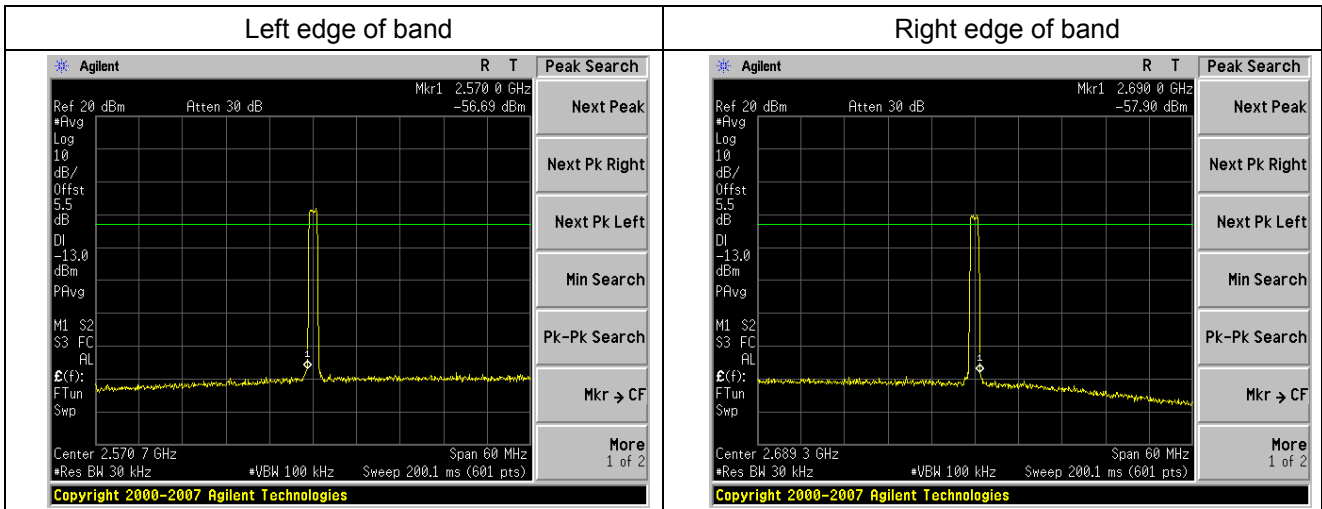

Band edge of LTE 3MHz Bandwidth

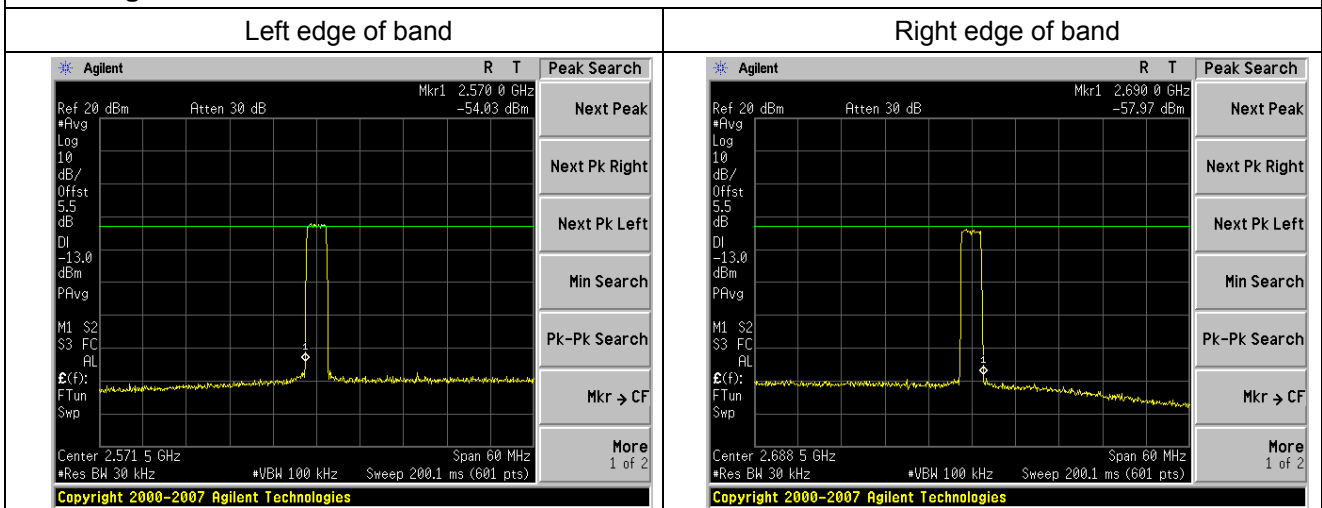

Band edge of LTE 5MHz Bandwidth

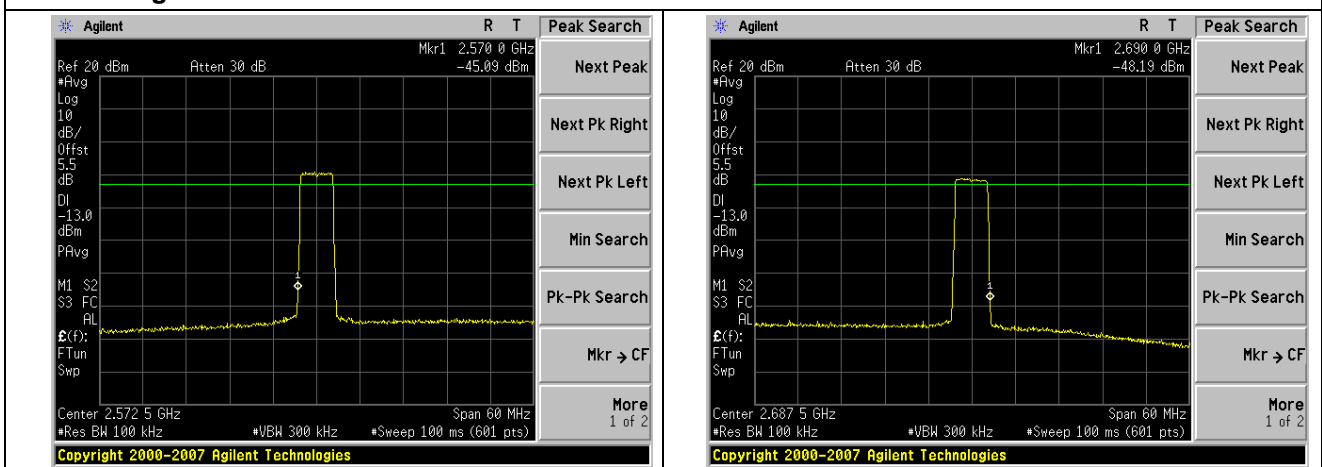

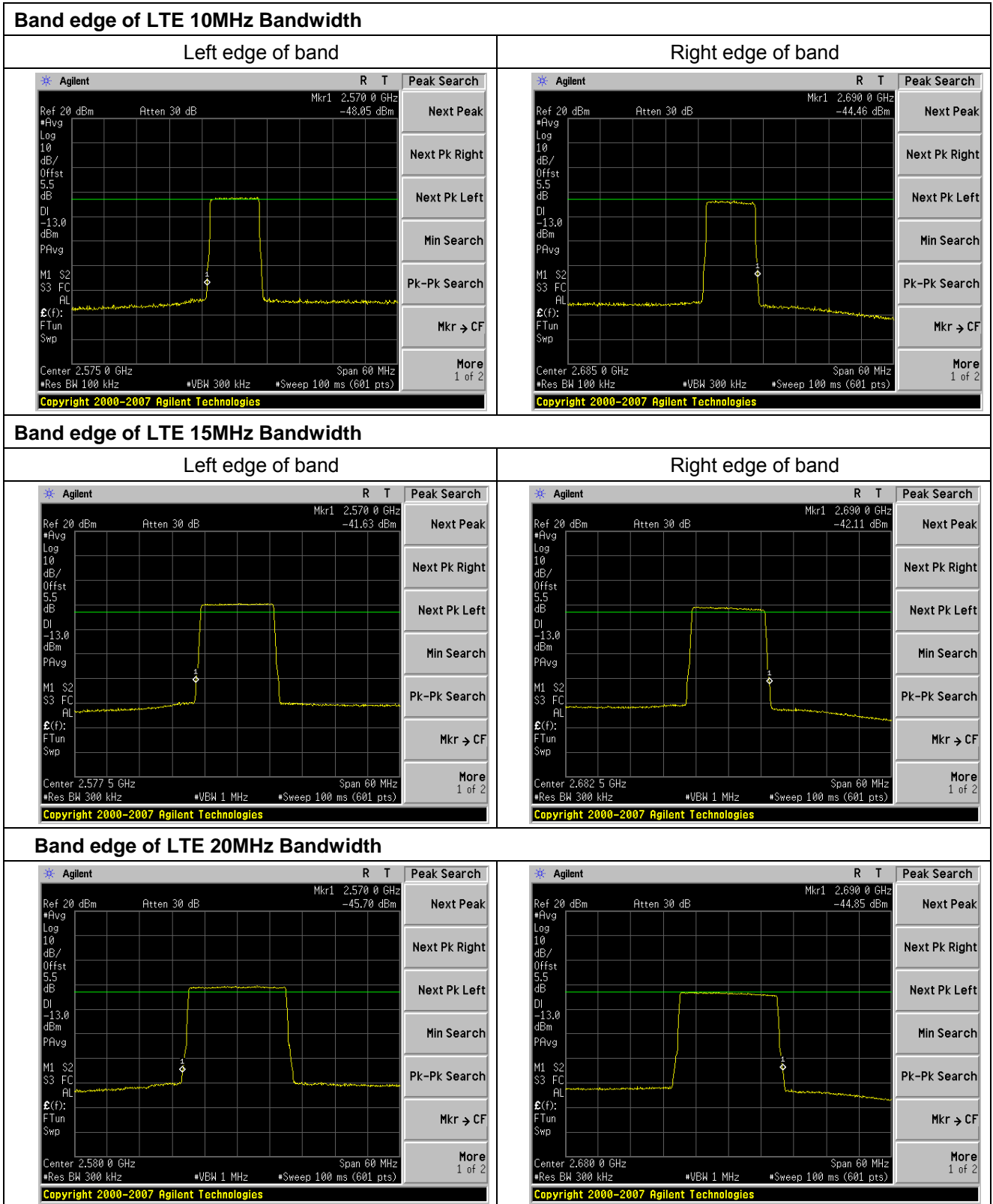

10 INTERMODULATION

10.1 Standard Applicable

According to FCC § 2.1051 and § 27.53(m)

10.2 Test setup

Please refer the section §6.2 Configuration of Tested System.

10.3 Measurement Procedure

1. The EUT RF output port was connected to spectrum analyzer. The EUT shall be set to maximum gain and maximum rated output power per channel.
2. Two continuous sinusoidal RF signals shall be fed to the input antenna port of the repeater using a combining device. The two channels near each other should be separated by at least one operating channel width.
3. The spurious emissions at antenna were measured at the RF output port of the EUT.
4. The modulation types tested is LTE.

Spectrum analyzer settings:

Detector: RMS.

Intermodulation:

RBW=100 kHz; VBW \geq RBW

Spurious emissions:

Below 1G: RBW=100kHz; Above 1G: RBW=1 MHz ; VBW \geq RBW

10.4 Test Result

Passed.

Downlink:

Intermodulation of LTE 1.4MHz Bandwidth

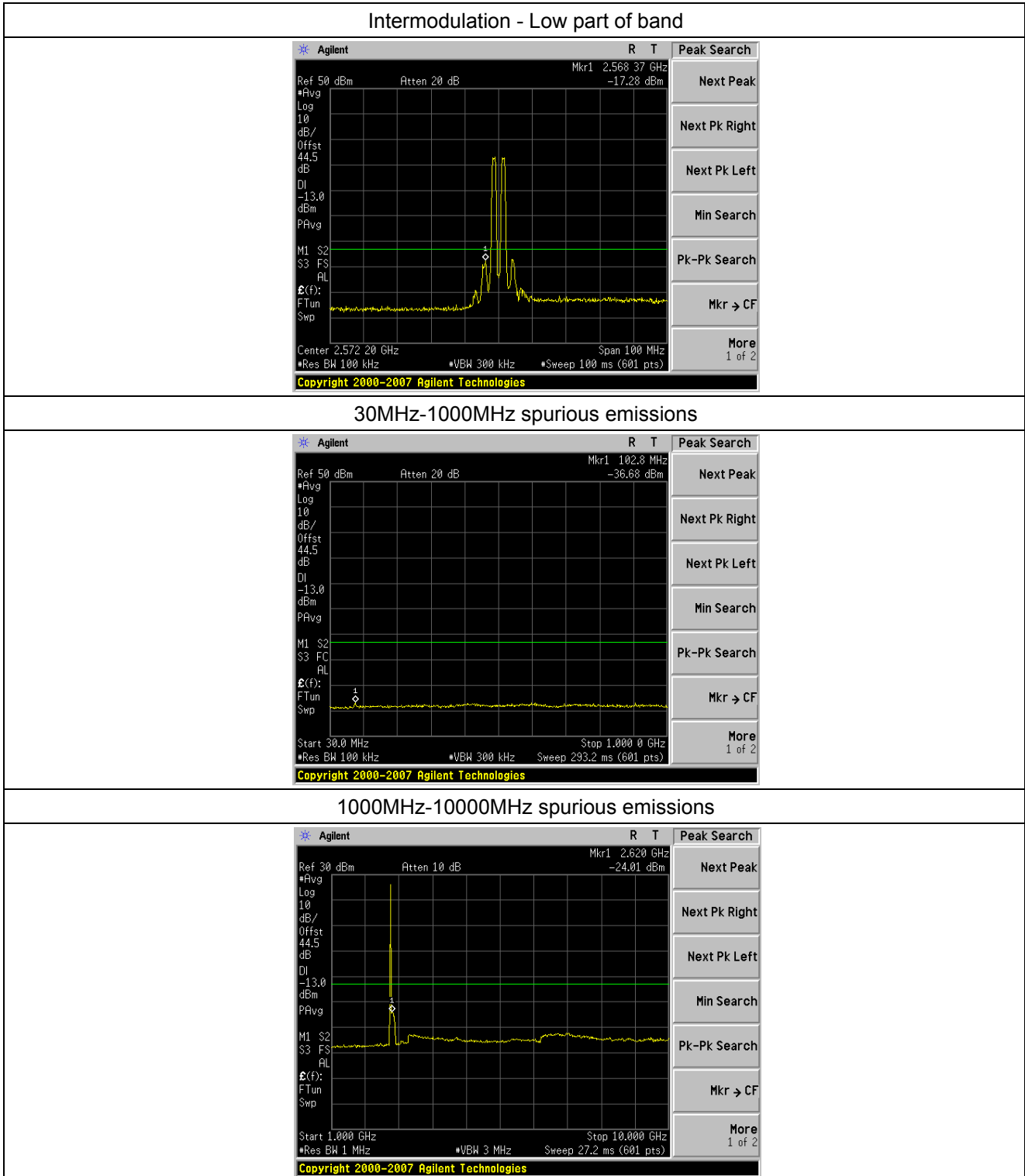

10000MHz-26500MHz spurious emissions

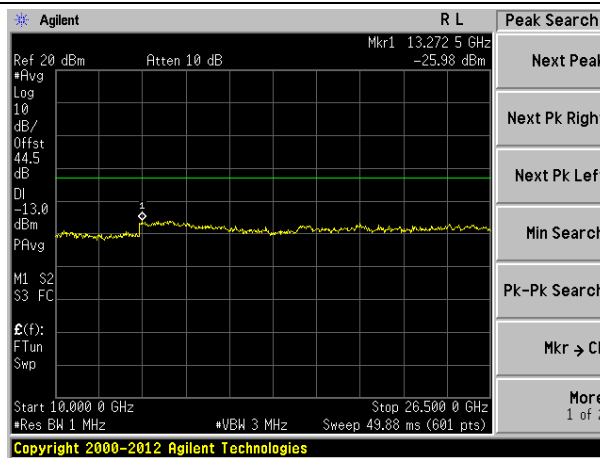

Intermodulation - High part of band

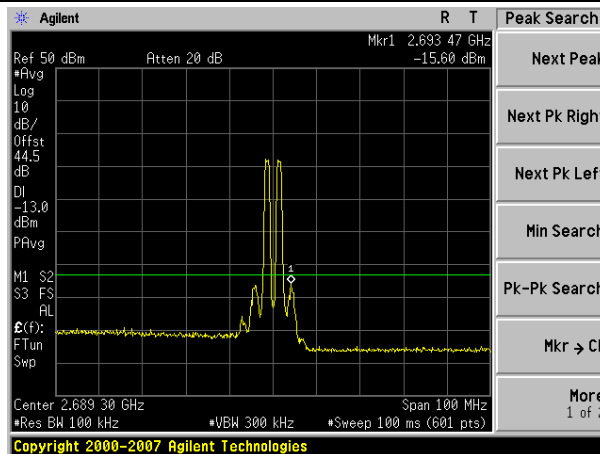

30MHz-1000MHz spurious emissions

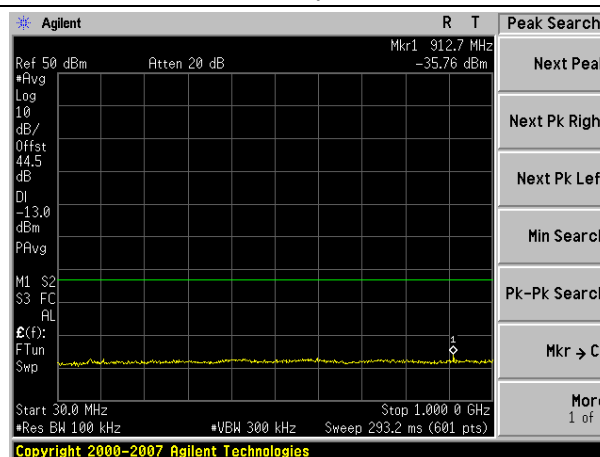

1000MHz-10000MHz spurious emissions

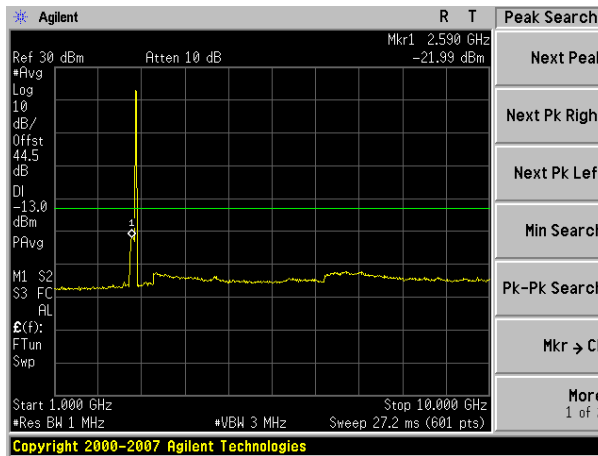

1000MHz-26500MHz spurious emissions

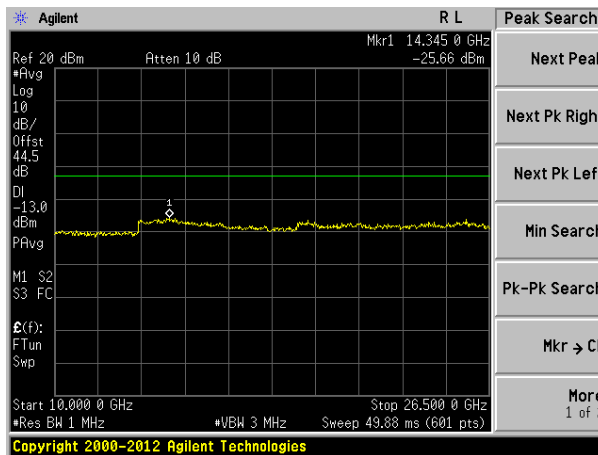

Intermodulation of LTE 3MHz Bandwidth

Intermodulation - Low part of band

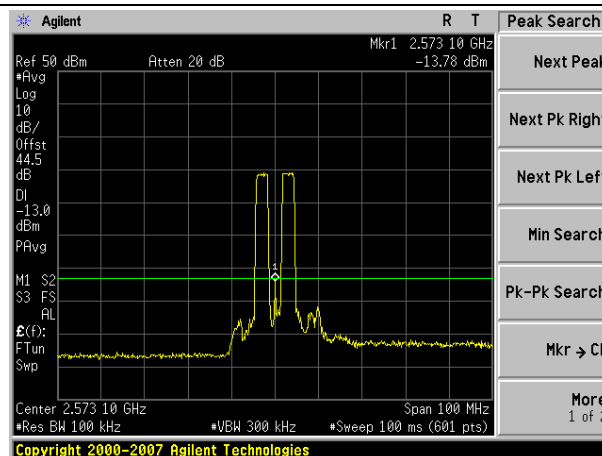

30MHz-1000MHz spurious emissions

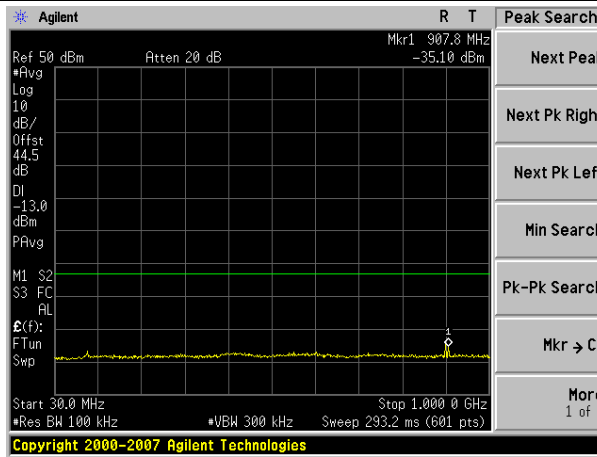

1000MHz-10000MHz spurious emissions

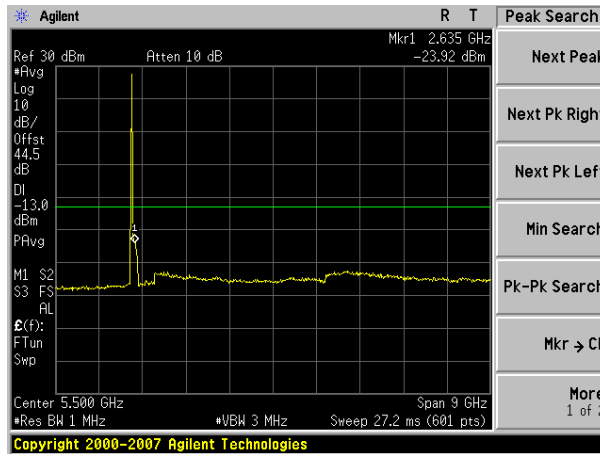

10000MHz-26500MHz spurious emissions

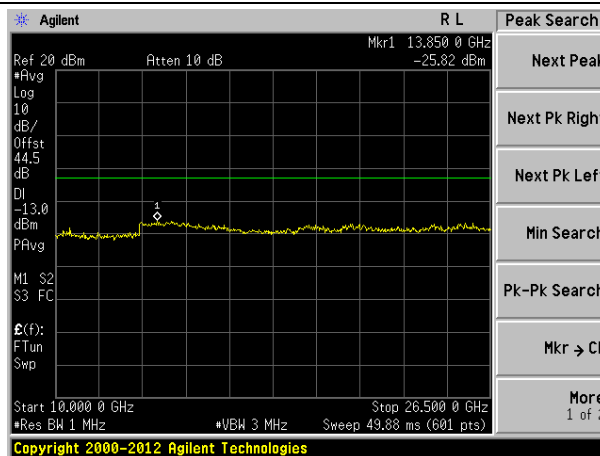

Intermodulation - High part of band

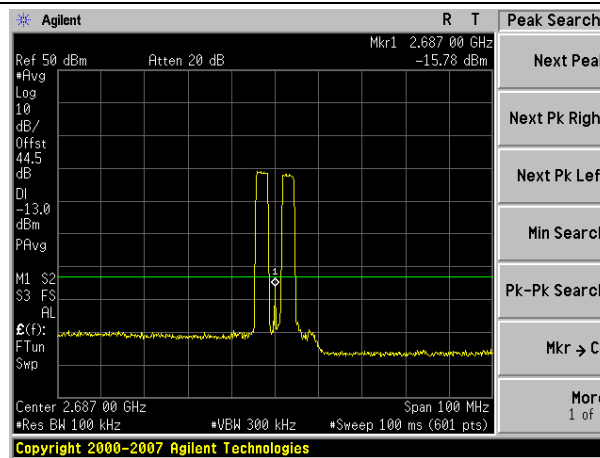

30MHz-1000MHz spurious emissions

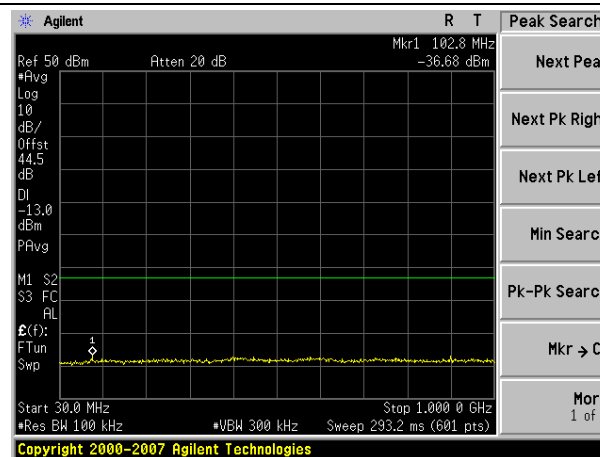

1000MHz-10000MHz spurious emissions

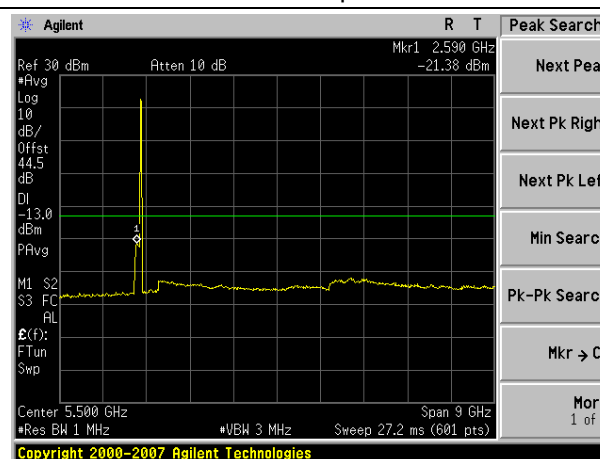

10000MHz-26500MHz spurious emissions

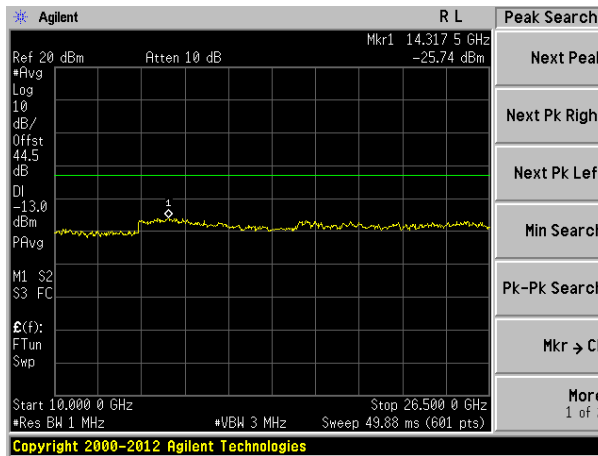

Intermodulation of LTE 5MHz Bandwidth

Intermodulation - Low part of band

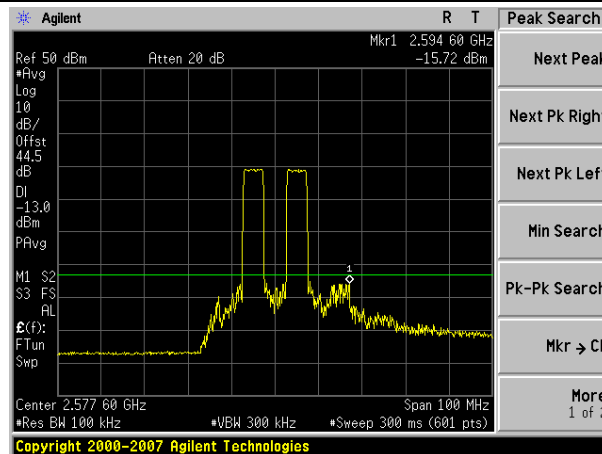

30MHz-1000MHz spurious emissions

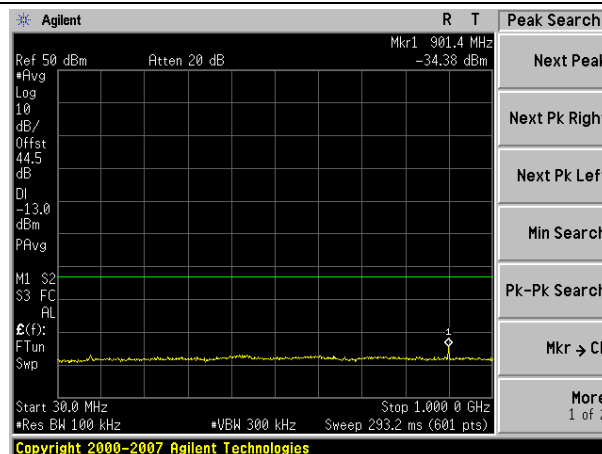

1000MHz-10000MHz spurious emissions

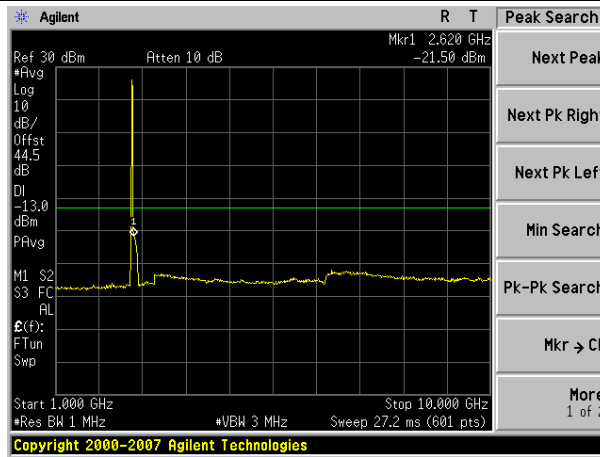

10000MHz-26500MHz spurious emissions

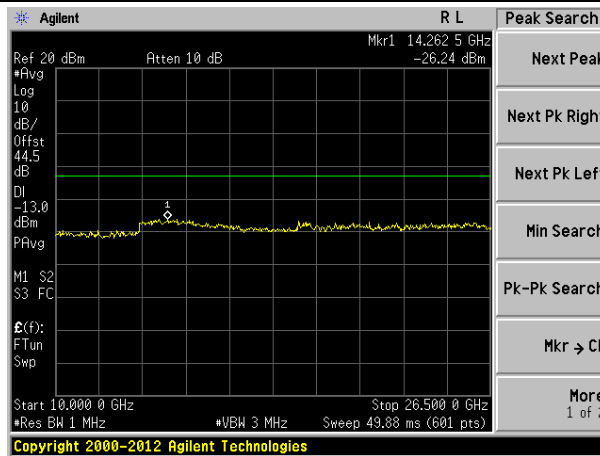

Intermodulation - High part of band

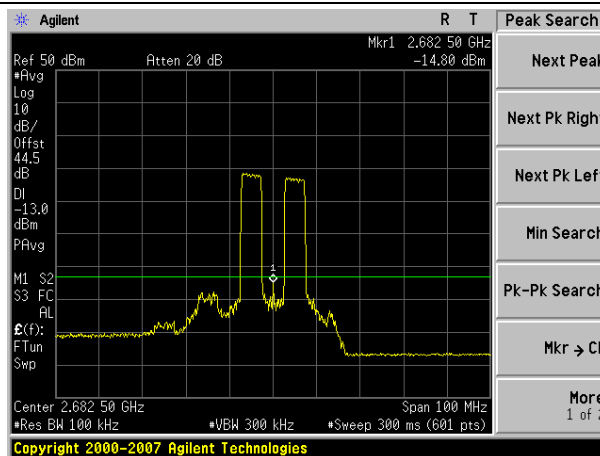

30MHz-1000MHz spurious emissions

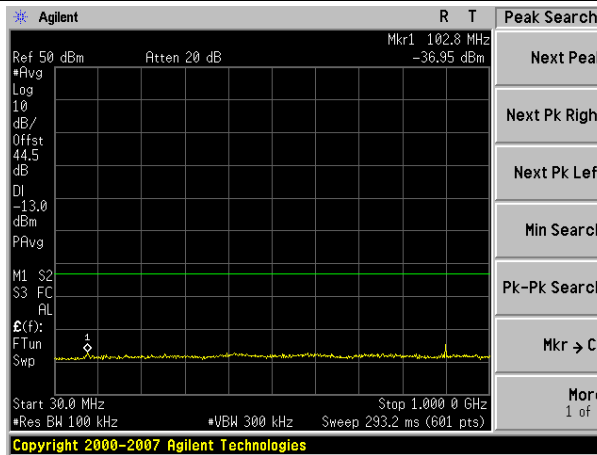

1000MHz-10000MHz spurious emissions

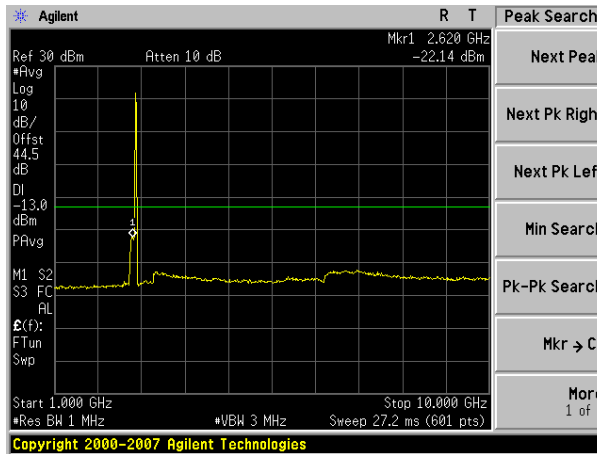

10000MHz-26500MHz spurious emissions

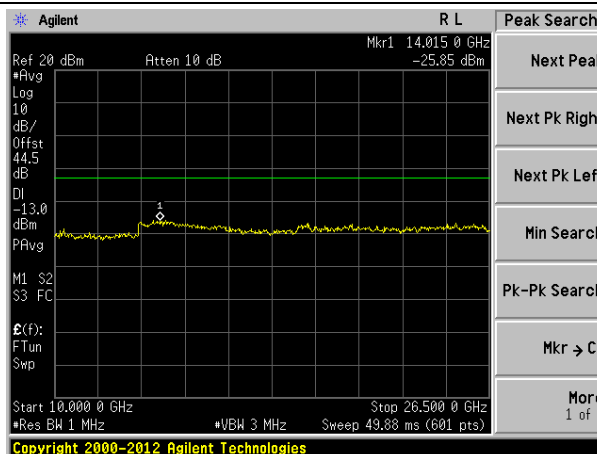

Intermodulation of LTE 10MHz Bandwidth

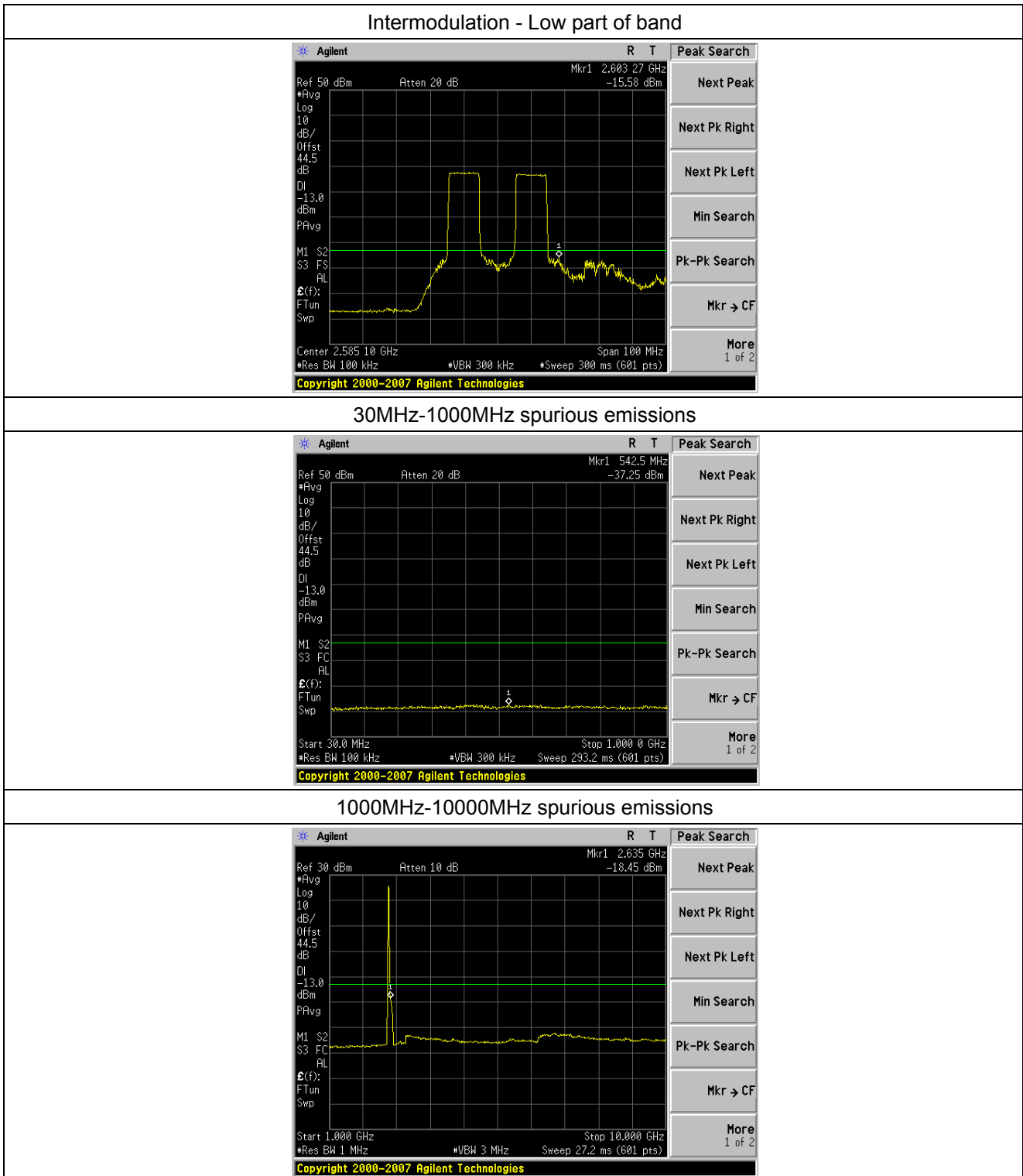

10000MHz-26500MHz spurious emissions

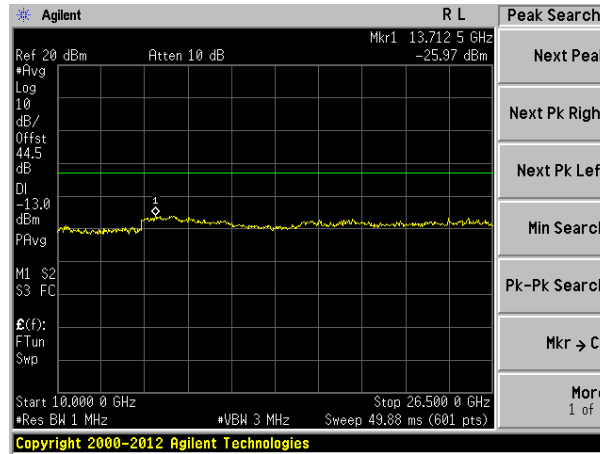

Intermodulation - High part of band

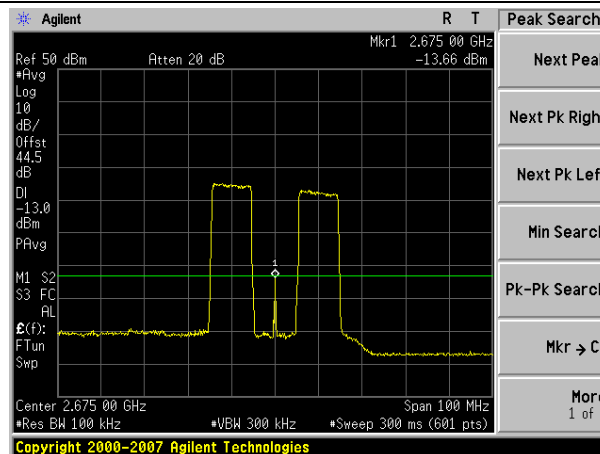

30MHz-1000MHz spurious emissions

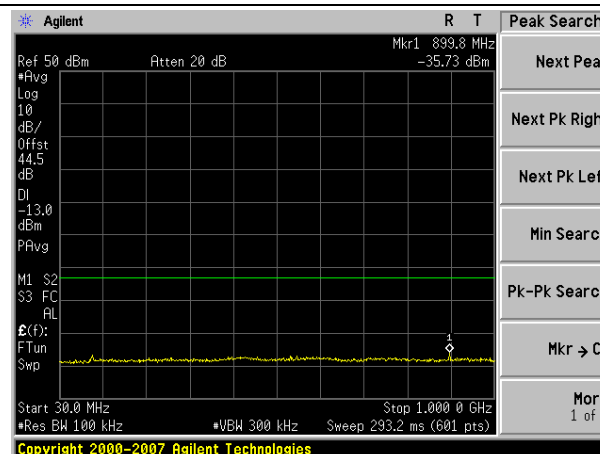

1000MHz-10000MHz spurious emissions

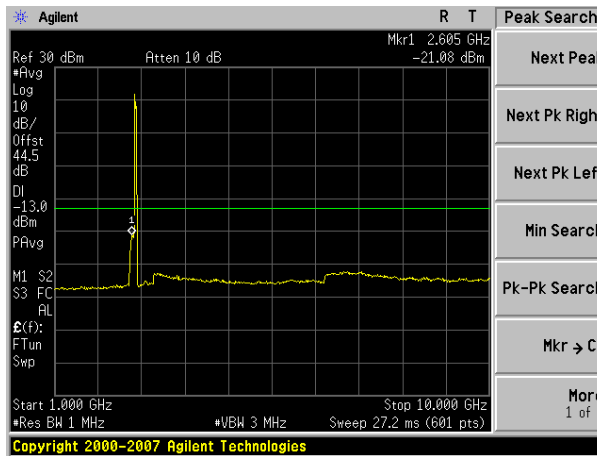

1000MHz-26500MHz spurious emissions

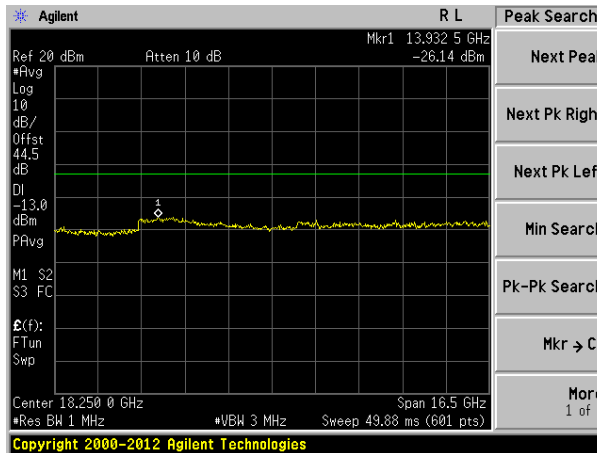

Intermodulation of LTE 15MHz Bandwidth

Intermodulation - Low part of band

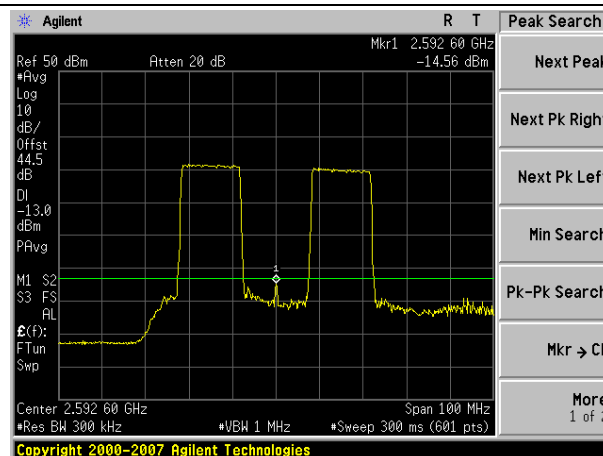

30MHz-1000MHz spurious emissions

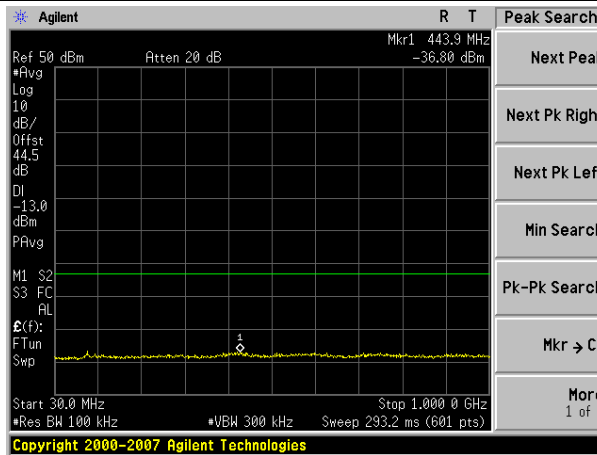

1000MHz-10000MHz spurious emissions

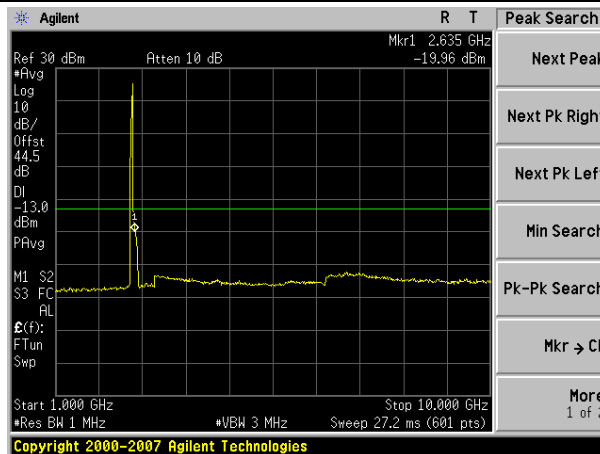

10000MHz-26500MHz spurious emissions

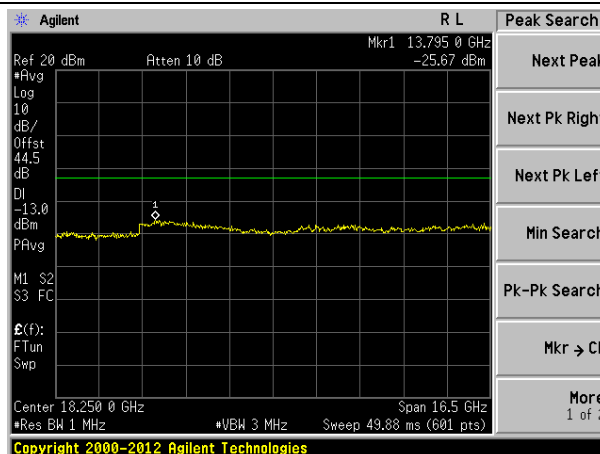

Intermodulation - High part of band

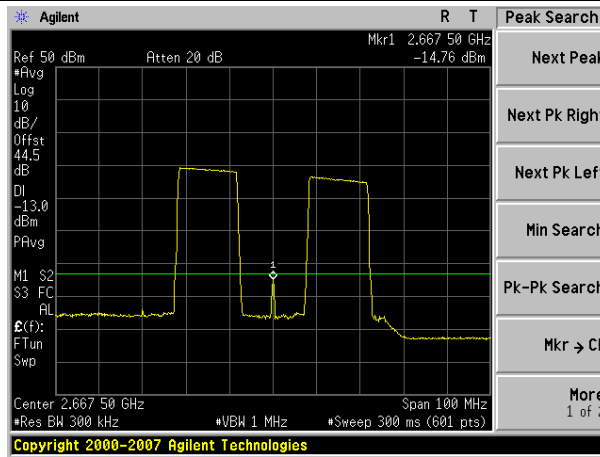

30MHz-1000MHz spurious emissions

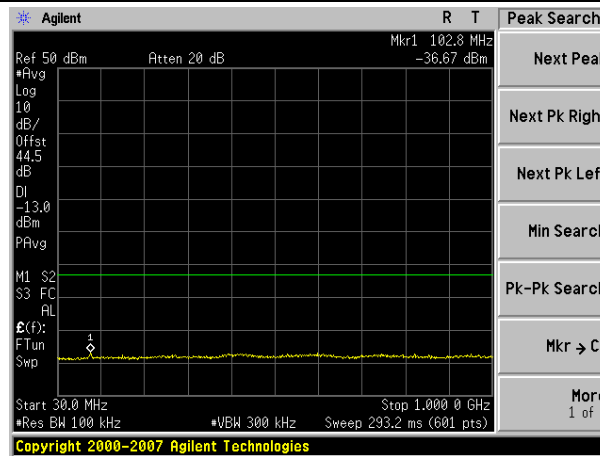

1000MHz-10000MHz spurious emissions

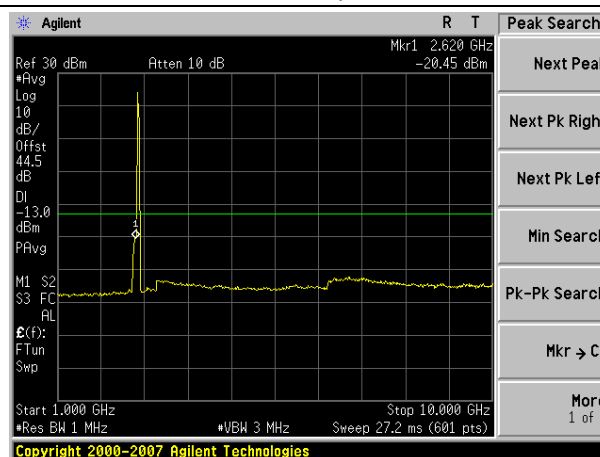

10000MHz-26500MHz spurious emissions

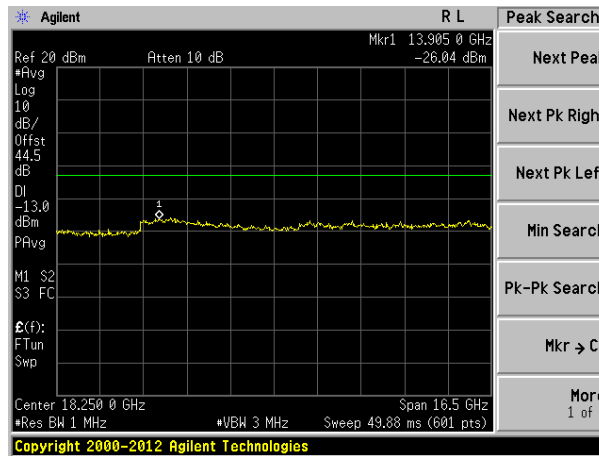

Intermodulation of LTE 20MHz Bandwidth

Intermodulation - Low part of band

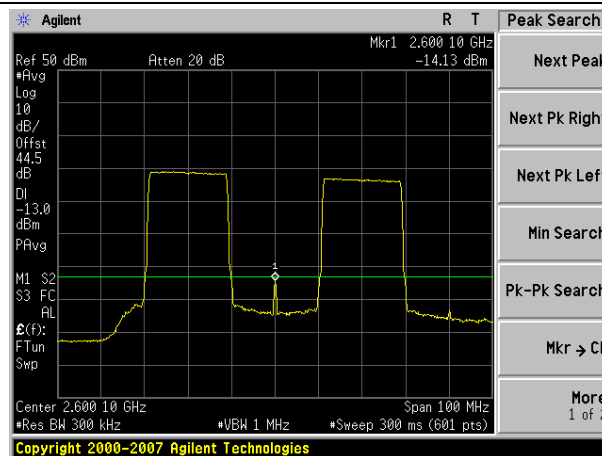

30MHz-1000MHz spurious emissions

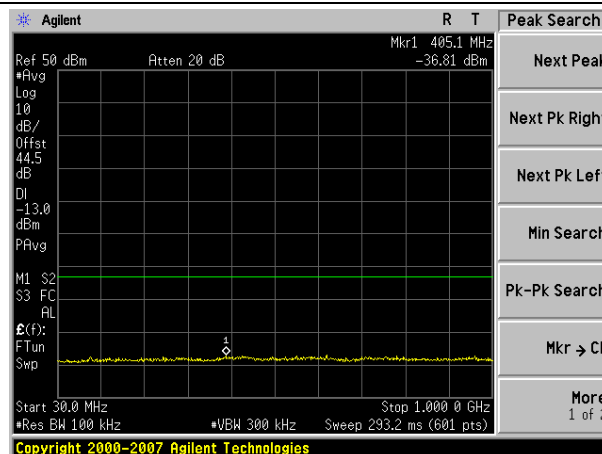

1000MHz-10000MHz spurious emissions

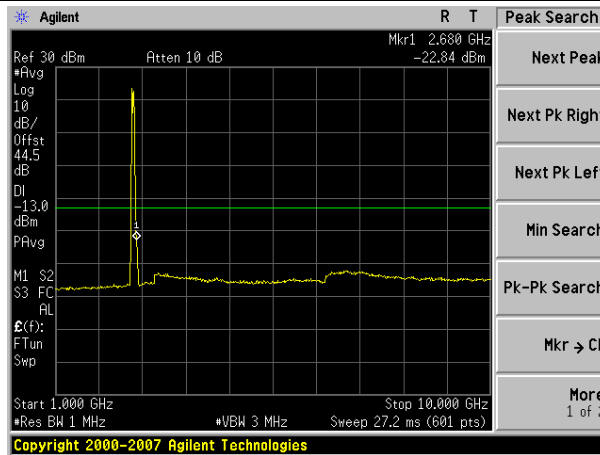

10000MHz-26500MHz spurious emissions

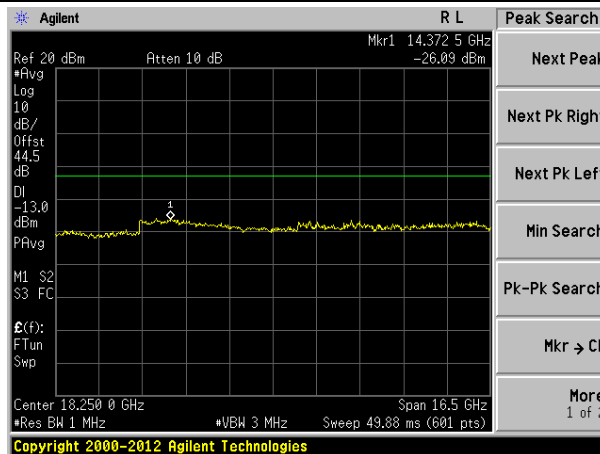

Intermodulation - High part of band

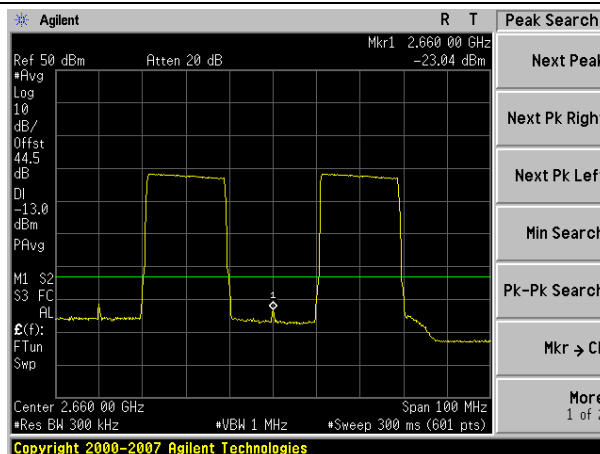

30MHz-1000MHz spurious emissions

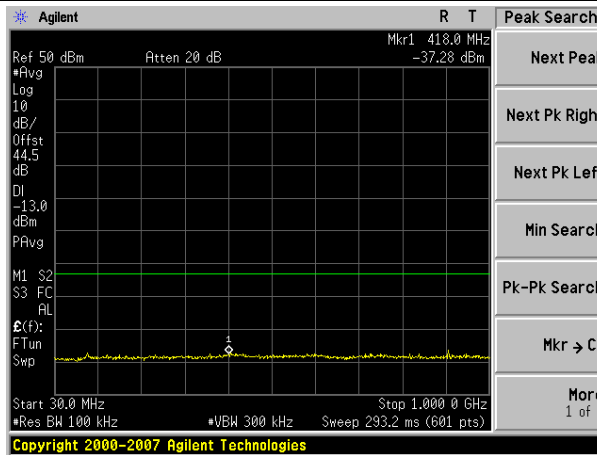

1000MHz-10000MHz spurious emissions

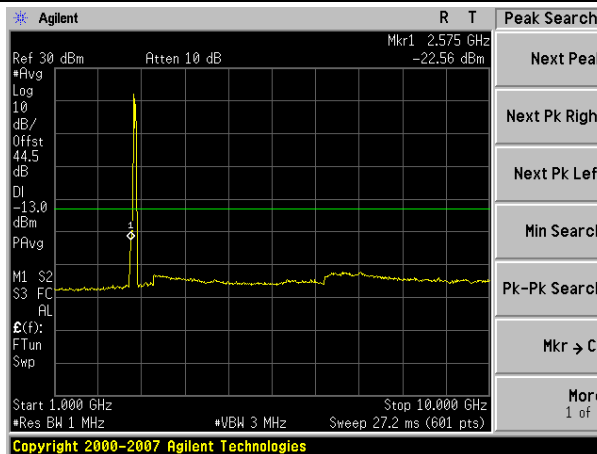

10000MHz-26500MHz spurious emissions

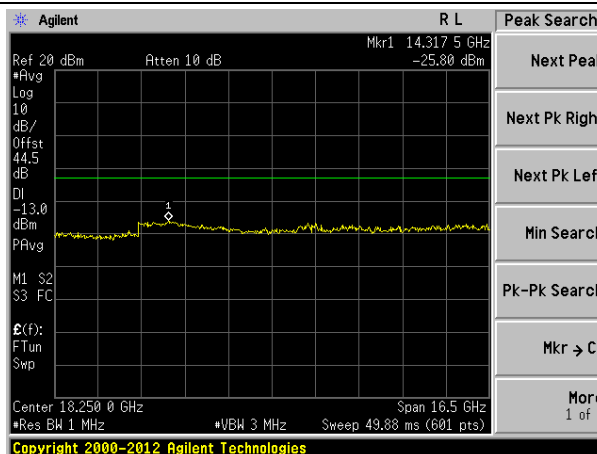

Uplink:

Intermodulation of LTE 1.4MHz Bandwidth

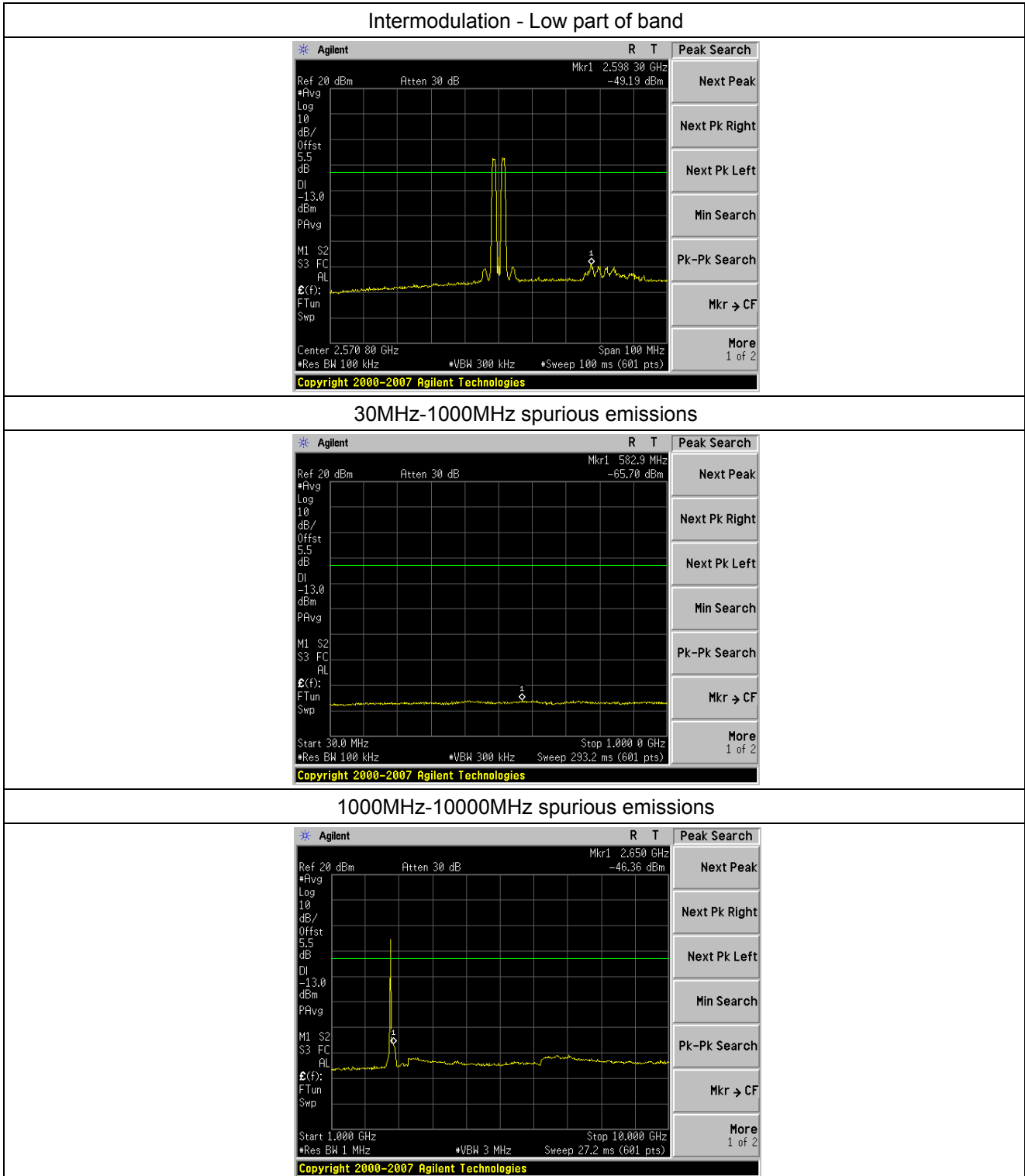

10000MHz-26500MHz spurious emissions

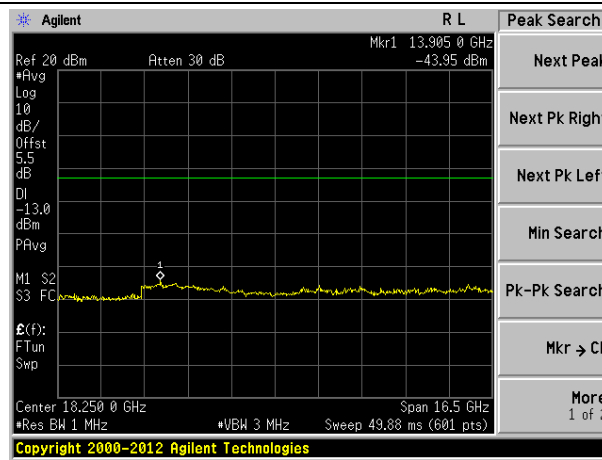

Intermodulation - High part of band

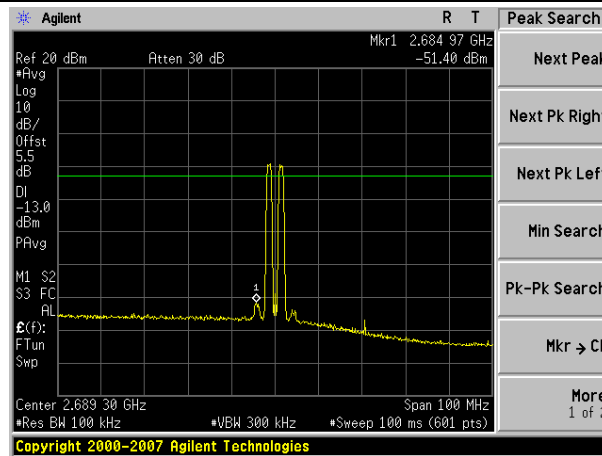

30MHz-1000MHz spurious emissions

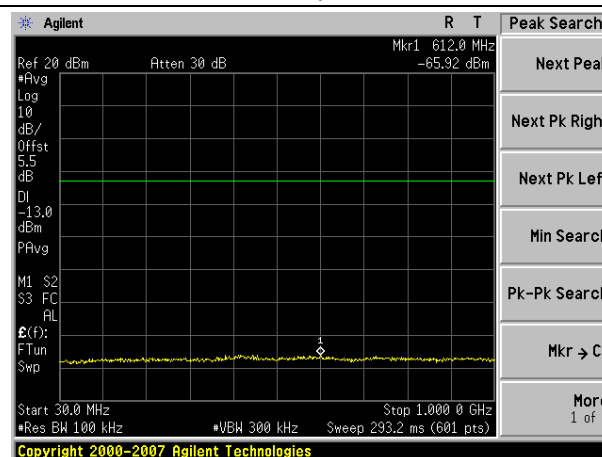

1000MHz-10000MHz spurious emissions

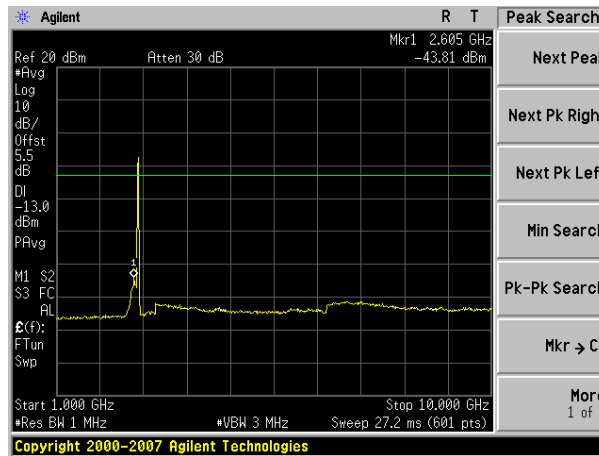

1000MHz-26500MHz spurious emissions

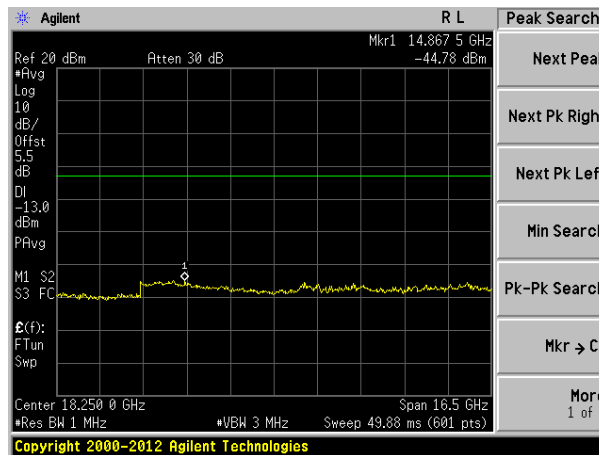

Intermodulation of LTE 3MHz Bandwidth

Intermodulation - Low part of band

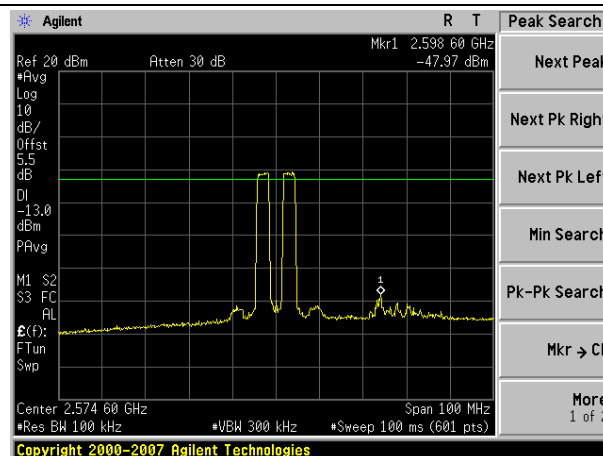

30MHz-1000MHz spurious emissions

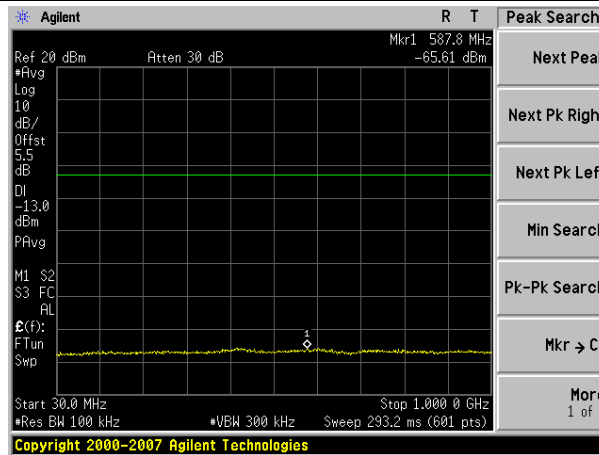

1000MHz-10000MHz spurious emissions

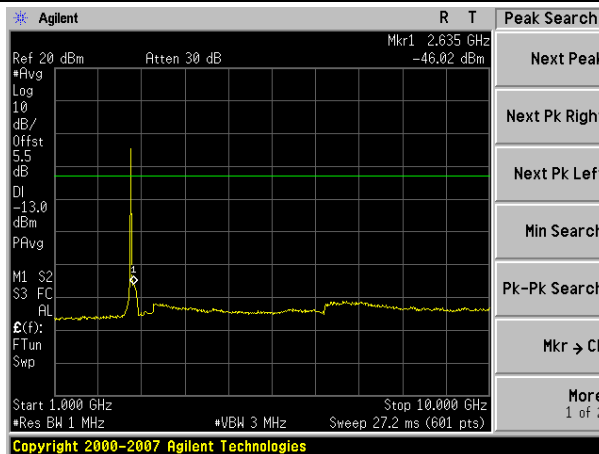

10000MHz-26500MHz spurious emissions

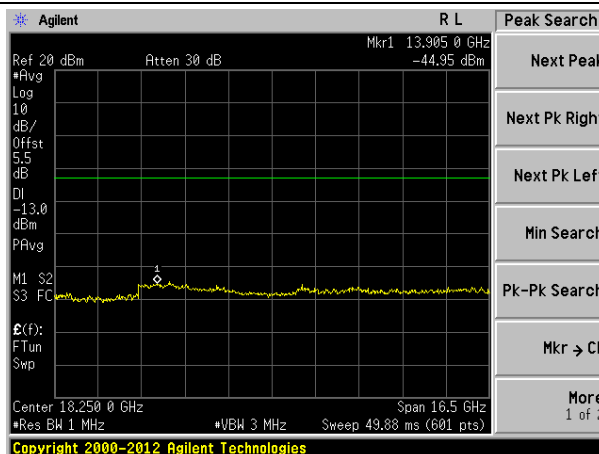

Intermodulation - High part of band

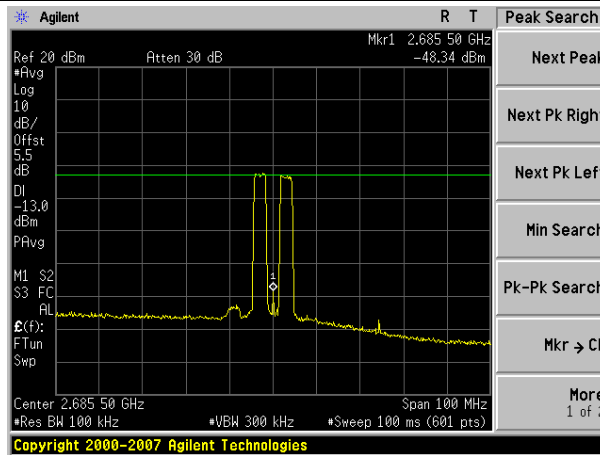

30MHz-1000MHz spurious emissions

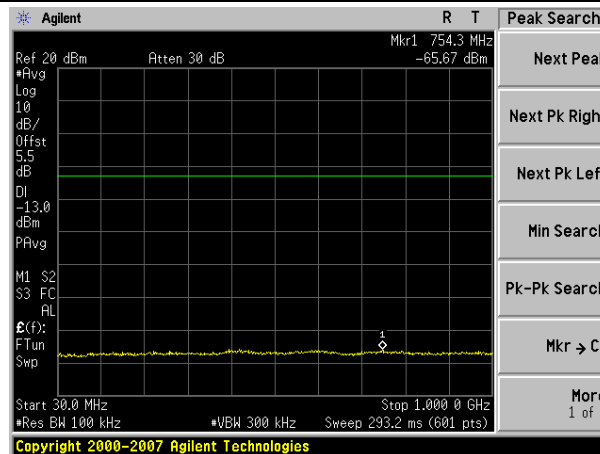

1000MHz-10000MHz spurious emissions

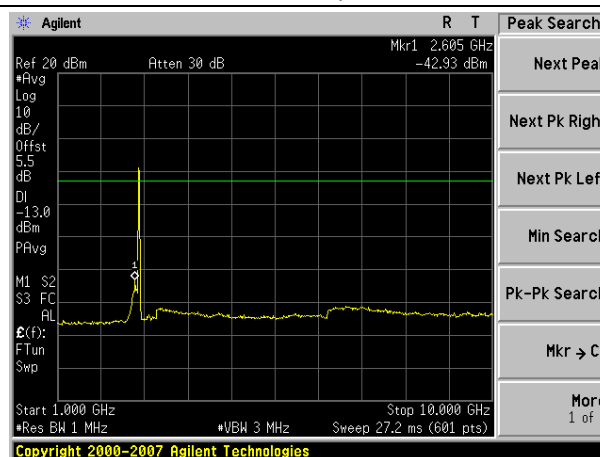

10000MHz-26500MHz spurious emissions

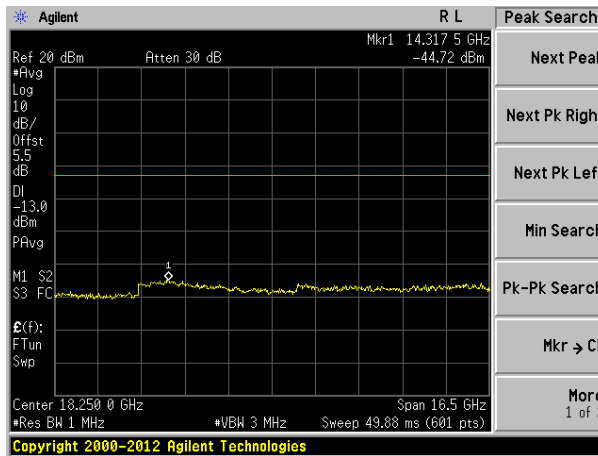

Intermodulation of LTE 5MHz Bandwidth

Intermodulation - Low part of band

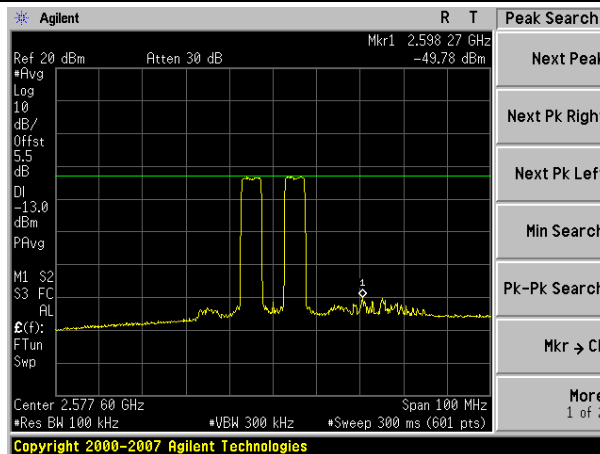

30MHz-1000MHz spurious emissions

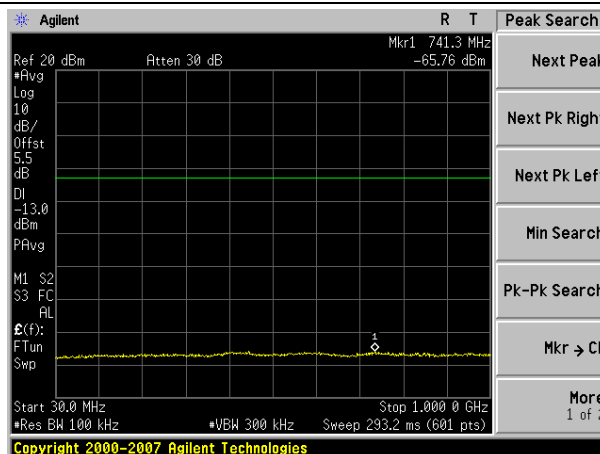

1000MHz-10000MHz spurious emissions

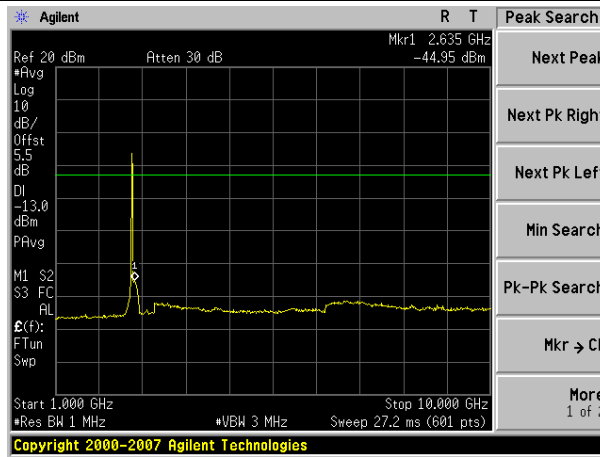

10000MHz-26500MHz spurious emissions

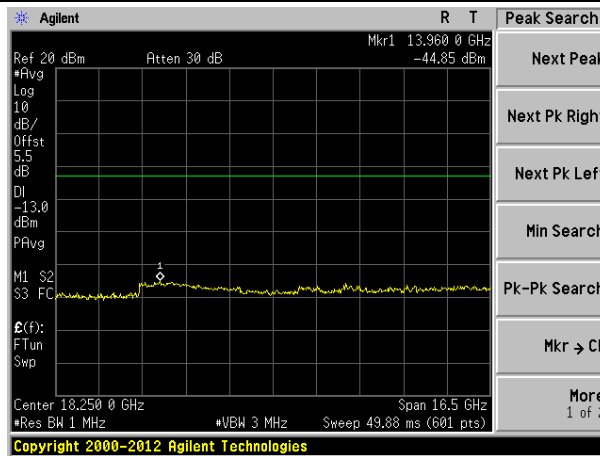

Intermodulation - High part of band

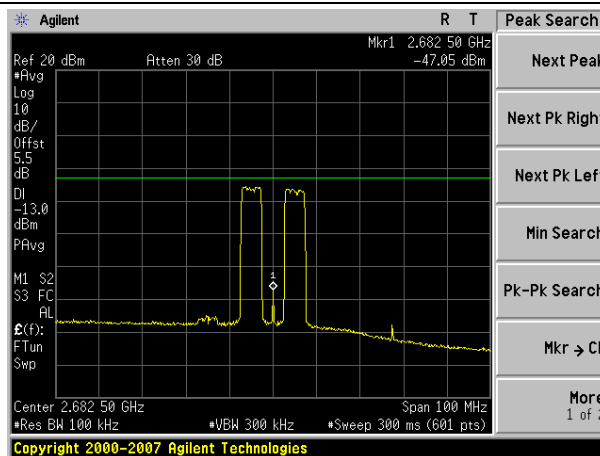

30MHz-1000MHz spurious emissions

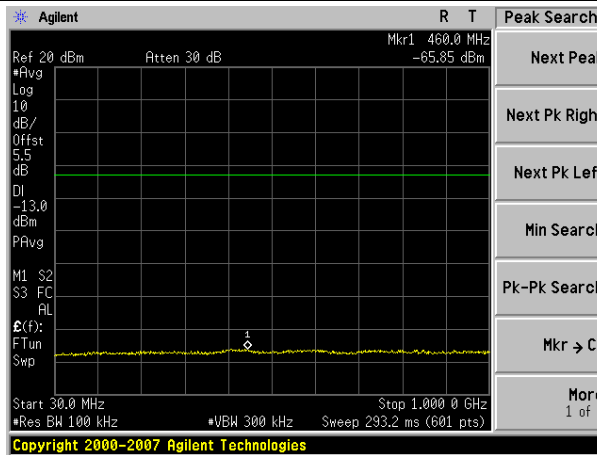

1000MHz-10000MHz spurious emissions

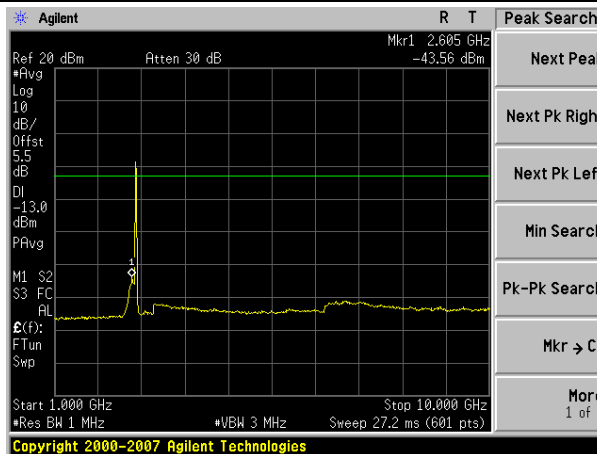

10000MHz-26500MHz spurious emissions

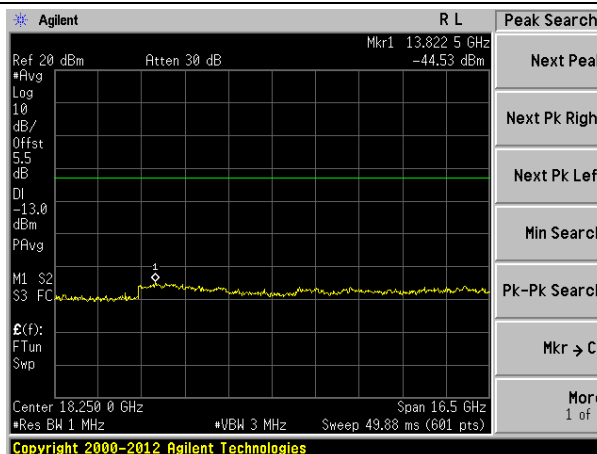

Intermodulation of LTE 10MHz Bandwidth

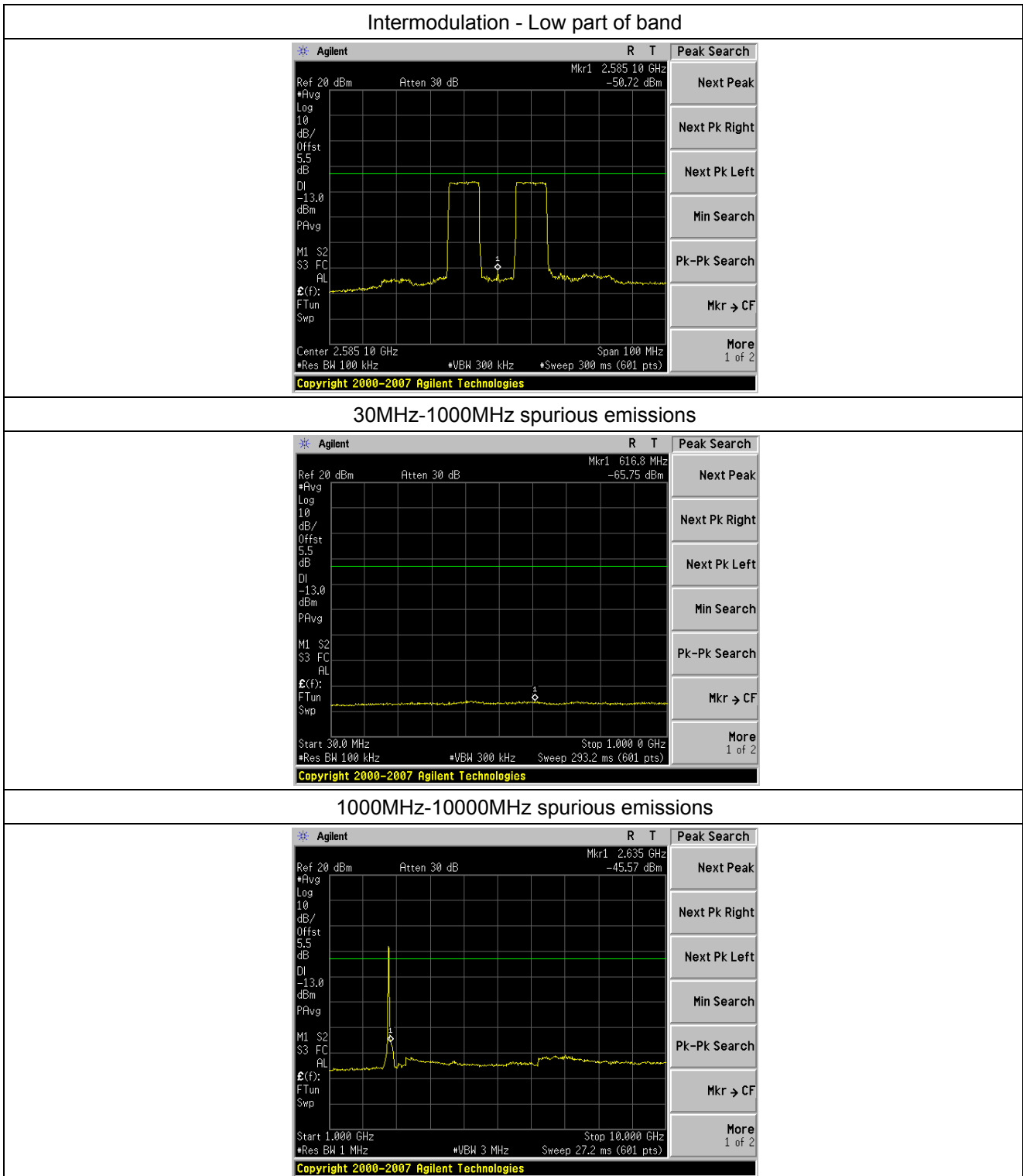

10000MHz-26500MHz spurious emissions

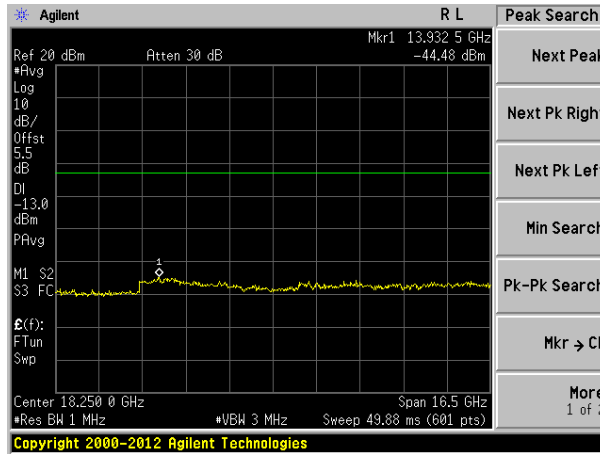

Intermodulation - High part of band

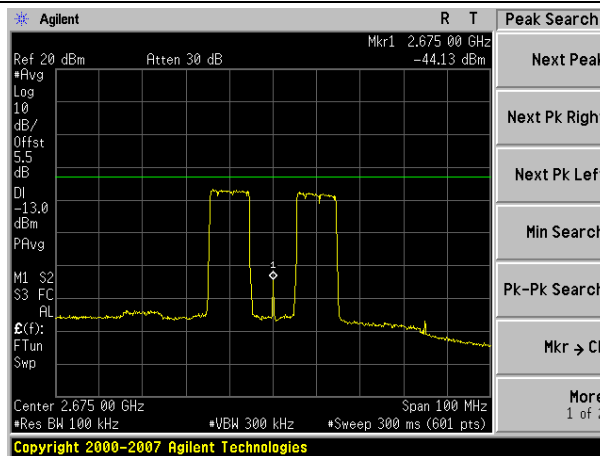

30MHz-1000MHz spurious emissions

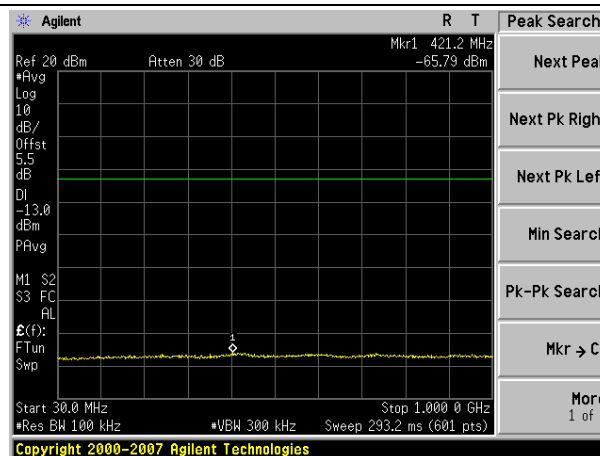

1000MHz-10000MHz spurious emissions

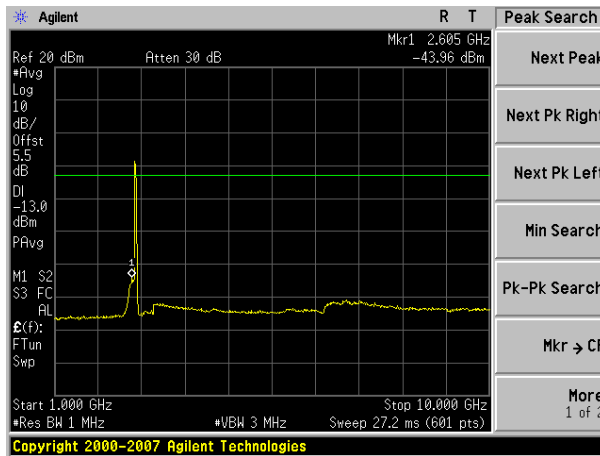

1000MHz-26500MHz spurious emissions

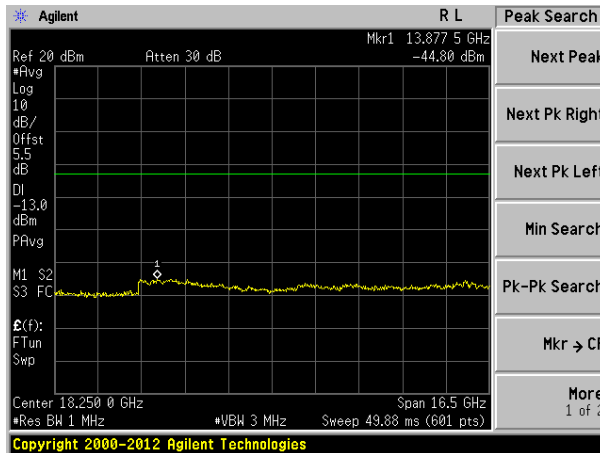

Intermodulation of LTE 15MHz Bandwidth

Intermodulation - Low part of band

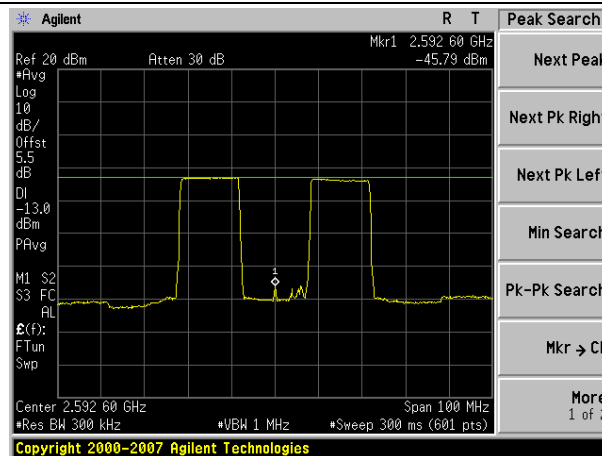

30MHz-1000MHz spurious emissions

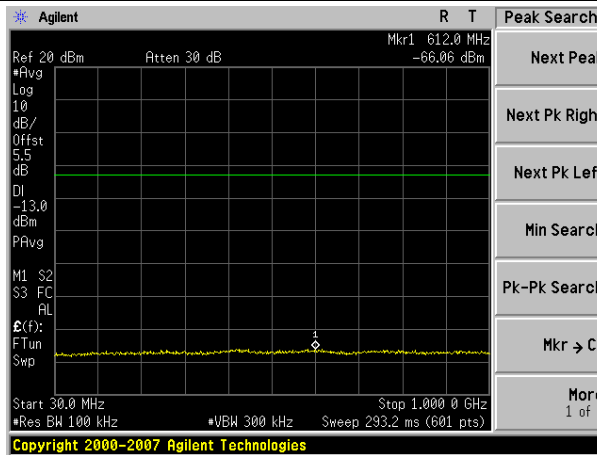

1000MHz-10000MHz spurious emissions

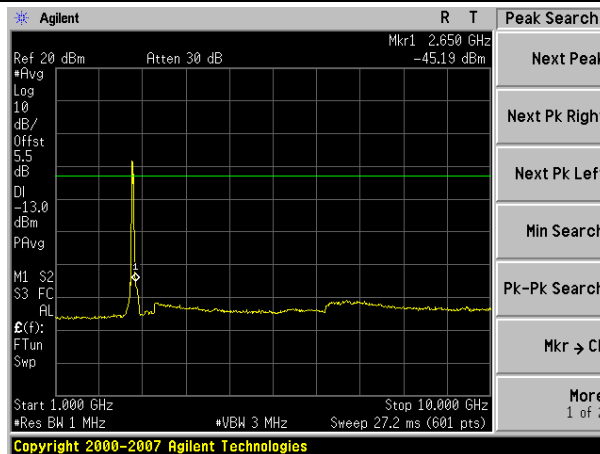

10000MHz-26500MHz spurious emissions

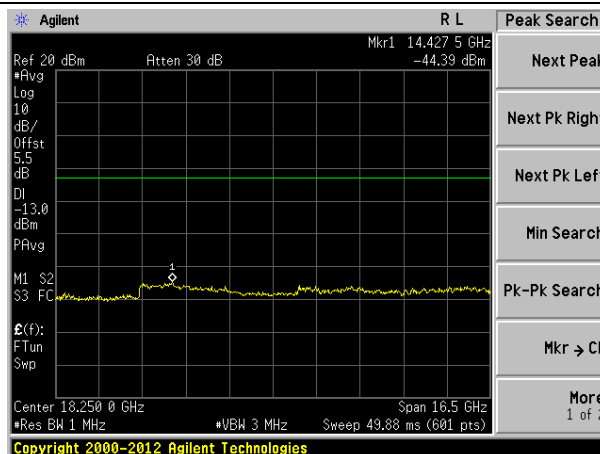

Intermodulation - High part of band

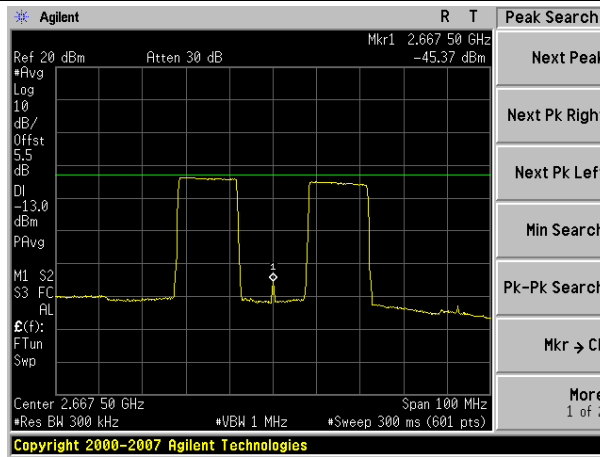

30MHz-1000MHz spurious emissions

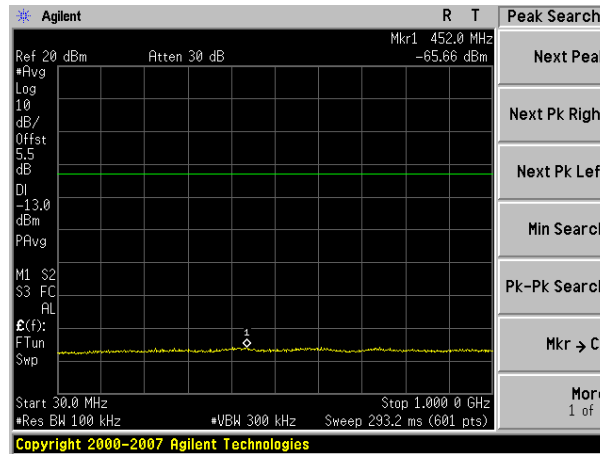

1000MHz-10000MHz spurious emissions

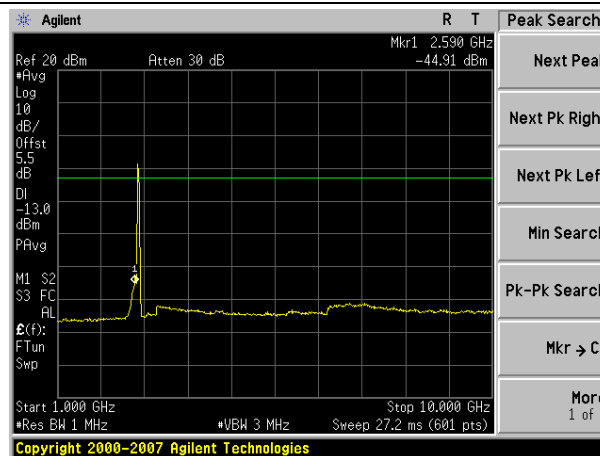

10000MHz-26500MHz spurious emissions

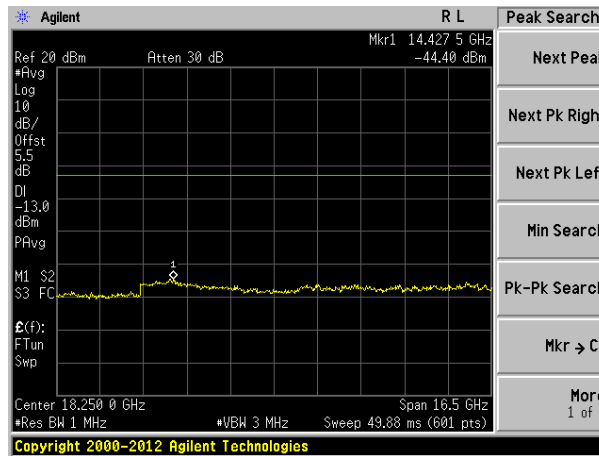

Intermodulation of LTE 20MHz Bandwidth

Intermodulation - Low part of band

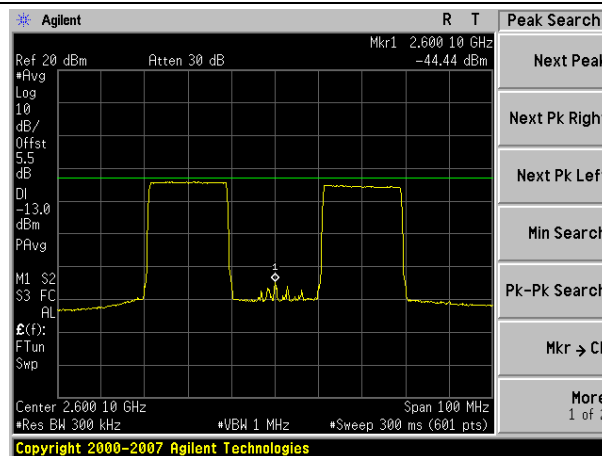

30MHz-1000MHz spurious emissions

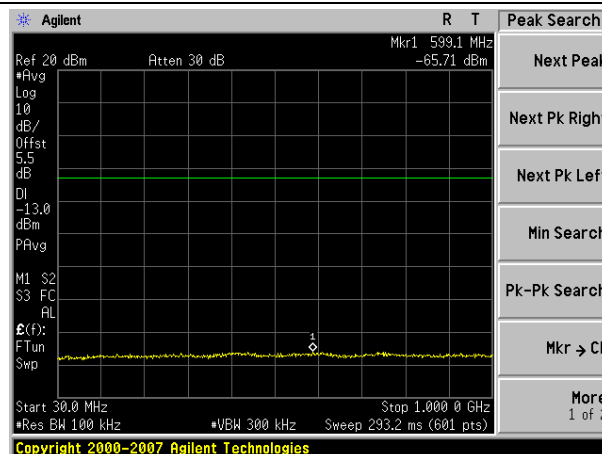

1000MHz-10000MHz spurious emissions

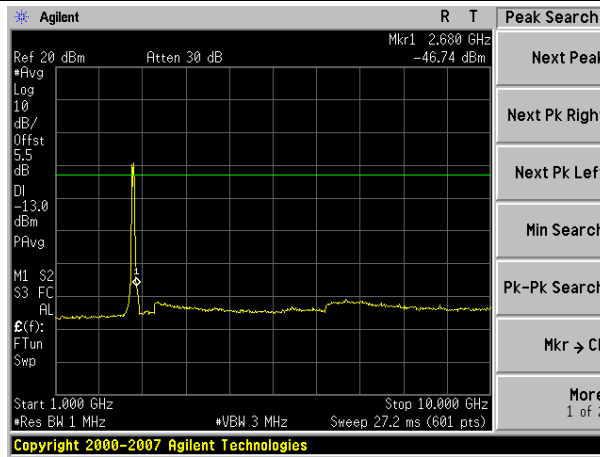

10000MHz-26500MHz spurious emissions

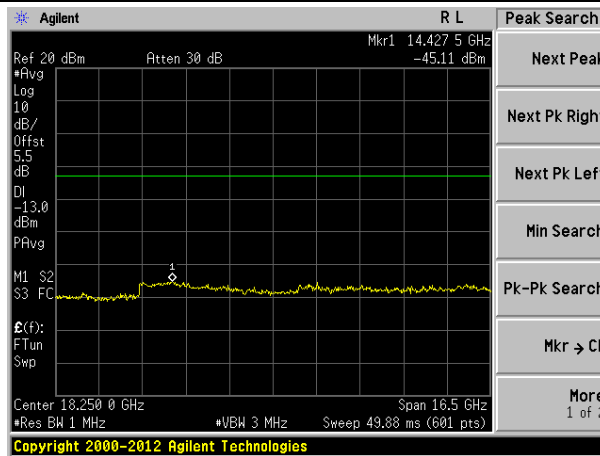

Intermodulation - High part of band

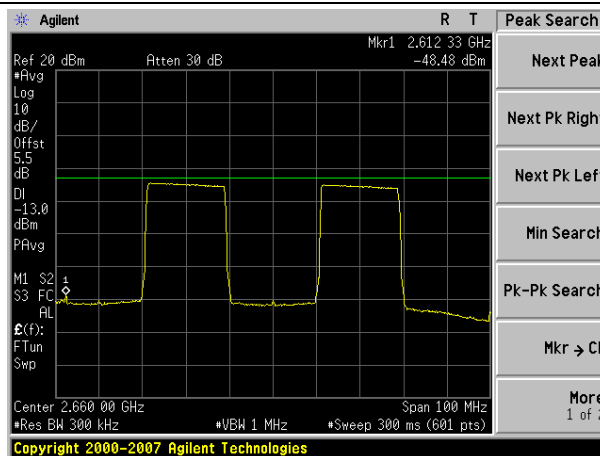

30MHz-1000MHz spurious emissions

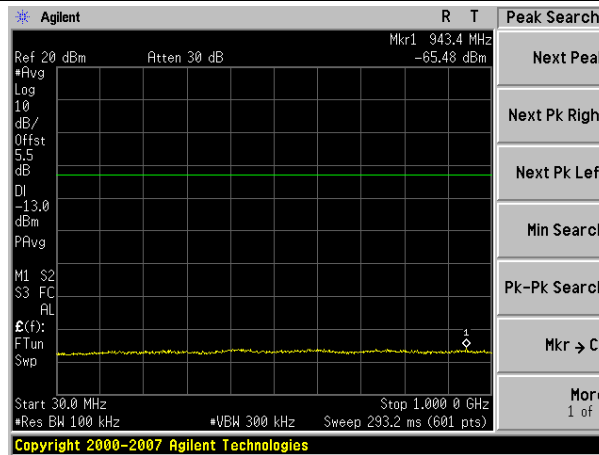

1000MHz-10000MHz spurious emissions

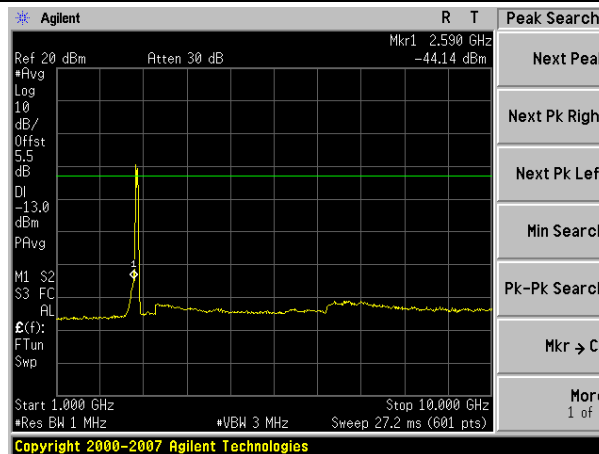

10000MHz-26500MHz spurious emissions

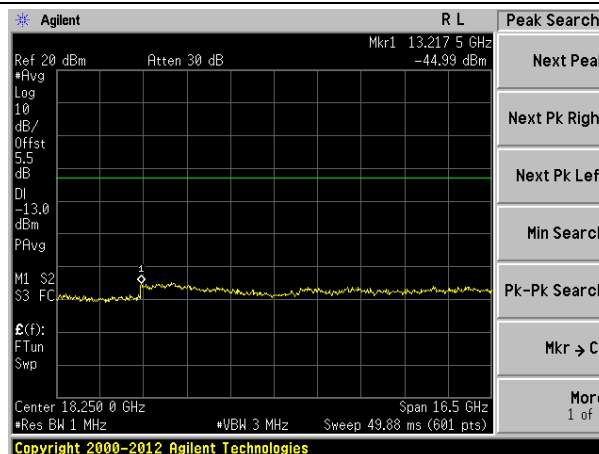

11 FIELD STRENGTH OF SPURIOUS RADIATION MEASUREMENT

11.1 Standard Applicable

According to FCC § 2.1053 and § 27.53(m)

11.2 EUT Setup (Block Diagram of Configuration)

Please refer the section §6.2 Configuration of Tested System.

11.3 Measurement Procedure

1. The EUT RF output port was connected to 50 ohm RF load.
2. The EUT input port was connected to signal generator and was setup to transmit maximum power.
3. The measurement antenna was placed at a distance of 3 meters from the EUT.
4. During the tests, the antenna height and polarization as well as EUT azimuth were varied in order to identify the maximum level of emissions from EUT.
5. The frequency range up to 10-th harmonic of each of the three fundamental frequencies (low, middle and high channels) was investigated. The worst case of emissions was reported.
6. For spurious emissions attenuation, the substitution method was used.
7. The EUT was substituted by a reference antenna (half-wave dipole – below 1 GHz, or Horn antenna – above 1 GHz), connected to a signal generator.
8. The signal generator output level was adjusted to obtain the same reading as from EUT. The EIRP at the spurious emissions frequency was calculated as follows:
$$\text{EIRP} = \text{S.G. output (dBm)} + \text{Antenna Gain(dBi)} - \text{Cable Loss (dB)}$$
9. The antenna substitution method is used to determine the equivalent radiated power at spurious frequencies. The spurious emissions are measured at a distance of 3 meters. The EUT is then replaced with a reference substitution antenna with a known gain referenced to a dipole. This antenna is fed with a signal at the spurious frequency. The level of the signal is adjusted to repeat the previously measured level. The resulting eirp is the signal level fed to the reference antenna corrected for gain referenced to an isotropic dipole
10. From KDB (AMPLIFIER, BOOSTER, AND REPEATER REMINDER SHEET): Radiated spurs (enclosure) – Use of CW signal (low, mid. and high freq.) is acceptable rather than all modulations.
11. The maximum RFI field strength was determined during the measurement by rotating the turntable (± 180 degrees) and varying the height of the receive antenna ($h = 1 \dots 4$ m) as like defined in ANSI C63.4. A measurement receiver has been used with a RBW 120 kHz up to 1 GHz and 1 MHz above 1 GHz. Steps with during pre measurement was half the RBW.
12. Both, the Fully Anechoic Chamber (FAC) and the Semi Anechoic Chamber (SAC) fulfil the requirements of ANSI C63.4 and CISPR 16-1-4 with regards to NSA and SVSWR.

11.4 Measurement data

Downlink mode

Test mode:	Below 1G		Test channel:	Lowest channel
Frequency (MHz)	Spurious Emission		Limit (dBm)	Result
	Polarization	Level (dBm)		
38.46	Vertical	-49.83	-13.00	Pass
57.46	V	-52.46		
124.47	V	-51.26		
194.66	V	-53.27		
586.52	V	---		
857.16	V	---		
54.56	Horizontal	-53.16	-13.00	Pass
120.24	H	-52.73		
212.47	H	-48.36		
247.86	H	-46.28		
738.85	H	---		
946.75	H	---		
Test mode:	Above 1G		Test channel:	Lowest channel
Frequency (MHz)	Spurious Emission		Limit (dBm)	Result
	Polarization	Level (dBm)		
1853.00	Vertical	-53.12	-13.00	Pass
3263.00	V	-51.38		
5636.00	V	-52.44		
7534.00	V	---		
8456.00	V	---		
1769.00	Horizontal	-56.12		
3758.00	H	-55.76	-13.00	Pass
5216.00	H	-53.82		
6536.00	H	---		
8471.00	H	---		

Test mode:	Below 1G		Test channel:	Middle channel
Frequency (MHz)	Spurious Emission		Limit (dBm)	Result
	Polarization	Level (dBm)		
32.66	Vertical	-47.27	-13.00	Pass
41.27	V	-49.58		
53.67	V	-48.35		
75.71	V	-50.11		
121.63	V	---		
215.39	V	---		
66.39	Horizontal	-52.85	-13.00	Pass
123.55	H	-51.25		
203.49	H	-49.77		
243.54	H	-42.03		
396.21	H	---		
943.64	H	---		
Test mode:	Above 1G		Test channel:	Middle channel
Frequency (MHz)	Spurious Emission		Limit (dBm)	Result
	Polarization	Level (dBm)		
1348.00	Vertical	-53.82	-13.00	Pass
3712.00	V	-51.61		
5361.00	V	-52.35		
7235.00	V	---		
8684.00	V	---		
2371.00	Horizontal	-56.85	-13.00	Pass
4346.00	H	-55.21		
5890.00	H	-53.18		
6725.00	H	---		
8651.00	H	---		

Test mode:	Below 1G		Test channel:	Highest channel
Frequency (MHz)	Spurious Emission		Limit (dBm)	Result
	Polarization	Level (dBm)		
34.16	Vertical	-48.42	-13.00	Pass
56.38	V	-50.85		
124.16	V	-49.25		
213.57	V	-51.26		
368.86	V	---		
857.53	V	---		
67.85	Horizontal	-53.46	-13.00	Pass
125.26	H	-54.15		
197.86	H	-49.26		
247.86	H	-44.49		
571.58	H	---		
857.51	H	---		
Test mode:	Above 1G		Test channel:	Highest channel
Frequency (MHz)	Spurious Emission		Limit (dBm)	Result
	Polarization	Level (dBm)		
1815.00	Vertical	-53.12	-13.00	Pass
3381.00	V	-52.87		
5264.00	V	-52.46		
7257.00	V	---		
8476.00	V	---		
1721.00	Horizontal	-56.42	-13.00	Pass
3256.00	H	-55.17		
5247.00	H	-53.27		
6371.00	H	---		
8267.00	H	---		

Remark:

1. Remark"---" means that the emission level is too low to be measured
2. 10GHz-26.5GHz: No substitution measurement has been performed, because there were no emissions detected during the pre measurement other than noise.

Uplink mode

Test mode:	Below 1G		Test channel:	Lowest channel
Frequency (MHz)	Spurious Emission		Limit (dBm)	Result
	Polarization	Level (dBm)		
33.46	Vertical	-45.83	-13.00	Pass
56.19	V	-42.86		
114.64	V	-46.83		
191.46	V	-45.53		
264.49	V	---		
682.61	V	---		
50.35	Horizontal	-48.69	-13.00	Pass
105.64	H	-49.53		
243.85	H	-47.25		
373.52	H	-46.84		
683.45	H	---		
896.53	H	---		
Test mode:	Above 1G		Test channel:	Lowest channel
Frequency (MHz)	Spurious Emission		Limit (dBm)	Result
	Polarization	Level (dBm)		
1664.00	Vertical	-57.85	-13.00	Pass
3314.00	V	-56.43		
4523.00	V	-56.51		
7142.00	V	---		
8475.00	V	---		
1852.00	Horizontal	-57.23	-13.00	Pass
2865.00	H	-57.86		
4526.00	H	-55.35		
6532.00	H	---		
8108.00	H	---		

Test mode:	Below 1G		Test channel:	Middle channel
Frequency (MHz)	Spurious Emission		Limit (dBm)	Result
	Polarization	Level (dBm)		
39.02	Vertical	-41.52	-13.00	Pass
49.71	V	-43.56		
71.83	V	-40.38		
170.20	V	-41.57		
218.31	V	---		
397.63	V	---		
55.81	Horizontal	-46.53	-13.00	Pass
64.89	H	-47.55		
107.51	H	-46.29		
239.99	H	-45.26		
329.04	H	---		
397.63	H	---		
Test mode:	Above 1G		Test channel:	Middle channel
Frequency (MHz)	Spurious Emission		Limit (dBm)	Result
	Polarization	Level (dBm)		
2475.00	Vertical	-57.28	-13.00	Pass
3754.00	V	-56.75		
5127.00	V	-56.21		
7239.00	V	---		
8714.00	V	---		
1638.00	Horizontal	-57.24	-13.00	Pass
2964.00	H	-57.58		
4825.00	H	-55.83		
6452.00	H	---		
8236.00	H	---		

Test mode:	Below 1G		Test channel:	Highest channel
Frequency (MHz)	Spurious Emission		Limit (dBm)	Result
	Polarization	Level (dBm)		
52.16	Vertical	-48.86	-13.00	Pass
124.61	V	-51.53		
213.16	V	-47.58		
361.19	V	-47.36		
519.26	V	---		
756.63	V	---		
50.16	Horizontal	-48.26	-13.00	Pass
103.52	H	-49.17		
242.86	H	-47.88		
356.25	H	-46.85		
564.58	H	---		
758.86	H	---		
Test mode:	Above 1G		Test channel:	Highest channel
Frequency (MHz)	Spurious Emission		Limit (dBm)	Result
	Polarization	Level (dBm)		
2164.00	Vertical	-57.71	-13.00	Pass
3883.00	V	-56.32		
5304.00	V	-56.10		
7182.00	V	---		
8927.00	V	---		
1536.00	Horizontal	-57.23	-13.00	Pass
3264.00	H	-57.46		
4426.00	H	-55.36		
6143.00	H	---		
8733.00	H	---		

Remark:

1. Remark"---" means that the emission level is too low to be measured
2. 10GHz-26.5GHz: No substitution measurement has been performed, because there were no emissions detected during the pre measurement other than noise.

12 FREQUENCY STABILITY

12.1 Standard Applicable

According to FCC § 2.1055 and § 27.54

12.2 Test setup

Please refer the section §6.2 Configuration of Tested System.

12.3 Test Procedure

1. The EUT was placed inside the temperature chamber.
2. The RF output port was connected to a spectrum analyzer.
3. The level of RF input signal shall be increased, until the maximum output power per channel, declared by client, is reached.
4. After the temperature stabilized for approximately 20 min, the transmitting frequency was measured by the spectrum analyzer and recorded.
5. At room temperature, the frequency was measured when EUT was powered with the nominal voltage and with 85% and 115% of the nominal voltage.

12.4 Test Result

Passed.

Downlink:

Reference Frequency: Middle channel=2630MHz					
Voltage with nominal Voltage	Power Supplied (VAC)	Temperature (°C)	Frequency Error (Hz)	Frequency Error (ppm)	Result
100%	120V	-40	16	0.0061	Passed
100%		-30	13	0.0049	Passed
100%		-20	11	0.0042	Passed
100%		-10	8	0.0030	Passed
100%		0	5	0.0019	Passed
100%		10	7	0.0027	Passed
100%		20	12	0.0046	Passed
100%		30	14	0.0053	Passed
100%		40	15	0.0057	Passed
100%		50	14	0.0053	Passed
100%		55	15	0.0057	Passed
85%		102V	20	13	0.0049
115%	138V	20	11	0.0042	Passed

Remark: EUT is specified for outdoor use with temperature range of -40° to +55° C, and was tested with its range.

Uplink:

Reference Frequency: Middle channel=2630MHz					
Voltage with nominal Voltage	Power Supplied (VAC)	Temperature (°C)	Frequency Error (Hz)	Frequency Error (ppm)	Result
100%	120V	-40	14	0.0053	Passed
100%		-30	14	0.0053	Passed
100%		-20	11	0.0042	Passed
100%		-10	8	0.0030	Passed
100%		0	7	0.0027	Passed
100%		10	4	0.0015	Passed
100%		20	12	0.0046	Passed
100%		30	11	0.0042	Passed
100%		40	13	0.0049	Passed
100%		50	15	0.0057	Passed
100%		55	13	0.0049	Passed
85%		102V	20	12	0.0046
115%	138V	20	9	0.0034	Passed

Remark: EUT is specified for outdoor use with temperature range of -40° to +55° C, and was tested with its range.

13 OUT-OF-BAND REJECTION

13.1 Standard Applicable

According to KDB (AMPLIFIER, BOOSTER, AND REPEATER REMINDER SHEET):

Out of Band Rejection – Test for rejection of out of band signals. Filter freq. response plots are acceptable.

13.2 Test setup

Please refer the section §6.2 Configuration of Tested System.

13.3 Test Procedure

1. The EUT RF output port was connected to spectrum analyzer.
2. The level of RF input signal shall be increased, until the maximum output power per channel, declared by client, is reached.
3. A continuous sinusoidal RF signal shall be fed successively at frequency offsets 100 MHz from the edges of the relevant MS or BTS transmit frequency band into the relevant input port of the repeater.
4. The RF output curve was recorded by spectrum analyzer.

13.4 Test Result

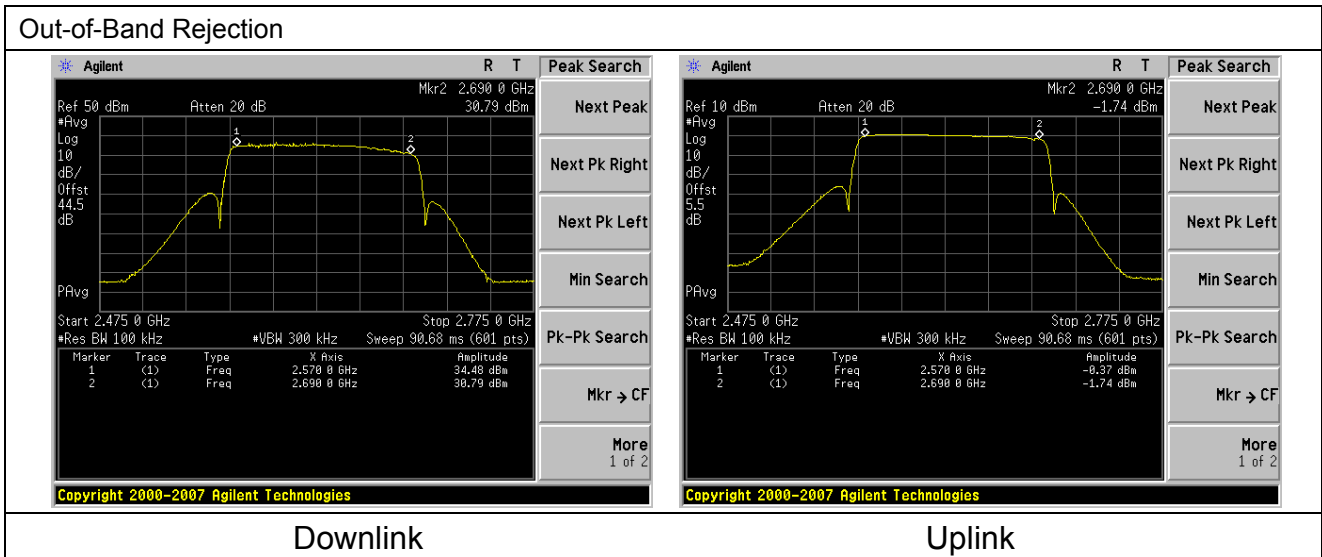

14 AC POWER LINE CONDUCTED EMISSION TEST

14.1 Standard Applicable

According to FCC §15.207. The emission value for frequency within 150KHz to 30MHz shall not Exceed criteria of below chart.

Frequency range (MHz)	Limits dB(uV)	
	Quasi-peak	Average
0.15 to 0.50	79	66
0.50 to 30	73	60
<p>Note</p> <p>1.The lower limit shall apply at the transition frequencies</p> <p>2.The limit decreases linearly with the logarithm of the frequency in the range 0.15 MHz to 0.50 MHz.</p>		

14.2 Test setup

1. The conducted emission tests were performed in the test site, using the setup in accordance with the ANSI C63.4-2001.
2. The EUT was plug-in DC power adaptor and was placed on the center of the back edge on the test table. The peripherals like earphone was placed on the side of the EUT. The rear of the EUT and peripherals were placed flushed with the rear of the tabletop.
3. The Power adaptor was connected with 110VAC/60Hz power source.

14.3 Test Procedure

1. The EUT was placed on a table which is 0.8m above ground plane.
2. Maximum procedure was performed on the six highest emissions to ensure EUT compliance.
3. Repeat above procedures until all frequency measured were complete.

14.4 Measurement Result

Downlink:

Line:

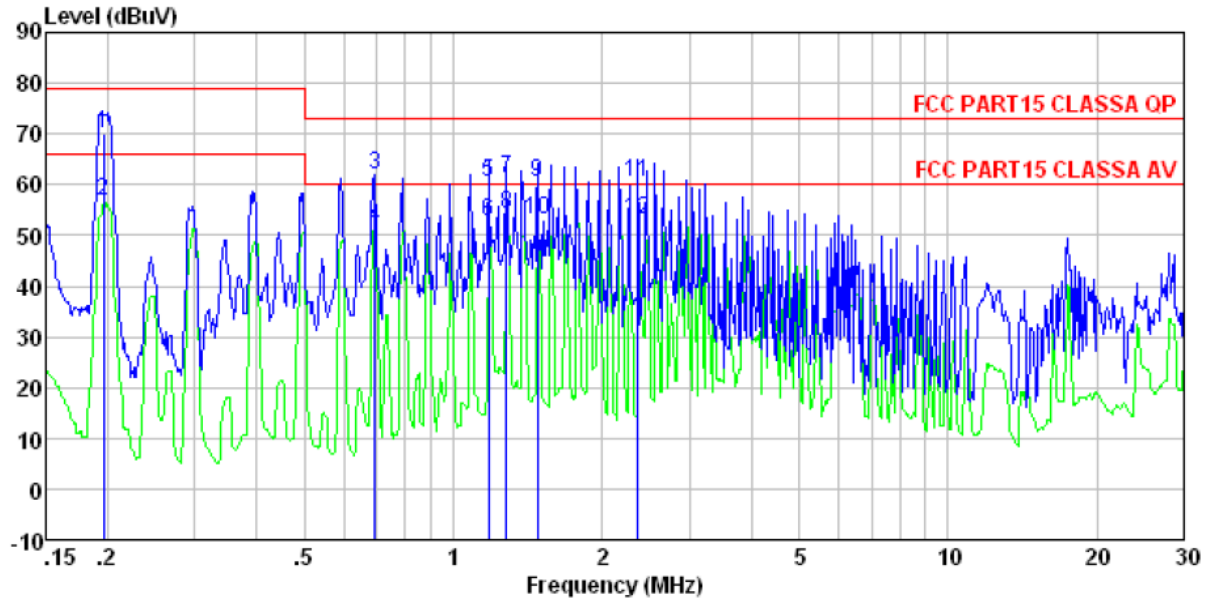

Condition : FCC PART15 CLASSA QP LISN-2013 LINE
 Job NO. : 0101RF
 Test mode : Downlink mode
 Test Engineer: Edward

	Freq	Read Level	LISN Factor	Cable Loss	Level	Limit Line	Over Limit	Remark
	MHz	dBuV	dB	dB	dBuV	dBuV	dB	
1	0.197	69.75	0.14	0.13	70.02	79.00	-8.98	QP
2	0.197	56.57	0.14	0.13	56.84	66.00	-9.16	Average
3	0.694	61.51	0.14	0.13	61.78	73.00	-11.22	QP
4	0.694	51.51	0.14	0.13	51.78	60.00	-8.22	Average
5	1.178	60.30	0.13	0.13	60.56	73.00	-12.44	QP
6	1.178	52.33	0.13	0.13	52.59	60.00	-7.41	Average
7	1.282	60.90	0.12	0.13	61.15	73.00	-11.85	QP
8	1.282	53.80	0.12	0.13	54.05	60.00	-5.95	Average
9	1.480	60.26	0.12	0.13	60.51	73.00	-12.49	QP
10	1.480	52.98	0.12	0.13	53.23	60.00	-6.77	Average
11	2.358	60.31	0.13	0.15	60.59	73.00	-12.41	QP
12	2.358	52.64	0.13	0.15	52.92	60.00	-7.08	Average

Neutral:

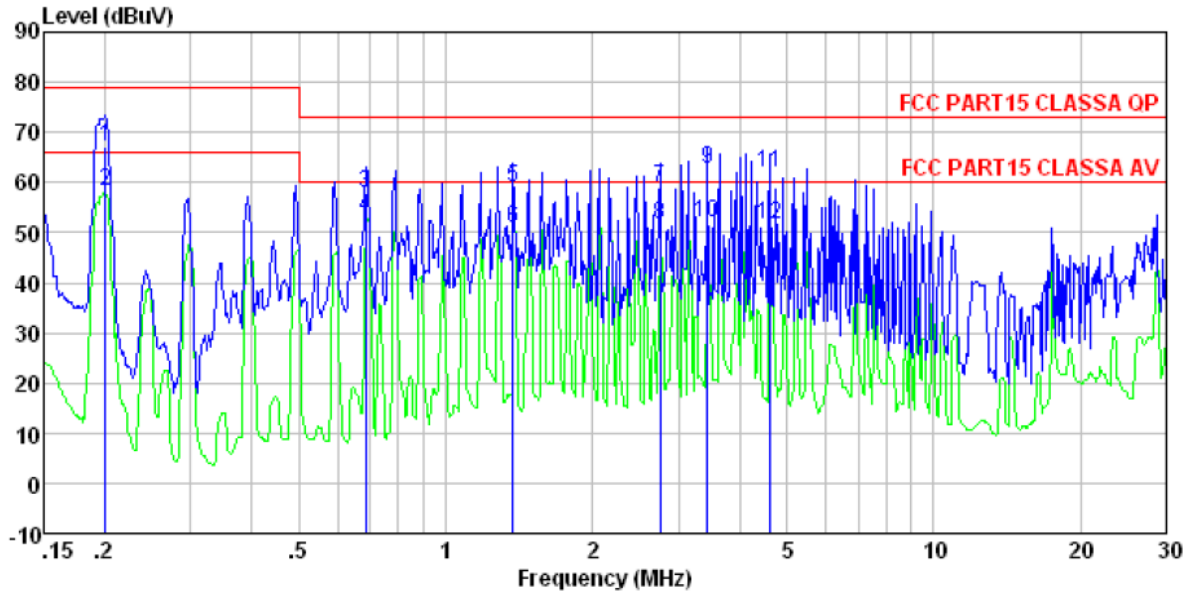

Condition : FCC PART15 CLASS A QP LISN-2013 NEUTRAL
 Job NO. : 0101RF
 Test mode : Downlink mode
 Test Engineer: Edward

	Freq	Read Level	LISN Factor	Cable Loss	Level	Limit Line	Over Limit	Remark
	MHz	dBuV	dB	dB	dBuV	dBuV	dB	
1	0.201	66.89	0.07	0.13	67.09	79.00	-11.91	QP
2	0.201	58.15	0.07	0.13	58.35	66.00	-7.65	Average
3	0.686	57.64	0.07	0.13	57.84	73.00	-15.16	QP
4	0.686	52.89	0.07	0.13	53.09	60.00	-6.91	Average
5	1.374	58.79	0.09	0.13	59.01	73.00	-13.99	QP
6	1.374	50.65	0.09	0.13	50.87	60.00	-9.13	Average
7	2.750	58.76	0.10	0.15	59.01	73.00	-13.99	QP
8	2.750	51.44	0.10	0.15	51.69	60.00	-8.31	Average
9	3.436	62.48	0.13	0.15	62.76	73.00	-10.24	QP
10	3.436	51.88	0.13	0.15	52.16	60.00	-7.84	Average
11	4.622	61.54	0.15	0.15	61.84	73.00	-11.16	QP
12	4.622	51.42	0.15	0.15	51.72	60.00	-8.28	Average

Uplink:

Line:

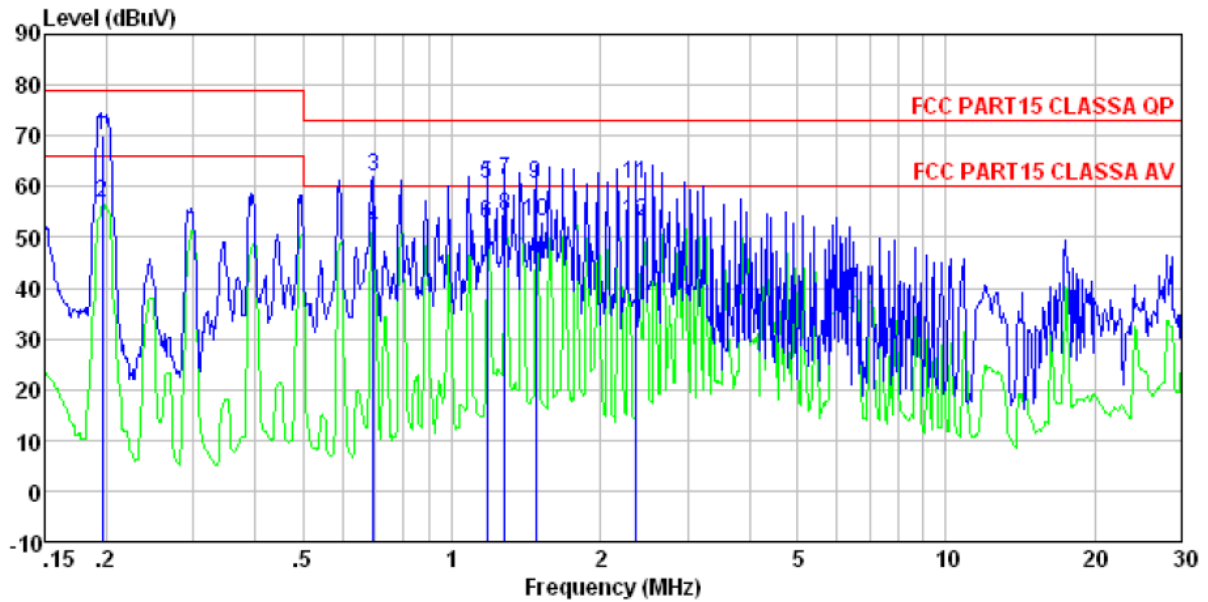

Condition : FCC PART15 CLASSA QP LISN-2013 LINE
 Job NO. : 0101RF
 Test mode : Uplink mode
 Test Engineer: Edward

	Freq	Read Level	LISN Factor	Cable Loss	Level	Limit Line	Over Limit	Remark
	MHz	dBuV	dB	dB	dBuV	dBuV	dB	
1	0.197	69.75	0.14	0.13	70.02	79.00	-8.98	QP
2	0.197	56.57	0.14	0.13	56.84	66.00	-9.16	Average
3	0.694	61.51	0.14	0.13	61.78	73.00	-11.22	QP
4	0.694	51.51	0.14	0.13	51.78	60.00	-8.22	Average
5	1.178	60.30	0.13	0.13	60.56	73.00	-12.44	QP
6	1.178	52.33	0.13	0.13	52.59	60.00	-7.41	Average
7	1.282	60.90	0.12	0.13	61.15	73.00	-11.85	QP
8	1.282	53.80	0.12	0.13	54.05	60.00	-5.95	Average
9	1.480	60.26	0.12	0.13	60.51	73.00	-12.49	QP
10	1.480	52.98	0.12	0.13	53.23	60.00	-6.77	Average
11	2.358	60.31	0.13	0.15	60.59	73.00	-12.41	QP
12	2.358	52.64	0.13	0.15	52.92	60.00	-7.08	Average

Neutral:

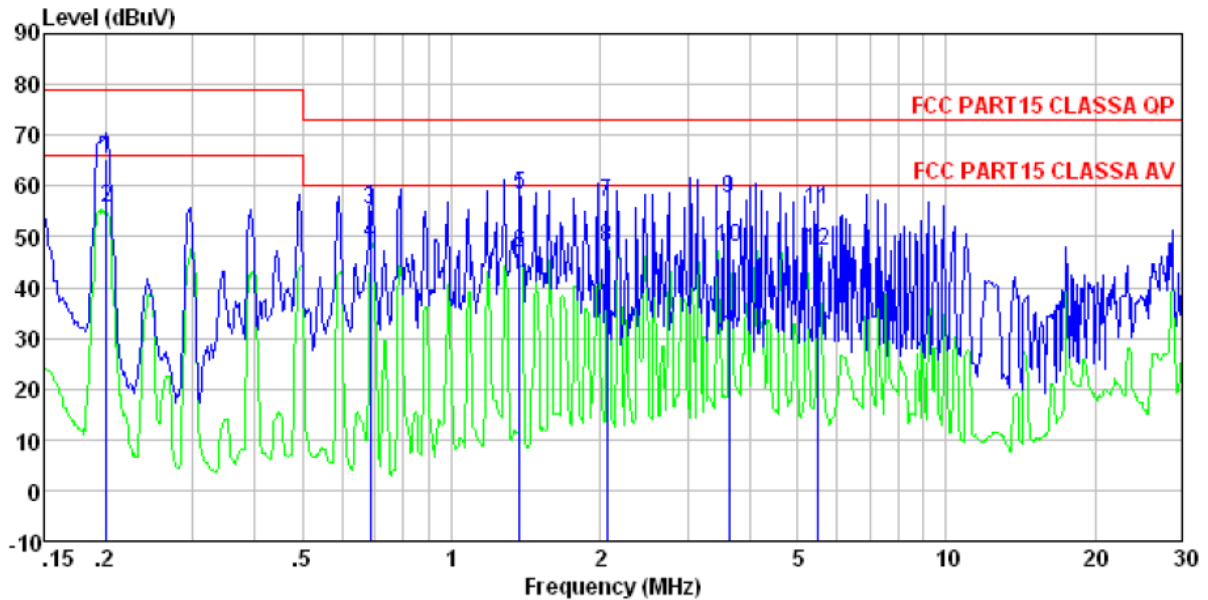

Condition : FCC PART15 CLASSA QP LISN-2013 NEUTRAL
 Job NO. : 0101RF
 Test mode : Uplink mode
 Test Engineer: Edward

	Read Freq	LISN Level	Cable Factor	Cable Loss	Limit Level	Over Line	Over Limit	Remark
	MHz	dBuV	dB	dB	dBuV	dBuV	dB	
1	0.201	64.89	0.07	0.13	65.09	79.00	-13.91	QP
2	0.201	55.32	0.07	0.13	55.52	66.00	-10.48	Average
3	0.686	55.16	0.07	0.13	55.36	73.00	-17.64	QP
4	0.686	48.65	0.07	0.13	48.85	60.00	-11.15	Average
5	1.374	58.14	0.09	0.13	58.36	73.00	-14.64	QP
6	1.374	46.76	0.09	0.13	46.98	60.00	-13.02	Average
7	2.066	56.46	0.09	0.15	56.70	73.00	-16.30	QP
8	2.066	47.88	0.09	0.15	48.12	60.00	-11.88	Average
9	3.642	57.15	0.14	0.15	57.44	73.00	-15.56	QP
10	3.642	47.46	0.14	0.15	47.75	60.00	-12.25	Average
11	5.505	55.16	0.16	0.15	55.47	73.00	-17.53	QP
12	5.505	46.71	0.16	0.15	47.02	60.00	-12.98	Average

15 Test Setup Photo

Radiated Emission

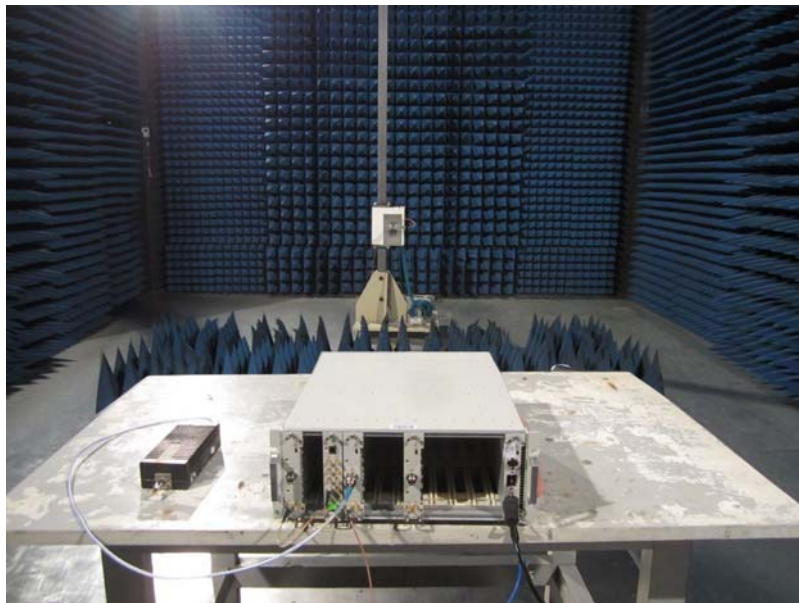
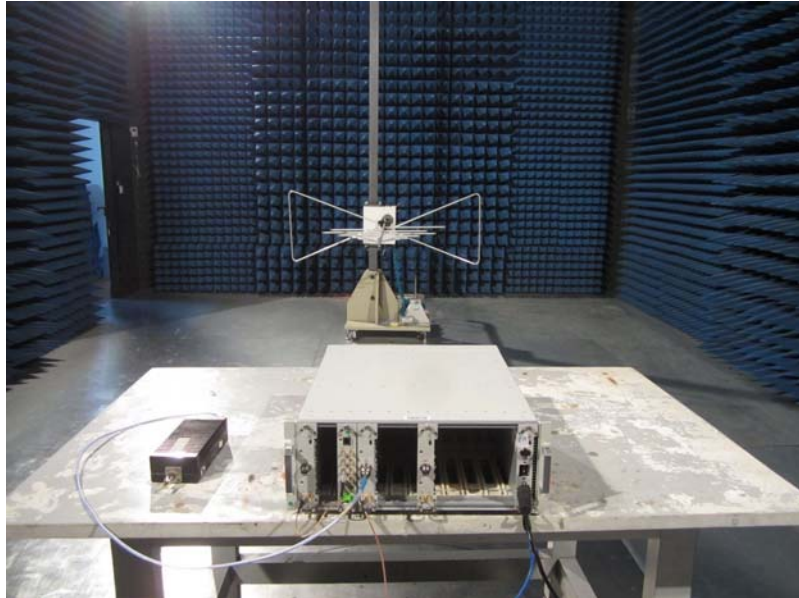

Conducted Emission



16 EUT Constructional Details

RUM- Front view

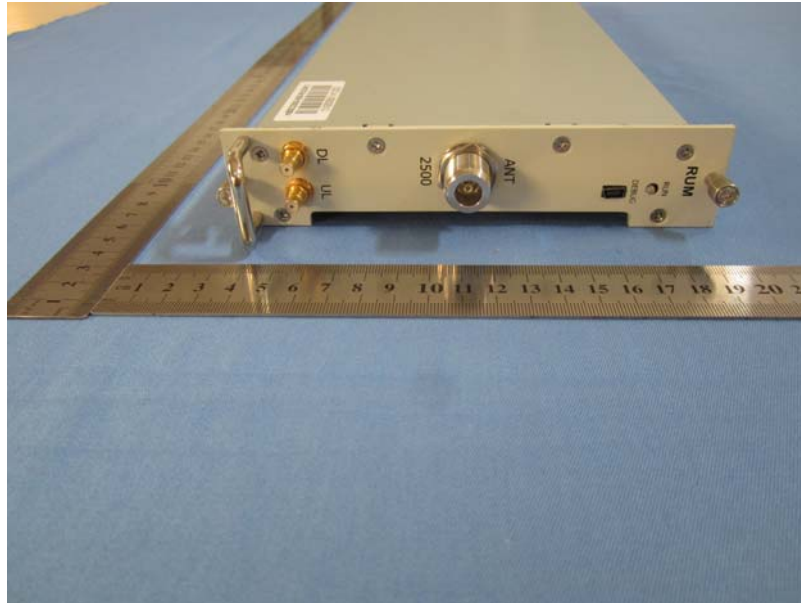

RUM- Rear view



RUM- Top view



RUM- Bottom view



RUM- Left view



RUM- Right view

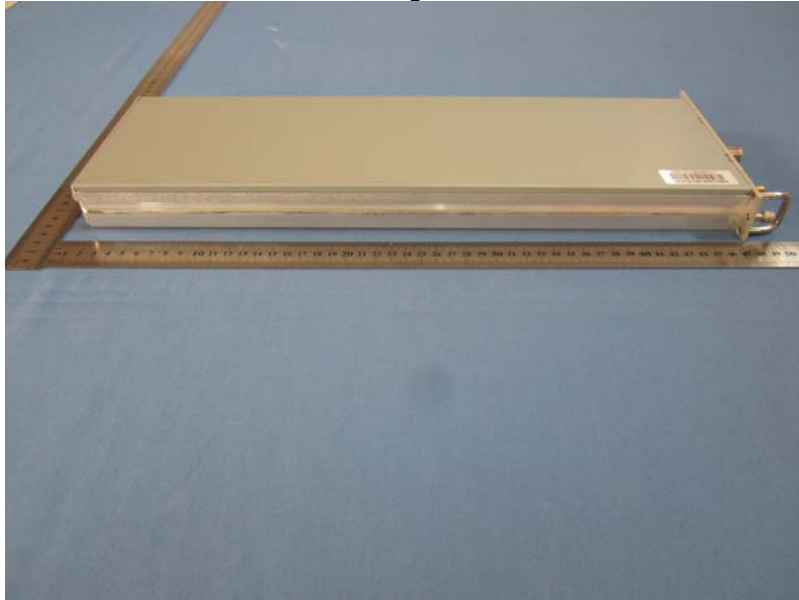

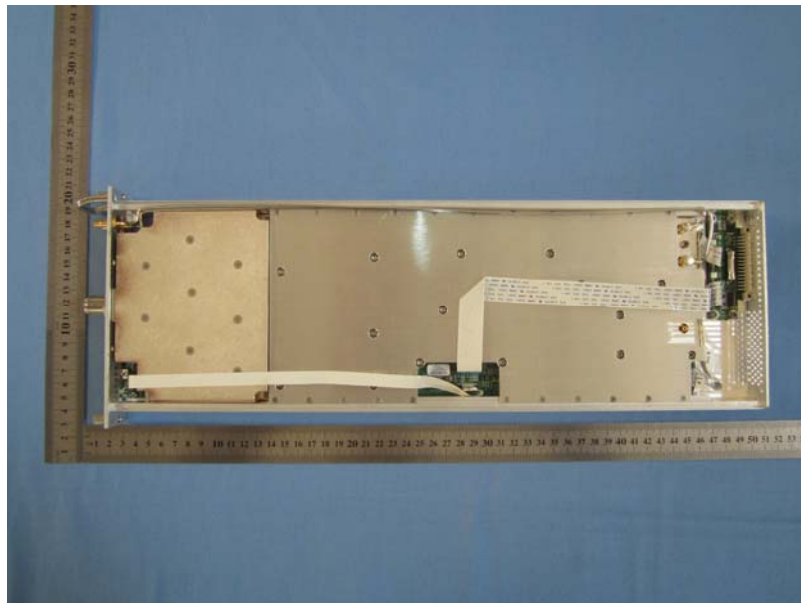
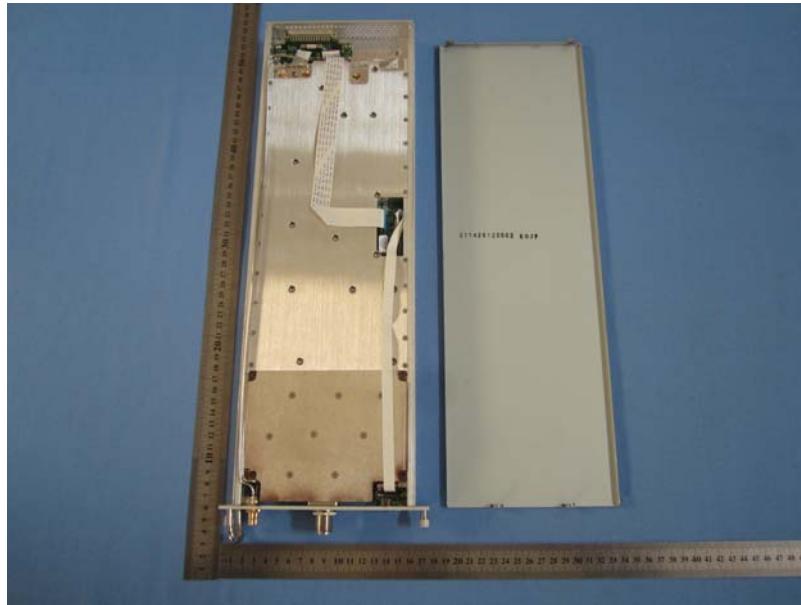

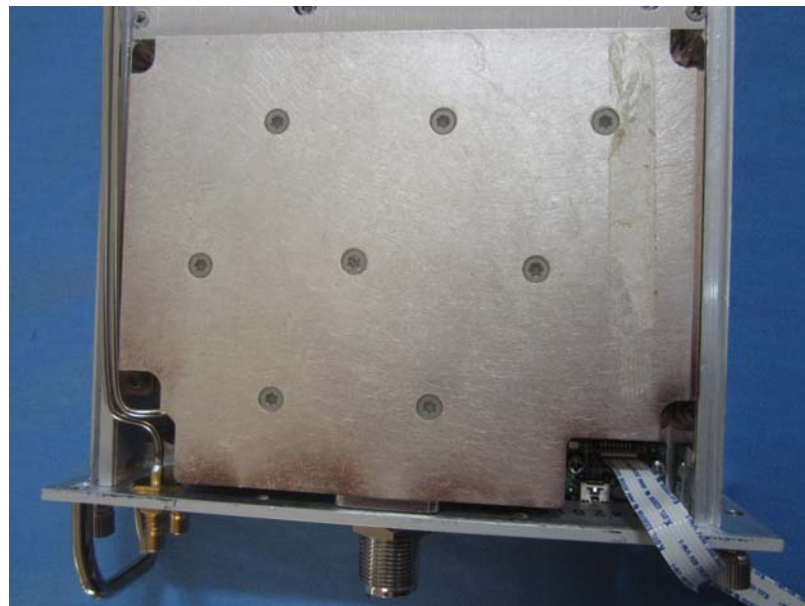
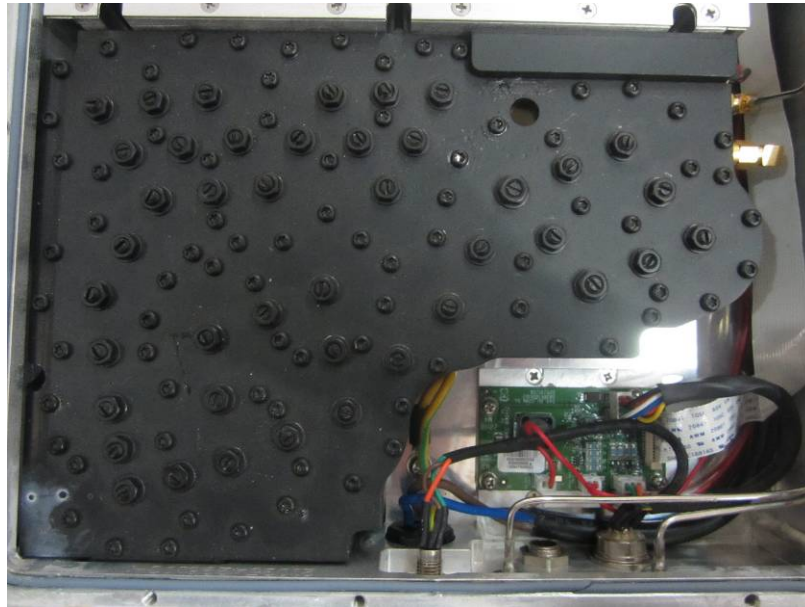

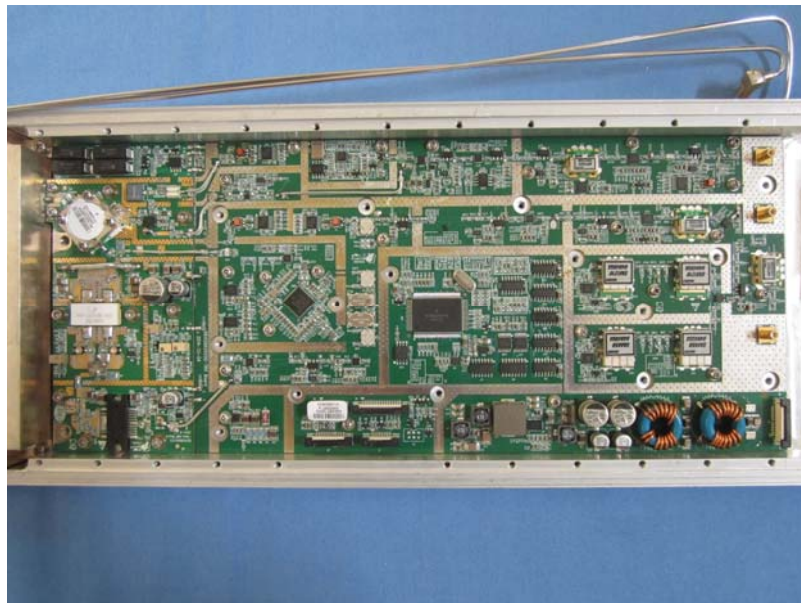
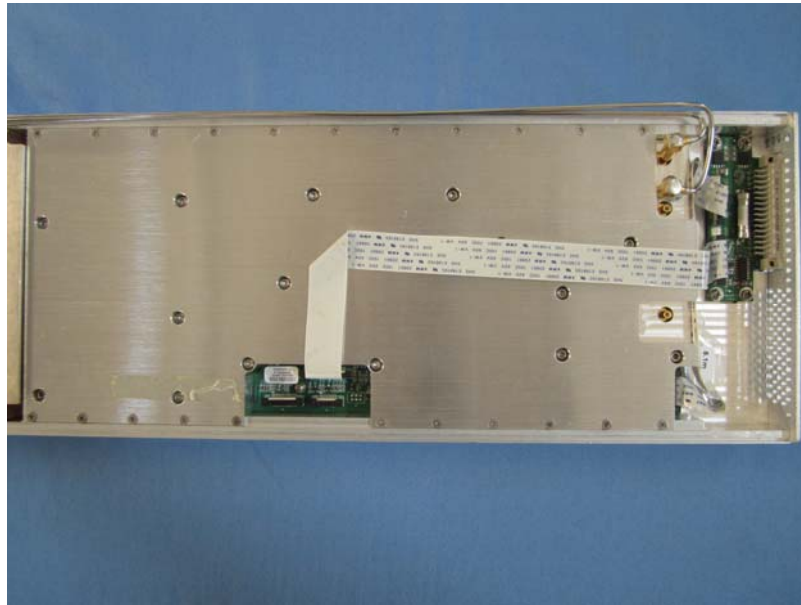

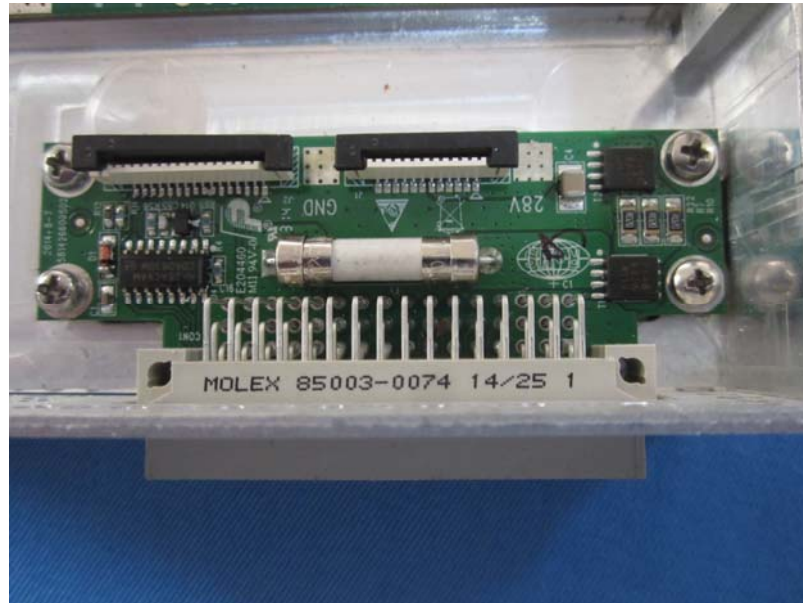

-----end-----