

FCC REPORT

Applicant: Bravo Tech(shenzhen)Co.Ltd
Address of Applicant: No. 8 Building, The 3rd Zone, Tangtou Industrial P Shiyan, Baoan District, Shenzhen, China

Equipment Under Test (EUT)

Product Name: mBSC-020 DAS System

Model No.: mBSC2100-040-RUM01

Trade mark:



FCC ID: WBKMBSC2100040RUM

Applicable standards: FCC CFR Title 47 Part 2:2012
FCC CFR Title 47 Part27 Subpart C:2012

Date of sample receipt: Nov. 15, 2012

Date of Test: Nov. 15-26, 2012

Date of report issued: Nov. 26, 2012

Test Result : PASS *

* In the configuration tested, the EUT complied with the standards specified above.

Authorized Signature:

A handwritten signature in black ink is written over a circular blue stamp. The stamp contains the text 'GLOBAL TECHNOLOGY SERVICES CO., LTD.' around the perimeter, 'GTS' in the center, and 'ELECTRICAL TESTING' below it. The date 'NOV. 26, 2012' is also visible at the bottom of the stamp.

Robinson Luo
Laboratory Manager

This report details the results of the testing carried out on one sample. The results contained in this test report do not relate to other samples of the same product and does not permit the use of the GTS product certification mark. The manufacturer should ensure that all products in series production are in conformity with the product sample detailed in this report.

This report may only be reproduced and distributed in full. If the product in this report is used in any configuration other than that detailed in the report, the manufacturer must ensure the new system complies with all relevant standards. Any mention of GTS International Electrical Approvals or testing done by GTS International Electrical Approvals in connection with, distribution or use of the product described in this report must be approved by GTS International Electrical Approvals in writing.

This document cannot be reproduced except in full, without prior written approval of the Company. Any unauthorized alteration, forgery or falsification of the content or appearance of this document is unlawful and offenders may be prosecuted to the fullest extent of the law. Unless otherwise stated the results shown in this test report refer only to the sample(s) tested and such sample(s) are retained for 90 days only."

2 Version

Version No.	Date	Description
00	Nov. 26, 2012	Original

Prepared By: Oscear. Li **Date:** Nov. 26, 2012
Project Engineer

Check By: Hans. Hu **Date:** Nov. 26, 2012
Reviewer

3 Contents

	Page
1 COVER PAGE	1
2 VERSION	2
3 CONTENTS	3
4 TEST SUMMARY	5
5 GENERAL INFORMATION	6
5.1 CLIENT INFORMATION	6
5.2 GENERAL DESCRIPTION OF E.U.T.	6
5.3 RELATED SUBMITTAL(S) / GRANT (S)	7
5.4 TEST METHODOLOGY	7
5.5 TEST FACILITY	7
5.6 TEST LOCATION	7
5.7 TEST INSTRUMENTS LIST	8
6 TEST CONFIGURATION AND CONDITIONS	9
6.1 EUT CONFIGURATION	9
6.2 EUT CONFIGURATION	9
6.3 BLOCK DIAGRAM	9
6.4 CONFIGURATION OF TESTED SYSTEM	10
6.5 TEST ENVIRONMENTS	12
6.6 TEST SIGNAL	12
6.7 TEST FREQUENCY SELECTION	12
6.8 DESCRIPTION OF TEST MODES	13
7 RF POWER OUTPUT MEASUREMENT	14
7.1 STANDARD APPLICABLE	14
7.2 TEST SETUP	14
7.3 MEASUREMENT PROCEDURE	14
7.4 TEST RESULT	15
7.4.1 RF Output Power	15
7.4.2 Peak to Average Ratio	18
8 MODULATION CHARACTERISTIC	19
9 OCCUPIED BANDWIDTH	20
9.1 STANDARD APPLICABLE	20
9.2 TEST SETUP	20
9.3 TEST PROCEDURE	20
9.4 TEST RESULT	20
10 OUT OF BAND EMISSION AT ANTENNA TERMINALS	37
10.1 STANDARD APPLICABLE	37
10.2 TEST SETUP	37
10.3 MEASUREMENT PROCEDURE	37
10.4 MEASUREMENT RESULT	39
10.4.1 Spurious emission	39
10.4.2 Band edge emission	76

11	INTERMODULATION.....	76
11.1	STANDARD APPLICABLE	76
11.2	TEST SETUP	76
11.3	MEASUREMENT PROCEDURE.....	76
11.4	TEST RESULT	76
12	FIELD STRENGTH OF SPURIOUS RADIATION MEASUREMENT	76
12.1	STANDARD APPLICABLE	76
12.2	EUT SETUP (BLOCK DIAGRAM OF CONFIGURATION).....	76
12.3	MEASUREMENT PROCEDURE.....	76
12.4	TEST RESULT	76
13	FREQUENCY STABILITY.....	76
13.1	STANDARD APPLICABLE	76
13.2	TEST SETUP	76
13.3	TEST PROCEDURE	76
13.4	TEST RESULT	76
14	OUT-OF-BAND REJECTION.....	76
14.1	STANDARD APPLICABLE	76
14.2	TEST SETUP	76
14.3	TEST PROCEDURE	76
14.4	TEST RESULT	76
15	AC POWER LINE CONDUCTED EMISSION TEST.....	76
15.1	STANDARD APPLICABLE	76
15.2	TEST SETUP	76
15.3	TEST PROCEDURE	76
15.4	MEASUREMENT RESULT.....	76
16	TEST SETUP PHOTO	76
17	EUT CONSTRUCTIONAL DETAILS	76

4 Test Summary

Test Item	Section in CFR 47	Result
Maximum Permissible exposure(MPE)	§1.1307(b)(1), §2.1091	PASS* (Please refer to MPE Report)
RF Output Power	§2.1046(a); §27.50(d)	PASS
Modulation Characteristics	§ 2.1047	N/A*
99% Occupied Bandwidth	§ 2.1049 §27.53(h)	PASS
Spurious Emissions at Antenna Terminal	§2.1051; §27.53(h)	PASS
Intermodulation	§2.1051; §27.53(h)	PASS
Field Strength of Spurious Radiation	§ 2.1053 §27.53(h)	PASS
Out of band emission, Band Edge	§27.53(h)	PASS
Frequency stability vs. temperature Frequency stability vs. voltage	§ 2.1055 §27.54	PASS
Out-of-Band Rejection	--	PASS

Remark:

N/A*:According to FCC § 2.1047(d), part 27 there is no specific requirement for digital modulation, therefore modulation characteristic is not presented.

5 General Information

5.1 Client Information

Applicant:	Bravo Tech (ShenZhen) Co., Ltd.
Address of Applicant:	No. 8 Building, The 3rd Zone, Tangtou Industrial P Shiyuan, Baoan District, Shenzhen, China
Manufacturer/Factory:	Bravo Tech (ShenZhen) Co., Ltd.
Address of Manufacturer/Factory :	No. 8 Building, The 3rd Zone, Tangtou Industrial P Shiyuan, Baoan District, Shenzhen, China

5.2 General Description of E.U.T.

Product Name:	mBSC-020 DAS System	
Model No.:	mBSC2100-040-RUM01	
Power supply:	Remote Unit: Input: AC 110-220V, 50/60Hz Normal test voltage: 120V AC 60Hz	
Operating Temperature:	Remote Unit: -40°C to + 55°C	
Operating Humidity:	up to 95%	
Technical Parameter:		
Frequency Range	Downlink	2110MHz~2155MHz
	Uplink	1710MHz~1755MHz
Operating Bandwidth	45MHz	
Multiple Carrier Supported	4	
Channel Spacing(s) / Bandwidth(s)	WCDMA: 5MHz LTE:1.4MHz, 3MHz, 5MHz, 10MHz, 15MHz, 20MHz, CDMA / EVDO: 1.25MHz	
Maximun RF Output Power	Downlink: 46dBm±1dB Uplink: N/A Note: The EUT does not transmit over the air in the uplink direction.	
Max Gain	40dB to 65dB Gain for DL	
Type of modulation and Designator	WCDMA(F9W); LTE(G7D); CDMA(F9W); EVDO(F9W)	
Antenna Type	External antenna ("7/16 DIN" type)	
Antenna Gain	16.15dBi	
Software Version:	RU_2.0.0.3_20120808 LPA2100060\$W03_3000A	
Hardware Version:	V1.0	

5.3 Related Submittal(s) / Grant (s)

47 CFR Part 2	Frequency Allocations and Radio Treaty Matters; General Rules and Regulations
47 CFR Part 27	Miscellaneous Wireless Communications Services

5.4 Test Methodology

ANSI C63.4: 2003	Methods of Measurement of Radio-Noise Emissions from Low Voltage Electrical and Electronic Equipment in the Range of 9 kHz to 40 GHz
ANSI/TIA-603-C 2004	Land Mobile FM or PM Communications Equipment Measurement and Performance Standards
KDB	AMPLIFIER, BOOSTER, AND REPEATER REMINDER SHEET

5.5 Test Facility

<p>The test facility is recognized, certified, or accredited by the following organizations:</p> <ul style="list-style-type: none"> ● CNAS —Registration No.: CNAS L5775 CNAS has accredited Global United Technology Services Co., Ltd. To ISO/IEC 17025 General Requirements for the competence of testing and calibration laboratories (CNAS-CL01 Accreditation Criteria for the Competence of Testing and Calibration Laboratories) for the competence in the field of testing. ● FCC —Registration No.: 600491 Global United Technology Services Co., Ltd., Shenzhen EMC Laboratory has been registered and fully described in a report filed with the (FCC) Federal Communications Commission. The acceptance letter from the FCC is maintained in files. Registration 600491, July 20, 2010. ● Industry Canada (IC) The 3m Semi-anechoic chamber of Global United Technology Services Co., Ltd. has been Registered by Certification and Engineering Bureau of Industry Canada for radio equipment testing with Registration No.: 9079A-1.
--

5.6 Test Location

All tests were performed at:
<p>Global United Technology Services Co., Ltd. Address: 2nd Floor, Block No.2, Laodong Industrial Zone, Xixiang Road Baoan District, Shenzhen, China Tel: 0755-27798480 Fax: 0755-27798960</p>

5.7 Test Instruments list

Item	Test Equipment	Manufacturer	Model No.	Inventory No.	Cal.Date (dd-mm-yy)	Cal.Due date (dd-mm-yy)
1	3m Semi- Anechoic Chamber	ZhongYu Electron	9.2(L)*6.2(W)* 6.4(H)	GTS201	Mar. 30 2011	Mar. 29 2013
2	Control Room	ZhongYu Electron	6.2(L)*2.5(W)* 2.4(H)	GTS251	N/A	N/A
3	EMI Test Receiver	Rohde & Schwarz	ESU26	GTS203	Jul. 05 2012	Jul. 04 2013
4	BiConiLog Antenna	SCHWARZBECK MESS-ELEKTRONIK	VULB9163	GTS214	May 10 2012	May 09 2013
5	Double -ridged waveguide horn	SCHWARZBECK MESS-ELEKTRONIK	9120D-829	GTS208	Mar. 09 2012	Mar. 08 2013
6	EMI Test Software	AUDIX	E3	N/A	N/A	N/A
7	Coaxial Cable	GTS	N/A	GTS210	Jul. 05 2012	Jul. 04 2013
8	Coaxial Cable	GTS	N/A	GTS211	Jul. 05 2012	Jul. 04 2013
9	Coaxial cable	GTS	N/A	GTS212	Jul. 05 2012	Jul. 04 2013
10	Coaxial Cable	GTS	N/A	GTS213	Jul. 05 2012	Jul. 04 2013
11	Coaxial Cable	GTS	N/A	GTS214	Jul. 05 2012	Jul. 04 2013
12	Amplifier(10KHz-5GHz)	HP	8347A	GTS204	Jul. 03 2012	Jul. 02 2013
13	Amplifier(2GHz-20GHz)	HP	8349B	GTS206	Jul. 03 2012	Jul. 02 2013
14	Shielding Room	ZhongYu Electron	7.0(L)x3.0(W)x3.0(H)	GTS206	May 10 2012	May 09 2013
15	EMI Test Receiver	Rohde & Schwarz	ESCS30	GTS208	Sept. 13 2012	Sept. 12 2013
16	10dB Pulse Limita	Rohde & Schwarz	N/A	GTS209	Sept. 13 2012	Sept. 12 2013
17	LISN	SCHWARZBECK MESS-ELEKTRONIK	NSLK 8127	GTS207	May. 13 2012	May. 12 2013
18	Temp. Humidity/Barometer	Oregon Scientific	BA-888	GTS248	May 10 2012	May 09 2013
19	Spectrum Analyzer	Rohde & Schwarz	ESU26	GTS203	Sept. 10 2012	Sept. 09 2013
20	Spectrum Analyzer	Rohde & Schwarz	FSEA	DE31309	Sept. 10 2012	Sept. 09 2013
21	Splitter	Agilent	11636B	GTS237	May 10 2012	May 09 2013
22	Signal Generator	AEROFLEX	IFR3413	341001/232	Sept. 10 2012	Sept. 09 2013
23	Signal Generator	AEROFLEX	IFR3414	341300/019	Sept. 10 2012	Sept. 09 2013
24	Power Meter	Giga-tronics	8541C	1831177	Sept. 10 2012	Sept. 09 2013
25	Power Sensor	Giga-tronics	80601A	1831785	Sept. 10 2012	Sept. 09 2013
26	Power Attenuator	BTI	30dB/250W	040706090	Sept. 10 2012	Sept. 09 2013
27	Power Attenuator	BTI	30dB/250W	040706089	Sept. 10 2012	Sept. 09 2013

6 TEST CONFIGURATION AND CONDITIONS

6.1 EUT Configuration

6.2 EUT Configuration

This mBSC2100-040-RUM01 is the Remote Unit on BTI DAS system. This remote unit supports 2.1GHz AWS band with the air standard CDMA, CDMA EV-DO, WCDMA, and LTE. The unit consists of Power Amplifier, Duplexer, RF Transmitter, Optic Transceiver and AC-DC Converter for AC 100V to 240V range. This product is designed to operate in an outdoor environment. The output power of the RU at Antenna interface port is average 40W for Downlink path with Convection Cooling.

6.3 Block Diagram

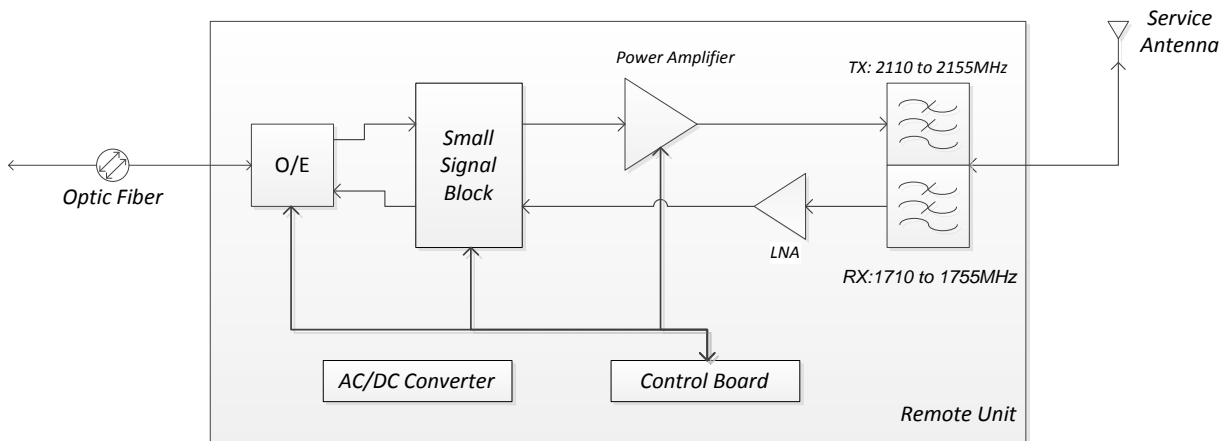
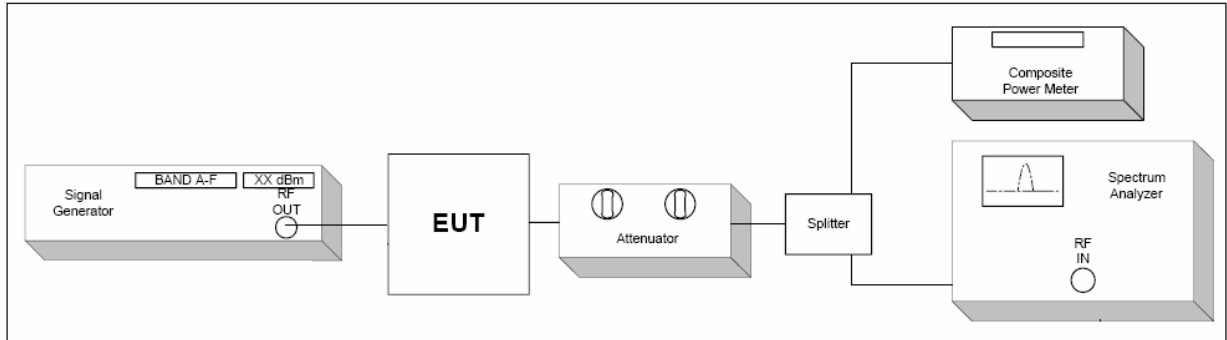

Figure: The Master Remote Unit block diagram

For details, refer to technical document and the user manual.

6.4 Configuration of Tested System

(A) RF Output Power, Occupied Bandwidth, Spurious Emissions at Antenna Terminal, Band Edge, Test Set-UP



(B) Intermodulation Test Set-UP

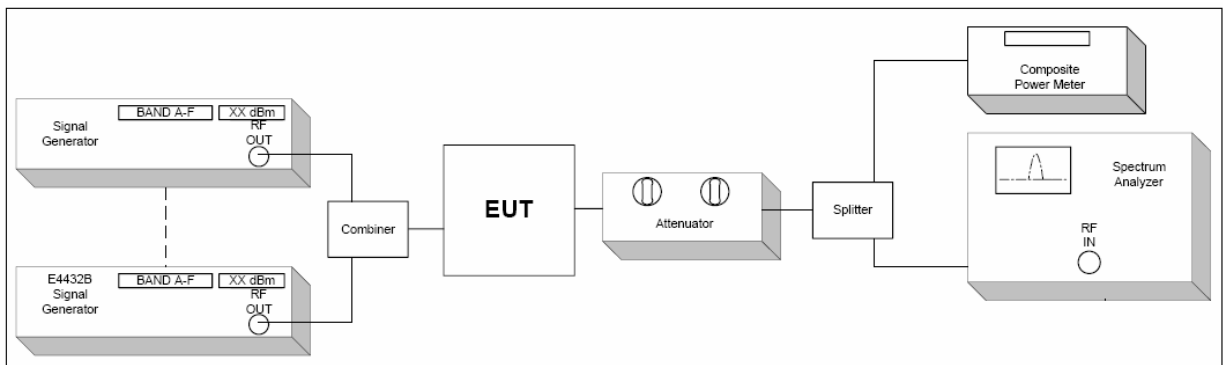

(C) Frequency stability Test Set-UP

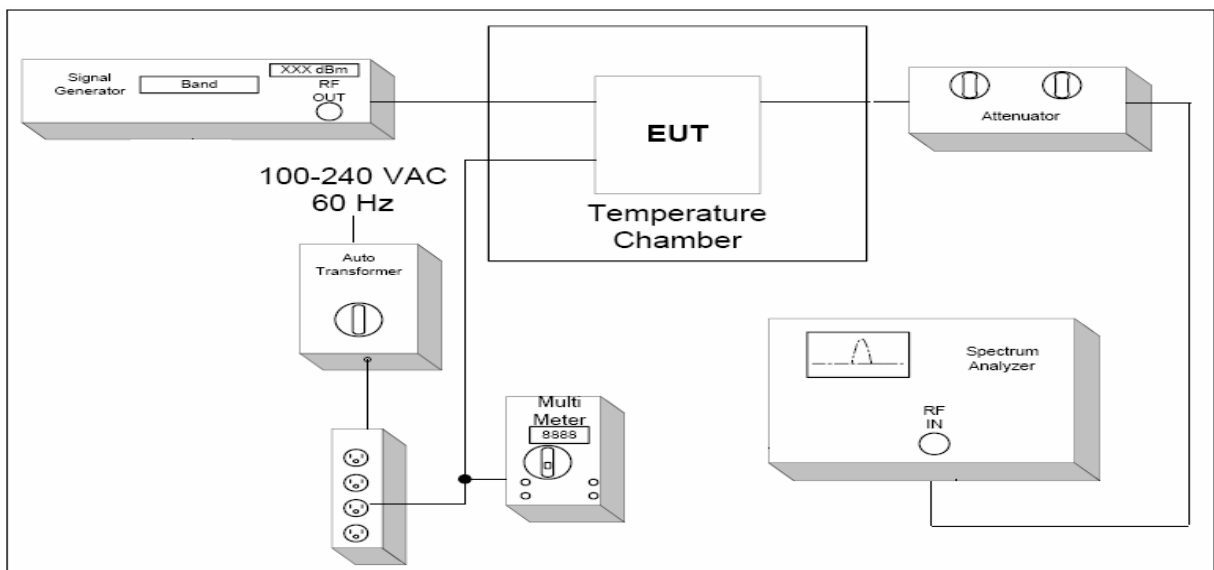

(D) Radiated Emission Test Set-Up, Frequency below 1000MHz

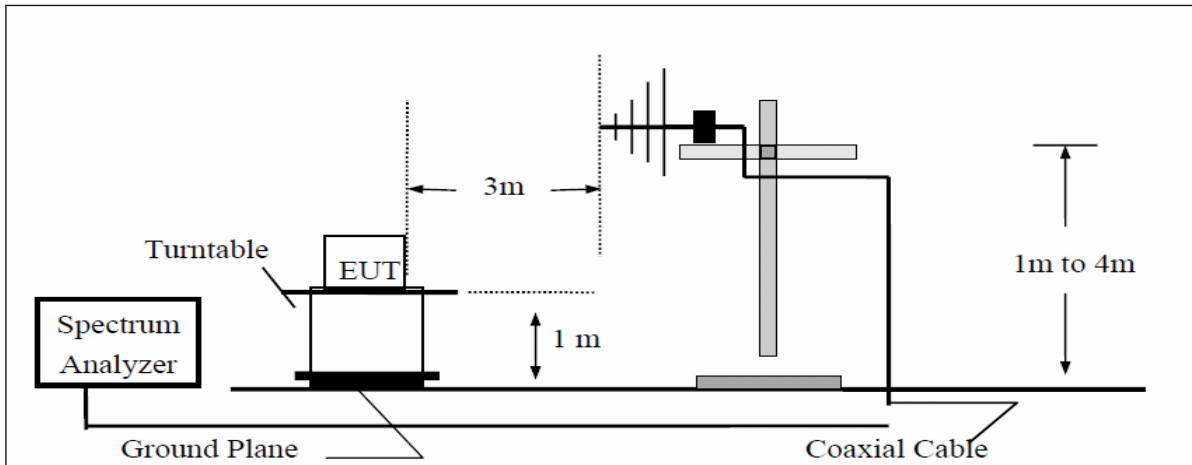

(E) Radiated Emission Test Set-UP Frequency over 1 GHz

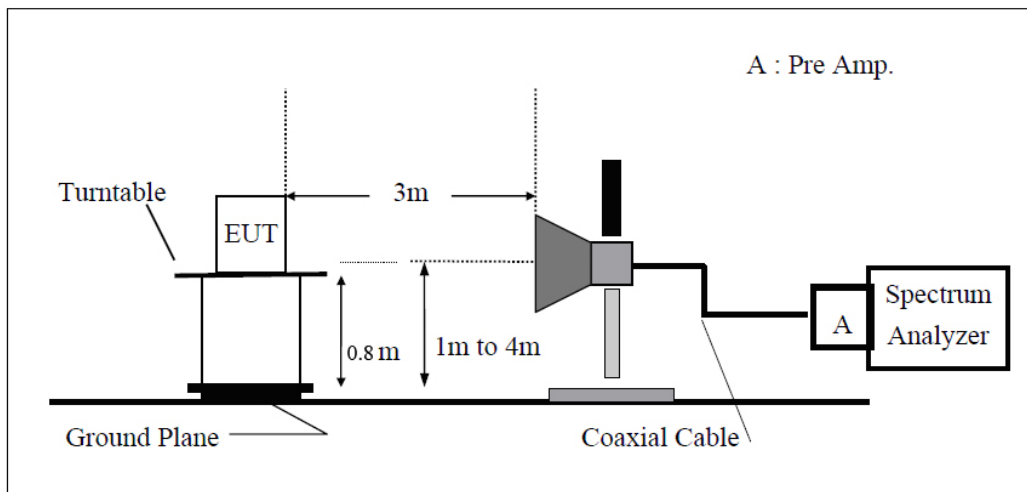

(F) Substituted Method Test Set-UP

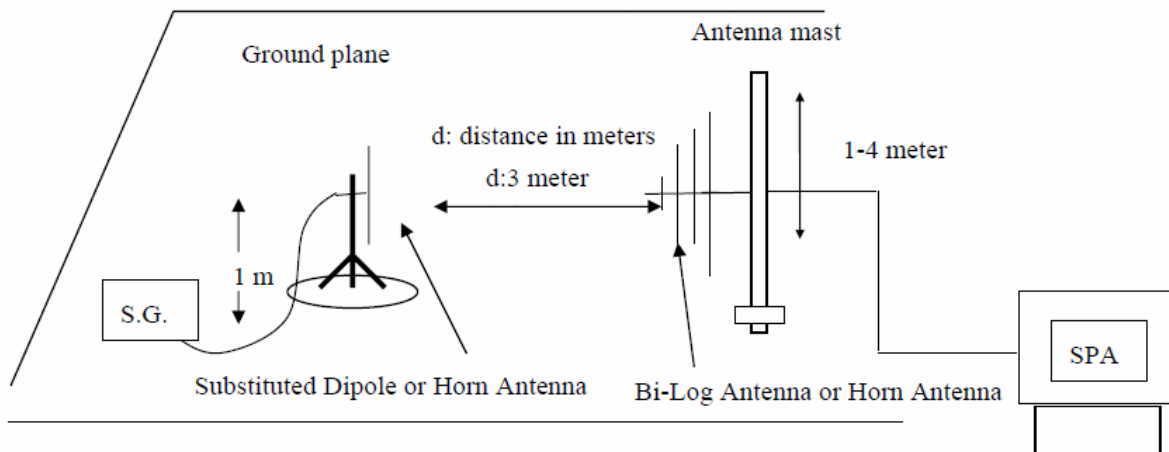

6.5 Test Environments

Condition	Minimum value	Maximum value
Barometric pressure	86 kPa	106 kPa
Temperature	15°C	30°C
Relative Humidity	20 %	75 %
Power supply range	±5% of rated voltages	
Normal Test Condition	(1).Temperature: +15 °C to +30 °C; (2).voltage is 120VAC.60Hz	
Extreme Test Conditions:	(1). Temperatures: -40°C to +55°C. (2). Voltages: 102 VAC to 138V AC.	

6.6 Test signal

1: Test signal WCDMA

Signal waveform according to Test Model 1 of standard specification 3GPP TS25.141. Signal modulated with a combination of PCCPCH, SCCPCH and Dedicated Physical Channels specified as test model 1 64 DPCH.

2: Test signal LTE:

Signal waveform according to Test Model 1.1, E-TM1.1, clause 6.1.1.1-1, table 6.1.1.1-1 of standard specification 3GPP TS 36.141 V9.3.0 (2010-03).

3: Test signal CDMA

Signal waveform according to table 6.2-1 of standard specification 3GPP2 C.P0051-0 pilot, sync, paging, 37 traffics, which is equal to the table 6.5.2.1 of 3GPP2 C.S0010-C

4: Test signal EVDO

Signal waveform according to 3GPP2 C.S0032-B

6.7 Test frequency selection

Operating Mode(TX)	Channels No. Multi- Carriers	Channels frequency (MHz)		
		Low Ch.	Mid Ch.	High Ch.
WCDMA	Single Carrier	2112.5	2132.5	2152.5
	Two Carriers	2115	2132.5	2150
	Three Carrier	2117.5	2132.5	2147.5
	Four Carrier	2120	2132.5	2145
CDMA/ EVDO	Single Carrier	2111.25	2132.5	2153.75
	Two Carriers	2112.5	2132.5	2152.5
	Three Carrier	2113.75	2132.5	2151.25
	Four Carrier	2115	2132.5	2150

Operating Mode(TX)	Channels No. Multi- Carriers	Channels frequency (MHz)		
		Low Ch.	Mid Ch.	High Ch.
LTE 1.4MHz Bandwidth	Single Carrier	2110.7	2132.5	2154.3
LTE 3MHz Bandwidth	Single Carrier	2111.5	2132.5	2153.5
LTE 5MHz Bandwidth	Single Carrier	2112.5	2132.5	2152.5
LTE 10MHz Bandwidth	Single Carrier	2115	2132.5	2150
LTE 15MHz Bandwidth	Single Carrier	2117.5	2132.5	2147.5
LTE 20MHz Bandwidth	Single Carrier	2120	2132.5	2145

6.8 DESCRIPTION OF TEST MODES

Test mode	Detail description of the test mode
Downlink	Downlink (Low channel; middle channel; high channel)
Uplink	N/A
Multi-carrier	Single Carrier; two carrier; three carrier; four carrier
Multi-bandwidth	WCDMA: 5MHz, CDMA / EVDO: 1.25MHz LTE:1.4MHz, 3MHz, 5MHz, 10MHz, 15MHz, 20MHz,
Modulation type	WCDMA/LTE/CDMA/EVDO

Remark:

- 1: The EUT was powered by 120VAC.
- 2: The EUT was configured for maximum gain and maximum output power. The input power was the maximum declared by the manufacturer. This is to ensure that the equipment is operating in the linear output range.
- 3: Signal generator was used to provide the input signals to the EUT. Tests were performed with WCDMA/LTE/CDMA/EVDO signal input and multi-carrier signal mode input.
- 4: Pre-test all test modes as above, only the worst case and typical mode is list in report it.
- 5: N/A: The EUT does not transmit over the air in the uplink direction.

7 RF POWER OUTPUT MEASUREMENT

7.1 Standard Applicable

According to FCC §2.1046. §.27.50(d)(2)(B)

(d) The following power and antenna height requirements apply to stations transmitting in the 1710–1755 MHz and 2110–2155 MHz bands:

(2) The power of each fixed or base station transmitting in the 2110–2155 MHz band and situated in any geographic location other than that described in paragraph (d)(1) is limited to:

(B) an EIRP of 1640 watts/MHz when transmitting with an emission bandwidth greater than 1 MHz.

7.2 Test setup

Please refer the section §6.2 Configuration of Tested System.

7.3 Measurement Procedure

1. The output from the EUT antenna connector was connected to the power meter.
2. The power meter level was offset by 44.9 dB to compensate for attenuators and cable loss between the EUT and the power meter.
3. The level of RF input signal shall be increased, until the maximum output power per channel, declared by client, is reached. The input signal level is – 19dBm.
4. The carrier output, below, was conducted using a single WCDMA, LTE, CDMA, and EVDO signal generator.
5. The RF output power was measured at low, middle and high channel of each type of modulation and each type of carrier.

7.4 Test Result

7.4.1 RF Output Power

Test mode	Carrier Conf.	Channel	Average Power (dBm)	Average Power (W)	Result
WCDMA	Single Carrier	Low	45.82	38.19	Compliant
		Middle	45.92	39.08	Compliant
		High	45.47	35.24	Compliant
	Two Carriers	Low	46.01	39.90	Compliant
		Middle	46.08	40.55	Compliant
		High	46.13	41.02	Compliant
	Three Carriers	Low	45.88	38.73	Compliant
		Middle	45.93	39.17	Compliant
		High	45.79	37.93	Compliant
	Four Carriers	Low	45.63	36.56	Compliant
		Middle	46.03	40.09	Compliant
		High	45.83	38.28	Compliant
CDMA	Single Carrier	Low	45.63	36.56	Compliant
		Middle	45.51	35.56	Compliant
		High	45.45	35.08	Compliant
	Two Carriers	Low	45.69	37.07	Compliant
		Middle	46.01	39.90	Compliant
		High	45.79	37.93	Compliant
	Three Carriers	Low	45.78	37.84	Compliant
		Middle	45.37	34.43	Compliant
		High	45.86	38.55	Compliant
	Four Carriers	Low	45.90	38.90	Compliant
		Middle	45.80	38.02	Compliant
		High	45.63	36.56	Compliant

Test mode	Carrier Conf.	Channel	Average Power (dBm)	Average Power (W)	Result
EVDO 0%	Single Carrier	Low	39.86	9.68	Compliant
		Middle	39.02	7.98	Compliant
		High	39.54	8.99	Compliant
	Two Carriers	Low	39.48	8.87	Compliant
		Middle	39.21	8.34	Compliant
		High	39.68	9.29	Compliant
	Three Carriers	Low	39.29	8.49	Compliant
		Middle	39.61	9.14	Compliant
		High	39.97	9.93	Compliant
	Four Carriers	Low	39.50	8.91	Compliant
		Middle	39.87	9.71	Compliant
		High	39.49	8.89	Compliant
EVDO 50%	Single Carrier	Low	43.64	23.12	Compliant
		Middle	43.24	21.09	Compliant
		High	43.13	20.56	Compliant
	Two Carriers	Low	43.67	23.28	Compliant
		Middle	43.61	22.96	Compliant
		High	43.88	24.43	Compliant
	Three Carriers	Low	43.57	22.75	Compliant
		Middle	43.90	24.55	Compliant
		High	43.39	21.83	Compliant
	Four Carriers	Low	43.84	24.21	Compliant
		Middle	43.67	23.28	Compliant
		High	43.29	21.33	Compliant

Test mode	Carrier Conf.	Channel	Average Power (dBm)	Average Power (W)	Result
EVDO 100%	Single Carrier	Low	45.66	36.81	Compliant
		Middle	45.90	38.90	Compliant
		High	45.70	37.15	Compliant
	Two Carriers	Low	45.56	35.97	Compliant
		Middle	45.71	37.24	Compliant
		High	45.82	38.19	Compliant
	Three Carriers	Low	45.79	37.93	Compliant
		Middle	45.97	39.54	Compliant
		High	45.78	37.84	Compliant
	Four Carriers	Low	45.89	38.82	Compliant
		Middle	46.01	39.90	Compliant
		High	45.83	38.28	Compliant
.LTE	LTE 1.4MHz Bandwidth	Low	45.83	38.28	Compliant
		Middle	46.20	41.69	Compliant
		High	45.84	38.37	Compliant
	LTE 3MHz Bandwidth	Low	45.79	37.93	Compliant
		Middle	45.84	38.37	Compliant
		High	45.88	38.73	Compliant
	LTE 5MHz Bandwidth	Low	45.92	39.08	Compliant
		Middle	45.69	37.07	Compliant
		High	45.66	36.81	Compliant
	LTE 10MHz Bandwidth	Low	45.88	38.73	Compliant
		Middle	45.58	36.14	Compliant
		High	45.93	39.17	Compliant
	LTE 15MHz Bandwidth	Low	45.79	37.93	Compliant
		Middle	45.08	32.21	Compliant
		High	45.82	38.19	Compliant
	LTE 20MHz Bandwidth	Low	45.67	36.90	Compliant
		Middle	45.93	39.17	Compliant
		High	45.77	37.76	Compliant

7.4.2 Peak to Average Ratio

Test mode	Carrier Conf.	Peak to Average Ratio (dB)			Result
		Low Ch.	Middle Ch.	High Ch.	
WCDMA	5MHz(40W)	7.4	7.5	7.5	Compliant
CDMA	1.25MHz(40W)	7.6	7.5	7.4	Compliant
EVDO 0%	1.25MHz(40W)	12.1	12.2	12.1	Compliant
EVDO 50%	1.25MHz(40W)	11.5	11.5	11.6	Compliant
EVDO 100%	1.25MHz(40W)	9.8	9.8	9.7	Compliant
LTE	1.4MHz(40W)	10.4	10.5	10.5	Compliant
	3MHz(40W)	10.3	10.2	10.2	Compliant
	5MHz(40W)	10.5	10.4	10.4	Compliant
	10MHz(40W)	10.1	10.1	10.2	Compliant
	15MHz(40W)	10.00	10.04	10.02	Compliant
	20MHz(40W)	10.14	10.16	10.15	Compliant

8 MODULATION CHARACTERISTIC

According to FCC § 2.1047(d), Part 27 there is no specific requirement for digital modulation, therefore modulation characteristic is not presented.

9 OCCUPIED BANDWIDTH

9.1 Standard Applicable

CFR 47 §2.1049

The occupied bandwidth, that is the frequency bandwidth such that, below its lower and above its upper frequency limits, the mean powers radiated are each equal to 0.5 percent of the total mean power radiated by a given emission shall be measured (as 99% Bandwidth)

9.2 Test setup

Please refer the section §6.2 Configuration of Tested System.

9.3 Test Procedure

1. The EUT RF output port was connected to spectrum analyzer.
2. The level of RF input signal shall be increased, until the maximum output power per channel, declared by client, is reached. The input signal level is – 19dBm.
3. The spectrum analyzer was setup to measure the Occupied Bandwidth (defined as the 99% Power Bandwidth).
4. The Occupied Bandwidth was measured at the input and output ports of the EUT at low, middle and high channel of each type of modulation and each type of carrier signal.

Spectrum analyzer settings:

Detector: RMS.

WCDMA/LTE: RBW= 100 kHz VBW \geq RBW Sweep: Auto

CDMA/EVDO: RBW= 30 kHz VBW=100kHz Sweep: Auto

9.4 Test Result

Remark:

only middle channel of comparison of input/output is list in the following pages.

Input/output Bandwidth Comparison for WCDMA

1. Number of Carriers: Single carrier

Output(Middle channel)

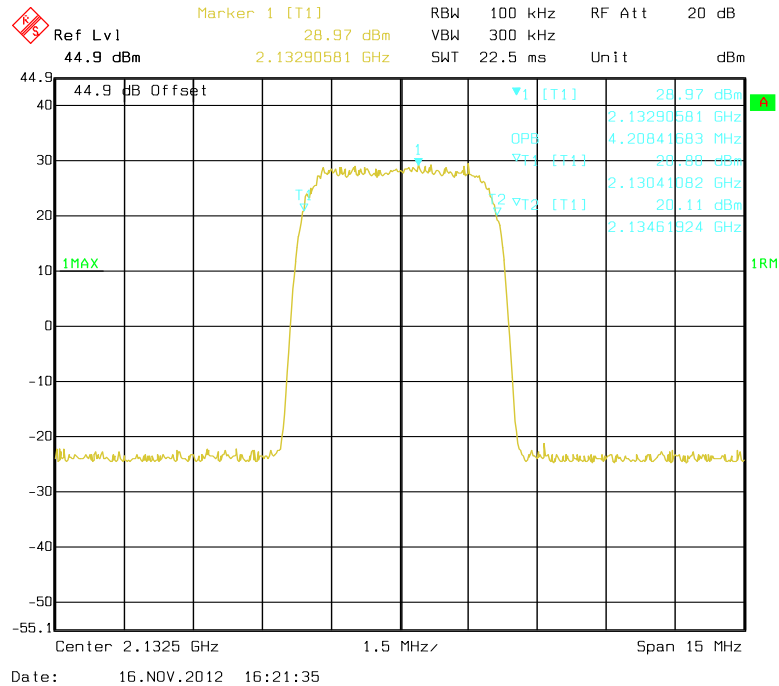

Input(Middle channel)

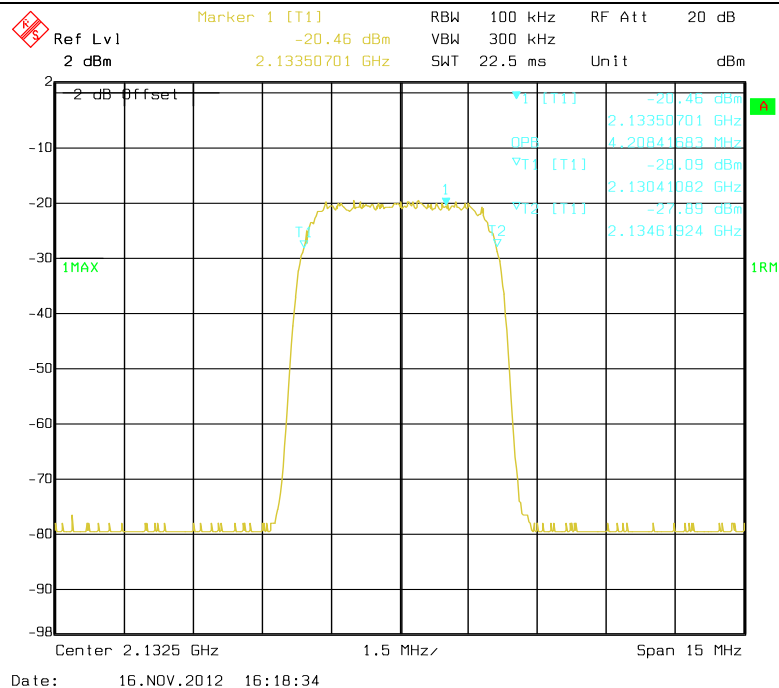

2. Number of Carriers: Four carriers

Output(Middle channel)

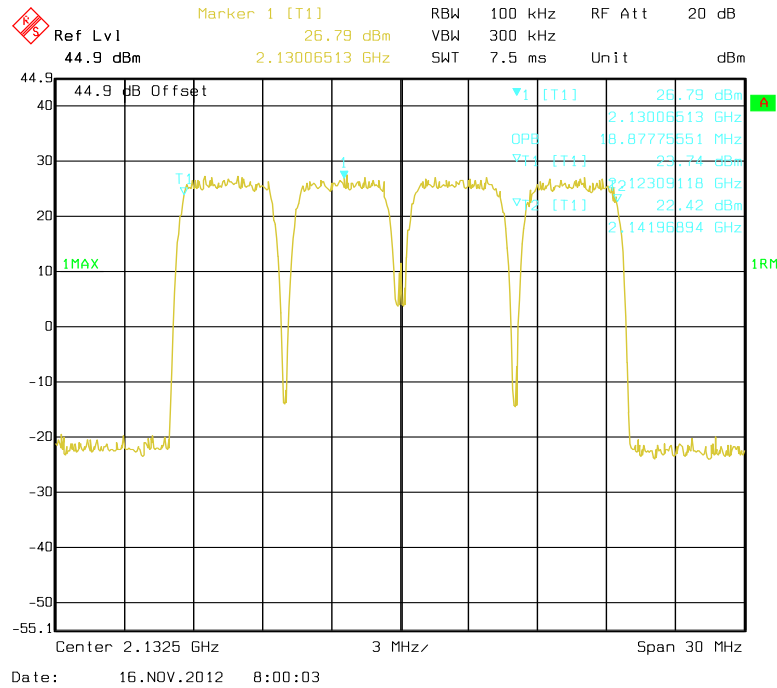

Input(Middle channel)

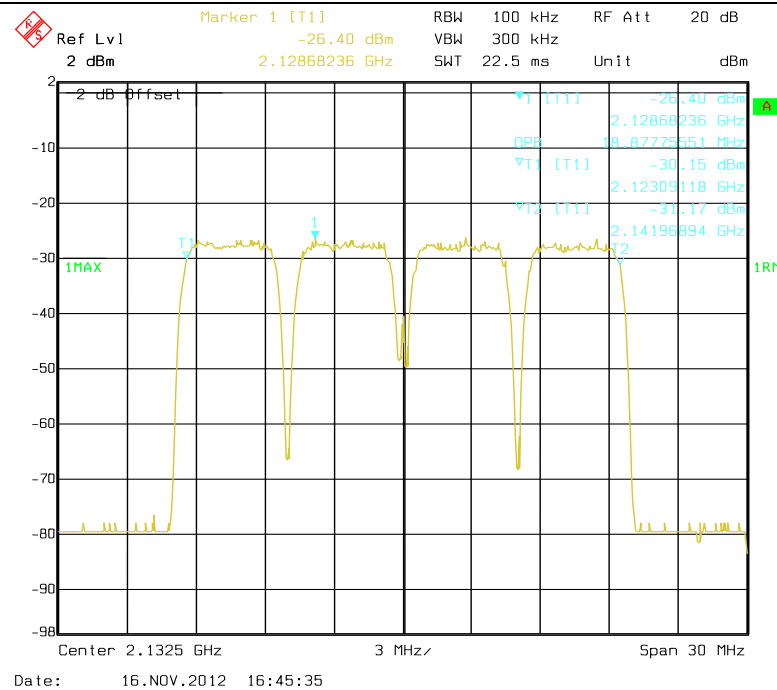

Input/output Bandwidth Comparison for LTE (1.4MHz Bandwidth)

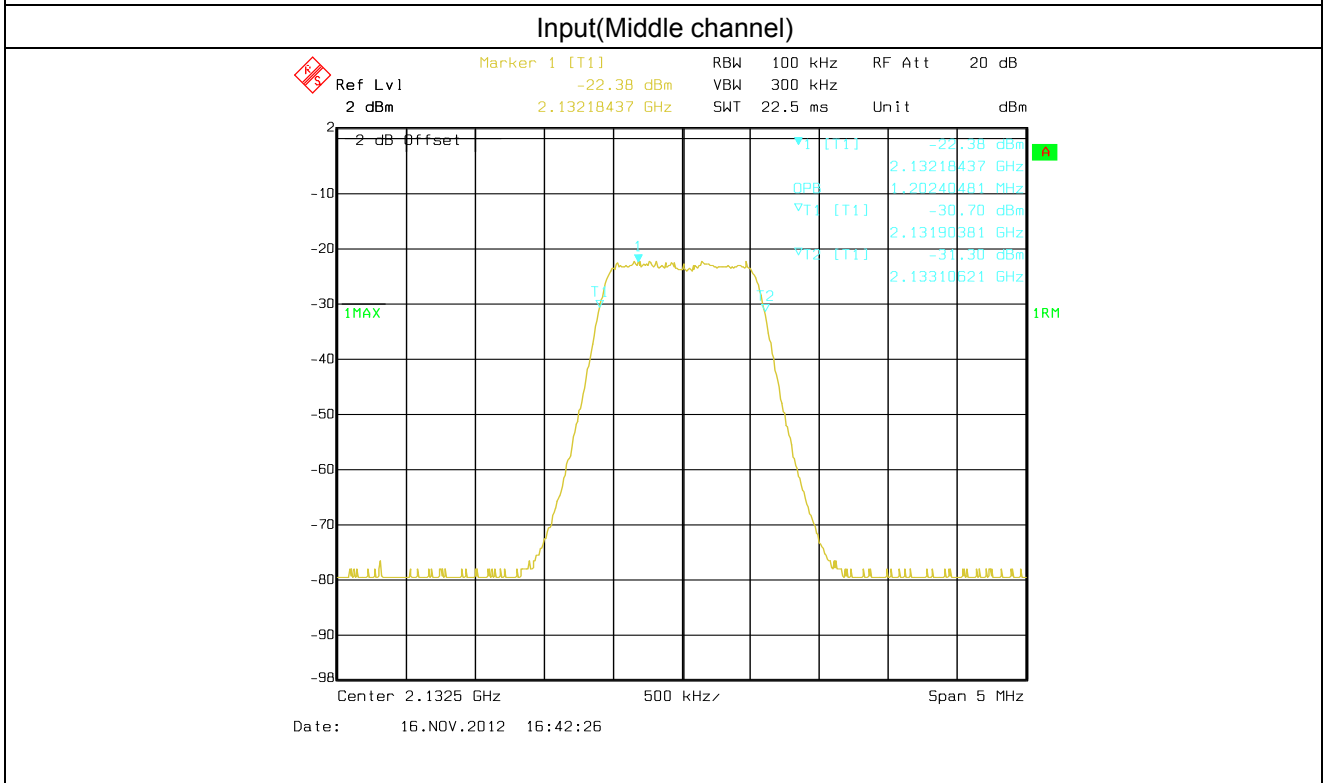
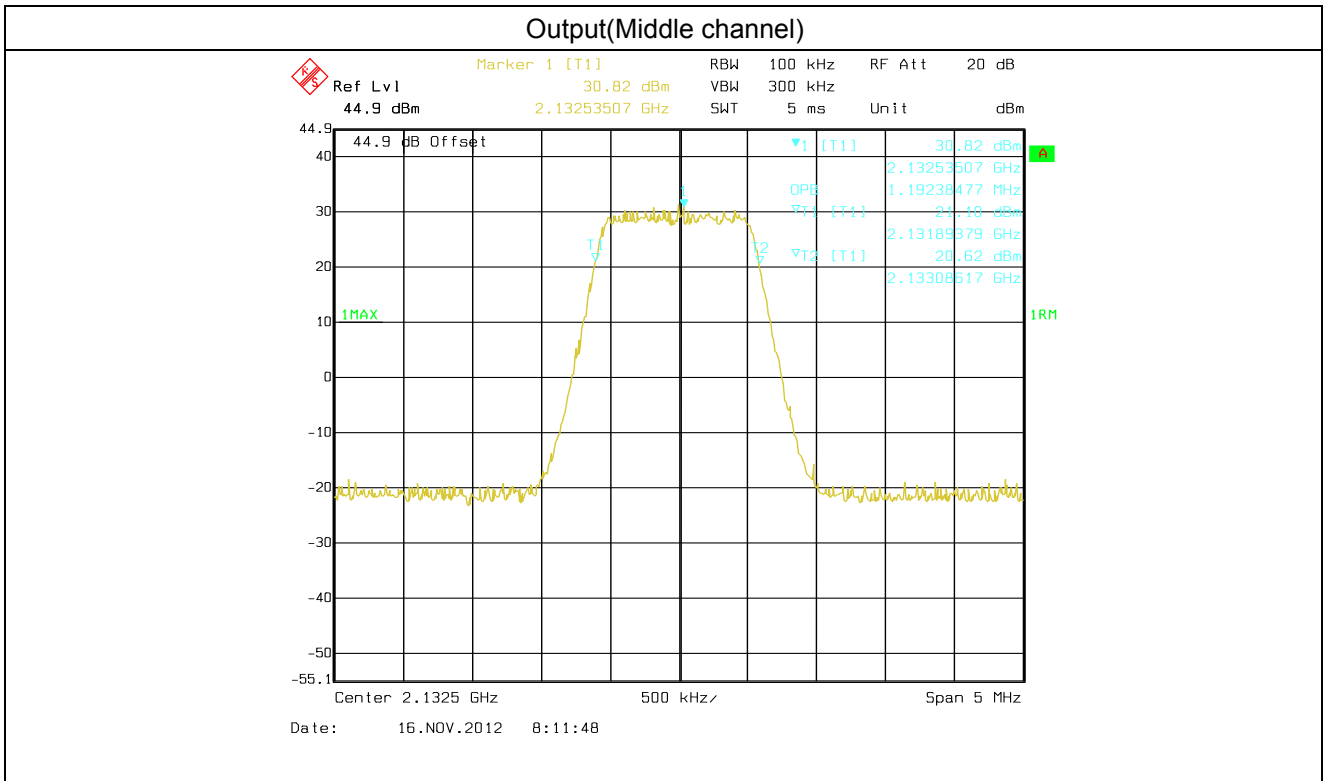

Input/output Bandwidth Comparison for LTE (3MHz Bandwidth)

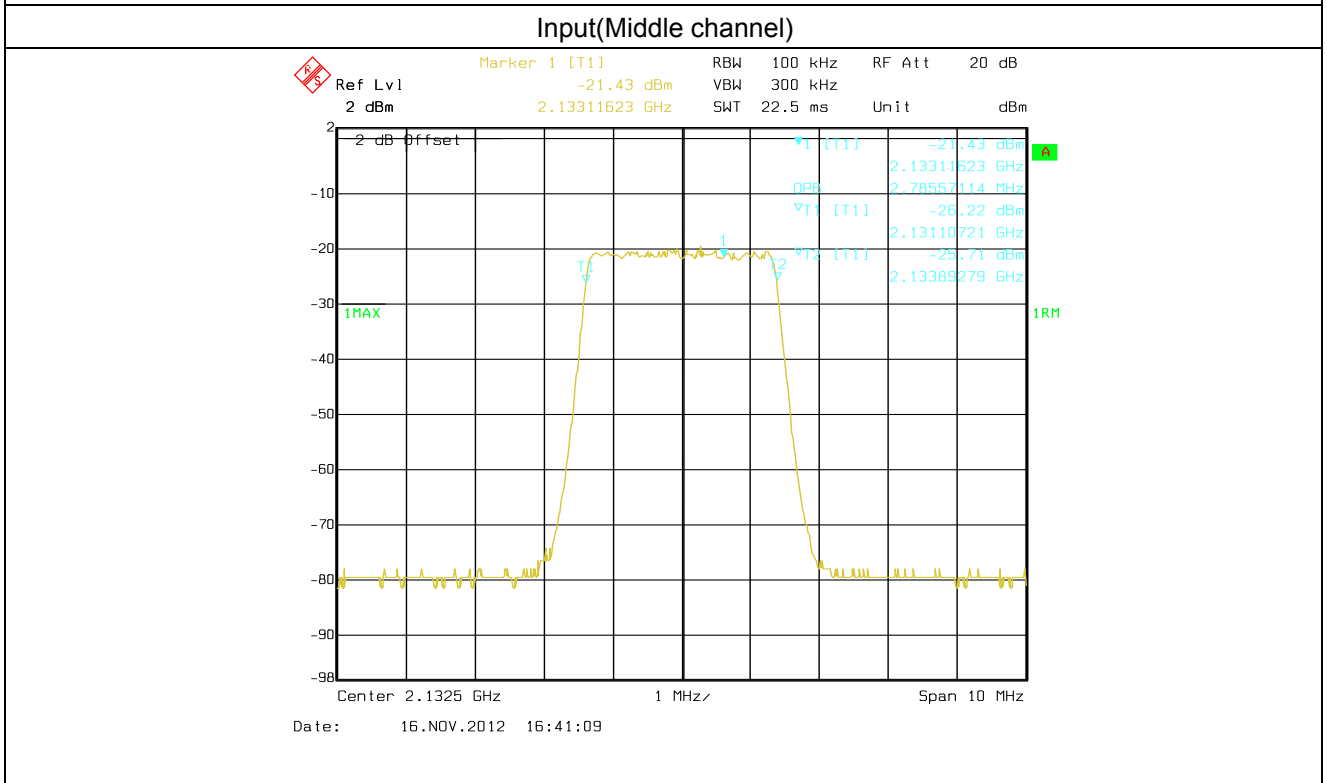
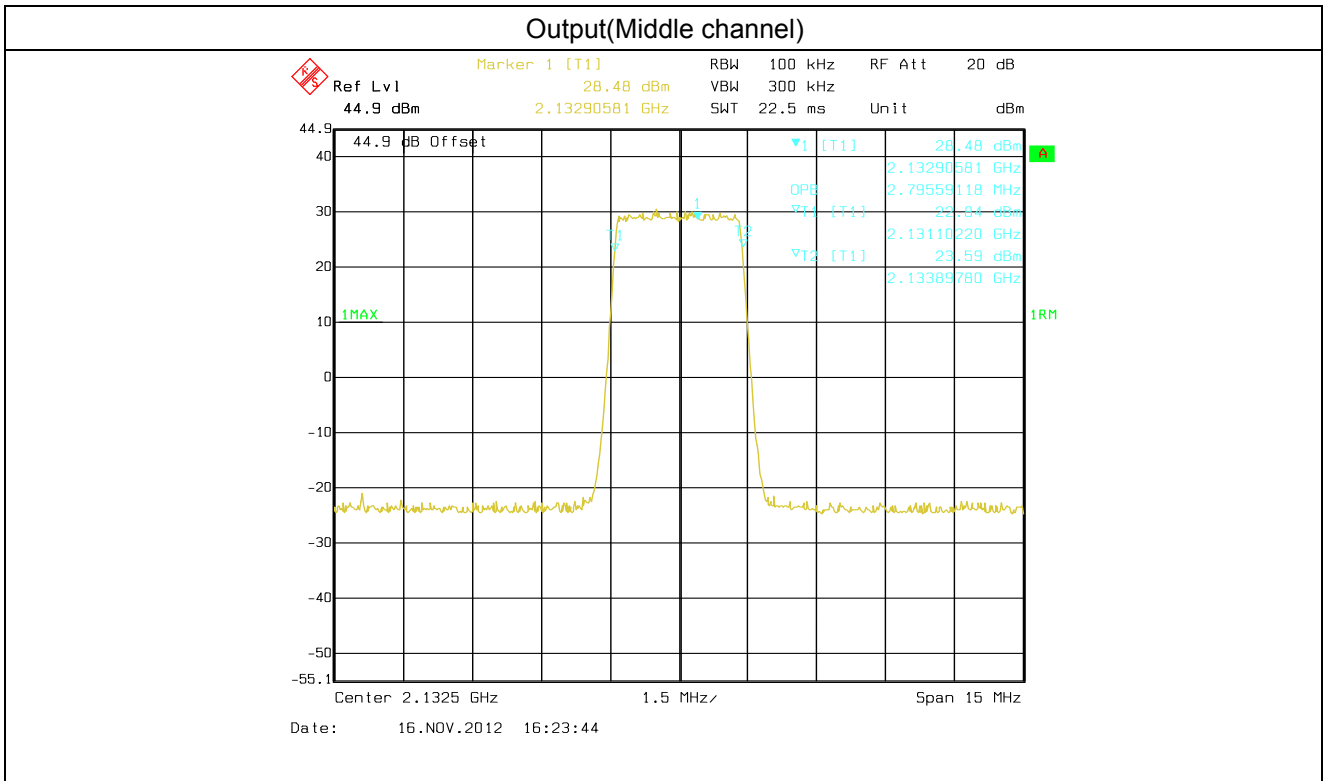

Input/output Bandwidth Comparison for LTE (5MHz Bandwidth)

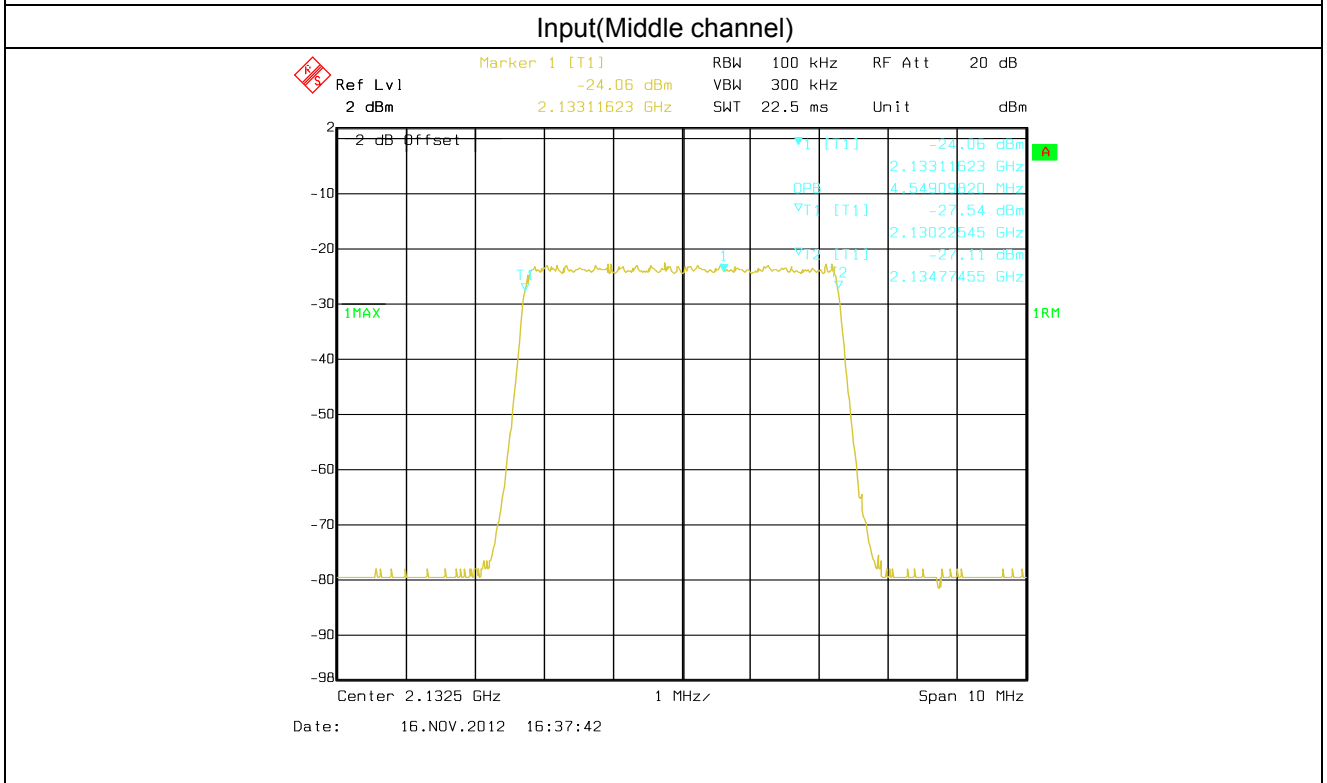
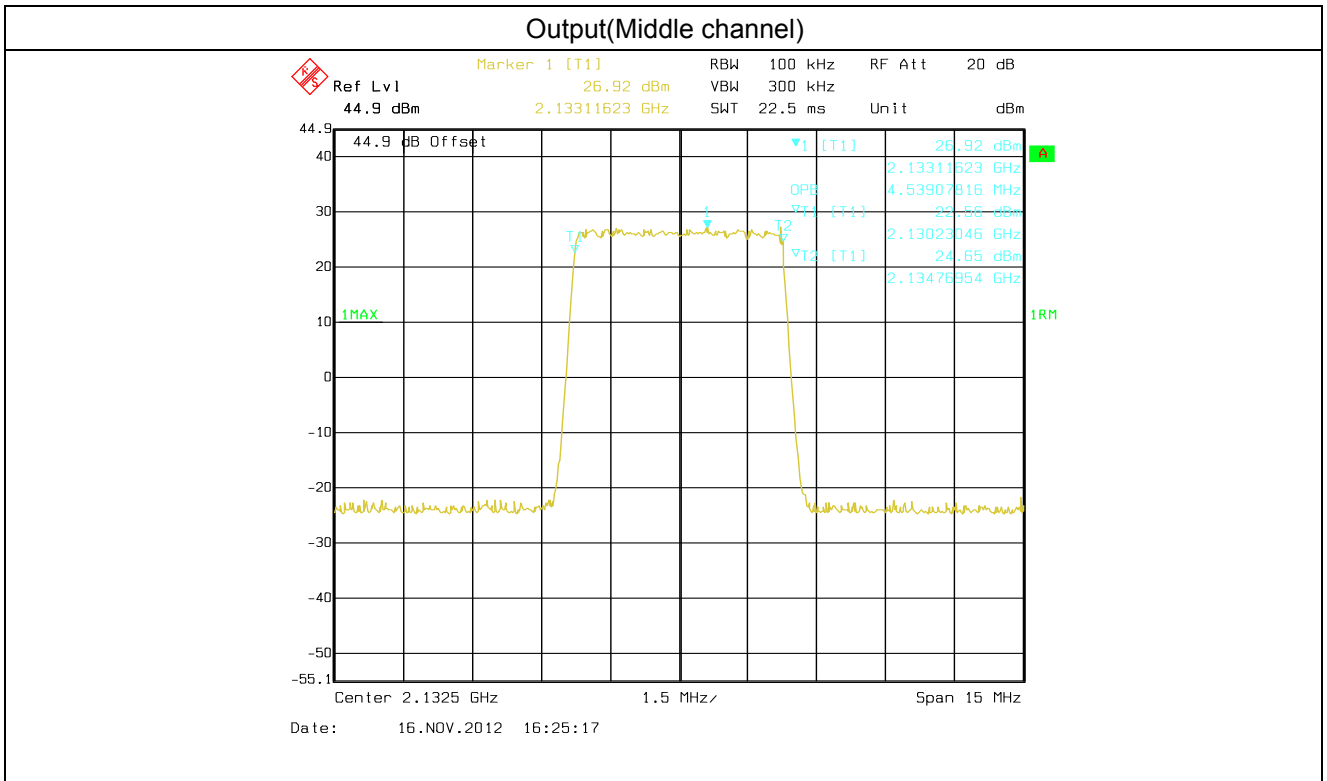

Input/output Bandwidth Comparison for LTE (10MHz Bandwidth)

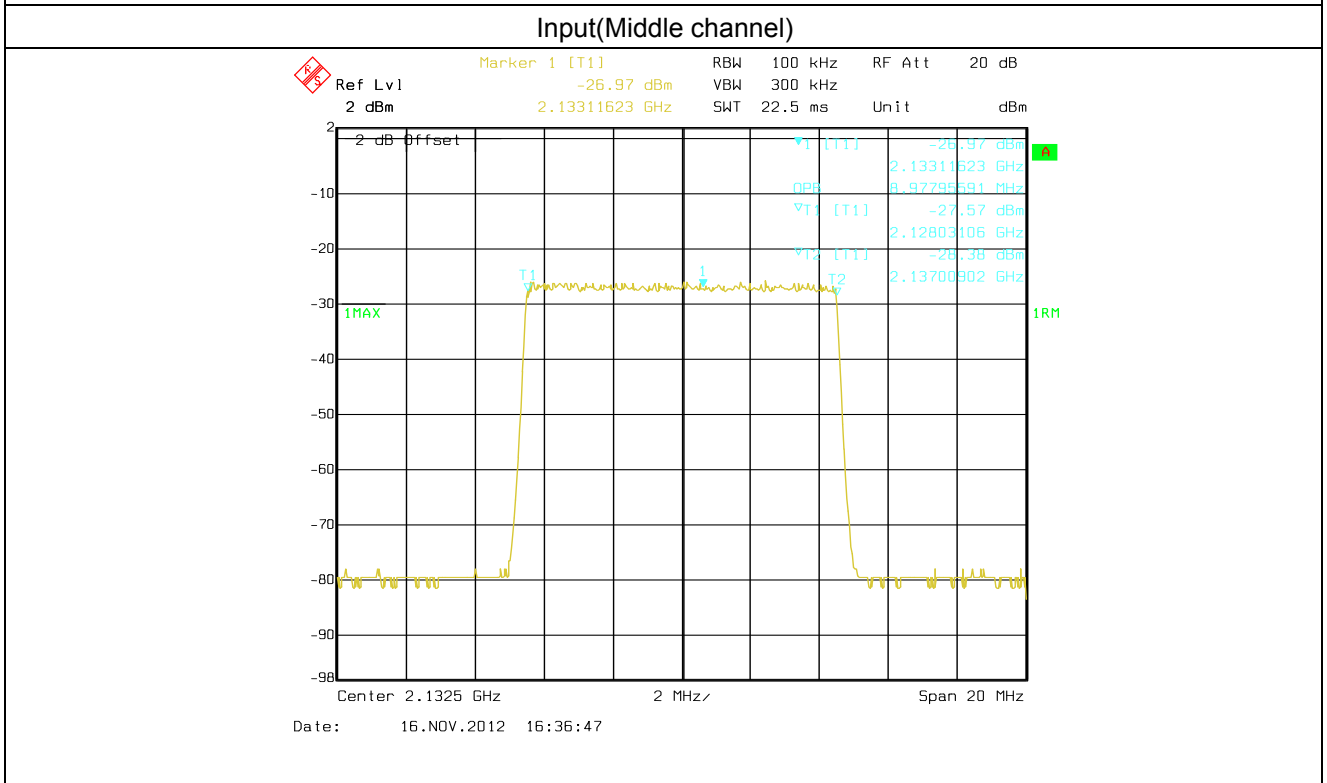
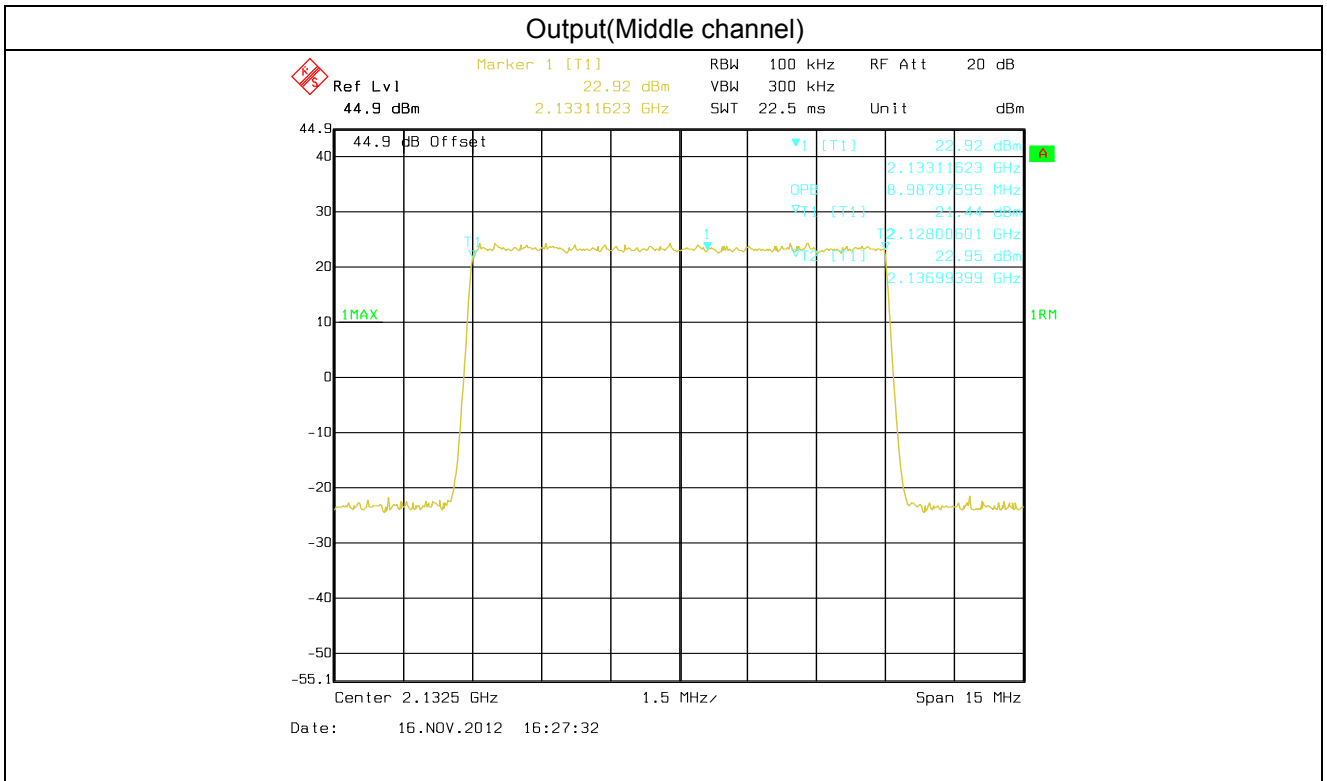

Input/output Bandwidth Comparison for LTE (15MHz Bandwidth)

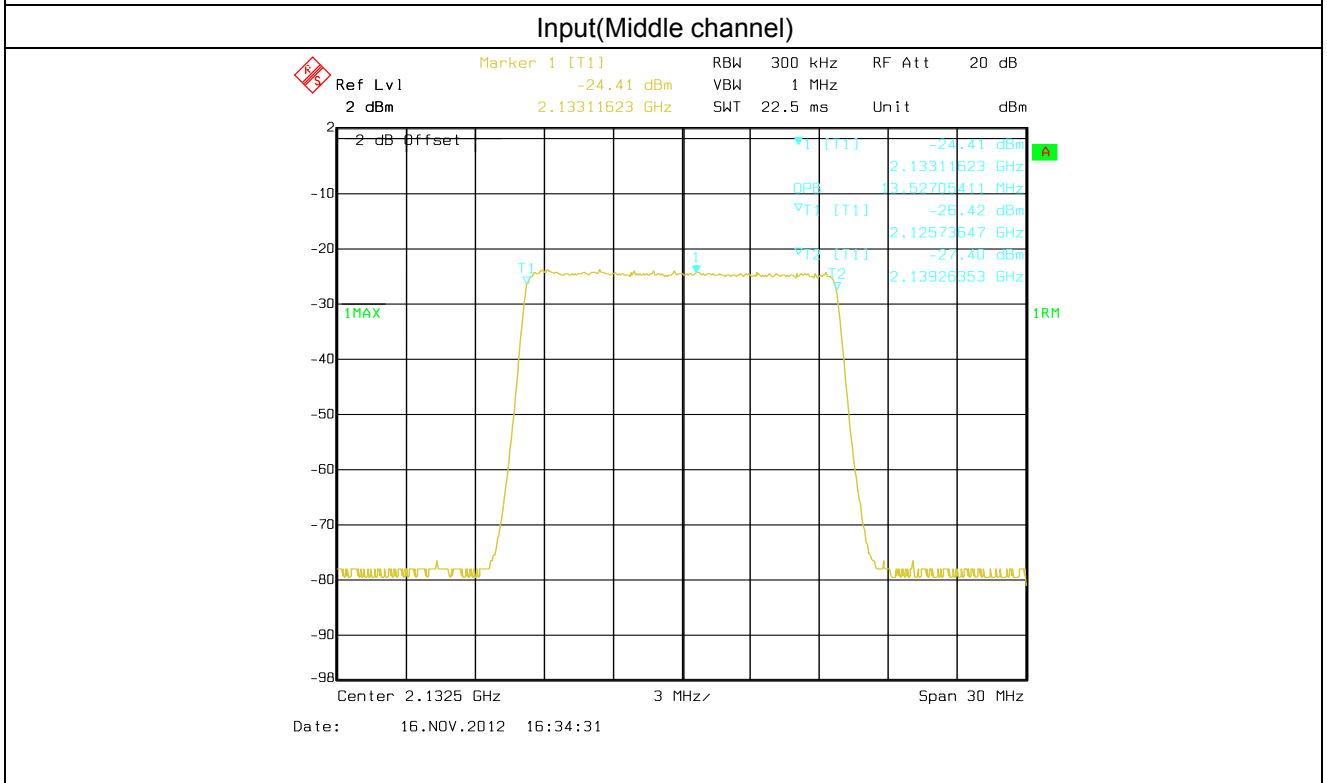
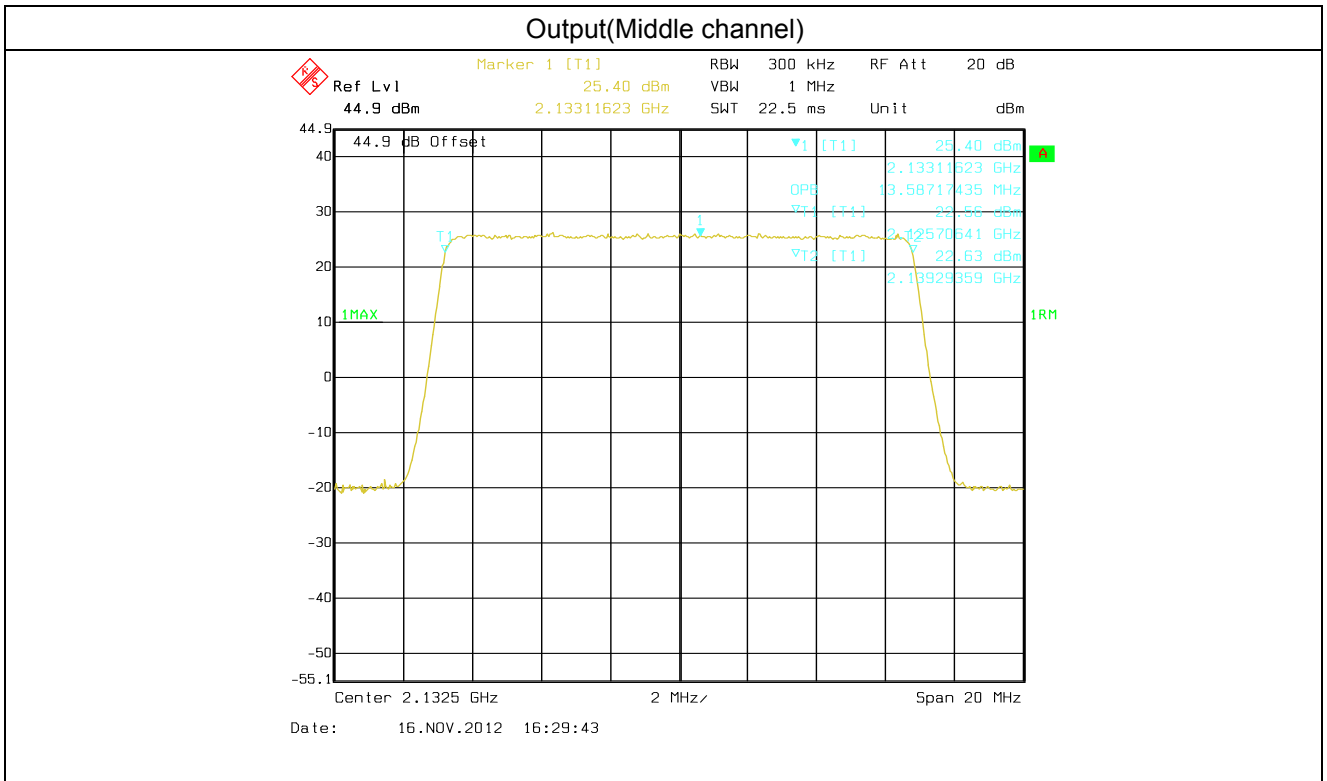

Input/output Bandwidth Comparison for LTE (20MHz Bandwidth)

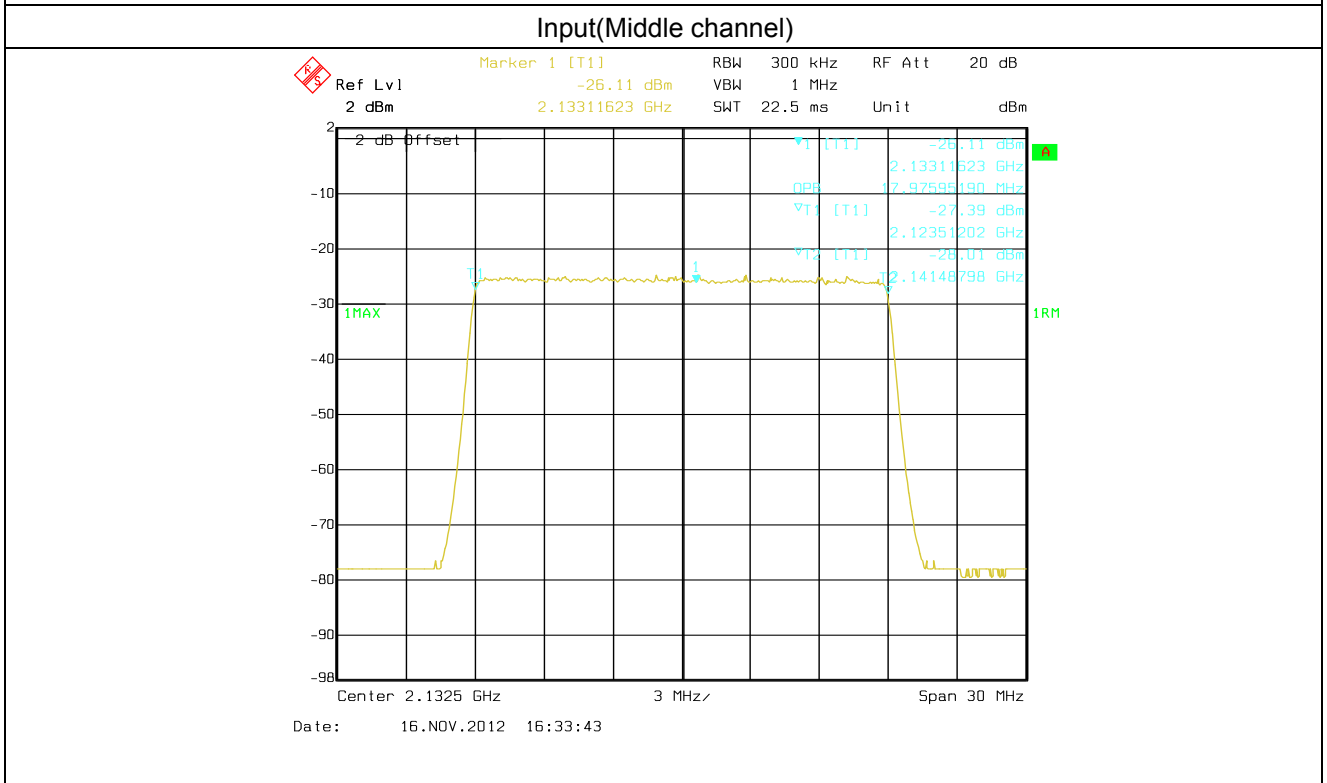
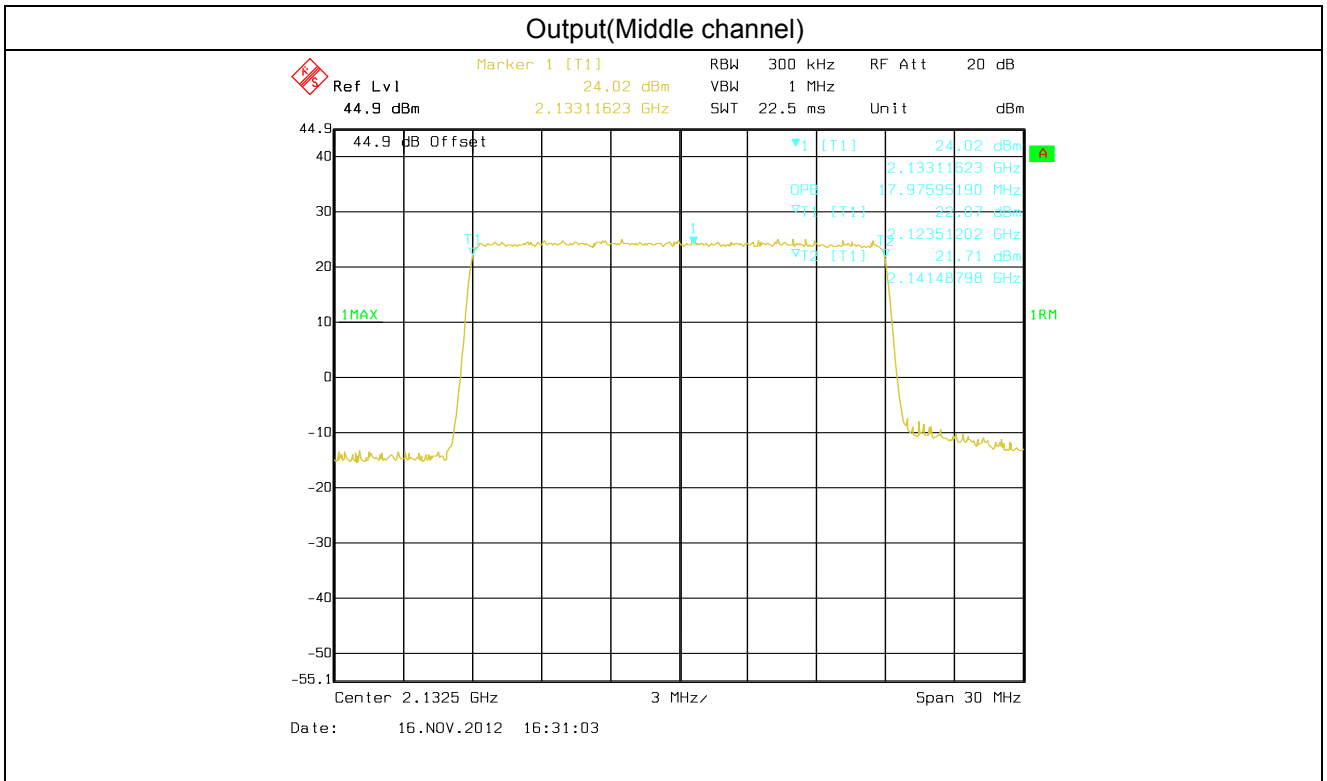

Input/output Bandwidth Comparison for CDMA

1. Number of Carriers: Single carrier

Output(Middle channel)

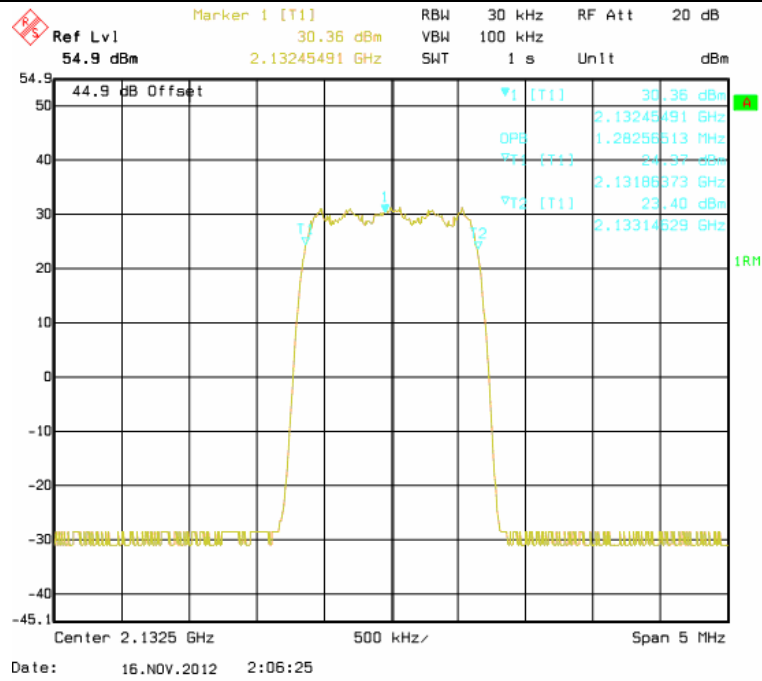

Input(Middle channel)

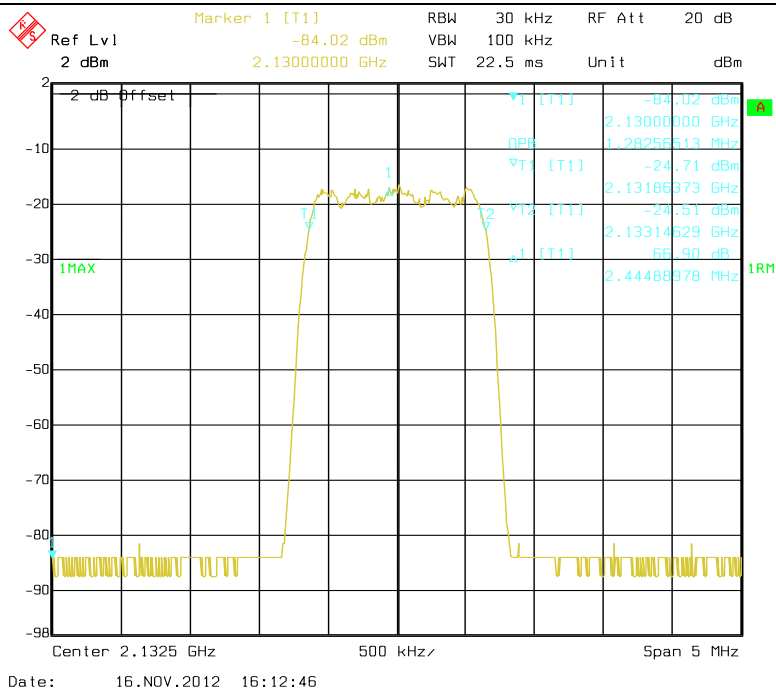

2. Number of Carriers: Four carriers

Output(Middle channel)

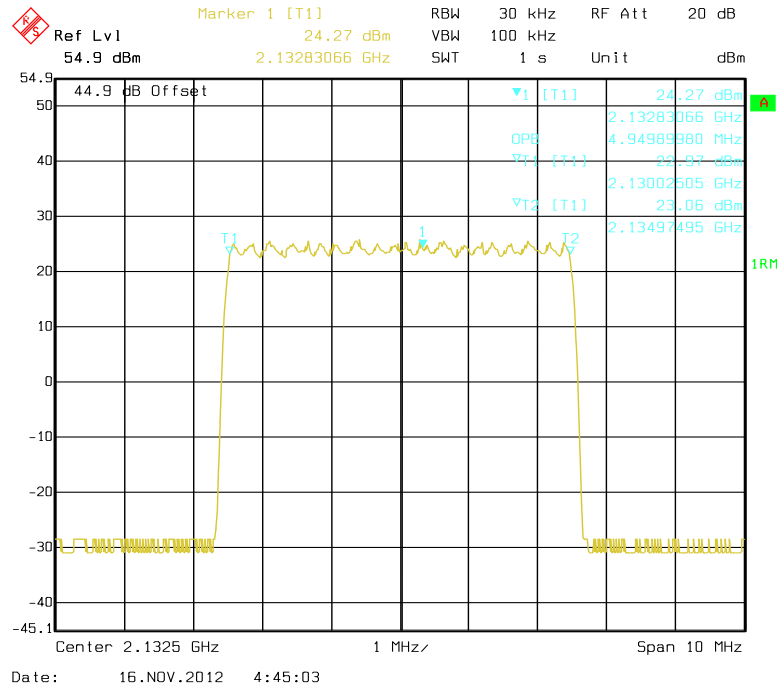

Input(Middle channel)

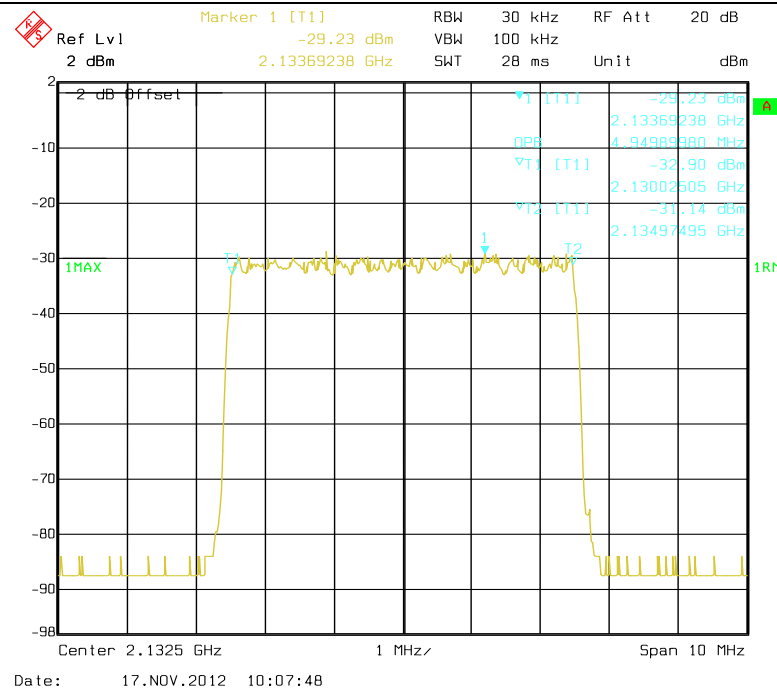

Input/output Bandwidth Comparison for EVDO(0%)

1. Number of Carriers: Single carrier

Output(Middle channel)

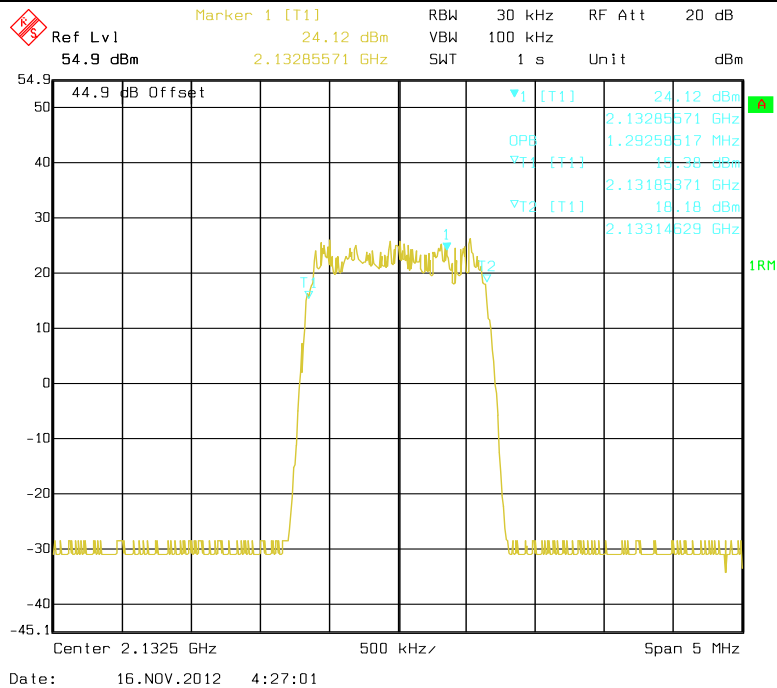

Input(Middle channel)

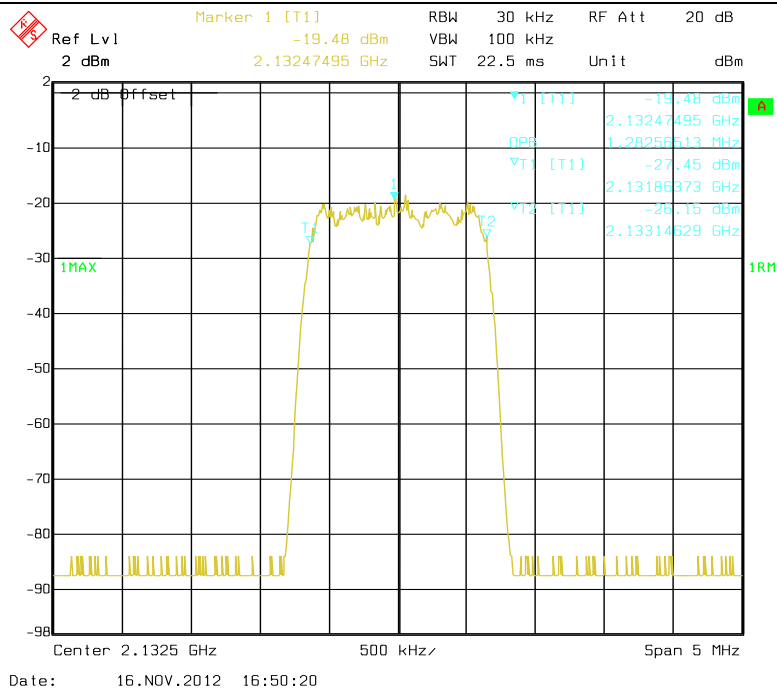

2. Number of Carriers: Four carriers

Output(Middle channel)

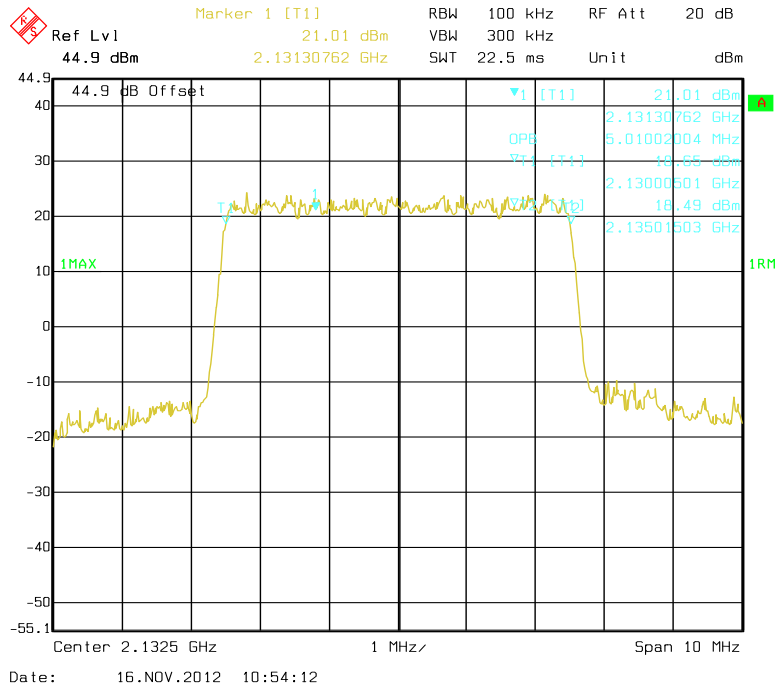

Input(Middle channel)

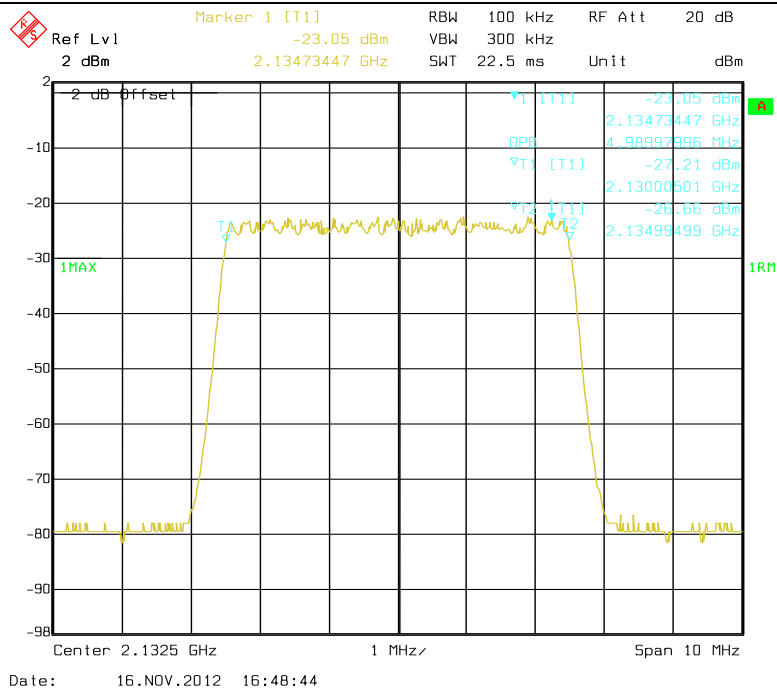

Input/output Bandwidth Comparison for EVDO(50%)

1. Number of Carriers: Single carrier

Output(Middle channel)

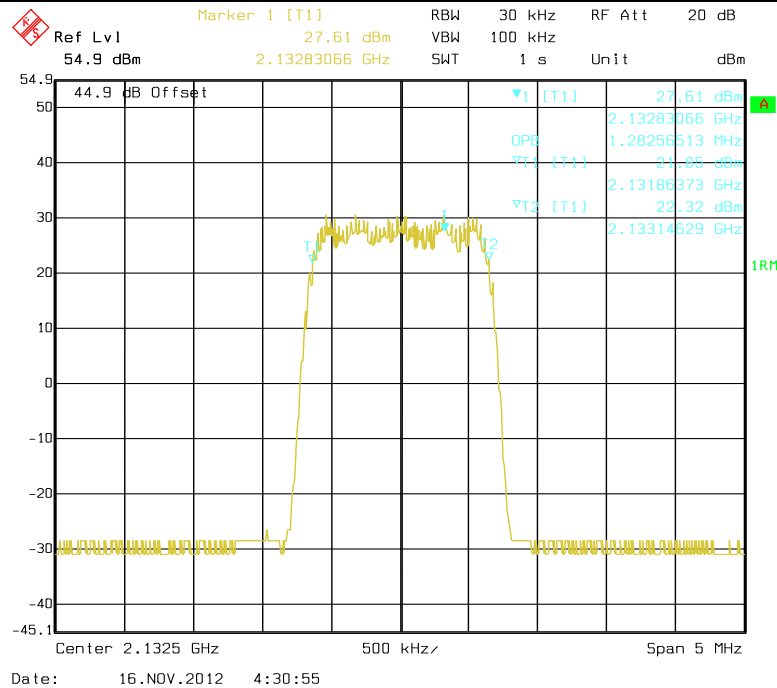

Input(Middle channel)

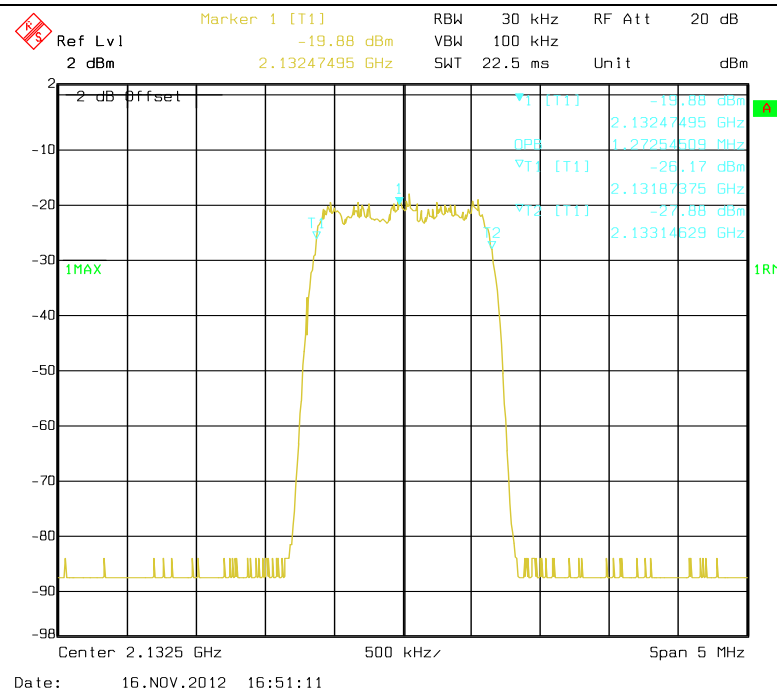

2. Number of Carriers: Four carriers

Output(Middle channel)

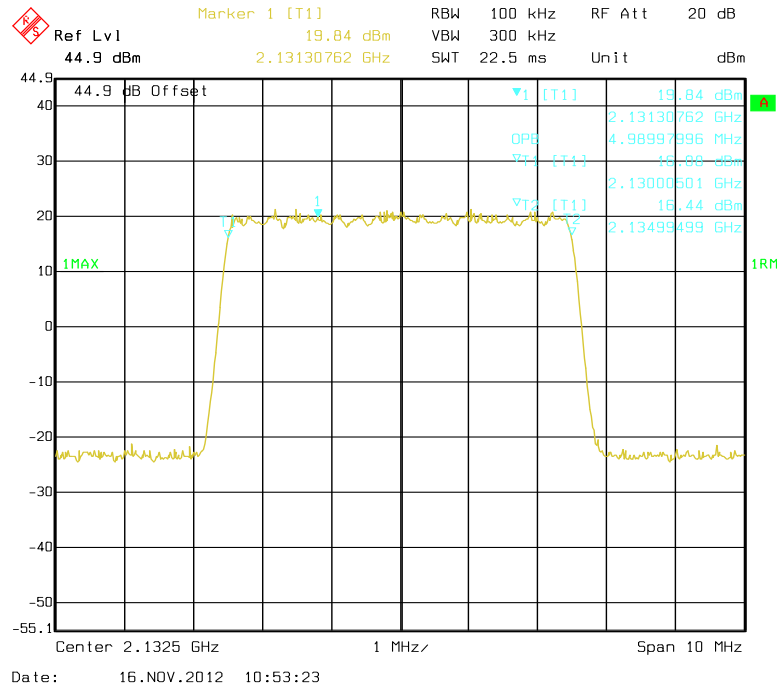

Input(Middle channel)

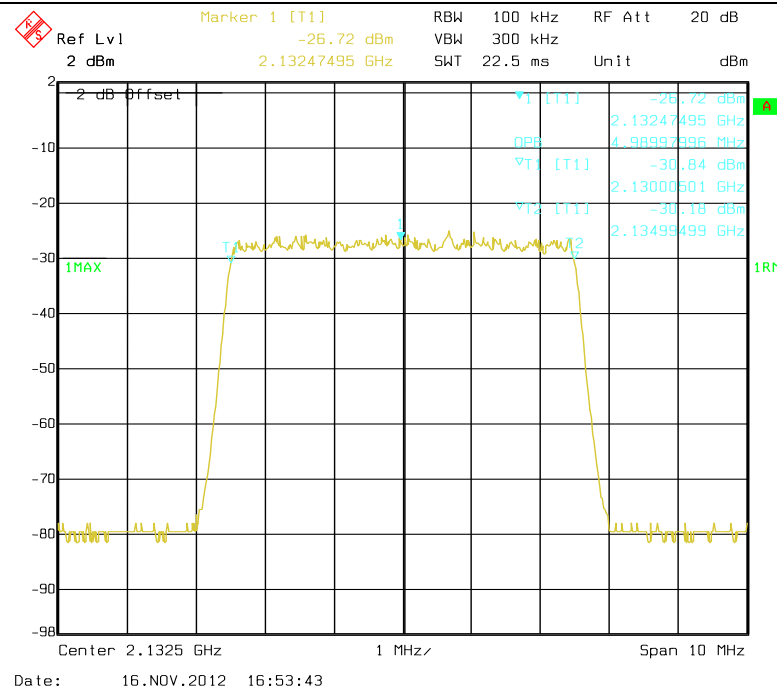

Input/output Bandwidth Comparison for EVDO(100%)

1. Number of Carriers: Single carrier



2. Number of Carriers: Four carriers

Output(Middle channel)

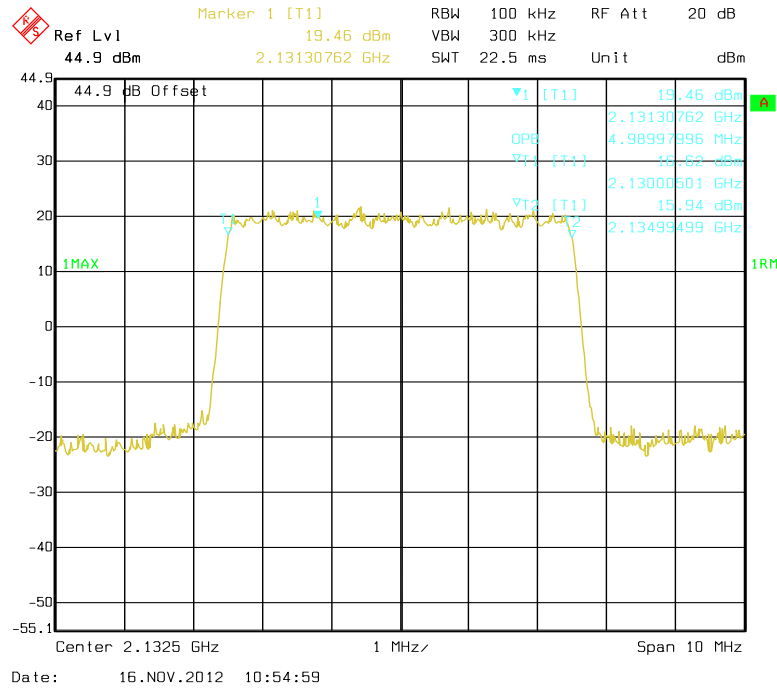

Input(Middle channel)

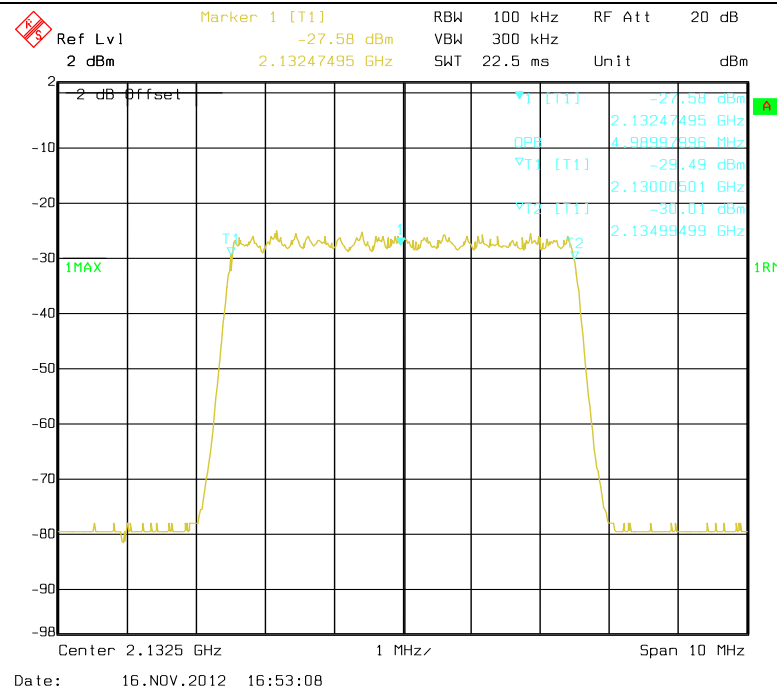

10 OUT OF BAND EMISSION AT ANTENNA TERMINALS

10.1 Standard Applicable

According to FCC §2.1051.and FCC §27.53(h)

h) For operations in the 1710–1755 MHz and 2110–2155 MHz bands, the power of any emission outside a licensee’s frequency block shall be attenuated below the transmitter power (P) by at least $43 + 10 \log_{10}(P)$ dB.

(1) Compliance with this provision is based on the use of measurement instrumentation employing a resolution bandwidth of 1 megahertz or greater. However, in the 1 megahertz bands immediately outside and adjacent to the licensee’s frequency block, a resolution bandwidth of at least one percent of the emission bandwidth of the fundamental emission of the transmitter may be employed. The emission bandwidth is defined as the width of the signal between two points, one below the carrier center frequency and one above the carrier center frequency, outside of which all emissions are attenuated at least 26 dB below the transmitter power.

(2) When measuring the emission limits, the nominal carrier frequency shall be adjusted as close to the licensee’s frequency block edges, both upper and lower, as the design permits.

(3) The measurements of emission power can be expressed in peak or average values, provided they are expressed in the same parameters as the transmitter power.

The following method was used to determine the Limit for Spurious Emissions:

Maximum output power in watts: P (W).

The emission must be reduced by $43+10\log(P)$ dB

Therefore, the Emission Limit equals:

$$10\log(P) \text{ dBW} + 30\text{dB} - (43+10\log(P) \text{ dB}) = - 13 \text{ dBm}$$

10.2 Test setup

Please refer the section §6.2 Configuration of Tested System.

10.3 Measurement Procedure

The out of band emissions were measured directly from the EUT antenna output with a spectrum analyzer from 30 MHz to the 10th harmonic of the highest carrier frequency. Test signals used are WCDMA, LTE, CDMA, and EVDO. The different signals were input one at a time to the EUT. Tests were performed with WCDMA/LTE/CDMA/EVDO signal input and multi-carrier signal mode input.

Band edge compliance is also demonstrated using a WCDMA, LTE, CDMA, and EVDO signal at the upper and lower limits of the band.

1. The EUT RF output port was connected to spectrum analyzer.
2. The level of RF input signal shall be increased, until the maximum output power per channel, declared by client, is reached.
3. The spurious emissions at antenna were measured at the RF output port of the EUT at middle channel of each type of modulation.

Spectrum analyzer settings:

Detector: RMS.

> 1 MHz from Band Edge

Below 1G: RBW=100kHz; Above 1G: RBW=1 MHz ; VBW \geq RBW

< 1 MHz from Band Edge

RBW=30 kHz; VBW \geq RBW

10.4 Measurement Result

10.4.1 Spurious emission

Spurious emission of WCDMA

1. Number of Carriers: Single carrier (Low channel)

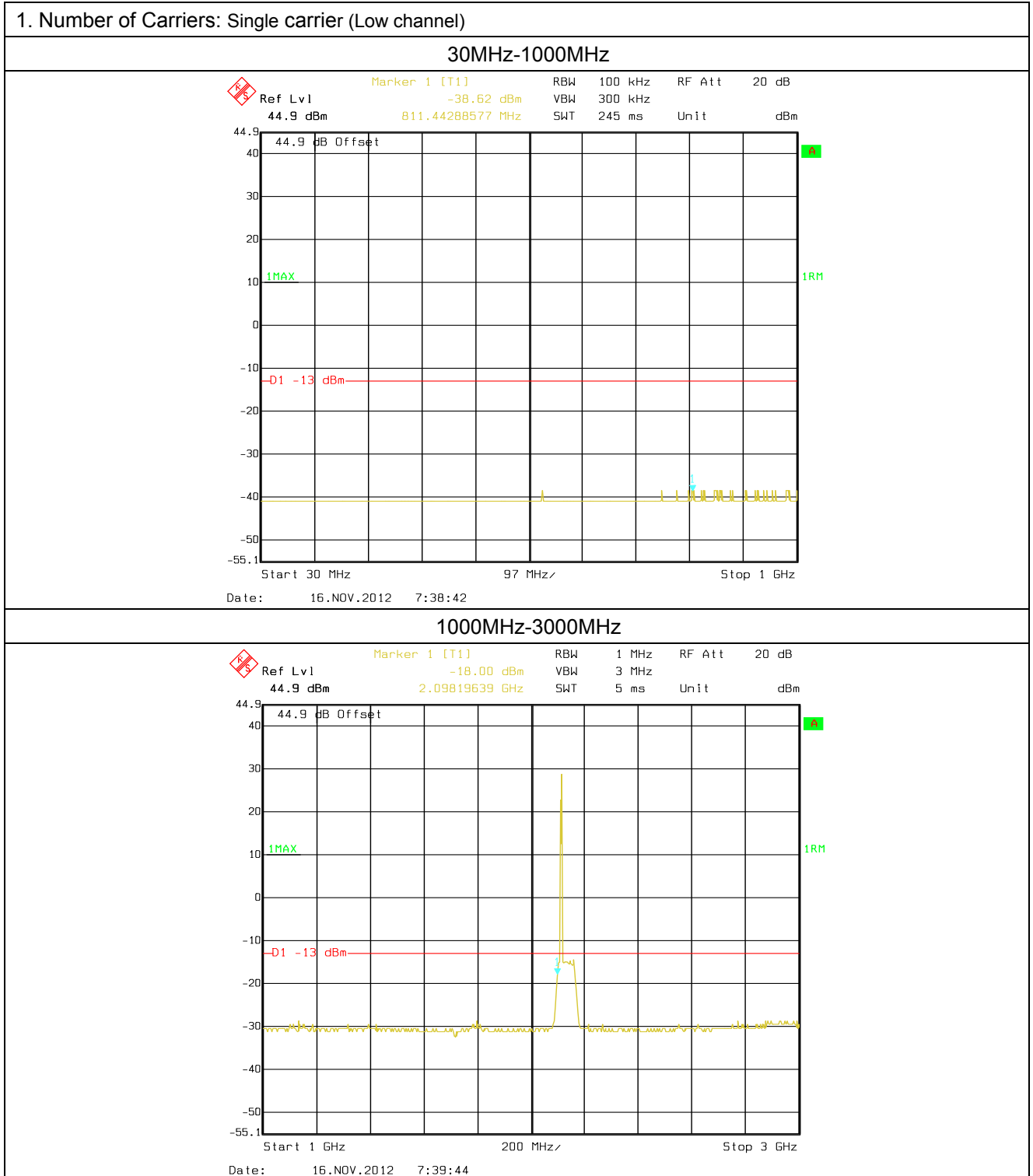

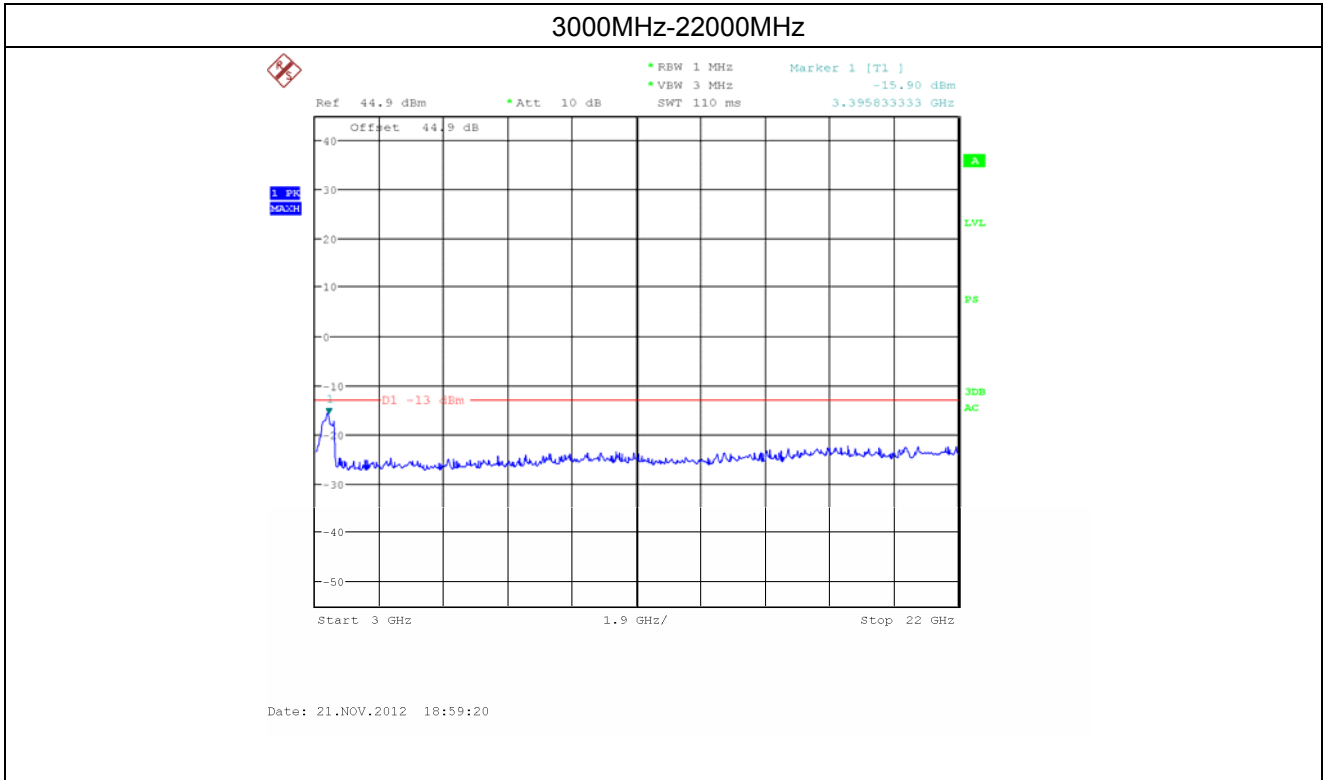

2. Number of Carriers: Four carriers (Low channel)

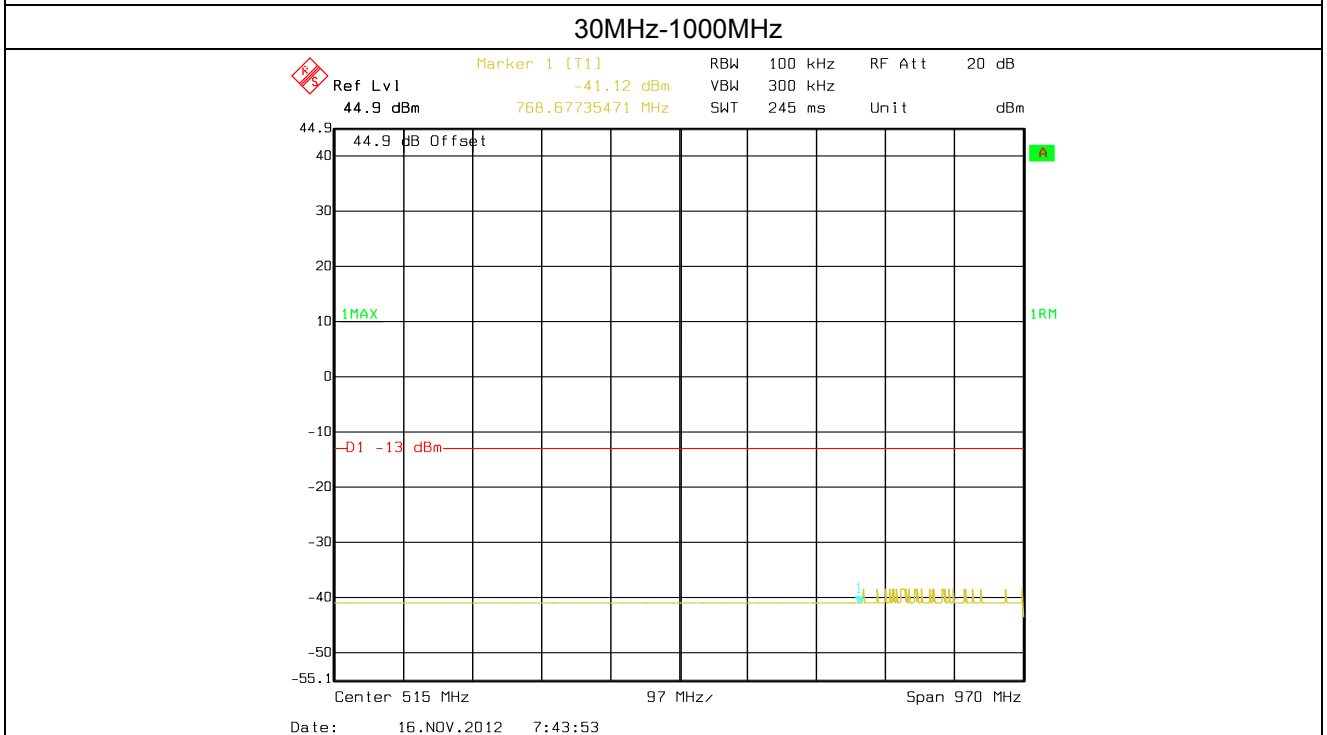

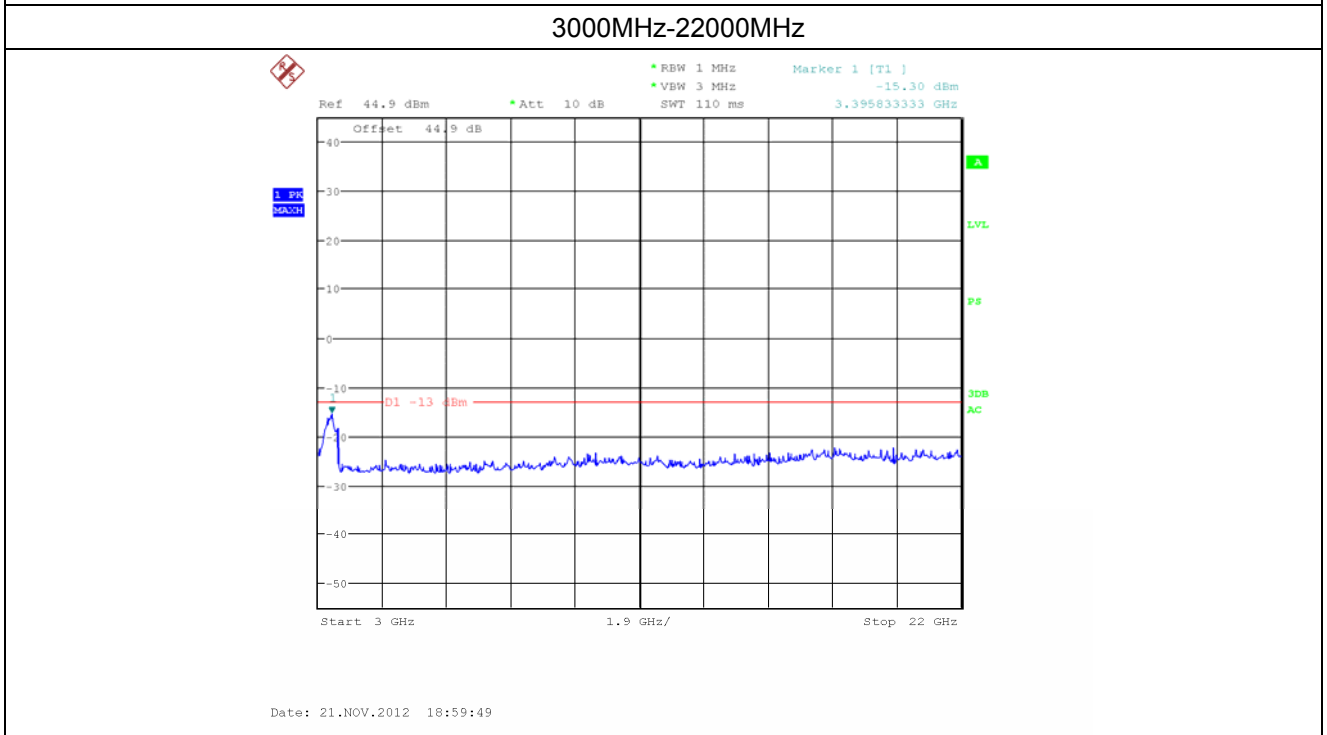
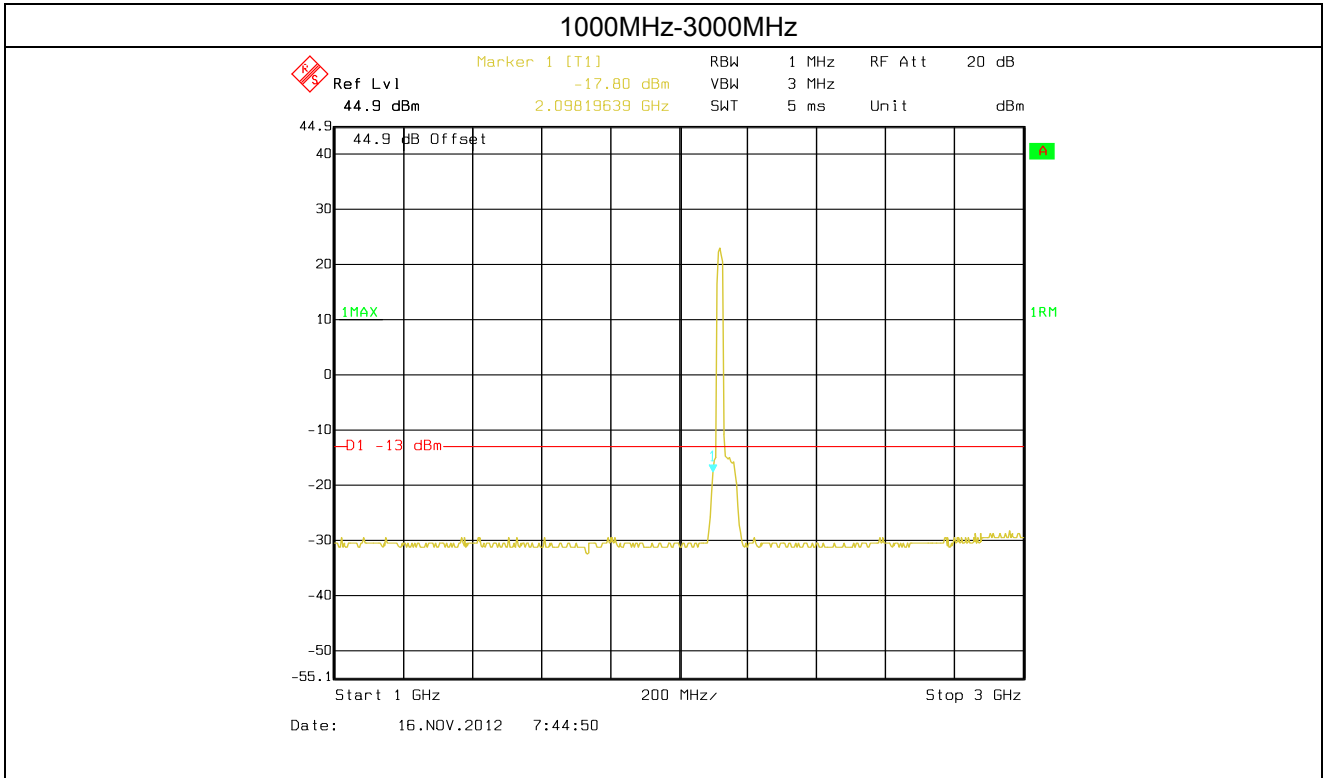

3. Number of Carriers: Single carrier (High channel)

30MHz-1000MHz

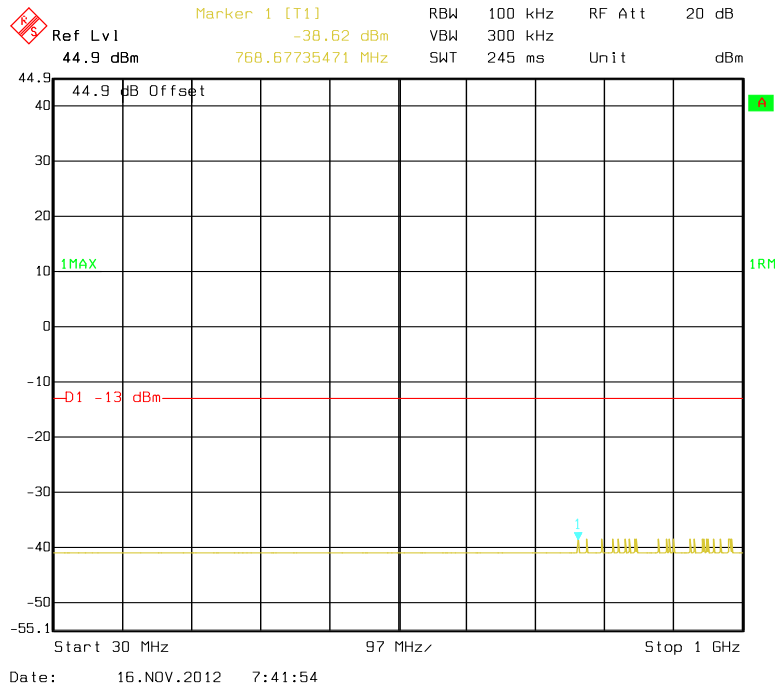

1000MHz-3000MHz

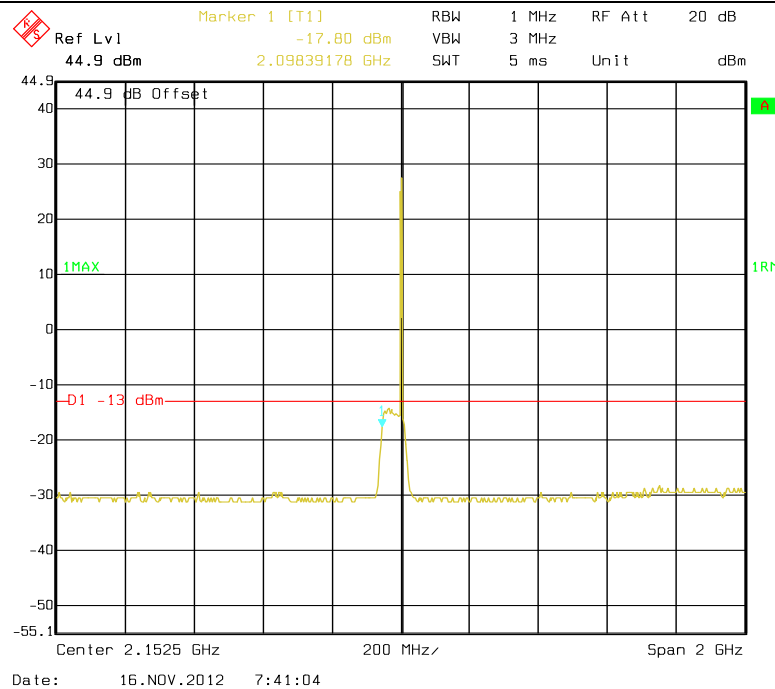

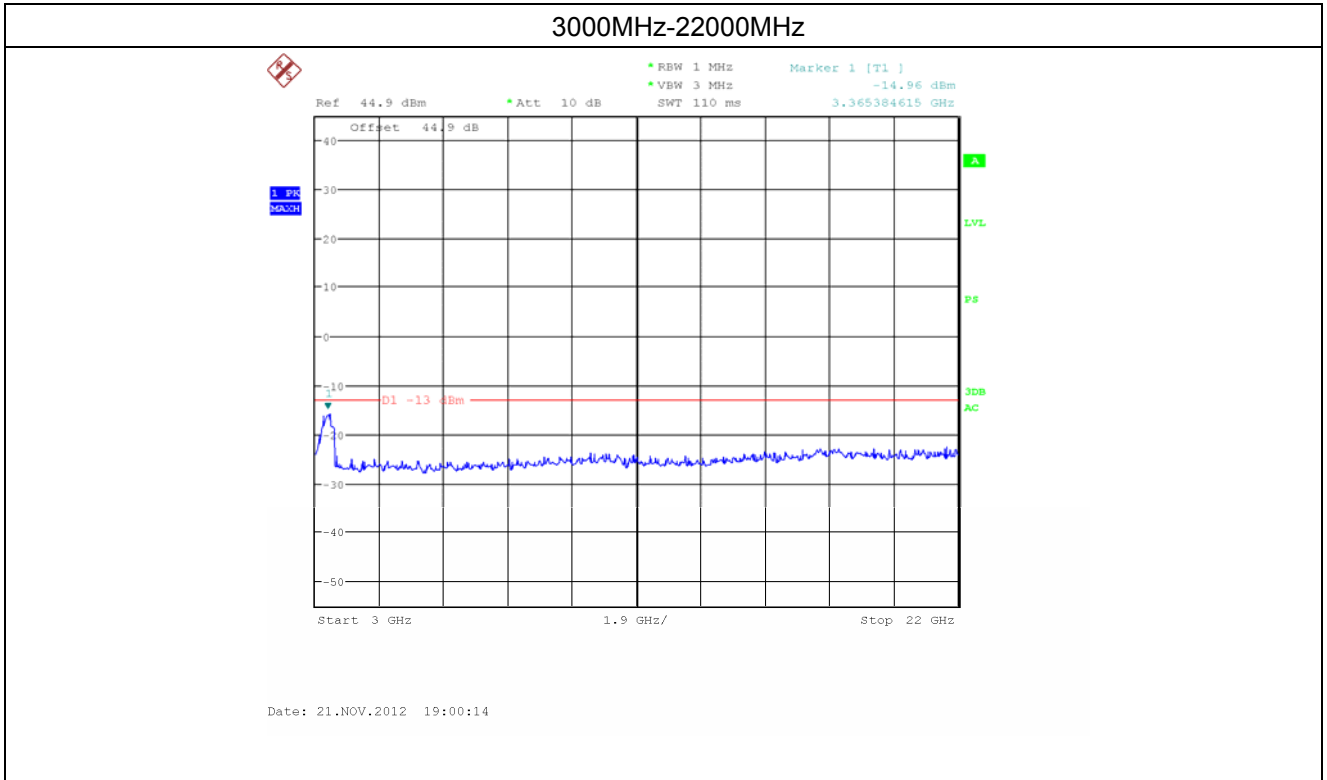

4. Number of Carriers: Four carriers (High channel)

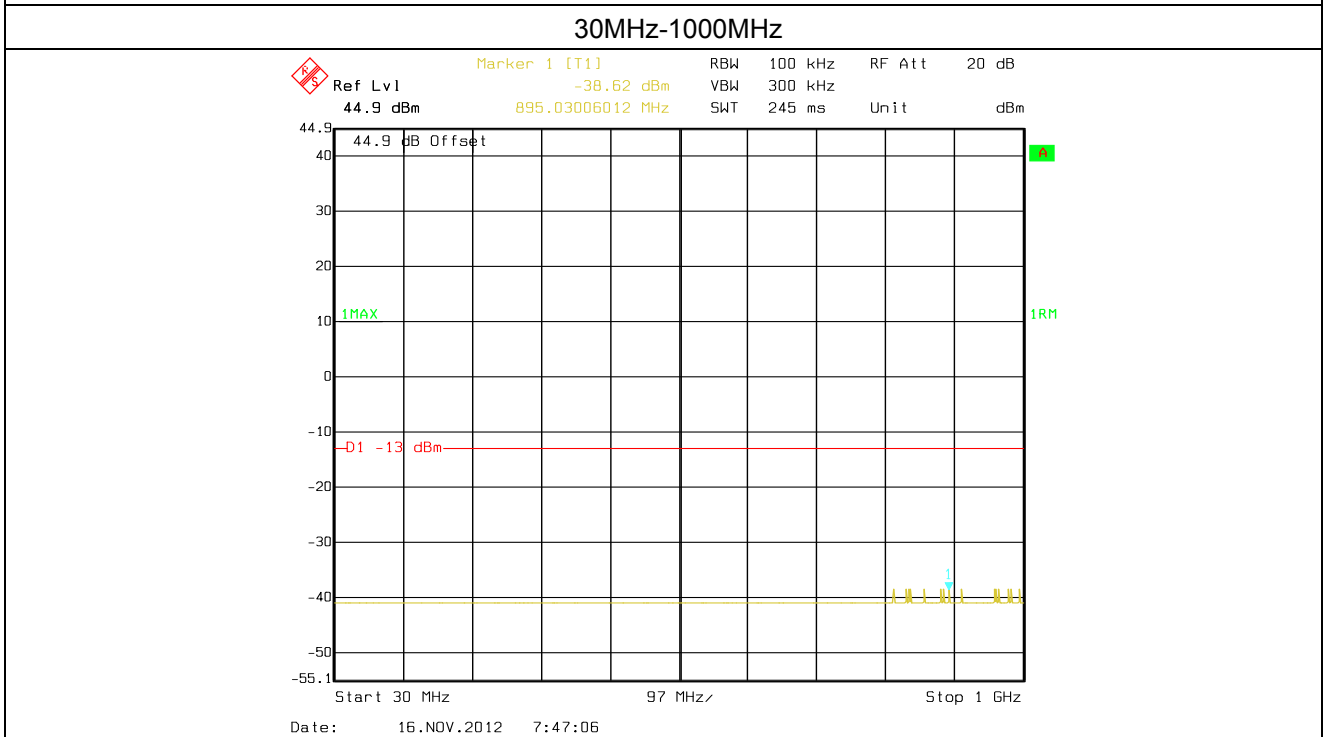

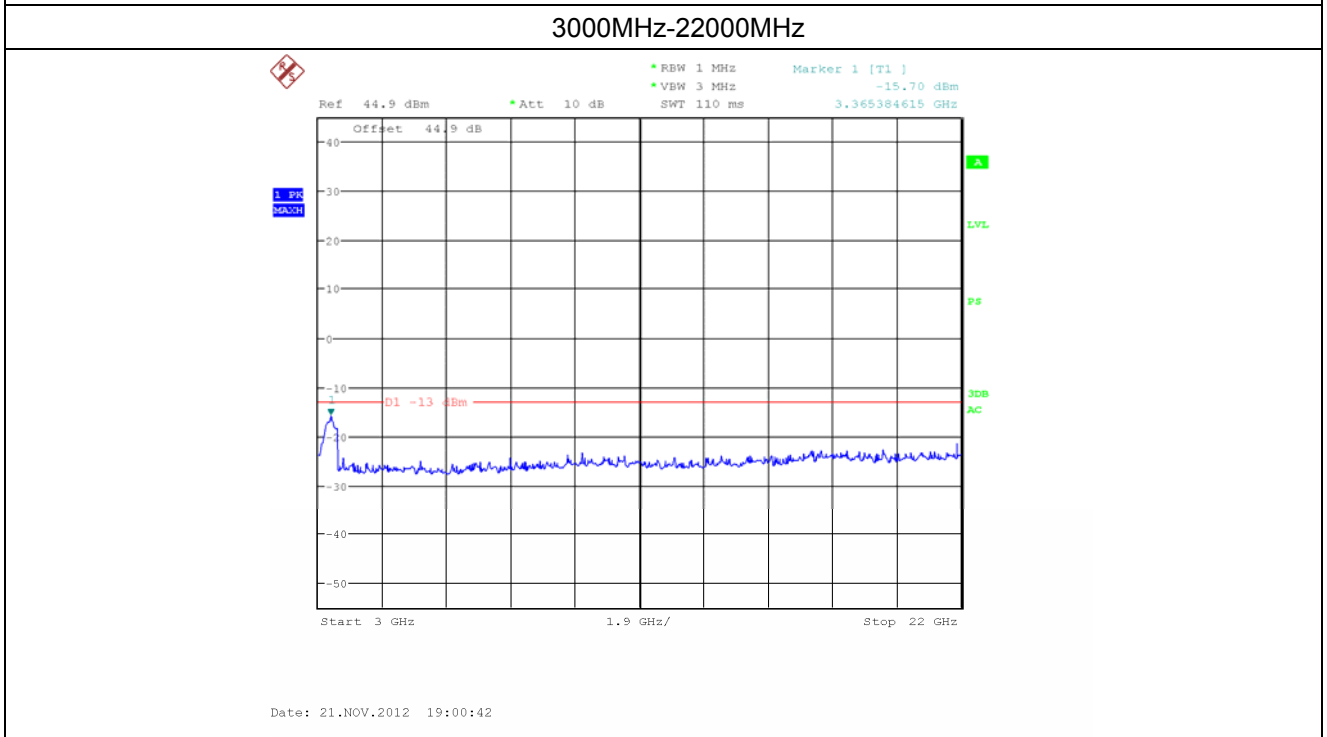
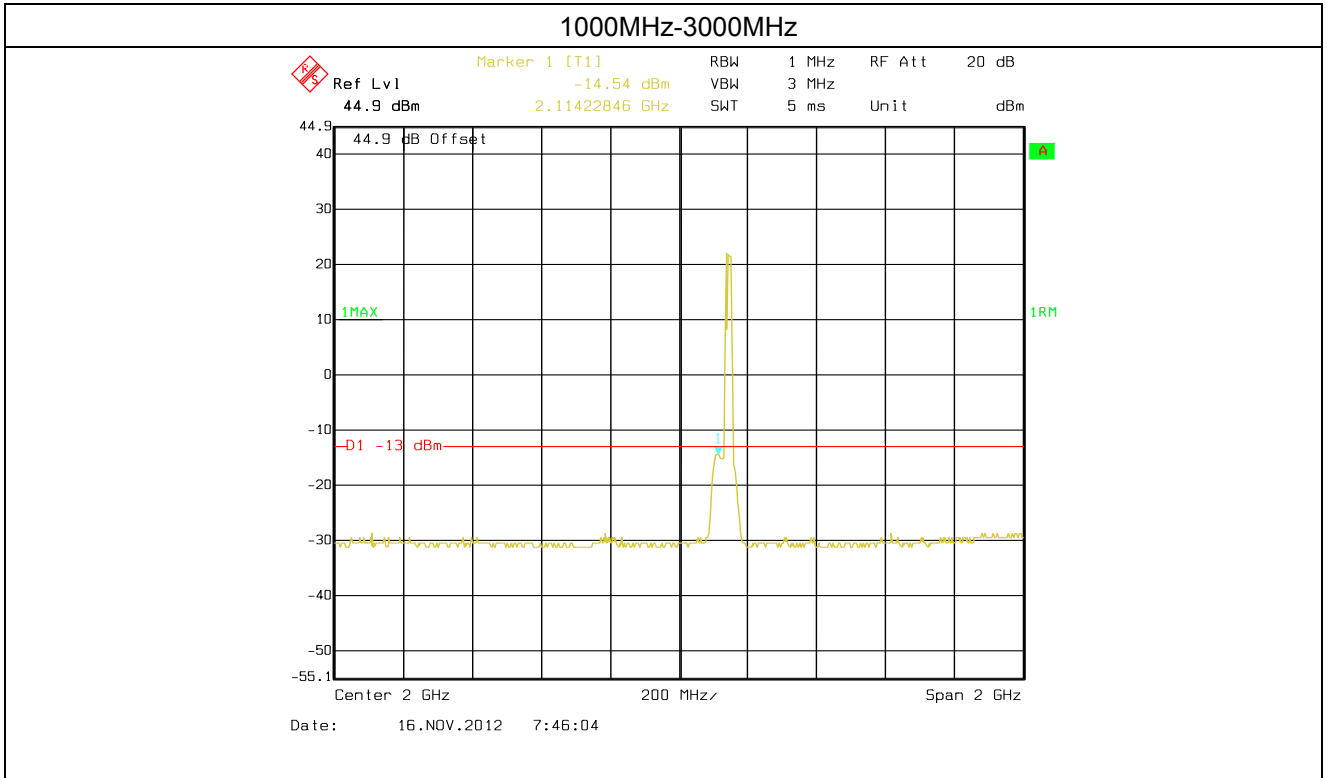

Spurious emission of CDMA

1. Number of Carriers: Single carrier (Low channel)

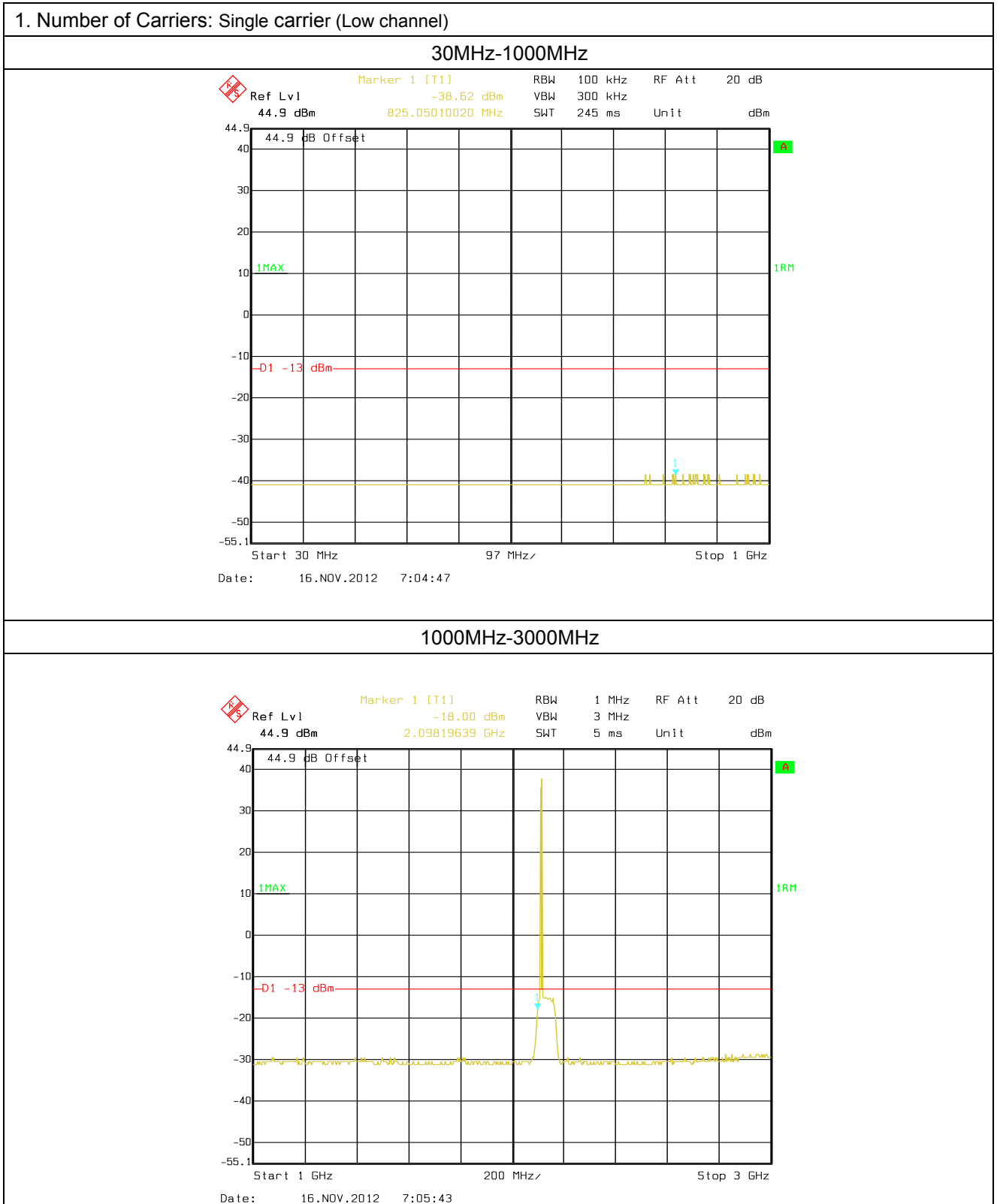

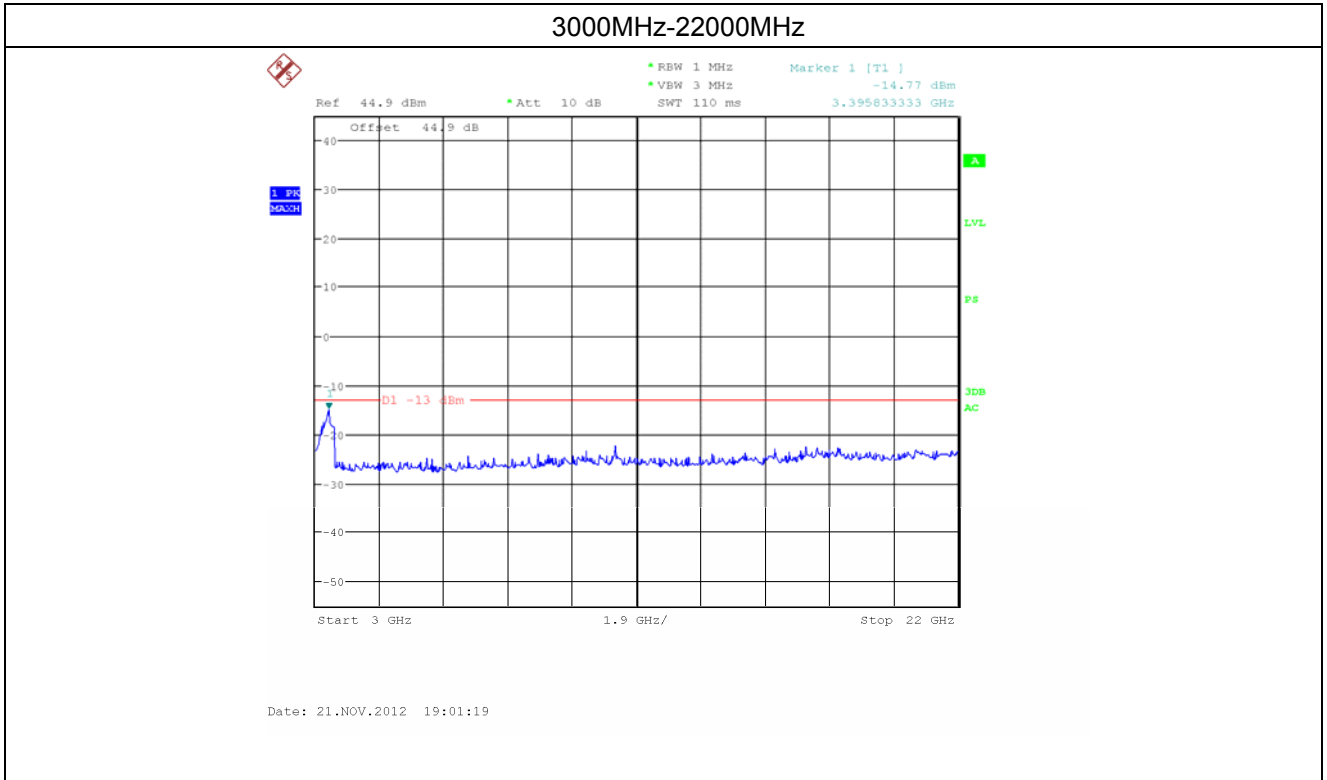

2. Number of Carriers: Four carriers (Low channel)

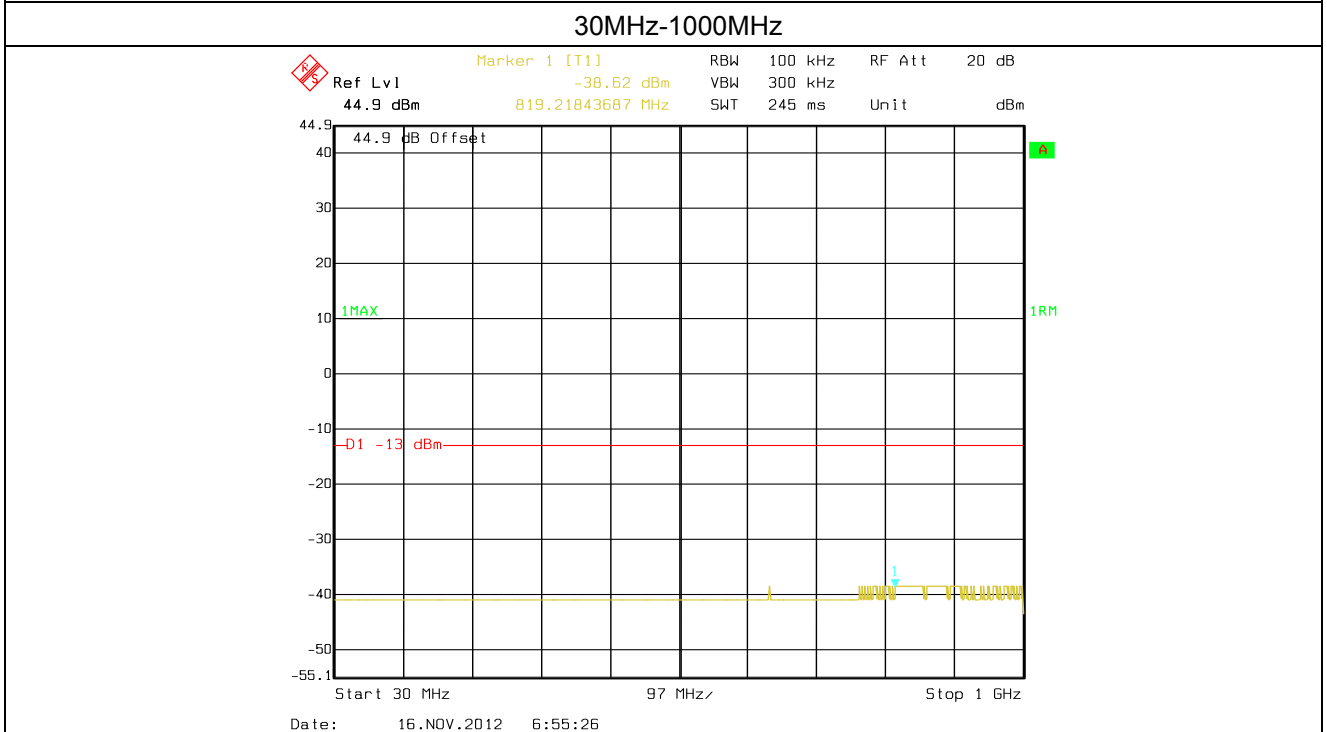

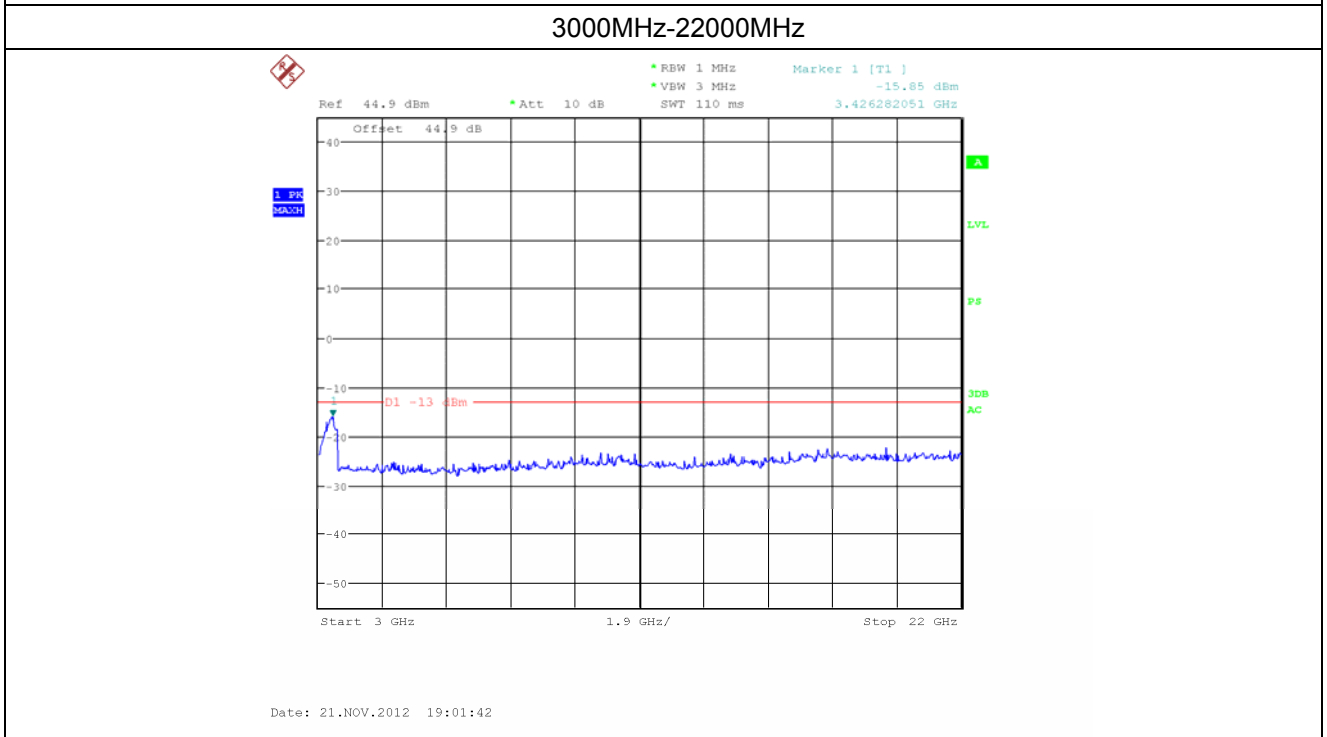
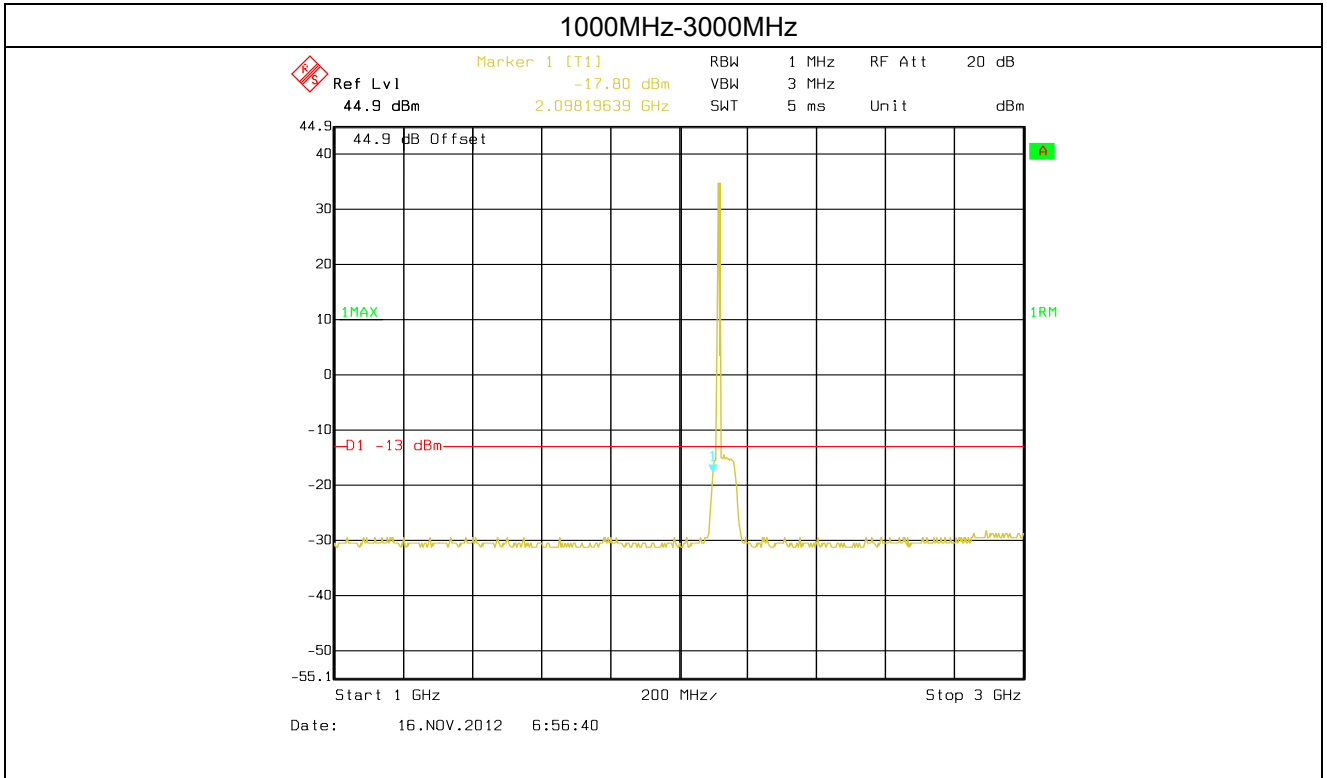

3. Number of Carriers: Single carrier (High channel)

30MHz-1000MHz

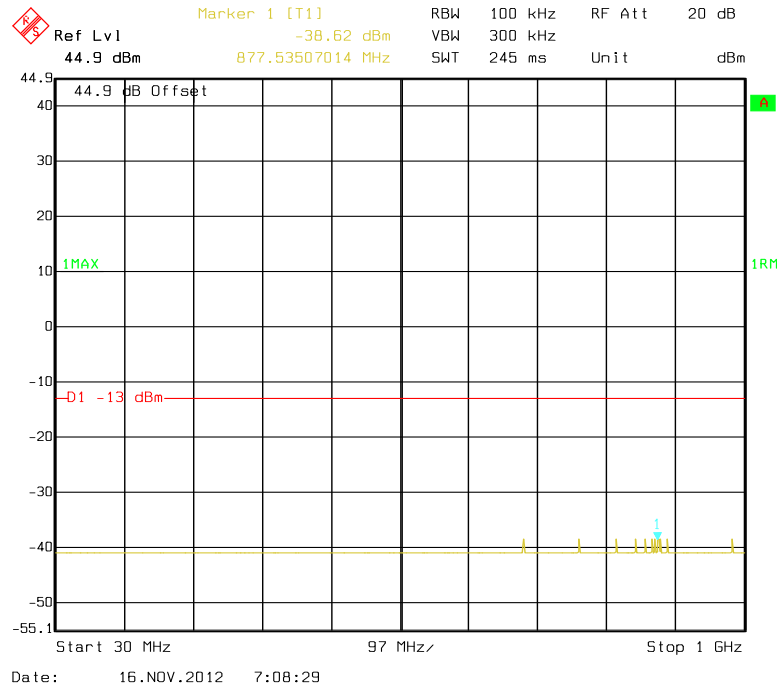

1000MHz-3000MHz

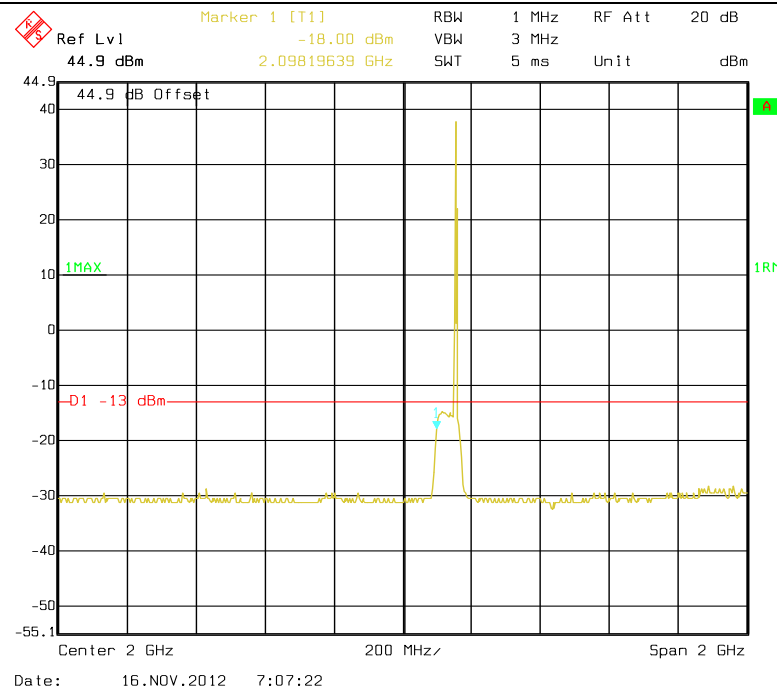

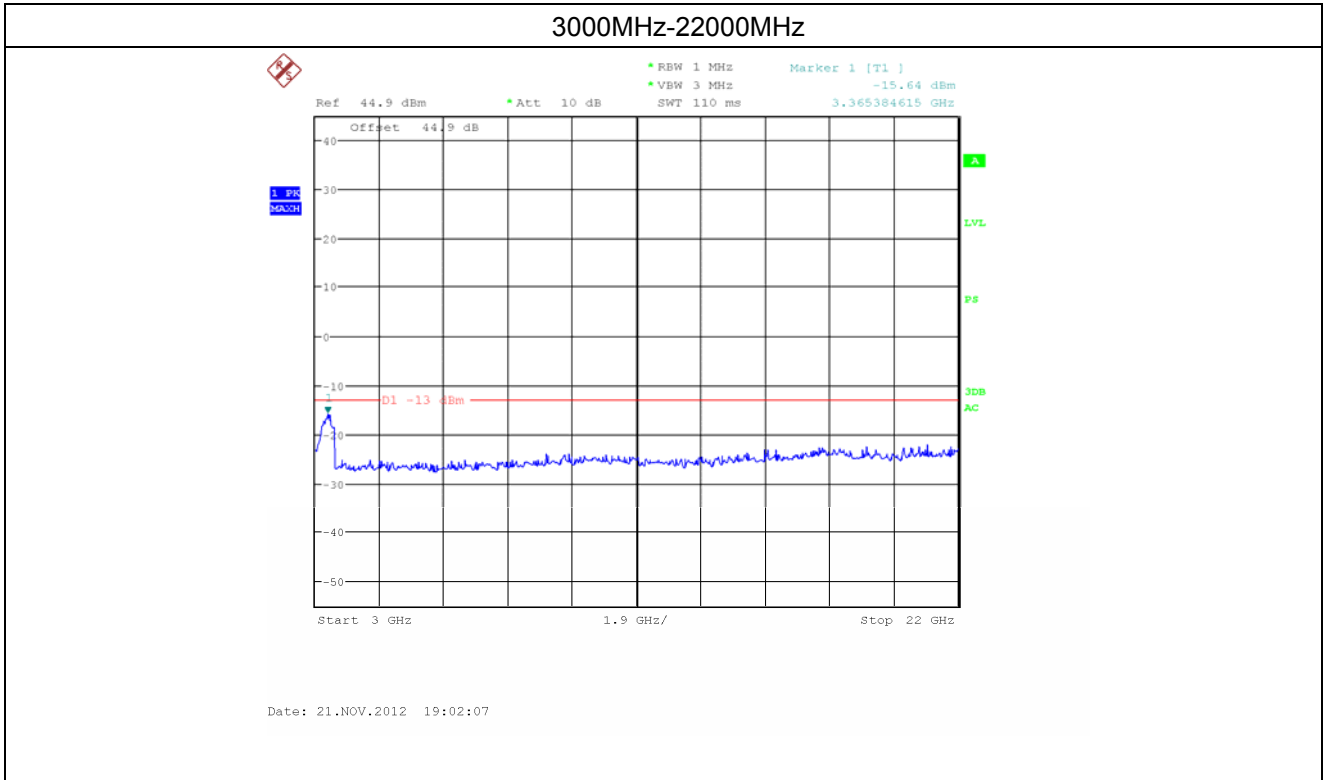

4. Number of Carriers: Four carriers (High channel)

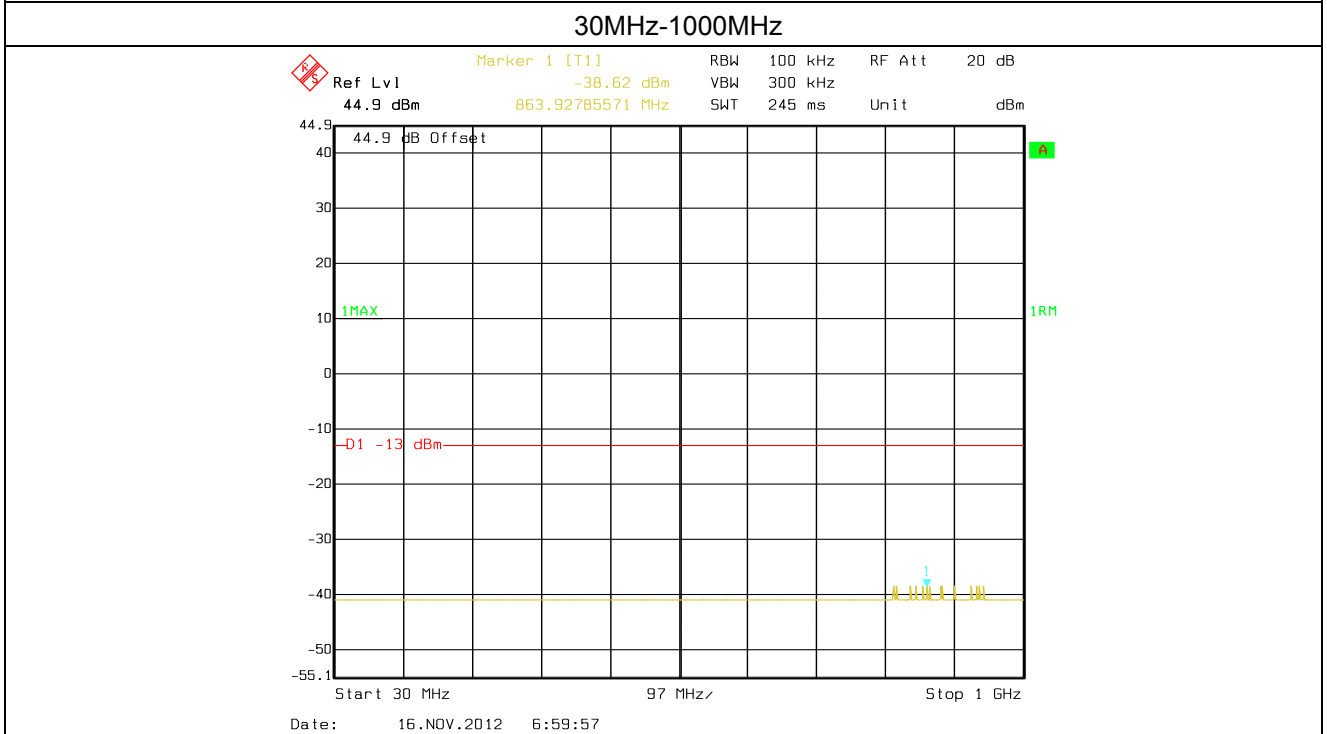

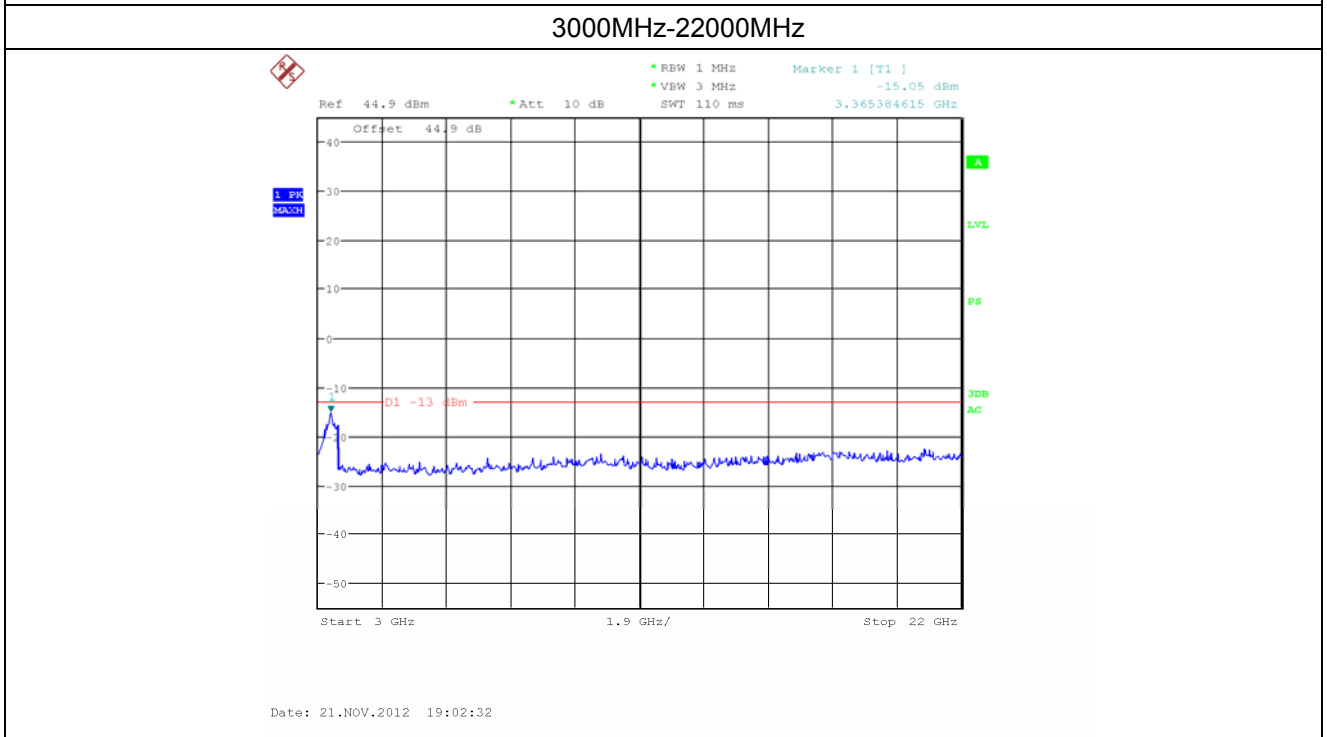
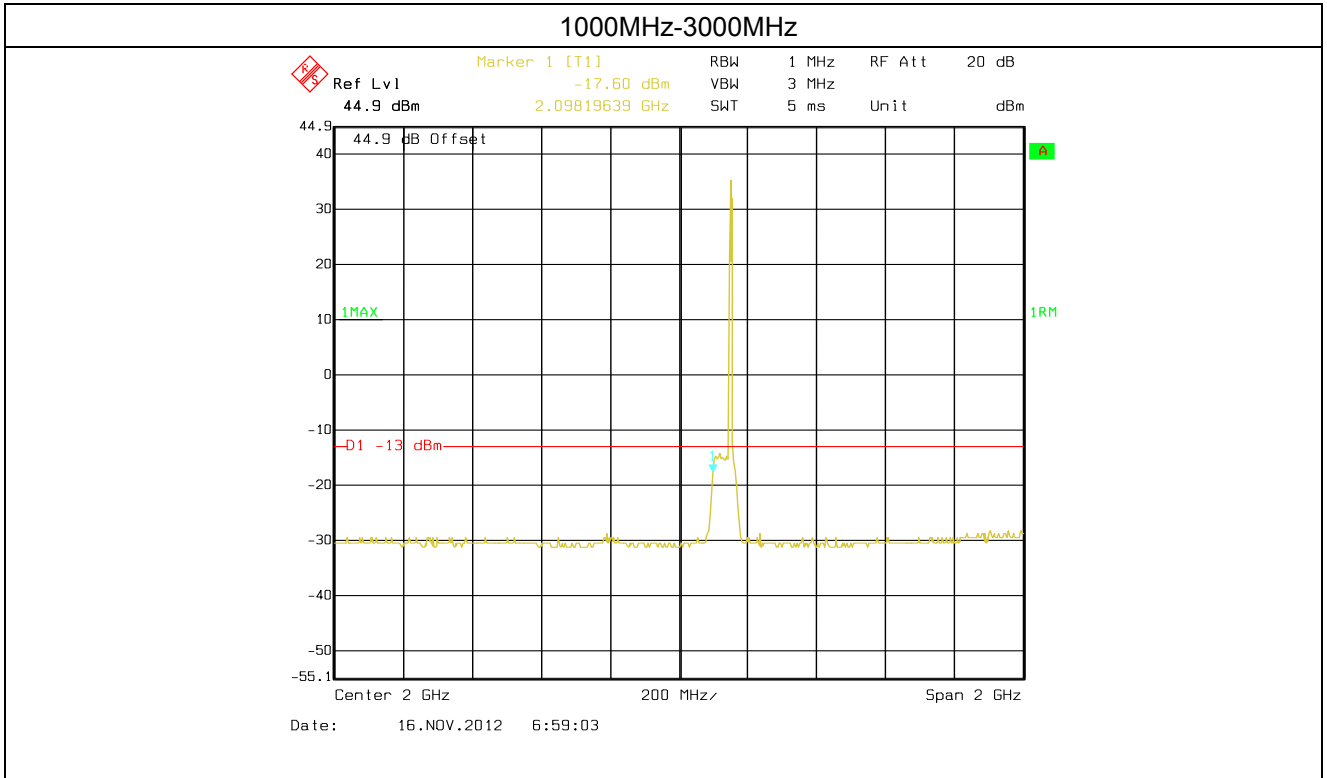

Spurious emission of EVDO(0%)

1. Number of Carriers: Single carrier (Low channel)

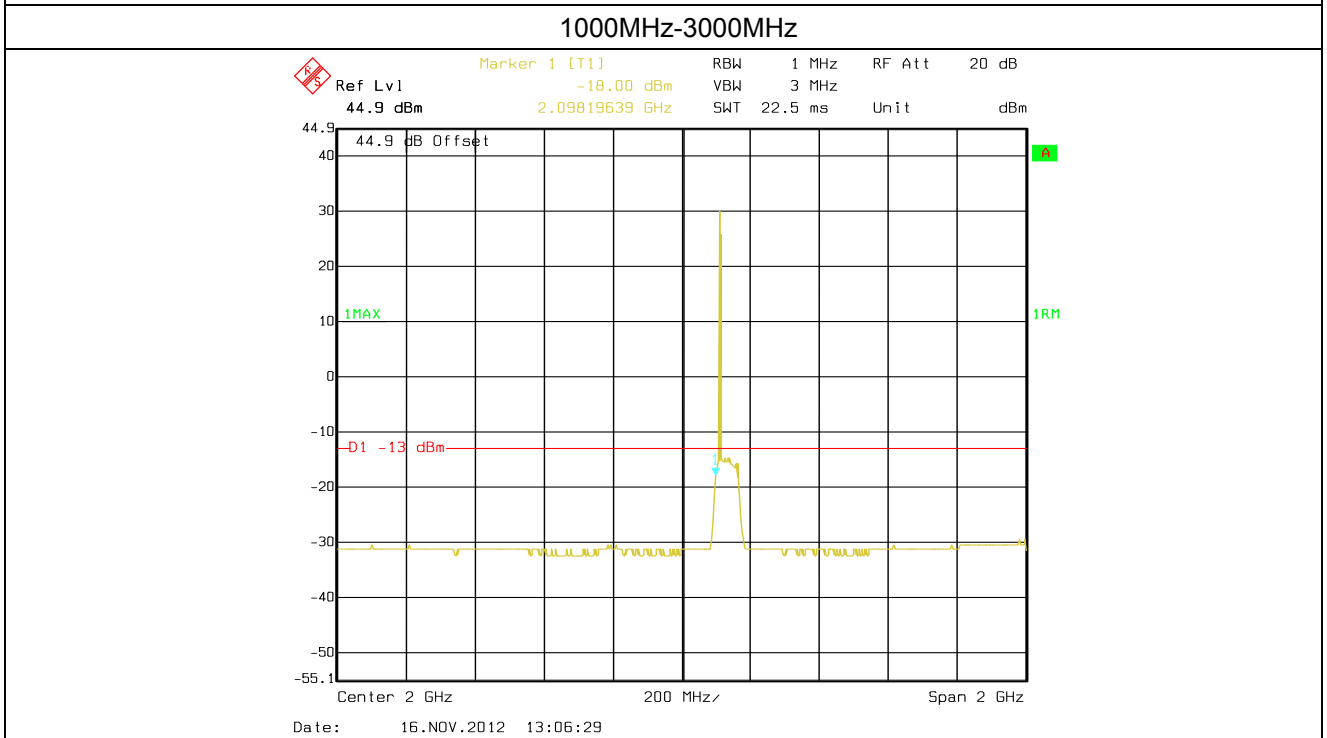
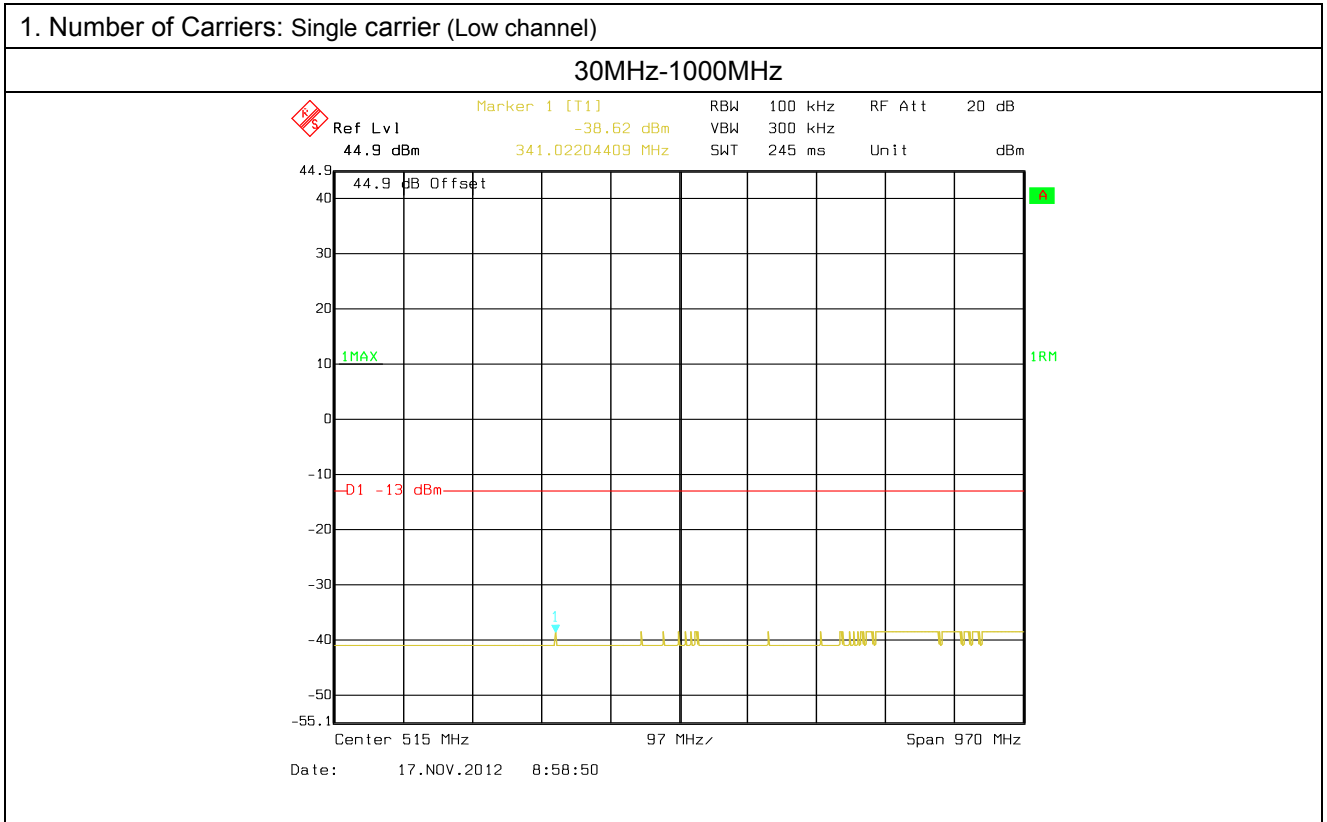

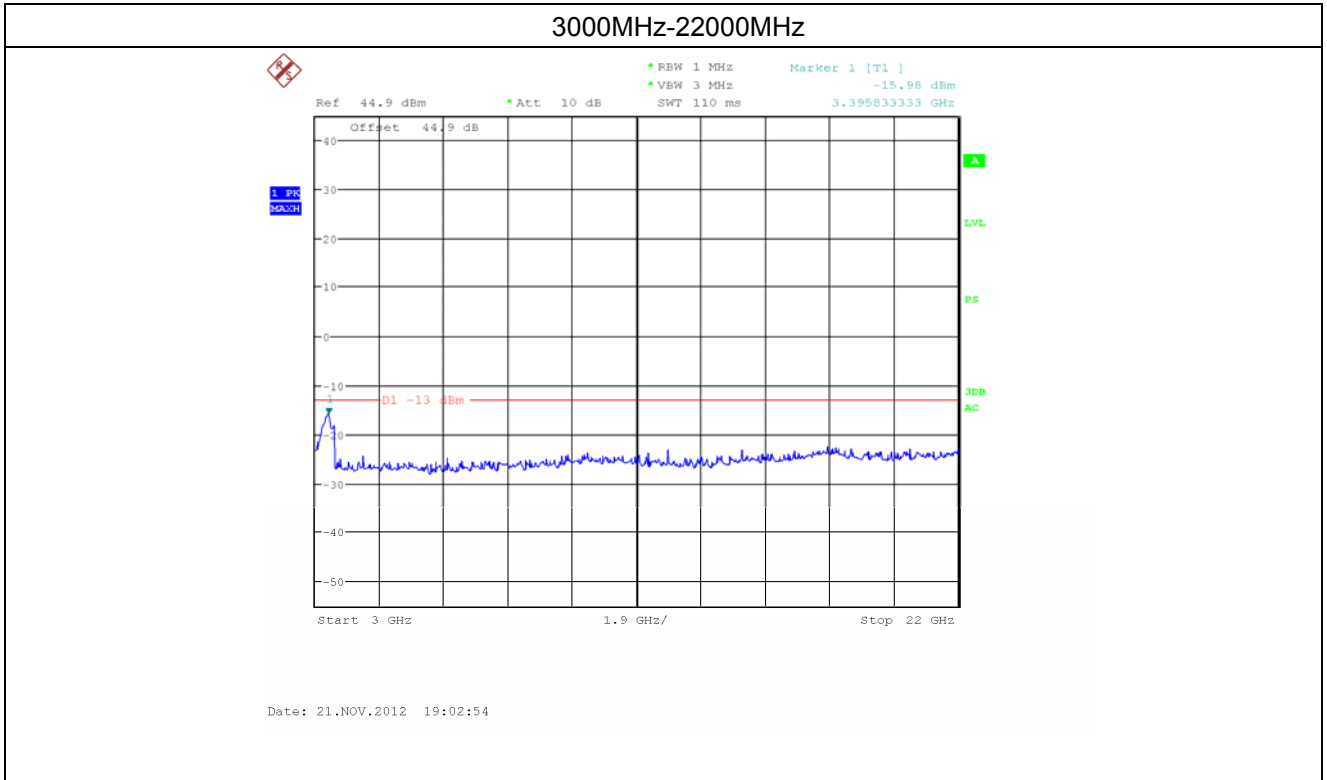

2. Number of Carriers: Four carriers (Low channel)

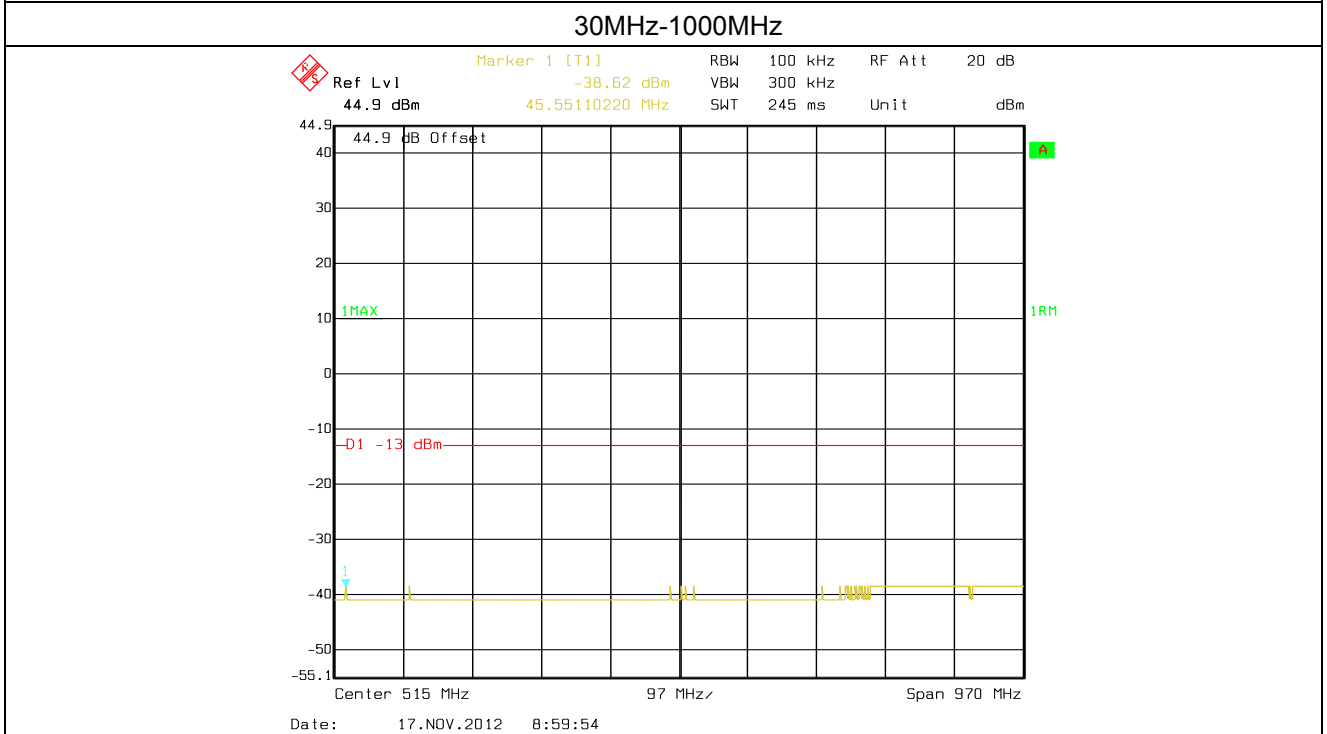

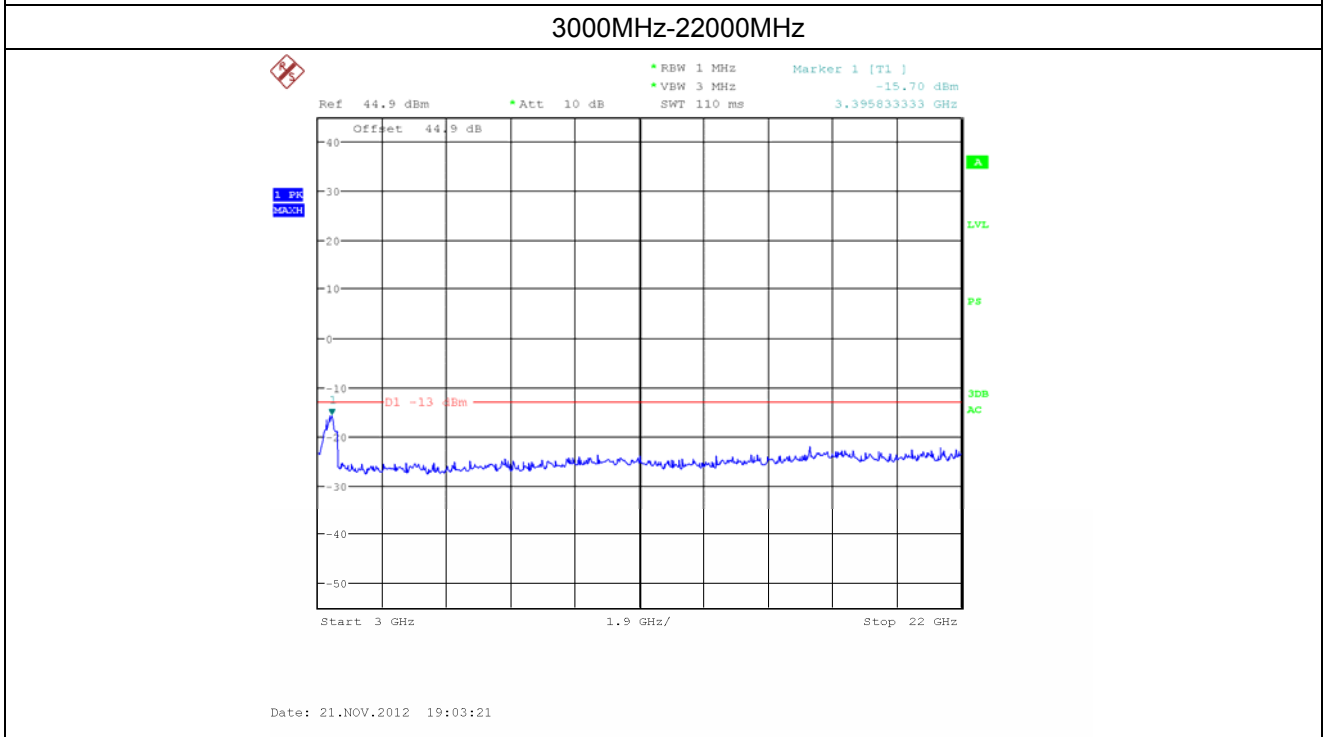
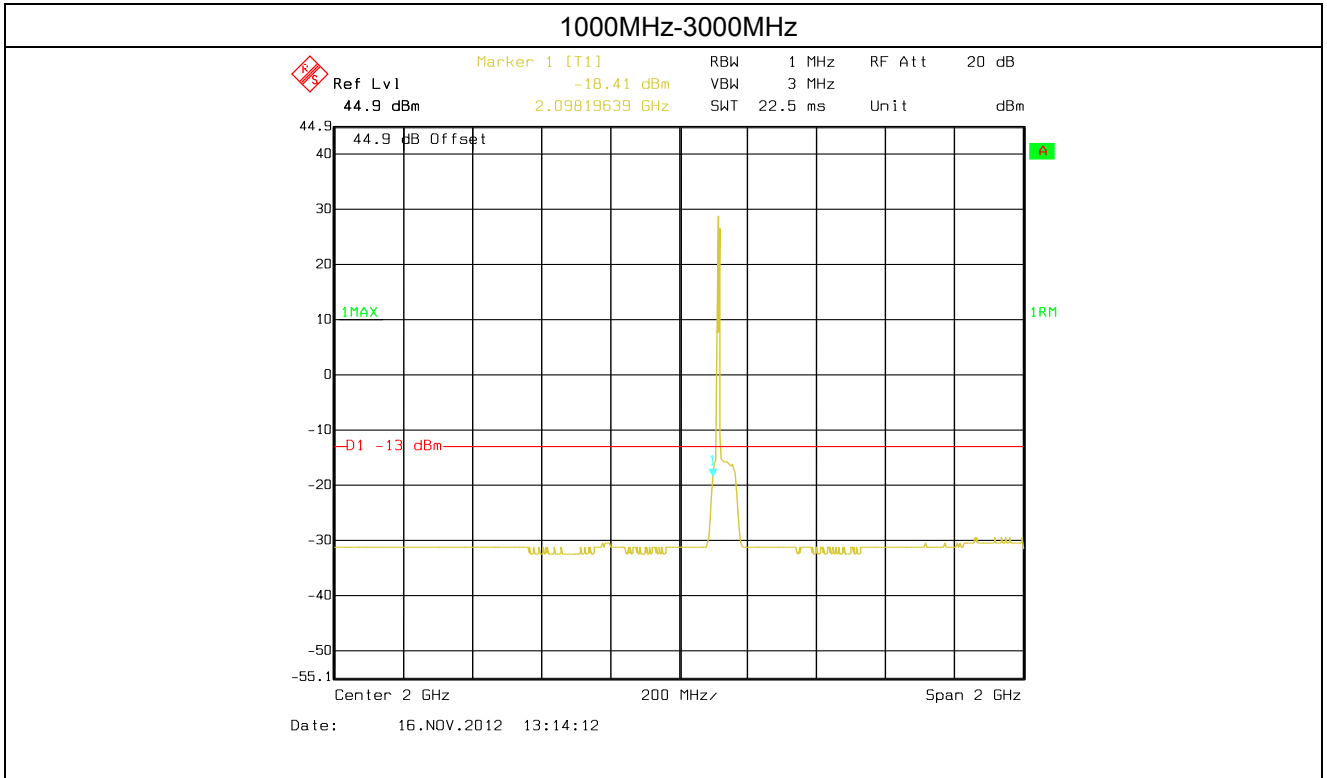

3. Number of Carriers: Single carrier (High channel)

30MHz-1000MHz

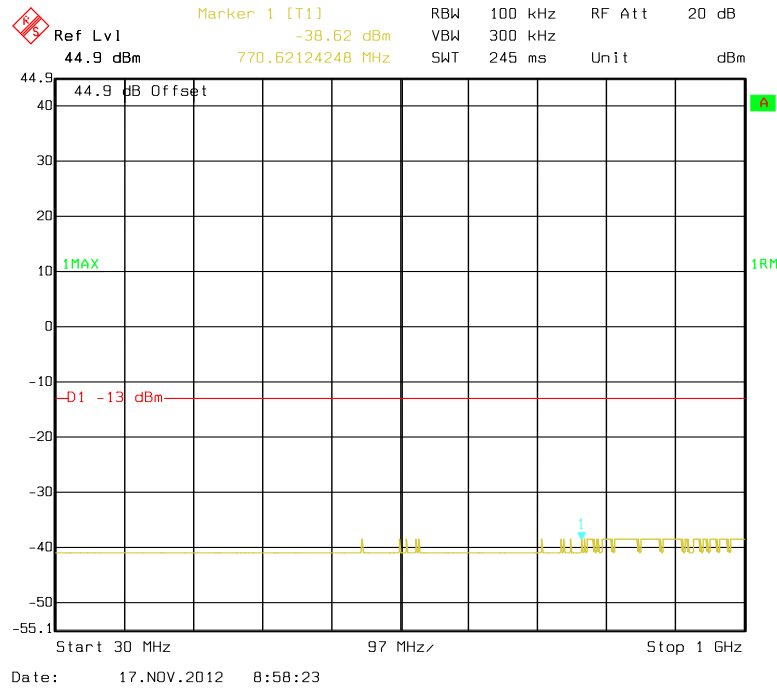

1000MHz-3000MHz

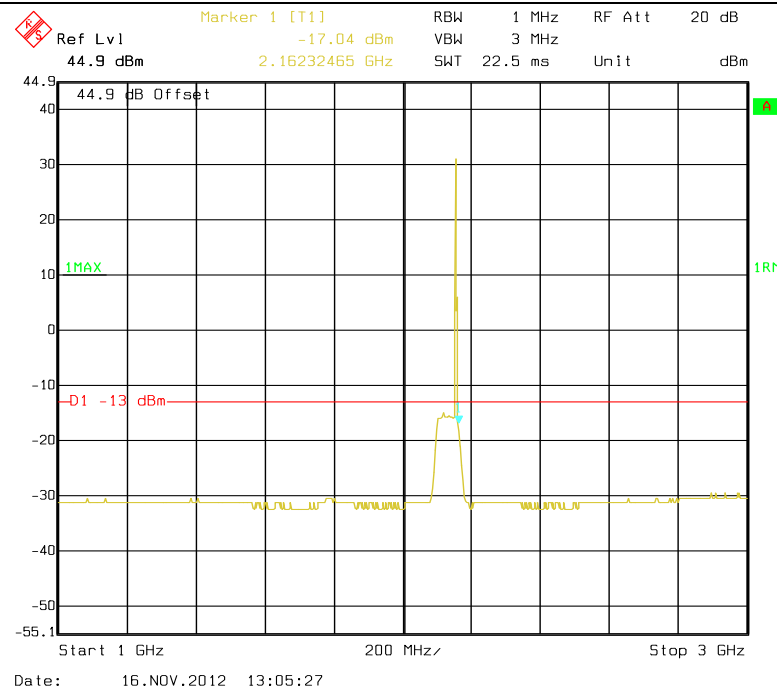

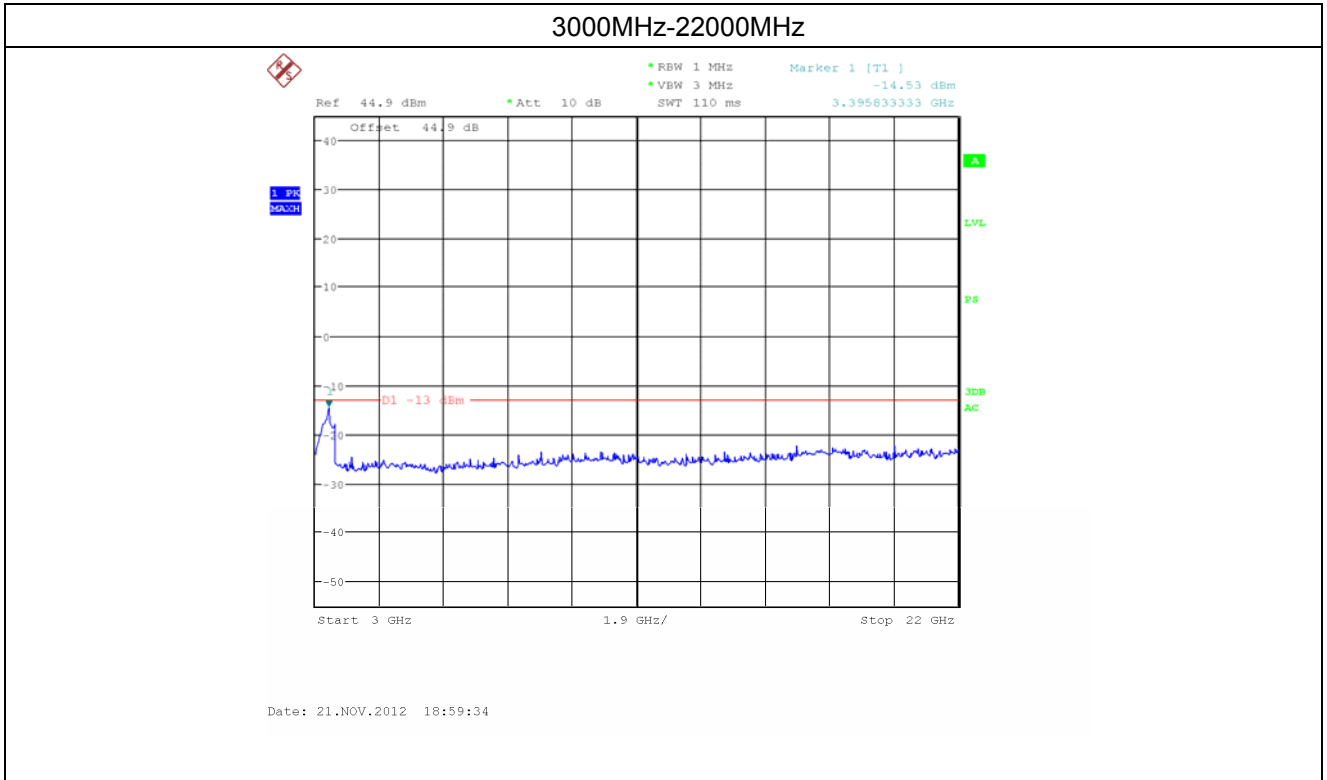

4. Number of Carriers: Four carriers (High channel)

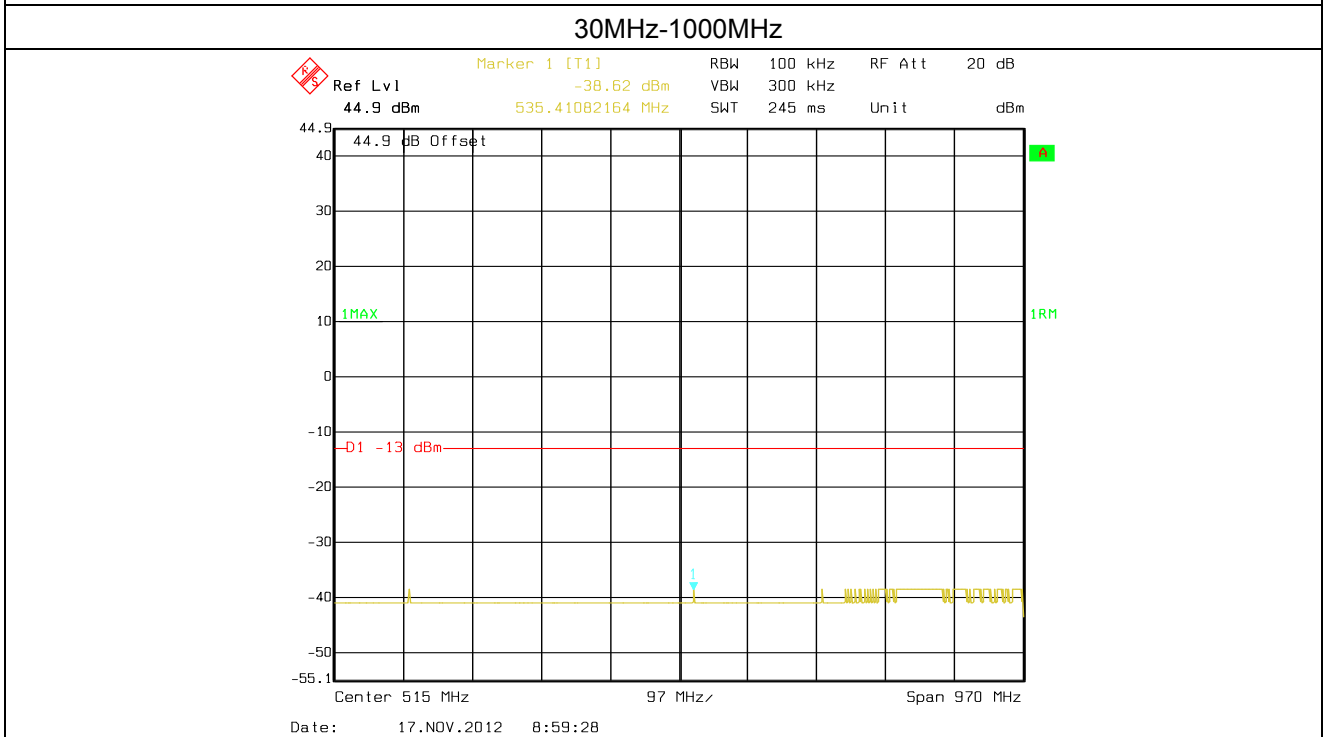

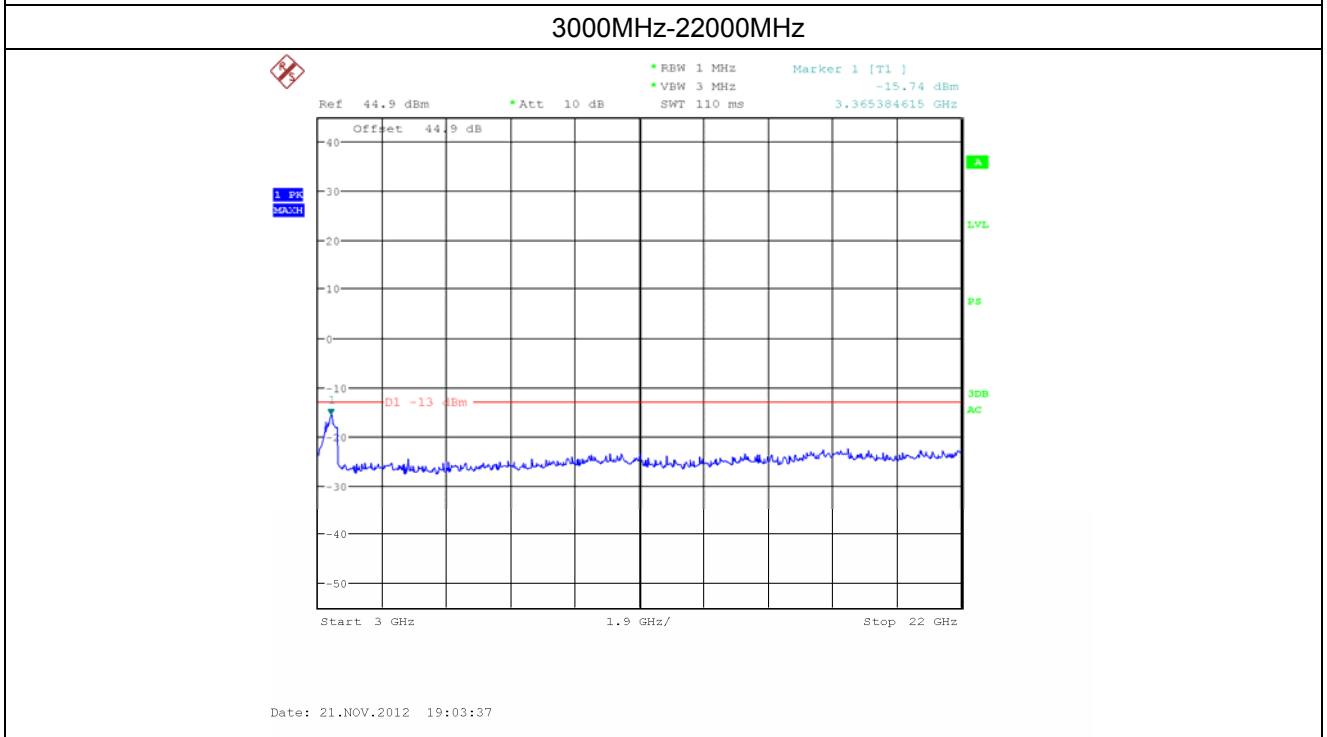
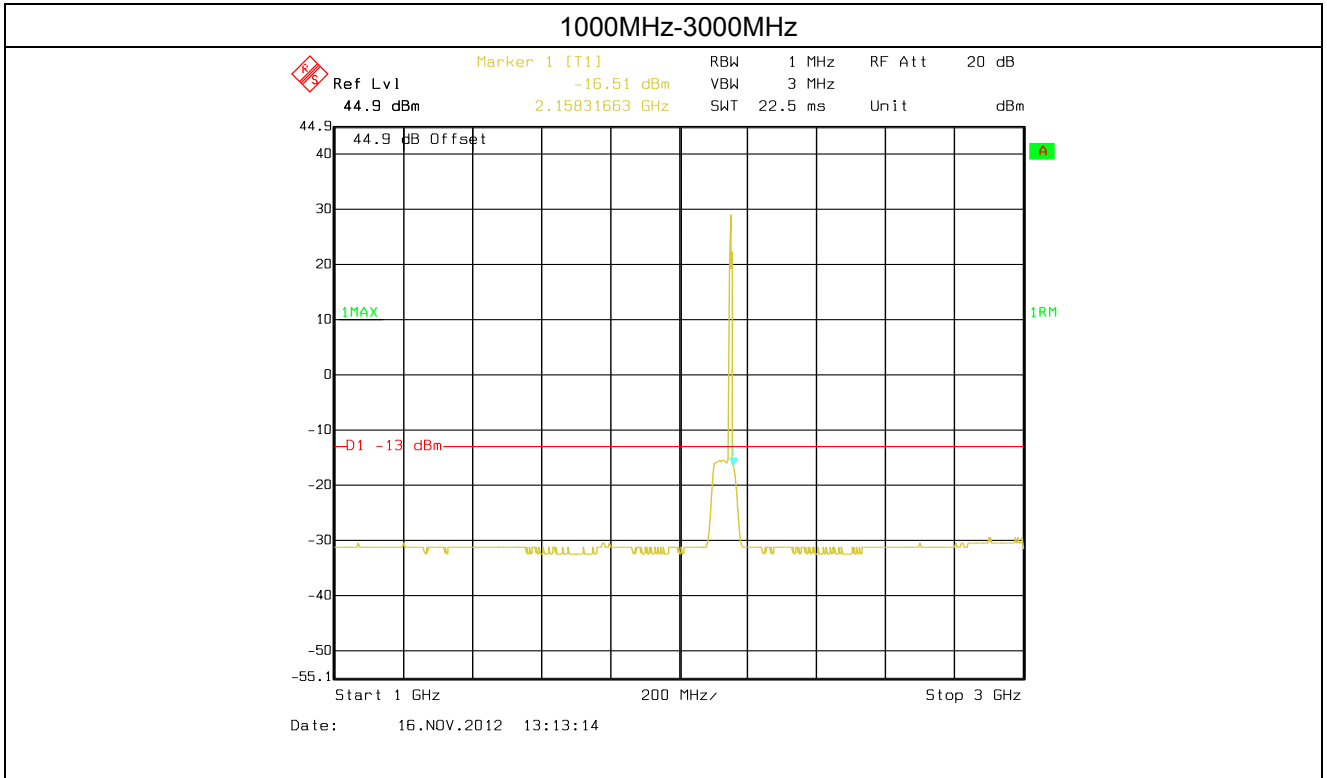

Spurious emission of EVDO(50%)

1. Number of Carriers: Single carrier (Low channel)

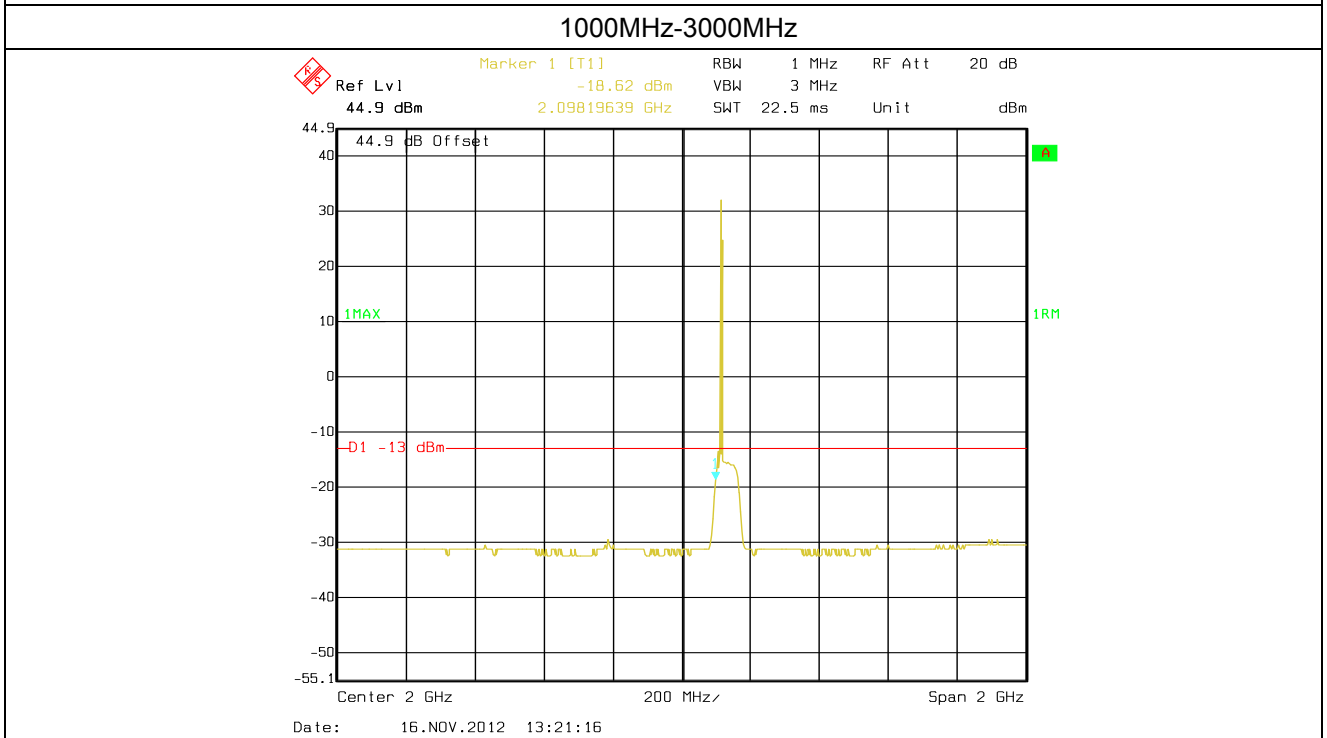
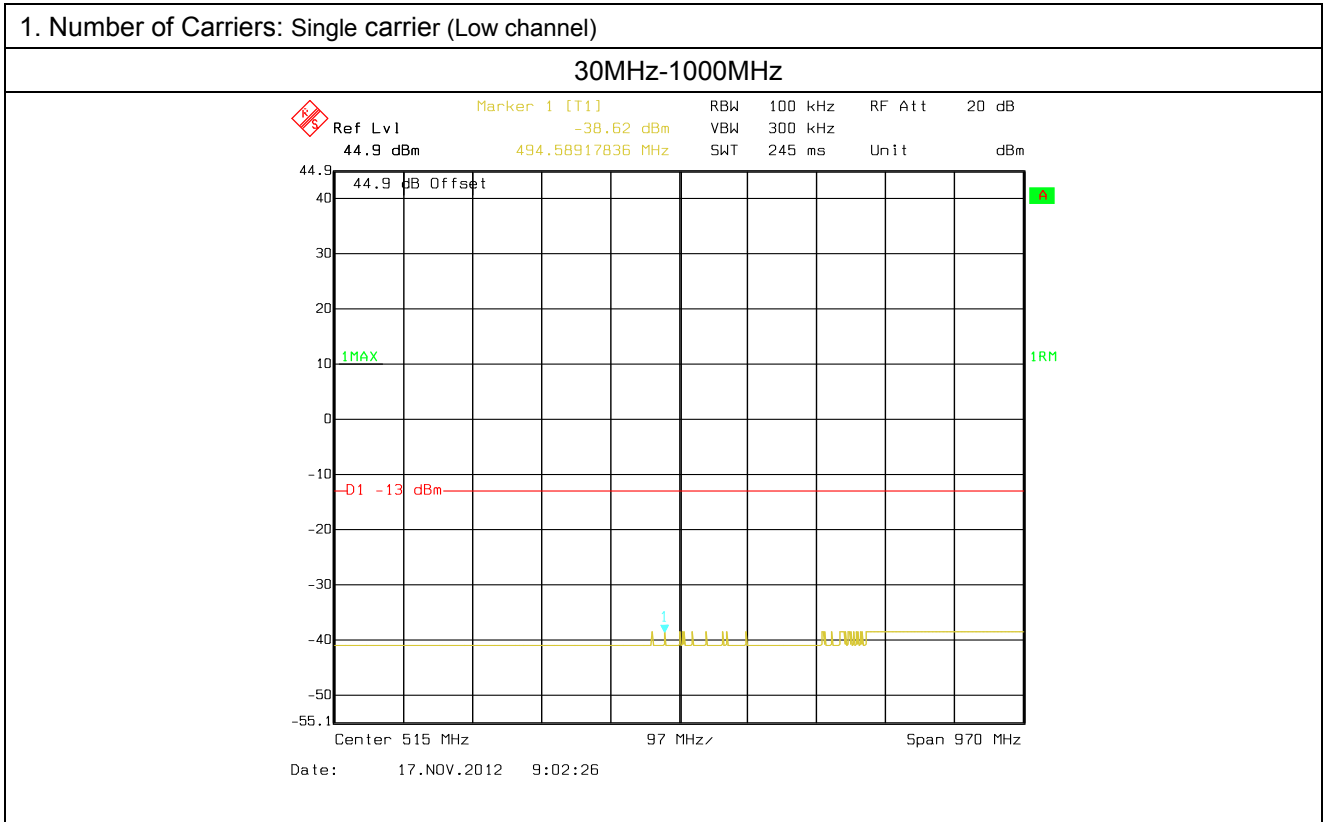

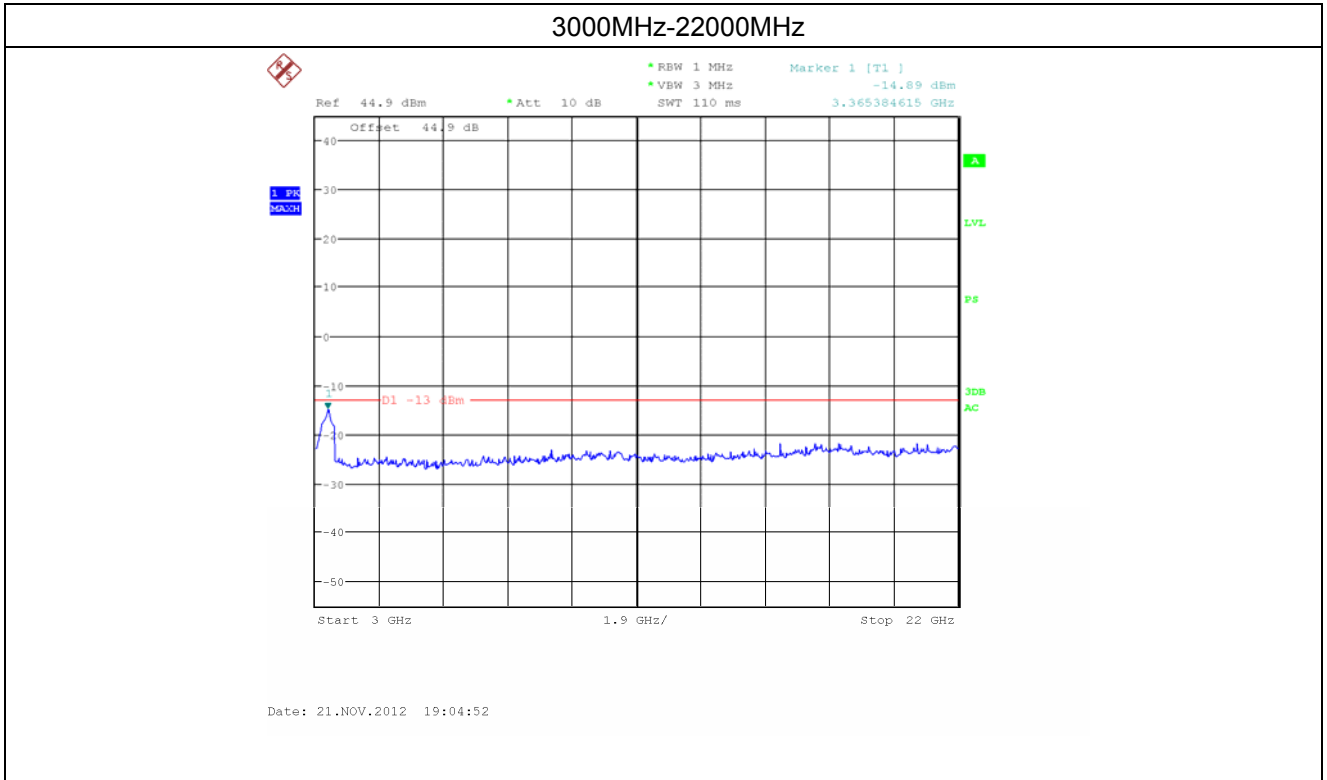

2. Number of Carriers: Four carriers (Low channel)

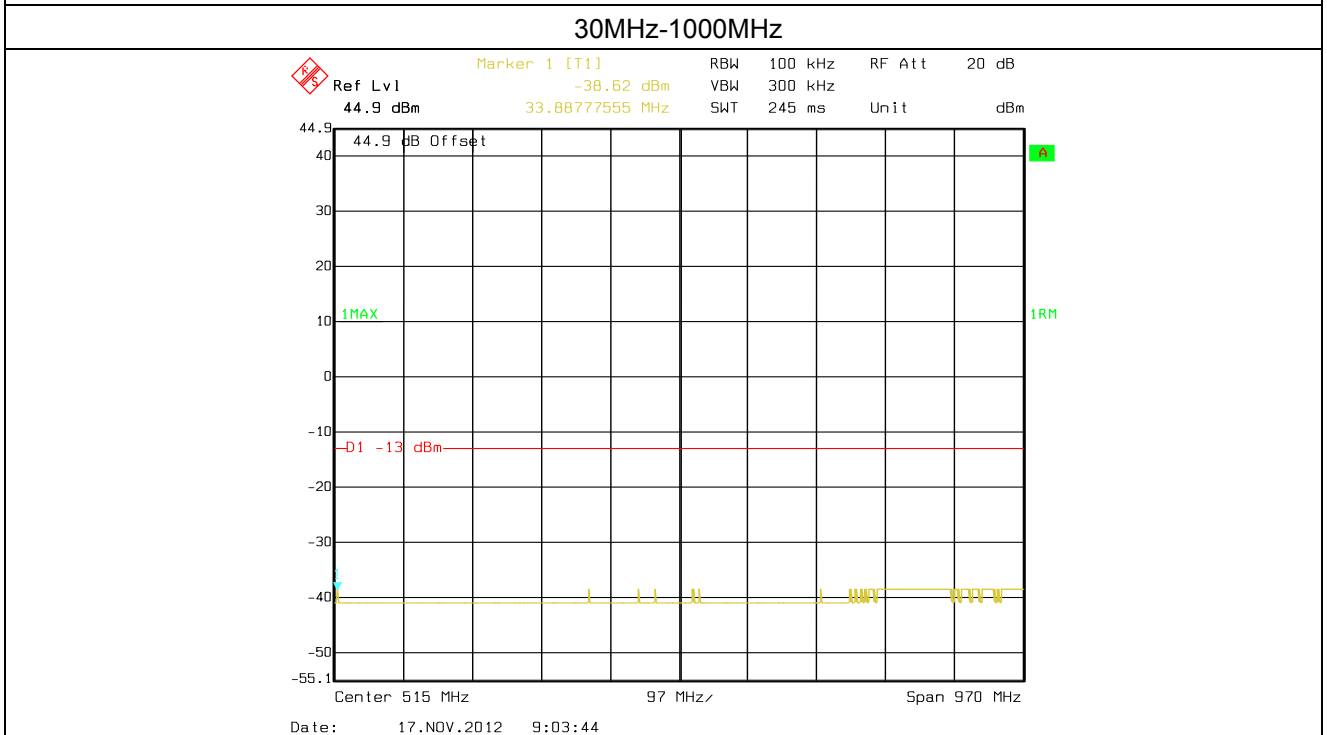

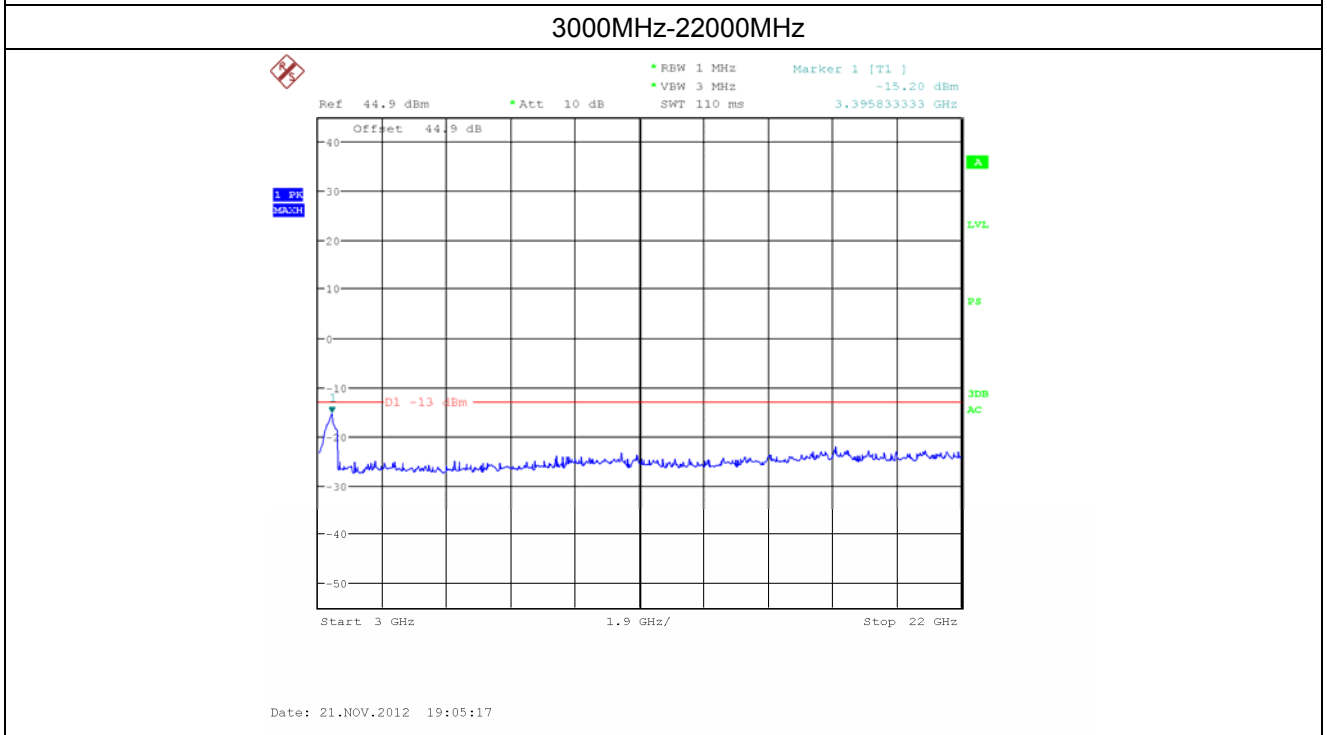
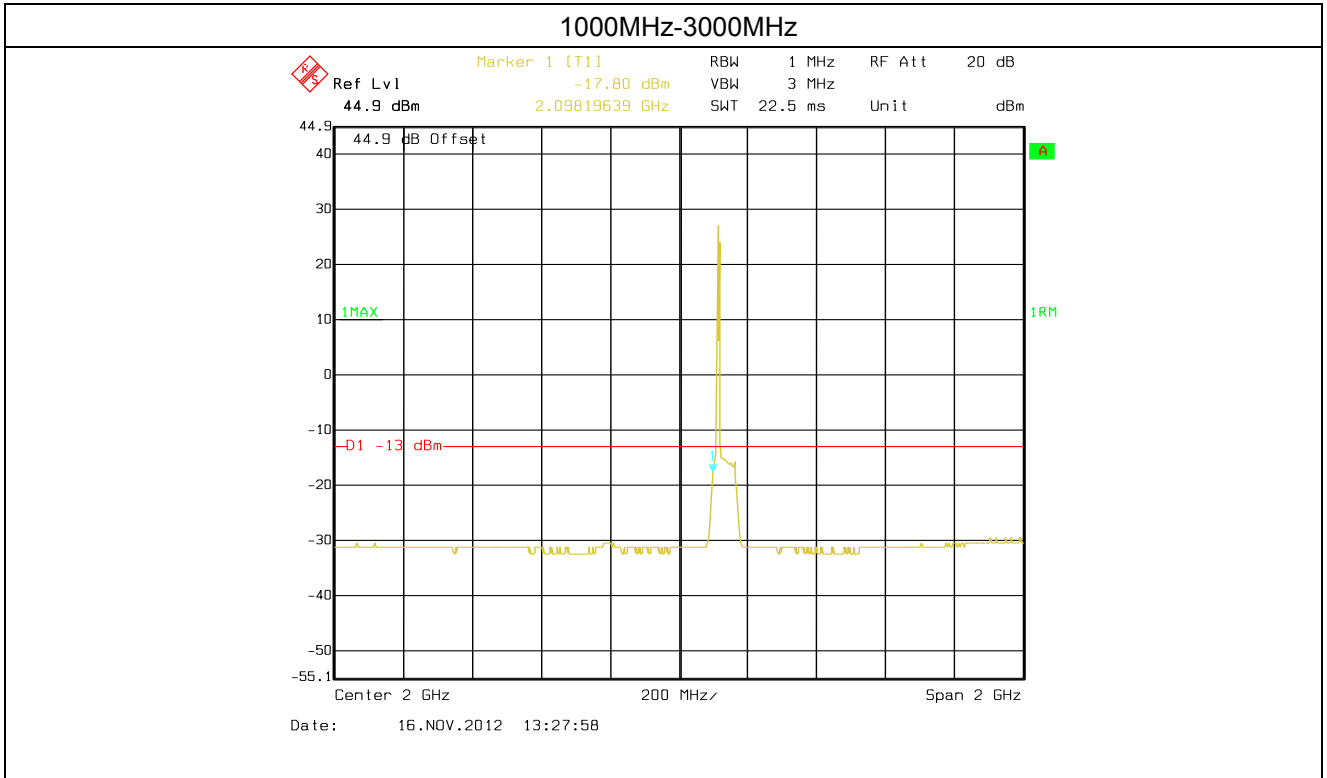

3. Number of Carriers: Single carrier (High channel)

30MHz-1000MHz

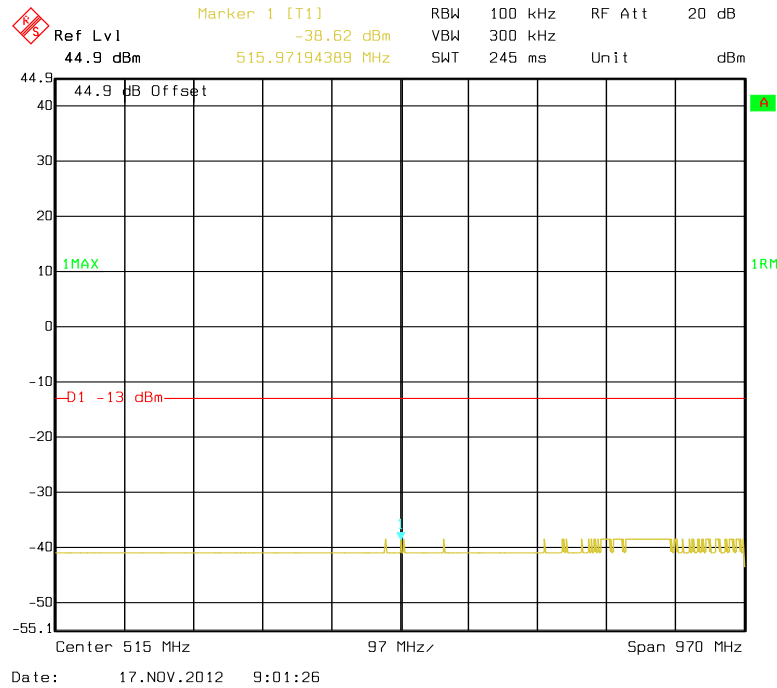

1000MHz-3000MHz

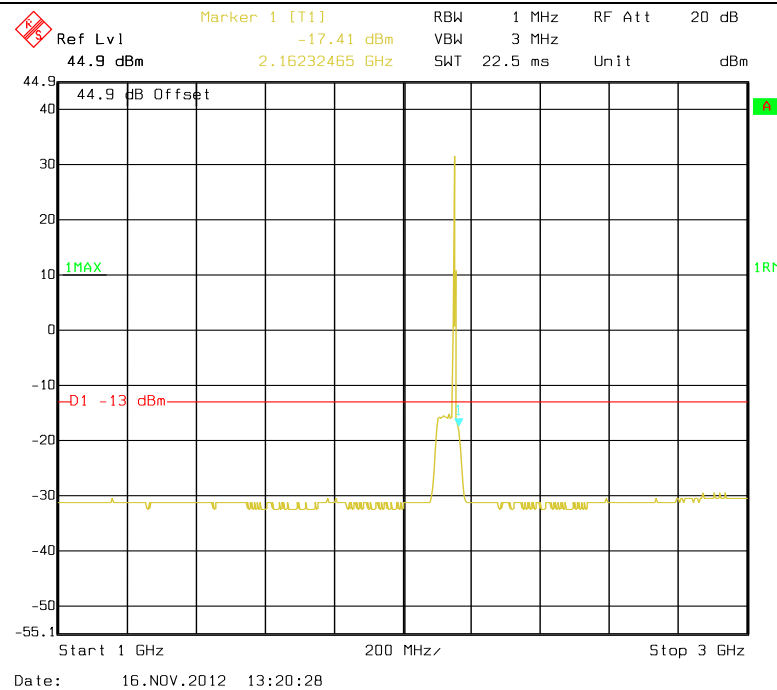

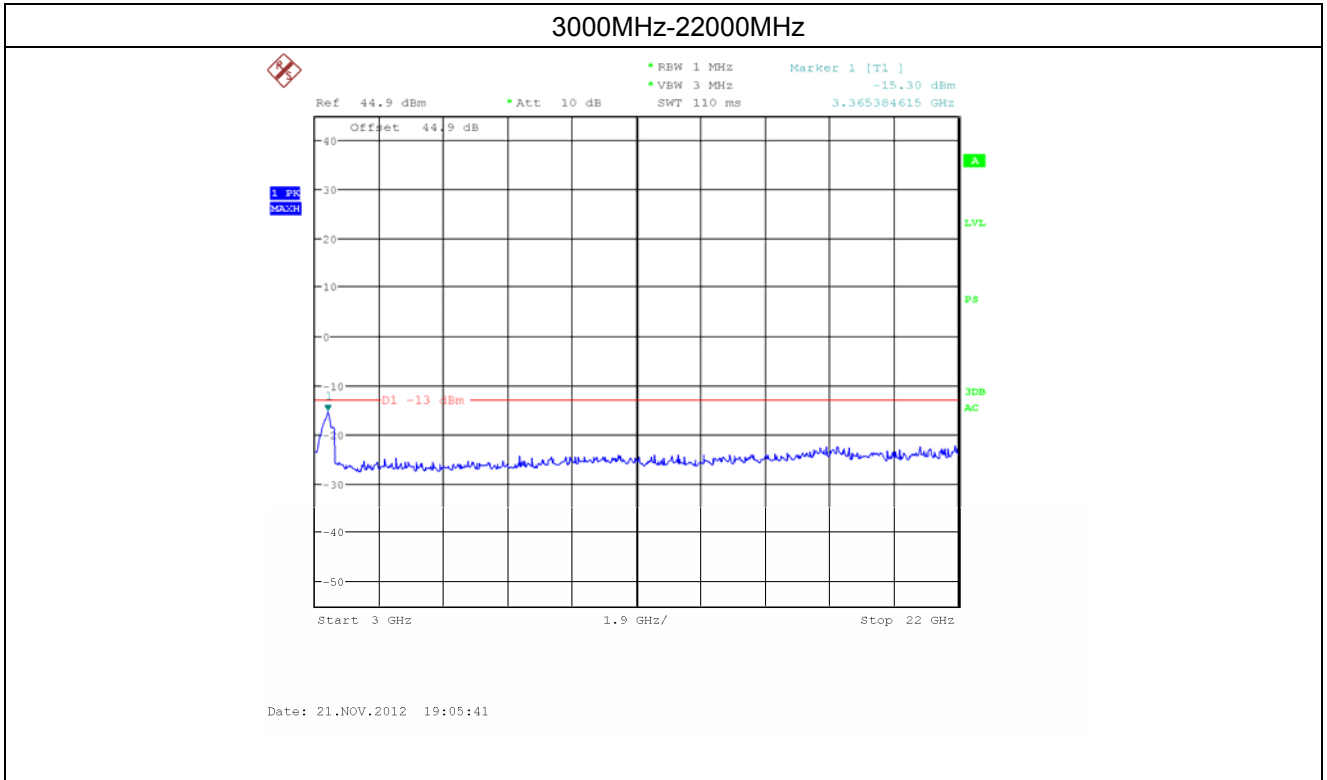

4. Number of Carriers: Four carriers (High channel)

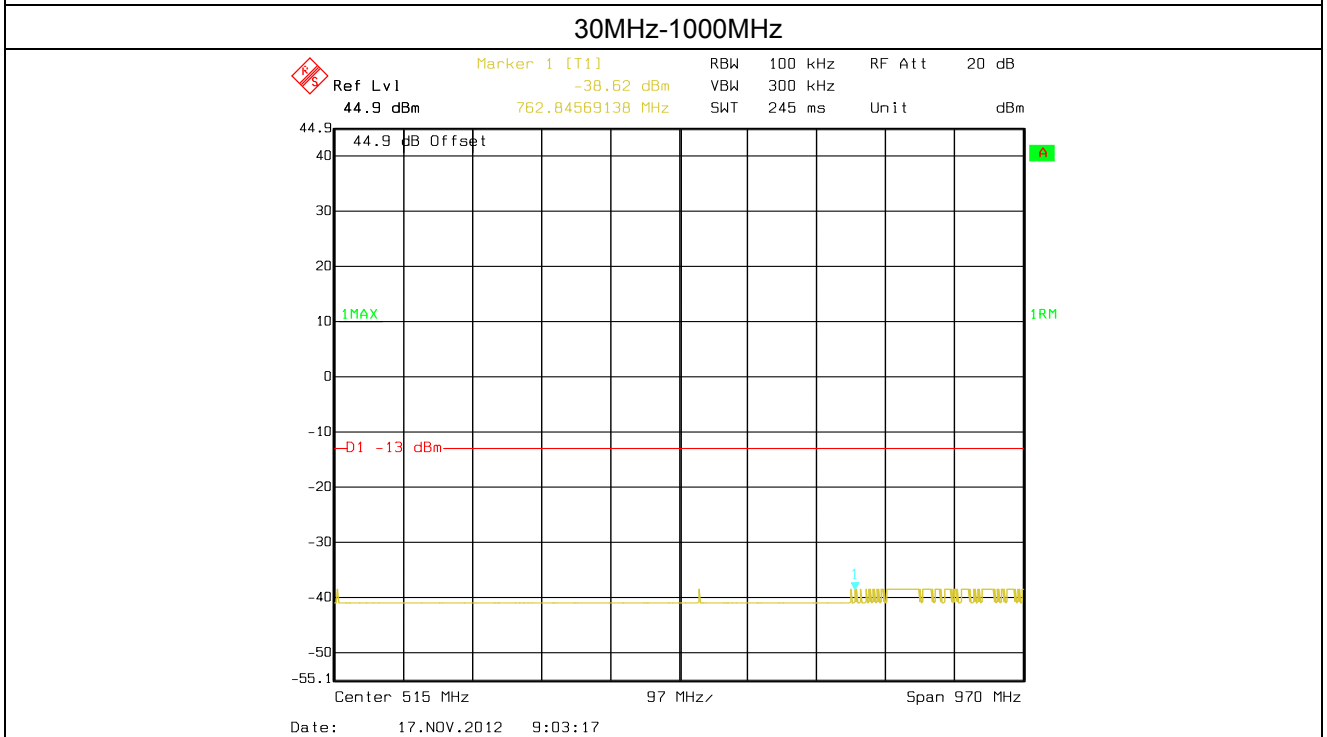

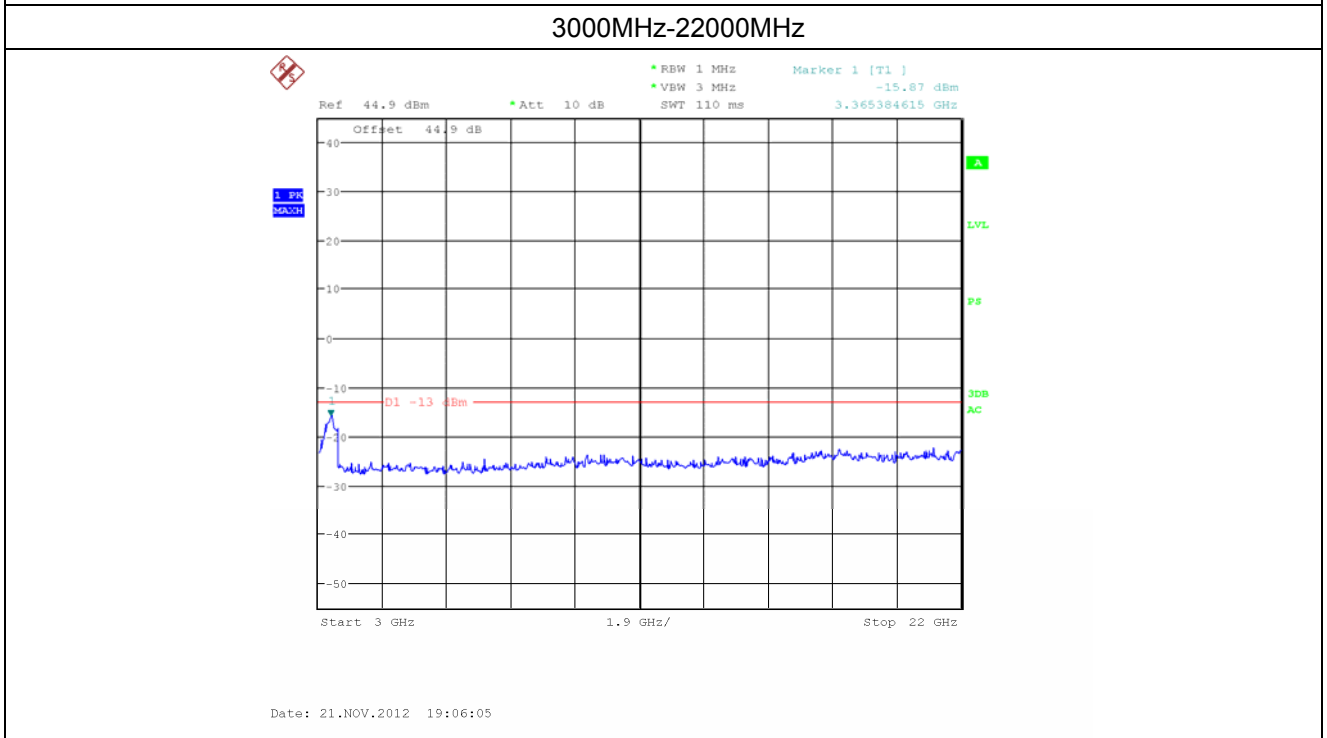
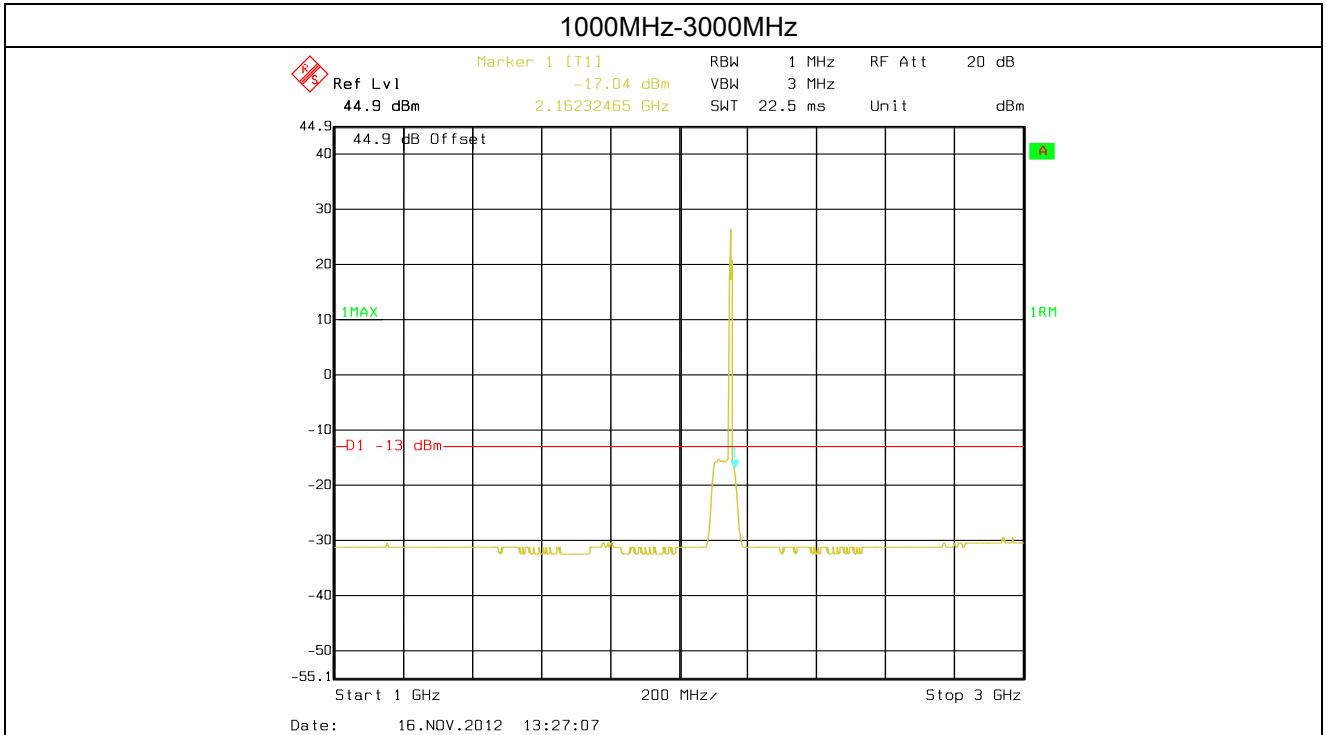

Spurious emission of EVDO(100%)

1. Number of Carriers: Single carrier (Low channel)

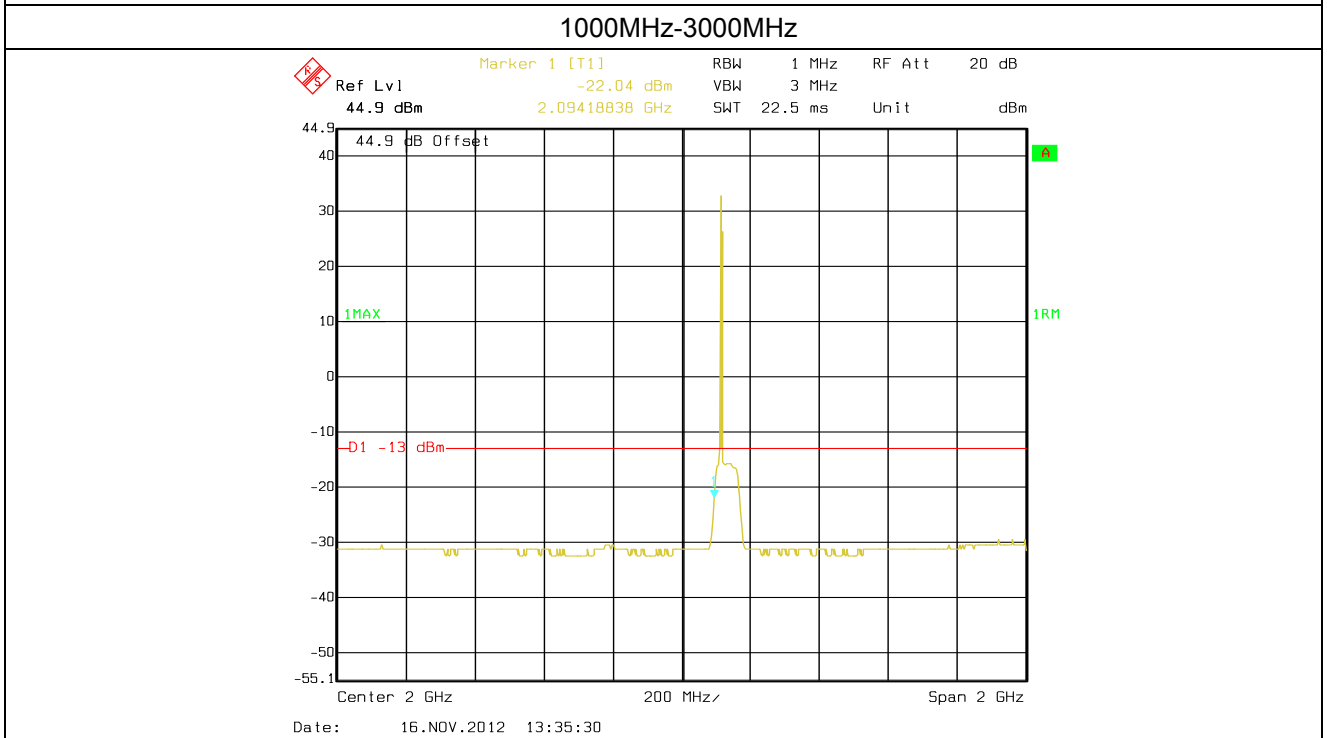
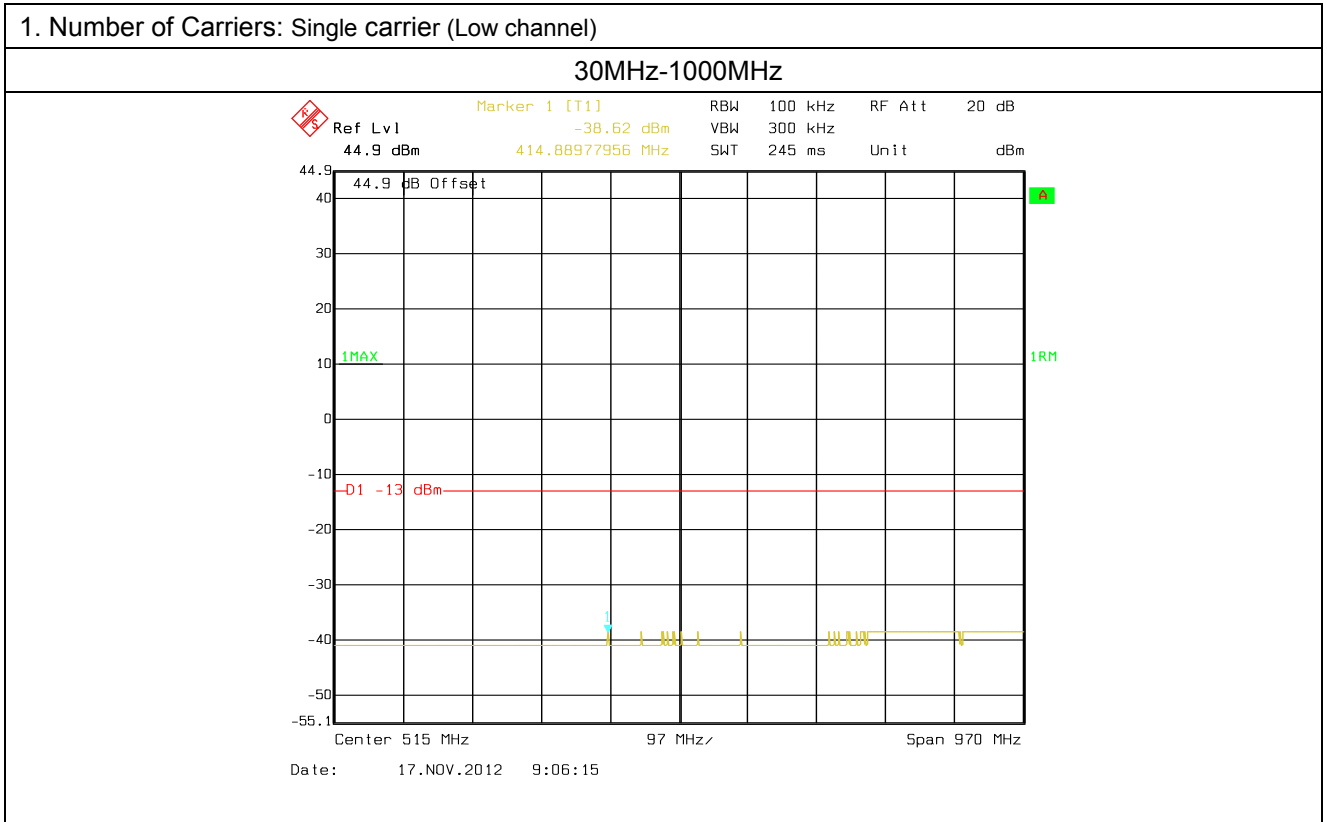

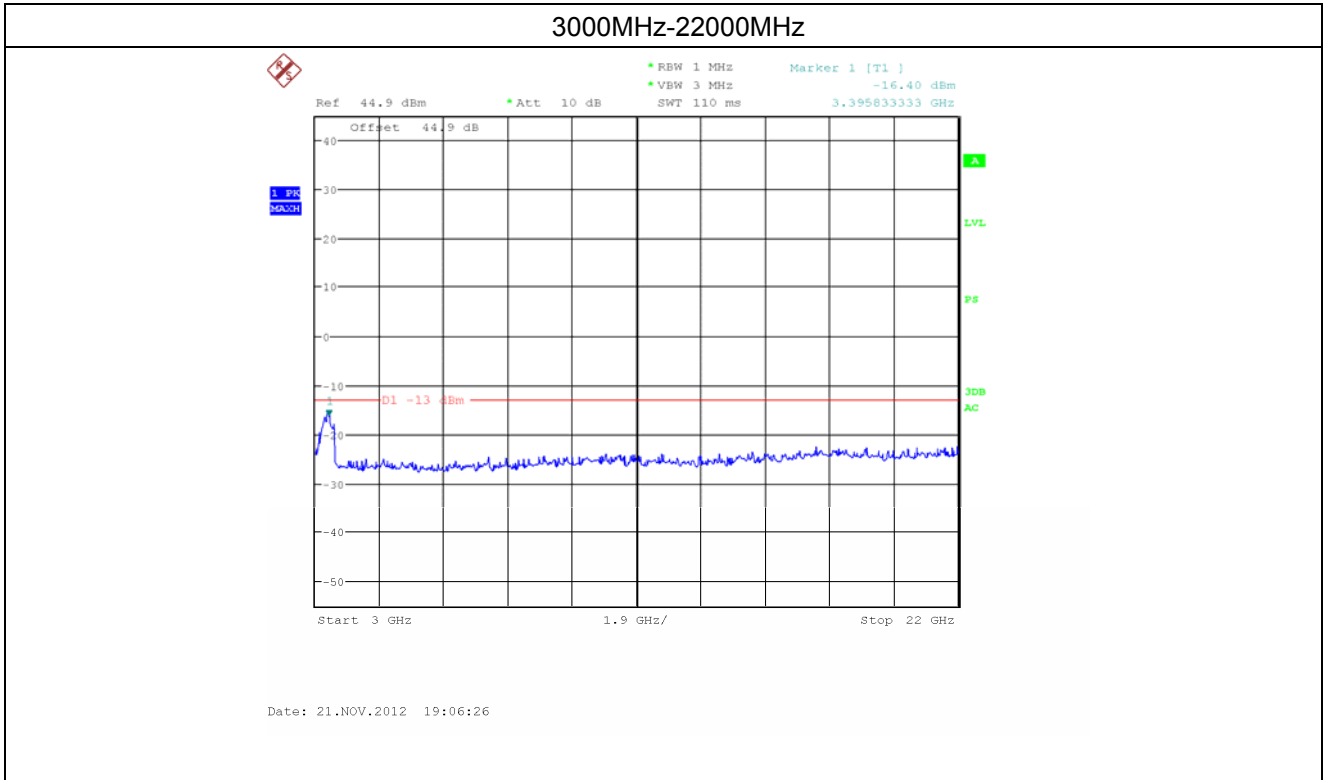

2. Number of Carriers: Four carriers (Low channel)

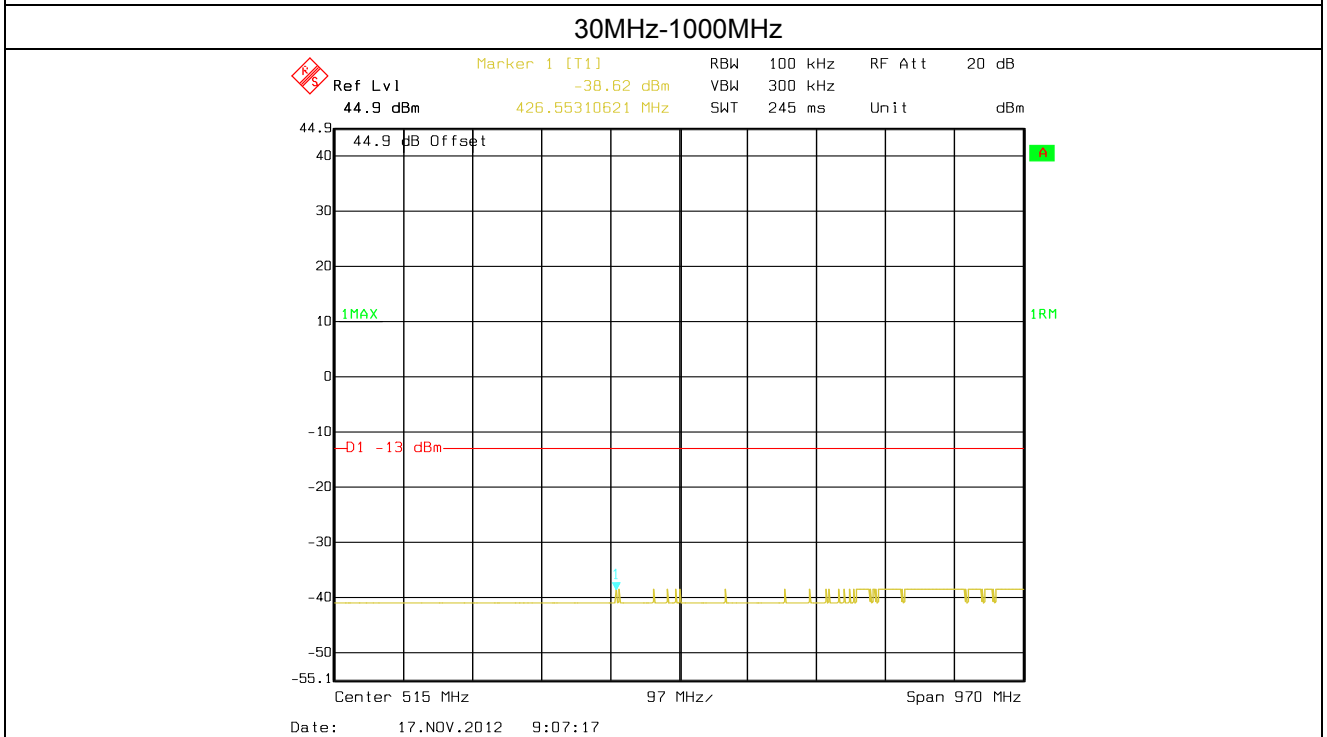

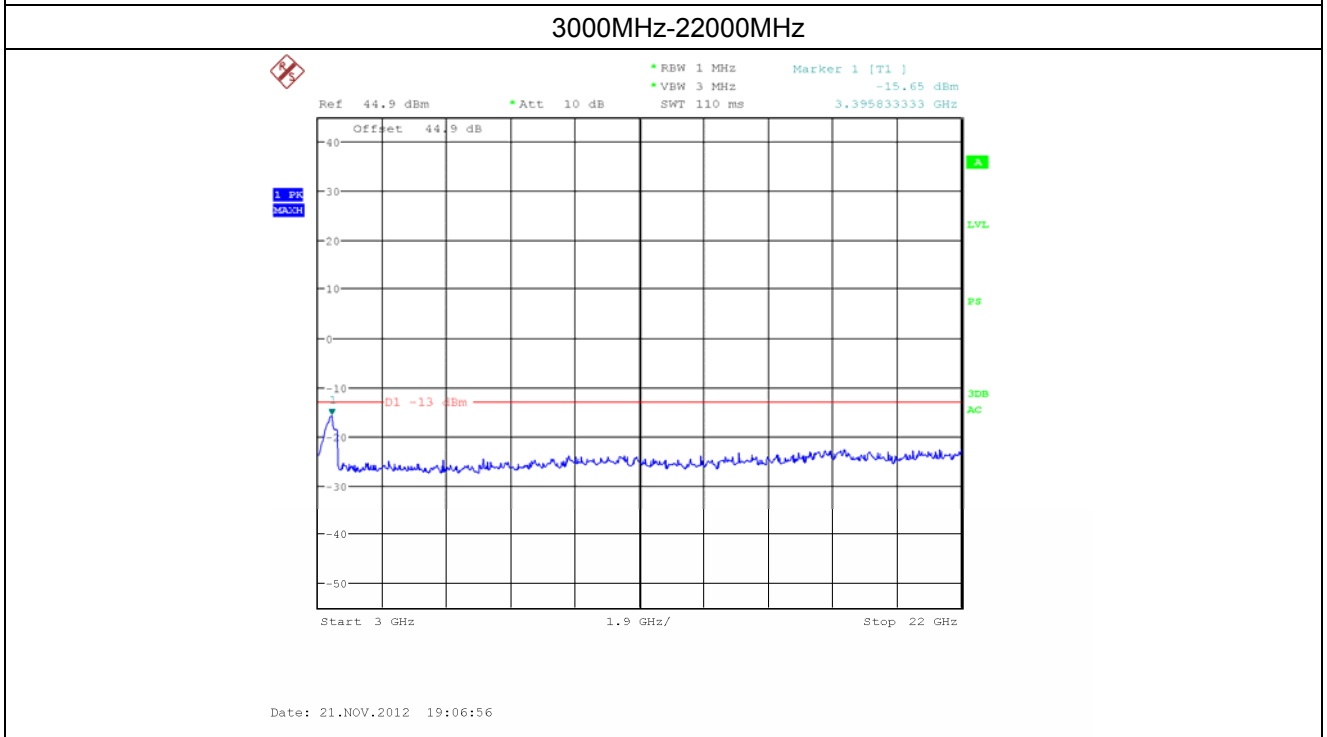
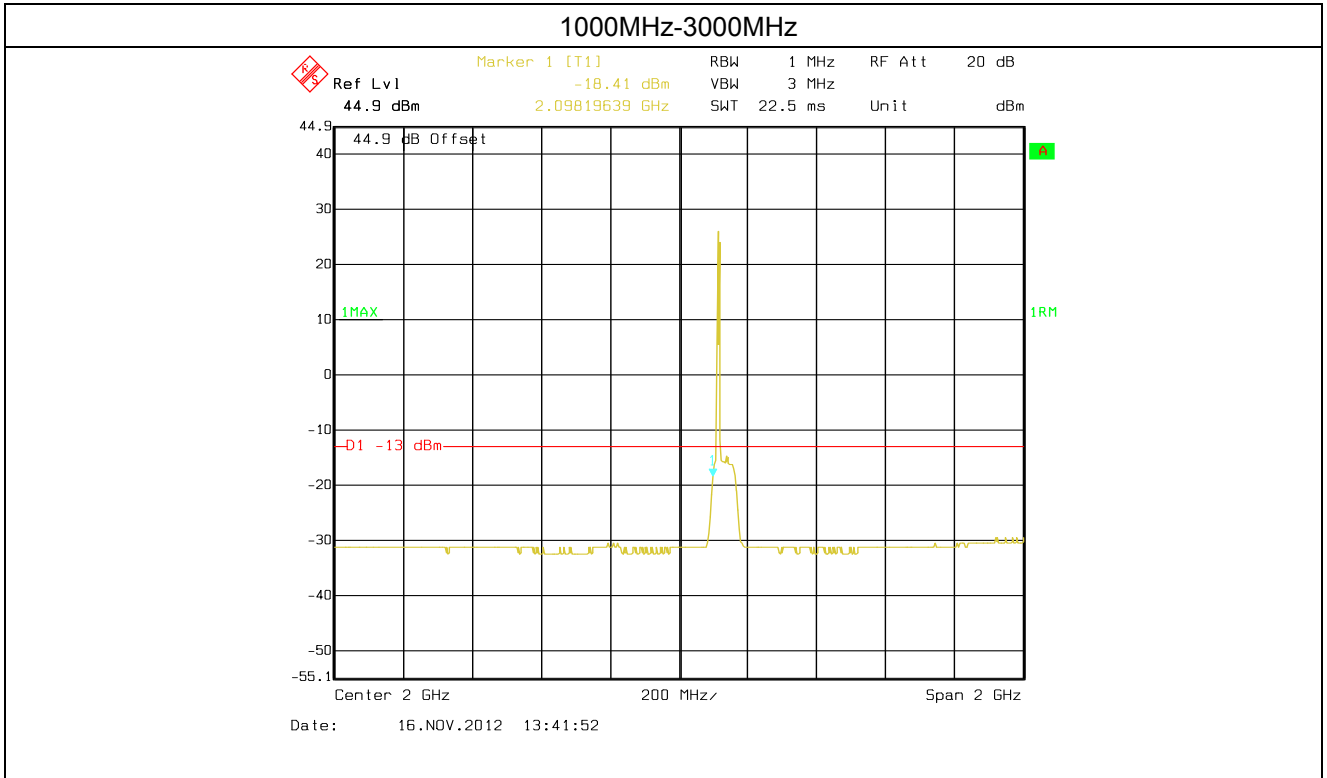

3. Number of Carriers: Single carrier (High channel)

30MHz-1000MHz

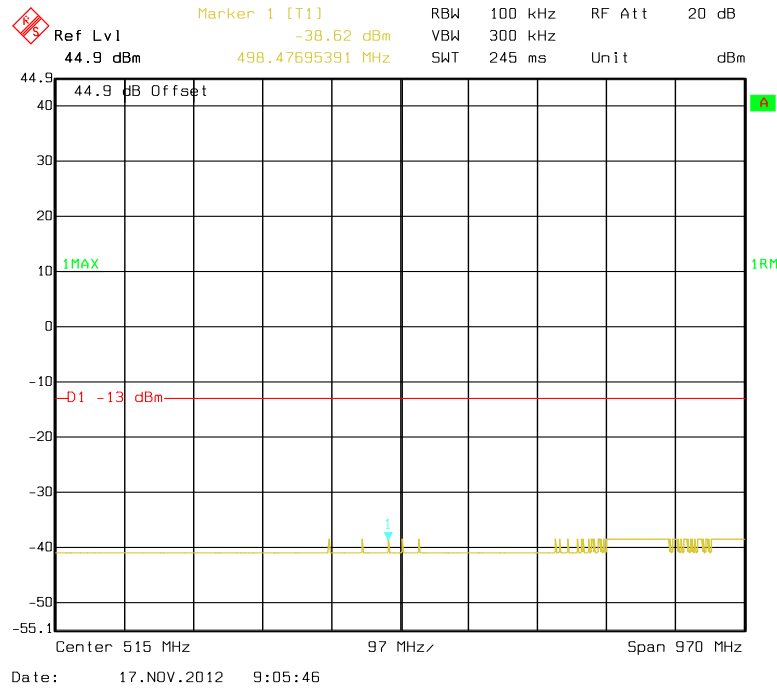

1000MHz-3000MHz

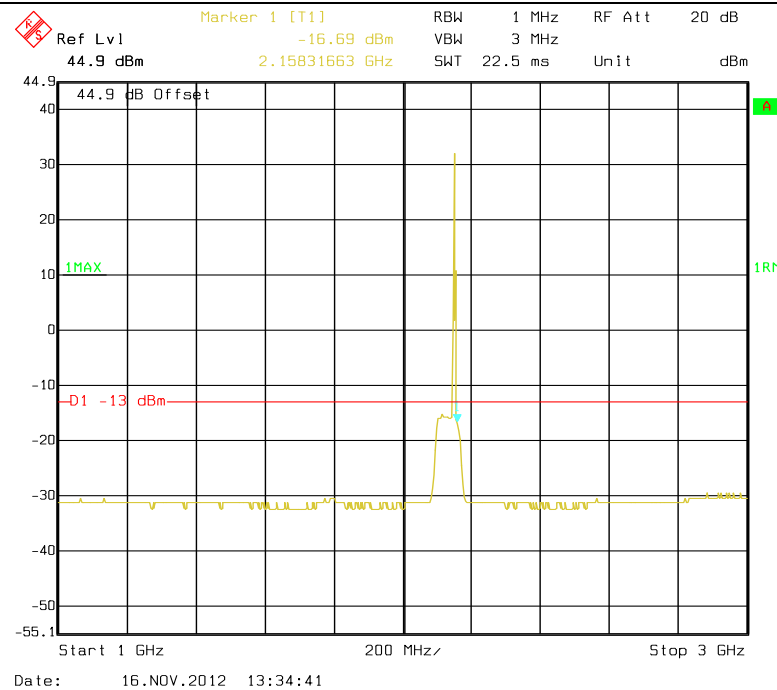

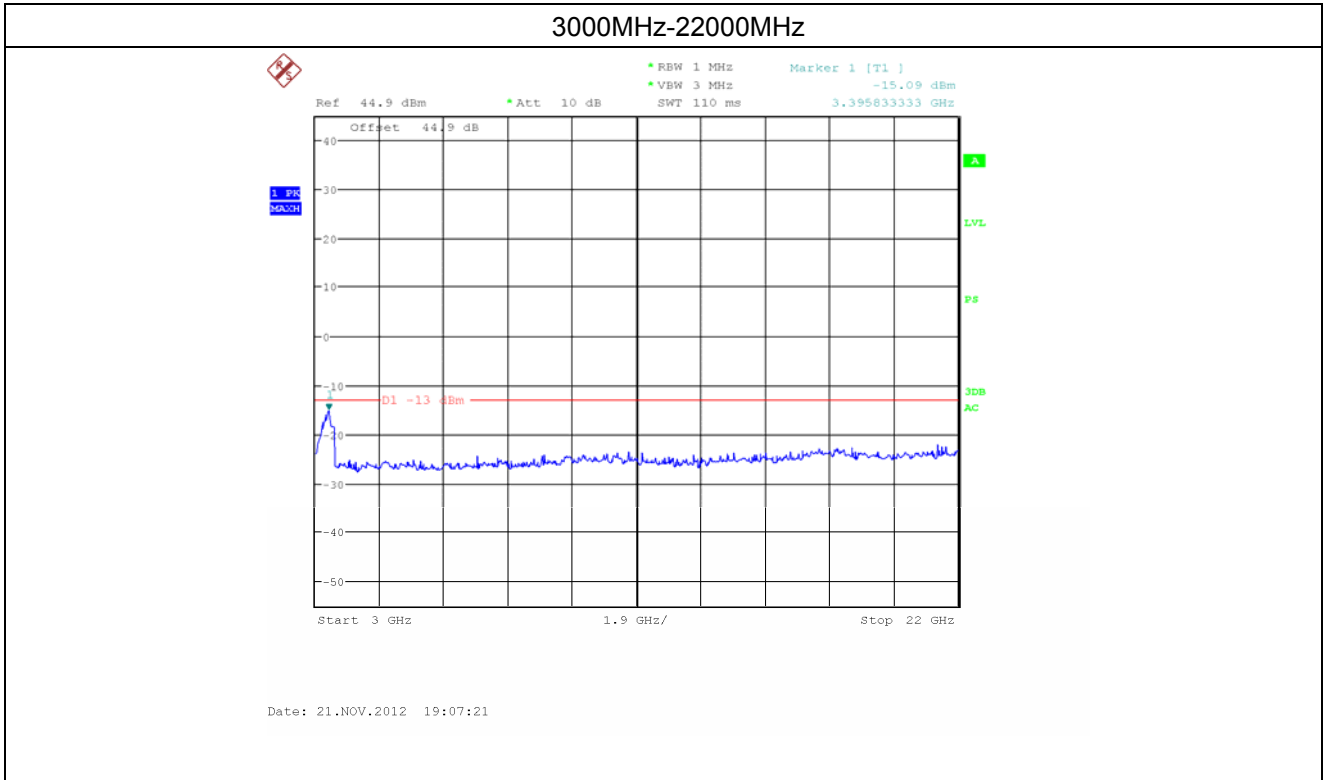

4. Number of Carriers: Four carriers (High channel)

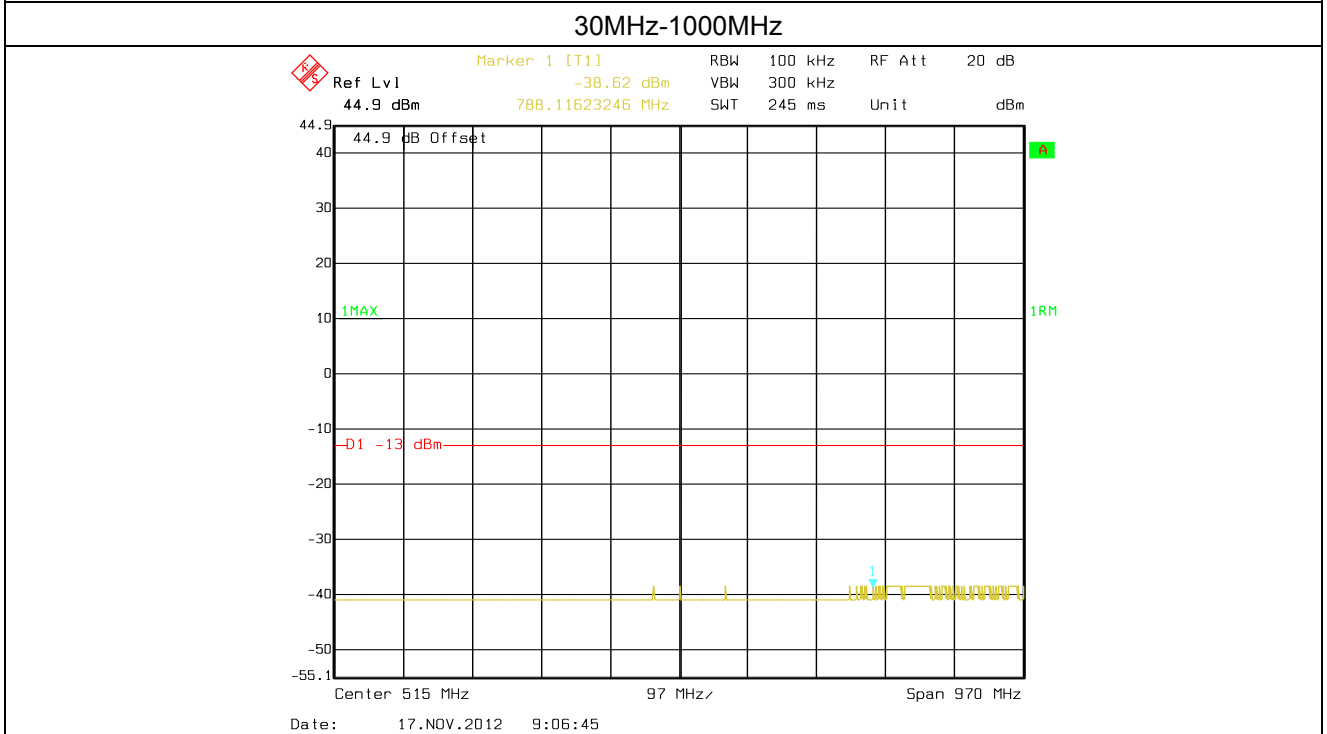

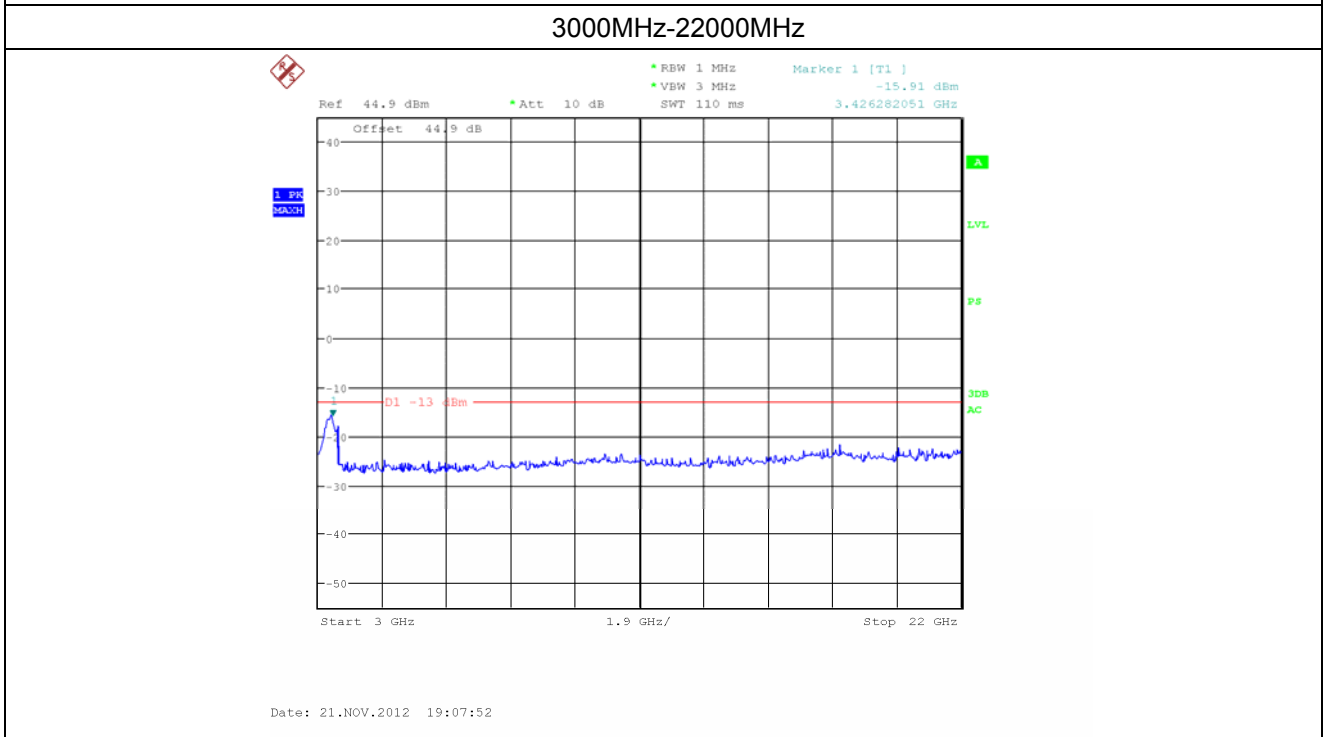
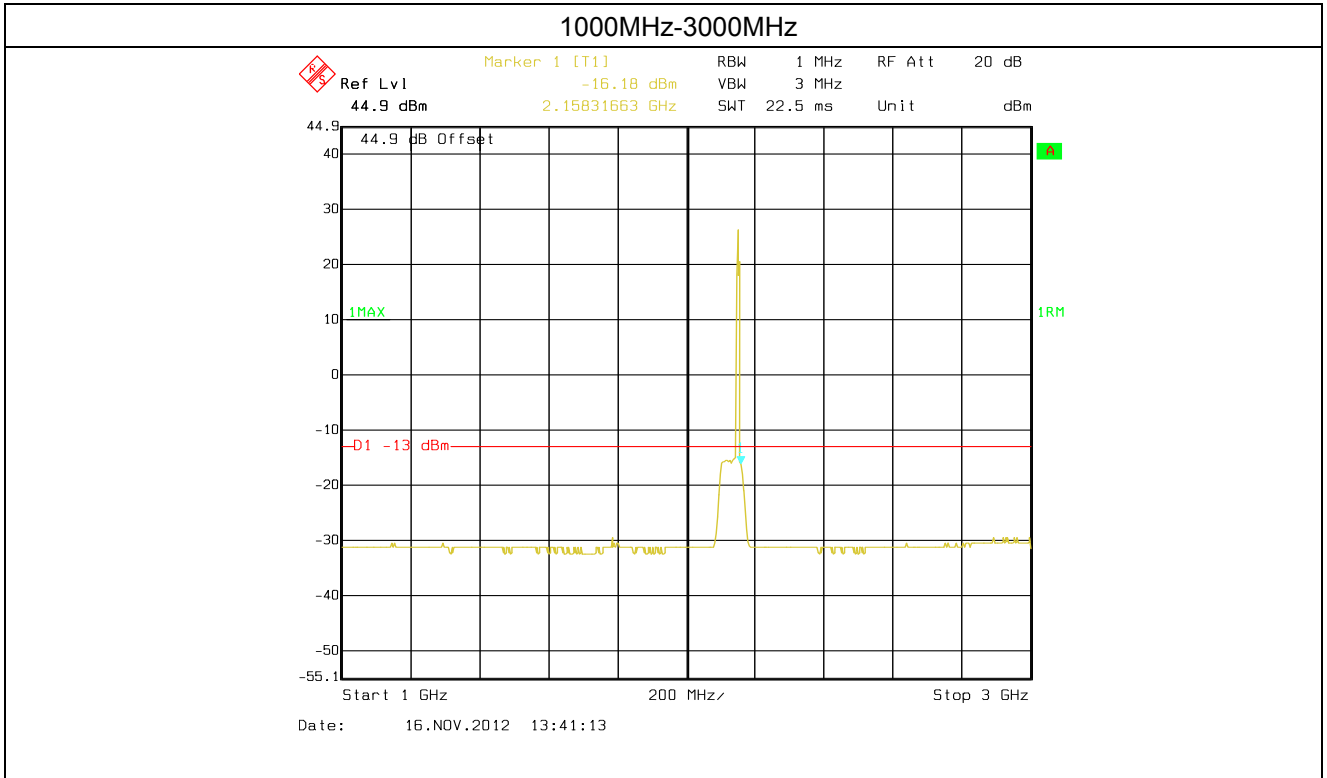

Spurious emission of LTE1.4MHz Bandwidth

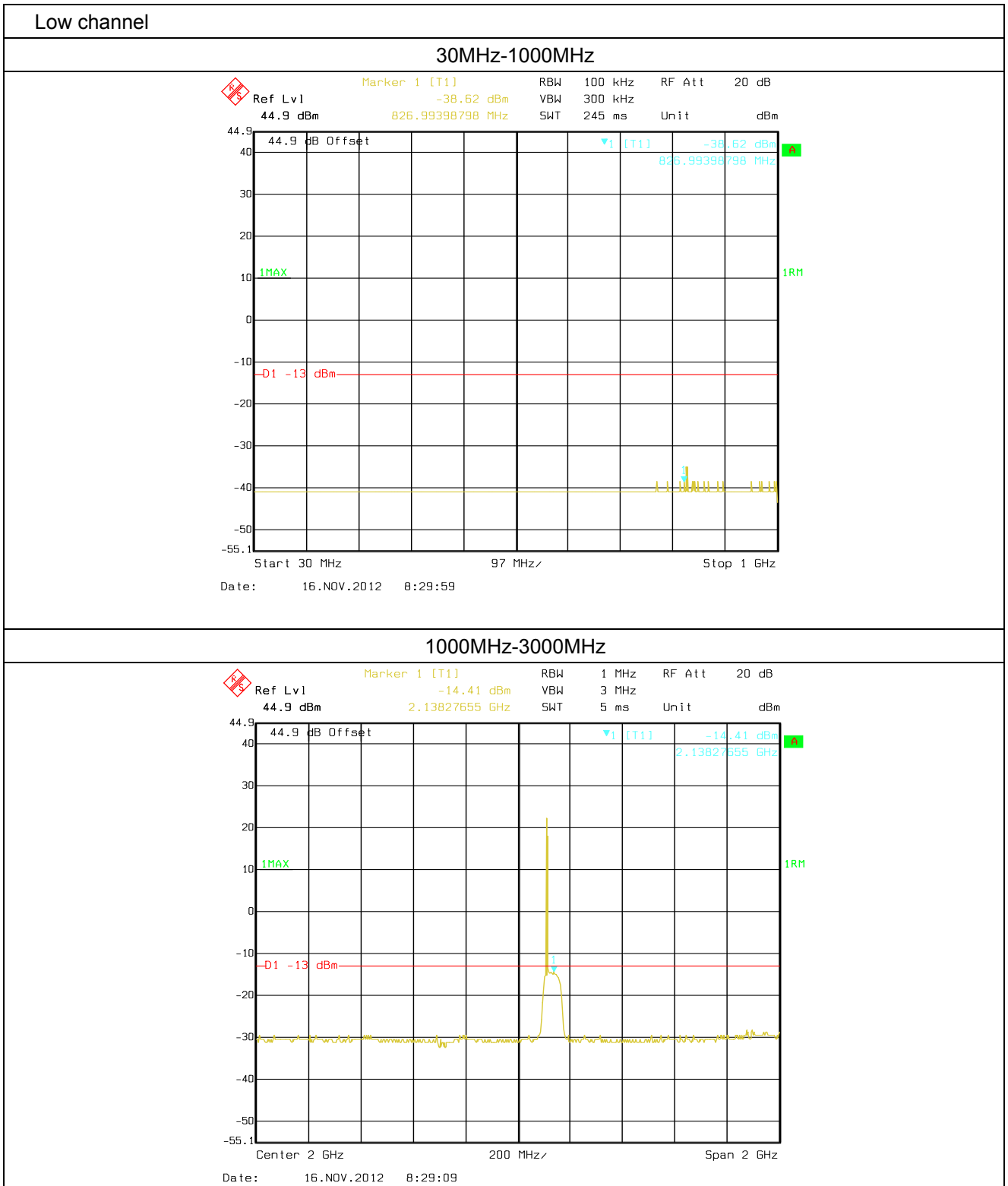

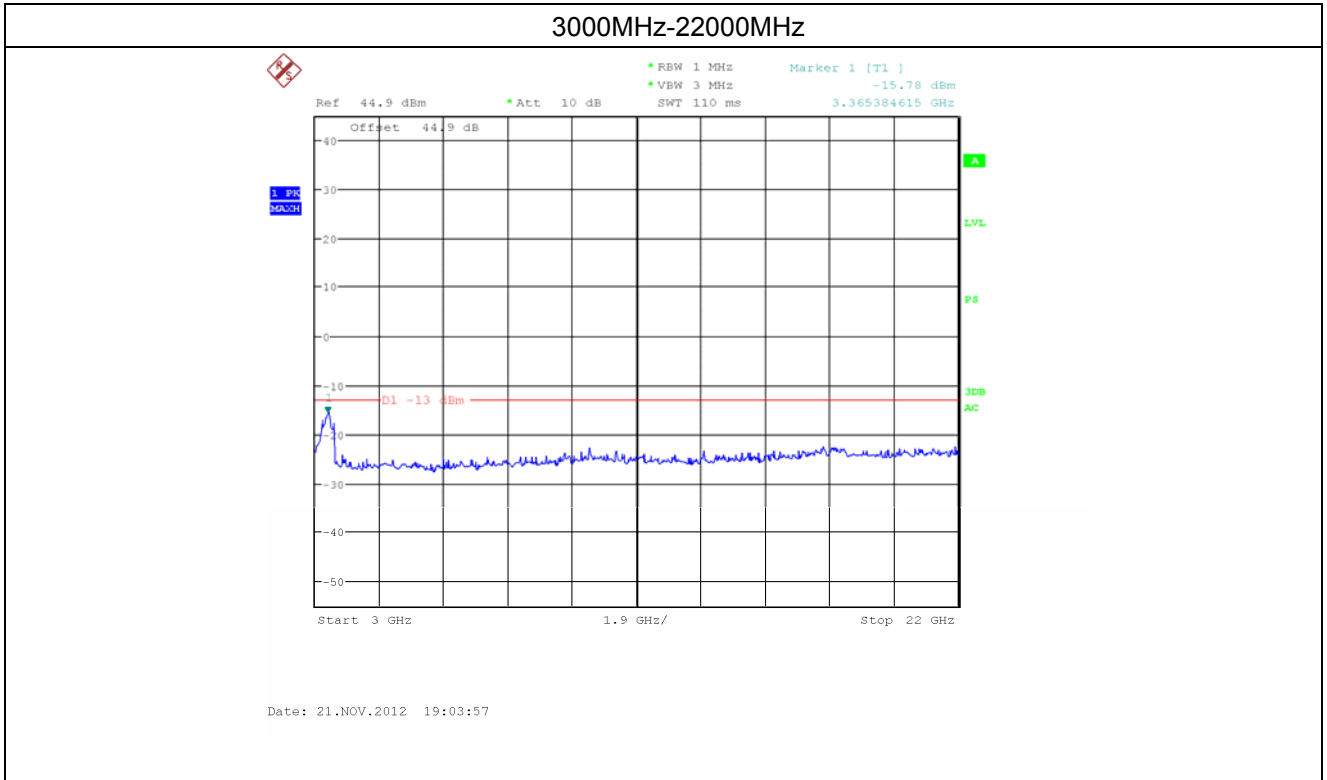

High channel

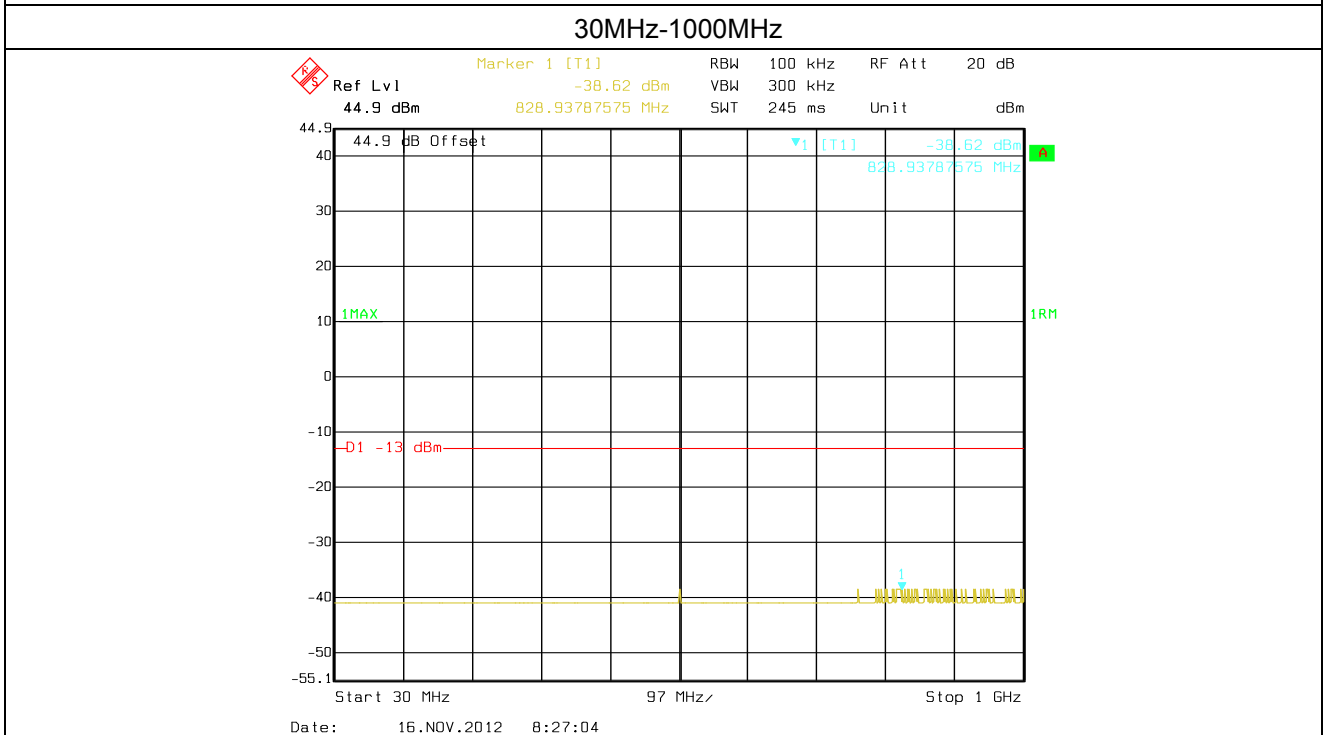

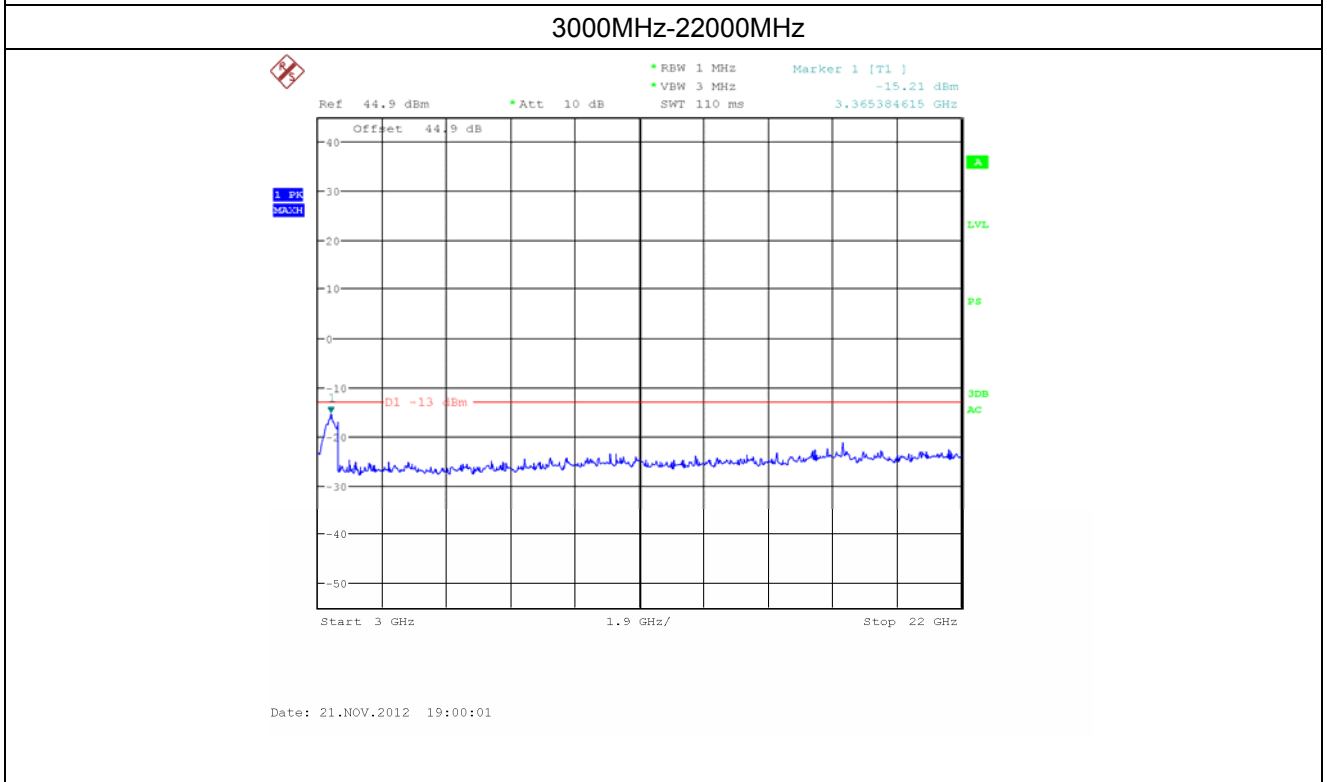
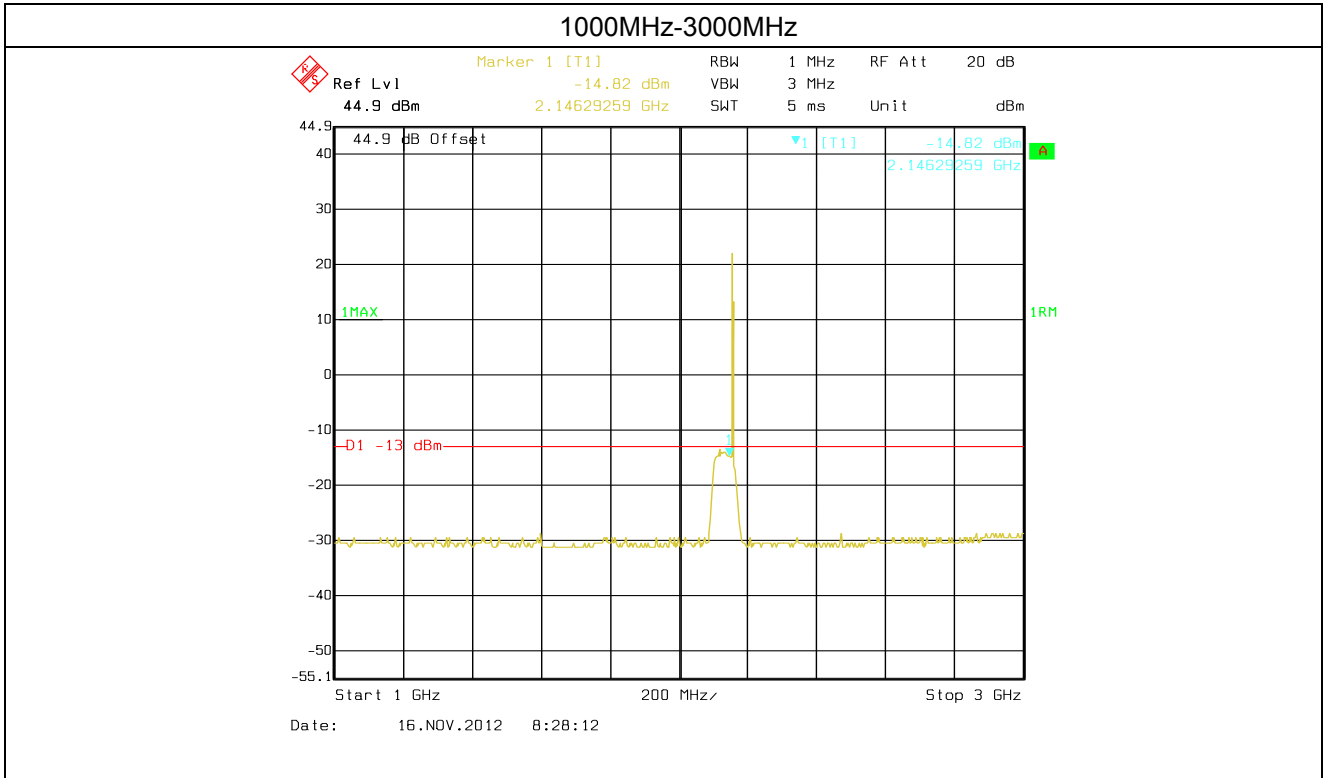

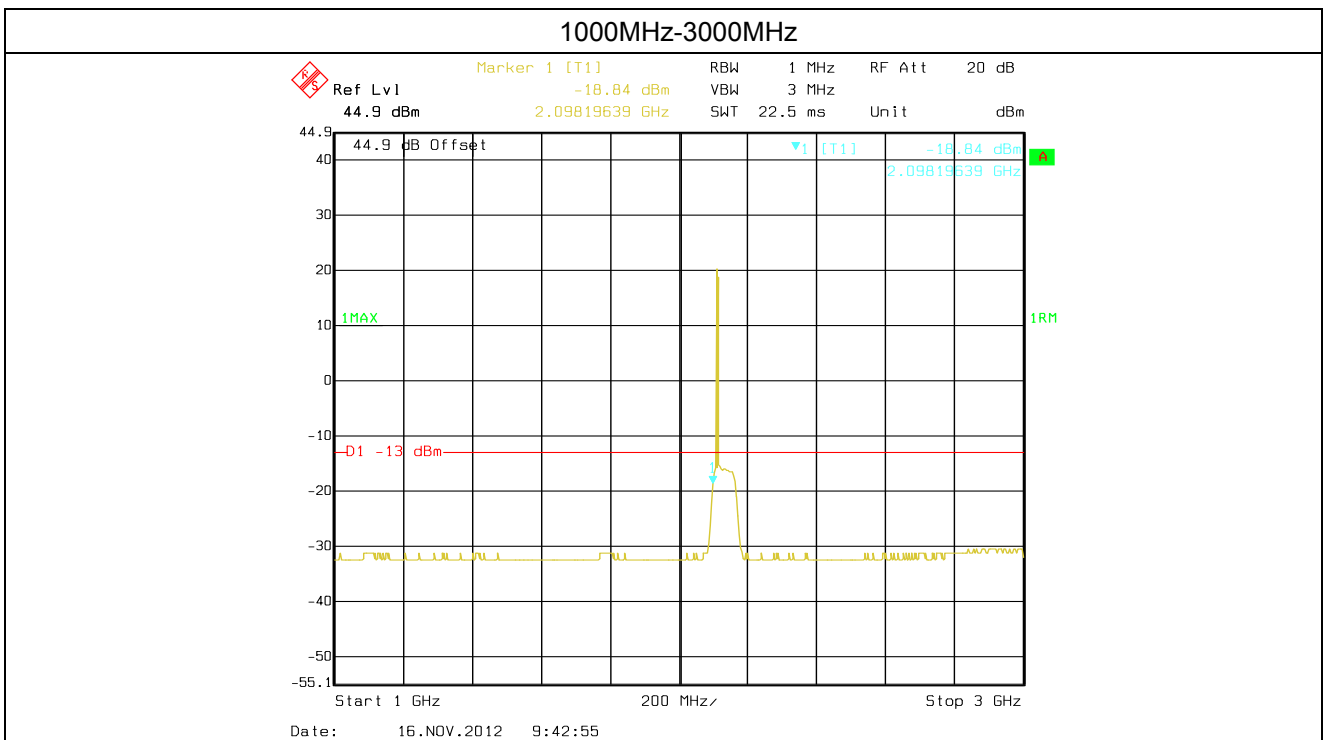
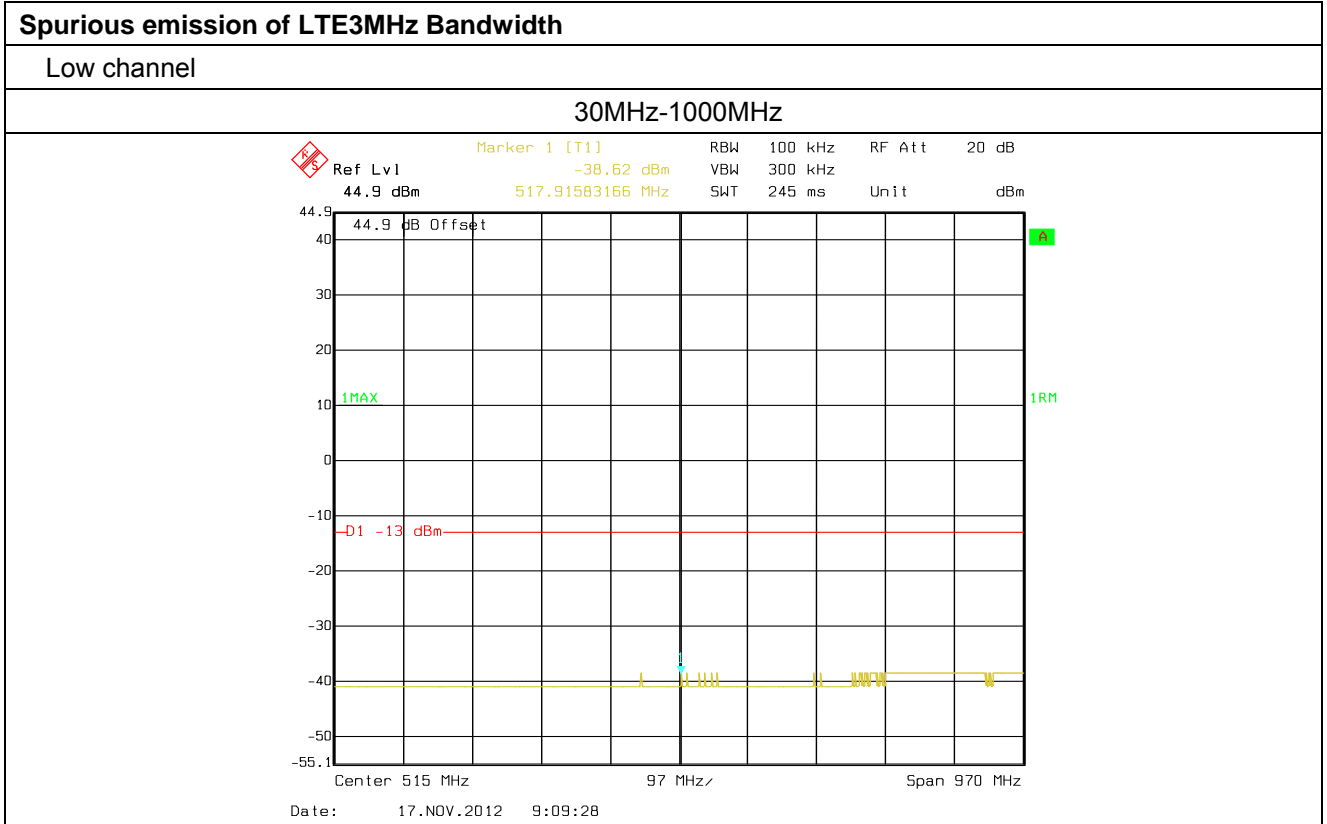

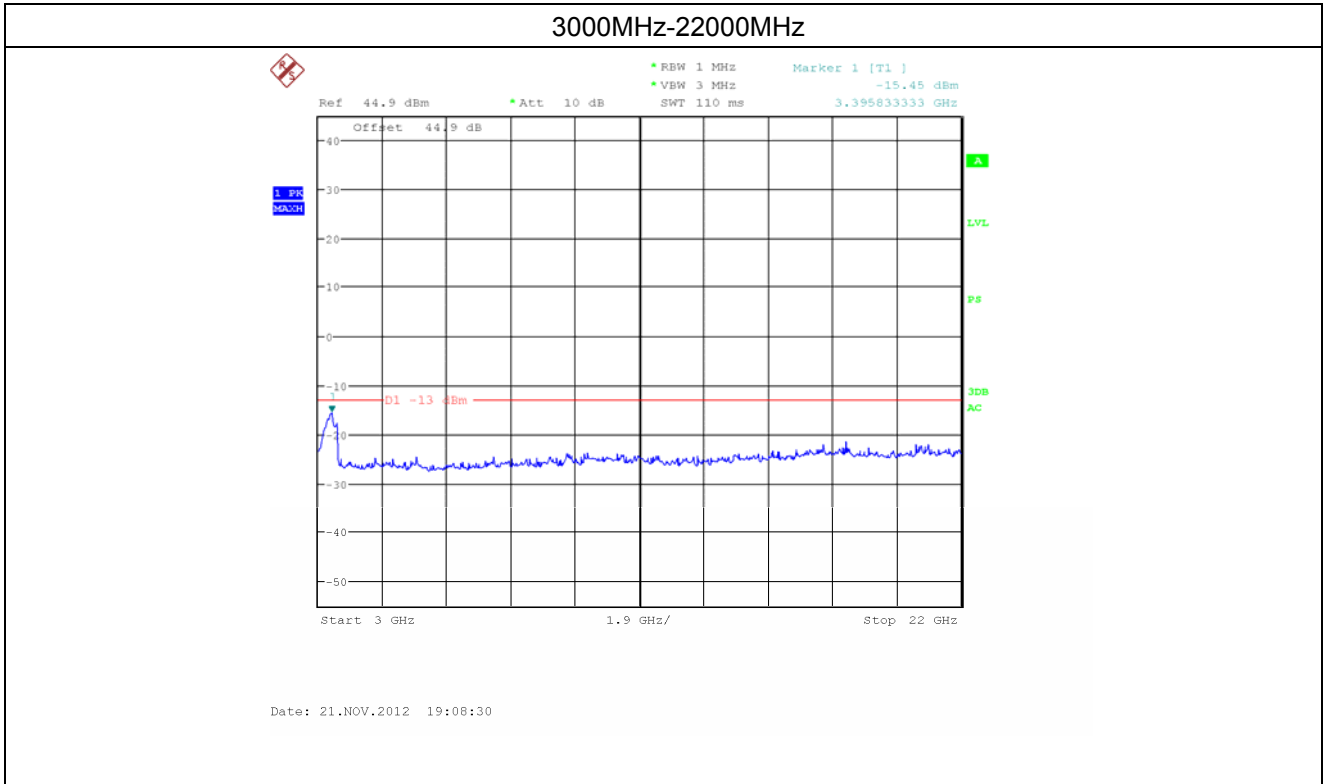

High channel

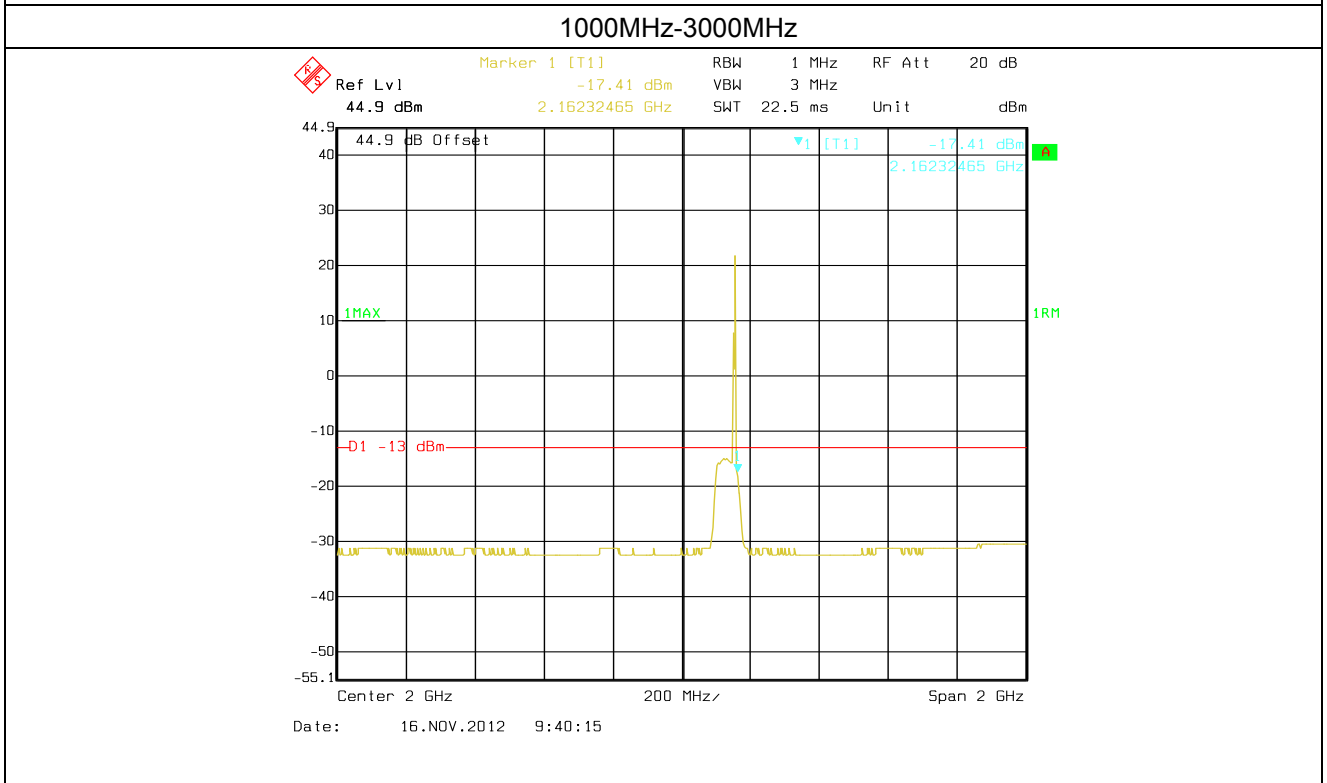
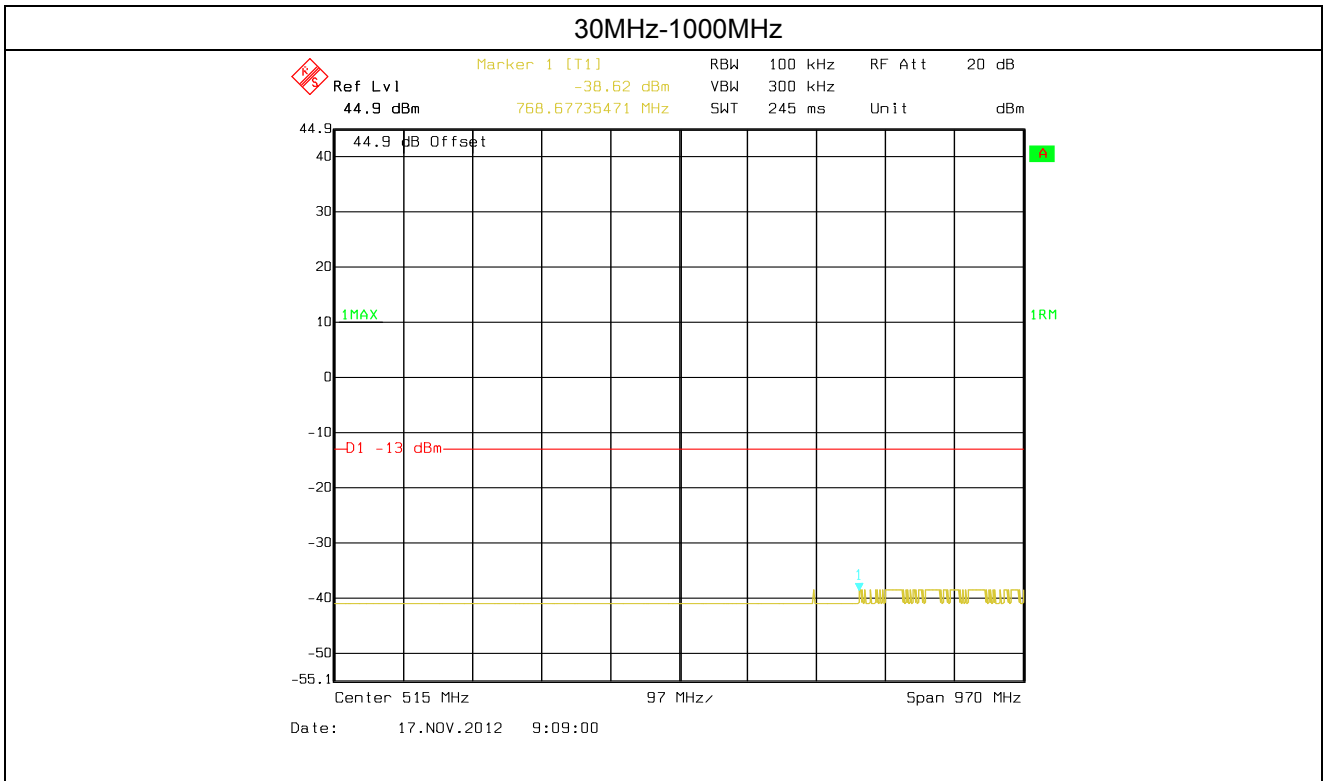

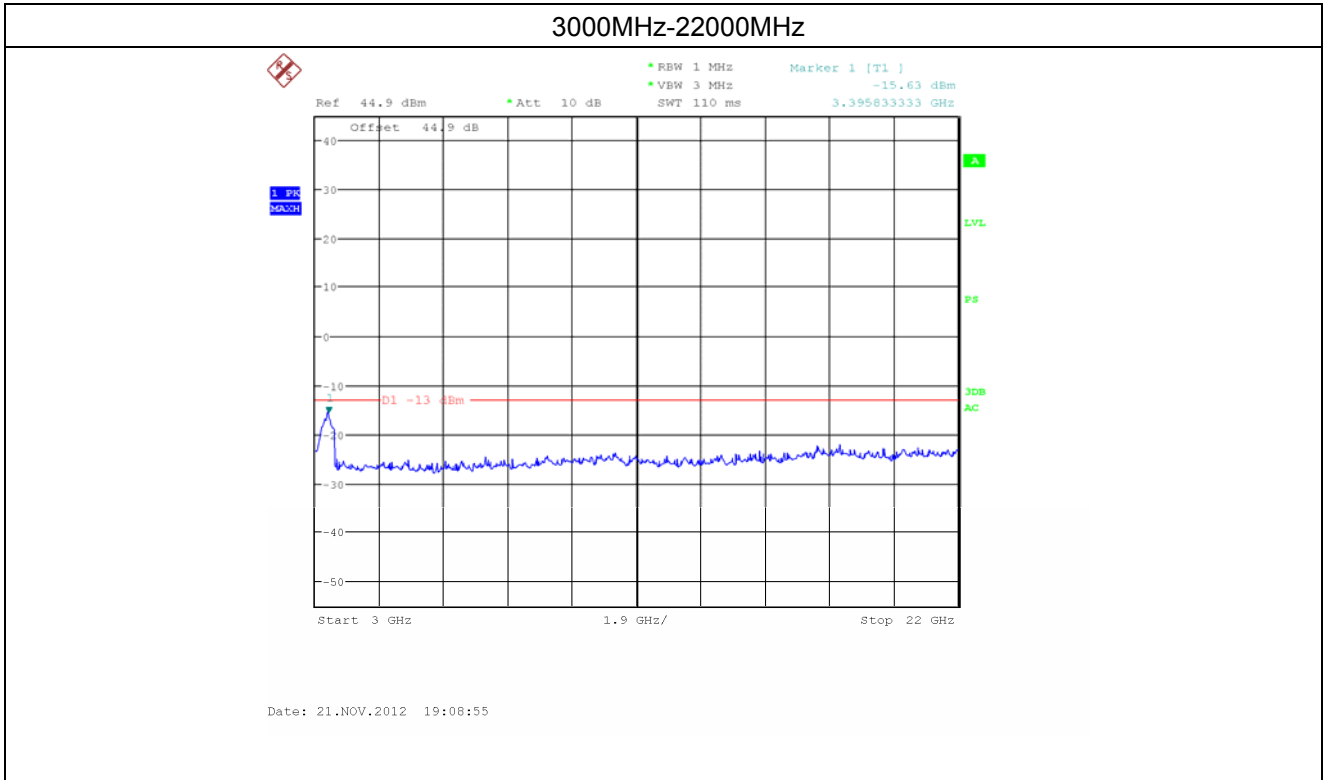

Spurious emission of LTE 5MHz Bandwidth

Low channel

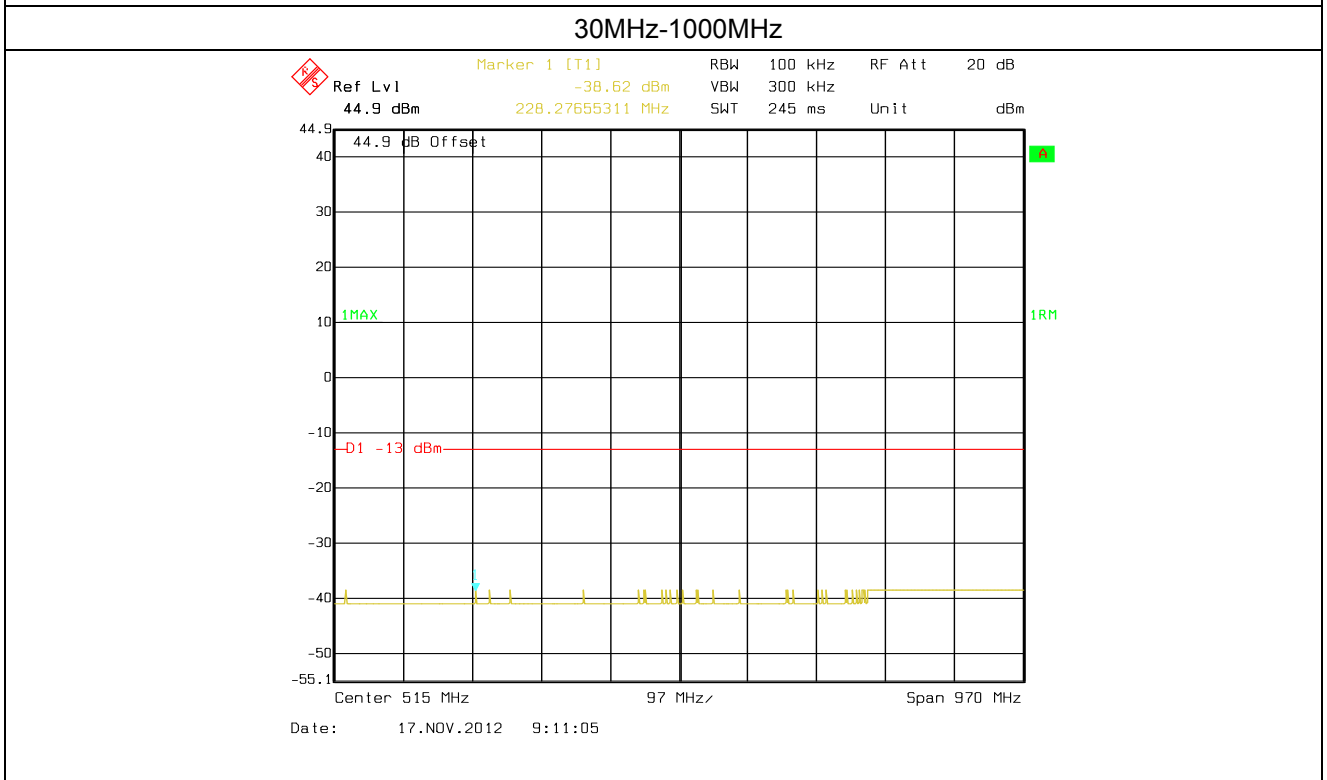

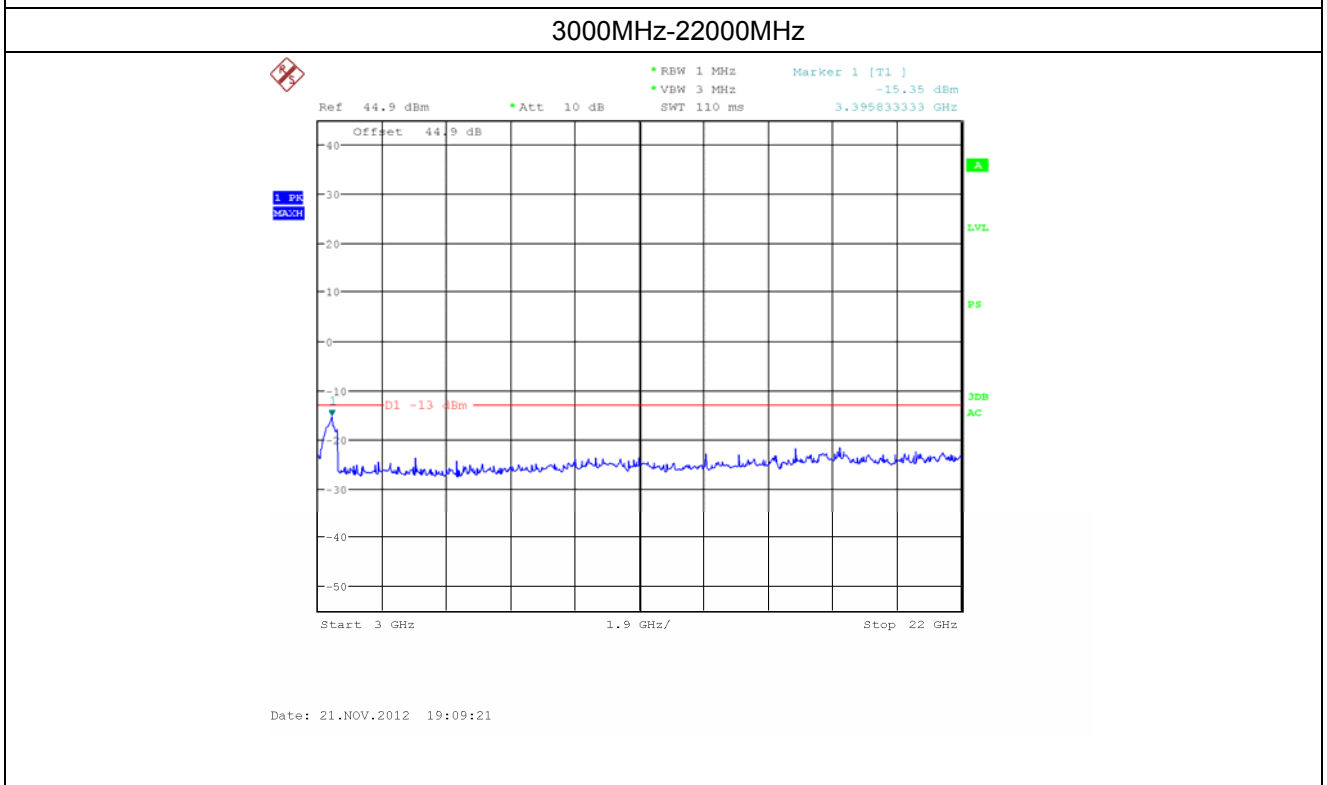
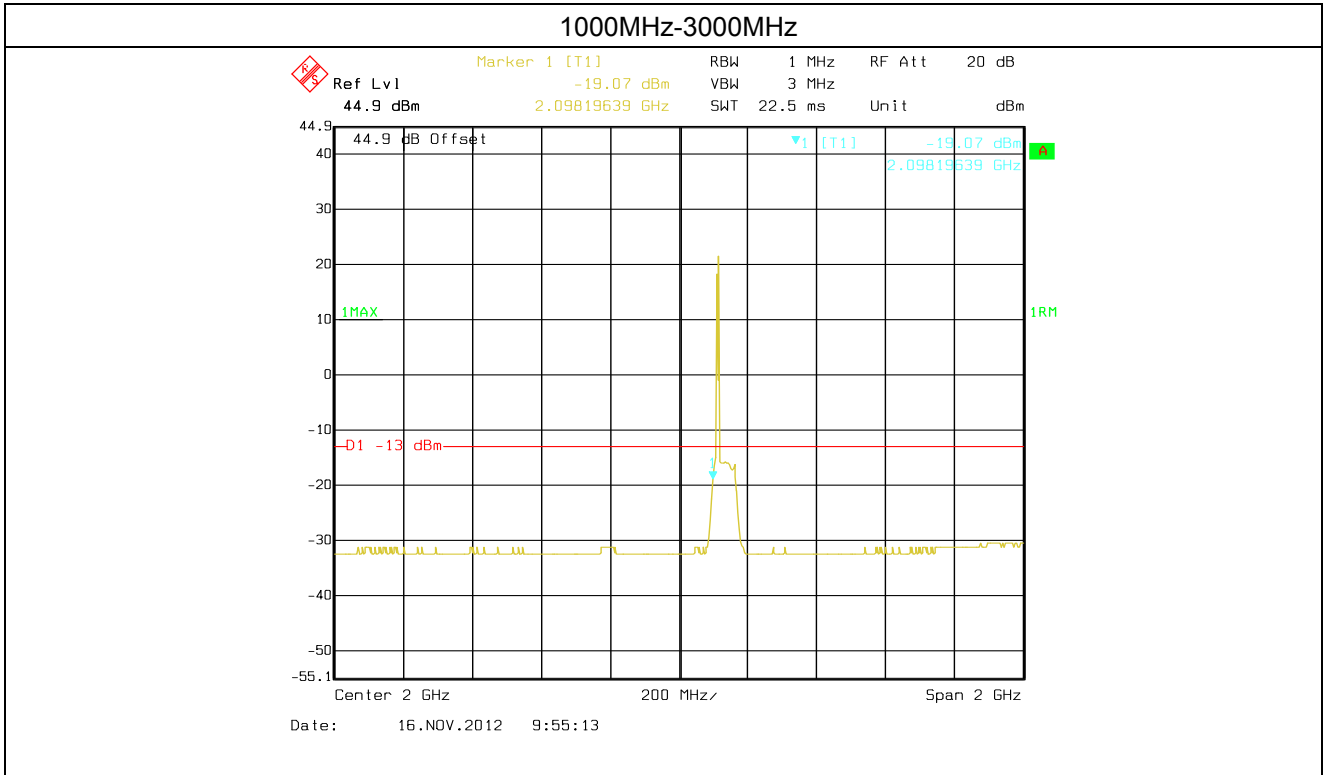

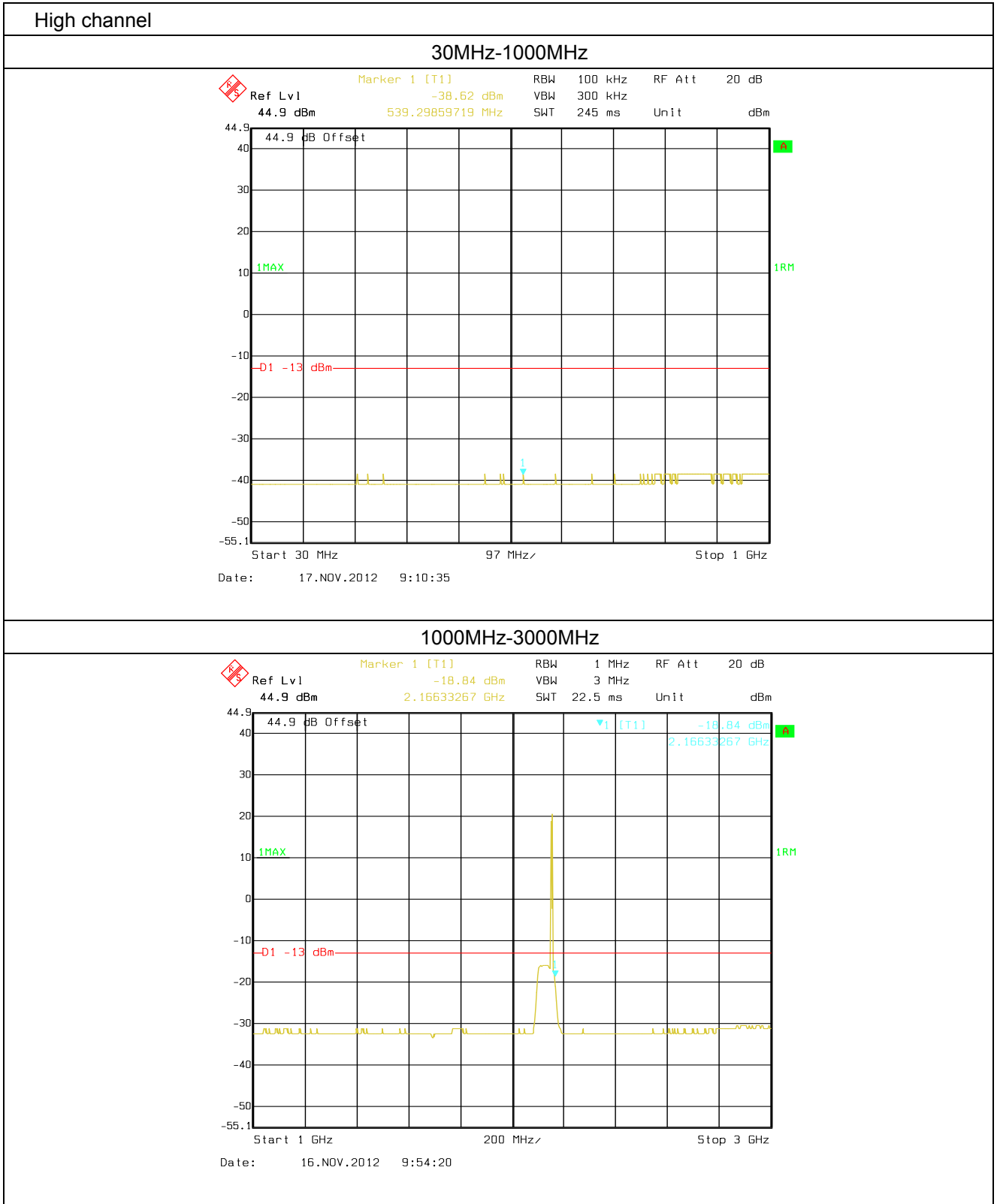

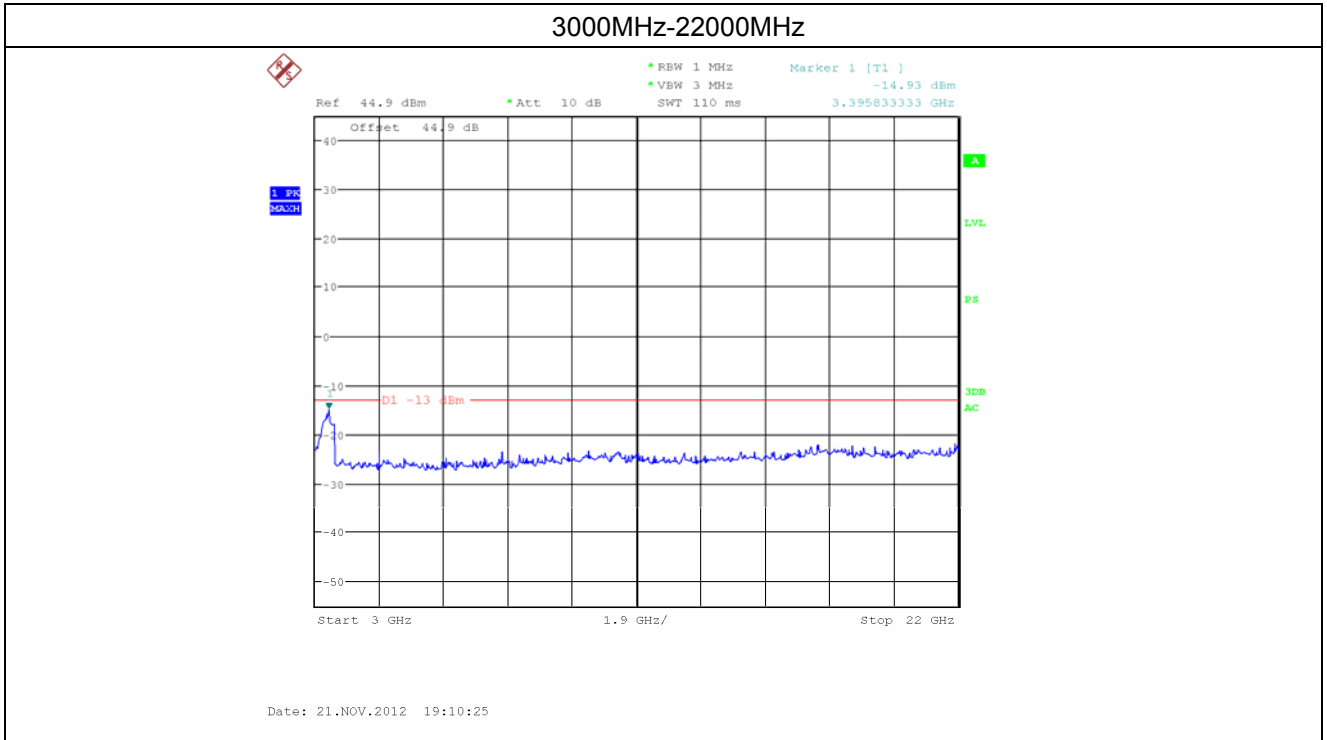

Spurious emission of LTE10MHz Bandwidth

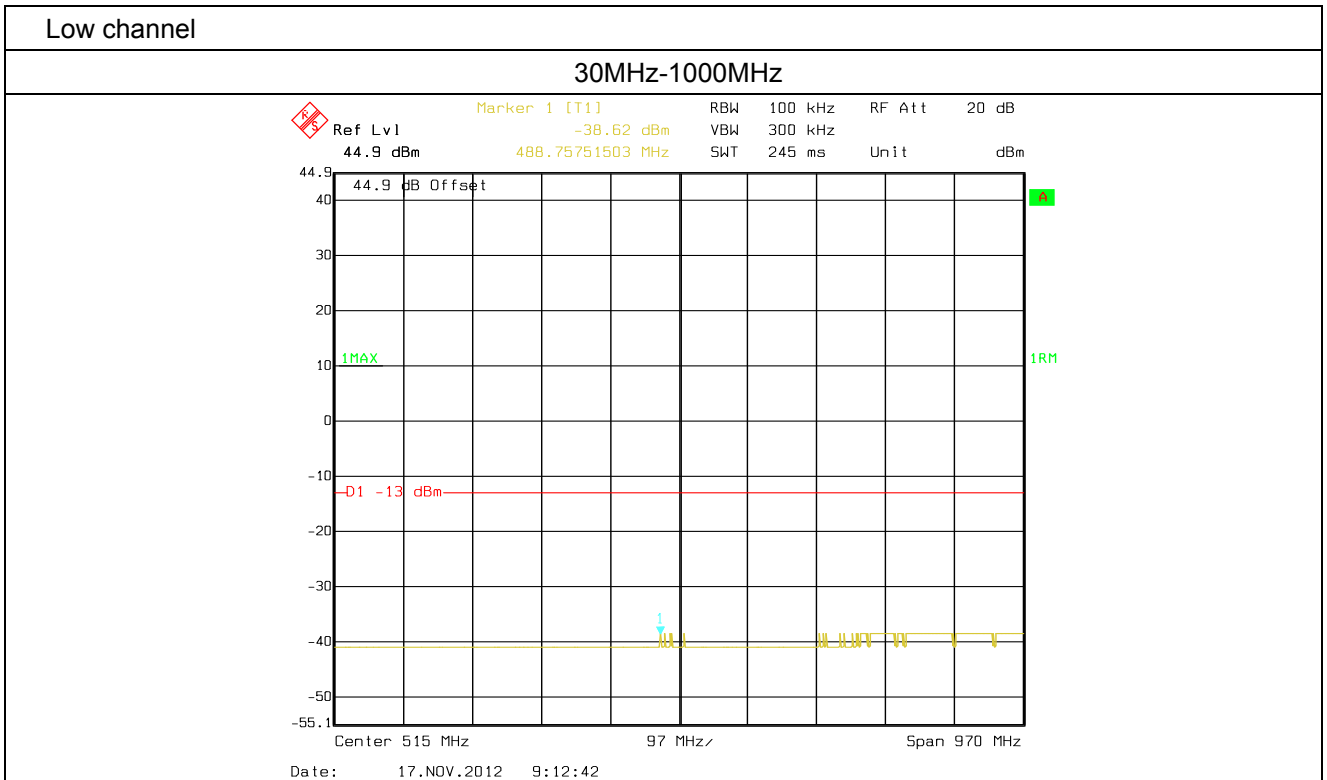

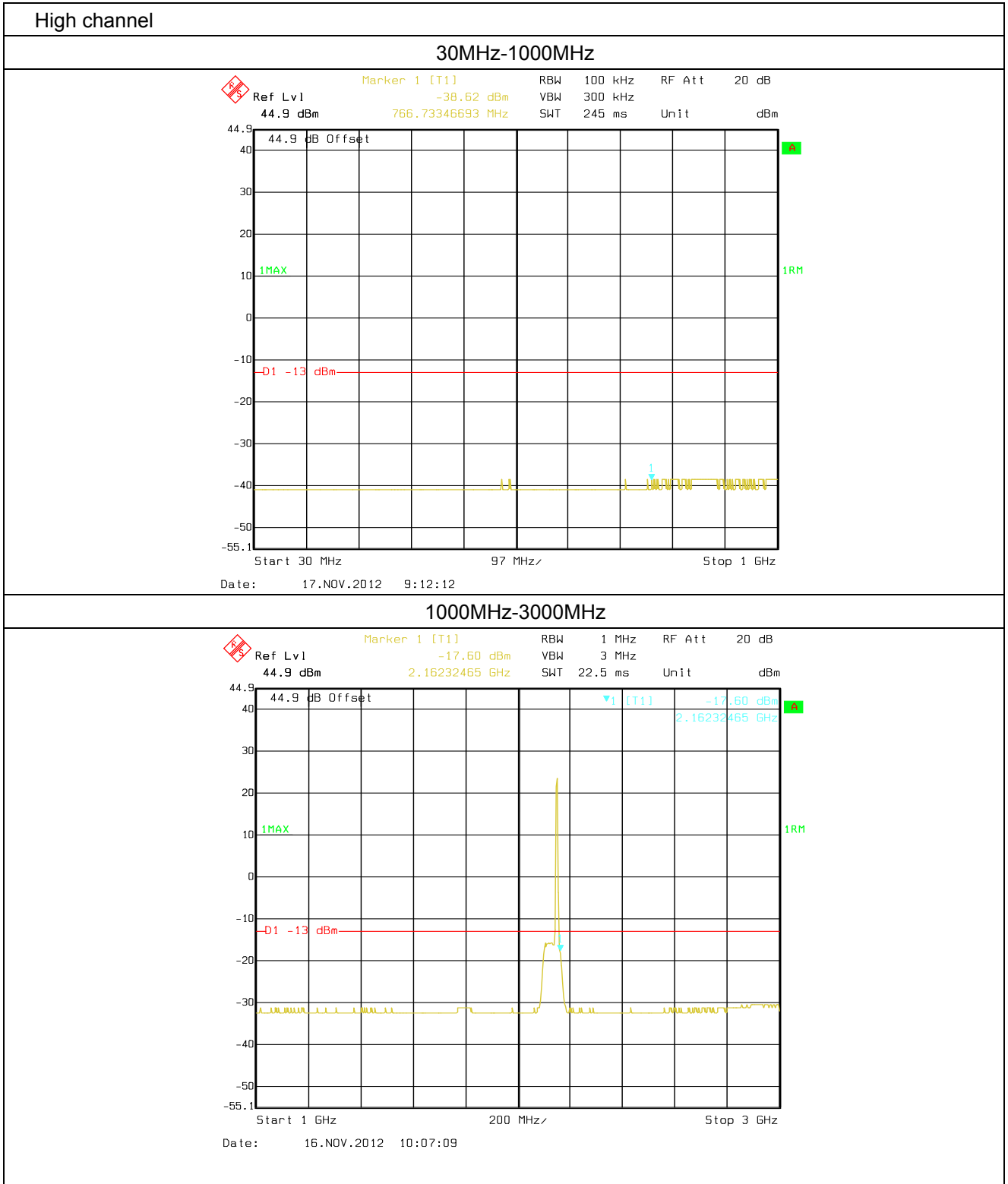

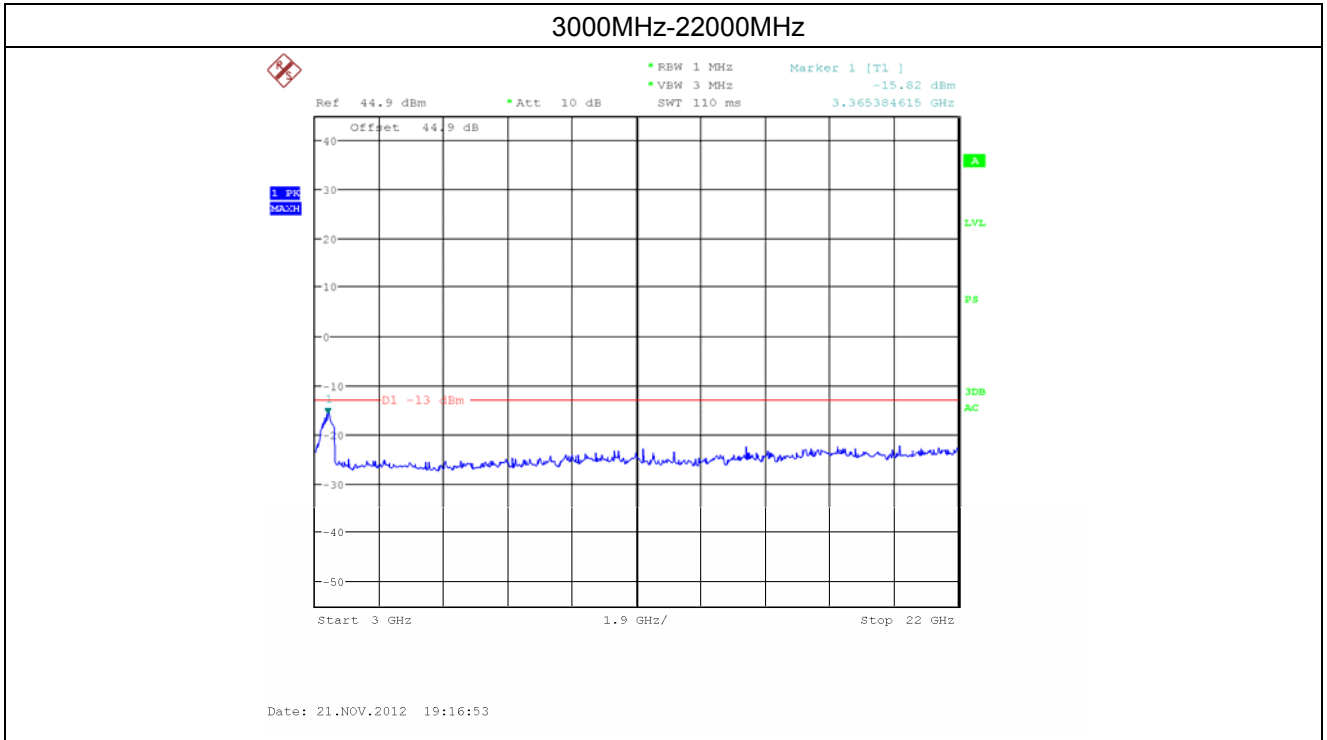

Spurious emission of LTE15MHz Bandwidth

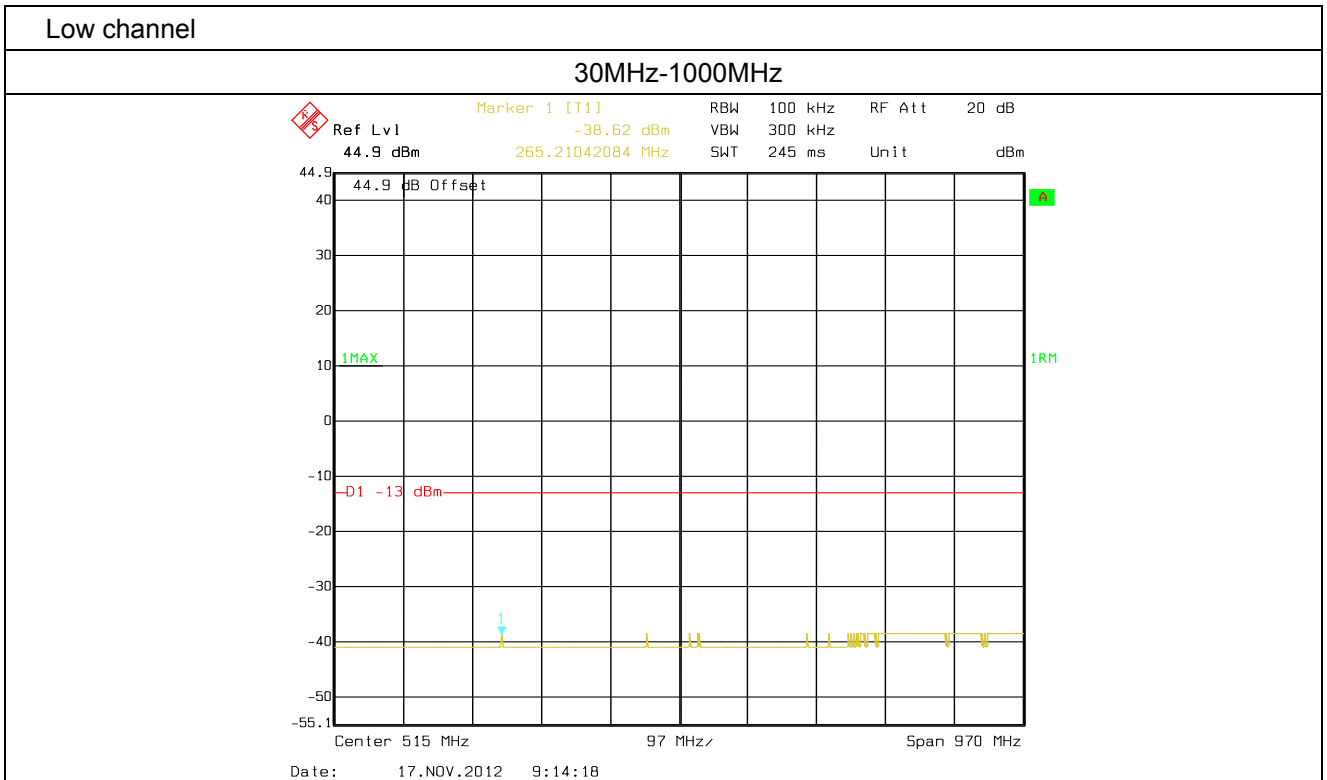

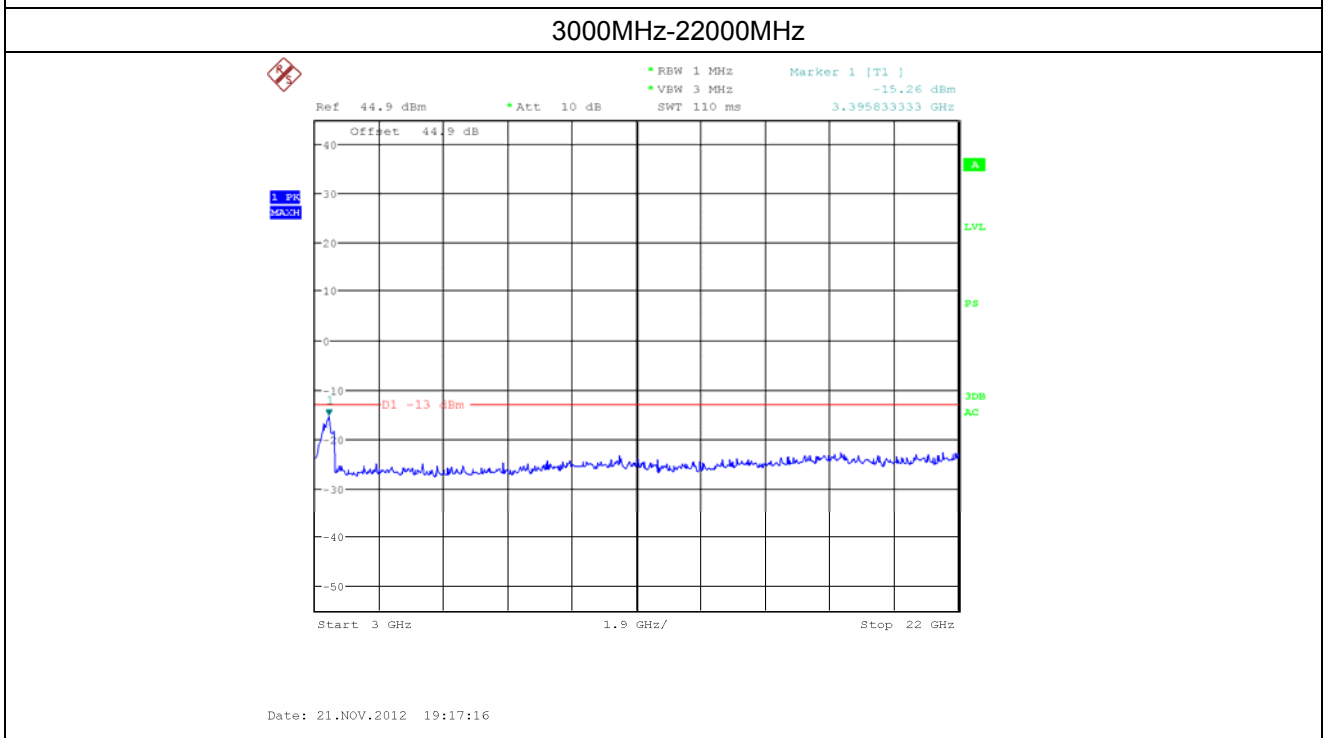
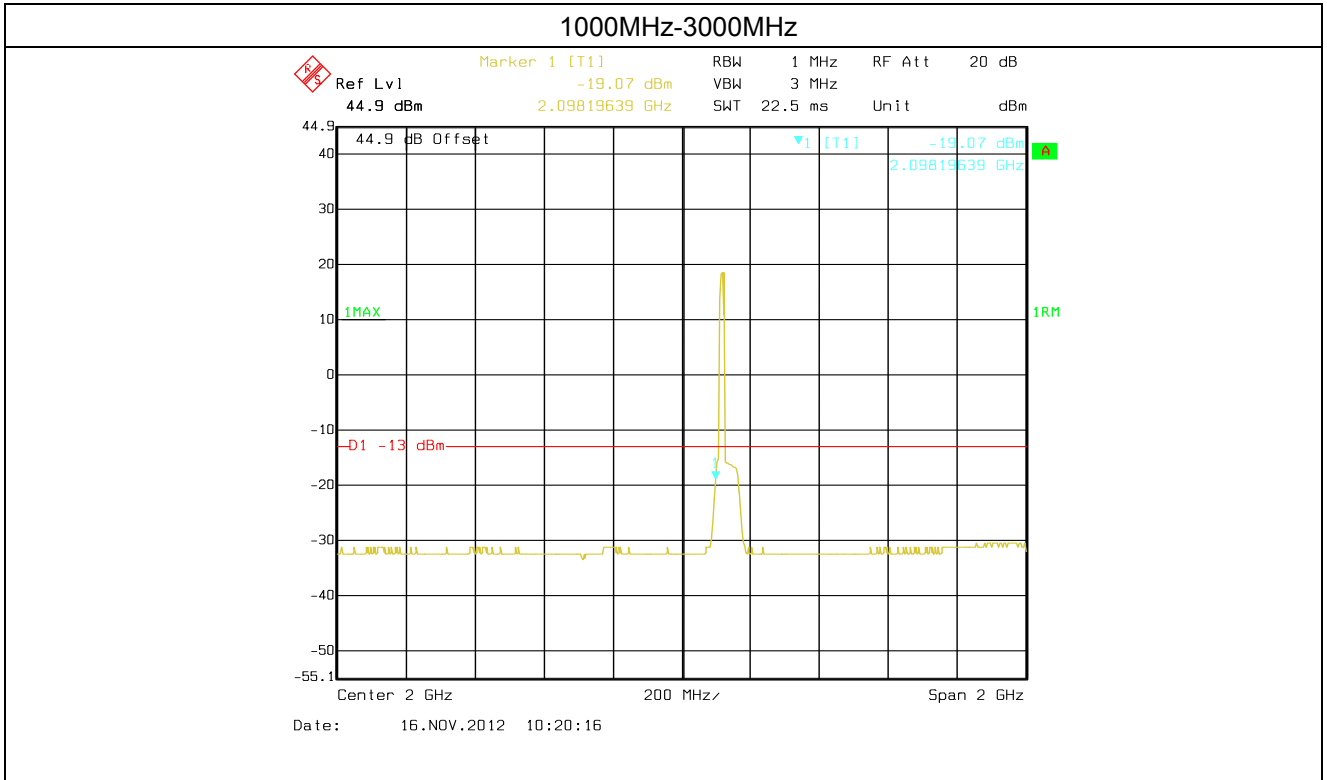

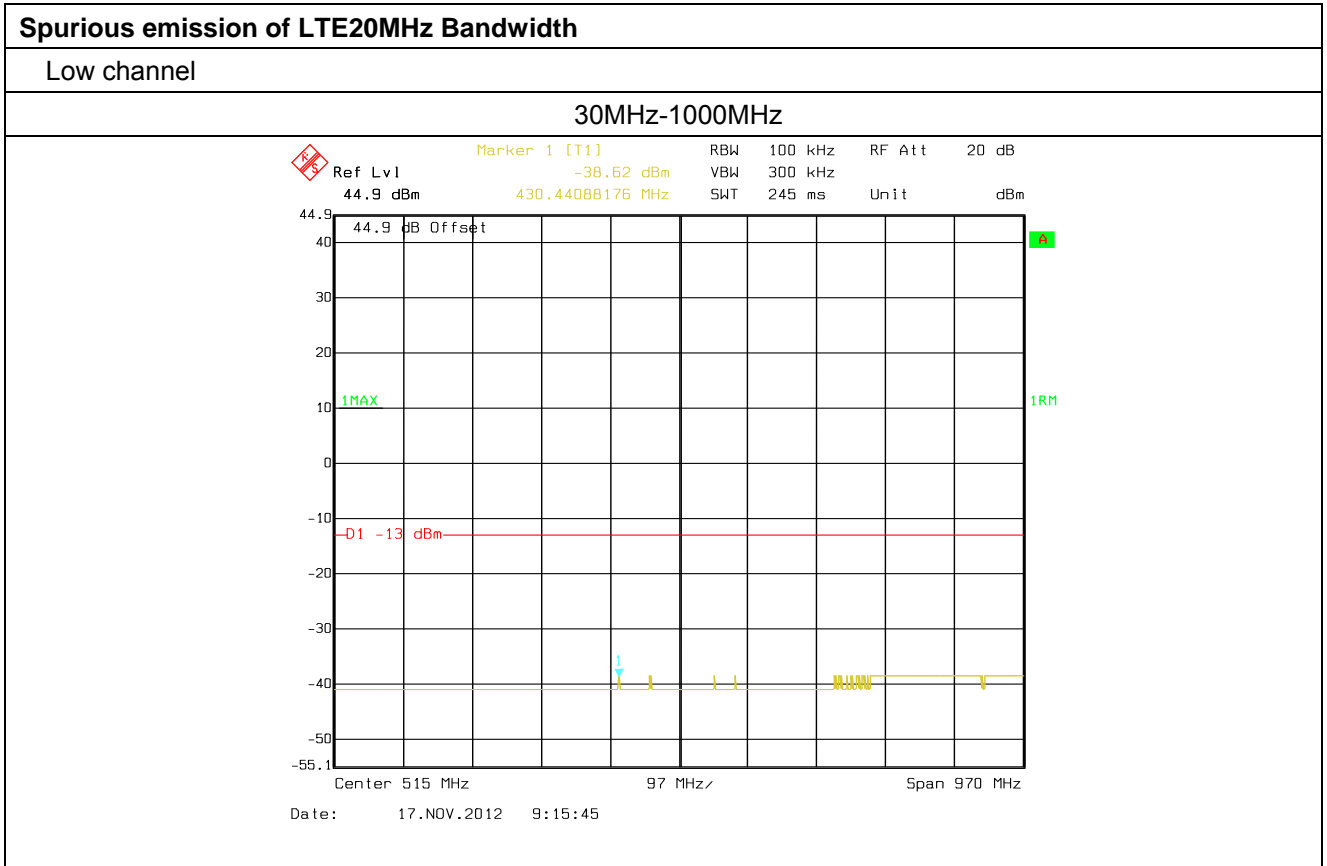
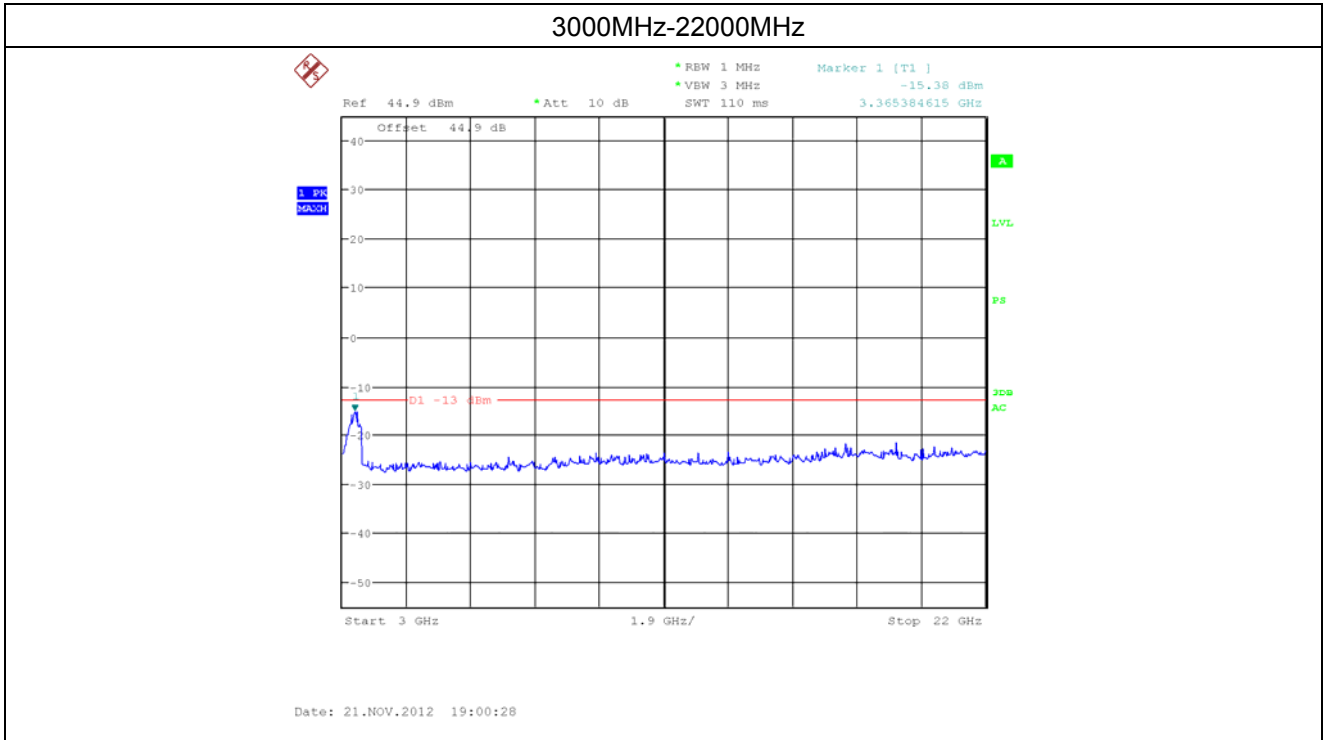

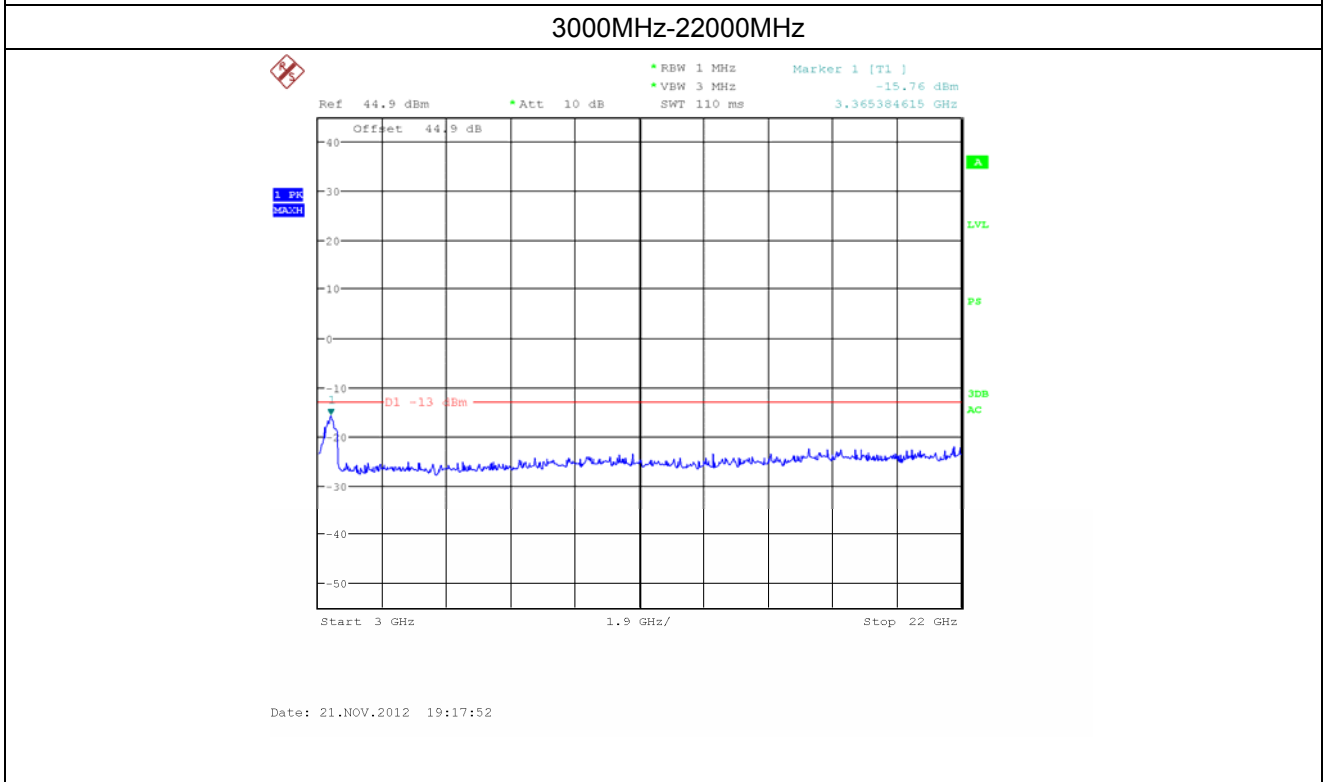
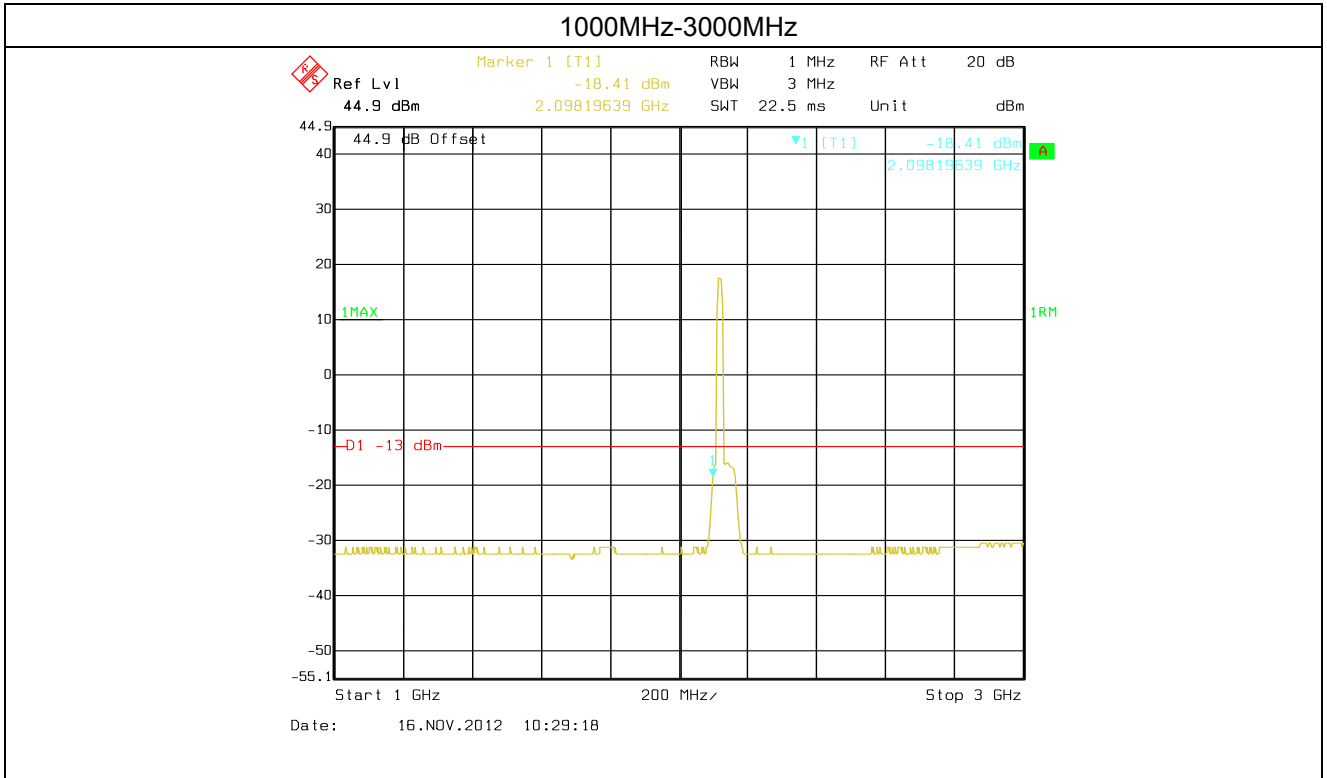

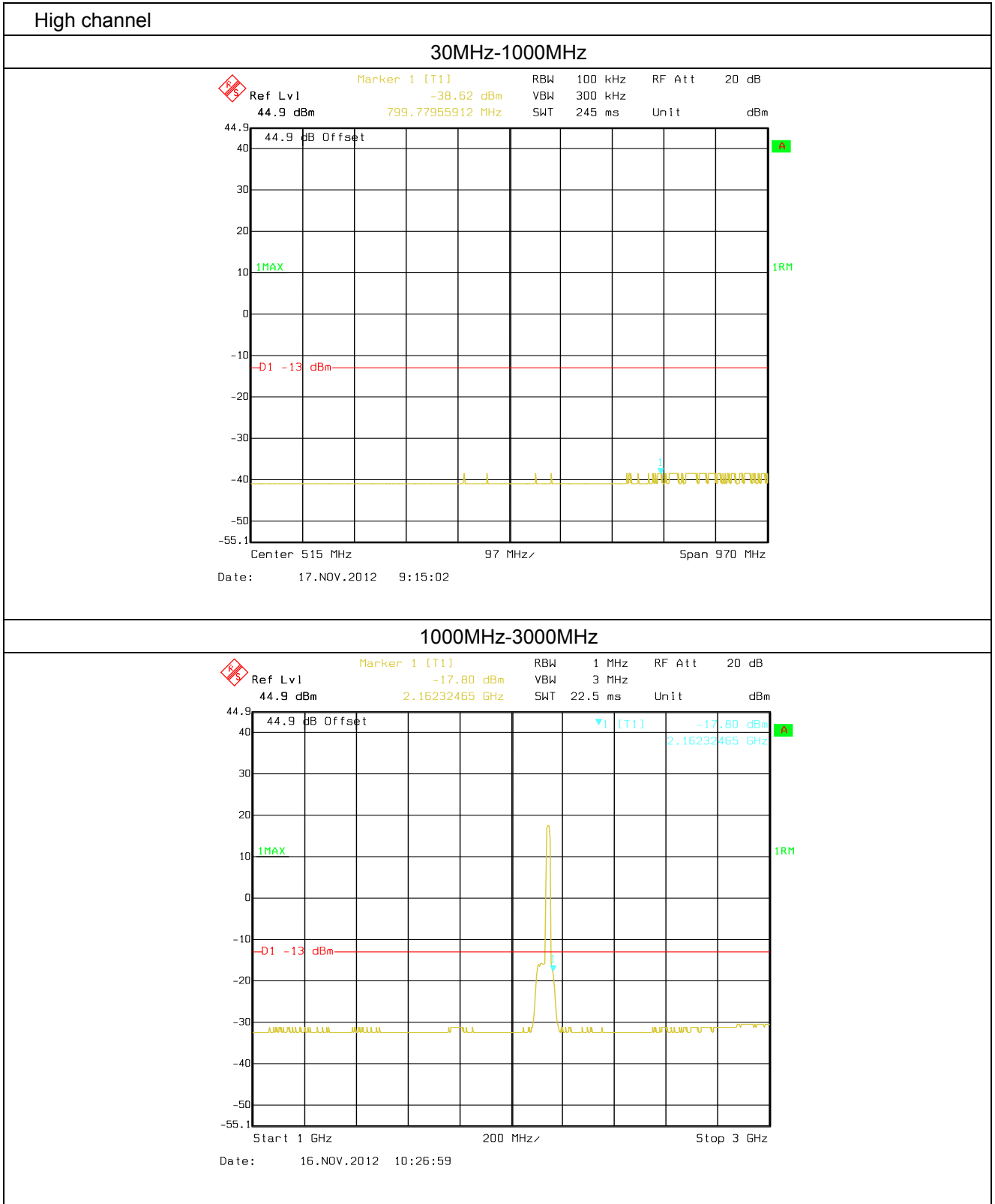

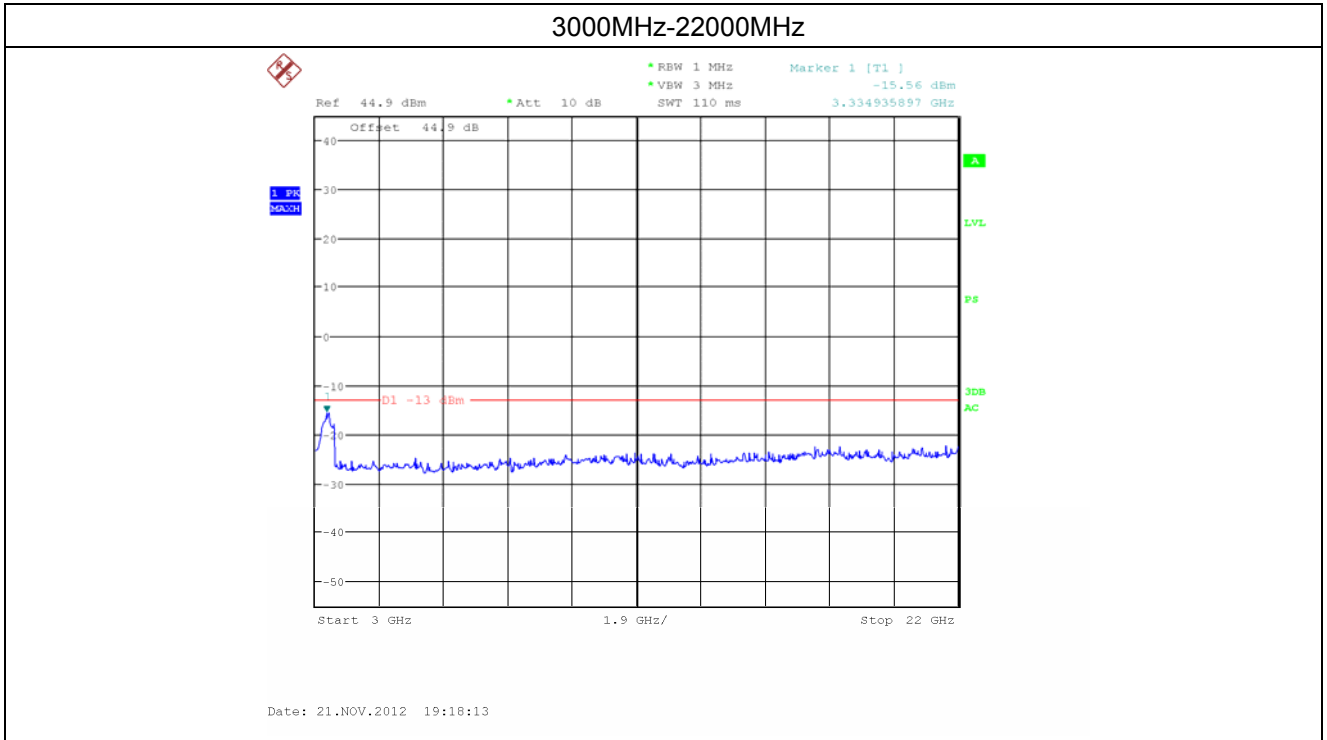

10.4.2 Band edge emission

Band edge of WCDMA

1. Number of Carriers: Single carrier

Left edge of band

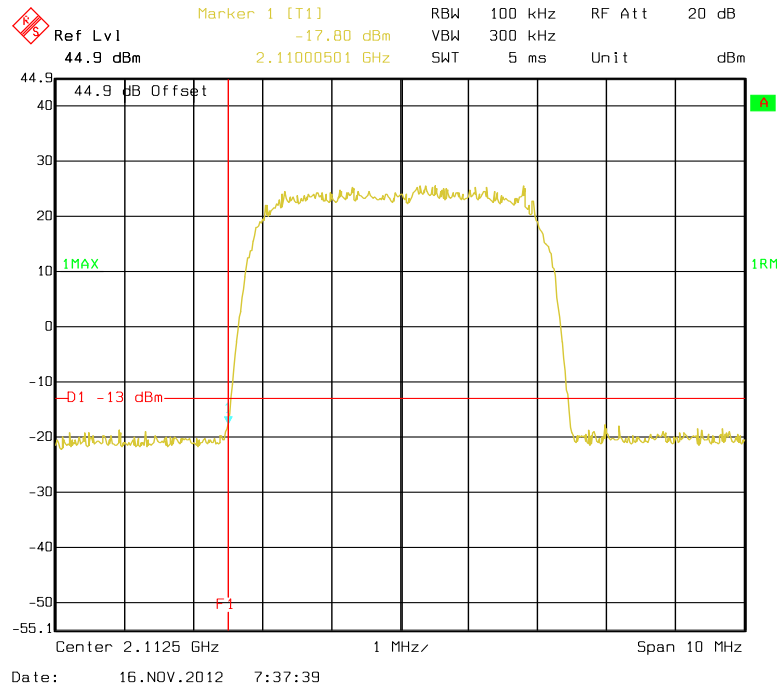

Right edge of band

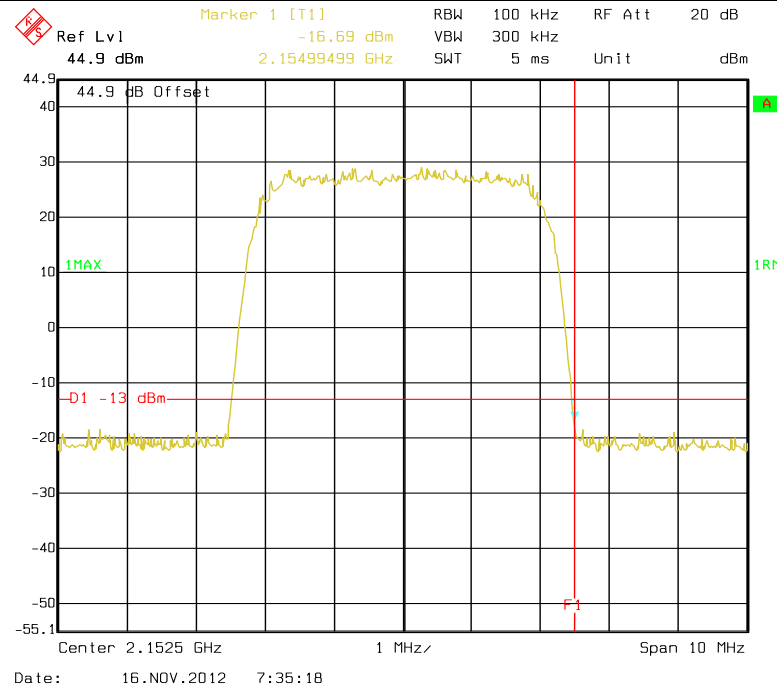

2. Number of Carriers: Four carriers

Left edge of band

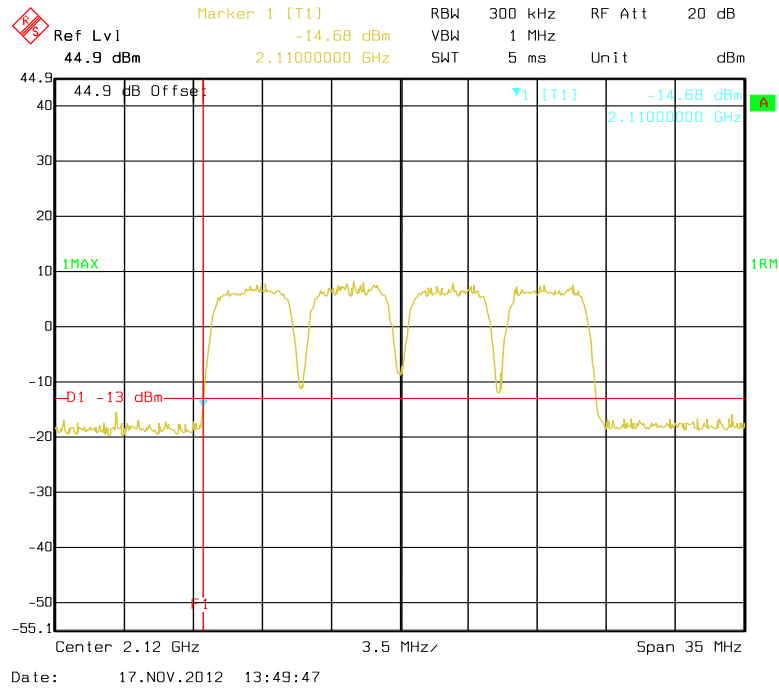

Right edge of band

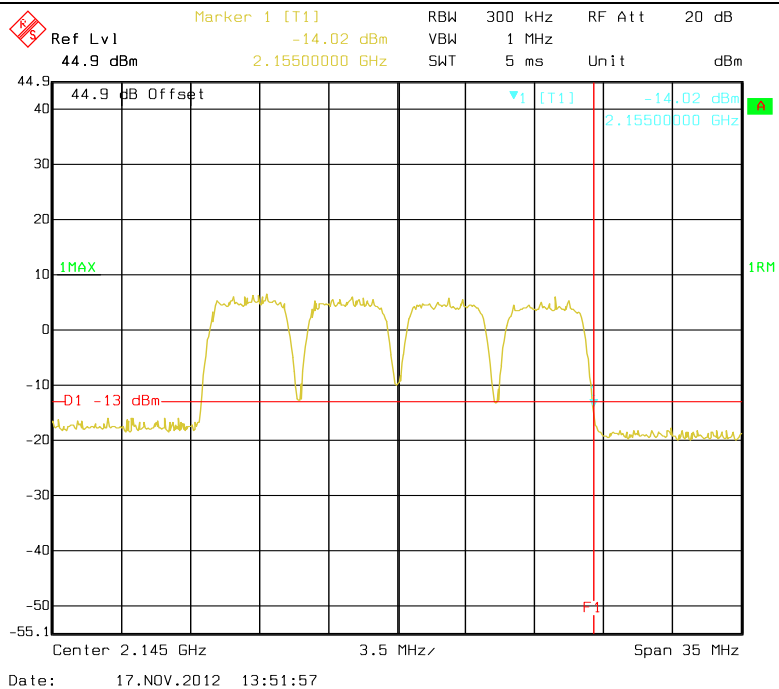

Band edge of CDMA

1. Number of Carriers: Single carrier

Left edge of band

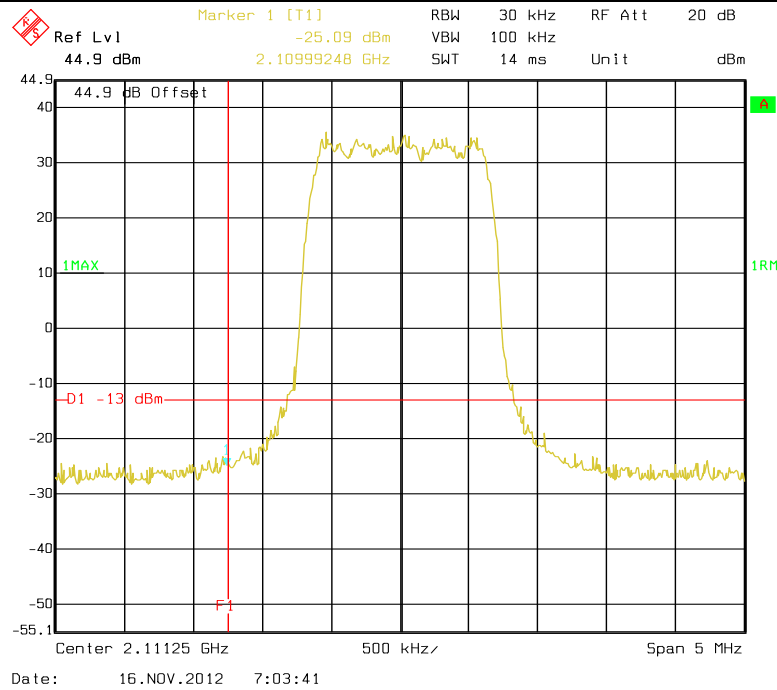

Right edge of band

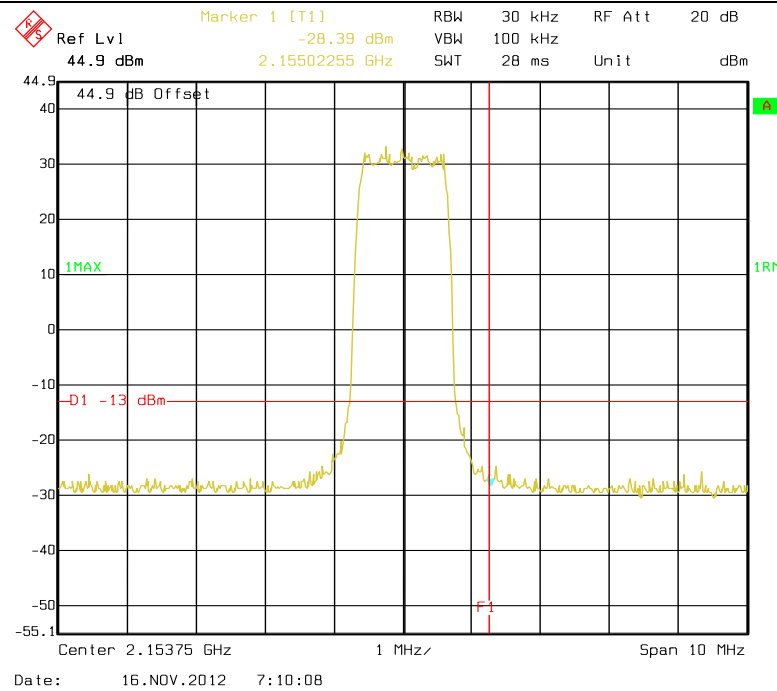

2. Number of Carriers: Four carriers

Left edge of band

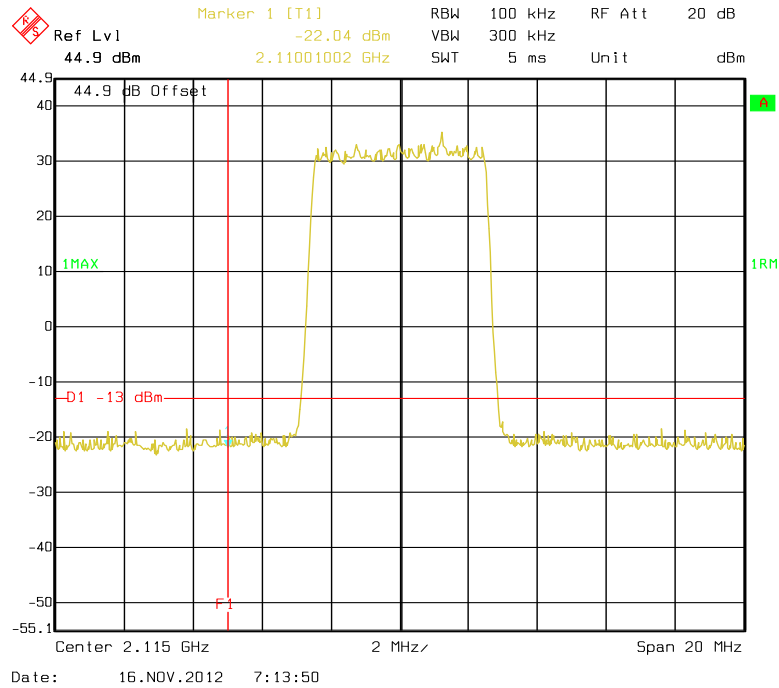

Right edge of band

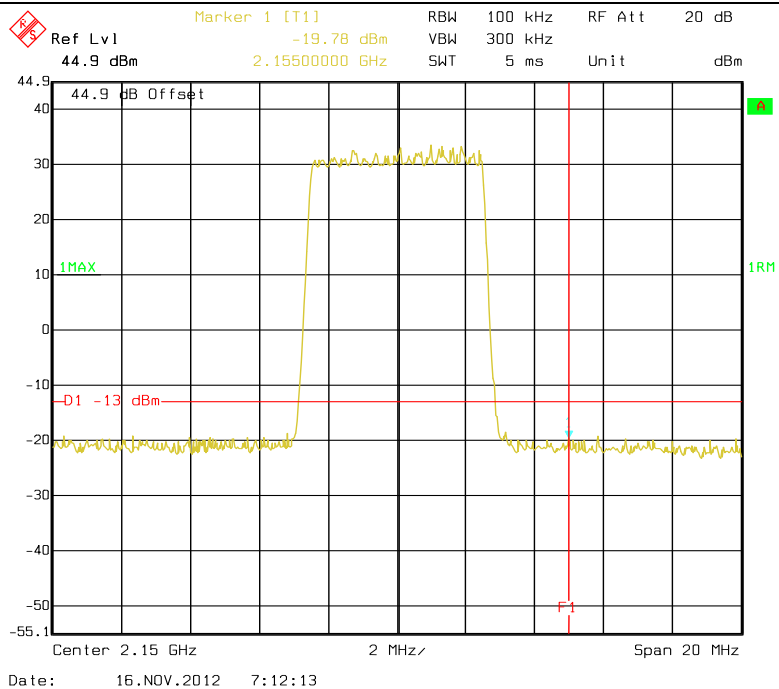

Band edge of EVDO(0%)

1. Number of Carriers: Single carrier

Left edge of band

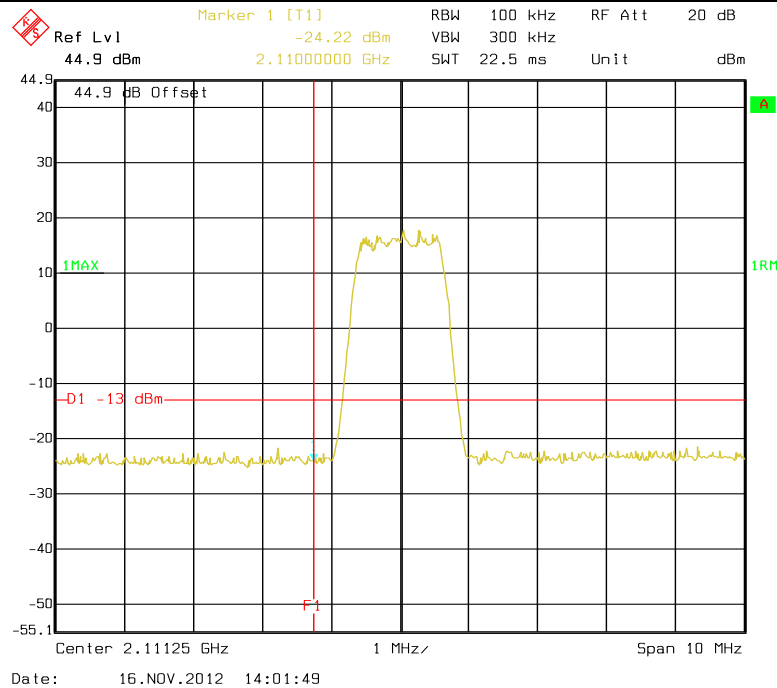

Right edge of band

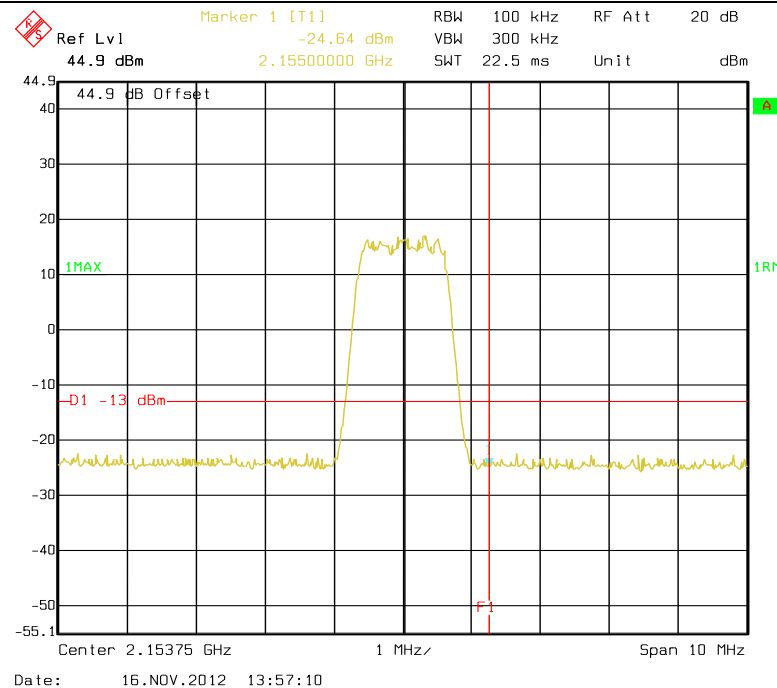

2. Number of Carriers: Four carriers

Left edge of band

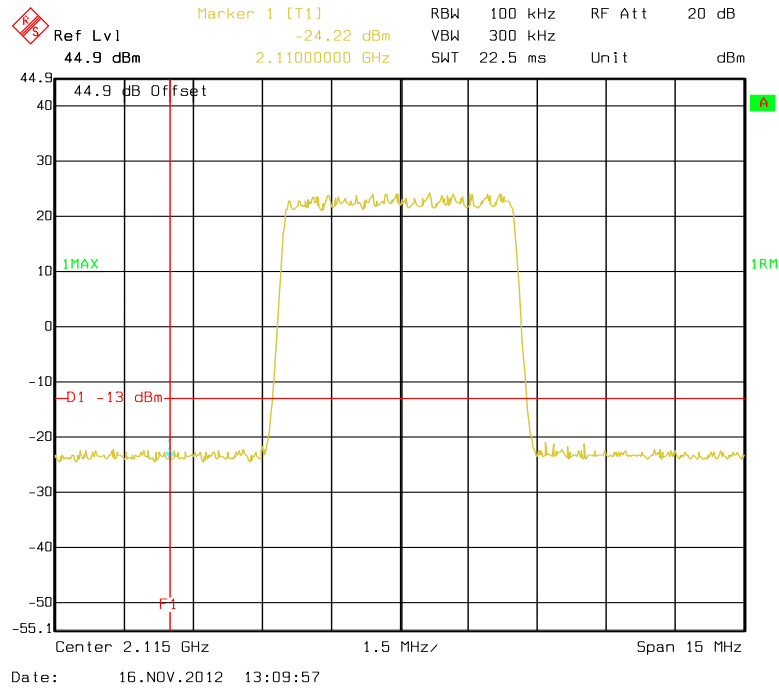

Right edge of band

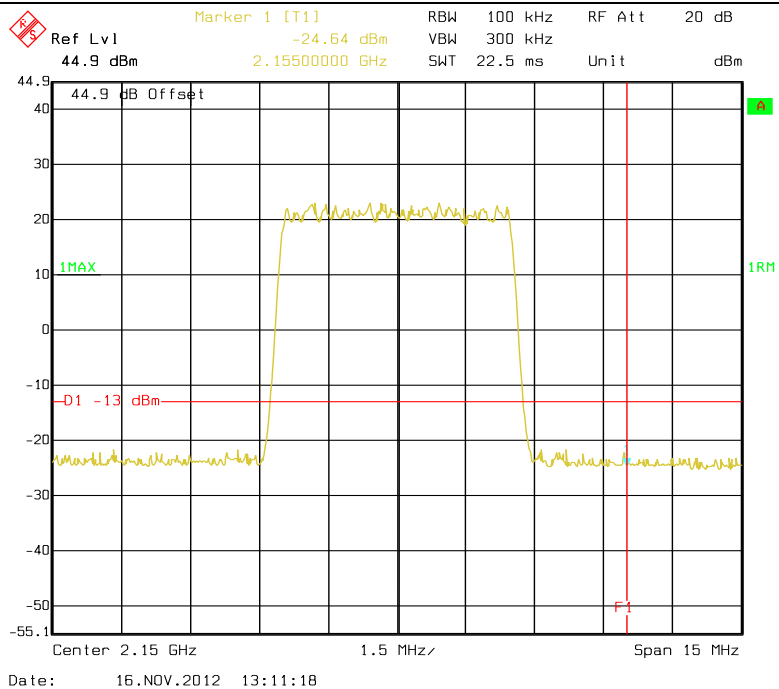

Band edge of EVDO(50%)

1. Number of Carriers: Single carrier

Left edge of band

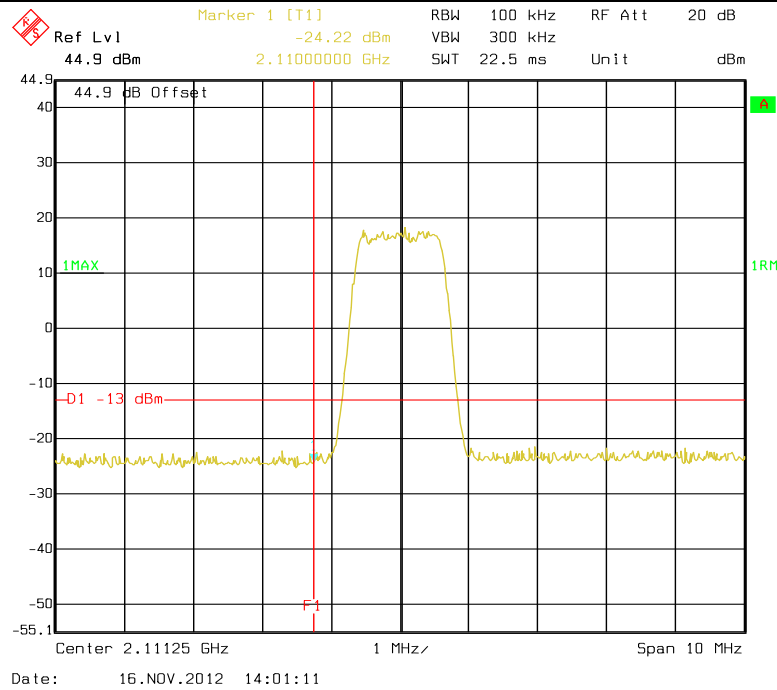

Right edge of band

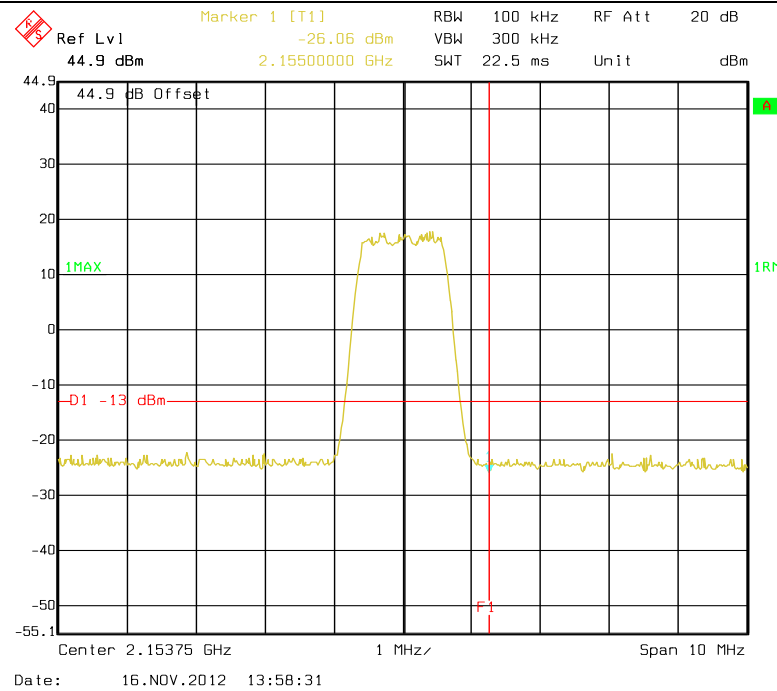

2. Number of Carriers: Four carriers

Left edge of band

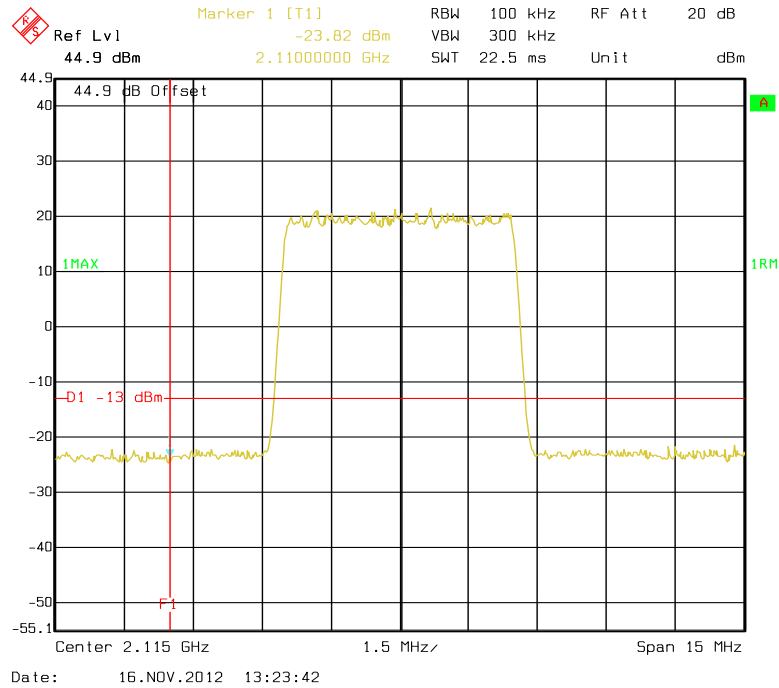

Right edge of band

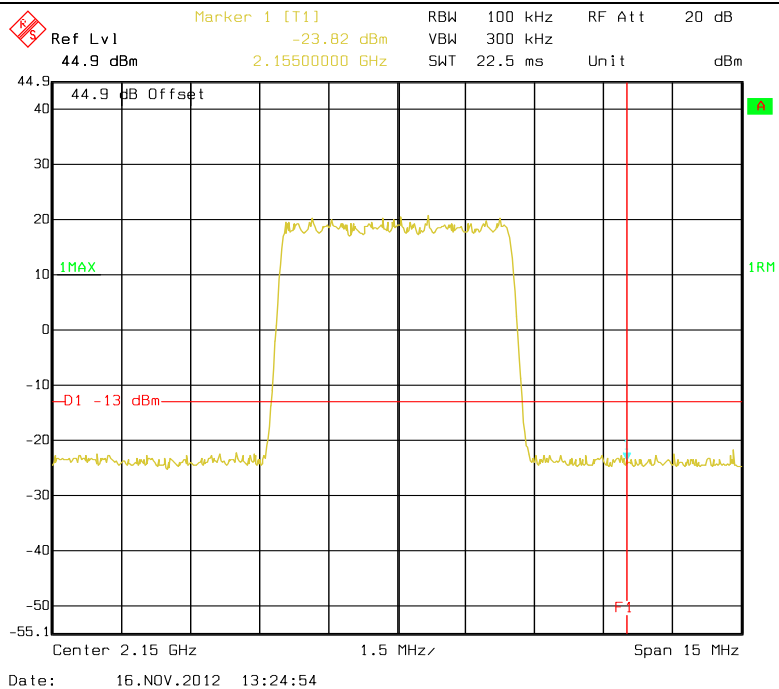

Band edge of EVDO(100%)

1. Number of Carriers: Single carrier

Left edge of band

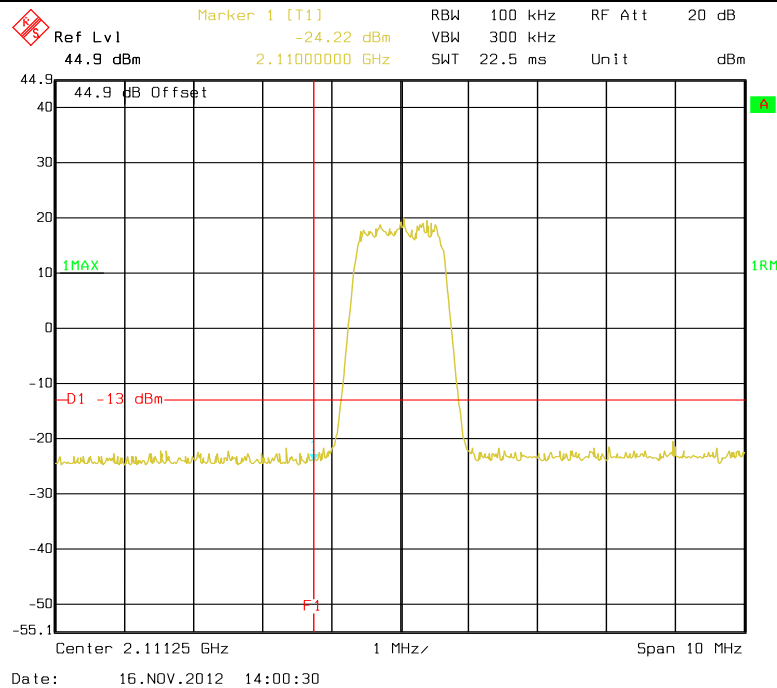

Right edge of band

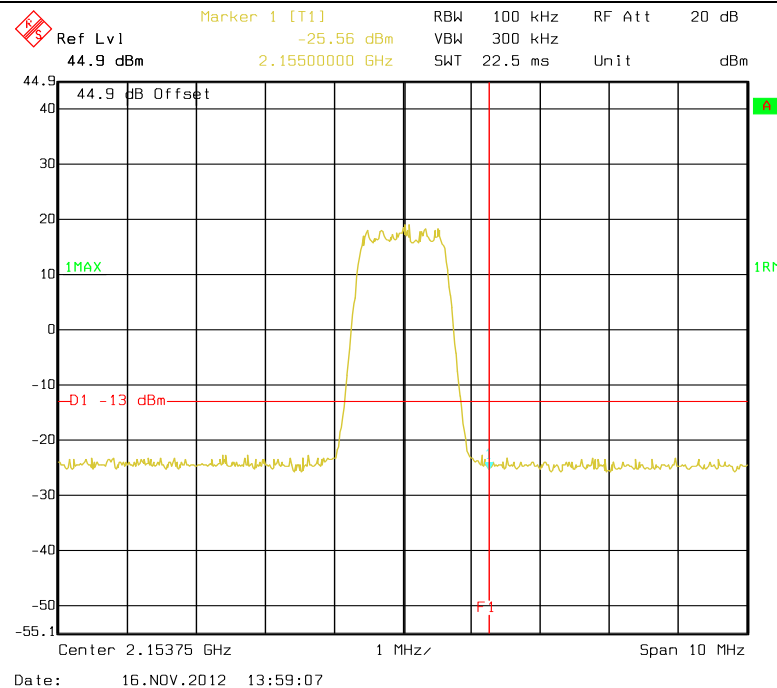

2. Number of Carriers: Four carriers

Left edge of band

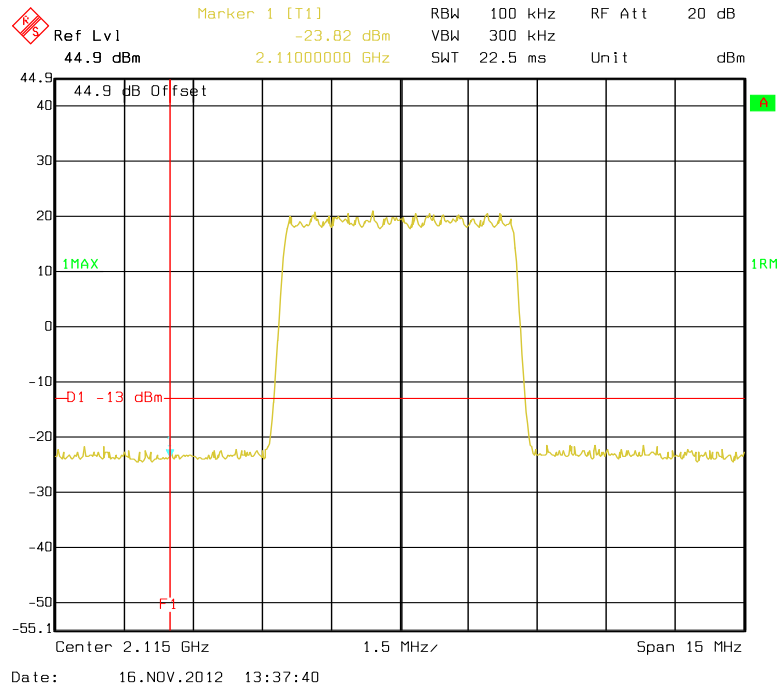

Right edge of band

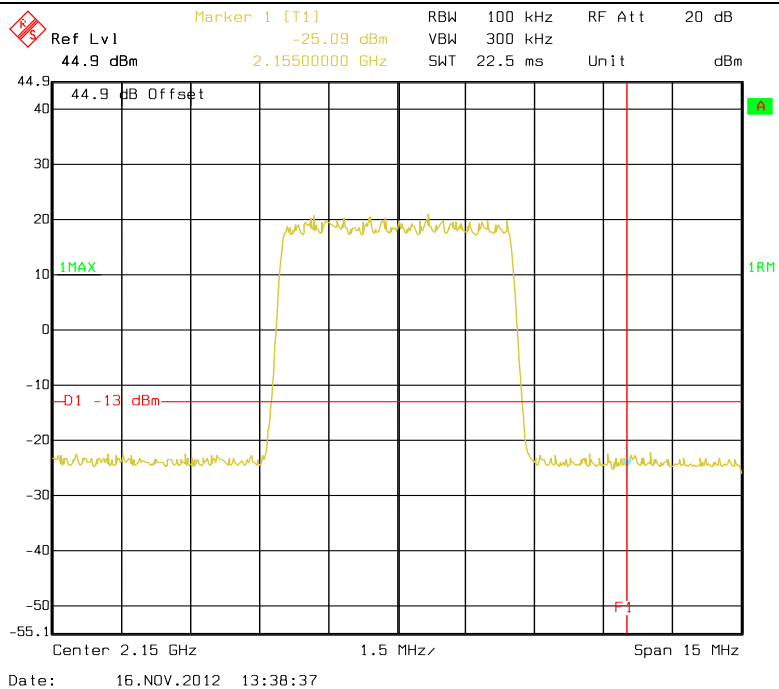

Band edge of LTE 1.4 MHz Bandwidth

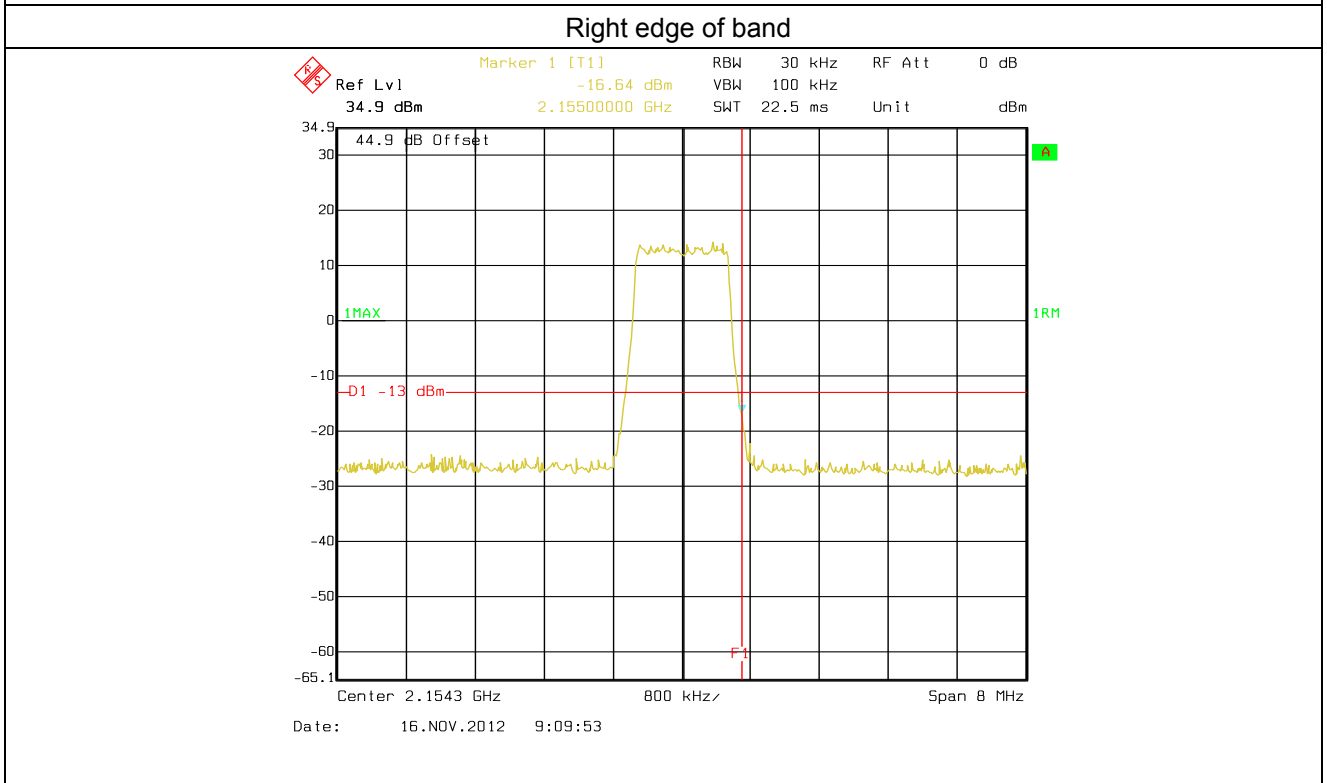
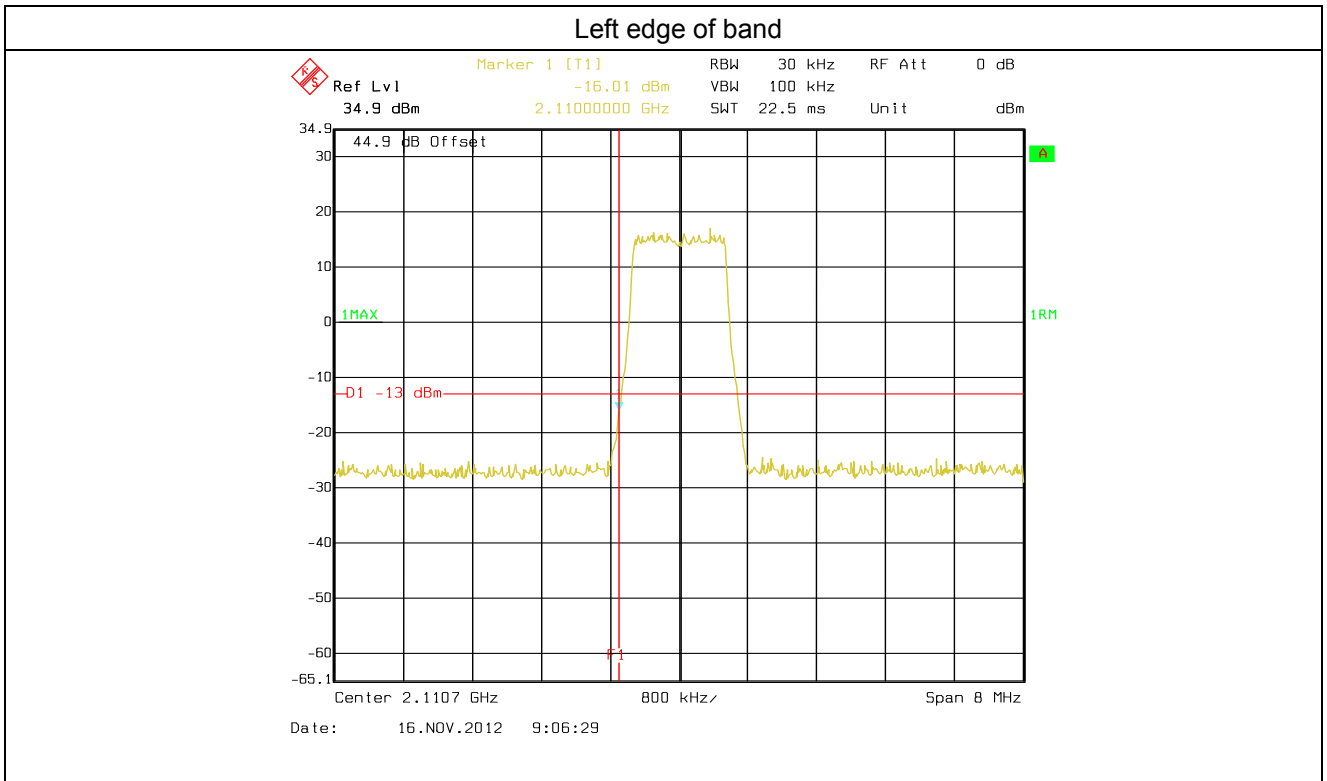

Band edge of LTE 3 MHz Bandwidth

Left edge of band

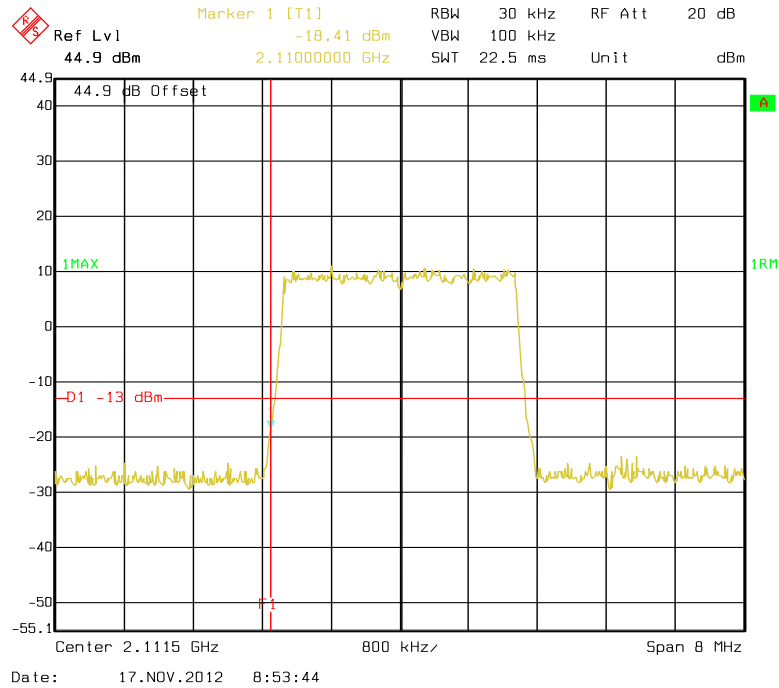

Right edge of band

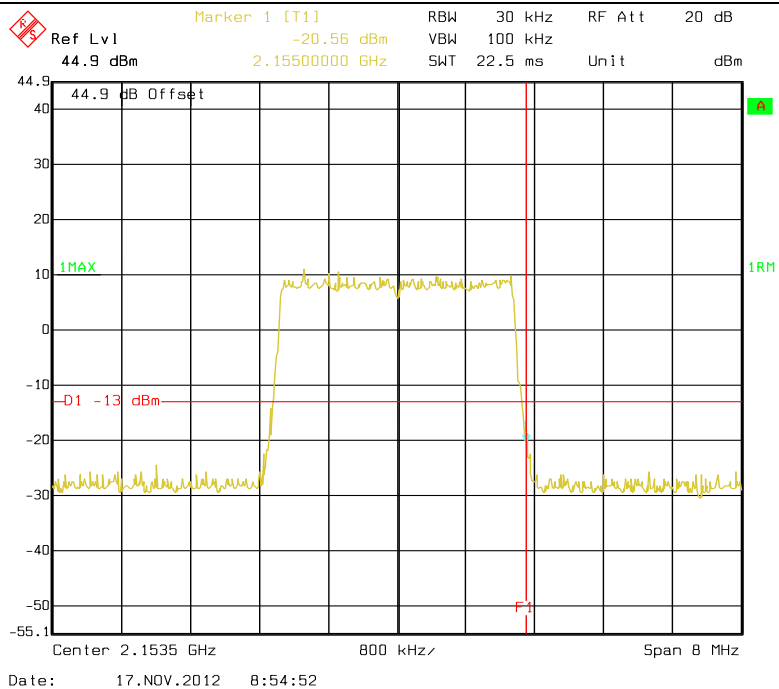

Band edge of LTE 5 MHz Bandwidth

Left edge of band

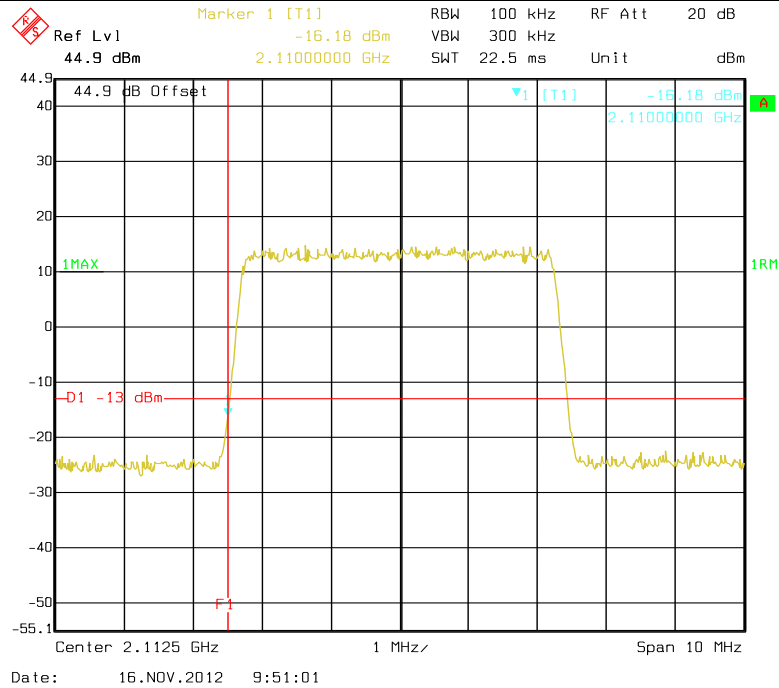

Right edge of band

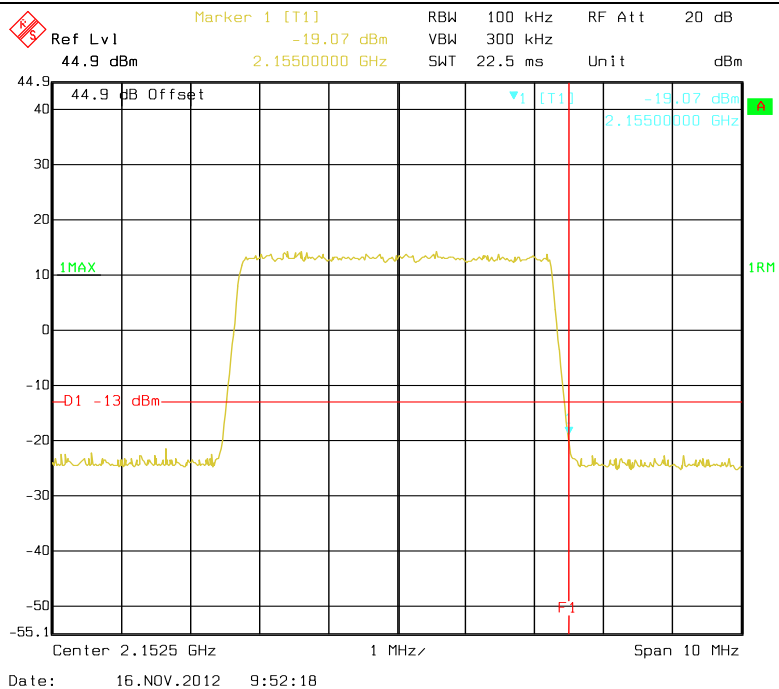

Band edge of LTE 10 MHz Bandwidth

Left edge of band

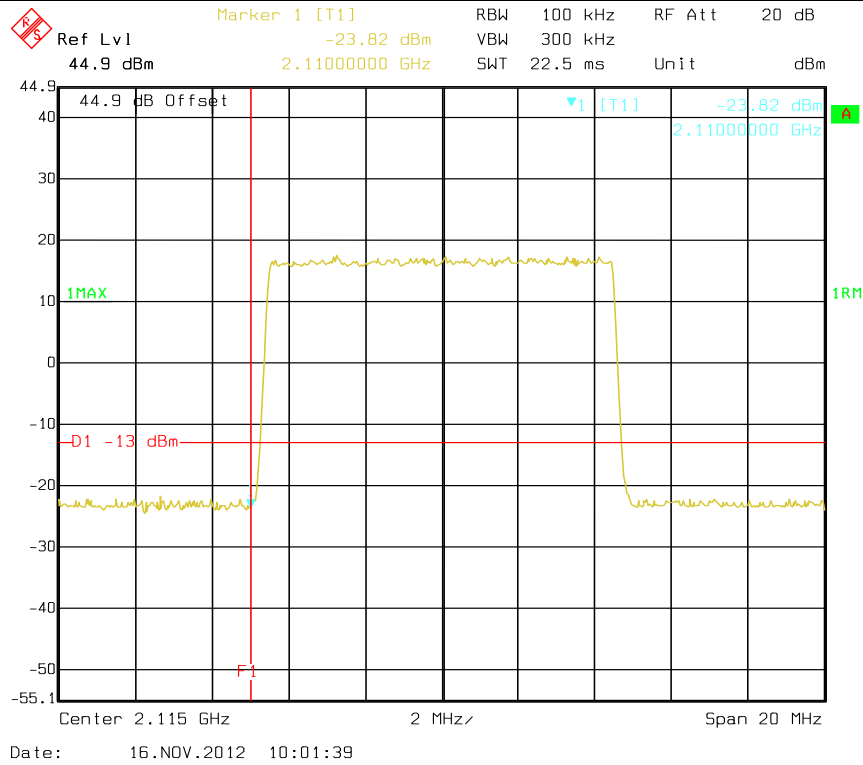

Right edge of band

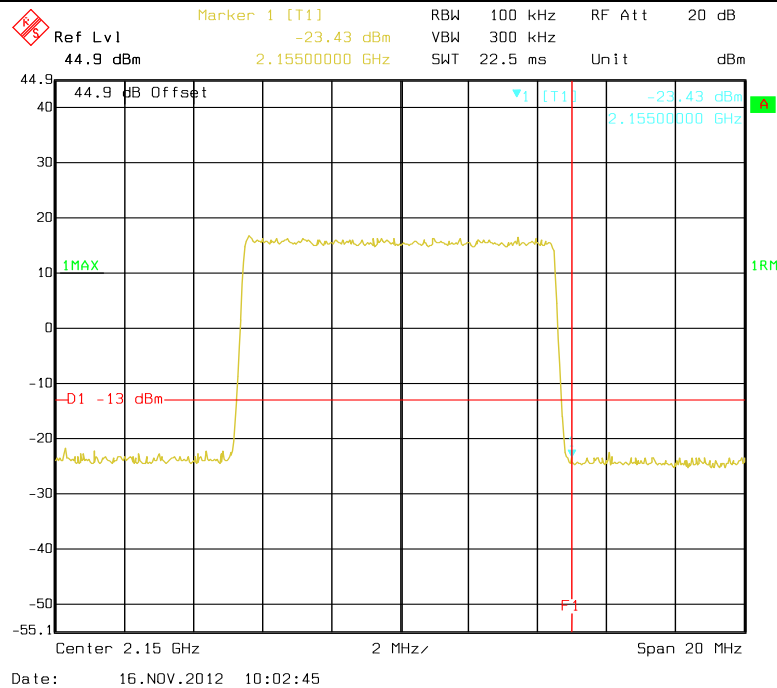

Band edge of LTE 15 MHz Bandwidth

Left edge of band

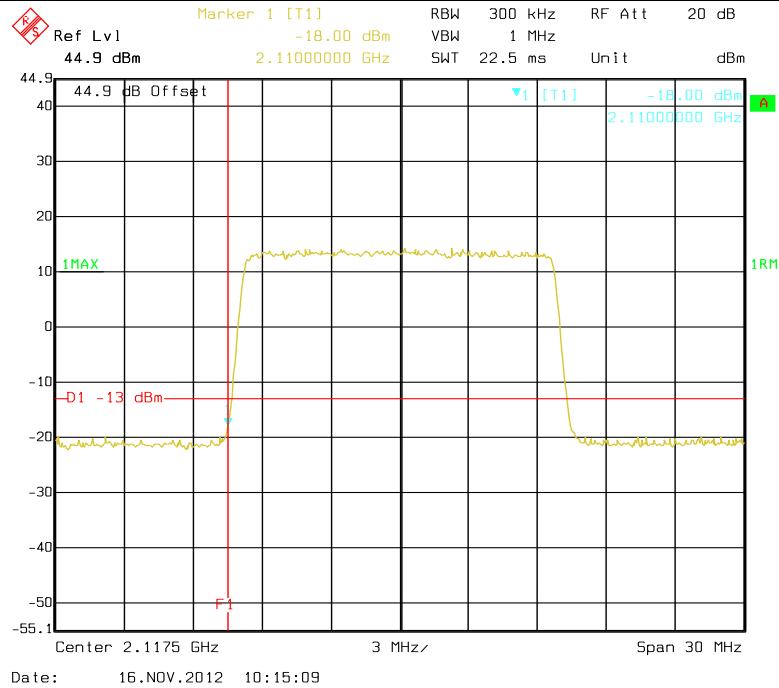

Right edge of band

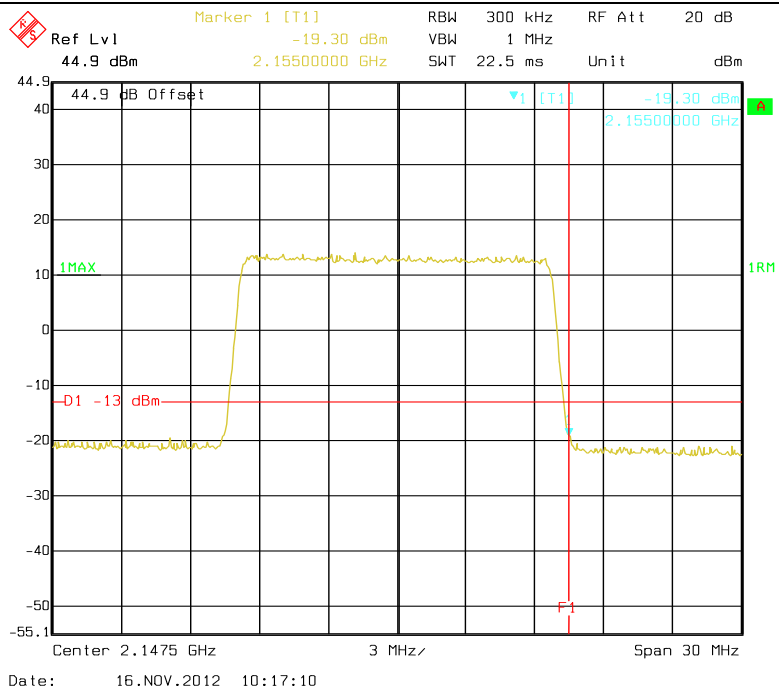

Band edge of LTE 20 MHz Bandwidth

Left edge of band

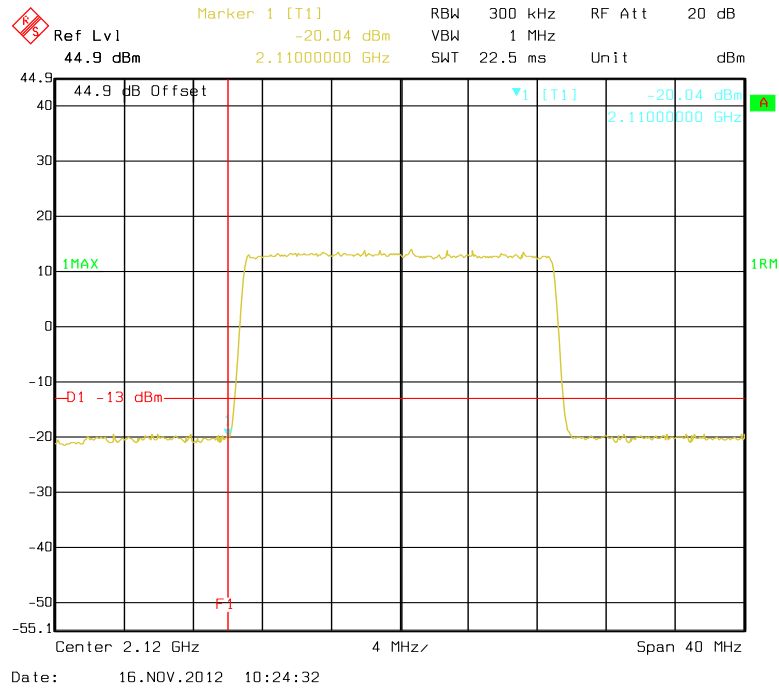

Right edge of band

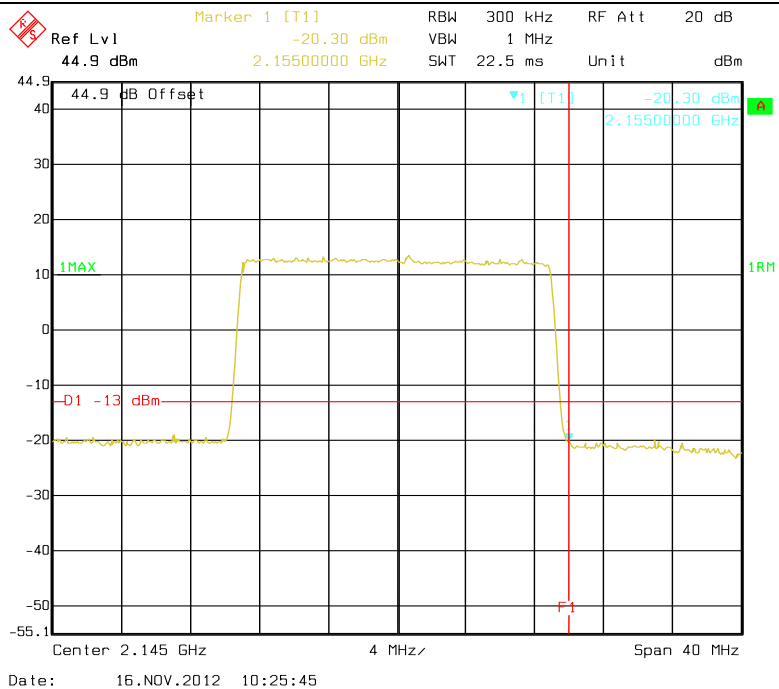

11 INTERMODULATION

11.1 Standard Applicable

According to FCC §2.1051.and FCC §27.53(h)

h) For operations in the 1710–1755 MHz and 2110–2155 MHz bands, the power of any emission outside a licensee’s frequency block shall be attenuated below the transmitter power (P) by at least $43 + 10 \log_{10}(P)$ dB.

(1) Compliance with this provision is based on the use of measurement instrumentation employing a resolution bandwidth of 1 megahertz or greater. However, in the 1 megahertz bands immediately outside and adjacent to the licensee’s frequency block, a resolution bandwidth of at least one percent of the emission bandwidth of the fundamental emission of the transmitter may be employed. The emission bandwidth is defined as the width of the signal between two points, one below the carrier center frequency and one above the carrier center frequency, outside of which all emissions are attenuated at least 26 dB below the transmitter power.

(2) When measuring the emission limits, the nominal carrier frequency shall be adjusted as close to the licensee’s frequency block edges, both upper and lower, as the design permits.

(3) The measurements of emission power can be expressed in peak or average values, provided they are expressed in the same parameters as the transmitter power.

The following method was used to determine the Limit for Spurious Emissions:

Maximum output power in watts: P (W).

The emission must be reduced by $43+10\log(P)$ dB

Therefore, the Emission Limit equals:

$$10\log(P) \text{ dBW} + 30\text{dB} - (43+10\log(P) \text{ dB}) = - 13 \text{ dBm}$$

11.2 Test setup

Please refer the section §6.2 Configuration of Tested System.

11.3 Measurement Procedure

1. The EUT RF output port was connected to spectrum analyzer. The EUT shall be set to maximum gain and maximum rated output power per channel.
2. Two continuous sinusoidal RF signals shall be fed to the input antenna port of the repeater using a combining device. The two channels near each other should be separated by at least one operating channel width.

3. The spurious emissions at antenna were measured at the RF output port of the EUT.

4. The modulation types tested were WCDMA, LTE, CDMA, and EVDO.

Spectrum analyzer settings:

Detector: RMS.

Intermodulation:

WCDMA/LTE: RBW=100 kHz; VBW \geq RBW

CDMA/EVDO: RBW=30 kHz; VBW \geq RBW

Spurious emissions:

Below 1G: RBW=100kHz; Above 1G: RBW=1 MHz ; VBW \geq RBW

11.4 Test Result

Passed.

Intermodulation of WCDMA

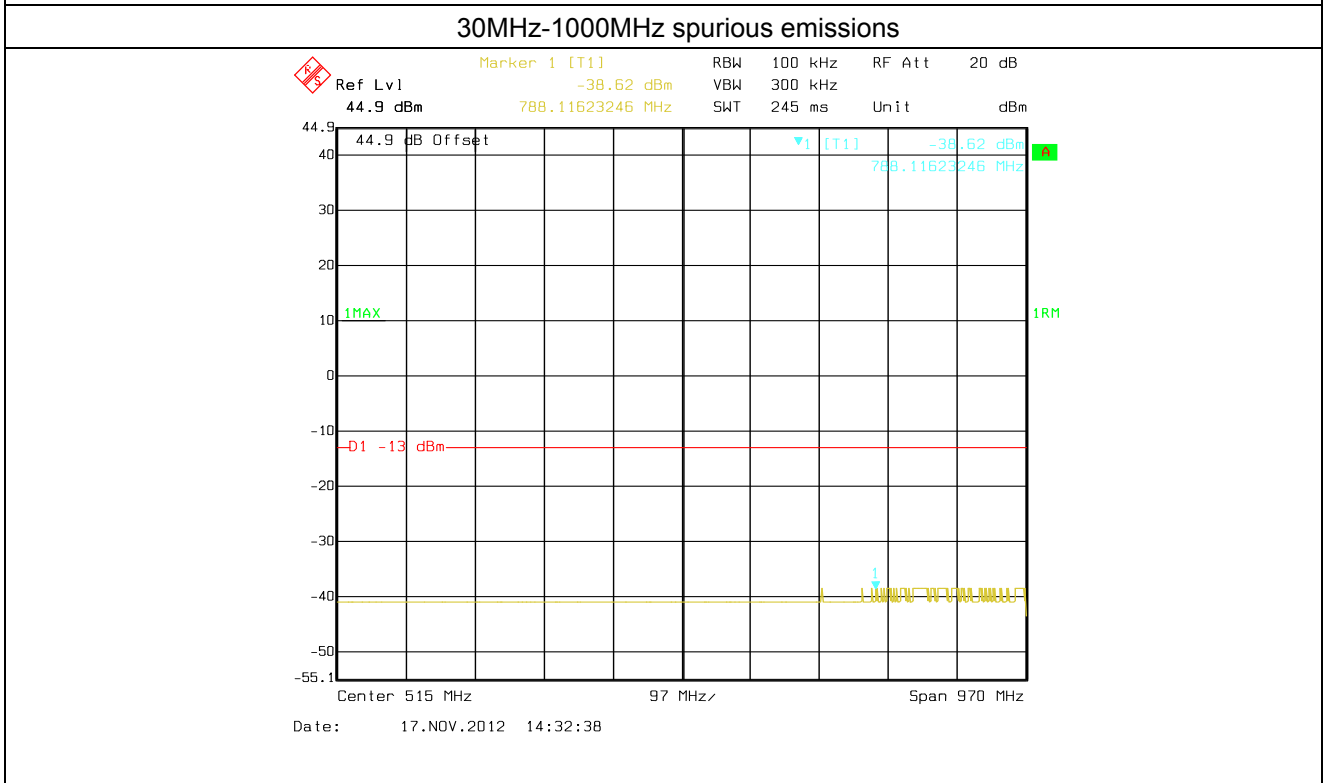
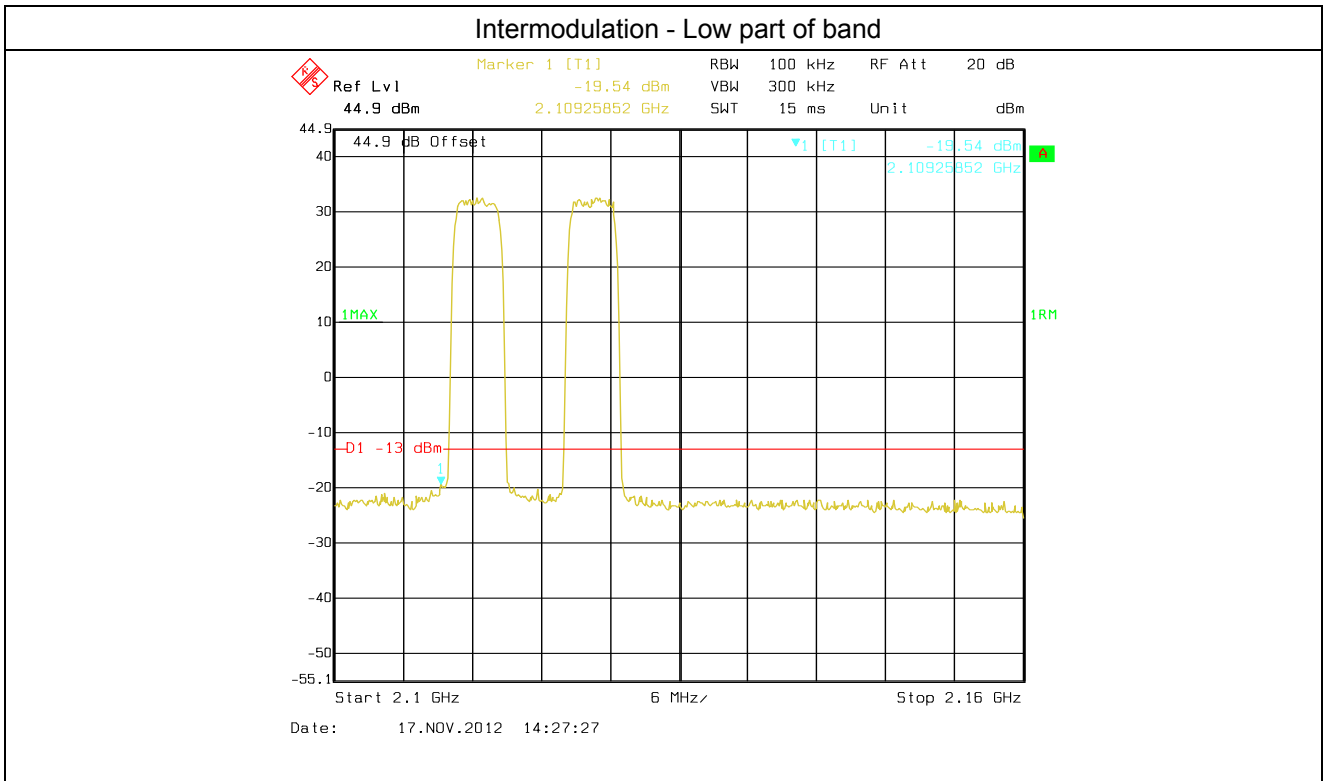

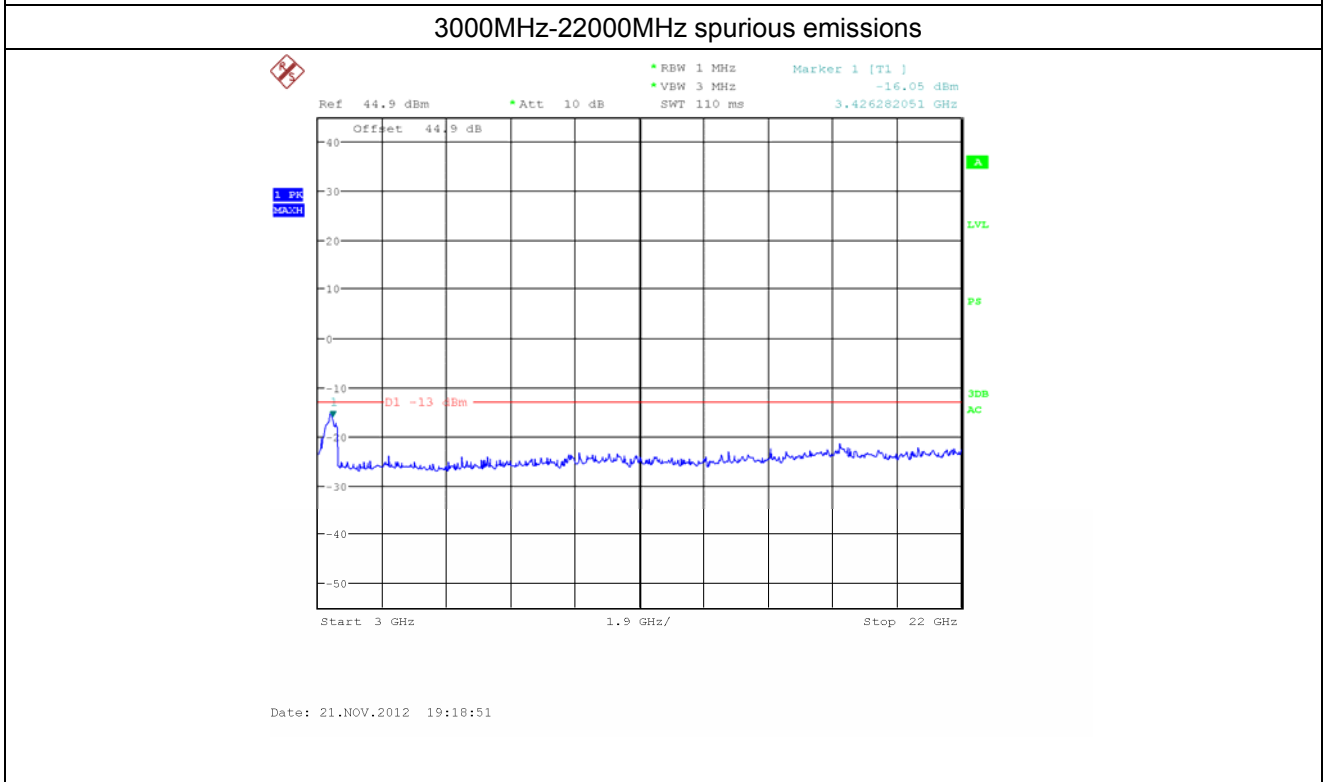
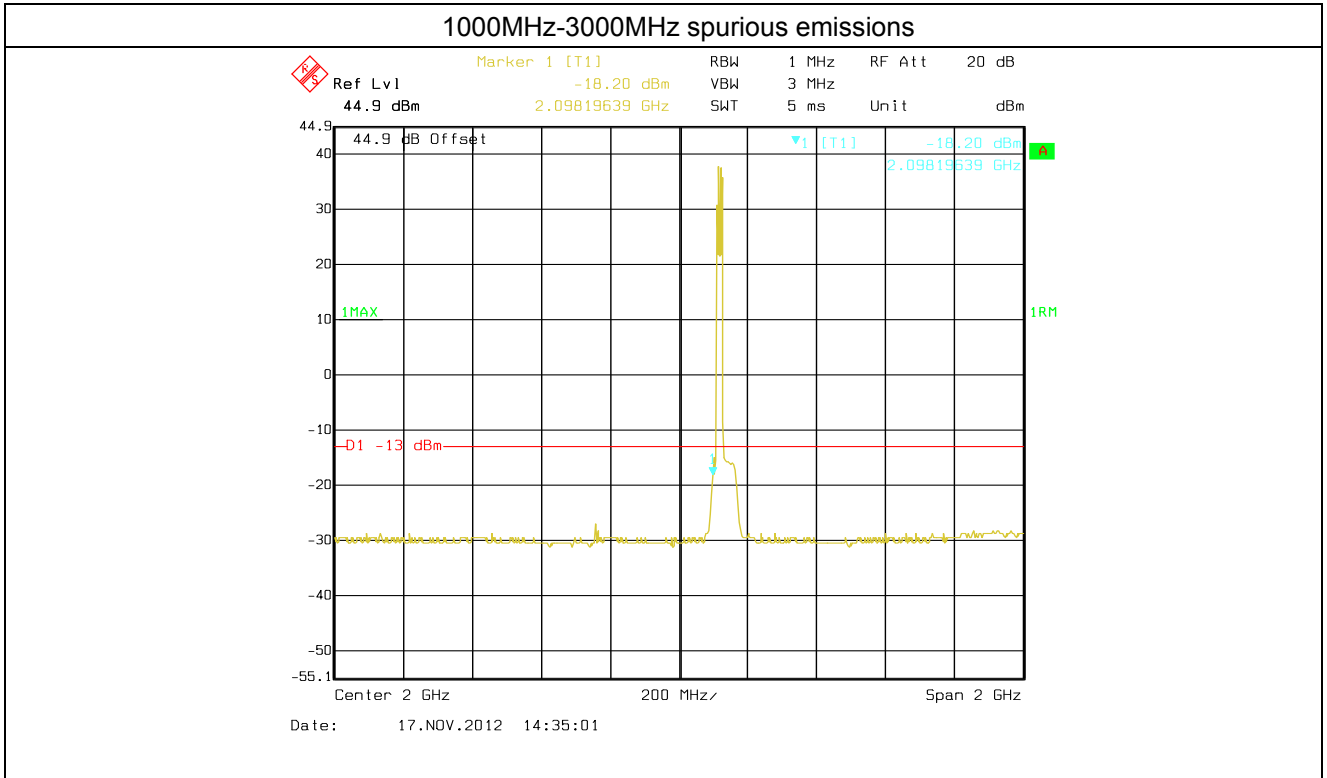

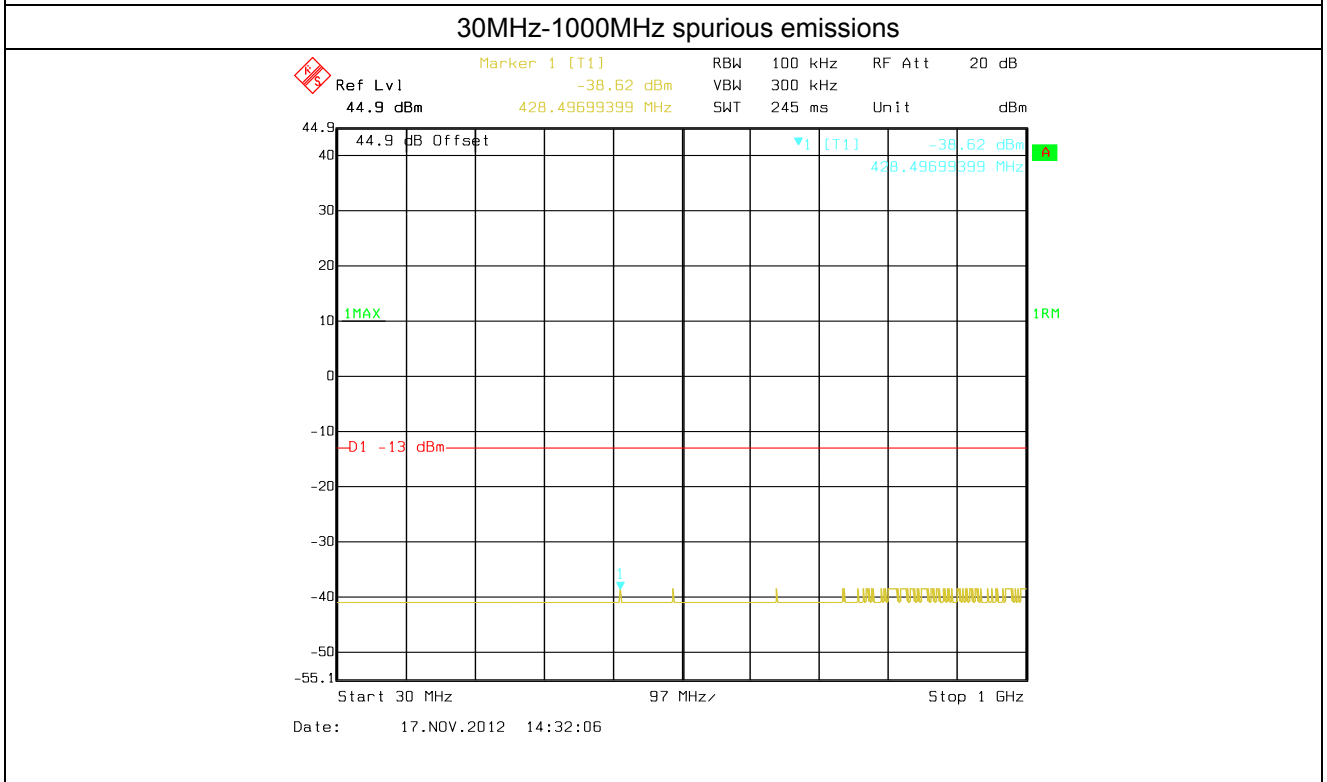
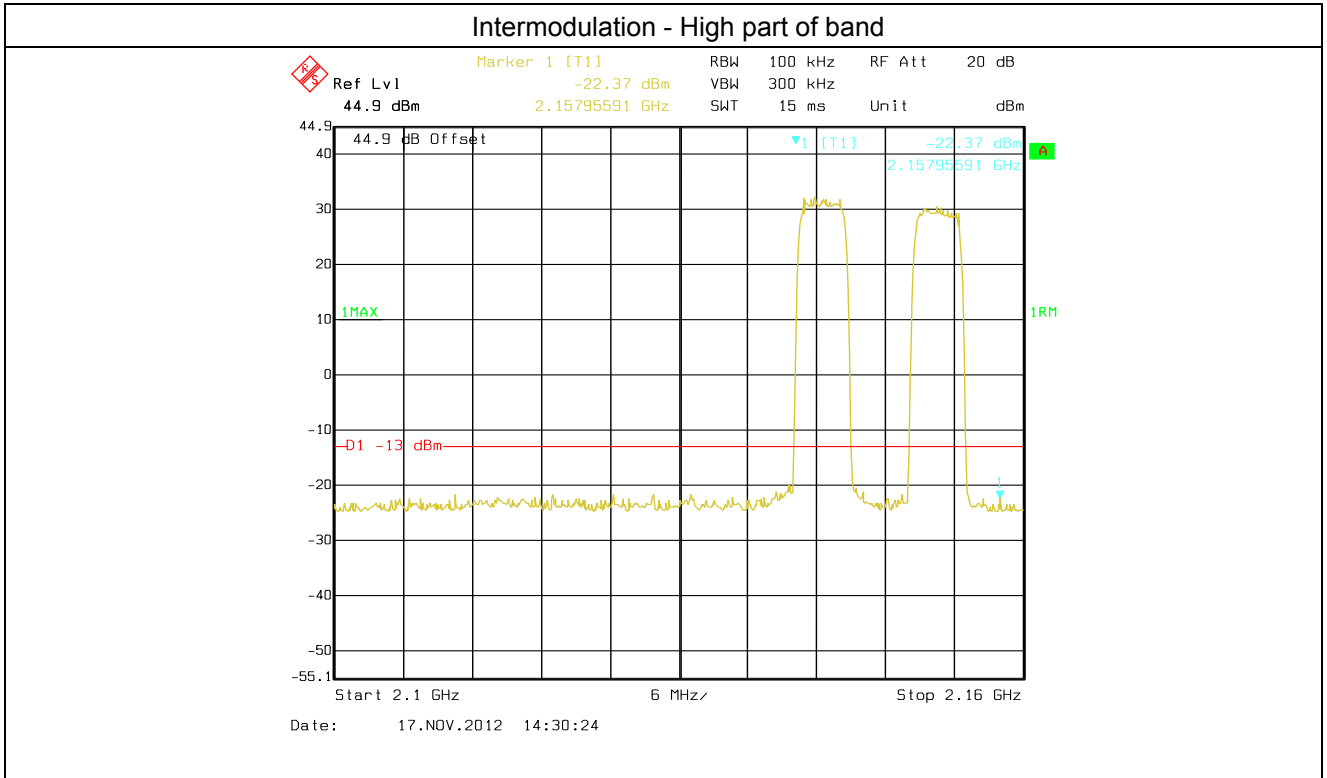

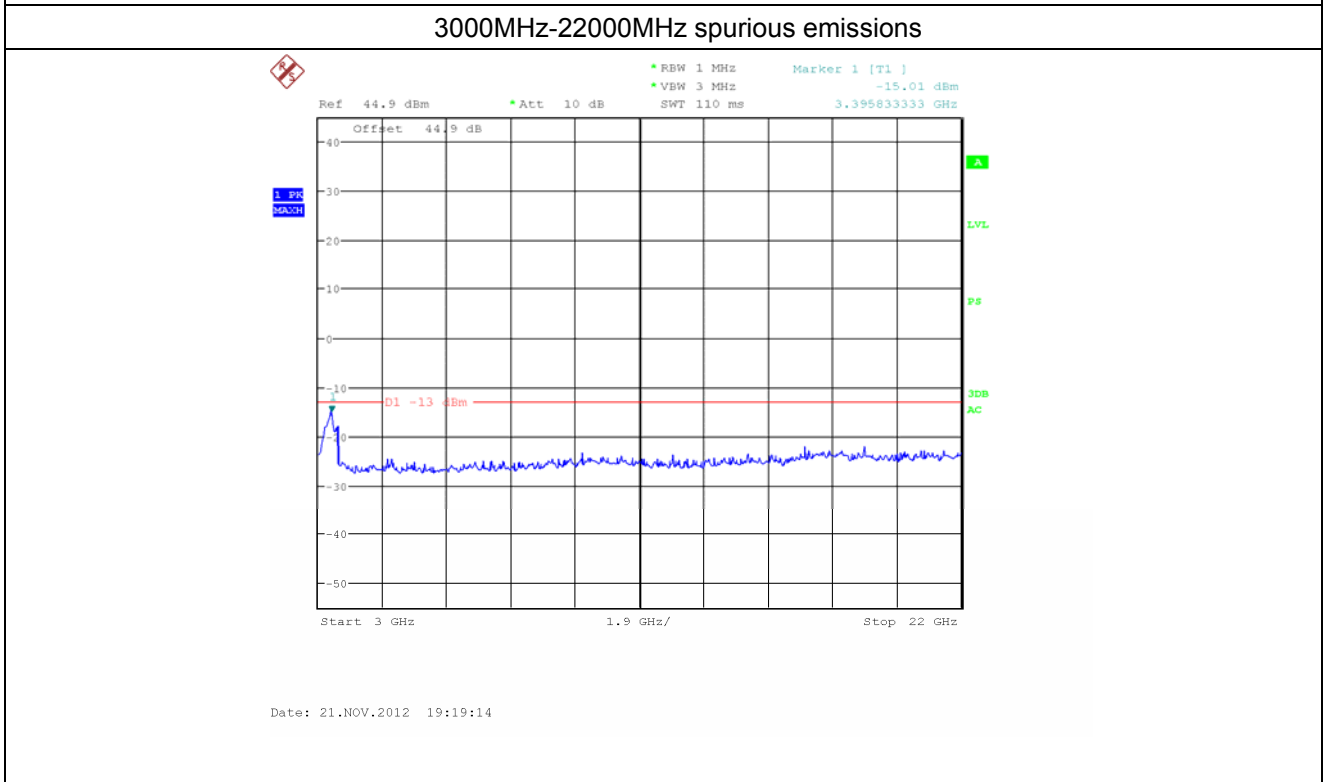
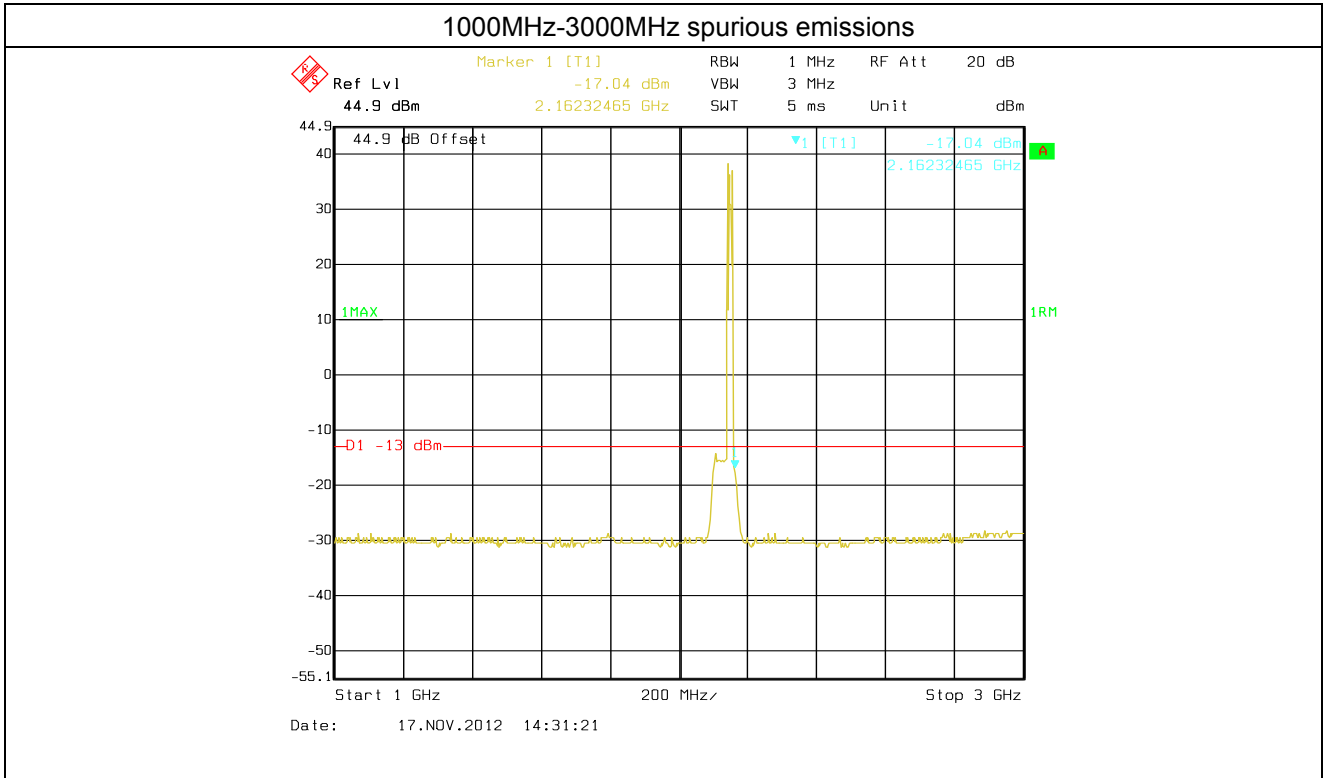

Intermodulation of CDMA

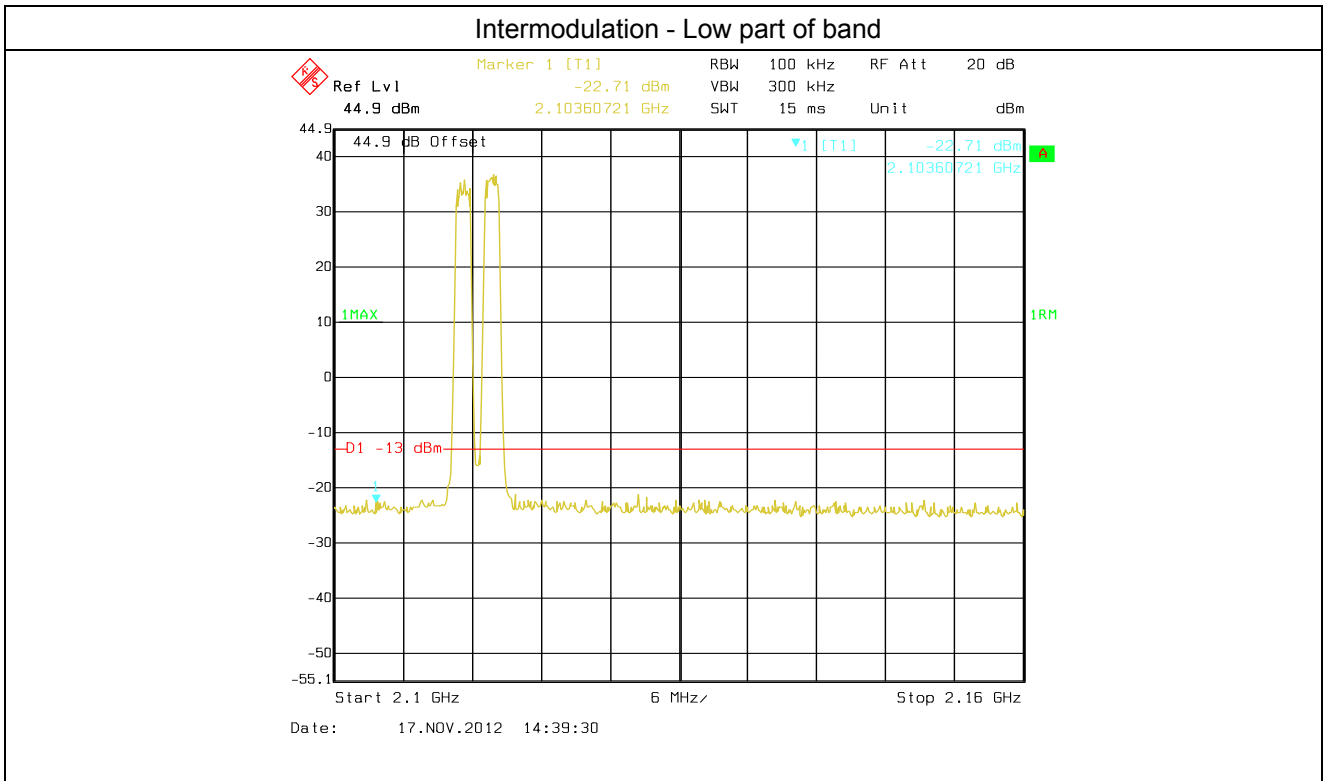

30MHz-1000MHz spurious emissions

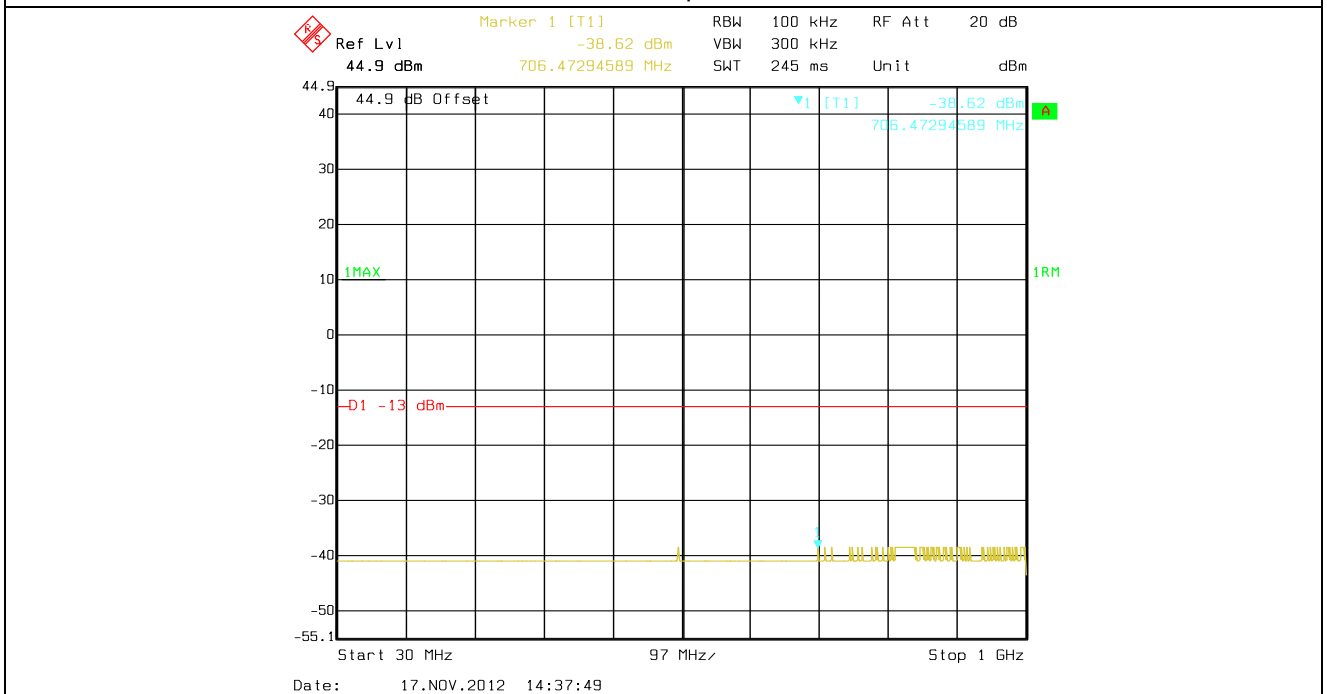

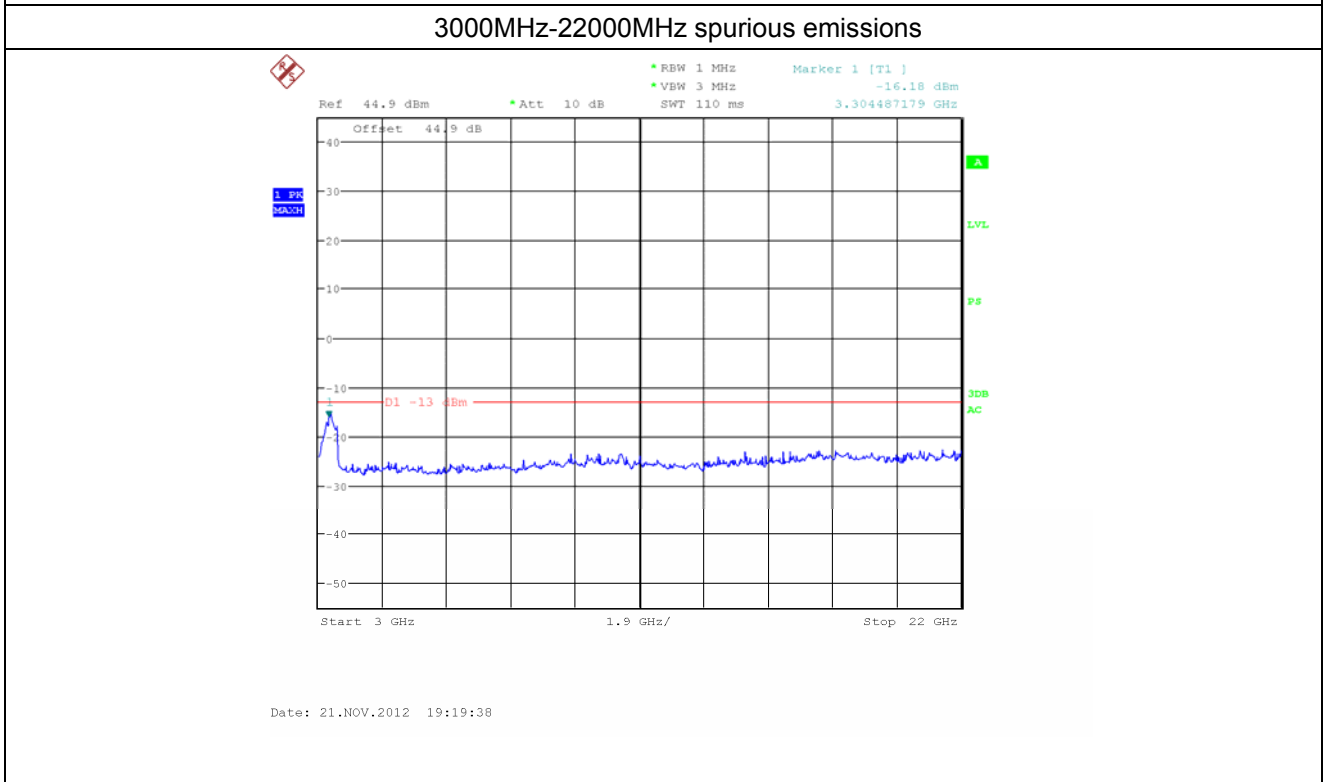
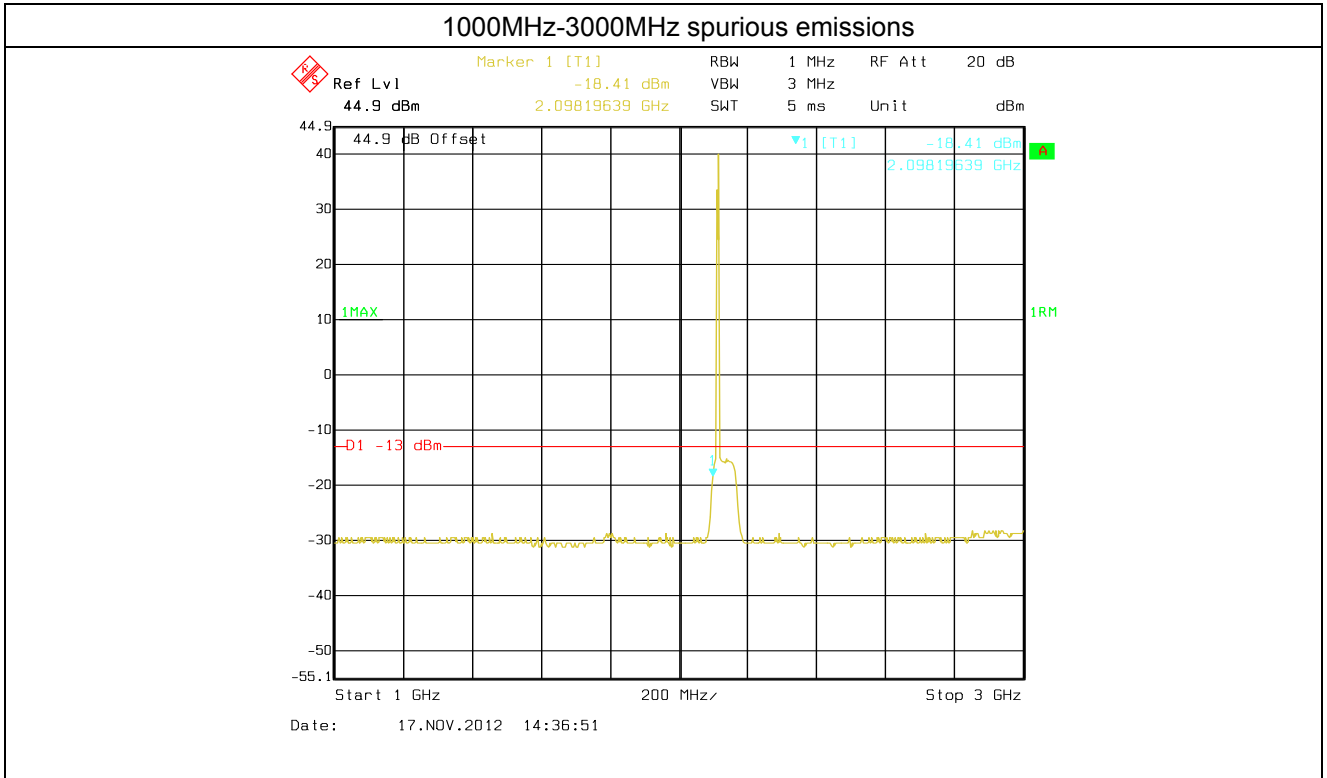

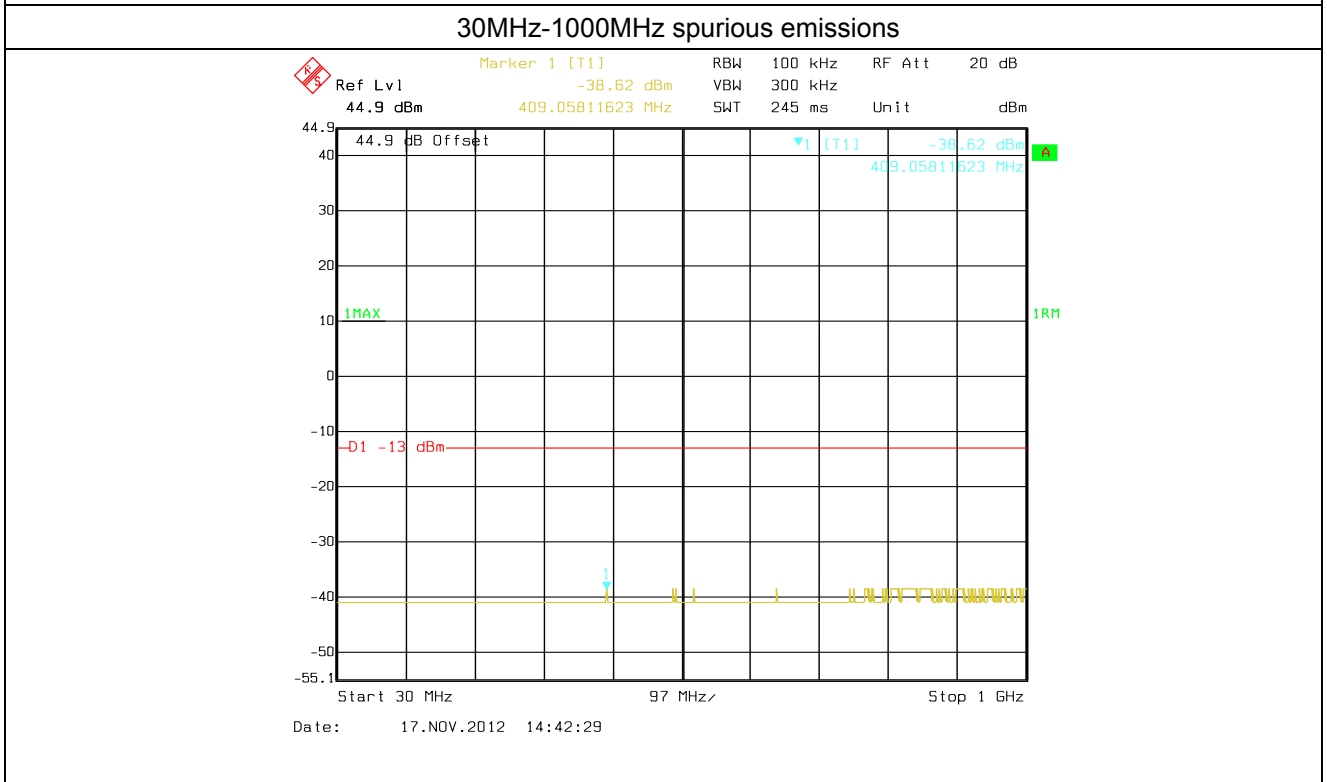
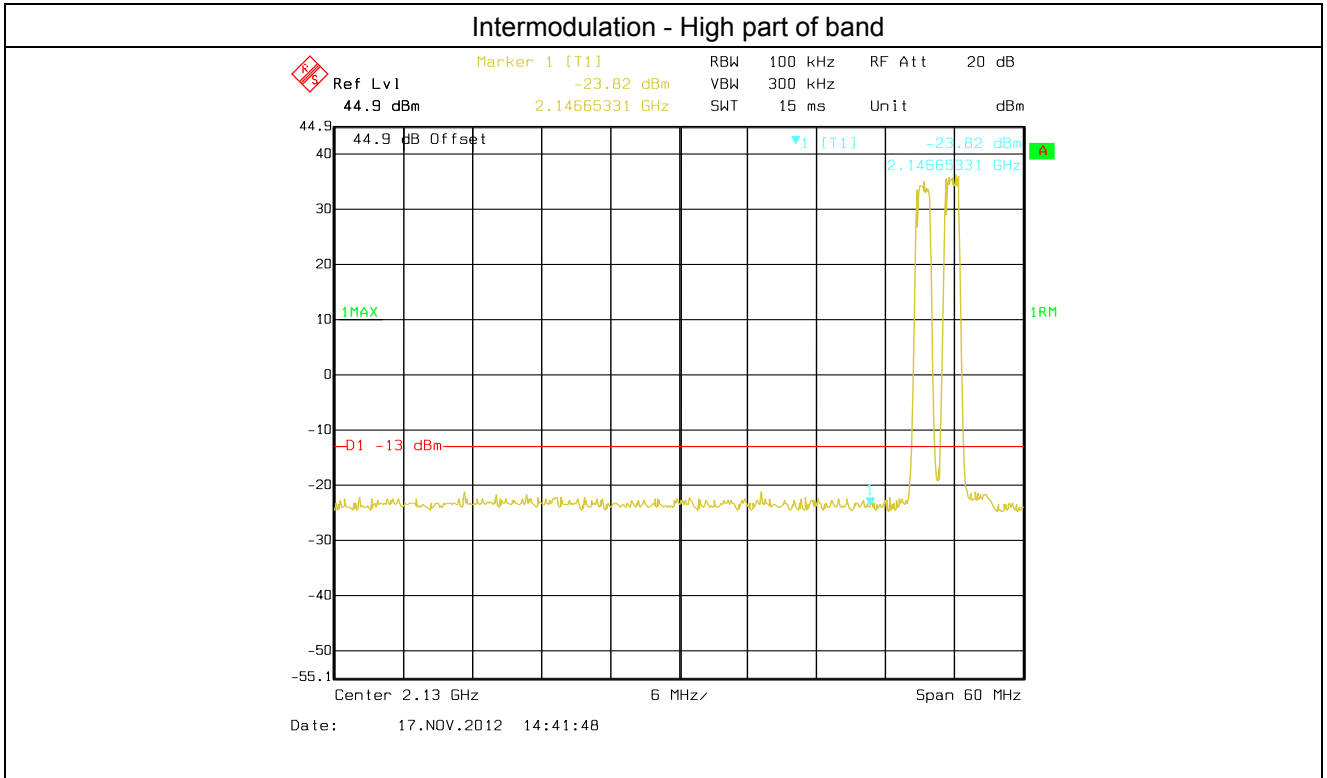

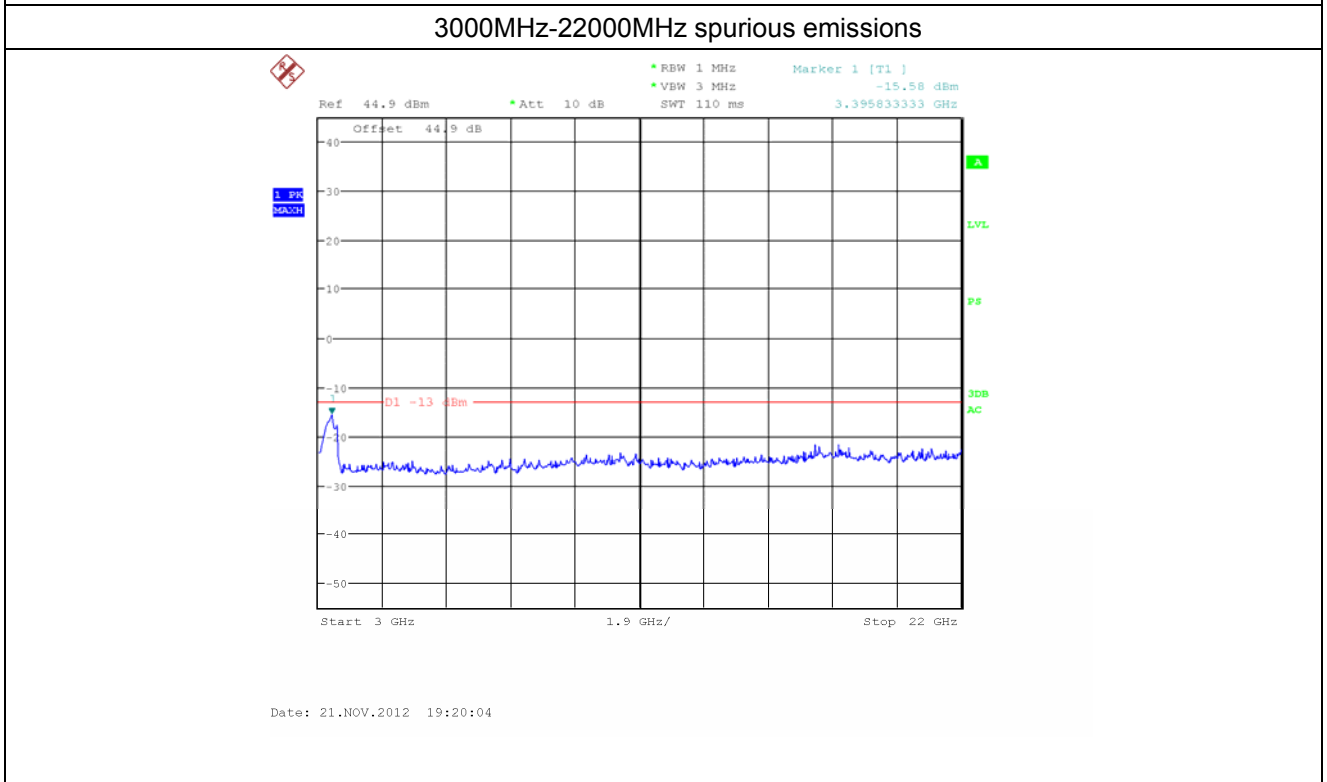
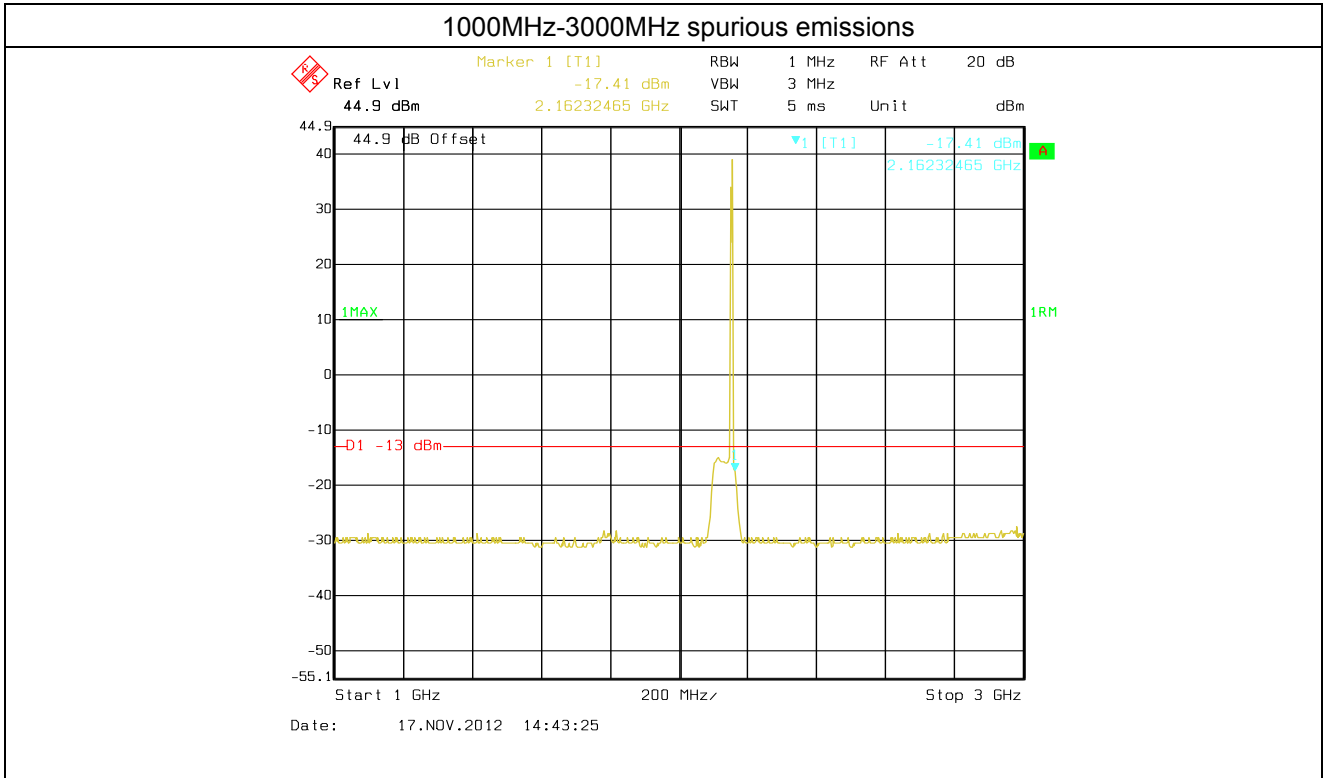

Intermodulation of EVDO(0%)

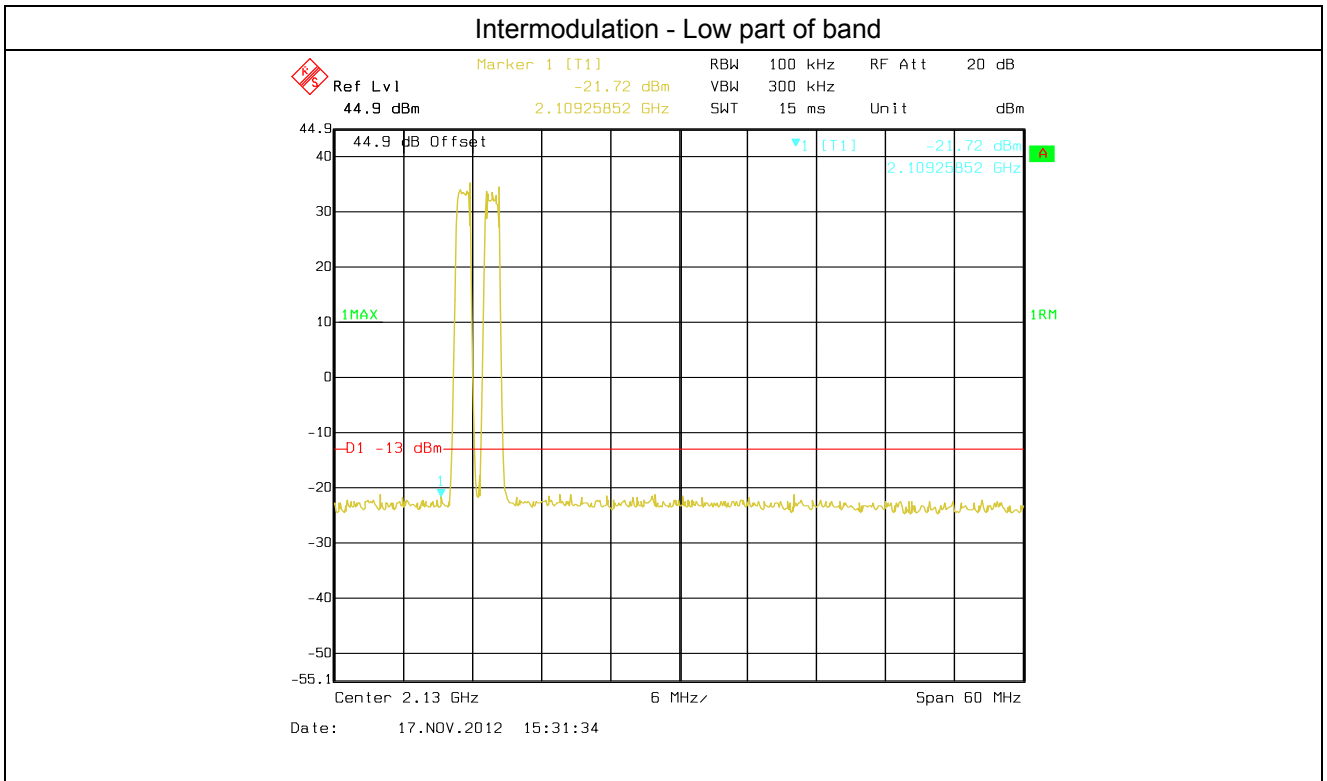

30MHz-1000MHz spurious emissions

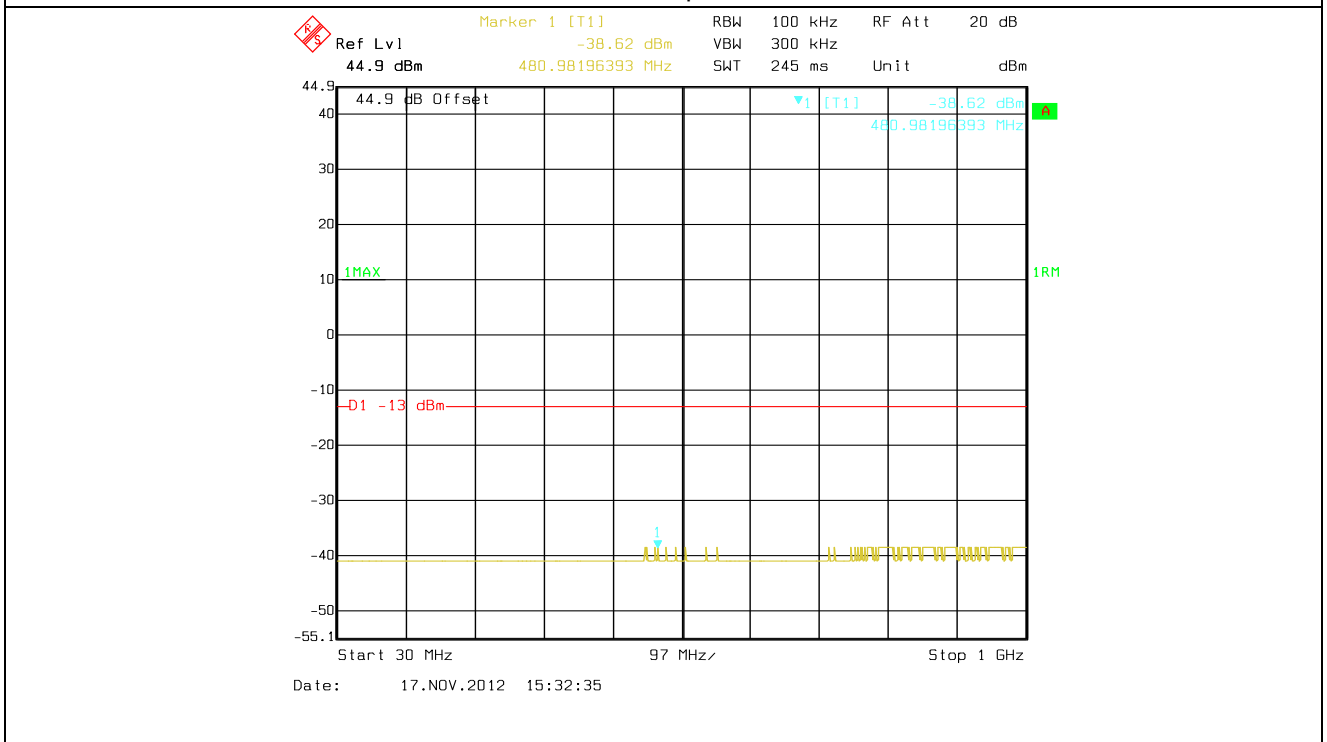

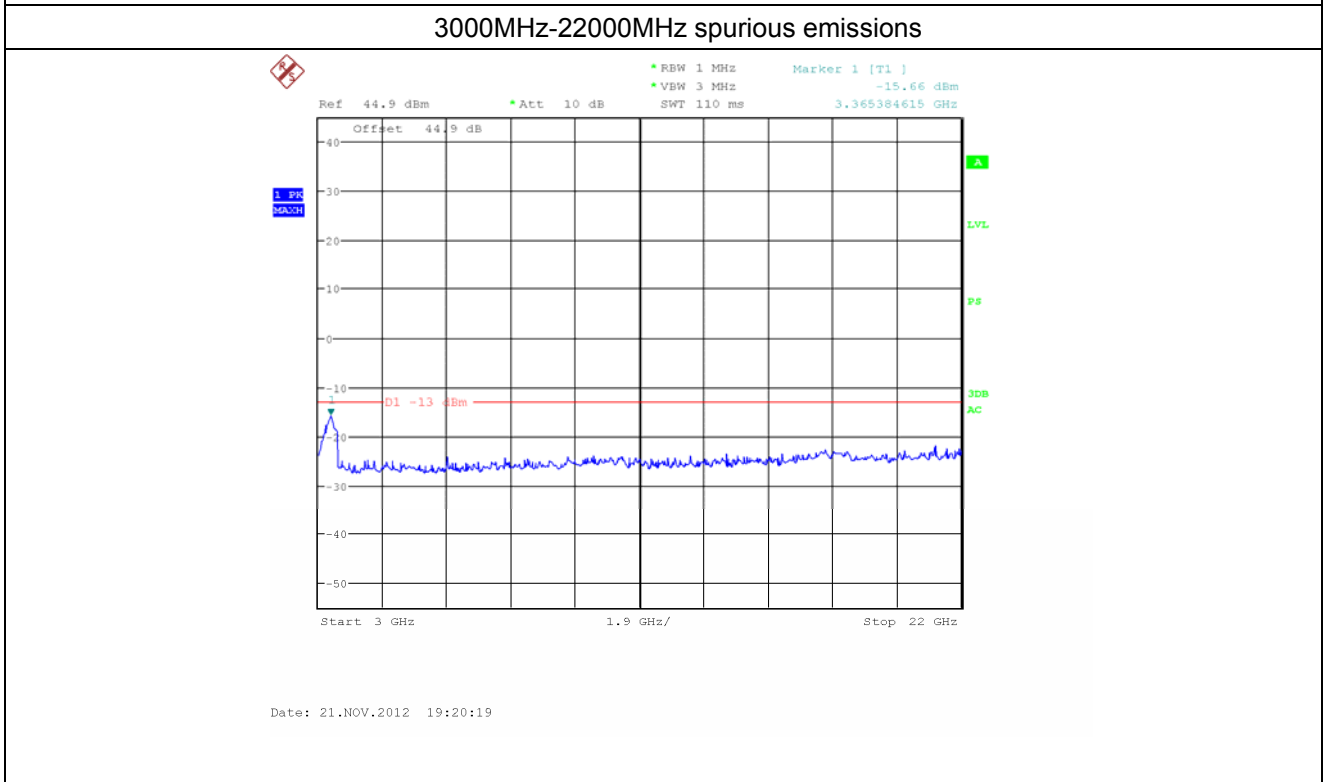
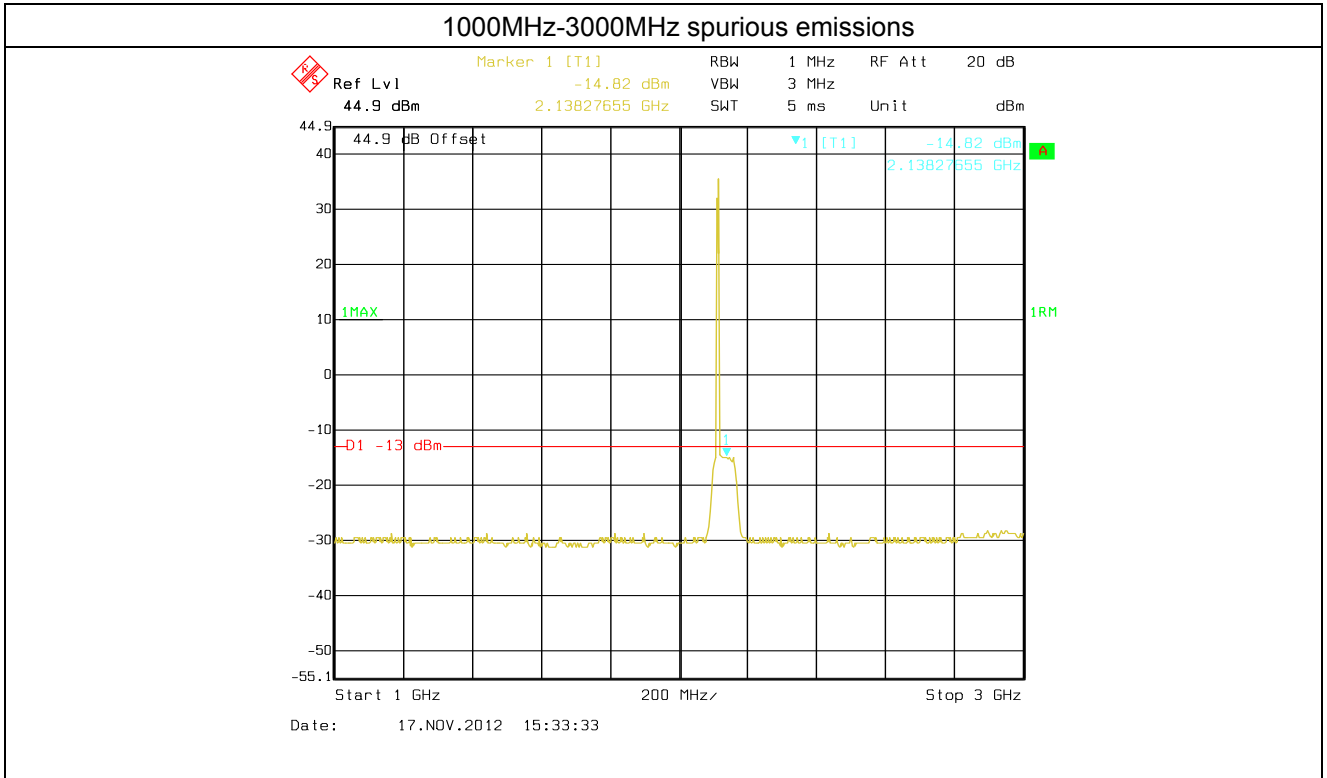

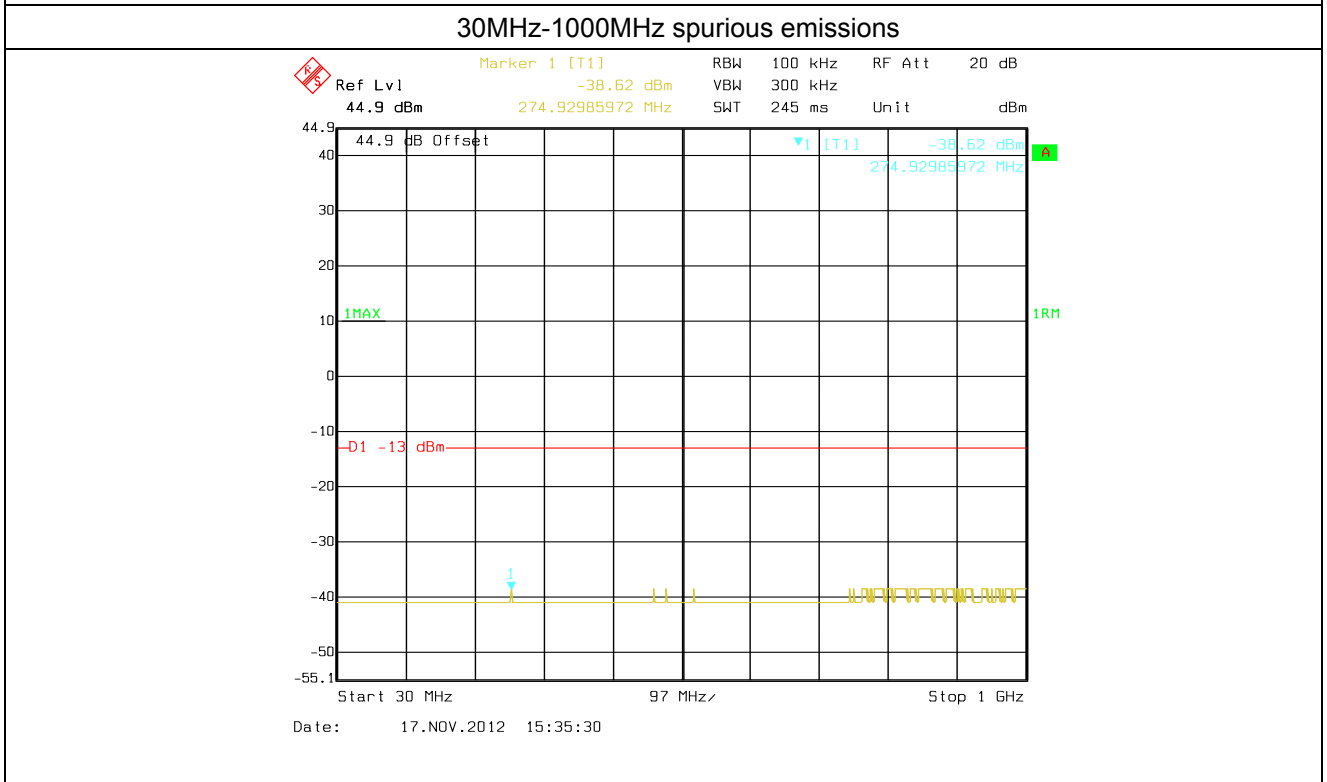
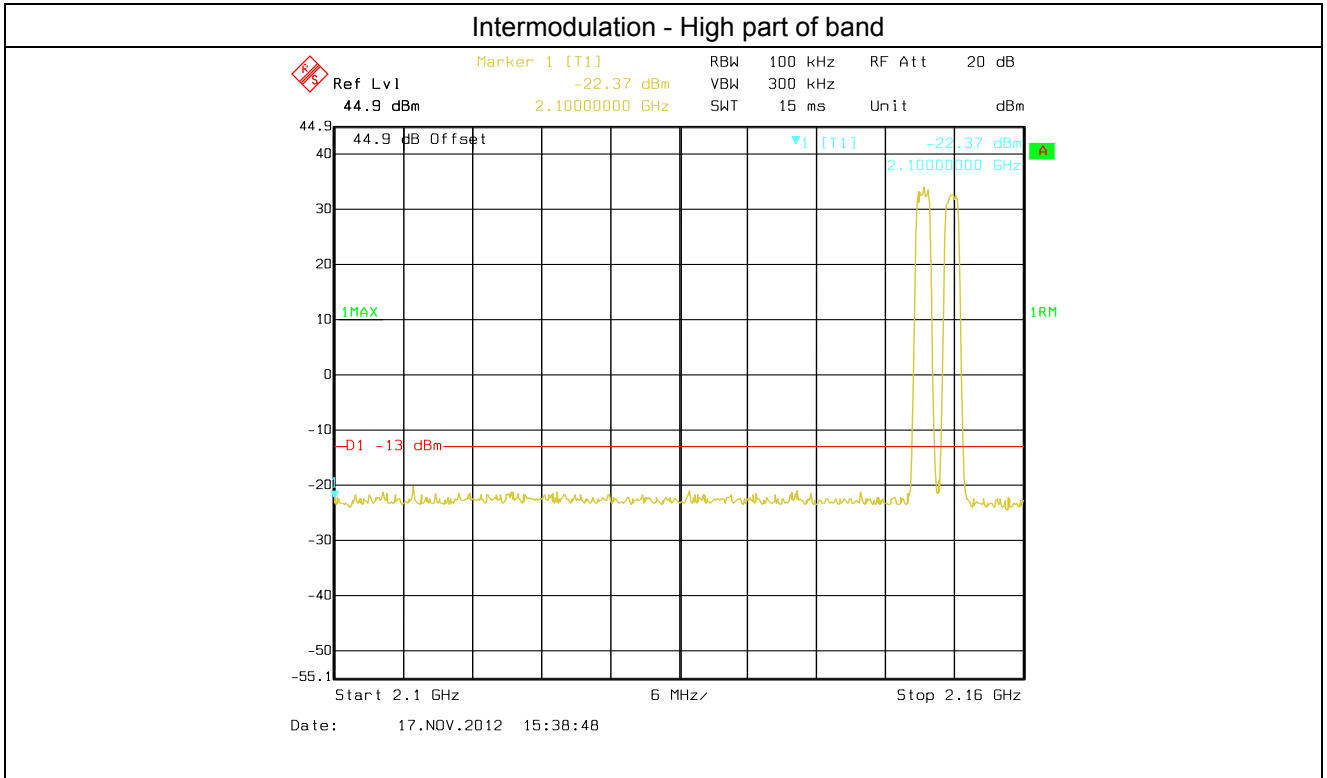

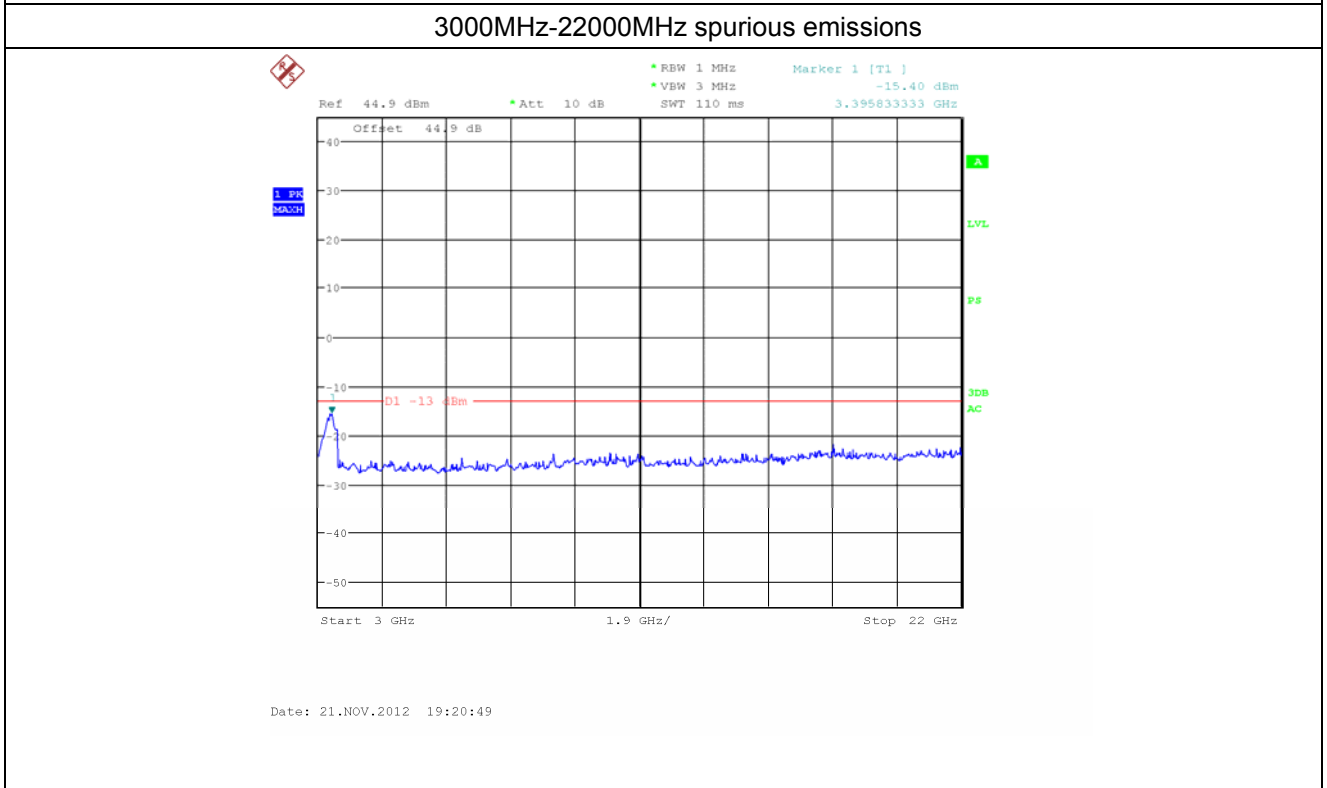
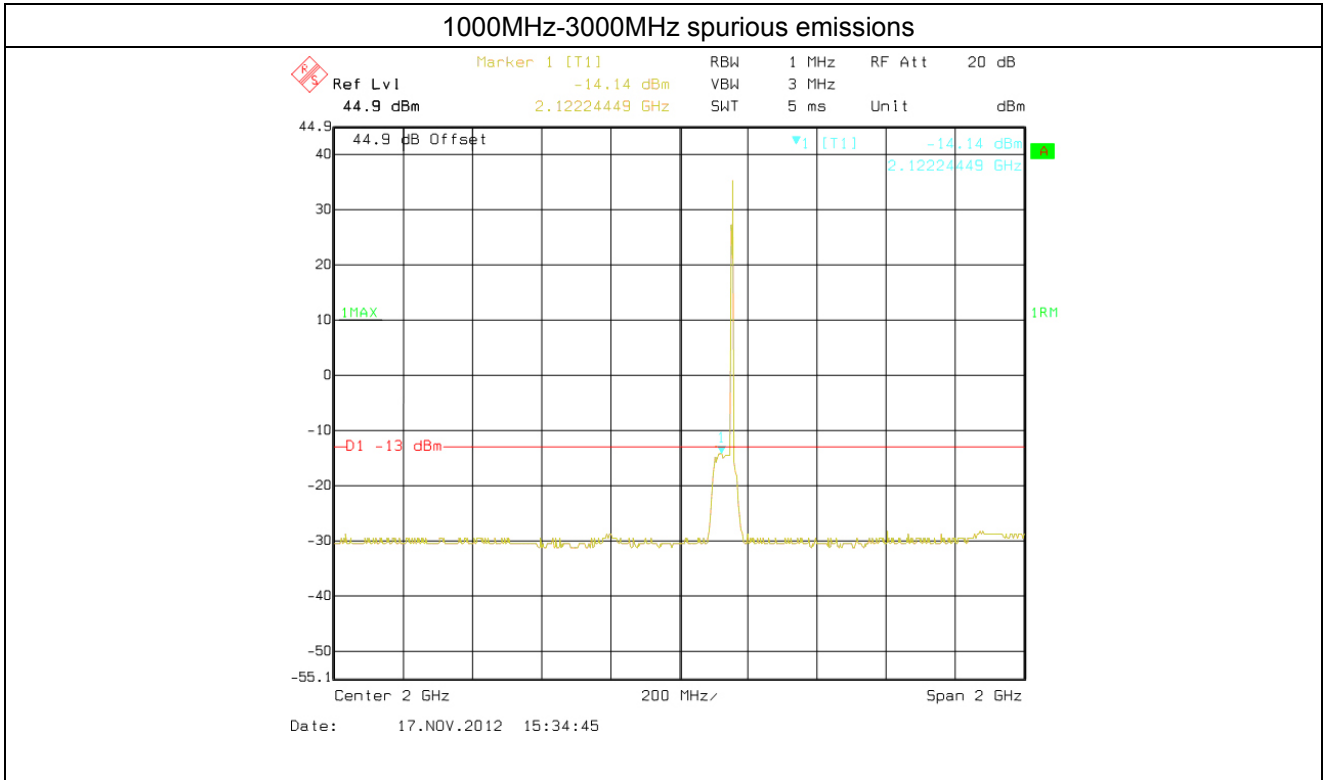

Intermodulation of EVDO(50%)

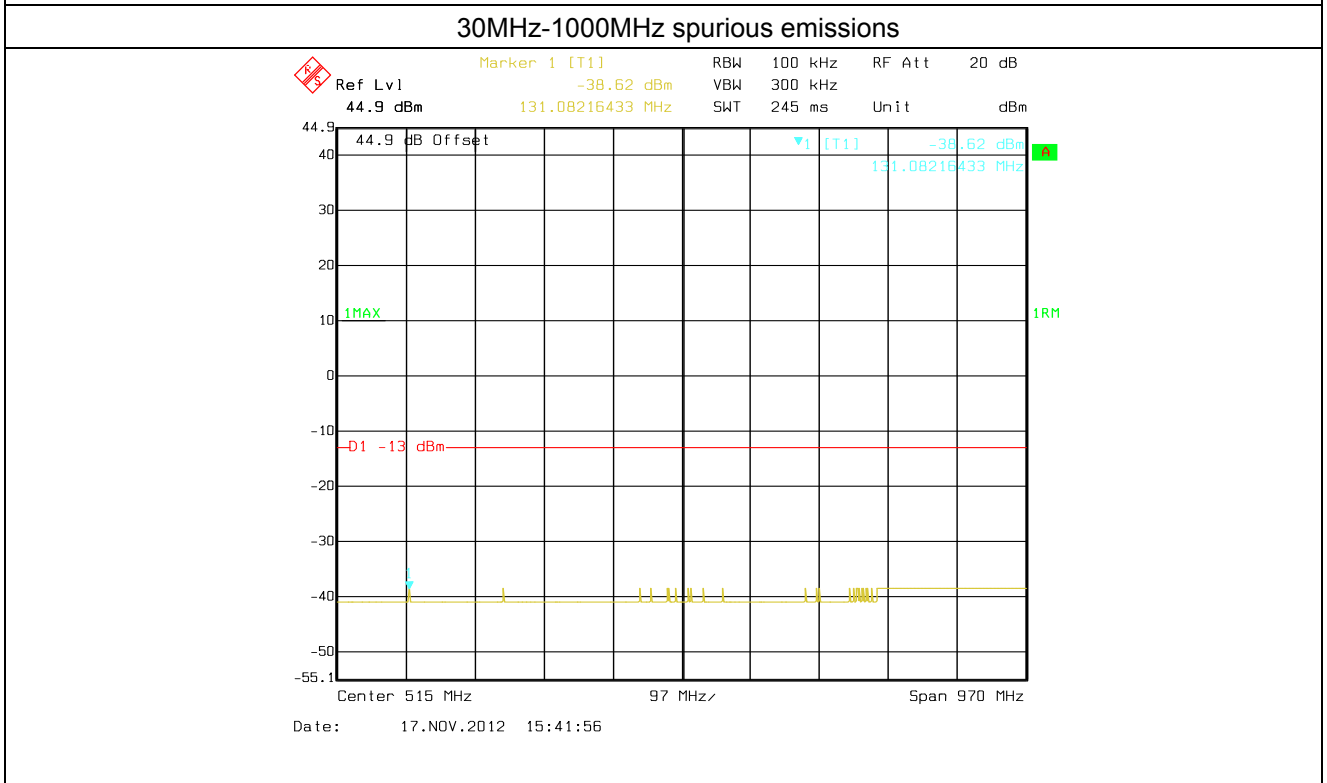
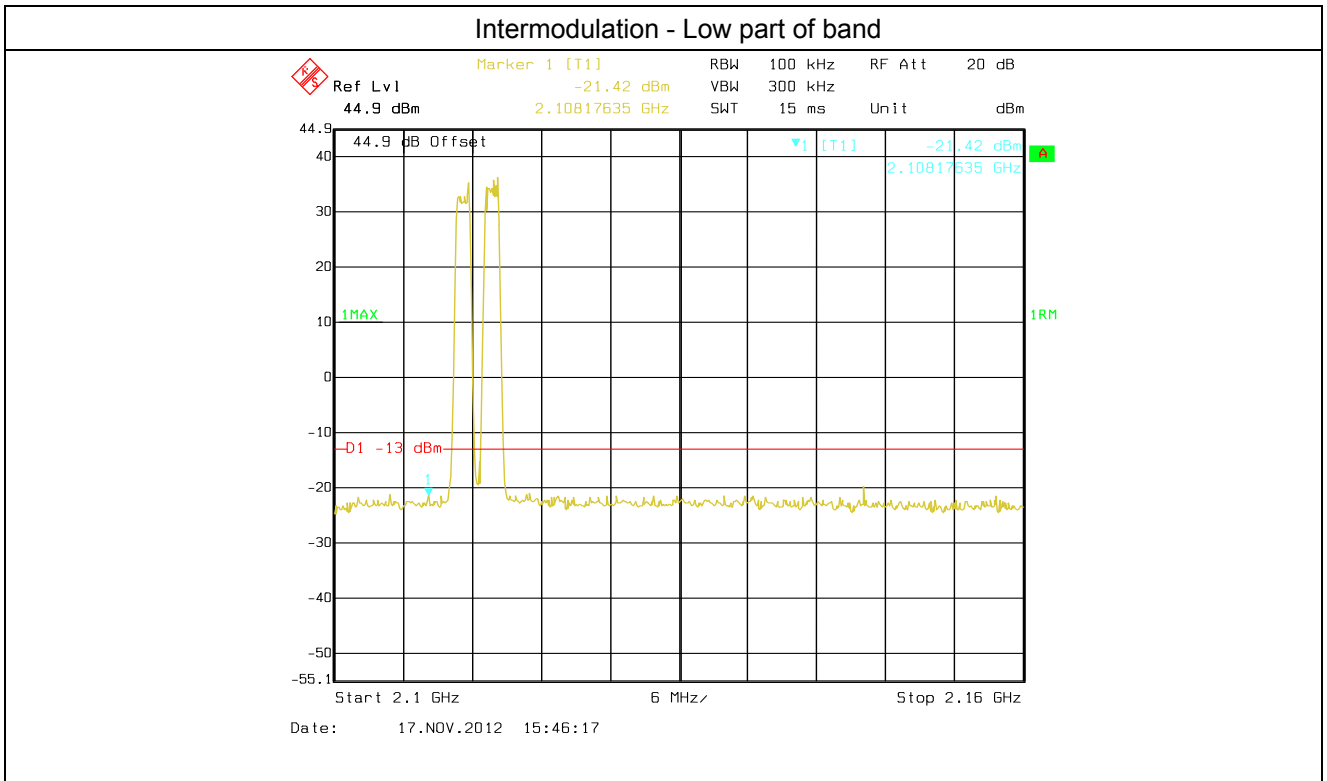

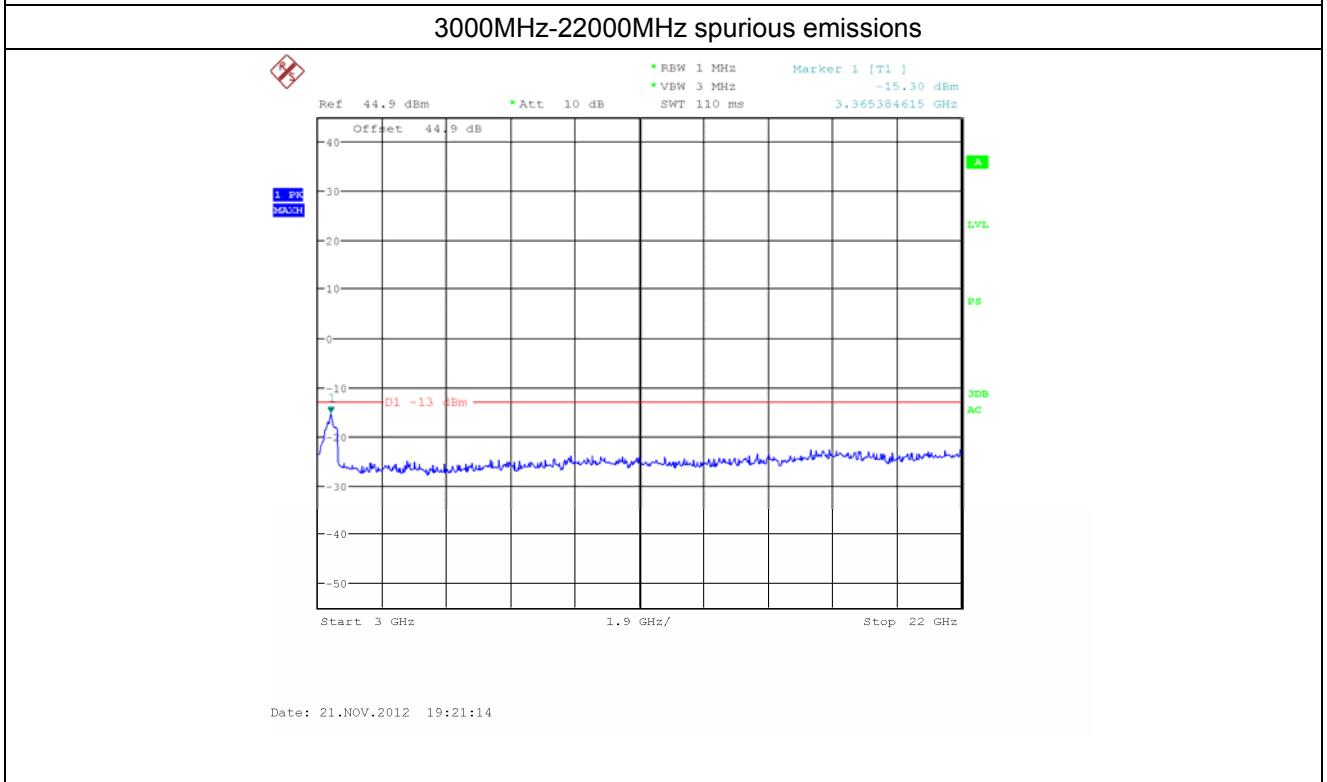
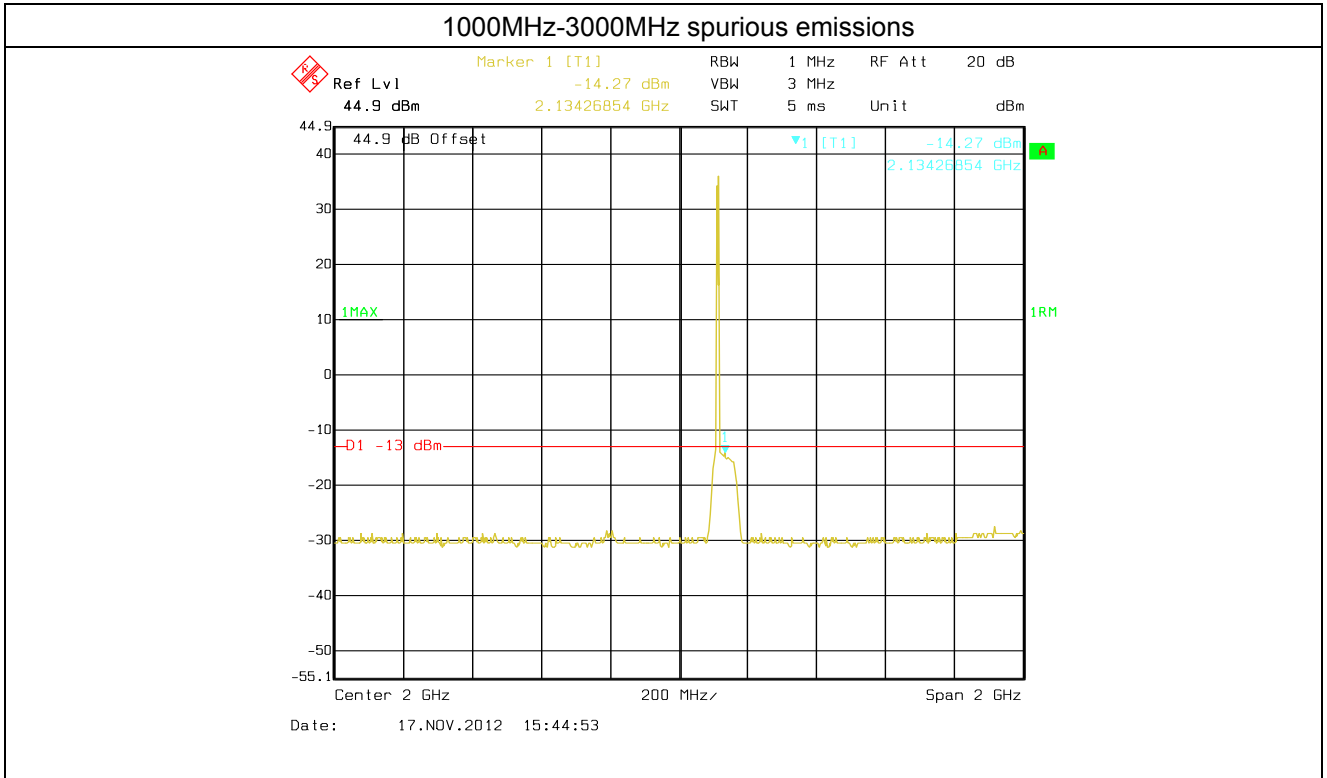

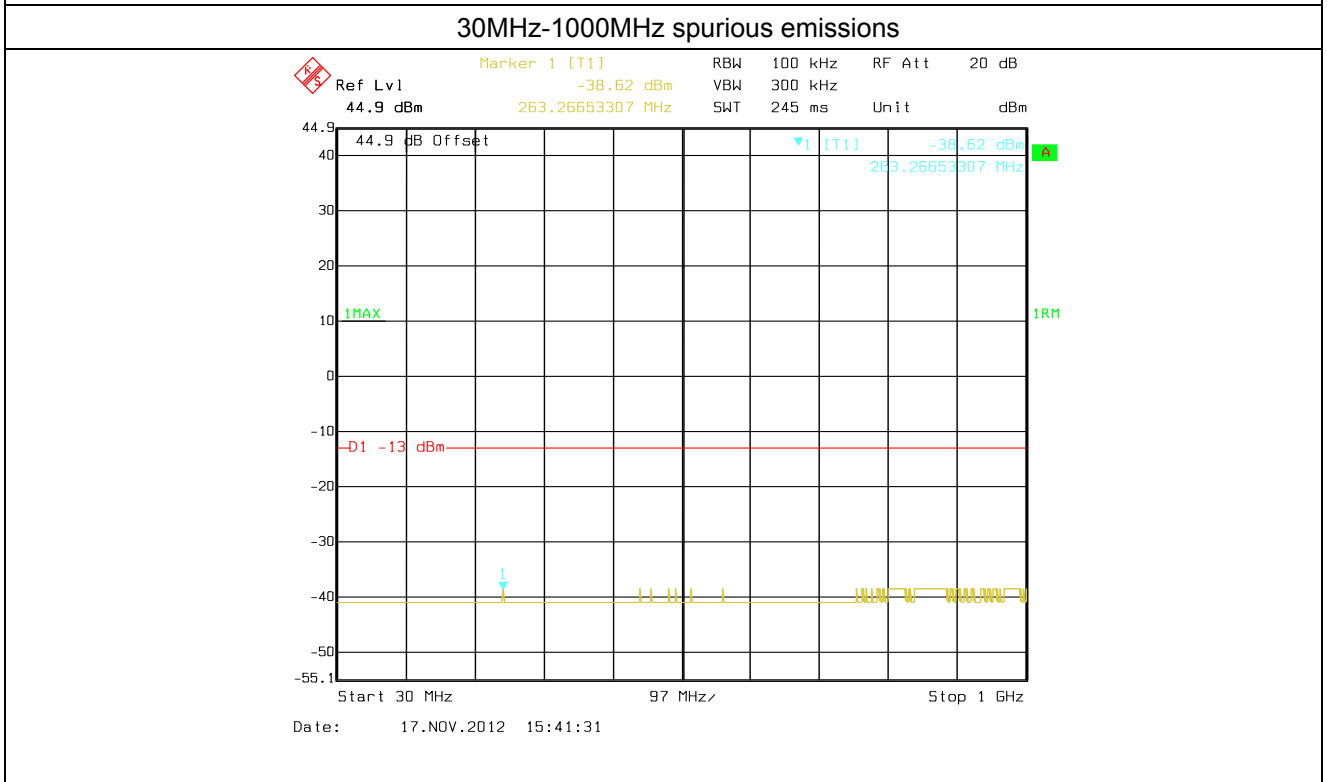
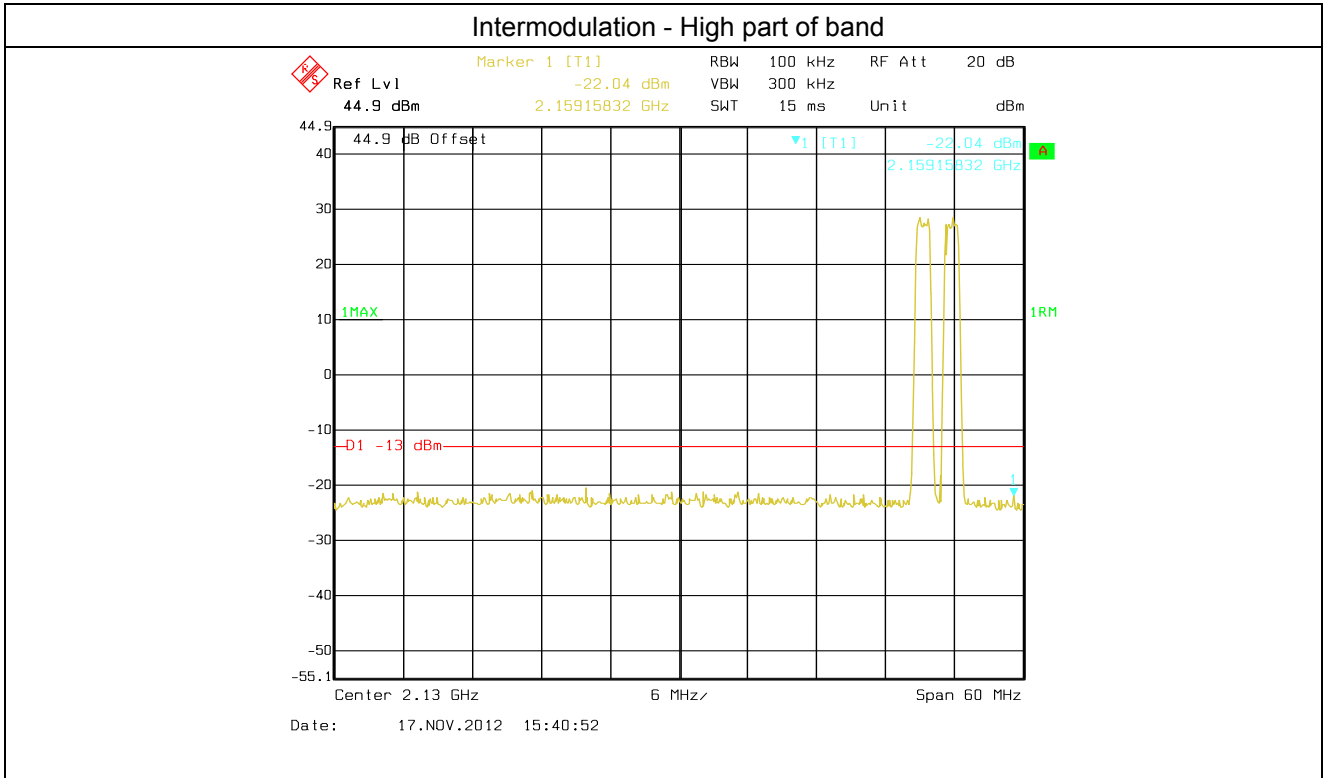

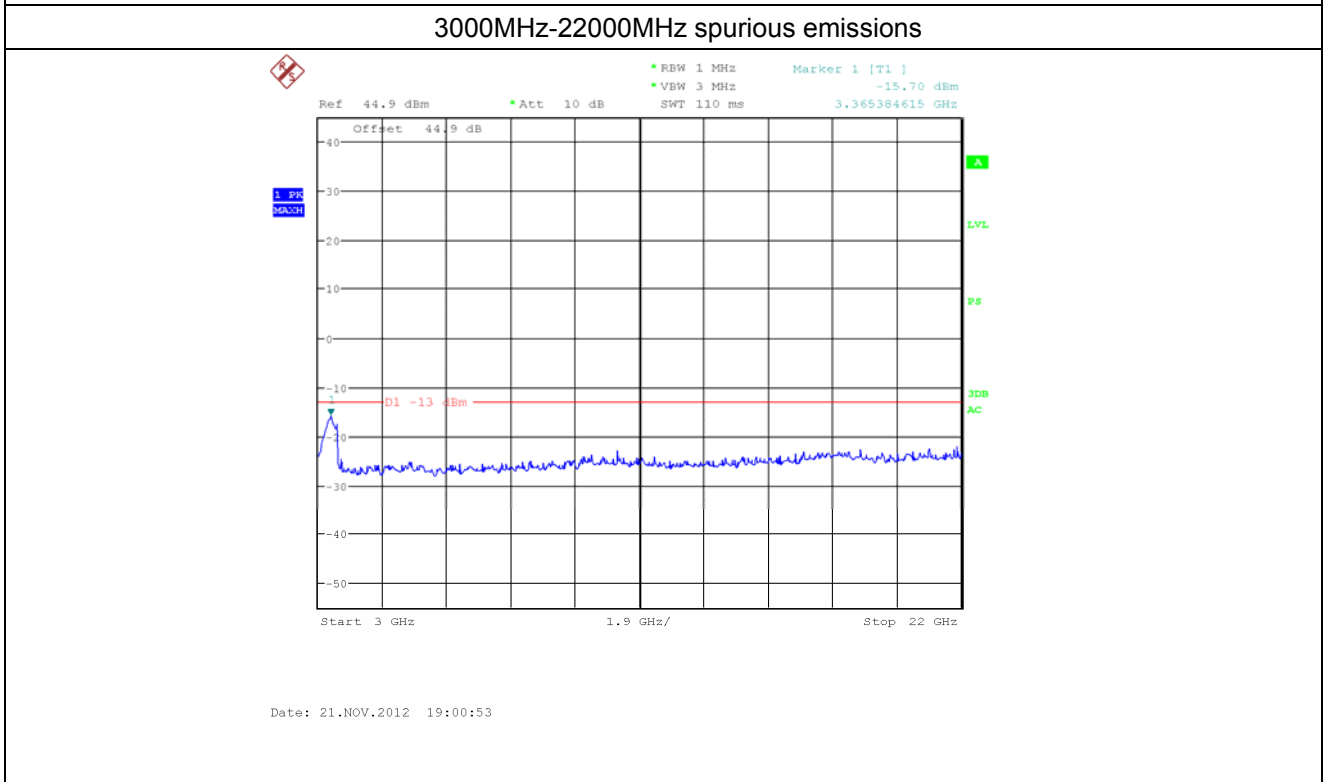
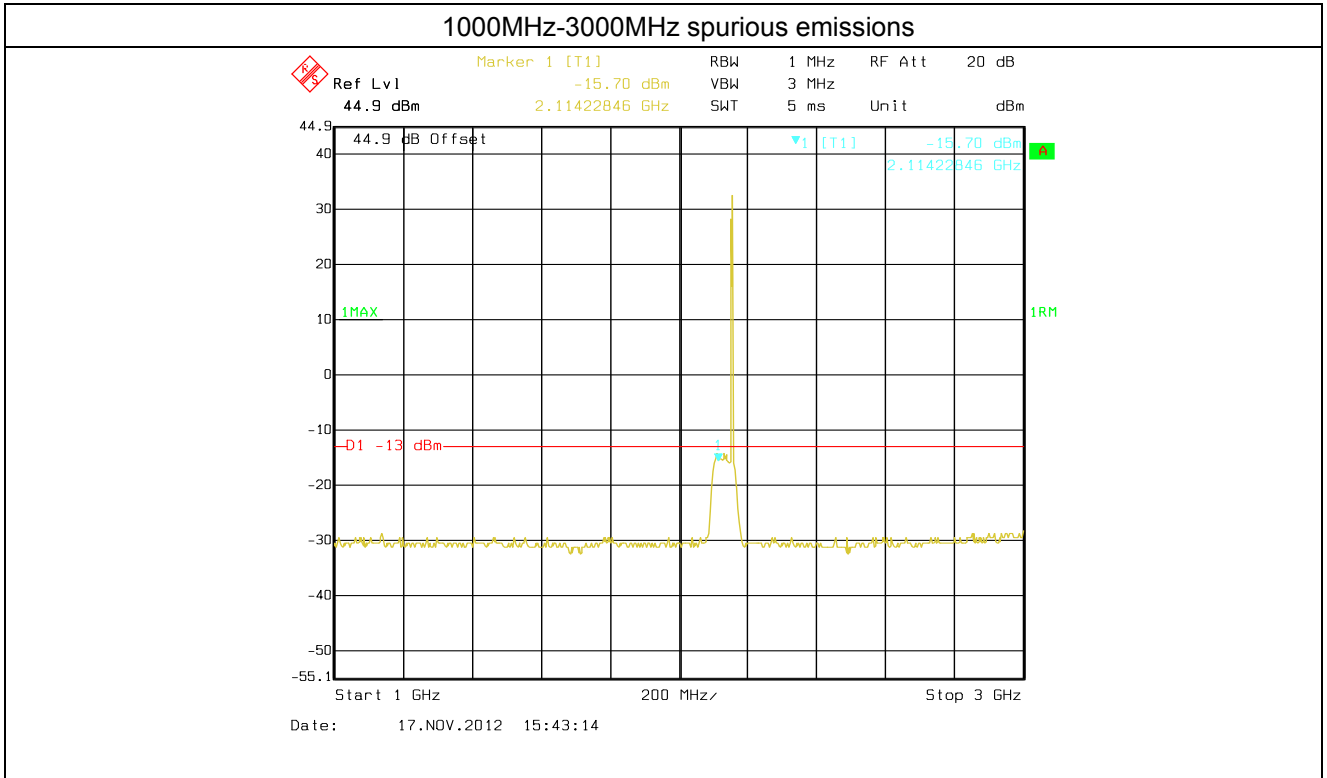

Intermodulation of EVDO(100%)

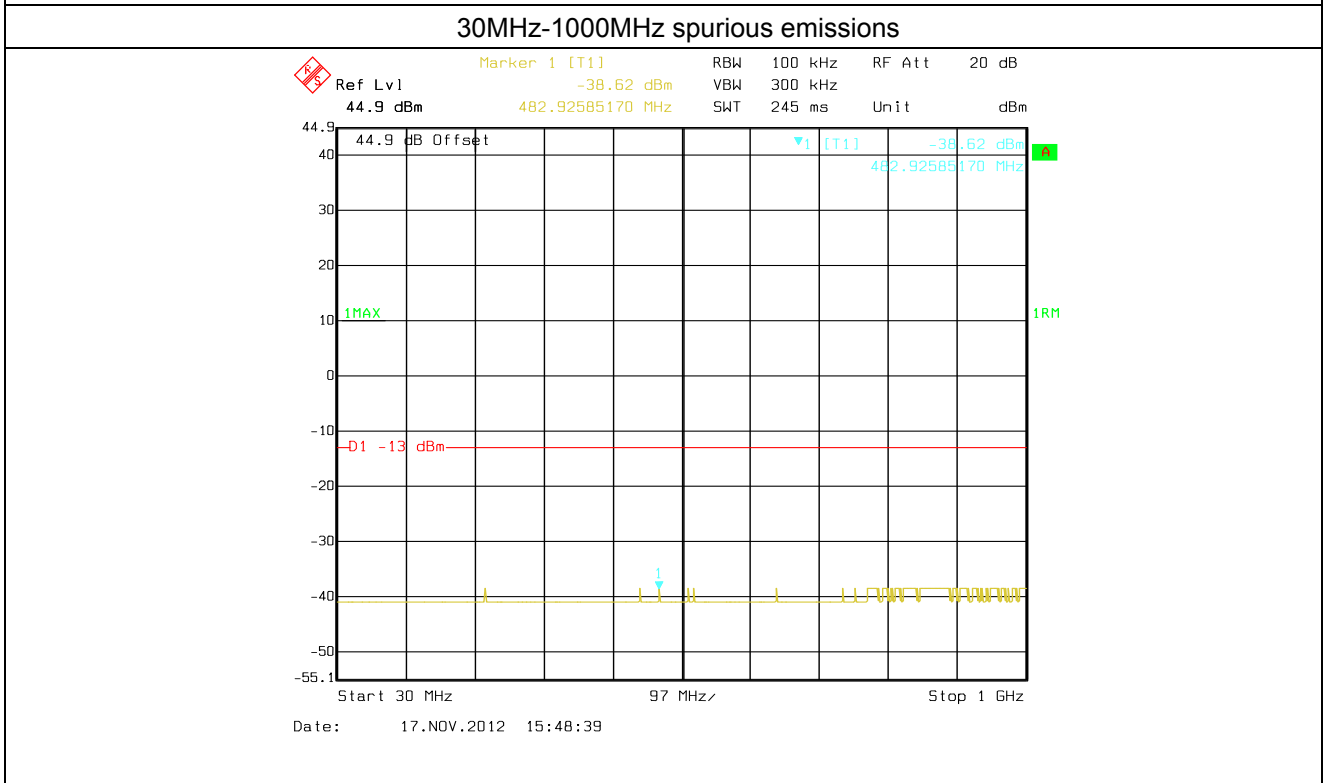
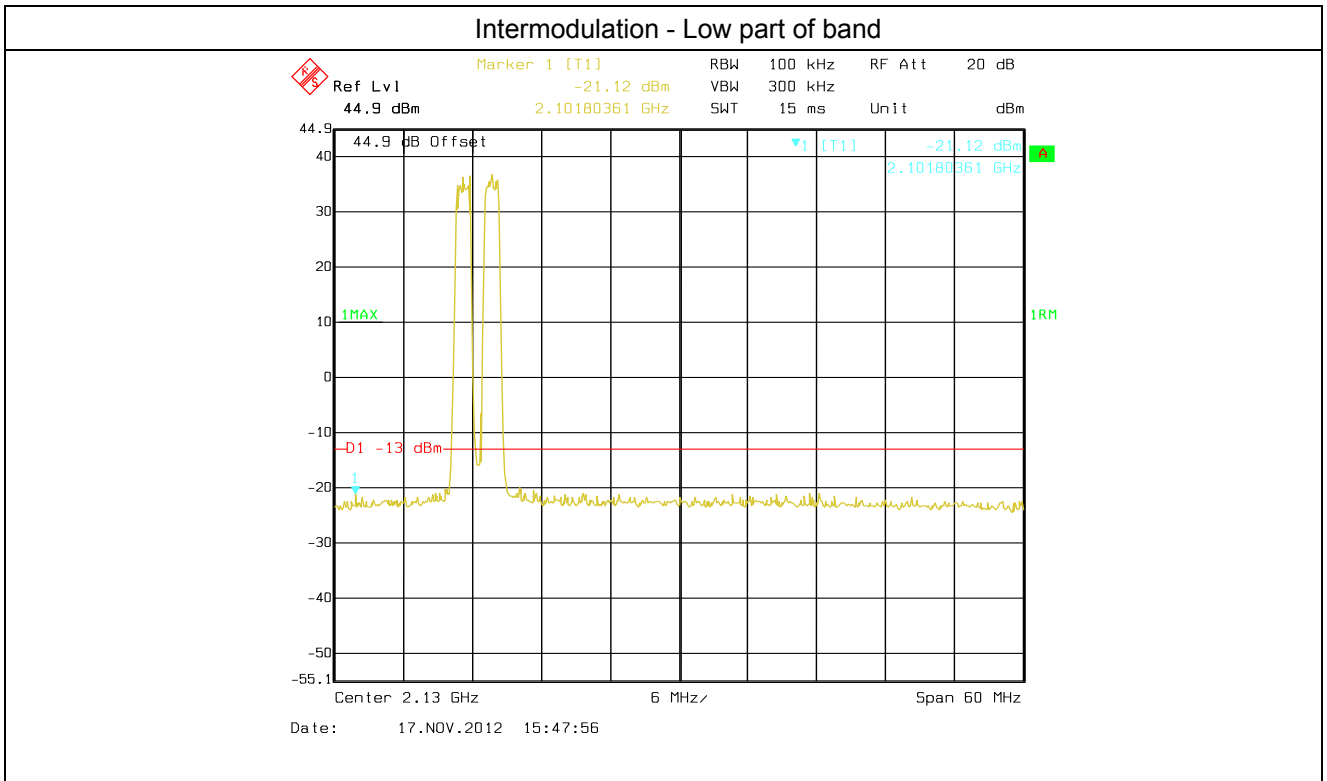

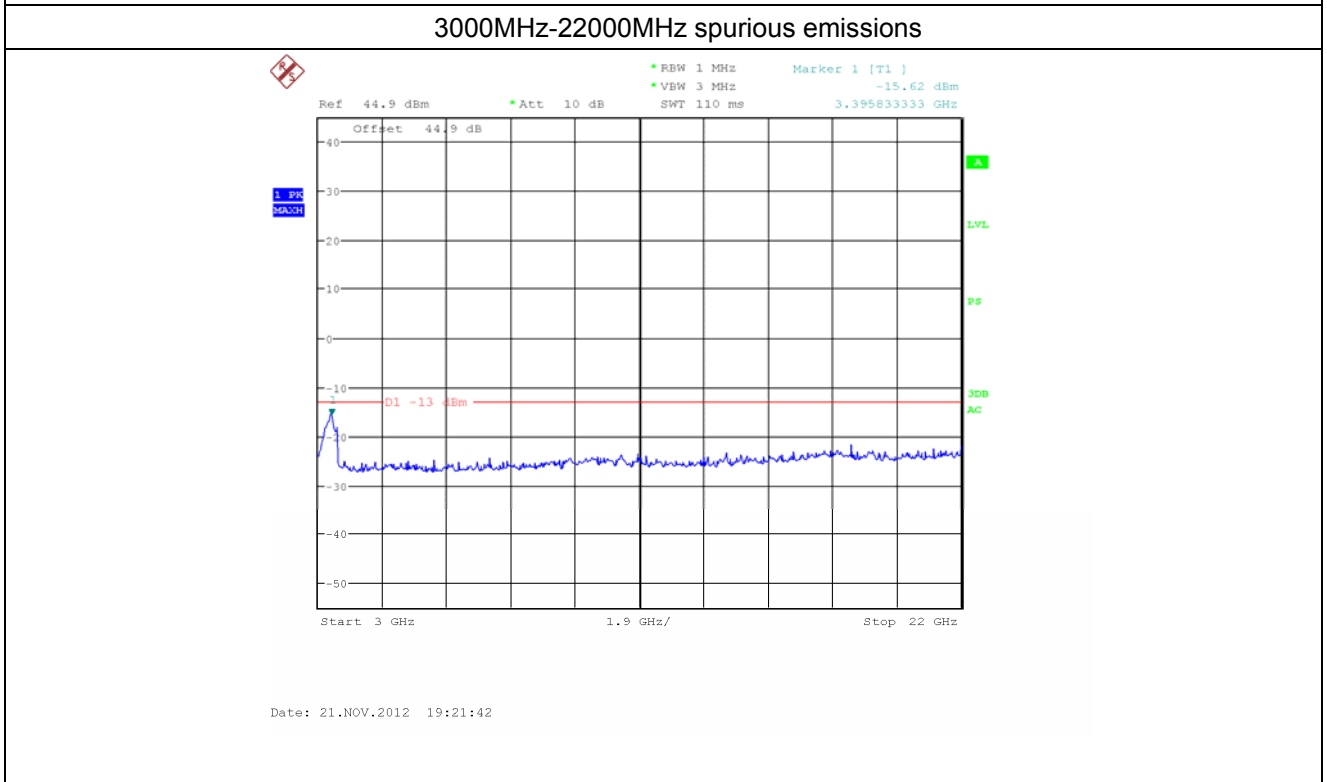
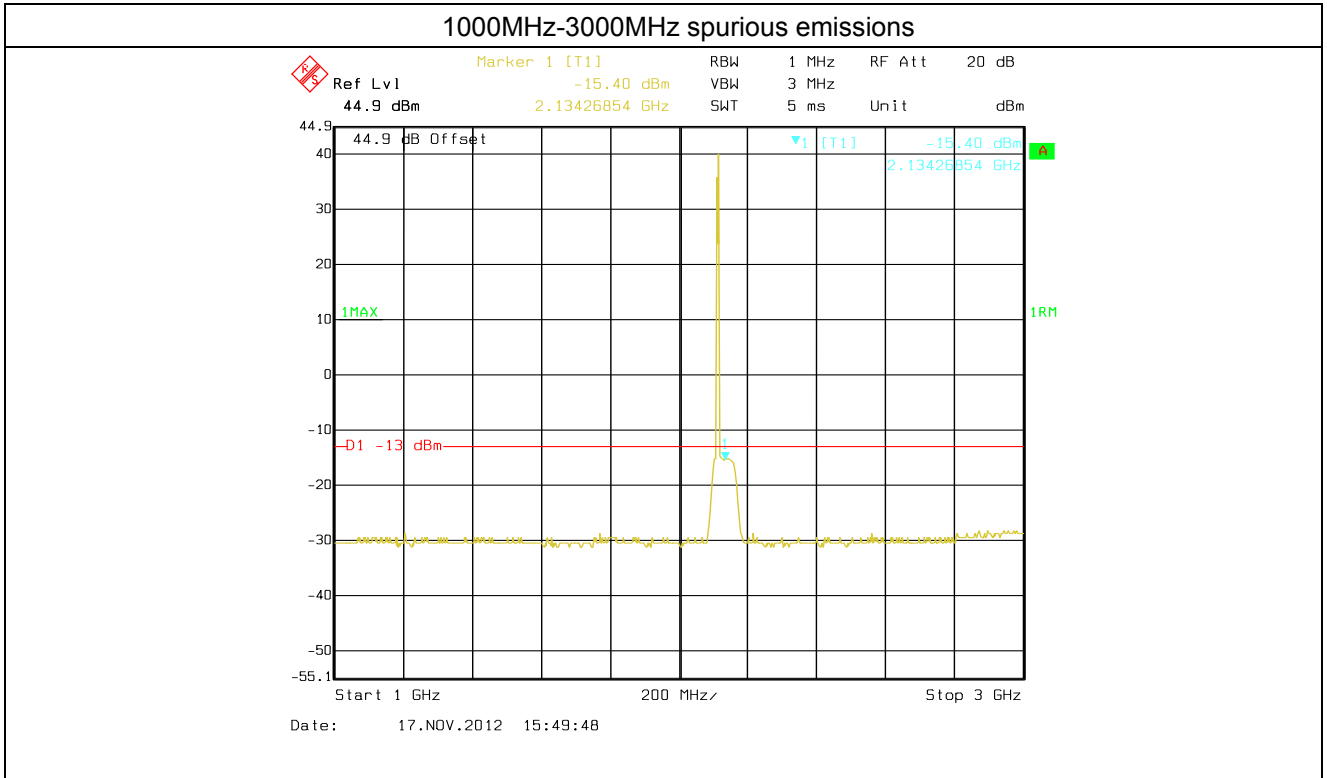

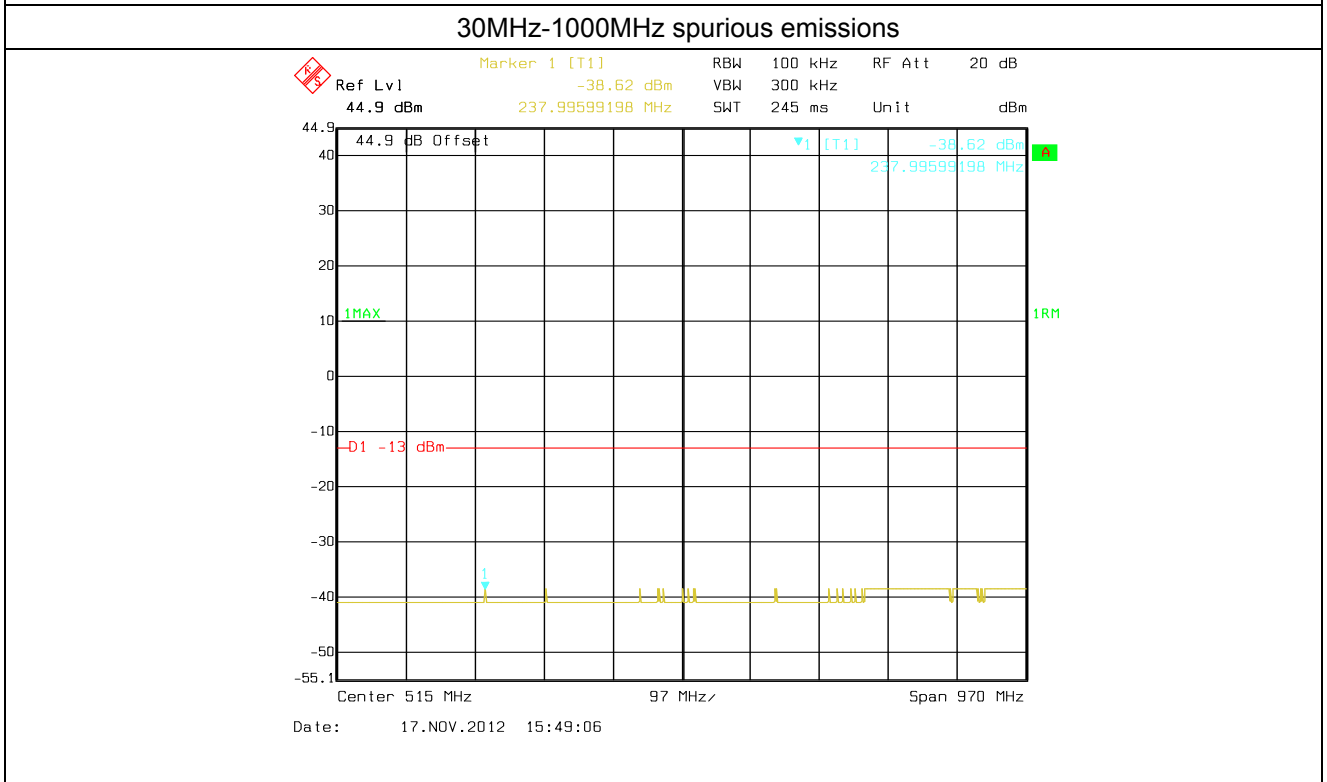
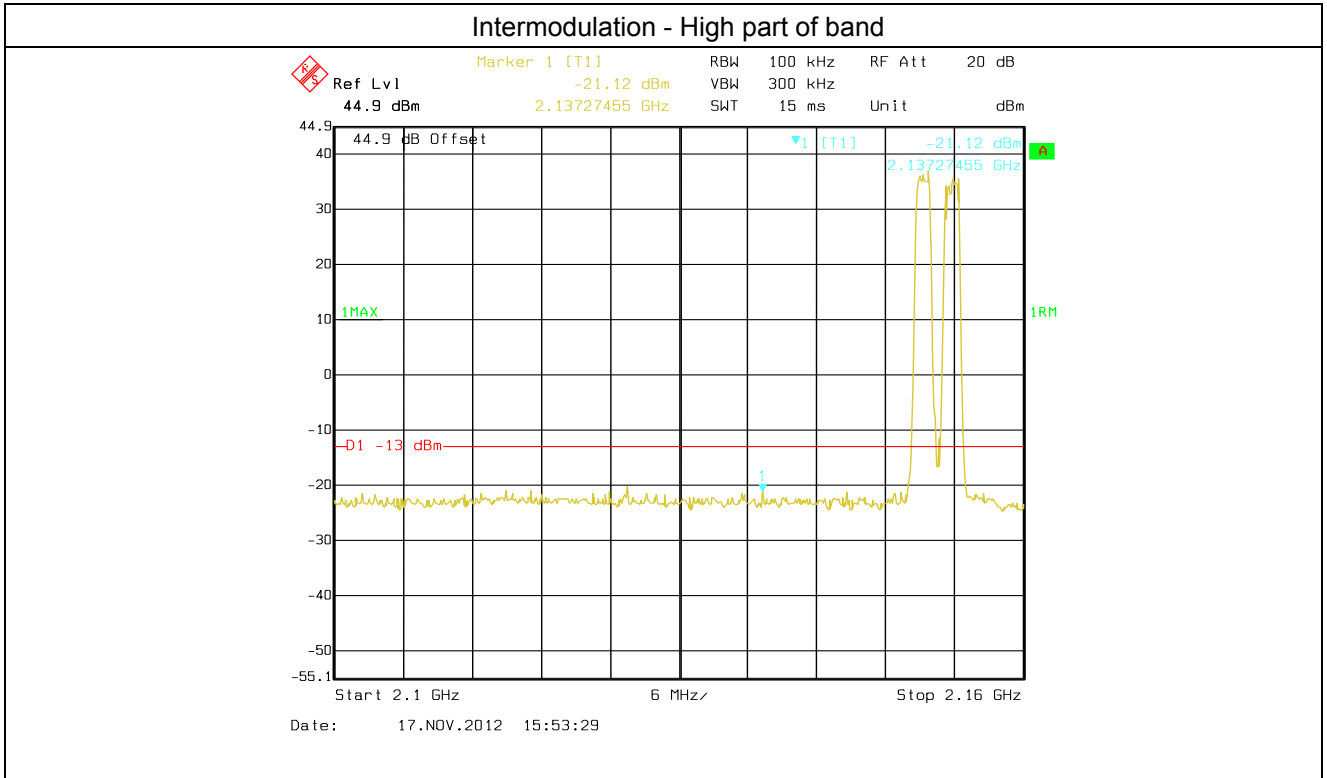

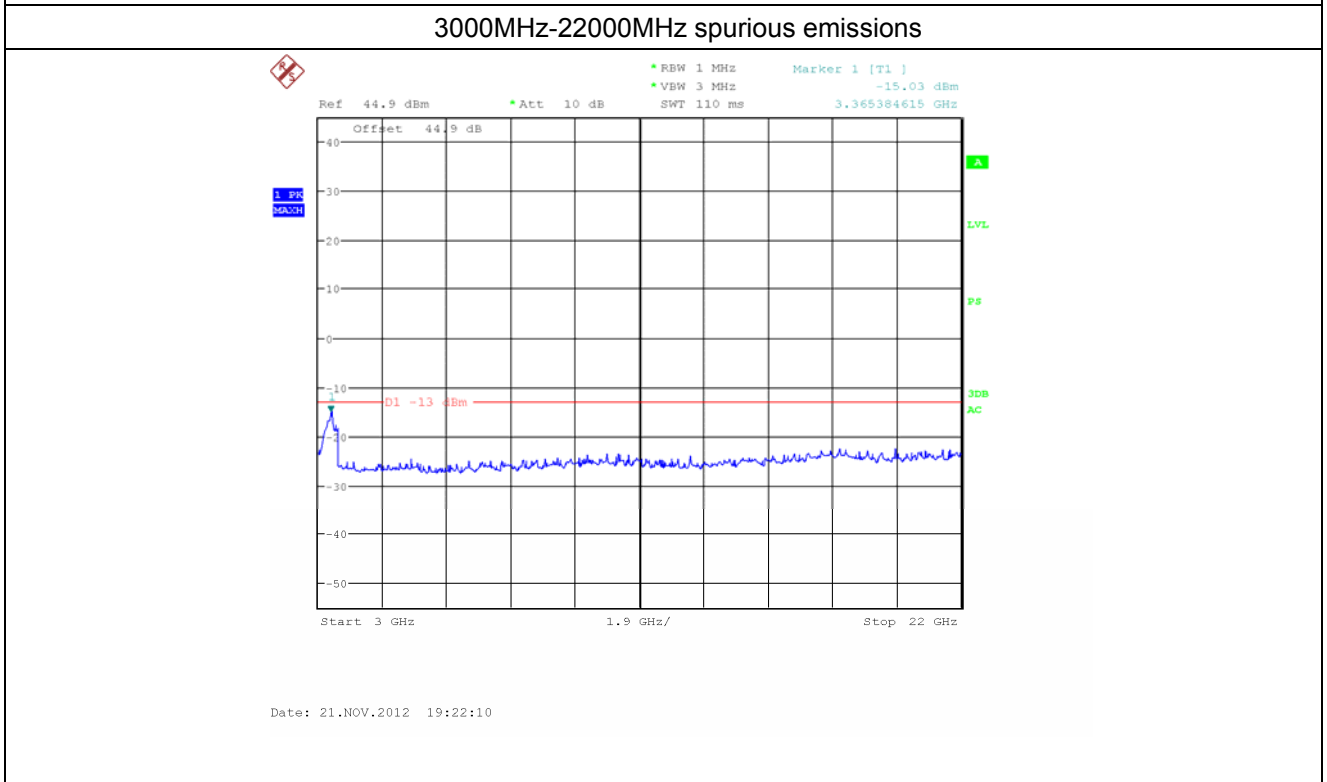
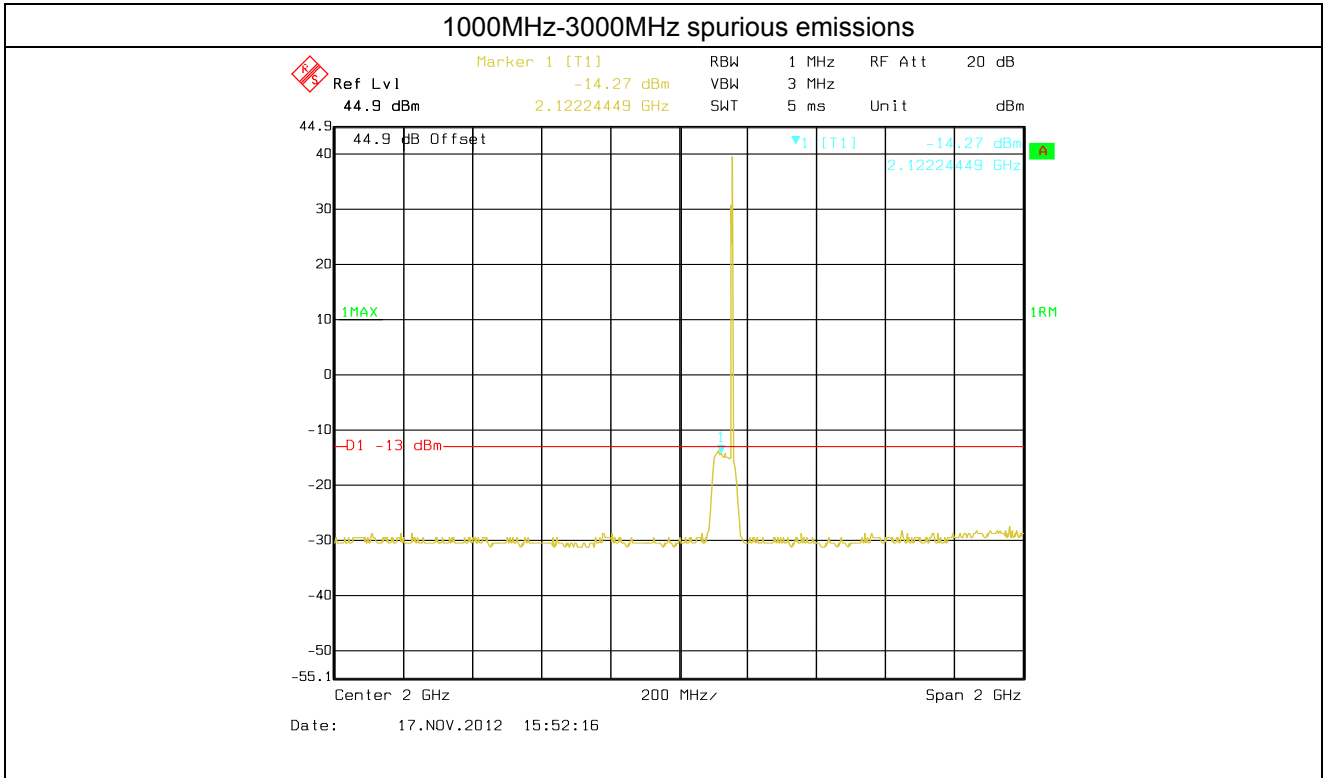

Intermodulation of LTE 1.4MHz Bandwidth

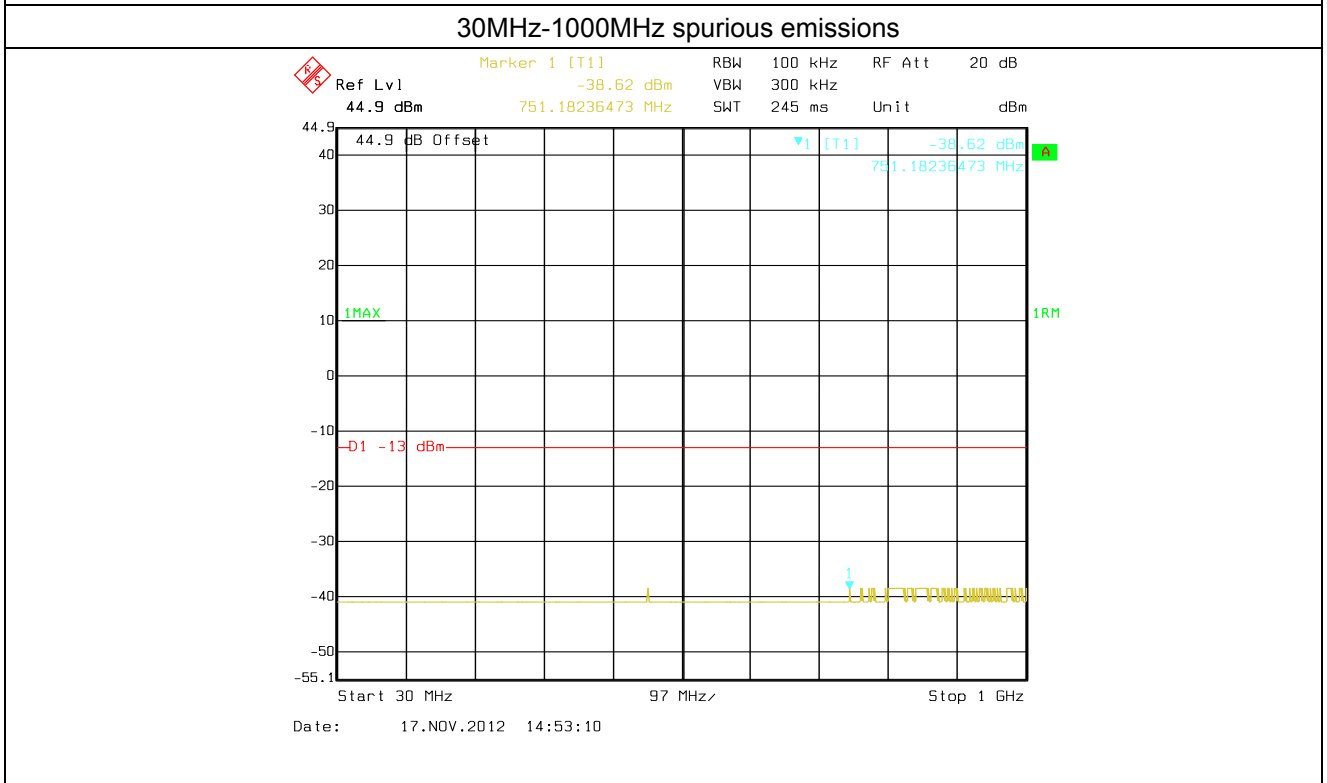
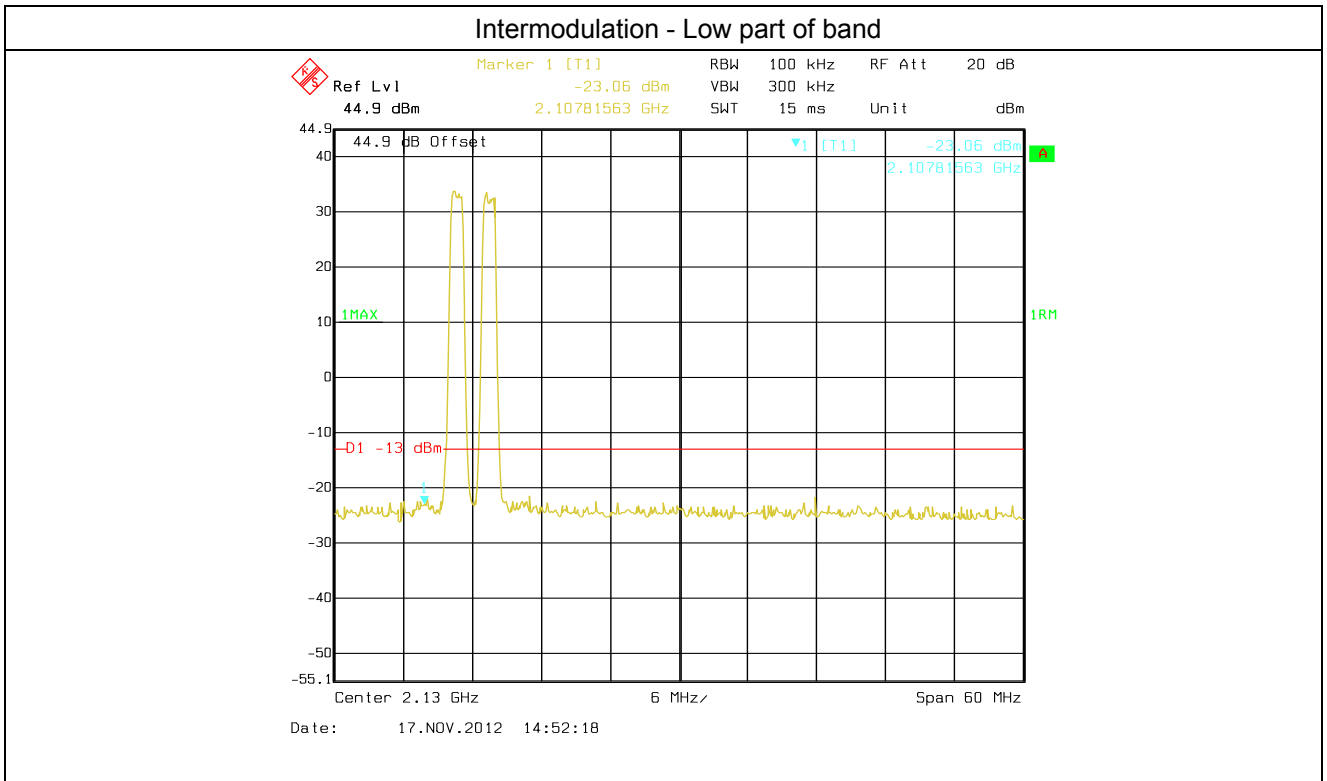

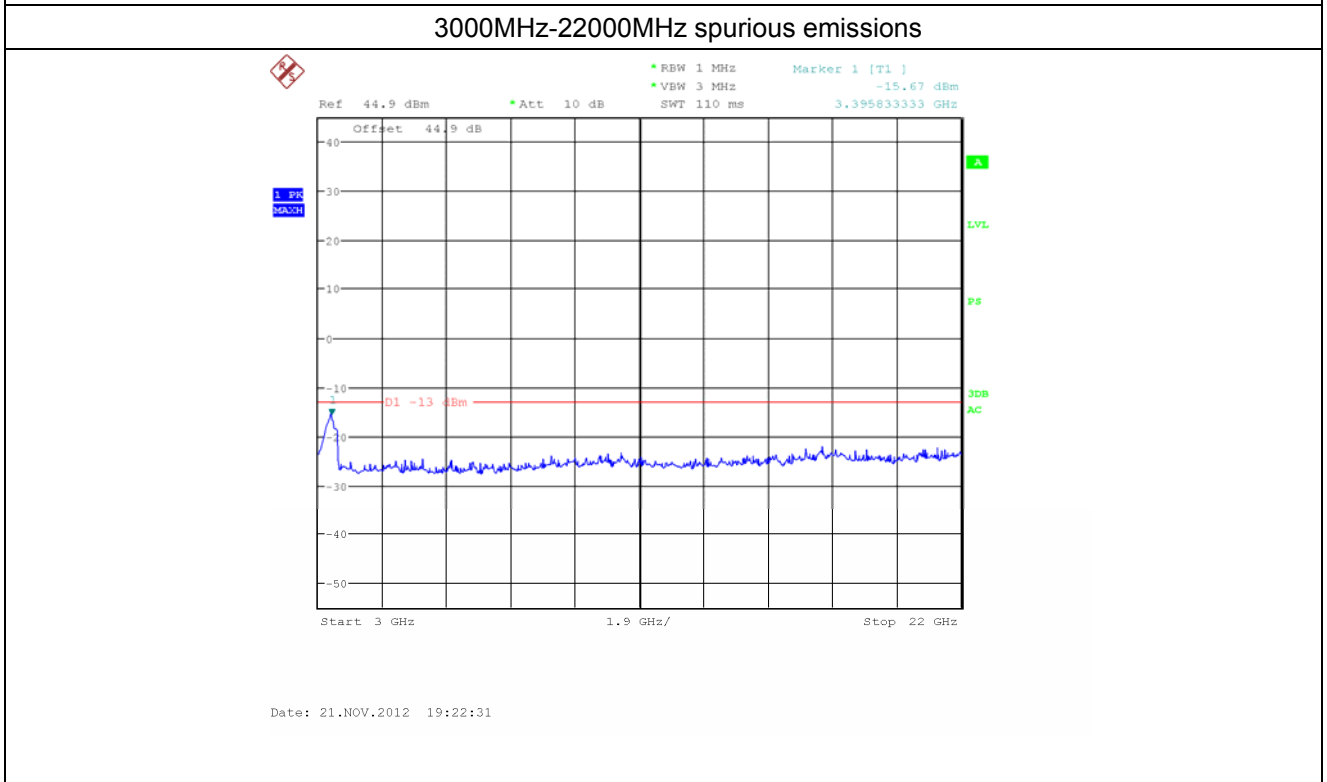
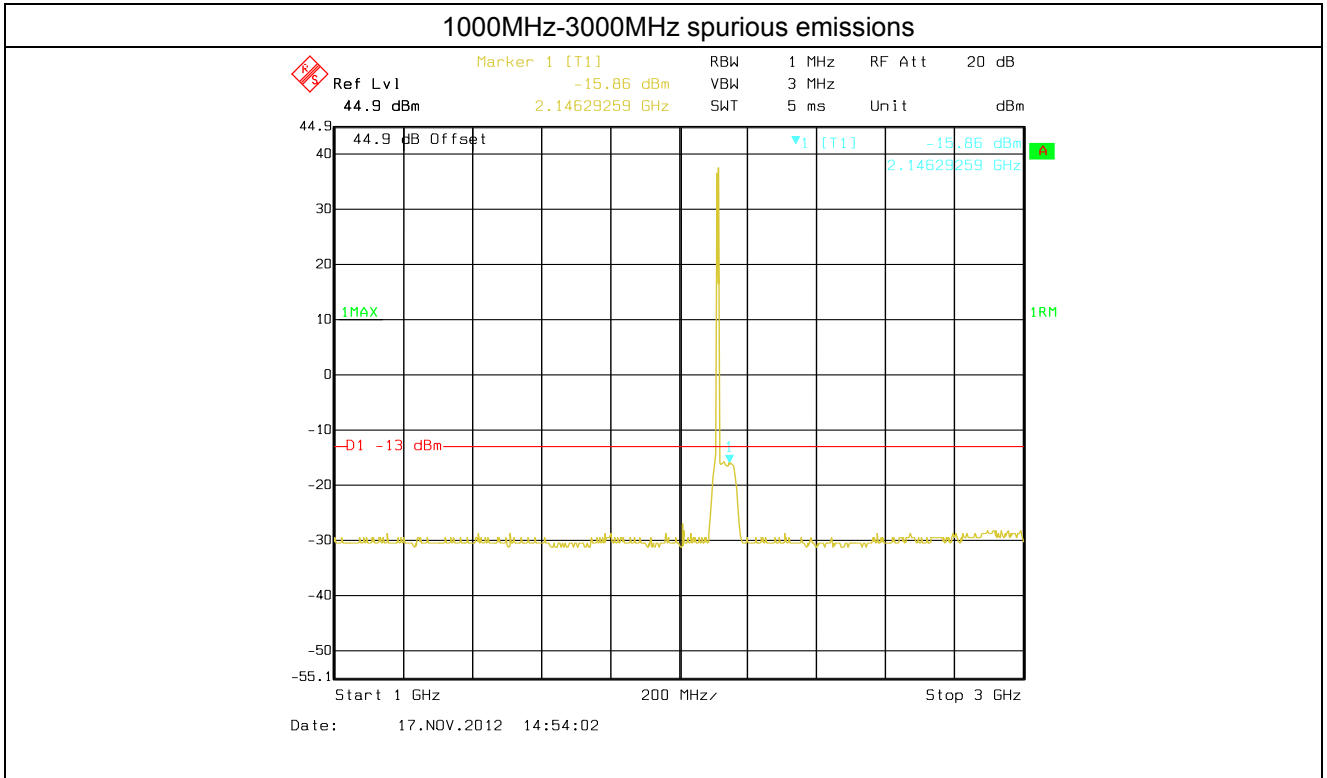

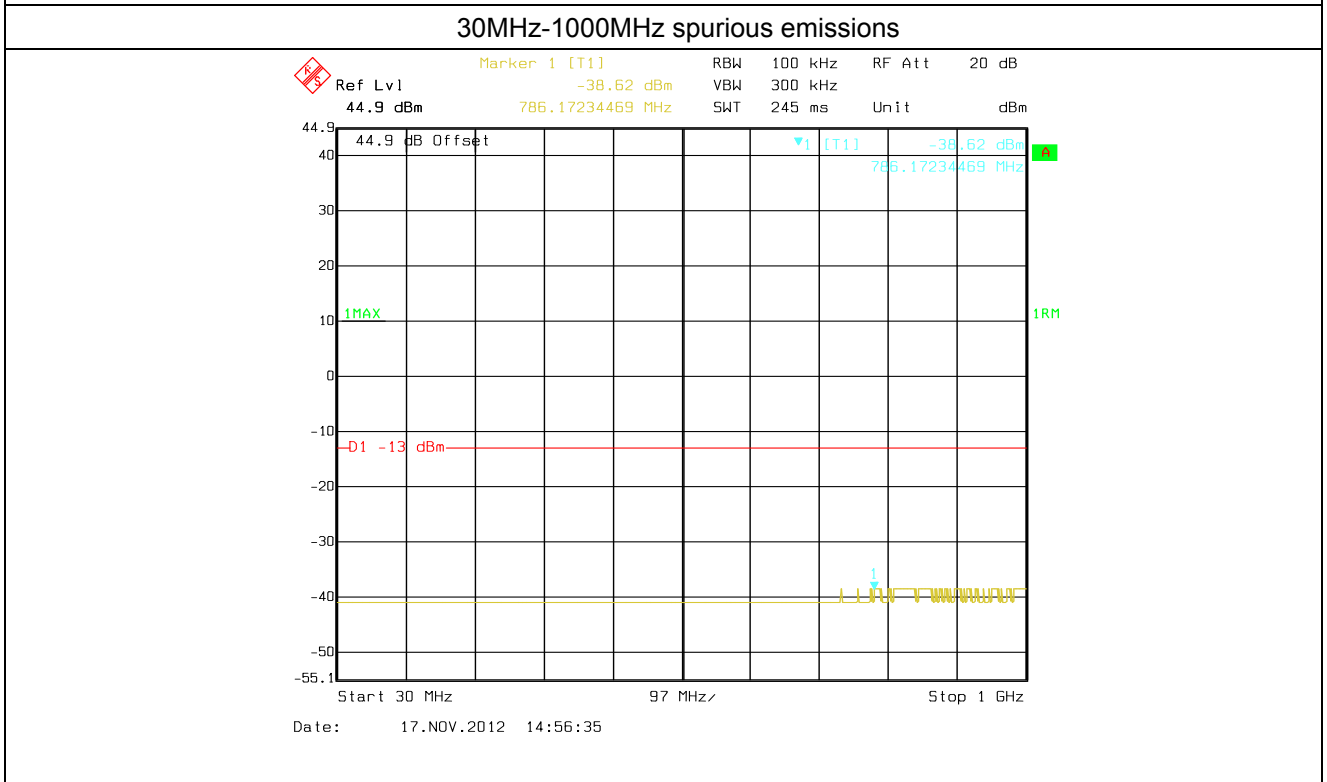
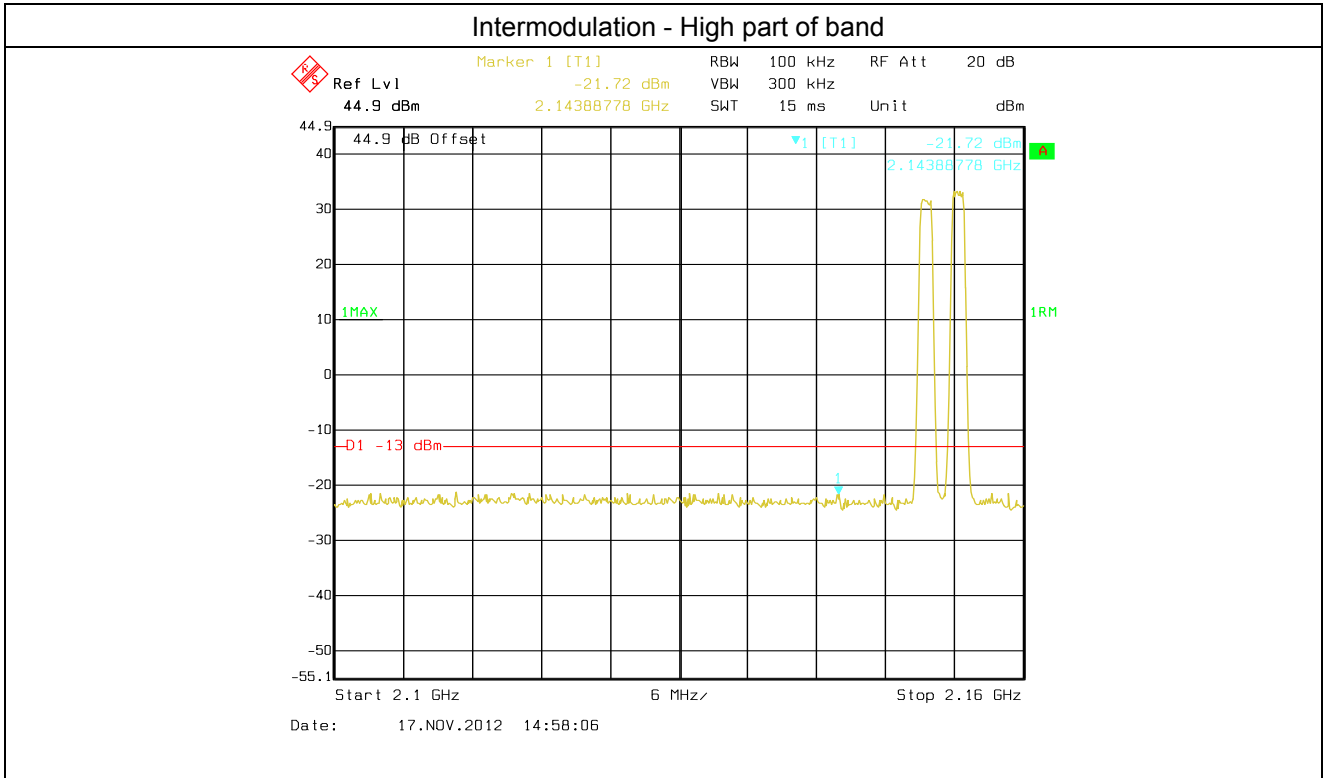

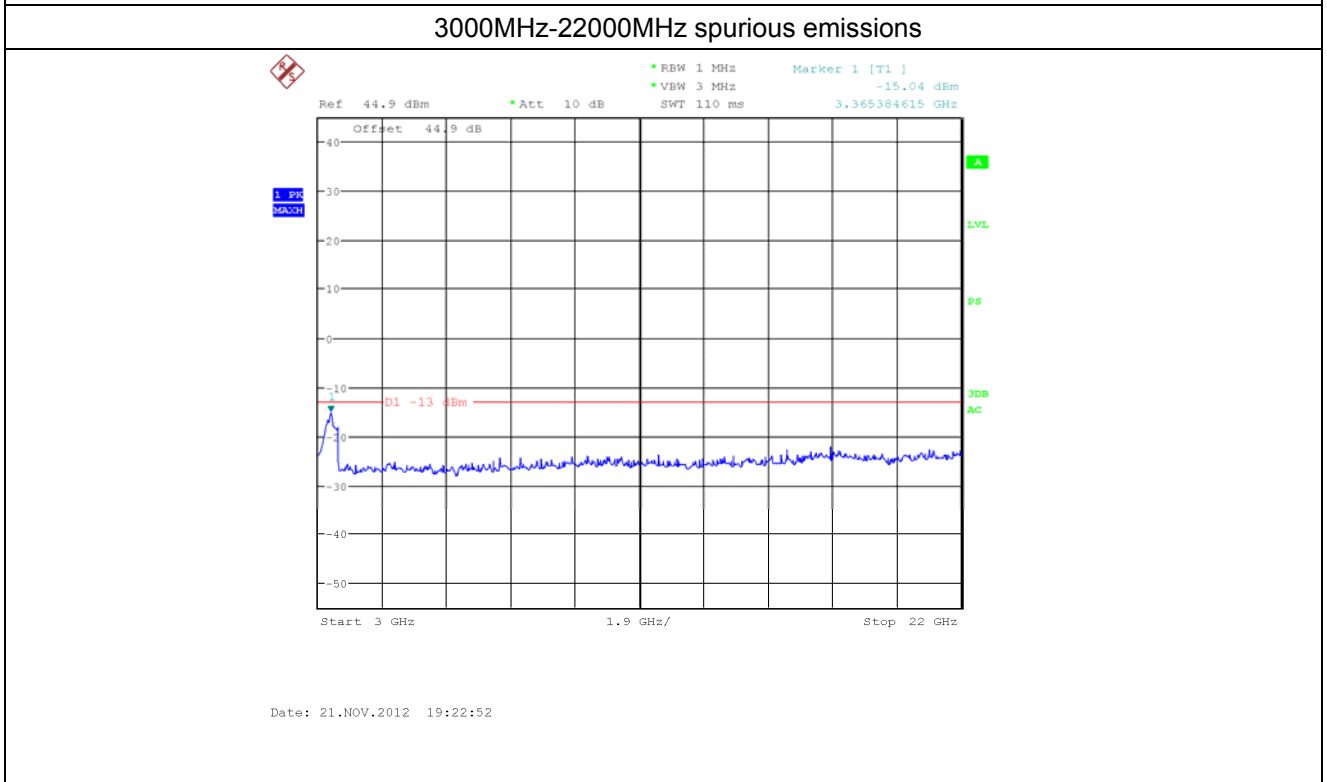
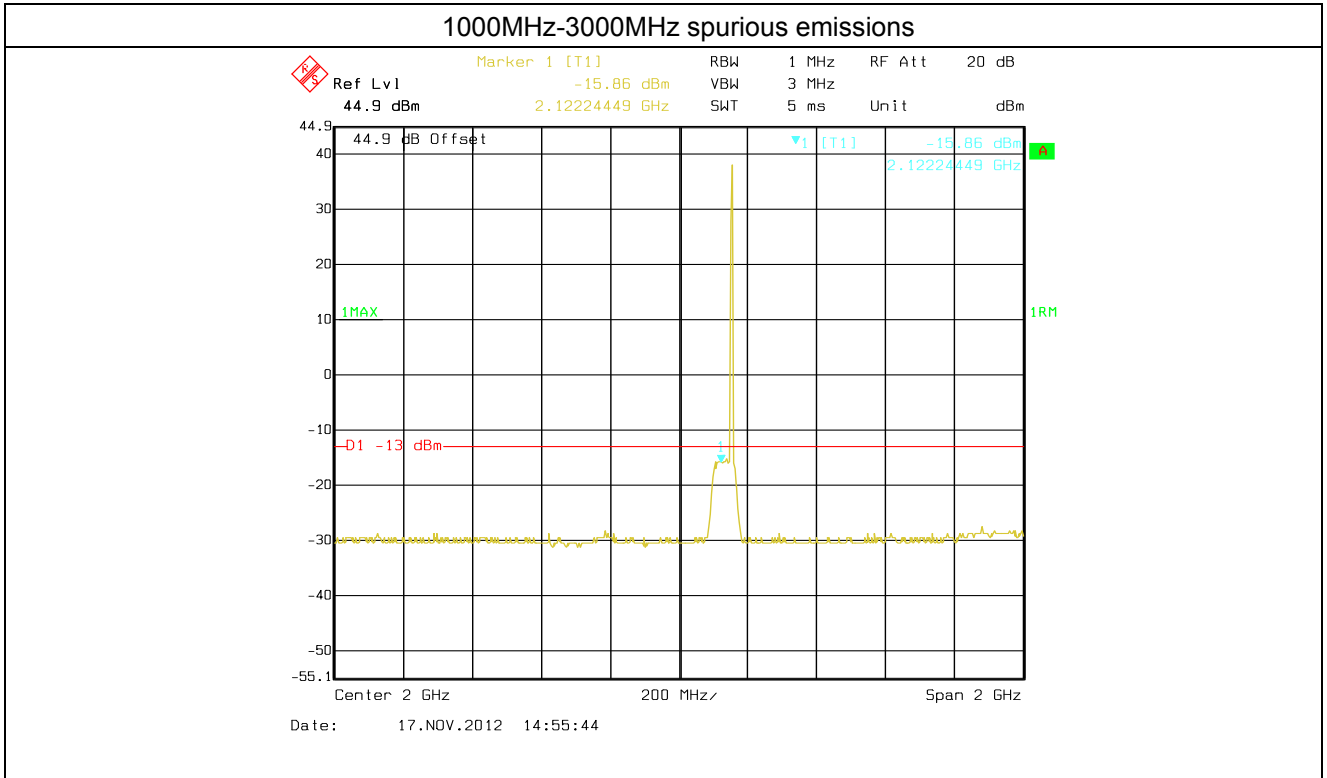

Intermodulation of LTE 3MHz Bandwidth

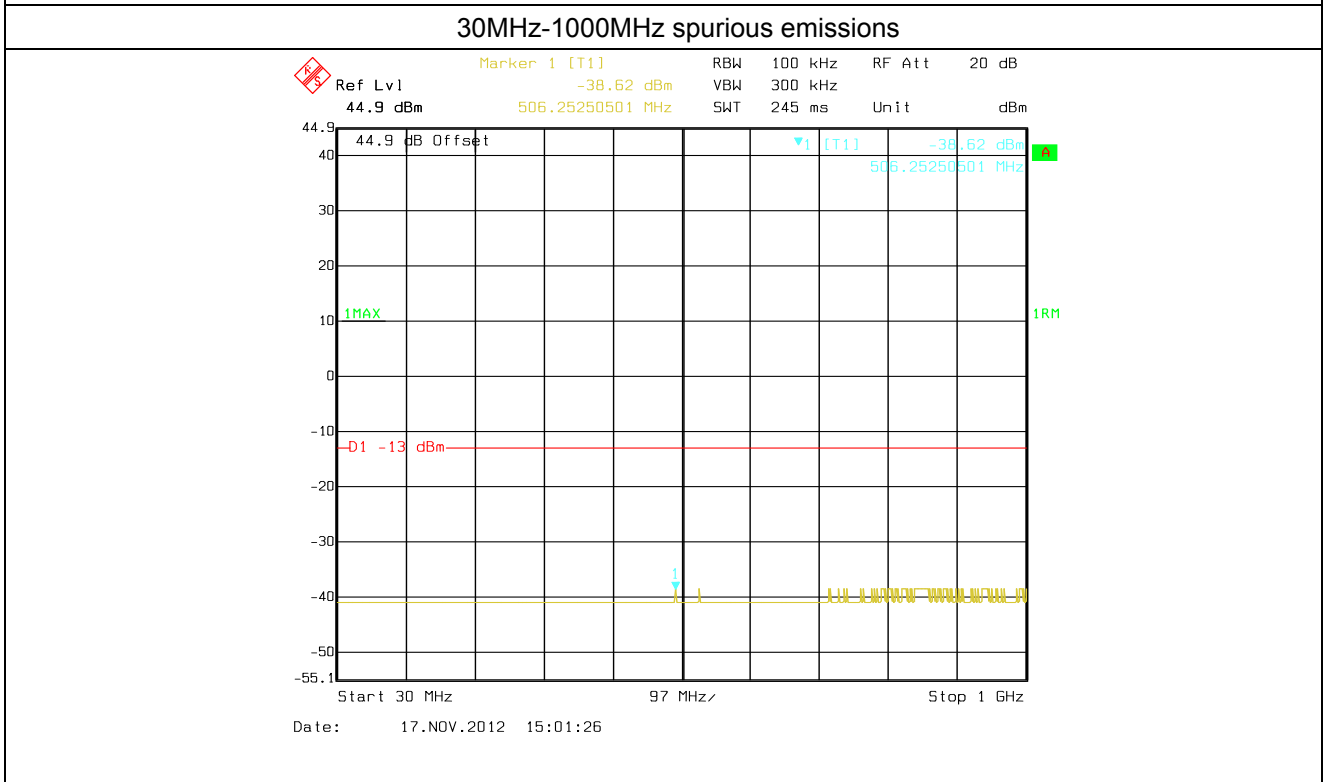
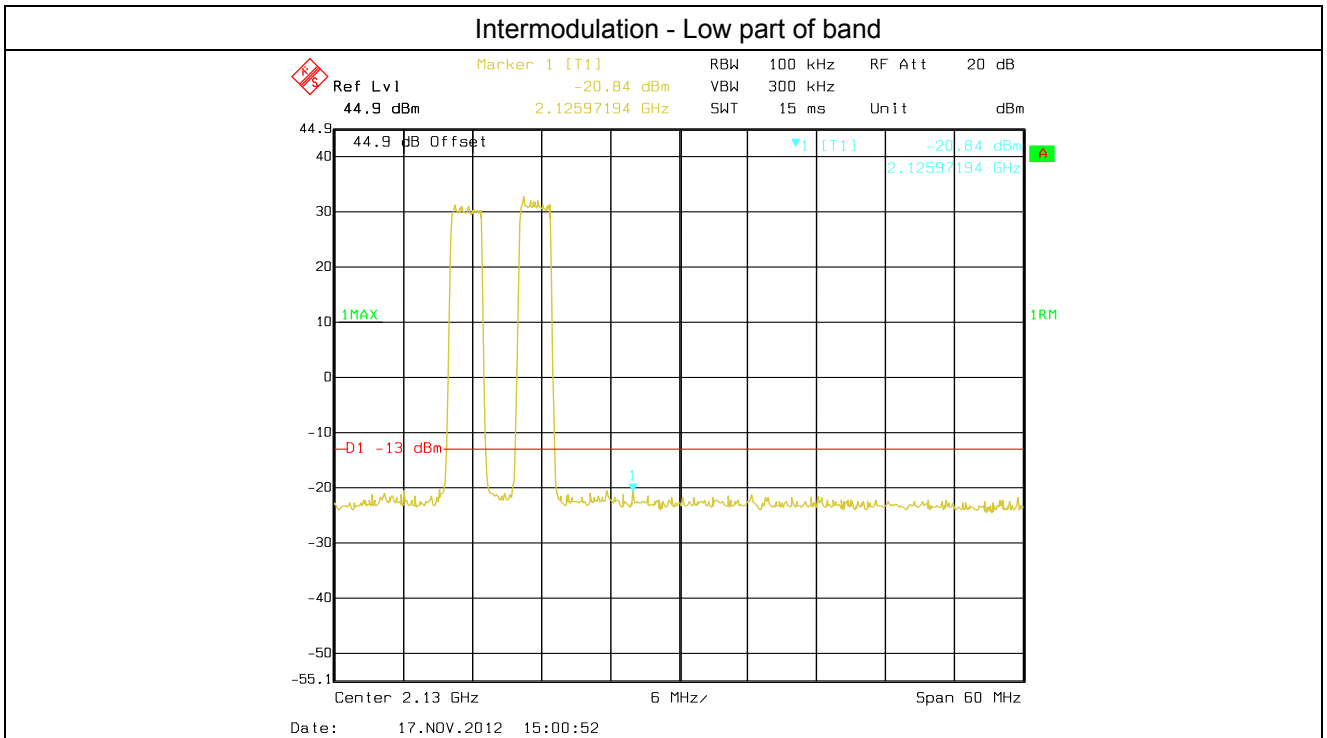

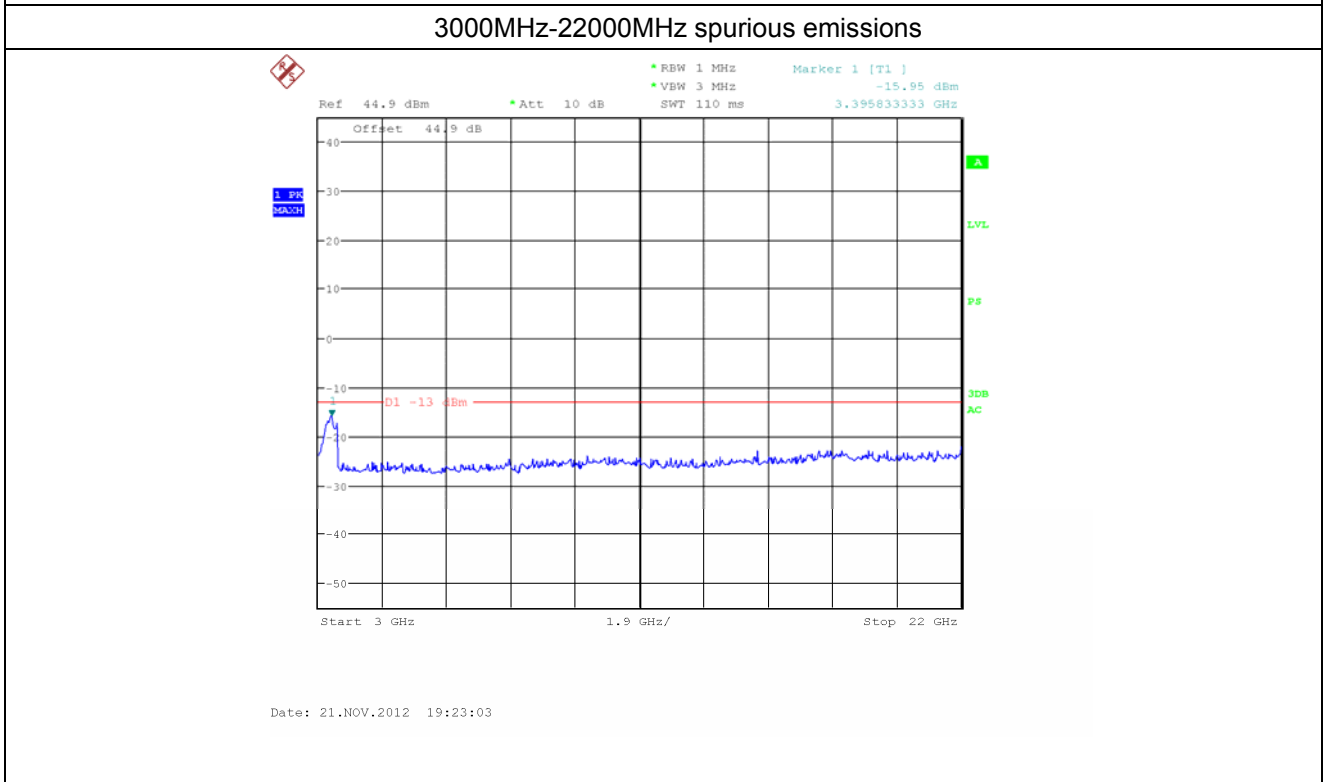
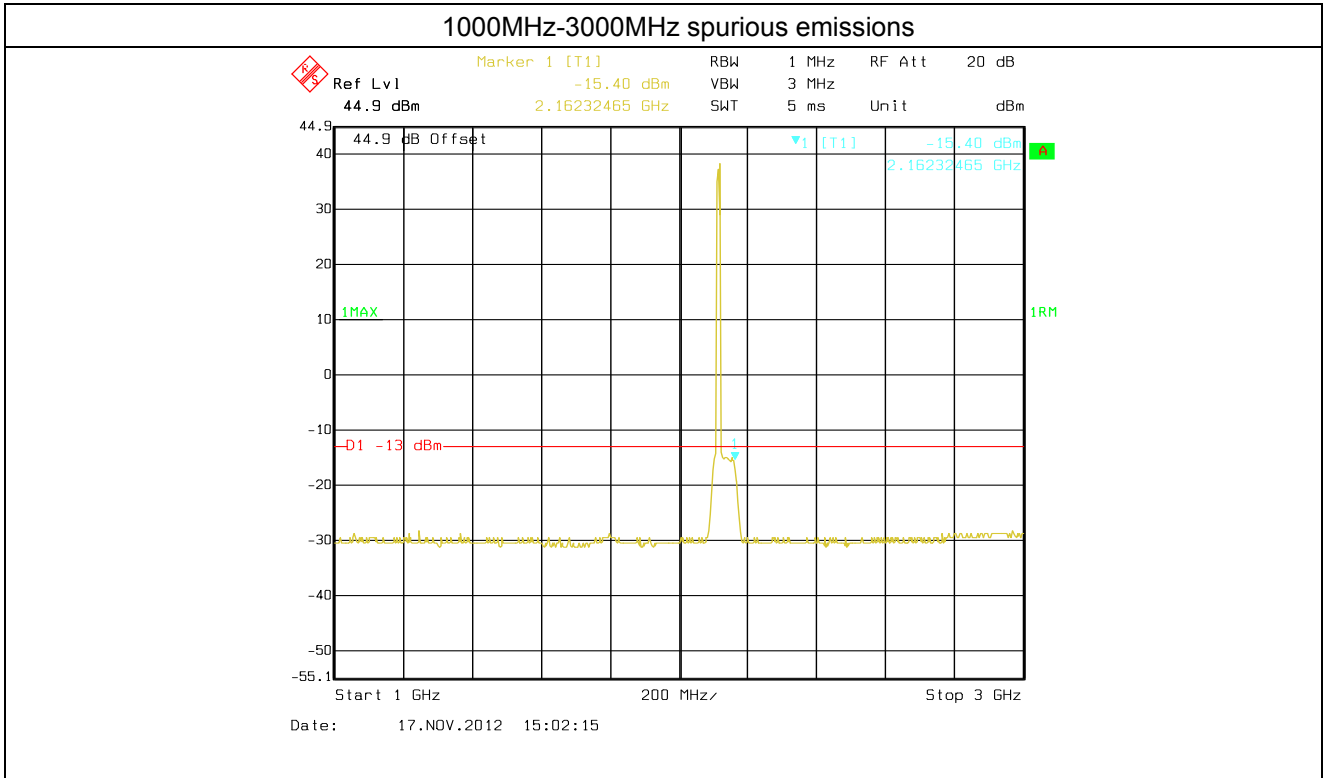

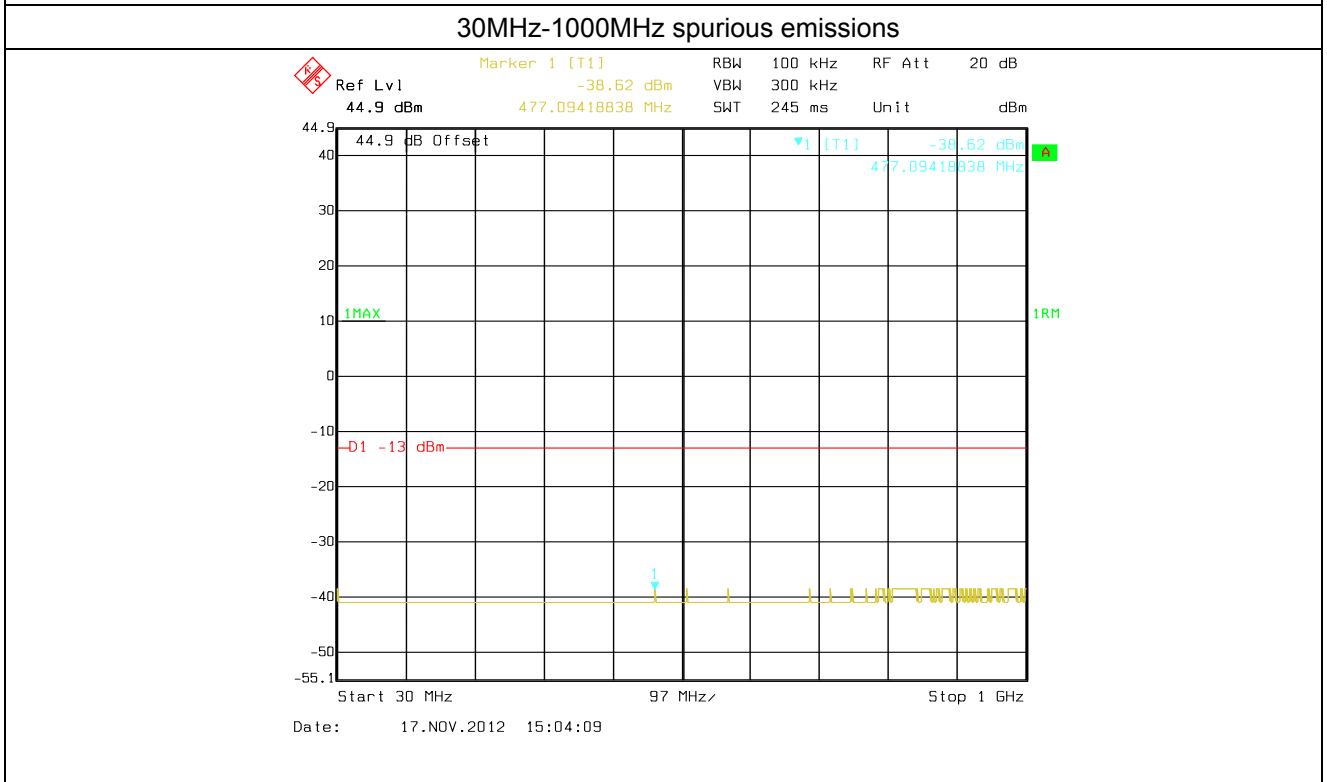
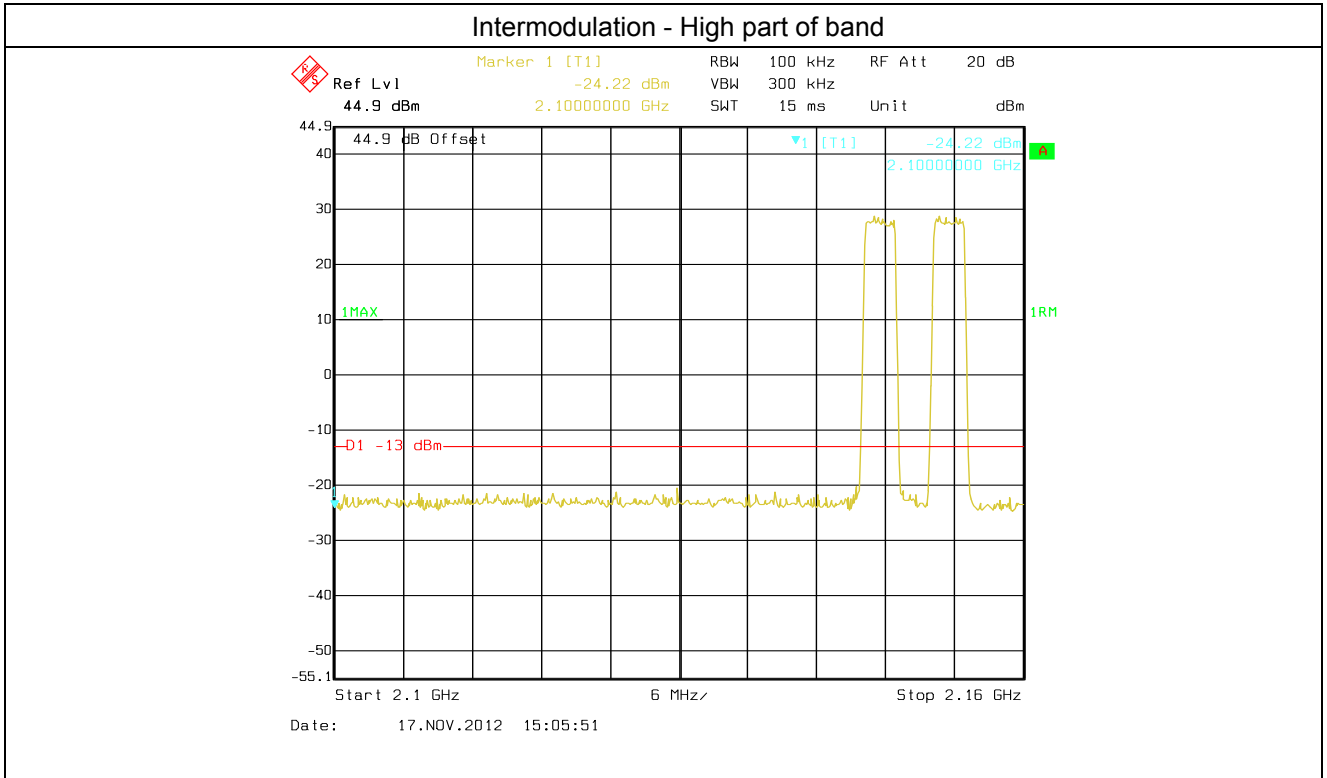

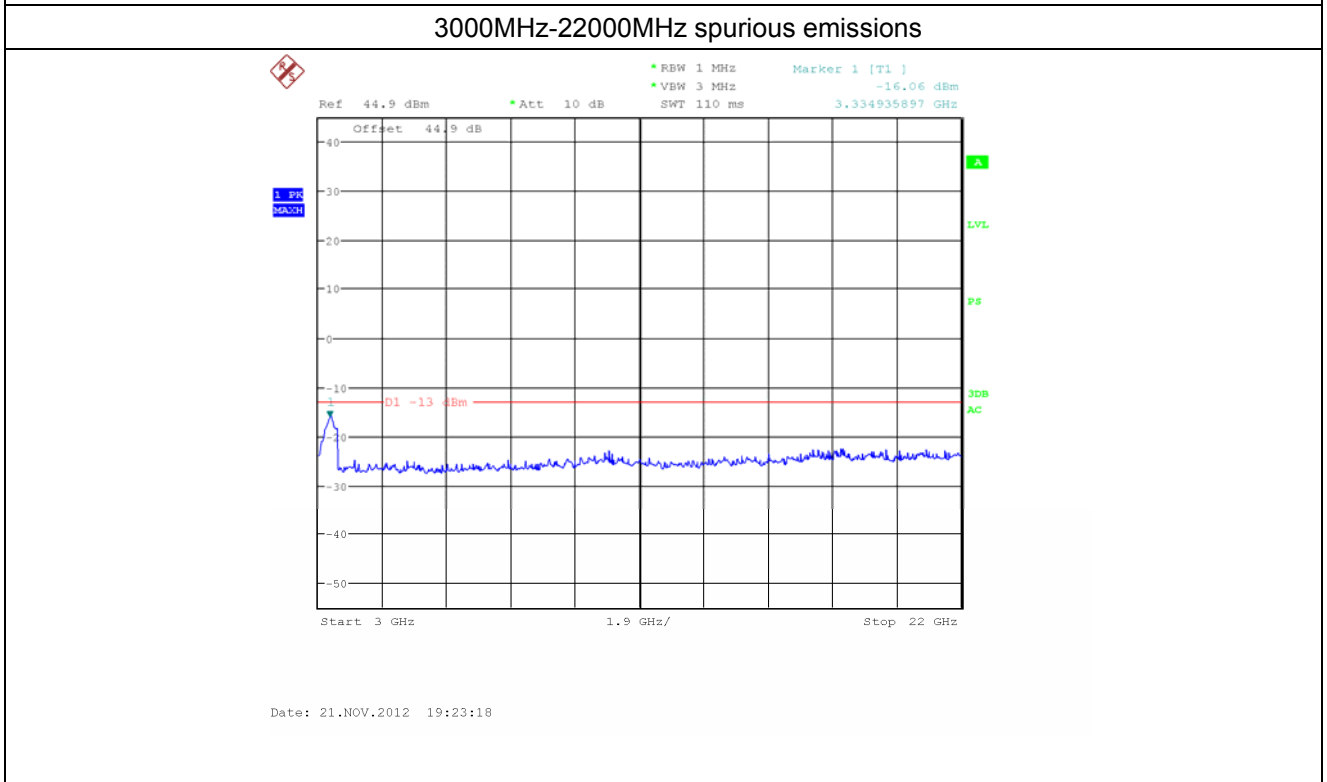
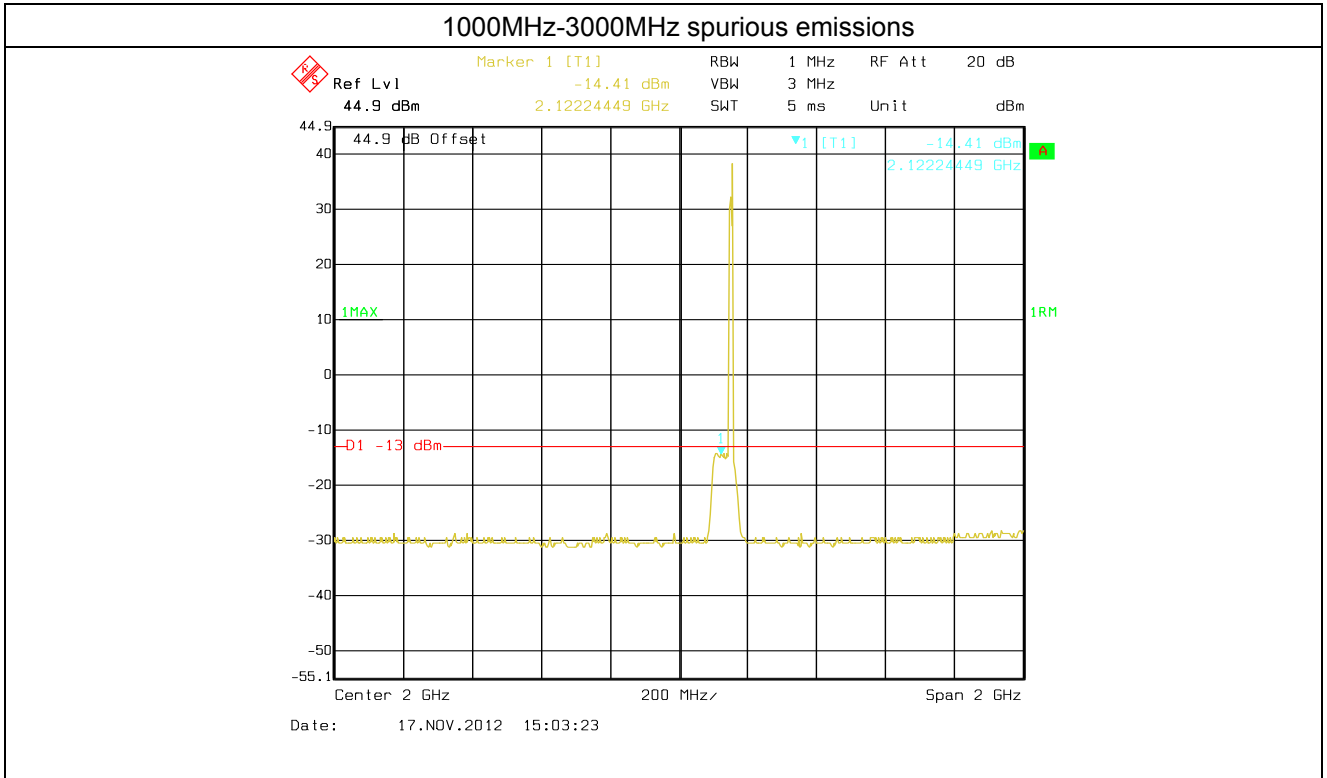

Intermodulation of LTE 5MHz Bandwidth

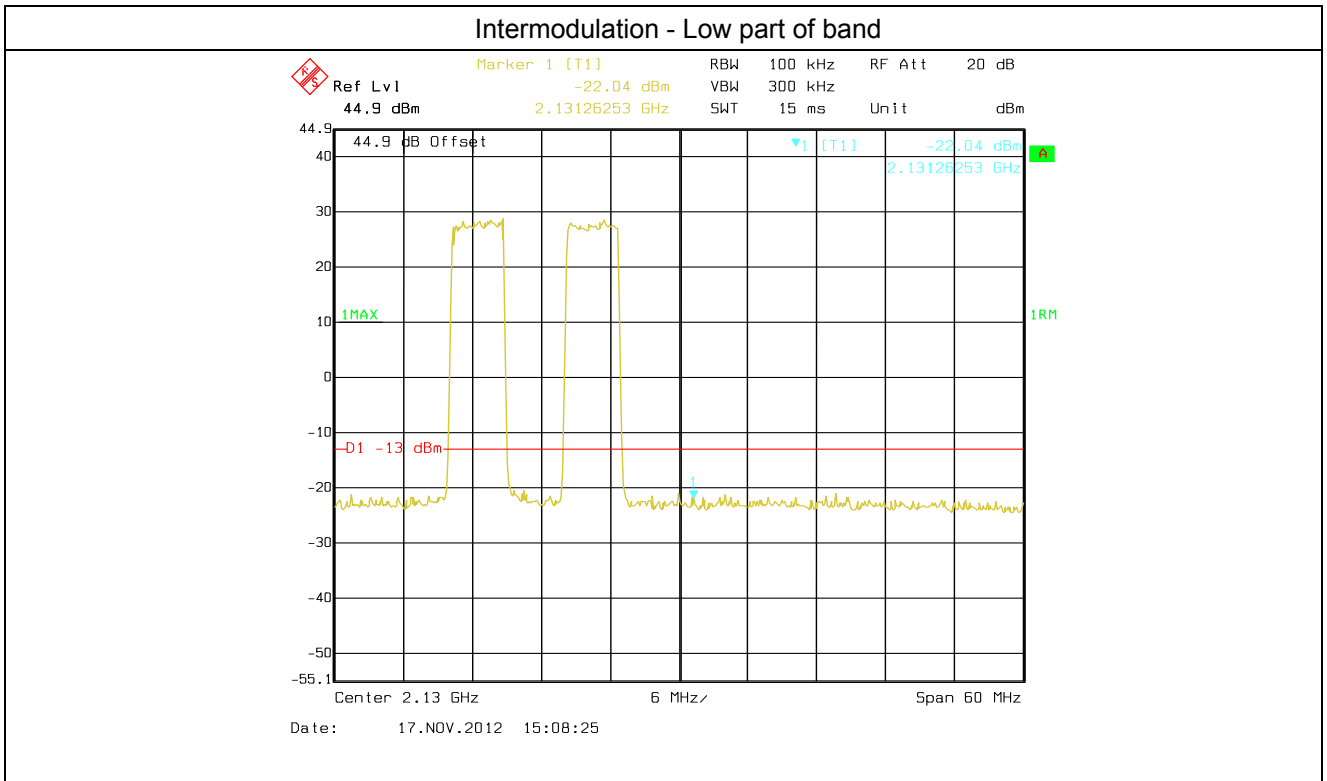

30MHz-1000MHz spurious emissions

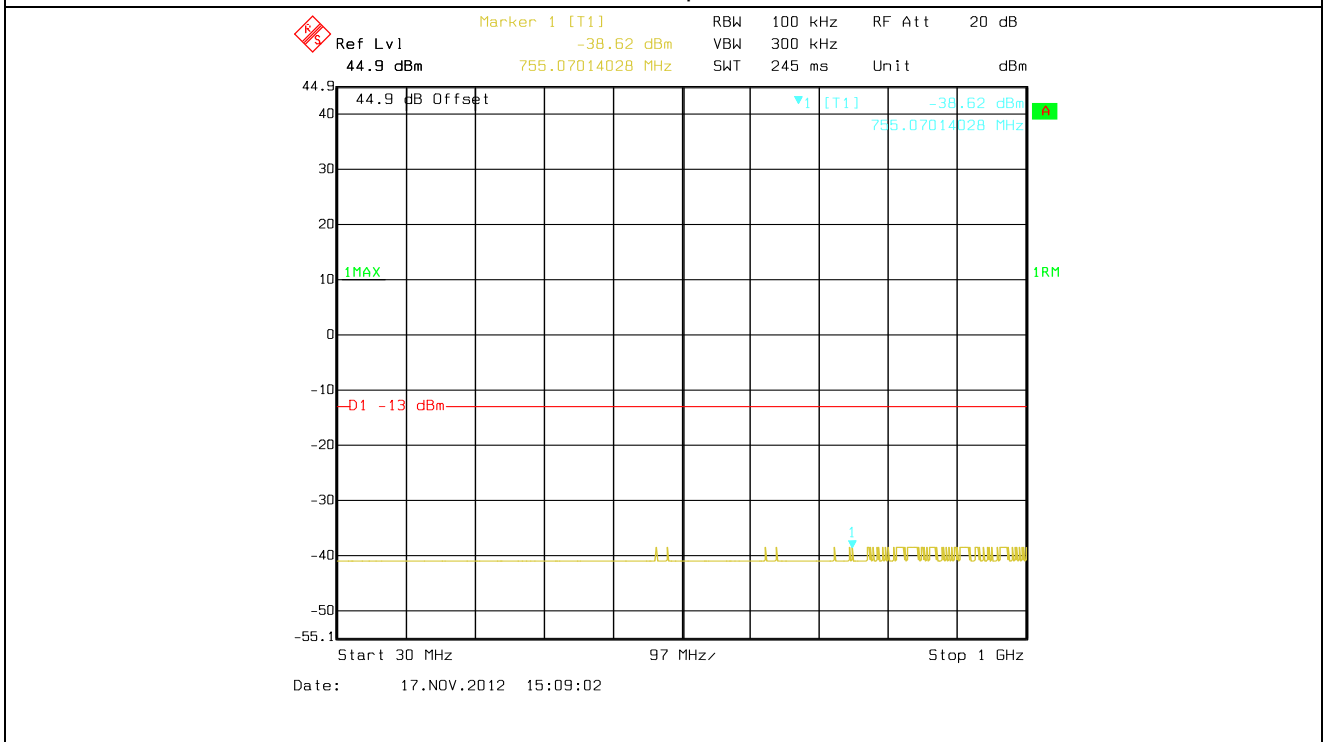

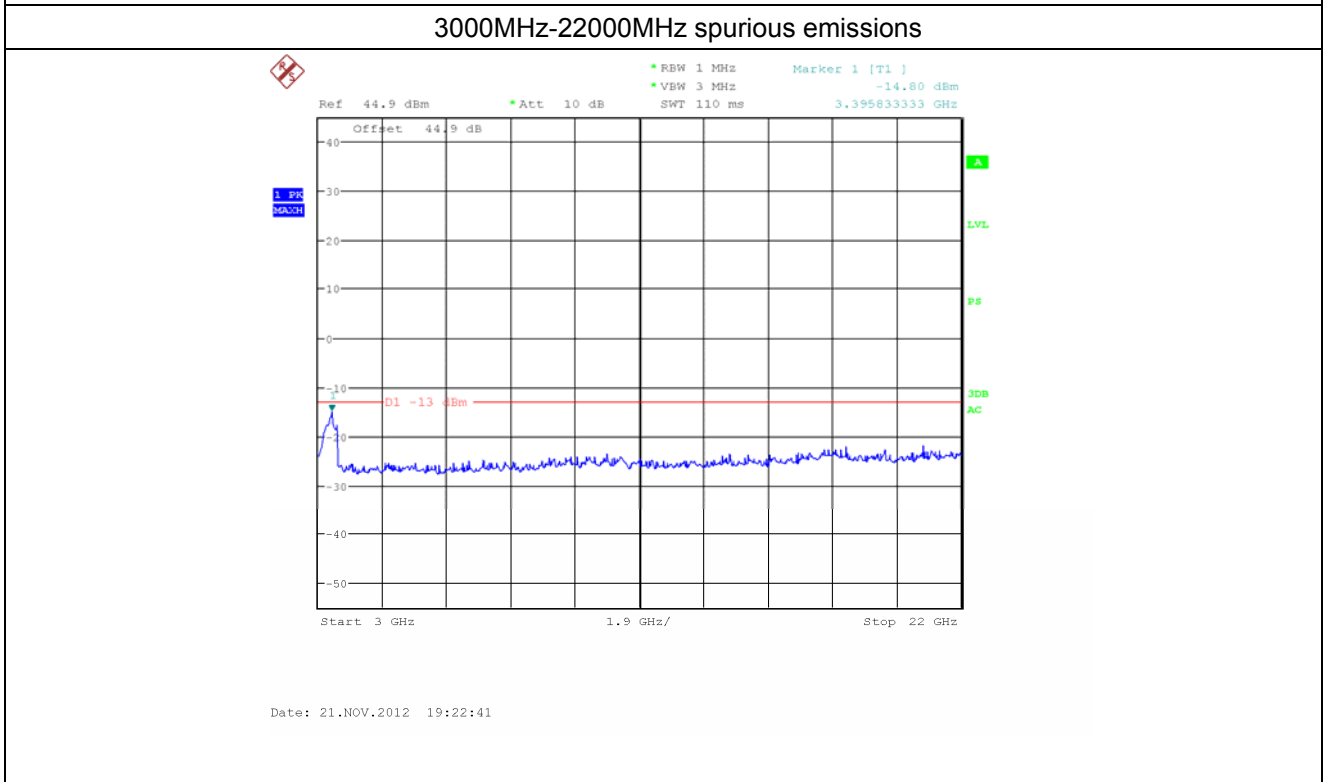
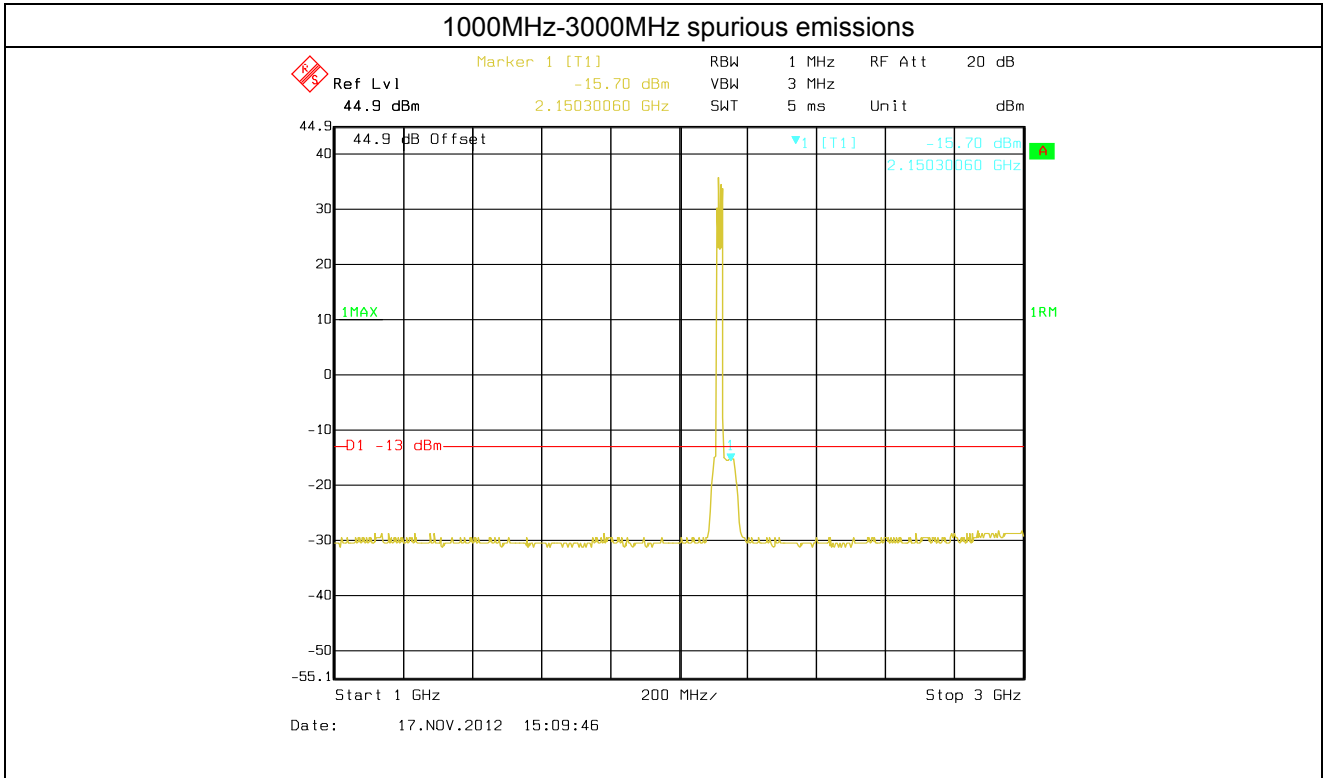

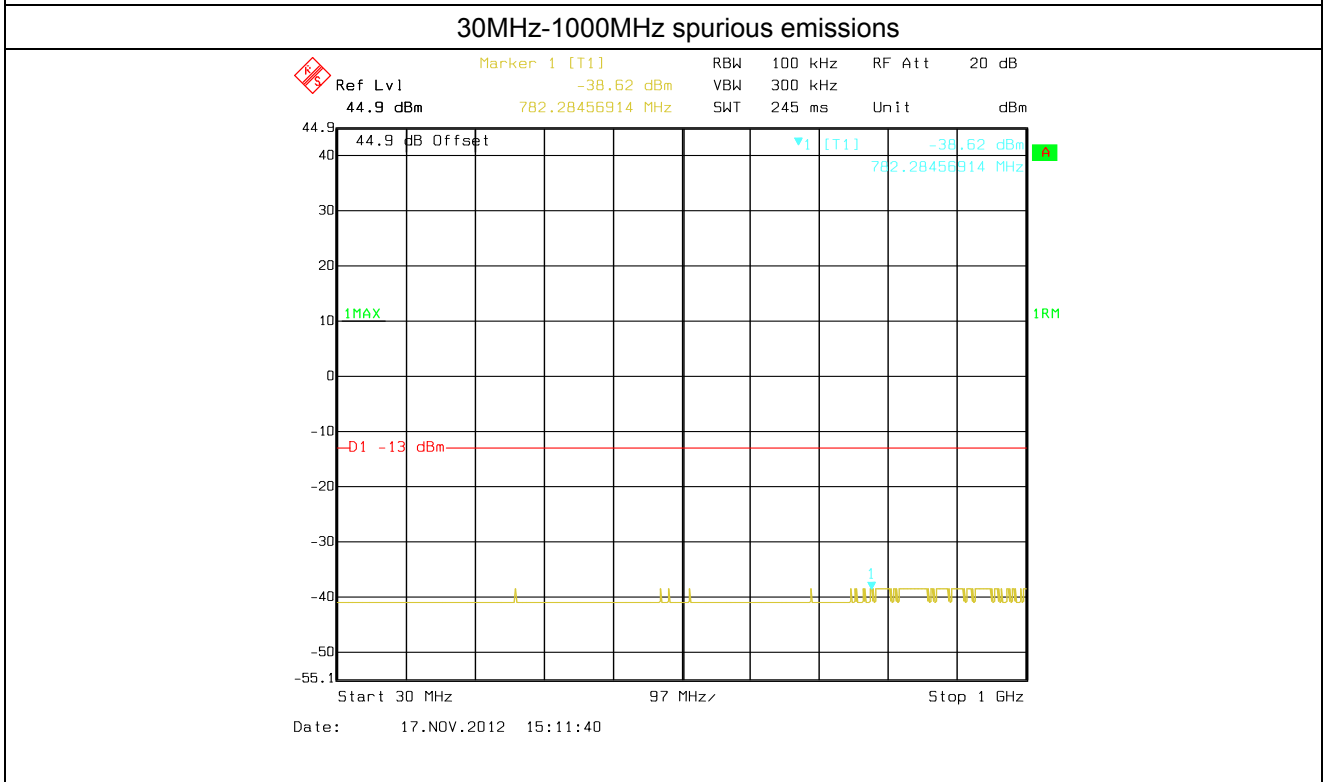
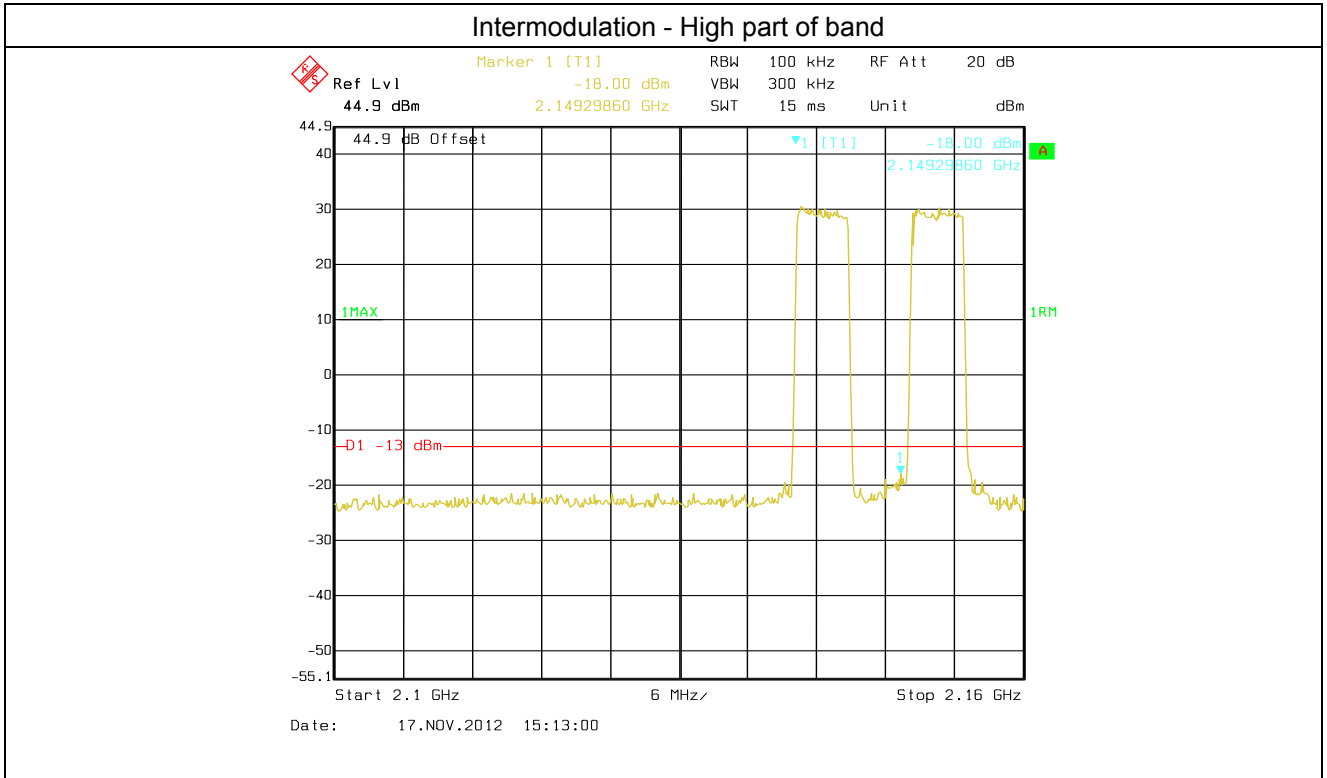

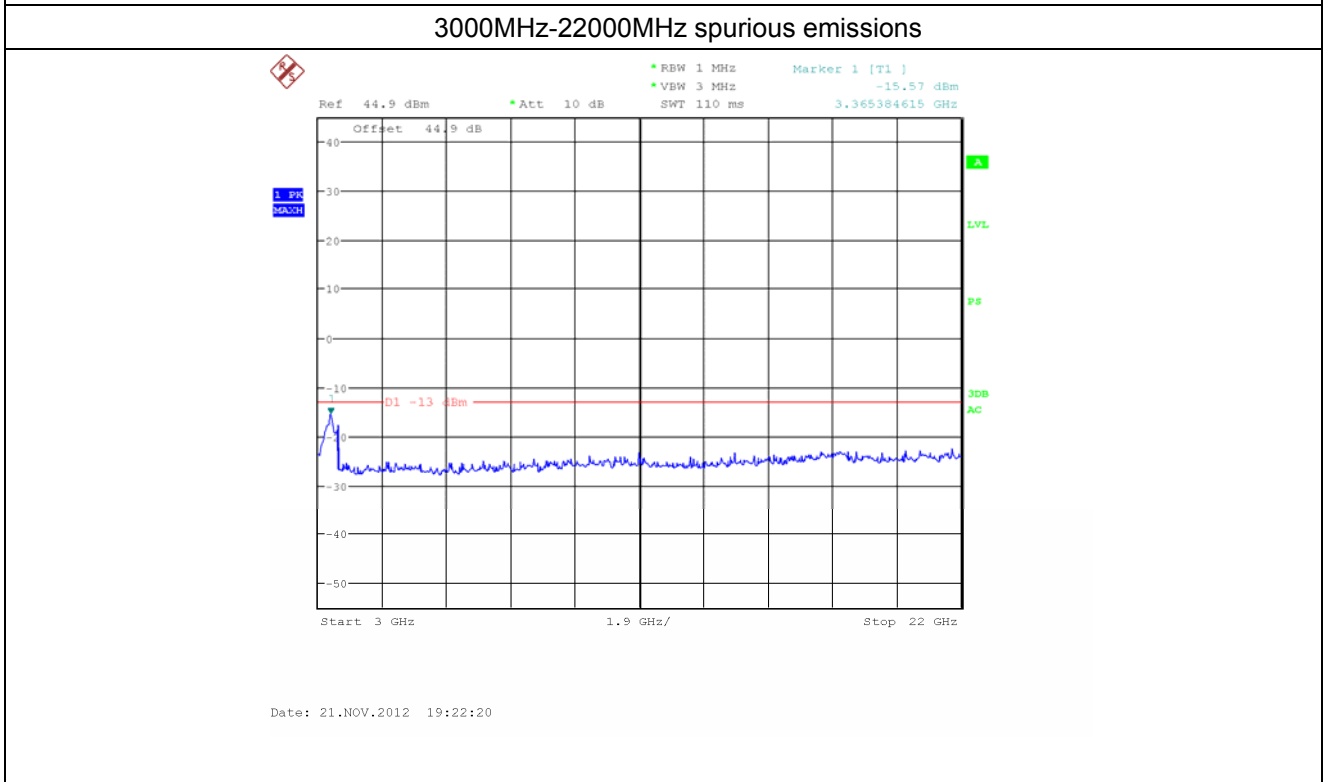
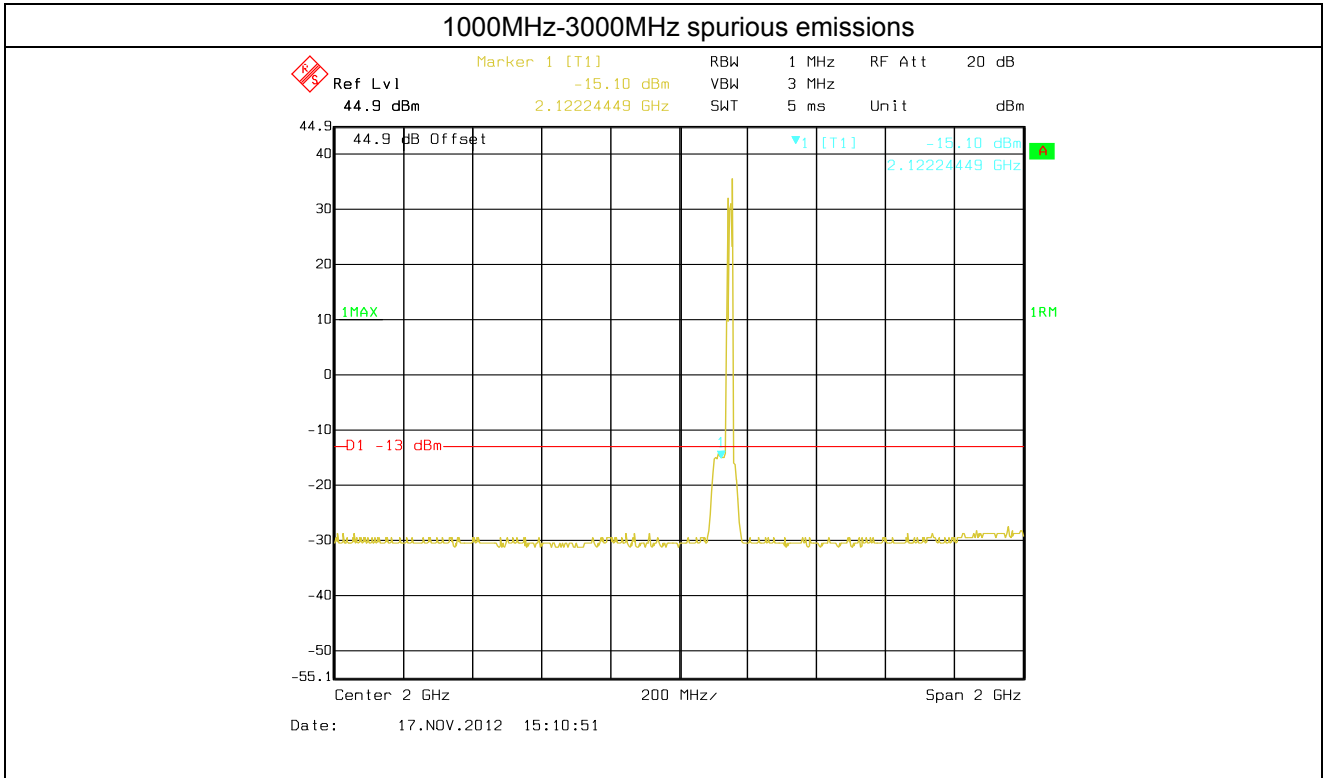

Intermodulation of LTE 10MHz Bandwidth

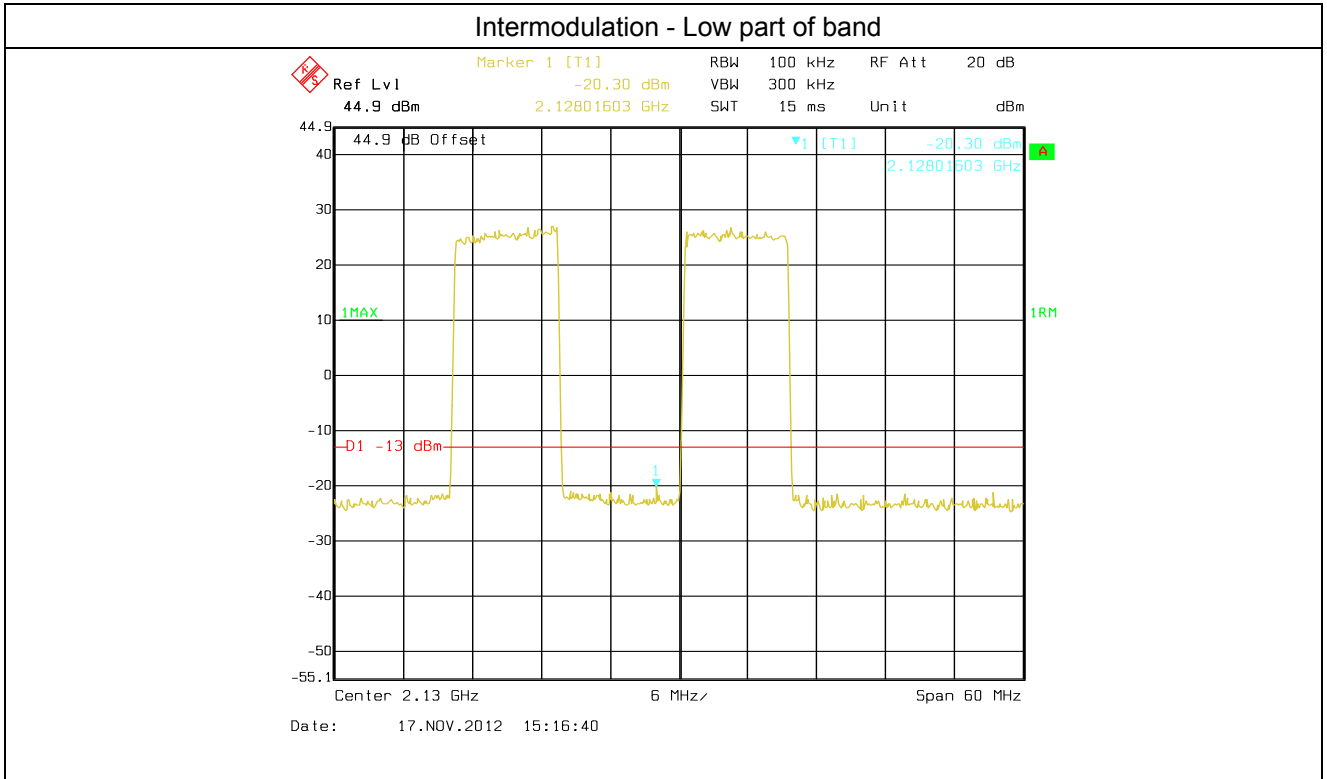

30MHz-1000MHz spurious emissions

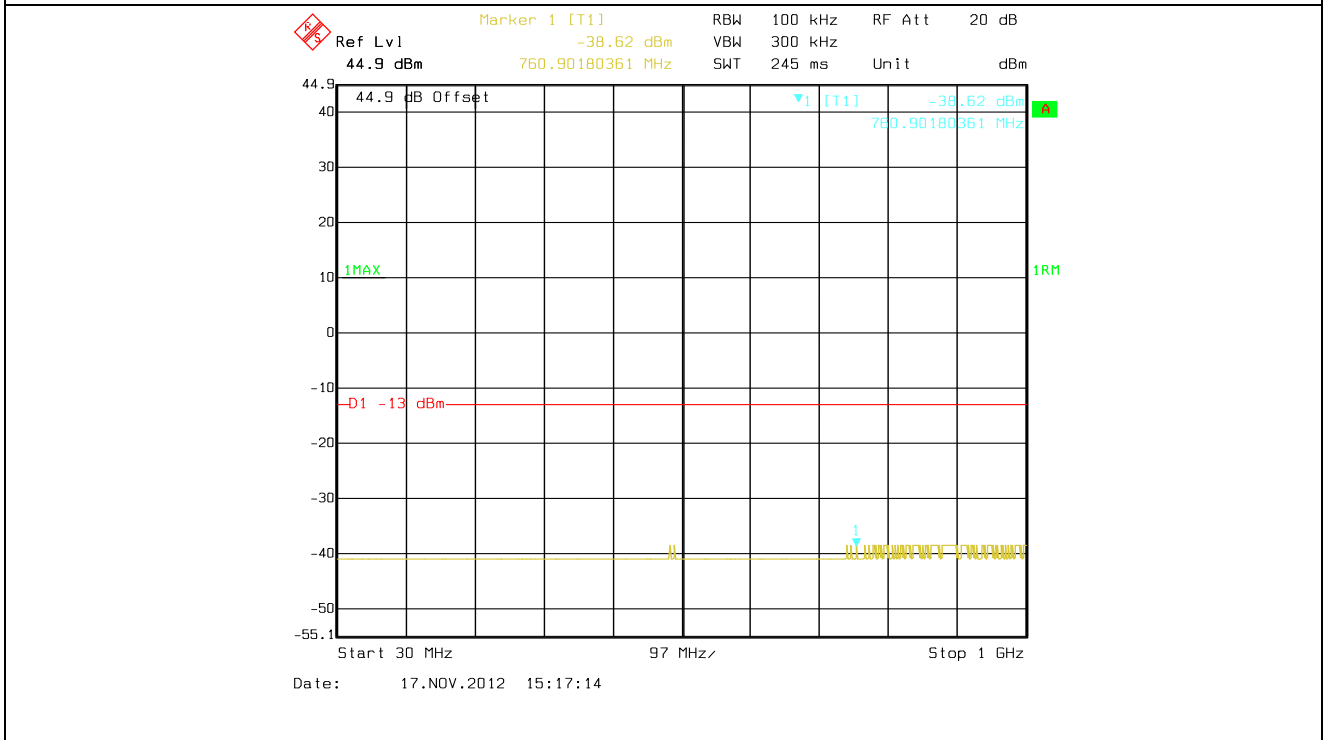

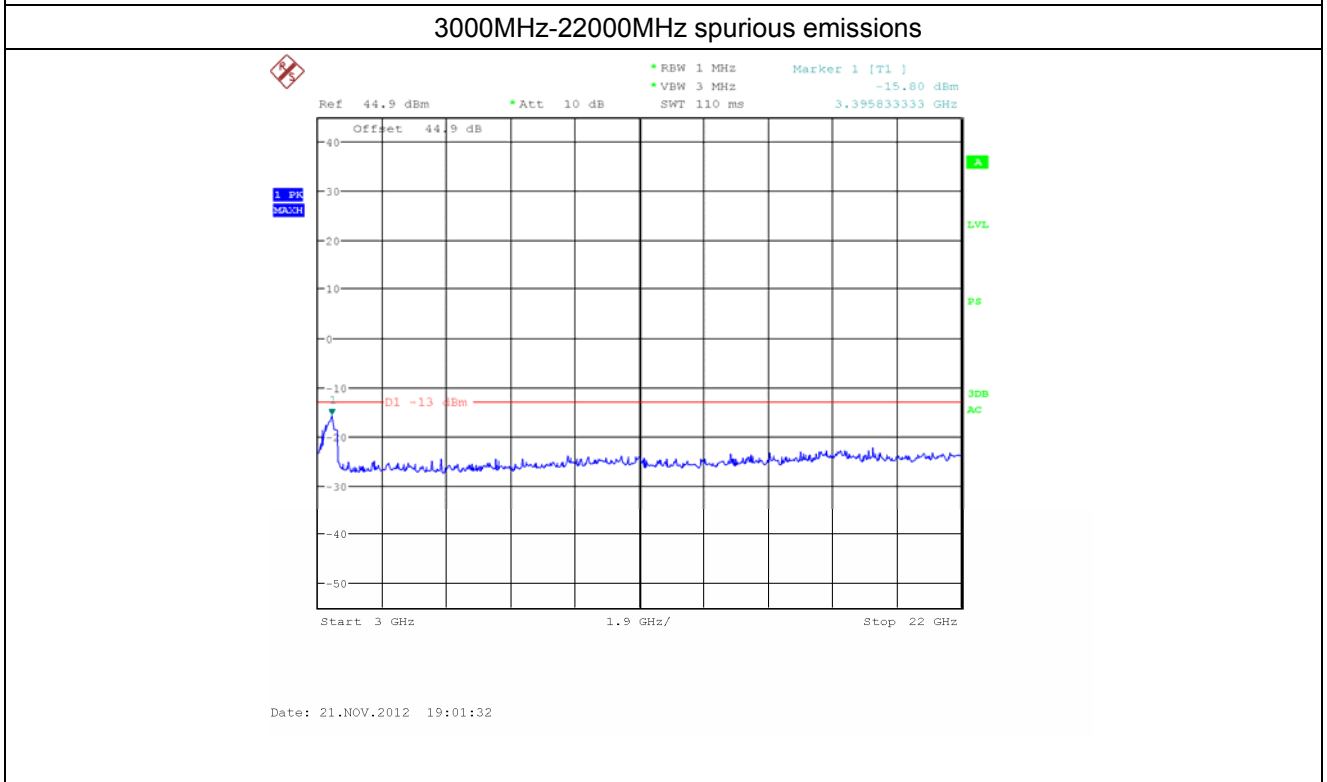
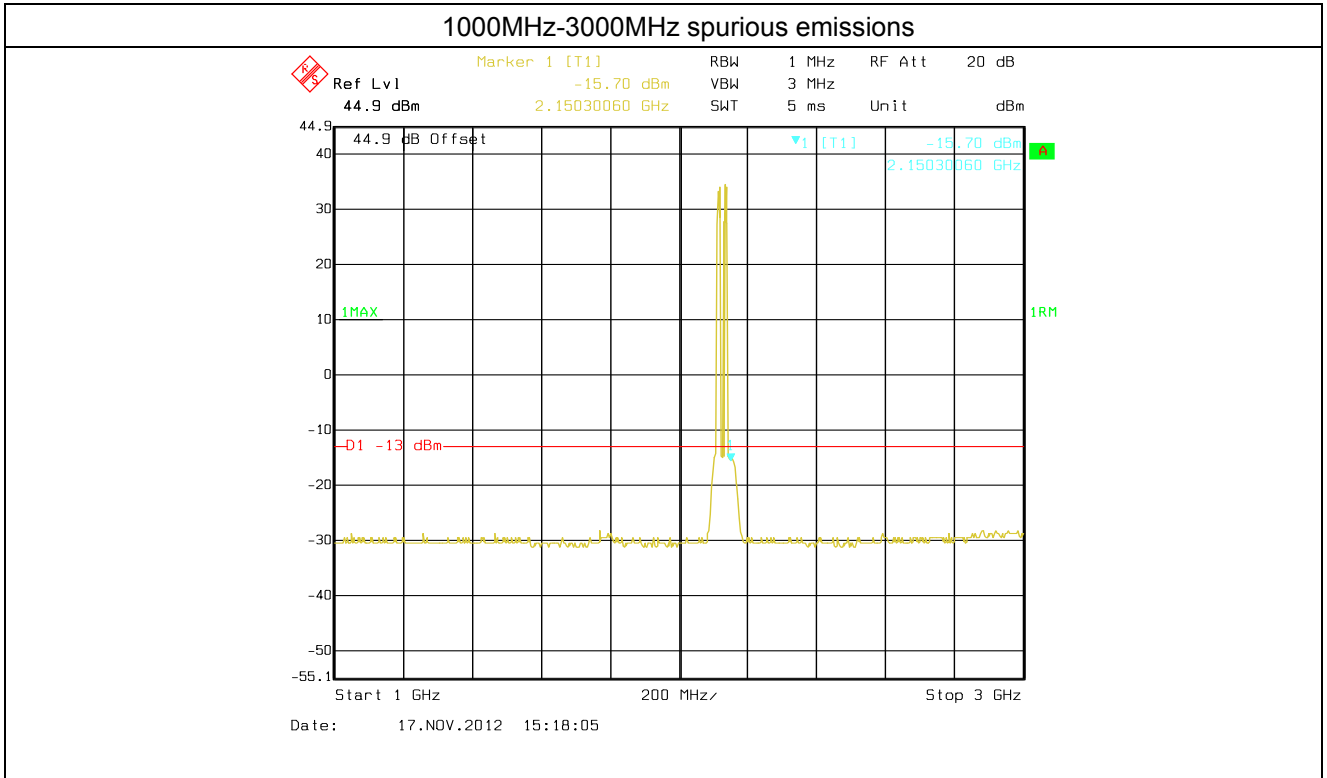

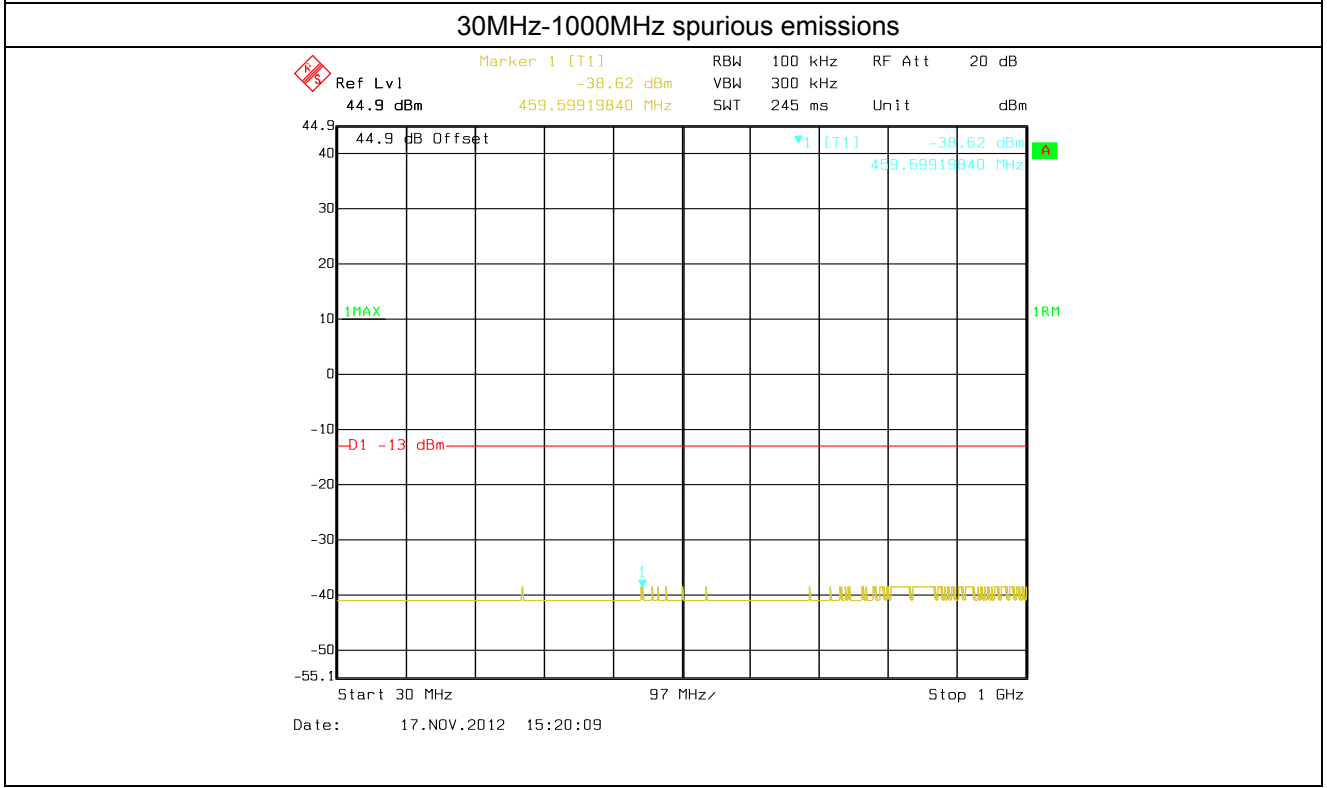
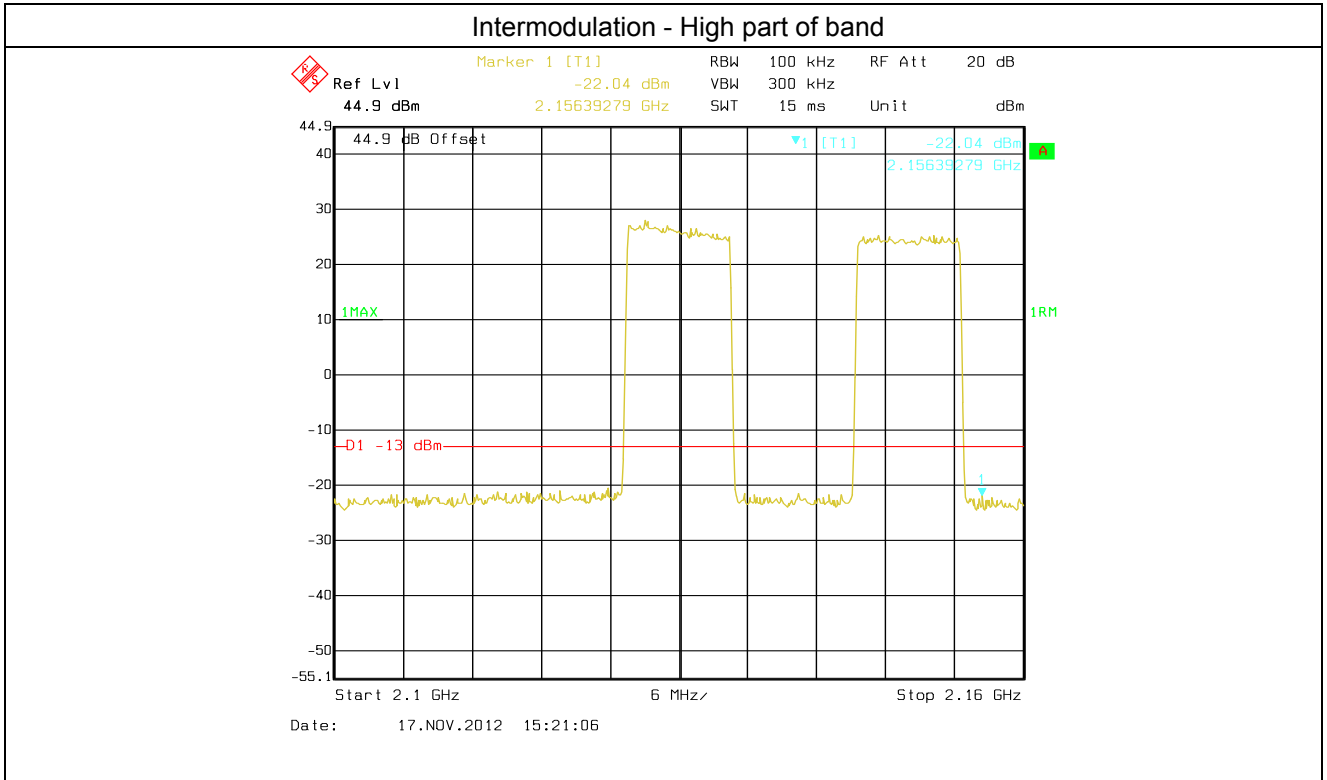

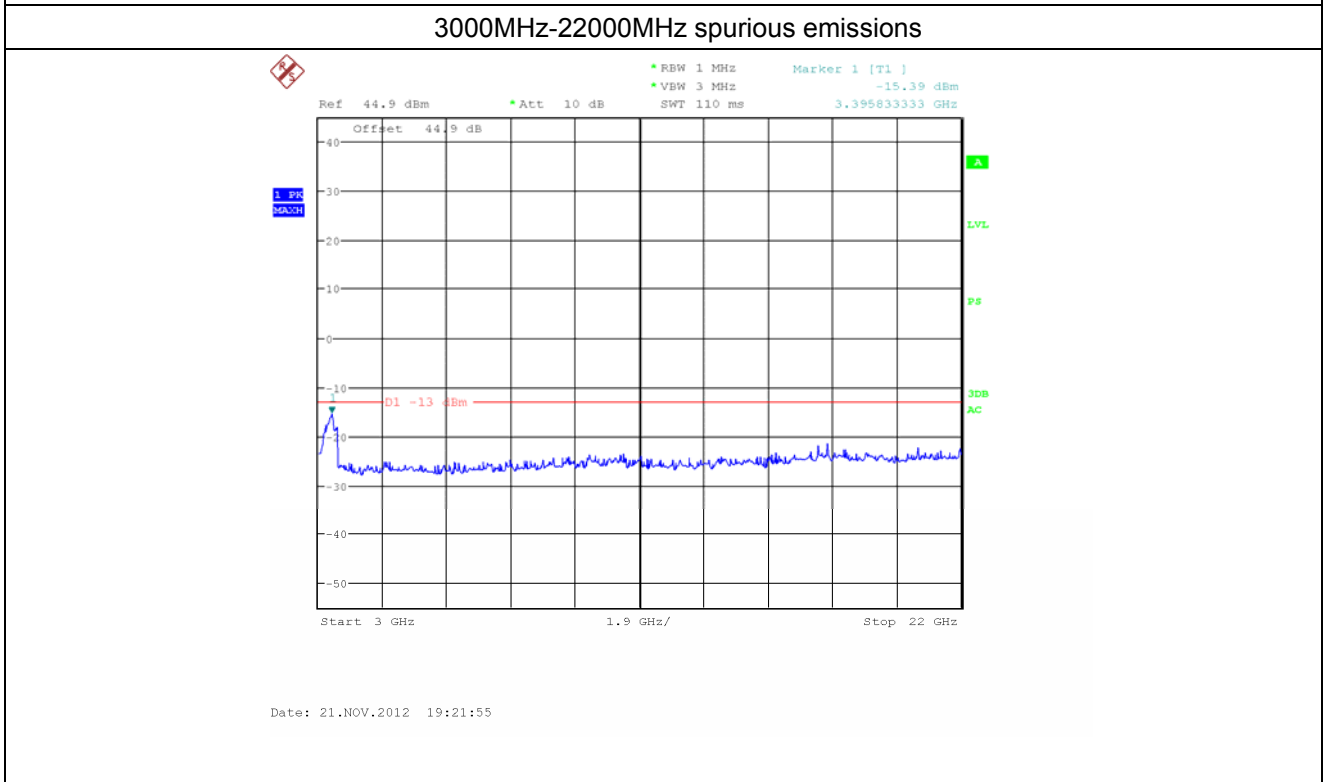
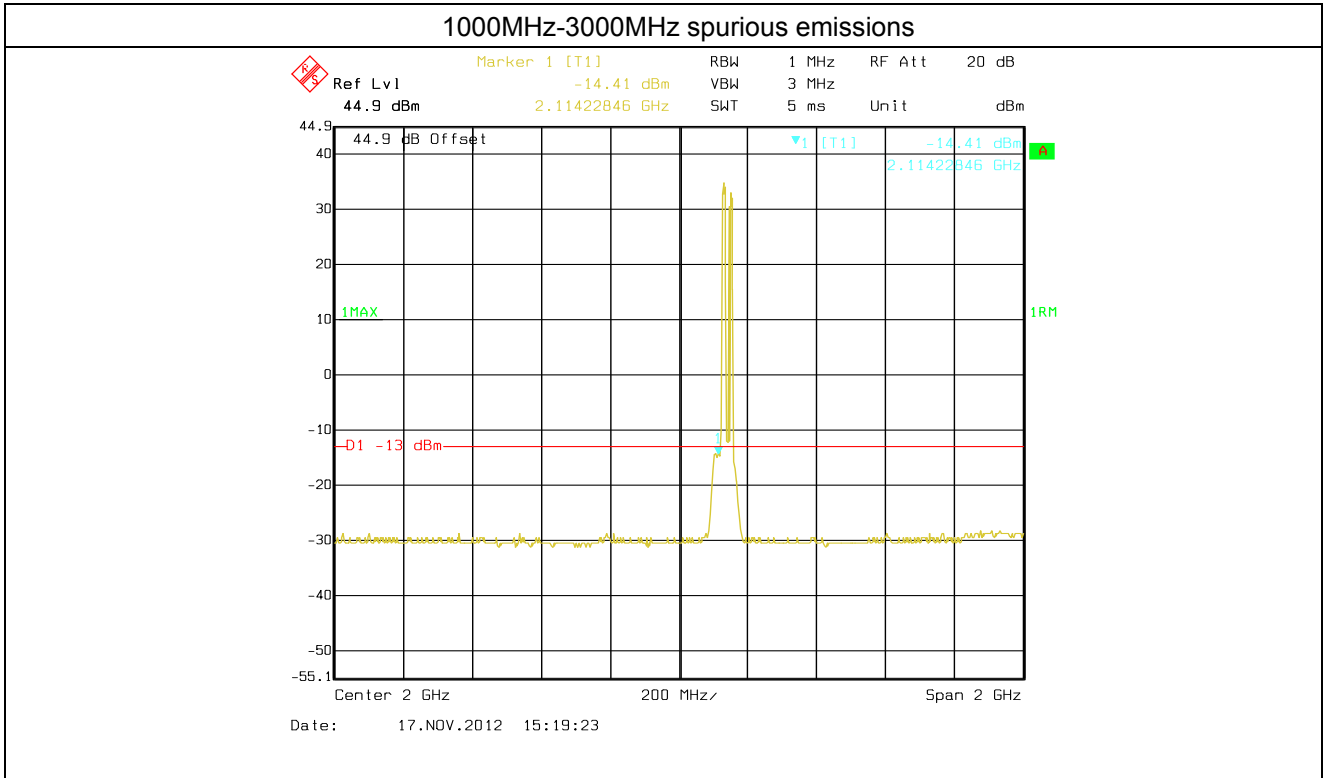

12 FIELD STRENGTH OF SPURIOUS RADIATION MEASUREMENT

12.1 Standard Applicable

According to FCC §2.1053, FCC §27.53(h),

For operations in the 1710–1755 MHz and 2110–2155 MHz bands, the power of any emission outside a licensee's frequency block shall be attenuated below the transmitter power (P) by at least $43 + 10 \log_{10}(P)$ dB.

The following method was used to determine the Limit for Spurious Emissions:

Maximum output power in watts: P (W).

The emission must be reduced by $43+10\text{Log}(P)$ dB

Therefore, the Emission Limit equals:

$$10\text{Log}(P) \text{ dBW} + 30\text{dB} - (43+10\text{Log}(P) \text{ dB}) = -13 \text{ dBm}$$

12.2 EUT Setup (Block Diagram of Configuration)

Please refer the section §6.2 Configuration of Tested System.

12.3 Measurement Procedure

1. The EUT RF output port was connected to 50 ohm RF load.
2. The EUT input port was connected to signal generator and was setup to transmit maximum power.
3. The measurement antenna was placed at a distance of 3 meters from the EUT.
4. During the tests, the antenna height and polarization as well as EUT azimuth were varied in order to identify the maximum level of emissions from EUT.
5. The frequency range up to 10-th harmonic of each of the three fundamental frequencies (low, middle and high channels) was investigated. The worst case of emissions was reported.
6. For spurious emissions attenuation, the substitution method was used.
7. The EUT was substituted by a reference antenna (half-wave dipole – below 1 GHz, or Horn antenna – above 1 GHz), connected to a signal generator.
8. The signal generator output level was adjusted to obtain the same reading as from EUT. The EIRP at the spurious emissions frequency was calculated as follows:

$$\text{EIRP} = \text{S.G. output (dBm)} + \text{Antenna Gain(dBi)} - \text{Cable Loss (dB)}$$

9. The antenna substitution method is used to determine the equivalent radiated power at spurious frequencies. The spurious emissions are measured at a distance of 3 meters. The EUT is then replaced with a reference substitution antenna with a known gain referenced to a dipole. This antenna is fed with a signal at the spurious frequency. The level of the signal is adjusted to repeat the previously measured level. The resulting eirp is the signal level fed to the reference antenna corrected for gain referenced to an isotropic dipole
10. From KDB (AMPLIFIER, BOOSTER, AND REPEATER REMINDER SHEET): Radiated spurs (enclosure) – Use of CW signal (low, mid. and high freq.) is acceptable rather than all modulations.
11. The maximum RFI field strength was determined during the measurement by rotating the turntable (± 180 degrees) and varying the height of the receive antenna ($h = 1 \dots 4$ m) as like defined in ANSI C63.4. A measurement receiver has been used with a RBW 120 kHz up to 1 GHz and 1 MHz above 1 GHz. Steps with during pre measurement was half the RBW.
12. Both, the Fully Anechoic Chamber (FAC) and the Semi Anechoic Chamber (SAC) fulfil the requirements of ANSI C63.4 and CISPR 16-1-4 with regards to NSA and SVSWR.

12.4 Test Result

Passed.

Test mode:	WCDMA (below 1G)		Test channel:	Middle
Frequency (MHz)	Spurious Emission		Limit (dBm)	Result
	Polarization	Level (dBm)		
40.37	Vertical	-28.47	-13.00	Pass
124.54	V	-29.85		
143.26	V	-30.24		
254.67	V	-31.64		
600.34	V	---		
981.24	V	---		
55.47	Horizontal	-30.86	-13.00	Pass
144.98	H	-29.78		
240.65	H	-31.12		
350.64	H	-31.99		
650.47	H	---		
910.24	H	---		
Test mode:	WCDMA (above 1G)		Test channel:	Middle
Frequency (MHz)	Spurious Emission		Limit (dBm)	Result
	Polarization	Level (dBm)		
1589.54	Vertical	-29.57	-13.00	Pass
4445.57	V	-31.54		
6658.54	V	-31.98		
792.47	V	---		
9887.54	V	---		
1880.14	Horizontal	-30.51	-13.00	Pass
4231.14	H	-31.64		
6750.64	H	-33.78		
7776.54	H	---		
9145.36	H	---		

Remark :

1. Remark"---" means that the emission level is too low to be measured
2. 18GHz-22GHz: No substitution measurement has been performed, because there were no emissions detected during the pre measurement other than noise.

Test mode:	CDMA (below 1G)		Test channel:	Middle
Frequency (MHz)	Spurious Emission		Limit (dBm)	Result
	Polarization	Level (dBm)		
35.47	Vertical	-30.57	-13.00	Pass
60.57	V	-29.87		
125.67	V	-29.34		
134.21	V	-30.47		
333.64	V	---		
840.29	V	---		
60.89	Horizontal	-30.29	-13.00	Pass
154.67	H	-31.67		
256.37	H	-31.54		
356.44	H	-29.31		
579.49	H	---		
776.78	H	---		
Test mode:	CDMA (above 1G)		Test channel:	Middle
Frequency (MHz)	Spurious Emission		Limit (dBm)	Result
	Polarization	Level (dBm)		
1859.89	Vertical	-30.54	-13.00	Pass
4358.56	V	-31.24		
6500.57	V	-29.78		
7796.24	V	---		
9346.27	V	---		
1689.58	Horizontal	-31.29	-13.00	Pass
4648.23	H	-30.21		
6649.98	H	-31.08		
7789.55	H	---		
9234.37	H	---		

Remark :

1. Remark"---" means that the emission level is too low to be measured
2. 18GHz-22GHz: No substitution measurement has been performed, because there were no emissions detected during the pre measurement other than noise.

Test mode:	EVDO(100%) (below 1G)		Test channel:	Middle
Frequency (MHz)	Spurious Emission		Limit (dBm)	Result
	Polarization	Level (dBm)		
46.59	Vertical	-29.61	-13.00	Pass
60.24	V	-28.57		
120.36	V	-30.31		
188.45	V	-30.12		
264.79	V	---		
398.57	V	---		
60.16	Horizontal	-29.98	-13.00	Pass
130.46	H	-31.51		
245.61	H	-31.00		
369.96	H	-30.61		
641.47	H	---		
920.51	H	---		
Test mode:	EVDO(100%) (above 1G)		Test channel:	Middle
Frequency (MHz)	Spurious Emission		Limit (dBm)	Result
	Polarization	Level (dBm)		
1846.51	Vertical	-30.14	-13.00	Pass
4224.30	V	-28.69		
6663.49	V	-30.81		
7986.84	V	---		
9357.49	V	---		
1895.47	Horizontal	-29.99	-13.00	Pass
4220.10	H	-30.96		
6556.31	H	-31.3		
796.34	H	---		
9513.14	H	---		

Remark :

1. Remark"---" means that the emission level is too low to be measured
2. 18GHz-22GHz: No substitution measurement has been performed, because there were no emissions detected during the pre measurement other than noise.

Test mode:	LTE 10MHz Bandwidth (below 1G)		Test channel:	Middle
Frequency (MHz)	Spurious Emission		Limit (dBm)	Result
	Polarization	Level (dBm)		
60.34	Vertical	-30.24	-13.00	Pass
156.36	V	-29.57		
298.68	V	-30.60		
366.31	V	-29.56		
598.15	V	---		
898.49	V	---		
55.47	Horizontal	-32.49	-13.00	Pass
146.30	H	-29.56		
269.48	H	-30.87		
370.98	H	-29.21		
589.09	H	---		
930.03	H	---		
Test mode:	LTE 10MHz Bandwidth (above 1G)		Test channel:	Middle
Frequency (MHz)	Spurious Emission		Limit (dBm)	Result
	Polarization	Level (dBm)		
1896.47	Vertical	-28.99	-13.00	Pass
3246.19	V	-30.49		
6598.17	V	-31.64		
7968.59	V	---		
9651.23	V	---		
1780.18	Horizontal	-30.58	-13.00	Pass
3323.64	H	-31.29		
6694.71	H	-31.99		
7796.45	H	---		
9237.36	H	---		

Remark :

1. Remark"---" means that the emission level is too low to be measured
2. 18GHz-22GHz: No substitution measurement has been performed, because there were no emissions detected during the pre measurement other than noise.

13 FREQUENCY STABILITY

13.1 Standard Applicable

According to FCC §2.1055, FCC part 27.54

The frequency stability shall be sufficient to ensure that the fundamental emissions stay within the authorized frequency block.

Limits: No specific frequency stability requirement in part 2.1055 and part 27.54.

In addition, In accordance with the technical requirements of the EUT, The frequency stability of the transmitter shall be maintained within $\pm 0.00025\%$ (± 2.5 ppm) of the center frequency.

13.2 Test setup

Please refer the section §6.2 Configuration of Tested System.

13.3 Test Procedure

1. The EUT was placed inside the temperature chamber.
2. The RF output port was connected to a spectrum analyzer.
3. The level of RF input signal shall be increased, until the maximum output power per channel, declared by client, is reached.
4. After the temperature stabilized for approximately 20 min, the transmitting frequency was measured by the spectrum analyzer and recorded.
5. At room temperature, the frequency was measured when EUT was powered with the nominal voltage and with 85% and 115% of the nominal voltage.

13.4 Test Result

Passed.

WCDMA mode					
Reference Frequency: Middle channel=2132.5MHz					
Voltage with nominal Voltage	Power Supplied (VAC)	Temperature (°C)	Measured Max. Frequency Error		Result
			(Hz)	(ppm)	
100%	120V	-40	10	0.00469	Passed
100%		-30	11	0.00516	Passed
100%		-20	7	0.00328	Passed
100%		-10	12	0.00563	Passed
100%		0	2	0.00094	Passed
100%		10	4	0.00188	Passed
100%		20	0	0.00000	Passed
100%		30	7	0.00328	Passed
100%		40	10	0.00469	Passed
100%		50	7	0.00328	Passed
100%		55	9	0.00422	Passed
85%		102V	20	7	0.00328
115%	138V	20	10	0.00469	Passed

Remark: EUT is specified for outdoor use with temperature range of -40° to +55° C, and was tested with its range.

CDMA mode					
Reference Frequency: Middle channel=2132.5MHz					
Voltage with nominal Voltage	Power Supplied (VAC)	Temperature (°C)	Frequency Error (Hz)	Frequency Error (ppm)	Result
100%	120V	-40	6	0.00281	Passed
100%		-30	8	0.00375	Passed
100%		-20	12	0.00563	Passed
100%		-10	6	0.00281	Passed
100%		0	4	0.00188	Passed
100%		10	5	0.00234	Passed
100%		20	0	0.00000	Passed
100%		30	9	0.00422	Passed
100%		40	11	0.00516	Passed
100%		50	10	0.00469	Passed
100%		55	9	0.00422	Passed
85%		102V	20	11	0.00516
115%	138V	20	8	0.00375	Passed

Remark: EUT is specified for outdoor use with temperature range of -40° to +55° C, and was tested with its range.

EVDO(100%) mode					
Reference Frequency: Middle channel=2132.5MHz					
Voltage with nominal Voltage	Power Supplied (VAC)	Temperature (°C)	Frequency Error (Hz)	Frequency Error (ppm)	Result
100%	120V	-40	11	0.00516	Passed
100%		-30	8	0.00375	Passed
100%		-20	6	0.00281	Passed
100%		-10	7	0.00328	Passed
100%		0	4	0.00188	Passed
100%		10	2	0.00094	Passed
100%		20	1	0.00047	Passed
100%		30	8	0.00375	Passed
100%		40	7	0.00328	Passed
100%		50	11	0.00516	Passed
100%		55	9	0.00422	Passed
85%		102V	20	11	0.00516
115%	138V	20	10	0.00469	Passed

Remark: EUT is specified for outdoor use with temperature range of -40° to +55° C, and was tested with its range.

LTE 1.4MHz Bandwidth mode					
Reference Frequency: Middle channel=2132.5MHz					
Voltage with nominal Voltage	Power Supplied (VAC)	Temperature (°C)	Frequency Error (Hz)	Frequency Error (ppm)	Result
100%	120V	-40	6	0.00281	Passed
100%		-30	10	0.00469	Passed
100%		-20	8	0.00375	Passed
100%		-10	6	0.00281	Passed
100%		0	0	0.00000	Passed
100%		10	5	0.00234	Passed
100%		20	0	0.00000	Passed
100%		30	9	0.00422	Passed
100%		40	6	0.00281	Passed
100%		50	12	0.00563	Passed
100%		55	11	0.00516	Passed
85%		102V	20	8	0.00375
115%	138V	20	6	0.00281	Passed

Remark: EUT is specified for outdoor use with temperature range of -40° to +55° C, and was tested with its range.

LTE 20MHz Bandwidth mode					
Reference Frequency: Middle channel=2132.5MHz					
Voltage with nominal Voltage	Power Supplied (VAC)	Temperature (°C)	Frequency Error (Hz)	Frequency Error (ppm)	Result
100%	120V	-40	8	0.00375	Passed
100%		-30	9	0.00422	Passed
100%		-20	11	0.00516	Passed
100%		-10	7	0.00328	Passed
100%		0	6	0.00281	Passed
100%		10	4	0.00188	Passed
100%		20	3	0.00141	Passed
100%		30	7	0.00328	Passed
100%		40	12	0.00563	Passed
100%		50	11	0.00516	Passed
100%		55	26	0.01219	Passed
85%		102V	20	4	0.00188
115%	138V	20	15	0.00703	Passed

Remark: EUT is specified for outdoor use with temperature range of -40° to +55° C, and was tested with its range.

14 OUT-OF-BAND REJECTION

14.1 Standard Applicable

According to KDB (AMPLIFIER, BOOSTER, AND REPEATER REMINDER SHEET):

Out of Band Rejection – Test for rejection of out of band signals. Filter freq. response plots are acceptable.

14.2 Test setup

Please refer the section §6.2 Configuration of Tested System.

14.3 Test Procedure

1. The EUT RF output port was connected to spectrum analyzer.
2. The level of RF input signal shall be increased, until the maximum output power per channel, declared by client, is reached.
3. A continuous sinusoidal RF signal shall be fed successively at frequency offsets 100 MHz from the edges of the relevant MS or BTS transmit frequency band into the relevant input port of the repeater.
4. The RF output curve was recorded by spectrum analyzer.

14.4 Test Result

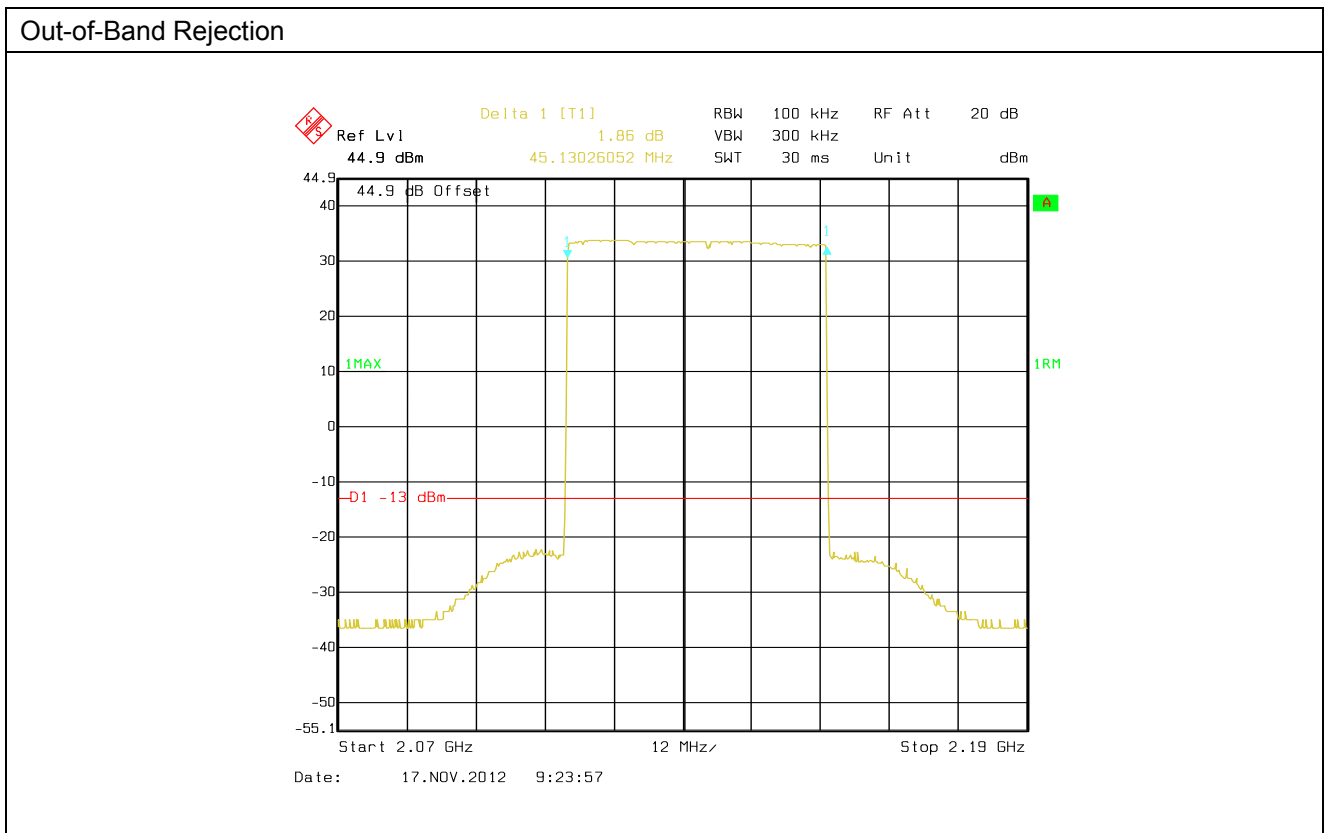

15 AC POWER LINE CONDUCTED EMISSION TEST

15.1 Standard Applicable

According to FCC §15.107. The emission value for frequency within 150KHz to 30MHz shall not Exceed criteria of below chart.

Frequency range (MHz)	Limits dB(uV)	
	Quasi-peak	Average
0.15 to 0.50	79	66
0.50 to 30	73	60
Note 1.The lower limit shall apply at the transition frequencies 2.The limit decreases linearly with the logarithm of the frequency in the range 0.15 MHz to 0.50 MHz.		

15.2 Test setup

1. The conducted emission tests were performed in the test site, using the setup in accordance with the ANSI C63.4-2001.
2. The EUT was plug-in DC power adaptor and was placed on the center of the back edge on the test table. The peripherals like earphone was placed on the side of the EUT. The rear of the EUT and peripherals were placed flushed with the rear of the tabletop.
3. The Power adaptor was connected with 110Vac/60Hz power source.

15.3 Test Procedure

1. The EUT was placed on a table which is 0.8m above ground plane.
2. Maximum procedure was performed on the six highest emissions to ensure EUT compliance.
3. Repeat above procedures until all frequency measured were complete.

15.4 Measurement Result

Test mode: WCDMA

Line:

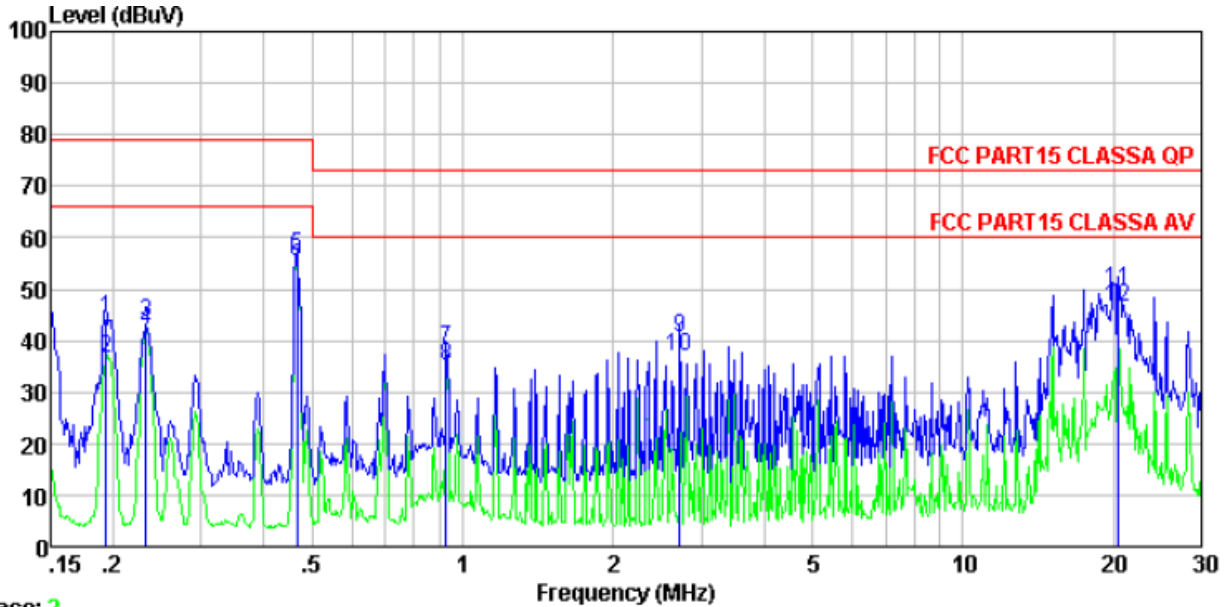

Trace: 2

Condition : FCC PART15 CLASSA QP LISN-2012 LINE
 Job No. : 1416RF
 Test mode : Operation mode
 Test Engineer: Osccar
 Remark : WCDMA

	Freq	Read Level	LISN Factor	Cable Loss	Level	Limit Line	Over Limit	Remark
	MHz	dBuV	dB	dB	dBuV	dBuV	dB	
1	0.193	44.37	-0.23	0.10	44.24	79.00	-34.76	QP
2	0.193	36.74	-0.23	0.10	36.61	66.00	-29.39	Average
3	0.233	43.76	-0.23	0.10	43.63	79.00	-35.37	QP
4	0.233	42.28	-0.23	0.10	42.15	66.00	-23.85	Average
5	0.466	56.59	-0.21	0.10	56.48	79.00	-22.52	QP
6	0.466	55.56	-0.21	0.10	55.45	66.00	-10.55	Average
7	0.928	38.64	-0.21	0.10	38.53	73.00	-34.47	QP
8	0.928	35.03	-0.21	0.10	34.92	60.00	-25.08	Average
9	2.721	40.65	-0.25	0.10	40.50	73.00	-32.50	QP
10	2.721	36.94	-0.25	0.10	36.79	60.00	-23.21	Average
11	20.486	50.27	-0.64	0.21	49.84	73.00	-23.16	QP
12	20.486	46.99	-0.64	0.21	46.56	60.00	-13.44	Average

Neutral:

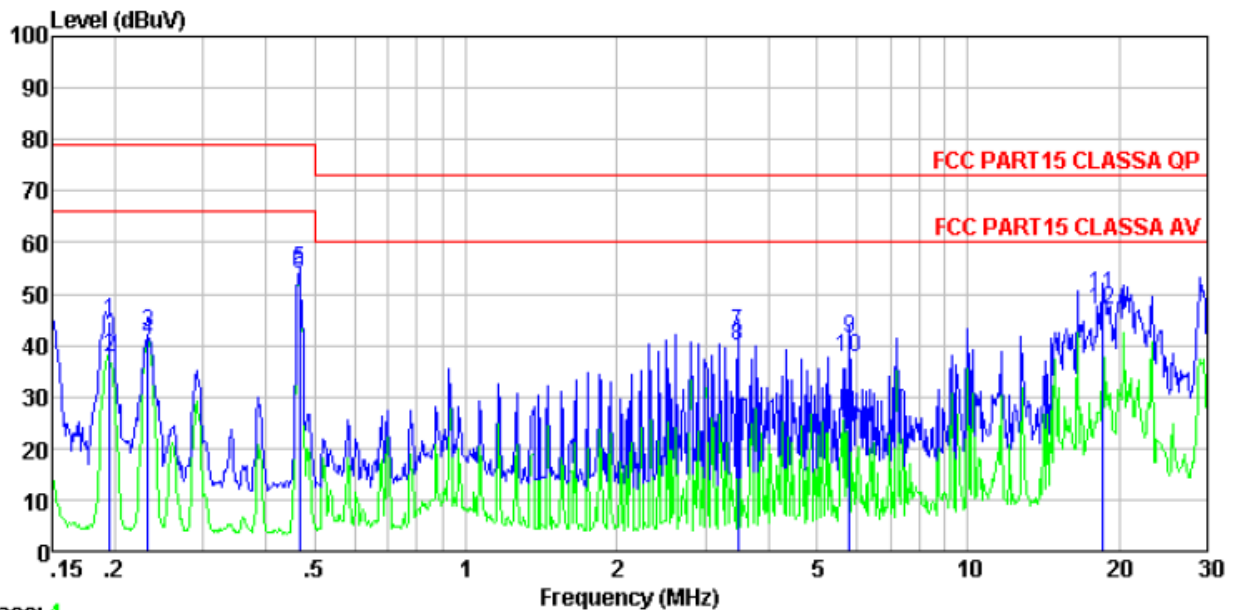

Trace: 4

Condition : FCC PART15 CLASSA QP LISN-2012 NEUTRAL
 Job No. : 1416RF
 Test mode : Operation mode
 Test Engineer: Osccar
 Remark : WCDMA

	Freq	Read Level	LISN Factor	Cable Loss	Level	Limit Line	Over Limit	Remark
	MHz	dBuV	dB	dB	dBuV	dBuV	dB	
1	0.195	44.59	-0.09	0.10	44.60	79.00	-34.40	QP
2	0.195	37.54	-0.09	0.10	37.55	66.00	-28.45	Average
3	0.233	42.47	-0.09	0.10	42.48	79.00	-36.52	QP
4	0.233	41.13	-0.09	0.10	41.14	66.00	-24.86	Average
5	0.466	54.59	-0.08	0.10	54.61	79.00	-24.39	QP
6	0.466	53.84	-0.08	0.10	53.86	66.00	-12.14	Average
7	3.491	42.38	-0.13	0.10	42.35	73.00	-30.65	QP
8	3.491	39.88	-0.13	0.10	39.85	60.00	-20.15	Average
9	5.805	41.23	-0.17	0.11	41.17	73.00	-31.83	QP
10	5.805	37.60	-0.17	0.11	37.54	60.00	-22.46	Average
11	18.622	50.15	-0.51	0.21	49.85	73.00	-23.15	QP
12	18.622	47.34	-0.51	0.21	47.04	60.00	-12.96	Average

Test mode: CDMA

Line:

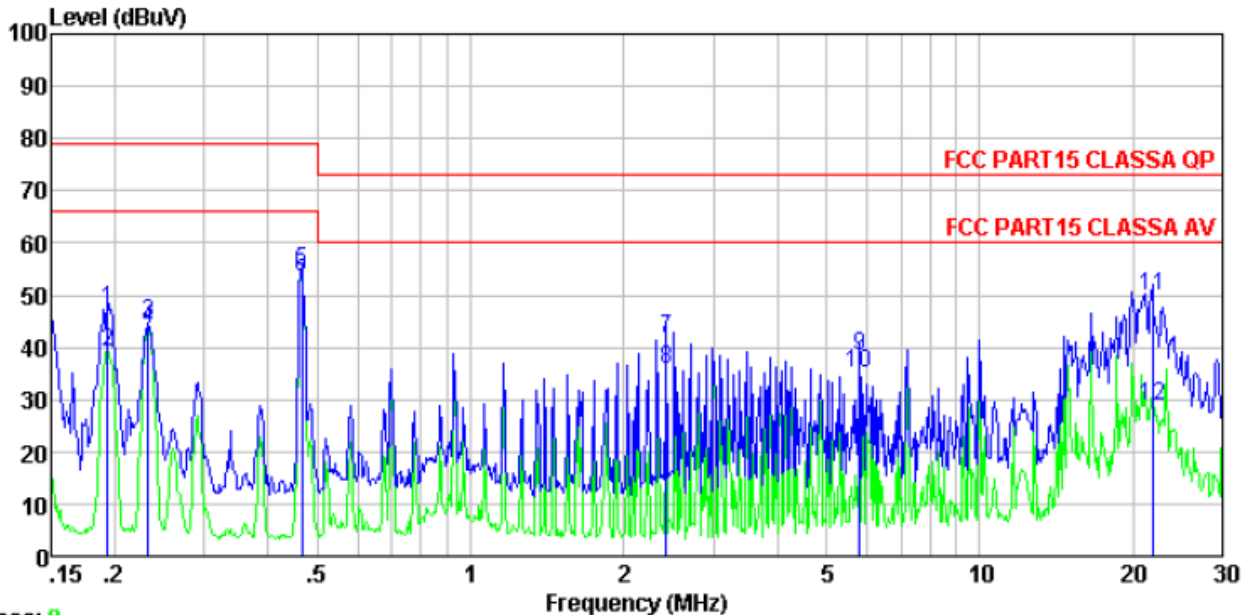

Trace: 8

Condition : FCC PART15 CLASSA QP LISN-2012 LINE
 Job No. : 1416RF
 Test mode : Operation mode
 Test Engineer: Osccar
 Remark : CDMA

	Read Freq	LISN Level	Cable Factor	Cable Loss	Limit Level	Over Line	Limit	Remark
	MHz	dBuV	dB	dB	dBuV	dBuV	dB	
1	0.193	47.25	-0.23	0.10	47.12	79.00	-31.88	QP
2	0.193	39.20	-0.23	0.10	39.07	66.00	-26.93	Average
3	0.233	44.77	-0.23	0.10	44.64	79.00	-34.36	QP
4	0.233	43.68	-0.23	0.10	43.55	66.00	-22.45	Average
5	0.466	54.58	-0.21	0.10	54.47	79.00	-24.53	QP
6	0.466	53.79	-0.21	0.10	53.68	66.00	-12.32	Average
7	2.422	41.93	-0.24	0.10	41.79	73.00	-31.21	QP
8	2.422	35.96	-0.24	0.10	35.82	60.00	-24.18	Average
9	5.805	38.65	-0.31	0.11	38.45	73.00	-34.55	QP
10	5.805	35.19	-0.31	0.11	34.99	60.00	-25.01	Average
11	21.830	50.29	-0.68	0.21	49.82	73.00	-23.18	QP
12	21.830	29.32	-0.68	0.21	28.85	60.00	-31.15	Average

Neutral:

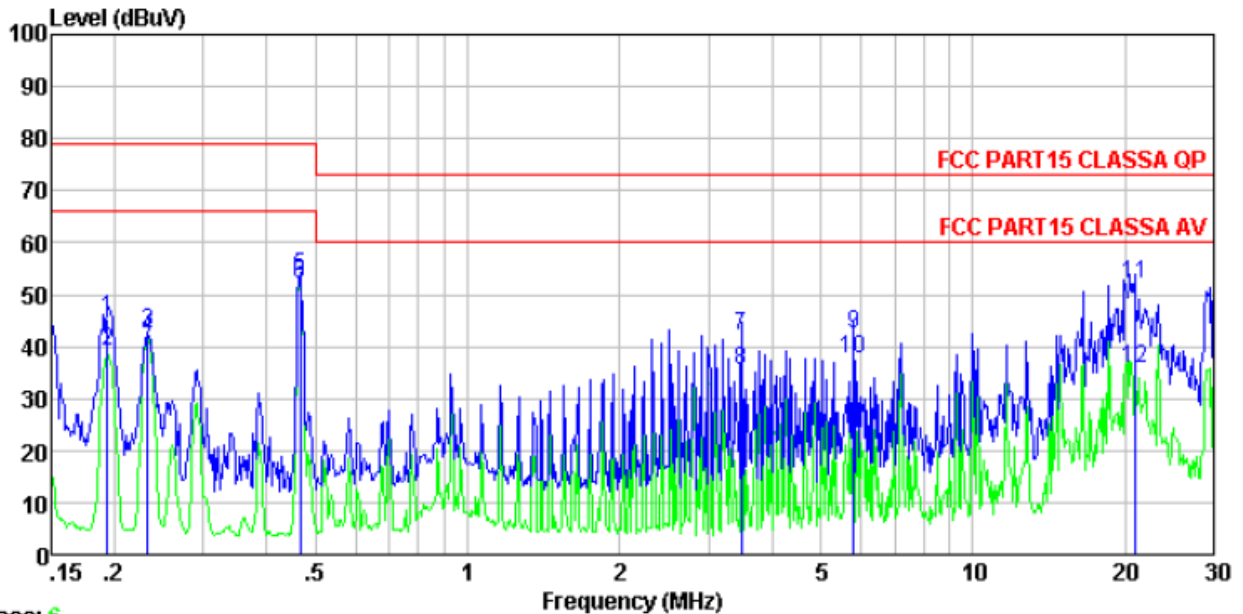

Trace: 6
 Condition : FCC PART15 CLASSA QP LISN-2012 NEUTRAL
 Job No. : 1416RF
 Test mode : Operation mode
 Test Engineer: Osccar
 Remark : CDMA

	Freq	Read Level	LISN Factor	Cable Loss	Level	Limit Line	Over Limit	Remark
	MHz	dBuV	dB	dB	dBuV	dBuV	dB	
1	0.193	45.27	-0.09	0.10	45.28	79.00	-33.72	QP
2	0.193	38.94	-0.09	0.10	38.95	66.00	-27.05	Average
3	0.233	42.83	-0.09	0.10	42.84	79.00	-36.16	QP
4	0.233	41.80	-0.09	0.10	41.81	66.00	-24.19	Average
5	0.466	53.59	-0.08	0.10	53.61	79.00	-25.39	QP
6	0.466	52.17	-0.08	0.10	52.19	66.00	-13.81	Average
7	3.491	42.25	-0.13	0.10	42.22	73.00	-30.78	QP
8	3.491	35.58	-0.13	0.10	35.55	60.00	-24.45	Average
9	5.805	42.35	-0.17	0.11	42.29	73.00	-30.71	QP
10	5.805	37.82	-0.17	0.11	37.76	60.00	-22.24	Average
11	20.924	52.19	-0.55	0.21	51.85	73.00	-21.15	QP
12	20.924	36.25	-0.55	0.21	35.91	60.00	-24.09	Average

Test mode: EVDO(100%)

Line:

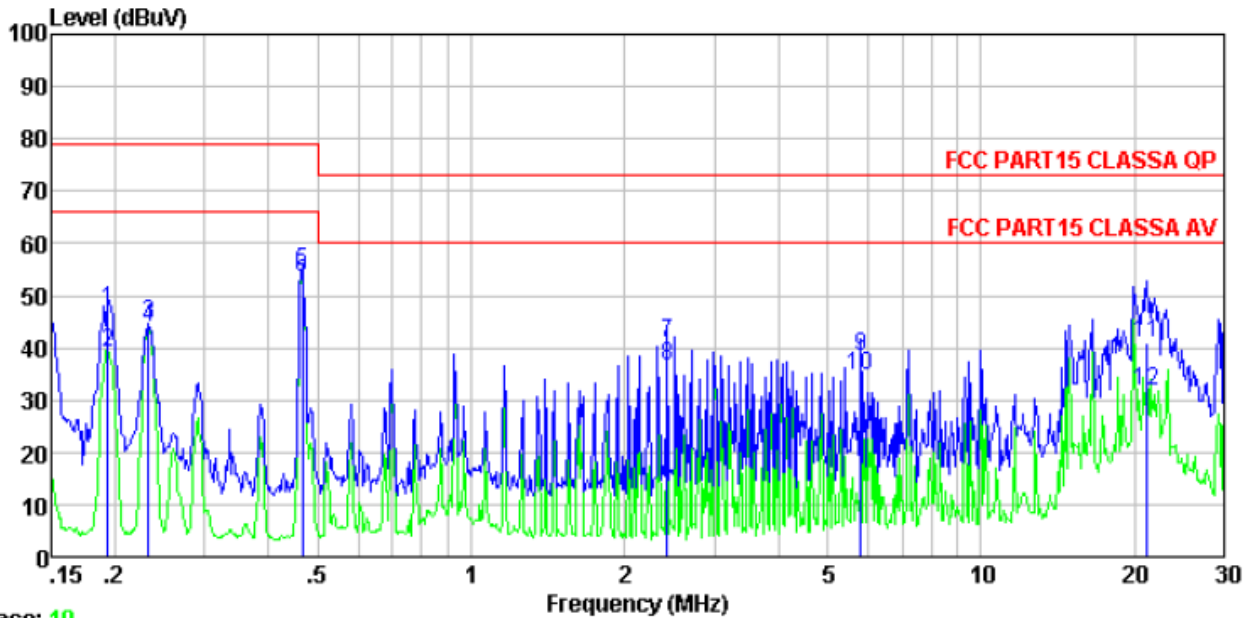

Trace: 10

Condition : FCC PART15 CLASSA QP LISN-2012 LINE
 Job No. : 1416RF
 Test mode : Operation mode
 Test Engineer: Osccar
 Remark : EVDO 100%

	Freq	Read Level	LISN Factor	Cable Loss	Level	Limit Line	Over Limit	Remark
	MHz	dBuV	dB	dB	dBuV	dBuV	dB	
1	0.193	47.29	-0.23	0.10	47.16	79.00	-31.84	QP
2	0.193	39.34	-0.23	0.10	39.21	66.00	-26.79	Average
3	0.233	44.76	-0.23	0.10	44.63	79.00	-34.37	QP
4	0.233	43.88	-0.23	0.10	43.75	66.00	-22.25	Average
5	0.466	54.68	-0.21	0.10	54.57	79.00	-24.43	QP
6	0.466	53.79	-0.21	0.10	53.68	66.00	-12.32	Average
7	2.422	41.25	-0.24	0.10	41.11	73.00	-31.89	QP
8	2.422	36.52	-0.24	0.10	36.38	60.00	-23.62	Average
9	5.805	38.69	-0.31	0.11	38.49	73.00	-34.51	QP
10	5.805	34.97	-0.31	0.11	34.77	60.00	-25.23	Average
11	21.147	41.26	-0.65	0.21	40.82	73.00	-32.18	QP
12	21.147	32.33	-0.65	0.21	31.89	60.00	-28.11	Average

Neutral:

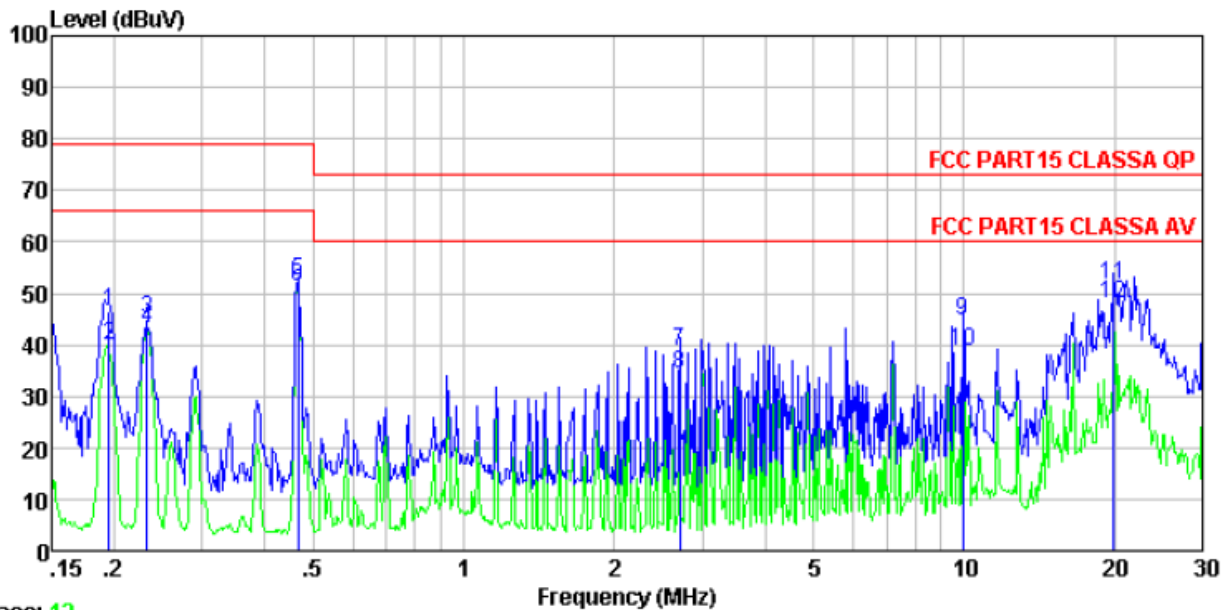

Trace: 12
 Condition : FCC PART15 CLASSA QP LISN-2012 NEUTRAL
 Job No. : 1416RF
 Test mode : Operation mode
 Test Engineer: Oscscar
 Remark : EVDO 100%

	Freq	Read Level	LISN Factor	Cable Loss	Level	Limit Line	Over Limit	Remark
	MHz	dBuV	dB	dB	dBuV	dBuV	dB	
1	0.195	46.35	-0.09	0.10	46.36	79.00	-32.64	QP
2	0.195	39.88	-0.09	0.10	39.89	66.00	-26.11	Average
3	0.233	44.88	-0.09	0.10	44.89	79.00	-34.11	QP
4	0.233	43.02	-0.09	0.10	43.03	66.00	-22.97	Average
5	0.466	52.25	-0.08	0.10	52.27	79.00	-26.73	QP
6	0.466	51.16	-0.08	0.10	51.18	66.00	-14.82	Average
7	2.707	38.68	-0.12	0.10	38.66	73.00	-34.34	QP
8	2.707	34.39	-0.12	0.10	34.37	60.00	-25.63	Average
9	9.966	44.62	-0.29	0.20	44.53	73.00	-28.47	QP
10	9.966	38.73	-0.29	0.20	38.64	60.00	-21.36	Average
11	19.950	52.14	-0.53	0.21	51.82	73.00	-21.18	QP
12	19.950	48.13	-0.53	0.21	47.81	60.00	-12.19	Average

Test mode: LTE 10MHz Bandwidth

Line:

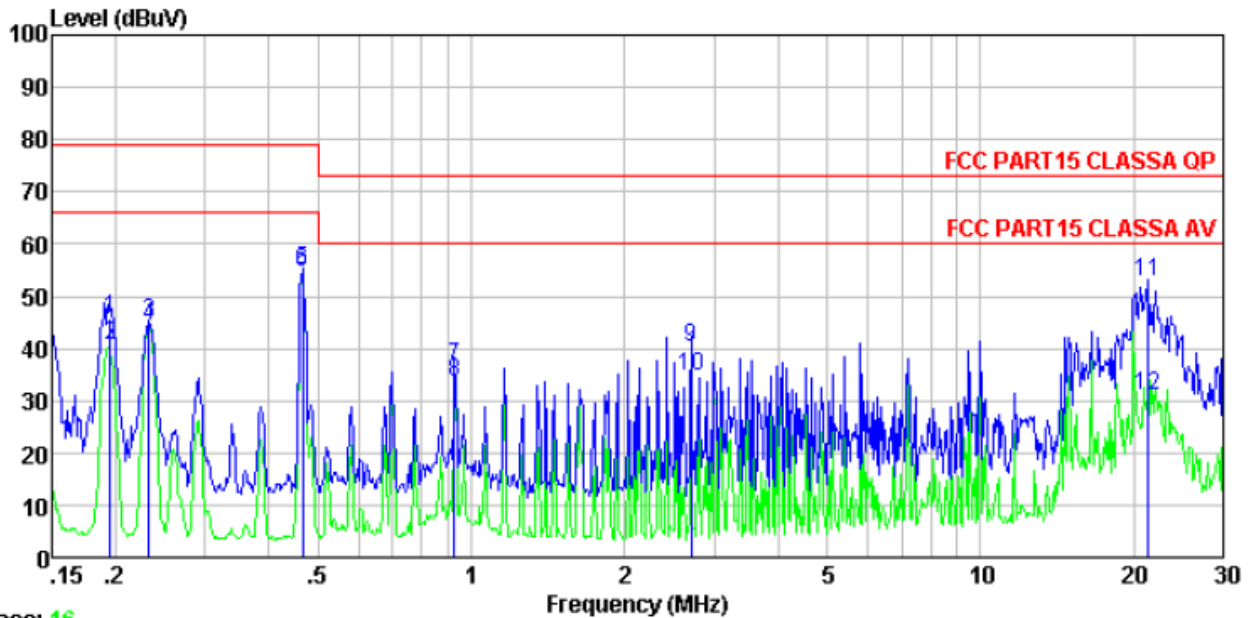

Trace: 16

Condition : FCC PART15 CLASS A QP LISN-2012 LINE
 Job No. : 1416RF
 Test mode : Operation mode
 Test Engineer: Osccar
 Remark : LTE 10M

	Read Freq	Level	LISN Factor	Cable Loss	Level	Limit	Over	Remark
	MHz	dBuV	dB	dB	dBuV	dBuV	dB	
1	0.195	45.89	-0.23	0.10	45.76	79.00	-33.24	QP
2	0.195	40.74	-0.23	0.10	40.61	66.00	-25.39	Average
3	0.233	45.32	-0.23	0.10	45.19	79.00	-33.81	QP
4	0.233	44.36	-0.23	0.10	44.23	66.00	-21.77	Average
5	0.466	55.27	-0.21	0.10	55.16	79.00	-23.84	QP
6	0.466	54.62	-0.21	0.10	54.51	66.00	-11.49	Average
7	0.928	36.51	-0.21	0.10	36.40	73.00	-36.60	QP
8	0.928	33.59	-0.21	0.10	33.48	60.00	-26.52	Average
9	2.707	40.28	-0.25	0.10	40.13	73.00	-32.87	QP
10	2.707	34.68	-0.25	0.10	34.53	60.00	-25.47	Average
11	21.260	53.15	-0.66	0.21	52.70	73.00	-20.30	QP
12	21.260	31.51	-0.66	0.21	31.06	60.00	-28.94	Average

Neutral:

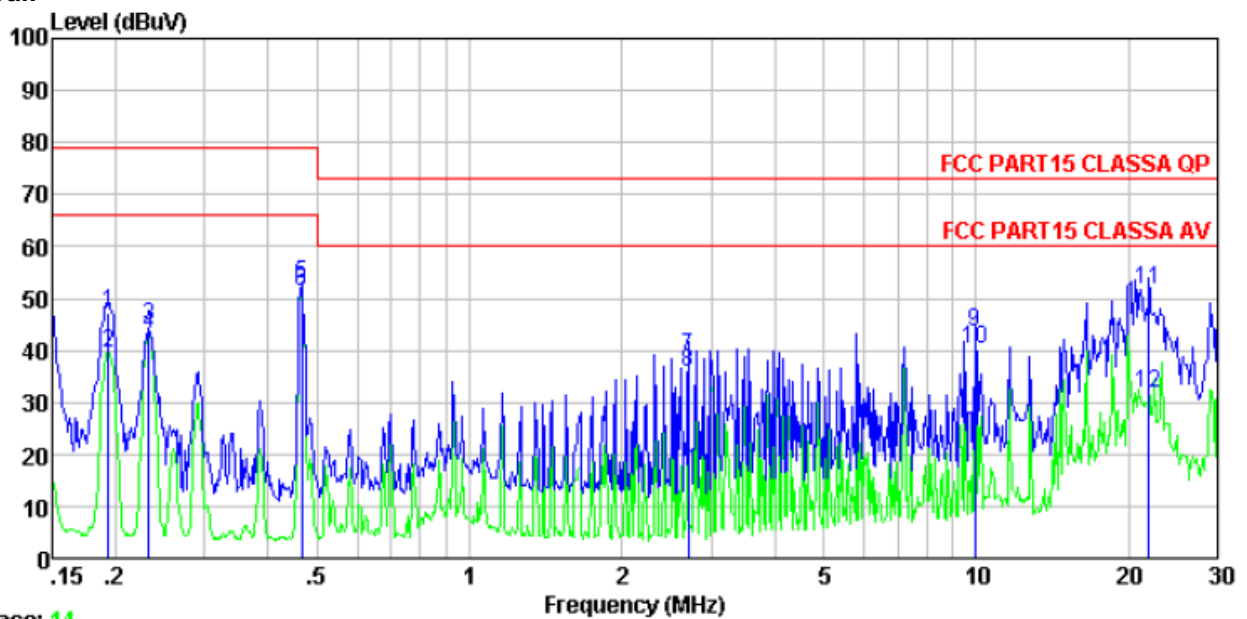

Trace: 14

Condition : FCC PART15 CLASSA QP LISN-2012 NEUTRAL
 Job No. : 1416RF
 Test mode : Operation mode
 Test Engineer: Osccar
 Remark : LTE 10M

	Freq	Read Level	LISN Factor	Cable Loss	Level	Limit Line	Over Limit	Remark
	MHz	dBuV	dB	dB	dBuV	dBuV	dB	
1	0.193	47.29	-0.09	0.10	47.30	79.00	-31.70	QP
2	0.193	39.59	-0.09	0.10	39.60	66.00	-26.40	Average
3	0.233	44.57	-0.09	0.10	44.58	79.00	-34.42	QP
4	0.233	43.32	-0.09	0.10	43.33	66.00	-22.67	Average
5	0.466	52.59	-0.08	0.10	52.61	79.00	-26.39	QP
6	0.466	51.24	-0.08	0.10	51.26	66.00	-14.74	Average
7	2.707	38.69	-0.12	0.10	38.67	73.00	-34.33	QP
8	2.707	35.64	-0.12	0.10	35.62	60.00	-24.38	Average
9	9.966	43.57	-0.29	0.20	43.48	73.00	-29.52	QP
10	9.966	40.29	-0.29	0.20	40.20	60.00	-19.80	Average
11	21.946	52.15	-0.58	0.21	51.78	73.00	-21.22	QP
12	21.946	32.25	-0.58	0.21	31.88	60.00	-28.12	Average

16 Test Setup Photo

Radiated Emission

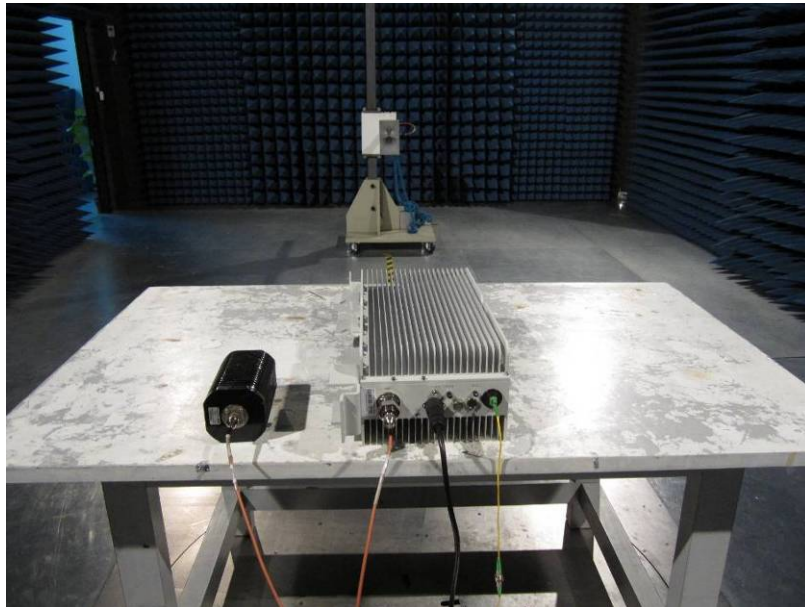
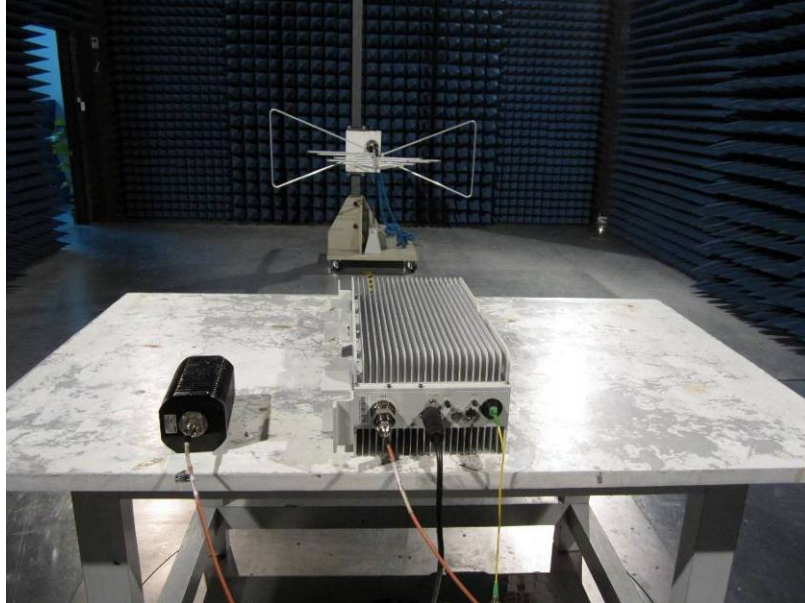

Conducted Emission



RF Test



17 EUT Constructional Details

EUT front view

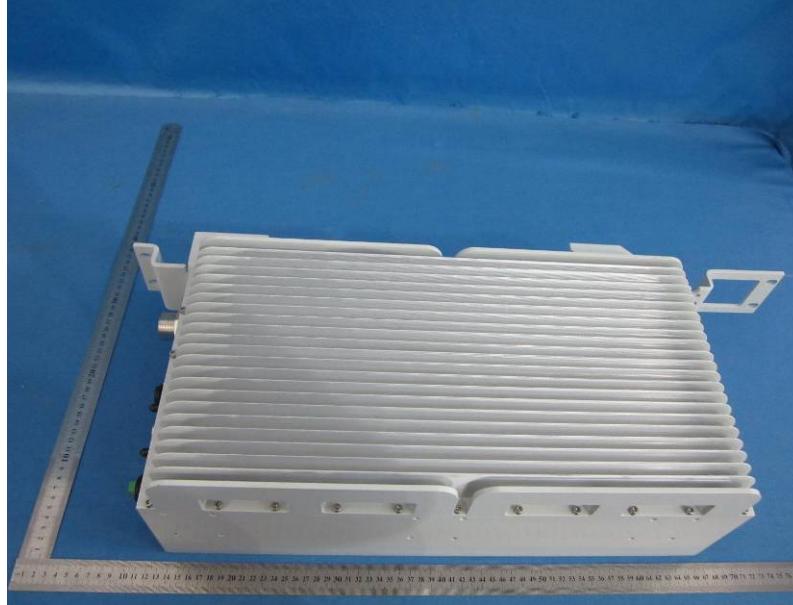

Eut side view-1

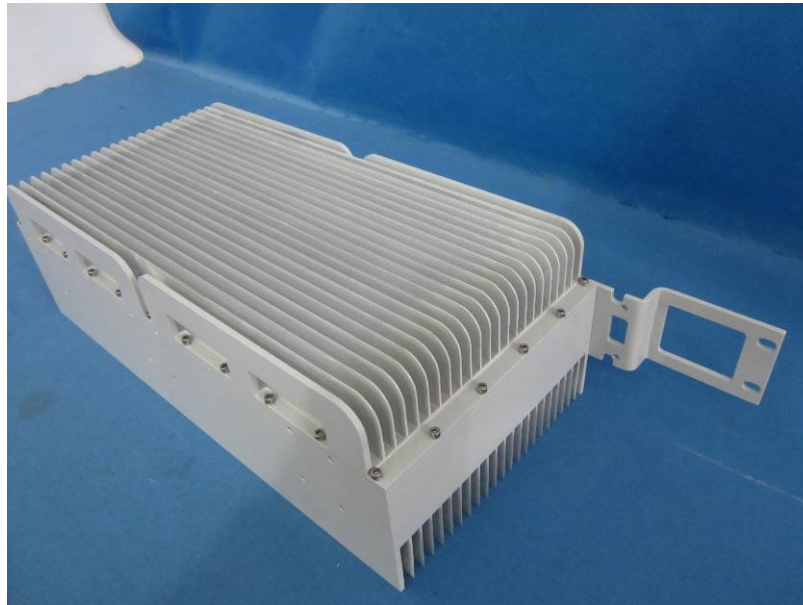

Eut side view-2



Eut port view



Eut cover off view-1

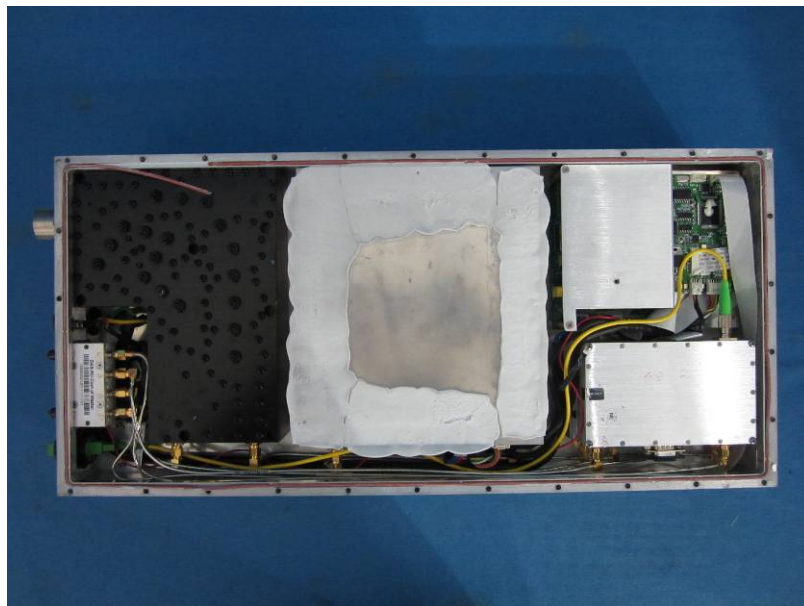
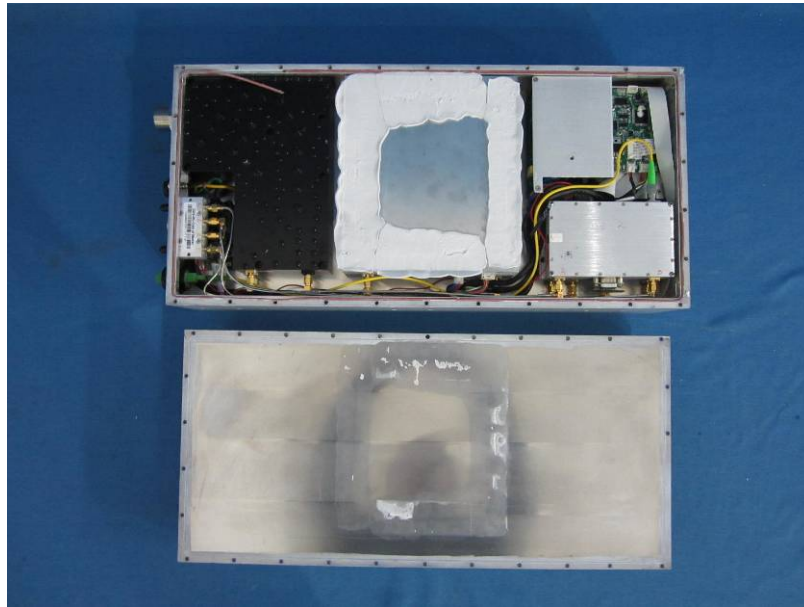

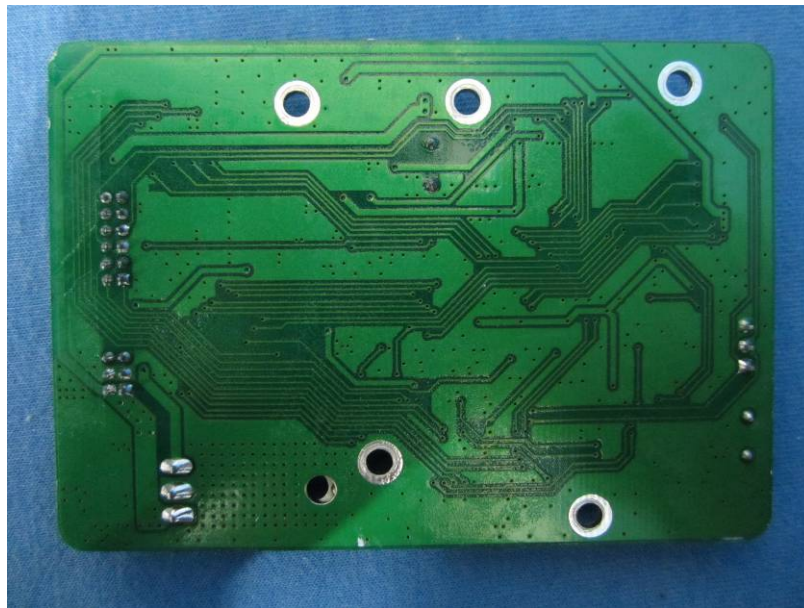
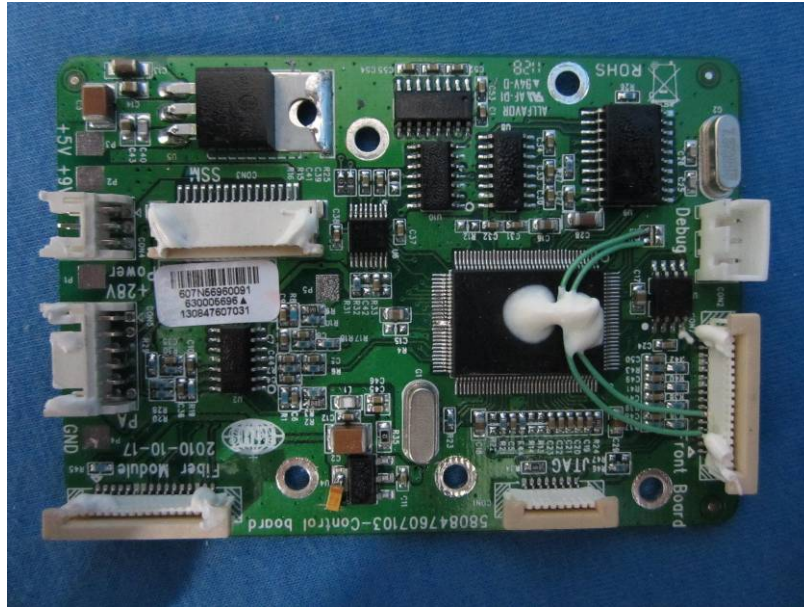

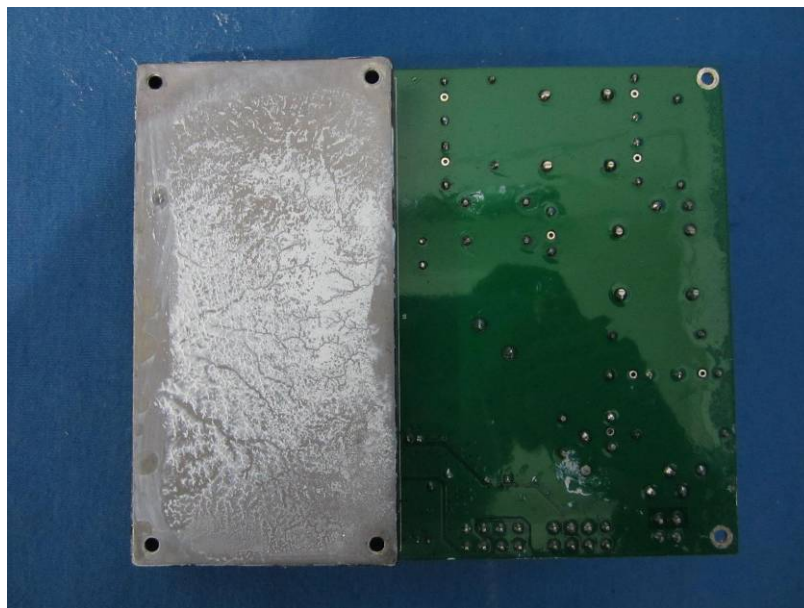
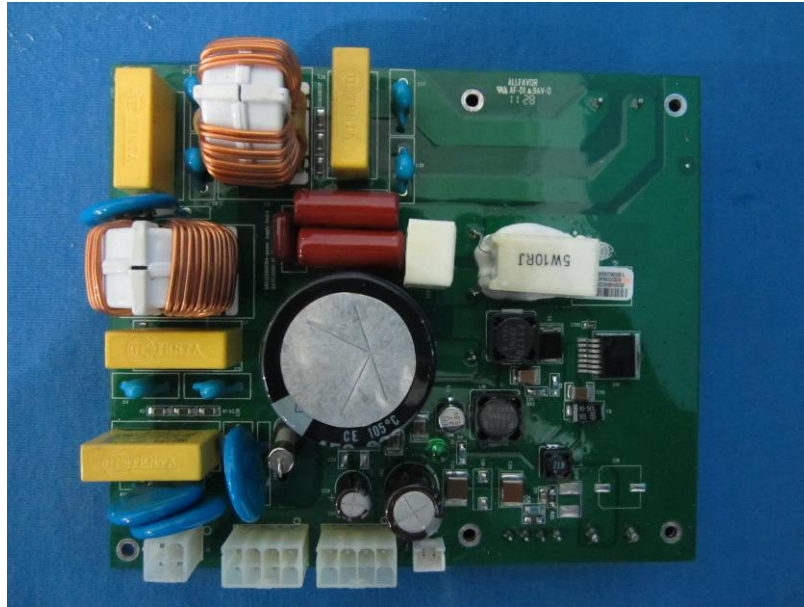

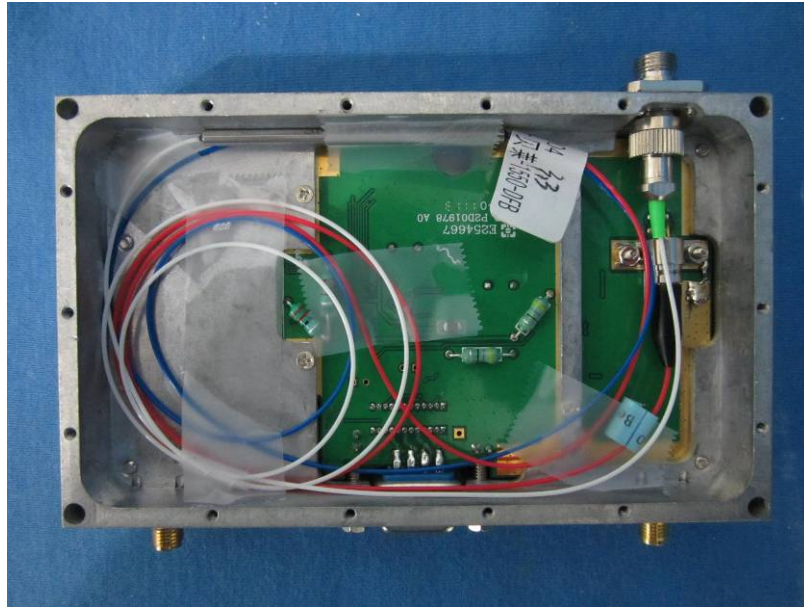

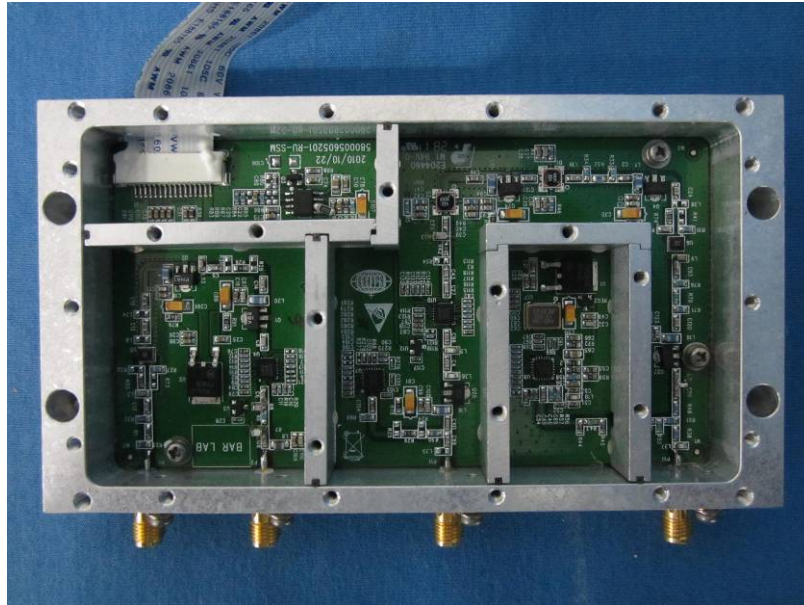

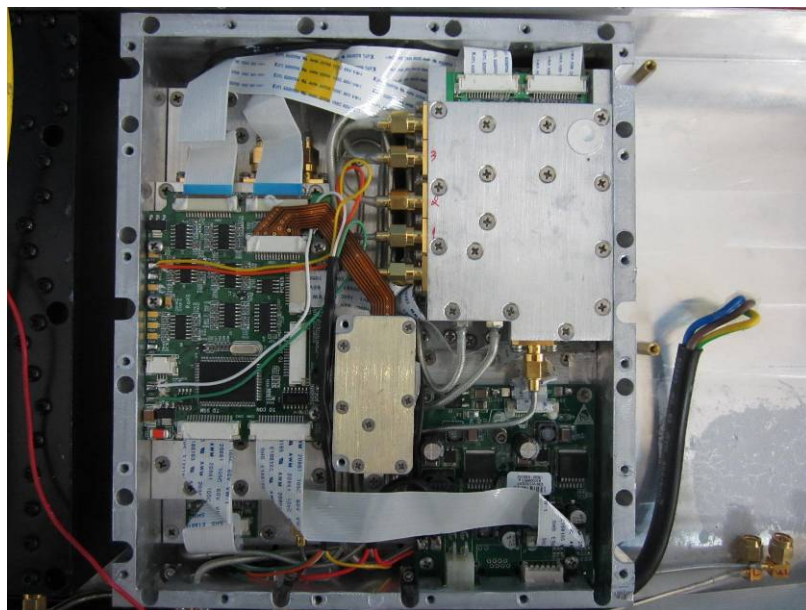
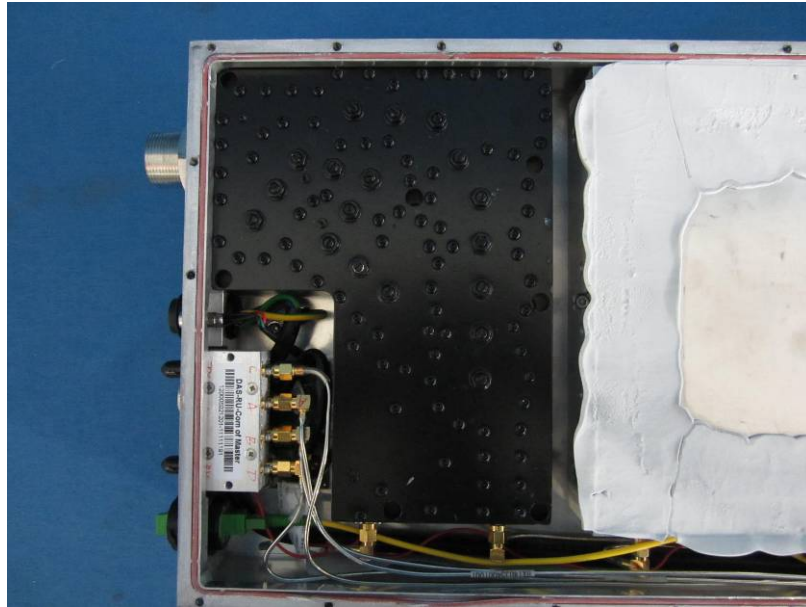

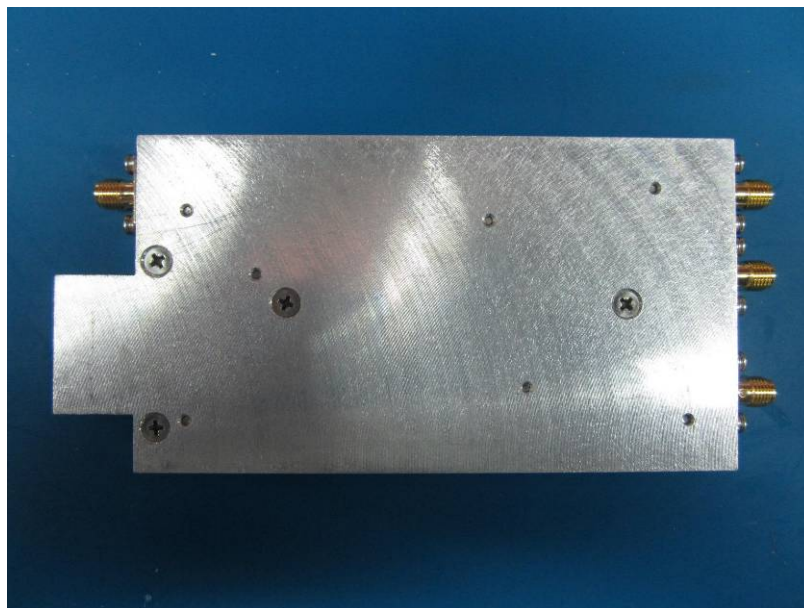
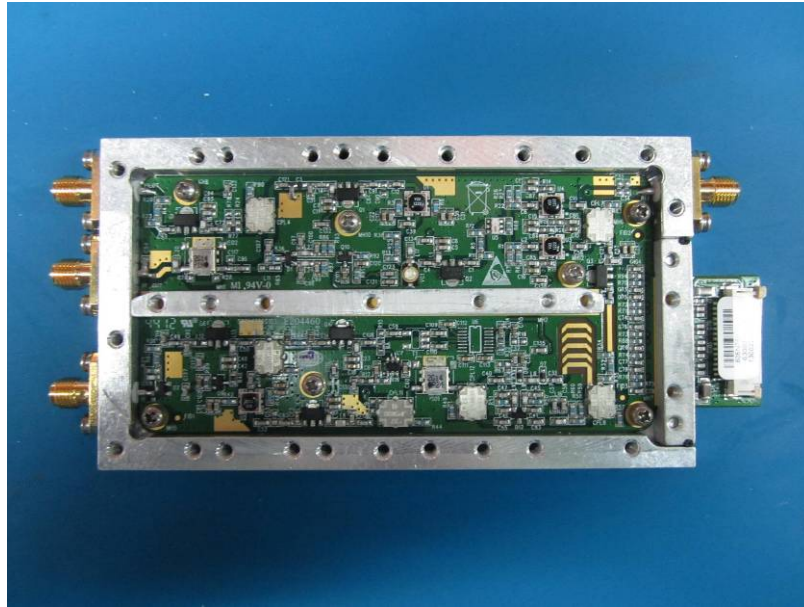

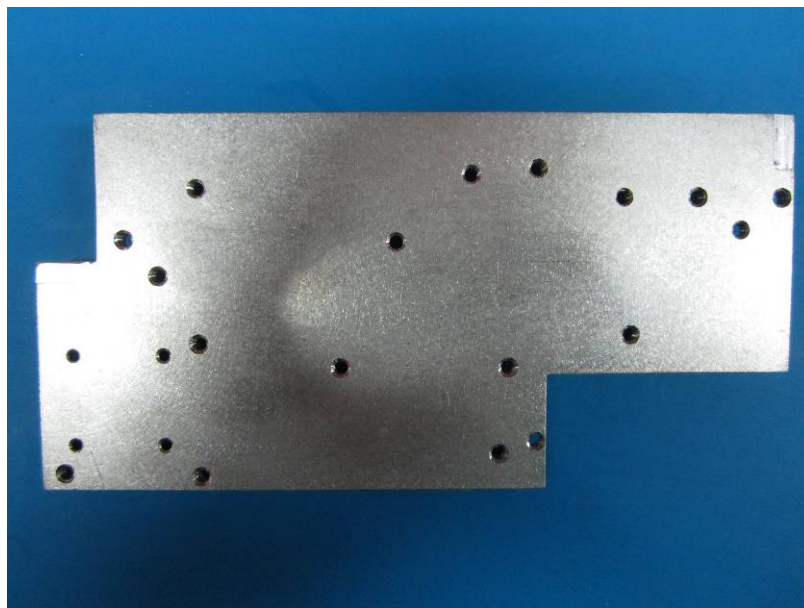
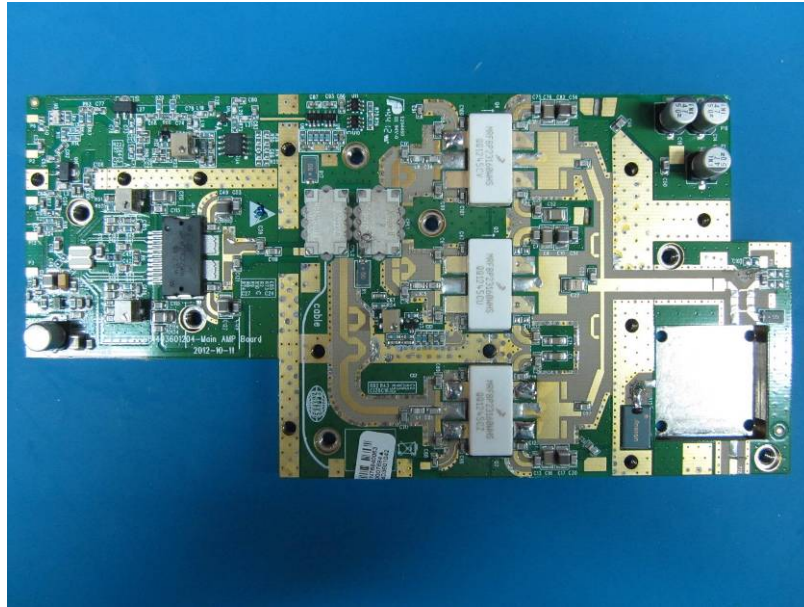

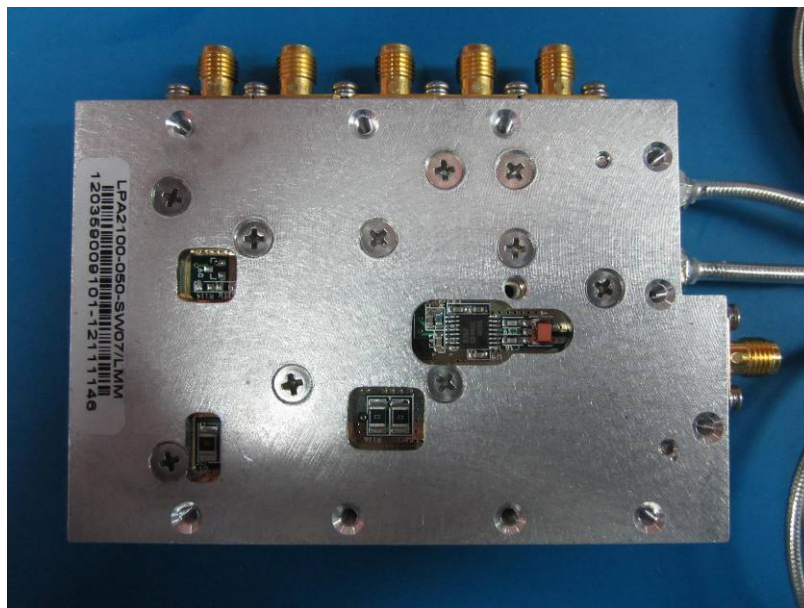
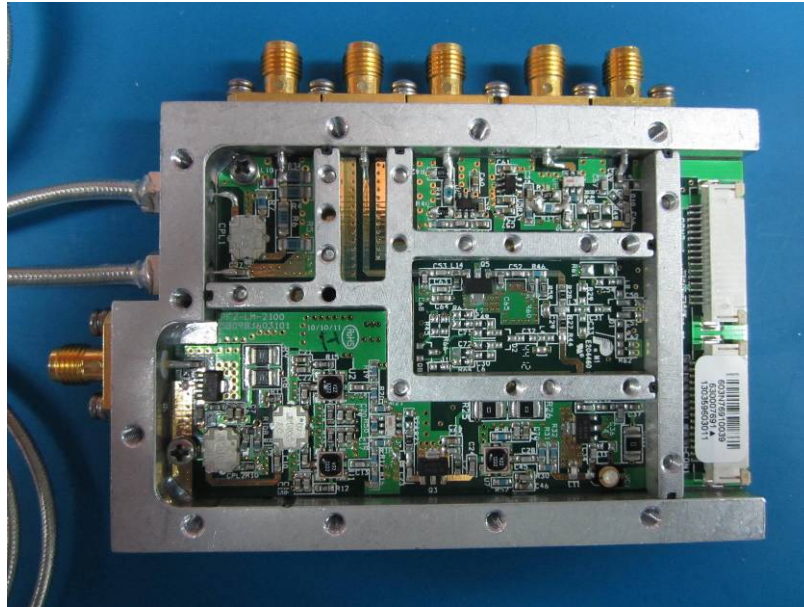

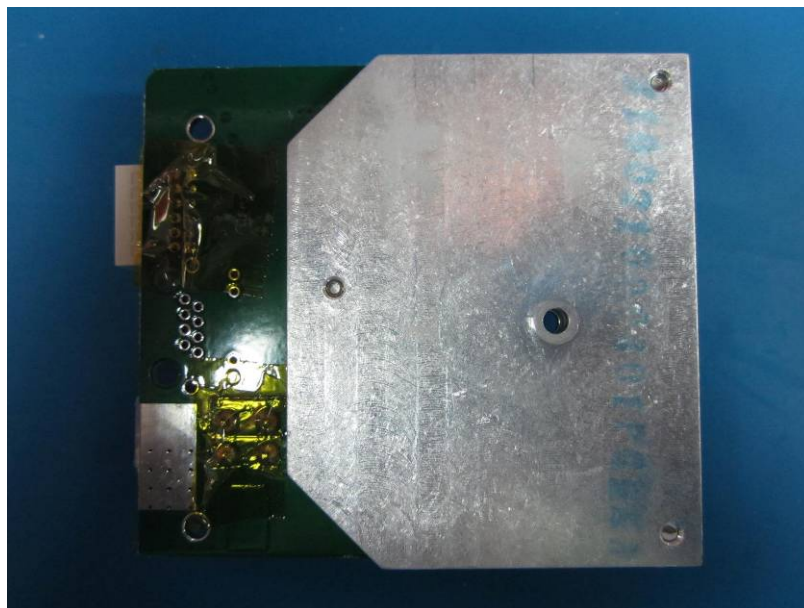
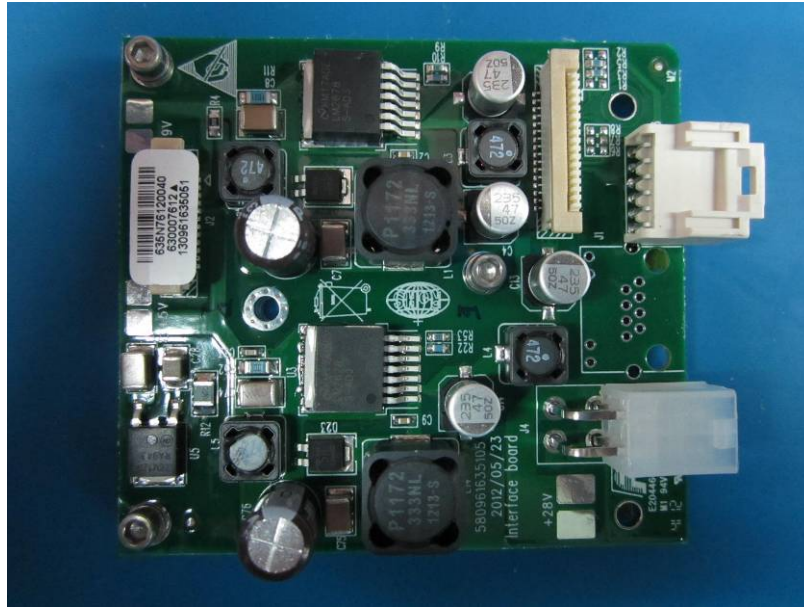

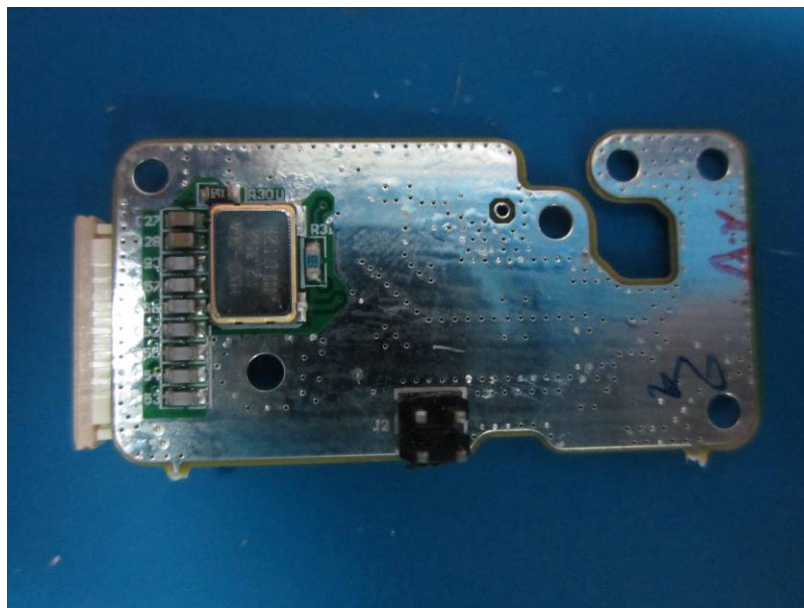
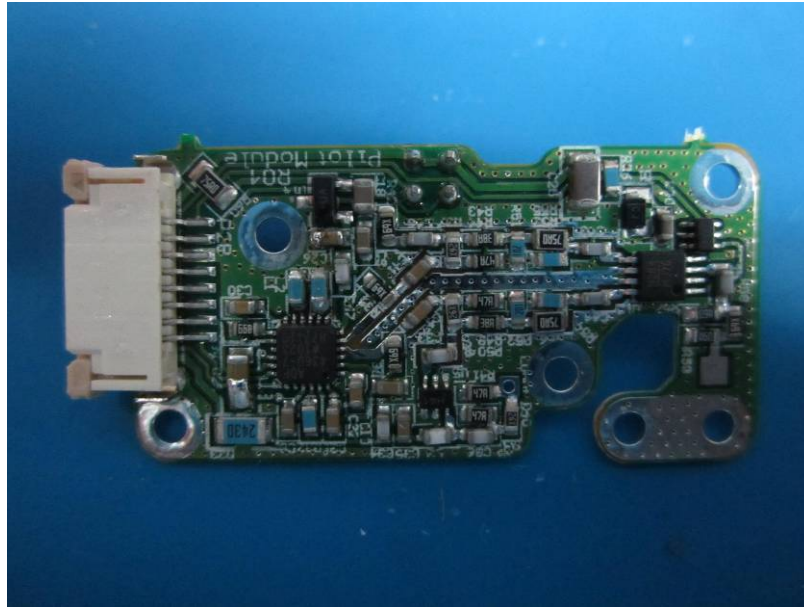

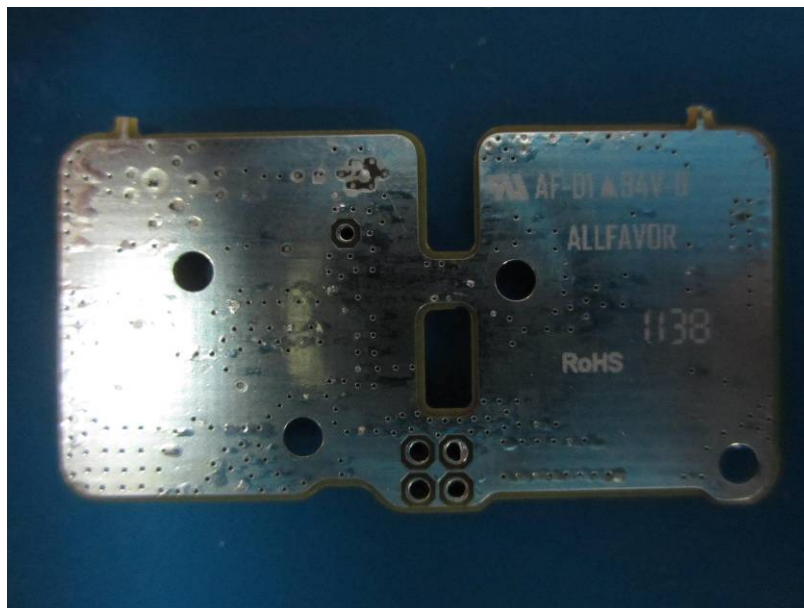
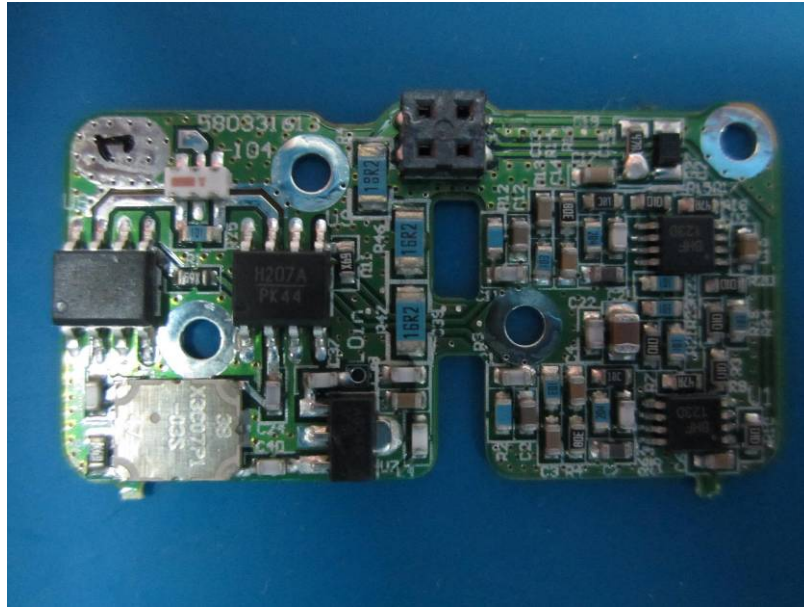

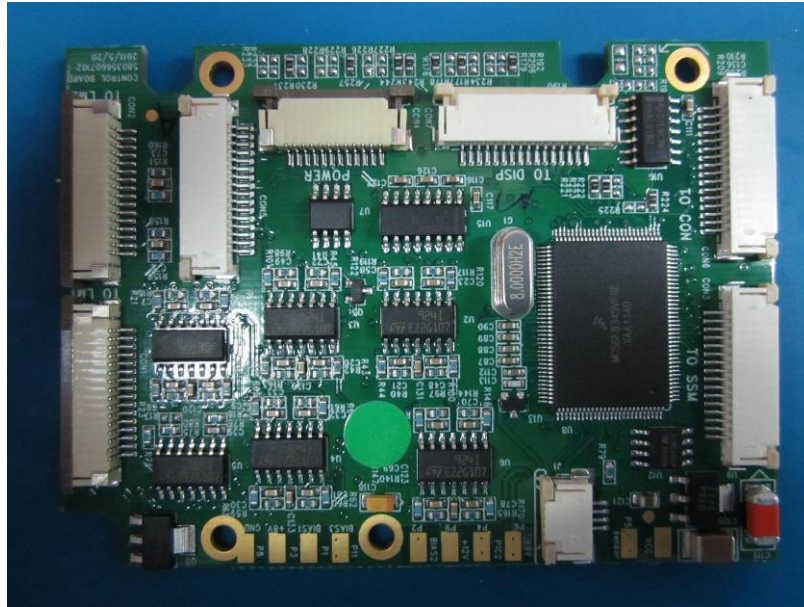

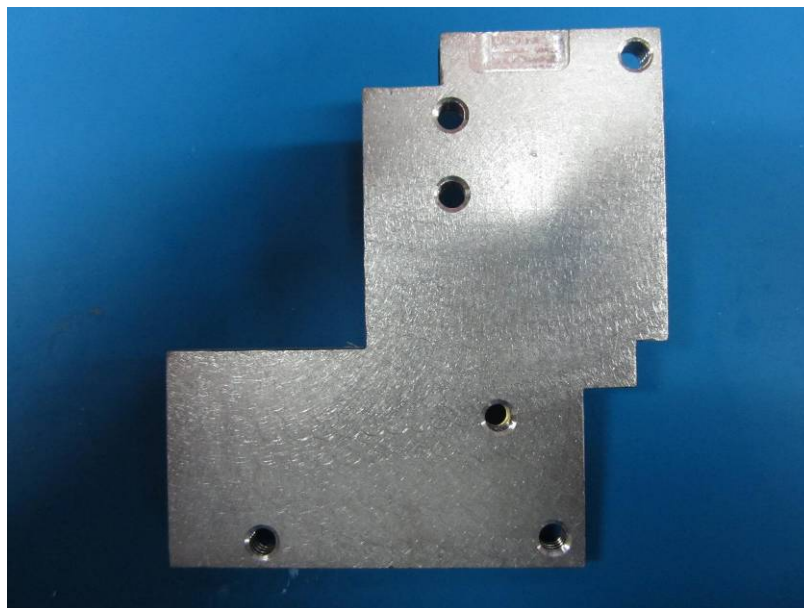

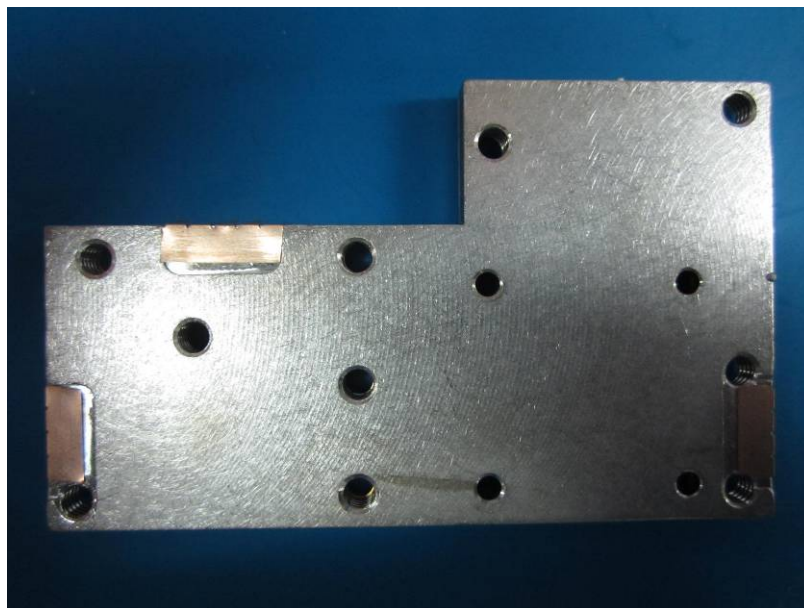

-----end-----