



# FCC RF Test Report

**APPLICANT** : BTI Wireless  
**EQUIPMENT** : LTE CAT12 Outdoor CPE  
**BRAND NAME** : BTI Wireless  
**MODEL NAME** : CP880-B  
**FCC ID** : WBKCP880-B2  
**STANDARD** : 47 CFR Part 2, 96  
**CLASSIFICATION** : Citizens Band Category A and B Devices (CBD)  
**EQUIPMENT TYPE** : CPE-CBSD (Category B)

The product was received on Jul. 04, 2020 and completely tested on Aug. 04, 2020. We, Sporton International (Kunshan) Inc., would like to declare that the tested sample has been evaluated in accordance with the procedures given in ANSI C63.26 and shown compliance with the applicable technical standards.

The test results in this report apply exclusively to the tested model / sample. Without written approval of Sporton International (Kunshan) Inc., the test report shall not be reproduced except in full.

Reviewed by: Jason Jia / Supervisor

Approved by: James Huang / Manager



**Sporton International (Kunshan) Inc.**

**No. 1098, Pengxi North Road, Kunshan Economic Development Zone Jiangsu Province 215300  
People's Republic of China**



# Table of Contents

History of this test report..... 3

Summary of Test Result..... 4

**1 General Description ..... 5**

    1.1 Applicant..... 5

    1.2 Manufacturer ..... 5

    1.3 Feature of Equipment Under Test..... 5

    1.4 Maximum EIRP Power, Frequency Tolerance, and Emission Designator..... 6

    1.5 Testing Site..... 8

    1.6 Test Software ..... 8

    1.7 Applied Standards ..... 8

**2 Test Configuration of Equipment Under Test ..... 9**

    2.1 Test Mode..... 9

    2.2 Connection Diagram of Test System ..... 10

    2.3 Support Unit used in test configuration ..... 10

    2.4 Measurement Results Explanation Example ..... 10

    2.5 Frequency List of Low/Middle/High Channels..... 11

**3 Conducted Test Items..... 12**

    3.1 Measuring Instruments..... 12

    3.2 Conducted Output Power ..... 13

    3.3 Peak-to-Average Ratio ..... 14

    3.4 EIRP ..... 15

    3.5 Occupied Bandwidth ..... 16

    3.6 Conducted Band Edge ..... 17

    3.7 Conducted Spurious Emission ..... 18

    3.8 Frequency Stability..... 19

**4 Radiated Test Items ..... 20**

    4.1 Measuring Instruments..... 20

    4.2 Test Setup ..... 20

    4.3 Test Result of Radiated Test..... 20

    4.4 Radiated Spurious Emission ..... 21

**5 List of Measuring Equipment..... 22**

**6 Uncertainty of Evaluation ..... 23**

**Appendix A. Test Results of Conducted Test**

**Appendix B. Test Results of EIRP and Radiated Test**

**Appendix C. Test Setup Photographs**



### History of this test report

Report No.	Version	Description	Issued Date
FG082614	01	Initial issue of report	Sep. 03, 2020



### Summary of Test Result

Report Clause	Ref Std. Clause	Test Items	Result (PASS/FAIL)	Remark
3.2	§2.1046	Conducted Output Power	Reporting only	-
3.3	§96.41	Peak-to-Average Ratio	Pass	-
3.4	§96.41	Maximum E.I.R.P	Pass	-
		Maximum Power Spectral Density	Pass	-
3.5	§2.1049 §96.41	Occupied Bandwidth	Reporting only	-
3.6	§2.1051 §96.41	Conducted Band Edge Measurement	Pass	-
3.7	§2.1051 §96.41	Conducted Spurious Emission	Pass	
3.8	§2.1055	Frequency Stability for Temperature & Voltage	Pass	-
4.4	§2.1051 §96.41	Radiated Spurious Emission	Pass	Under limit 5.48 dB at 7240.00 MHz

**Declaration of Conformity:**

The test results with all measurement uncertainty excluded are presented in accordance with the regulation limits or requirements declared by manufacturers.

**Comments and Explanations:**

The declared of product specification for EUT presented in the report are provided by the manufacturer, and the manufacturer takes all the responsibilities for the accuracy of product specification.



# 1 General Description

## 1.1 Applicant

**BTI Wireless**

6185 Phyllis Drive #D, Cypress, California 90630, United States

## 1.2 Manufacturer

**BTI Wireless**

6185 Phyllis Drive #D, Cypress, California 90630, United States

## 1.3 Feature of Equipment Under Test

Product Feature	
Equipment	LTE CAT12 Outdoor CPE
Brand Name	BTI Wireless
Model Name	CP880-B
FCC ID	WBKCP880-B2
Tx Frequency	LTE Band 42: 3552.5 MHz ~ 3597.5 MHz LTE Band 43: 3602.5 MHz ~ 3697.5 MHz LTE Band 48: 3552.5 MHz ~ 3697.5 MHz
Rx Frequency	LTE Band 42: 3552.5 MHz ~ 3597.5 MHz LTE Band 43: 3602.5 MHz ~ 3697.5 MHz LTE Band 48: 3552.5 MHz ~ 3697.5 MHz
Bandwidth	5MHz / 10MHz / 15MHz / 20MHz
Type of Modulation	QPSK / 16QAM / 64QAM
IMEI Code	Conducted: N/A Radiation: 862165040667956
HW Version	V1.1.0
SW Version	ST2.0.4
EUT Stage	Identical Prototype

**Remark:**

1. The above EUT's information was declared by manufacturer. Please refer to the specifications or user's manual for more detailed description.
2. This is a test report for change in FCC ID, there is no difference on the product design between FCC ID: WBKCP880-B2 and Original FCC ID: 2AU8HSRW410, all the test results are leveraged from original FCC ID: 2AU8HSRW410, report number FG070403.



### 1.4 Maximum EIRP Power, Frequency Tolerance, and Emission Designator

LTE Band 48		QPSK			16QAM		
BW (MHz)	Frequency Range (MHz)	Emission Designator (99%OBW)	Frequency Tolerance (ppm)	Maximum EIRP (W)	Emission Designator (99%OBW)	Frequency Tolerance (ppm)	Maximum EIRP (W)
5	3552.5~3697.5	4M52G7D	-	3.8019	4M53W7D	-	3.7757
10	3555~3695	9M09G7D	0.0017	3.8107	9M11W7D	-	3.8282
15	3557.5~3692.5	13M5G7D	-	3.7154	13M5W7D	-	3.9628
20	3560~3690	18M4G7D	-	3.9902	18M4W7D	-	3.9811
LTE Band 48		64QAM					
BW (MHz)	Frequency Range (MHz)	Emission Designator (99%OBW)	Frequency Tolerance (ppm)		Maximum EIRP (W)		
5	3552.5~3697.5	4M55W7D	-		3.8371		
10	3555~3695	9M09W7D	-		3.8726		
15	3557.5~3692.5	13M5W7D	-		3.7239		
20	3560~3690	18M5W7D	-		4.0551		

LTE Band 42		QPSK			16QAM		
BW (MHz)	Frequency Range (MHz)	Emission Designator (99%OBW)	Frequency Tolerance (ppm)	Maximum EIRP (W)	Emission Designator (99%OBW)	Frequency Tolerance (ppm)	Maximum EIRP (W)
5	3552.5~3597.5	4M52G7D	-	3.8019	4M53W7D	-	3.7757
10	3555~3595	9M09G7D	0.0017	3.8107	9M11W7D	-	3.8282
15	3557.5~3592.5	13M5G7D	-	3.7154	13M5W7D	-	3.9628
20	3560~3590	18M4G7D	-	3.9902	18M4W7D	-	3.9811
LTE Band 42		64QAM					
BW (MHz)	Frequency Range (MHz)	Emission Designator (99%OBW)	Frequency Tolerance (ppm)		Maximum EIRP (W)		
5	3552.5~3597.5	4M55W7D	-		3.8371		
10	3555~3595	9M09W7D	-		3.8726		
15	3557.5~3592.5	13M5W7D	-		3.7239		
20	3560~3590	18M5W7D	-		4.0551		



LTE Band 43		QPSK			16QAM		
BW (MHz)	Frequency Range (MHz)	Emission Designator (99%OBW)	Frequency Tolerance (ppm)	Maximum EIRP (W)	Emission Designator (99%OBW)	Frequency Tolerance (ppm)	Maximum EIRP (W)
5	3602.5~3697.5	4M52G7D	-	3.8019	4M53W7D	-	3.7757
10	3605~3695	9M09G7D	0.0017	3.8107	9M11W7D	-	3.8282
15	3607.5~3692.5	13M5G7D	-	3.7154	13M5W7D	-	3.9628
20	3610~3690	18M4G7D	-	3.9902	18M4W7D	-	3.9811
LTE Band 43		64QAM					
BW (MHz)	Frequency Range (MHz)	Emission Designator (99%OBW)	Frequency Tolerance (ppm)	Maximum EIRP (W)			
5	3552.5~3697.5	4M55W7D	-	3.8371			
10	3555~3695	9M09W7D	-	3.8726			
15	3557.5~3692.5	13M5W7D	-	3.7239			
20	3560~3690	18M5W7D	-	4.0551			

**Note:**

LTE Band 48 overlaps the entire frequency range of LTE Band 42 and Band 43 under Part 96 rule. Therefore, the test results of LTE Band 48 provided in this report covers Band 42 and Band 43.



### 1.5 Testing Site

Sporton International (Kunshan) Inc. is accredited to ISO/IEC 17025:2017 by American Association for Laboratory Accreditation with Certificate Number 5145.02.

<b>Test Firm</b>	Sporton International (Kunshan) Inc.		
<b>Test Site Location</b>	No. 1098, Pengxi North Road, Kunshan Economic Development Zone Jiangsu Province 215300 People's Republic of China TEL : +86-512-57900158 FAX : +86-512-57900958		
<b>Test Site No.</b>	<b>Sporton Site No.</b>	<b>FCC Designation No.</b>	<b>FCC Test Firm Registration No.</b>
	03CH04-KS TH01-KS	CN1257	314309

### 1.6 Test Software

Item	Site	Manufacture	Name	Version
1.	03CH04-KS	AUDIX	E3	6.2009-8-24a

### 1.7 Applied Standards

According to the specifications of the manufacturer, the EUT must comply with the requirements of the following standards:

- ♦ ANSI C63.26-2015
- ♦ ANSI / TIA-603-E
- ♦ 47 CFR Part 2, 96
- ♦ FCC KDB 971168 D01 Power Meas. License Digital Systems v03r01
- ♦ FCC KDB 940660 D01 Part 96 CBRS v02
- ♦ FCC KDB 412172 D01 Determining ERP and EIRP v01r01

**Remark:**

1. All test items were verified and recorded according to the standards and without any deviation during the test.
2. This EUT has also been tested and complied with the requirements of FCC Part 15, Subpart B, recorded in a separate test report.





## 2 Test Configuration of Equipment Under Test

### 2.1 Test Mode

Antenna port conducted and radiated test items listed below are performed according to KDB 971168 D01 Power Meas. License Digital Systems v03r01 with maximum output power.

For radiated measurement, pre-scanned in three orthogonal panels, X, Y, Z. The worst cases (Y plane) were recorded in this report.

Test Items	Band	Bandwidth (MHz)						Modulation			RB #			Test Channel		
		1.4	3	5	10	15	20	QPSK	16QAM	64QAM	1	Half	Full	L	M	H
Max. Output Power	48	-	-	v	v	v	v	v	v	v	v	v	v	v	v	v
Peak EIRP Density	48	-	-	v	v	v	v	v	v	v	v		v	v	v	v
26dB and 99% Bandwidth	48	-	-	v	v	v	v	v	v	v			v	v	v	v
Conducted Band Edge	48	-	-	v	v	v	v	v	v	v	v		v	v		v
Peak-to-Average Ratio	48	-	-				v	v	v	v	v		v	v	v	v
Conducted Spurious Emission	48	-	-	v	v	v	v	v	v	v	v		v	v	v	v
E.R.P / E.I.R.P	48	-	-	v	v	v	v	v	v	v	v			v	v	v
Frequency Stability	48	-	-		v			v	v	v	v			v	v	v
Radiated Spurious Emission	48	<b>Worst Case</b>											v	v	v	
Remark	<ol style="list-style-type: none"> <li>The mark "v" means that this configuration is chosen for testing</li> <li>The mark "-" means that this bandwidth is not supported.</li> <li>The device is investigated from 30MHz to 10 times of fundamental signal for radiated spurious emission test under different RB size/offset and modulations in exploratory test. Subsequently, only the worst case emissions are reported.</li> </ol>															

## 2.2 Connection Diagram of Test System

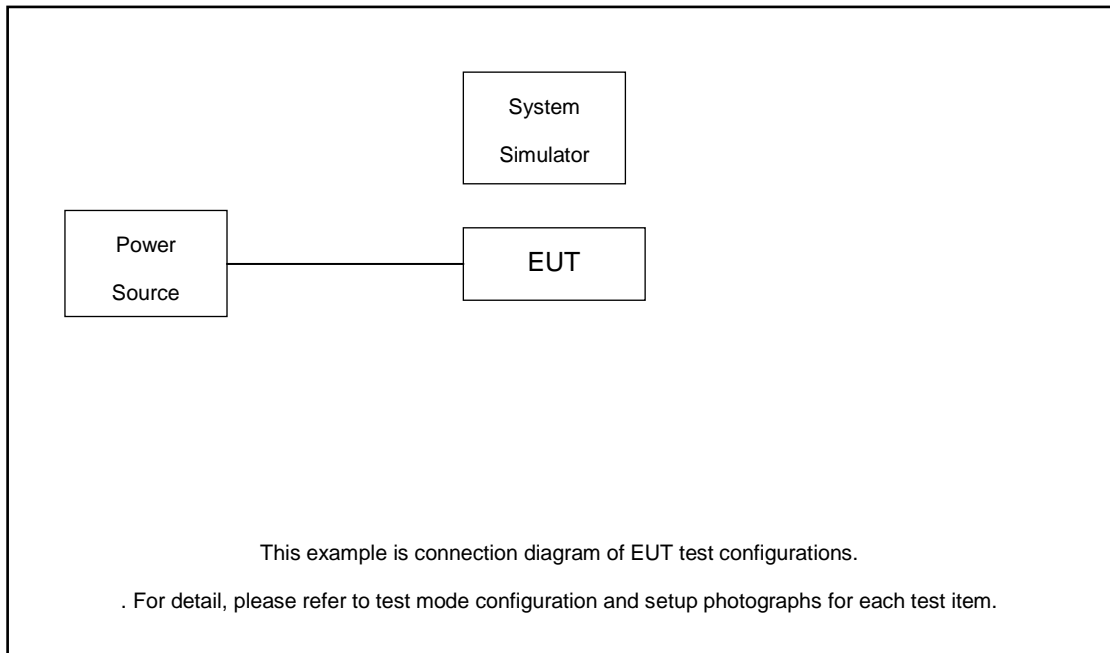

## 2.3 Support Unit used in test configuration

Item	Equipment	Trade Name	Model No.	FCC ID	Data Cable	Power Cord
1.	Power Supply	GWINSTEK	PSS-2002	N/A	N/A	Unshielded, 1.8 m
2.	LTE Base Station	Anritsu	MT8821C	N/A	N/A	Unshielded, 1.8 m

## 2.4 Measurement Results Explanation Example

### For all conducted test items:

The offset level is set in the spectrum analyzer to compensate the RF cable loss and attenuator factor between EUT conducted output port and spectrum analyzer. With the offset compensation, the spectrum analyzer reading level is exactly the EUT RF output level.

The spectrum analyzer offset is derived from RF cable loss and attenuator factor.

*Offset = RF cable loss.*

Following shows an offset computation example with cable loss 6.0 Db.

Example :

$$\begin{aligned} \text{Offset(dB)} &= \text{RF cable loss(dB)}. \\ &= 6.0 \text{ (dB)} \end{aligned}$$



## 2.5 Frequency List of Low/Middle/High Channels

LTE Band 48 Channel and Frequency List				
BW [MHz]	Channel/Frequency(MHz)	Lowest	Middle	Highest
20	Channel	55340	55990	56640
	Frequency	3560.0	3625.0	3690.0
15	Channel	55315	55990	56665
	Frequency	3557.5	3625.0	3692.5
10	Channel	55290	55990	56690
	Frequency	3555.0	3625.0	3695.0
5	Channel	55265	55990	56715
	Frequency	3552.5	3625.0	3697.5

### 3 Conducted Test Items

#### 3.1 Measuring Instruments

See list of measuring instruments of this test report.

##### 3.1.1 Test Setup

##### 3.1.2 Conducted Output Power



##### 3.1.3 EIRP, Peak-to-Average Ratio, Occupied Bandwidth, Conducted Band-Edge and Conducted Spurious Emission

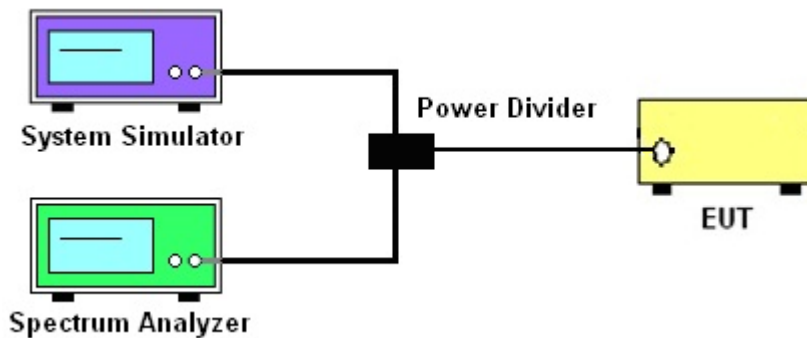

##### 3.1.4 Frequency Stability

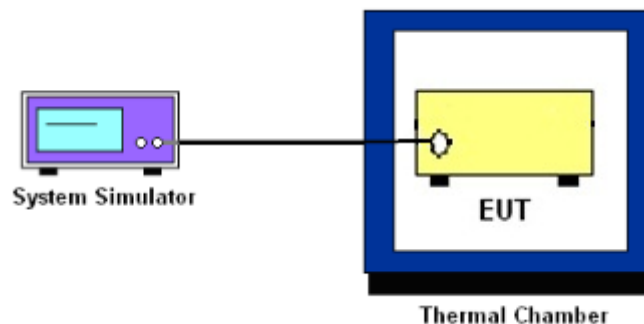

##### 3.1.5 Test Result of Conducted Test

Please refer to Appendix A.



## **3.2 Conducted Output Power**

### **3.2.1 Description of the Conducted Output Power Measurement**

A system simulator was used to establish communication with the EUT. Its parameters were set to force the EUT transmitting at maximum output power. The measured power in the radio frequency on the transmitter output terminals shall be reported.

### **3.2.2 Test Procedures**

1. The transmitter output port was connected to the system simulator.
2. Set EUT at maximum power through the system simulator.
3. Select lowest, middle, and highest channels for each band and different modulation.
4. Measure and record the power level from the system simulator.



### 3.3 Peak-to-Average Ratio

#### 3.3.1 Description of the PAR Measurement

Power Complementary Cumulative Distribution Function (CCDF) curves provide a means for characterizing the power peaks of a digitally modulated signal on a statistical basis. A CCDF curve depicts the probability of the peak signal amplitude exceeding the average power level. Most contemporary measurement instrumentation include the capability to produce CCDF curves for an input signal provided that the instrument's resolution bandwidth can be set wide enough to accommodate the entire input signal bandwidth. In measuring transmissions in this band using an average power technique, the peak-to-average ratio (PAR) of the transmission may not exceed 13 dB.

#### 3.3.2 Test Procedures

The testing follows ANSI C63.26-2015 Section 5.2.6

1. The EUT was connected to spectrum and system simulator via a power divider.
2. Set the CCDF (Complementary Cumulative Distribution Function) option in spectrum analyzer.
3. The highest RF powers were measured and recorded the maximum PAPR level associated with a probability of 0.1 %.
4. Record the deviation as Peak to Average Ratio

### 3.4 EIRP

#### 3.4.1 Description of the EIRP Measurement

EIRP and PSD limits for CBRS equipment as below table:

Device		Maximum EIRP (dBm/10 MHz)	Maximum PSD (dBm/MHz)
	End User Device	23	n/a
	Category A CBSD	30	20
V	Category B CBSD	47	37

**Remark:** Maximum PSD values are radiated. Measurements can be done conducted and add antenna gain back in.

1. Set instrument center frequency to OBW center frequency.
2. Set span to at least 2 times the OBW.
3. Set the RBW to the specified reference bandwidth (often 1 MHz).
4. Set VBW  $\geq 3 \times$  RBW.
5. Detector = RMS (power averaging).
6. Ensure that the number of measurement points in the sweep  $\geq 2 \times$  span/RBW.
7. Sweep time = auto couple.
8. Employ trace averaging (RMS) mode over a minimum of 100 traces.
9. Use the peak marker function to determine the maximum amplitude level within the reference bandwidth (PSD).
10. Determine the EIRP by adding the effective antenna gain to the adjusted power level.
11. Add  $10 \log(1/\text{duty cycle})$  to the measured power level to compute the average power during continuous transmission.

The testing follows ANSI C63.26-2015 Section 5.2.5.5

According to KDB 412172 D01 Power Approach,

$EIRP = P_T + G_T - L_C$ , where

$P_T$  = transmitter output power in dBm

$G_T$  = gain of the transmitting antenna in dBi

$L_C$  = signal attenuation in the connecting cable between the transmitter and antenna in dB



### 3.5 Occupied Bandwidth

#### 3.5.1 Description of Occupied Bandwidth Measurement

The occupied bandwidth is the width of a frequency band such that, below the lower and above the upper frequency limits, the mean powers emitted are each equal to a specified percentage 0.5% of the total mean transmitted power.

The 26 dB emission bandwidth is defined as the frequency range between two points, one above and one below the carrier frequency, at which the spectral density of the emission is attenuated 26 dB below the maximum in-band spectral density of the modulated signal. Spectral density (power per unit bandwidth) is to be measured with a detector of resolution bandwidth equal to approximately 1.0% of the emission bandwidth.

#### 3.5.2 Test Procedures

The testing follows ANSI C63.26-2015 Section 5.4.3 (26dB) and Section 5.4.4 (99OB)

1. The EUT was connected to spectrum analyzer and system simulator via a power divider.
2. The spectrum analyzer center frequency is set to the nominal EUT channel center frequency. The span range for the spectrum analyzer shall be between two and five times the anticipated OBW.
3. The nominal resolution bandwidth (RBW) shall be in the range of 1 to 5 % of the anticipated OBW, and the VBW shall be at least 3 times the RBW.
4. Set the detection mode to peak, and the trace mode to max hold.
5. Determine the reference value: Set the EUT to transmit a modulated signal. Allow the trace to stabilize. Set the spectrum analyzer marker to the highest level of the displayed trace.  
(this is the reference value)
6. Determine the “-26 dB down amplitude” as equal to (Reference Value – X).
7. Place two markers, one at the lowest and the other at the highest frequency of the envelope of the spectral display such that each marker is at or slightly below the “-X dB down amplitude” determined in step 6. If a marker is below this “-X dB down amplitude” value it shall be placed as close as possible to this value. The OBW is the positive frequency difference between the two markers.
8. Use the 99 % power bandwidth function of the spectrum analyzer and report the measured bandwidth.



## 3.6 Conducted Band Edge

### 3.6.1 Description of Conducted Band Edge Measurement

Part 96.41 (e) (1) (i)

For CBSD the emission limits outside the fundamental are as follows:

Within 0 MHz to 10 MHz above and below the assigned channel  $\leq -13$  dBm/MHz

Greater than 10 MHz above and below the assigned channel  $\leq -25$  dBm/MHz

Part 96.41 (e) (1) (ii)

For End User Devices the emission limits outside the fundamental are as follows:

Within 0 MHz to B MHz above and below the assigned channel  $\leq -13$  dBm/MHz

Greater than B MHz above and below the assigned channel  $\leq -25$  dBm/MHz

where B is the bandwidth in megahertz of the assigned channel or multiple contiguous channels of the End User Device.

Notwithstanding the emission limits in this paragraph, the Adjacent Channel Leakage Ratio for End User Devices shall be at least 30 dB.

Part 96.41 (e) (2)

For CBSDs and End User Devices, the conducted power of emissions below 3540 MHz or above 3710 MHz shall not exceed  $-25$  dBm/MHz, and the conducted power of emissions below 3530 MHz or above 3720 MHz shall not exceed  $-40$  dBm/MHz

### 3.6.2 Test Procedures

The testing follows FCC KDB 971168 D01 v03r01 Section 6.1.

1. The EUT was connected to spectrum analyzer and system simulator via a power divider.
2. The band edges of low and high channels for the highest RF powers were measured.
3. Set RBW  $\geq 1\%$  EBW in the 1MHz band immediately outside and adjacent to the band edge.
4. Beyond the 1 MHz band from the band edge, RBW=1MHz was used
5. Offset has included the duty factor for LTE Band 48. Duty factor  $=10 \log (1/x)$ , where x is the measured duty cycle.
6. Set spectrum analyzer with RMS detector.
7. The RF fundamental frequency should be excluded against the limit line in the operating frequency band.



## 3.7 Conducted Spurious Emission

### 3.7.1 Description of Conducted Spurious Emission Measurement

96.41 (e)(2)

The conducted power of any emissions below 3530 MHz or above 3720 MHz shall not exceed -40dBm/MHz.

### 3.7.2 Test Procedures

The testing follows FCC KDB 971168 D01 v03r01 Section 6.1.

1. The EUT was connected to spectrum analyzer and system simulator via a power divider.
2. The RF output of EUT was connected to the spectrum analyzer by RF cable and attenuator. The path loss was compensated to the results for each measurement.
3. The middle channel for the highest RF power within the transmitting frequency was measured.
4. The conducted spurious emission for the whole frequency range was taken.
5. Make the measurement with the spectrum analyzer's RBW = 1MHz, VBW = 3MHz.
6. Set spectrum analyzer with RMS detector.
7. Taking the record of maximum spurious emission.
8. The RF fundamental frequency should be excluded against the limit line in the operating frequency band.
9. The limit line is -40dBm/MHz.



## 3.8 Frequency Stability

### 3.8.1 Description of Frequency Stability Measurement

The frequency stability shall be measured by variation of ambient temperature and variation of primary supply voltage to ensure that the fundamental emission stays within the authorized frequency block. The frequency stability of the transmitter shall be maintained within  $\pm 0.00025\%$  ( $\pm 2.5\text{ppm}$ ) of the center frequency

### 3.8.2 Test Procedures for Temperature Variation

The testing follows FCC KDB 971168 D01 v03r01 Section 9.0.

1. The EUT was set up in the thermal chamber and connected with the system simulator.
2. With power OFF, the temperature was decreased to  $-30^{\circ}\text{C}$  and the EUT was stabilized before testing. Power was applied and the maximum change in frequency was recorded within one minute.
3. With power OFF, the temperature was raised in  $10^{\circ}\text{C}$  step up to  $50^{\circ}\text{C}$ . The EUT was stabilized at each step for at least half an hour. Power was applied and the maximum frequency change was recorded within one minute.

### 3.8.3 Test Procedures for Voltage Variation

The testing follows FCC KDB 971168 D01 v03r01 Section 9.0.

1. The EUT was placed in a temperature chamber at  $25\pm 5^{\circ}\text{C}$  and connected with the system simulator.
2. The power supply voltage to the EUT was varied from 85% to 115% of the nominal value measured at the input to the EUT.
3. The variation in frequency was measured for the worst case.

## 4 Radiated Test Items

### 4.1 Measuring Instruments

See list of measuring instruments of this test report.

### 4.2 Test Setup

For radiated emissions from 30MHz to 1GHz

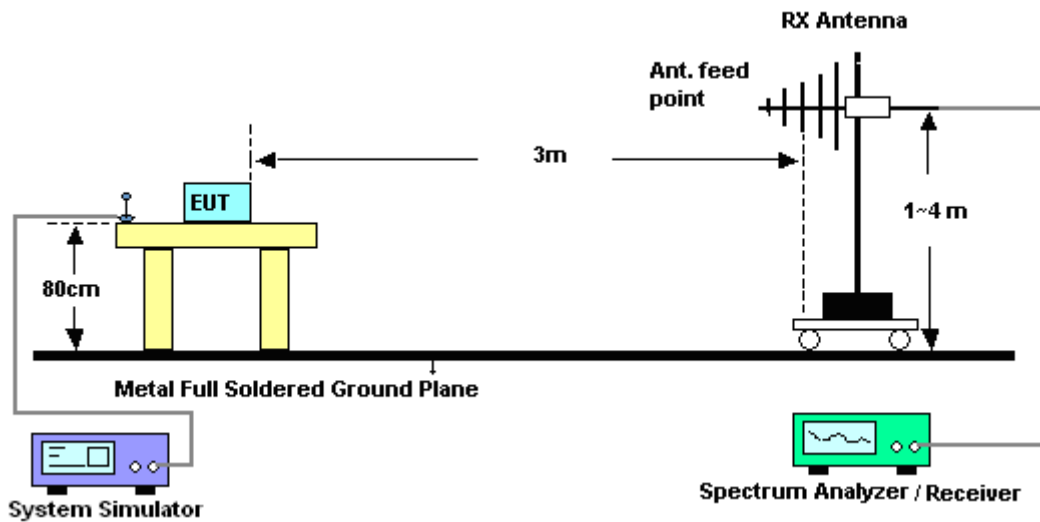

For radiated emissions above 1GHz

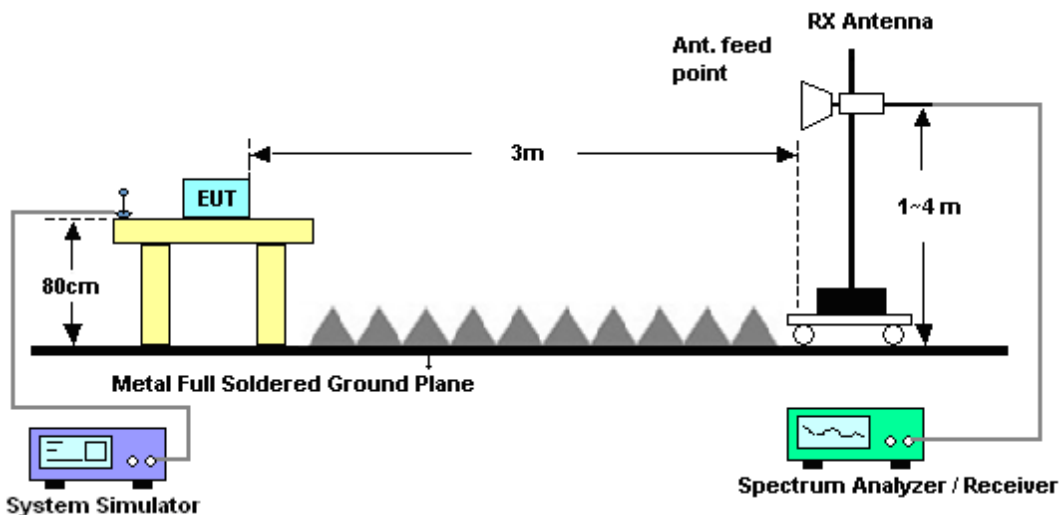

### 4.3 Test Result of Radiated Test

Please refer to Appendix B.



## 4.4 Radiated Spurious Emission

### 4.4.1 Description of Radiated Spurious Emission Measurement

The radiated spurious emission was measured by substitution method according to ANSI / TIA-603-E. The power of any emission outside of the authorized operating frequency ranges must be attenuated below the transmitter power (P) by a factor of at least -40dBm / MHz. The spectrum is scanned from 30 MHz up to a frequency including its 10th harmonic.

### 4.4.2 Test Procedures

1. The EUT was placed on a turntable with 0.8 meter height for frequency below 1GHz and 1.5 meter height for frequency above 1GHz respectively above ground.
2. The EUT was set 3 meters from the receiving antenna mounted on the antenna tower.
3. The table was rotated 360 degrees to determine the position of the highest spurious emission.
4. The height of the receiving antenna is varied between 1m to 4m to search the maximum spurious emission for both horizontal and vertical polarizations.
5. During the measurement, the system simulator parameters were set to force the EUT transmitting at maximum output power.
6. Make the measurement with the spectrum analyzer's RBW = 1MHz, VBW = 3MHz, taking the record of maximum spurious emission.
7. A horn antenna was substituted in place of the EUT and was driven by a signal generator. Tune the output power of signal generator to the same emission level with EUT maximum spurious emission.  
$$\text{EIRP (dBm)} = \text{S.G. Power} - \text{Tx Cable Loss} + \text{Tx Antenna Gain}$$
$$\text{ERP (dBm)} = \text{EIRP} - 2.15$$
8. The RF fundamental frequency should be excluded against the limit line in the operating frequency band.  
The limit line is -40dBm/MHz



## 5 List of Measuring Equipment

Instrument	Manufacturer	Model No.	Serial No.	Characteristics	Calibration Date	Test Date	Due Date	Remark
Spectrum Analyzer	R&S	FSV40	101040	10Hz~40GHz	Nov. 02, 2019	Aug. 01, 2020~ Aug. 02, 2020	Nov. 01, 2020	Conducted (TH01-KS)
Thermal Chamber	Ten Billion	TTC-B3S	TBN-9605 02	-40~+150°C	Oct. 28, 2019	Aug. 01, 2020~ Aug. 02, 2020	Oct. 27, 2020	Conducted (TH01-KS)
EXA Spectrum Analyzer	Keysight	N9010A	MY551502 44	10Hz-44G,MAX 30dB	Apr. 15, 2020	Aug. 04, 2020	Apr. 14, 2021	Radiation (03CH04-KS)
Bilog Antenna	TeseQ	CBL6111D	49922	30MHz-1GHz	Jan. 02, 2020	Aug. 04, 2020	Jan. 01, 2021	Radiation (03CH04-KS)
Horn Antenna	Schwarzbeck	BBHA9120D	1356	1GHz~18GHz	Apr. 20, 2020	Aug. 04, 2020	Apr. 19, 2021	Radiation (03CH04-KS)
SHF-EHF Horn	Com-power	AH-840	101115	18GHz~40GHz	Nov. 10, 2019	Aug. 04, 2020	Nov. 09, 2020	Radiation (03CH04-KS)
Amplifier	SONOMA	310N	187289	9KHz-1GHz	Jan. 02, 2020	Aug. 04, 2020	Jan. 03, 2021	Radiation (03CH04-KS)
Amplifier	MITEQ	EM18G40GG A	060728	18~40GHz	Jan. 08, 2020	Aug. 04, 2020	Jan. 07, 2021	Radiation (03CH04-KS)
high gain Amplifier	MITEQ	AMF-7D-0010 1800-30-10P	2025788	1Ghz-18Ghz	Jan. 02, 2020	Aug. 04, 2020	Jan. 03, 2021	Radiation (03CH04-KS)
Amplifier	Keysight	83017A	MY572801 06	500MHz~26.5G Hz	Oct. 15, 2019	Aug. 04, 2020	Oct. 14, 2020	Radiation (03CH04-KS)
AC Power Source	Chroma	61601	F1040900 04	N/A	NCR	Aug. 04, 2020	NCR	Radiation (03CH04-KS)
Turn Table	ChamPro	EM 1000-T	060762-T	0~360 degree	NCR	Aug. 04, 2020	NCR	Radiation (03CH04-KS)
Antenna Mast	ChamPro	EM 1000-A	060762-A	1 m~4 m	NCR	Aug. 04, 2020	NCR	Radiation (03CH04-KS)

NCR: No Calibration Required



## 6 Uncertainty of Evaluation

### Uncertainty of Radiated Emission Measurement (30 MHz ~ 1000 MHz)

Measuring Uncertainty for a Level of Confidence of 95% ( $U = 2Uc(y)$ )	3.3dB
---	-------

### Uncertainty of Radiated Emission Measurement (1 GHz ~ 18 GHz)

Measuring Uncertainty for a Level of Confidence of 95% ( $U = 2Uc(y)$ )	2.8dB
---	-------

### Uncertainty of Radiated Emission Measurement (18 GHz ~ 40 GHz)

Measuring Uncertainty for a Level of Confidence of 95% ( $U = 2Uc(y)$ )	2.8dB
---	-------



### Appendix A. Test Results of Conducted Test

#### Conducted Output Power(Average power)

LTE Band 48 Maximum Average Power [dBm]						
BW [MHz]	RB Size	RB Offset	Mod	Lowest	Middle	Highest
20	1	0	QPSK	18.94	19.52	19.45
20	1	49		18.80	18.68	19.25
20	1	99		19.55	18.98	20.01
20	50	0		19.00	19.35	19.61
20	50	24		18.96	18.86	19.59
20	50	50		19.58	19.10	19.83
20	100	0		19.23	19.28	19.78
20	1	0	16-QAM	18.75	19.41	19.30
20	1	49		18.68	18.57	19.17
20	1	99		19.43	18.89	20.00
20	50	0		19.00	19.36	19.55
20	50	24		19.11	18.90	19.56
20	50	50		19.65	19.10	19.92
20	100	0		19.30	19.33	19.77
20	1	0	64-QAM	18.89	19.54	19.40
20	1	49		18.81	18.69	19.23
20	1	99		19.57	19.00	20.08
20	50	0		19.04	19.38	19.54
20	50	24		19.01	18.88	19.53
20	50	50		19.57	19.10	19.91
20	100	0		19.33	19.38	19.79





15	1	0	QPSK	18.70	19.14	19.27
15	1	37		18.43	18.55	19.18
15	1	74		19.18	18.70	19.70
15	36	0		18.45	18.85	19.31
15	36	20		18.50	18.81	19.36
15	36	39		18.90	18.74	19.45
15	75	0		18.62	18.80	19.55
15	1	0	16-QAM	18.48	18.92	19.06
15	1	37		18.25	18.36	19.98
15	1	74		18.99	18.50	19.61
15	36	0		18.42	18.80	19.26
15	36	20		18.50	18.78	19.33
15	36	39		18.91	18.72	19.60
15	75	0		18.64	18.92	19.61
15	1	0	64-QAM	19.05	19.03	19.13
15	1	37		18.44	18.43	19.05
15	1	74		19.05	18.61	19.71
15	36	0		18.52	18.81	19.24
15	36	20		18.59	18.83	19.31
15	36	39		19.00	18.73	19.57
15	75	0		18.73	18.92	19.58



LTE Band 48 Maximum Average Power [dBm]						
BW [MHz]	RB Size	RB Offset	Mod	Lowest	Middle	Highest
10	1	0	QPSK	18.40	18.65	19.20
10	1	25		18.38	18.36	19.13
10	1	49		18.70	18.65	19.65
10	25	0		18.66	18.92	19.58
10	25	12		18.64	18.86	19.48
10	25	25		18.68	18.81	19.81
10	50	0		18.80	18.90	19.53
10	1	0	16-QAM	18.30	18.55	18.93
10	1	25		18.21	18.26	18.96
10	1	49		18.54	18.58	19.50
10	25	0		18.65	18.95	19.56
10	25	12		18.62	18.90	19.51
10	25	25		18.66	18.75	19.83
10	50	0		18.77	18.91	19.55
10	1	0	64-QAM	18.40	18.66	19.08
10	1	25		18.32	18.38	19.11
10	1	49		18.79	18.68	19.65
10	25	0		18.63	18.94	19.60
10	25	12		18.66	18.88	19.54
10	25	25		18.65	18.75	19.88
10	50	0		18.77	18.90	19.60



5	1	0	QPSK	17.64	17.83	18.42
5	1	12		18.69	18.69	19.57
5	1	24		17.66	17.70	18.58
5	12	0		19.03	19.15	19.80
5	12	7		18.48	18.65	19.64
5	12	13		18.45	18.63	19.63
5	25	0		18.44	18.67	19.66
5	1	0	16-QAM	17.46	17.74	18.32
5	1	12		18.50	18.55	19.45
5	1	24		17.46	17.55	18.43
5	12	0		18.98	19.14	19.77
5	12	7		18.41	18.65	19.62
5	12	13		18.43	18.65	19.61
5	25	0		18.44	18.68	19.68
5	1	0	64-QAM	17.58	17.89	18.42
5	1	12		18.61	18.70	19.53
5	1	24		17.57	17.68	18.49
5	12	0		19.07	19.14	19.84
5	12	7		18.55	18.78	19.71
5	12	13		18.51	18.73	19.67
5	25	0		18.46	18.70	19.63



**EIRP**

The worst case EIRP shown in this section is found with LTE operating only using 1RB. As such, the EIRP/10MHz and full channel EIRP values will be identical since 1RB is fully contained within all available channel bandwidths for LTE Band 48 (i.e. 5, 10, 15, 20MHz)

LTE Band 48 (GT - LC = 16.00 dB) QPSK									
Bandwidth	5M			10M			15M		
Channel	(Low)	(Mid)	(High)	(Low)	(Mid)	(High)	(Low)	(Mid)	(High)
Conducted Power (dBm/10MHz)	19.03	19.15	19.80	18.68	18.81	19.81	19.18	18.70	19.70
Conducted Power (Watts/10MHz)	0.0800	0.0822	0.0955	0.0738	0.0760	0.0957	0.0828	0.0741	0.0933
EIRP (dBm/10MHz)	35.03	35.15	35.80	34.68	34.81	35.81	35.18	34.70	35.70
EIRP (Watts/10MHz)	3.1842	3.2734	3.8019	2.9376	3.0269	3.8107	3.2961	2.9512	3.7154

LTE Band 48 (GT - LC = 16.00 dB) QPSK			
Bandwidth	20M		
Channel	(Low)	(Mid)	(High)
Conducted Power (dBm/10MHz)	19.55	18.98	20.01
Conducted Power (Watts/10MHz)	0.0902	0.0791	0.1002
EIRP (dBm/10MHz)	35.55	34.98	36.01
EIRP (Watts/10MHz)	3.5892	3.1477	3.9902



LTE Band 48 (GT - LC = 16.00 dB) 16QAM									
Bandwidth	5M			10M			15M		
Channel	(Low)	(Mid)	(High)	(Low)	(Mid)	(High)	(Low)	(Mid)	(High)
Conducted Power (dBm/10MHz)	18.98	19.14	19.77	18.66	18.75	19.83	18.25	18.36	19.98
Conducted Power (Watts/10MHz)	0.0791	0.0820	0.0948	0.0735	0.0750	0.0962	0.0668	0.0685	0.0995
EIRP (dBm/10MHz)	34.98	35.14	35.77	34.66	34.75	35.83	34.25	34.36	35.98
EIRP (Watts/10MHz)	3.1477	3.2659	3.7757	2.9242	2.9854	3.8282	2.6607	2.7290	3.9628

LTE Band 48 (GT - LC = 16.00 dB) 16QAM			
Bandwidth	20M		
Channel	(Low)	(Mid)	(High)
Conducted Power (dBm/10MHz)	19.43	18.89	20.00
Conducted Power (Watts/10MHz)	0.0877	0.0774	0.1000
EIRP (dBm/10MHz)	35.43	34.89	36.00
EIRP (Watts/10MHz)	3.4914	3.0832	3.9811



LTE Band 48 (GT - LC = 16.00 dB) 64QAM									
Bandwidth	5M			10M			15M		
Channel	(Low)	(Mid)	(High)	(Low)	(Mid)	(High)	(Low)	(Mid)	(High)
Conducted Power (dBm/10MHz)	19.07	19.14	19.84	18.65	18.75	19.88	19.05	18.61	19.71
Conducted Power (Watts/10MHz)	0.0807	0.0820	0.0964	0.0733	0.0750	0.0973	0.0804	0.0726	0.0935
EIRP (dBm/10MHz)	35.07	35.14	35.84	34.65	34.75	35.88	35.05	34.61	35.71
EIRP (Watts/10MHz)	3.2137	3.2659	3.8371	2.9174	2.9854	3.8726	3.1989	2.8907	3.7239

LTE Band 48 (GT - LC = 16.00 dB) 64QAM			
Bandwidth	20M		
Channel	(Low)	(Mid)	(High)
Conducted Power (dBm/10MHz)	19.57	19.00	20.08
Conducted Power (Watts/10MHz)	0.0906	0.0794	0.1019
EIRP (dBm/10MHz)	35.57	35.00	36.08
EIRP (Watts/10MHz)	3.6058	3.1623	4.0551



**Peak-to-Average Ratio**

Mode	LTE Band 48 / 20MHz				
Mod.	QPSK		16QAM		Limit: 13dB
RB Size	1RB	Full RB	1RB	Full RB	Result
Lowest CH	7.65	7.65	7.30	6.43	<b>PASS</b>
Middle CH	7.65	5.65	6.93	5.62	
Highest CH	6.99	6.55	6.55	6.38	
Mode	LTE Band 48 / 20MHz				
Mod.	64QAM				Limit: 13dB
RB Size	1RB	Full RB			Result
Lowest CH	8.09	6.46	-	-	<b>PASS</b>
Middle CH	7.51	6.32	-	-	
Highest CH	8.14	6.78	-	-	



LTE Band 48 / 20MHz / QPSK

Lowest Channel / 1RB

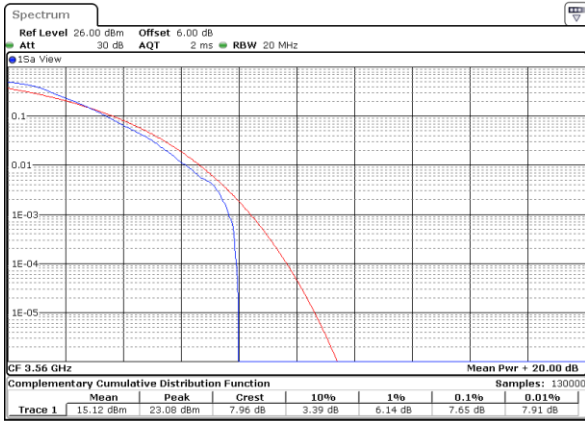

Date: 1.AUG.2020 21:53:32

Lowest Channel / Full RB

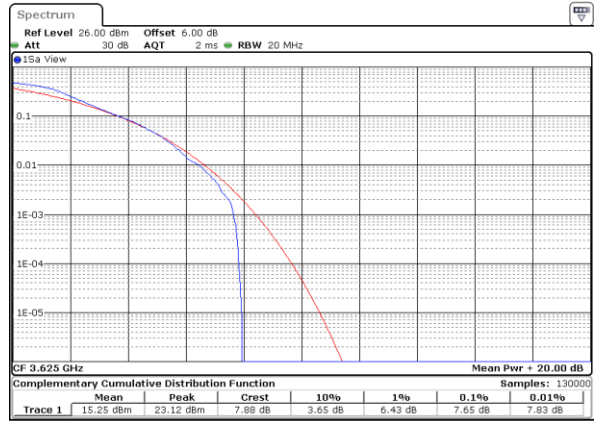

Date: 1.AUG.2020 21:52:23

Middle Channel / 1RB



Date: 1.AUG.2020 21:52:23

Middle Channel / Full RB

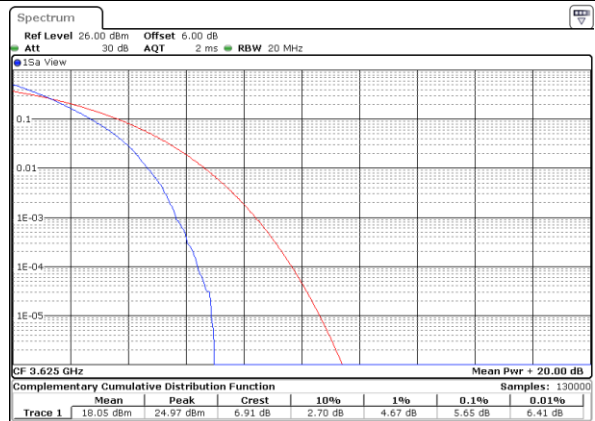

Date: 1.AUG.2020 21:57:37

Highest Channel / 1RB



Date: 1.AUG.2020 21:48:07

Highest Channel / Full RB

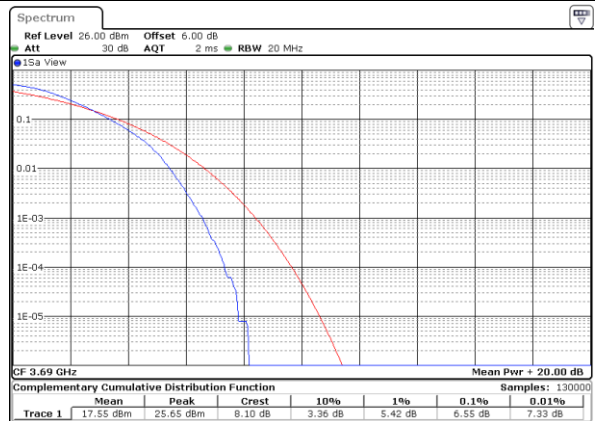

Date: 1.AUG.2020 22:01:09





LTE Band 48 / 20MHz / 16QAM

Lowest Channel / 1RB

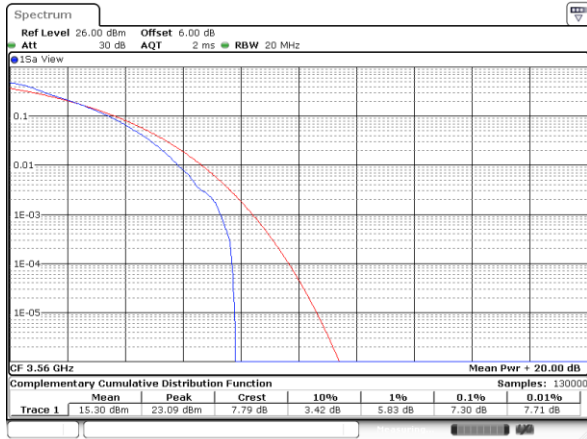

Date: 1.AUG.2020 21:54:27

Lowest Channel / Full RB

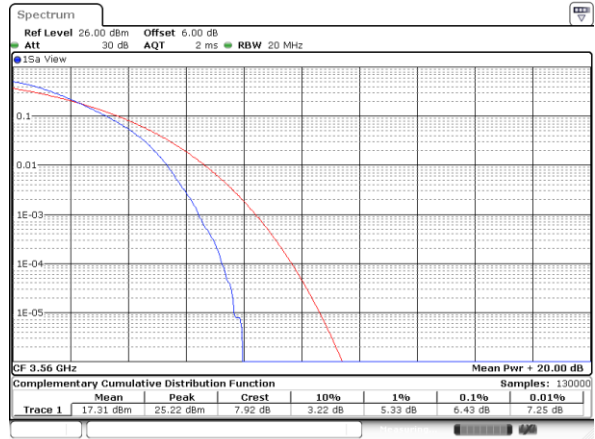

Date: 1.AUG.2020 21:56:15

Middle Channel / 1RB

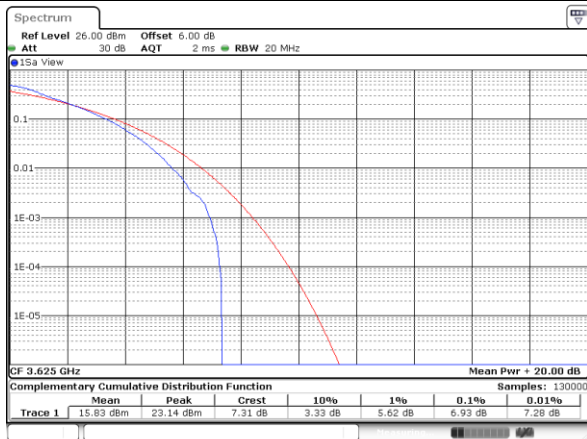

Date: 1.AUG.2020 21:51:57

Middle Channel / Full RB

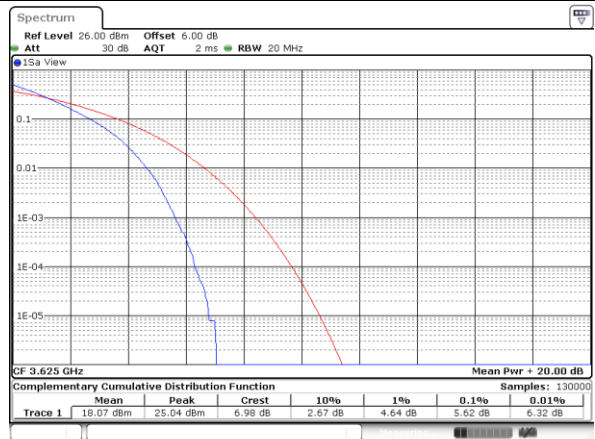

Date: 1.AUG.2020 21:58:07

Highest Channel / 1RB



Date: 1.AUG.2020 21:49:44

Highest Channel / Full RB

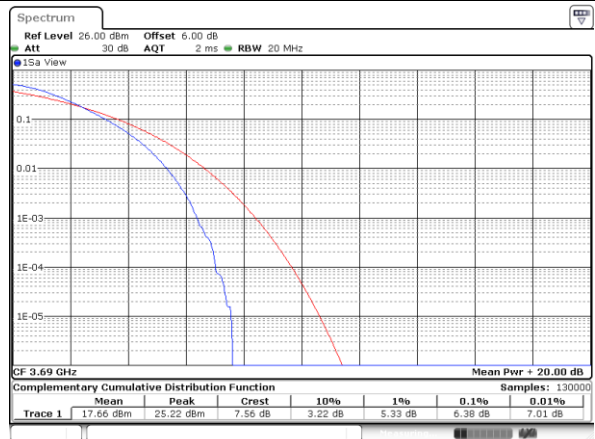

Date: 1.AUG.2020 22:00:28



LTE Band 48 / 20MHz / 64QAM

Lowest Channel / 1RB

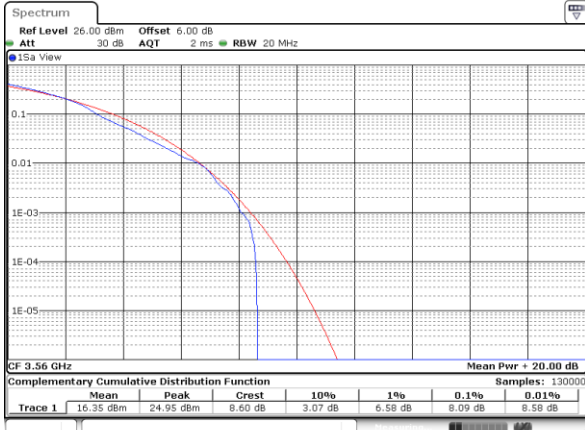

Date: 1.AUG.2020 21:55:10

Lowest Channel / Full RB

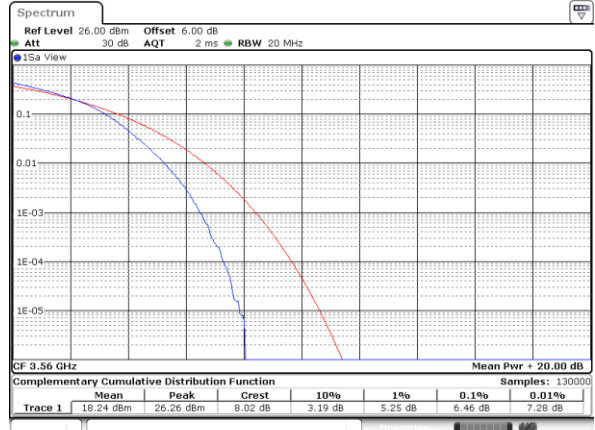

Date: 1.AUG.2020 21:55:57

Middle Channel / 1RB

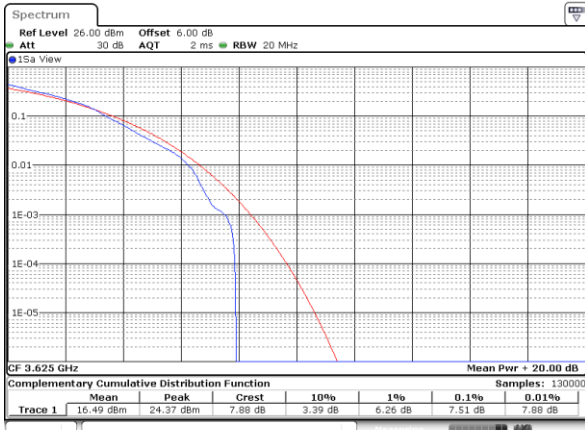

Date: 1.AUG.2020 21:51:06

Middle Channel / Full RB

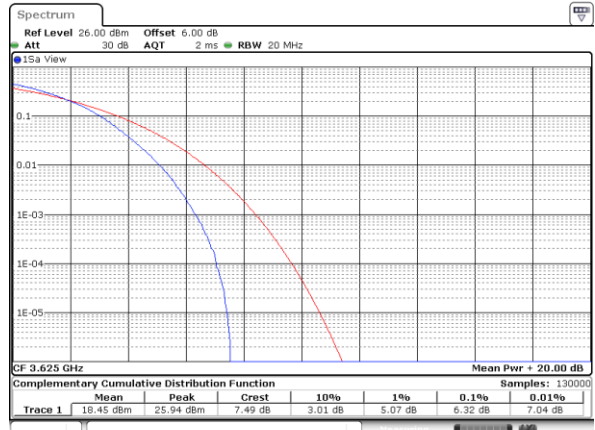

Date: 1.AUG.2020 21:58:39

Highest Channel / 1RB

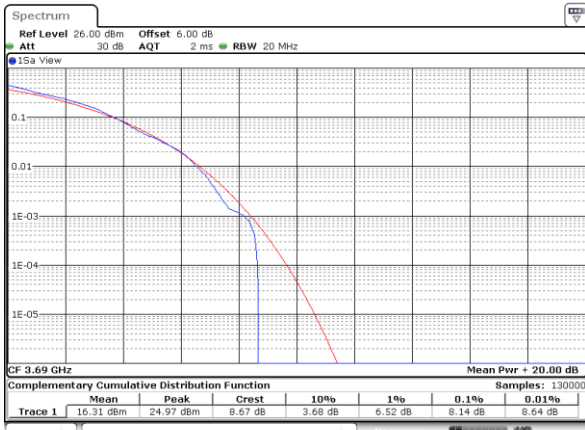

Date: 1.AUG.2020 21:50:14

Highest Channel / Full RB

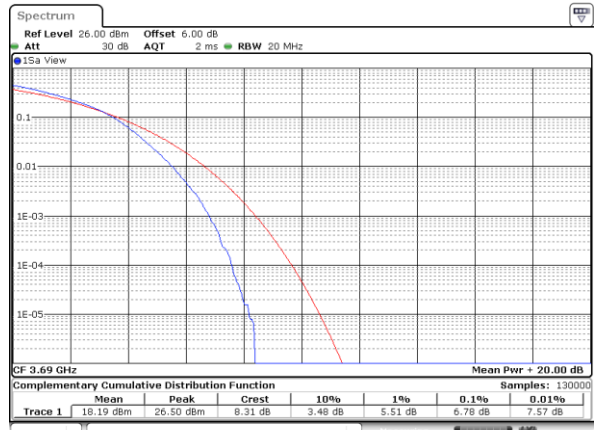

Date: 1.AUG.2020 22:00:07



**EIRP Power Density**

**1RB0**

Mode	LTE Band 48 : (dBm/1MHz)											
BW	5MHz		10MHz		15MHz		20MHz		5MHz	10MHz	15MHz	20MHz
Mod.	QPSK	16QAM	QPSK	16QAM	QPSK	16QAM	QPSK	16QAM	64QAM	64QAM	64QAM	64QAM
Lowest CH	33.87	33.60	34.21	34.36	34.07	34.05	35.11	34.76	34.08	34.53	34.46	35.78
Middle CH	33.71	33.62	34.23	34.09	34.65	34.31	35.51	35.13	34.28	35.04	35.18	35.78
Highest CH	34.51	34.72	34.82	34.74	34.36	34.75	34.96	35.09	34.85	34.65	34.82	35.79
Limit	37dBm /MHz											
Result	Pass											

**1RB Max**

Mode	LTE Band 48 : (dBm/1MHz)											
BW	5MHz		10MHz		15MHz		20MHz		5MHz	10MHz	15MHz	20MHz
Mod.	QPSK	16QAM	QPSK	16QAM	QPSK	16QAM	QPSK	16QAM	64QAM	64QAM	64QAM	64QAM
Lowest CH	33.35	33.35	34.49	34.10	34.48	34.51	35.30	35.28	33.94	35.09	35.19	35.95
Middle CH	33.71	33.62	34.19	34.46	34.06	33.92	34.34	34.69	34.28	34.47	34.76	35.07
Highest CH	34.08	33.82	35.83	35.68	34.68	35.08	35.48	35.51	34.53	35.62	35.13	36.25
Limit	37dBm /MHz											
Result	Pass											

**Full RB0**

Mode	LTE Band 48 : (dBm/1MHz)											
BW	5MHz		10MHz		15MHz		20MHz		5MHz	10MHz	15MHz	20MHz
Mod.	QPSK	16QAM	QPSK	16QAM	QPSK	16QAM	QPSK	16QAM	64QAM	64QAM	64QAM	64QAM
Lowest CH	28.49	28.64	26.20	25.66	24.12	24.43	23.81	23.65	28.61	26.07	24.25	24.38
Middle CH	28.44	28.42	25.82	25.90	23.94	24.27	23.57	23.63	28.65	26.14	24.21	23.80
Highest CH	29.63	29.50	26.49	26.58	24.57	25.01	23.69	24.08	28.89	26.62	24.93	23.92
Limit	37dBm /MHz											
Result	Pass											

Note: EIRP Power Density = Conducted Power Density + Antenna Gain (16dBi)



Conducted Power Density:

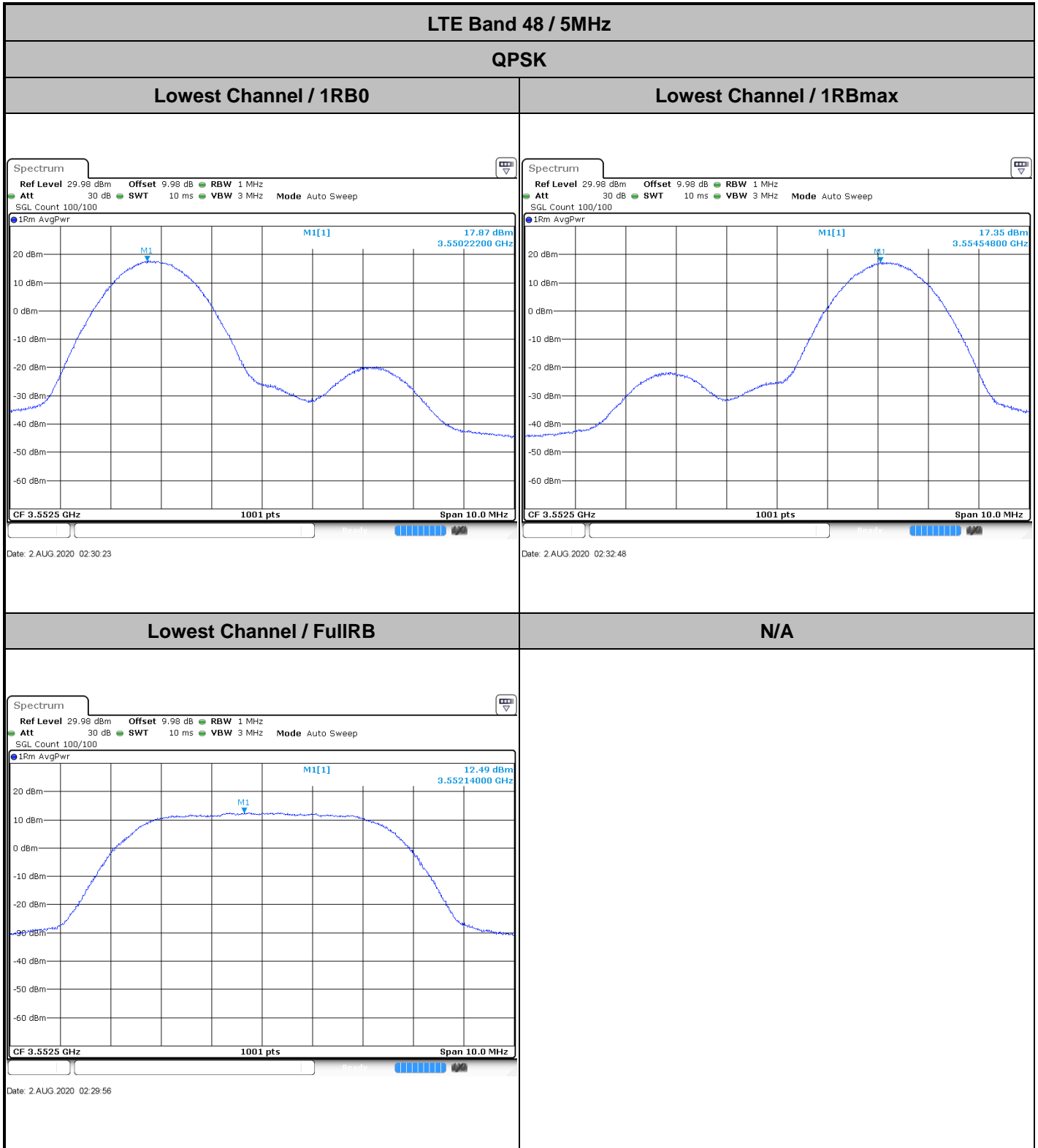



LTE Band 48 / 5MHz

QPSK

Middle Channel / 1RB0

Middle Channel / 1RBmax

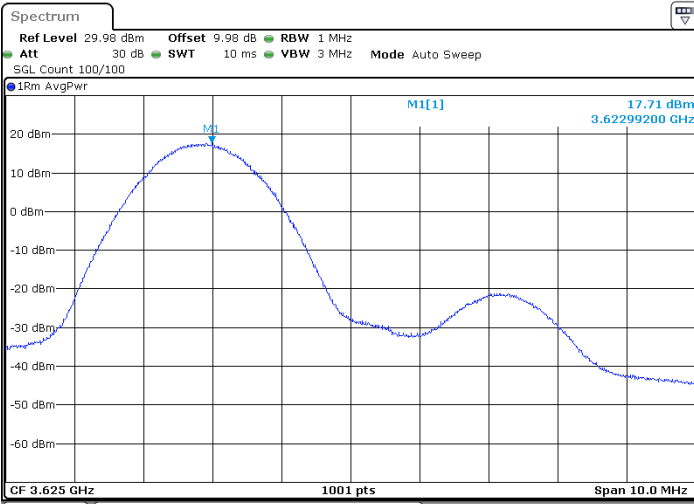

Date: 2 AUG.2020 02:36:32

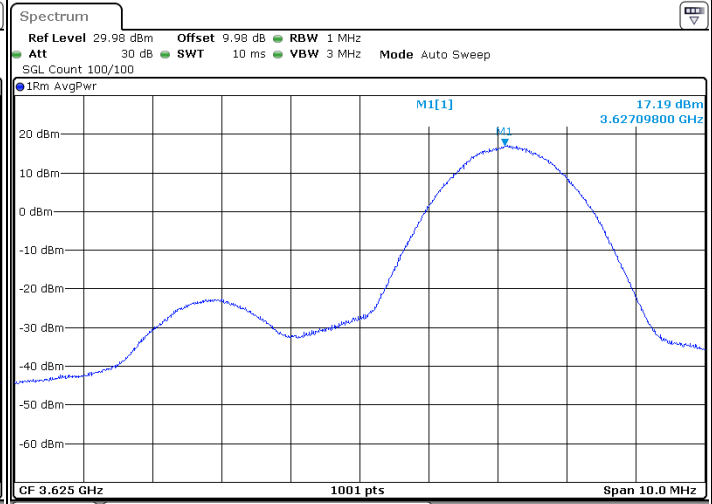

Date: 2 AUG.2020 02:35:40

Middle Channel / FullIRB

N/A

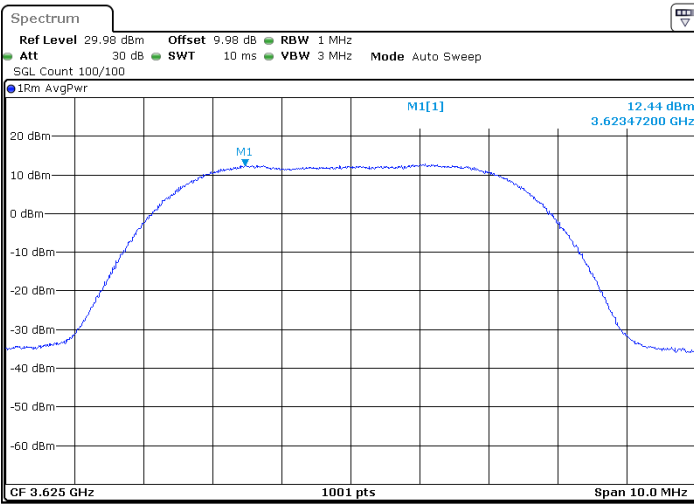

Date: 2 AUG.2020 02:40:25



LTE Band 48 / 5MHz

QPSK

Highest Channel / 1RB0

Highest Channel / 1RBmax

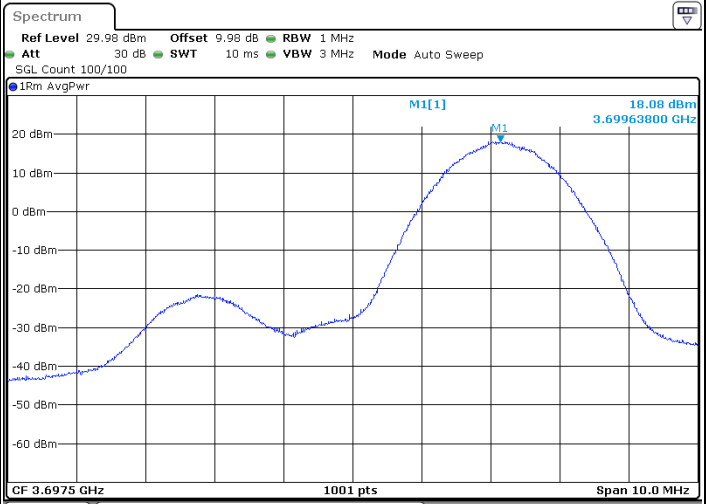
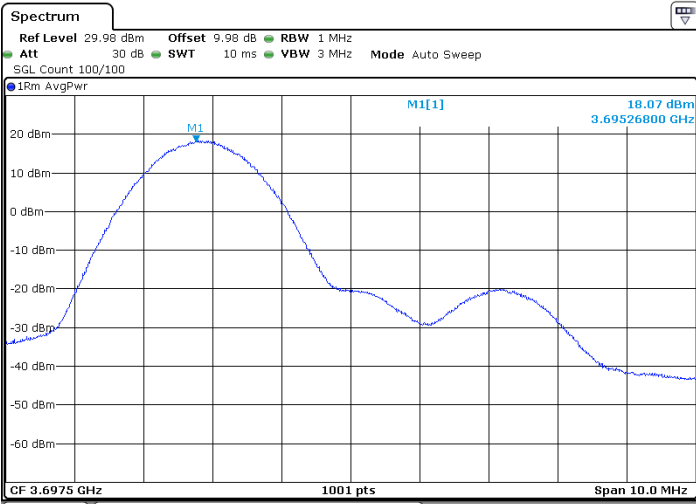

Date: 2 AUG.2020 07:22:27

Date: 2 AUG.2020 02:44:35

Highest Channel / FullRB

N/A

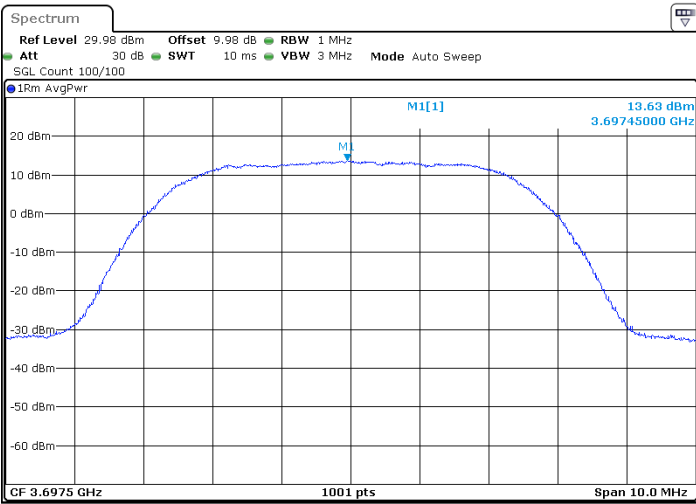

Date: 2 AUG.2020 02:41:21



LTE Band 48 / 10MHz

QPSK

Lowest Channel / 1RB0

Lowest Channel / 1RBmax

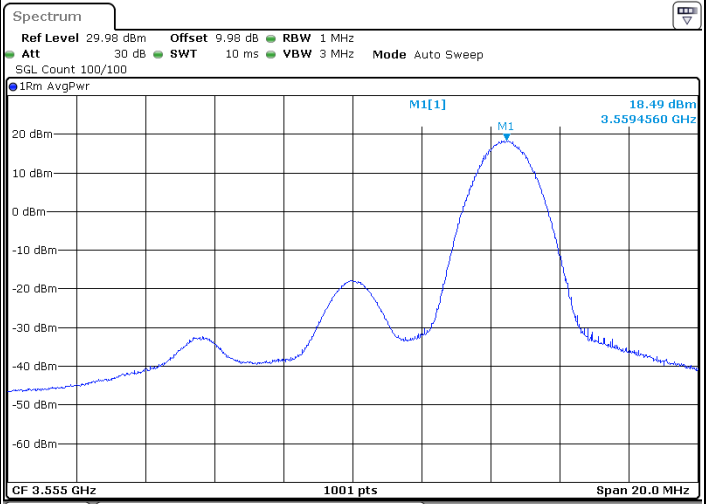
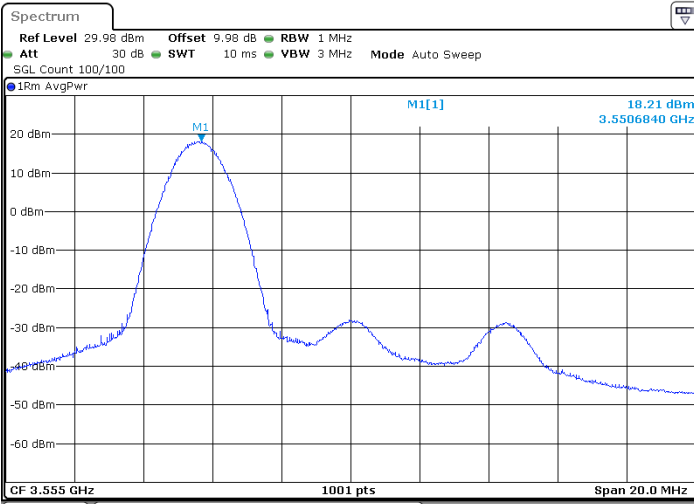

Date: 2 AUG.2020 02:06:18

Date: 2 AUG.2020 02:09:29

Lowest Channel / FullIRB

N/A

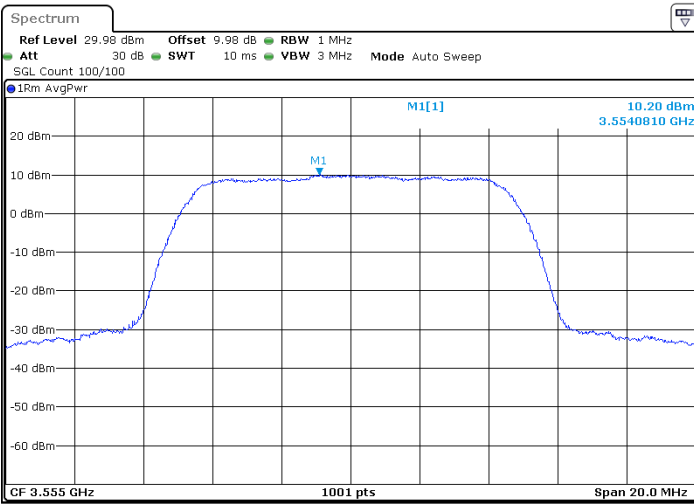

Date: 2 AUG.2020 02:05:46



LTE Band 48 / 10MHz

QPSK

MiddleChannel / 1RB0

Middle Channel / 1RBmax

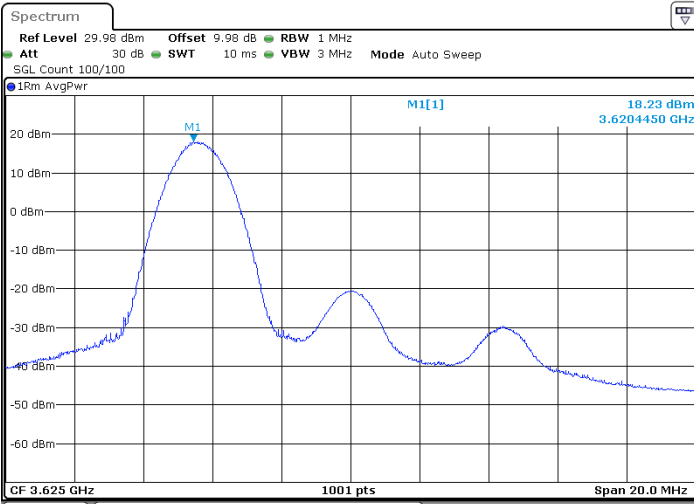

Date: 2 AUG.2020 02:14:32

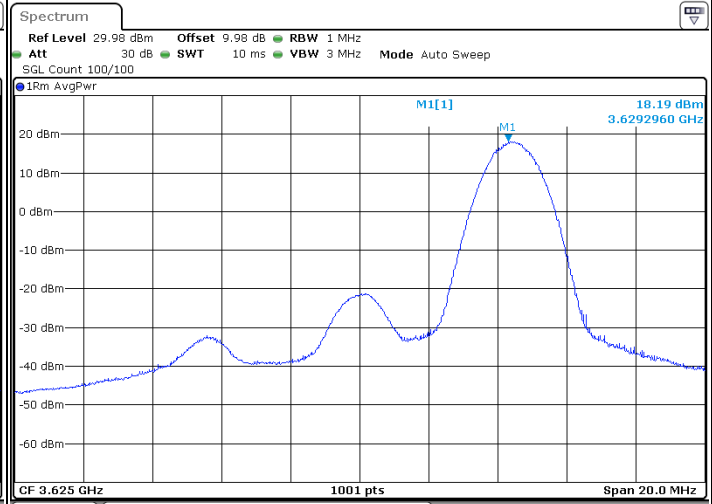

Date: 2 AUG.2020 02:10:58

Middle Channel / FullRB

N/A

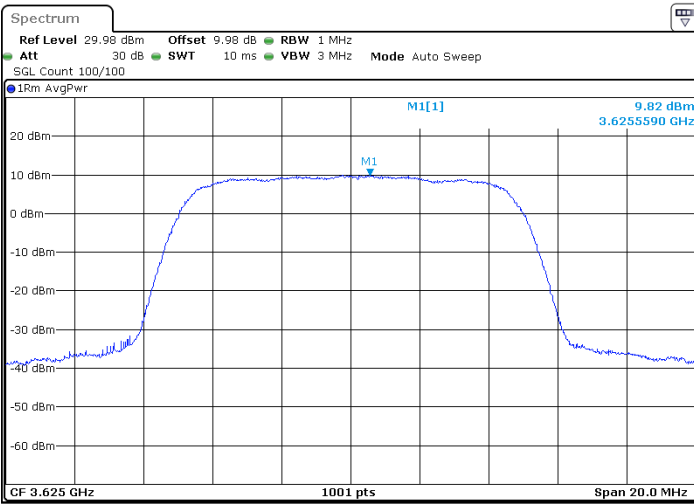

Date: 2 AUG.2020 02:15:18





LTE Band 48 / 10MHz

QPSK

Highest Channel / 1RB0

Highest Channel / 1RBmax

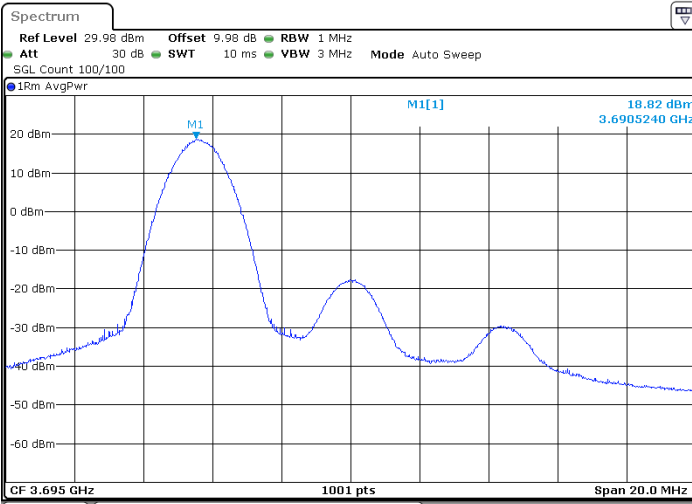

Date: 2 AUG.2020 02:19:40

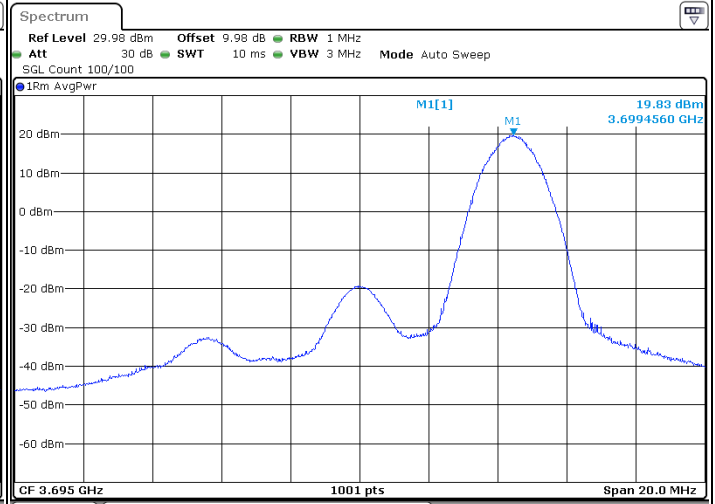

Date: 2 AUG.2020 02:22:51

Highest Channel / FullRB

N/A

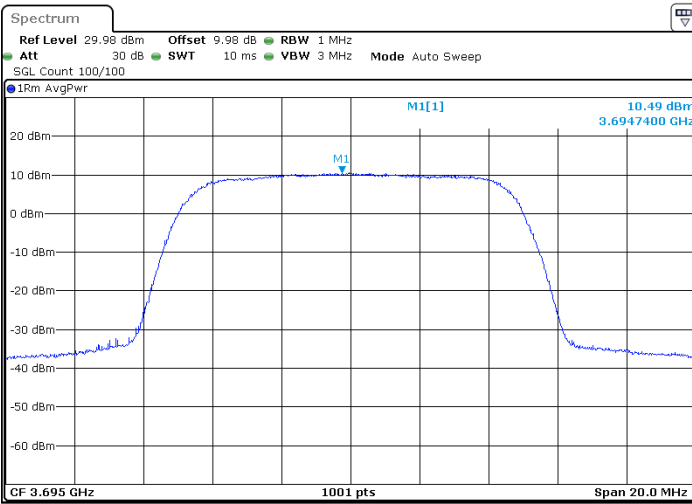

Date: 2 AUG.2020 02:18:53



LTE Band 48 / 15MHz

QPSK

Lowest Channel / 1RB0

Lowest Channel / 1RBmax

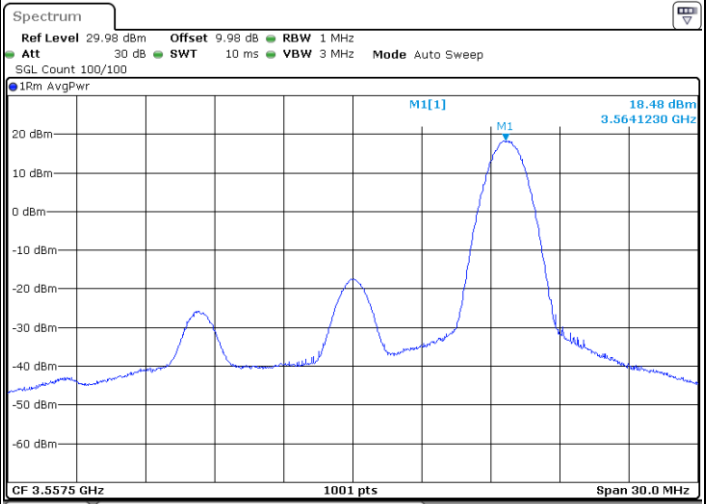
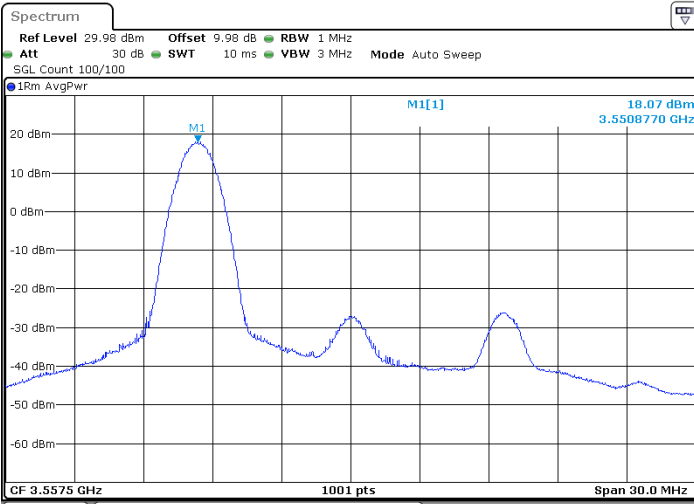

Date: 2.AUG.2020 01:33:58

Date: 2.AUG.2020 01:47:49

Lowest Channel / FullIRB

N/A

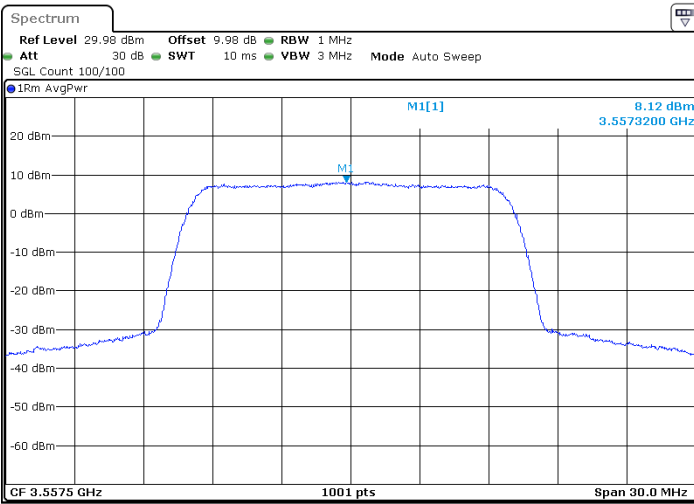

Date: 2.AUG.2020 01:45:16



LTE Band 48 / 15MHz

QPSK

Middle Channel / 1RB0

Middle Channel / 1RBmax

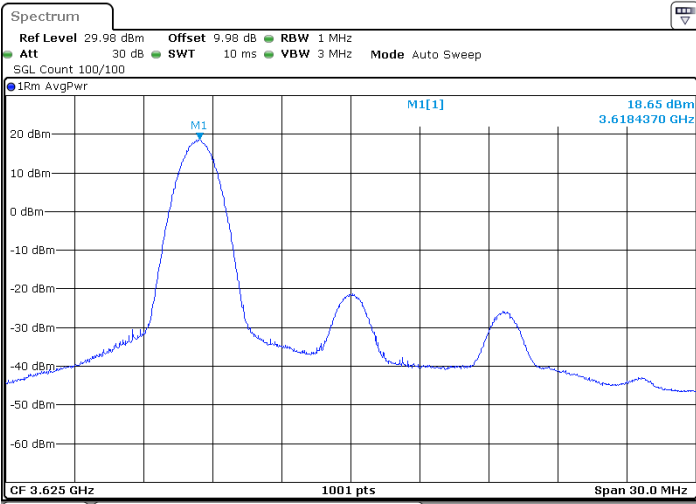

Date: 2.AUG.2020 01:39:35

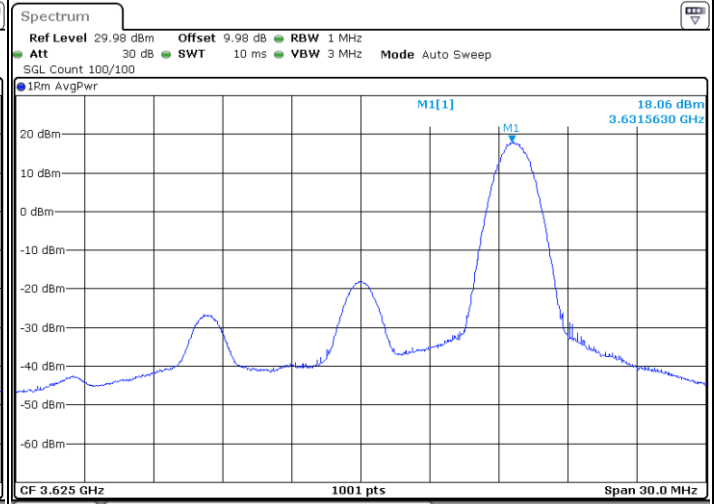

Date: 2.AUG.2020 01:38:34

Middle Channel / FullRB

N/A

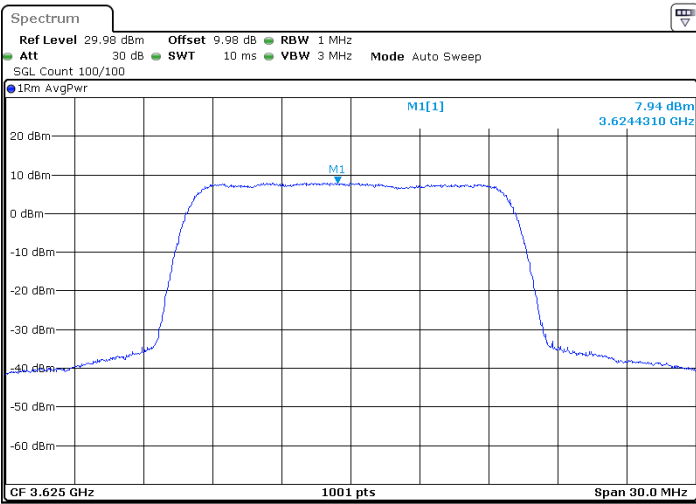

Date: 2.AUG.2020 01:43:52



LTE Band 48 / 15MHz

QPSK

Highest Channel / 1RB0

Highest Channel / 1RBmax

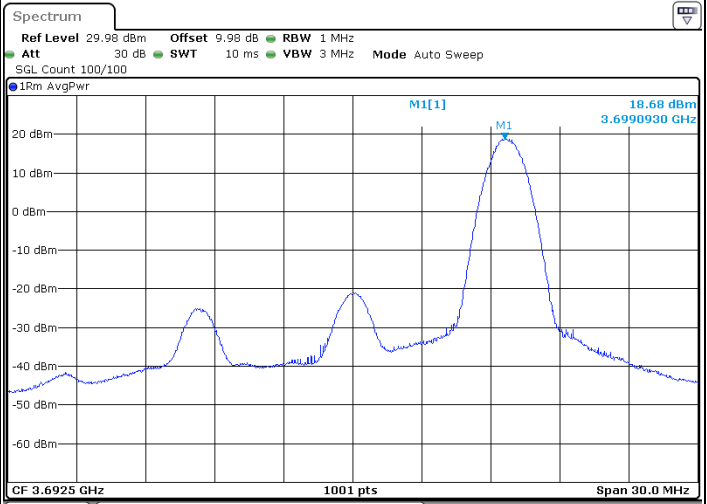
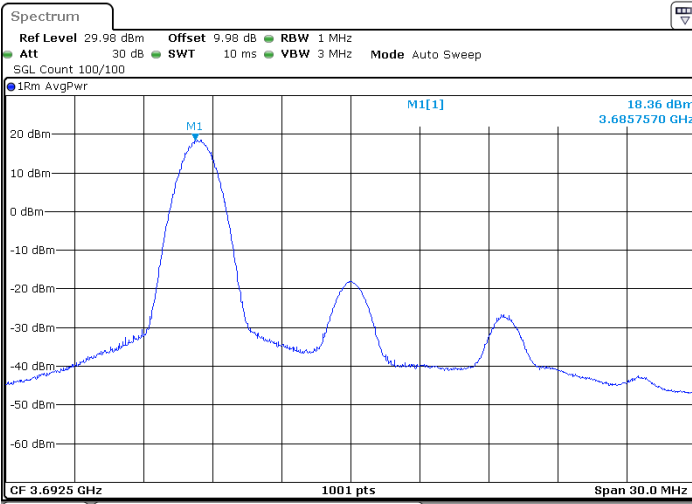

Date: 2 AUG.2020 02:00:31

Date: 2 AUG.2020 01:52:27

Highest Channel / FullRB

N/A

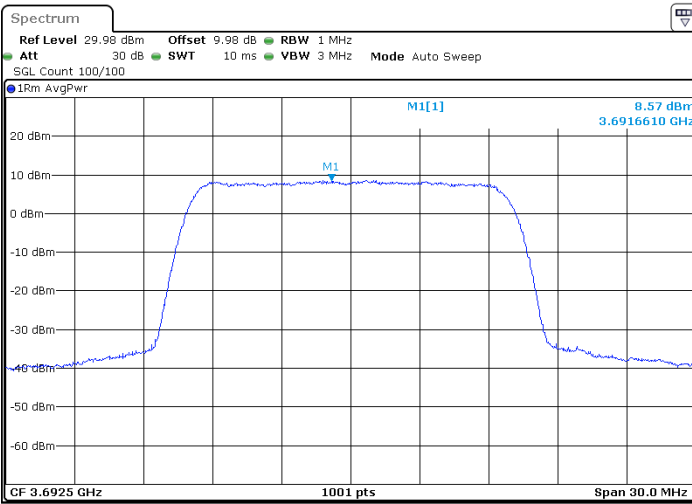

Date: 2 AUG.2020 02:01:29



LTE Band 48 / 20MHz

QPSK

Lowest Channel / 1RB0

Lowest Channel / 1RBmax

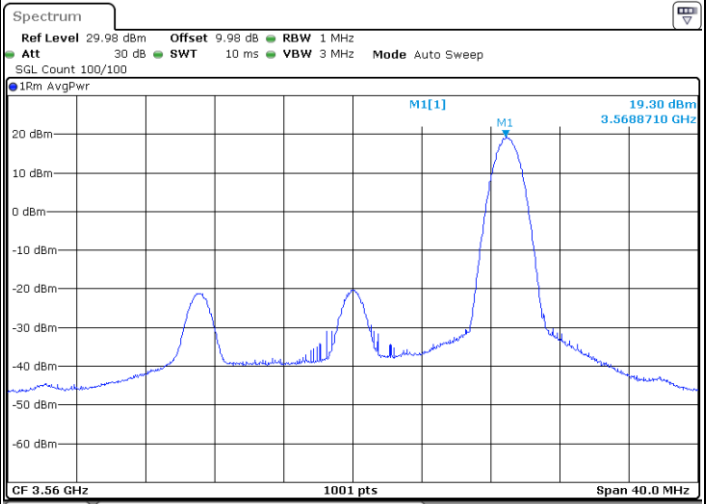
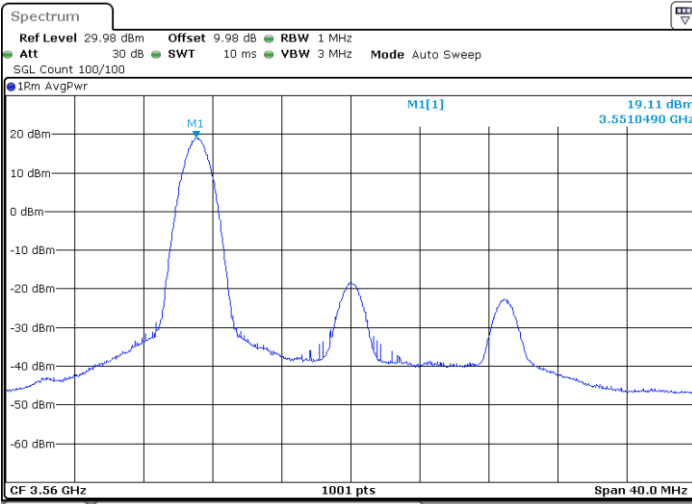

Date: 2.AUG.2020 00:59:37

Date: 2.AUG.2020 00:57:08

Lowest Channel / FullIRB

N/A

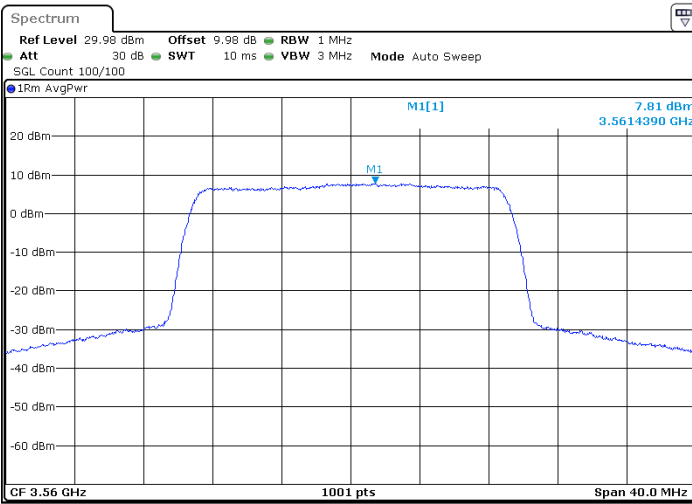

Date: 2.AUG.2020 01:04:06



LTE Band 48 / 20MHz

QPSK

Middle Channel / 1RB0

Middle Channel / 1RBmax

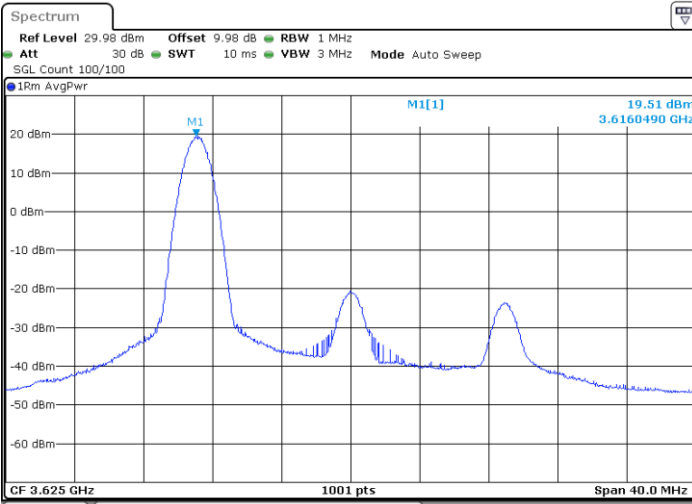

Date: 2.AUG.2020 01:09:38

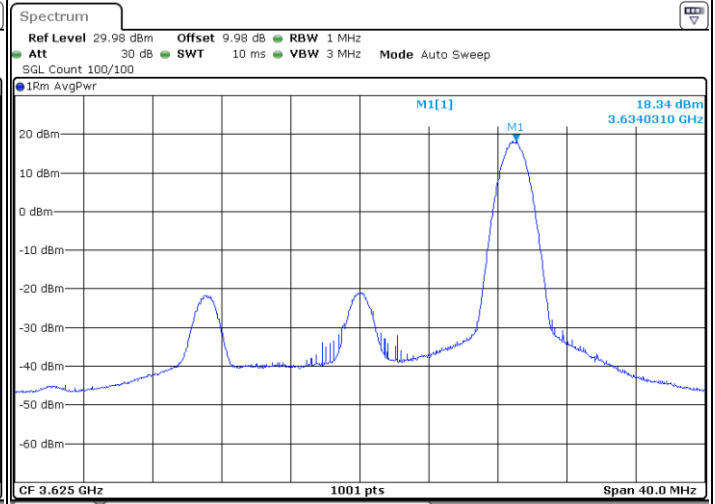

Date: 2.AUG.2020 01:10:47

Middle Channel / FullRB

N/A

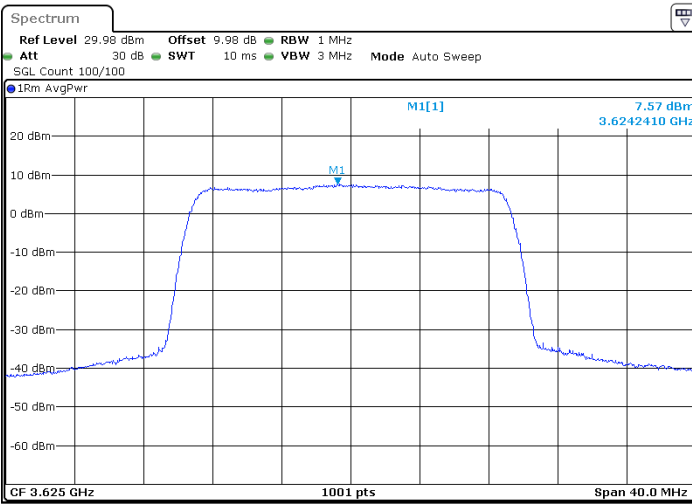

Date: 2.AUG.2020 01:05:37



LTE Band 48 / 20MHz

QPSK

Highest Channel / 1RB0

Highest Channel / 1RBmax

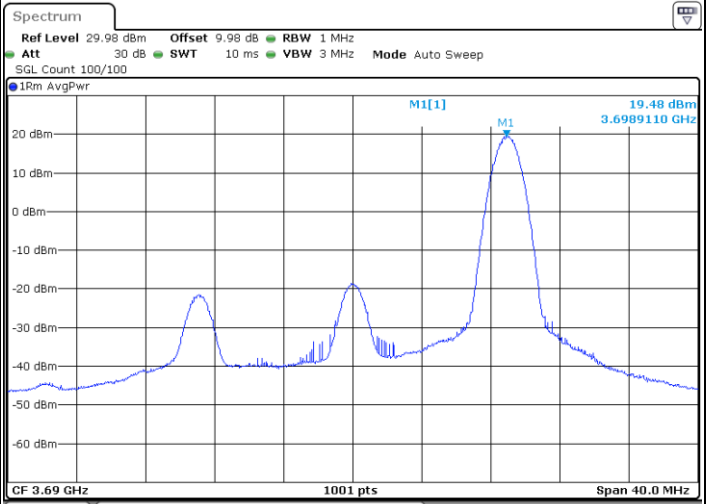
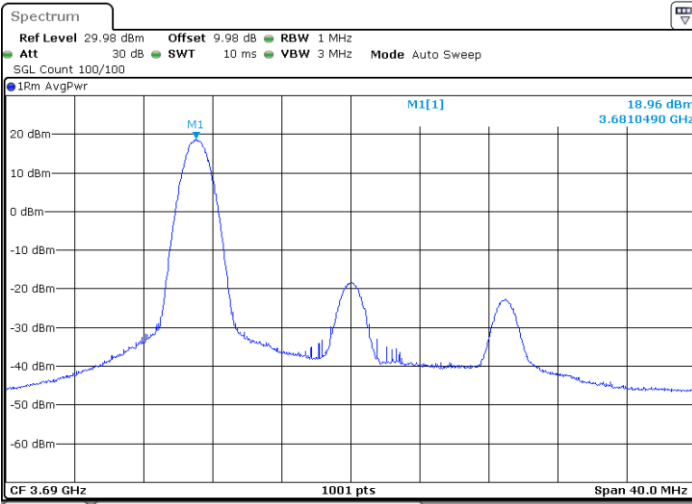

Date: 2.AUG.2020 01:15:42

Date: 2.AUG.2020 01:15:01

Highest Channel / FullRB

N/A

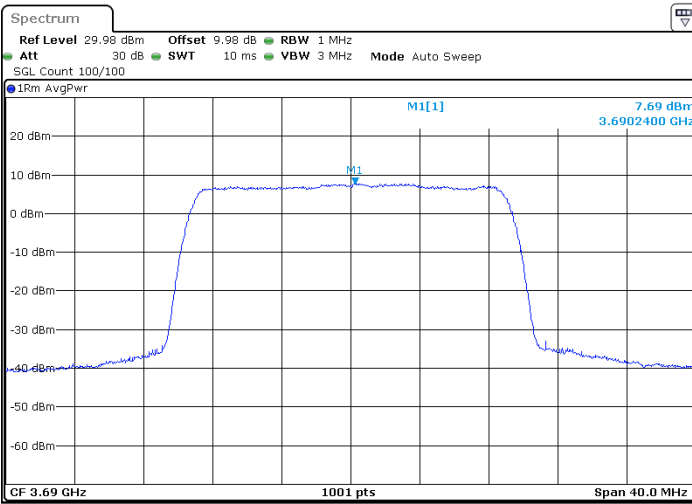

Date: 2.AUG.2020 01:18:49



LTE Band 48 / 5MHz

16QAM

Lowest Channel / 1RB0

Lowest Channel / 1RBmax

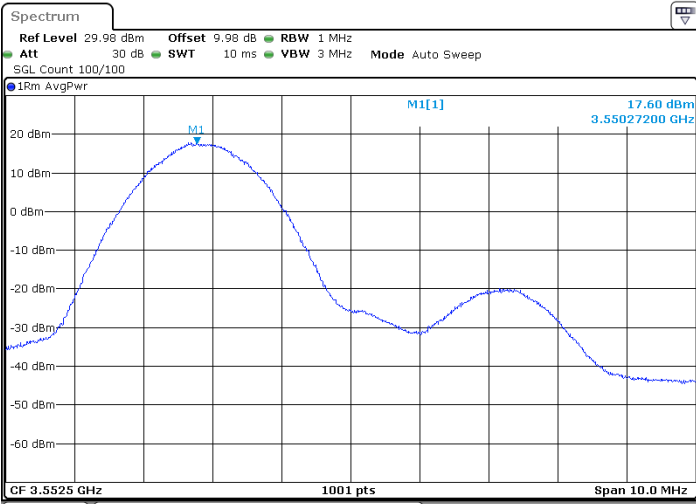

Date: 2 AUG 2020 02:30:49

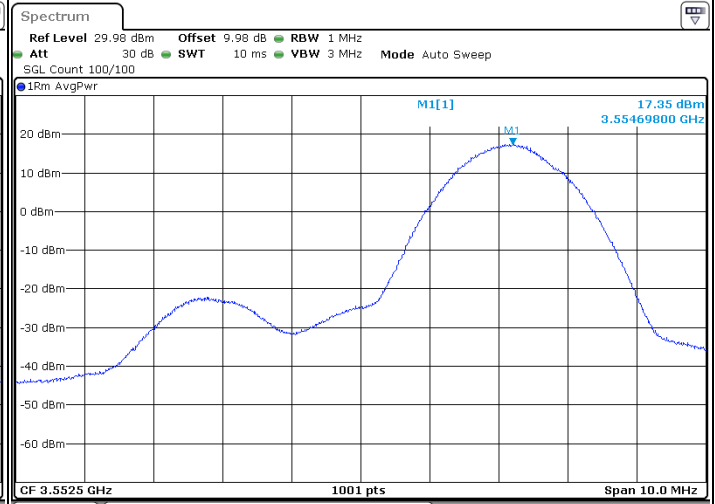

Date: 2 AUG 2020 02:32:10

Lowest Channel / FullIRB

N/A

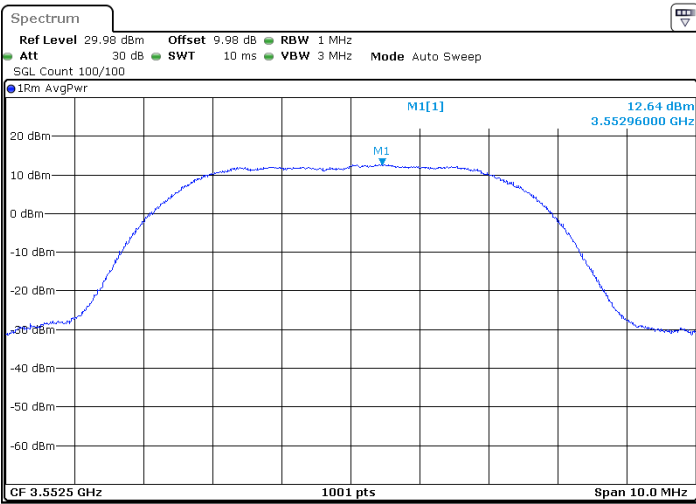

Date: 2 AUG 2020 02:29:09





LTE Band 48 / 5MHz

16QAM

Middle Channel / 1RB0

Middle Channel / 1RBmax

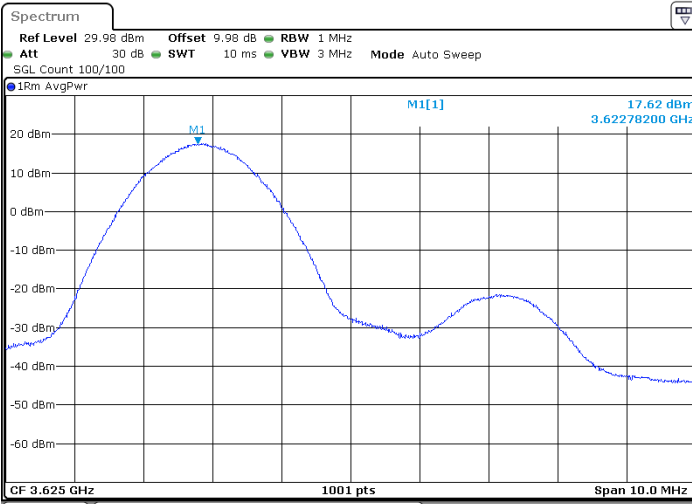

Date: 2 AUG.2020 02:37:02

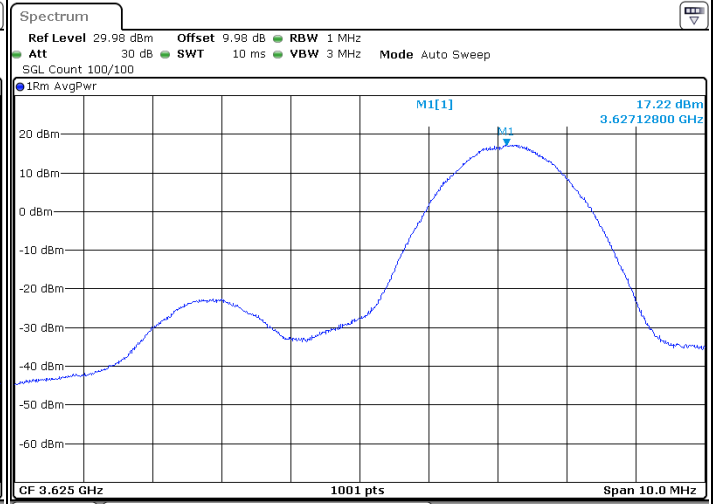

Date: 2 AUG.2020 02:35:15

Middle Channel / FullIRB

N/A

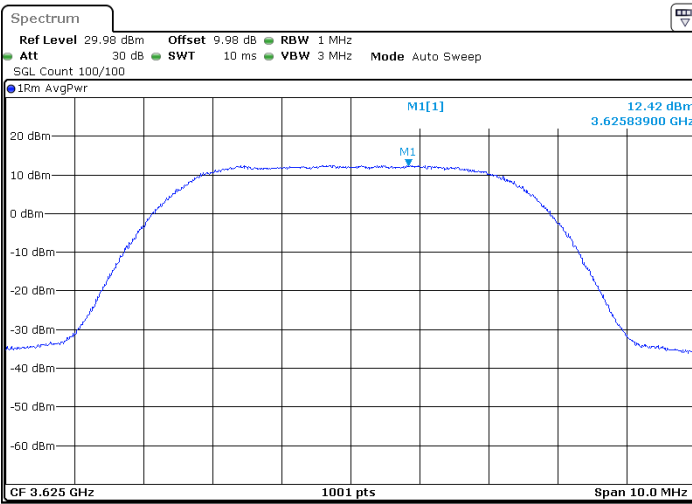

Date: 2 AUG.2020 02:39:50



LTE Band 48 / 5MHz

16QAM

Highest Channel / 1RB0

Highest Channel / 1RBmax

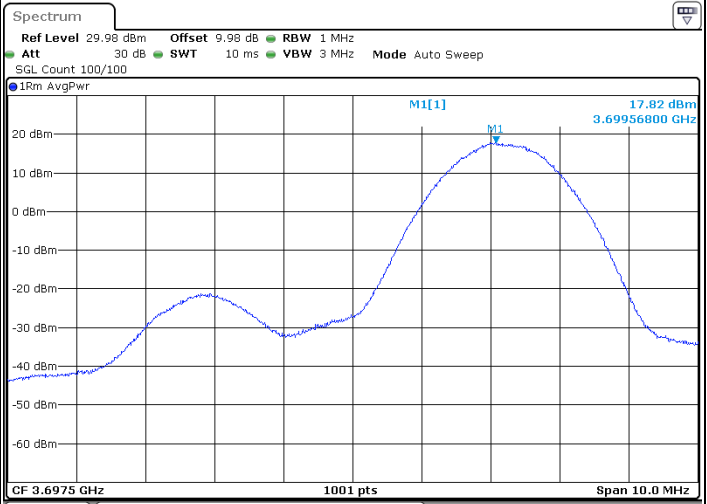
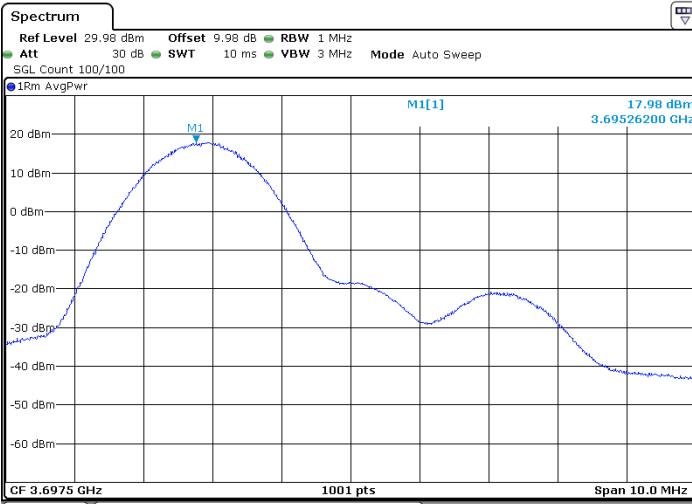

Date: 2 AUG.2020 07:24:13

Date: 2 AUG.2020 02:44:59

Highest Channel / FullRB

N/A

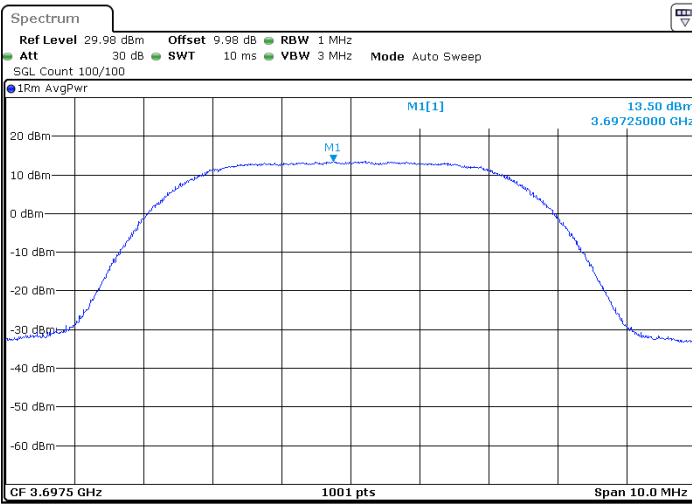

Date: 2 AUG.2020 02:41:50



LTE Band 48 / 10MHz

16QAM

Lowest Channel / 1RB0

Lowest Channel / 1RBmax

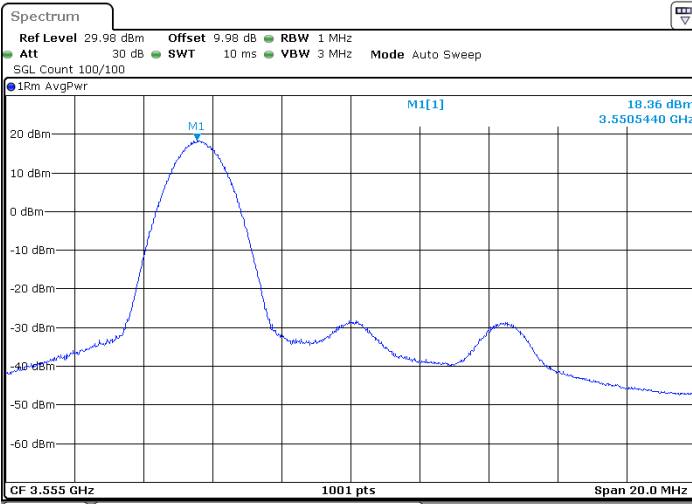

Date: 2 AUG.2020 02:06:51

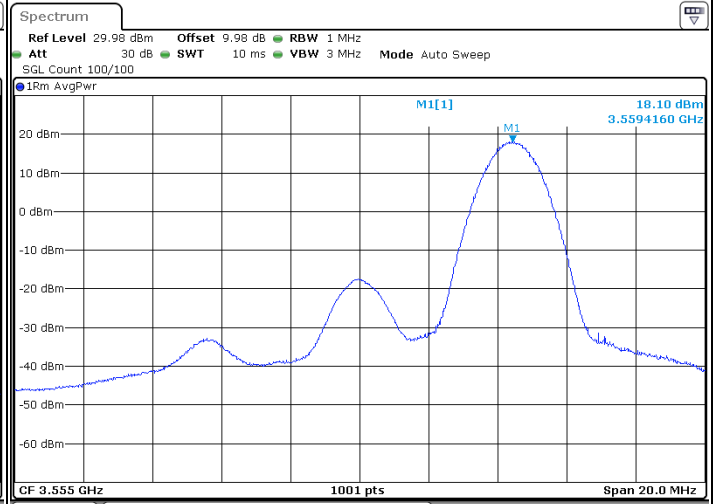

Date: 2 AUG.2020 02:08:55

Lowest Channel / FullIRB

N/A

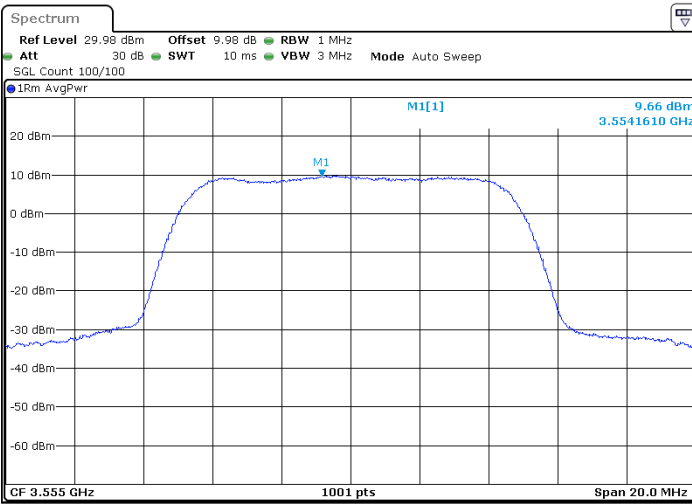

Date: 2 AUG.2020 02:05:19



LTE Band 48 / 10MHz

16QAM

MiddleChannel / 1RB0

Middle Channel / 1RBmax

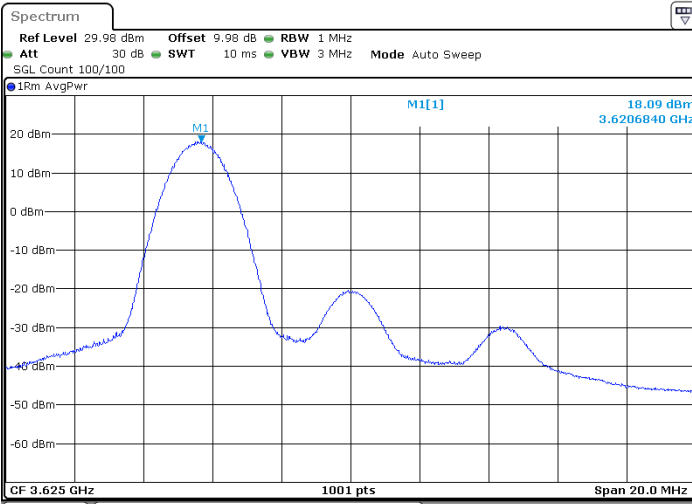

Date: 2.AUG.2020 02:13:51

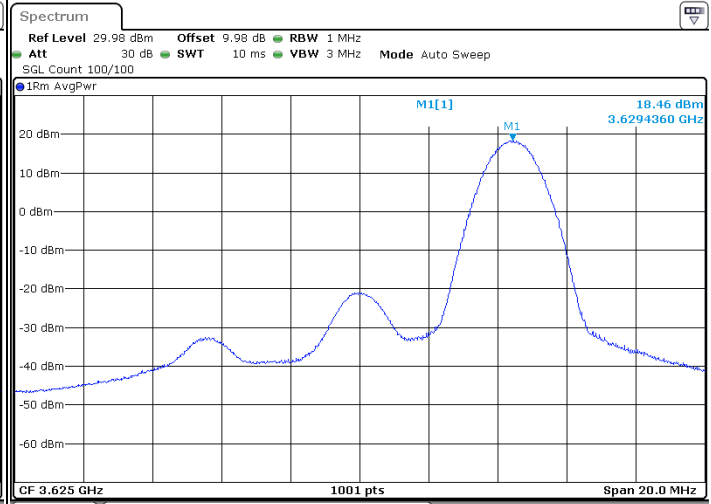

Date: 2.AUG.2020 02:11:44

Middle Channel / FullIRB

N/A

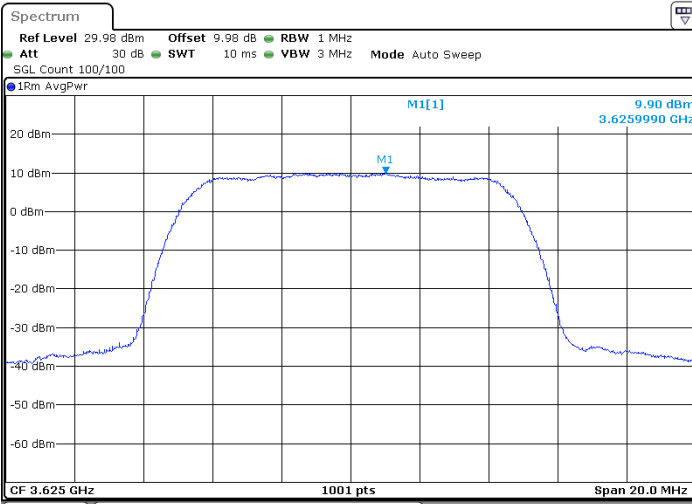

Date: 2.AUG.2020 02:15:41



LTE Band 48 / 10MHz

16QAM

Highest Channel / 1RB0

Highest Channel / 1RBmax

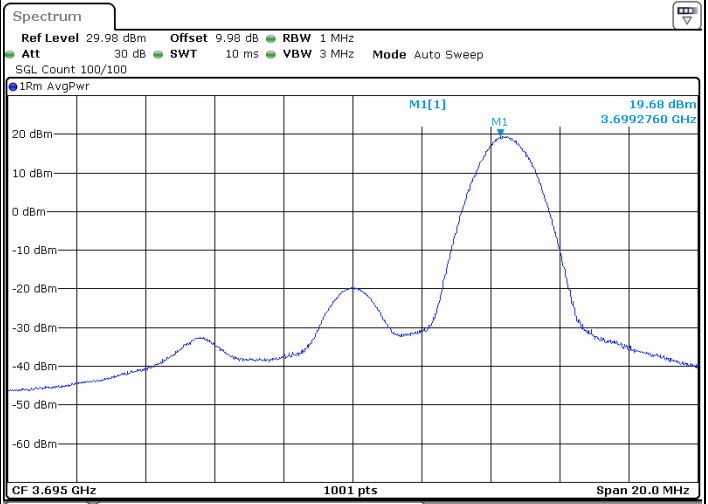
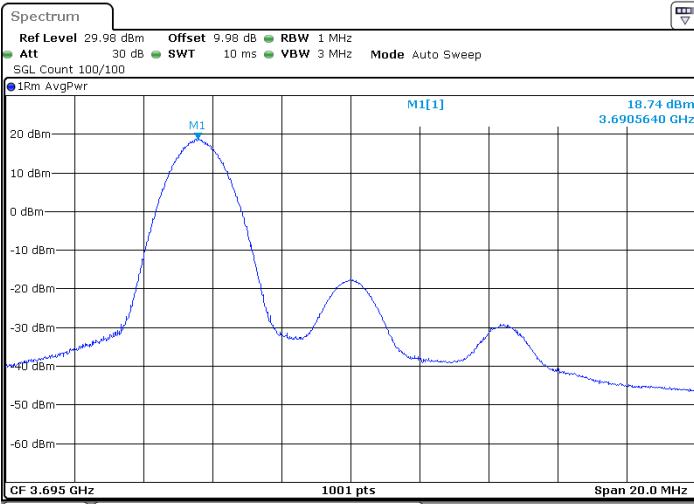

Date: 2 AUG.2020 02:20:05

Date: 2 AUG.2020 02:22:05

Highest Channel / FullRB

N/A

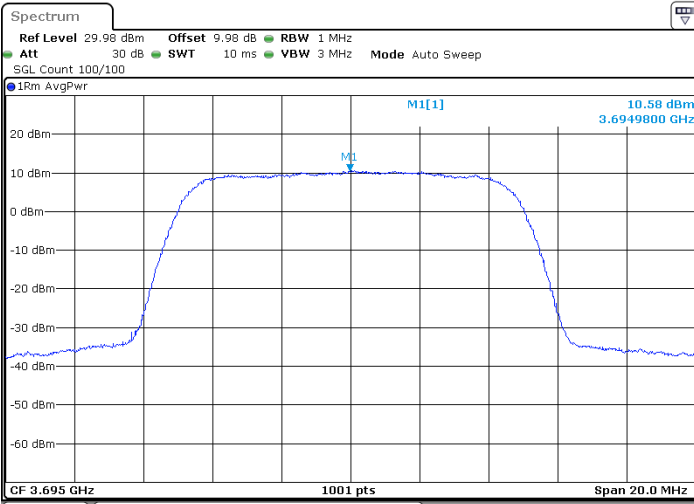

Date: 2 AUG.2020 02:18:28



LTE Band 48 / 15MHz

16QAM

Lowest Channel / 1RB0

Lowest Channel / 1RBmax

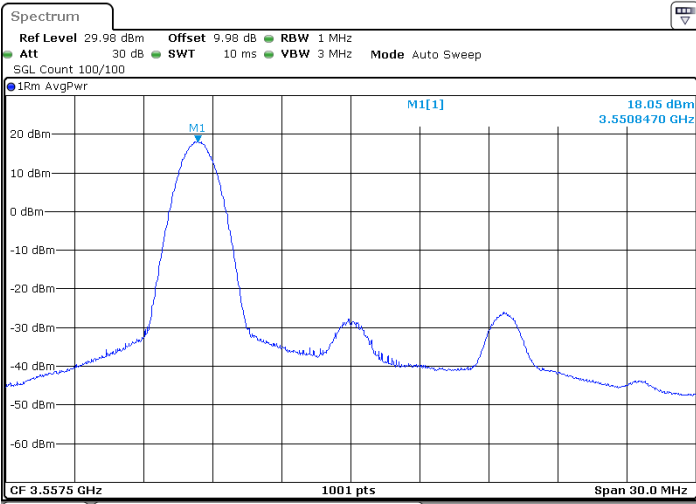

Date: 2.AUG.2020 01:33:36

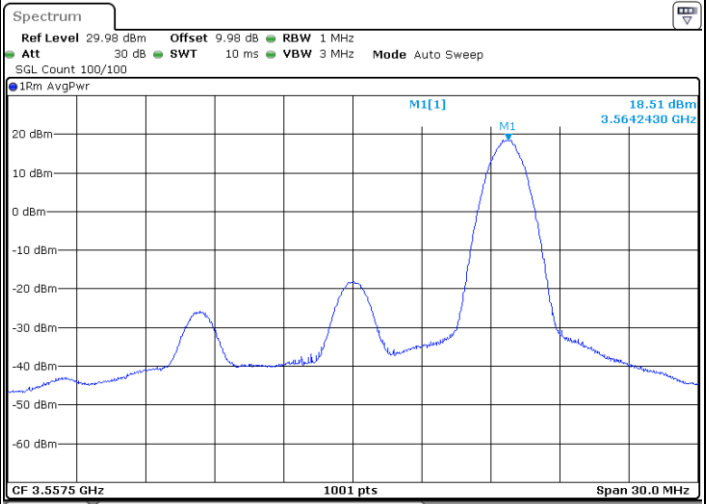

Date: 2.AUG.2020 01:47:24

Lowest Channel / FullIRB

N/A

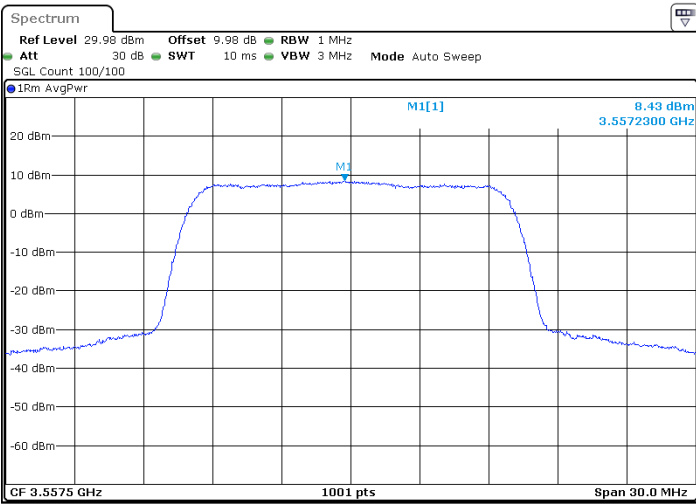

Date: 2.AUG.2020 01:45:44



LTE Band 48 / 15MHz

16QAM

Middle Channel / 1RB0

Middle Channel / 1RBmax

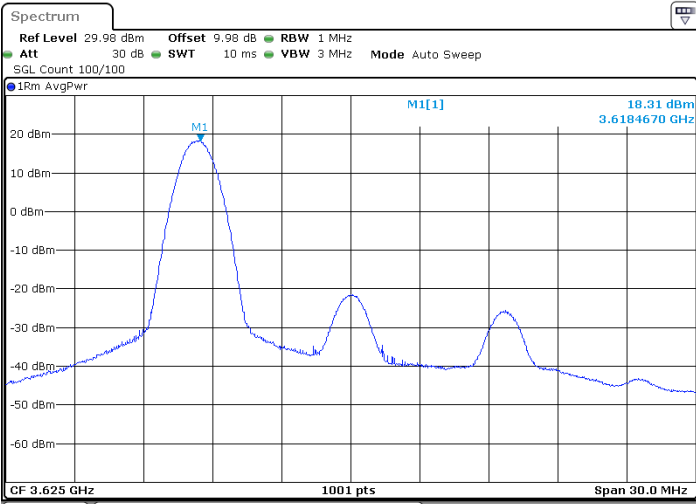

Date: 2 AUG.2020 01:40:57

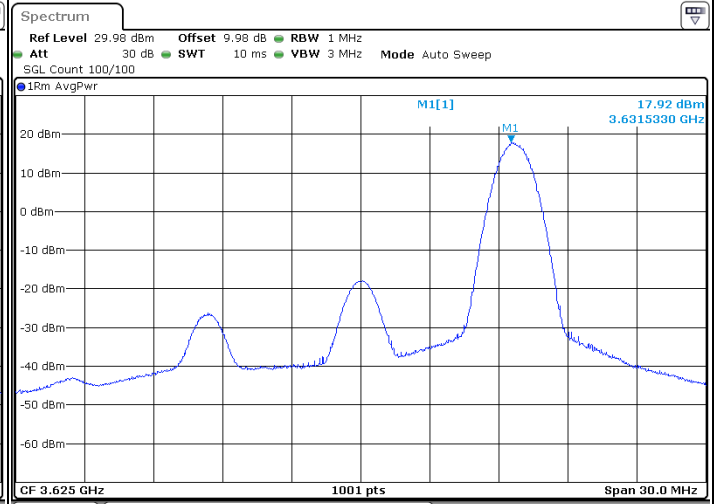

Date: 2 AUG.2020 01:38:01

Middle Channel / FullRB

N/A

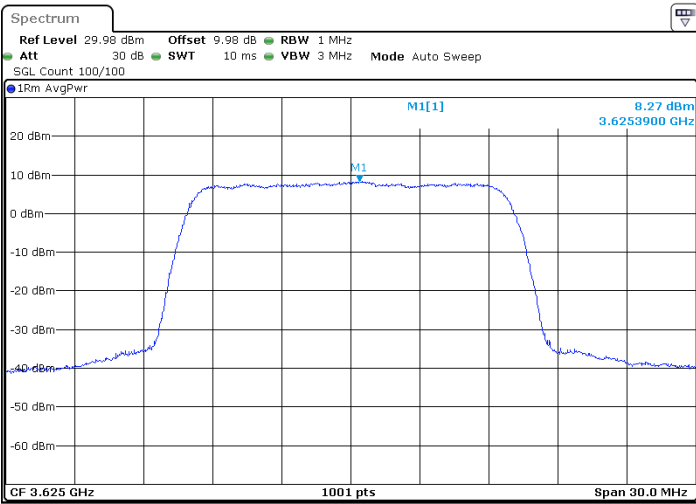

Date: 2 AUG.2020 01:43:15



LTE Band 48 / 15MHz

16QAM

Highest Channel / 1RB0

Highest Channel / 1RBmax

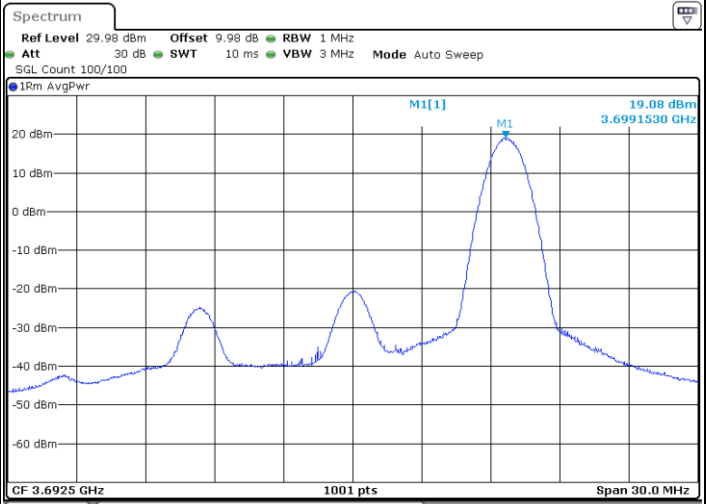
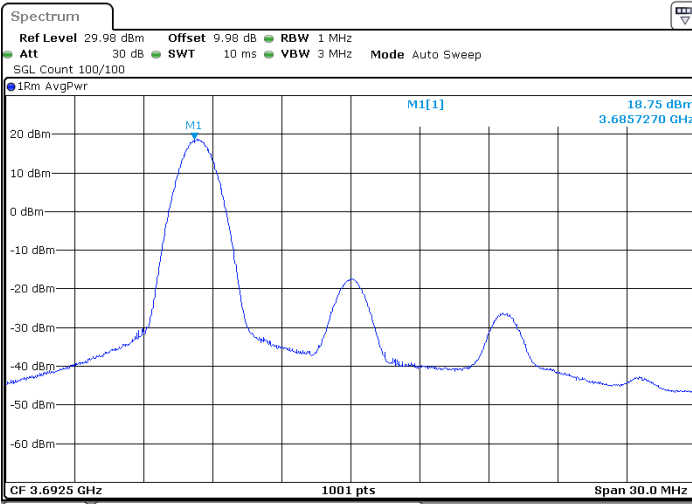

Date: 2 AUG.2020 01:56:55

Date: 2 AUG.2020 01:52:57

Highest Channel / FullRB

N/A

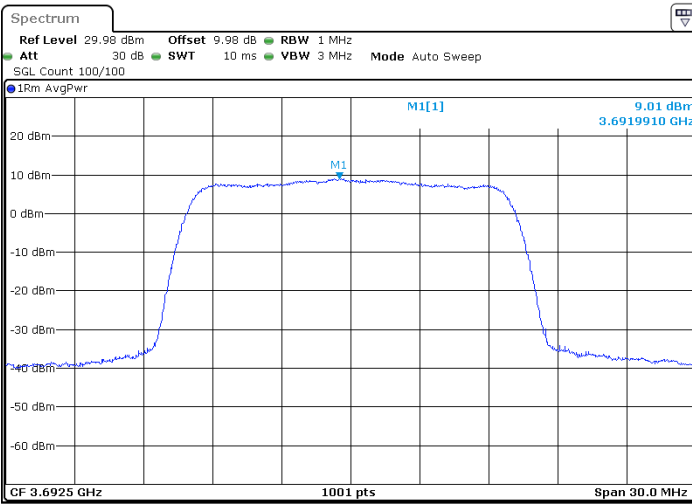

Date: 2 AUG.2020 02:01:55





LTE Band 48 / 20MHz

16QAM

Lowest Channel / 1RB0

Lowest Channel / 1RBmax

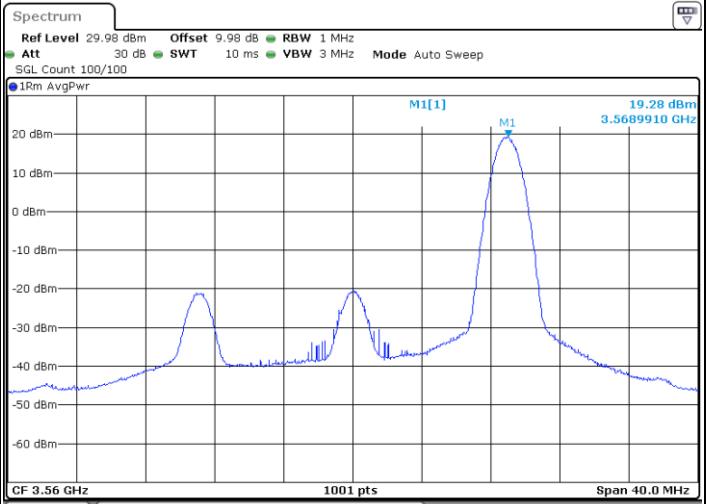
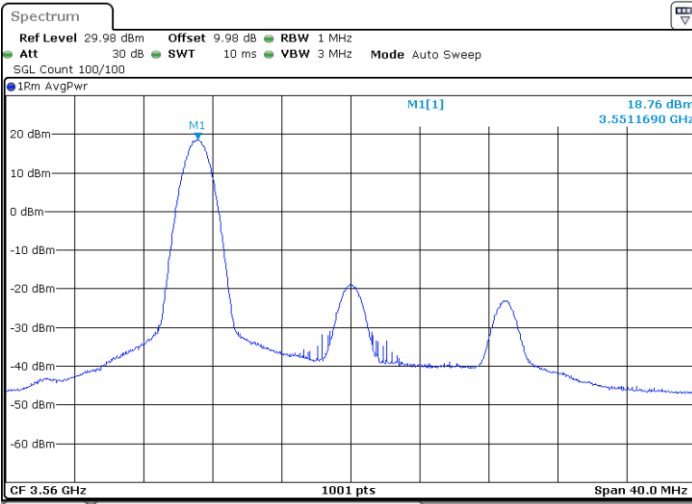

Date: 2.AUG.2020 01:00:04

Date: 2.AUG.2020 00:56:39

Lowest Channel / FullIRB

N/A

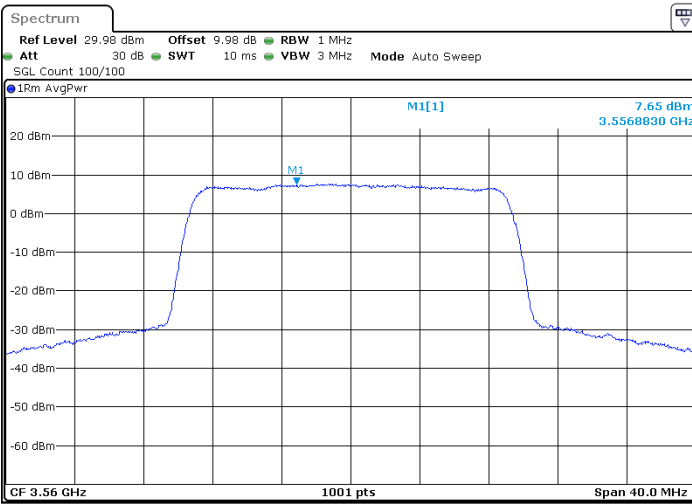

Date: 2.AUG.2020 01:03:19



LTE Band 48 / 20MHz

16QAM

Middle Channel / 1RB0

Middle Channel / 1RBmax

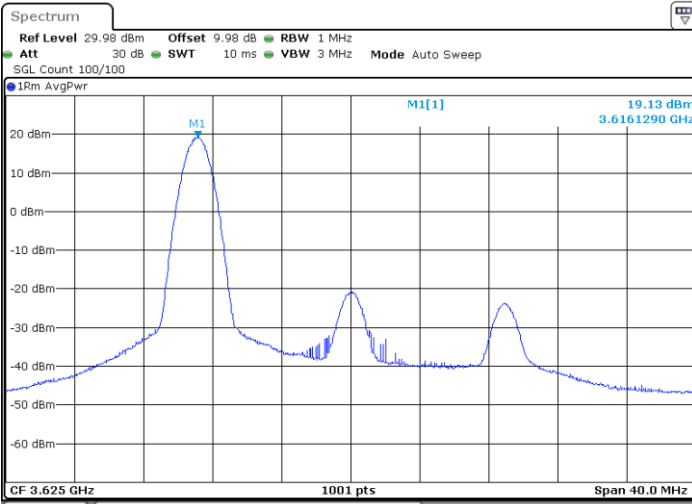

Date: 2.AUG.2020 01:08:05

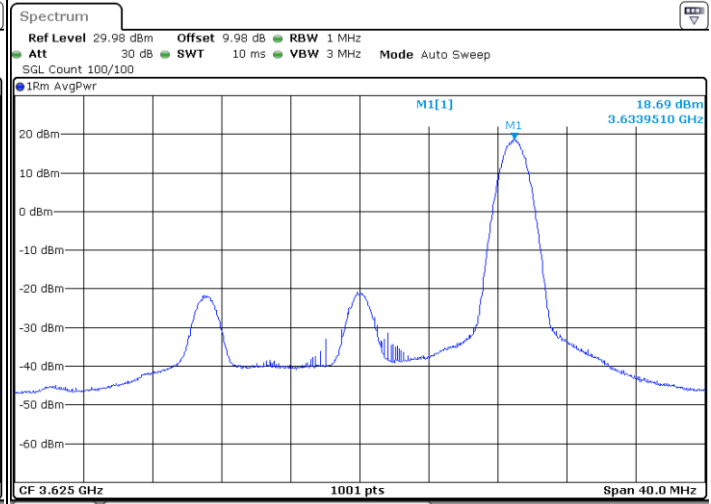

Date: 2.AUG.2020 01:11:23

Middle Channel / FullRB

N/A

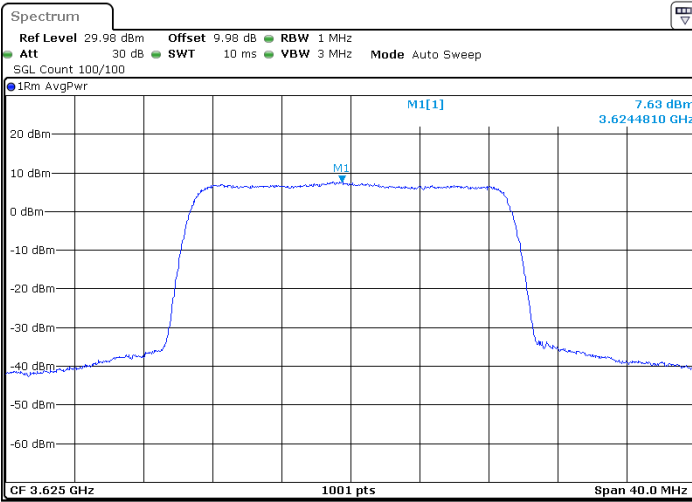

Date: 2.AUG.2020 01:06:05



LTE Band 48 / 20MHz

16QAM

Highest Channel / 1RB0

Highest Channel / 1RBmax

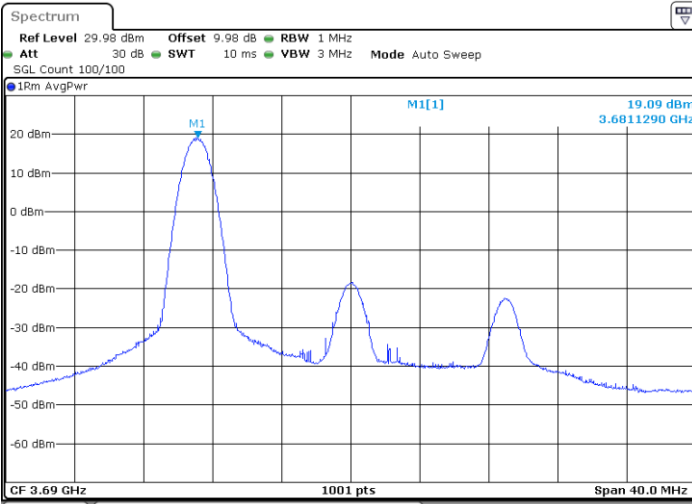

Date: 2.AUG.2020 01:16:05

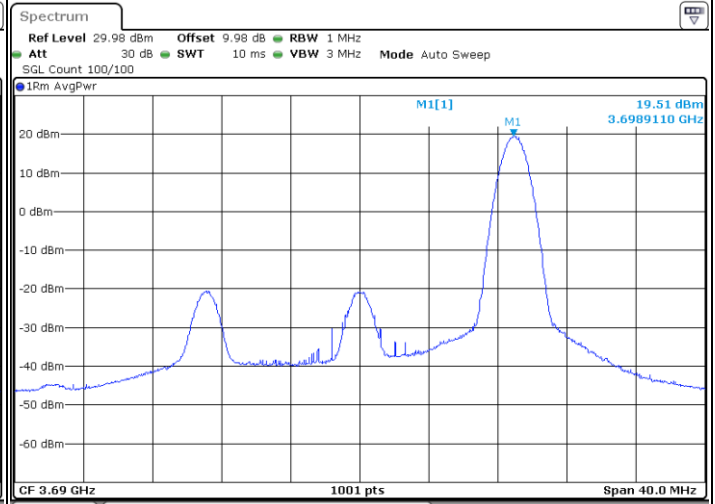

Date: 2.AUG.2020 01:14:37

Highest Channel / FullRB

N/A

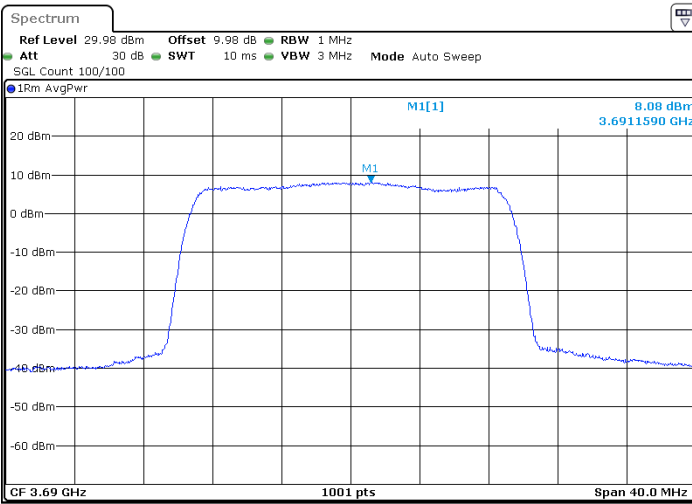

Date: 2.AUG.2020 01:18:19



LTE Band 48 / 5MHz

64QAM

Lowest Channel / 1RB0

Lowest Channel / 1RBmax

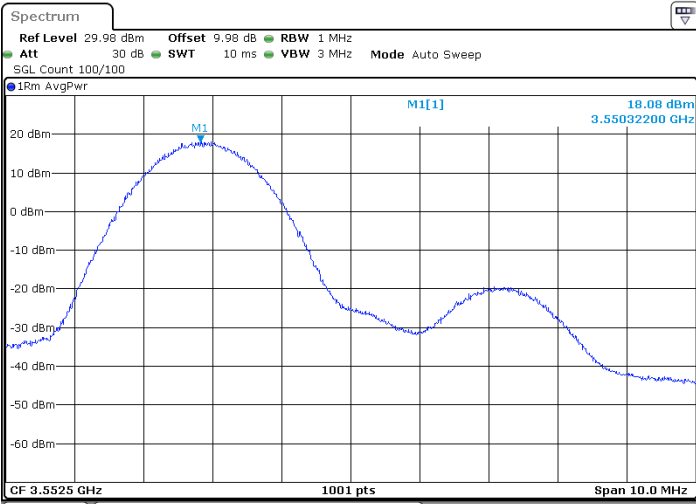

Date: 2 AUG.2020 02:31:15

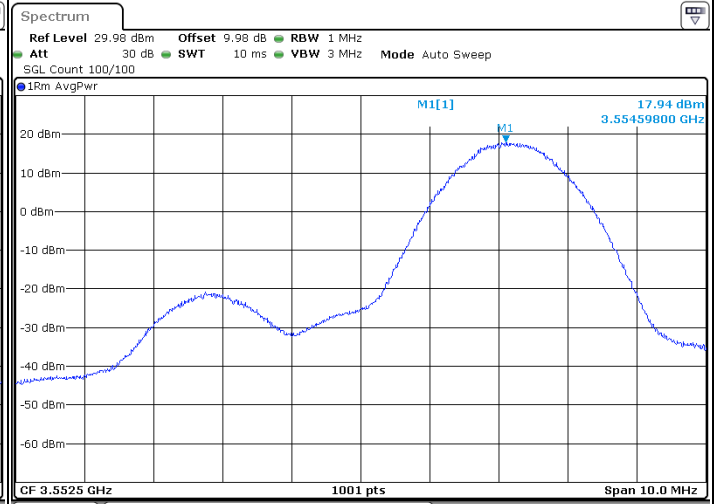

Date: 2 AUG.2020 02:33:47

Lowest Channel / FullIRB

N/A

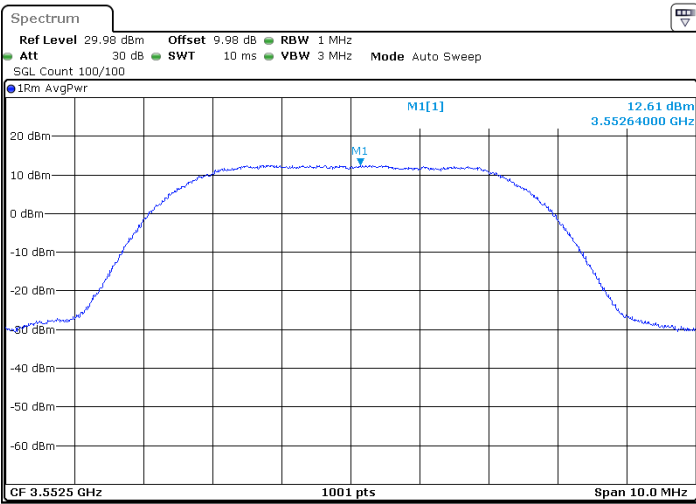

Date: 2 AUG.2020 02:28:37



LTE Band 48 / 5MHz

64QAM

Middle Channel / 1RB0

Middle Channel / 1RBmax

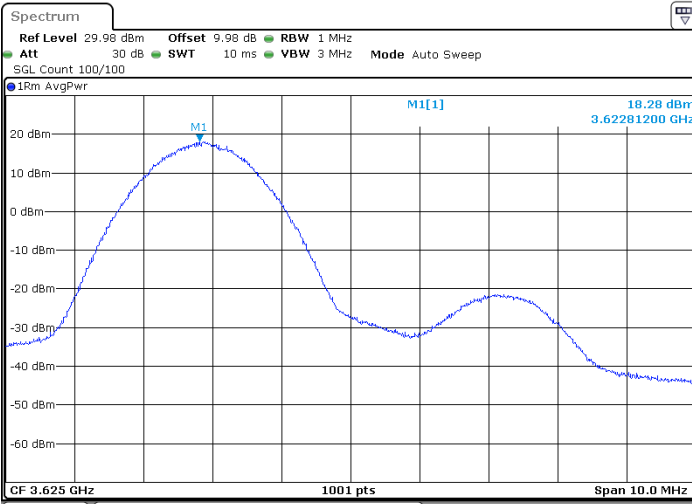

Date: 2 AUG.2020 02:38:41

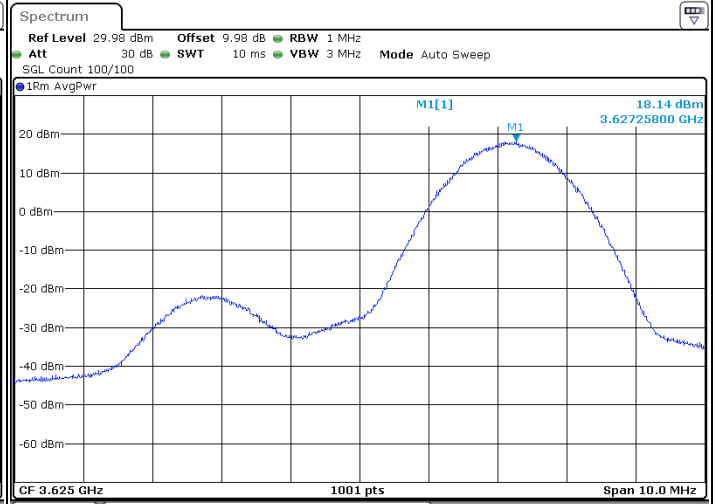

Date: 2 AUG.2020 02:34:44

Middle Channel / FullIRB

N/A

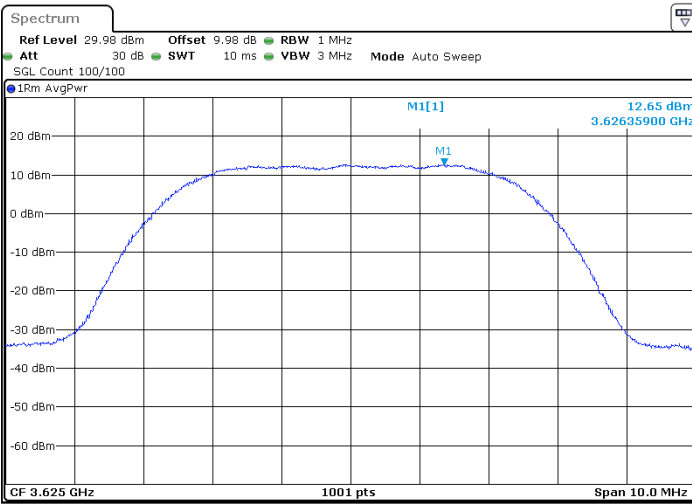

Date: 2 AUG.2020 02:39:26



LTE Band 48 / 5MHz

64QAM

Highest Channel / 1RB0

Highest Channel / 1RBmax

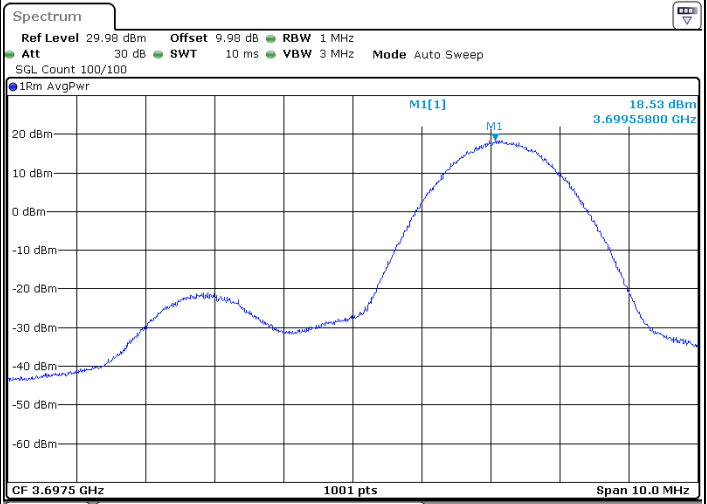
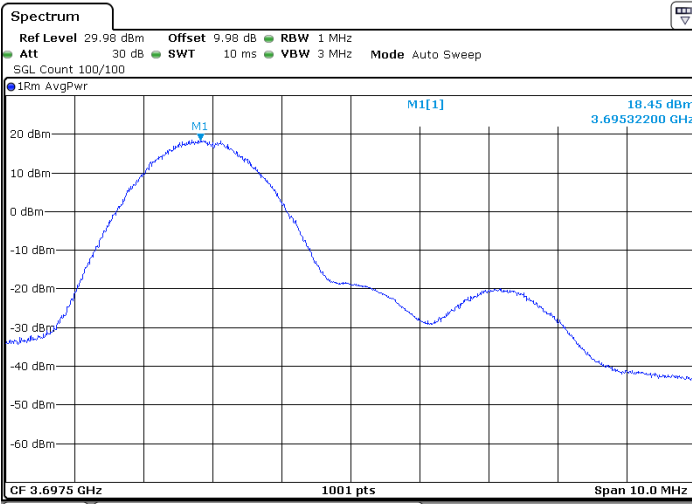

Date: 2 AUG.2020 07:24:59

Date: 2 AUG.2020 02:45:24

Highest Channel / FullRB

N/A

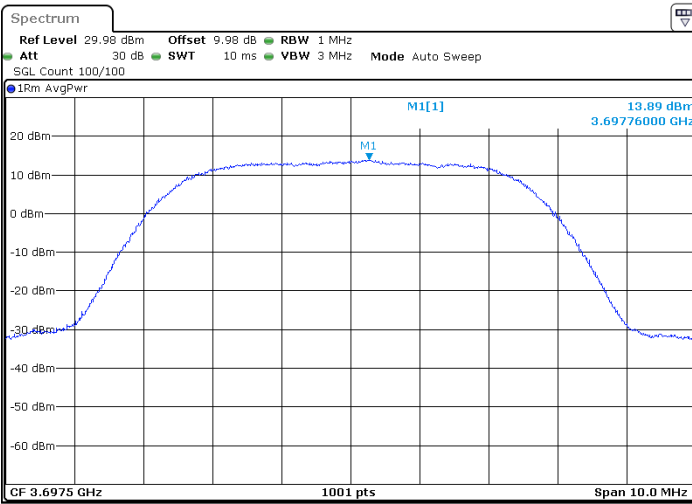

Date: 2 AUG.2020 02:42:16



LTE Band 48 / 10MHz

64QAM

Lowest Channel / 1RB0

Lowest Channel / 1RBmax

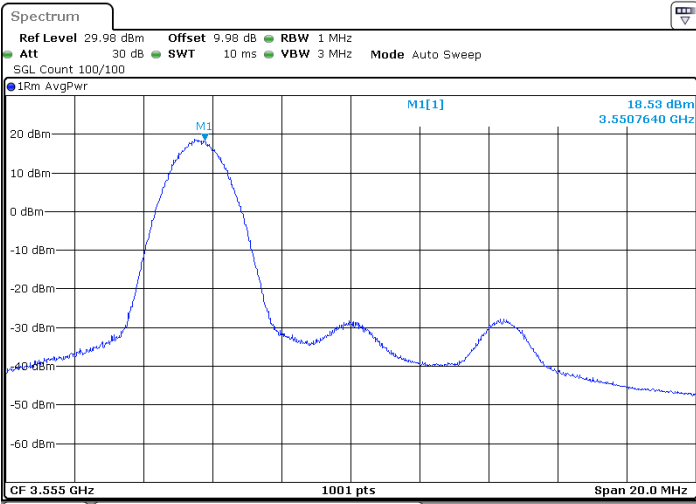

Date: 2 AUG.2020 02:07:32

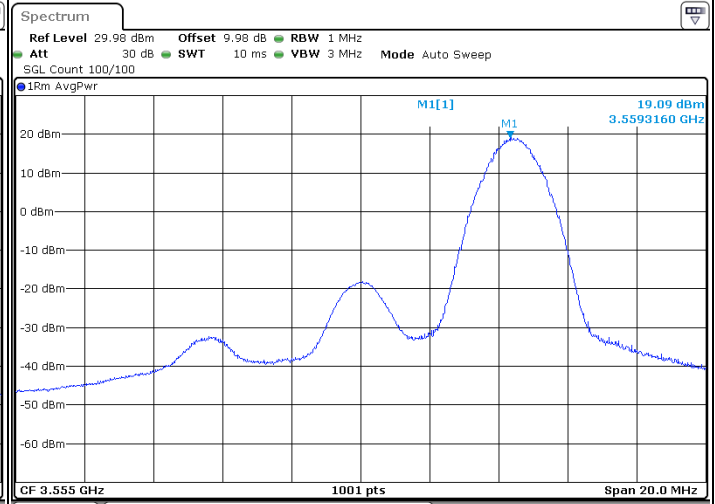

Date: 2 AUG.2020 02:08:09

Lowest Channel / FullIRB

N/A

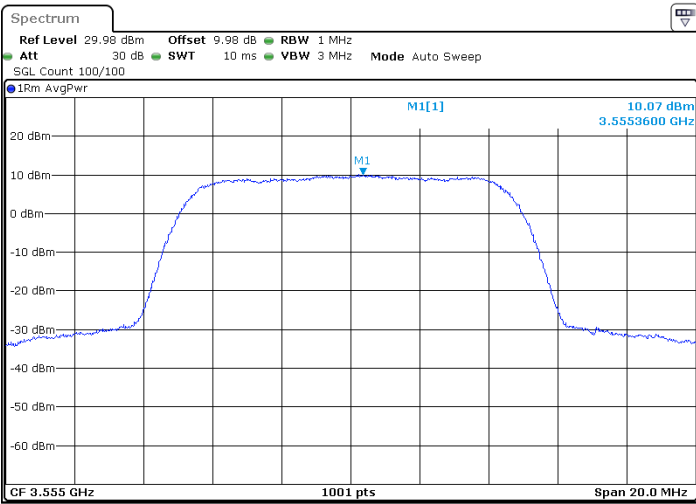

Date: 2 AUG.2020 02:04:19



LTE Band 48 / 10MHz

64QAM

MiddleChannel / 1RB0

Middle Channel / 1RBmax

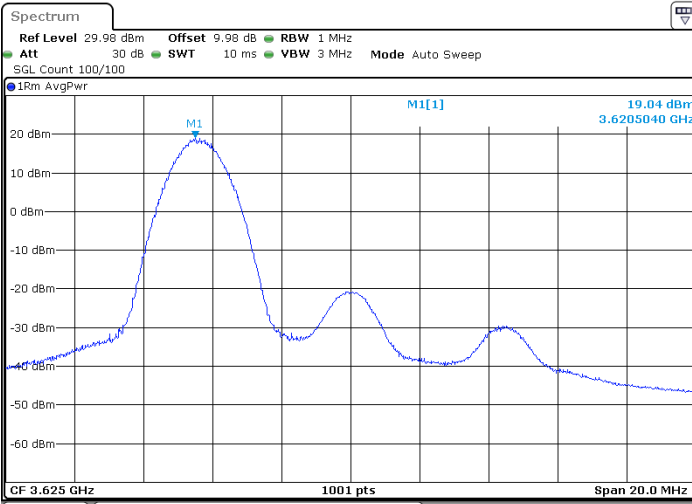

Date: 2 AUG.2020 02:13:23

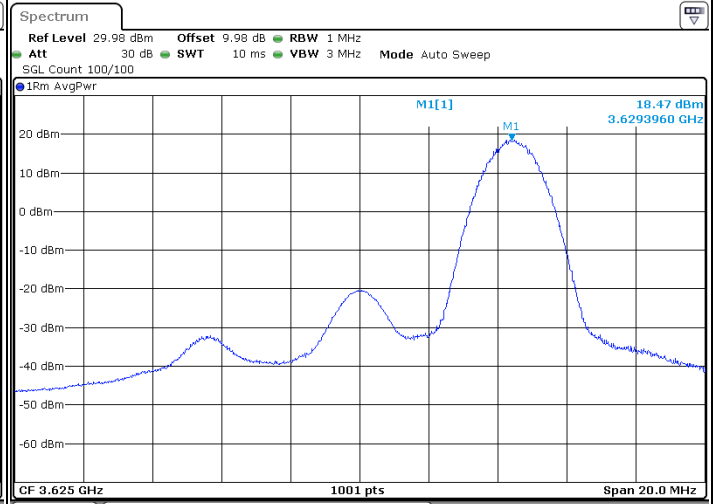

Date: 2 AUG.2020 02:12:35

Middle Channel / FullIRB

N/A

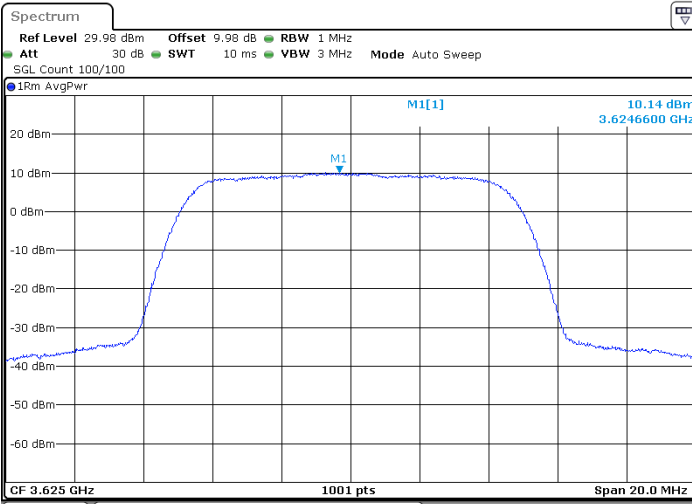

Date: 2 AUG.2020 02:16:16





LTE Band 48 / 10MHz

64QAM

Highest Channel / 1RB0

Highest Channel / 1RBmax

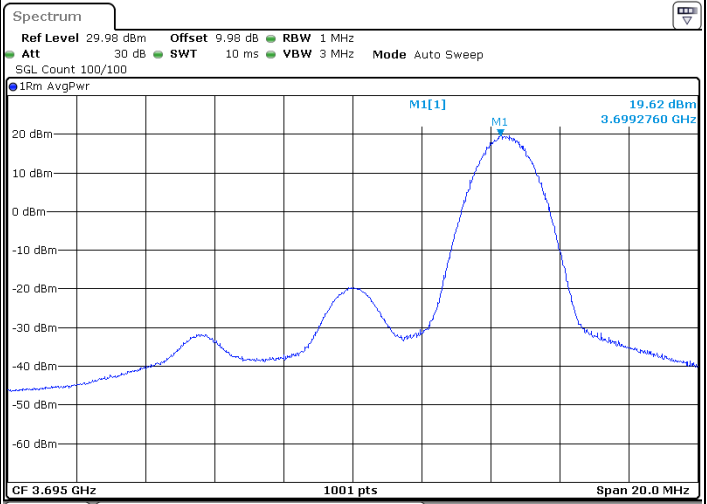
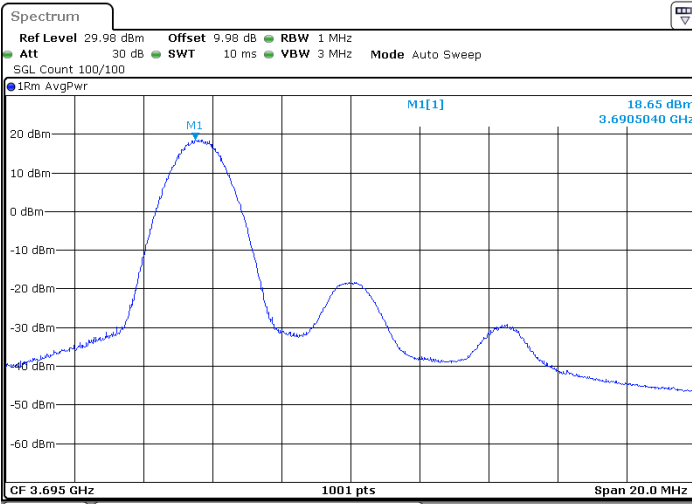

Date: 2 AUG.2020 02:20:39

Date: 2 AUG.2020 02:21:35

Highest Channel / FullRB

N/A

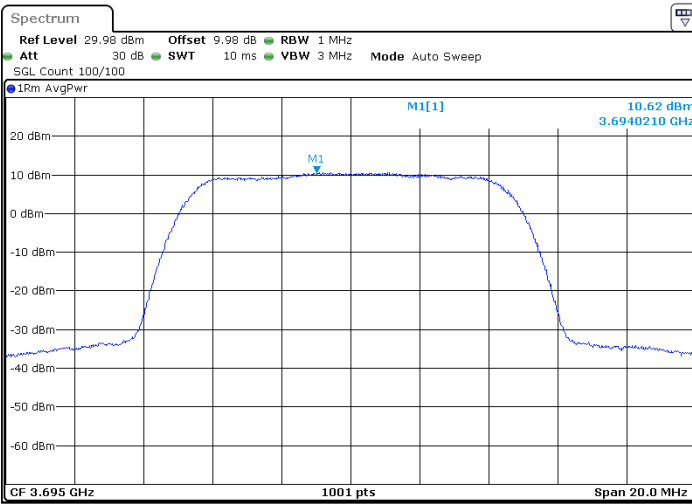

Date: 2 AUG.2020 02:18:00



LTE Band 48 / 15MHz

64QAM

Lowest Channel / 1RB0

Lowest Channel / 1RBmax

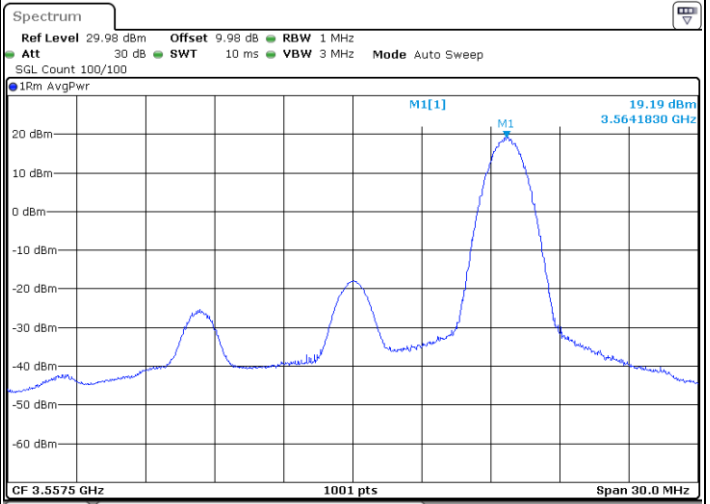
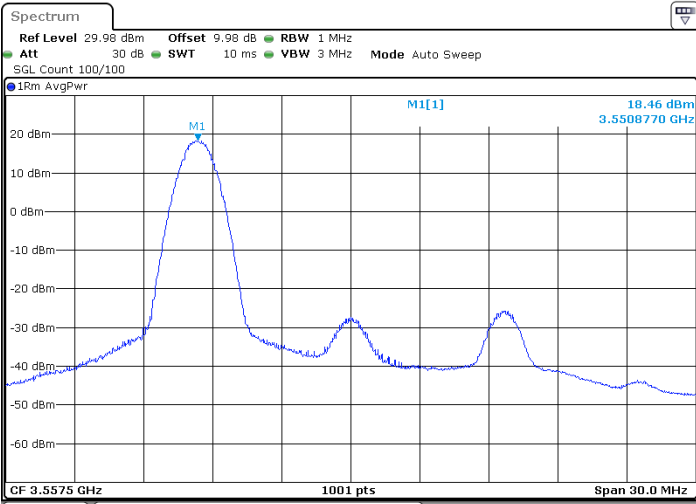

Date: 2 AUG.2020 01:33:08

Date: 2 AUG.2020 01:46:58

Lowest Channel / FullIRB

N/A

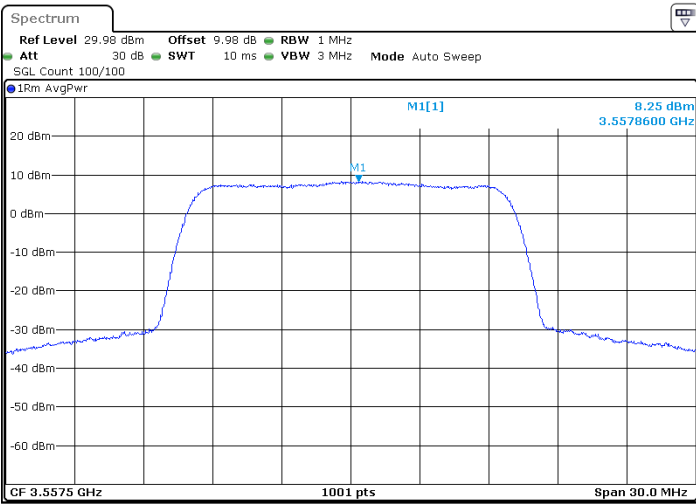

Date: 2 AUG.2020 01:46:26



LTE Band 48 / 15MHz

64QAM

Middle Channel / 1RB0

Middle Channel / 1RBmax

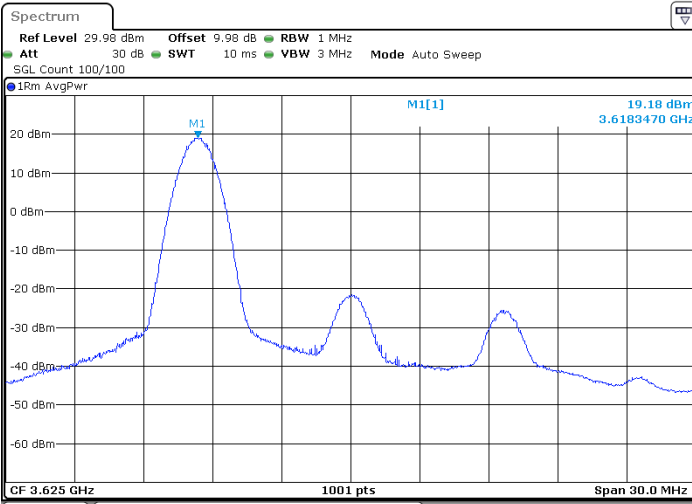

Date: 2 AUG.2020 01:41:57

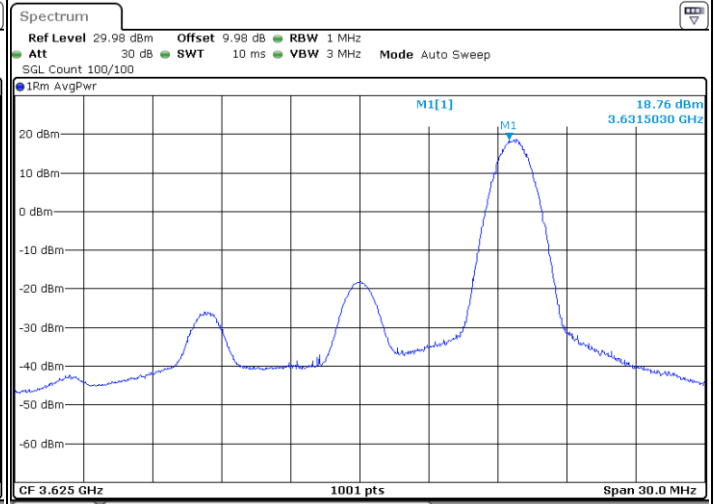

Date: 2 AUG.2020 01:36:54

Middle Channel / FullRB

N/A

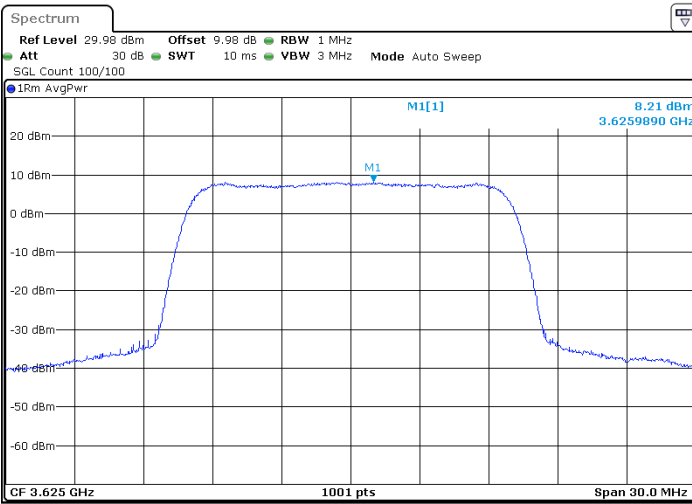

Date: 2 AUG.2020 01:42:46



LTE Band 48 / 15MHz

64QAM

Highest Channel / 1RB0

Highest Channel / 1RBmax

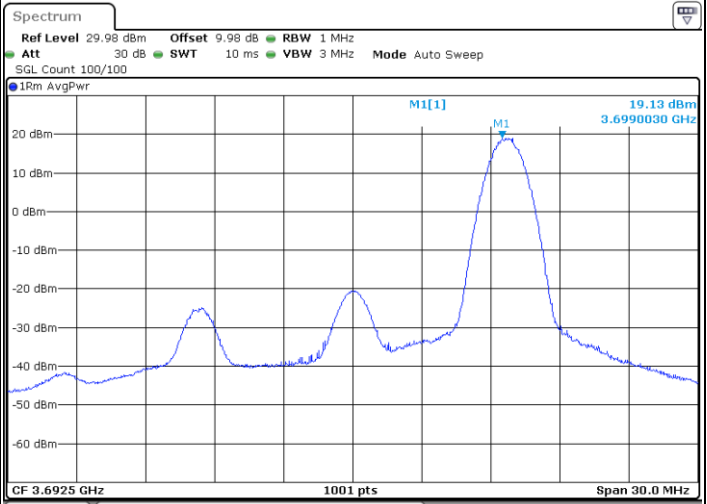
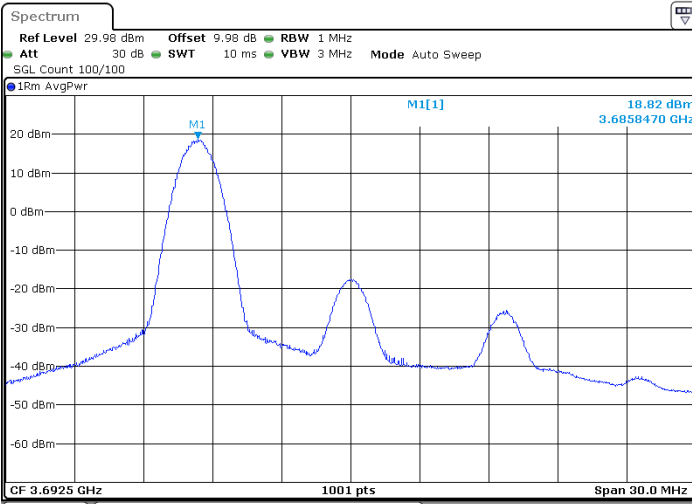

Date: 2 AUG.2020 01:56:28

Date: 2 AUG.2020 01:53:42

Highest Channel / FullRB

N/A

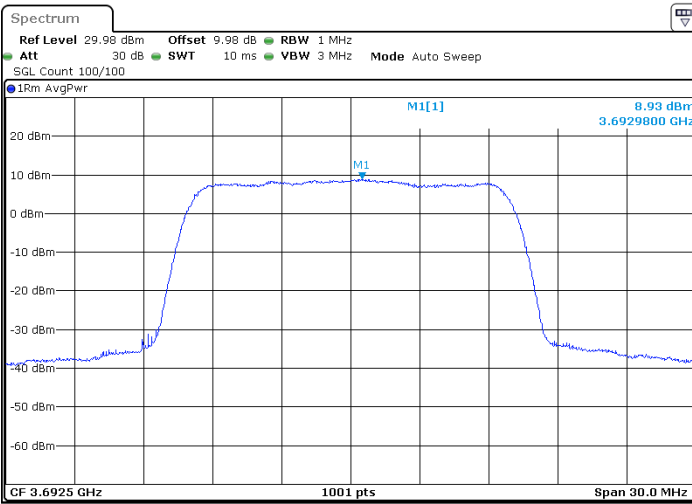

Date: 2 AUG.2020 02:02:20



LTE Band 48 / 20MHz

64QAM

Lowest Channel / 1RB0

Lowest Channel / 1RBmax

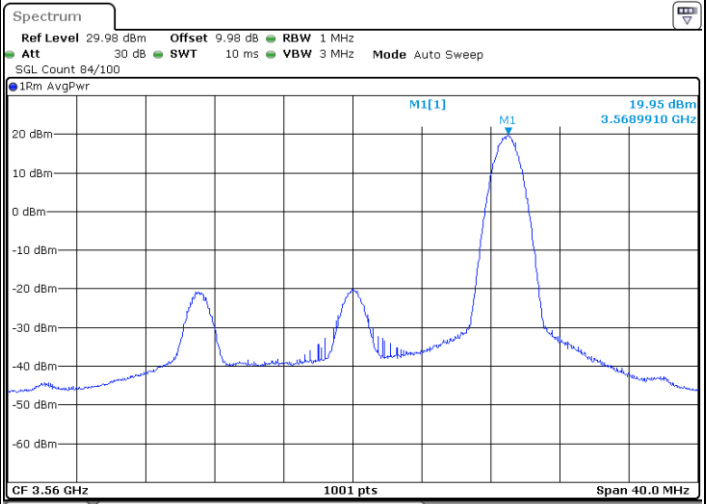
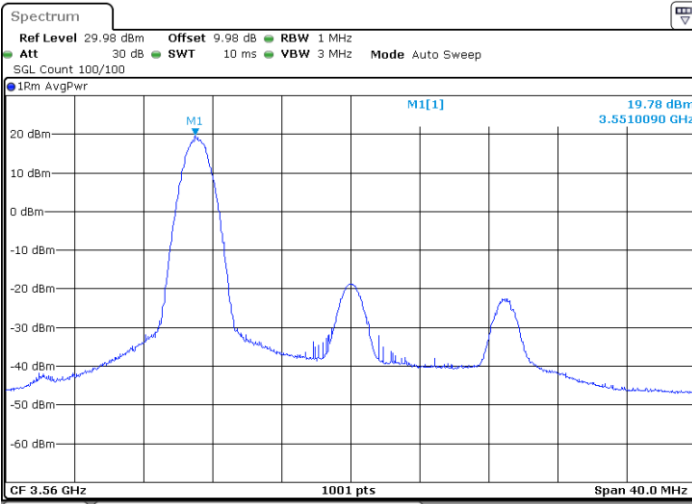

Date: 2.AUG.2020 01:01:17

Date: 2.AUG.2020 00:55:28

Lowest Channel / FullIRB

N/A

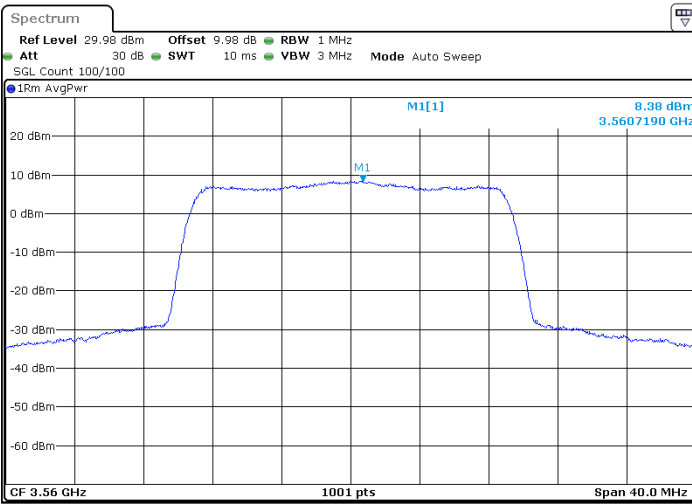

Date: 2.AUG.2020 01:02:48



LTE Band 48 / 20MHz

64QAM

Middle Channel / 1RB0

Middle Channel / 1RBmax

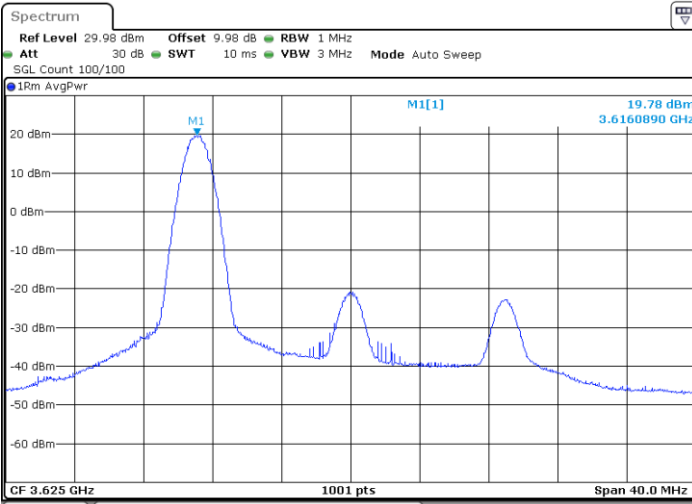

Date: 2.AUG.2020 01:07:40

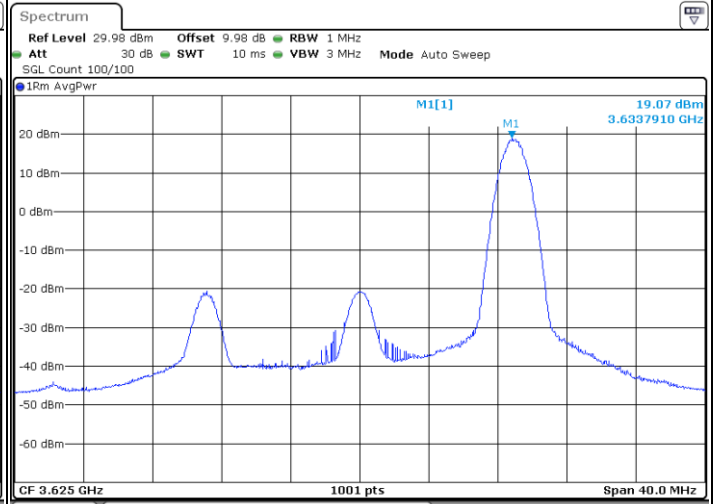

Date: 2.AUG.2020 01:11:47

Middle Channel / FullIRB

N/A

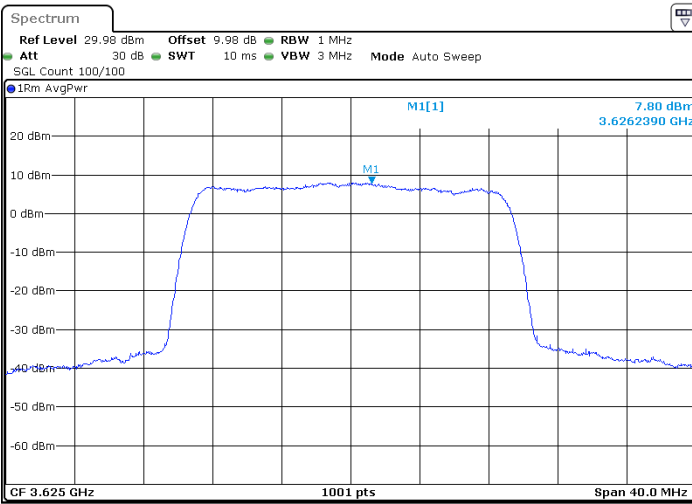

Date: 2.AUG.2020 01:06:32



LTE Band 48 / 20MHz

64QAM

Highest Channel / 1RB0

Highest Channel / 1RBmax

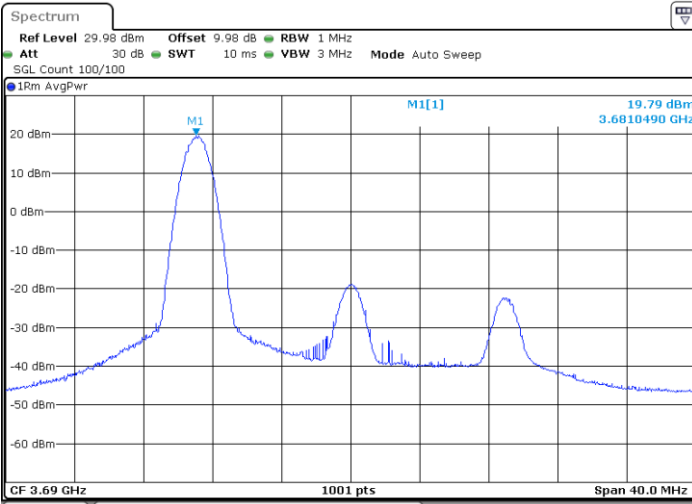

Date: 2.AUG.2020 01:16:50

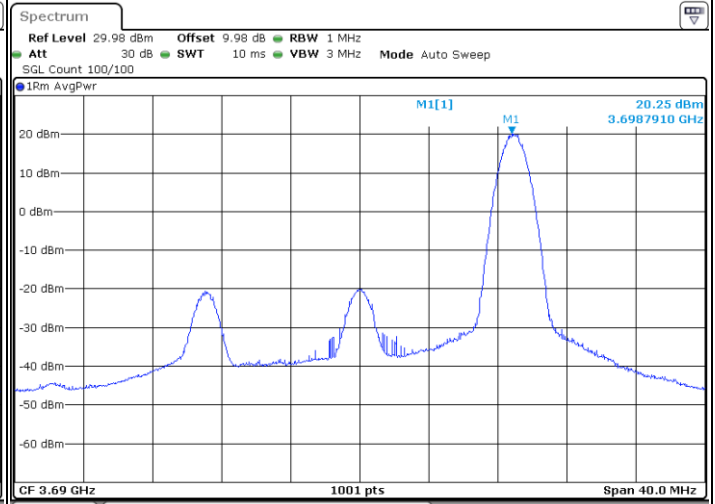

Date: 2.AUG.2020 01:13:56

Highest Channel / FullRB

N/A

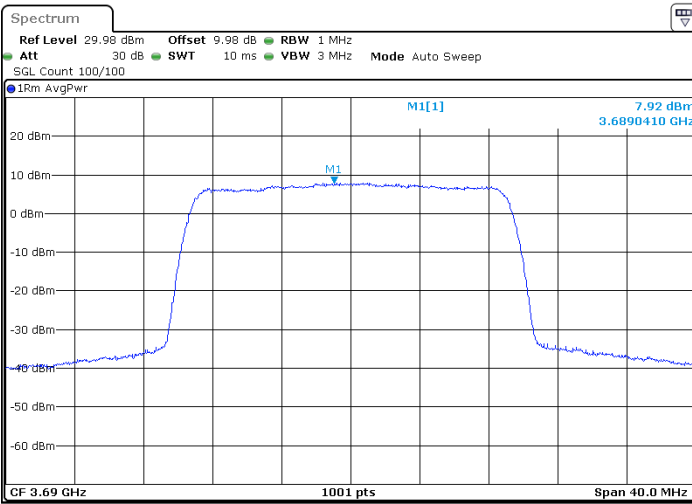

Date: 2.AUG.2020 01:17:51



**26dB Bandwidth**

Mode	LTE Band 48 : 26dB BW(MHz)											
BW	1.4MHz		3MHz		5MHz		10MHz		15MHz		20MHz	
Mod.	QPSK	16QAM	QPSK	16QAM	QPSK	16QAM	QPSK	16QAM	QPSK	16QAM	QPSK	16QAM
Lowest CH	-	-	-	-	5.18	4.82	9.81	9.73	14.33	14.18	20.22	20.38
Middle CH	-	-	-	-	5.05	5.16	10.11	9.77	14.12	14.30	20.06	20.26
Highest CH	-	-	-	-	5.01	5.11	9.61	10.23	14.09	14.21	20.14	20.22
Mode	LTE Band 48 : 26dB BW(MHz)											
BW	1.4MHz		3MHz		5MHz		10MHz		15MHz		20MHz	
Mod.	64QAM		64QAM		64QAM		64QAM		64QAM		64QAM	
Lowest CH	-	-	-	-	5.56	-	9.63	-	14.27	-	20.22	-
Middle CH	-	-	-	-	4.96	-	9.75	-	14.21	-	20.10	-
Highest CH	-	-	-	-	5.05	-	9.77	-	14.21	-	20.14	-





LTE Band 48

Lowest Channel / 5MHz / QPSK



Date: 1.AUG.2020 22:21:59

Lowest Channel / 5MHz / 16QAM



Date: 1.AUG.2020 22:22:30

Middle Channel / 5MHz / QPSK

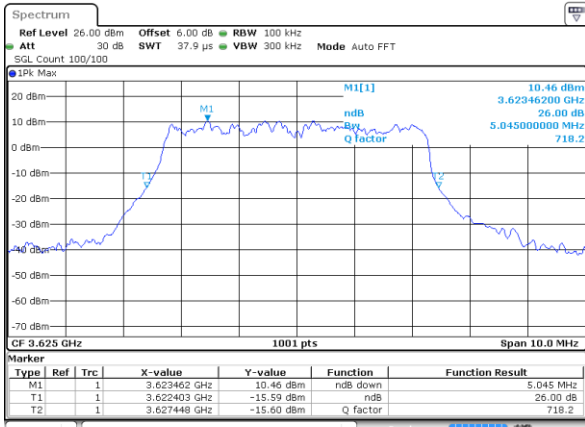

Date: 1.AUG.2020 22:25:48

Middle Channel / 5MHz / 16QAM

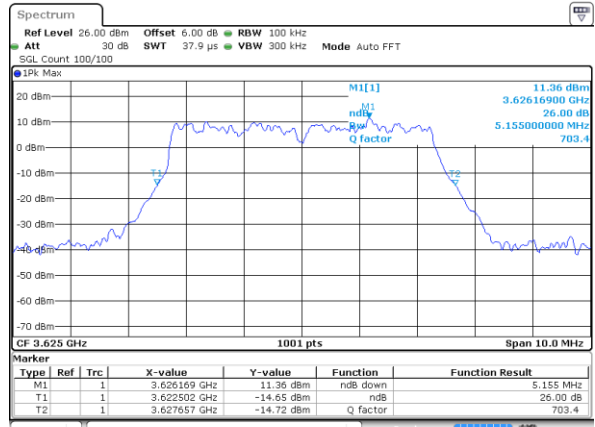

Date: 1.AUG.2020 22:24:59

Highest Channel / 5MHz / QPSK

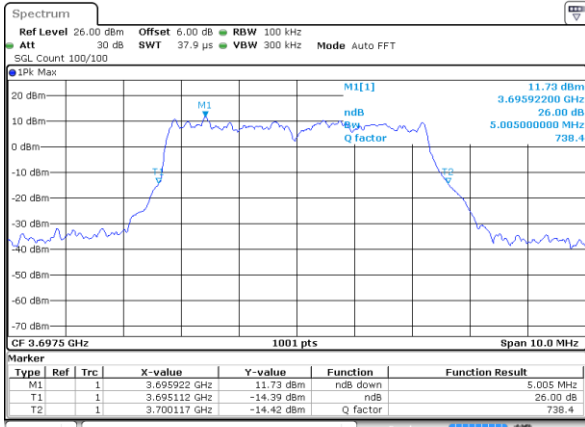

Date: 1.AUG.2020 22:26:52

Highest Channel / 5MHz / 16QAM

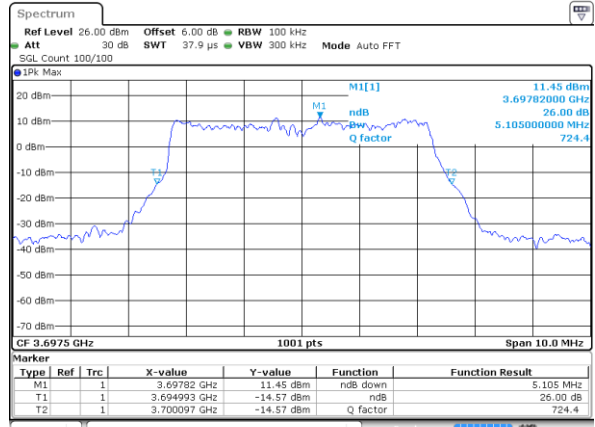

Date: 1.AUG.2020 22:27:31



LTE Band 48

Lowest Channel / 10MHz / QPSK

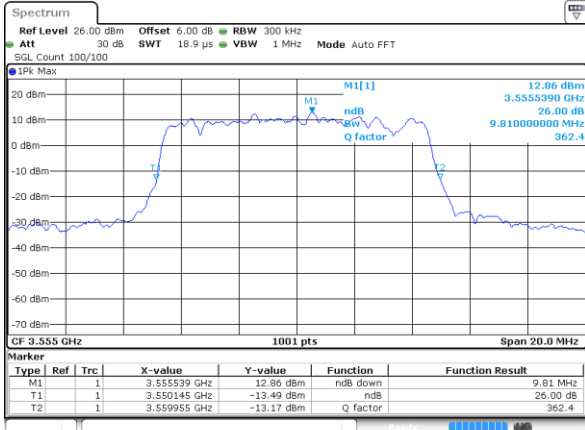

Date: 1.AUG.2020 22:31:23

Lowest Channel / 10MHz / 16QAM

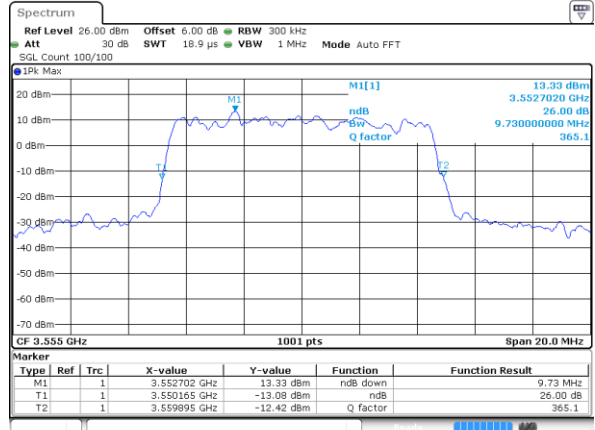

Date: 1.AUG.2020 22:30:55

Middle Channel / 10MHz / QPSK

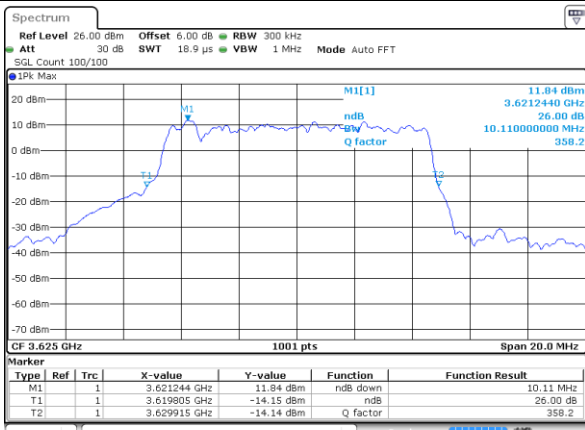

Date: 1.AUG.2020 22:32:23

Middle Channel / 10MHz / 16QAM

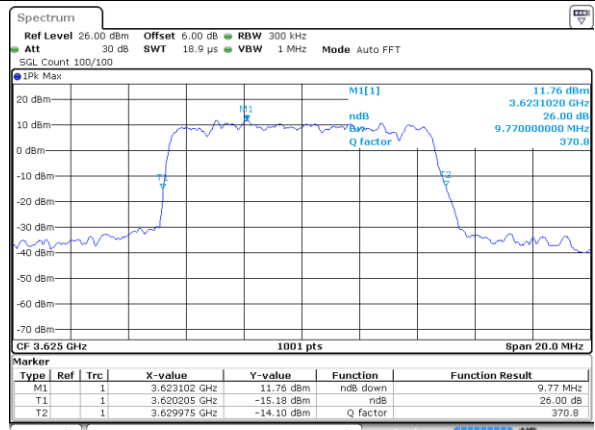

Date: 1.AUG.2020 22:34:43

Highest Channel / 10MHz / QPSK

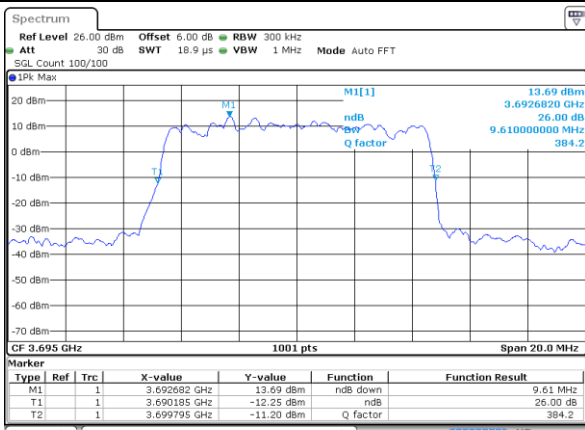

Date: 1.AUG.2020 22:39:04

Highest Channel / 10MHz / 16QAM

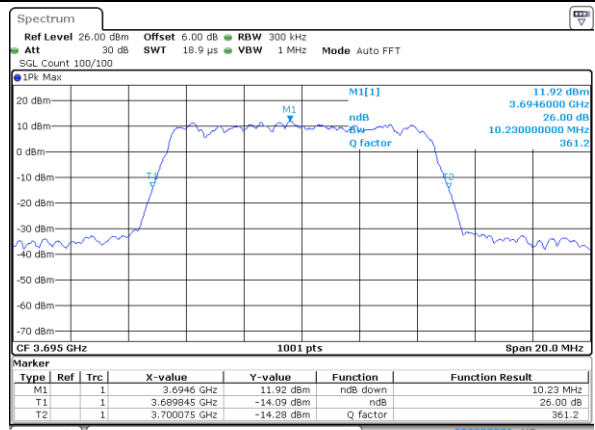

Date: 1.AUG.2020 22:38:07



LTE Band 48

Lowest Channel / 15MHz / QPSK

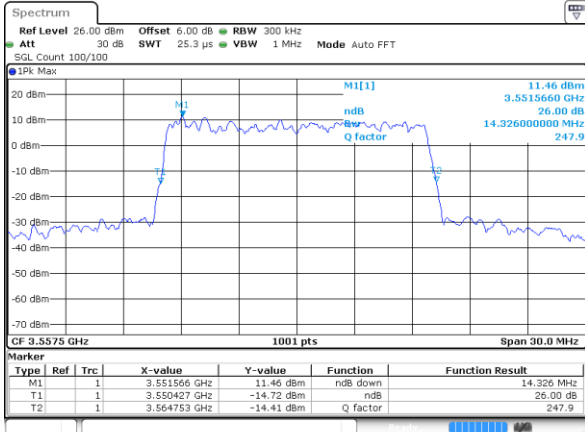

Date: 1.AUG.2020 22:40:28

Lowest Channel / 15MHz / 16QAM

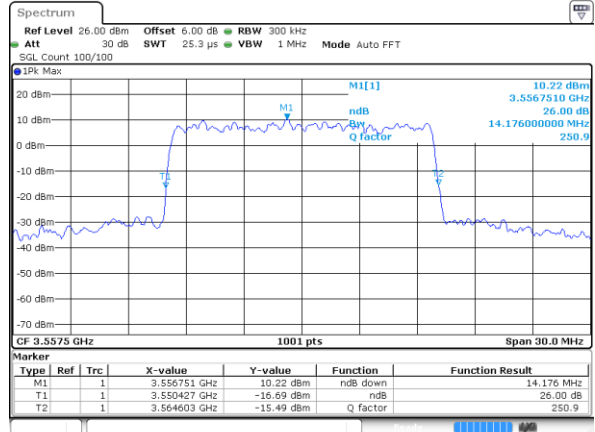

Date: 1.AUG.2020 22:41:06

Middle Channel / 15MHz / QPSK

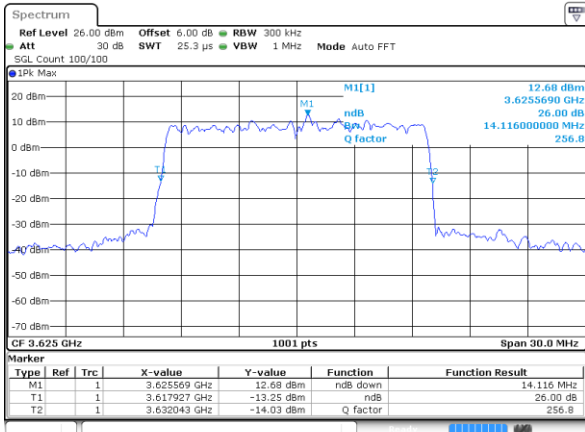

Date: 1.AUG.2020 22:44:40

Middle Channel / 15MHz / 16QAM

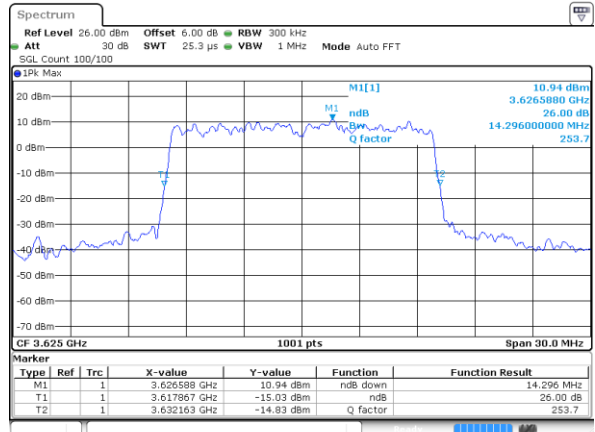

Date: 1.AUG.2020 22:43:44

Highest Channel / 15MHz / QPSK

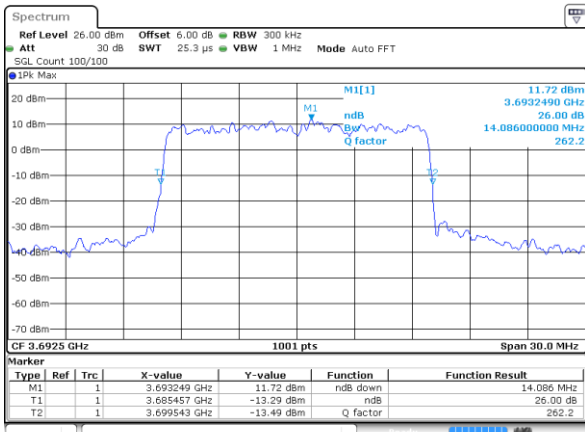

Date: 1.AUG.2020 22:45:32

Highest Channel / 15MHz / 16QAM

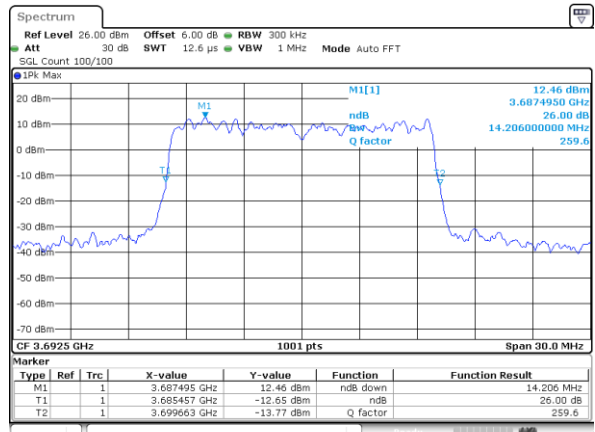

Date: 1.AUG.2020 21:35:34



LTE Band 48

Lowest Channel / 20MHz / QPSK

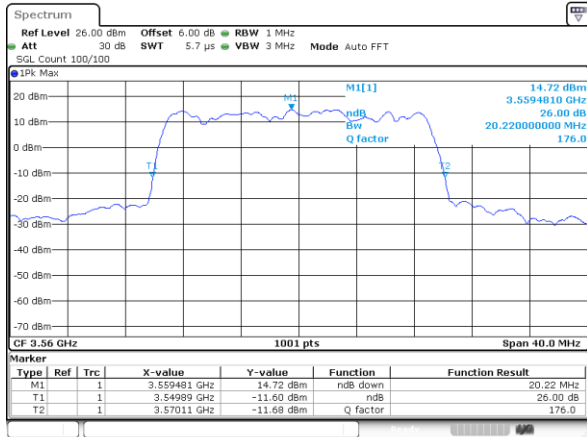

Date: 1.AUG.2020 21:40:33

Lowest Channel / 20MHz / 16QAM

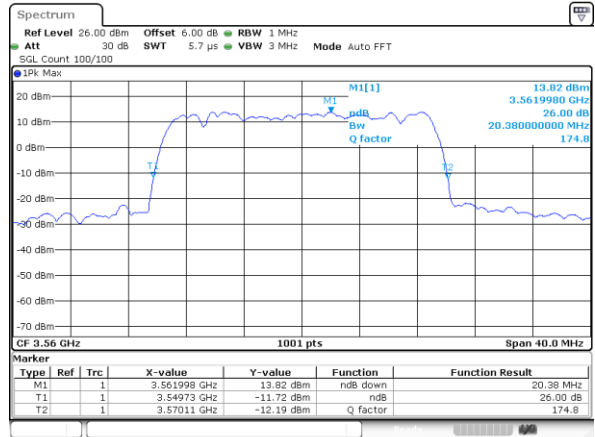

Date: 1.AUG.2020 21:39:45

Middle Channel / 20MHz / QPSK

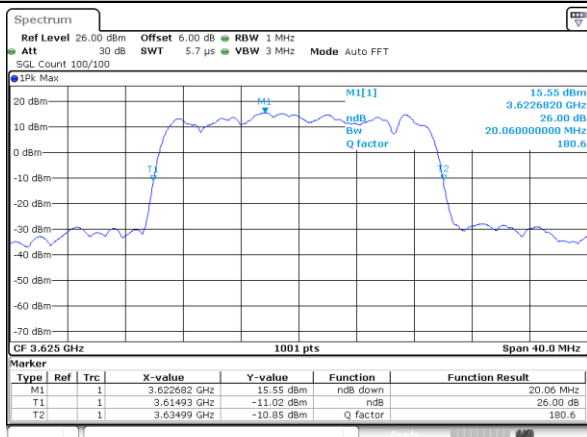

Date: 1.AUG.2020 21:41:54

Middle Channel / 20MHz / 16QAM

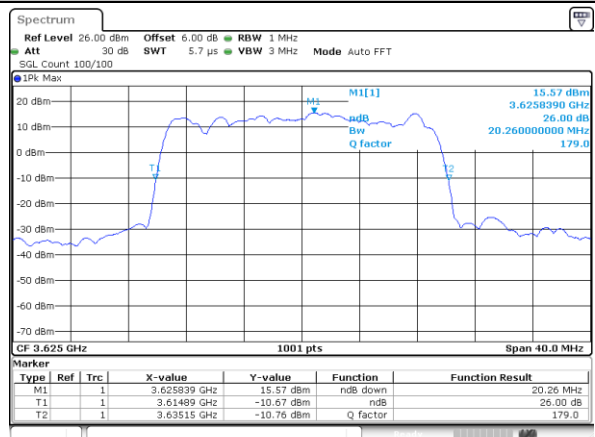

Date: 1.AUG.2020 21:42:28

Highest Channel / 20MHz / QPSK

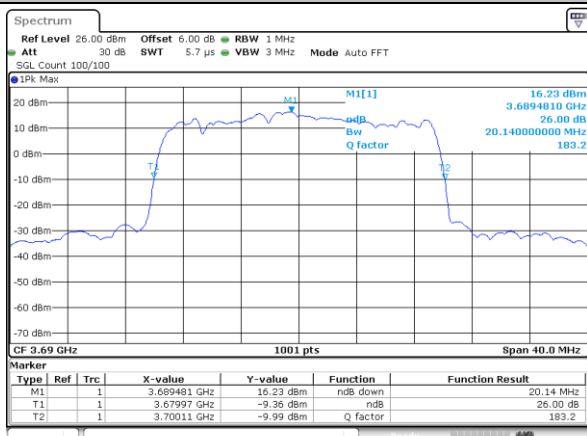

Date: 1.AUG.2020 21:45:24

Highest Channel / 20MHz / 16QAM

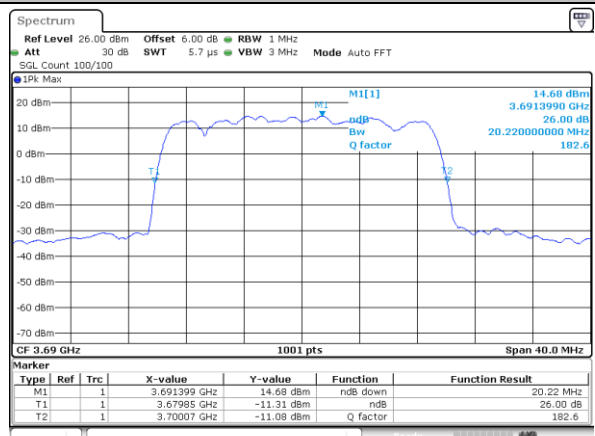

Date: 1.AUG.2020 21:44:55