





RADIO TEST REPORT

Test Report No. 14795644H-A-R1

Customer	Mitsubishi Electric Corporation Himeji works
Description of EUT	Smart Keyless System Hand Unit
Model Number of EUT	SKEA7A-05
FCC ID	WAZSKEA7A05
Test Regulation	FCC Part 15 Subpart C
Test Result	Complied
Issue Date	August 8, 2023
Remarks	-

Representative test engineer	Approved by
	
Junya Okuno Engineer	Tsubasa Takayama Leader
 	
CERTIFICATE 5107.02	
<input type="checkbox"/> The testing in which "Non-accreditation" is displayed is outside the accreditation scopes in UL Japan, Inc.	
<input checked="" type="checkbox"/> There is no testing item of "Non-accreditation".	

Report Cover Page - Form-ULID-003532 (DCS:13-EM-F0429) Issue# 22.0

ANNOUNCEMENT

- This test report shall not be reproduced in full or partial, without the written approval of UL Japan, Inc.
- The results in this report apply only to the sample tested. (Laboratory was not involved in sampling.)
- This sample tested is in compliance with the limits of the above regulation.
- The test results in this test report are traceable to the national or international standards.
- This test report must not be used by the customer to claim product certification, approval, or endorsement by the A2LA accreditation body.
- This test report covers Radio technical requirements.
It does not cover administrative issues such as Manual or non-Radio test related Requirements. (if applicable)
- The all test items in this test report are conducted by UL Japan, Inc. Ise EMC Lab.
- The opinions and the interpretations to the result of the description in this report are outside scopes where UL Japan, Inc. has been accredited.
- The information provided from the customer for this report is identified in SECTION 1.
- For test report(s) referred in this report, the latest version (including any revisions) is always referred.

REVISION HISTORY

Original Test Report No. 14795644H-A

This report is a revised version of 14795644H-A. 14795644H-A is replaced with this report.

Revision	Test Report No.	Date	Page Revised Contents
- (Original)	14795644H-A	June 23, 2023	-
1	14795644H-A-R1	August 8, 2023	Correction of the Test date in Clause 2.1 due to the duty additional test.
1	14795644H-A-R1	August 8, 2023	Addition of the Duty data in Maximum RF Output Power test.
1	14795644H-A-R1	August 8, 2023	Correction of the Test Equipment list due to the duty additional test.

Reference: Abbreviations (Including words undescribed in this report)

A2LA	The American Association for Laboratory Accreditation	ICES	Interference-Causing Equipment Standard
AC	Alternating Current	IEC	International Electrotechnical Commission
AFH	Adaptive Frequency Hopping	IEEE	Institute of Electrical and Electronics Engineers
AM	Amplitude Modulation	IF	Intermediate Frequency
Amp, AMP	Amplifier	ILAC	International Laboratory Accreditation Conference
ANSI	American National Standards Institute	ISED	Innovation, Science and Economic Development Canada
Ant, ANT	Antenna	ISO	International Organization for Standardization
AP	Access Point	JAB	Japan Accreditation Board
ASK	Amplitude Shift Keying	LAN	Local Area Network
Atten., ATT	Attenuator	LIMS	Laboratory Information Management System
AV	Average	MCS	Modulation and Coding Scheme
BPSK	Binary Phase-Shift Keying	MRA	Mutual Recognition Arrangement
BR	Bluetooth Basic Rate	N/A	Not Applicable
BT	Bluetooth	NIST	National Institute of Standards and Technology
BT LE	Bluetooth Low Energy	NS	No signal detect.
BW	BandWidth	NSA	Normalized Site Attenuation
Cal Int	Calibration Interval	NVLAP	National Voluntary Laboratory Accreditation Program
CCK	Complementary Code Keying	OBW	Occupied Band Width
Ch., CH	Channel	OFDM	Orthogonal Frequency Division Multiplexing
CISPR	Comite International Special des Perturbations Radioelectriques	P/M	Power meter
CW	Continuous Wave	PCB	Printed Circuit Board
DBPSK	Differential BPSK	PER	Packet Error Rate
DC	Direct Current	PHY	Physical Layer
D-factor	Distance factor	PK	Peak
DFS	Dynamic Frequency Selection	PN	Pseudo random Noise
DQPSK	Differential QPSK	PRBS	Pseudo-Random Bit Sequence
DSSS	Direct Sequence Spread Spectrum	PSD	Power Spectral Density
EDR	Enhanced Data Rate	QAM	Quadrature Amplitude Modulation
EIRP, e.i.r.p.	Equivalent Isotropically Radiated Power	QP	Quasi-Peak
EMC	ElectroMagnetic Compatibility	QPSK	Quadri-Phase Shift Keying
EMI	ElectroMagnetic Interference	RBW	Resolution Band Width
EN	European Norm	RDS	Radio Data System
ERP, e.r.p.	Effective Radiated Power	RE	Radio Equipment
EU	European Union	RF	Radio Frequency
EUT	Equipment Under Test	RMS	Root Mean Square
Fac.	Factor	RSS	Radio Standards Specifications
FCC	Federal Communications Commission	Rx	Receiving
FHSS	Frequency Hopping Spread Spectrum	SA, S/A	Spectrum Analyzer
FM	Frequency Modulation	SG	Signal Generator
Freq.	Frequency	SVSWR	Site-Voltage Standing Wave Ratio
FSK	Frequency Shift Keying	TR	Test Receiver
GFSK	Gaussian Frequency-Shift Keying	Tx	Transmitting
GNSS	Global Navigation Satellite System	VBW	Video BandWidth
GPS	Global Positioning System	Vert.	Vertical
Hori.	Horizontal	WLAN	Wireless LAN

CONTENTS	PAGE
SECTION 1: Customer Information	5
SECTION 2: Equipment Under Test (EUT)	5
SECTION 3: Test Specification, Procedures & Results	6
SECTION 4: Operation of EUT during testing	9
SECTION 5: Radiated Spurious Emission	12
SECTION 6: Automatically deactivate	14
SECTION 7: -20 dB Bandwidth and 99% emission bandwidth	14
SECTION 8: Maximum RF Output Power	14
APPENDIX 1: Test Data	15
Automatically deactivate	15
Maximum RF Output Power.....	16
Radiated Emission (Fundamental and Spurious Emission).....	17
-20 dB Bandwidth / 99% emission bandwidth.....	19
APPENDIX 2: Test Instruments	20
APPENDIX 3: Photographs of Test Setup	21
Radiated Spurious Emission.....	21
Worst Case Position	23
Maximum RF Output Power.....	25

SECTION 1: Customer Information

Company Name	Mitsubishi Electric Corporation Himeji works
Address	840, Chiyoda-machi, Himeji, Hyogo 670-8677, Japan
Telephone Number	+81-79-298-9580
Contact Person	Yasuhiro Takahashi

The information provided from the customer is as follows;

- Customer, Description of EUT, Model Number of EUT, FCC ID on the cover and other relevant pages
- Operating/Test Mode(s) (Mode(s)) on all the relevant pages
- SECTION 1: Customer Information
- SECTION 2: Equipment Under Test (EUT) other than the Receipt Date and Test Date
- SECTION 4: Operation of EUT during testing

* The laboratory is exempted from liability of any test results affected from the above information in SECTION 2 and 4.

SECTION 2: Equipment Under Test (EUT)

2.1 Identification of EUT

Description	Smart Keyless System Hand Unit
Model Number	SKEA7A-05
Serial Number	Refer to SECTION 4.2
Condition	Engineering prototype (Not for Sale: This sample is equivalent to mass-produced items.)
Modification	No Modification by the test lab
Receipt Date	May 16, 2023
Test Date	May 21 to August 8, 2023

2.2 Product Description

General Specification

Rating	DC 3.0 V
--------	----------

Radio Specification

[RF Part]

Equipment Type	Transmitter
Frequency of Operation	315 MHz
Type of Modulation	FSK

[LF Part] *1)

Equipment Type	Receiver
Frequency of Operation	125 kHz

*1) The test of receiver part was performed separately from this test report, and the conformability is confirmed.

SECTION 3: Test Specification, Procedures & Results

3.1 Test Specification

Test Specification	FCC Part 15 Subpart C The latest version on the first day of the testing period
Title	FCC 47CFR Part15 Radio Frequency Device Subpart C Intentional Radiators Section 15.231 Periodic operation in the band 40.66-40.70 MHz and above 70 MHz.

*Also the EUT complies with FCC Part 15 Subpart B.

3.2 Procedures and Results

Item	Test Procedure	Specification	Worst margin	Results	Remarks
Conducted emission	FCC: ANSI C63.10:2013 6 Standard test methods ISED: RSS-Gen 8.8	FCC: Section 15.207 ISED: RSS-Gen 8.8	N/A	N/A	*1)
Automatically Deactivate	FCC: ANSI C63.10:2013 6 Standard test methods ISED: -	FCC: Section 15.231(a)(1) ISED: RSS-210 A1.1	N/A	Complied	Radiated
Electric Field Strength of Fundamental Emission	FCC: ANSI C63.10:2013 6 Standard test methods ISED: RSS-Gen 6.12	FCC: Section 15.231(b) ISED: RSS-210 A1.2	4.2 dB 315.00 MHz Horizontal, AV	Complied	Radiated
Electric Field Strength of Spurious Emission	FCC: ANSI C63.10:2013 6 Standard test methods ISED: RSS-Gen 6.13	FCC: Section 15.205 Section 15.209 Section 15.231(b) ISED: RSS-210 A1.2 RSS-Gen 8.9	3.2 dB 2835.000 MHz Horizontal, AV	Complied	Radiated
-20 dB Bandwidth	FCC: ANSI C63.10:2013 6 Standard test methods ISED: -	FCC: Section 15.231(c) ISED: Reference data	N/A	Complied	Radiated

Note: UL Japan, Inc.'s EMI Work Procedures: Work Instructions-ULID-003591 and Work Instructions-ULID-003593.

*1) The test is not applicable since the EUT does not have AC Mains.

FCC Part 15.31 (e)

The test was performed with the New Battery (3.0 V) during the tests.
Therefore, this EUT complies with the requirement.

FCC Part 15.203 Antenna requirement

It is impossible for end users to replace the antenna, because the antenna is mounted inside of the EUT.
Therefore, the equipment complies with the antenna requirement of Section 15.203.

3.3 Addition to Standard

Item	Test Procedure	Specification	Worst margin	Results	Remarks
Maximum RF Output Power	ANSI C63.10:2013 11 Procedures for testing DTS devices	Reference data	N/A	-	Conducted
99% emission bandwidth	ANSI C63.10:2013 6 Standard test methods	Reference data	N/A	-	Radiated

Other than above, no addition, exclusion nor deviation has been made from the standard.

3.4 Uncertainty

Measurement uncertainty is not taken into account when stating conformity with a specified requirement. Note: When margins obtained from test results are less than the measurement uncertainty, the test results may exceed the limit.

The following uncertainties have been calculated to provide a confidence level of 95 % using a coverage factor $k = 2$.

Radiated emission

Measurement distance	Frequency Range		Unit	Calculated Uncertainty (+/-)
3 m	9 kHz to 30 MHz		dB	3.3
10 m			dB	3.1
3 m	30 MHz to 200 MHz	Horizontal	dB	4.8
		Vertical	dB	5.0
	200 MHz to 1000 MHz	Horizontal	dB	5.1
		Vertical	dB	6.2
10 m	30 MHz to 200 MHz	Horizontal	dB	4.8
		Vertical	dB	4.8
	200 MHz to 1000 MHz	Horizontal	dB	4.9
		Vertical	dB	5.0
3 m	1 GHz to 6 GHz		dB	4.9
	6 GHz to 18 GHz		dB	5.2
1 m	10 GHz to 26.5 GHz		dB	5.5
	26.5 GHz to 40 GHz		dB	5.4

Antenna Terminal Conducted Tests

Item	Unit	Calculated Uncertainty (+/-)
Antenna Terminated Conducted Emission / Power Density / Burst Power	dB	3.28
Adjacent Channel Power (ACP)	dB	2.27
Bandwidth (OBW)	%	0.96
Time Readout (Time span upto 100 msec)	%	0.11
Time Readout (Time span upto 1000 msec)	%	0.11
Time Readout (Time span upto 60 sec)	%	0.02
Power Measurement (Power meter)	dB	1.50
Frequency Readout (Frequency counter)	ppm	0.67
Frequency Readout (Spectrum analyzer frequency readout function)	ppm	1.61
Temperature (Constant temperature bath)	deg. C	0.78
Humidity (Constant temperature bath)	%RH	2.80
Modulation Characteristics	%	6.93
Frequency for Mobile	ppm	0.08

3.5 Test Location

UL Japan, Inc. Ise EMC Lab.
4383-326 Asama-cho, Ise-shi, Mie-ken 516-0021 Japan
Telephone: +81-596-24-8999

*A2LA Certificate Number: 5107.02 / FCC Test Firm Registration Number: 884919

ISED Lab Company Number: 2973C / CAB identifier: JP0002

Test site	Width x Depth x Height (m)	Size of reference ground plane (m) / horizontal conducting plane	Other rooms	Maximum measurement distance
No.1 semi-anechoic chamber	19.2 x 11.2 x 7.7	7.0 x 6.0	No.1 Power source room	10 m
No.2 semi-anechoic chamber	7.5 x 5.8 x 5.2	4.0 x 4.0	-	3 m
No.3 semi-anechoic chamber	12.0 x 8.5 x 5.9	6.8 x 5.75	No.3 Preparation room	3 m
No.3 shielded room	4.0 x 6.0 x 2.7	N/A	-	-
No.4 semi-anechoic chamber	12.0 x 8.5 x 5.9	6.8 x 5.75	No.4 Preparation room	3 m
No.4 shielded room	4.0 x 6.0 x 2.7	N/A	-	-
No.5 semi-anechoic chamber	6.0 x 6.0 x 3.9	6.0 x 6.0	-	-
No.5 measurement room	6.4 x 6.4 x 3.0	6.4 x 6.4	-	-
No.6 shielded room	4.0 x 4.5 x 2.7	4.0 x 4.5	-	-
No.6 measurement room	4.75 x 5.4 x 3.0	4.75 x 4.15	-	-
No.7 shielded room	4.7 x 7.5 x 2.7	4.7 x 7.5	-	-
No.8 measurement room	3.1 x 5.0 x 2.7	3.1 x 5.0	-	-
No.9 measurement room	8.8 x 4.6 x 2.8	2.4 x 2.4	-	-
No.10 shielded room	3.8 x 2.8 x 2.8	3.8 x 2.8	-	-
No.11 measurement room	4.0 x 3.4 x 2.5	N/A	-	-
No.12 measurement room	2.6 x 3.4 x 2.5	N/A	-	-
Large Chamber	16.9 x 22.1 x 10.17	16.9 x 22.1	-	10 m
Small Chamber	5.3 x 6.69 x 3.59	5.3 x 6.69	-	-

3.6 Test Data, Test Instruments, and Test Set Up

Refer to APPENDIX.

SECTION 4: Operation of EUT during testing

4.1 Operating Mode(s)

Test mode	Remarks
1) Normal use mode	-
2) Transmitting mode (Tx 315.00 MHz) *1)	-
* The system was configured in typical fashion (as a user would normally use it) for testing.	
*Power of the EUT was set by the software as follows; Software: F9753002 (Date: 2022.10.17, Storage location: EUT memory)	
*This setting of software is the worst case. Any conditions under the normal use do not exceed the condition of setting. In addition, end users cannot change the settings of the output power of the product.	
Justification: The system was configured in typical fashion (as a user would normally use it) for testing.	

*1) The software of this mode is the same as one of normal product, except that EUT continues to transmit (For Normal use mode, EUT stops to transmit in a given time, and EUT don't transmit signals, even if external button is being pressed).

This EUT has two modes which mechanical key is inserted or not. The worst case was confirmed with and without mechanical key inserted, as a result, the test without mechanical key inserted was the worst case. Therefore, the test without mechanical key inserted was performed only.

4.2 Configuration and Peripherals

Mode 1

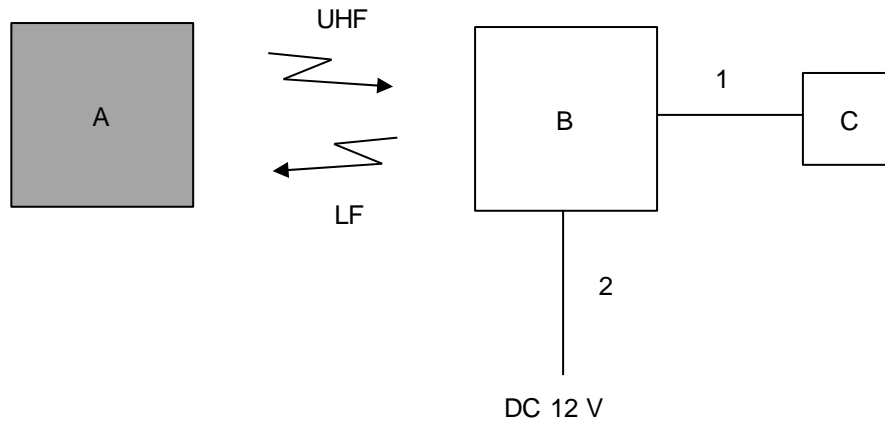

* Cabling and setup(s) were taken into consideration and test data was taken under worse case conditions.

* Item No. A includes Receiver Antenna.

Description of EUT and Support Equipment

No.	Item	Model number	Serial Number	Manufacturer	Remark
A	Smart Keyless System Hand Unit	SKEA7A-05	20230414-T9 (No.13)	Mitsubishi Electric Corporation Himeji works	EUT
B	Smart keyless System Smart Unit	SKEA7A-04	20230414-E2 (No.14)	Mitsubishi Electric Corporation Himeji works	-
C	LED Indicator	-	-	Mitsubishi Electric Corporation Himeji works	-

List of Cables Used

No.	Name	Length (m)	Shield		Remark
			Cable	Connector	
1	Signal Cable	1.1	Unshielded	Unshielded	-
2	DC Cable	1.4	Unshielded	Unshielded	-

Mode 2

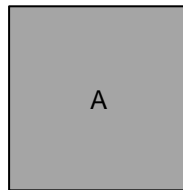

* Setup was taken into consideration and test data was taken under worse case conditions.

Description of EUT

No.	Item	Model number	Serial Number	Manufacturer	Remark
A	Smart Keyless System Hand Unit	SKEA7A-05	20230414-T10 (No.14) *1)	Mitsubishi Electric Corporation Himeji works	EUT
			20230523-T3 (No.22) *2)		

*1) Other than Maximum RF Output Power test

*2) Maximum RF Output Power test

SECTION 5: Radiated Spurious Emission

Test Procedure

[For below 30 MHz]

The noise level was checked by moving a search-coil (Loop Antenna) close to the EUT.

[For 30 MHz to 1 GHz]

EUT was placed on a urethane platform of nominal size, 1.0 m by 1.5 m, raised 0.8 m above the conducting ground plane.

The Radiated Electric Field Strength has been measured in a Semi Anechoic Chamber with a ground plane.

[For above 1 GHz]

EUT was placed on a urethane platform of nominal size, 0.5 m by 0.5 m, raised 1.5 m above the conducting ground plane.

The Radiated Electric Field Strength has been measured in a Semi Anechoic Chamber with absorbent materials lined on a ground plane.

The measuring antenna height was varied between 1 and 4 m and EUT was rotated a full revolution in order to obtain the maximum value of the electric field strength.

Test antenna was aimed at the EUT for receiving the maximum signal and always kept within the illumination area of the 3 dB beamwidth of the antenna.

The measurements were performed for both vertical and horizontal antenna polarization.

The radiated emission measurements were made with the following detector function of the test receiver / spectrum analyzer.

Test Antennas are used as below;

Frequency	Below 30 MHz	30 MHz to 200 MHz	200 MHz to 1 GHz	Above 1 GHz
Antenna Type	Loop	Biconical	Logperiodic	Horn

Frequency	From 9 kHz to 90 kHz and From 110 kHz to 150 kHz	From 90 kHz to 110 kHz	From 150 kHz to 490 kHz	From 490 kHz to 30 MHz	From 30 MHz to 1 GHz	Above 1 GHz
Detector Type	Peak	Peak	Peak	Peak	Peak and Peak with Duty factor	Peak and Peak with Duty factor
IF Bandwidth	200 Hz	200 Hz	9.1 kHz	9.1 kHz	120 kHz	PK: S/A: RBW: 1 MHz, VBW: 3 MHz

[Test Setup]
 Below 1 GHz

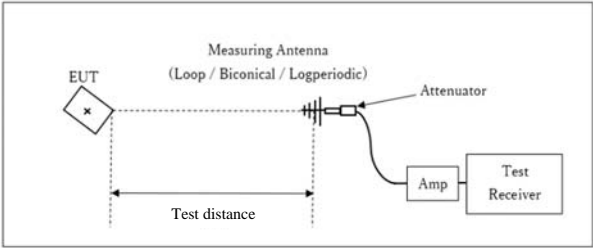

Test Distance: 3 m

x : Center of turn table

1 GHz to 3.2 GHz

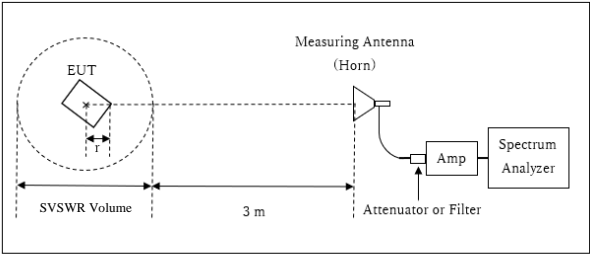

Distance Factor: $20 \times \log(4.0 \text{ m} / 3.0 \text{ m}) = 2.50 \text{ dB}$
 * Test Distance: $(3 + \text{SVSWR Volume} / 2) - r = 4.0 \text{ m}$

SVSWR Volume : 2.0 m
 (SVSWR Volume has been calibrated based on CISPR 16-1-4.)
 $r = 0.0 \text{ m}$

* The test was performed with $r = 0.0 \text{ m}$ since EUT is small and it was the rather conservative condition.

r : Radius of an outer periphery of EUT
 x : Center of turn table

- The carrier level and noise levels were confirmed at each position of X, Y and Z axes of EUT to see the position of maximum noise, and the test was made at the position that has the maximum noise.

The test results and limit are rounded off to one decimal place, so some differences might be observed.

Measurement range : 9 kHz to 3.2 GHz
Test data : APPENDIX
Test result : Pass

SECTION 6: Automatically deactivate

Test Procedure

The measurement was performed with Electric field strength using a spectrum analyzer.

Test data : APPENDIX
Test result : Pass

SECTION 7: -20 dB Bandwidth and 99% emission bandwidth

Test Procedure

The test was measured with a spectrum analyzer using a test fixture.

Test	Span	RBW	VBW	Sweep	Detector	Trace	Instrument used
-20 dB Bandwidth / 99% emission bandwidth	Enough width to display emission skirts	1 to 5 % of OBW	Three times of RBW	Auto	Peak *1)	Max Hold *1)	Spectrum Analyzer
*1) Peak hold was applied as Worst-case measurement.							

Test data : APPENDIX
Test result : Pass

SECTION 8: Maximum RF Output Power

Test Procedure

Maximum RF Output Power was measured with a Power Meter. The measurement was performed under the worst duty cycle conditions.

The test data is reference data for RF Exposure.

Test data : APPENDIX

APPENDIX 1: Test Data

Automatically deactivate

Test place	Ise EMC Lab.
Semi Anechoic Chamber	No.4
Date	May 21, 2023
Temperature / Humidity	22 deg. C / 55 % RH
Engineer	Junya Okuno
Mode	Mode 1

Time of Transmitting [s]	Limit [s]	Result
0.06	5.00	Pass

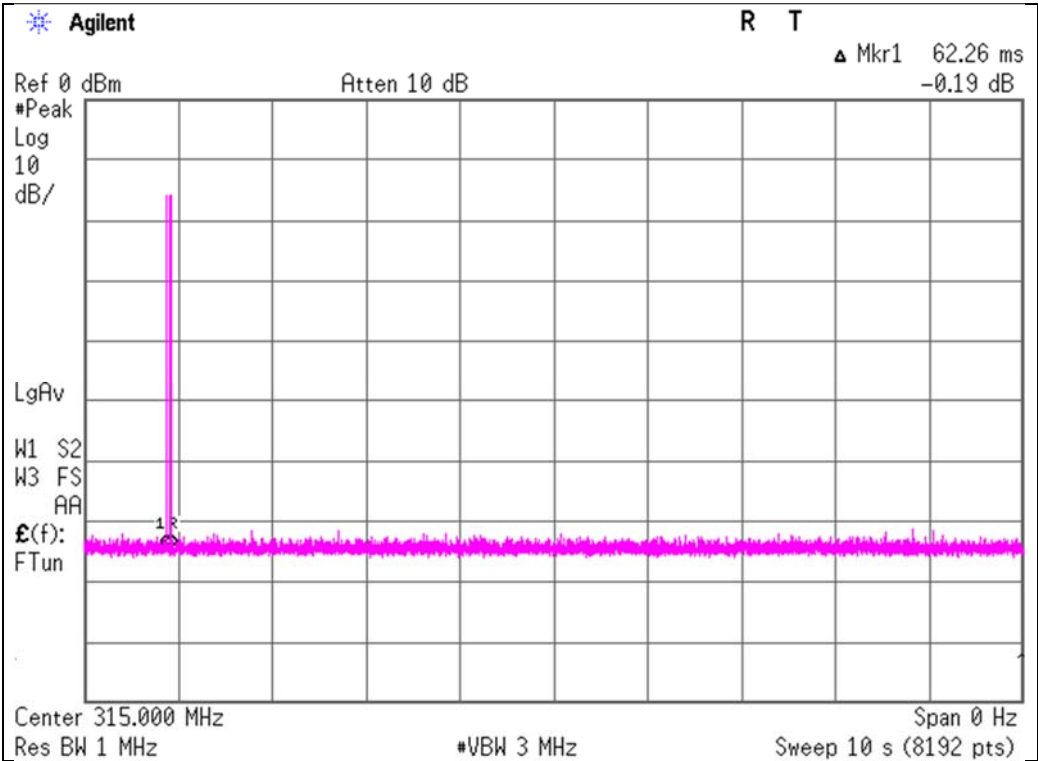

**Maximum RF Output Power
 (Reference data for RF Exposure)**

Test place	Ise EMC Lab.	No.8
Measurement Room	No.8	No.8
Date	June 14, 2023	August 8, 2023
Temperature / Humidity	21 deg. C / 66 % RH	22 deg. C / 55 % RH
Engineer	Keiya Ido	Junya Okuno
Mode	Mode 2	

Freq. [MHz]	Reading (P/M) [dBm]	Cable Loss [dB]	Atten. Loss [dB]	Conducted Power Result (Time average)	
				[dBm]	[mW]
315.00	-14.91	0.24	9.90	-4.77	0.33

Sample Calculation:
 Result (Conducted Power) = Reading + Cable Loss + Atten. Loss

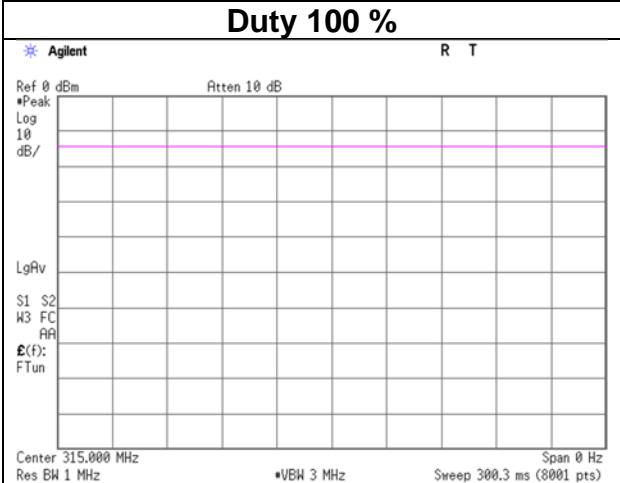

Radiated Emission (Fundamental and Spurious Emission)

Test place	Ise EMC Lab.
Semi Anechoic Chamber	No.4
Date	May 21, 2023
Temperature / Humidity	22 deg. C / 55 % RH
Engineer	Junya Okuno
Mode	Mode 2

Polarity [Hori/Vert]	Frequency [MHz]	Reading (PK) [dBuV]	Ant Factor [dB/m]	Loss [dB]	Gain [dB]	Duty Factor [dB]	Result (PK) [dBuV/m]	Result (PK with Duty Factor) [dBuV/m]	Limit (PK) [dBuV/m]	Limit (AV) [dBuV/m]	Margin (PK) [dB]	Margin (AV) [dB]	Inside or Outside of Restricted Bands	Remarks
Hori.	315.000	79.5	14.1	9.8	32.0	0.0	71.4	71.4	95.6	75.6	24.2	4.2	Carrier	
Hori.	630.000	35.4	19.6	11.4	32.3	0.0	34.1	34.1	75.6	55.6	41.5	21.5	Outside	
Hori.	945.000	30.2	22.1	12.6	30.9	0.0	34.0	34.0	75.6	55.6	41.6	21.6	Outside	
Hori.	1260.000	47.2	25.8	5.9	34.2	0.0	44.7	44.7	75.6	55.6	30.9	10.9	Outside	
Hori.	1575.000	52.8	25.2	5.1	33.4	0.0	49.7	49.7	73.9	53.9	24.2	4.2	Inside	
Hori.	1890.000	51.5	25.6	5.1	32.5	0.0	49.7	49.7	75.6	55.6	25.9	5.9	Outside	
Hori.	2205.000	47.0	28.3	5.2	32.1	0.0	48.4	48.4	73.9	53.9	25.5	5.5	Inside	
Hori.	2520.000	48.3	27.5	5.3	31.9	0.0	49.2	49.2	75.6	55.6	26.4	6.4	Outside	
Hori.	2835.000	48.6	28.4	5.5	31.8	0.0	50.7	50.7	73.9	53.9	23.2	3.2	Inside	
Hori.	3150.000	47.3	28.6	5.7	31.6	0.0	50.0	50.0	75.6	55.6	25.6	5.6	Outside	
Vert.	315.000	76.2	14.1	9.8	32.0	0.0	68.1	68.1	95.6	75.6	27.5	7.5	Carrier	
Vert.	630.000	34.5	19.6	11.4	32.3	0.0	33.2	33.2	75.6	55.6	42.4	22.4	Outside	
Vert.	945.000	29.6	22.1	12.6	30.9	0.0	33.4	33.4	75.6	55.6	42.2	22.2	Outside	
Vert.	1260.000	46.5	25.8	5.9	34.2	0.0	44.0	44.0	75.6	55.6	31.6	11.6	Outside	
Vert.	1575.000	53.2	25.2	5.1	33.4	0.0	50.1	50.1	73.9	53.9	23.8	3.8	Inside	
Vert.	1890.000	50.7	25.6	5.1	32.5	0.0	48.9	48.9	75.6	55.6	26.7	6.7	Outside	
Vert.	2205.000	46.0	28.3	5.2	32.1	0.0	47.4	47.4	73.9	53.9	26.5	6.5	Inside	
Vert.	2520.000	49.0	27.5	5.3	31.9	0.0	49.9	49.9	75.6	55.6	25.7	5.7	Outside	
Vert.	2835.000	48.3	28.4	5.5	31.8	0.0	50.4	50.4	73.9	53.9	23.5	3.5	Inside	
Vert.	3150.000	48.2	28.6	5.7	31.6	0.0	50.9	50.9	75.6	55.6	24.7	4.7	Outside	

Sample calculation:

Result of PK = Reading + Ant Factor + Loss {Cable + Attenuator + Filter (above 1 GHz) + Distance factor (above 1 GHz)} - Gain (Amplifier)

Result of PK with Duty factor (PK / W) = Reading + Ant Factor + Loss {Cable + Attenuator + Filter (above 1 GHz) + Distance factor (above 1 GHz)} - Gain (Amplifier) + Duty factor

For above 1 GHz: Distance Factor: $20 \times \log(4.0 \text{ m}/3.0 \text{ m}) = 2.50 \text{ dB}$

*Other frequency noises omitted in this report were not seen or had enough margin (more than 20 dB).

Since the peak emission result satisfied the average limit, duty factor was omitted.

Radiated Spurious Emission (Plot data, Worst case for Spurious Emission)

Test place Ise EMC Lab.
Semi Anechoic Chamber No.4
Date May 21, 2023
Temperature / Humidity 22 deg. C / 55 % RH
Engineer Junya Okuno
Mode Mode 2

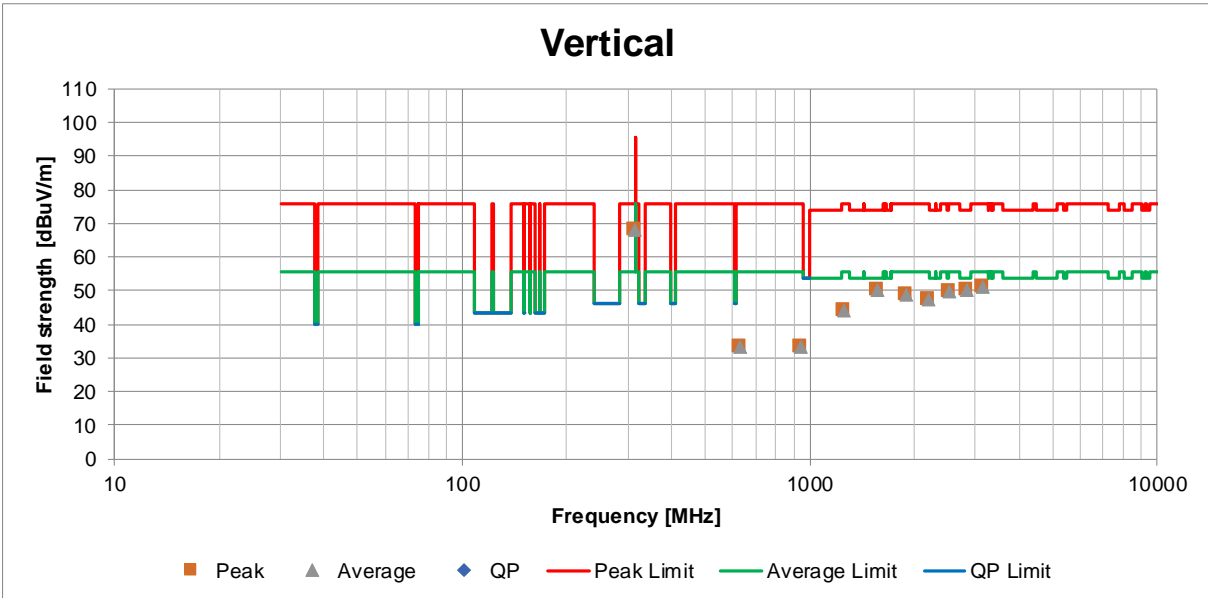
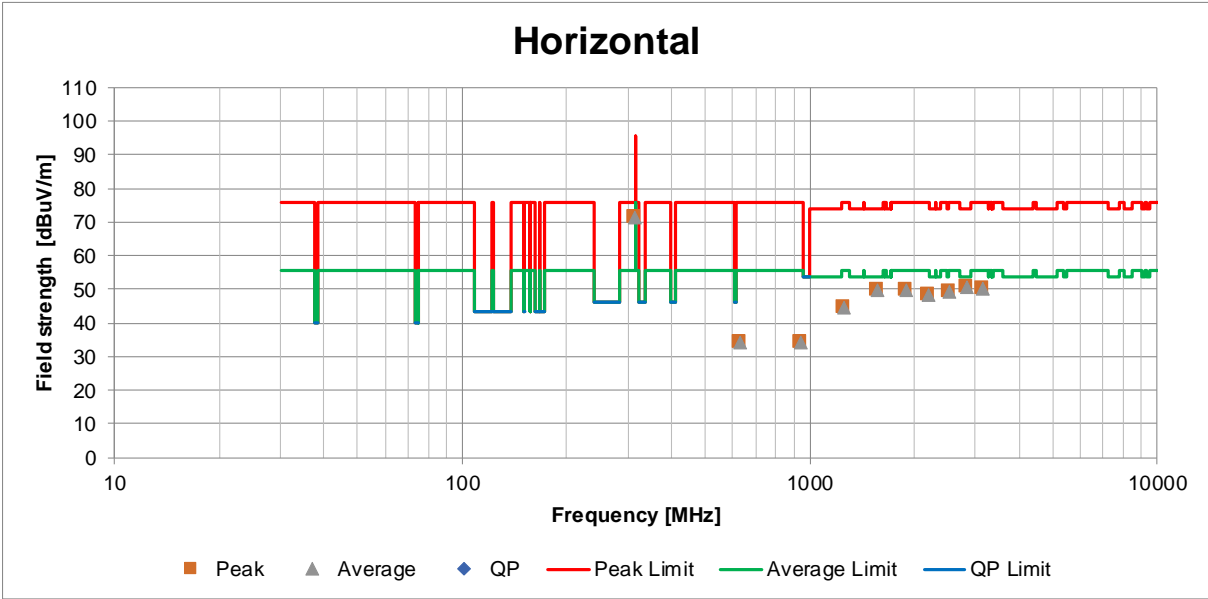

-20 dB Bandwidth / 99% emission bandwidth

Test place Ise EMC Lab.
Semi Anechoic Chamber No.4
Date May 21, 2023
Temperature / Humidity 22 deg. C / 55 % RH
Engineer Junya Okuno
Mode Mode 2

Bandwidth Limit : Fundamental Frequency 315.00 MHz x 0.25 % = 787.500 kHz

-20 dB Bandwidth [kHz]	Bandwidth Limit [kHz]	Result
107.792	787.500	Pass

99% emission bandwidth [kHz]	Bandwidth Limit [kHz]	Result
112.9129	787.500	Pass

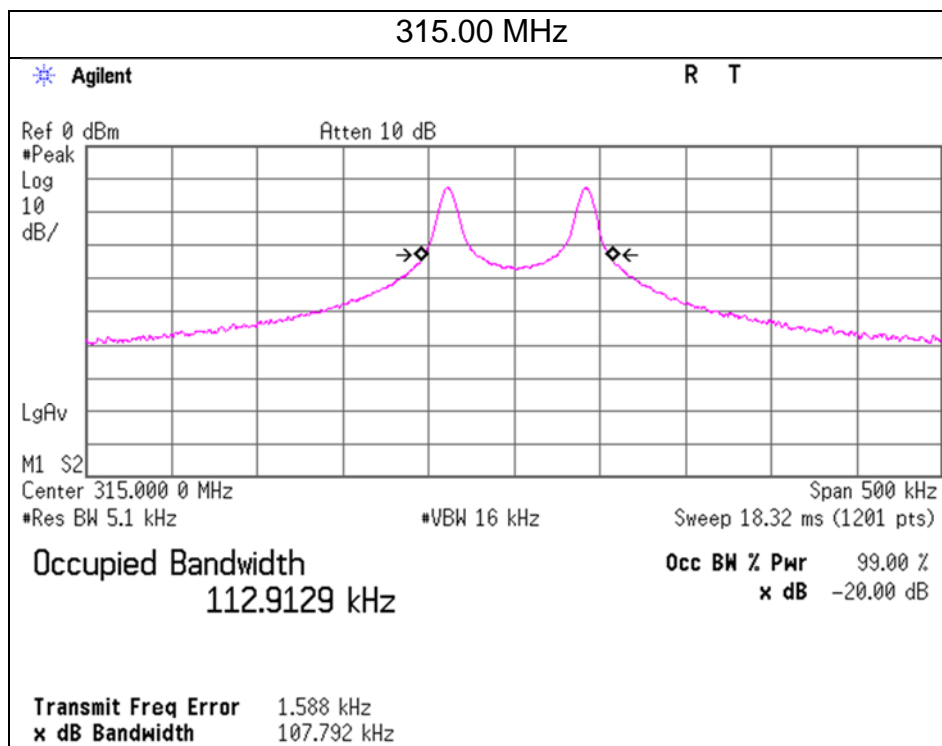

APPENDIX 2: Test Instruments

Test Equipment

Test Item	Local ID	LIMS ID	Description	Manufacturer	Model	Serial	Last Calibration Date	Cal Int
RE	COTS-MEMI-02	178648	EMI measurement program	TSJ (Techno Science Japan)	TEPTO-DV	-	-	-
RE	MAEC-04	142011	AC4_Semi Anechoic Chamber(NSA)	TDK	Semi Anechoic Chamber 3m	DA-10005	05/22/2022	24
RE	MAEC-04-SVSWR	142017	AC4_Semi Anechoic Chamber(SVSWR)	TDK	Semi Anechoic Chamber 3m	DA-10005	04/14/2023	24
RE	MAT-34	141331	Attenuator(6dB)	TME	UFA-01	-	02/01/2023	12
RE	MBA-05	141425	Biconical Antenna	Schwarzbeck Mess-Elektronik OHG	VHA9103+ BBA9106	VHA 91031302	08/26/2022	12
RE	MCC-265	234602	Microwave Cable	Huber+Suhner	SF126E/11PC35/11PC35/1000M,5000M	537063/126E / 537074/126E	03/16/2023	-
RE	MCC-50	141397	Coaxial Cable	UL Japan	-	-	11/18/2022	12
RE	MHA-05	141511	Horn Antenna 1-18GHz	Schwarzbeck Mess-Elektronik OHG	BBHA9120D	253	09/20/2022	12
RE	MHF-04	141403	High Pass Filter 1.22-4.60GHz	Mini-Circuits	VHF-1200	10435	08/01/2022	12
RE	MJM-29	142230	Measure, Tape, Steel	KOMELON	KMC-36	-	-	-
RE	MLA-23	141267	Logperiodic Antenna (200-1000MHz)	Schwarzbeck Mess-Elektronik OHG	VUSLP9111B	9111B-192	09/21/2022	12
RE	MLPA-07	142645	Loop Antenna	UL Japan	-	-	-	-
RE	MMM-10	141545	DIGITAL HiTESTER	HIOKI E.E. CORPORATION	3805	51201148	01/18/2023	12
RE	MOS-15	141562	Thermo-Hygrometer	CUSTOM. Inc	CTH-201	0010	01/13/2023	12
RE	MPA-12	141581	MicroWave System Amplifier	Keysight Technologies Inc	83017A	00650	10/05/2022	12
RE	MPA-14	141583	Pre Amplifier	SONOMA INSTRUMENT	310	260833	04/05/2023	12
RE	MRENT-130	141855	Spectrum Analyzer	Keysight Technologies Inc	E4440A	MY46187750	12/01/2022	12
RE	MTR-10	141951	EMI Test Receiver	Rohde & Schwarz	ESR26	101408	04/10/2023	12
AT	MAT-10	141156	Attenuator(10dB)	Weinschel Corp	2	BL1173	11/10/2022	12
AT	MCC-243	196430	Microwave Cable	Huber+Suhner	SF102D/11PC24/11PC24/1000mm	537059/126EA	02/02/2023	12
AT	MMM-17	141557	DIGITAL HiTESTER	HIOKI E.E. CORPORATION	3805	70900530	01/18/2023	12
AT	MOS-28	141567	Thermo-Hygrometer	CUSTOM. Inc	CTH-201	0008	01/13/2023	12
AT	MPM-08	141805	Power Meter	Anritsu Corporation	ML2495A	6K00003338	07/04/2022	12
AT	MPSE-11	141840	Power sensor	Anritsu Corporation	MA2411B	11737	07/04/2022	12
AT	MSA-16	141903	Spectrum Analyzer	Keysight Technologies Inc	E4440A	MY46186390	01/16/2023	12

*Hyphens for Last Calibration Date and Cal Int (month) are instruments that Calibration is not required (e.g. software), or instruments checked in advance before use.

The expiration date of the calibration is the end of the expired month.
As for some calibrations performed after the tested dates, those test equipment have been controlled by means of an unbroken chains of calibrations.

All equipment is calibrated with valid calibrations. Each measurement data is traceable to the national or international standards.

Test item:

RE: Radiated Emission

AT: Antenna Terminal Conducted