

---

# FCC Test Report

---

Report No.: AGC00797160301FE03

**FCC ID** : WAD-BTT005E  
**APPLICATION PURPOSE** : Original Equipment  
**PRODUCT DESIGNATION** : Bluetooth audio transmitter  
**BRAND NAME** : K-mate  
**MODEL NAME** : BTT005E, BTT005A, BTT005N  
**CLIENT** : Zhongshan K-mate General Electronics Co., Ltd.  
**DATE OF ISSUE** : Apr.28,2016  
**STANDARD(S)** : FCC Part 15 Rules  
**TEST PROCEDURE(S)**  
**REPORT VERSION** : V1.0

Attestation of Global Compliance (Shenzhen) Co., Ltd



**CAUTION:**

This report shall not be reproduced except in full without the written permission of the test laboratory and shall not be quoted out of context.



**Report Revise Record**

Report Version	Revise Time	Issued Date	Valid Version	Notes
V1.0	/	Apr.28,2016	Valid	Original Report

## TABLE OF CONTENTS

<b>1. VERIFICATION OF CONFORMITY .....</b>	<b>4</b>
<b>2. GENERAL INFORMATION .....</b>	<b>5</b>
2.1. PRODUCT DESCRIPTION.....	5
2.2. TABLE OF CARRIER FREQUENCYS.....	5
<b>3. MEASUREMENT UNCERTAINTY.....</b>	<b>6</b>
<b>4. DESCRIPTION OF TEST MODES.....</b>	<b>6</b>
<b>5. SYSTEM TEST CONFIGURATION .....</b>	<b>7</b>
5.1. CONFIGURATION OF EUT SYSTEM .....	7
5.2. EQUIPMENT USED IN EUT SYSTEM .....	7
5.3. SUMMARY OF TEST RESULTS .....	7
<b>6. TEST FACILITY .....</b>	<b>8</b>
<b>TEST METHODOLOGY.....</b>	<b>8</b>
<b>7. ALL TEST EQUIPMENT LIST .....</b>	<b>8</b>
<b>8. RADIATED EMISSION .....</b>	<b>10</b>
8.1TEST LIMIT.....	10
8.2. MEASUREMENT PROCEDURE .....	11
8.3. TEST SETUP.....	13
8.4. TEST RESULT .....	15
9.1. MEASUREMENT PROCEDURE .....	30
9.2 TEST SETUP .....	30
9.3 RADIATED TEST RESULT .....	31
<b>10. 20DB BANDWIDTH.....</b>	<b>35</b>
10.1. MEASUREMENT PROCEDURE .....	35
10.2. TEST SET-UP .....	35
10.3. LIMITS AND MEASUREMENT RESULTS.....	35
<b>11. FCC LINE CONDUCTED EMISSION TEST .....</b>	<b>42</b>
11.1. LIMITS OF LINE CONDUCTED EMISSION TEST .....	42
11.2. BLOCK DIAGRAM OF LINE CONDUCTED EMISSION TEST.....	42
11.3. PRELIMINARY PROCEDURE OF LINE CONDUCTED EMISSION TEST .....	43
11.4. FINAL PROCEDURE OF LINE CONDUCTED EMISSION TEST.....	43
11.5. TEST RESULT OF LINE CONDUCTED EMISSION TEST.....	44
<b>APPENDIX A: PHOTOGRAPHS OF TEST SETUP .....</b>	<b>46</b>
<b>APPENDIX B: PHOTOGRAPHS OF EUT .....</b>	<b>48</b>

## 1. VERIFICATION OF CONFORMITY

<b>Applicant</b>	Zhongshan K-mate General Electronics Co., Ltd.
<b>Address</b>	NO.2, 5th Xinsheng Street, Gangkou Town, Zhongshan, China 528447
<b>Manufacturer</b>	Zhongshan K-mate General Electronics Co., Ltd.
<b>Address</b>	NO.2, 5th Xinsheng Street, Gangkou Town, Zhongshan, China 528447
<b>Product Designation</b>	Bluetooth audio transmitter
<b>Brand Name</b>	K-mate
<b>Test Model</b>	BTT005E
<b>Series Model</b>	BTT005A, BTT005N
<b>Difference description</b>	All the same except the model name.
<b>Date of test</b>	Apr.19,2016 to Apr.21,2016
<b>Deviation</b>	None
<b>Condition of Test Sample</b>	Normal
<b>Report Template</b>	AGCRT-US-BR/RF

We hereby certify that:

The above equipment was tested by Dongguan Precise Testing Service Co., Ltd. The test data, the energy emitted by the sample tested as described in this report is in compliance with the requirements of FCC Rules Part 15.249.

Tested By   
Time Huang(Huang Nanhui) Apr.28,2016

Reviewed By   
Forrest Lei(Lei Yonggang) Apr.28,2016

Approved By   
Solger Zhang(Zhang Hongyi)  
Authorized Officer Apr.28,2016

## 2. GENERAL INFORMATION

### 2.1. PRODUCT DESCRIPTION

A major technical description of EUT is described as following

<b>Operation Frequency</b>	2.402 GHz to 2.480GHz
<b>RF Output Power</b>	3.90dBm(Max)
<b>Bluetooth Version</b>	V3.0
<b>Modulation</b>	GFSK, $\pi$ /4-DQPSK, 8DPSK
<b>Number of channels</b>	79 for BR/EDR
<b>Hardware Version</b>	V01
<b>Software Version</b>	V1.2
<b>Antenna Designation</b>	PCB Antenna (Met 15.203 Antenna requirement)
<b>Antenna Gain</b>	0dBi
<b>Power Supply</b>	DC 5.0V

### 2.2. TABLE OF CARRIER FREQUENCIES

BR/EDR channel List

Frequency Band	Channel Number	Frequency
2400~2483.5MHZ	0	2402MHZ
	1	2403MHZ
	:	:
	38	2440 MHZ
	39	2441 MHZ
	40	2442 MHZ
	:	:
	77	2479 MHZ
	78	2480 MHZ

### 3. MEASUREMENT UNCERTAINTY

The reported uncertainty of measurement  $y \pm U$ , where expanded uncertainty  $U$  is based on a standard uncertainty multiplied by a coverage factor of  $k=2$ , providing a level of confidence of approximately 95 %.

No.	Item	Uncertainty
1	Conducted Emission Test	$\pm 3.18\text{dB}$
2	All emissions, radiated	$\pm 3.91\text{dB}$
3	Temperature	$\pm 0.5^\circ\text{C}$
4	Humidity	$\pm 2\%$

### 4. DESCRIPTION OF TEST MODES

NO.	TEST MODE DESCRIPTION
1	Low channel GFSK
2	Middle channel GFSK
3	High channel GFSK
4	Low channel $\pi/4$ -DQPSK
5	Middle channel $\pi/4$ -DQPSK
6	High channel $\pi/4$ -DQPSK
7	Low channel 8DPSK
8	Middle channel 8DPSK
9	High channel 8DPSK
10	BT Link

Note:

- only the result of the worst case was recorded in the report, if no other cases.
- For Radiated Emission, 3axis were chosen for testing for each applicable mode.

## 5. SYSTEM TEST CONFIGURATION

### 5.1. CONFIGURATION OF EUT SYSTEM

Configure 1: (Normal hopping)

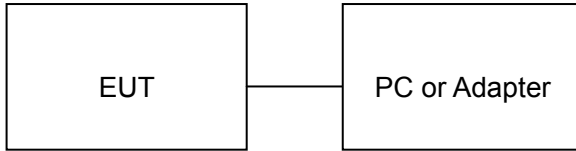

Configure 2: (Control continuous TX)

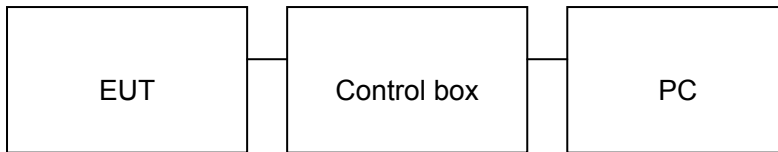

### 5.2. EQUIPMENT USED IN EUT SYSTEM

Item	Equipment	Model No.	ID or Specification	Remark
1	Bluetooth Speaker	BT152	FCC ID: WAD-BTT005E	EUT
2	PC	E1412AYCW	Sony	A.E
3	Control box	N/A	N/A	A.E
4	Adapter	ETPCA-050100U3W	N/A	A.E

### 5.3. SUMMARY OF TEST RESULTS

FCC RULES	DESCRIPTION OF TEST	RESULT
§15.249	Radiated Emission	Compliant
§15.249	Band Edges	Compliant
§15.207	Conduction Emission	Compliant
§15.215	BANDWIDTH	Compliant

## 6. TEST FACILITY

<b>Site</b>	Dongguan Precise Testing Service Co., Ltd.
<b>Location</b>	Building D, Baoding Technology Park, Guangming Road2, Dongcheng District, Dongguan, Guangdong, China,
<b>FCC Registration No.</b>	371540
<b>Description</b>	The test site is constructed and calibrated to meet the FCC requirements in documents ANSI C63.10:2013.

## TEST METHODOLOGY

All measurements contained in this report were conducted with ANSI C63.10-2013

## 7. ALL TEST EQUIPMENT LIST

FOR RADIATED EMISSION TEST (BELOW 1GHZ)

Radiated Emission Test Site					
Name of Equipment	Manufacturer	Model Number	Serial Number	Last Calibration	Due Calibration
EMI Test Receiver	Rohde & Schwarz	ESCI	101417	July 4, 2015	July 3, 2016
Trilog Broadband Antenna (25M-1GHz)	SCHWARZBECK	VULB9160	9160-3355	July 4, 2015	July 3, 2016
Signal Amplifier	SCHWARZBECK	BBV 9475	9745-0013	July 4, 2015	July 3, 2016
RF Cable	SCHWARZBECK	AK9515E	96221	July 4, 2015	July 3, 2016
3m Anechoic Chamber	CHENGYU	966	PTS-001	June 6, 2015	June 5, 2016
MULTI-DEVICE Positioning Controller	Max-Full	MF-7802	MF780208339	N/A	N/A
Active loop antenna (9K-30MHz)	Schwarzbeck	FMZB1519	1519-038	June 6, 2015	June 5, 2016
Spectrum analyzer	Agilent	E4407B	MY46185649	June 6, 2015	June 5, 2016
Radiation Cable 1	MXT	RS1	R005	June 6, 2015	June 5, 2016
Radiation Cable 2	MXT	RS1	R006	June 6, 2015	June 5, 2016



## FOR RADIATED EMISSION TEST (1GHZ ABOVE)

Radiated Emission Test Site					
Name of Equipment	Manufacturer	Model Number	Serial Number	Last Calibration	Due Calibration
EMI Test Receiver	Rohde & Schwarz	ESCI	101417	July 4, 2015	July 3, 2016
Horn Antenna (1G-18GHz)	SCHWARZBECK	BBHA9120D	9120D-1246	July 11, 2015	July 10, 2016
Spectrum Analyzer	Agilent	E4411B	MY4511453	July 4, 2015	July 3, 2016
Signal Amplifier	SCHWARZBECK	BBV 9718	9718-269	July 7, 2015	July 6, 2016
RF Cable	SCHWARZBECK	AK9515H	96220	July 8, 2015	July 7, 2016
3m Anechoic Chamber	CHENGYU	966	PTS-001	June 6, 2015	June 5, 2016
MULTI-DEVICE Positioning Controller	Max-Full	MF-7802	MF780208339	N/A	N/A
Horn Ant (18G-40GHz)	Schwarzbeck	BBHA 9170	9170-181	June 6, 2015	June 5, 2016
Radiation Cable 1	MXT	RS1	R005	June 6, 2015	June 5, 2016
Radiation Cable 2	MXT	RS1	R006	June 6, 2015	June 5, 2016

Conducted Emission Test Site					
Name of Equipment	Manufacturer	Model Number	Serial Number	Last Calibration	Due Calibration
EMI Test Receiver	- Rohde & Schwarz	ESCI	101417	July 4, 2015	July 3, 2016
Artificial Mains Network	Narda	L2-16B	000WX31025	July 8, 2015	July 7, 2016
Artificial Mains Network (AUX)	Narda	L2-16B	000WX31026	July 8, 2015	July 7, 2016
RF Cable	SCHWARZBECK	AK9515E	96222	July 4, 2015	July 3, 2016
Shielded Room	CHENGYU	843	PTS-002	June 6,2015	June 5,2016
Conduction Cable	MXT	SE1	S003	June 6,2015	June 5,2016

## 8. RADIATED EMISSION

### 8.1 TEST LIMIT

#### Standard FCC15.249

Fundamental Frequency	Field Strength of Fundamental (millivolts/meter)	Field Strength of Harmonics (microvolts/meter)
900-928MHz	50	500
2400-2483.5MHz	50	500
5725-5875MHz	50	500
24.0-24.25GHz	250	2500

#### Standard FCC 15.209

Frequency (MHz)	Distance Meters	Field Strengths Limit	
		$\mu$ V/m	dB( $\mu$ V)/m
0.009 ~ 0.490	300	2400/F(kHz)	---
0.490 ~ 1.705	30	24000/F(kHz)	---
1.705 ~ 30	30	30	---
30 ~ 88	3	100	40.0
88 ~ 216	3	150	43.5
216 ~ 960	3	200	46.0
960 ~ 1000	3	500	54.0
Above 1000	3	Other:74.0 dB( $\mu$ V)/m (Peak) 54.0 dB( $\mu$ V)/m (Average)	

Remark: (1) Emission level dB  $\mu$  V = 20 log Emission level  $\mu$  V/m  
(2) The smaller limit shall apply at the cross point between two frequency bands.  
(3) Distance is the distance in meters between the measuring instrument, antenna and the closest point of any part of the device or system.

## 8.2. MEASUREMENT PROCEDURE

1. The measuring distance of 3m shall be used for measurements. The EUT was placed on the top of a rotating table 0.8 meter above the ground at a 3 meter semi-anechoic chamber. The table was rotated 360 degrees to determine the position of the highest radiation(below 1GHz)
2. The measuring distance of 3m shall used for measurements. The EUT was placed on the top of a rotating table 1.5 meter above the ground at a 3 meter semi-anechoic chamber. The table was rotated 360 degrees to determine the position of the highest radiation(above 1GHz)
3. The height of the test antenna shall vary between 1m to 4m.Both horizontal and vertical polarization Of the antenna are set to make the measurement.
4. The initial step in collecting radiated emission data is a receive peak detector mode. Pre-scanning the measurement frequency range. Significant peaks are then marked and then Quasi Peak detector mode re-measured.
5. All readings are peak unless otherwise stated QP in column of Note. Peak denoted that the Peak reading compliance with the QP limits and then QP Mode measurement didn't perform(Below 1GHz)
- 6.All readings are Peak mode value unless otherwise stated AVG in column of Note. If the Peak mode measured value compliance with the Peak limits and lower than AVG Limits, the EUT shall be deemed to meet Peak&AVG limits and then only Peak mode was measured, but AVG mode didn't perform.(above 1GHz)

The following table is the setting of spectrum analyzer and receiver.

<b>Spectrum Parameter</b>	<b>Setting</b>
Start ~Stop Frequency	9KHz~150KHz/RB 200Hz for QP
Start ~Stop Frequency	150KHz~30MHz/RB 9KHz for QP
Start ~Stop Frequency	30MHz~1000MHz/RB 120KHz for QP
Start ~Stop Frequency	1GHz~26.5GHz 1MHz/3MHz for Peak, 1MHz/10Hz for Average
<b>Receiver Parameter</b>	<b>Setting</b>
Start ~Stop Frequency	9KHz~150KHz/RB 200Hz for QP
Start ~Stop Frequency	150KHz~30MHz/RB 9KHz for QP
Start ~Stop Frequency	30MHz~1000MHz/RB 120KHz for QP

8.3. TEST SETUP

Radiated Emission Test-Setup Frequency Below 30MHz

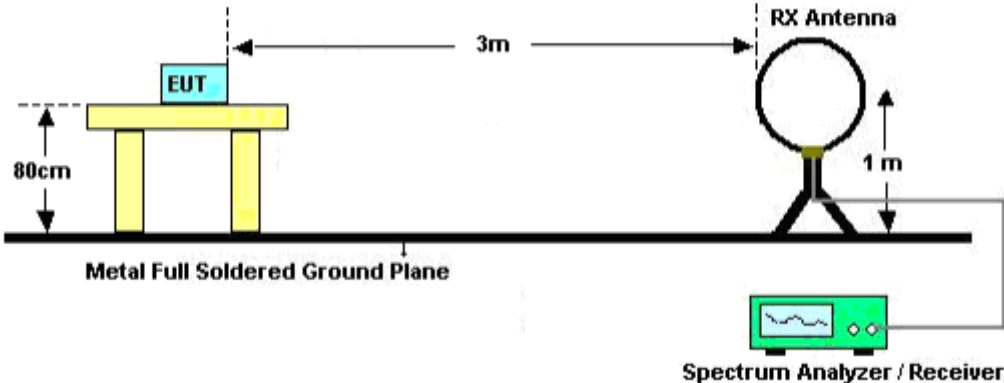

RADIATED EMISSION TEST SETUP 30MHz-1000MHz

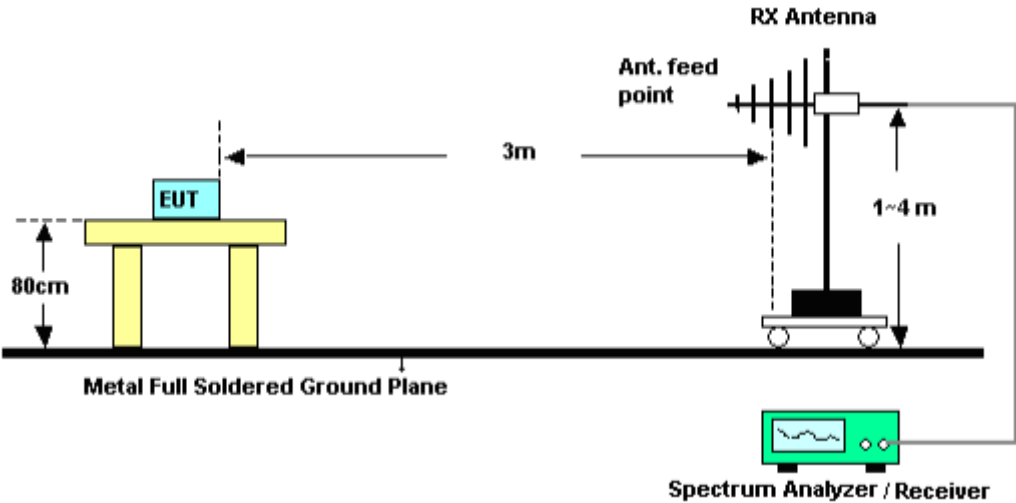

RADIATED EMISSION TEST SETUP ABOVE 1000MHz

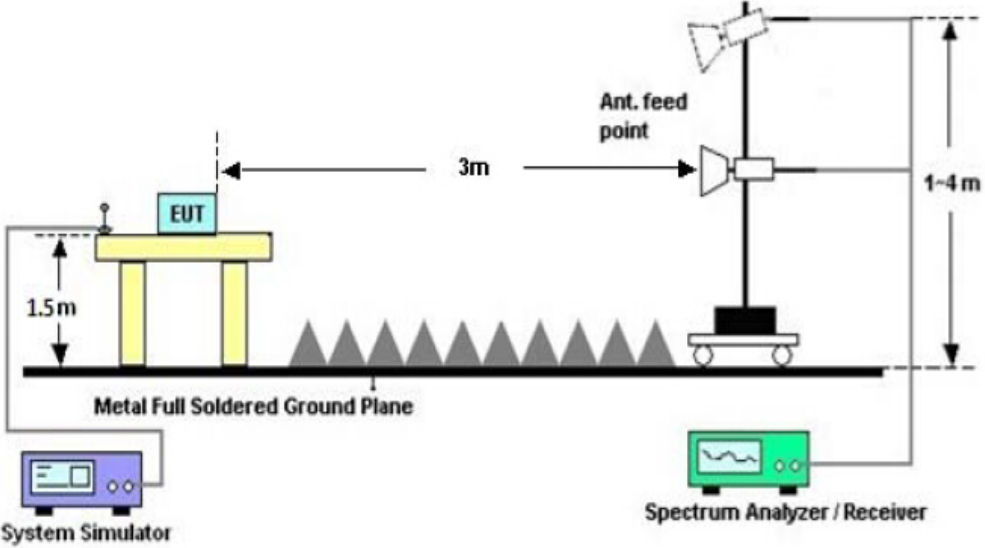

**8.4. TEST RESULT**

**(Worst modulation:GFSK)  
FOR BR/EDR**

**RADIATED EMISSION BELOW 30MHZ**

No emission found between lowest internal used/generated frequencies to 30MHz.

**RADIATED EMISSION BELOW 1GHZ**

**RADIATED EMISSION TEST- (30MHZ-1GHZ)-LOW CHANNEL-HORIZONTAL**



Site: site #1	Polarization: <i>Horizontal</i>	Temperature: 22.7
Limit: FCC Class B 3M Radiation	Power:	Humidity: 56.5 %
EUT:Bluetooth audio transmitter	Distance:	
M/N:BTT005E		
Mode:Low Channel TX		
Note:		

No.	Mk	Freq.	Reading	Factor	Measurement	Limit	Over	Detector	Antenna	Table	Comment
		MHz	dBuV	dB/m	dBuV/m	dBuV/m	dB		Height	Degree	
									cm	degree	
1	*	215.9166	26.42	10.38	36.80	43.50	-6.70	peak			
2		299.9832	19.40	15.41	34.81	46.00	-11.19	peak			
3		430.9332	11.23	20.01	31.24	46.00	-14.76	peak			
4		599.0666	4.64	23.71	28.35	46.00	-17.65	peak			
5		899.7667	4.65	28.60	33.25	46.00	-12.75	peak			
6		983.8333	5.60	29.68	35.28	54.00	-18.72	peak			

**RESULT: PASS**

RADIATED EMISSION TEST- (30MHZ-1GHZ)-LOW CHANNEL -VERTICAL

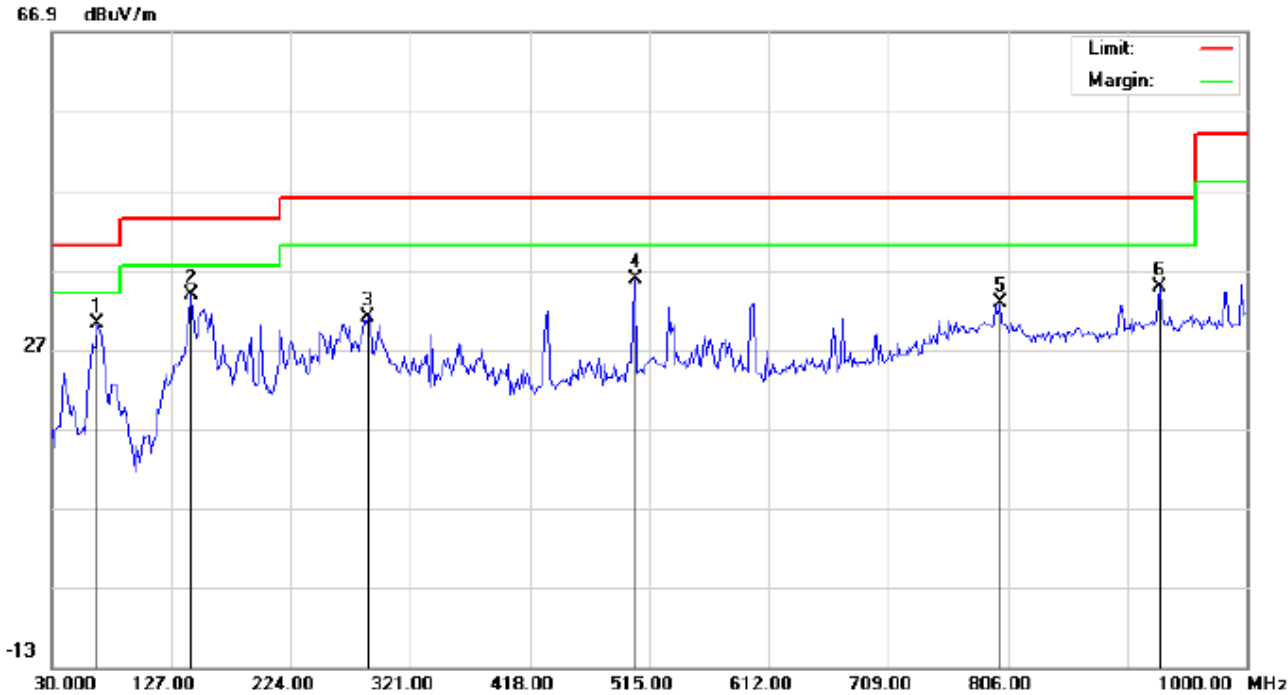

Site: site #1  
 Limit: FCC Class B 3M Radiation  
 EUT:Bluetooth audio transmitter  
 M/N:BTT005E  
 Mode:Low Channel TX  
 Note:

Polarization: *Vertical*  
 Power:  
 Distance:

Temperature: 22.7  
 Humidity: 56.5 %

No.	Mk	Freq.	Reading	Factor	Measurement	Limit	Over	Detector	Antenna Height	Table Degree	Comment
		MHz	dBuV	dB/m	dBuV/m	dBuV/m	dB		cm	degree	
1		67.1833	24.87	5.36	30.23	40.00	-9.77	peak			
2	*	143.1665	18.53	15.22	33.75	43.50	-9.75	peak			
3		287.0500	15.98	15.02	31.00	46.00	-15.00	peak			
4		503.6832	14.53	21.23	35.76	46.00	-10.24	peak			
5		799.5333	5.45	27.31	32.76	46.00	-13.24	peak			
6		928.8667	5.37	29.41	34.78	46.00	-11.22	peak			

**RESULT: PASS**

- Note:** 1. Factor=Antenna Factor + Cable loss, Margin=Measurement-Limit.  
 2. The "Factor" value can be calculated automatically by software of measurement system.



RADIATED EMISSION TEST- (30MHZ-1GHZ)-MIDDLE CHANNEL-HORIZONTAL

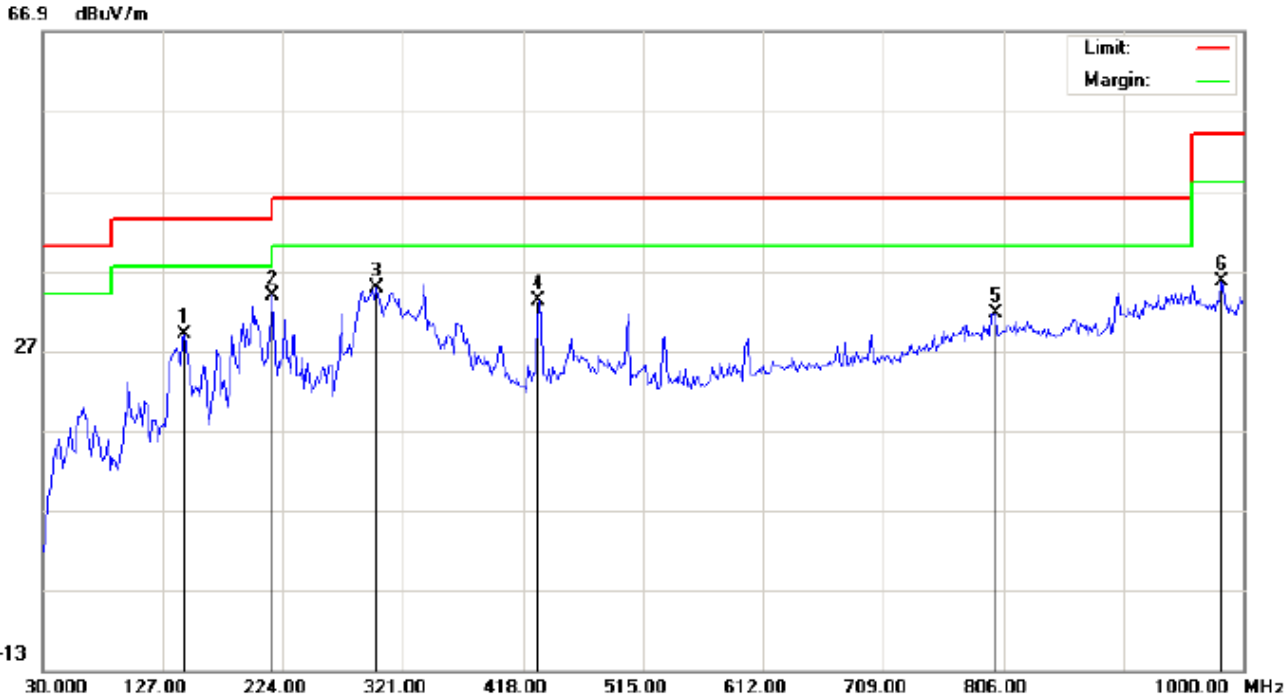

Site: site #1  
 Limit: FCC Class B 3M Radiation  
 EUT:Bluetooth audio transmitter  
 M/N:BTT005E  
 Mode:Middle Channel TX  
 Note:

Polarization: *Horizontal*  
 Power:  
 Distance:

Temperature: 22.7  
 Humidity: 56.5 %

No.	Mk	Freq.	Reading	Factor	Measurement	Limit	Over	Detector	Antenna Height	Table Degree	Comment
		MHz	dBuV	dB/m	dBuV/m	dBuV/m	dB		cm	degree	
1		144.7832	15.00	14.04	29.04	43.50	-14.46	peak			
2	*	215.9166	23.42	10.38	33.80	43.50	-9.70	peak			
3		299.9832	19.40	15.41	34.81	46.00	-11.19	peak			
4		430.9332	13.23	20.01	33.24	46.00	-12.76	peak			
5		799.5333	4.38	27.31	31.69	46.00	-14.31	peak			
6		982.2166	5.97	29.69	35.66	54.00	-18.34	peak			

**RESULT: PASS**

RADIATED EMISSION TEST- (30MHZ-1GHZ)- MIDDLE CHANNEL -VERTICAL

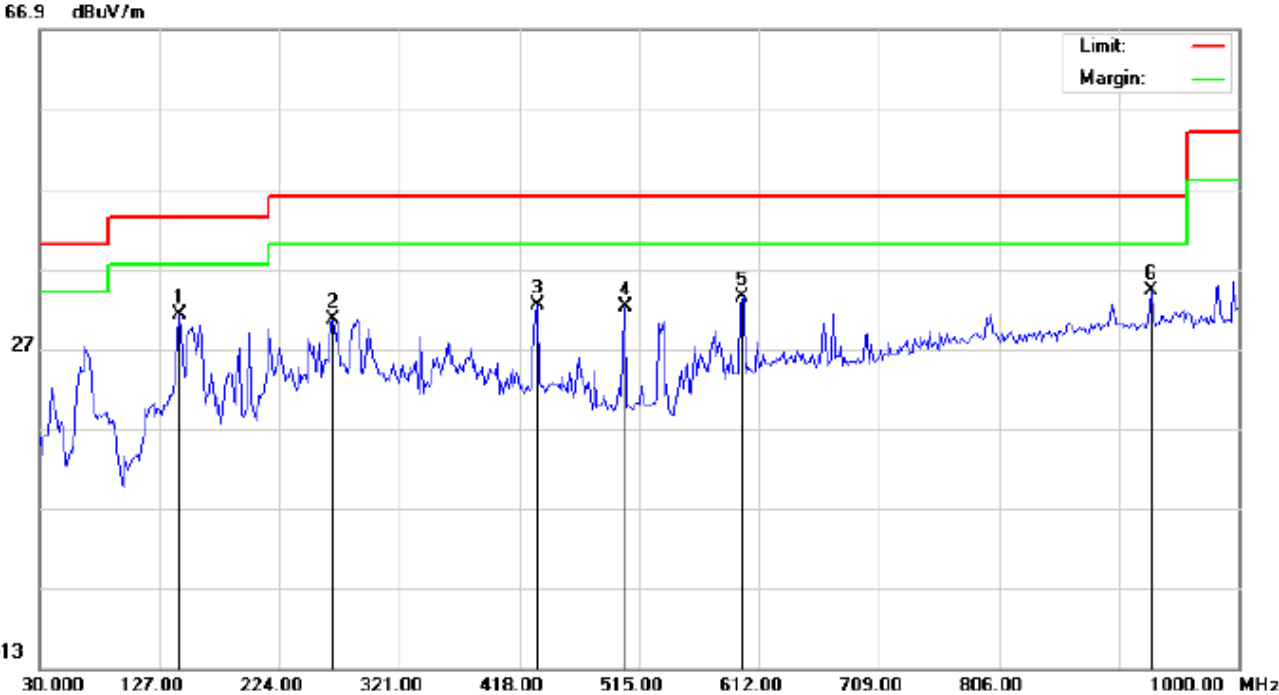

Site: site #1  
 Limit: FCC Class B 3M Radiation  
 EUT:Bluetooth audio transmitter  
 M/N:BTT005E  
 Mode:Middle Channel TX  
 Note:

Polarization: *Vertical*  
 Power:  
 Distance:

Temperature: 22.7  
 Humidity: 56.5 %

No.	Mk	Freq.	Reading	Factor	Measurement	Limit	Over	Detector	Antenna	Table	Comment
		MHz	dBuV	dB/m	dBuV/m	dBuV/m	dB		Height	Degree	
									cm	degree	
1		143.1665	16.03	15.22	31.25	43.50	-12.25	peak			
2		267.6499	16.18	14.43	30.61	46.00	-15.39	peak			
3		432.5500	12.34	20.06	32.40	46.00	-13.60	peak			
4		503.6832	11.03	21.23	32.26	46.00	-13.74	peak			
5		599.0666	10.60	22.73	33.33	46.00	-12.67	peak			
6	*	928.8667	4.87	29.41	34.28	46.00	-11.72	peak			

**RESULT: PASS**

- Note:** 1. Factor=Antenna Factor + Cable loss, Margin=Measurement-Limit.  
 2. The "Factor" value can be calculated automatically by software of measurement system.

RADIATED EMISSION TEST- (30MHZ-1GHZ)-HIGH CHANNEL-HORIZONTAL

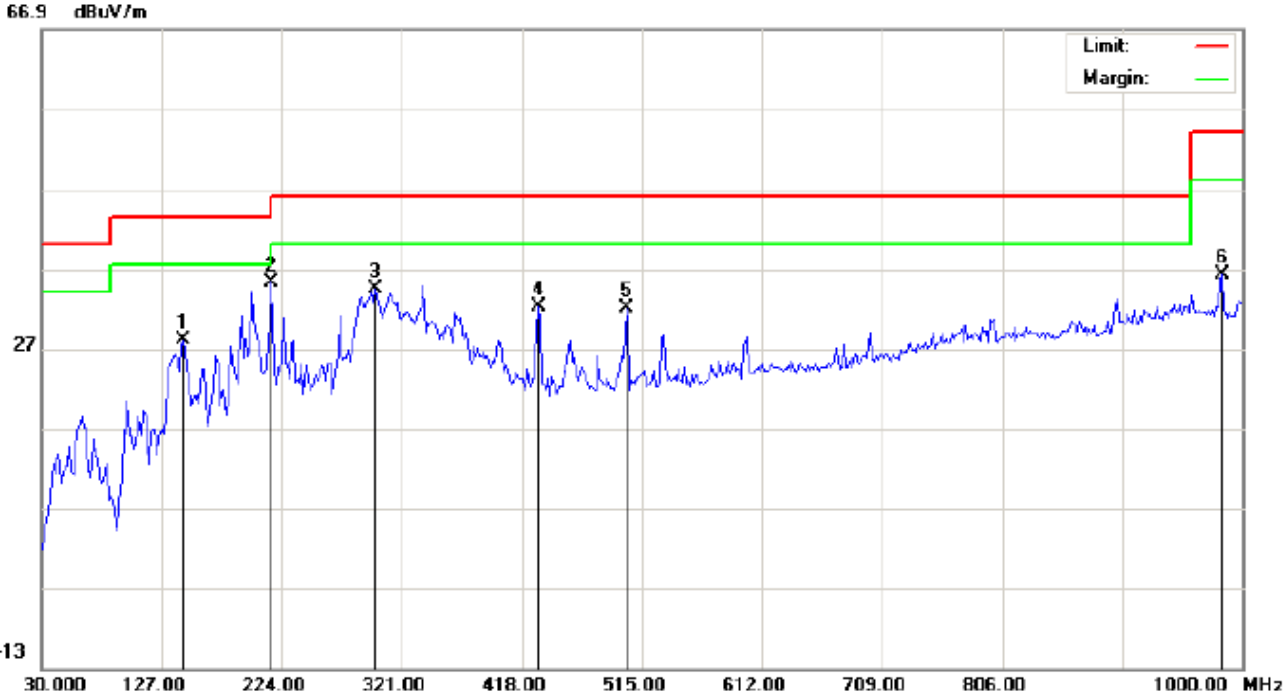

Site: site #1  
 Limit: FCC Class B 3M Radiation  
 EUT:Bluetooth audio transmitter  
 M/N:BTT005E  
 Mode:High Channel TX  
 Note:

Polarization: *Horizontal*  
 Power:  
 Distance:

Temperature: 22.7  
 Humidity: 56.5 %

No.	Mk	Freq.	Reading	Factor	Measurement	Limit	Over	Detector	Antenna Height	Table Degree	Comment
		MHz	dBuV	dB/m	dBuV/m	dBuV/m	dB		cm	degree	
1		144.7833	14.00	14.04	28.04	43.50	-15.46	peak			
2	*	215.9167	24.92	10.38	35.30	43.50	-8.20	peak			
3		299.9833	18.90	15.41	34.31	46.00	-11.69	peak			
4		430.9333	12.23	20.01	32.24	46.00	-13.76	peak			
5		502.0667	10.90	21.19	32.09	46.00	-13.91	peak			
6		983.8333	6.60	29.68	36.28	54.00	-17.72	peak			

RESULT: PASS

RADIATED EMISSION TEST- (30MHZ-1GHZ)-HIGH CHANNEL -VERTICAL

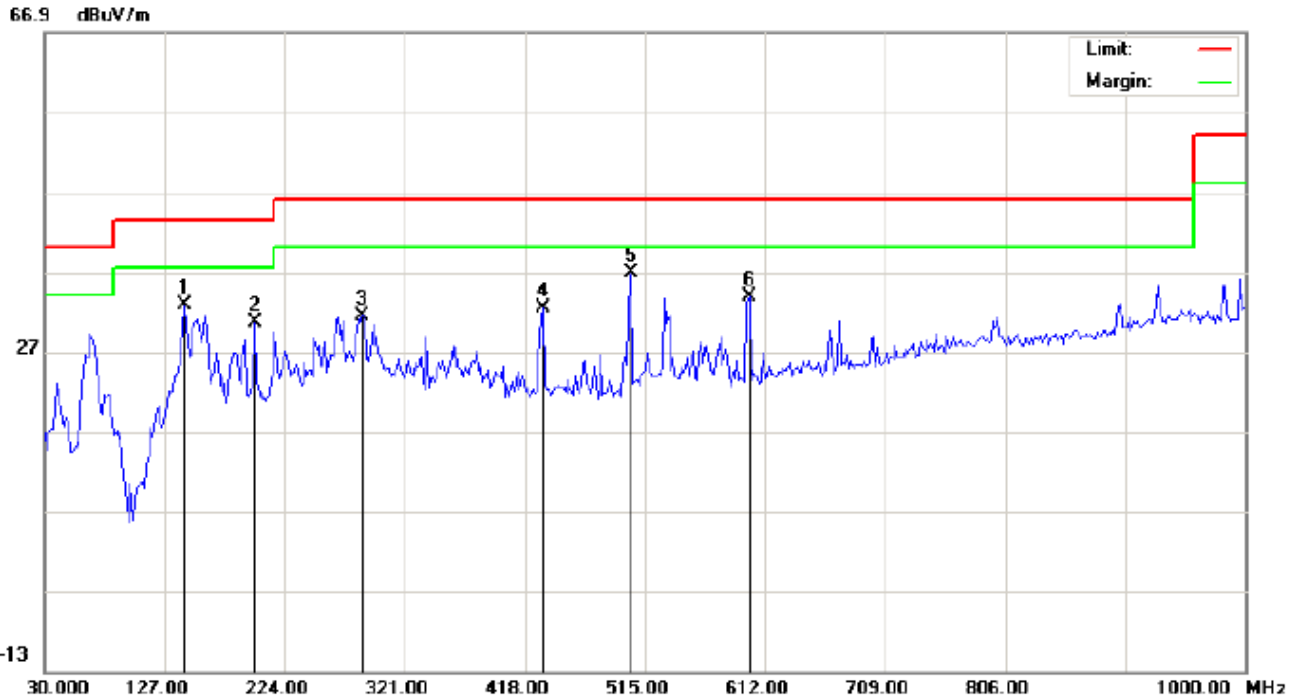

Site: site #1  
Limit: FCC Class B 3M Radiation  
EUT:Bluetooth audio transmitter  
M/N:BTT005E  
Mode:High Channel TX  
Note:

Polarization: *Vertical*  
Power:  
Distance:

Temperature: 22.7  
Humidity: 56.5 %

No.	Mk	Freq.	Reading	Factor	Measurement	Limit	Over	Detector	Antenna	Table	Comment
		MHz	dBuV	dB/m	dBuV/m	dBuV/m	dB		Height	Degree	
									cm	degree	
1		143.1667	17.53	15.22	32.75	43.50	-10.75	peak			
2		199.7500	21.45	9.06	30.51	43.50	-12.99	peak			
3		287.0500	16.48	15.02	31.50	46.00	-14.50	peak			
4		432.5500	12.34	20.06	32.40	46.00	-13.60	peak			
5	*	503.6833	15.53	21.23	36.76	46.00	-9.24	peak			
6		599.0667	11.10	22.73	33.83	46.00	-12.17	peak			

**RESULT: PASS**

**Note:** 1. Factor=Antenna Factor + Cable loss, Margin=Measurement-Limit.

2. The "Factor" value can be calculated automatically by software of measurement system.

**RADIATED EMISSION ABOVE 1GHZ**  
**(Worst modulation: GFSK)**  
**FOR BR/EDR**

**RADIATED EMISSION TEST- (ABOVE 1GHZ)-LOW CHANNEL-HORIZONTAL**

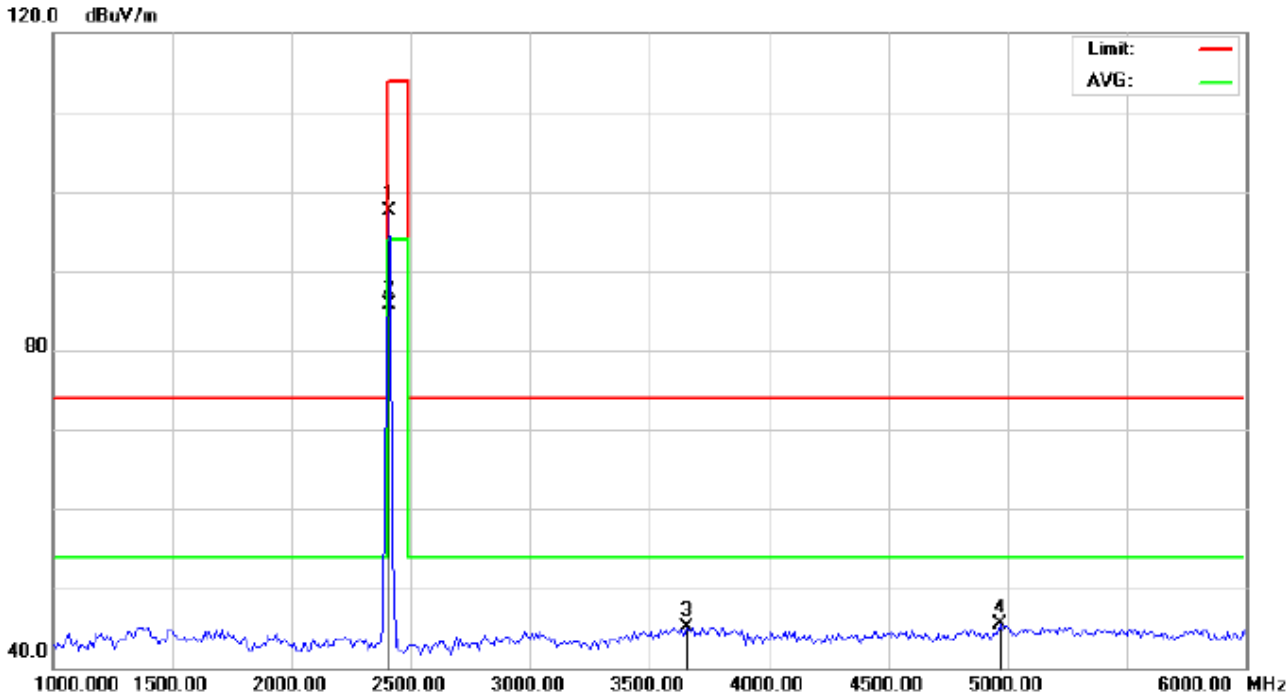

Site: Conduction	Polarization: <i>Horizontal</i>	Temperature: 26
Limit: FCC Class B 3M Radiation above 1GHZ(PK)-	Power:	Humidity: 60 %
EUT:Bluetooth audio transmitter	Distance: 3m	
M/N:BTT005E		
Mode: Low Channel TX		
Note:		

No.	Mk	Freq.	Reading	Factor	Measurement	Limit	Over	Detector	Antenna Height	Table Degree	Comment
		MHz	dBuV	dBuV/m	dBuV/m	dBuV/m	dB		cm	degree	
1		2402.000	107.23	-9.68	97.55	114.00	-16.45	peak			
2	*	2402.000	95.35	-9.68	85.67	94.00	-8.33	AVG	100	232	
3		3658.333	52.00	-6.91	45.09	74.00	-28.91	peak			
4		4966.667	47.31	-1.89	45.42	74.00	-28.58	peak			

**RESULT: PASS**

RADIATED EMISSION TEST- (ABOVE 1GHZ)-LOW CHANNEL- VERTICAL

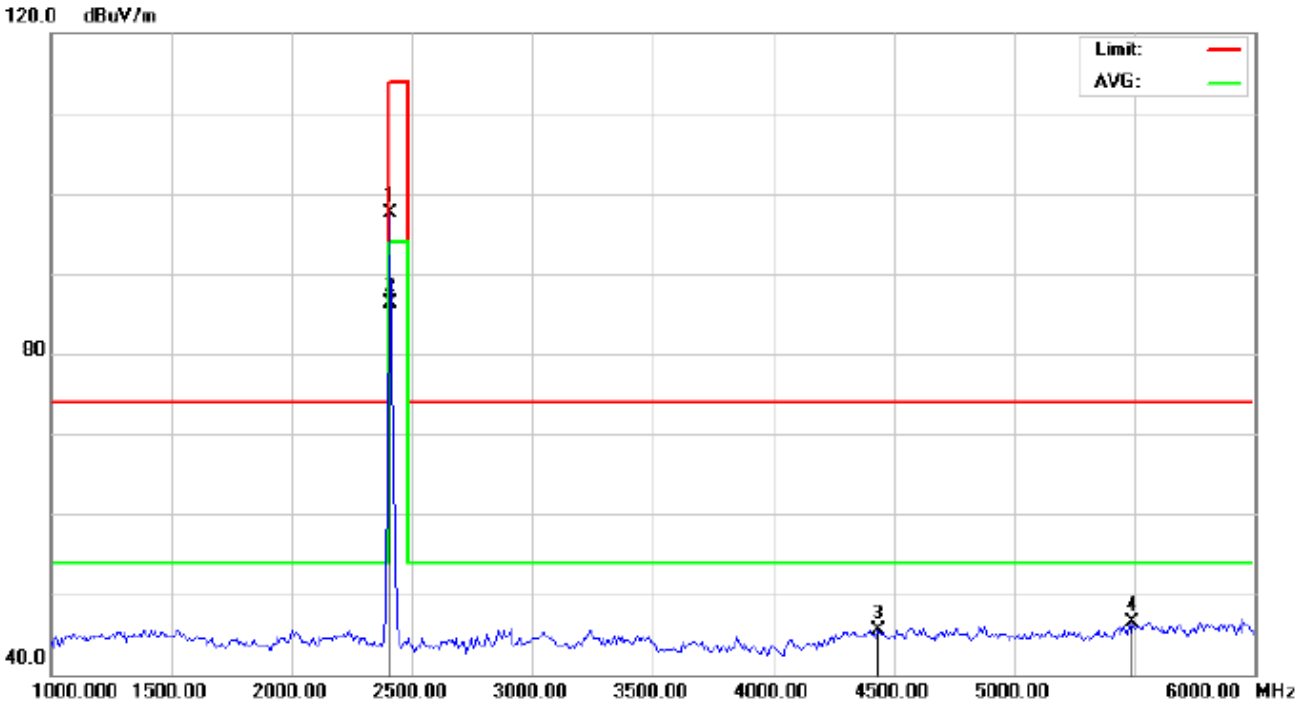

Site: Conduction Polarization: *Vertical* Temperature: 26  
 Limit: FCC Class B 3M Radiation above 1GHZ(PK)- Power: Humidity: 60 %  
 EUT:Bluetooth audio transmitter Distance: 3m  
 M/N:BTT005E  
 Mode: Low Channel TX  
 Note:

No.	Mk	Freq.	Reading	Factor	Measurement	Limit	Over	Detector	Antenna Height	Table Degree	Comment
		MHz	dBuV	dBuV/m	dBuV/m	dBuV/m	dB		cm	degree	
1		2402.000	107.27	-9.68	97.59	114.00	-16.41	peak			
2	*	2402.000	95.89	-9.68	86.21	94.00	-7.79	AVG	100	62	
3		4433.333	48.82	-3.34	45.48	74.00	-28.52	peak			
4		5491.667	48.26	-1.81	46.45	74.00	-27.55	peak			

**RESULT: PASS**

RADIATED EMISSION TEST- (ABOVE 1GHZ)-MIDDLE CHANNEL-HORIZONTAL

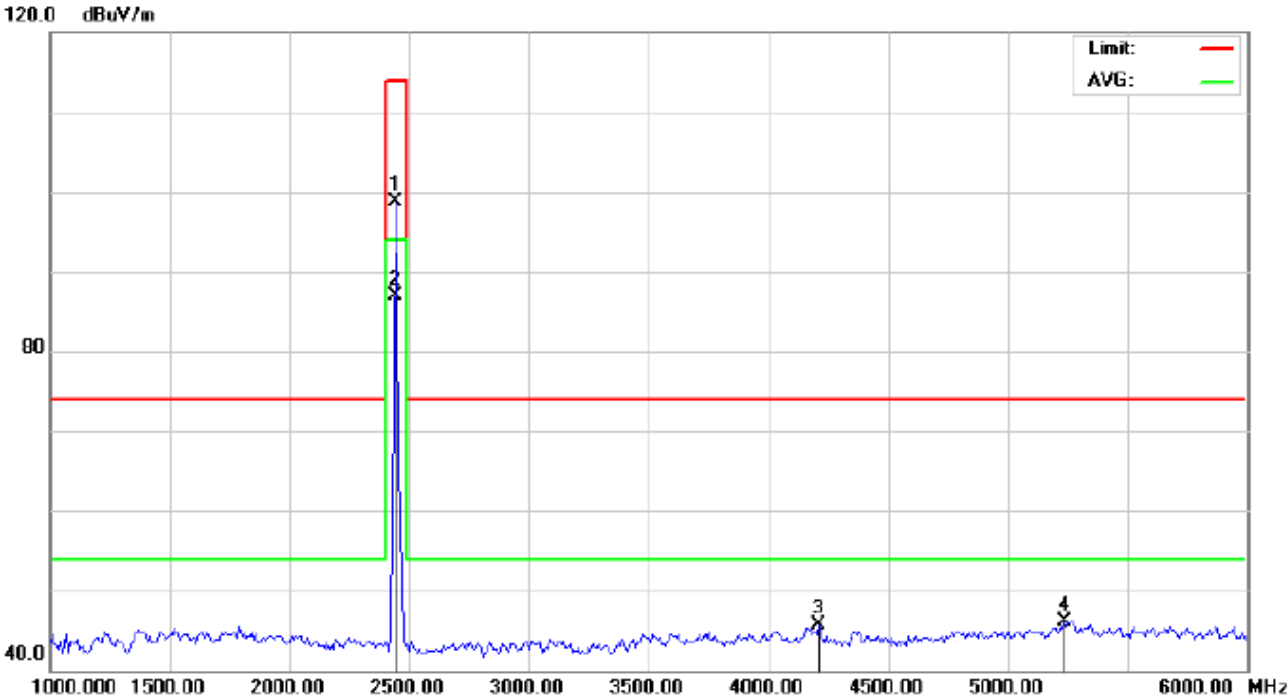

Site: Conduction Polarization: *Horizontal* Temperature: 26  
 Limit: FCC Class B 3M Radiation above 1GHZ(PK)- Power: Humidity: 60 %  
 EUT:Bluetooth audio transmitter Distance: 3m  
 M/N:BTT005E  
 Mode: Middle Channel TX  
 Note:

No.	Mk	Freq.	Reading	Factor	Measurement	Limit	Over	Detector	Antenna	Table	Comment
		MHz	dBuV	dBuV/m	dBuV/m	dBuV/m	dB		Height	Degree	
									cm	degree	
1		2441.000	108.29	-9.63	98.66	114.00	-15.34	peak			
2	*	2441.000	96.51	-9.63	86.88	94.00	-7.12	AVG	150	210	
3		4208.333	49.71	-4.10	45.61	74.00	-28.39	peak			
4		5233.333	47.87	-1.80	46.07	74.00	-27.93	peak			

RESULT: PASS

RADIATED EMISSION TEST- (ABOVE 1GHZ)-MIDDLE CHANNEL- VERTICAL

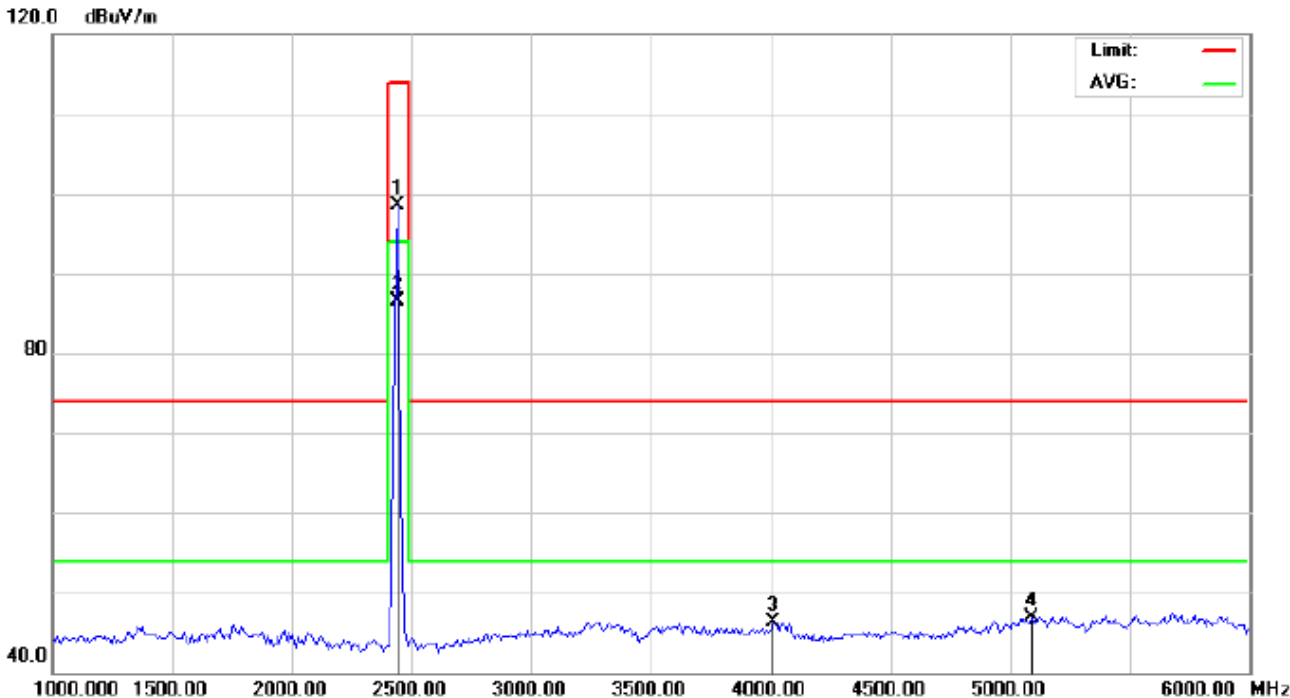

Site: Conduction Polarization: *Vertical* Temperature: 26  
 Limit: FCC Class B 3M Radiation above 1GHZ(PK)- Power: Humidity: 60 %  
 EUT:Bluetooth audio transmitter Distance: 3m  
 M/N:BTT005E  
 Mode: Middle Channel TX  
 Note:

No.	Mk	Freq.	Reading	Factor	Measurement	Limit	Over	Detector	Antenna Height	Table Degree	Comment
		MHz	dBuV	dBuV/m	dBuV/m	dBuV/m	dB		cm	degree	
1		2441.000	108.23	-9.63	98.60	114.00	-15.40	peak			
2	*	2441.000	96.09	-9.63	86.46	94.00	-7.54	AVG	150	121	
3		4008.333	51.03	-4.78	46.25	74.00	-27.75	peak			
4		5091.667	48.72	-1.80	46.92	74.00	-27.08	peak			

**RESULT: PASS**



RADIATED EMISSION TEST- (ABOVE 1GHZ)-HIGH CHANNEL-HORIZONTAL

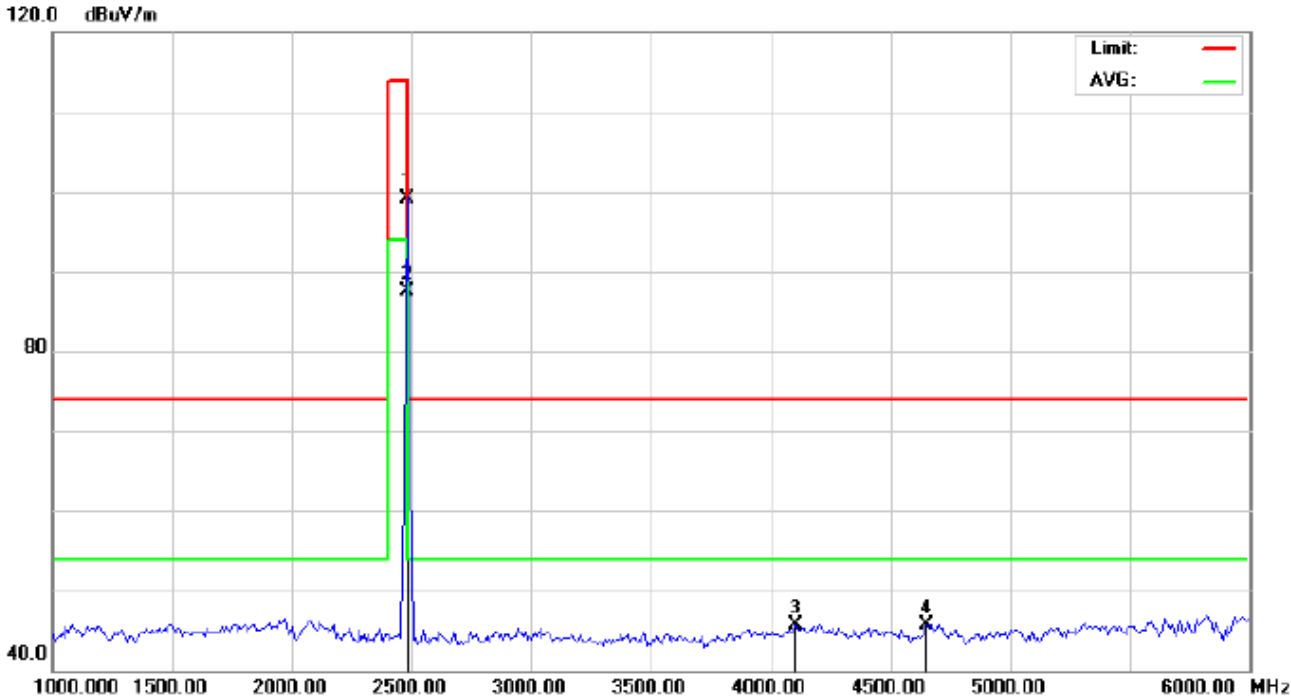

Site: Conduction Polarization: *Horizontal* Temperature: 26  
 Limit: FCC Class B 3M Radiation above 1GHZ(PK)- Power: Humidity: 60 %  
 EUT:Bluetooth audio transmitter Distance: 3m  
 M/N:BTT005E  
 Mode: High Channel TX  
 Note:

No.	Mk	Freq.	Reading	Factor	Measurement	Limit	Over	Detector	Antenna Height	Table Degree	Comment
		MHz	dBuV	dBuV/m	dBuV/m	dBuV/m	dB		cm	degree	
1		2480.000	108.71	-9.59	99.12	114.00	-14.88	peak			
2	*	2480.000	97.02	-9.59	87.43	94.00	-6.57	AVG	100	203	
3		4100.000	50.16	-4.47	45.69	74.00	-28.31	peak			
4		4650.000	48.52	-2.72	45.80	74.00	-28.20	peak			

**RESULT: PASS**

RADIATED EMISSION TEST- (ABOVE 1GHZ)-HIGH CHANNEL- VERTICAL

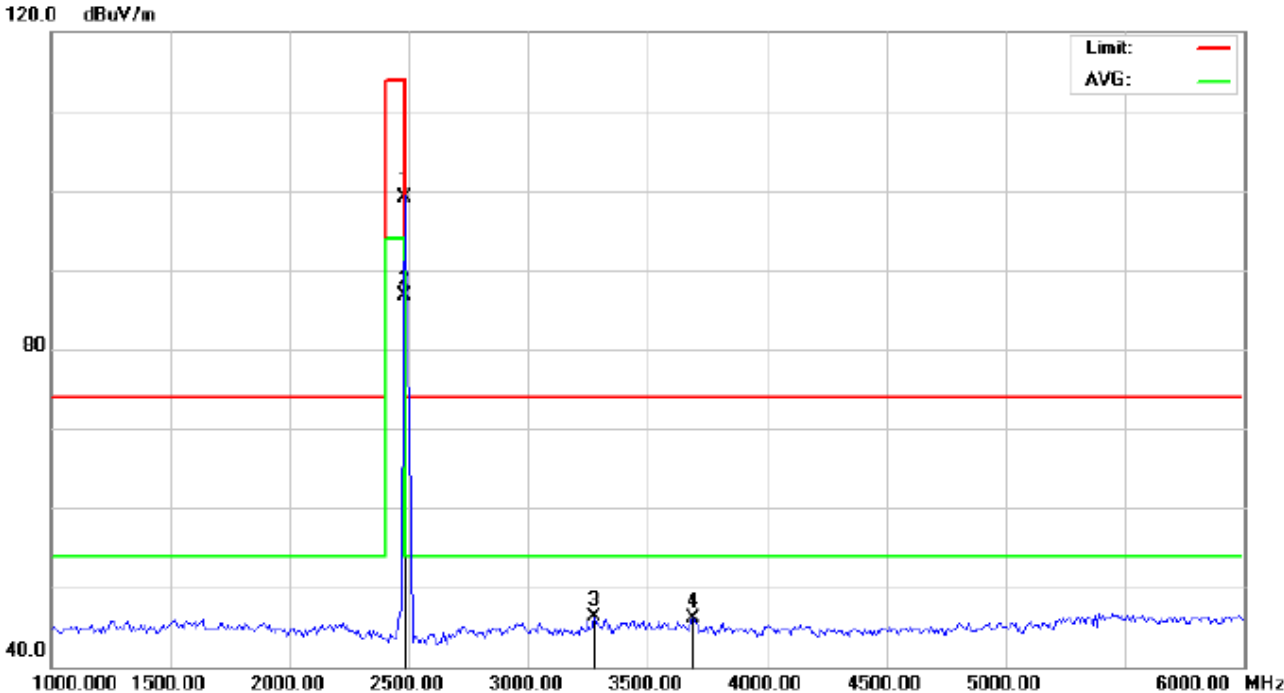

Site: Conduction Polarization: *Vertical* Temperature: 26  
 Limit: FCC Class B 3M Radiation above 1GHZ(PK)- Power: Humidity: 60 %  
 EUT:Bluetooth audio transmitter Distance: 3m  
 M/N:BTT005E  
 Mode: High Channel TX  
 Note:

No.	Mk	Freq.	Reading	Factor	Measurement	Limit	Over	Detector	Antenna Height	Table Degree	Comment
		MHz	dBuV	dBuV/m	dBuV/m	dBuV/m	dB		cm	degree	
1		2480.000	108.66	-9.59	99.07	114.00	-14.93	peak			
2	*	2480.000	96.26	-9.59	86.67	94.00	-7.33	AVG	100	249	
3		3275.000	54.48	-8.10	46.38	74.00	-27.62	peak			
4		3691.667	52.81	-6.71	46.10	74.00	-27.90	peak			

**RESULT: PASS**

**Note:** 6~25GHz at least have 20dB margin. No recording in the test report.  
 Factor=Antenna Factor + Cable loss - Amplifier gain, Margin=Measurement-Limit.  
 The "Factor" value can be calculated automatically by software of measurement system.

**Field strength of the fundamental signal**

**1Mbps Result:**

**Peak value**

Frequency	Reading Level	Factor	Measurement	Limit	Over	Antenna
(MHz)	(dBuv)	(dB/m)	(dBuv/m)	(dBuv/m)	(dB)	Polarization
2402	107.23	-9.68	97.55	114	-16.45	Horizontal
2402	107.27	-9.68	97.59	114	-16.41	Vertical
2441	108.29	-9.63	98.66	114	-15.34	Horizontal
2441	108.23	-9.63	98.60	114	-15.40	Vertical
2480	108.71	-9.59	99.12	114	-14.88	Horizontal
2480	108.66	-9.59	99.07	114	-14.93	Vertical

**Average value**

Frequency	Reading Level	Factor	Measurement	Limit	Over	Antenna
(MHz)	(dBuv)	(dB/m)	(dBuv/m)	(dBuv/m)	(dB)	Polarization
2402	95.35	-9.68	85.67	94	-8.33	Horizontal
2402	95.89	-9.68	86.21	94	-7.79	Vertical
2441	96.51	-9.63	86.88	94	-7.12	Horizontal
2441	96.09	-9.63	86.46	94	-7.45	Vertical
2480	97.02	-9.59	87.43	94	-6.57	Horizontal
2480	96.26	-9.59	86.67	94	-7.33	Vertical

**2Mbps Result:****Peak value**

Frequency	Reading Level	Factor	Measurement	Limit	Over	Antenna
(MHz)	(dBuv)	(dB/m)	(dBuv/m)	(dBuv/m)	(dB)	Polarization
2402	106.53	-9.68	96.85	114	-17.15	Horizontal
2402	106.44	-9.68	96.76	114	-17.24	Vertical
2441	107.66	-9.63	98.03	114	-15.97	Horizontal
2441	107.74	-9.63	98.11	114	-15.89	Vertical
2480	108.11	-9.59	98.52	114	-15.48	Horizontal
2480	108.03	-9.59	98.44	114	-15.56	Vertical

**Average value**

Frequency	Reading Level	Factor	Measurement	Limit	Over	Antenna
(MHz)	(dBuv)	(dB/m)	(dBuv/m)	(dBuv/m)	(dB)	Polarization
2402	93.57	-9.68	83.89	94	-10.11	Horizontal
2402	94.95	-9.68	85.27	94	-8.73	Vertical
2441	95.92	-9.63	86.29	94	-7.71	Horizontal
2441	96.11	-9.63	86.48	94	-7.52	Vertical
2480	95.84	-9.59	86.25	94	-7.75	Horizontal
2480	95.52	-9.59	85.93	94	-8.07	Vertical

**3Mbps Result:****Peak value**

Frequency	Reading Level	Factor	Measurement	Limit	Over	Antenna
(MHz)	(dBuv)	(dB/m)	(dBuv/m)	(dBuv/m)	(dB)	Polarization
2402	105.71	-9.68	96.03	114	-17.97	Horizontal
2402	105.83	-9.68	96.15	114	-17.85	Vertical
2441	107.17	-9.63	97.54	114	-16.46	Horizontal
2441	107.26	-9.63	97.63	114	-16.37	Vertical
2480	107.47	-9.59	97.88	114	-16.12	Horizontal
2480	107.35	-9.59	97.76	114	-16.24	Vertical

**Average value**

Frequency	Reading Level	Factor	Measurement	Limit	Over	Antenna
(MHz)	(dBuv)	(dB/m)	(dBuv/m)	(dBuv/m)	(dB)	Polarization
2402	94.97	-9.68	85.29	94	-8.71	Horizontal
2402	95.2	-9.68	85.52	94	-8.48	Vertical
2441	94.96	-9.63	85.33	94	-8.67	Horizontal
2441	94.49	-9.63	84.86	94	-9.14	Vertical
2480	94.52	-9.59	84.93	94	-9.07	Horizontal
2480	95.96	-9.59	86.37	94	-7.63	Vertical

## 9. BAND EDGE EMISSION

### 9.1. MEASUREMENT PROCEDURE

- 1The EUT operates at hopping-off test mode. The lowest or highest channels are tested to verify the largest transmission and spurious emissions power at the continuous transmission mode.
- 2Max hold the trace of the setp 1,and the EUT operates at hopping-on test mode to verify the largest spurious emissions power.
- 3Set the spectrum analyzer in the following setting in order to capture the lower and upper band-edges of the emission

### 9.2 TEST SETUP

RADIATED EMISSION TEST SETUP

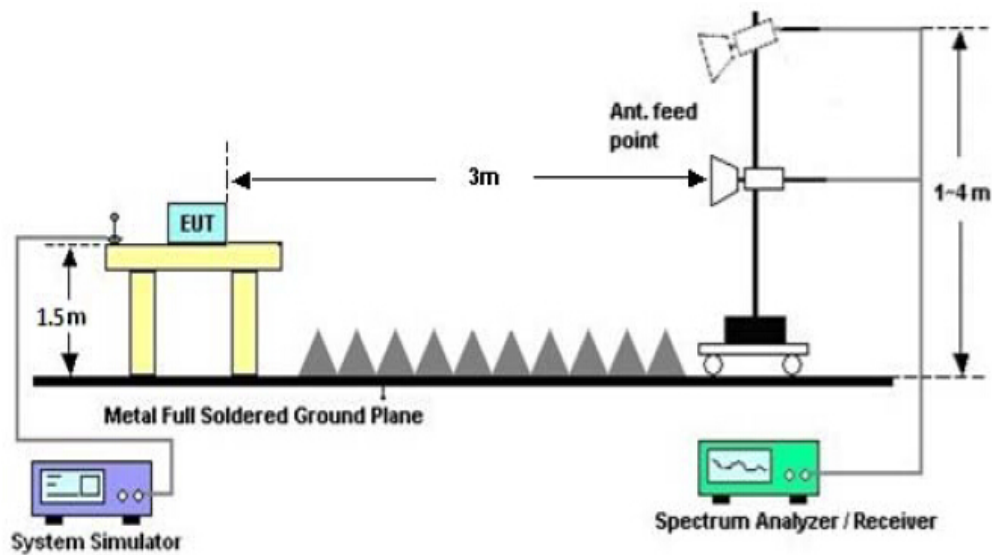

**9.3 RADIATED TEST RESULT**  
**(Worst modulation: GFSK)**  
**FOR BR/EDR**

TEST PLOT OF BAND EDGE FOR LOW CHANNEL-Horizontal

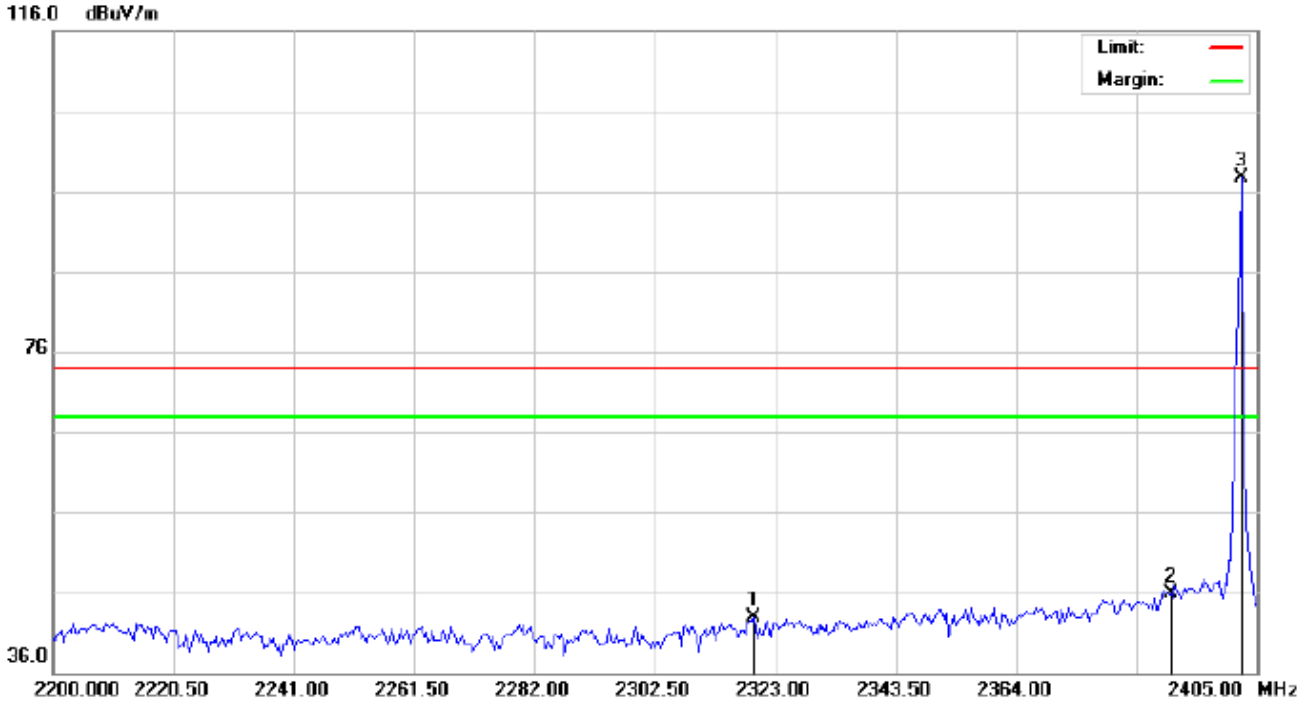

Site: Conduction Polarization: *Horizontal* Temperature: 26  
 Limit: FCC Class B 3M Radiation above 1GHZ(PK) Power: Humidity: 60 %  
 EUT:Bluetooth audio transmitter Distance:  
 M/N:BTT005E  
 Mode: Low Channel TX  
 Note:

No.	Mk	Freq.	Reading	Factor	Measurement	Limit	Over	Detector	Antenna Height	Table Degree	Comment
		MHz	dBuV	dBuV/m	dBuV/m	dBuV/m	dB		cm	degree	
1		2319.242	32.75	10.23	42.98	74.00	-31.02	peak			
2		2390.000	35.62	10.31	45.93	74.00	-28.07	peak			
3	*	2402.000	87.41	10.32	97.73	74.00	23.73	peak			

TEST PLOT OF BAND EDGE FOR LOW CHANNEL -Vertical

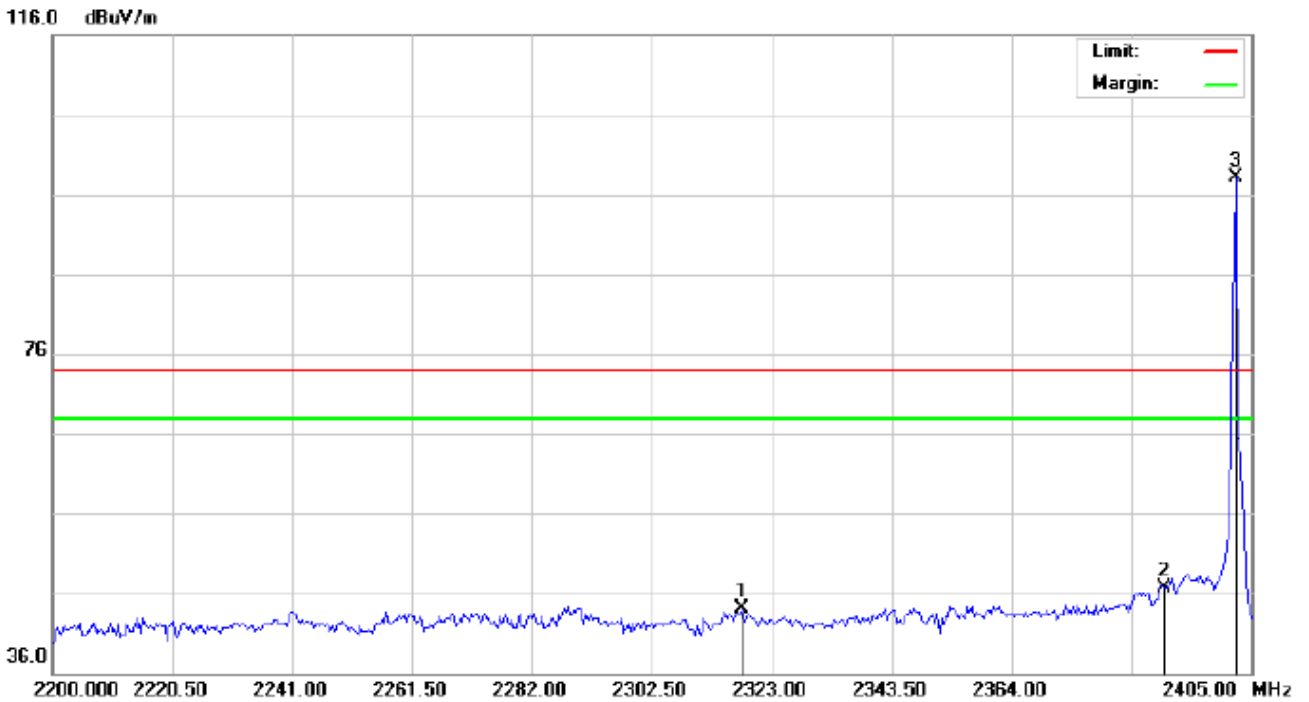

Site: Conduction Polarization: *Vertical* Temperature: 26  
 Limit: FCC Class B 3M Radiation above 1GHZ(PK) Power: Humidity: 60 %  
 EUT:Bluetooth audio transmitter Distance:  
 M/N:BTT005E  
 Mode: Low Channel TX  
 Note:

No.	Mk	Freq.	Reading	Factor	Measurement	Limit	Over	Detector	Antenna Height	Table Degree	Comment
		MHz	dBuV	dBuV/m	dBuV/m	dBuV/m	dB		cm	degree	
1		2317.875	33.91	10.23	44.14	74.00	-29.86	peak			
2		2390.000	36.35	10.31	46.66	74.00	-27.34	peak			
3	*	2402.000	87.76	10.32	98.08	74.00	24.08	peak			



TEST PLOT OF BAND EDGE FOR HIGH CHANNEL -Horizontal

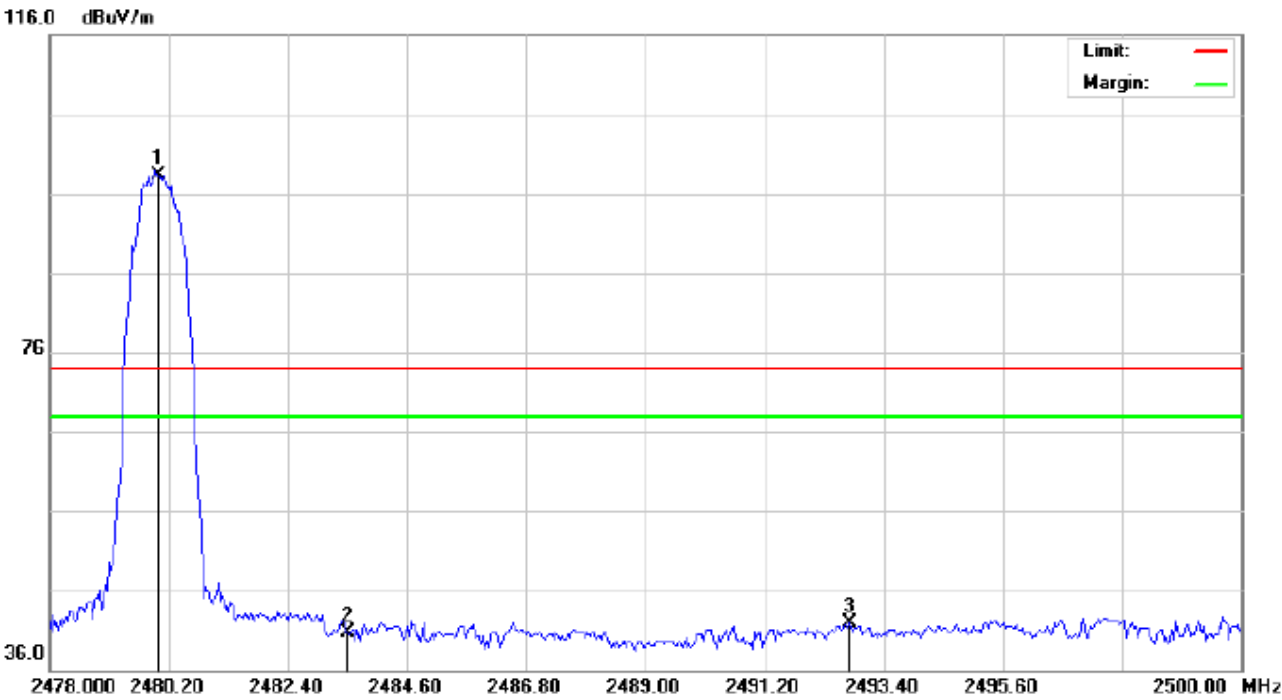

Site: Conduction                                      Polarization: **Horizontal**                                      Temperature: 26  
Limit: FCC Class B 3M Radiation above 1GHZ(PK)      Power:    Humidity: 60 %  
EUT:Bluetooth audio transmitter                                      Distance:  
M/N:BTT005E  
Mode: High Channel TX  
Note:

No.	Mk	Freq.	Reading	Factor	Measurement	Limit	Over	Detector	Antenna Height	Table Degree	Comment
		MHz	dBuV	dBuV/m	dBuV/m	dBuV/m	dB		cm	degree	
1	*	2480.000	87.96	10.41	98.37	74.00	24.37	peak			
2		2483.500	30.25	10.41	40.66	74.00	-33.34	peak			
3		2492.777	31.40	10.42	41.82	74.00	-32.18	peak			

TEST PLOT OF BAND EDGE FOR HIGH CHANNEL-Vertical

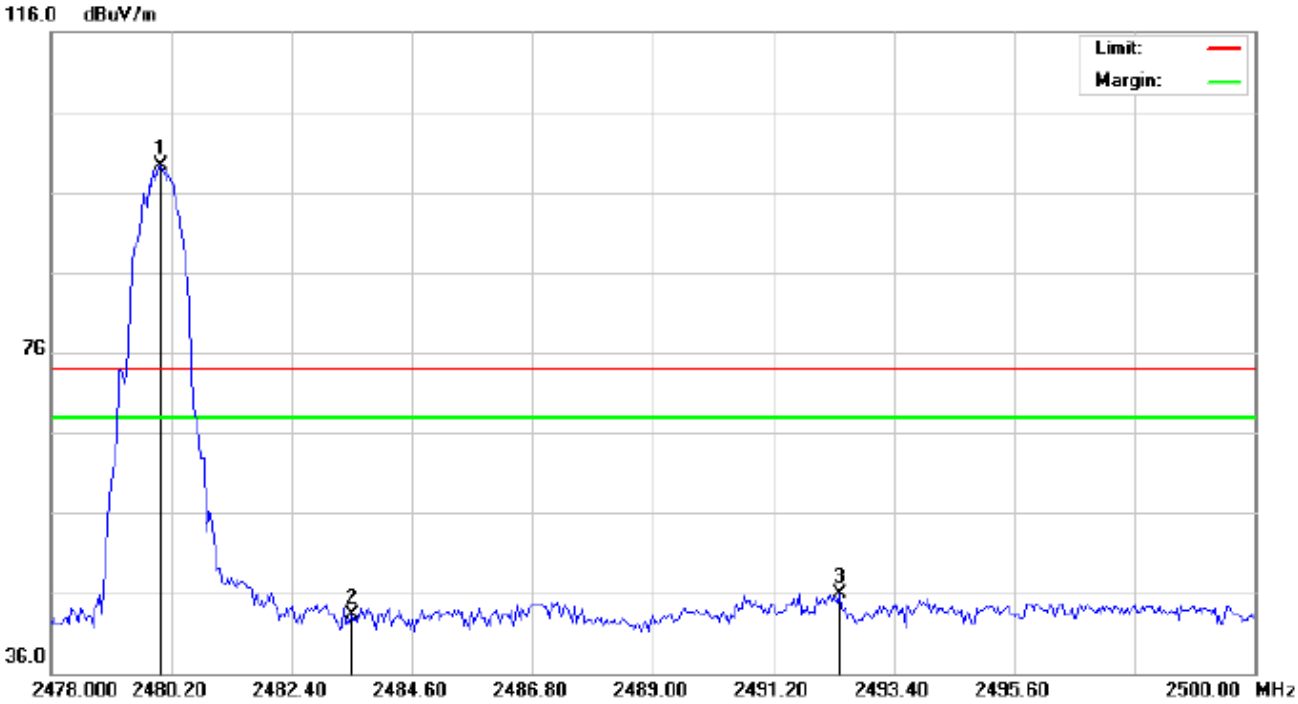

Site: Conduction      Polarization: *Vertical*      Temperature: 26  
 Limit: FCC Class B 3M Radiation above 1GHZ(PK)      Power:      Humidity: 60 %  
 EUT:Bluetooth audio transmitter      Distance:  
 M/N:BTT005E  
 Mode: High Channel TX  
 Note:

No.	Mk	Freq.	Reading	Factor	Measurement	Limit	Over	Detector	Antenna Height	Table Degree	Comment
		MHz	dBuV	dBuV/m	dBuV/m	dBuV/m	dB		cm	degree	
1	*	2480.000	88.85	10.41	99.26	74.00	25.26	peak			
2		2483.500	32.87	10.41	43.28	74.00	-30.72	peak			
3		2492.410	35.41	10.42	45.83	74.00	-28.17	peak			

**RESULT: PASS**

**Note:** The other modes radiation emission have enough 20dB margin.  
 Factor=Antenna Factor + Cable loss - Amplifier gain, Over=Measure-Limit.  
 The "Factor" value can be calculated automatically by software of measurement system.

## 10. 20DB BANDWIDTH

### 10.1. MEASUREMENT PROCEDURE

1. Connect EUT RF output port to the Spectrum Analyzer through an RF attenuator
2. Set the EUT Work on the top, the middle and the bottom operation frequency individually.
3. Set Span = approximately 2 to 3 times the 20 dB bandwidth, centered on a hopping channel  
 $RBW \geq 1\%$  of the 20 dB bandwidth,  $VBW \geq RBW$ ; Sweep = auto; Detector function = peak
4. Set SPA Trace 1 Max hold, then View.

### 10.2. TEST SET-UP

(BLOCK DIAGRAM OF CONFIGURATION)

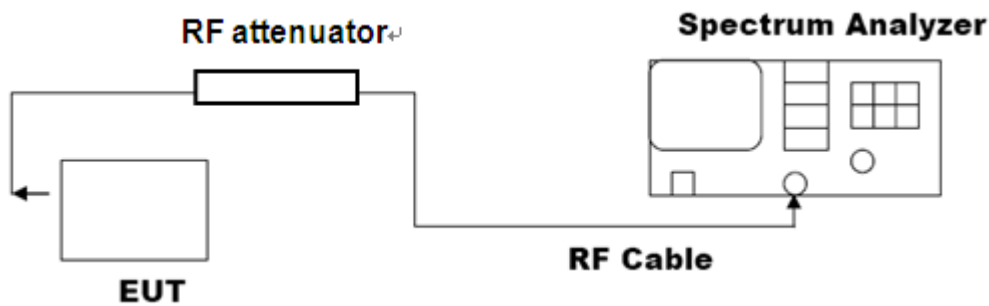

Note: The EUT has been used temporary antenna connector for testing.

### 10.3. LIMITS AND MEASUREMENT RESULTS

FOR BR/EDR

BLUETOOTH 1MBPS LIMITS AND MEASUREMENT RESULT			
Applicable Limits	Measurement Result		
	Test Data (MHz)		Criteria
N/A	Low Channel	1.108	PASS
	Middle Channel	1.103	PASS
	High Channel	1.098	PASS

TEST PLOT OF BANDWIDTH FOR LOW CHANNEL

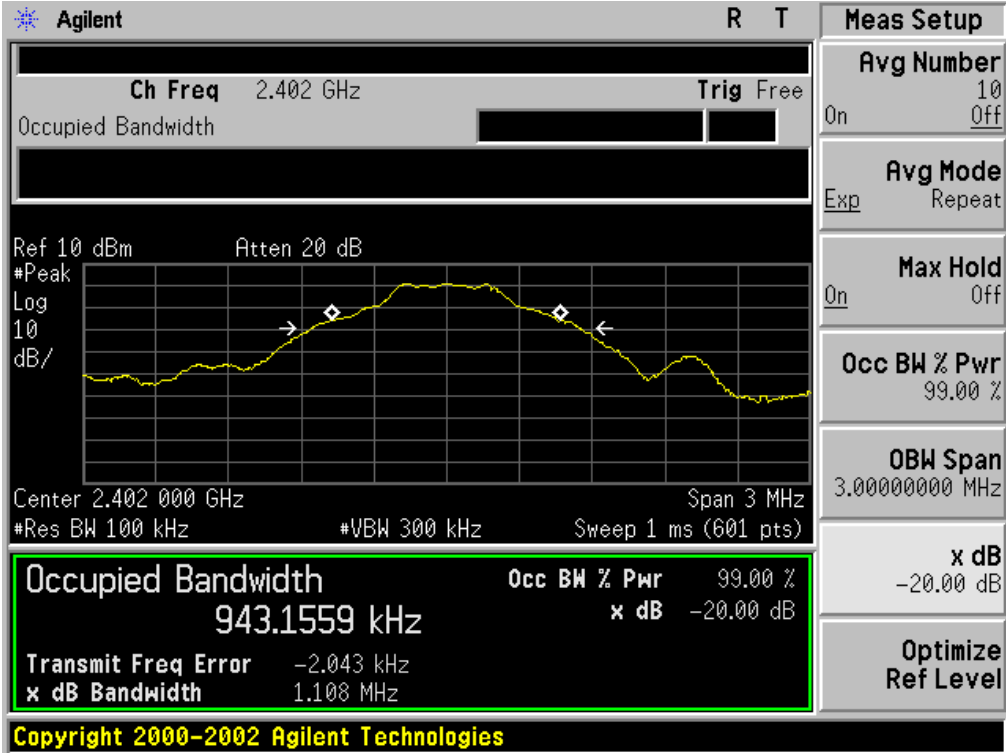

TEST PLOT OF BANDWIDTH FOR MIDDLE CHANNEL

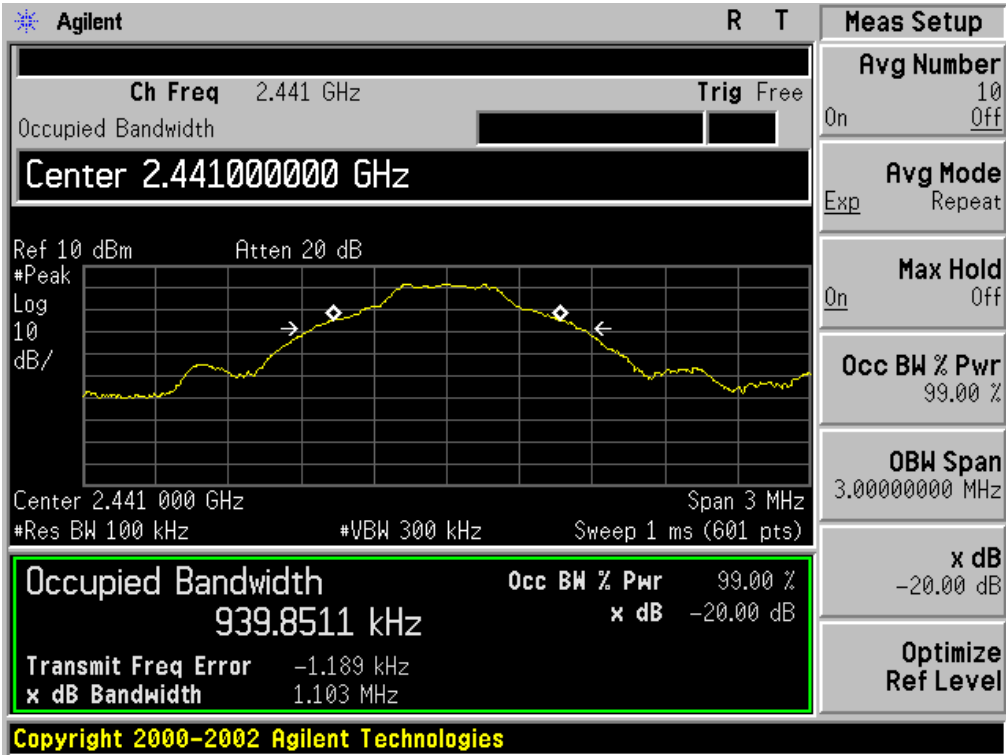

TEST PLOT OF BANDWIDTH FOR HIGH CHANNEL

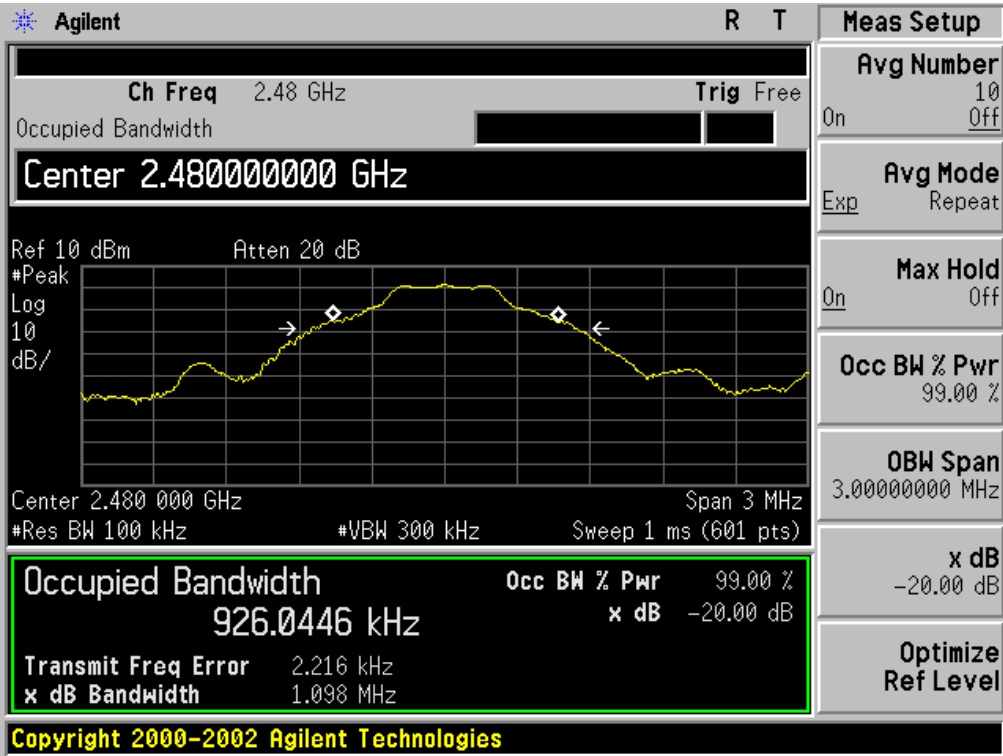

BLUETOOTH 2MBPS LIMITS AND MEASUREMENT RESULT			
Applicable Limits	Measurement Result		
	Test Data (MHz)		Criteria
N/A	Low Channel	1.390	PASS
	Middle Channel	1.391	PASS
	High Channel	1.374	PASS

TEST PLOT OF BANDWIDTH FOR LOW CHANNEL

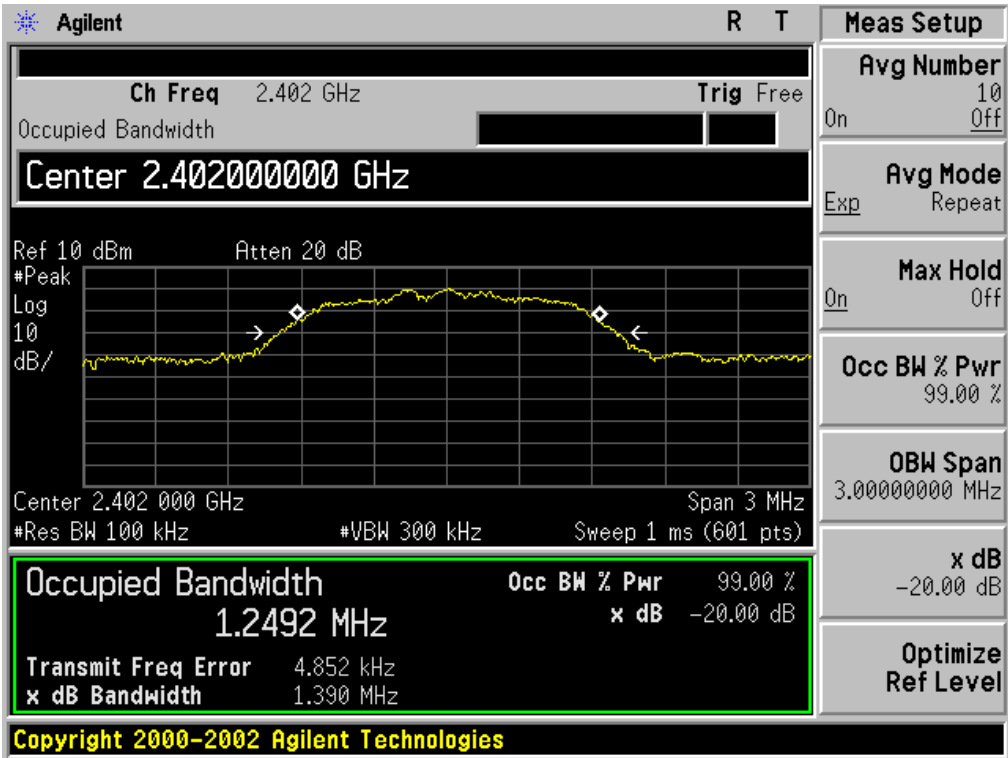

TEST PLOT OF BANDWIDTH FOR MIDDLE CHANNEL

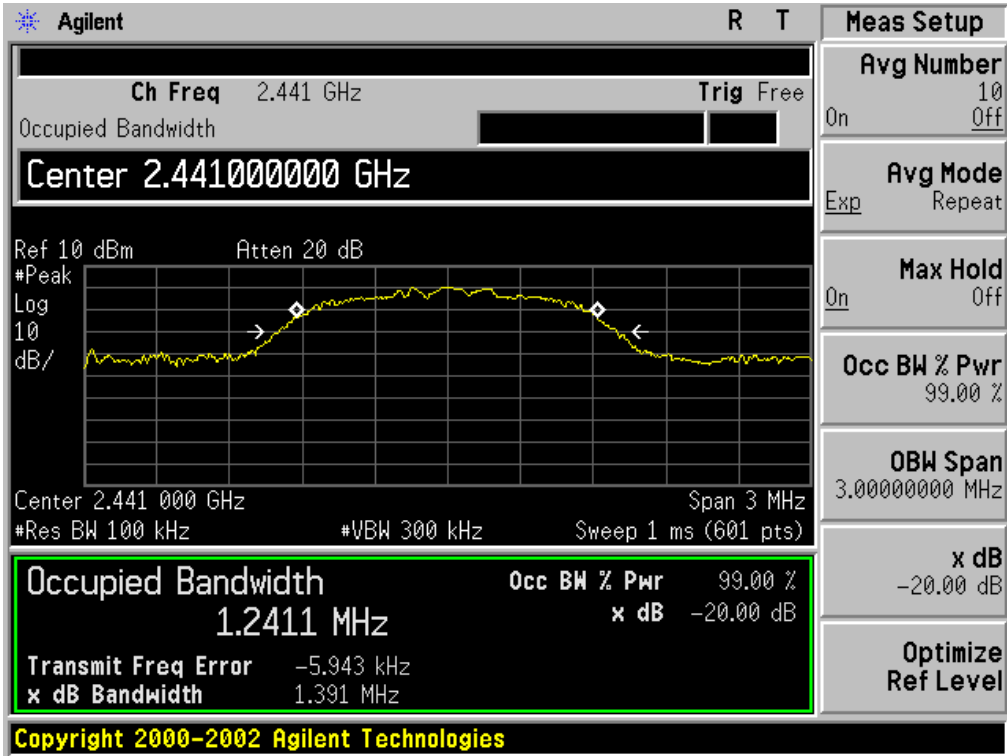

TEST PLOT OF BANDWIDTH FOR HIGH CHANNEL

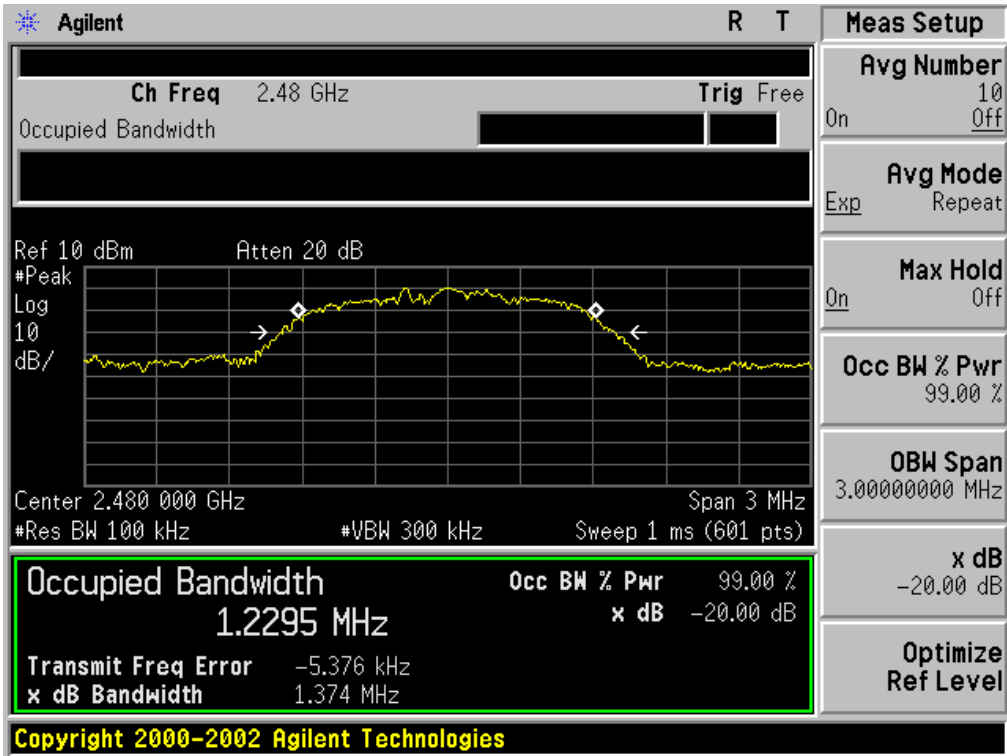

BLUETOOTH 3MBPS LIMITS AND MEASUREMENT RESULT			
Applicable Limits	Measurement Result		
	Test Data (MHz)		Criteria
N/A	Low Channel	1.406	PASS
	Middle Channel	1.388	PASS
	High Channel	1.388	PASS

TEST PLOT OF BANDWIDTH FOR LOW CHANNEL

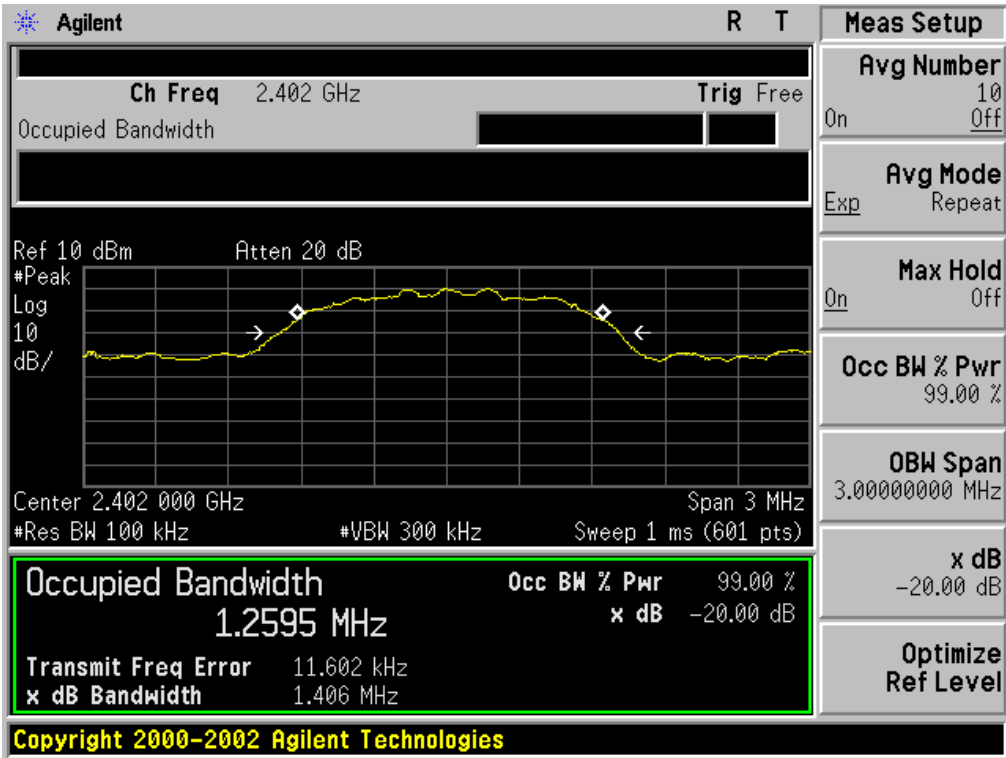



TEST PLOT OF BANDWIDTH FOR MIDDLE CHANNEL

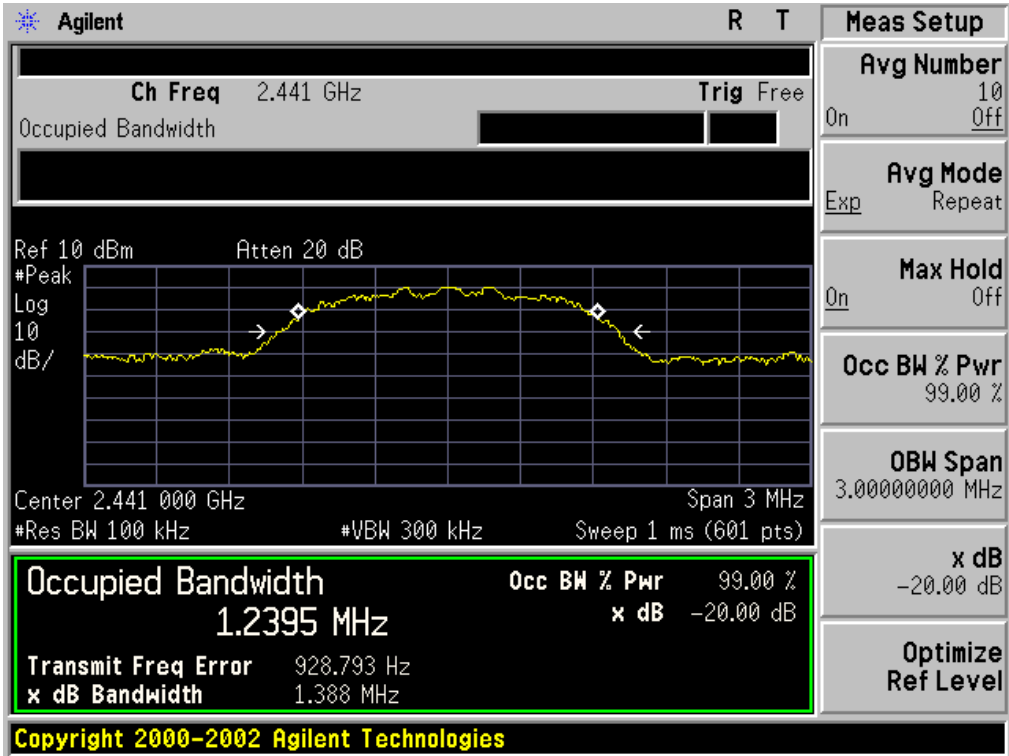

TEST PLOT OF BANDWIDTH FOR HIGH CHANNEL

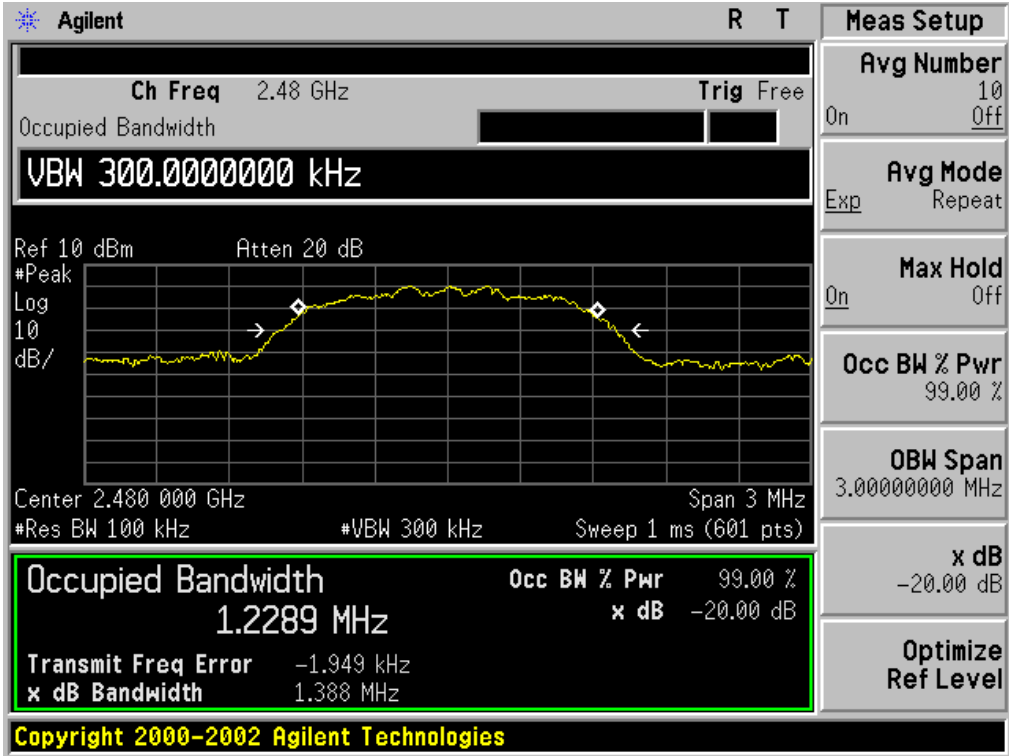

**11. FCC LINE CONDUCTED EMISSION TEST**

**11.1. LIMITS OF LINE CONDUCTED EMISSION TEST**

Frequency	Maximum RF Line Voltage	
	Q.P.( dBuV)	Average( dBuV)
150kHz~500kHz	66-56	56-46
500kHz~5MHz	56	46
5MHz~30MHz	60	50

Note:

1. The lower limit shall apply at the transition frequency.
2. The limit decreases linearly with the logarithm of the frequency in the range 0.15 MHz to 0.50 MHz.

**11.2. BLOCK DIAGRAM OF LINE CONDUCTED EMISSION TEST**

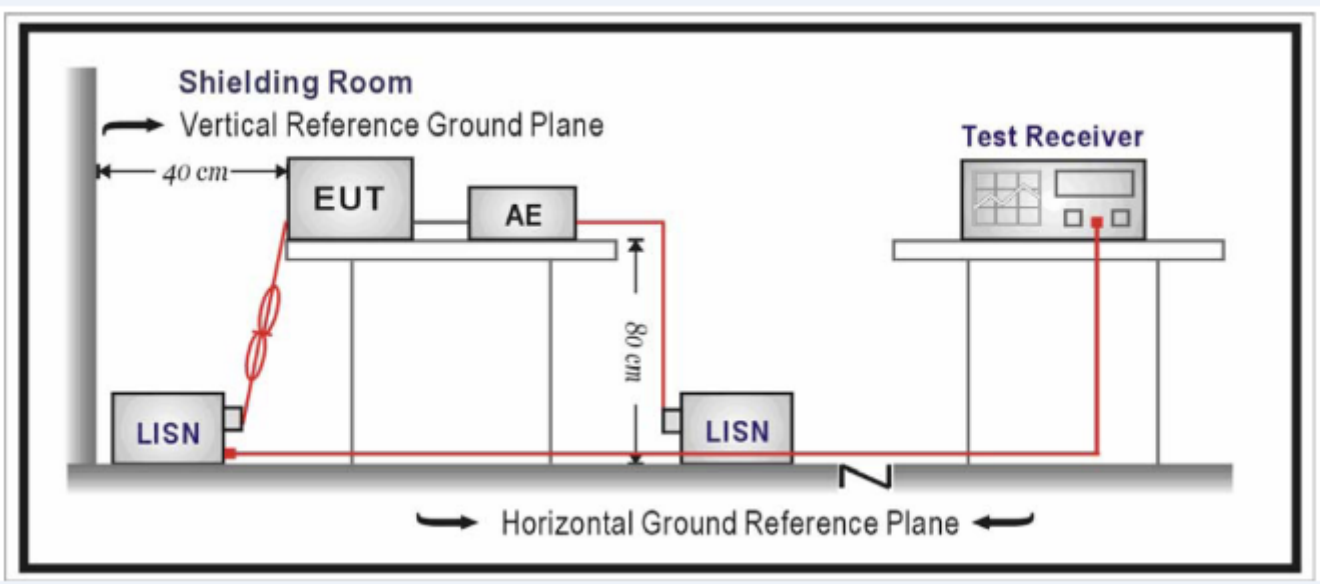

### 11.3. PRELIMINARY PROCEDURE OF LINE CONDUCTED EMISSION TEST

1. The equipment was set up as per the test configuration to simulate typical actual usage per the user's manual. When the EUT is a tabletop system, a wooden table with a height of 0.8 meters is used and is placed on the ground plane as per ANSI C63.10 (see Test Facility for the dimensions of the ground plane used). When the EUT is a floor-standing equipment, it is placed on the ground plane which has a 3-12 mm non-conductive covering to insulate the EUT from the ground plane.
2. Support equipment, if needed, was placed as per ANSI C63.10.
3. All I/O cables were positioned to simulate typical actual usage as per ANSI C63.10.
4. All support equipments received AC120V/60Hz power from a LISN, if any.
5. The EUT received DC voltage by adapter or PC which received 120V/60Hz power by a LISN.
6. The test program was started. Emissions were measured on each current carrying line of the EUT using a spectrum Analyzer / Receiver connected to the LISN powering the EUT. The LISN has two monitoring points: Line 1 (Hot Side) and Line 2 (Neutral Side). Two scans were taken: one with Line 1 connected to Analyzer / Receiver and Line 2 connected to a 50 ohm load; the second scan had Line 1 connected to a 50 ohm load and Line 2 connected to the Analyzer / Receiver.
7. Analyzer / Receiver scanned from 150 kHz to 30MHz for emissions in each of the test modes.
8. During the above scans, the emissions were maximized by cable manipulation.
9. The test mode(s) were scanned during the preliminary test.

Then, the EUT configuration and cable configuration of the above highest emission level were recorded for reference of final testing.

### 11.4. FINAL PROCEDURE OF LINE CONDUCTED EMISSION TEST

- EUT and support equipment was set up on the test bench as per step 2 of the preliminary test.
2. A scan was taken on both power lines, Line 1 and Line 2, recording at least the six highest emissions. Emission frequency and amplitude were recorded into a computer in which correction factors were used to calculate the emission level and compare reading to the applicable limit. If EUT emission level was less -2dB to the A.V. limit in Peak mode, then the emission signal was re-checked using Q.P and Average detector.
3. The test data of the worst case condition(s) was reported on the Summary Data page.

**11.5. TEST RESULT OF LINE CONDUCTED EMISSION TEST**

**By adapter(worst case)  
 FOR BR/EDR**

Line Conducted Emission Test Line 1-L

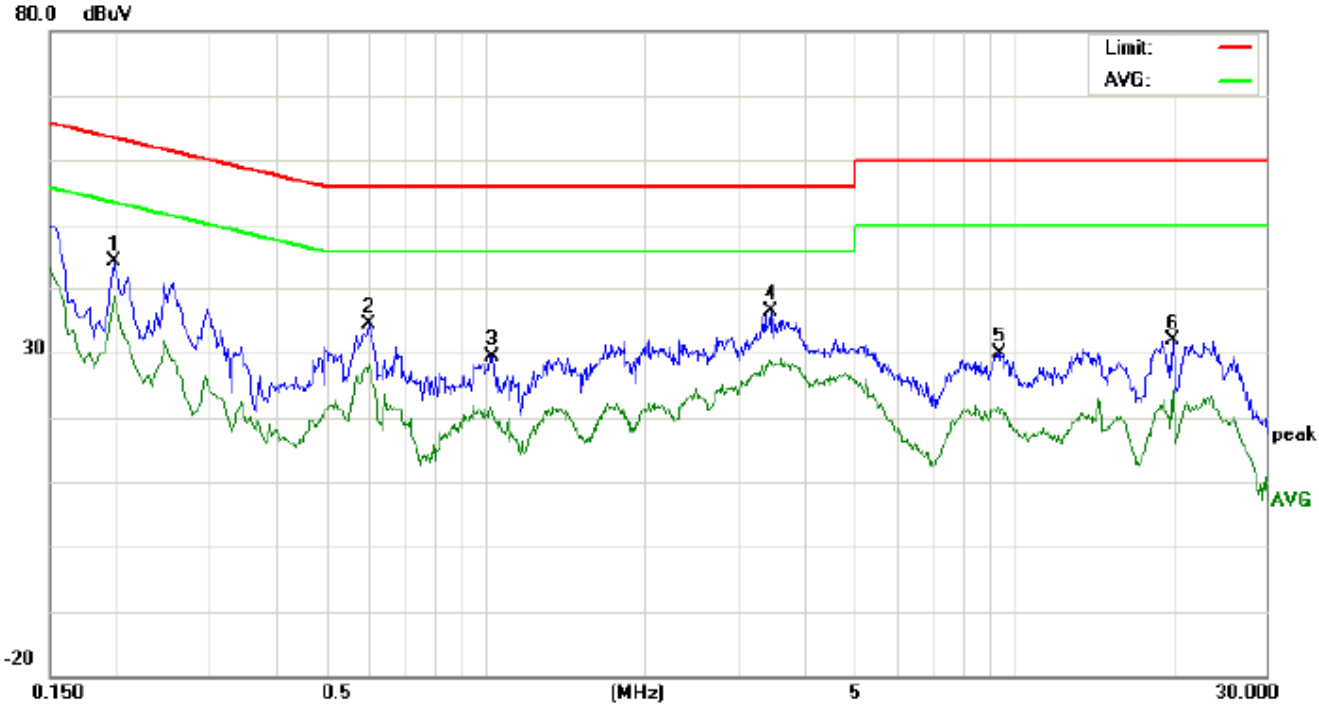

Site: Conduction Phase: *L1* Temperature: 23.9  
 Limit: FCC Class B Conduction(QP) Power: Humidity: 55.2 %  
 EUT:Bluetooth audio transmitter  
 M/N:BTT005E  
 Mode:BT Link  
 Note:

No.	Freq. (MHz)	Reading_Level (dBuV)			Correct Factor (dB)	Measurement (dBuV)			Limit (dBuV)		Margin (dB)		P/F	Comment
		Peak	QP	AVG		Peak	QP	AVG	QP	AVG	QP	AVG		
1	0.1980	34.19		28.48	10.21	44.40		38.69	63.69	53.69	-19.29	-15.00	P	
2	0.6018	24.19		17.72	10.31	34.50		28.03	56.00	46.00	-21.50	-17.97	P	
3	1.0300	19.08		10.14	10.37	29.45		20.51	56.00	46.00	-26.55	-25.49	P	
4	3.4700	25.96		18.14	10.51	36.47		28.65	56.00	46.00	-19.53	-17.35	P	
5	9.3739	19.66		10.55	10.34	30.00		20.89	60.00	50.00	-30.00	-29.11	P	
6	20.0180	21.78		14.06	10.11	31.89		24.17	60.00	50.00	-28.11	-25.83	P	

Line Conducted Emission Test Line 2-N

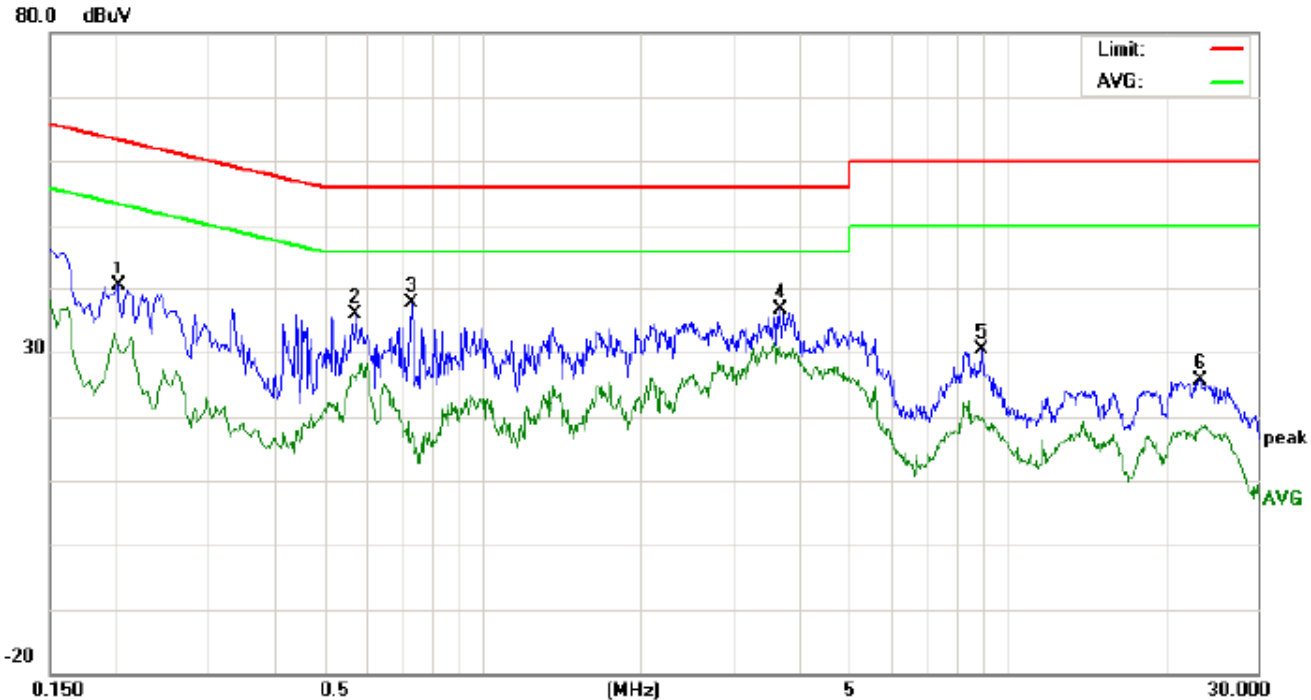

Site: Conduction Phase: **N** Temperature: 23.9  
 Limit: FCC Class B Conduction(QP) Power: Humidity: 55.2 %  
 EUT:Bluetooth audio transmitter  
 M/N:BTT005E  
 Mode:BT Link  
 Note:

No.	Freq. (MHz)	Reading_Level (dBuV)			Correct Factor (dB)	Measurement (dBuV)			Limit (dBuV)		Margin (dB)		P/F	Comment
		Peak	QP	AVG		Peak	QP	AVG	QP	AVG	QP	AVG		
1	0.2020	30.20		20.67	10.22	40.42		30.89	63.52	53.52	-23.10	-22.63	P	
2	0.5736	25.61		15.23	10.33	35.94		25.56	56.00	46.00	-20.06	-20.44	P	
3	0.7338	27.32		7.09	10.33	37.65		17.42	56.00	46.00	-18.35	-28.58	P	
4	3.6939	26.23		20.42	10.48	36.71		30.90	56.00	46.00	-19.29	-15.10	P	
5	8.9298	20.06		9.57	10.23	30.29		19.80	60.00	50.00	-29.71	-30.20	P	
6	23.2896	15.58		8.34	10.11	25.69		18.45	60.00	50.00	-34.31	-31.55	P	

**APPENDIX A: PHOTOGRAPHS OF TEST SETUP**  
FCC LINE CONDUCTED EMISSION TEST SETUP

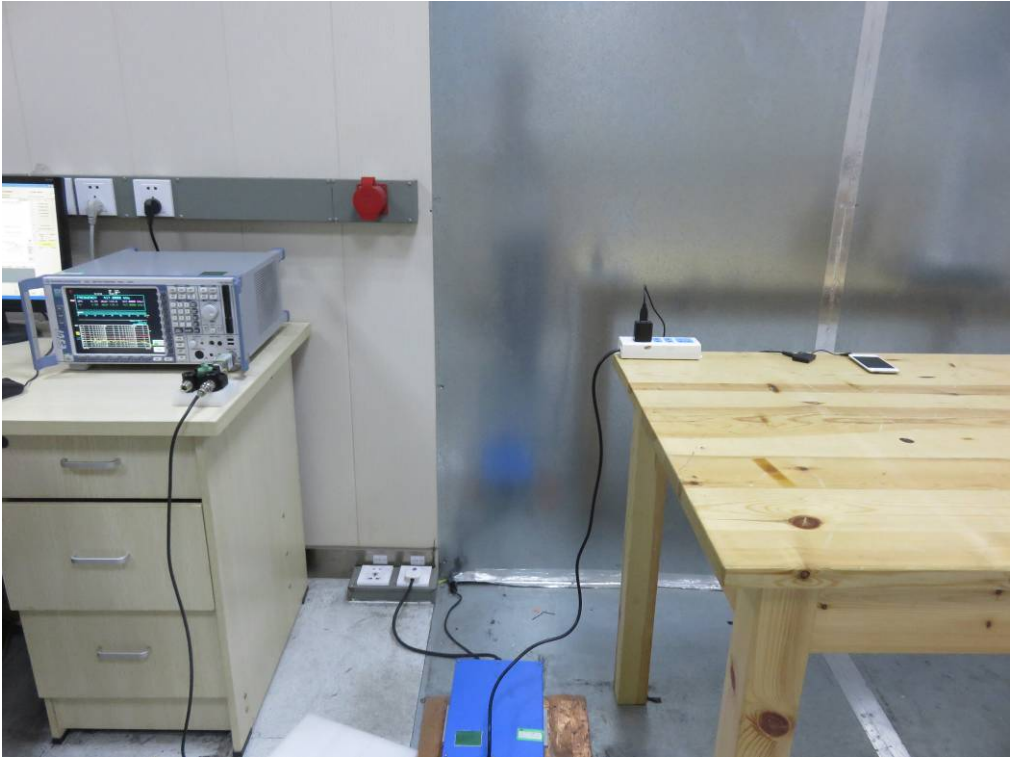

FCC RADIATED EMISSION TEST SETUP

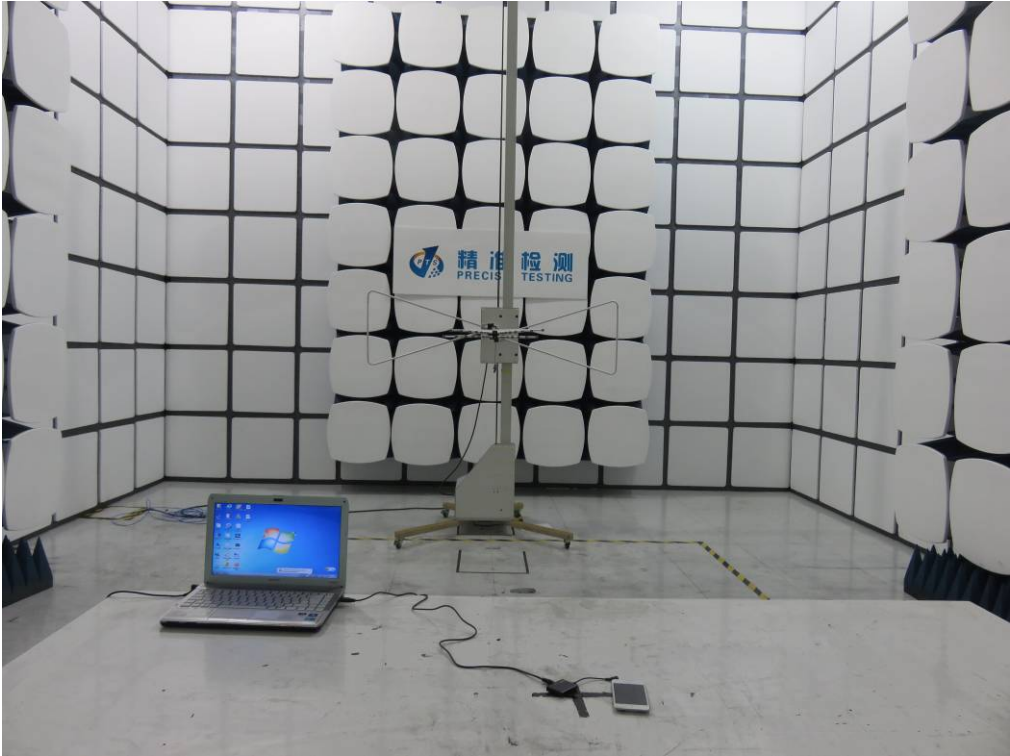

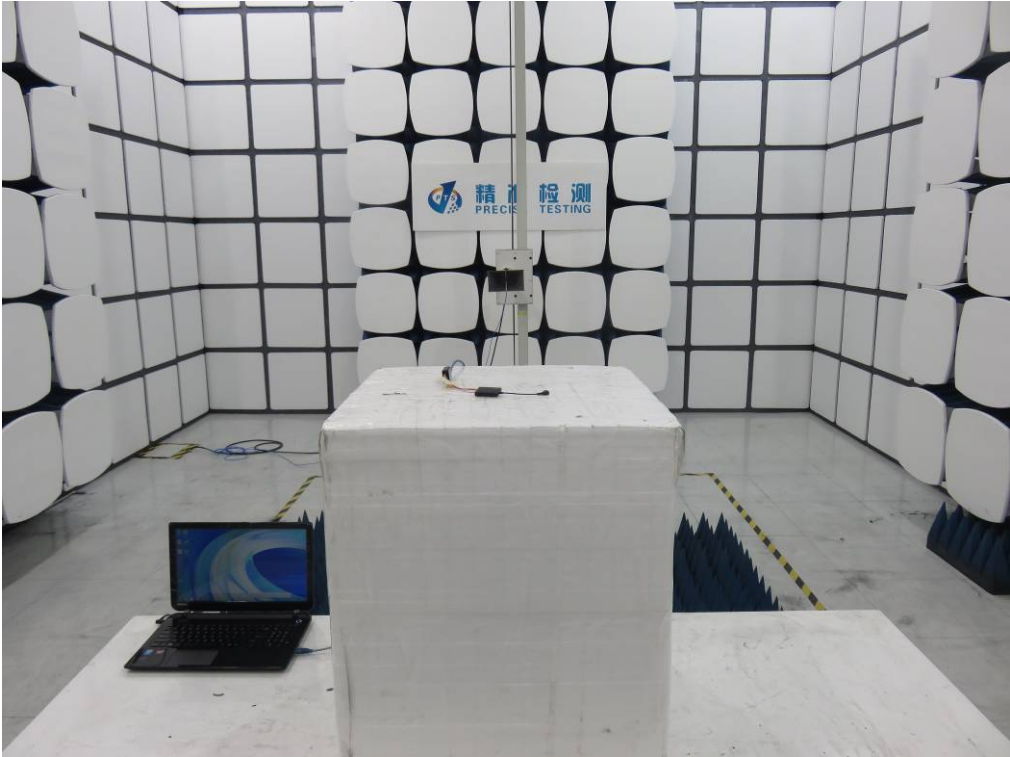

**APPENDIX B: PHOTOGRAPHS OF EUT**  
TOTAL VIEW OF EUT



TOP VIEW OF EUT





BOTTOM VIEW OF EUT



FRONT VIEW OF EUT



BACK VIEW OF EUT



LEFT VIEW OF EUT



RIGHT VIEW OF EUT



OPEN VIEW OF EUT

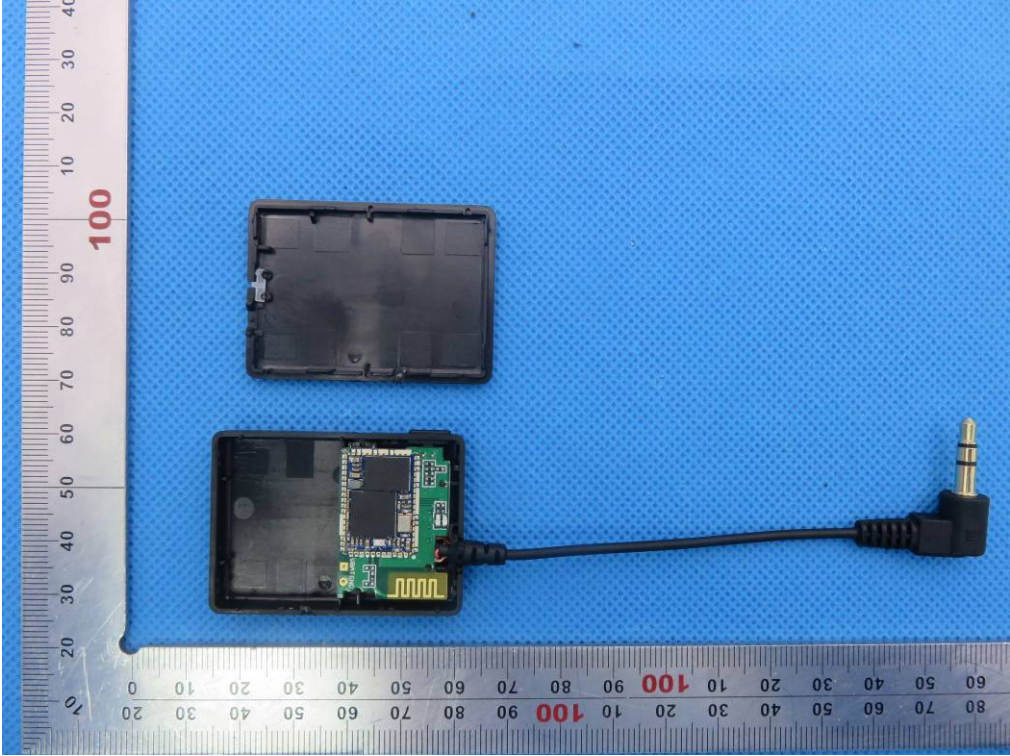

INTERNAL VIEW OF EUT-1

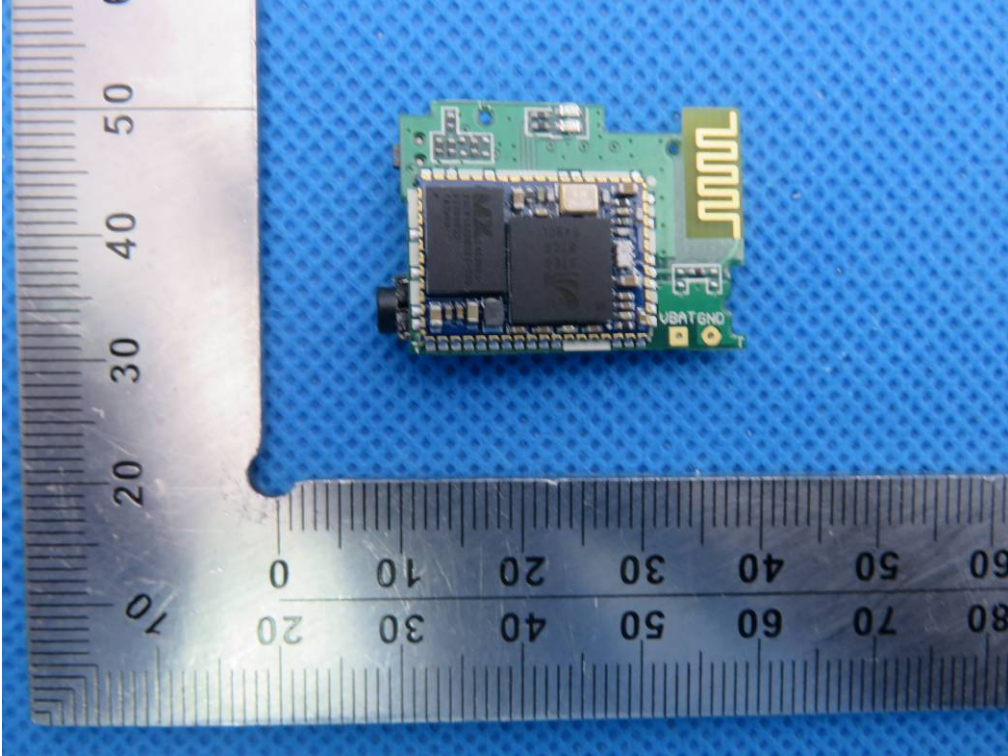

INTERNAL VIEW OF EUT-2

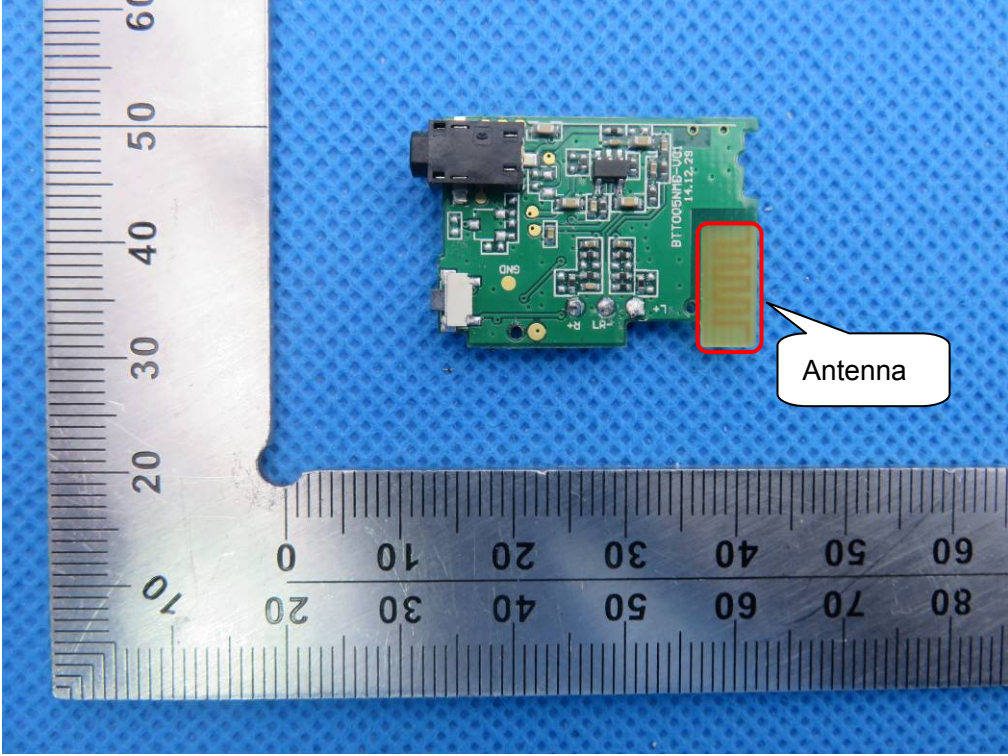

INTERNAL VIEW OF EUT-3



----END OF REPORT----