

**BTH109A**  
**True Wireless Bluetooth Headset**  
**User's manual**



# Contents

■ <b>Brief introduction</b> .....	1
■ <b>Before use</b> .....	1
1. <b>Overview</b> .....	1
2. <b>Charging for headset</b> .....	2
■ <b>Getting started</b> .....	3
1. <b>Wearing headset</b> .....	3
2. <b>Use one piece earbuds</b> .....	3
3. <b>Use two earbuds</b> .....	5
4. <b>Earbuds pairing/connecting</b> .....	6
5. <b>Function operation-one earbuds connecting with cellphone</b> .....	7
6. <b>Function operation-two earbuds connecting with cellphone</b> .....	8
7. <b>Battery display</b> .....	9
8. <b>LED indicator</b> .....	9
9. <b>Factory Reset</b> .....	10
■ <b>Care and maintenance</b> .....	10
■ <b>FAQs</b> .....	11
■ <b>Specification</b> .....	12

Welcome to use this True Wireless Bluetooth headset, BTH109A. Please read this user's manual carefully before use.

## ■ Brief introduction

BTH109A is a True Wireless Bluetooth Headset without any wire, each piece comes with one Mic that can be used individually or be used together for stereo sound. The headset support music and calling function.

## ■ Before use

### 1. Overview

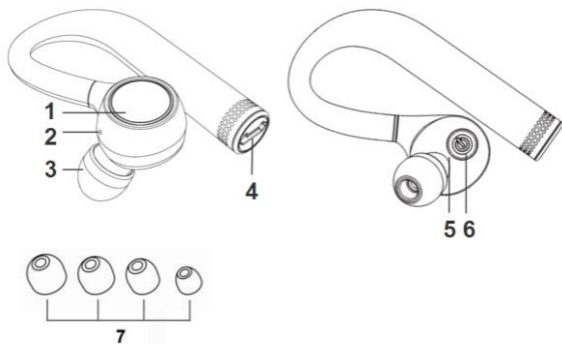

1	MFB touch-button	5	LED indicator
2	Microphone	6	Power on/off button
3	Ear tips	7	Four different size ear tips
4	Charging jack		

## 2. Charging for headset

When the headset is low power, the headset emits “please charge” every 2 minutes and the red LED flashes instead of blue LED. Please recharge the battery of the headset.

The way of charging as following:

### Using USB cable

1. Plug the USB charging cable to headset charging jack
2. Plug another side of cable to the USB port of PC  
Red light on: Charging  
Blue light on: Finish charging
3. It will takes about 1.5 hours to finish charging

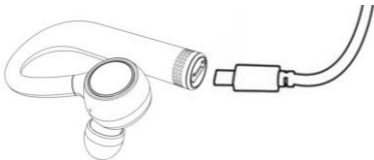

### Remarks:

- 1) The battery is recyclable.
- 2) Batteries (battery pack or batteries installed) shall not be exposed to excessive heat place, such as sunshine, fire or the like.

## ■ Getting started

### 1. Wearing headset

- Choose the suitable size ear tips
- Wear the headset of L and R accordingly,adjust each earbuds for your ear to get best experience



Left ear



Right ear

### 2. Use one earbuds

In this mode, only one earbuds of the headset connecting with device.

#### 1. Power on

Press power button about 3s and release it till blue LED on, and earbuds prompt "Power on".

#### 2. Pairing

a. Power off mode: Press power button about 6s and release it till red LED and blue LED flash alternately, and earbuds prompt "Pairing"

b. Standby mode without connecting: Press power button about 2s and release it till red LED and blue LED flash alternately, and earbuds prompt "Pairing".



### 3.Connecting

Make sure the earbuds in pairing mode, search the Bluetooth name and connect it.

Bluetooth name : BTH109AL is left earbuds,BTH109AR is right earbuds

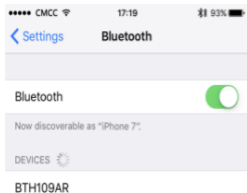

### 4.Power off

Press power button about 6s and release it till red LED on,and earbuds prompt "Power off".

#### Remark:

- ◆ The earbuds will automatically connecting with the latest Bluetooth device when power on
- ◆ The earbuds will automatically switch to standby mode if disconnect with device,and will power off automatically after 5 minutes to save power.
- ◆ The function operation are same for each earbuds.

### 3. Use two earbuds

In this mode use two earbuds simultaneously to enjoy stereo sound. There are two ways for both earbuds to connect.

#### The first way as below:

1. Power on both earbuds, then they will connecting with each other automatically. After connected successfully, the headset will prompt “Master”, “Slave”.

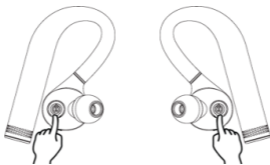

2. Press power button of “Master” headset about 2s to make it into pairing mode.

3. Active Bluetooth function in cellphone and connect headset name “BTH109AL”/ (“BTH109AR”) in the list.

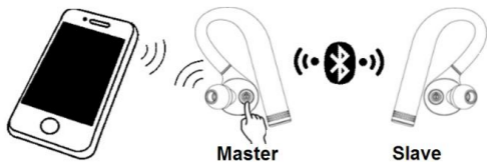

**The second way as below:**

Operate one of earbuds to connect with cellphone, power on the other earbuds, then the two earbuds will connect with each other automatically. Please note that the headset which connect with cellphone is Master headset, the other is Slave headset.

**Remarks:**

- ◆ Pairing mode keeps 2 minutes, the headset will switch to standby mode if no device can be connected, and they will power off automatically after 3 minutes.
- ◆ After connected successfully, the two headset (Master/Slave) will remember each other. The headset will connect with the latest device automatically when power on.
- ◆ The headset can reconnecting with devices automatically if return back to effective range within 5 minutes.

**4. Earbuds pairing/connecting**

Please use this step if two headset can not be connect with each other or you need to change the Master headset.

1. Power on two headset and make it enter pairing mode, red LED and blue LED flash alternately .
2. Press power button about 2s in one of earbud to enter search mode, red LED and blue LED slow flash. The headset which connect with cell phone is Master headset.
3. Two earbuds will pairing and connecting. After two earbuds connecting, the Master headset will enter pairing mode automatically.

**Remarks:**

- ◆ In normally the two earbuds will connecting automatically once power on, which set in factory.
- ◆ You can connect the two earbuds according above operation if they failed connecting.



## 5.Function operation-one earbuds connecting with cellphone.

### a.Answer /end a call

Incoming calling(blue LED quickly flash),click touch button once will answer or end a call.

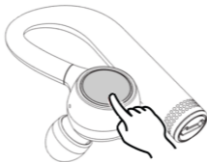

Click once

### b.Reject calling

Incoming calling(blue LED quickly flash), long press touch button and release it till hear prompt tone “DUDU”.

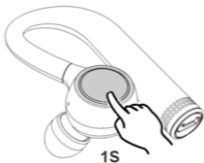

Long press about 1 second

### c.Voice assistant

After connect with cellphone(blue LED flash twice every 5s),then press touch button about 5s can active voice assistant like Siri. When you long press touch button 2s under music mode, please not release if you will hear a prompt tone.

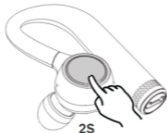

Long press about 5 seconds

#### **d.Playing/Pause**

Connecting with cellphone,double click touch button will play music,double click again will pause playing.



Double click

#### **e.Next song**

Press touch button about 2s under music mode, release it until hear a prompt tone.

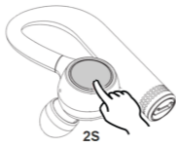

Long press about 2s

### **6.Function operation-two earbuds connecting with cellphone**

a.If two earbuds connect with cellphone,one of earbuds power off,the other one will turned off also.

b.If two earbuds connect with cellphone,operate any one earbuds can control playing/pause/nex song/voice assistant.

**Last song:** under music mode, long press touch button of left earbud about 2 seconds, release it until hear a prompt tone.

**Next song:** under music mode, long press touch button of right earbud about 2 seconds, release it until hear a prompt tone.

## Remarks:

- ◆ The function of operation are same for one earbuds or two earbuds.
- ◆ If headset in calling mode, only the earbuds connecting with cellphone can communicate and operate function.

## 7. Battery display

When the earbuds connected with IOS device, it will display the battery of earbuds on the device. When the earbuds is in low battery, power symbol show red, it emits you to charge for your headset.

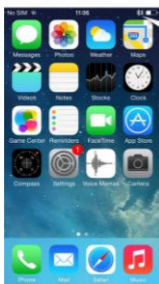

**Full charge**

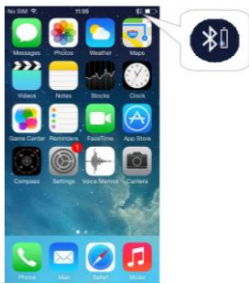

**Low battery**

## 8. LED indicator

LED indicator	Status of headset
Emits “please charge” every 2 minutes	Low battery
Emits “DU” once every 8s in 5 minutes	Headset out of range with cellphone
Emits “DU” once	Out of range with the other earbuds
Emits “ search for slave”	Searching mode

## 9. Factory Reset

In the status of charging, long press power button about 5 seconds and release it until the red and blue LED flashes simultaneously.

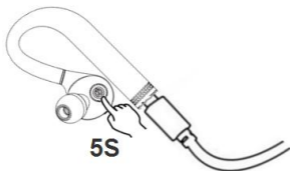

Long press about 5 seconds

### Remarks:

After factory reset, the paired list of earbuds will be deleted. After turn it on again, the earbuds will enter pairing mode automatically, and you need to re-pair and connect with Bluetooth devices.

But factory reset won't affect connecting with the other earbuds.

### ■ Care and maintenance

Read the following recommendations carefully before using BTH109A. Following these you will be able to enjoy this product for many years.

- ◆ Keep it dry and don't put it in the dump place to avoid the product's internal circuit being affected. Don't wear the headset when in strong exercise to avoid sweat enter.
- ◆ Keep the product away from direct sunlight or hot places. High temperatures will shorten the life of electronic devices, destroy the battery or distort certain plastic parts.
- ◆ Don't expose the product to cold areas. It may damage the internal circuit board.
- ◆ Don't try to disassemble the product as it may get damaged if you are not professional.
- ◆ cannot

- ◆ Don't let it fall down onto the floor or other hard surfaces. The internal circuit might get damaged.
- ◆ Don't use intensive chemical products or detergent to clean the product.
- ◆ Don't scratch the surface with sharp things.
- ◆ Don't use this product during strenuous exercise. It may get damaged by sweat.

In case the product doesn't function properly, send it to the store you bought it. The staff will help you to solve the problem

## ■ FAQs

### 1. What does it mean when red LED flashes instead of blue LED?

Battery is low power, need to be recharged.

### 2. Why is the red LED off when charging?

- a) Please make sure the charging device connect with headset well;
- b) The battery may dry up. Please charge the battery for 30 minutes, and then the red LED will be on.

### 3. Why can't I hear the sound on the headset?

- a) Make sure the volume is not too low or muted;
- b) Make sure the headset connects with the mobile phone correctly;
- c) Make sure the distance between the headset and the cell phone is in the available Bluetooth range.

### 4. Why can't I hear the sound clearly on the headset?

- a) Make sure the mobile phone is in the strong signal area;
- b) Make sure the headset is in the available range. and no other block.

### 5. Why the pause/play, last/next song not function when playing music?

Make sure your Bluetooth device supports AVRCP (Audio/Video Remote Control profile)

## ■ Specifications

<b>Bluetooth version</b>	Bluetooth V4.2
<b>Bluetooth profiles</b>	HFP, A2DP and AVRCP
<b>Operating distance</b>	10 meters
<b>Music time</b>	One earbuds: Up to 3.5 hours Two earbuds: Up to 3.5 hours
<b>Talk time</b>	UP to 3.5 hours
<b>Standby time</b>	About 60 hours
<b>Charging time</b>	About 1.5 hours
<b>Charging input</b>	DC 5.0V /500mA
<b>Weight (one earbuds)</b>	About 9.4 g
<b>Measure</b>	5.5*3.5*2.3cm

**NOTE:** This equipment has been tested and found to comply with the limits for a Class B digital device, pursuant to part 15 of the FCC Rules. These limits are designed to provide reasonable protection against harmful interference in a residential installation. This equipment generates uses and can radiate radio frequency energy and, if not installed and used in accordance with the instructions, may cause harmful interference to radio communications. However, there is no guarantee that interference will not occur in a particular installation. If this equipment does cause harmful interference to radio or television reception, which can be determined by turning the equipment off and on, the user is encouraged to try to correct the interference by one or more of the following measures:

- Reorient or relocate the receiving antenna.
- Increase the separation between the equipment and receiver.
- Connect the equipment into an outlet on a circuit different from that to which the receiver is connected.
- Consult the dealer or an experienced radio/TV technician for help

Changes or modifications not expressly approved by the party responsible for compliance could void the user's authority to operate the equipment. This device complies with Part 15 of the FCC Rules. Operation is subject to the following two conditions:

- (1) this device may not cause harmful interference, and
- (2) this device must accept any interference received, including interference that may cause undesired operation.