

BTH066N
Bluetooth stereo headset
User's manual



Contents

■ Brief introduction	1
■ Before use	1
1. Overview.....	1
2. Charging for headset.....	2
■ Getting started	3
1. Turning on/off the headset.....	3
2. Wearing the headset.....	3
3. Pairing/connecting.....	5
1) Pairing headset with Bluetooth cell phone via Bluetooth.....	5
2) Pairing headset with Bluetooth cell phone via NFC.....	5
3) Pairing headset with multi devices via Bluetooth	6
4. Making a call with the headset.....	6
5. Playing music.....	9
6. LED indicator.....	10
7. Factory Reset.....	10
■ Care and maintenance	11
■ FAQs	11
■ Specification	12

Welcome to use this Bluetooth stereo headset, BTH066N. Please read this

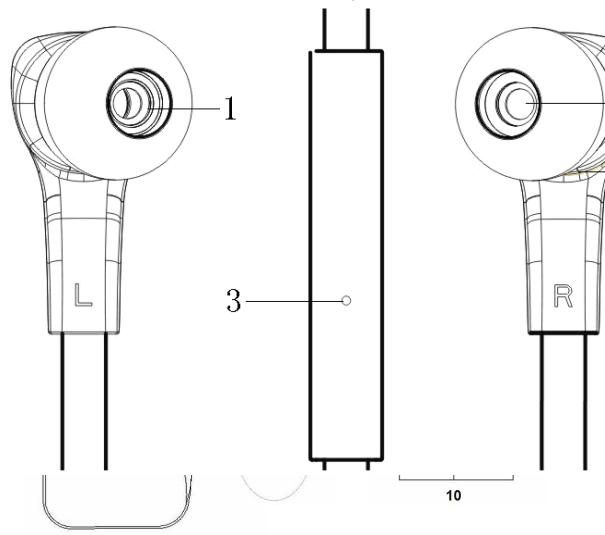

1	NFC area	6	▼: volume down/next song
2	Cover of charging jack	7	Stabilizer
3	Micro USB charging jack	8	LED indicator
4	▲ :volume up/previous song	9	Microphone
5	■ : Multi-functions button	10	Big/middle/small eartips

2. Charging for headset

The headset comes with a built-in rechargeable battery, prior to using it, it is recommended to charge the battery fully for the first time.

When the headset is low power, the headset emits prompt tones every 5 minutes and the red LED flashes. Please recharge the battery of the headset.

The way of charging as following:

Using USB cable

1. Turn on the cover of charging jack, and plug the USB charging cable
2. Plug another side of cable to the USB port of PC

Red light on: Charging

Red light off: Finish charging

3. It will takes about 2 hours to finish charging

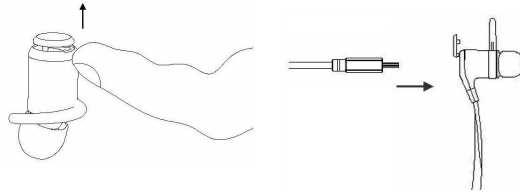



Remarks:

- 1) The battery is recyclable.
- 2) Batteries (battery pack or batteries installed) shall not be exposed to excessive heat place, such as sunshine, fire or the like.

■ Getting started

1. Turning on/off the headset

Functions	Operation	Prompt tone
Turning on	Press and hold  about 4 seconds until blue LED flashes	Four raise tone
Turning off	Press and hold  about 4 seconds until red LED flashes	Four fall tone

Remark: In order to save power, the headset will turn off automatically if no devices can be connected after 5 minutes.

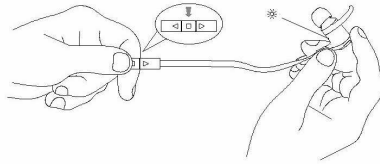

2. Wearing the headset

a. Put the stabilizer into the headset and rotate to the suitable position as following shown:

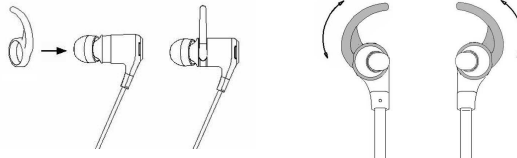

b. Choose the suitable size eartips according to your ear and wear as following shown:

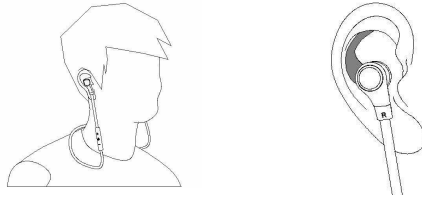

c. Set up the cord management clips (optional accessory) to get better wearing as following shown:

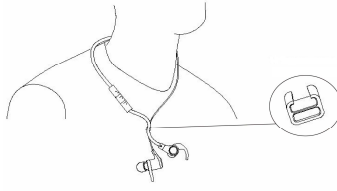
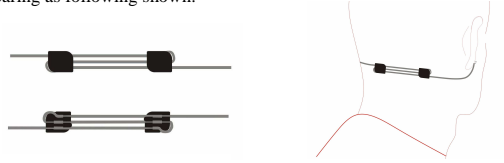

3. Pairing/connecting

1) Pairing headset with Bluetooth cell phone via Bluetooth

Prior to using the headset for the first time, you have to pair it with a Bluetooth-enabled cell phone. The pairing procedures are subject to different models of cell phones. Please refer to your cell phone user's manual for further information.

The general pairing procedures are as follows:

- 1) Keep your headset turned off and within 1 meter of phone ;
- 2) Press and hold  about 8 seconds until the red and blue LED flash alternately, the headset enter into pairing mode;
- 3) Activate your cell phone's Bluetooth function and search for Bluetooth devices within range, select "BTH066N" from the list of devices shown (enter password "0000" if the headset prompt);
- 4) After successful connecting, blue LED of headset flashes twice every 4 seconds

Remarks:

- ◆ Pairing mode will last 2 minutes, the headset will back to standby mode if the pairing failure.
- ◆ If the pairing is not successful, turn off the headset and repeat the steps as above.
- ◆ Every time the headset is turned on, it will connect to last connected device automatically. The headset can remember 8 paired devices, when the number of paired devices exceeds 8, the first one will be replaced.

2) Pairing headset with a Bluetooth cell phone via NFC

BTH066N support NFC technology, it can quickly connect with Bluetooth cell phone via NFC.

The general pairing procedures are as follows:

- 1) Please activate the Bluetooth and NFC function of cell phone;
- 2) Pairing and connecting with cell phone.

Please refer to the right pictures:



Remarks:

- Please keep the NFC area of cell phone and headset within 1 centimeter until the red and blue LED of headset flash alternately(First pairing time maybe 3 seconds).
- The headset will disconnect when you make the NFC area of cell phone and headset touch each other again.





3) Pairing headset with multi devices via Bluetooth

The headset can connect with two Bluetooth cell phones at the same time.

The general pairing procedures are as follows:



- 1) Pairing the headset with device one
- 2) Turn on the headset and make it enter pairing mode again, and pairing it with device two
- 3) Operate device one to connect with headset. The headset has already connected with two devices in this moment

Remarks:

- The multi-pair function is off in factory set, please turn on this function as following:
Turn on: long press  and  button under standby mode (not connected device), and release it until you hear four raise tone
Turn off: long press  and  button under standby mode(not connected device), and release it until you hear four fall tone
- To improve the stabilization of headset, we suggest you turn off the multi-pair function when you only connect with one cell phone.

4. Making a call with the headset

1) Basic operation

Functions	Status of headset	Operation	Prompt tone
Cancel a call	Calling	Short press  once	One short tone
Answer a call	Incoming call ringing	Short press  once	Two raise tone

Reject a call	Incoming call ringing	Long press ■ about 2 seconds and release it until listen a tone	Two fall tone
End a call	During a call	Short press ■ once	One short tone
Volume up	During a call	Short press ▲ button	
Volume down	During a call	Short press ▼ button	
Transfer conversation to mobile phone	During a call	Long press ■ about 2 seconds	One short tone
Transfer conversation to headset	During a call	Long press ■ about 2 seconds	One short tone
Microphone mute	During a call	Long press ▲ about 2 seconds	Two fall tone
Cancel mute	During a call (microphone mute)	Long press ▲ about 2 seconds	Two raise tone
Voice dial	Standby mode (connected device)	Short press ■ and ▲ button simultaneously	One short tone
Redial the last number	Standby mode (connected device)	Double click ■ button	One short tone

Warning: Excessive pressure from earphones and headphones can cause hearing loss.





Note:

- ◆ Not all the mobile phones support all the functions listed above. Different function and prompt tone according to different mobile phone. Please refer to your mobile phone user's manual.
- ◆ When the volume is adjusted to max or min, you will hear one prompt tone.
- ◆ When the headset under microphone mute mode, you will hear two tone continuously every 10 seconds.
- ◆ When pressing the answer button on some mobile phones, the call will be transferred to the mobile phone. You can switch the call to the headset by using the conversation switch button or through operating on the mobile phone. Please refer to your mobile phone user manual for further information.







2) Three-ways call operation

Functions	Status of headsets	Operation
Answer new call and end current call	There are second incoming call	Short press ■ once
Answer new call and retain current call	There are second incoming call	Double click ■ button
Switch calls	Keep conversation	Double click ■ button
End current call and switch retain call	Keep conversation	Short press ■ once

3) Connect with two cell phones

Functions	Status of headset	Operation
End phone call #1 and answer phone call #2	During phone call #1, phone 2 has incoming call	Short press  once
Retain phone call #1 and answer phone call #2	During phone call #1, phone 2 has incoming call	Double click  button
Switch call	During call, one of phone call is retained	Double click  button
End current call, back to retain phone call	During call, one of phone call is retained	Short press  once

5. Playing music

Functions	Status of the headset	Operation
Volume up	Playing music	Short press  button
Volume down	Playing music	Short press  button
Last song	Playing music	Long press  button
Next song	Playing music	Long press  button
Pause	Playing music	Short press  once
play	Pausing	Short press  once

Notes:

- ◆ When the volume is adjusted to max or min., you will hear one prompt tone.
- ◆ If you want to remote control last/next song, pause/play, it needs your Bluetooth mobile phone or Bluetooth transmitter paired with the headset to support AVRCP profile, please refer to the user's manual of your mobile phone or Bluetooth transmitter for further information.

6. LED indicator

LED indicator	Status of headset
Red and blue LED flashes alternately	Pairing mode
Blue LED flashes once every 2 seconds	Not connected to device
Blue LED flashes twice every 4 seconds	Connected to device
Red LED flashes instead of blue LED	Low battery

7. Factory Reset

In the status of charging, long press ▲ button about 4 seconds and release it until the red and blue LED flashes simultaneously, you will hear 4 prompt tone.

Remarks:

After factory reset, the paired list of headset will be deleted. After turn it on again, the headset will enter pairing mode automatically, and you need to re-pair and connect with Bluetooth devices.

■ Care and maintenance

Read the following recommendations carefully before using BTH066N. Following these you will be able to enjoy this product for many years.

- ◆ Please note that the cord management clips are optional accessory for better wearing.
- ◆ Keep it dry and don't put it in the dump place to avoid the product's internal circuit being affected.
- ◆ Keep the product away from direct sunlight or hot places. High temperatures will shorten the life of electronic devices, destroy the battery or distort certain plastic parts.
- ◆ Don't expose the product to cold areas. It may damage the internal circuit board.
- ◆ Don't try to disassemble the product as it may get damaged if you are not professional.
- ◆ Don't let it fall down onto the floor or other hard surfaces. The internal circuit might get damaged.
- ◆ Don't use intensive chemical products or detergent to clean the product.

- ◆ Don't scratch the surface with sharp things.
- ◆ Don't use this product during strenuous exercise. It may get damaged by sweat.

In case the product doesn't function properly, send it to the store you bought it. The staff will help you to solve the problem

■ FAQs

1. What does it mean when red LED flashes instead of blue LED?

Battery is low power, need to be recharged.

2. Why is the red LED off when charging?

- a) Please make sure the charging device connect with headset well;
- b) The battery may dry up. Please charge the battery for 30 minutes, and then the red LED will be ON.

3. Why my mobile phone can not search and find the headset?

Please make sure the headset is under the pairing mode and in the effective working range, and then the headset can be paired and connected.

4. Why my mobile phone can not pair with headset via NFC?

- a) Make sure activate NFC function of your mobile phone
- b) Please keep the NFC chip of cell phone and headset within 1 centimeter until the red and blue LED of headset flash alternately (First pairing time maybe 3 seconds).

5. Why can't I hear the sound on the headset?

- a) Make sure the headset has been switched on;
- b) Make sure the volume is not too low or muted;
- c) Make sure the headset connects with the mobile phone correctly;
- d) Make sure the distance between the headset and the cell phone is in the available Bluetooth range.

6. Why can't I hear the sound clearly on the headset?

- a) Make sure the mobile phone is in the strong signal area;
- b) Make sure the headset is in the available range of this product.

7. Why the pause/play, last/next song not function when playing music?
Make sure your Bluetooth device supports AVRCP (Audio/Video Remote Control profile)

■ **Specifications**

Bluetooth version	Bluetooth V4.0
Bluetooth profiles	Headset, Hands free, A2DP, AVRCP
Operating distance	10meters
Headset music time	About 5 hours
Headset talk time	About 5.5 hours
Standby time	About 200 hours
Headset charging time	About 2 hours
Dimension	Headset: 30x13.3x24 mm
Weight	About 13 g

This device complies with Part 15 of the FCC Rules. Operation is subject to the following two conditions: (1) this device may not cause harmful interference, and (2) this device must accept any interference received, including interference that may cause undesired operation.

Warning: Changes or modifications to this unit not expressly approved by the party responsible for compliance could void the user's authority to operate the equipment.

NOTE: This equipment has been tested and found to comply with the limits for a Class B digital device, pursuant to Part 15 of the FCC Rules. These limits are designed to provide reasonable protection against harmful interference in a residential installation. This equipment generates, uses and can radiate radio frequency energy and, if not installed and used in accordance with the instructions, may cause harmful interference to radio communications.

However, there is no guarantee that interference will not occur in a particular installation. If this equipment does cause harmful interference to radio or television reception, which can be determined by turning the equipment off and on, the user is encouraged to try to correct the interference by one or more of the following measures:

- Reorient or relocate the receiving antenna.
- Increase the separation between the equipment and receiver.
- Connect the equipment into an outlet on a circuit different from that to which the receiver is connected.
- Consult the dealer or an experienced radio/TV technician for help.