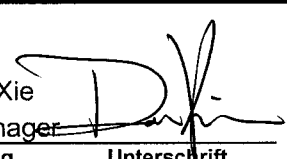

Prüfbericht - Nr.: 16025534 001		Seite 1 von 28 Page 1 of 28
<i>Test Report No.:</i>		
Auftraggeber: <i>Client:</i>	Zhongshan K-mate General Elec. Co., Ltd. <i>Fuwan Industrial Zone, Fuwan South Road, Sunwen East Road, East District, Zhongshan, Guangdong 528403, P.R. China</i>	
Gegenstand der Prüfung: <i>Test item:</i>	Bluetooth Mono Headset	
Bezeichnung: <i>Identification:</i>	BTE018	Certificate Number: FCC ID: WAD-BTE018 <i>Certificate Number</i>
Wareneingangs-Nr.: <i>Receipt No.:</i>	173055828	Eingangsdatum: Sep. 3, 2010 <i>Date of receipt:</i>
Prüfort: <i>Testing location:</i>	TÜV Rheinland (Guangdong) Ltd. EMC Laboratory Guangzhou Auto Market, Yuan Gang Section of Guangshan Road, Guangzhou 510650, P. R. China	Listed test laboratory according to FCC rules section 2.948 for measuring devices.
Prüfgrundlage: <i>Test specification:</i>	ANSI C63.4: 2003 FCC Part 15: July 10, 2008, Subpart C section 15.247	
Prüfergebnis: <i>Test Result:</i>	Der Prüfgegenstand entspricht oben genannter Prüfgrundlage(n). <i>The test item passed the test specification(s).</i>	
Prüflaboratorium: <i>Testing Laboratory:</i>	TÜV Rheinland (Guangdong) Ltd.	
geprüft/ tested by:	kontrolliert/ reviewed by:	
<i>Oct. 19, 2010</i> Datum Date	Ken Kuang Name/Stellung Name/Position	<i>Oct. 19, 2010</i> Datum Date
	Project Engineer Unterschrift Signature	Liangdong Xie Name/Stellung Name/Position
		Project Manager Unterschrift Signature
		
Sonstiges/ Other Aspects:		
Abkürzungen: P(ass) = entspricht Prüfgrundlage F(ail) = entspricht nicht Prüfgrundlage N/A = nicht anwendbar N/T = nicht getestet		
Abbreviations: P(ass) = passed F(ail) = failed N/A = not applicable N/T = not tested		
Dieser Prüfbericht bezieht sich nur auf das o.g. Prüfmuster und darf ohne Genehmigung der Prüfstelle nicht auszugsweise vervielfältigt werden. Dieser Bericht berechtigt nicht zur Verwendung eines Prüfzeichens. <i>This test report relates to the a. m. test sample. Without permission of the test center this test report is not permitted to be duplicated in extracts. This test report does not entitle to carry any safety mark on this or similar products.</i>		

Prüfbericht - Nr.:
Test Report No.:

16025534 001

Seite 2 von 28
Page 2 of 28

Test Summary

FCC test specification	Test items	Result
FCC rules		
Part 15 Per Section 15.209(a)	Transmitter Radiated Spurious Emission	Pass
Part 15 Per Section 15.203	Antenna Requirement	Pass
Part 15 Per Section 15.247(b)(1)	Maximum Peak Conducted Output Power	Pass
Part 15 Per Section 15.247(a)(1)	20dB Bandwidth	Pass
Part 15 Per Section 15.247(a)(1)	Hopping Channel Carrier Frequency Separation	Pass
Part 15 Per Section 15.247(a)(1)(iii)	Number of Hopping Frequency Used	Pass
Part 15 Per Section 15.247(a)(1)(iii)	Time of Occupancy (Dwell Time)	Pass
Part 15 Per Section 15.247(d)	Out-Of-Band Emission measurement	Pass

Contents

1	GENERAL REMARKS.....	5
1.1	COMPLEMENTARY MATERIALS.....	5
2	TEST SITES.....	5
2.1	TEST FACILITIES.....	5
2.2	LIST OF TEST AND MEASUREMENT INSTRUMENTS.....	6
2.3	TRACEABILITY.....	6
2.4	CALIBRATION.....	7
2.5	MEASUREMENT UNCERTAINTY.....	7
2.6	LOCATION OF ORIGINAL DATA.....	7
2.7	STATUS OF FACILITY USED FOR TESTING.....	7
3	GENERAL PRODUCT INFORMATION.....	8
3.1	PRODUCT FUNCTION AND INTENDED USE.....	8
3.2	RATINGS AND SYSTEM DETAILS.....	8
3.3	INDEPENDENT OPERATION MODES.....	9
3.4	SUBMITTED DOCUMENTS.....	9
4	TEST SET-UP AND OPERATION MODE.....	10
4.1	PRINCIPLE OF CONFIGURATION SELECTION.....	10
4.2	TEST OPERATION AND TEST SOFTWARE.....	10
4.3	SPECIAL ACCESSORIES AND AUXILIARY EQUIPMENT.....	10
4.4	COUNTERMEASURES TO ACHIEVE EMC COMPLIANCE.....	10
4.5	TEST SET-UP.....	11
5	TEST RESULTS.....	13
5.1	TRANSMITTER RADIATED SPURIOUS EMISSION.....	13
5.2	ANTENNA REQUIREMENT.....	16
5.3	MAXIMUM PEAK CONDUCTED OUTPUT POWER.....	17
5.4	20dB BANDWIDTH.....	18
5.5	HOPPING CHANNEL CARRIER FREQUENCY SEPARATION.....	19
5.6	NUMBER OF HOPPING FREQUENCY USED.....	21
5.7	TIME OF OCCUPANCY (DWELL TIME).....	22
5.8	OUT-OF-BAND EMISSION.....	24

Prüfbericht - Nr.:
Test Report No.:

16025534 001

Seite 4 von 28
Page 4 of 28

6	PHOTOGRAPHS OF THE TEST SET-UP	26
7	LIST OF TABLES.....	28
8	LIST OF PHOTOGRAPHS.....	28

Prüfbericht - Nr.:
Test Report No.:

16025534 001

Seite 5 von 28
Page 5 of 28

1 General Remarks

1.1 Complementary Materials

All attachments are integral parts of this test report. This applies especially to the following appendix:

Appendix 1: Test result

2 Test Sites

2.1 Test Facilities

TÜV Rheinland (Guangdong) Ltd. EMC Laboratory

Guangzhou Auto Market, Yuan Gang Section of Guangshan Road
Guangzhou 510650

P. R. China

2.2 List of Test and Measurement Instruments

Table 1: List of Test and Measurement Equipment

Kind of Equipment	Type	Manufacturer	S/N	Calibrated until	Calibrated Interval
EMI Test Receiver	ESCI-3	Rohde & Schwarz	100216	2011-03-16	1 year
Spectrum Analyzer	FSP30	Rohde & Schwarz	100286	2011-03-16	1 year
Loop Antenna	HFH2-Z2	Rohde & Schwarz	100111	2011-03-16	1 year
Trilog-Broadband Antenna	VULB9168	SCHWARZBECK MESS- ELEKTRONIK	209	2011-08-21	2 years
Double-Ridged Waveguide Horn Antenna	HF906	Rohde & Schwarz	100385	2011-08-24	2 years
Pre-amplifier	AFS42-00101800- 25-S-42	MITEQ	1101599	2011-03-16	2 years
Band Reject Filter	BRM50702	Micro-Tronics	023	2011-03-16	2 years
Standard Gain Horn Antenna	3160-09	EMCO	21642	2014-06-26	5 years
Pre-amplifier	AFS33-18002650- 30-8P-44	MITEQ	1108282	2011-03-16	2 years
3m Anechoic Chamber	N/A	Albatross Project GmbH	N/A	2011-03-16	1 year
Spectrum Analyzer	E4404B	Agilent	MY414 40753	2011-03-16	1 year

2.3 Traceability

All measurement equipment calibrations are traceable to NIST or where calibration is performed outside the United States, to equivalent nationally recognized standards organizations.

2.4 Calibration

Equipment requiring calibration is calibrated periodically by the manufacturer or according to manufacturer's specifications. Additionally all equipment is verified for proper performance on a regular basis using in house standards or comparisons.

2.5 Measurement Uncertainty

Uncertainty for conducted emissions measurements is $\pm 2.68\text{dB}$.

Uncertainty for radiated emissions measurements is $\pm 4.94\text{dB}$ (30MHz-1GHz), $\pm 4.88\text{dB}$ (>1GHz).

The reported expanded uncertainty is based on a standard uncertainty multiply by a coverage factor $k=2$, providing a level of confidence of approximately 95%.

2.6 Location of original data

The original copies of test data taken during actual testing were attached at Appendix 1 of this report and delivered to the applicant. A copy has been retained in the TÜV Rheinland (Guangdong) file for certification follow-up purposes.

2.7 Status of facility used for testing

TÜV Rheinland (Guangdong) Ltd. EMC Laboratory; Guangzhou Auto Market, Yuan Gang Section of Guangshan Road, Guangzhou 510650, P. R. China is listed on the US Federal Communications Commission list of facilities approved to perform measurements, the register no. 833845

Prüfbericht - Nr.:
Test Report No.:

16025534 001

Seite 8 von 28
Page 8 of 28

3 General Product Information

The submitted sample is a Bluetooth mono headset.

3.1 Product Function and Intended Use

Refer to user manual for more information.

3.2 Ratings and System Details

Bluetooth Specification	:	V2.1+EDR
Frequency range	:	2402.0MHz – 2480.0MHz
Total Number of channels	:	79 channels
Channel Spacing	:	1MHz
Modulation Type	:	FHSS
Type of antenna	:	Integral antenna
Power supply	:	DC 3.7V (battery)
Ports	:	DC 5V charge port
Protection Class	:	III

The above information was declared by client. Refer to the Technical Documentation for further information

Prüfbericht - Nr.:
Test Report No.:

16025534 001

Seite 9 von 28
Page 9 of 28

3.3 Independent Operation Modes

- A: RF Transmitting and receiving at BR mode.
- B: RF Transmitting and receiving at EDR mode

For further information refer to User Manual

3.4 Submitted Documents

- Operation Description
- Block Diagram
- Schematics
- FCC label and its location
- User Manual
- Internal Photos
- External Photos
- Application form

4 Test Set-up and Operation Mode

4.1 Principle of Configuration Selection

Emission: The equipment under test (EUT) was configured to measure its highest possible radiation level. The test modes were adapted accordingly in reference to the instructions for use.

4.2 Test Operation and Test Software

Refer to test set-up in chapter 5.

4.3 Special Accessories and Auxiliary Equipment

The products have been tested together with the following device:

Device	Manufacture	Model	Serial no./ Version
Laptop notebook	IBM R40e	2684	99-CYY55
Bluetooth test Software	CSR	BlueTest	1.2.4

4.4 Countermeasures to achieve EMC Compliance

The test sample, which has been tested, contained the noise suppression parts as described in the technical document. No additional measures were employed to achieve compliance.

4.5 Test set-up

Diagram 1 of Configuration for Testing Radiated Emission below 30MHz

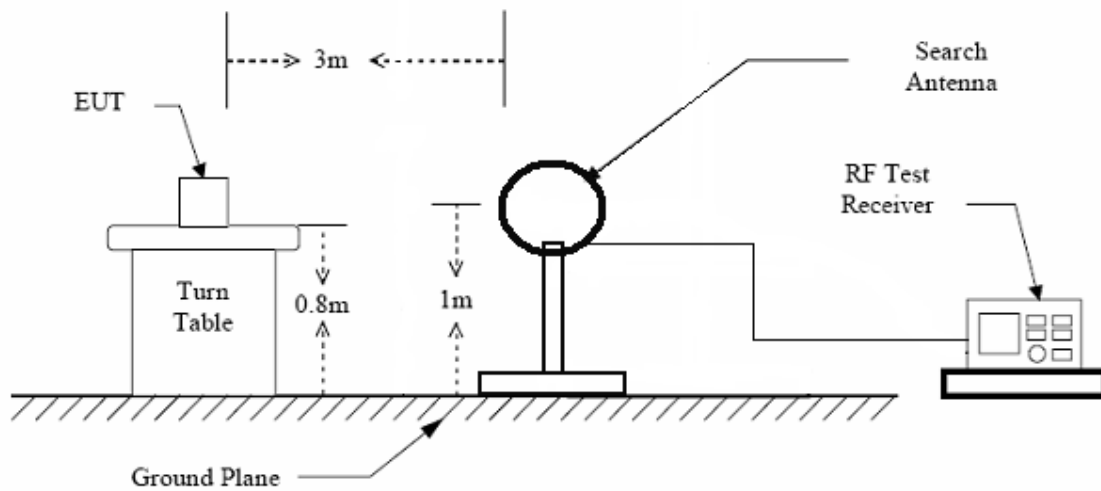

Diagram 2 of Configuration for Testing Radiated Emission from 30MHz to 1 GHz

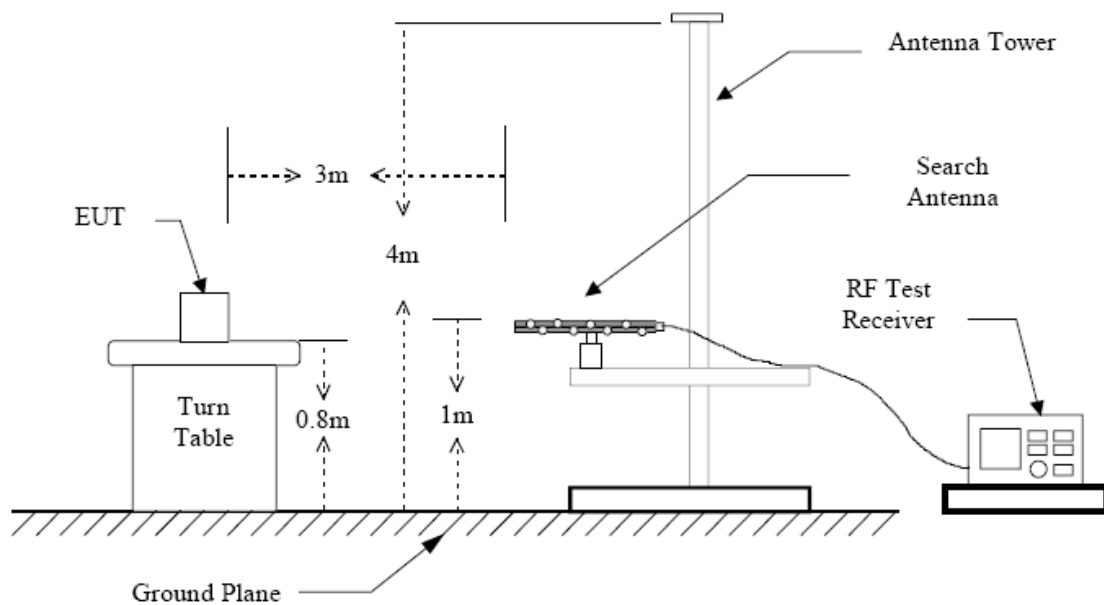

Diagram 3 of Configuration for Testing Radiated Emission above 1 GHz

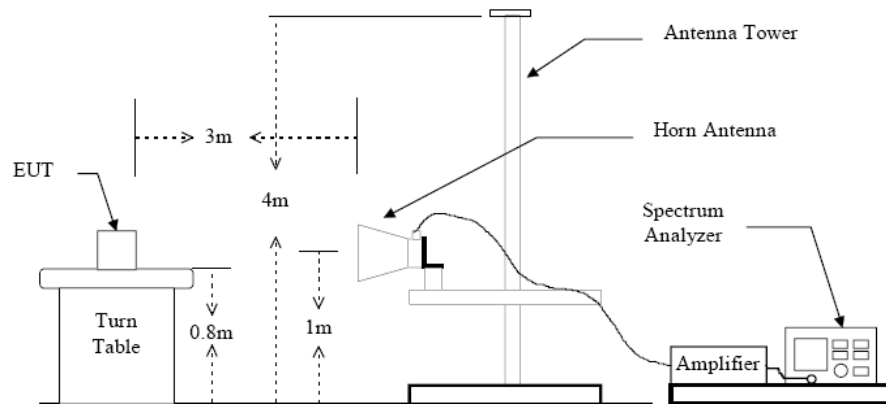
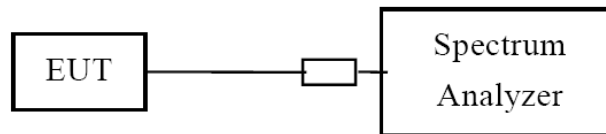

Diagram 4 of Configuration for Testing other test items



5 Test Results

5.1 Transmitter Radiated Spurious Emission

RESULT:

Pass

Date of testing	:	Sep. 20, 2010 to Sep. 21, 2010
Test specification	:	FCC Part 15 Per Section 15.209(a)
Limits	:	FCC Part 15 Per Section 15.209(a)
Test procedure	:	Procedure specified in ANSI C63.4 were followed
Deviations from Standard Test procedures	:	None
Kind of test site	:	3m Semi-anechoic chamber
Operation mode	:	Transmitting at BR / EDR mode
Power supply	:	DC 3.7V
Temperature	:	23°C
Humidity	:	50%

Test procedure:

1. The EUT was placed on the top of a rotatable table 0.8 meters above the ground with 3-orthogonal direction and be kept close enough to the receiving antenna. The table was rotated 360 degrees to determine the suspected emission frequency and the position of the worst radiation case with both horizontal and vertical antenna polarization.
2. The EUT was then set 3 meters away from the receiving antenna, which was mounted on a variable-height antenna tower.
3. For each suspected emission frequency recorded in step 1, the EUT was arranged to its worst case and:
for tests below 30MHz the loop antenna is positioned with its plane vertical and the center of it is 1m above the ground. During the tests it is rotated about its vertical axis for maximum response at each azimuth about the EUT;
for tests above 30MHz the antenna was tuned to heights from 1 meter to 4 meters and the rotatable table was turned from 0 degrees to 360 degrees to read the maximum emission.
4. The RBW and VBW of the test receiver were 120 kHz and 120 kHz for Quasi-peak detection at frequency below 1GHz.
The RBW and VBW of the test receiver were 1MHz and 3MHz for Peak detection at frequency above 1GHz.
For Average measurement at frequency above 1GHz. The resolution bandwidth of the test receiver was 1MHz, video bandwidth is 10Hz. If the peak value was below the AV limit, AV measurement was skipped.

Prüfbericht - Nr.:
Test Report No.:

16025534 001

Seite 14 von 28
Page 14 of 28

Table 2: Radiated Emission (BR mode, Transmitting at 2402MHz)

Frequency	QP	AV	PK	Polarity	Limit		
					QP	AV	PK
[MHz]	[dB μ V/m]			(H/V)	[dB μ V/m]		
1601.00	--	--	36.4	H	N/A	54	74
4804.00	--	43.3	57.2	H	N/A	54	74
8418.00	--	--	46.8	H	N/A	54	74
1601.00	--	--	47.0	V	N/A	54	74
4804.00	--	48.2	62.1	V	N/A	54	74
9400.00	--	--	48.3	V	N/A	54	74
*)---							

Table 3: Radiated Emission (BR mode, Transmitting at 2441MHz)

Frequency	QP	AV	PK	Polarity	Limit		
					QP	AV	PK
[MHz]	[dB μ V/m]			(H/V)	[dB μ V/m]		
1627.00	--	--	36.8	H	N/A	54	74
4882.00	--	--	52.8	H	N/A	54	74
11636.00	--	--	49.1	H	N/A	54	74
1627.00	--	--	40.8	V	N/A	54	74
4882.00	--	50.3	57.5	V	N/A	54	74
9874.00	--	--	48.0	V	N/A	54	74
*)---							

Prüfbericht - Nr.:
Test Report No.:

16025534 001

Seite 15 von 28
Page 15 of 28

Table 4: Radiated Emission (BR mode, Transmitting at 2480MHz)

Frequency	QP	AV	PK	Polarity	Limit		
					QP	AV	PK
[MHz]	[dB μ V/m]			(H/V)	[dB μ V/m]		
1831.00	--	--	35.4	H	N/A	54	74
4960.00	--	--	53.2	H	N/A	54	74
9419.00	--	--	48.3	H	N/A	54	74
1652.00	--	--	39.4	V	N/A	54	74
4960.00	--	48.6	55.6	V	N/A	54	74
9551.00	--	--	49.1	V	N/A	54	74
*)---							

*) Measurement is made from 26MHz to 26 GHz. Disturbances other than those mentioned above are small or not detectable.

Emission at BR mode was found to be the worse case in the test.

Prüfbericht - Nr.:
Test Report No.:

16025534 001

Seite 16 von 28
Page 16 of 28

5.2 Antenna requirement

RESULT:

Pass

Date of testing : ---
Test specification : FCC Part 15 Per Section 15.203
FCC Part 15 Per Section 15.247(b)

For intentional device, according to 15.203, and intentional radiator shall be designed to ensure that no antenna other than that furnished by the responsible party shall be used with the device.

And according to 15.247(b), if transmitting antennas of directional gain greater than 6dBi are used, the power shall be reduced by amount in dB than the directional gain of the antenna exceeds of 6dBi.

As the antenna is permanently mounted on RF Board, there is no possibility of replacement.

And the max gain of the antenna is 2dBi.

5.3 Maximum Peak Conducted Output Power

RESULT:

Pass

Date of testing : Sep. 25, 2010
 Test specification : FCC Part 15 Per Section 15.247(b)(1)
 Limits : FCC Part 15 Per Section 15.247(b)(1)
 For frequency hopping systems operating in the band 2400-2483.5 MHz employing at least 75 hopping channels, the maximum peak conducted output power shall not exceed 1 W.

Deviations from Standard Test procedures : None
 Test procedure : Procedure specified in ANSI C63.4 were followed

Kind of test site : Shielded room
 Operation mode : Transmitting at BR / EDR mode
 Power supply : DC 3.7V
 Temperature : 22°C
 Humidity : 50%

Test procedure:

1. Connect the antenna output of the EUT to the power meter by a low lost cable.
2. Set the EUT to proper test mode with relative test software and hardware.
3. Read the power from power meter and add the cable loss correction.

Table 5: Peak Conducted Power (BR mode)

Channel	Frequency (MHz)	Power Reading(dBm)	Cable Loss (dB)	Output Power		Limit (mW) *
				(dBm)	(mW)	
Low	2402	2.53	0.40	2.93	1.96	1000
Mid	2441	2.66	0.40	3.06	2.02	1000
High	2480	2.46	0.40	2.86	1.93	1000

Table 6: Peak Conducted Power (EDR mode)

Channel	Frequency (MHz)	Power Reading(dBm)	Cable Loss (dB)	Output Power		Limit (mW) *
				(dBm)	(mW)	
Low	2402	0.17	0.40	0.57	1.14	1000
Mid	2441	0.13	0.40	0.53	1.13	1000
High	2480	-0.15	0.40	0.25	1.06	1000

*Note: Refer to the test result of “Number of Hopping Channel Used” for the non-overlap channel number.

Prüfbericht - Nr.:
Test Report No.:

16025534 001

Seite 18 von 28
Page 18 of 28

5.4 20dB Bandwidth

RESULT:

Pass

Date of testing : Sep. 25, 2010
 Test specification : FCC Part 15 Per Section 15.247(a)(1)
 Limits : No limit
 Deviations from Standard Test procedures : None
 Test procedure : Procedure specified in ANSI C63.4 were followed
 Operation mode : Transmitting at BR / EDR mode
 Kind of test site : Shielded room
 Power supply : DC 3.7V
 Temperature : 23°C
 Humidity : 50%

Test procedure:

1. Connect the antenna port of the EUT to the spectrum analyzer by a low lost cable.
2. Set the EUT to proper test mode with relative test software and hardware.
3. Spectrum analyzer setting: Centered Frequency= measured channel, RBW=10kHz, VBW=30kHz.
4. Mark the peak power frequency point and the -20dB upper and lower frequency points.
5. Read the frequency delta value between the -20dB upper and lower frequency points.
6. Repeat step 2 to 5 until all the channels required are finished.

Table 7: 20dB Bandwidth (BR mode)

Channel	Frequency (MHz)	Test Result (kHz)
Low	2402	945
Mid	2441	945
High	2480	953

Table 8: 20dB Bandwidth (EDR mode)

Channel	Frequency (MHz)	Test Result (kHz)
Low	2402	1328
Mid	2441	1328
High	2480	1328

Please refer to Appendix 1 for the plot.

Prüfbericht - Nr.:
Test Report No.:

16025534 001

Seite 19 von 28
Page 19 of 28

5.5 Hopping Channel Carrier Frequency Separation

RESULT:

Pass

Date of testing	:	Sep. 25, 2010
Test specification	:	FCC Part 15 Per Section 15.247(a)(1)
Limits	:	FCC Part 15 Per Section 15.247(a)(1) Frequency hopping systems operating in the band 2400-2483.5 MHz may have hopping channel carrier frequencies that are separated by 25 kHz or two-thirds of the 20 dB bandwidth of the hopping channel, whichever is greater, provided the systems operate with an output power no greater than 0.125W.
Deviations from Standard Test procedures	:	None
Test procedure	:	Procedure specified in ANSI C63.4
Kind of test site	:	Shielded room
Operation mode	:	Bluetooth transmitting with hopping at the full channel set
Power supply	:	DC 3.7V
Temperature	:	23°C
Humidity	:	50%

Test procedure:

1. Connect the antenna port of the EUT to the spectrum analyzer by a low loss cable.
2. Set the EUT to proper test mode with relative test software and hardware.
3. Spectrum analyzer setting: Centered Frequency = measured channel, RBW = 100 kHz, VBW = 100 kHz, Frequency Span = wide enough to cover the adjacent channel.
4. Mark the peak power frequency point of the measured channel and its adjacent channel(s)
5. Read the frequency delta value between the measured channel and its adjacent channel(s)
6. Repeat step 3 to 5 until all the channels measured are finished.

Prüfbericht - Nr.:
Test Report No.:

16025534 001

Seite 20 von 28
Page 20 of 28

Table 9: Hopping Channel Carrier Frequency Separation

Channel	Adjacent Hopping channel separation (kHz)	Limit
Low	998	At least 25kHz or tow-thirds of the 20dB bandwidth of the hopping channel, whichever is greater. <i>Note: refer to table 8 and 9 for the value of 20dB bandwidth</i>
Mid	1005	
High	1035	

Please refer to Appendix 1 for the plot.

5.6 Number of Hopping Frequency Used

RESULT:

Pass

Date of testing	:	Sep. 25, 2010
Test specification	:	FCC Part 15 Per Section 15.247(a)(1)(iii)
Limits	:	FCC Part 15 Per Section 15.247(a)(1)(iii) Frequency hopping system in the 2400-2483.5 MHz band shall use at least 15 non-overlapping channels
Deviations from Standard Test procedures	:	None
Test procedure	:	Procedure specified in ANSI C63.4
Kind of test site	:	Shielded room
Operation mode	:	Bluetooth transmitting with hopping at the full channel set
Power supply	:	DC 3.7V
Temperature	:	23°C
Humidity	:	50%

Test procedure:

1. Connect the antenna port of the EUT to the spectrum analyzer by a low lost cable.
2. Set the EUT to proper test mode with relative test software and hardware.
3. Spectrum analyzer setting: RBW = 100 kHz, VBW≥RBW, Frequency Span = wide enough to cover the channels to be plotted.
4. Set the spectrum analyzer to Max-hold mode and plot the result(s) with record of all hopping channel.

Table 10: Number of hopping frequency

Number of hopping frequency:	79
Limit:	At least 15 non-overlapping channels

Please refer to Appendix 1 for measurement data.

5.7 Time of Occupancy (Dwell Time)

RESULT:

Pass

Date of testing	:	Sep. 25, 2010
Test specification	:	FCC Part 15 Per Section 15.247(a)(1)(iii)
Limits	:	FCC Part 15 Per Section 15.247(a)(1)(iii) For frequency hopping system operating in the 2400-2483.5MHz band, the average time of occupancy on any channel shall not be greater than 0.4 seconds within a period of 0.4 seconds multiplied by the number of hopping channels employed.
Deviations from Standard Test procedures	:	None
Test Procedure	:	Procedure specified in ANSI C63.4
Kind of test site	:	Shielded room
Operation mode	:	Bluetooth transmitting with hopping at the full channel set (DH5 mode)
Power supply	:	DC 3.7V
Temperature	:	23°C
Humidity	:	50%

Test procedure:

1. Connect the antenna port of the EUT to the spectrum analyzer by a low loss cable.
2. Set the EUT to proper test mode with relative test software and hardware.
3. Spectrum analyzer setting: Centered Frequency = measured channel, RBW = 1MHz, VBW \geq RBW, Frequency Span = 0 Hz.
4. Set sweep time properly to capture the entire dwell time per hopping channel.
5. Set detector type to Peak and trace mode to Max Hold and make the measurement.
6. Repeat step 3-5 until all channels measured were complete.

Prüfbericht - Nr.:
Test Report No.:

16025534 001

Seite 23 von 28
Page 23 of 28

Table 11: Dwell Time (DH5 mode)

channel	Frequency (MHz)	Dwell time of one signal Burst (ms)	Total Dwell Time (ms)	Limit (ms)
Low	2402	2.98	$(2.98 \times \mathbf{106.81}) = 318.29$	400
Mid	2441	2.98	$(2.98 \times \mathbf{106.81}) = 318.29$	400
High	2480	2.98	$(2.98 \times \mathbf{106.81}) = 318.29$	400

Note :

DH5 mode was found to be the worst case in the test.

Period = 0.4 (seconds) x 79 (channels) = 31.6 seconds

For Bluetooth system, there are 1600 timeslots in one second. The DH5 mode operates on a 5-slot transmission and 1-slot receiving basis. Thus there are $1600 / (5+1) = 266.7$ transmission per second. In one period for each particular channel there are $(266.7/79) \times 31.6 = 106.81$ times of transmission.

Dwell Time in one period(ms) = Dwell time of one-slot transmission(ms) multiplexes **106.81**

Please refer to Appendix 1 for measurement data.

5.8 Out-of-Band Emission

RESULT:

Pass

Date of testing : Sep. 25, 2010
Test specification : FCC Part 15 Per Section 15.247(d)
Limits : FCC Part 15 Per Section 15.247(d)
In any 100kHz bandwidth outside the frequency band in which the spread spectrum or digitally modulated intentional radiator is operating, the radio frequency power that is produced by the intentional radiator shall be at least 20dB below that in the 100kHz bandwidth within the band that contains the highest level of the desired power, based on either an RF conducted or a radiated measurement.

In addition:

FCC Part 15 - radiated emission which fall in the restricted bands, as defined in Section 15.205(a), must also comply with the radiated emission limits specified in section 15.209(a).

Deviations from Standard Test procedures : None
Test Procedure : Procedure specified in ANSI C63.4 were followed
Kind of test site : Shielded room
Operation mode : Transmitting at BR / EDR mode
Power supply : DC 3.7V
Temperature : 23°C
Humidity : 50%

Test procedure:

1. Connect the antenna port of the EUT to the spectrum analyzer by a low loss cable.
2. Set the EUT to proper test mode with relative test software and hardware.
3. Spectrum analyzer setting: RBW = 100 kHz, VBW ≥ RBW.
4. Set proper frequency span respectively for out-of-band emission measurement of the band edge and the whole range (up to 10 times of the carrier frequency.)
5. Set the trace mode to Max Hold and mark the peak reading of any spurious emission recorded.
6. The band edge radiated emission was measured according to the procedure in clause 5.2 of this report.

Prüfbericht - Nr.:
Test Report No.:

16025534 001

Seite 25 von 28
Page 25 of 28

Table 12: Out-Of-Band Emission measurement (conducted)

Emission (Max reading among Channel low, mid and high)	Attenuation	Limit (dB)
30MHz to 25GHz	All emission in this 100kHz bandwidth are attenuated more than 20dB from the carrier	$\Delta \geq 20$

* **Note:** Please refer to the Appendix 1 for the plot of the peak value.

Table 13: Band Edges Emission in the Restricted Bands (BR mode)

Frequency [MHz]	dBc [dB]	PK [dBμV/m]	AV [dBμV/m]	Polarity (H/V)	PK limit [dBμV/m]	AV limit [dBμV/m]
2483.5	48.3	40.6	---	V	74	54
Remark: The max. peak carrier field strength of the high channel is 88.9 dBuV/m (vertical)						

Table 14: Band Edges Emission in the Restricted Bands (EDR mode)

Frequency [MHz]	dBc [dB]	PK [dBμV/m]	AV [dBμV/m]	Polarity (H/V)	PK limit [dBμV/m]	AV limit [dBμV/m]
2483.5	45.6	38.2	---	V	74	54
Remark: The max. peak carrier field strength of the high channel is 83.8dBuV/m (vertical)						

NOTE:

1. Marker-delta method was used to calculate the band edges emission: The dBc value between the carrier maximum power and band edge emission power of the frequency listed in the table is calculated from the test record showed in Appendix 1.

Peak value of the high/low band edge emission listed in the table is calculated by the below formula:
PK value of band edge emission = Peak carrier field strength – dBc value

2. Disturbances other than those mentioned above are small or not detectable.

6 Photographs of the Test Set-Up

Photograph 1: Set-up for Radiation Measurement below 1GHz



Prüfbericht - Nr.:
Test Report No.:

16025534 001

Seite 27 von 28
Page 27 of 28

Photograph 2: Set-up for Radiation Measurement above 1GHz



7 List of Tables

Table 1: List of Test and Measurement Equipment	6
Table 2: Radiated Emission (BR mode, Transmitting at 2402MHz)	14
Table 3: Radiated Emission (BR mode, Transmitting at 2441MHz)	14
Table 4: Radiated Emission (BR mode, Transmitting at 2480MHz)	15
Table 5: Peak Conducted Power (BR mode)	17
Table 6: Peak Conducted Power (EDR mode)	17
Table 7: 20dB Bandwidth (BR mode)	18
Table 8: 20dB Bandwidth (EDR mode)	18
Table 9: Hopping Channel Carrier Frequency Separation	20
Table 10: Number of hopping frequency	21
Table 11: Dwell Time (DH5 mode)	23
Table 12: Out-Of-Band Emission measurement (conducted)	25
Table 13: Band Edges Emission in the Restricted Bands (BR mode)	25
Table 14: Band Edges Emission in the Restricted Bands (EDR mode)	25

8 List of Photographs

Photograph 1: Set-up for Radiation Measurement below 1GHz	26
Photograph 2: Set-up for Radiation Measurement above 1GHz	27

Prüfbericht - Nr.:

16025534 001

Seite 1 von 14

Test Report no.

Page 1 of 14

20dB Bandwidth (BR mode)

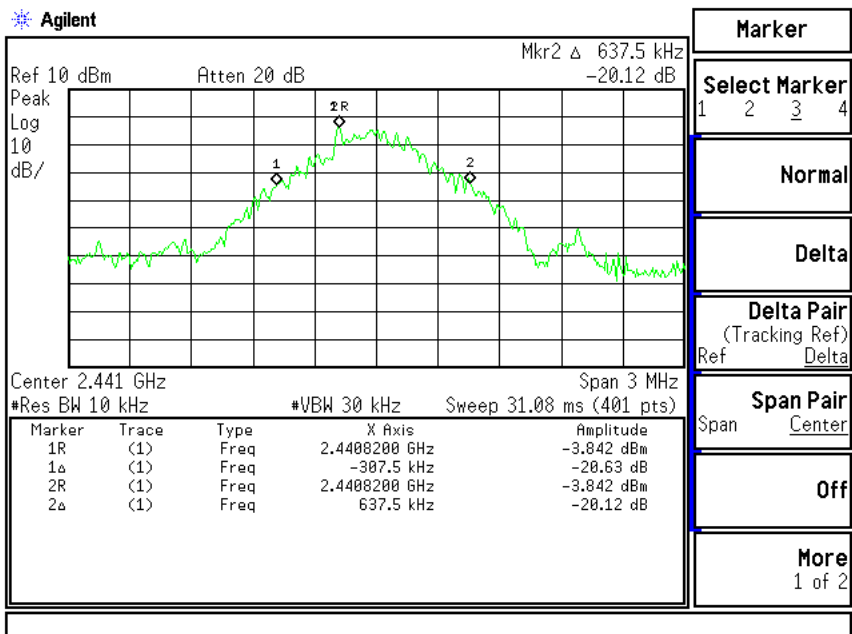
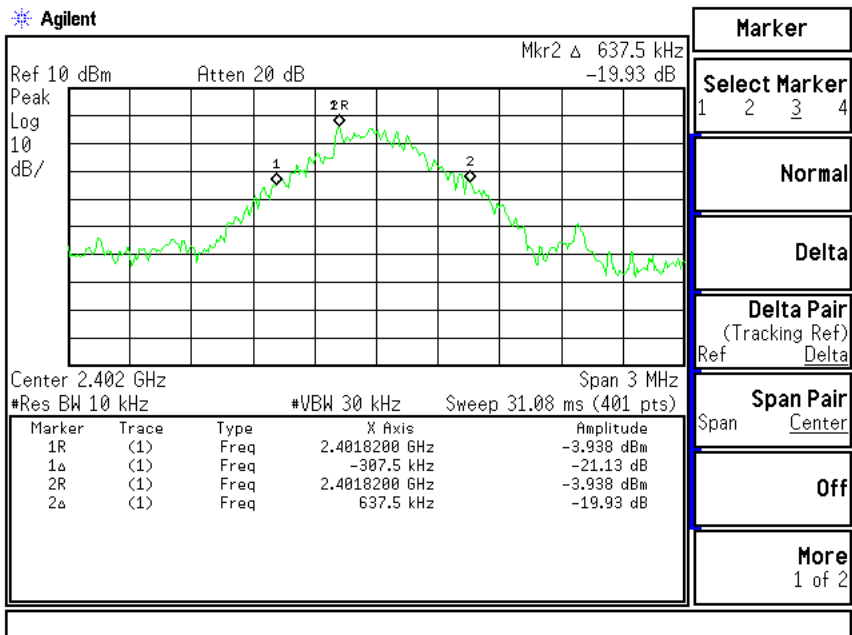

Prüfbericht - Nr.:

16025534 001

Seite 2 von 14

Test Report no.

Page 2 of 14

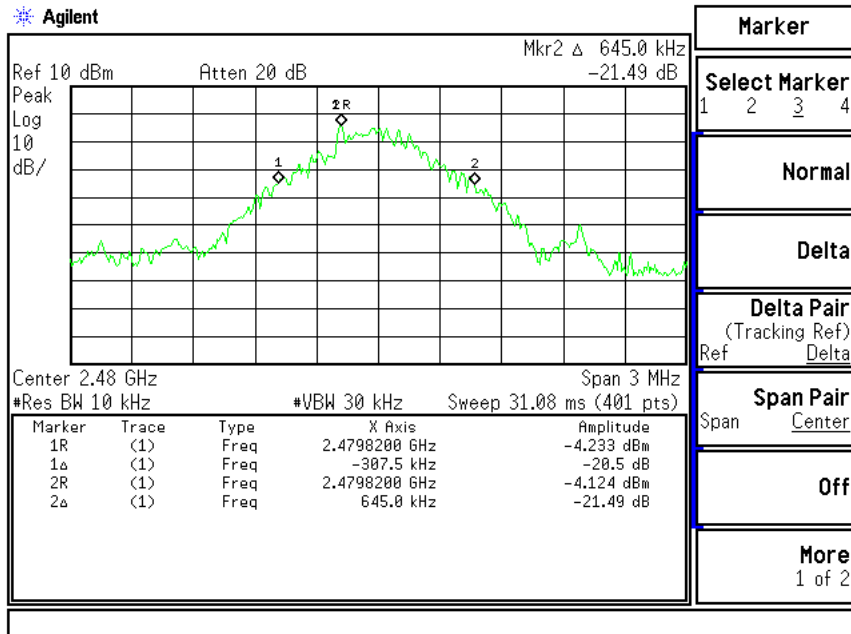

20dB Bandwidth (EDR mode)

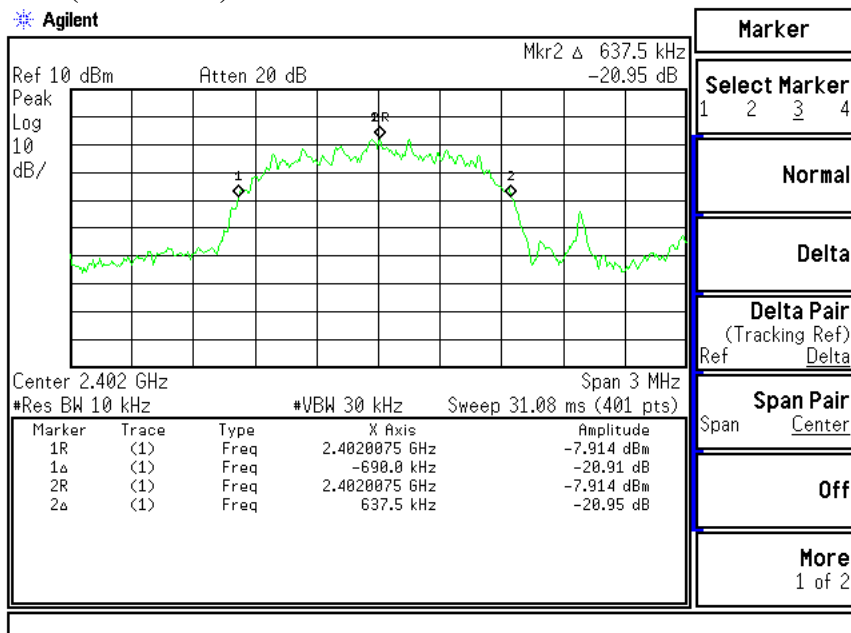

Prüfbericht - Nr.:

16025534 001

Seite 3 von 14

Test Report no.

Page 3 of 14

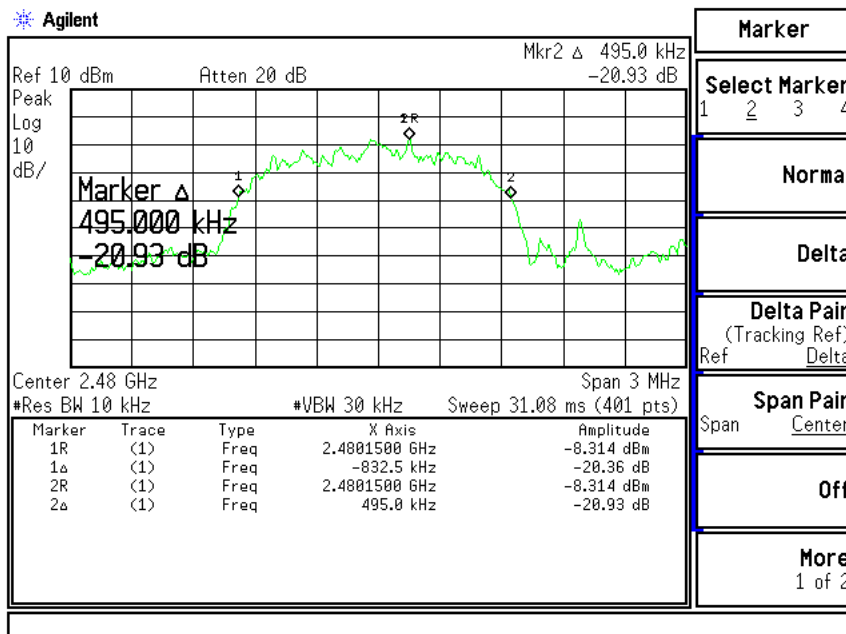
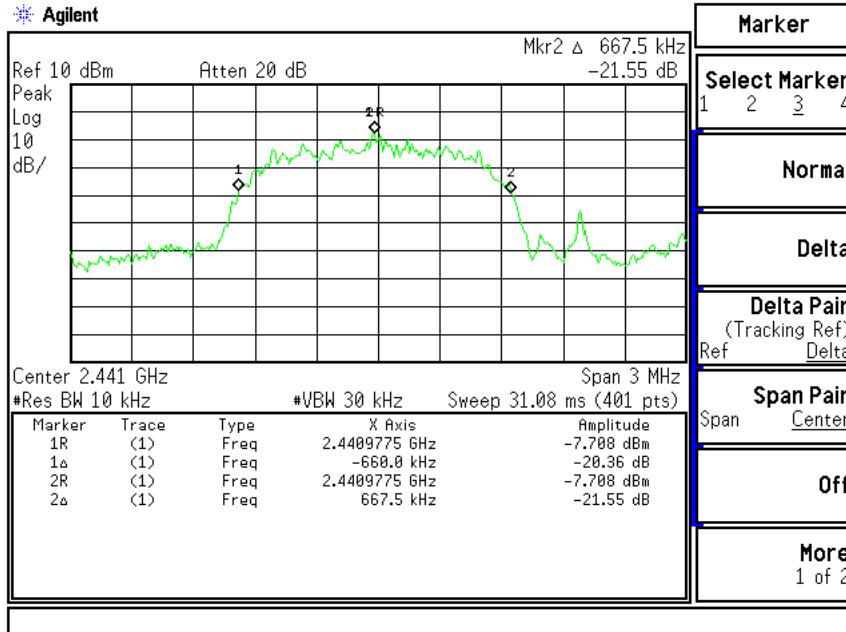

Prüfbericht - Nr.:

16025534 001

Seite 4 von 14

Test Report no.

Page 4 of 14

Hopping Channel Carrier Frequency Separation

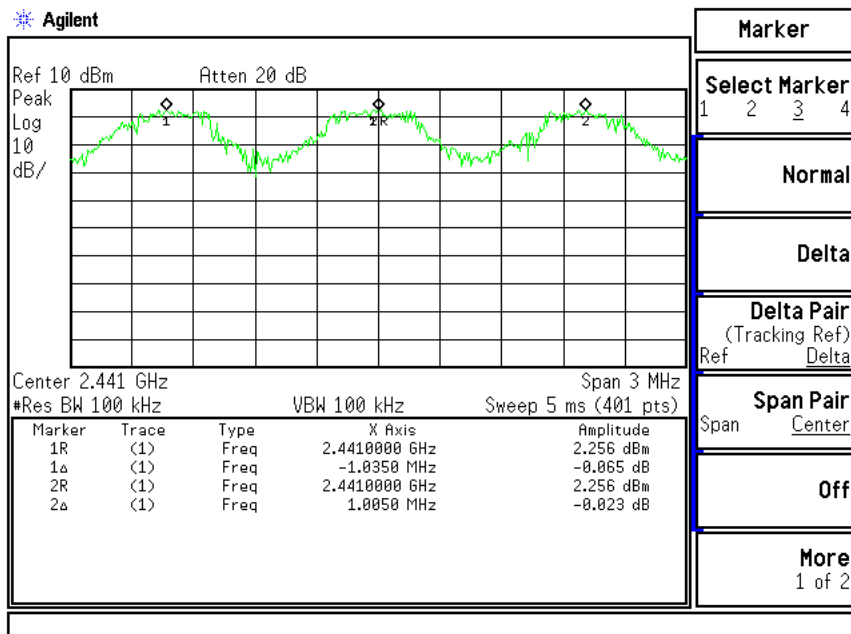
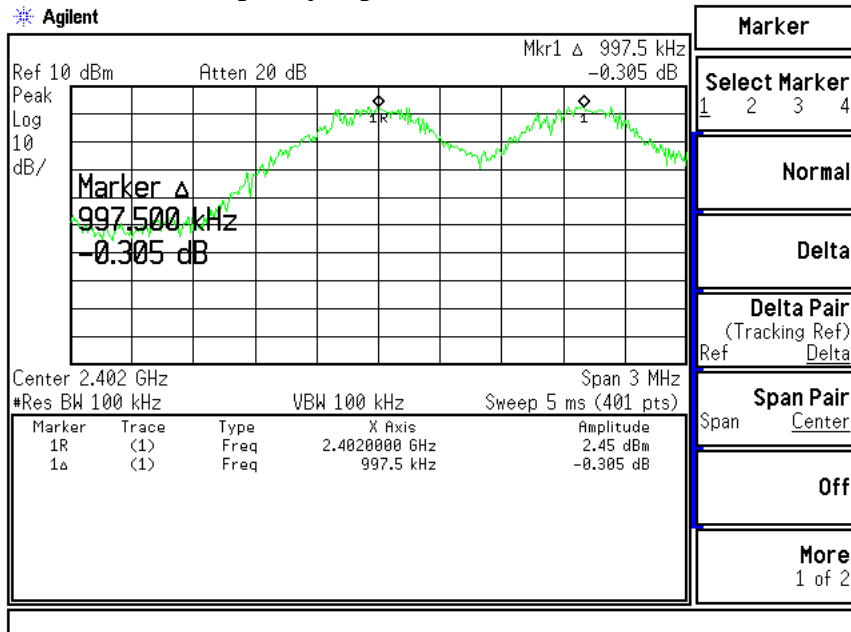

Prüfbericht - Nr.:

16025534 001

Seite 5 von 14

Page 5 of 14

Test Report no.

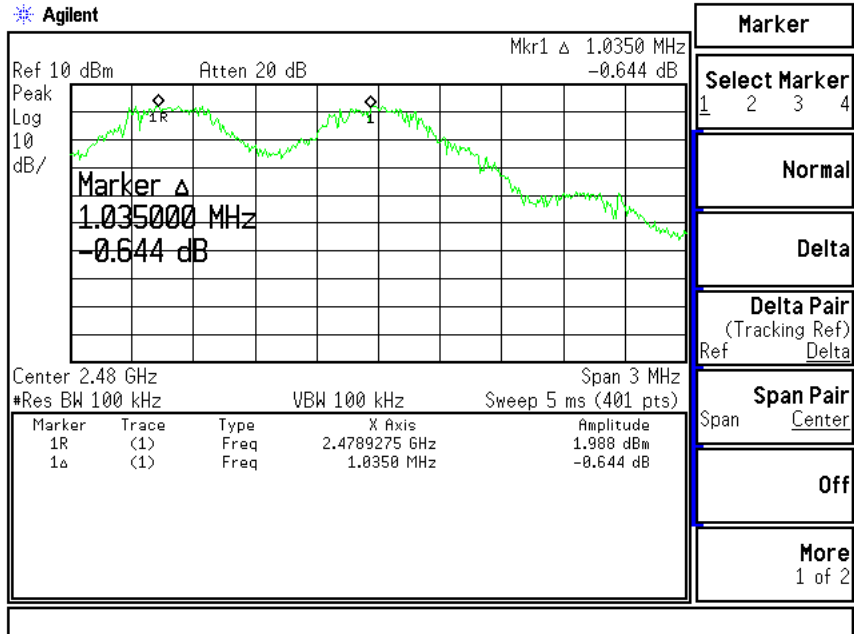

Prüfbericht - Nr.: 16025534 001
Test Report no.

Seite 6 von 14
Page 6 of 14

Number of Hopping Frequency Used

Agilent

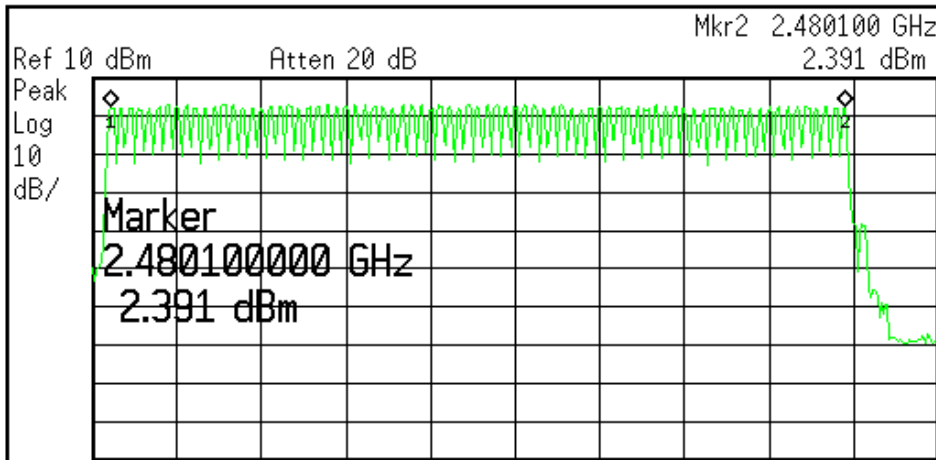

Start 2.4 GHz Stop 2.49 GHz
#Res BW 100 kHz VBW 100 kHz Sweep 11.6 ms (401 pts)

Marker	Trace	Type	X Axis	Amplitude
1	(1)	Freq	2.480225 GHz	2.273 dBm
2	(1)	Freq	2.480100 GHz	2.391 dBm

Marker

Select Marker
1 2 3 4

Normal

Delta

Delta Pair
(Tracking Ref)
Ref Delta

Span Pair
Span Center

Off

More
1 of 2

Prüfbericht - Nr.:

16025534 001

Seite 7 von 14

Test Report no.

Page 7 of 14

Time of Occupancy (Dwell Time)

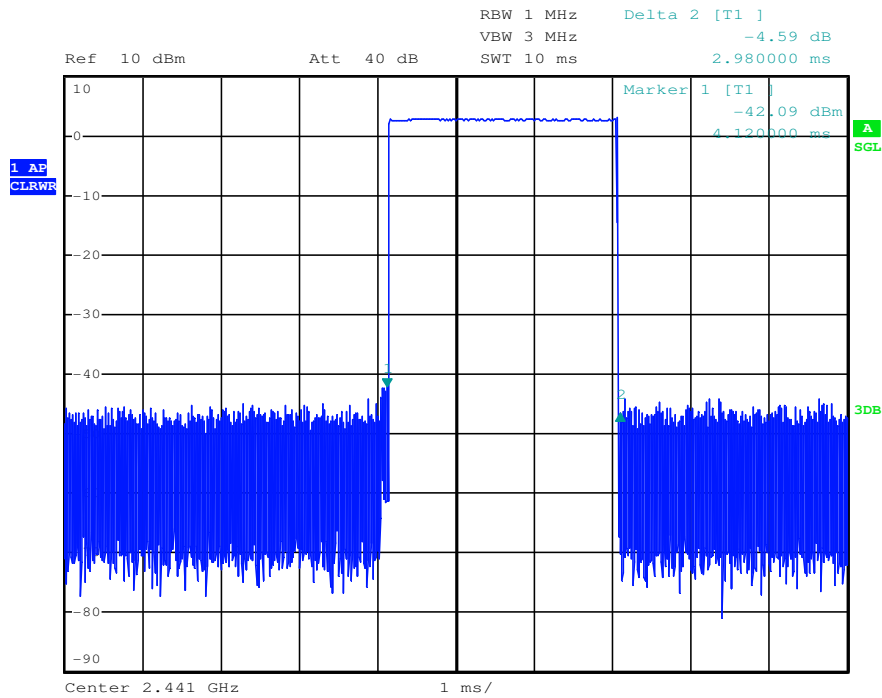
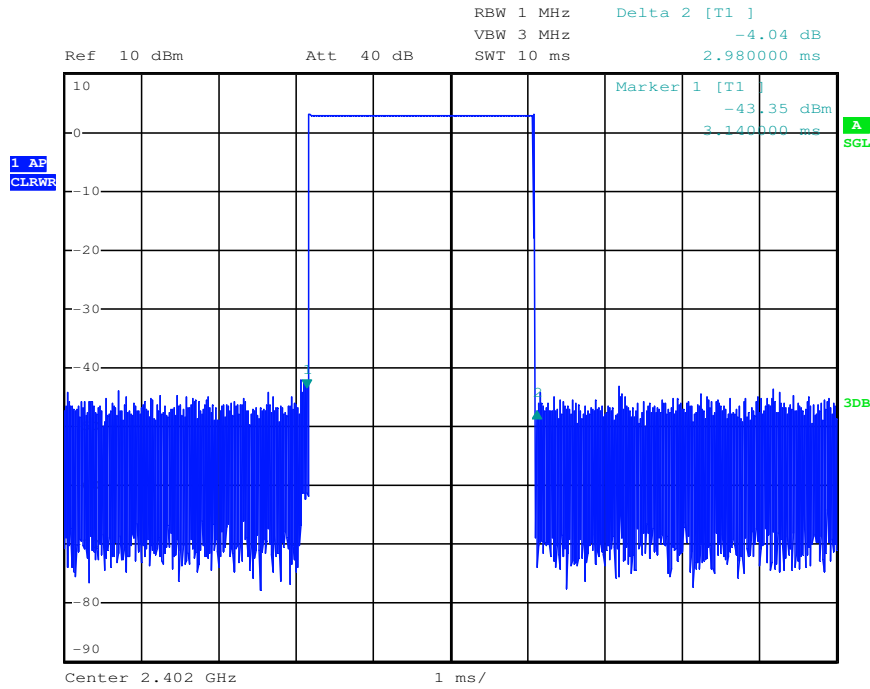

Prüfbericht - Nr.:

16025534 001

Seite 8 von 14

Test Report no.

Page 8 of 14

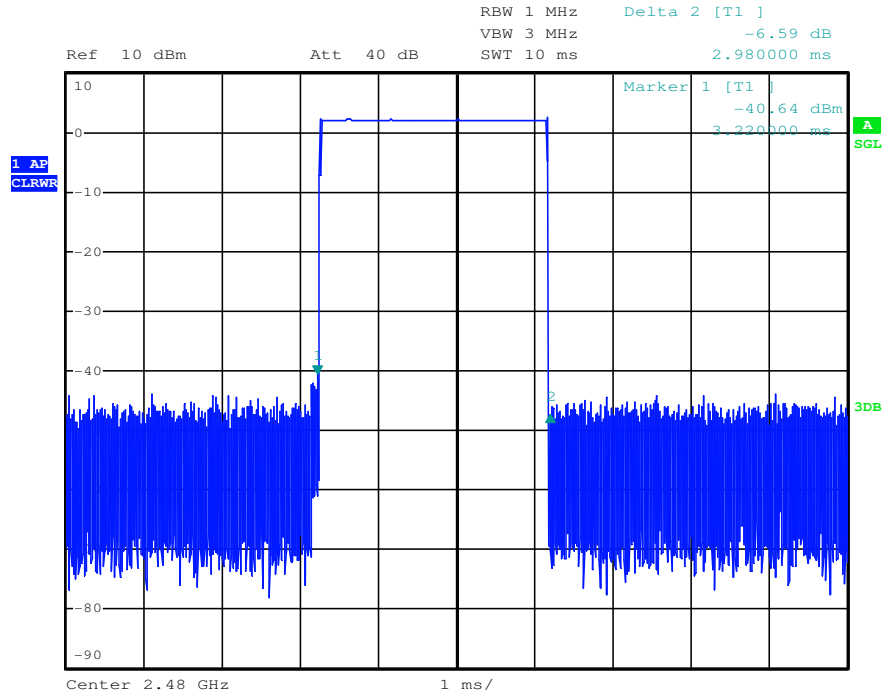

Prüfbericht - Nr.:

16025534 001

Seite 9 von 14

Test Report no.

Page 9 of 14

Band Edge Emission (BR mode)

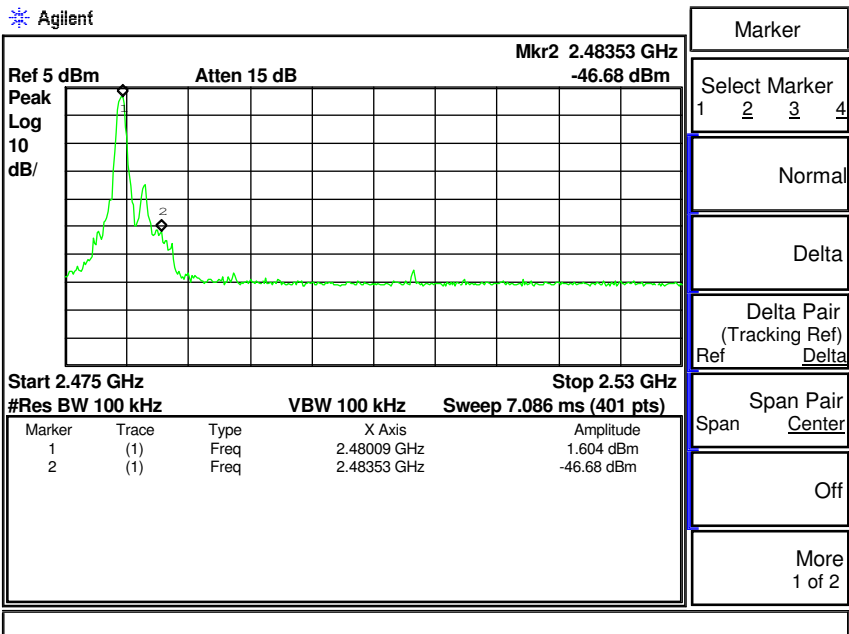
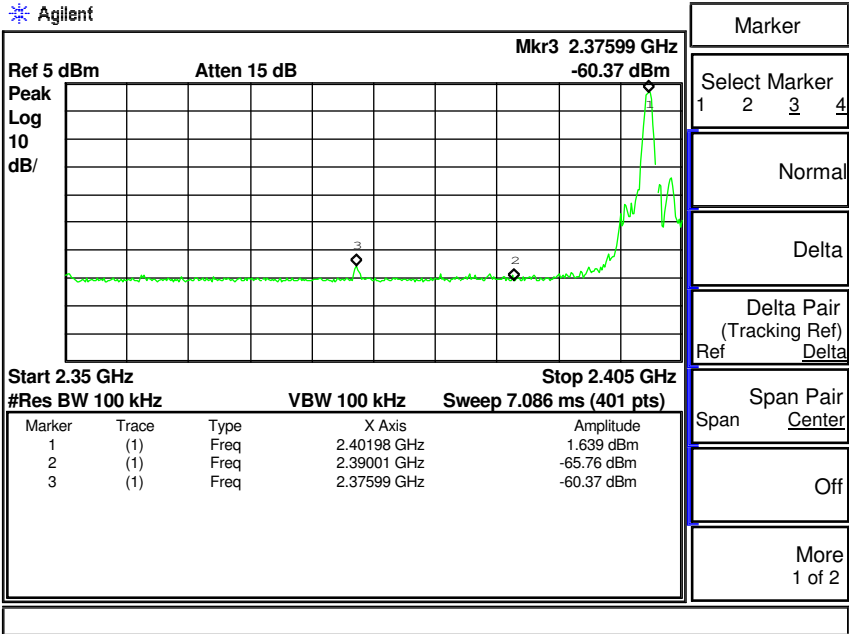

Band Edge Emission (EDR mode)

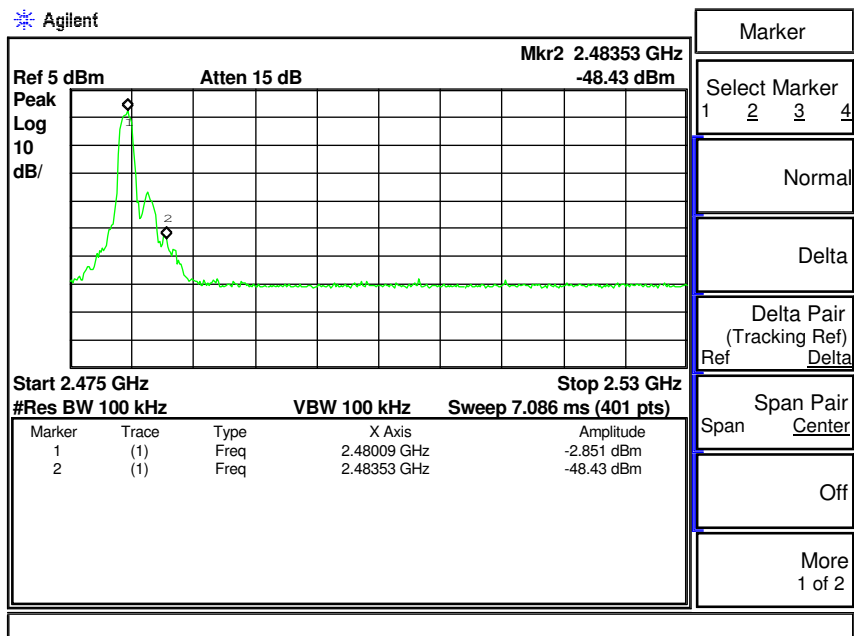
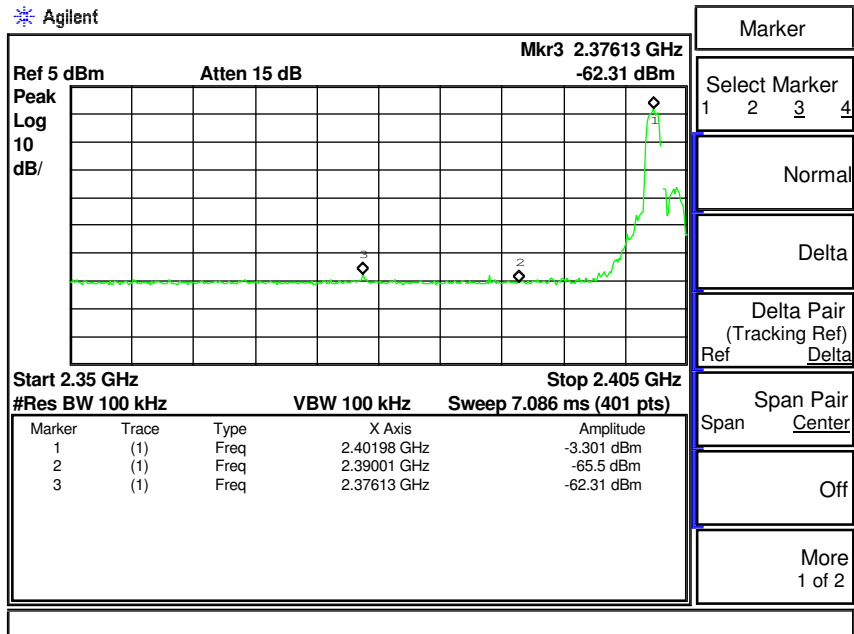

Out-Of-Band Emission (BR mode)

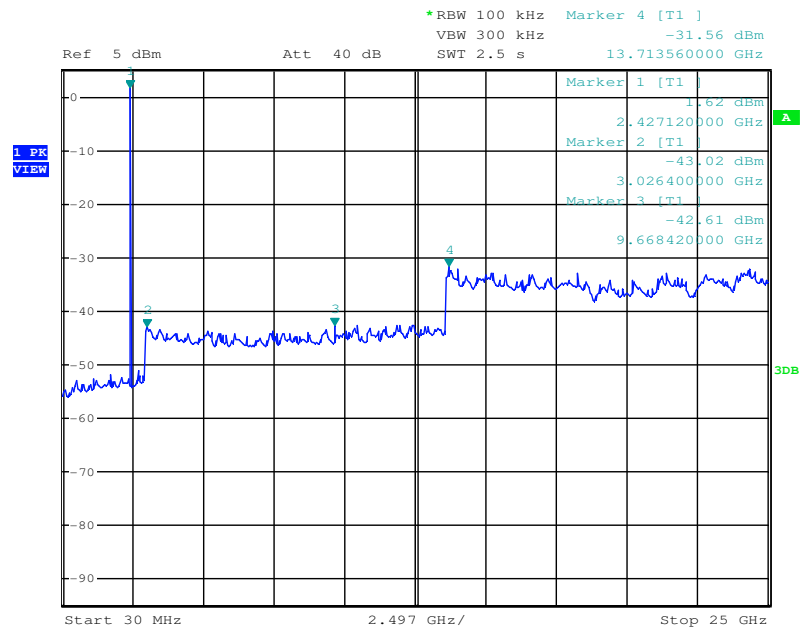
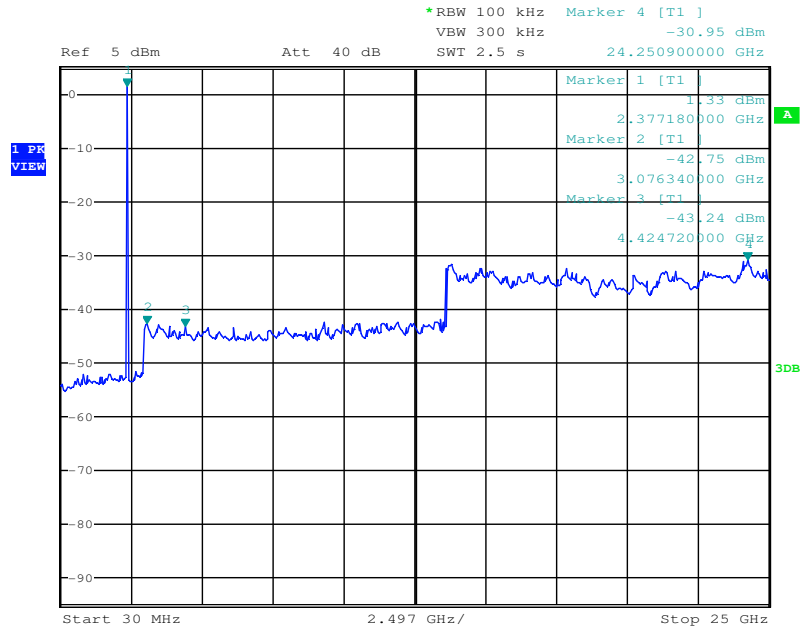

Prüfbericht - Nr.:

16025534 001

Seite 12 von 14

Test Report no.

Page 12 of 14

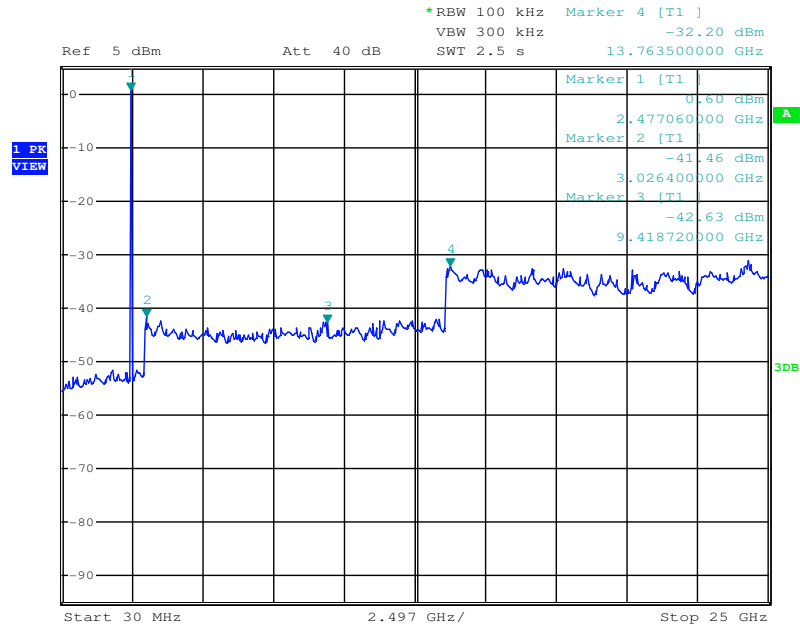

Prüfbericht - Nr.:

16025534 001

Seite 13 von 14

Test Report no.

Page 13 of 14

Out-Of-Band Emission (EDR mode)

Controlled by EMC32

*RBW 1 MHz

Marker 1 [T1]

VBW 3 MHz

0.33 dBm

Ref 10 dBm

*Att 20 dB

SWT 500 ms

2.377180000 GHz

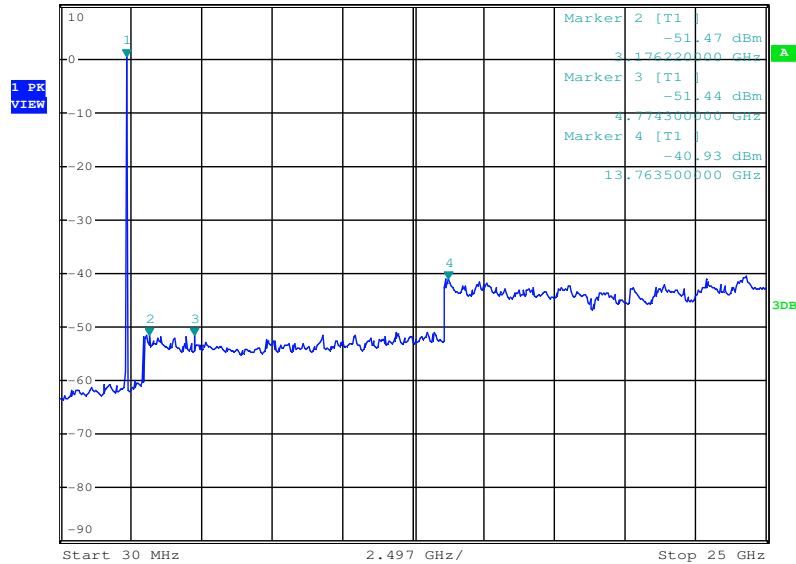

Controlled by EMC32

*RBW 1 MHz

Marker 1 [T1]

VBW 3 MHz

-0.04 dBm

Ref 10 dBm

*Att 20 dB

SWT 500 ms

2.427120000 GHz

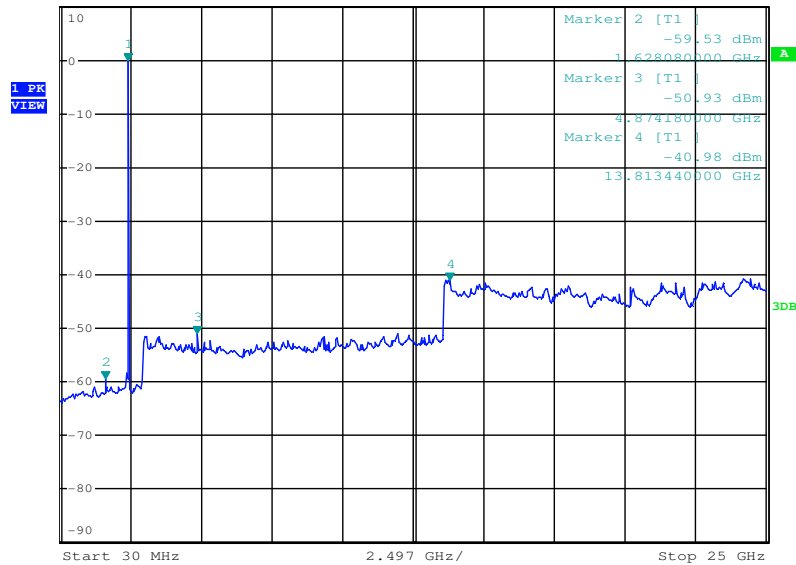

Prüfbericht - Nr.:

16025534 001

Seite 14 von 14

Test Report no.

Page 14 of 14

