

FCC PART 15.247

TEST REPORT

For

Zhongshan K-mate General Electronics Co.,Ltd.

NO.2, 5th Xinsheng Street, Gangkou Town, Zhongshan City, Guangdong, China

FCC ID: WAD-BTC021L

Report Type: Original Report	Product Type: Bluetooth car kit
Test Engineer: Dean Liu	<i>Dean Liu</i>
Report Number: RDG140824001-00B	
Report Date: 2014-09-11	
Reviewed By: Sula Huang RF Engineer	<i>Sula Huang</i>
Test Laboratory: Bay Area Compliance Laboratories Corp. (Dongguan) No.69 Pulongcun, Puxinhu Industrial Zone, Tangxia, Dongguan, Guangdong, China Tel: +86-769-86858888 Fax: +86-769-86858891 www.baclcorp.com.cn	

Note: This test report is prepared for the customer shown above and for the device described herein. It may not be duplicated or used in part without prior written consent from Bay Area Compliance Laboratories Corp. (Dongguan). This report is valid only with a valid digital signature. The digital signature may be available only under the Adobe software above version 7.0.

TABLE OF CONTENTS

GENERAL INFORMATION.....	4
PRODUCT DESCRIPTION FOR EQUIPMENT UNDER TEST (EUT)	4
OBJECTIVE	4
RELATED SUBMITTAL(S)/GRANT(S).....	4
TEST METHODOLOGY	4
TEST FACILITY	4
SYSTEM TEST CONFIGURATION.....	5
DESCRIPTION OF TEST CONFIGURATION	5
EUT EXERCISE SOFTWARE	5
EQUIPMENT MODIFICATIONS	5
SUPPORT EQUIPMENT LIST AND DETAILS	5
EXTERNAL CABLE.....	5
BLOCK DIAGRAM OF TEST SETUP	6
SUMMARY OF TEST RESULTS	7
FCC §15.247 (i) & §1.1310 & §2.1091- MAXIMUM PERMISSIBLE EXPOSURE (MPE).....	8
APPLICABLE STANDARD	8
FCC §15.203 - ANTENNA REQUIREMENT.....	9
APPLICABLE STANDARD	9
ANTENNA CONNECTOR CONSTRUCTION	9
FCC §15.209, §15.205 & §15.247(d) - SPURIOUS EMISSIONS.....	10
APPLICABLE STANDARD	10
MEASUREMENT UNCERTAINTY	10
EUT SETUP	10
EMI TEST RECEIVER & SPECTRUM ANALYZER SETUP	11
TEST PROCEDURE	11
CORRECTED AMPLITUDE & MARGIN CALCULATION	12
TEST EQUIPMENT LIST AND DETAILS.....	12
TEST RESULTS SUMMARY	13
TEST DATA	13
FCC §15.247(a) (2) – 6 dB EMISSION BANDWIDTH.....	17
APPLICABLE STANDARD	17
TEST PROCEDURE	17
TEST EQUIPMENT LIST AND DETAILS.....	17
TEST DATA	17
FCC §15.247(b) (3) - MAXIMUM PEAK OUTPUT POWER	20
APPLICABLE STANDARD	20
TEST PROCEDURE	20
TEST EQUIPMENT LIST AND DETAILS.....	20
TEST DATA	20
FCC §15.247(d) – 100 kHz BANDWIDTH OF FREQUENCY BAND EDGE.....	23
APPLICABLE STANDARD	23
TEST PROCEDURE	23
TEST EQUIPMENT LIST AND DETAILS.....	23

TEST DATA23

FCC §15.247(e) - POWER SPECTRAL DENSITY25

APPLICABLE STANDARD25

TEST PROCEDURE25

TEST EQUIPMENT LIST AND DETAILS.....25

TEST DATA25

FEMVAL

GENERAL INFORMATION

Product Description for Equipment under Test (EUT)

The *Zhongshan K-mate General Electronics Co., Ltd.*'s product, model number: *BTC021L* (the "EUT") in this report is a *Bluetooth car kit*, which was measured approximately: 4.2 cm (L) x 4.2 cm (W) x 1.5 cm (H) for main Unit, 5.4 cm (L) x 2.4 cm (W) x 2.4 cm (H) for Car Charger, rated input voltage: DC 12-24 V.

All measurement and test data in this report was gathered from production sample serial number: 140824001. (Assigned by BACL, Dongguan). The EUT was received on 2014-08-25.

Objective

This report is prepared on behalf of *Zhongshan K-mate General Electronics Co.,Ltd.* in accordance with Part 2-Subpart J, Part 15-Subparts A, B and C of the Federal Communications Commission's rules.

The tests were performed in order to determine the compliance of the EUT with FCC Part 15-Subpart C, section 15.203, 15.205, 15.207, 15.209 and 15.247 rules.

Related Submittal(s)/Grant(s)

FCC Part15C DSS submissions with FCC ID: *WAD-BTC021L for Bluetooth BDR, EDR mode.*

Test Methodology

All measurements contained in this report were conducted with ANSI C63.4-2003, American National Standard for Methods of Measurement of Radio-Noise Emissions from Low-Voltage Electrical and Electronic Equipment in the range of 9 kHz to 40 GHz.

All emissions measurement was performed and Bay Area Compliance Laboratories Corp. (Dongguan). The radiated testing was performed at an antenna-to-EUT distance of 3 meters.

Test Facility

The Test site used by Bay Area Compliance Laboratories Corp. (Dongguan) to collect test data is located on the No.69 Pulongcun, Puxinhu Industrial Zone, Tangxia, Dongguan, Guangdong, China

Test site at Bay Area Compliance Laboratories Corp. (Dongguan) has been fully described in reports submitted to the Federal Communications Commission (FCC). The details of these reports have been found to be in compliance with the requirements of Section 2.948 of the FCC Rules on February 02, 2012. The facility also complies with the radiated and AC line conducted test site criteria set forth in ANSI C63.4-2003.

The Federal Communications Commission has the reports on file and is listed under FCC Registration No.: 273710. The test site has been approved by the FCC for public use and is listed in the FCC Public Access Link (PAL) database.

SYSTEM TEST CONFIGURATION

Description of Test Configuration

The system was configured for testing in an engineering mode, which was provided by manufacturer. The engineering mode was configured the system transmitting with maximum power.

For Bluetooth LE mode, 40 channels are provided for testing:

Channel	Frequency (MHz)	Channel	Frequency (MHz)
0	2402	20	2442
1	2404
...
...
..	...	38	2478
19	2440	39	2480

EUT was tested with channel 0, 19 and 39.

EUT Exercise Software

The software “CSR Blue Suite 2.5.0” was used.

Equipment Modifications

No modification was made to the EUT.

Support Equipment List and Details

Manufacturer	Description	Model	Serial Number
Pro Instrument	DC power supply	Pps3300	/

External Cable

Cable Description	Shielding Type	Ferrite Core	Length (m)	From Port	To
DC Cable	no	no	1.5	Car Charger	DC power supply

Block Diagram of Test Setup

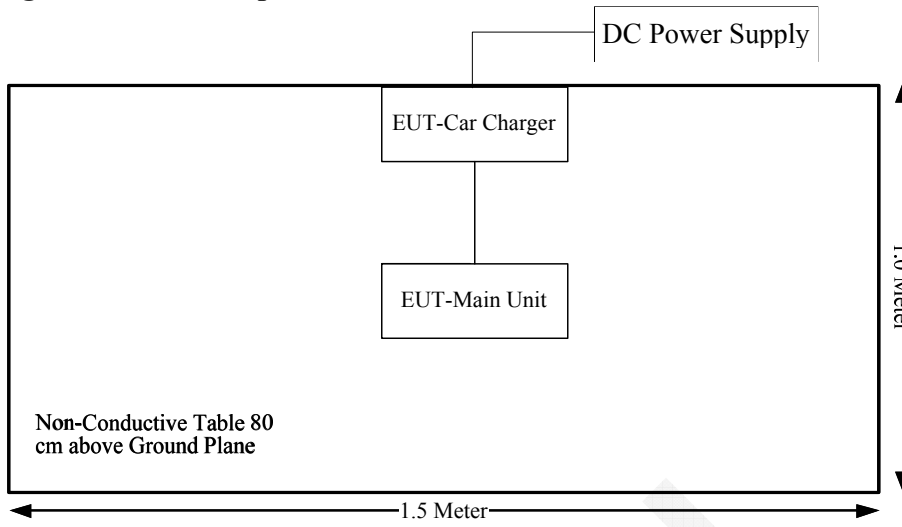

SUMMARY OF TEST RESULTS

FCC Rules	Description of Test	Result
FCC §15.247 (i) & §1.1310 & §2.1091	RF EXPOSURE	Compliance
§15.203	Antenna Requirement	Compliance
§15.207 (a)	AC Line Conducted Emissions	Not Applicable
§15.247(d)	Spurious Emissions at Antenna Port	Compliance
§15.205, §15.209, §15.247(d)	Spurious Emissions	Compliance
§15.247 (a)(2)	6 dB Emission Bandwidth	Compliance
§15.247(b)(3)	Maximum Peak Output Power	Compliance
§15.247(d)	100 kHz Bandwidth of Frequency Band Edge	Compliance
§15.247(e)	Power Spectral Density	Compliance

Not Applicable: The EUT is for vehicular use.

FCC §15.247 (i) & §1.1310 & §2.1091- MAXIMUM PERMISSIBLE EXPOSURE (MPE)

Applicable Standard

According to subpart 15.247(i) and subpart §1.1310, systems operating under the provisions of this section shall be operated in a manner that ensures that the public is not exposed to radio frequency energy level in excess of the Commission’s guidelines.

Limits for Maximum Permissible Exposure (MPE) (§1.1310, §2.1091)

(B) Limits for General Population/Uncontrolled Exposure				
Frequency Range (MHz)	Electric Field Strength (V/m)	Magnetic Field Strength (A/m)	Power Density (mW/cm ²)	Averaging Time (minutes)
0.3–1.34	614	1.63	*(100)	30
1.34–30	824/f	2.19/f	*(180/f ²)	30
30–300	27.5	0.073	0.2	30
300–1500	/	/	f/1500	30
1500–100,000	/	/	1.0	30

f = frequency in MHz; * = Plane-wave equivalent power density;

According to §1.1310 and §2.1091 RF exposure is calculated.

Calculated Formulary:

Predication of MPE limit at a given distance

$S = PG/4\pi R^2$ = power density (in appropriate units, e.g. mW/cm²);

P = power input to the antenna (in appropriate units, e.g., mW);

G = power gain of the antenna in the direction of interest relative to an isotropic radiator, the power gain factor, is normally numeric gain;

R = distance to the center of radiation of the antenna (appropriate units, e.g., cm);

Calculated Data:

Frequency (MHz)	Antenna Gain		Conducted Power		Evaluation Distance (cm)	Power Density (mW/cm ²)	MPE Limit (mW/cm ²)
	(dBi)	(numeric)	(dBm)	(mW)			
2440	0	1.0	6.67	4.65	20	0.00093	1.0

Result: The device meet FCC MPE at 20 cm distance

FCC §15.203 - ANTENNA REQUIREMENT

Applicable Standard

According to § 15.203, an intentional radiator shall be designed to ensure that no antenna other than that furnished by the responsible party shall be used with the device. The use of a permanently attached antenna or of an antenna that uses a unique coupling to the intentional radiator shall be considered sufficient to comply with the provisions of this section. The manufacturer may design the unit so that a broken antenna can be replaced by the user, but the user of a standard antenna jack or electrical connector is prohibited. The structure and application of the EUT were analyzed to determine compliance with section §15.203 of the rules. §15.203 state that the subject device must meet the following criteria:

- a. Antenna must be permanently attached to the unit.
- b. Antenna must use a unique type of connector to attach to the EUT.

Unit must be professionally installed, and installer shall be responsible for verifying that the correct antenna is employed with the unit.

Antenna Connector Construction

The EUT has one integral antenna arrangement, which was permanently attached and the antenna gain is 0dBi, fulfill the requirement of this section. Please refer to the EUT photos.

Result: Compliance.

FCC §15.209, §15.205 & §15.247(d) - SPURIOUS EMISSIONS

Applicable Standard

FCC §15.247 (d); §15.209; §15.205;

Measurement Uncertainty

Compliance or non-compliance with a disturbance limit shall be determined in the following manner:

If U_{lab} is less than or equal to U_{cispr} of Table 2, then:

- compliance is deemed to occur if no measured disturbance level exceeds the disturbance limit;
- non-compliance is deemed to occur if any measured disturbance level exceeds the disturbance limit.

If U_{lab} is greater than U_{cispr} of Table 1, then:

- compliance is deemed to occur if no measured disturbance level, increased by $(U_{lab} - U_{cispr})$, exceeds the disturbance limit;
- non-compliance is deemed to occur if any measured disturbance level, increased by $(U_{lab} - U_{cispr})$, exceeds the disturbance limit.

Based on CISPR 16-4-2: 2011, measurement uncertainty of radiated emission at a distance of 3m at Bay Area Compliance Laboratories Corp. (Dongguan) is:

- 30M~200MHz: 5.0 dB
- 200M~1GHz: 6.2 dB
- 1G~6GHz: 4.45 dB
- 6G~18GHz: 5.23 dB

Table 2 – Values of U_{cispr}

Measurement	U_{cispr}
Radiated disturbance (electric field strength at an OATS or in a SAC) (30 MHz to 1000 MHz)	6.3 dB
Radiated disturbance (electric field strength in a FAR) (1 GHz to 6 GHz)	5.2 dB
Radiated disturbance (electric field strength in a FAR) (6 GHz to 18 GHz)	5.5 dB

EUT Setup

Below 1GHz:

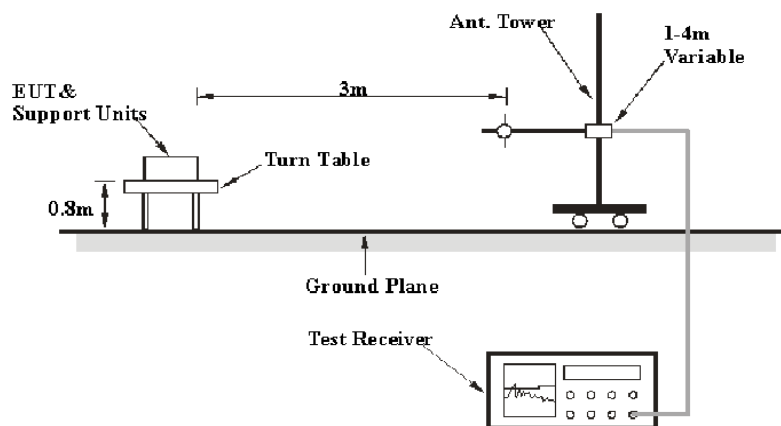

Above 1GHz:

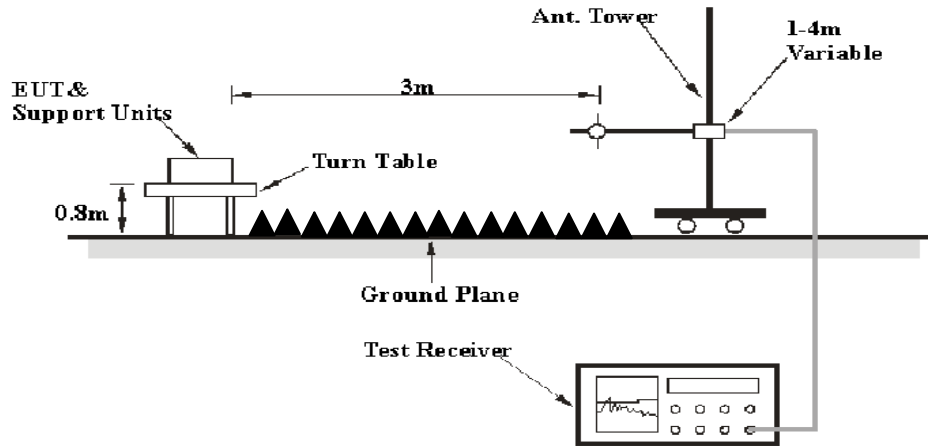

The radiated emission tests were performed in the 3 meters test site, using the setup accordance with the ANSI C63.4-2003. The specification used was the FCC 15.209, and FCC 15.247 limits.

The external I/O cables were draped along the test table and formed a bundle 30 to 40 cm long in the middle.

The spacing between the peripherals was 10 cm.

EMI Test Receiver & Spectrum Analyzer Setup

The system was investigated from 30 MHz to 25 GHz.

During the radiated emission test, the EMI test receiver & Spectrum Analyzer Setup were set with the following configurations:

Frequency Range	RBW	Video B/W	IF B/W	Detector
30 MHz – 1000 MHz	120 kHz	300 kHz	120 kHz	QP
Above 1 GHz	1MHz	3 MHz	/	PK
	1MHz	10 Hz	/	Ave.

Test Procedure

Maximizing procedure was performed on the highest emissions to ensure that the EUT complied with all installation combinations.

Data was recorded in Quasi-peak detection mode for frequency range of 30 MHz-1 GHz, peak and Average detection modes for frequencies above 1 GHz.

Corrected Amplitude & Margin Calculation

The Corrected Amplitude is calculated by adding the Antenna Factor and Cable Loss, and subtracting the Amplifier Gain from the Meter Reading. The basic equation is as follows:

$$\text{Corrected Amplitude} = \text{Meter Reading} + \text{Antenna Factor} + \text{Cable Loss} - \text{Amplifier Gain}$$

The “**Margin**” column of the following data tables indicates the degree of compliance with the applicable limit. For example, a margin of 7dB means the emission is 7dB below the limit. The equation for margin calculation is as follows:

$$\text{Margin} = \text{Limit} - \text{Corrected Amplitude}$$

Test Equipment List and Details

Manufacturer	Description	Model	Serial Number	Calibration Date	Calibration Due Date
R&S	EMI Test Receiver	ESCI	100224	2014-05-09	2015-05-09
Sunol Sciences	Antenna	JB3	A060611-1	2011-09-06	2014-09-05
HP	Amplifier	8447E	2434A02181	2013-09-06	2014-09-06
R&S	Spectrum Analyzer	FSEM	DE31388	2014-05-09	2015-05-09
ETS LINDGREN	Horn Antenna	3115	000 527 35	2012-09-06	2015-09-06
Mini-Circuit	Amplifier	ZVA-213-S+	054201245	2014-02-19	2015-02-19
R&S	Spectrum Analyzer	FSP 38	100478	2014-05-09	2015-05-09
Ducommun Technologies	Horn Antenna	ARH-4223-02	1007726-01 1304	2014-06-16	2017-06-15
Quinstar	Amplifier	QLW-18405536-JO	15964001001	2013-09-06	2014-09-06

* **Statement of Traceability:** Bay Area Compliance Laboratories Corp. (Dongguan) attests that all calibrations have been performed, traceable to National Primary Standards and International System of Units (SI).

Test Results Summary

According to the recorded data in following table, the EUT complied with the FCC Title 47, Part 15, Section 15.205, 15.209 and 15.247, with the worst margin reading of:

6.30 dB at 4960 MHz in the Horizontal polarization

Test Data

Environmental Conditions

Temperature:	28.3 °C
Relative Humidity:	56%
ATM Pressure:	100.4kPa

The testing was performed by Dean Liu on 2014-09-01.

Test Mode: Transmitting

Frequency (MHz)	Receiver		Rx Antenna		Cable loss (dB)	Amplifier Gain (dB)	Corrected Amplitude (dBµV/m)	FCC 15.247	
	Reading (dBµV)	Detector (PK/QP/AV)	Polar (H/V)	Factor (dB)				Limit (dBµV/m)	Margin (dB)
Low Channel: 2402 MHz									
2402	97.53	PK	H	25.65	4.42	27.32	100.28	N/A	N/A
2402	91.26	AV	H	25.65	4.42	27.32	94.01	N/A	N/A
2402	88.48	PK	V	25.65	4.42	27.32	91.23	N/A	N/A
2402	82.16	AV	V	25.65	4.42	27.32	84.91	N/A	N/A
2390	40.27	PK	H	25.61	4.39	27.32	42.95	74.00	31.05
2390	33.08	AV	H	25.61	4.39	27.32	35.76	54.00	18.24
4804	37.76	PK	H	30.59	5.98	27.41	46.92	74.00	27.08
4804	33.48	AV	H	30.59	5.98	27.41	42.64	54.00	11.36
7206	38.08	PK	H	34.09	7.45	25.91	53.71	74.00	20.29
7206	27.96	AV	H	34.09	7.45	25.91	43.59	54.00	10.41
9608	37.89	PK	H	35.96	8.80	27.55	55.10	74.00	18.90
9608	25.96	AV	H	35.96	8.80	27.55	43.17	54.00	10.83
7330	36.16	PK	H	34.39	7.52	25.88	52.19	74.00	21.81
7330	25.67	AV	H	34.39	7.52	25.88	41.70	54.00	12.30
163.2	38.12	QP	H	12.55	1.56	21.44	30.79	43.50	12.71
Middle Channel: 2440 MHz									
2440	98.18	PK	H	25.74	4.40	27.34	100.98	N/A	N/A
2440	94.69	AV	H	25.74	4.40	27.34	97.49	N/A	N/A
2440	91.75	PK	V	25.74	4.40	27.34	94.55	N/A	N/A
2440	86.90	AV	V	25.74	4.40	27.34	89.70	N/A	N/A
4880	44.31	PK	H	30.79	6.08	27.42	53.76	74.00	20.24
4880	37.86	AV	H	30.79	6.08	27.42	47.31	54.00	6.69
7320	39.42	PK	H	34.37	7.51	25.88	55.42	74.00	18.58
7320	27.06	AV	H	34.37	7.51	25.88	43.06	54.00	10.94
9760	37.13	PK	H	36.32	8.83	27.21	55.07	74.00	18.93
9760	25.1	AV	H	36.32	8.83	27.21	43.04	54.00	10.96
7330	38.79	PK	H	34.39	7.52	25.88	54.82	74.00	19.18
7330	27.94	AV	H	34.39	7.52	25.88	43.97	54.00	10.03
1870	36.76	PK	H	24.34	3.70	27.51	37.29	74.00	36.71
1870	26.1	AV	H	24.34	3.70	27.51	26.63	54.00	27.37
163.2	38.41	QP	H	12.55	1.56	21.44	31.08	43.50	12.42
High Channel: 2480 MHz									
2480	97.80	PK	H	25.85	4.48	27.36	100.77	N/A	N/A
2480	93.08	AV	H	25.85	4.48	27.36	96.05	N/A	N/A
2480	91.03	PK	V	25.85	4.48	27.36	94.00	N/A	N/A
2480	86.56	AV	V	25.85	4.48	27.36	89.53	N/A	N/A
2483.5	50.97	PK	H	25.86	4.49	27.36	53.96	74.00	20.04
2483.5	35.23	AV	H	25.86	4.49	27.36	38.22	54.00	15.78
4960	45.41	PK	H	31.00	5.90	27.43	54.88	74.00	19.12
4960	38.23	AV	H	31.00	5.90	27.43	47.70	54.00	6.30
7440	40.29	PK	H	34.66	7.58	25.97	56.56	74.00	17.44
7440	27.97	AV	H	34.66	7.58	25.97	44.24	54.00	9.76
9920	37.68	PK	H	36.71	8.87	26.66	56.60	74.00	17.40
9920	25.72	AV	H	36.71	8.87	26.66	44.64	54.00	9.36
7330	39	PK	H	34.39	7.52	25.88	55.03	74.00	18.97
7330	28.23	AV	H	34.39	7.52	25.88	44.26	54.00	9.74
163.2	38.33	QP	H	12.55	1.56	21.44	31.00	43.50	12.50

Conducted Spurious at Antenna Port

Low Channel

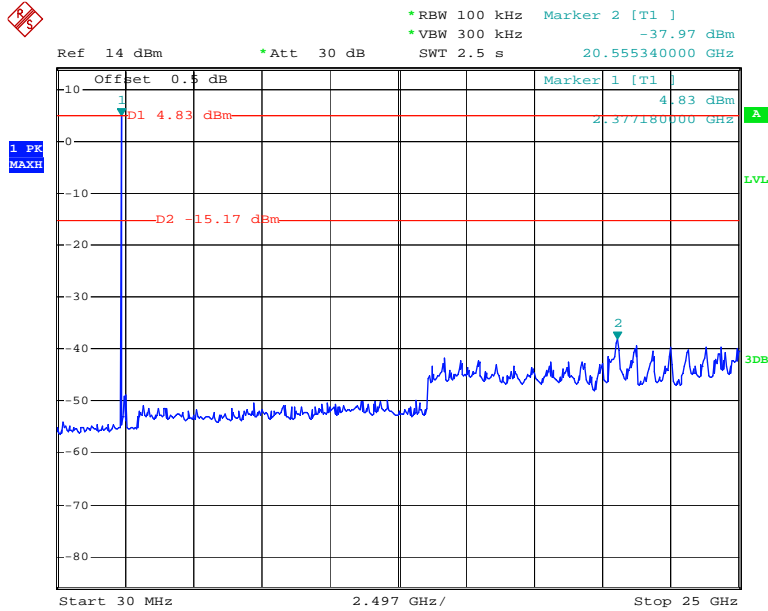

Date: 1.SEP.2014 11:26:43

Middle Channel

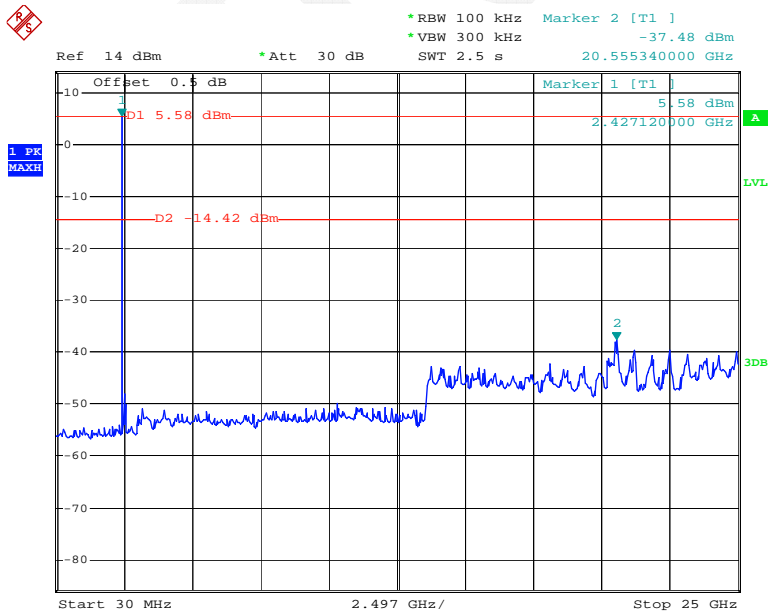

Date: 1.SEP.2014 11:23:08

High Channel

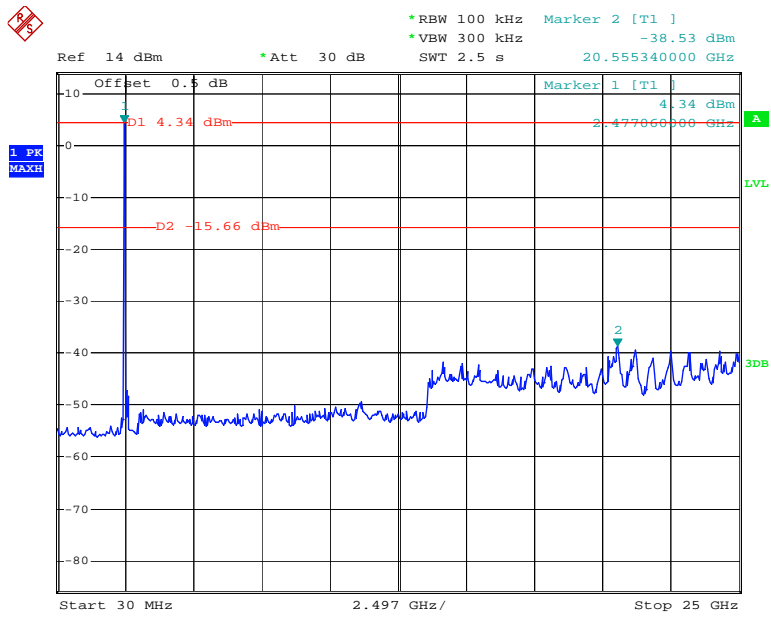

Date: 1.SEP.2014 11:24:59

FCC §15.247(a) (2) – 6 dB EMISSION BANDWIDTH

Applicable Standard

Systems using digital modulation techniques may operate in the 902–928 MHz, 2400–2483.5 MHz, and 5725–5850 MHz bands. The minimum 6 dB bandwidth shall be at least 500 kHz.

Test Procedure

According to KDB 558074 D01 DTS Meas Guidance v03r02clause8.1 Option 1:

- a) Set RBW = 100 kHz.
- b) Set the video bandwidth (VBW) $\geq 3 \times$ RBW.
- c) Detector = Peak.
- d) Trace mode = max hold.
- e) Sweep = auto couple.
- f) Allow the trace to stabilize.
- g) Measure the maximum width of the emission that is constrained by the frequencies associated with the two outermost amplitude points (upper and lower frequencies) that are attenuated by 6 dB relative to the maximum level measured in the fundamental emission.



Test Equipment List and Details

Manufacturer	Description	Model	Serial Number	Calibration Date	Calibration Due Date
R&S	Spectrum Analyzer	FSP 38	100478	2014-05-09	2015-05-09

* **Statement of Traceability:** Bay Area Compliance Laboratories Corp. (Dongguan) attests that all calibrations have been performed, traceable to National Primary Standards and International System of Units (SI).

Test Data

Environmental Conditions

Temperature:	30.1 °C
Relative Humidity:	60%
ATM Pressure:	100.8 kPa

The testing was performed by Dean Liu on 2014-08-29.

Test Result: Pass. Please refer to the following tables and plots.

Channel	Frequency	6 dB Bandwidth	Limit
	(MHz)	(MHz)	(kHz)
Low	2402	0.716	≥500
Middle	2440	0.708	≥500
High	2480	0.704	≥500

Low Channel

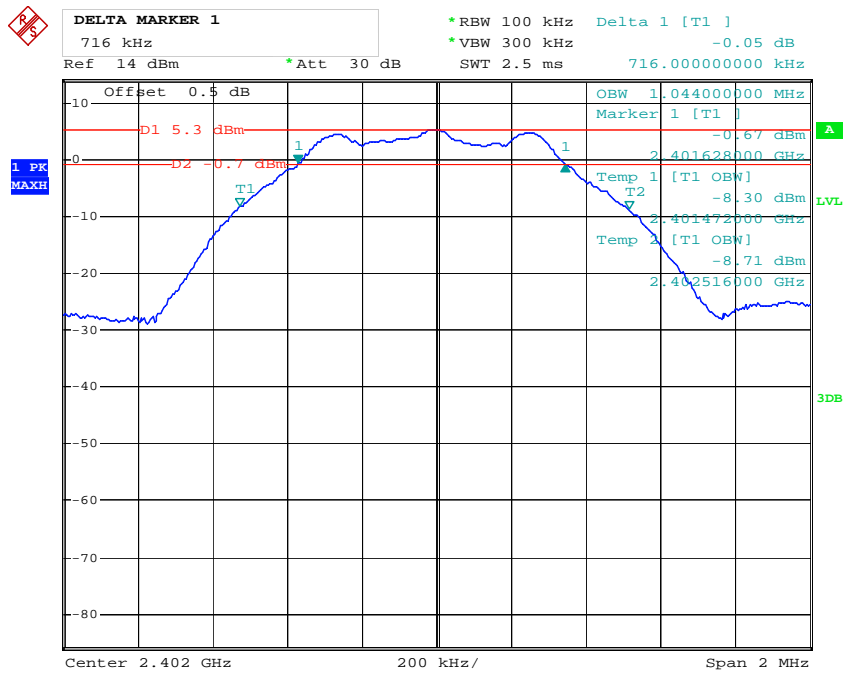

Date: 29.AUG.2014 23:38:55

Middle Channel

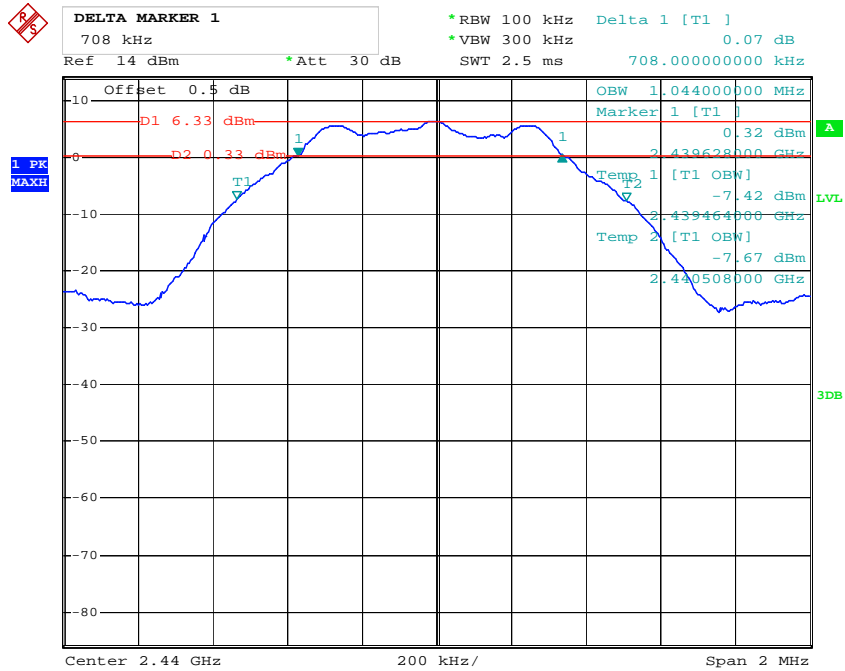

Date: 29.AUG.2014 23:29:33

High Channel

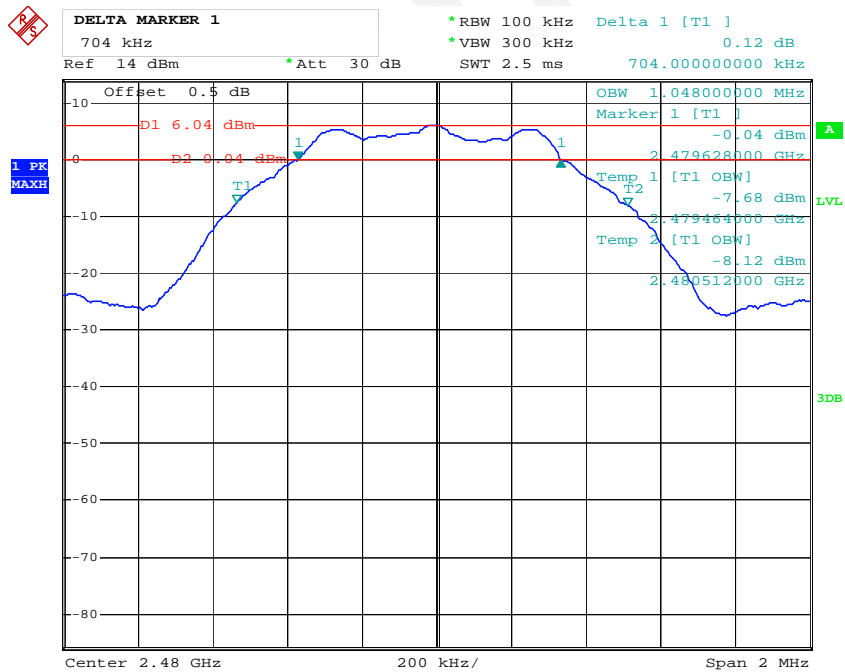

Date: 29.AUG.2014 23:30:24

FCC §15.247(b) (3) - MAXIMUM PEAK OUTPUT POWER

Applicable Standard

According to FCC §15.247(b) (3), for systems using digital modulation in the 902-928 MHz, 2400-2483.5 MHz, and 5725-5850 MHz bands: 1 Watt. As an alternative to a peak power measurement, compliance with the one Watt limit can be based on a measurement of the maximum conducted output power. Maximum Conducted Output Power is defined as the total transmit power delivered to all antennas and antenna elements averaged across all symbols in the signaling alphabet when the transmitter is operating at its maximum power control level. Power must be summed across all antennas and antenna elements. The average must not include any time intervals during which the transmitter is off or is transmitting at a reduced power level. If multiple modes of operation are possible (e.g., alternative modulation methods), the maximum conducted output power is the highest total transmit power occurring in any mode.

Test Procedure

According to KDB 558074 D01 DTS Meas Guidance v03r02 clause9.1.1:

- Set the RBW \geq DTS bandwidth.
- Set VBW $\geq 3 \times$ RBW.
- Set span $\geq 3 \times$ RBW
- Sweep time = auto couple.
- Detector = peak.
- Trace mode = max hold.
- Allow trace to fully stabilize.
- Use peak marker function to determine the peak amplitude level.



Test Equipment List and Details

Manufacturer	Description	Model	Serial Number	Calibration Date	Calibration Due Date
R&S	Spectrum Analyzer	FSP 38	100478	2014-05-09	2015-05-09

* **Statement of Traceability:** Bay Area Compliance Laboratories Corp. (Dongguan) attests that all calibrations have been performed, traceable to National Primary Standards and International System of Units (SI).

Test Data

Environmental Conditions

Temperature:	30.1 °C
Relative Humidity:	60%
ATM Pressure:	100.8 kPa

The testing was performed by Dean Liu on 2014-08-29.

Test Mode: Transmitting

Channel	Frequency	Max Peak Conducted Output Power	Limit	Result
	(MHz)	(dBm)	(dBm)	
Low	2402	5.66	30	PASS
Middle	2440	6.67	30	PASS
High	2480	6.38	30	PASS

Please refer to the following plots

Output Power, Low Channel

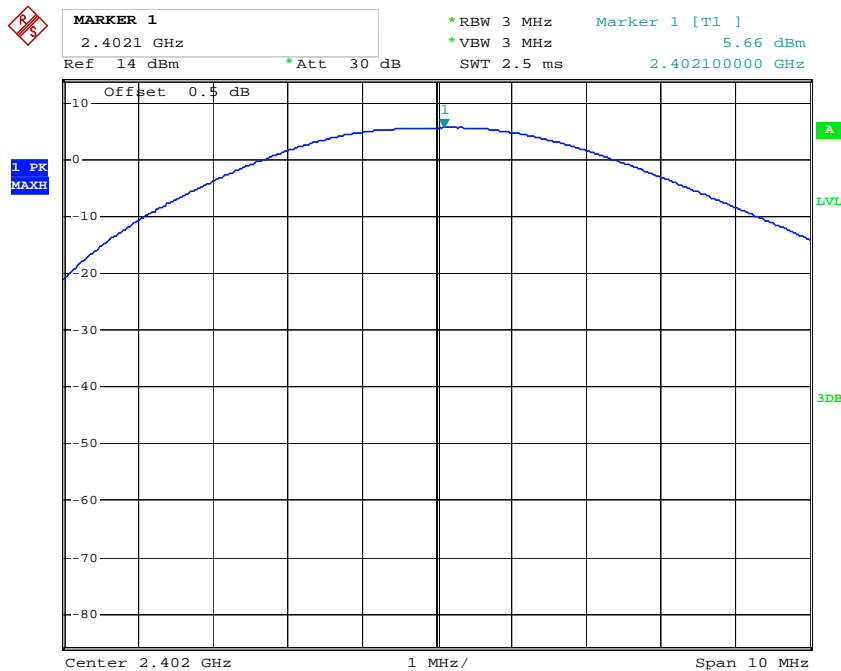

Date: 29.AUG.2014 23:36:09

Output Power, Middle Channel

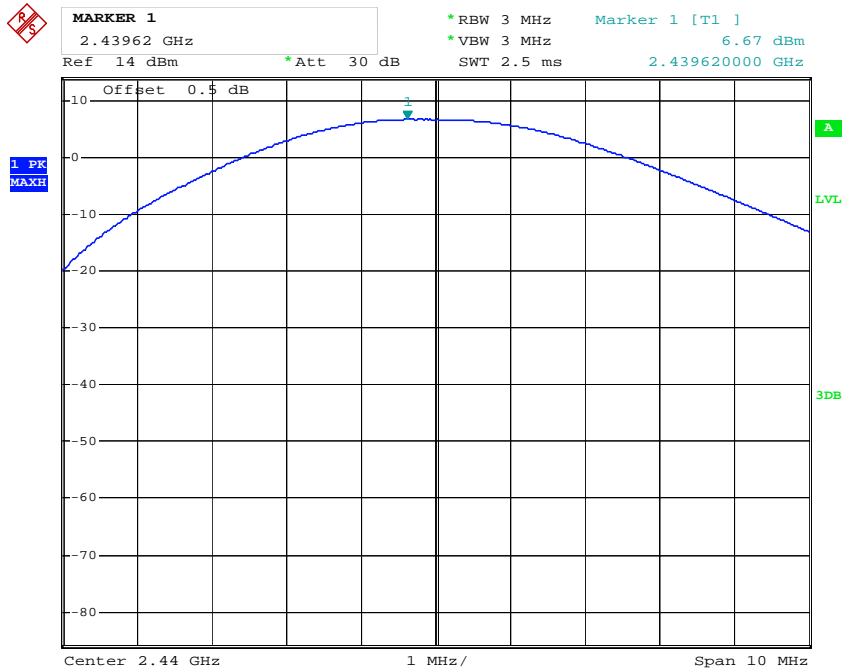

Date: 29.AUG.2014 23:28:15

Output Power, High Channel

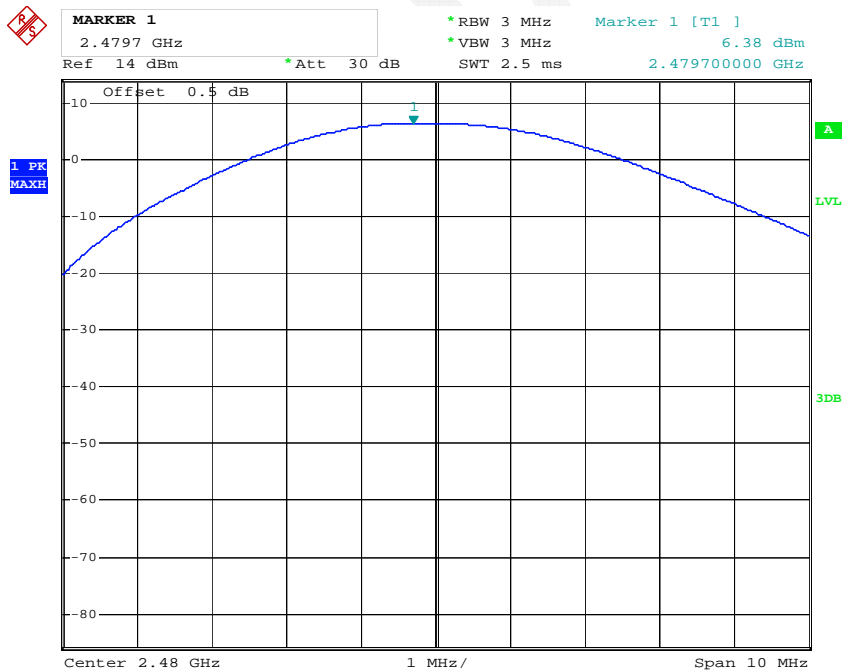

Date: 29.AUG.2014 23:32:15

FCC §15.247(d) – 100 kHz BANDWIDTH OF FREQUENCY BAND EDGE

Applicable Standard

In any 100 kHz bandwidth outside the frequency band in which the spread spectrum or digitally modulated intentional radiator is operating, the radio frequency power that is produced by the intentional radiator shall be at least 20 dB below that in the 100 kHz bandwidth within the band that contains the highest level of the desired power, based on either an RF conducted or a radiated measurement, provided the transmitter demonstrates compliance with the peak conducted power limits. If the transmitter complies with the conducted power limits based on the use of RMS averaging over a time interval, as permitted under paragraph (b)(3) of this section, the attenuation required under this paragraph shall be 30 dB instead of 20 dB. Attenuation below the general limits specified in §15.209(a) is not required. In addition, radiated emissions which fall in the restricted bands, as defined in §15.205(a), must also comply with the radiated emission limits specified in §15.209(a) (see §15.205(c)).

Test Procedure

1. Check the calibration of the measuring instrument using either an internal calibrator or a known signal from an external generator.
2. Position the EUT without connection to measurement instrument. Turn on the EUT and connect its antenna terminal to measurement instrument via a low loss cable. Then set it to any one measured frequency within its operating range, and make sure the instrument is operated in its linear range.
3. Set RBW to 100 kHz and VBW of spectrum analyzer to 300 kHz with a convenient frequency span including 100 kHz bandwidth from band edge.
4. Measure the highest amplitude appearing on spectral display and set it as a reference level. Plot the graph with marking the highest point and edge frequency.
5. Repeat above procedures until all measured frequencies were complete.

Test Equipment List and Details

Manufacturer	Description	Model	Serial Number	Calibration Date	Calibration Due Date
R&S	Spectrum Analyzer	FSP 38	100478	2014-05-09	2015-05-09

* **Statement of Traceability:** Bay Area Compliance Laboratories Corp. (Dongguan) attests that all calibrations have been performed, traceable to National Primary Standards and International System of Units (SI).

Test Data

Environmental Conditions

Temperature:	30.1 °C
Relative Humidity:	60%
ATM Pressure:	100.8 kPa

The testing was performed by Dean Liu on 2014-08-29.

Test Result: *Compliance*

Please refer to following plots.

Band Edge, Left Side

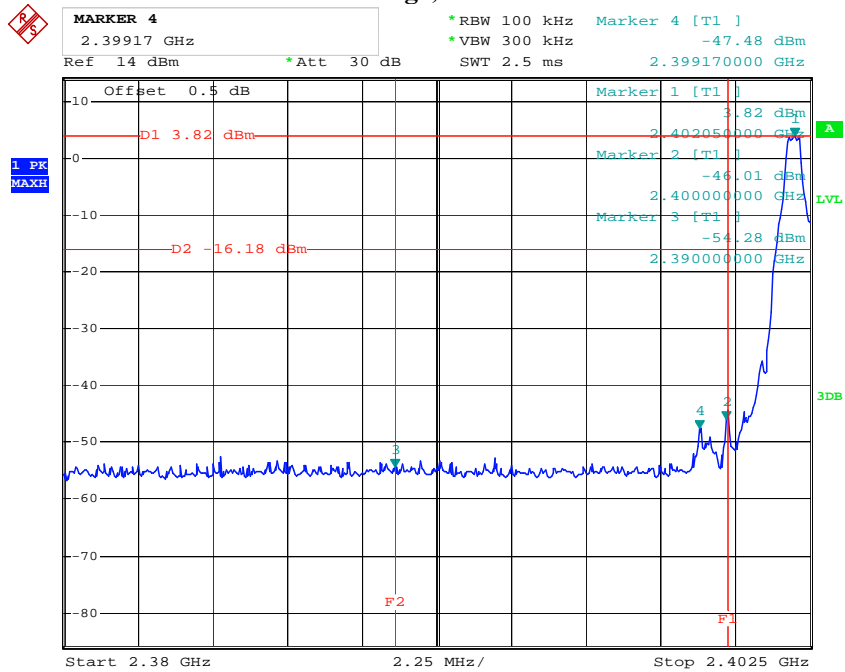

Date: 29.AUG.2014 23:25:20

Band Edge, Right Side

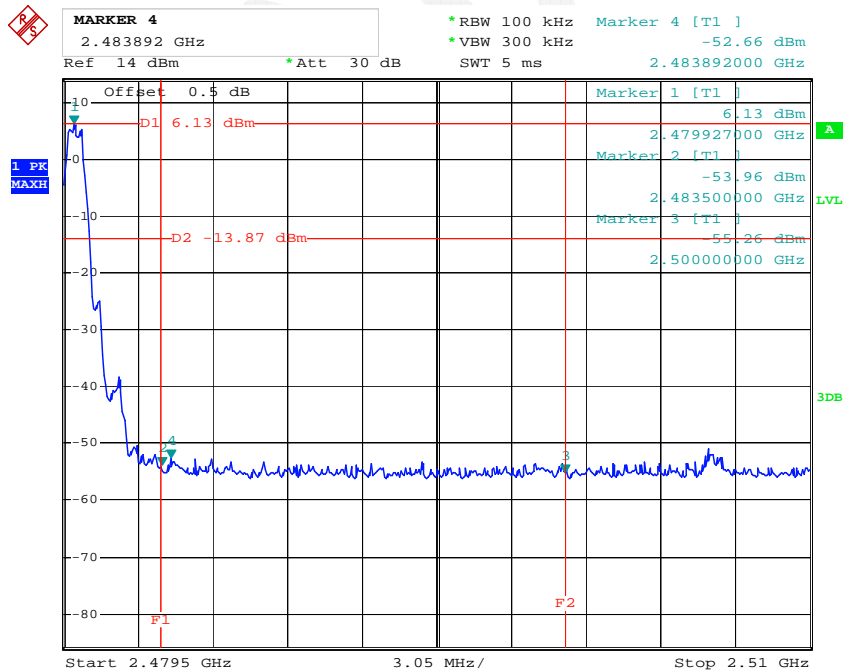

Date: 29.AUG.2014 23:31:45

FCC §15.247(e) - POWER SPECTRAL DENSITY

Applicable Standard

For digitally modulated systems, the power spectral density conducted from the intentional radiator to the antenna shall not be greater than 8 dBm in any 3 kHz band during any time interval of continuous transmission. This power spectral density shall be determined in accordance with the provisions of paragraph (b) of this section. The same method of determining the conducted output power shall be used to determine the power spectral density.

Test Procedure

According to KDB 558074 D01 DTS Meas Guidance v03r02 clause10.2:

- a) Set analyzer center frequency to DTS channel center frequency.
- b) Set the span to 1.5 times the DTS bandwidth.
- c) Set the RBW to: $3 \text{ kHz} \leq \text{RBW} \leq 100 \text{ kHz}$.
- d) Set the VBW $\geq 3 \times \text{RBW}$.
- e) Detector = peak.
- f) Sweep time = auto couple.
- g) Trace mode = max hold.
- h) Allow trace to fully stabilize.
- i) Use the peak marker function to determine the maximum amplitude level within the RBW.
- j) If measured value exceeds limit, reduce RBW (no less than 3 kHz) and repeat.

Test Equipment List and Details

Manufacturer	Description	Model	Serial Number	Calibration Date	Calibration Due Date
R&S	Spectrum Analyzer	FSP 38	100478	2014-05-09	2015-05-09

* **Statement of Traceability:** Bay Area Compliance Laboratories Corp. (Dongguan) attests that all calibrations have been performed, traceable to National Primary Standards and International System of Units (SI).

Test Data

Environmental Conditions

Temperature:	30.1 °C
Relative Humidity:	60%
ATM Pressure:	100.8 kPa

The testing was performed by Dean Liu on 2014-08-29.

Test Mode: Transmitting

Test Result: Pass

Channel	Frequency	PSD	Limit	Result
	MHz	(dBm/3kHz)	(dBm/3kHz)	
Low	2402	-9.97	≤8	PASS
Middle	2440	-8.95	≤8	PASS
High	2480	-9.39	≤8	PASS

Please refer to the following plots

Power Spectral Density, Low Channel

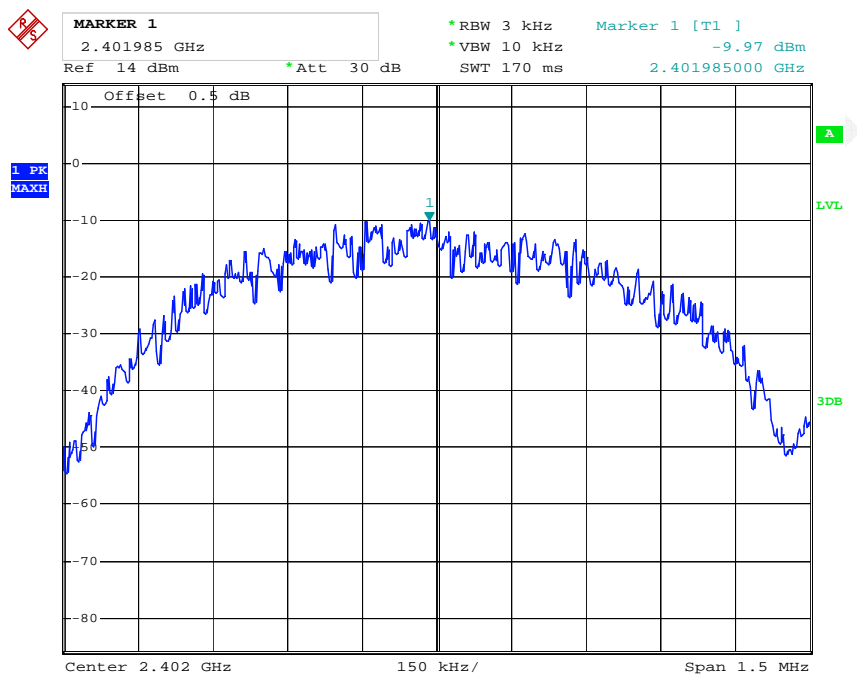

Date: 29.AUG.2014 14:35:50

Power Spectral Density, Middle Channel

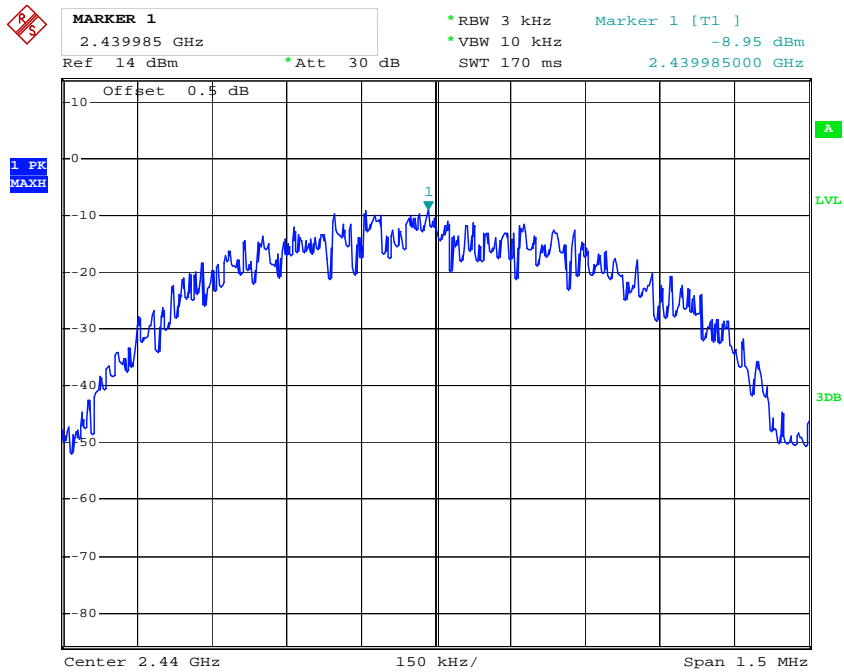

Date: 29.AUG.2014 23:28:39

Power Spectral Density, High Channel

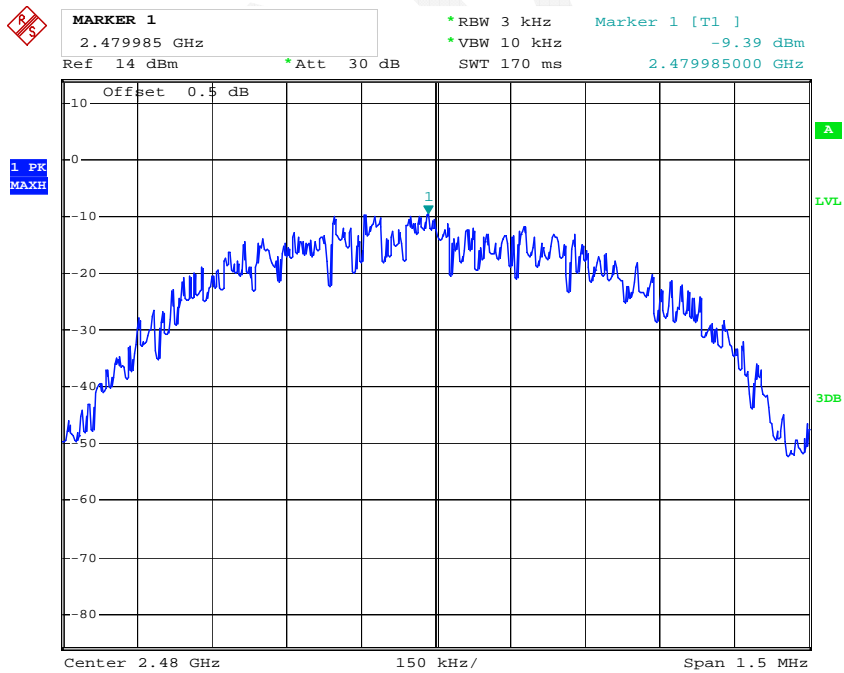

Date: 29.AUG.2014 23:32:28

***** END OF REPORT *****