

### LTE Band 17 (Part 27)

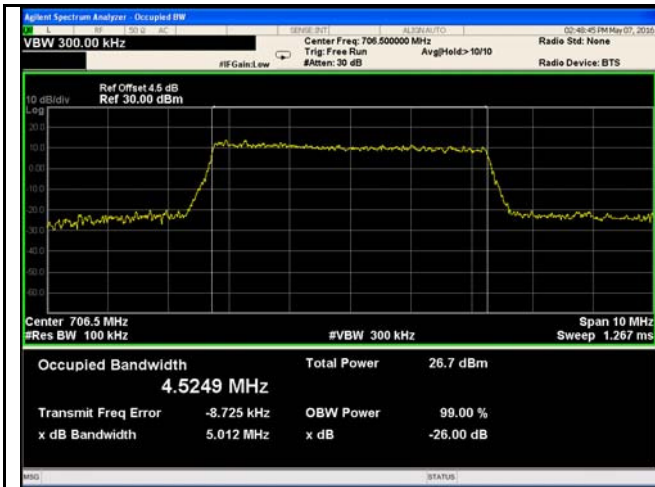

LTE band 17 - Low CH QPSK-5

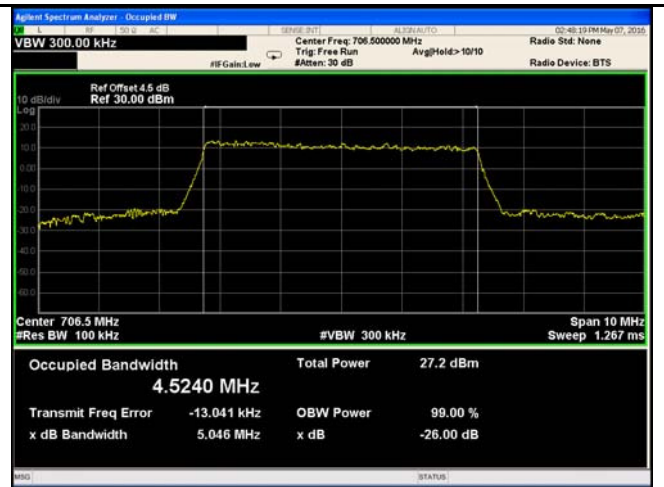

LTE band 17 - Low CH 16QAM-5

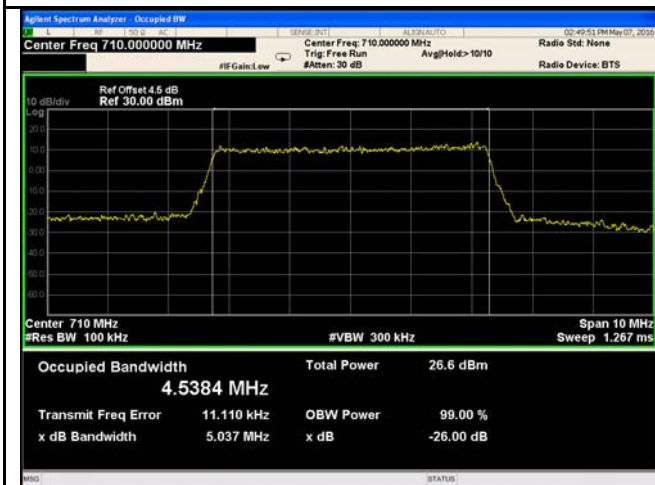

LTE band 17 - Middle CH QPSK-5

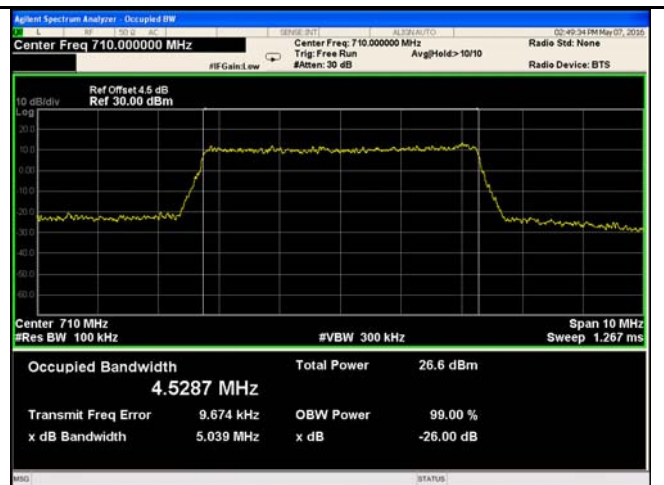

LTE band 17 - Middle CH 16QAM-5

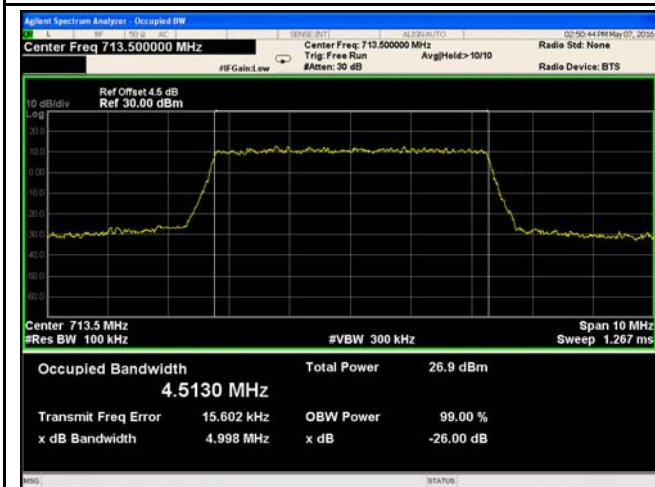

LTE band 17 - High CH QPSK-5

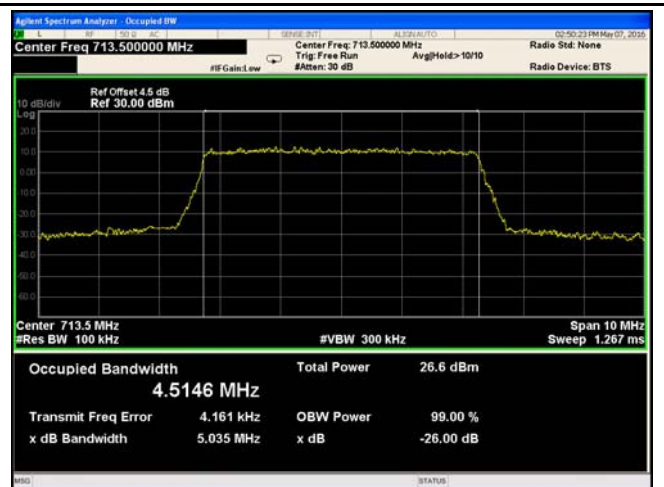

LTE band 17 - High CH 16QAM-5

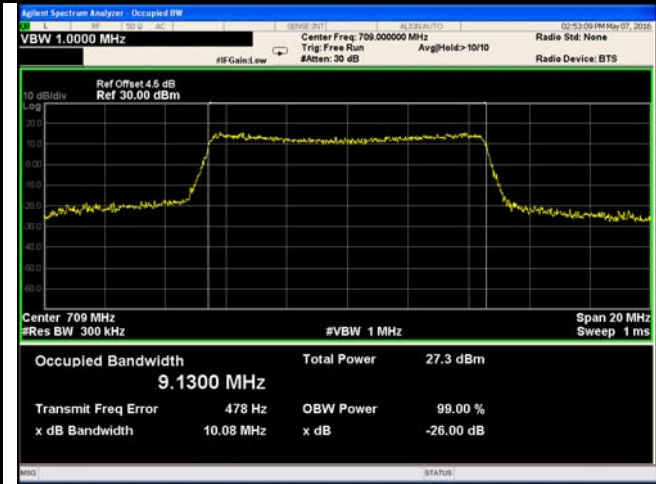

LTE band 17 - Low CH QPSK-10

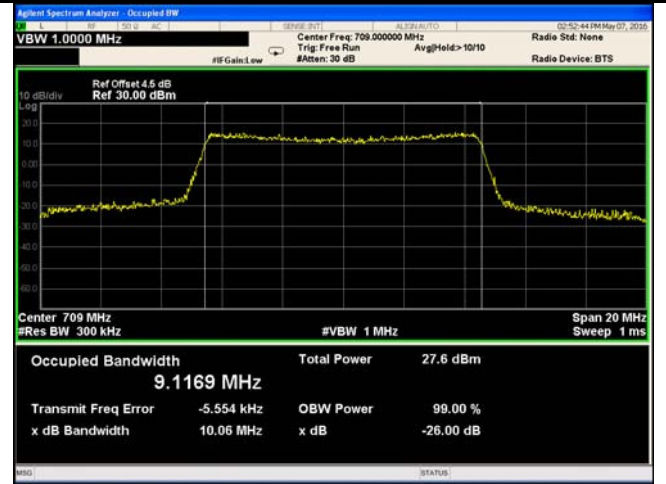

LTE band 17 - Low CH 16QAM-10

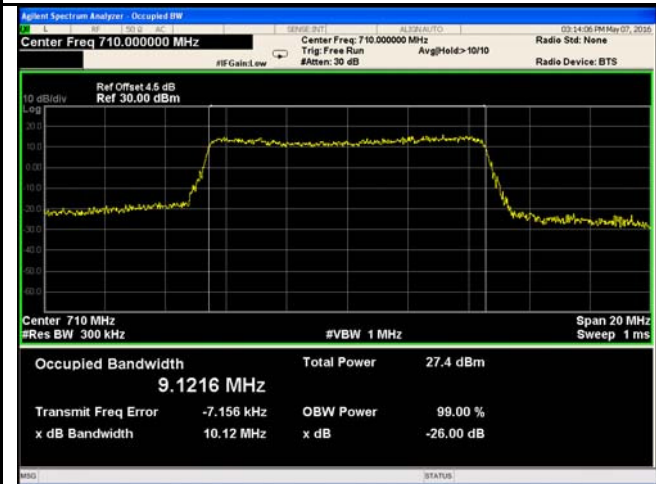

LTE band 17 - Middle CH QPSK-10

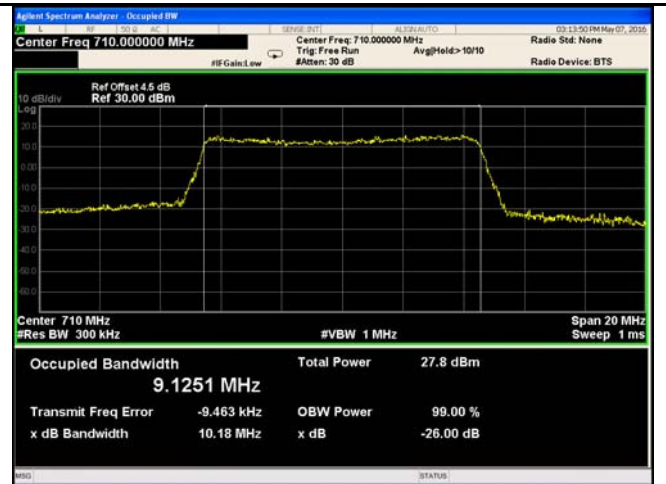

LTE band 17 - Middle CH 16QAM-10

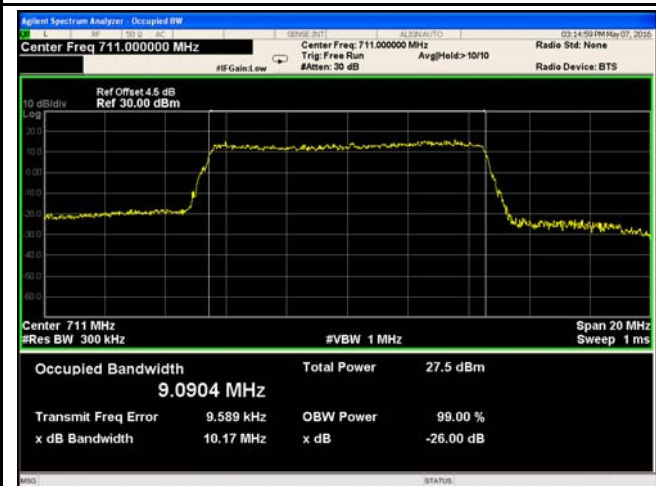

LTE band 17 - High CH QPSK-10

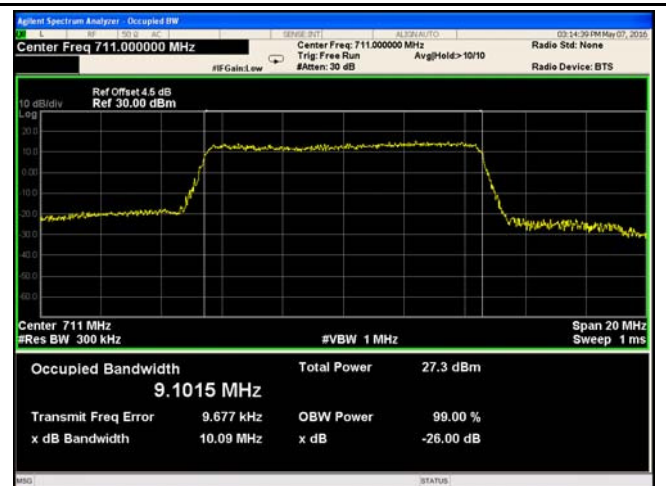

LTE band 17 - High CH 16QAM-10

## 6.5 Spurious Emissions at Antenna Terminals

Temperature	22°C
Relative Humidity	51%
Atmospheric Pressure	1009mbar
Test date :	May 09, 2016
Tested By :	Winnie Zhang

### Requirement(s):

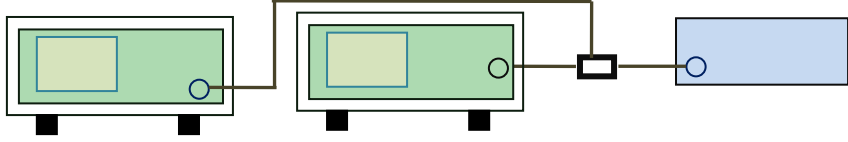
Spec	Item	Requirement	Applicable
§2.1051, §22.917(a)& §24.238(a) § 27.53(h)	a)	The power of any emission outside of the authorized operating frequency ranges must be lower than the transmitter power (P) by a factor of at least $43 + 10 \log(P)$ dB	<input checked="" type="checkbox"/>
Test Setup			
Test Procedure	<ul style="list-style-type: none"> <li>- The EUT was connected to Spectrum Analyzer and Base Station via power divider.</li> <li>- The Band Edges of low and high channels for the highest RF powers were measured.</li> <li>- Setting RBW as roughly BW/100.</li> </ul>		
Remark			
Result	<input checked="" type="checkbox"/> Pass <input type="checkbox"/> Fail		

Test Data     Yes                       N/A  
 Test Plot     Yes (See below)       N/A

**Test Plots 30MHz-5GHz**  
**LTE Band 2 (Part 24E)**

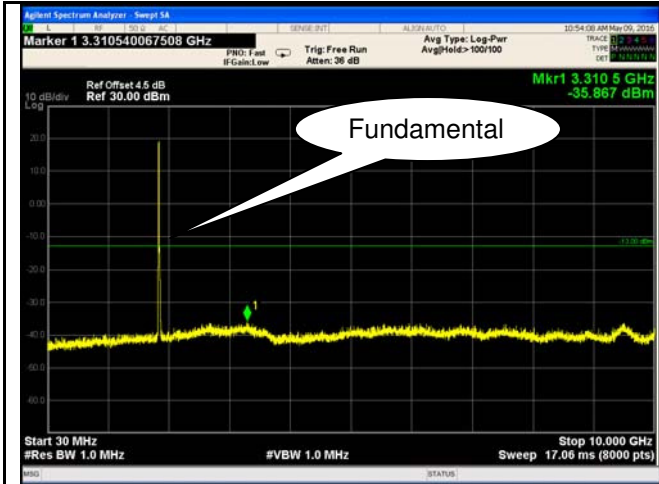

LTE Band 2 - Low Channel-1

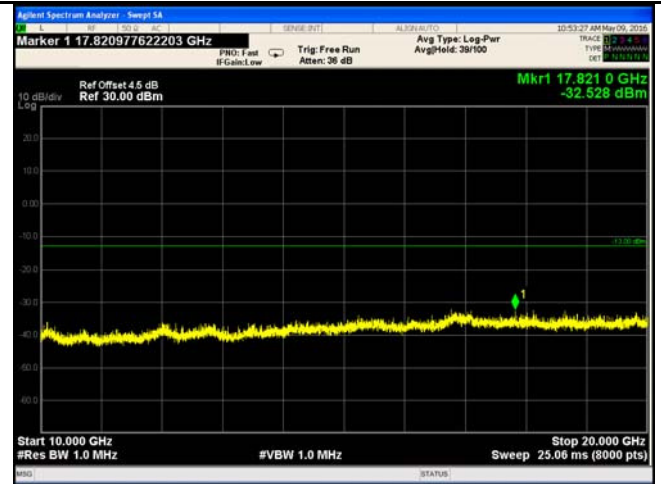

LTE Band 2 - Low Channel-2

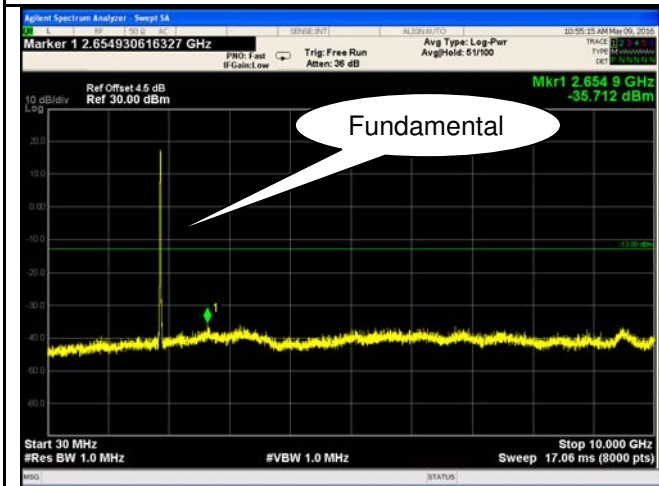

LTE Band 2 Middle Channel-1

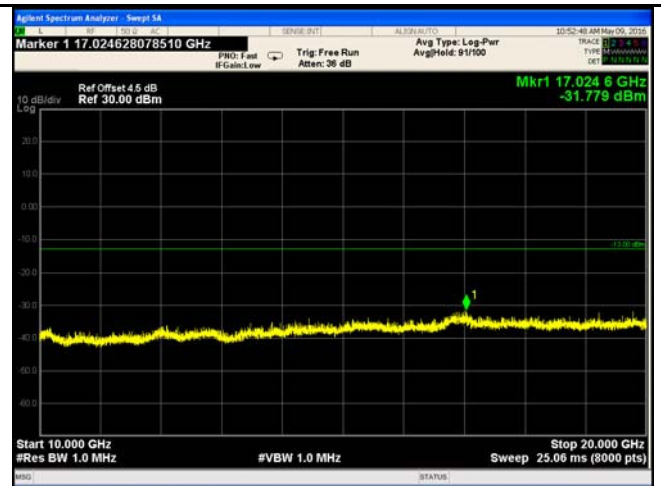

LTE Band 2 Middle Channel-2

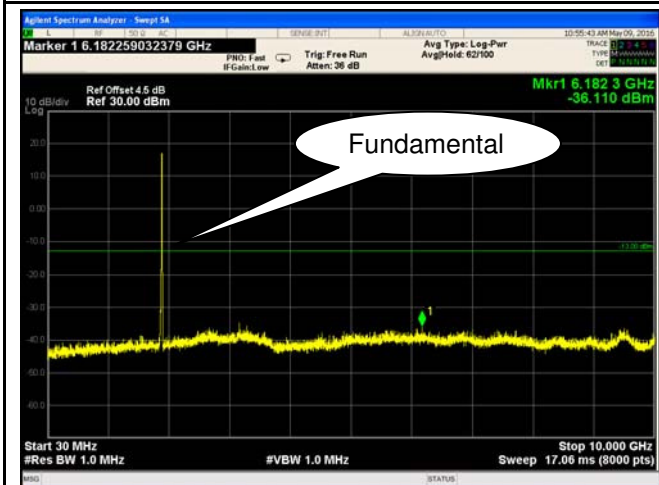

LTE Band 2 - High Channel-1



LTE Band 2 - High Channel-2

**LTE Band 4 (Part27) result**

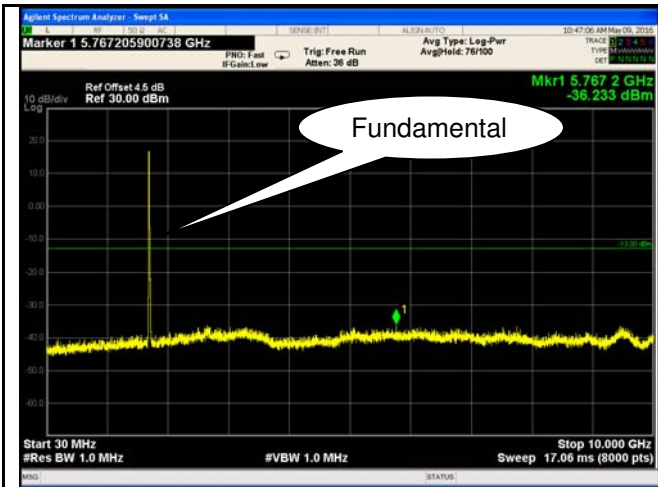

LTE Band 4 - Low Channel-1

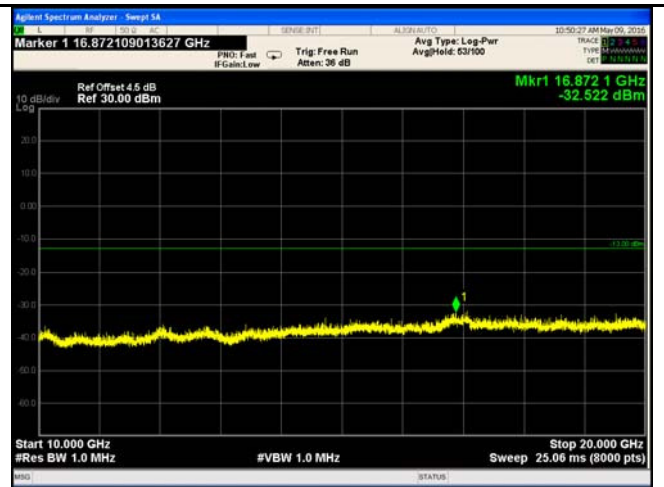

LTE Band 4 - Low Channel-2

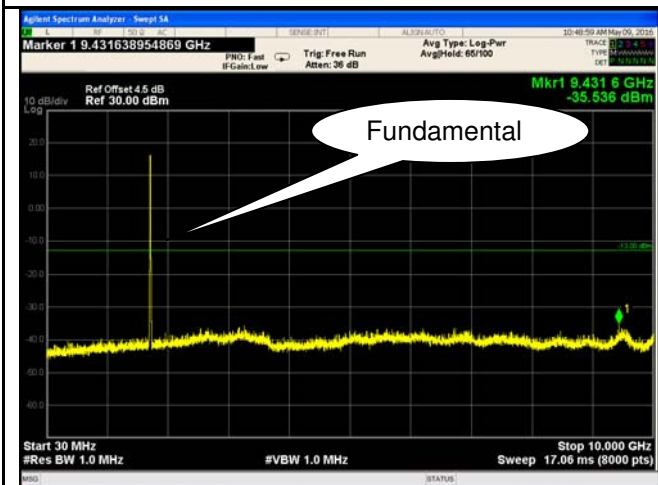

LTE Band 4 - Middle Channel-1

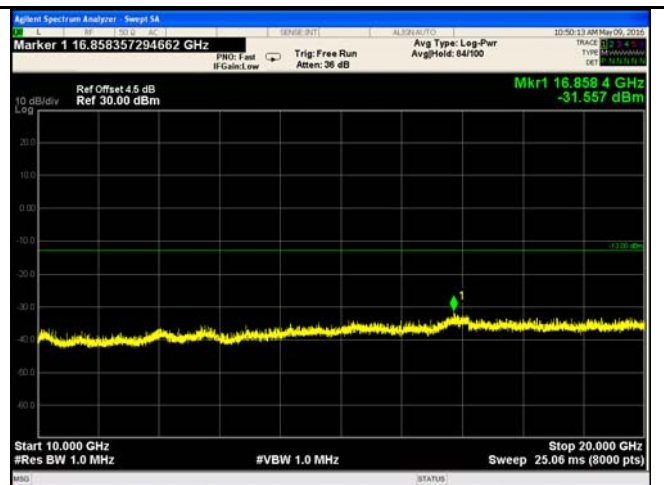

LTE Band 4 - Middle Channel-2

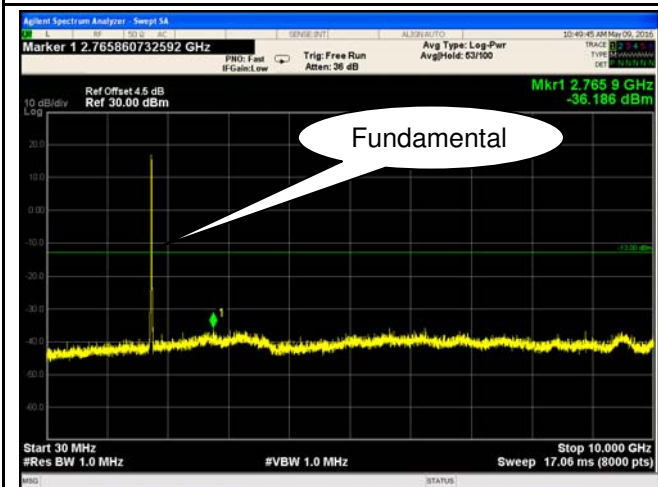

LTE Band 4 - High Channel-1

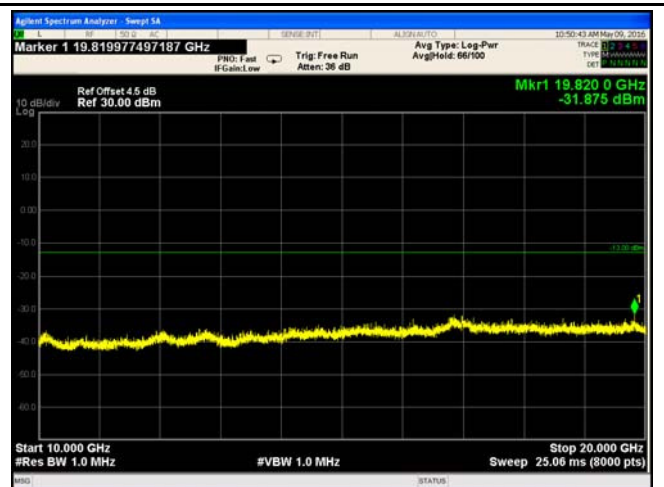

LTE Band 4 - High Channel-2

**LTE Band 5 (Part 22H)**

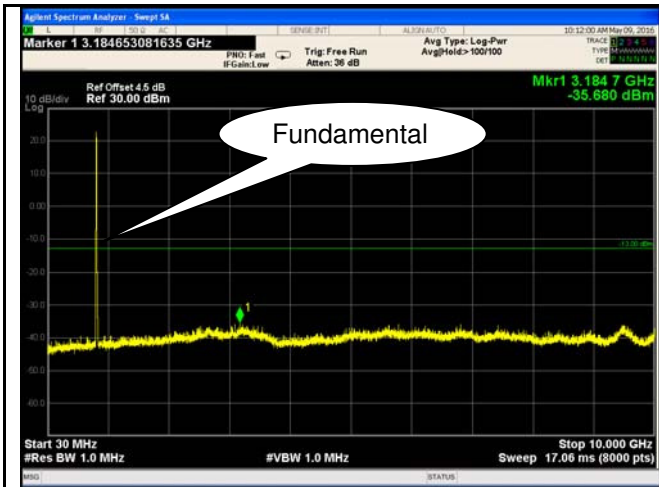

LTE Band 5 - Low Channel-1

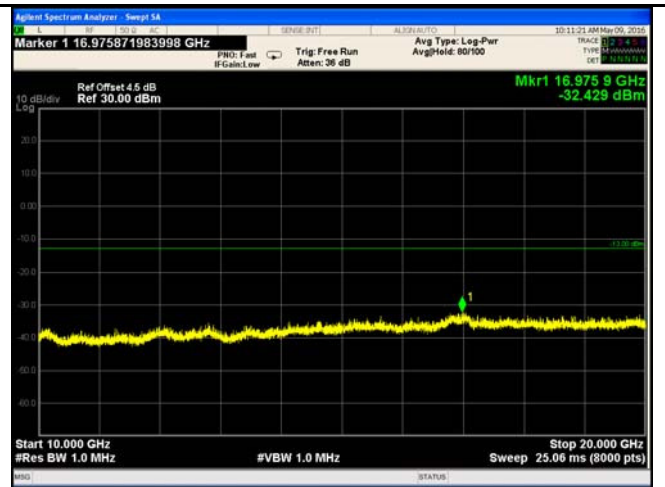

LTE Band 5 - Low Channel-2

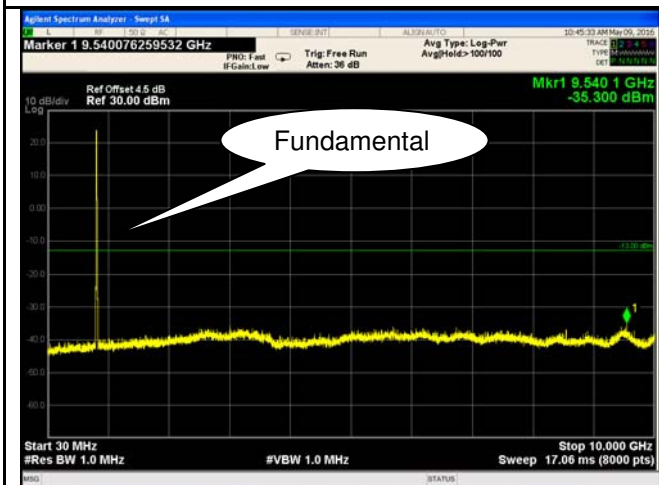

LTE Band 5 - Middle Channel-1

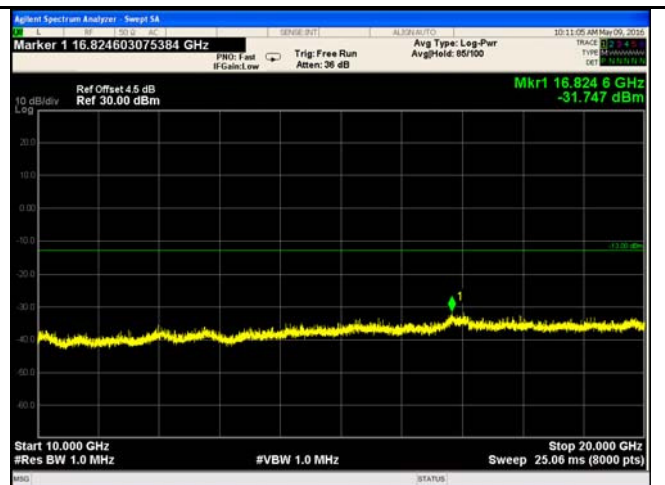

LTE Band 5 - Middle Channel-2

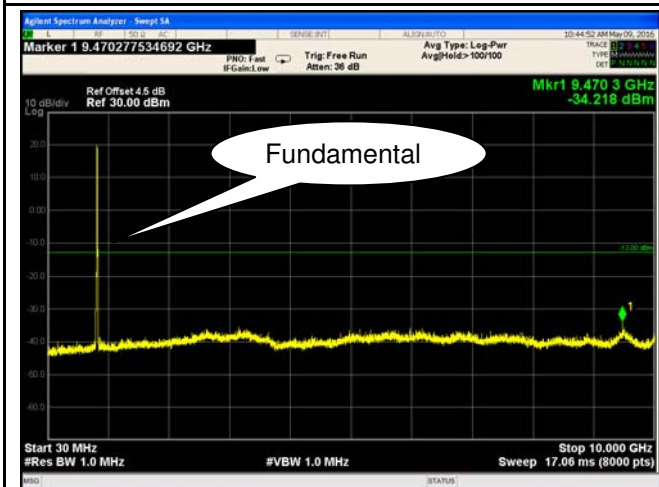

LTE Band 5 - High Channel-1

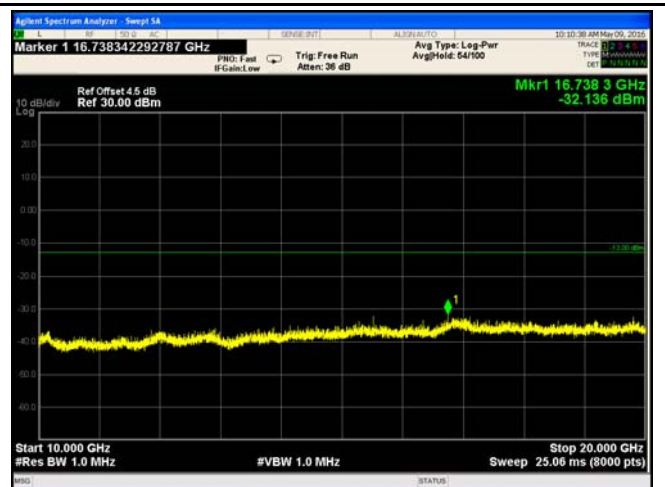

LTE Band 5 - High Channel-2

### LTE Band 7 (Part 27)

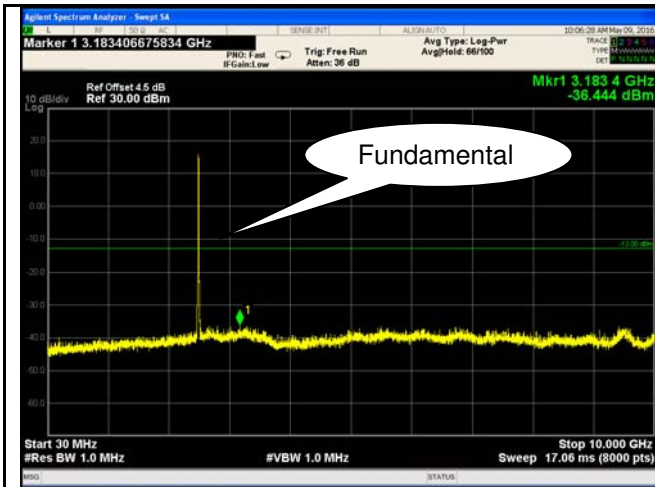

LTE Band 7 - Low Channel-1

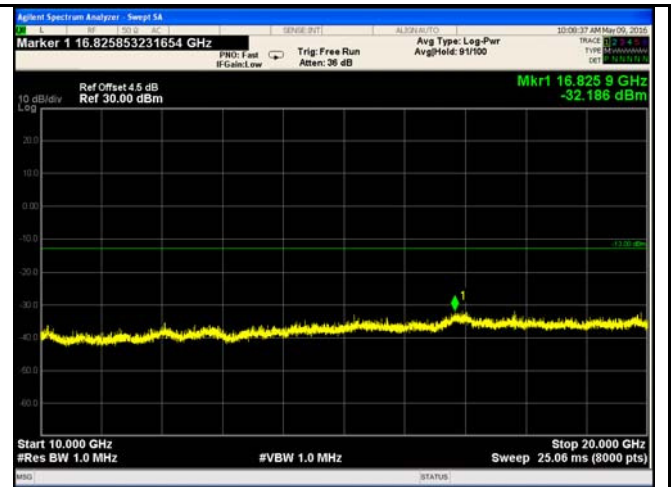

LTE Band 7 - Low Channel-2

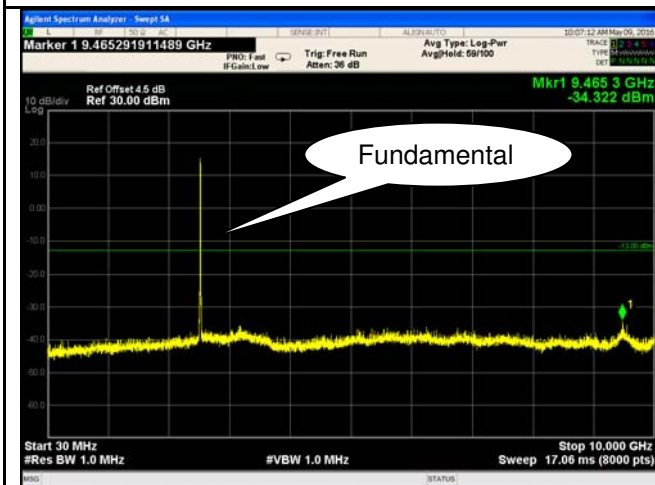

LTE Band 7 - Middle Channel-1

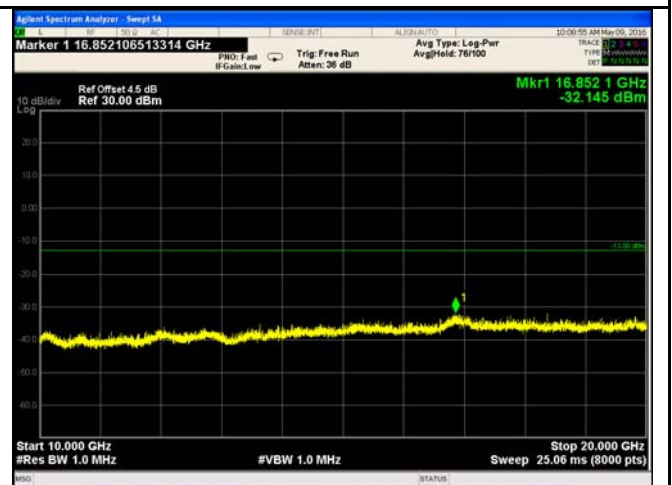

LTE Band 7 - Middle Channel-2

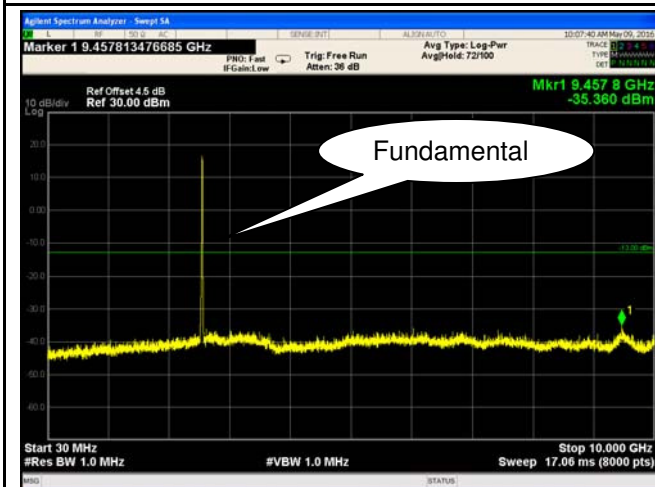

LTE Band 7 - High Channel-1

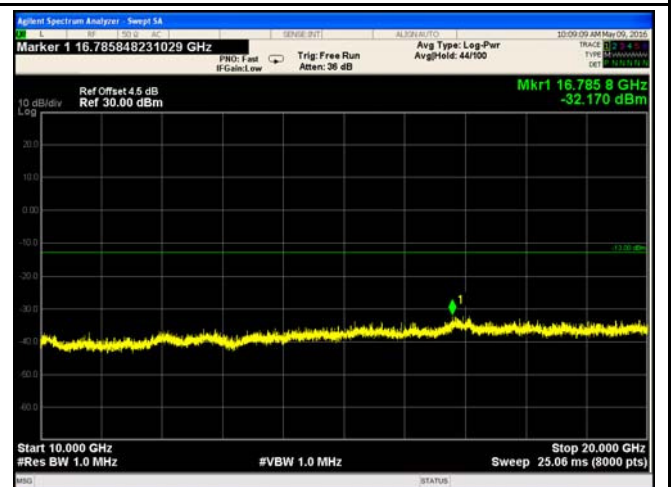

LTE Band 7 - High Channel-2

**LTE Band 17 (Part 27)**

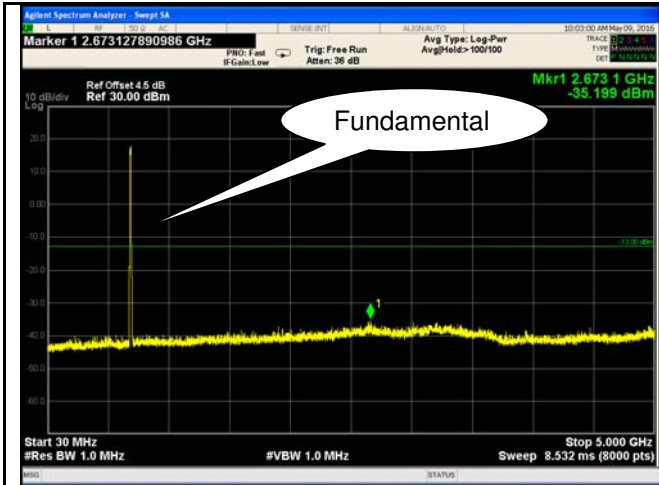

LTE Band 17 - Low Channel-1

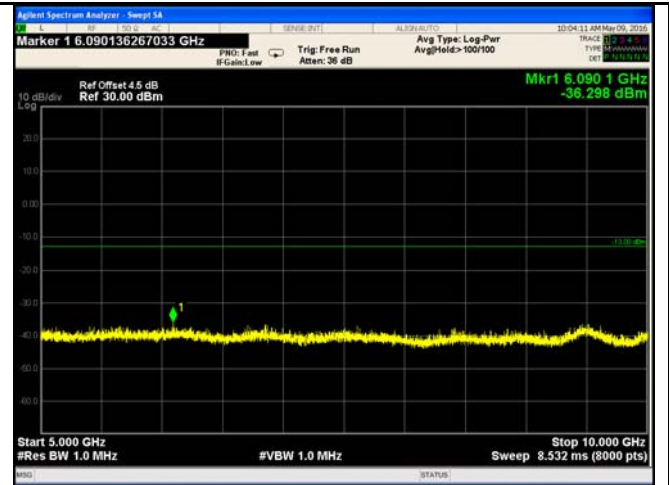

LTE Band 17 - Low Channel-2

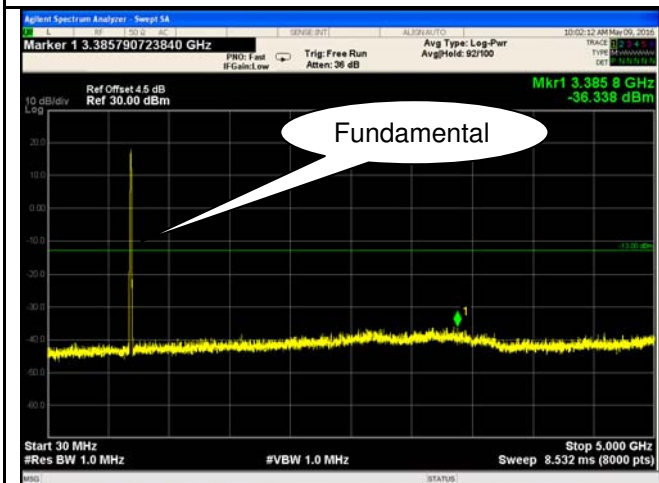

LTE Band 17 - Middle Channel-1

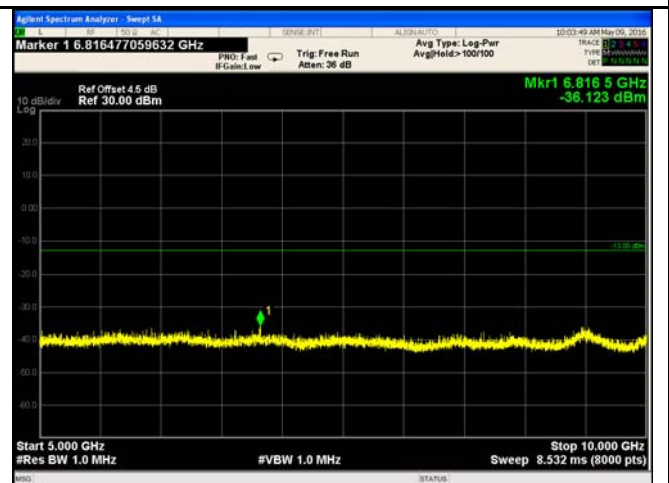

LTE Band 17 - Middle Channel-2

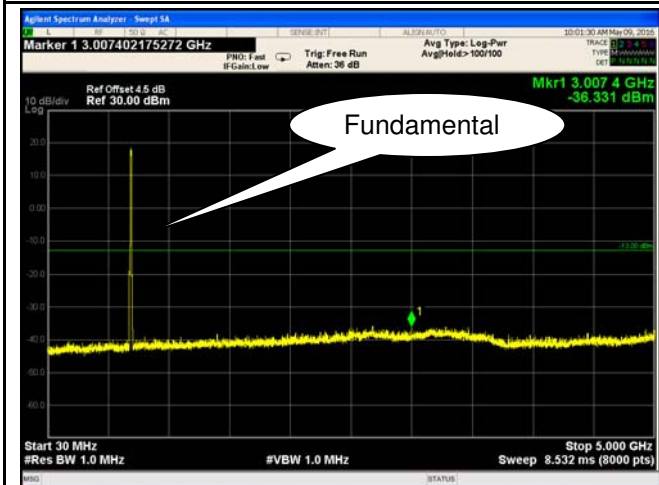

LTE Band 17 - High Channel-1

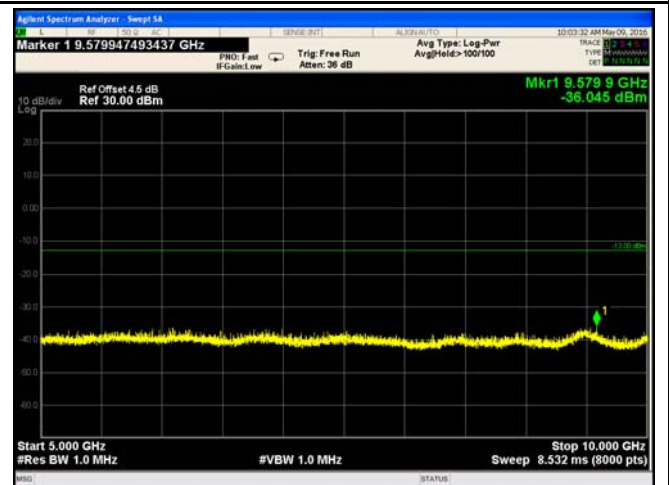

LTE Band 17 - High Channel-2



## 6.6 Spurious Radiated Emissions

Temperature	24°C
Relative Humidity	59%
Atmospheric Pressure	1007mbar
Test date :	May 07, 2016
Tested By :	Winnie Zhang

### Requirement(s):

Spec	Item	Requirement	Applicable
§2.1053, §22.917 & §24.238 § 27.53(h)	a)	The power of any emission outside of the authorized operating frequency ranges must be attenuated below the transmitter power (P) by a factor of at least $43 + 10 \log (P)$ dB. The spectrum is scanned from 30 MHz up to a frequency including its 10th harmonic.	<input checked="" type="checkbox"/>

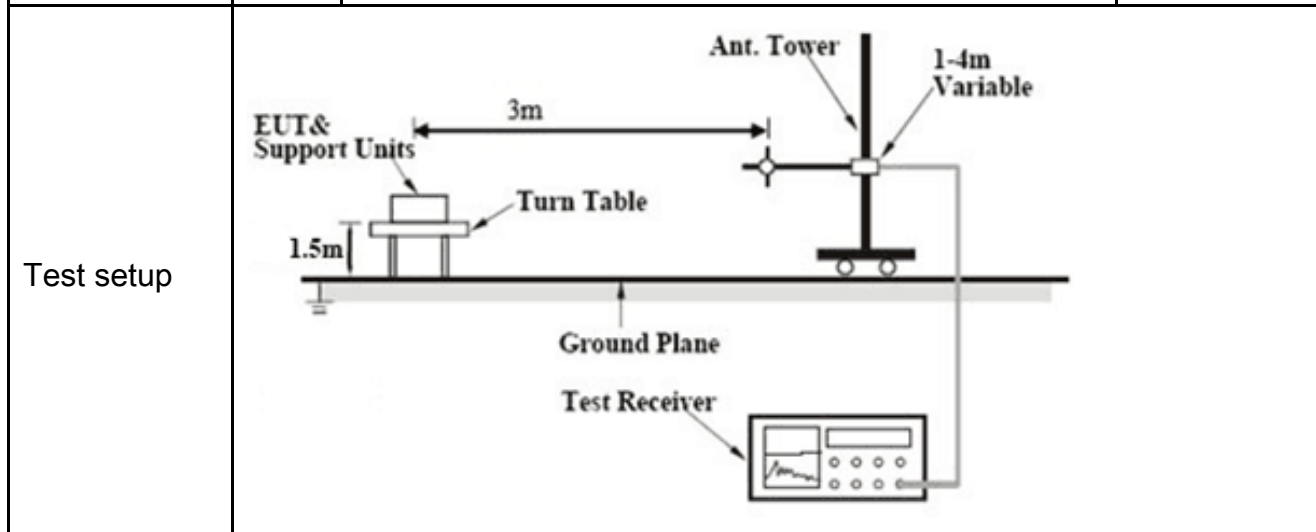

Test Procedure	<ol style="list-style-type: none"> <li>The transmitter was placed on a wooden turntable, and it was transmitting into a non-radiating load which was also placed on the turntable.</li> <li>The measurement antenna was placed at a distance of 3 meters from the EUT. During the tests, the antenna height and polarization as well as EUT azimuth were varied in order to identify the maximum level of emissions from the EUT. The test was performed by placing the EUT on 3-orthogonal axis.</li> <li>Remove the EUT and replace it with substitution antenna. A signal generator was connected to the substitution antenna by a non-radiating cable. The absolute levels of the spurious emissions were measured by the substitution. Sample Calculation: EUT Field Strength = Raw Amplitude (dB<math>\mu</math>V/m) – Amplifier Gain (dB) + Antenna Factor (dB) + Cable Loss (dB) + Filter Attenuation (dB, if used)</li> </ol>
----------------	--

Test Report	16070460-FCC-R5
Page	85 of 134

Remark	
Result	<input checked="" type="checkbox"/> Pass <input type="checkbox"/> Fail

Test Data  Yes  N/A  
Test Plot  Yes (See below)  N/A

## LTE Band 2 (Part 24E) result

### Low channel

Frequency (MHz)	Substituted level (dBm)	Polarity (H/V)	Antenna Gain Correction (dB)	Cable Loss (dB)	Corrected Reading (dBm)	Limit (dBm)	Margin (dB)
3720	-46.22	V	10.25	2.73	-38.7	-13	-25.7
3720	-46.85	H	10.25	2.73	-39.33	-13	-26.33
56.3	-39.17	V	-2.2	0.11	-41.48	-13	-28.48
220.7	-48.51	H	6.3	0.18	-42.39	-13	-29.39

### Middle channel

Frequency (MHz)	Substituted level (dBm)	Polarity (H/V)	Antenna Gain Correction (dB)	Cable Loss (dB)	Corrected Reading (dBm)	Limit (dBm)	Margin (dB)
3760	-46.19	V	10.25	2.73	-38.67	-13	-25.67
3760	-47.02	H	10.25	2.73	-39.5	-13	-26.5
56.8	-39.17	V	-2.4	0.11	-41.68	-13	-28.68
220.1	-48.51	H	6.4	0.19	-42.3	-13	-29.3

### High channel

Frequency (MHz)	Substituted level (dBm)	Polarity (H/V)	Antenna Gain Correction (dB)	Cable Loss (dB)	Corrected Reading (dBm)	Limit (dBm)	Margin (dB)
3800	-45.88	V	10.36	2.73	-38.25	-13	-25.25
3800	-46.74	H	10.36	2.73	-39.11	-13	-26.11
56.5	-39.17	V	-2.5	0.13	-41.8	-13	-28.8
220.9	-48.51	H	6.6	0.2	-42.11	-13	-29.11

#### Note:

- 1, The testing has been conformed to  $10 \times 1907.5 \text{ MHz} = 19,075 \text{ MHz}$
- 2, All other emissions more than 30 dB below the limit
- 3, X-Axis, Y-Axis and -Axis were investigated. The results above show only the worst case.

## LTE Band 4(Part27) result

### Low channel

Frequency (MHz)	Substituted level (dBm)	Polarity (H/V)	Antenna Gain Correction (dB)	Cable Loss (dB)	Corrected Reading (dBm)	Limit (dBm)	Margin (dB)
3440	-47.28	V	10.06	2.52	-39.74	-13	-26.74
3440	-47.17	H	10.06	2.52	-39.63	-13	-26.63
52.8	-40.3	V	-3.4	0.11	-43.81	-13	-30.81
200.4	-47.24	H	4.1	0.15	-43.29	-13	-30.29

### Middle channel

Frequency (MHz)	Substituted level (dBm)	Polarity (H/V)	Antenna Gain Correction (dB)	Cable Loss (dB)	Corrected Reading (dBm)	Limit (dBm)	Margin (dB)
3465	-46.08	V	10.09	2.52	-38.51	-13	-25.51
3465	-46.86	H	10.09	2.52	-39.29	-13	-26.29
52.3	-40.37	V	-3.4	0.12	-43.89	-13	-30.89
200.6	-48.12	H	4.1	0.16	-44.18	-13	-31.18

### High channel

Frequency (MHz)	Substituted level (dBm)	Polarity (H/V)	Antenna Gain Correction (dB)	Cable Loss (dB)	Corrected Reading (dBm)	Limit (dBm)	Margin (dB)
3490	-45.73	V	10.09	2.52	-38.16	-13	-25.16
3490	-47.04	H	10.09	2.52	-39.47	-13	-26.47
52.1	-40.29	V	-3	0.13	-43.42	-13	-30.42
200.3	-48.78	H	4.2	0.17	-44.75	-13	-31.75

**Note:**

- 1, The testing has been conformed to  $10 \times 1752.5 \text{MHz} = 17,525 \text{MHz}$
- 2, All other emissions more than 30 dB below the limit
- 3, X-Axis, Y-Axis and -Axis were investigated. The results above show only the worst case.

## LTE Band 5(Part22H) result

### Low channel

Frequency (MHz)	Substituted level (dBm)	Polarity (H/V)	Antenna Gain Correction (dB)	Cable Loss (dB)	Corrected Reading (dBm)	Limit (dBm)	Margin (dB)
1658	-44.47	V	7.95	0.78	-37.3	-13	-24.30
1658	-45.18	H	7.95	0.78	-38.01	-13	-25.01
50.8	-39.26	V	-4.2	0.12	-43.58	-13	-30.58
202.1	-48.12	H	4.2	0.18	-44.1	-13	-31.10

### Middle channel

Frequency (MHz)	Substituted level (dBm)	Polarity (H/V)	Antenna Gain Correction (dB)	Cable Loss (dB)	Corrected Reading (dBm)	Limit (dBm)	Margin (dB)
1673	-44.56	V	7.95	0.78	-37.39	-13	-24.39
1673	-45.02	H	7.95	0.78	-37.85	-13	-24.85
50.5	-39.66	V	-4.2	0.13	-43.99	-13	-30.99
202.8	-48.85	H	4.2	0.19	-44.84	-13	-31.84

### High channel

Frequency (MHz)	Substituted level (dBm)	Polarity (H/V)	Antenna Gain Correction (dB)	Cable Loss (dB)	Corrected Reading (dBm)	Limit (dBm)	Margin (dB)
1688	-44.66	V	7.95	0.78	-37.49	-13	-24.49
1688	-45.07	H	7.95	0.78	-37.9	-13	-24.90
50.7	-39.16	V	-4	0.15	-43.31	-13	-30.31
202.2	-48.16	H	4.3	0.2	-44.06	-13	-31.06

**Note:**

- 1, The testing has been conformed to  $10 \times 846.5 \text{MHz} = 8,465 \text{MHz}$
- 2, All other emissions more than 30 dB below the limit
- 3, X-Axis, Y-Axis and -Axis were investigated. The results above show only the worst case.

## LTE Band 7(Part27) result

### Low channel

Frequency (MHz)	Substituted level (dBm)	Polarity (H/V)	Antenna Gain Correction (dB)	Cable Loss (dB)	Corrected Reading (dBm)	Limit (dBm)	Margin (dB)
5020	-48.02	V	10.29	0.98	-38.71	-13	-25.71
5020	-47.89	H	10.29	0.98	-38.58	-13	-25.58
54.1	-39.29	V	-2.7	0.1	-42.09	-13	-29.09
204.5	-48.08	H	4.9	0.16	-43.34	-13	-30.34

### Middle channel

Frequency (MHz)	Substituted level (dBm)	Polarity (H/V)	Antenna Gain Correction (dB)	Cable Loss (dB)	Corrected Reading (dBm)	Limit (dBm)	Margin (dB)
5070	-47.83	V	10.3	0.99	-38.52	-13	-25.52
5070	-47.92	H	10.3	0.99	-38.61	-13	-25.61
54.6	-39.77	V	-2.7	0.1	-42.57	-13	-29.57
204.8	-48.16	H	4.9	0.16	-43.42	-13	-30.42

### High channel

Frequency (MHz)	Substituted level (dBm)	Polarity (H/V)	Antenna Gain Correction (dB)	Cable Loss (dB)	Corrected Reading (dBm)	Limit (dBm)	Margin (dB)
5120	-48.16	V	10.32	1	-38.84	-13	-25.84
5120	-48.12	H	10.32	1	-38.8	-13	-25.80
54.9	-39.94	V	-2.6	0.1	-42.64	-13	-29.64
204.3	-48.37	H	4.92	0.17	-42.63	-13	-30.23

**Note:**

- 1, The testing has been conformed to  $10 \times 2567.5 \text{ MHz} = 25,675 \text{ MHz}$
- 2, All other emissions more than 30 dB below the limit
- 3, X-Axis, Y-Axis and -Axis were investigated. The results above show only the worst case.

## LTE Band 17(Part27) result

### Low channel

Frequency (MHz)	Substituted level (dBm)	Polarity (H/V)	Antenna Gain Correction (dB)	Cable Loss (dB)	Corrected Reading (dBm)	Limit (dBm)	Margin (dB)
1418	-43.29	V	7.65	0.75	-36.39	-13	-23.39
1418	-44.52	H	7.65	0.75	-37.62	-13	-24.62
50.2	-38.95	V	-4.2	0.12	-43.27	-13	-30.27
203.4	-48.77	H	4.6	0.18	-44.35	-13	-31.35

### Middle channel

Frequency (MHz)	Substituted level (dBm)	Polarity (H/V)	Antenna Gain Correction (dB)	Cable Loss (dB)	Corrected Reading (dBm)	Limit (dBm)	Margin (dB)
1420	-43.35	V	7.65	0.75	-36.45	-13	-23.45
1420	-44.76	H	7.65	0.75	-37.86	-13	-24.86
50.7	-39.29	V	-4.2	0.12	-43.61	-13	-30.61
203.4	-48.84	H	4.6	0.19	-44.43	-13	-31.43

### High channel

Frequency (MHz)	Substituted level (dBm)	Polarity (H/V)	Antenna Gain Correction (dB)	Cable Loss (dB)	Corrected Reading (dBm)	Limit (dBm)	Margin (dB)
1422	-44.09	V	7.65	0.75	-37.19	-13	-24.19
1422	-44.81	H	7.65	0.75	-37.91	-13	-24.91
50.9	-39.07	V	-4.1	0.13	-43.3	-13	-30.30
203.1	-48.77	H	4.7	0.2	-44.27	-13	-31.27

#### Note:

- 1, The testing has been conformed to  $10 \times 713.5 \text{ MHz} = 7,135 \text{ MHz}$
- 2, All other emissions more than 30 dB below the limit
- 3, X-Axis, Y-Axis and -Axis were investigated. The results above show only the worst case.

## 6.7 Band Edge

Temperature	24°C
Relative Humidity	59%
Atmospheric Pressure	1007mbar
Test date :	May 07&08&09, 2016
Tested By :	Winnie Zhang

### Requirement(s):

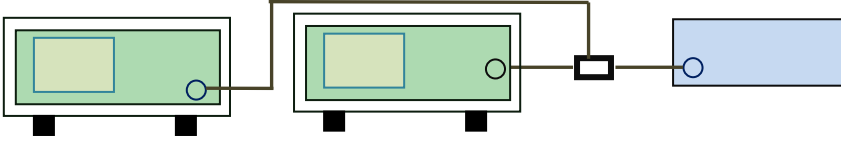
Spec	Item	Requirement	Applicable
§22.917(a) §24.238(a) § 27.53(h)	a)	The power of any emission outside of the authorized operating frequency ranges must be lower than the transmitter power (P) by a factor of at least $43 + 10 \log (P)$ dB.	<input checked="" type="checkbox"/>
Test setup			
Procedure	<ul style="list-style-type: none"> <li>- The EUT was connected to Spectrum Analyzer and Base Station via power divider.</li> <li>- The Band Edges of low and high channels for the highest RF powers were measured. Setting RBW as roughly BW/100.</li> </ul>		
Remark			
Result	<input checked="" type="checkbox"/> Pass <input type="checkbox"/> Fail		

Test Data     Yes                       N/A

Test Plot     Yes (See below)             N/A



### LTE Band 2 (Part 24E) result

BW(MHz)	Channel	Frequency (MHz)	Mode	Emission (dBm)	Limit (dBm)
1.4	18607	1850.7	QPSK	-24.227	-13
			16QAM	-19.404	-13
1.4	18900	1909.3	QPSK	-24.070	-13
			16QAM	-23.818	-13
3	18615	1851.5	QPSK	-20.234	-13
			16QAM	-18.215	-13
3	19185	1908.5	QPSK	-22.275	-13
			16QAM	-20.684	-13
5	18625	1852.5	QPSK	-16.483	-13
			16QAM	-16.299	-13
5	19175	1907.5	QPSK	-16.443	-13
			16QAM	-18.860	-13
10	18650	1855	QPSK	-18.310	-13
			16QAM	-19.463	-13
10	19150	1905	QPSK	-20.240	-13
			16QAM	-20.296	-13
15	18675	1857.5	QPSK	-19.147	-13
			16QAM	-19.544	-13
15	19125	1902.5	QPSK	-20.465	-13
			16QAM	-19.577	-13
20	18700	1860	QPSK	-19.990	-13
			16QAM	-20.530	-13
20	19100	1900	QPSK	-19.402	-13
			16QAM	-19.224	-13

### LTE Band 4 (Part 27) result

BW(MHz)	Channel	Frequency (MHz)	Mode	Emission (dBm)	Limit (dBm)
1.4	19957	1710.7	QPSK	-19.108	-13
			16QAM	-20.226	-13
1.4	20393	1754.3	QPSK	-26.434	-13
			16QAM	-27.253	-13
3	19965	1711.5	QPSK	-20.975	-13
			16QAM	-21.069	-13
3	20385	1753.5	QPSK	-21.776	-13
			16QAM	-21.145	-13
5	19975	1712.5	QPSK	-19.761	-13
			16QAM	-18.488	-13
5	20375	1752.5	QPSK	-19.407	-13
			16QAM	-18.415	-13
10	20000	1715	QPSK	-20.601	-13
			16QAM	-20.652	-13
10	20350	1750	QPSK	-19.606	-13
			16QAM	-19.054	-13
15	20025	1717.5	QPSK	-24.058	-13
			16QAM	-24.004	-13
15	20325	1747.5	QPSK	-22.822	-13
			16QAM	-23.397	-13
20	20050	1720	QPSK	-27.465	-13
			16QAM	-28.612	-13
20	20300	1745	QPSK	-23.336	-13
			16QAM	-24.800	-13

### LTE Band 5 (Part 22H) result

BW(MHz)	Channel	Frequency (MHz)	Mode	Emission (dBm)	Limit (dBm)
1.4	20407	824.7	QPSK	-20.329	-13
			16QAM	-23.427	-13
1.4	20643	848.3	QPSK	-21.163	-13
			16QAM	-21.669	-13
3	20415	825.5	QPSK	-18.006	-13
			16QAM	-17.692	-13
3	20635	847.5	QPSK	-22.194	-13
			16QAM	-21.378	-13
5	20425	826.5	QPSK	-14.686	-13
			16QAM	-16.479	-13
5	20625	846.5	QPSK	-17.643	-13
			16QAM	-17.356	-13
10	20450	829	QPSK	-17.186	-13
			16QAM	-18.672	-13
10	20800	844	QPSK	-19.804	-13
			16QAM	-16.683	-13

**LTE Band 17 (Part 27) result**

BW(MHz)	Channel	Frequency (MHz)	Mode	Emission (dBm)	Limit (dBm)
5	23755	706.5	QPSK	-15.132	-13
			16QAM	-15.208	-13
5	23825	713.5	QPSK	-19.970	-13
			16QAM	-20.206	-13
10	23780	709	QPSK	-19.802	-13
			16QAM	-19.524	-13
10	23800	711	QPSK	-20.825	-13
			16QAM	-19.825	-13

### Test Plots

#### LTE Band 2 (Part 24E)

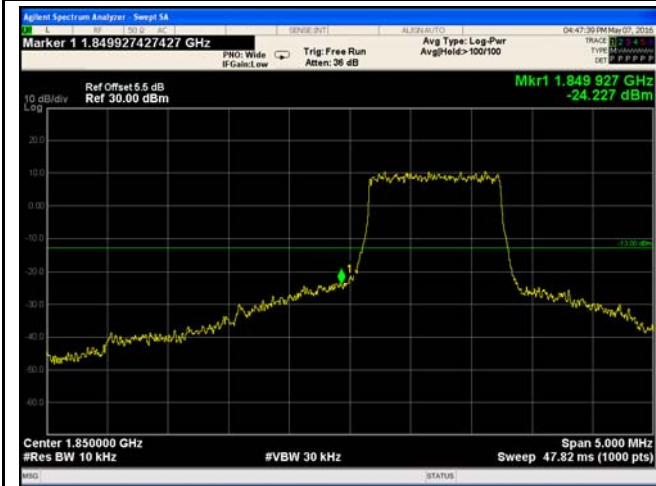

LTE Band 2 - Low Channel QPSK-1.4

Note: Offset=Cable loss (4.5) + 10log  
(12.56/10)=4.5+1.0=5.5dB



LTE Band 2 - High Channel QPSK-1.4

Note: Offset=Cable loss (4.5) + 10log  
(12.91/10)=4.5+1.1=5.6dB

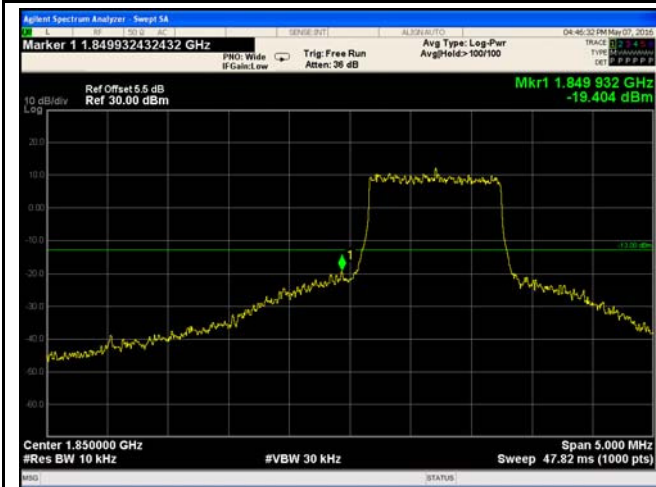

LTE Band 2 - Low Channel 16QAM-1.4

Note: Offset=Cable loss (4.5) + 10log  
(12.59/10)=4.5+1.0=5.5 dB

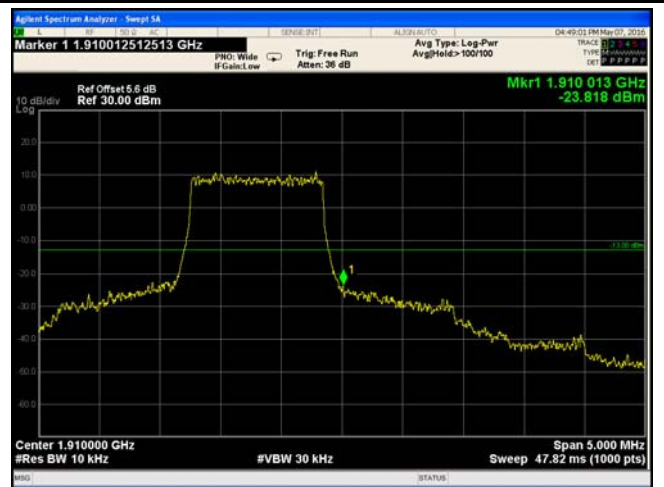

LTE Band 2 - High Channel 16QAM-1.4

Note: Offset=Cable loss (4.5) + 10log  
(12.81/10)=4.5+1.1=5.6 dB

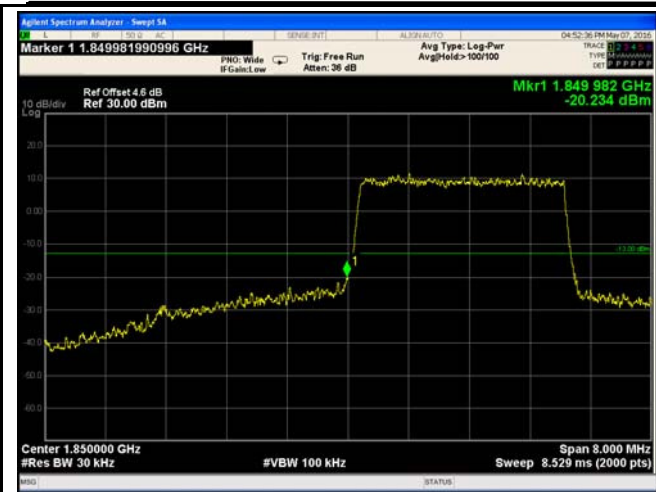

LTE Band 2 - Low Channel QPSK-3

Note: Offset=Cable loss (4.5) + 10log  
(30.42/30)=4.5+0.1=4.6 dB

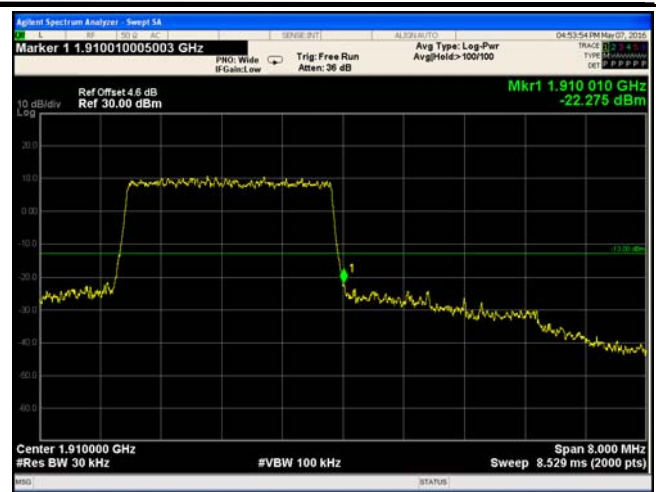

LTE Band 2 - High Channel QPSK-3

Note: Offset=Cable loss (4.5) + 10log  
(30.48/30)=4.5+0.1=4.6 dB

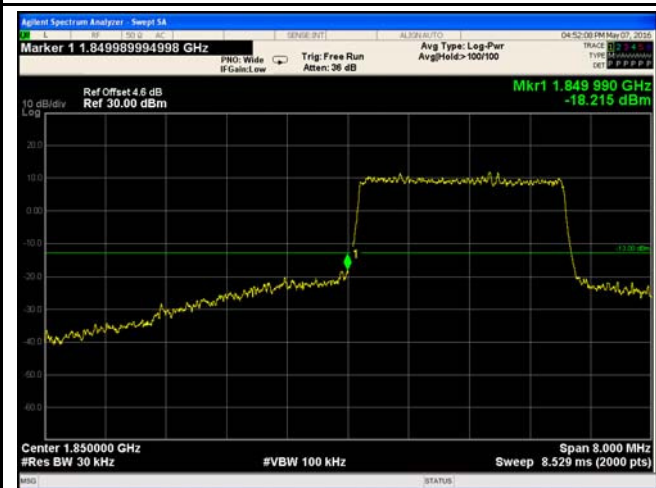

LTE Band 2 - Low Channel 16QAM-3

Note: Offset=Cable loss (4.5) + 10log  
(30.42/30)=4.5+0.1=4.6 dB

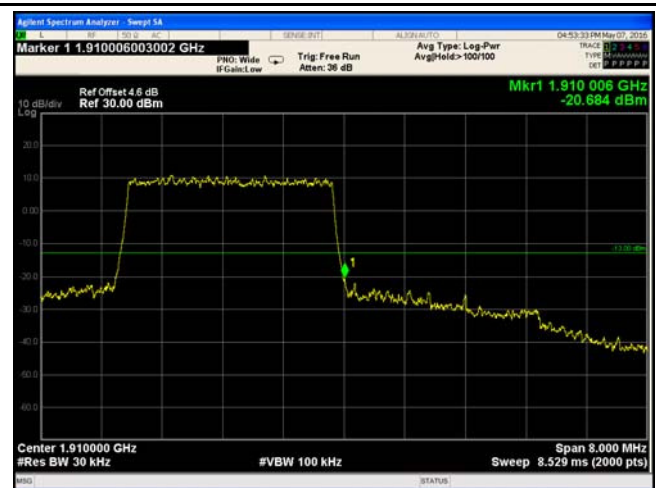

LTE Band 2 - High Channel 16QAM-3

Note: Offset=Cable loss (4.5) + 10log  
(30.42/30)=4.5+0.1=4.6 dB

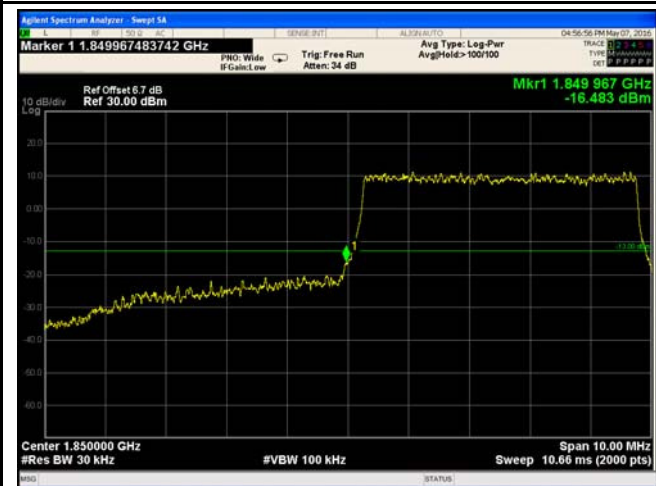

LTE Band 2 - Low Channel QPSK-5

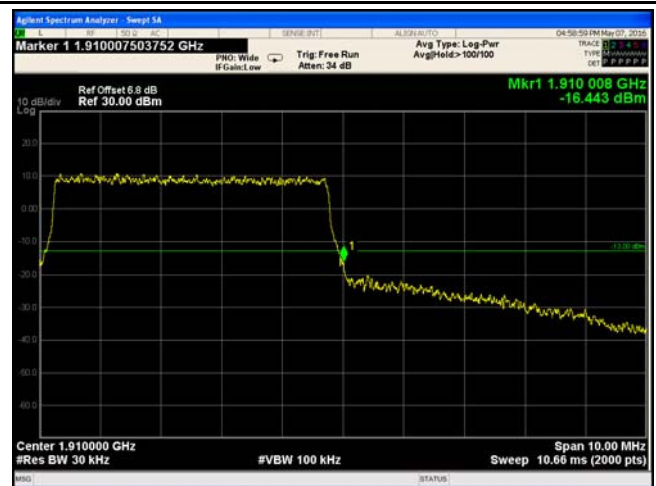

LTE Band 2 - High Channel QPSK-5

Note: Offset=Cable loss (4.5) + 10log  
(50.35/30)=4.5+2.2=6.7 dB

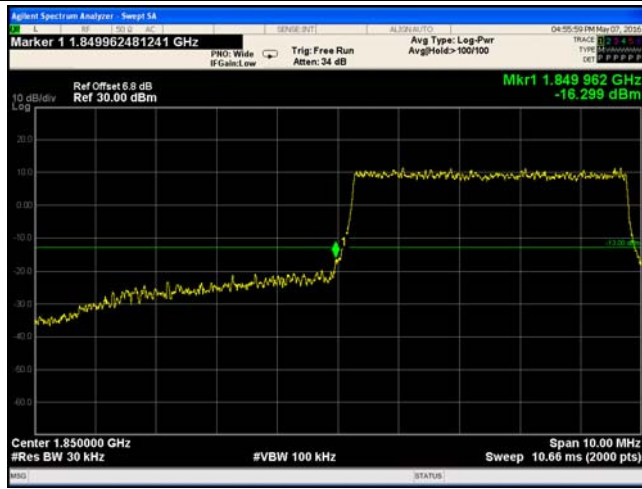

LTE Band 2 - Low Channel 16QAM-5

Note: Offset=Cable loss (4.5) + 10log  
(50.37/30)=4.5+2.3=6.8 dB



LTE Band 2 - High Channel 16QAM-5

Note: Offset=Cable loss (4.5) + 10log  
(50.53/30)=4.5+2.3=6.8 dB

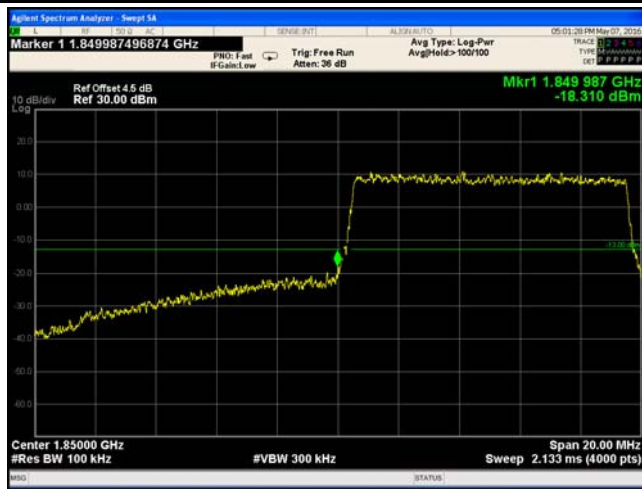

LTE Band 2 - Low Channel QPSK-10

Note: Offset=Cable loss (4.5) + 10log  
(50.85/30)=4.5+2.3=6.8 dB

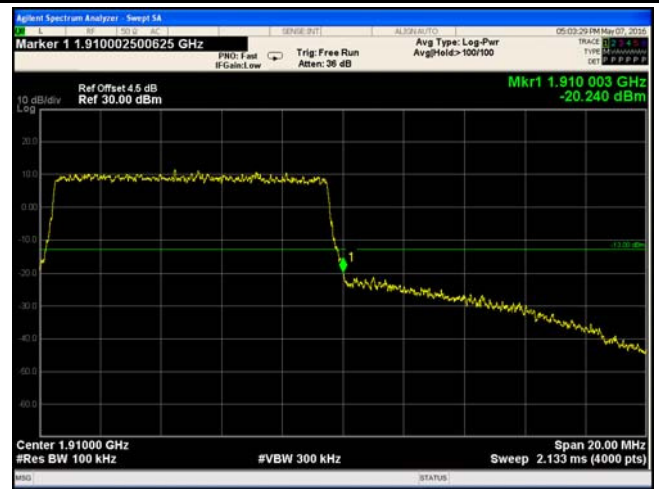

LTE Band 2 - High Channel QPSK-10

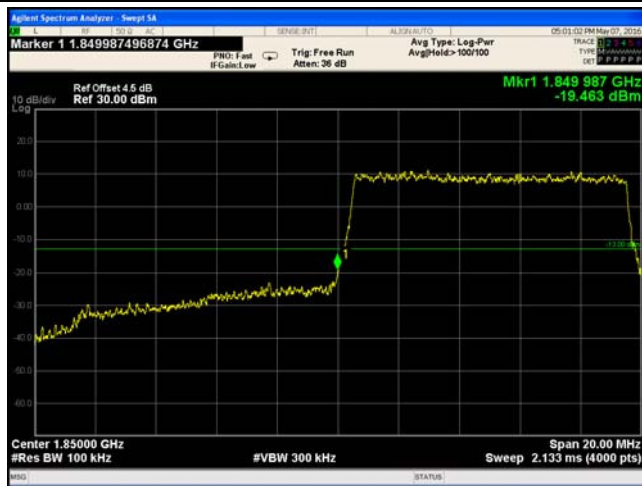

LTE Band 2 - Low Channel 16QAM-10

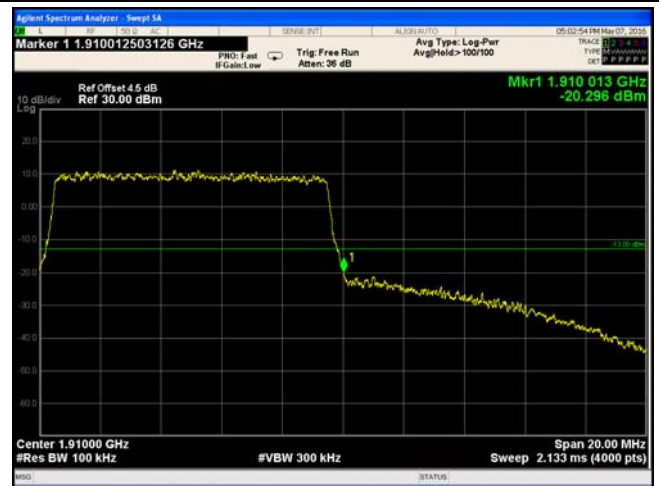

LTE Band 2 - High Channel 16QAM-10

Note: Offset=Cable loss (4.5) + 10log  
(100.5/100)=4.5+0.0=4.5 dB



LTE Band 2 - Low Channel QPSK-15

Note: Offset=Cable loss (4.5) + 10log  
(100.3/100)=4.5+0.0=4.5 dB



LTE Band 2 - High Channel QPSK-15

Note: Offset=Cable loss (4.5) + 10log  
(147.2/100)=4.5+1.7=6.2 dB

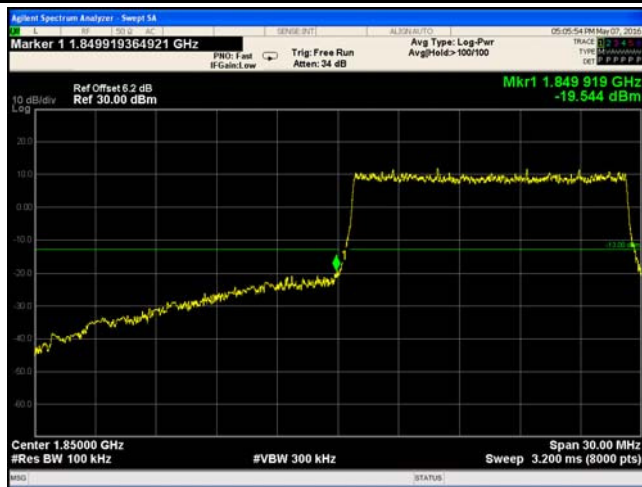

LTE Band 2 - Low Channel 16QAM-15

Note: Offset=Cable loss (4.5) + 10log  
(148.1/100)=4.5+1.7=6.2 dB

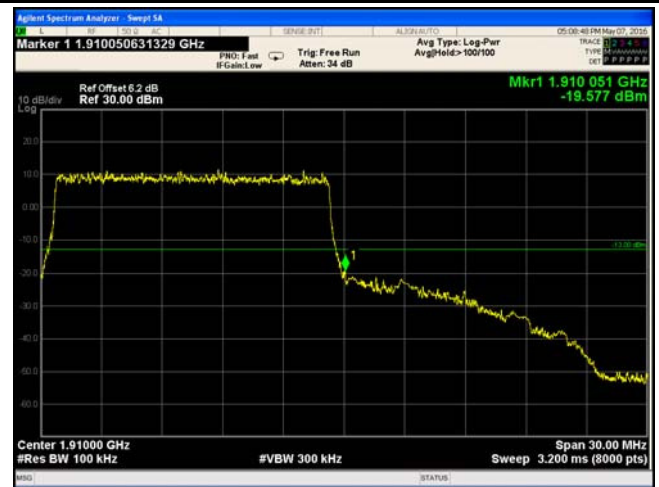

LTE Band 2 - High Channel 16QAM-15

Note: Offset=Cable loss (4.5) + 10log  
(147.5/100)=4.5+1.7=6.2 dB

Note: Offset=Cable loss (4.5) + 10log  
(147.1/100)=4.5+1.7=6.2 dB



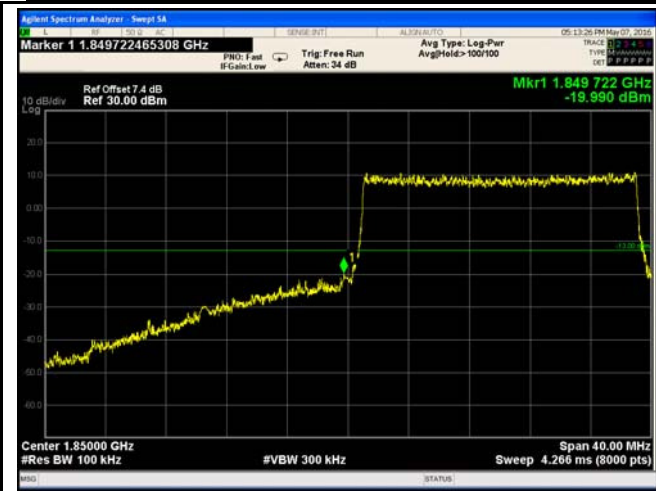

LTE Band 2 - Low Channel QPSK-20

Note: Offset=Cable loss (4.5) + 10log  
(195.5/100)=4.5+2.9=7.4 dB

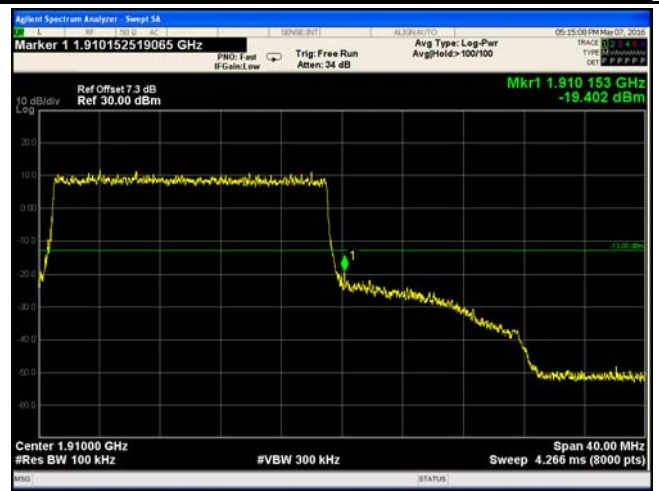

LTE Band 2 - High Channel QPSK-20

Note: Offset=Cable loss (4.5) + 10log  
(191.7/100)=4.5+2.8=7.3 dB

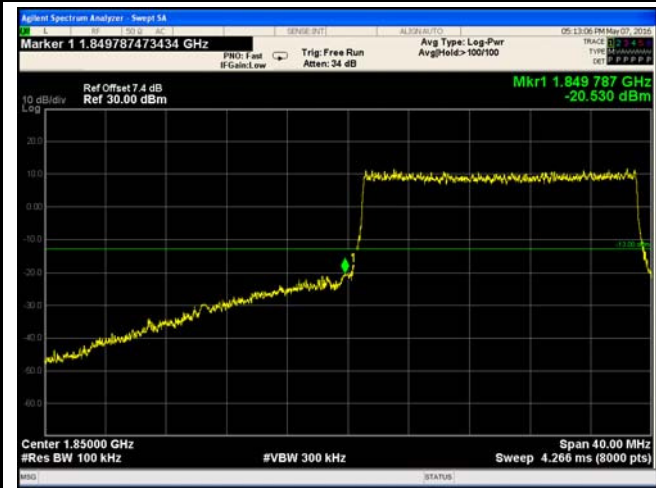

LTE Band 2 - Low Channel 16QAM-20

Note: Offset=Cable loss (4.5) + 10log  
(195.3/100)=4.5+2.9=7.4 dB

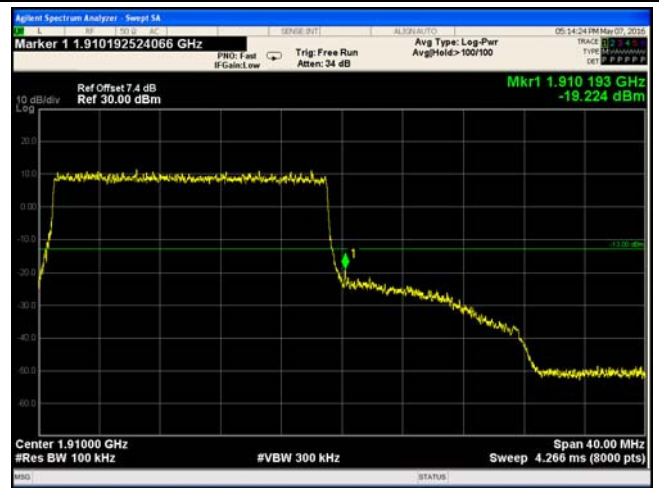

LTE Band 2 - High Channel 16QAM-20

Note: Offset=Cable loss (4.5) + 10log  
(194.6/100)=4.5+2.9=7.4 dB

### LTE Band 4 (Part 27)

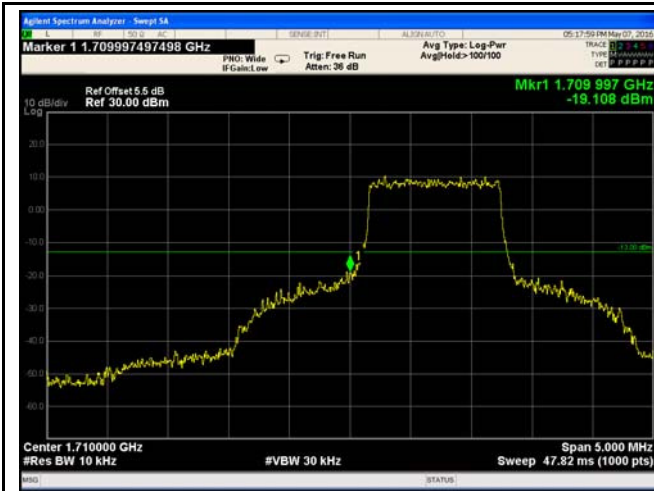

LTE Band 4 - Low Channel QPSK-1.4

Note: Offset=Cable loss (4.5) + 10log  
(12.61/10)=4.5+1.0=5.5 dB

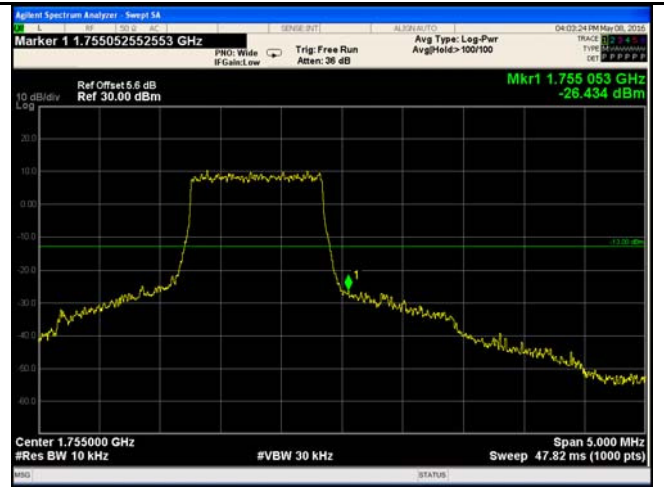

LTE Band 4 - High Channel QPSK-1.4

Note: Offset=Cable loss (4.5) + 10log  
(12.87/10)=4.5+1.1=5.6 dB

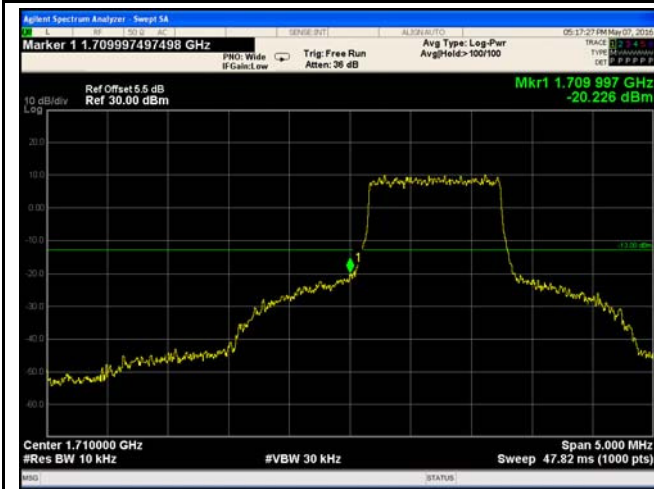

LTE Band 4 - Low Channel 16QAM-1.4

Note: Offset=Cable loss (4.5) + 10log  
(12.58/10)=4.5+1.0=5.5 dB

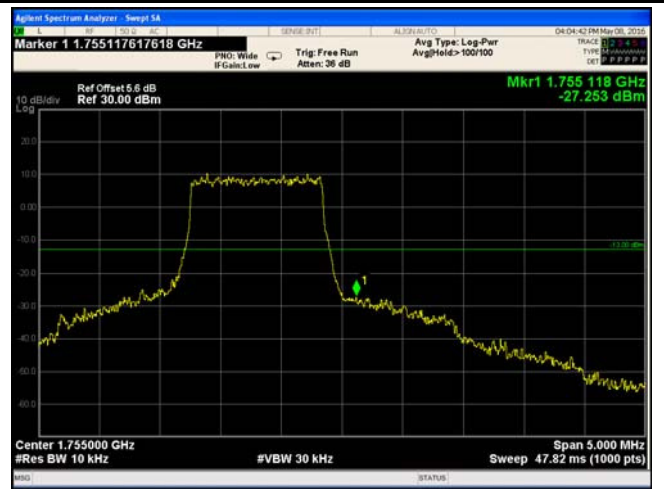

LTE Band 4 - High Channel 16QAM-1.4

Note: Offset=Cable loss (4.5) + 10log  
((12.80/10)=4.5+1.1=5.6. dB

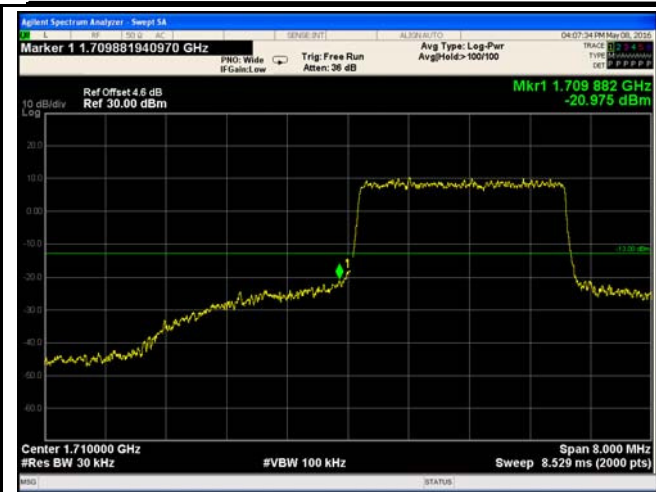

LTE Band 4 - Low Channel QPSK-3

Note: Offset=Cable loss (4.5) + 10log  
(30.55/30)=4.5+0.1=4.6 dB

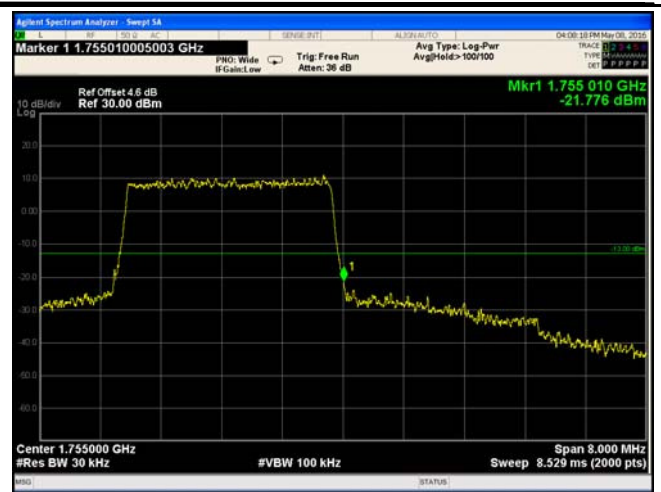

LTE Band 4 - High Channel QPSK-3

Note: Offset=Cable loss (4.5) + 10log  
(30.59/30)=4.5+0.1=4.6 dB

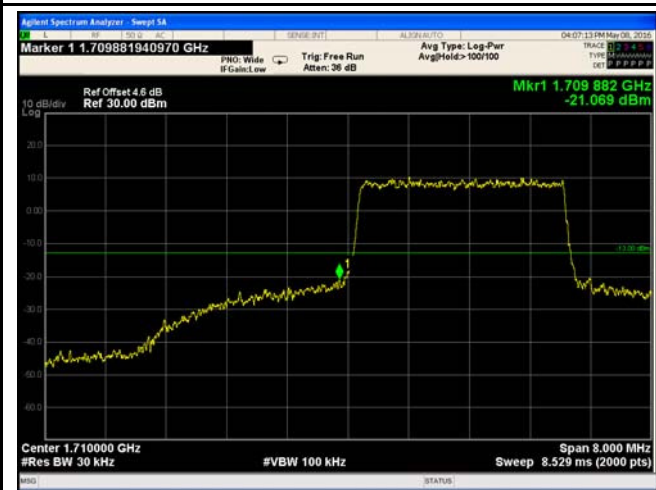

LTE Band 4 - Low Channel 16QAM-3

Note: Offset=Cable loss (4.5) + 10log  
(30.46/30)=4.5+0.1=4.6 dB

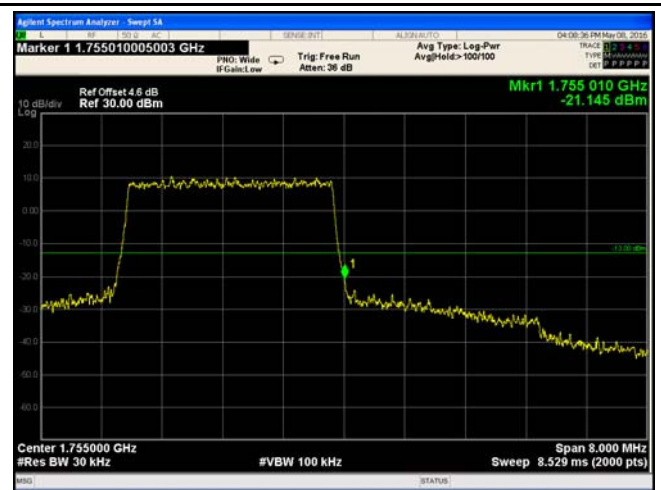

LTE Band 4 - High Channel 16QAM-3

Note: Offset=Cable loss (4.5) + 10log  
(30.45/30)=4.5+0.1=4.6 dB

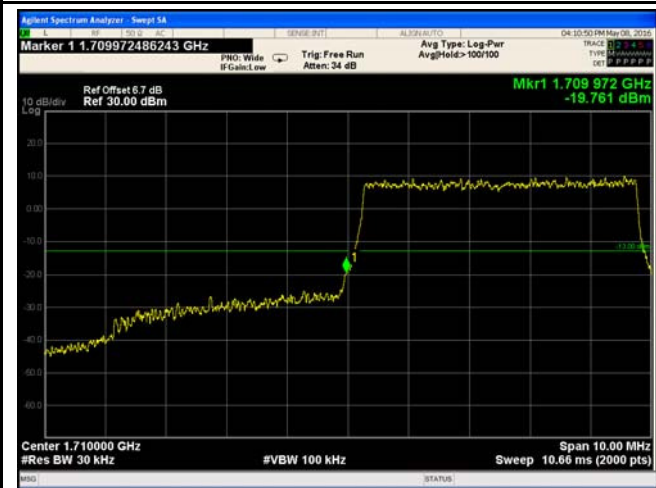

LTE Band 4 - Low Channel QPSK-5



LTE Band 4 - High Channel QPSK-5

Note: Offset=Cable loss (4.5) + 10log  
(50.28/30)=4.5+2.2=6.7 dB



LTE Band 4 - Low Channel 16QAM-5

Note: Offset=Cable loss (4.5) + 10log  
(50.95/30)=4.5+2.3=6.8 dB



LTE Band 4 - High Channel 16QAM-5

Note: Offset=Cable loss (4.5) + 10log  
(50.61/30)=4.5+2.3=6.8 dB

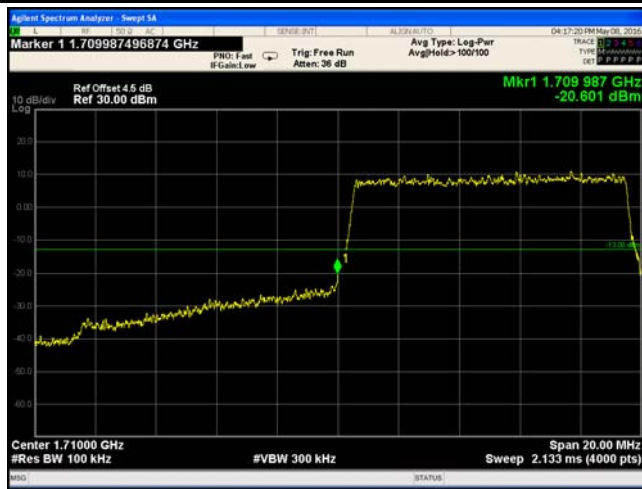

LTE Band 4 - Low Channel QPSK-10

Note: Offset=Cable loss (4.5) + 10log  
(50.43/30)=4.5+2.3=6.8 dB

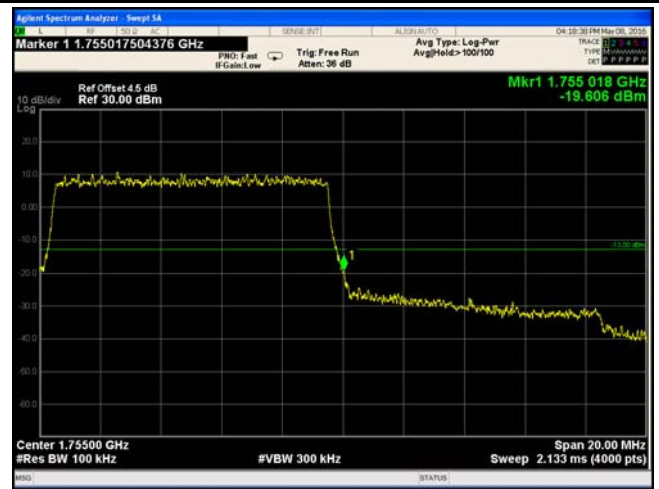

LTE Band 4 - High Channel QPSK-10

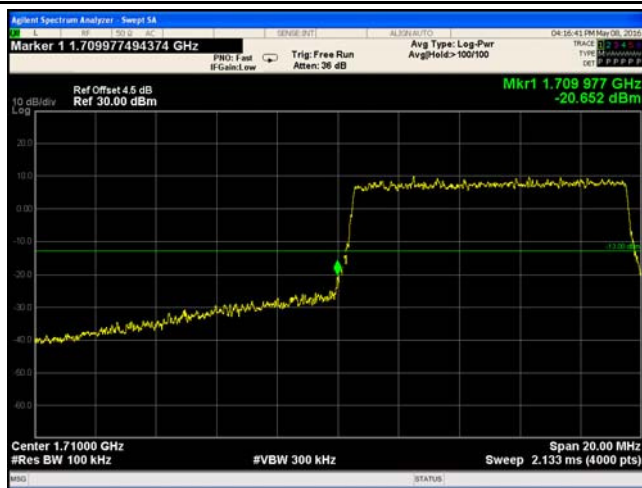

LTE Band 4 - Low Channel 16QAM-10

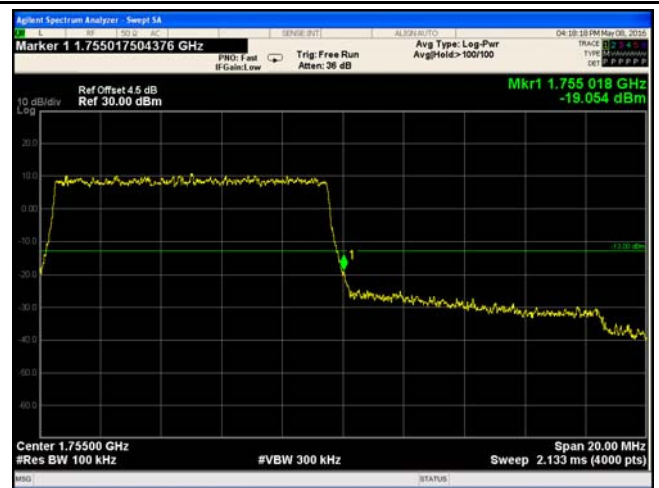

LTE Band 4 - High Channel 16QAM-10



LTE Band 4 - Low Channel QPSK-15

Note: Offset=Cable loss (4.5) + 10log  
(146.4/100)=4.5+1.7=6.2 dB

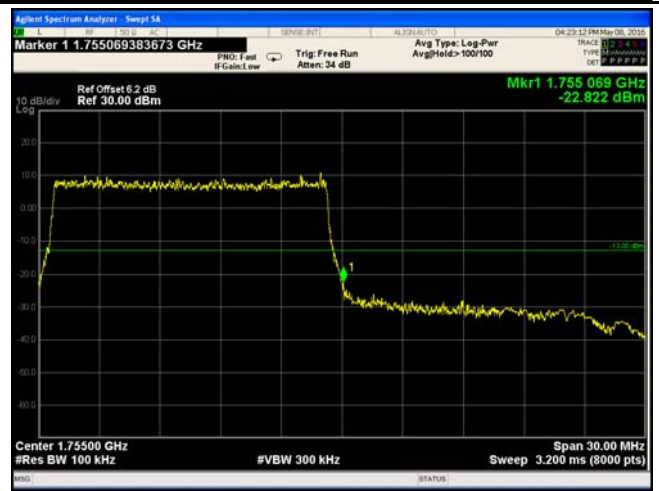

LTE Band 4 - High Channel QPSK-15

Note: Offset=Cable loss (4.5) + 10log  
(146.8/100)=4.5+1.7=6.2 dB



LTE Band 4 - Low Channel 16QAM-15

Note: Offset=Cable loss (4.5) + 10log  
(147.2/100)=4.5+1.7=6.2 dB

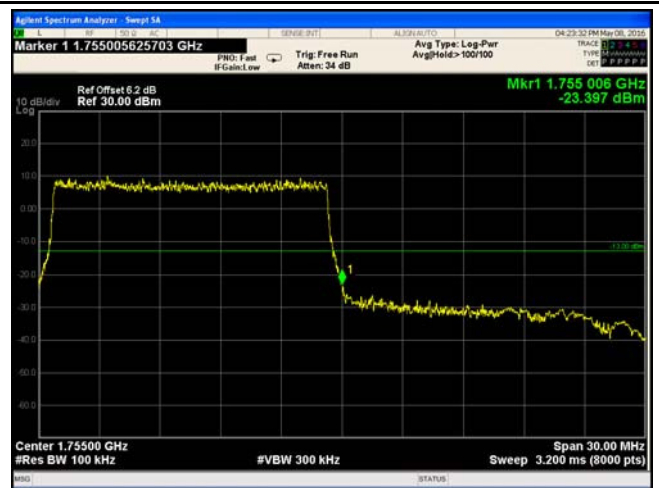

LTE Band 4 - High Channel 16QAM-15

Note: Offset=Cable loss (4.5) + 10log  
(148/100)=4.5+1.7=6.2 dB

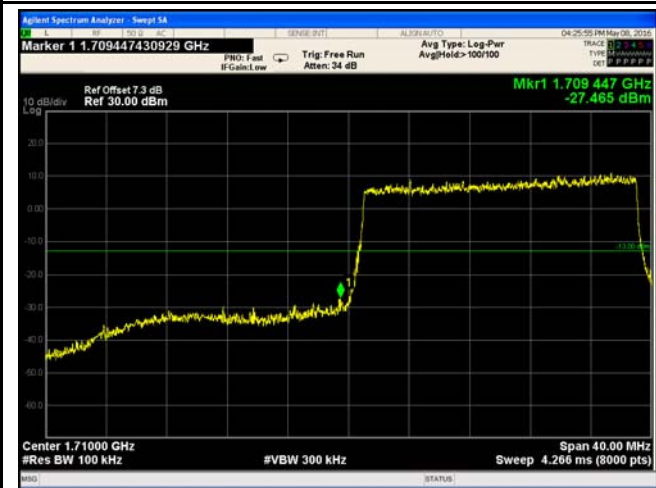

LTE Band 4 - Low Channel QPSK-20

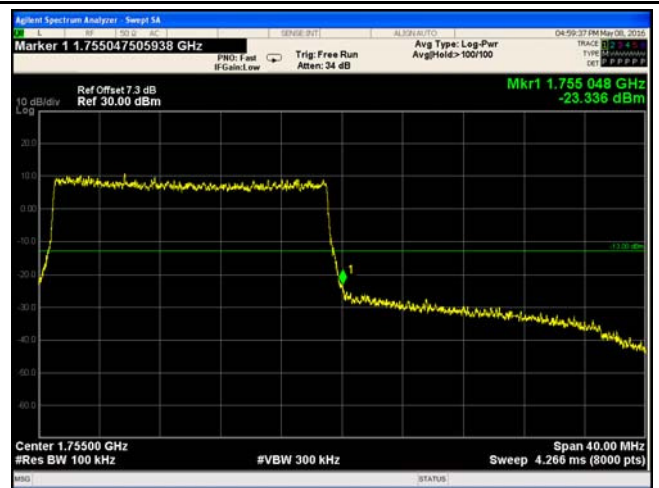

LTE Band 4 - High Channel QPSK-20

Note: Offset=Cable loss (4.5) + 10log  
 (192.7/100)=4.5+2.8=7.3 dB

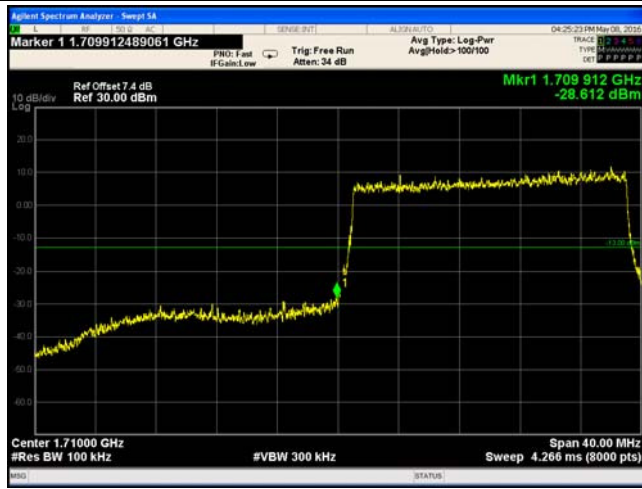

LTE Band 4 - Low Channel 16QAM-20

Note: Offset=Cable loss (4.5) + 10log  
 (193.5/100)=4.5+2.9=7.4dB

Note: Offset=Cable loss (4.5) + 10log  
 (193.4/100)=4.5+2.9=7.4 dB

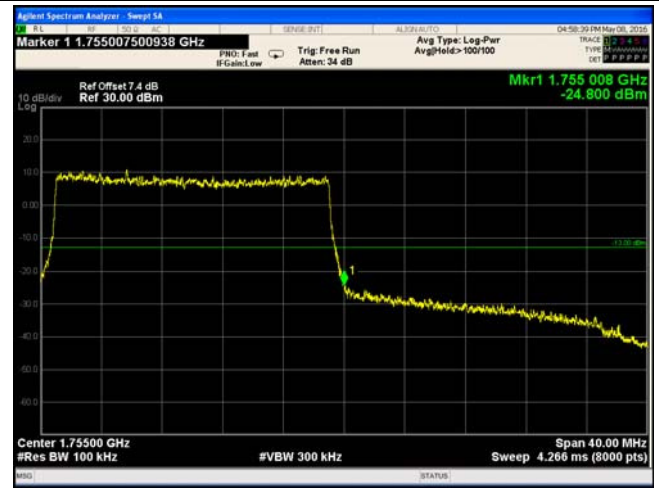

LTE Band 4 - High Channel 16QAM-20

Note: Offset=Cable loss (4.5) + 10log  
 (192.8/100)=4.5+2.9=7.4 dB

### LTE Band 5 (Part 22H)

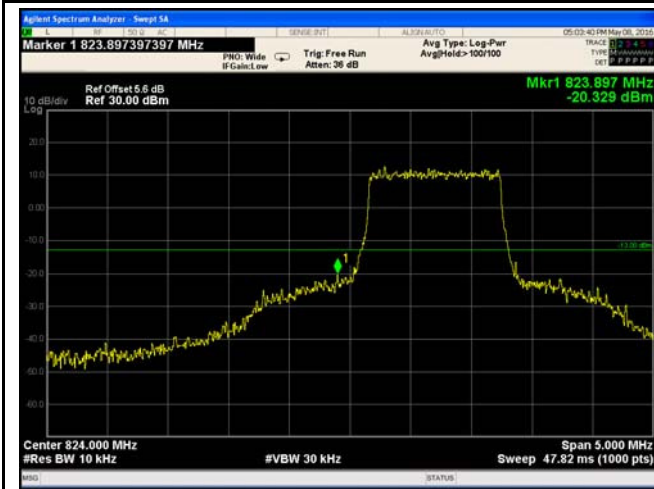

LTE Band 5 - Low Channel QPSK-1.4

Note: Offset=Cable loss (4.5) + 10log  
(12.91/10)=4.5+1.1=5.6 dB

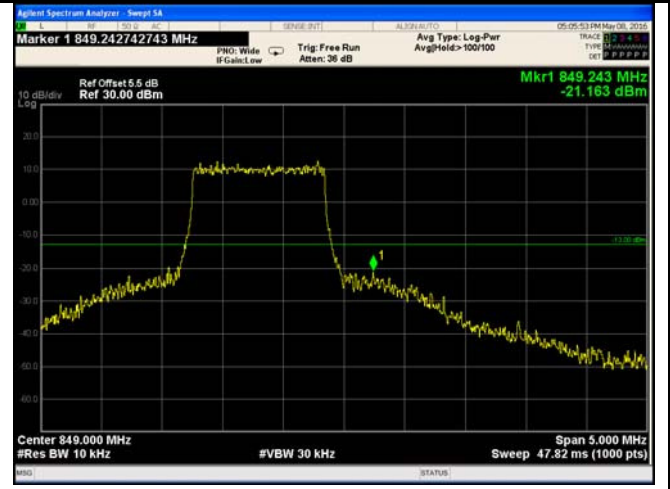

LTE Band 5 - High Channel QPSK-1.4

Note: Offset=Cable loss (4.5) + 10log  
(12.63/10)=4.5+1.0=5.5 dB

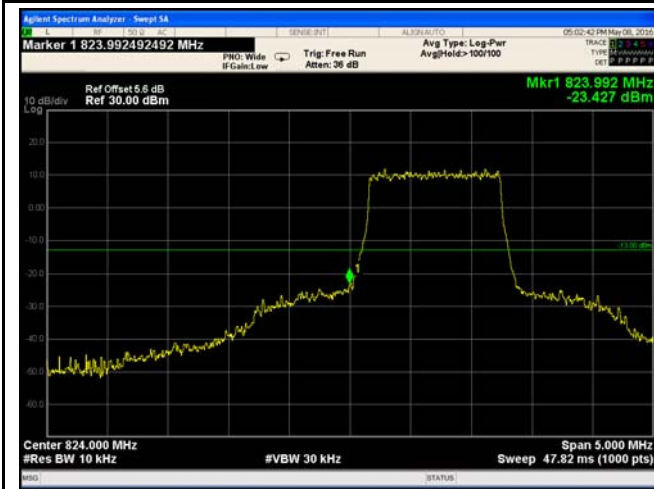

LTE Band 5 - Low Channel 16QAM-1.4

Note: Offset=Cable loss (4.5) + 10log  
(12.84/10)=4.5+1.1=5.6 dB

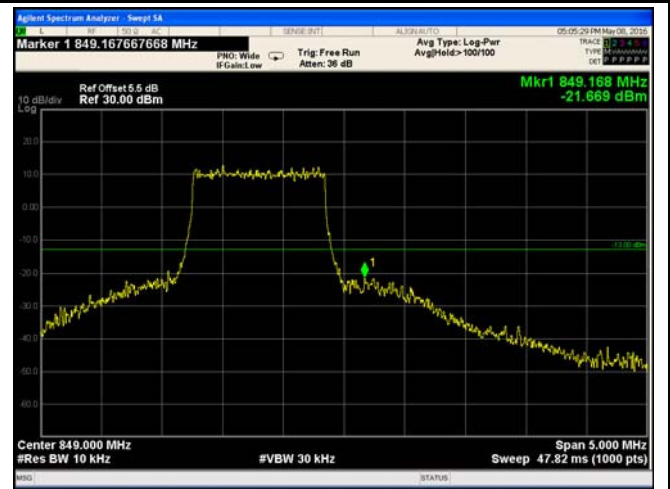

LTE Band 5 - High Channel 16QAM-1.4

Note: Offset=Cable loss (4.5) + 10log  
(12.61/10)=4.5+1.0=5.5 dB

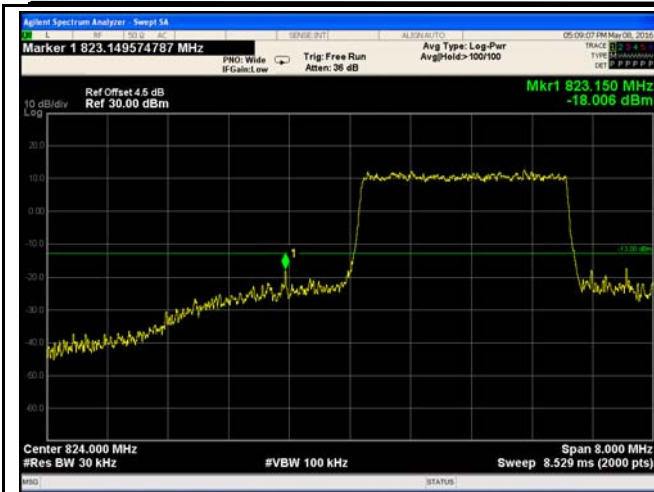

LTE Band 5 - Low Channel QPSK-3

Note: Offset=Cable loss (4.5) + 10log  
(30.11/30)=4.5+0.0=4.5dB

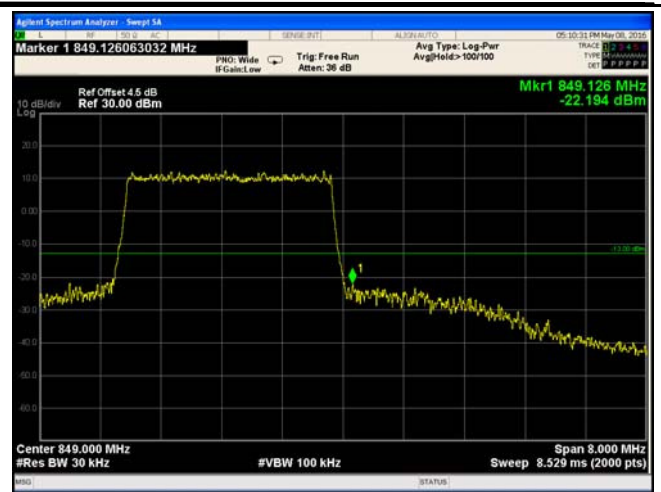

LTE Band 5 - High Channel QPSK-3

Note: Offset=Cable loss (4.5) + 10log  
(30.26/30)=4.5+0.0=4.5 dB

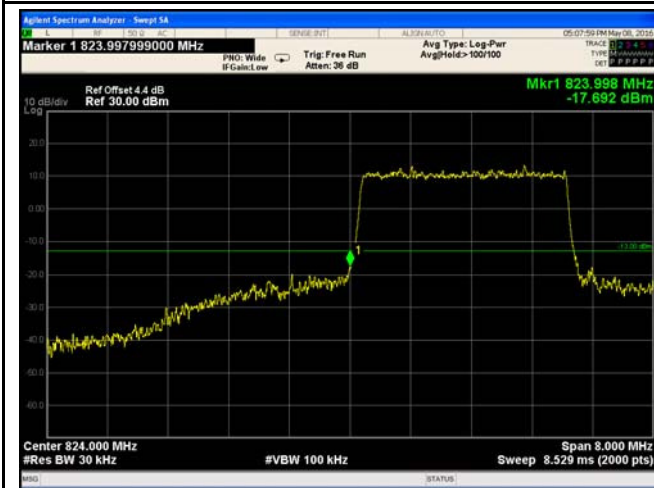

LTE Band 5 - Low Channel 16QAM-3

Note: Offset=Cable loss (4.5) + 10log  
(29.3/30)=4.5+(-0.1)=4.4 dB

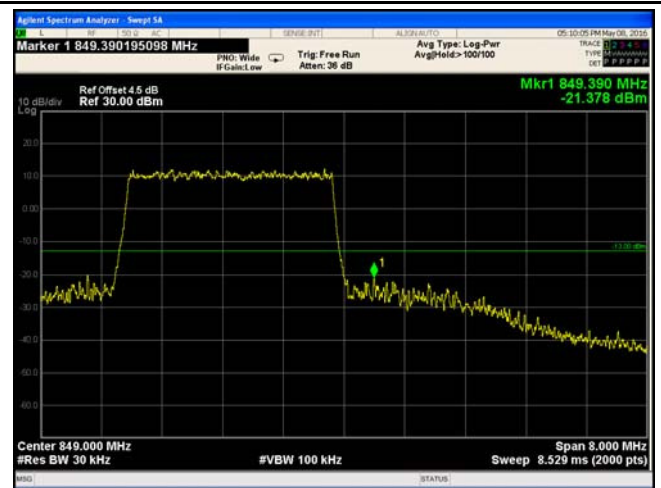

LTE Band 5 - High Channel 16QAM-3

Note: Offset=Cable loss (4.5) + 10log  
(30.25/30)=4.5+0.0=4.5 dB



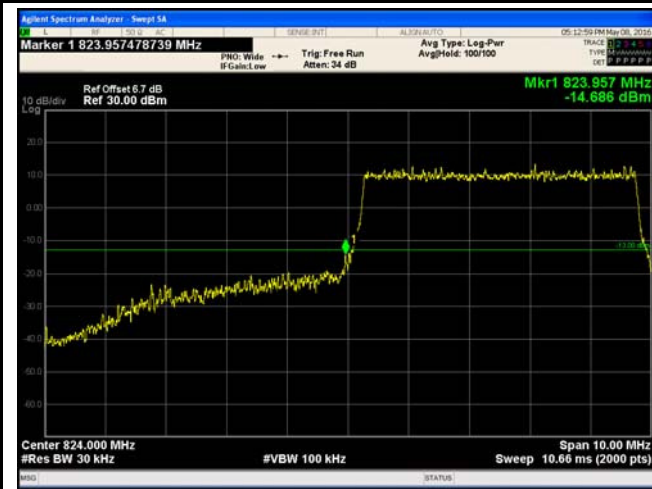

LTE Band 5 - Low Channel QPSK-5

Note: Offset=Cable loss (4.5) + 10log  
(50.06/30)=4.5+2.2=6.7 dB

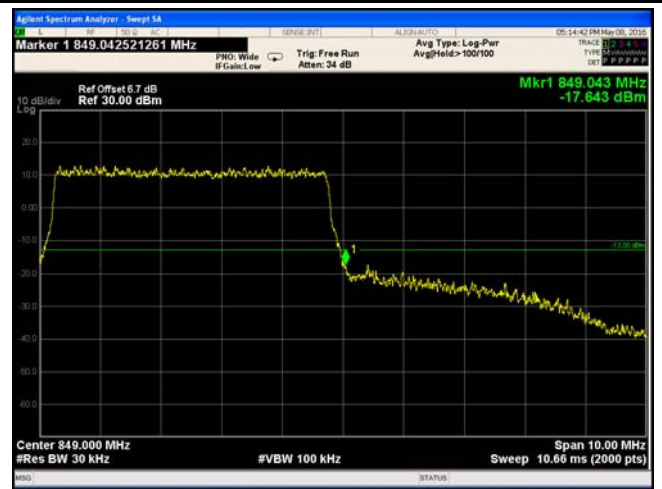

LTE Band 5 - High Channel QPSK-5

Note: Offset=Cable loss (4.5) + 10log  
(50.30/30)=4.5+2.2=6.7 dB

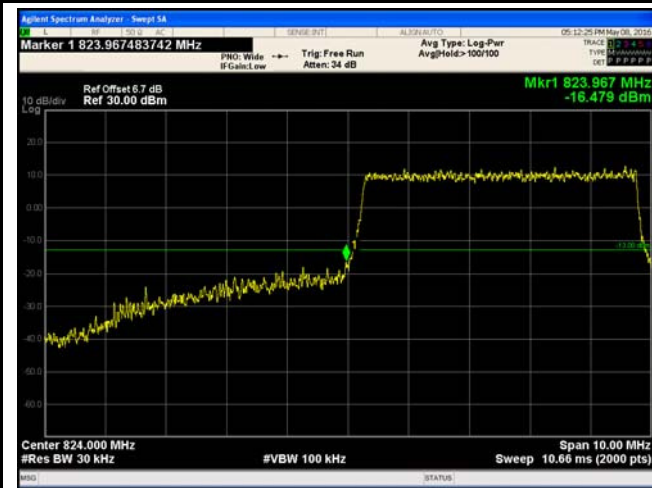

LTE Band 5 - Low Channel 16QAM-5

Note: Offset=Cable loss (4.5) + 10log  
(49.88/30)=4.5+2.2=6.7 dB

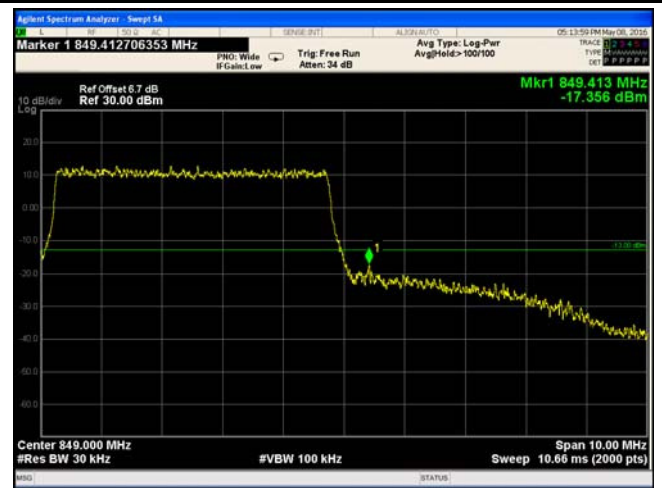

LTE Band 5 - High Channel 16QAM-5

Note: Offset=Cable loss (4.5) + 10log  
(50.23/30)=4.5+2.2=6.7 dB

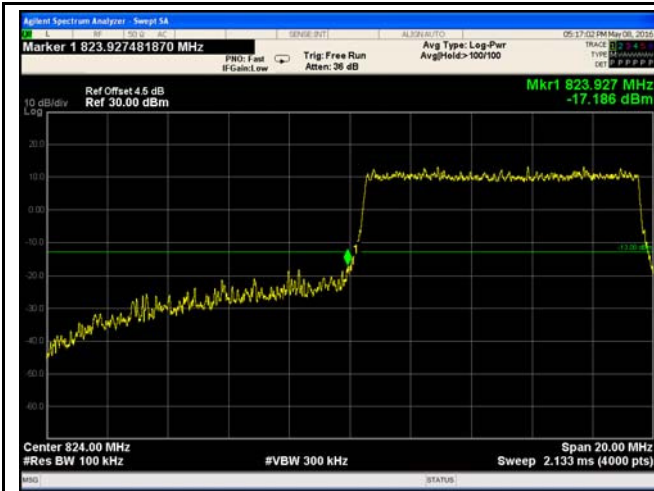

LTE Band 5 - Low Channel QPSK-10

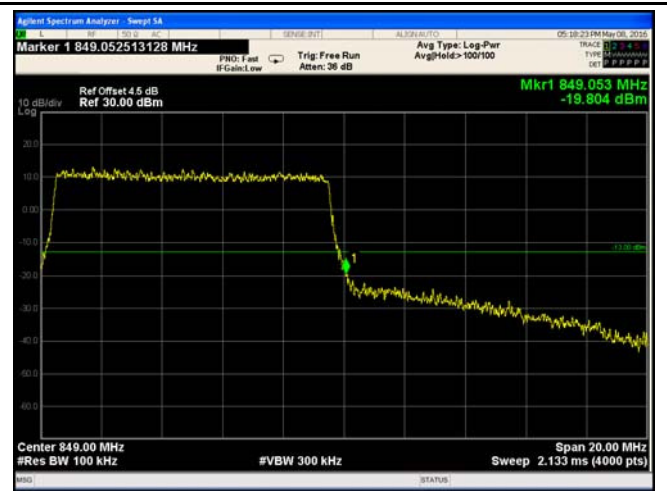

LTE Band 5 - High Channel QPSK-10

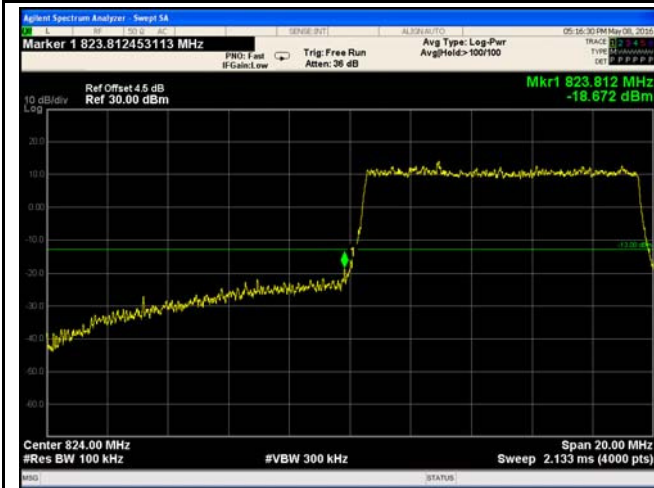

LTE Band 5 - Low Channel 16QAM-10

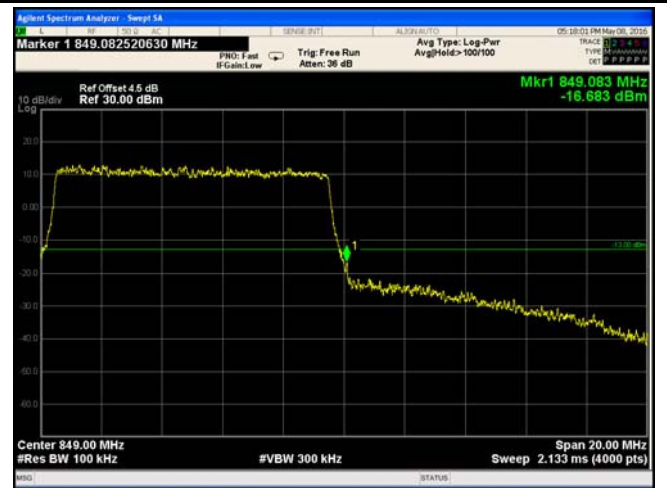

LTE Band 5 - High Channel 16QAM-10

### LTE Band 17 (Part 27)



LTE Band 17 - Low Channel QPSK-5

Note: Offset=Cable loss (4.0) + 10log  
(50.12/30)=4.5+2.2=6.7 dB

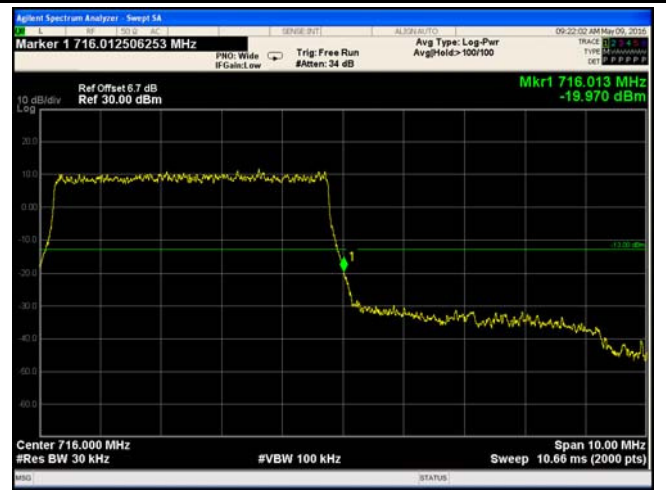

LTE Band 17 - High Channel QPSK-5

Note: Offset=Cable loss (4.0) + 10log  
(50.35/30)=4.5+2.2=6.7 dB

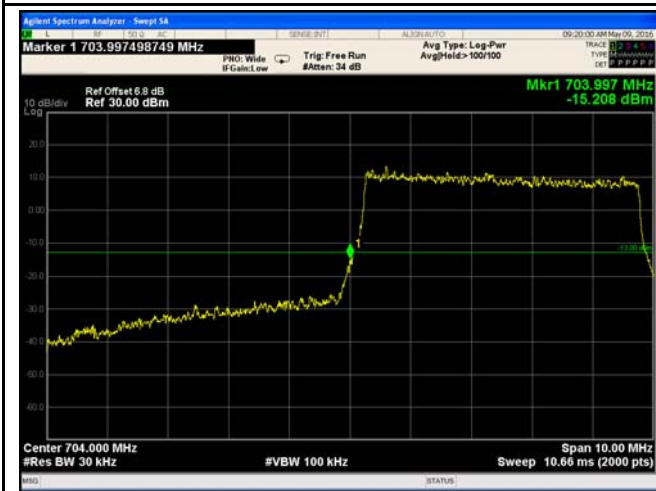

LTE Band 17 - Low Channel 16QAM-5

Note: Offset=Cable loss (4.0) + 10log  
(50.46/30)=4.5+2.3=6.8 dB

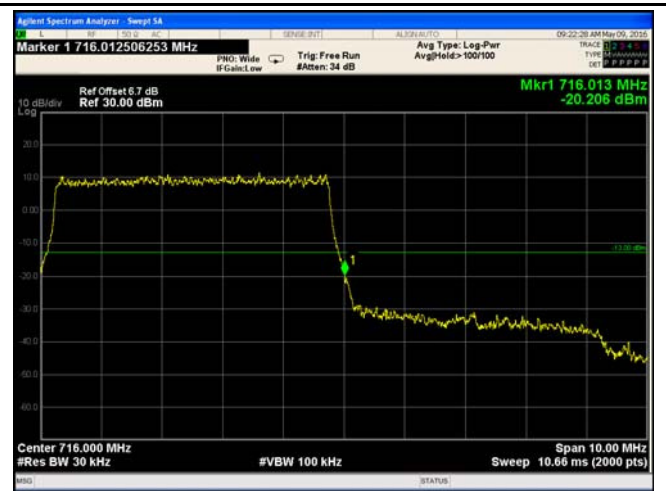

LTE Band 17 - High Channel 16QAM-5

Note: Offset=Cable loss (4.0) + 10log  
(49.98/30)=4.5+2.2=6.7 dB

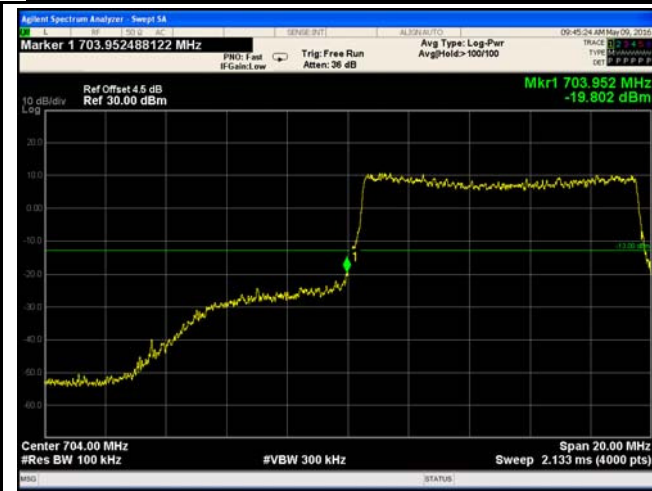

LTE Band 17 - Low Channel QPSK-10



LTE Band 17 - High Channel QPSK-10

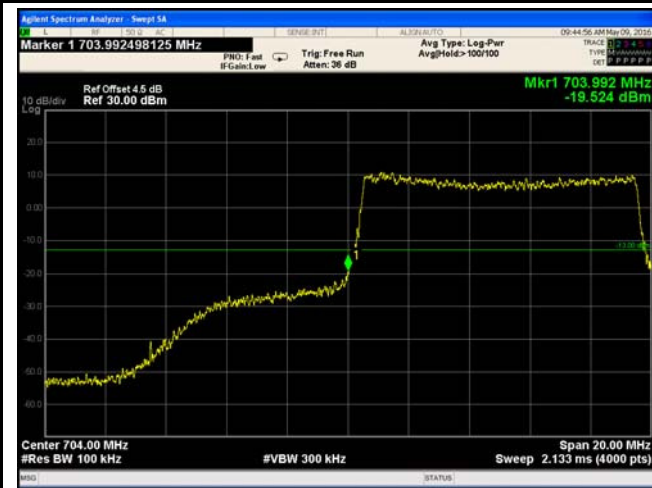

LTE Band 17 - Low Channel 16QAM-10

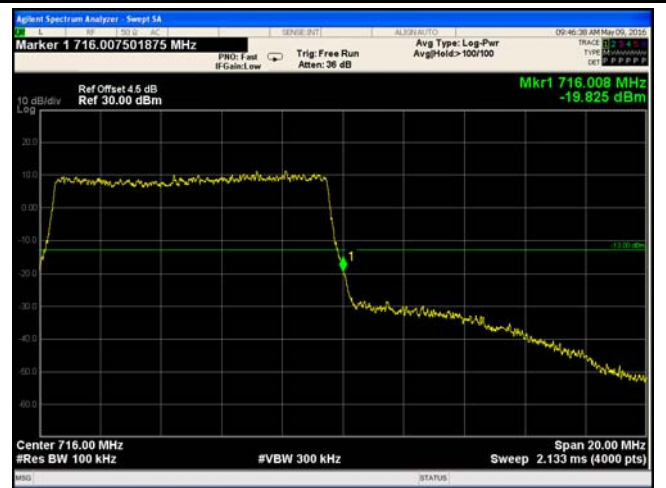

LTE Band 17 - High Channel 16QAM-10

## 6.8 Band Edge 27.53(m)

Temperature	25°C
Relative Humidity	50%
Atmospheric Pressure	1008mbar
Test date :	May 08, 2016
Tested By :	Winnie Zhang

### Requirement(s):

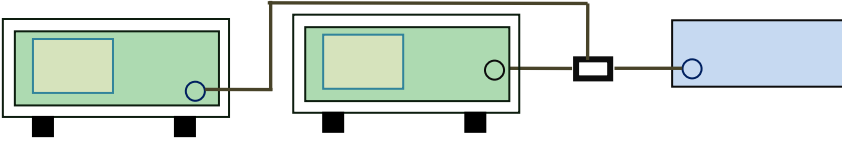
Spec	Requirement	Applicable
§27.53(m)	According to FCC 27.53(m)(4) specified that power of any emission outside of the channel edge must be attenuated below the transmitting power(P) by a factor shall be not less than $43+10\log(P)$ dB at the channel edge, the limit of emission equal to -13dBm. And $55+10\log(P)$ dB at 5.5MHz from the channel edges, the limit of emission equal to -25dBm. In the 1MHz bands immediately outside and adjacent to the frequency block a resolution bandwidth of at least one percent of the emission bandwidth of the fundamental emission of the transmitter may be employed.	<input checked="" type="checkbox"/>
Test Setup		
Test Procedure	<ul style="list-style-type: none"> <li>- The EUT was connected to Spectrum Analyzer and Base Station via power divider.</li> <li>- The 99% and 26 dB occupied bandwidth (BW) of the middle channel for the highest RF powers.</li> </ul>	
Remark		
Result	<input checked="" type="checkbox"/> Pass <input type="checkbox"/> Fail	

Test Data  Yes  N/A  
 Test Plot  Yes (See below)  N/A

### LTE Band 7 (Part 27) result

BW(MHz)	Channel	Frequency (MHz)	Mode	Emission (dBm)	Limit (dBm)
5	20775	2502.5	QPSK	-20.688	-13
			16QAM	-22.386	-13
5	21425	2567.5	QPSK	-18.378	-13
			16QAM	-17.737	-13
10	20800	2505	QPSK	-24.267	-13
			16QAM	-24.360	-13
10	21400	2562.5	QPSK	-22.285	-13
			16QAM	-22.817	-13
15	20825	2507.5	QPSK	-26.051	-13
			16QAM	-26.681	-13
15	21400	2562.5	QPSK	-25.306	-13
			16QAM	-25.201	-13
20	20850	2510	QPSK	-28.284	-13
			16QAM	-27.859	-13
20	21350	2560	QPSK	-26.982	-13
			16QAM	-26.913	-13

**LTE Band 7 (Part 27)**



LTE Band 7 - Low Channel QPSK-5

Note: Offset=Cable loss (4.5) + 10log  
(50.77/30)=4.5+2.3=6.8 dB

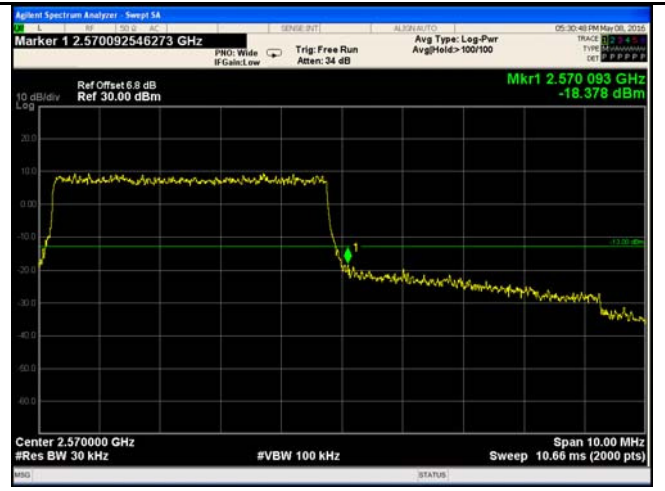

LTE Band 7 - High Channel QPSK-5

Note: Offset=Cable loss (4.5) + 10log  
(51.14/30)=4.5+2.3=6.8 dB

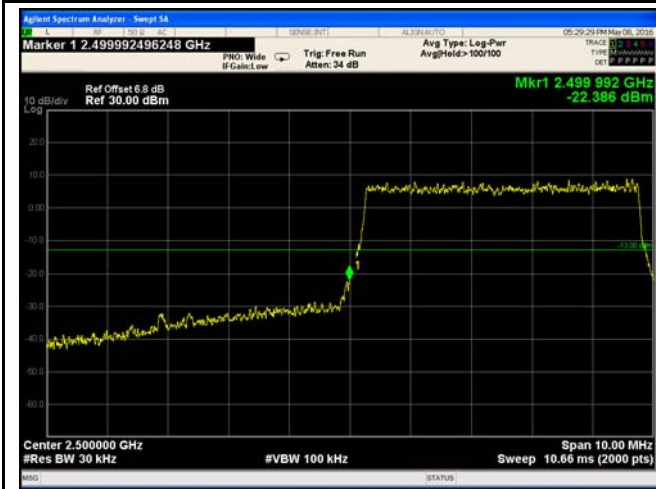

LTE Band 7 - Low Channel 16QAM-5

Note: Offset=Cable loss (4.5) + 10log  
(50.68/30)=4.5+2.3=6.8 dB

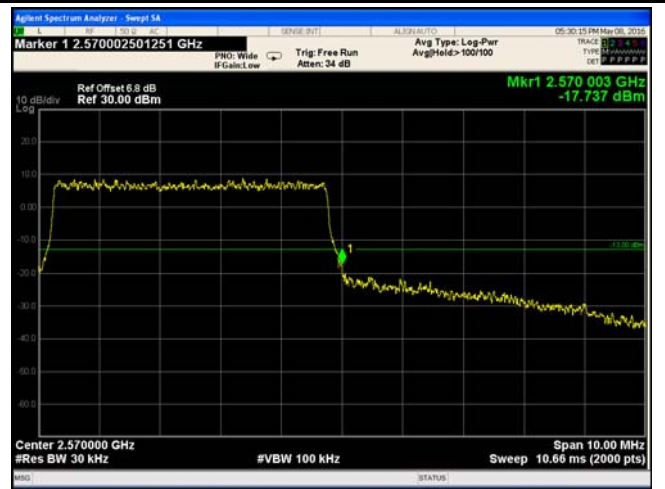

LTE Band 7 - High Channel 16QAM-5

Note: Offset=Cable loss (4.5) + 10log  
(50.56/30)=4.5+2.3=6.8 dB

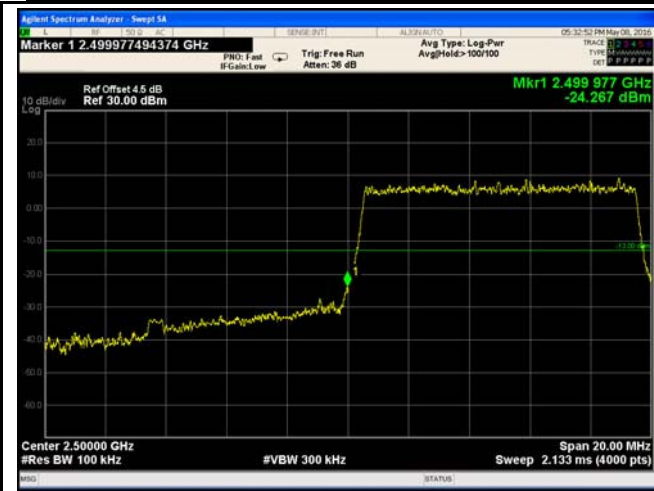

LTE Band 7 - Low Channel QPSK-10



LTE Band 7 - High Channel QPSK-10

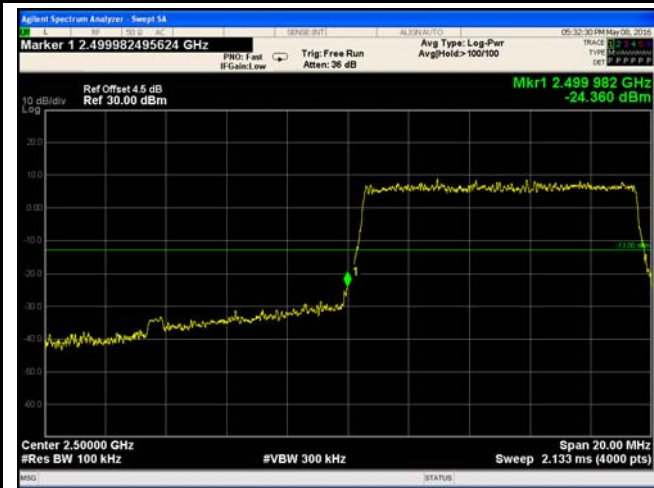

LTE Band 7 - Low Channel 16QAM-10

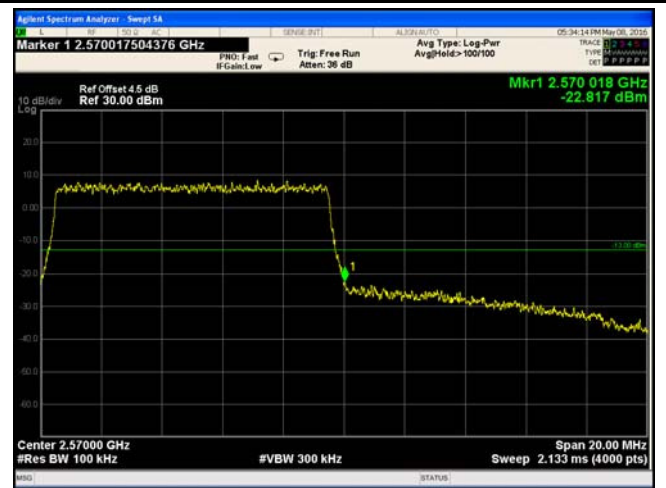

LTE Band 7 - High Channel 16QAM-10



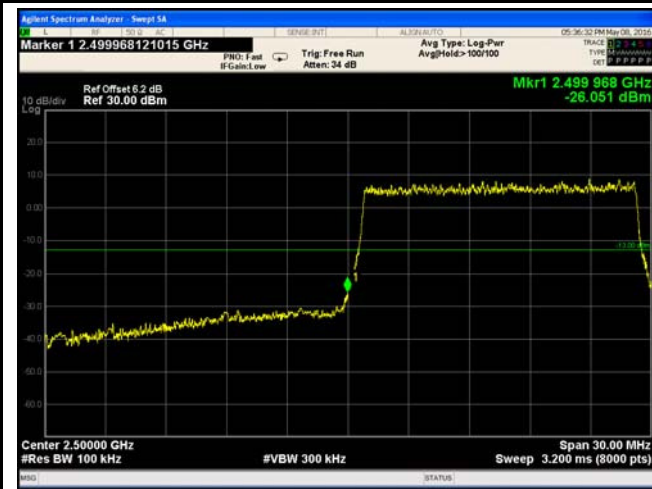

LTE Band 7 - Low Channel QPSK-15

Note: Offset=Cable loss (4.5) + 10log  
(147.6/100)=4.5+1.7=6.2 dB

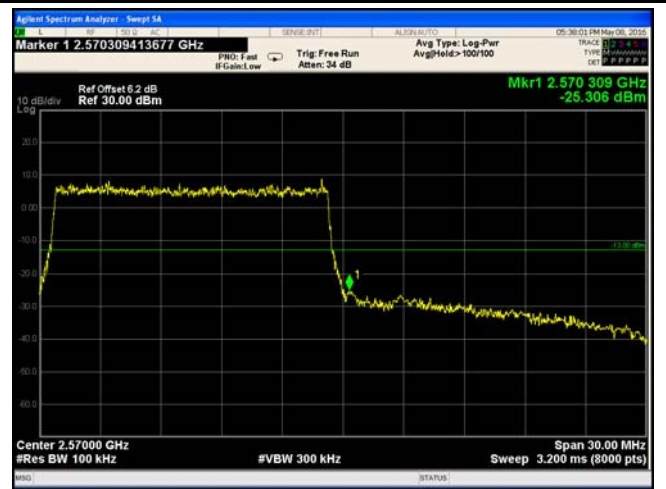

LTE Band 7 - High Channel QPSK-15

Note: Offset=Cable loss (4.5) + 10log  
(147.1/100)=4.5+1.7=6.2 dB

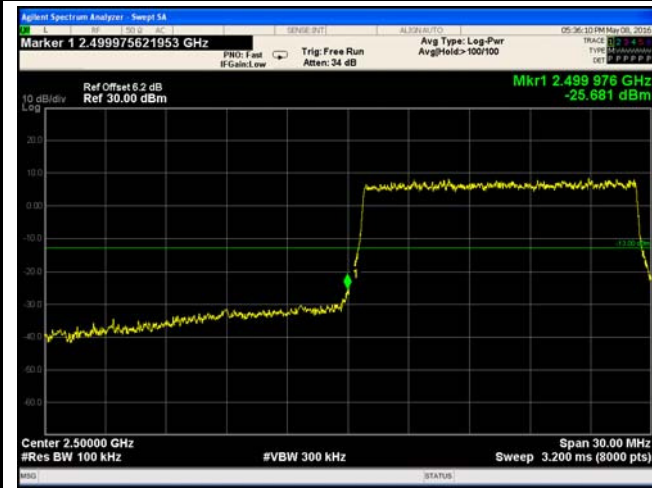

LTE Band 7 - Low Channel 16QAM-15

Note: Offset=Cable loss (4.5) + 10log  
(147/100)=4.5+1.7=6.2dB

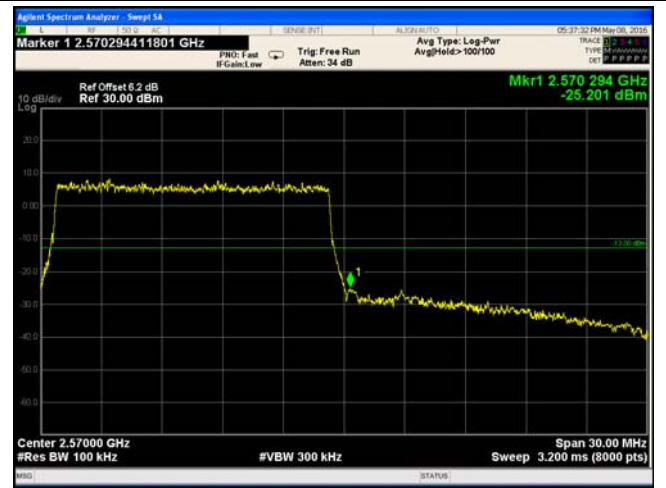

LTE Band 7 - High Channel 16QAM-15

Note: Offset=Cable loss (4.5) + 10log  
(147.6/100)=4.5+1.7=6.2 dB



LTE Band 7 - Low Channel QPSK-20

Note: Offset=Cable loss (4.5) + 10log  
(194.2/100)=4.5+2.9=7.4 dB

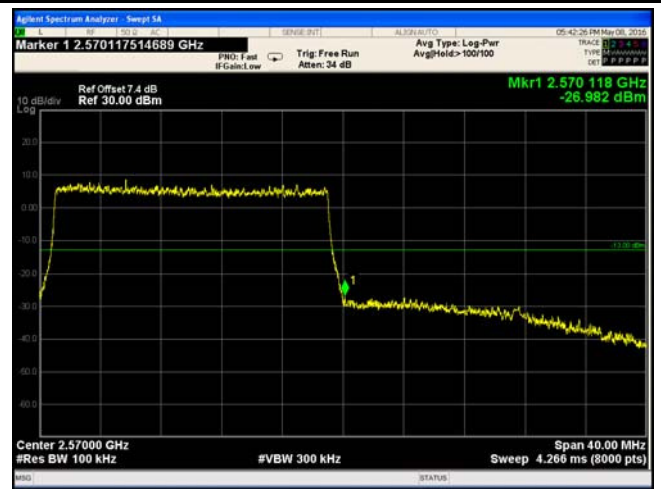

LTE Band 7 - High Channel QPSK-20

Note: Offset=Cable loss (4.5) + 10log  
(194.9/100)=4.5+2.9=7.4dB



LTE Band 7 - Low Channel 16QAM-20

Note: Offset=Cable loss (4.5) + 10log  
(195.2/100)=4.5+2.9=7.4 dB

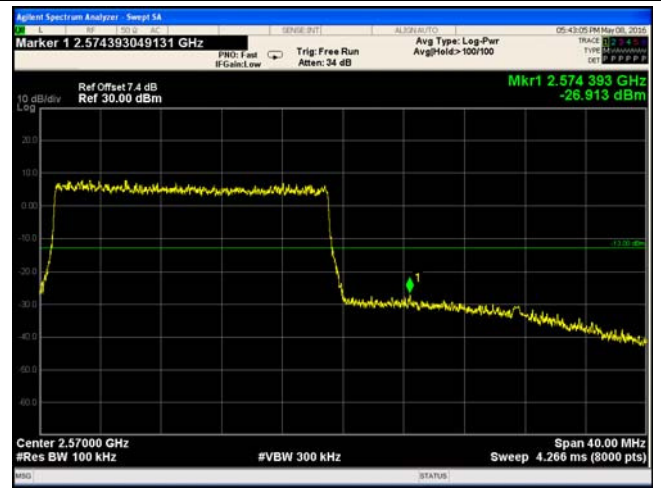

LTE Band 7 - High Channel 16QAM-20

Note: Offset=Cable loss (4.5) + 10log  
(193.7/100)=4.5+2.9=7.4 dB

## 6.9 Frequency Stability

Temperature	24°C
Relative Humidity	59%
Atmospheric Pressure	1007mbar
Test date :	May 07, 2016
Tested By :	Winnie Zhang

### Requirement(s):

Spec	Item	Requirement	Applicable																																
§2.1055, §22.355 & §24.235 § 27.5(h); § 27.54	a)	<p>According to §22.355, the carrier frequency of each transmitter in the Public Mobile Services must be maintained within the tolerances given in Table below:</p> <p>Frequency Tolerance for Transmitters in the Public Mobile Services</p> <table border="1"> <thead> <tr> <th>Frequency Range (MHz)</th> <th>Base, fixed (ppm)</th> <th>Mobile ≤ 3 watts (ppm)</th> <th>Mobile ≤ 3 watts (ppm)</th> </tr> </thead> <tbody> <tr> <td>25 to 50</td> <td>20.0</td> <td>20.0</td> <td>50.0</td> </tr> <tr> <td>to 450</td> <td>5.0</td> <td>5.0</td> <td>50.0</td> </tr> <tr> <td>450 to 512</td> <td>2.5</td> <td>5.0</td> <td>5 0</td> </tr> <tr> <td>821 to 896</td> <td>1.5</td> <td>2.5</td> <td>2.5</td> </tr> <tr> <td>928 to 929.</td> <td>5.0</td> <td>N/A</td> <td>N/A</td> </tr> <tr> <td>929 to 960.</td> <td>1.5</td> <td>N/A</td> <td>N/A</td> </tr> <tr> <td>2110 to 2220</td> <td>10.0</td> <td>N/A</td> <td>N/A</td> </tr> </tbody> </table> <p>According to §24.235, the frequency stability shall be sufficient to ensure that the fundamental emissions stay within the authorized frequency block.</p> <p>According to §27.54, The frequency stability shall be sufficient to ensure that the fundamental emissions stay within the authorized bands of operation.</p>	Frequency Range (MHz)	Base, fixed (ppm)	Mobile ≤ 3 watts (ppm)	Mobile ≤ 3 watts (ppm)	25 to 50	20.0	20.0	50.0	to 450	5.0	5.0	50.0	450 to 512	2.5	5.0	5 0	821 to 896	1.5	2.5	2.5	928 to 929.	5.0	N/A	N/A	929 to 960.	1.5	N/A	N/A	2110 to 2220	10.0	N/A	N/A	<input checked="" type="checkbox"/>
		Frequency Range (MHz)	Base, fixed (ppm)	Mobile ≤ 3 watts (ppm)	Mobile ≤ 3 watts (ppm)																														
		25 to 50	20.0	20.0	50.0																														
		to 450	5.0	5.0	50.0																														
		450 to 512	2.5	5.0	5 0																														
		821 to 896	1.5	2.5	2.5																														
		928 to 929.	5.0	N/A	N/A																														
		929 to 960.	1.5	N/A	N/A																														
		2110 to 2220	10.0	N/A	N/A																														

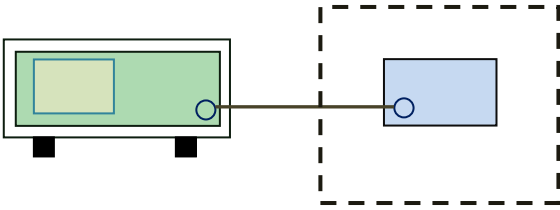
Test setup	
Procedure	<p>A communication link was established between EUT and base station. The frequency error was monitored and measured by base station under variation of ambient temperature and variation of primary supply voltage.</p> <p>Limit: The frequency stability of the transmitter shall be maintained within <math>\pm 0.00025\%</math> (<math>\pm 2.5\text{ppm}</math>) of the center frequency.</p>
Remark	<p>Frequency Stability versus Temperature: The Frequency tolerance of the carrier signal shall be maintained within 2.5ppm of the operating frequency over a temperature variation of <math>-10^{\circ}\text{C}</math> to <math>+55^{\circ}\text{C}</math> at normal supply voltage.</p>
Result	<input checked="" type="checkbox"/> Pass <input type="checkbox"/> Fail

Test Data     Yes                       N/A  
 Test Plot     Yes (See below)             N/A

### LTE Band 2 (Part 24E) result

Middle Channel, $f_0 = 1880$ MHz				
Temperature (°C)	Power Supplied (V <sub>DC</sub> )	Frequency Error (Hz)	Frequency Error (ppm)	Limit (ppm)
-10	3.7	-9	0.0048	2.5
0		-8	0.0043	2.5
10		-7	0.0037	2.5
20		-9	0.0048	2.5
30		-9	0.0048	2.5
40		-10	0.0053	2.5
50		-9	0.0048	2.5
55		-11	0.0059	2.5
25		4.2	-11	0.0059
	3.5	-8	0.0043	2.5

### LTE Band 4 (Part 27) result

Middle Channel, $f_0 = 1732.5$ MHz				
Temperature (°C)	Power Supplied (V <sub>DC</sub> )	Frequency Error (Hz)	Frequency Error (ppm)	Limit (ppm)
-10	3.7	-11	0.0063	2.5
0		-12	0.0069	2.5
10		-11	0.0063	2.5
20		-10	0.0058	2.5
30		-12	0.0069	2.5
40		-10	0.0058	2.5
50		-10	0.0058	2.5
55		-12	0.0069	2.5
25		4.2	-11	0.0063
	3.5	-13	0.0075	2.5

### LTE Band 5 (Part 22H) result

Middle Channel, $f_0 = 836.5$ MHz				
Temperature (°C)	Power Supplied (V <sub>DC</sub> )	Frequency Error (Hz)	Frequency Error (ppm)	Limit (ppm)
-10	3.7	7	0.0084	2.5
0		8	0.0096	2.5
10		8	0.0096	2.5
20		7	0.0084	2.5
30		10	0.0120	2.5
40		11	0.0132	2.5
50		9	0.0108	2.5
55		12	0.0143	2.5
25	4.2	9	0.0108	2.5
	3.5	12	0.0143	2.5

### LTE Band 7 (Part 27) result

Middle Channel, $f_0 = 2535$ MHz				
Temperature (°C)	Power Supplied (V <sub>DC</sub> )	Frequency Error (Hz)	Frequency Error (ppm)	Limit (ppm)
-10	3.7	-11	0.0043	2.5
0		-10	0.0039	2.5
10		-9	0.0036	2.5
20		-11	0.0043	2.5
30		-10	0.0039	2.5
40		-9	0.0036	2.5
50		-11	0.0043	2.5
55		-10	0.0039	2.5
25	4.2	-10	0.0039	2.5
	3.5	-12	0.0047	2.5

### LTE Band 17 (Part 27) result

Middle Channel, $f_0 = 710$ MHz				
Temperature (°C)	Power Supplied (V <sub>DC</sub> )	Frequency Error (Hz)	Frequency Error (ppm)	Limit (ppm)
-10	3.7	10	0.0141	2.5
0		10	0.0141	2.5
10		9	0.0127	2.5
20		6	0.0085	2.5
30		8	0.0113	2.5
40		5	0.0070	2.5
50		11	0.0155	2.5
55		8	0.0113	2.5
25		4.2	11	0.0155
	3.5	8	0.0113	2.5

## Annex A. TEST INSTRUMENT

Instrument	Model	Serial #	Cal Date	Cal Due	In use
<b>RF Conducted Test</b>					
Agilent ESA-E SERIES SPECTRUM ANALYZER	E4407B	MY45108319	09/16/2015	09/15/2016	<input checked="" type="checkbox"/>
Power Splitter	1#	1#	09/01/2015	08/31/2016	<input checked="" type="checkbox"/>
Universal Radio Communication Tester	CMU200	121393	09/25/2015	09/24/2016	<input checked="" type="checkbox"/>
Wideband Radio Communication Tester	CMW500	120906	03/28/2015	03/27/2016	<input checked="" type="checkbox"/>
Temperature/Humidity Chamber	UHL-270	001	10/09/2015	10/08/2016	<input checked="" type="checkbox"/>
DC Power Supply	E3640A	MY40004013	09/17/2015	09/16/2016	<input checked="" type="checkbox"/>
RF Power Sensor	Dare RPR3006C/P/W	AY554013	09/17/2015	09/16/2016	<input checked="" type="checkbox"/>
<b>Radiated Emissions</b>					
EMI test receiver	ESL6	100262	09/17/2015	09/16/2016	<input checked="" type="checkbox"/>
OPT 010 AMPLIFIER (0.1-1300MHz)	8447E	2727A02430	09/01/2015	08/31/2016	<input checked="" type="checkbox"/>
Microwave Preamplifier (0.5 ~ 18GHz)	PAM-118	443008	09/01/2015	08/31/2016	<input checked="" type="checkbox"/>
Bilog Antenna (30MHz~6GHz)	JB6	A110712	09/21/2015	09/20/2016	<input checked="" type="checkbox"/>
Bilog Antenna (30MHz~2GHz)	JB1	A112017	09/21/2015	09/20/2016	<input checked="" type="checkbox"/>
Double Ridge Horn Antenna (1 ~18GHz)	AH-118	71259	09/24/2015	09/23/2016	<input checked="" type="checkbox"/>
Double Ridge Horn Antenna (1 ~18GHz)	AH-118	71283	09/24/2015	09/23/2016	<input checked="" type="checkbox"/>
SYNTHESIZED SIGNAL GENERATOR	8665B	3744A01293	09/17/2015	09/16/2016	<input checked="" type="checkbox"/>
Tunable Notch Filter	3NF-800/1000-S	AA4	09/01/2015	08/31/2016	<input checked="" type="checkbox"/>



Test Report	16070460-FCC-R5
Page	124 of 134

Tunable Notch Filter	3NF- 1000/2000-S	AM 4	09/01/2015	08/31/2016	<input checked="" type="checkbox"/>
----------------------	---------------------	------	------------	------------	-------------------------------------

**Annex B. EUT And Test Setup Photographs**

**Annex B.i. Photograph: EUT External Photo**

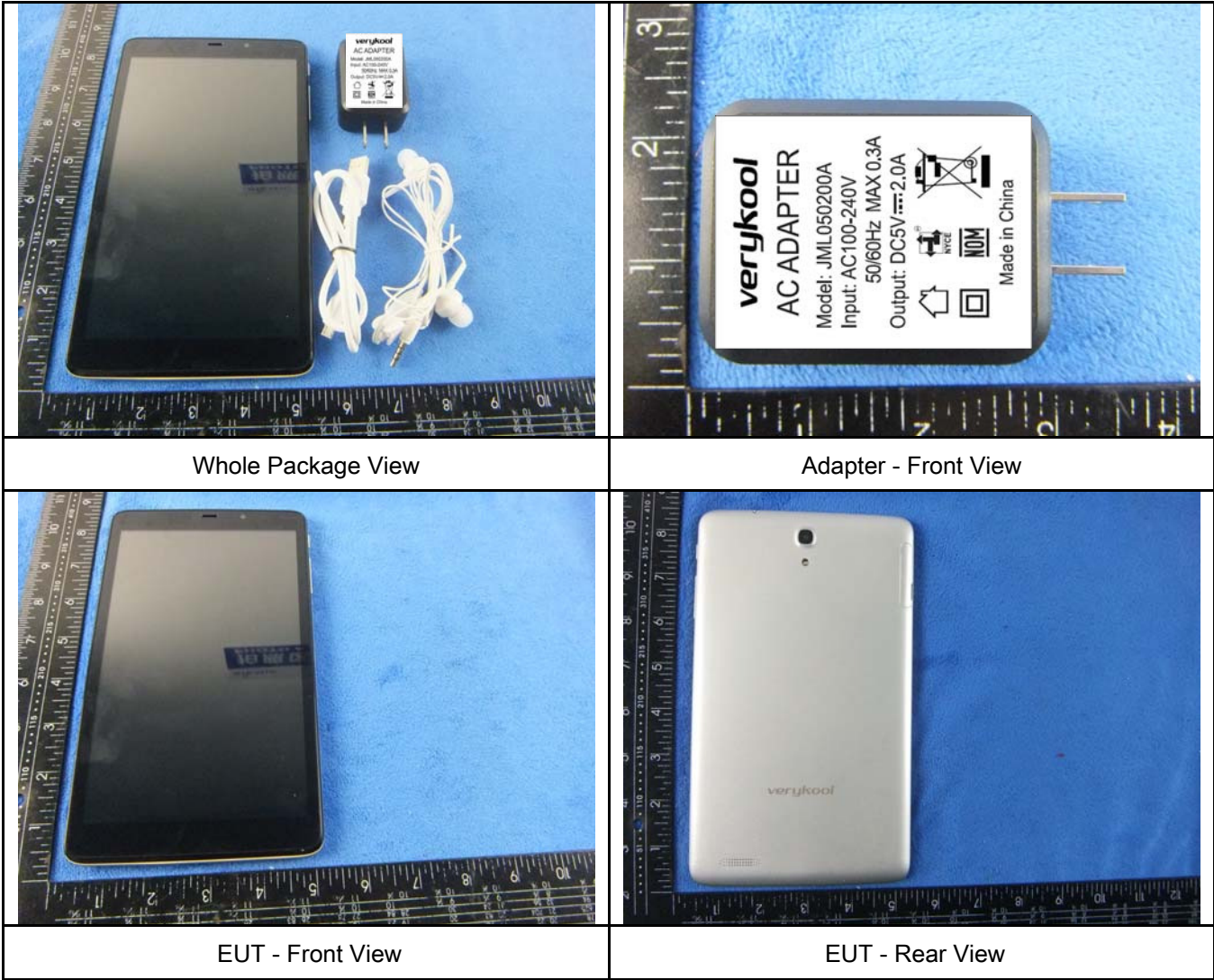



EUT - Top View



EUT - Bottom View



EUT - Left View



EUT - Right View

**Annex B.ii. Photograph: EUT Internal Photo**



Cover Off - Top View 1

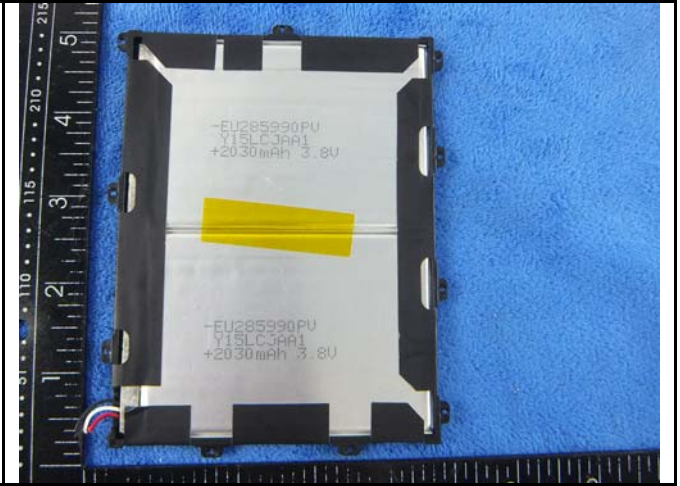

Battery - Front View

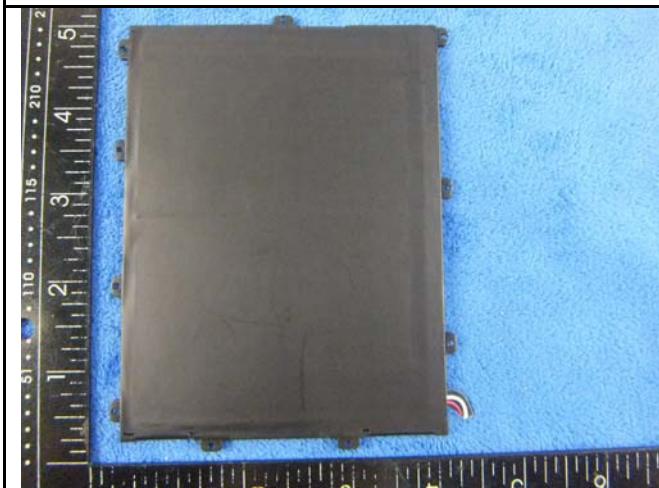

Battery - Rear View

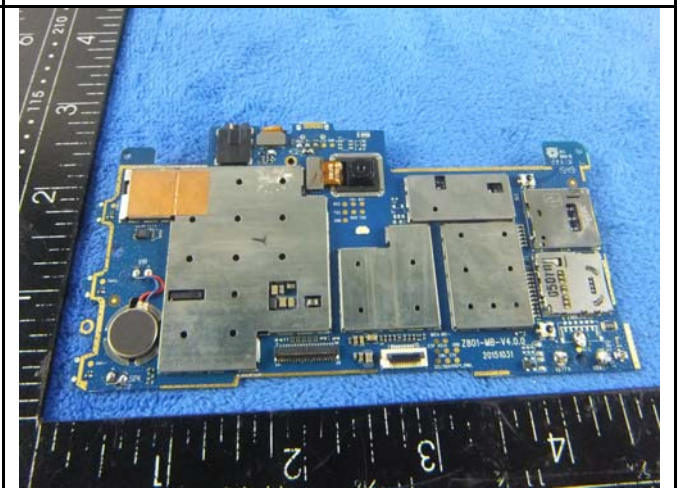

Mainboard with Shielding - Front View



Mainboard without Shielding - Front View

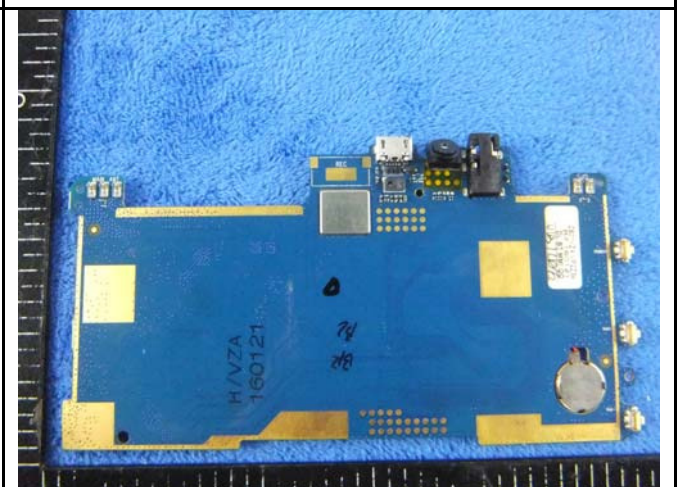

Mainboard - Rear View

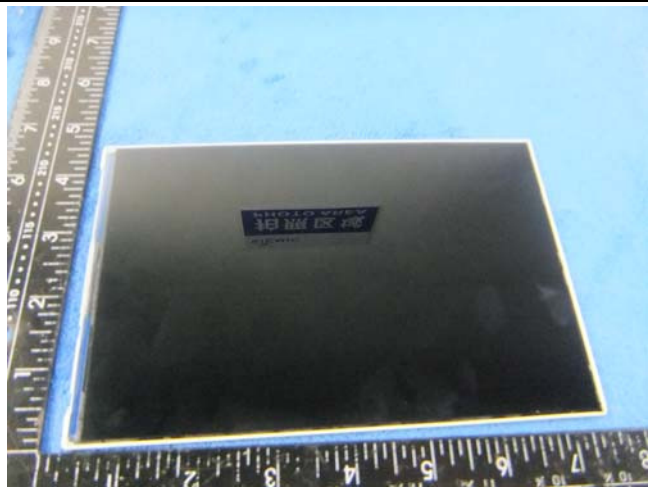

LCD – Front View

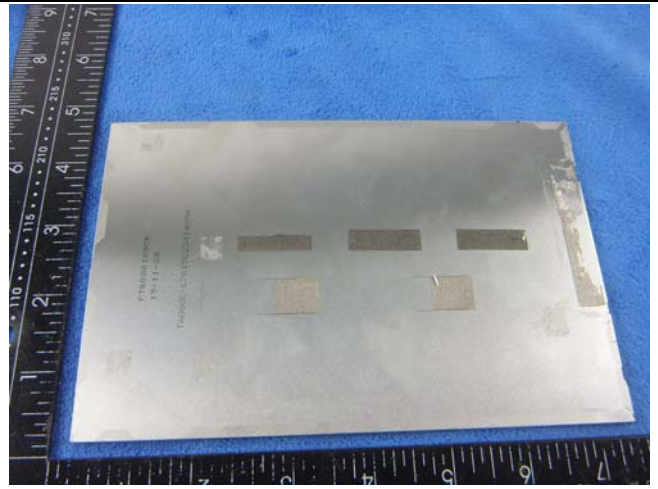

LCD – Rear View

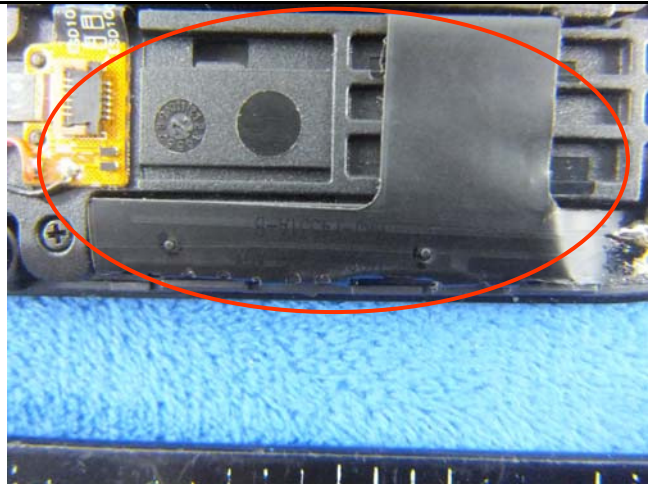

GSM/PCS/UMTS-FDD Antenna View



LTE - Antenna View



WIFI/BT/BLE/GPS - Antenna View

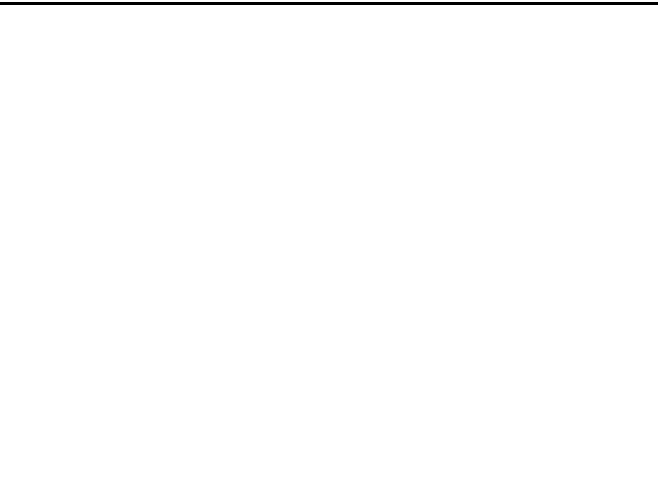

**Annex B.iii. Photograph: Test Setup Photo**

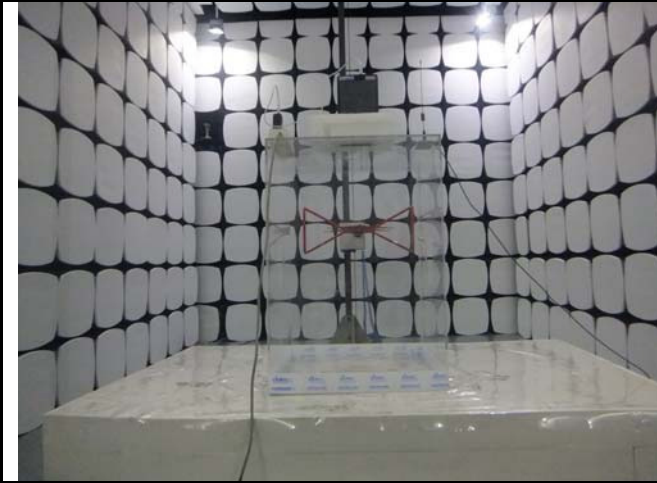

Radiated Spurious Emissions Test Setup Below 1GHz

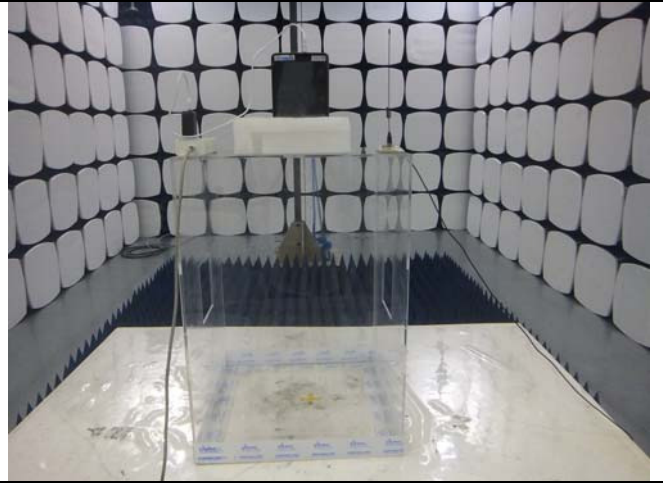

Radiated Spurious Emissions Test Setup Above  
1GHz

## Annex C. TEST SETUP AND SUPPORTING EQUIPMENT

### Annex C.ii. TEST SET UP BLOCK

#### Block Configuration Diagram for Radiated Emissions

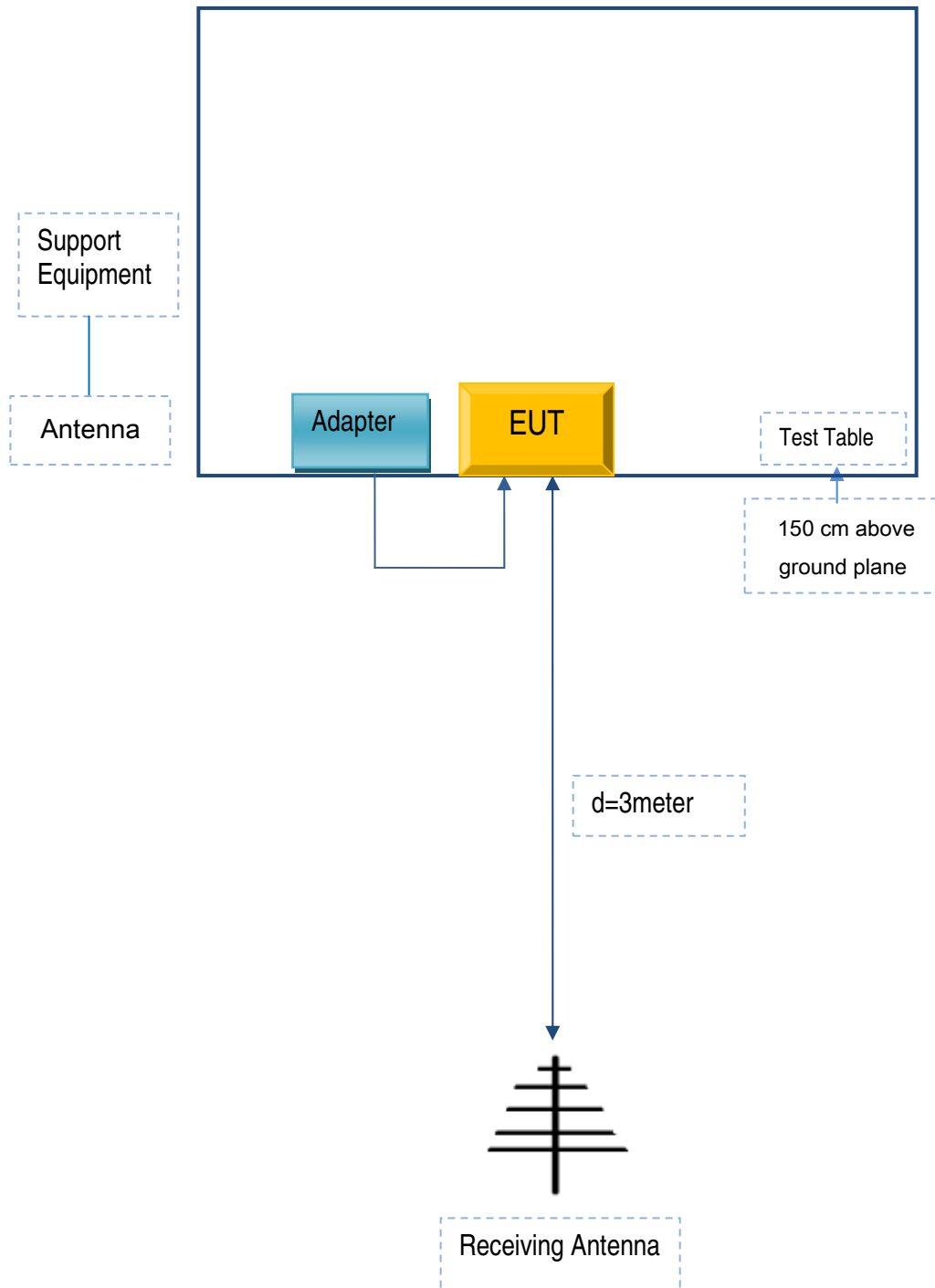

## **Annex C. ii. SUPPORTING EQUIPMENT DESCRIPTION**

The following is a description of supporting equipment and details of cables used with the EUT.

### **Supporting Equipment:**

<b>Manufacturer</b>	<b>Equipment Description</b>	<b>Model</b>	<b>Serial No</b>
Verykool USA Inc	Adapter	JML050200A	Y11243578

### **Supporting Cable:**

<b>Cable type</b>	<b>Shield Type</b>	<b>Ferrite Core</b>	<b>Length</b>	<b>Serial No</b>
USB Cable	Un-shielding	No	0.8m	Y1124222



Test Report	16070460-FCC-R5
Page	132 of 134

## Annex C.ii. EUT OPERATING CONKITIONS

N/A

Test Report	16070460-FCC-R5
Page	133 of 134

**Annex D. User Manual / Block Diagram / Schematics / Partlist**

N/A

Test Report	16070460-FCC-R5
Page	134 of 134

## Annex E. DECLARATION OF SIMILARITY

N/A