

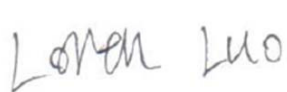

# RF TEST REPORT



Report No.: 16070911-FCC-R5

Supersede Report No.: N/A

Applicant	Verykool USA Inc.	
Product Name	Mobile phone	
Model No.	SL5200	
Serial No.	N/A	
Test Standard	FCC Part 22(H):2015, FCC Part 24(E):2015, FCC Part 27: 2015; ANSI/TIA-603-D: 2010	
Test Date	August 1 to August 29, 2016	
Issue Date	August 31, 2016	
Test Result	<input checked="" type="checkbox"/> Pass <input type="checkbox"/> Fail	
Equipment complied with the specification	<input checked="" type="checkbox"/>	
Equipment did not comply with the specification	<input type="checkbox"/>	
		
Loren Luo Test Engineer	David Huang Checked By	
This test report may be reproduced in full only Test result presented in this test report is applicable to the tested sample only		

Issued by:

**SIEMIC (SHENZHEN-CHINA) LABORATORIES**

Zone A, Floor 1, Building 2 Wan Ye Long Technology Park

South Side of Zhoushi Road, Bao' an District, Shenzhen, Guangdong China 518108

Phone: +86 0755 2601 4629801 Email: [China@siemic.com.cn](mailto:China@siemic.com.cn)

## Laboratories Introduction

SIEMIC, headquartered in the heart of Silicon Valley, with superior facilities in US and Asia, is one of the leading independent testing and certification facilities providing customers with one-stop shop services for Compliance Testing and Global Certifications.



In addition to testing and certification, SIEMIC provides initial design reviews and compliance management throughout a project. Our extensive experience with China, Asia Pacific, North America, European, and International compliance requirements, assures the fastest, most cost effective way to attain regulatory compliance for the global markets.

### Accreditations for Conformity Assessment

Country/Region	Scope
USA	EMC, RF/Wireless, SAR, Telecom
Canada	EMC, RF/Wireless, SAR, Telecom
Taiwan	EMC, RF, Telecom, SAR, Safety
Hong Kong	RF/Wireless, SAR, Telecom
Australia	EMC, RF, Telecom, SAR, Safety
Korea	EMI, EMS, RF, SAR, Telecom, Safety
Japan	EMI, RF/Wireless, SAR, Telecom
Singapore	EMC, RF, SAR, Telecom
Europe	EMC, RF, SAR, Telecom, Safety

Test Report	16070911-FCC-R5
Page	3 of 152

---

This page has been left blank intentionally.

# CONTENTS

1. REPORT REVISION HISTORY .....	5
2. CUSTOMER INFORMATION .....	5
3. TEST SITE INFORMATION.....	5
4. EQUIPMENT UNDER TEST (EUT) INFORMATION.....	6
5. TEST SUMMARY .....	9
6. MEASUREMENTS, EXAMINATION AND DERIVED RESULTS .....	10
6.1 RF EXPOSURE (SAR).....	10
6.2 RF OUTPUT POWER.....	11
6.3 PEAK-AVERAGE RATIO.....	51
6.4 OCCUPIED BANDWIDTH.....	56
6.5 SPURIOUS EMISSIONS AT ANTENNA TERMINALS .....	91
6.6 SPURIOUS RADIATED EMISSIONS.....	98
6.7 BAND EDGE.....	106
6.8 BAND EDGE 27.53(M).....	129
6.9 FREQUENCY STABILITY .....	135
ANNEX A. TEST INSTRUMENT.....	140
ANNEX B. EUT AND TEST SETUP PHOTOGRAPHS.....	142
ANNEX C. TEST SETUP AND SUPPORTING EQUIPMENT.....	148
ANNEX C.II. EUT OPERATING CONKITIONS.....	150
ANNEX D. USER MANUAL / BLOCK DIAGRAM / SCHEMATICS / PARTLIST .....	151
ANNEX E. DECLARATION OF SIMILARITY.....	152

## 1. Report Revision History

Report No.	Report Version	Description	Issue Date
16070911-FCC-R5	NONE	Original	August 31, 2016

## 2. Customer information

Applicant Name	Verykool USA Inc.
Applicant Add	3636 Nobel Drive, Suite 325, San Diego, California 92122 United States
Manufacturer	Kozen Mobile Co.,Ltd
Manufacturer Add	Floor 3rd,Building 29,No.368 Zhangjiang Road,Pudong District,Shanghai,China 201203

## 3. Test site information

Lab performing tests	SIEMIC (Shenzhen-China) LABORATORIES
Lab Address	Zone A, Floor 1, Building 2 Wan Ye Long Technology Park South Side of Zhoushi Road, Bao' an District, Shenzhen, Guangdong China 518108
FCC Test Site No.	718246
IC Test Site No.	4842E-1
Test Software	Radiated Emission Program-To Shenzhen v2.0

## 4. Equipment under Test (EUT) Information

Description of EUT:	Mobile phone
Main Model:	SL5200
Serial Model:	N/A
Date EUT received:	July 26, 2016
Test Date(s):	August 1 to August 29, 2016
Equipment Category :	PCE
Antenna Gain:	GSM850: -3.20 dBi PCS1900: -2.21 dBi UMTS-FDD Band V: -3.62 dBi UMTS-FDD Band IV: -2.42 dBi UMTS-FDD Band II: -2.42 dBi LTE Band 2: -2.5 dBi LTE Band 4: -3.0 dBi LTE Band 5: -3.20 dBi LTE Band 7: -3.0 dBi LTE Band 12: -4.2 dBi LTE Band 17: -4.2 dBi Bluetooth/BLE/WIFI: 0 dBi GPS: 0 dBi
Antenna Type:	PIFA antenna
Type of Modulation:	GSM / GPRS: GMSK EGPRS: GMSK,8PSK UMTS-FDD: QPSK LTE Band: QPSK, 16QAM 802.11b/g/n: DSSS, OFDM Bluetooth: GFSK, $\pi$ /4DQPSK, 8DPSK BLE: GFSK GPS:BPSK







## 5. Test Summary

The product was tested in accordance with the following specifications.

All testing has been performed according to below product classification:

FCC Rules	Description of Test	Result
§ 1.1307; § 2.1093	RF Exposure (SAR)	Compliance
§2.1046; § 22.913(a); § 24.232(c); § 27.50(c.10); § 27.50(d.4)	RF Output Power	Compliance
§ 24.232 (d); § 27.50(d)	Peak-Average Ratio	Compliance
§ 2.1049; § 22.905; § 22.917; § 24.238; § 27.53(a.5)	99% & -26 dB Occupied Bandwidth	Compliance
§ 2.1051; § 22.917(a); § 24.238(a); § 27.53(h)	Spurious Emissions at Antenna Terminal	Compliance
§ 2.1053; § 22.917(a); § 24.238(a); § 27.53(h)	Field Strength of Spurious Radiation	Compliance
§ 22.917(a); § 24.238(a);	Out of band emission, Band Edge	Compliance
§ 27.53(m)	Band Edge 27.53(m)	Compliance
§ 2.1055; § 22.355; § 24.235; § 27.5(h); § 27.54	Frequency stability vs. temperature Frequency stability vs. voltage	Compliance

Note: Testing was performed by configuring EUT to maximum output power status, the declared output power class for different

### Measurement Uncertainty

Emissions		
Test Item	Description	Uncertainty
Band Edge and Radiated Spurious Emissions	Confidence level of approximately 95% (in the case where distributions are normal), with a coverage factor of 2 (for EUTs < 0.5m X 0.5m X 0.5m)	+5.6dB/-4.5dB
-	-	-

Test Report	16070911-FCC-R5
Page	10 of 152

## 6. MEASUREMENTS, EXAMINATION AND DERIVED RESULTS

### 6.1 RF Exposure (SAR)

Test Result: Pass

The EUT is a portable device, thus requires SAR evaluation;

Please refer to RF Exposure Evaluation Report: 16070911-FCC-H.

## 6.2 RF Output Power

Temperature	23°C
Relative Humidity	59%
Atmospheric Pressure	1026mbar
Test date :	August 26, 2016
Tested By :	Loren Luo

### Requirement(s):

Spec	Item	Requirement	Applicable
§22.913 (a)	a)	ERP:38.45dBm	<input checked="" type="checkbox"/>
§24.232 (c)	b)	EIRP:33dBm	<input checked="" type="checkbox"/>
§27.50 (c)	c)	EIRP: 30dBm	<input checked="" type="checkbox"/>

### Test Setup

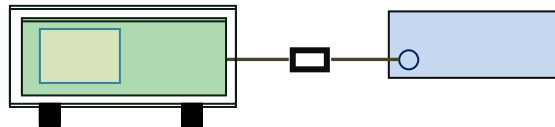

### Test Procedure

#### For Conducted Power:

- The transmitter output port was connected to base station.
- Set EUT at maximum power through base station.
- Select lowest, middle, and highest channels for each band and different test mode.

#### For ERP/EIRP:

- The transmitter was placed on a wooden turntable, and it was transmitting into a non-radiating load which was also placed on the turntable.
- The measurement antenna was placed at a distance of 3 meters from the EUT. During the tests, the antenna height and polarization as well as EUT azimuth were varied in order to identify the maximum level of emissions from the EUT. The test was performed by placing the EUT on 3-orthogonal axis.
- The frequency range up to tenth harmonic of the fundamental frequency was investigated.

Test Report	16070911-FCC-R5
Page	12 of 152

	<ul style="list-style-type: none"> <li>- Remove the EUT and replace it with substitution antenna. A signal generator was connected to the substitution antenna by a non-radiating cable. The absolute levels of the spurious emissions were measured by the substitution.</li> <li>- Spurious emissions in dB = 10 log (TX power in Watts/0.001) – the absolute level</li> <li>- Spurious attenuation limit in dB = 43 + 10 Log10 (power out in Watts).</li> </ul>
Remark	
Result	<input checked="" type="checkbox"/> Pass <input type="checkbox"/> Fail

**Test Data**     Yes                       N/A  
**Test Plot**     Yes (See below)             N/A

## Conducted Power

### LTE Band 2:

BW (MHz)	Ch	Freq. (MHz)	Mode	UL RB Allocation	UL RB Offset	MPR	Average power (dBm)	Tune up Power tolerant
20MHz	18700	1860.0	QPSK	1	0	0	22.86	22±1
				1	49	0	22.67	22±1
				1	99	0	22.68	22±1
				50	0	1	21.97	22±1
				50	24	1	21.84	22±1
				50	49	1	21.67	22±1
			100	0	1	21.82	22±1	
			16QAM	1	0	1	21.62	21.3±1
				1	49	1	21.12	21.3±1
				1	99	1	21.91	21.3±1
				50	0	2	21.62	21.3±1
				50	24	2	21.32	21.3±1
				50	49	2	21.45	21.3±1
				100	0	2	20.95	21.3±1
	18900	1880.0		QPSK	1	0	0	22.18
			1		49	0	22.68	22±1
			1		99	0	22.87	22±1
			50		0	1	21.27	22±1
			50		24	1	21.67	22±1
			50		49	1	21.17	22±1
			100	0	1	21.47	22±1	
			16QAM	1	0	1	21.37	21.3±1
				1	49	1	21.28	21.3±1
				1	99	1	21.64	21.3±1
				50	0	2	21.53	21.3±1
				50	24	2	21.93	21.3±1
				50	49	2	21.72	21.3±1
100	0	2		20.75	21.3±1			
19100	1900.0	QPSK	1	0	0	22.47	22±1	
			1	49	0	22.62	22±1	
			1	99	0	22.94	22±1	
			50	0	1	21.73	22±1	
			50	24	1	21.14	22±1	
			50	49	1	21.35	22±1	
			100	0	1	21.84	22±1	
		16QAM	1	0	1	21.47	21.3±1	
			1	49	1	21.37	21.3±1	
			1	99	1	21.59	21.3±1	
			50	0	2	21.53	21.3±1	
			50	24	2	21.63	21.3±1	
			50	49	2	21.13	21.3±1	
			100	0	2	20.77	21.3±1	

BW (MHz)	Ch	Freq. (MHz)	Mode	UL RB Allocation	UL RB Offset	MPR	Average power (dBm)	Tune up Power tolerant
15MHz	18675	1857.5	QPSK	1	0	0	22.93	22±1
				1	37	0	22.87	22±1
				1	74	0	22.27	22±1
				36	0	1	21.38	22±1
				36	16	1	21.47	22±1
				36	35	1	21.98	22±1
				75	0	1	21.29	22±1
			16QAM	1	0	1	21.62	21.3±1
				1	37	1	21.52	21.3±1
				1	74	1	21.92	21.3±1
				36	0	2	21.56	21.3±1
				36	16	2	21.45	21.3±1
				36	35	2	21.26	21.3±1
				75	0	2	20.91	21.3±1
	18900	1880.0	QPSK	1	0	0	22.57	22±1
				1	37	0	22.68	22±1
				1	74	0	22.58	22±1
				36	0	1	22.87	22±1
				36	16	1	22.67	22±1
				36	35	1	22.56	22±1
				75	0	1	21.28	22±1
			16QAM	1	0	1	21.95	21.3±1
				1	37	1	21.87	21.3±1
				1	74	1	21.56	21.3±1
				36	0	2	21.46	21.3±1
				36	16	2	21.36	21.3±1
				36	35	2	21.25	21.3±1
				75	0	2	20.83	21.3±1
	19125	1902.5	QPSK	1	0	0	22.63	22±1
				1	37	0	22.53	22±1
1				74	0	22.91	22±1	
36				0	1	22.25	22±1	
36				16	1	21.45	22±1	
36				35	1	21.95	22±1	
75				0	1	21.37	22±1	
16QAM			1	0	1	21.49	21.3±1	
			1	37	1	21.85	21.3±1	
			1	74	1	21.37	21.3±1	
			36	0	2	21.63	21.3±1	
			36	16	2	21.42	21.3±1	
			36	35	2	21.23	21.3±1	
			75	0	2	20.78	21.3±1	

BW (MHz)	Ch	Freq. (MHz)	Mode	UL RB Allocation	UL RB Offset	MPR	Average power (dBm)	Tune up Power tolerant
10MHz	18650	1855	QPSK	1	0	0	22.34	22±1
				1	24	0	22.53	22±1
				1	49	0	22.61	22±1
				25	0	1	21.17	22±1
				25	12	1	21.47	22±1
				25	24	1	21.74	22±1
				50	0	1	21.08	22±1
			16QAM	1	0	1	21.85	21.3±1
				1	24	1	21.65	21.3±1
				1	49	1	21.95	21.3±1
				25	0	2	21.16	21.3±1
				25	12	2	21.51	21.3±1
				25	24	2	21.91	21.3±1
				50	0	2	20.76	21.3±1
	18900	1880.0	QPSK	1	0	0	22.56	22±1
				1	24	0	22.64	22±1
				1	49	0	22.16	22±1
				25	0	1	22.46	22±1
				25	12	1	21.65	22±1
				25	24	1	21.36	22±1
				50	0	1	21.26	22±1
			16QAM	1	0	1	21.62	21.3±1
				1	24	1	21.81	21.3±1
				1	49	1	21.13	21.3±1
				25	0	2	21.89	21.3±1
				25	12	2	21.79	21.3±1
				25	24	2	21.29	21.3±1
				50	0	2	20.64	21.3±1
	19150	1905	QPSK	1	0	0	22.15	22±1
				1	24	0	22.43	22±1
1				49	0	22.93	22±1	
25				0	1	21.75	22±1	
25				12	1	21.95	22±1	
25				24	1	21.65	22±1	
50				0	1	21.46	22±1	
16QAM			1	0	1	21.82	21.3±1	
			1	24	1	21.92	21.3±1	
			1	49	1	21.43	21.3±1	
			25	0	2	21.47	21.3±1	
			25	12	2	21.58	21.3±1	
			25	24	2	21.91	21.3±1	
			50	0	2	20.96	21.3±1	

BW (MHz)	Ch	Freq. (MHz)	Mode	UL RB Allocation	UL RB Offset	MPR	Average power (dBm)	Tune up Power tolerant
5MHz	18625	1852.5	QPSK	1	0	0	22.39	22±1
				1	12	0	22.69	22±1
				1	24	0	22.31	22±1
				12	0	1	21.74	22±1
				12	6	1	12.67	22±1
				12	11	1	21.67	22±1
				25	0	1	21.24	22±1
			16QAM	1	0	1	21.87	21.3±1
				1	12	1	21.97	21.3±1
				1	24	1	21.67	21.3±1
				12	0	2	21.23	21.3±1
				12	6	2	21.63	21.3±1
				12	11	2	21.53	21.3±1
				25	0	2	20.56	21.3±1
	18900	1880.0	QPSK	1	0	0	22.47	22±1
				1	12	0	22.87	22±1
				1	24	0	22.17	22±1
				12	0	1	21.76	22±1
				12	6	1	21.36	22±1
				12	11	1	21.46	22±1
				25	0	1	21.19	22±1
			16QAM	1	0	1	21.36	21.3±1
				1	12	1	21.64	21.3±1
				1	24	1	21.53	21.3±1
				12	0	2	21.62	21.3±1
				12	6	2	21.82	21.3±1
				12	11	2	21.73	21.3±1
				25	0	2	20.46	21.3±1
	19175	1907.5	QPSK	1	0	0	22.47	22±1
				1	12	0	22.57	22±1
1				24	0	<b>22.97</b>	22±1	
12				0	1	22.37	22±1	
12				6	1	21.67	22±1	
12				11	1	21.56	22±1	
25				0	1	21.06	22±1	
16QAM			1	0	1	21.59	21.3±1	
			1	12	1	21.66	21.3±1	
			1	24	1	21.89	21.3±1	
			12	0	2	21.84	21.3±1	
			12	6	2	21.64	21.3±1	
			12	11	2	21.34	21.3±1	
			25	0	2	20.83	21.3±1	



BW (MHz)	Ch	Freq. (MHz)	Mode	UL RB Allocation	UL RB Offset	MPR	Average power (dBm)	Tune up Power tolerant
3MHz	18625	1852.5	QPSK	1	0	0	22.46	22±1
				1	7	0	22.45	22±1
				1	14	0	22.75	22±1
				8	0	1	21.86	22±1
				8	4	1	21.56	22±1
				8	7	1	21.96	22±1
				15	0	1	21.26	22±1
			16QAM	1	0	1	21.12	21.3±1
				1	7	1	21.34	21.3±1
				1	14	1	21.85	21.3±1
				8	0	2	21.62	21.3±1
				8	4	2	21.63	21.3±1
				8	7	2	21.67	21.3±1
				15	0	2	20.58	21.3±1
	18900	1880.0	QPSK	1	0	0	22.26	22±1
				1	7	0	22.36	22±1
				1	14	0	22.25	22±1
				8	0	1	21.61	22±1
				8	4	1	21.75	22±1
				8	7	1	21.56	22±1
				15	0	1	21.27	22±1
			16QAM	1	0	1	21.41	21.3±1
				1	7	1	21.35	21.3±1
				1	14	1	21.64	21.3±1
				8	0	2	20.82	21.3±1
				8	4	2	20.79	21.3±1
				8	7	2	20.89	21.3±1
				15	0	2	20.69	21.3±1
	19175	1907.5	QPSK	1	0	0	22.27	22±1
				1	7	0	22.86	22±1
1				14	0	22.26	22±1	
8				0	1	21.99	22±1	
8				4	1	21.56	22±1	
8				7	1	21.96	22±1	
15				0	1	21.54	22±1	
16QAM			1	0	1	21.46	21.3±1	
			1	7	1	21.26	21.3±1	
			1	14	1	21.36	21.3±1	
			8	0	2	21.64	21.3±1	
			8	4	2	20.45	21.3±1	
			8	7	2	20.84	21.3±1	
			15	0	2	20.79	21.3±1	

BW (MHz)	Ch	Freq. (MHz)	Mode	UL RB Allocation	UL RB Offset	MPR	Average power (dBm)	Tune up Power tolerant
1.4MHz	18607	1850.7	QPSK	1	0	0	22.73	22±1
				1	2	0	22.83	22±1
				1	5	0	22.71	22±1
				3	0	0	22.08	22±1
				3	1	0	22.59	22±1
				3	2	0	22.37	22±1
				6	0	1	21.81	22±1
			16QAM	1	0	1	21.15	21.3±1
				1	2	1	21.64	21.3±1
				1	5	1	21.95	21.3±1
				3	0	1	21.36	21.3±1
				3	1	1	21.49	21.3±1
				3	2	1	21.58	21.3±1
				6	0	2	20.96	21.3±1
	18900	1880.0	QPSK	1	0	0	22.36	22±1
				1	2	0	22.46	22±1
				1	5	0	22.26	22±1
				3	0	0	22.57	22±1
				3	1	0	22.45	22±1
				3	2	0	22.36	22±1
				6	0	1	21.65	22±1
			16QAM	1	0	1	21.25	21.3±1
				1	2	1	21.62	21.3±1
				1	5	1	21.35	21.3±1
				3	0	1	21.94	21.3±1
				3	1	1	21.83	21.3±1
				3	2	1	21.34	21.3±1
				6	0	2	20.63	21.3±1
19193	1909.3	QPSK	1	0	0	22.26	22±1	
			1	2	0	22.57	22±1	
			1	5	0	22.49	22±1	
			3	0	0	22.86	22±1	
			3	1	0	22.37	22±1	
			3	2	0	22.52	22±1	
			6	0	1	21.27	22±1	
		16QAM	1	0	1	21.42	21.3±1	
			1	2	1	21.35	21.3±1	
			1	5	1	21.73	21.3±1	
			3	0	1	21.13	21.3±1	
			3	1	1	21.24	21.3±1	
			3	2	1	21.19	21.3±1	
			6	0	2	20.67	21.3±1	

**LTE Band 4:**

BW (MHz)	Ch	Freq. (MHz)	Mode	UL RB Allocation	UL RB Offset	MPR	Average power (dBm)	Tune up Power tolerant
20MHz	20050	1720.0	QPSK	1	0	0	22.43	22 ± 1
				1	49	0	22.62	22 ± 1
				1	99	0	22.15	22 ± 1
				50	0	1	22.23	22 ± 1
				50	24	1	21.14	22 ± 1
				50	49	1	21.21	22 ± 1
				100	0	1	21.04	22 ± 1
			16QAM	1	0	1	22.47	22 ± 1
				1	49	1	22.68	22 ± 1
				1	99	1	22.48	22 ± 1
				50	0	2	22.62	22 ± 1
				50	24	2	22.54	22 ± 1
				50	49	2	22.53	22 ± 1
				100	0	2	21.16	22 ± 1
	20175	1732.5	QPSK	1	0	0	22.67	22 ± 1
				1	49	0	22.57	22 ± 1
				1	99	0	22.47	22 ± 1
				50	0	1	21.59	22 ± 1
				50	24	1	21.98	22 ± 1
				50	49	1	21.79	22 ± 1
				100	0	1	21.29	22 ± 1
			16QAM	1	0	1	22.52	22 ± 1
				1	49	1	22.61	22 ± 1
				1	99	1	22.67	22 ± 1
				50	0	2	21.68	22 ± 1
				50	24	2	21.58	22 ± 1
				50	49	2	21.98	22 ± 1
				100	0	2	21.92	22 ± 1
	20300	1745.0	QPSK	1	0	0	<b>23.81</b>	23 ± 1
				1	49	0	23.13	23 ± 1
1				99	0	23.24	23 ± 1	
50				0	1	22.36	23 ± 1	
50				24	1	22.61	23 ± 1	
50				49	1	22.92	23 ± 1	
100				0	1	22.05	23 ± 1	
16QAM			1	0	1	22.81	22 ± 1	
			1	49	1	22.32	22 ± 1	
			1	99	1	22.56	22 ± 1	
			50	0	2	21.46	22 ± 1	
			50	24	2	21.82	22 ± 1	
			50	49	2	21.42	22 ± 1	
			100	0	2	21.41	22 ± 1	

BW (MHz)	Ch	Freq. (MHz)	Mode	UL RB Allocation	UL RB Offset	MPR	Average power (dBm)	Tune up Power tolerant
15MHz	20025	1717.5	QPSK	1	0	0	22.99	22±1
				1	37	0	22.86	22±1
				1	74	0	23.05	22±1
				36	0	1	22.22	22±1
				36	16	1	22.29	22±1
				36	35	1	22.20	22±1
			75	0	1	22.06	22±1	
			75	0	1	22.69	22±1	
			1	37	1	22.65	22±1	
			1	74	1	22.63	22±1	
			36	0	2	22.23	22±1	
			36	16	2	22.15	22±1	
	36	35	2	22.65	22±1			
	75	0	2	21.32	22±1			
	75	0	2	21.32	22±1			
	20175	1732.5	QPSK	1	0	0	22.81	22±1
				1	37	0	22.86	22±1
				1	74	0	22.93	22±1
				36	0	1	21.73	22±1
				36	16	1	21.26	22±1
				36	35	1	21.53	22±1
			75	0	1	21.63	22±1	
			75	0	1	21.73	21.3±1	
			1	37	1	21.74	21.3±1	
			1	74	1	21.73	21.3±1	
			36	0	2	21.25	21.3±1	
			36	16	2	21.24	21.3±1	
	36	35	2	21.29	21.3±1			
	75	0	2	20.75	21.3±1			
	75	0	2	20.75	21.3±1			
	20325	1747.5	QPSK	1	0	0	22.50	22±1
				1	37	0	22.46	22±1
				1	74	0	22.42	22±1
				36	0	1	21.78	22±1
				36	16	1	21.76	22±1
				36	35	1	21.77	22±1
75			0	1	21.76	22±1		
75			0	1	21.96	21.3±1		
1			37	1	21.95	21.3±1		
1			74	1	21.93	21.3±1		
36			0	2	21.48	21.3±1		
36			16	2	21.42	21.3±1		
36	35	2	21.43	21.3±1				
75	0	2	20.94	21.3±1				
75	0	2	20.94	21.3±1				

BW (MHz)	Ch	Freq. (MHz)	Mode	UL RB Allocation	UL RB Offset	MPR	Average power (dBm)	Tune up Power tolerant
10MHz	20000	1715.0	QPSK	1	0	0	22.25	22±1
				1	24	0	22.83	22±1
				1	49	0	22.47	22±1
				25	0	1	22.33	22±1
				25	12	1	22.64	22±1
				25	24	1	22.71	22±1
				50	0	1	21.58	22±1
			16QAM	1	0	1	22.41	22±1
				1	24	1	22.63	22±1
				1	49	1	22.62	22±1
				25	0	2	21.36	22±1
				25	12	2	21.54	22±1
				25	24	2	21.17	22±1
				50	0	2	21.11	22±1
	20175	1732.5	QPSK	1	0	0	22.44	22±1
				1	24	0	22.85	22±1
				1	49	0	22.31	22±1
				25	0	1	21.74	22±1
				25	12	1	21.63	22±1
				25	24	1	21.47	22±1
				50	0	1	21.24	22±1
			16QAM	1	0	1	21.65	21.3±1
				1	24	1	21.43	21.3±1
				1	49	1	21.98	21.3±1
				25	0	2	21.61	21.3±1
				25	12	2	21.34	21.3±1
				25	24	2	21.33	21.3±1
				50	0	2	20.89	21.3±1
	20350	1750.0	QPSK	1	0	0	22.25	22±1
				1	24	0	22.32	22±1
1				49	0	22.64	22±1	
25				0	1	21.59	22±1	
25				12	1	21.67	22±1	
25				24	1	21.18	22±1	
50				0	1	21.35	22±1	
16QAM			1	0	1	21.45	21.3±1	
			1	24	1	21.36	21.3±1	
			1	49	1	21.88	21.3±1	
			25	0	2	21.64	21.3±1	
			25	12	2	21.53	21.3±1	
			25	24	2	21.87	21.3±1	
			50	0	2	20.77	21.3±1	

BW (MHz)	Ch	Freq. (MHz)	Mode	UL RB Allocation	UL RB Offset	MPR	Average power (dBm)	Tune up Power tolerant
5MHz	20000	1715.0	QPSK	1	0	0	22.37	22±1
				1	12	0	22.53	22±1
				1	24	0	22.45	22±1
				12	0	1	22.52	22±1
				12	6	1	22.84	22±1
				12	11	1	22.46	22±1
				25	0	1	21.55	22±1
			16QAM	1	0	1	22.82	22±1
				1	12	1	22.13	22±1
				1	24	1	22.64	22±1
				12	0	2	21.56	22±1
				12	6	2	21.58	22±1
				12	11	2	21.61	22±1
				25	0	2	21.41	22±1
	20175	1732.5	QPSK	1	0	0	23.13	23±1
				1	12	0	23.52	23±1
				1	24	0	23.48	23±1
				12	0	1	22.29	23±1
				12	6	1	22.67	23±1
				12	11	1	22.49	23±1
				25	0	1	22.33	23±1
			16QAM	1	0	1	22.53	22±1
				1	12	1	22.67	22±1
				1	24	1	22.42	22±1
				12	0	2	21.65	22±1
				12	6	2	21.71	22±1
				12	11	2	21.92	22±1
				25	0	2	21.07	22±1
20350	1750.0	QPSK	1	0	0	22.25	22±1	
			1	12	0	22.27	22±1	
			1	24	0	22.23	22±1	
			12	0	1	21.87	22±1	
			12	6	1	21.69	22±1	
			12	11	1	21.74	22±1	
			25	0	1	21.27	22±1	
		16QAM	1	0	1	21.66	21.3±1	
			1	12	1	21.45	21.3±1	
			1	24	1	21.57	21.3±1	
			12	0	2	21.59	21.3±1	
			12	6	2	21.45	21.3±1	
			12	11	2	21.48	21.3±1	
			25	0	2	20.86	21.3±1	

BW (MHz)	Ch	Freq. (MHz)	Mode	UL RB Allocation	UL RB Offset	MPR	Average power (dBm)	Tune up Power tolerant
3MHz	19965	1711.5	QPSK	1	0	0	22.07	22±1
				1	7	0	22.11	22±1
				1	14	0	22.62	22±1
				8	0	1	22.34	22±1
				8	4	1	22.52	22±1
				8	7	1	22.61	22±1
				15	0	1	21.55	22±1
			16QAM	1	0	1	21.47	21.3±1
				1	7	1	21.68	21.3±1
				1	14	1	21.47	21.3±1
				8	0	2	21.84	21.3±1
				8	4	2	21.62	21.3±1
				8	7	2	21.65	21.3±1
				15	0	2	20.74	21.3±1
	20175	1732.5	QPSK	1	0	0	23.32	23±1
				1	7	0	23.61	23±1
				1	14	0	23.75	23±1
				8	0	1	22.91	23±1
				8	4	1	22.56	23±1
				8	7	1	22.72	23±1
				15	0	1	22.06	23±1
			16QAM	1	0	1	22.41	22±1
				1	7	1	22.32	22±1
				1	14	1	22.97	22±1
				8	0	2	21.36	22±1
				8	4	2	21.61	22±1
				8	7	2	21.45	22±1
				15	0	2	21.09	22±1
	20385	1753.5	QPSK	1	0	0	22.21	22±1
				1	7	0	22.62	22±1
1				14	0	22.78	22±1	
8				0	1	21.16	22±1	
8				4	1	21.24	22±1	
8				7	1	21.15	22±1	
15				0	1	21.18	22±1	
16QAM			1	0	1	21.78	21.3±1	
			1	7	1	21.74	21.3±1	
			1	14	1	21.59	21.3±1	
			8	0	2	21.34	21.3±1	
			8	4	2	21.96	21.3±1	
			8	7	2	21.85	21.3±1	
			15	0	2	20.68	21.3±1	

BW (MHz)	Ch	Freq. (MHz)	Mode	UL RB Allocation	UL RB Offset	MPR	Average power (dBm)	Tune up Power tolerant
1.4MHz	19957	1710.7	QPSK	1	0	0	22.32	22±1
				1	2	0	22.63	22±1
				1	5	0	22.65	22±1
				3	0	0	22.35	22±1
				3	1	0	22.62	22±1
				3	2	0	22.53	22±1
			6	0	1	21.56	22±1	
			16QAM	1	0	1	22.15	22±1
				1	2	1	22.14	22±1
				1	5	1	22.19	22±1
				3	0	1	21.89	22±1
				3	1	1	21.86	22±1
	3	2		1	21.94	22±1		
	20175	1732.5	QPSK	1	0	0	23.17	23±1
				1	2	0	23.27	23±1
				1	5	0	23.22	23±1
				3	0	0	22.98	23±1
				3	1	0	22.76	23±1
				3	2	0	22.83	23±1
			6	0	1	22.17	23±1	
			16QAM	1	0	1	22.27	22±1
				1	2	1	22.28	22±1
				1	5	1	22.37	22±1
				3	0	1	21.85	22±1
				3	1	1	21.74	22±1
	3	2		1	21.79	22±1		
	20393	1754.3	QPSK	1	0	0	22.13	22±1
				1	2	0	22.31	22±1
				1	5	0	22.27	22±1
				3	0	0	22.24	22±1
3				1	0	22.19	22±1	
3				2	0	22.23	22±1	
6			0	1	21.65	22±1		
16QAM			1	0	1	21.69	21.3±1	
			1	2	1	21.65	21.3±1	
			1	5	1	21.72	21.3±1	
			3	0	1	21.67	21.3±1	
			3	1	1	21.61	21.3±1	
	3	2	1	21.79	21.3±1			
6	0	2	20.92	21.3±1				



**LTE Band 5:**

BW (MHz)	Ch	Freq. (MHz)	Mode	UL RB Allocation	UL RB Offset	MPR	Average power (dBm)	Tune up Power tolerant
10MHz	20450	829	QPSK	1	0	0	22.35	22±1
				1	12	0	22.34	22±1
				1	24	0	22.38	22±1
				12	0	1	21.79	22±1
				12	6	1	21.75	22±1
				12	11	1	21.74	22±1
				25	0	1	21.39	22±1
			16QAM	1	0	1	22.81	22±1
				1	12	1	22.78	22±1
				1	24	1	22.88	22±1
				12	0	2	23.83	22±1
				12	6	2	21.87	22±1
				12	11	2	21.84	22±1
				25	0	2	21.38	22±1
	20525	836.5	QPSK	1	0	0	22.47	22±1
				1	12	0	22.45	22±1
				1	24	0	22.48	22±1
				12	0	1	21.41	22±1
				12	6	1	21.46	22±1
				12	11	1	21.43	22±1
				25	0	1	21.31	22±1
			16QAM	1	0	1	22.82	22±1
				1	12	1	22.84	22±1
				1	24	1	22.87	22±1
				12	0	2	21.92	22±1
				12	6	2	21.98	22±1
				12	11	2	21.96	22±1
				25	0	2	21.39	22±1
	20600	844	QPSK	1	0	0	22.35	22±1
				1	12	0	22.33	22±1
1				24	0	22.38	22±1	
12				0	1	21.34	22±1	
12				6	1	21.36	22±1	
12				11	1	21.32	22±1	
25				0	1	21.23	22±1	
16QAM			1	0	1	21.31	21.3±1	
			1	12	1	21.36	21.3±1	
			1	24	1	21.38	21.3±1	
			12	0	2	21.86	21.3±1	
			12	6	2	21.84	21.3±1	
			12	11	2	21.82	21.3±1	
			25	0	2	21.34	21.3±1	

BW (MHz)	Ch	Freq. (MHz)	Mode	UL RB Allocation	UL RB Offset	MPR	Average power (dBm)	Tune up Power tolerant
5MHz	20425	826.5	QPSK	1	0	0	23.15	23±1
				1	24	0	23.24	23±1
				1	49	0	23.17	23±1
				25	0	1	22.25	23±1
				25	12	1	22.26	23±1
				25	24	1	22.31	23±1
				50	0	1	22.11	23±1
			16QAM	1	0	1	22.94	22±1
				1	24	1	22.85	22±1
				1	49	1	22.87	22±1
				25	0	2	21.14	22±1
				25	12	2	21.13	22±1
				25	24	2	21.17	22±1
				50	0	2	21.01	22±1
	20525	836.5	QPSK	1	0	0	23.12	23±1
				1	24	0	23.17	23±1
				1	49	0	23.21	23±1
				25	0	1	22.74	23±1
				25	12	1	22.55	23±1
				25	24	1	22.63	23±1
				50	0	1	22.19	23±1
			16QAM	1	0	1	22.47	22±1
				1	24	1	22.45	22±1
				1	49	1	22.48	22±1
				25	0	2	21.46	22±1
				25	12	2	21.58	22±1
				25	24	2	21.53	22±1
				50	0	2	21.29	22±1
	20625	846.5	QPSK	1	0	0	<b>23.83</b>	23±1
				1	24	0	23.51	23±1
1				49	0	23.47	23±1	
25				0	1	22.65	23±1	
25				12	1	22.84	23±1	
25				24	1	22.97	23±1	
50				0	1	22.48	23±1	
16QAM			1	0	1	22.97	22±1	
			1	24	1	22.57	22±1	
			1	49	1	22.65	22±1	
			25	0	2	21.78	22±1	
			25	12	2	21.89	22±1	
			25	24	2	21.79	22±1	
			50	0	2	21.57	22±1	

BW (MHz)	Ch	Freq. (MHz)	Mode	UL RB Allocation	UL RB Offset	MPR	Average power (dBm)	Tune up Power tolerant
3MHz	20415	825.5	QPSK	1	0	0	22.25	22 ± 1
				1	7	0	22.24	22 ± 1
				1	14	0	22.29	22 ± 1
				8	0	1	22.42	22 ± 1
				8	4	1	22.48	22 ± 1
				8	7	1	22.51	22 ± 1
				15	0	1	21.78	22 ± 1
			16QAM	1	0	1	22.83	22 ± 1
				1	7	1	22.78	22 ± 1
				1	14	1	22.86	22 ± 1
				8	0	2	21.73	22 ± 1
				8	4	2	21.74	22 ± 1
				8	7	2	21.78	22 ± 1
				15	0	2	21.44	22 ± 1
	20525	836.5	QPSK	1	0	0	22.37	22 ± 1
				1	7	0	22.35	22 ± 1
				1	14	0	22.38	22 ± 1
				8	0	1	22.45	22 ± 1
				8	4	1	22.48	22 ± 1
				8	7	1	22.41	22 ± 1
				15	0	1	21.88	22 ± 1
			16QAM	1	0	1	22.32	22 ± 1
				1	7	1	22.34	22 ± 1
				1	14	1	22.35	22 ± 1
				8	0	2	22.23	22 ± 1
				8	4	2	22.21	22 ± 1
				8	7	2	22.19	22 ± 1
				15	0	2	22.06	22 ± 1
	20635	847.5	QPSK	1	0	0	22.36	22 ± 1
				1	7	0	22.34	22 ± 1
1				14	0	22.31	22 ± 1	
8				0	1	22.21	22 ± 1	
8				4	1	22.19	22 ± 1	
8				7	1	22.18	22 ± 1	
15				0	1	21.87	22 ± 1	
16QAM			1	0	1	22.53	22 ± 1	
			1	7	1	22.55	22 ± 1	
			1	14	1	22.56	22 ± 1	
			8	0	2	21.86	22 ± 1	
			8	4	2	21.89	22 ± 1	
			8	7	2	21.82	22 ± 1	
			15	0	2	21.29	22 ± 1	

BW (MHz)	Ch	Freq. (MHz)	Mode	UL RB Allocation	UL RB Offset	MPR	Average power (dBm)	Tune up Power tolerant
1.4MHz	20407	824.7	QPSK	1	0	0	22.47	22±1
				1	2	0	22.42	22±1
				1	5	0	22.23	22±1
				3	0	0	22.45	22±1
				3	1	0	22.46	22±1
				3	2	0	22.41	22±1
				6	0	1	21.65	22±1
			16QAM	1	0	1	22.31	22±1
				1	2	1	22.35	22±1
				1	5	1	22.37	22±1
				3	0	1	21.86	22±1
				3	1	1	21.85	22±1
				3	2	1	21.89	22±1
				6	0	2	21.27	22±1
	20525	836.5	QPSK	1	0	0	22.34	22±1
				1	2	0	22.36	22±1
				1	5	0	22.33	22±1
				3	0	0	22.51	22±1
				3	1	0	22.56	22±1
				3	2	0	22.54	22±1
				6	0	1	21.55	22±1
			16QAM	1	0	1	21.79	22±1
				1	2	1	21.75	22±1
				1	5	1	21.69	22±1
				3	0	1	21.65	22±1
				3	1	1	21.68	22±1
				3	2	1	21.62	22±1
				6	0	2	21.26	22±1
	20643	848.3	QPSK	1	0	0	22.23	22±1
				1	2	0	22.21	22±1
1				5	0	22.25	22±1	
3				0	0	22.38	22±1	
3				1	0	22.24	22±1	
3				2	0	22.25	22±1	
6				0	1	21.89	22±1	
16QAM			1	0	1	22.12	22±1	
			1	2	1	22.15	22±1	
			1	5	1	22.17	22±1	
			3	0	1	21.64	22±1	
			3	1	1	21.65	22±1	
			3	2	1	21.68	22±1	
			6	0	2	21.22	22±1	

**LTE Band 7:**

BW (MHz)	Ch	Freq. (MHz)	Mode	UL RB Allocation	UL RB Offset	MPR	Average power (dBm)	Tune up Power tolerant
20MHz	20850	2510	QPSK	1	0	0	22.04	22±1
				1	49	0	22.06	22±1
				1	99	0	22.09	22±1
				50	0	1	22.22	22±1
				50	24	1	22.23	22±1
				50	49	1	22.28	22±1
				100	0	1	21.56	22±1
			16QAM	1	0	1	22.61	22±1
				1	49	1	22.63	22±1
				1	99	1	22.68	22±1
				50	0	2	21.68	22±1
				50	24	2	21.66	22±1
				50	49	2	21.61	22±1
				100	0	2	21.34	22±1
	21100	2535	QPSK	1	0	0	22.13	22±1
				1	49	0	22.12	22±1
				1	99	0	22.15	22±1
				50	0	1	21.85	22±1
				50	24	1	21.84	22±1
				50	49	1	21.89	22±1
				100	0	1	21.24	22±1
			16QAM	1	0	1	22.54	22±1
				1	49	1	22.52	22±1
				1	99	1	22.59	22±1
				50	0	2	22.45	22±1
				50	24	2	22.46	22±1
				50	49	2	22.41	22±1
				100	0	2	21.07	22±1
	21350	2560	QPSK	1	0	0	22.44	22±1
				1	49	0	22.45	22±1
1				99	0	22.49	22±1	
50				0	1	22.23	22±1	
50				24	1	22.25	22±1	
50				49	1	22.21	22±1	
100				0	1	21.78	22±1	
16QAM			1	0	1	21.86	21.3±1	
			1	49	1	21.84	21.3±1	
			1	99	1	21.81	21.3±1	
			50	0	2	20.98	21.3±1	
			50	24	2	20.97	21.3±1	
			50	49	2	20.96	21.3±1	
			100	0	2	20.65	21.3±1	

BW (MHz)	Ch	Freq. (MHz)	Mode	UL RB Allocation	UL RB Offset	MPR	Average power (dBm)	Tune up Power tolerant
15MHz	20825	1717.5	QPSK	1	0	0	22.31	22 ± 1
				1	37	0	22.33	22 ± 1
				1	74	0	22.38	22 ± 1
				36	0	1	22.85	22 ± 1
				36	16	1	22.87	22 ± 1
				36	35	1	22.86	22 ± 1
				75	0	1	21.77	22 ± 1
			16QAM	1	0	1	22.12	22 ± 1
				1	37	1	22.15	22 ± 1
				1	74	1	22.09	22 ± 1
				36	0	2	21.88	22 ± 1
				36	16	2	21.84	22 ± 1
				36	35	2	21.85	22 ± 1
				75	0	2	21.22	22 ± 1
	21100	1732.5	QPSK	1	0	0	22.62	22 ± 1
				1	37	0	22.65	22 ± 1
				1	74	0	22.64	22 ± 1
				36	0	1	21.92	22 ± 1
				36	16	1	21.88	22 ± 1
				36	35	1	21.85	22 ± 1
				75	0	1	21.34	22 ± 1
			16QAM	1	0	1	22.61	22 ± 1
				1	37	1	22.62	22 ± 1
				1	74	1	22.65	22 ± 1
				36	0	2	21.66	22 ± 1
				36	16	2	21.65	22 ± 1
				36	35	2	21.69	22 ± 1
				75	0	2	21.99	22 ± 1
	21375	1747.5	QPSK	1	0	0	22.37	22 ± 1
				1	37	0	22.34	22 ± 1
1				74	0	22.35	22 ± 1	
36				0	1	21.95	22 ± 1	
36				16	1	21.92	22 ± 1	
36				35	1	21.93	22 ± 1	
75				0	1	21.22	22 ± 1	
16QAM			1	0	1	22.51	22 ± 1	
			1	37	1	22.55	22 ± 1	
			1	74	1	22.52	22 ± 1	
			36	0	2	21.83	22 ± 1	
			36	16	2	21.85	22 ± 1	
			36	35	2	21.89	22 ± 1	
			75	0	2	21.78	22 ± 1	

BW (MHz)	Ch	Freq. (MHz)	Mode	UL RB Allocation	UL RB Offset	MPR	Average power (dBm)	Tune up Power tolerant
10MHz	20800	2502	QPSK	1	0	0	22.45	22 ± 1
				1	24	0	22.46	22 ± 1
				1	49	0	22.41	22 ± 1
				25	0	1	22.12	22 ± 1
				25	12	1	22.15	22 ± 1
				25	24	1	22.14	22 ± 1
				50	0	1	21.52	22 ± 1
			16QAM	1	0	1	22.84	22 ± 1
				1	24	1	22.85	22 ± 1
				1	49	1	22.87	22 ± 1
				25	0	2	21.86	22 ± 1
				25	12	2	21.85	22 ± 1
				25	24	2	21.81	22 ± 1
				50	0	2	21.23	22 ± 1
	21100	2535	QPSK	1	0	0	22.16	22 ± 1
				1	24	0	22.15	22 ± 1
				1	49	0	22.13	22 ± 1
				25	0	1	21.89	22 ± 1
				25	12	1	21.85	22 ± 1
				25	24	1	21.85	22 ± 1
				50	0	1	21.52	22 ± 1
			16QAM	1	0	1	21.64	22 ± 1
				1	24	1	21.62	22 ± 1
				1	49	1	21.69	22 ± 1
				25	0	2	21.02	22 ± 1
				25	12	2	21.03	22 ± 1
				25	24	2	20.99	22 ± 1
				50	0	2	20.65	22 ± 1
	21400	2565	QPSK	1	0	0	22.27	22 ± 1
				1	24	0	22.26	22 ± 1
				1	49	0	22.21	22 ± 1
				25	0	1	21.85	22 ± 1
				25	12	1	21.84	22 ± 1
				25	24	1	21.87	22 ± 1
				50	0	1	21.02	22 ± 1
			16QAM	1	0	1	21.71	22 ± 1
1				24	1	21.72	22 ± 1	
1				49	1	21.82	22 ± 1	
25				0	2	21.32	22 ± 1	
25				12	2	21.34	22 ± 1	
25				24	2	21.37	22 ± 1	
50				0	2	20.86	22 ± 1	

BW (MHz)	Ch	Freq. (MHz)	Mode	UL RB Allocation	UL RB Offset	MPR	Average power (dBm)	Tune up Power tolerant
5MHz	19975	1712.5	QPSK	1	0	0	21.82	21.3±1
				1	12	0	21.83	21.3±1
				1	24	0	21.88	21.3±1
				12	0	1	21.56	21.3±1
				12	6	1	21.55	21.3±1
				12	11	1	21.51	21.3±1
				25	0	1	21.05	21.3±1
			16QAM	1	0	1	22.12	22±1
				1	12	1	22.13	22±1
				1	24	1	22.15	22±1
				12	0	2	21.85	22±1
				12	6	2	21.87	22±1
				12	11	2	21.81	22±1
				25	0	2	21.64	22±1
	20175	1732.5	QPSK	1	0	0	22.54	22±1
				1	12	0	22.52	22±1
				1	24	0	22.56	22±1
				12	0	1	22.87	22±1
				12	6	1	22.84	22±1
				12	11	1	22.85	22±1
				25	0	1	21.23	22±1
			16QAM	1	0	1	22.56	22±1
				1	12	1	22.57	22±1
				1	24	1	22.52	22±1
				12	0	2	21.67	22±1
				12	6	2	21.65	22±1
				12	11	2	21.61	22±1
				25	0	2	20.19	22±1
	20375	1752.5	QPSK	1	0	0	22.85	22±1
				1	12	0	22.84	22±1
1				24	0	<b>22.89</b>	22±1	
12				0	1	21.87	22±1	
12				6	1	21.88	22±1	
12				11	1	21.82	22±1	
25				0	1	21.35	22±1	
16QAM			1	0	1	21.82	21.3±1	
			1	12	1	21.84	21.3±1	
			1	24	1	21.88	21.3±1	
			12	0	2	20.89	21.3±1	
			12	6	2	20.85	21.3±1	
			12	11	2	20.78	21.3±1	
			25	0	2	20.61	21.3±1	



**LTE Band 12:**

BW (MHz)	Ch	Freq. (MHz)	Mode	UL RB Allocation	UL RB Offset	MPR	Average power (dBm)	Tune up Power tolerant
10MHz	23060	704	QPSK	1	0	0	22.21	22±1
				1	24	0	22.23	22±1
				1	49	0	22.29	22±1
				25	0	1	21.78	22±1
				25	12	1	21.75	22±1
				25	24	1	21.74	22±1
				50	0	1	21.06	22±1
			16QAM	1	0	1	22.66	22±1
				1	24	1	22.65	22±1
				1	49	1	22.63	22±1
				25	0	2	21.71	22±1
				25	12	2	21.75	22±1
				25	24	2	21.72	22±1
				50	0	2	21.03	22±1
	23095	707.5	QPSK	1	0	0	22.35	22±1
				1	24	0	22.31	22±1
				1	49	0	22.32	22±1
				25	0	1	22.25	22±1
				25	12	1	22.21	22±1
				25	24	1	22.23	22±1
				50	0	1	21.23	22±1
			16QAM	1	0	1	22.52	22±1
				1	24	1	22.54	22±1
				1	49	1	22.57	22±1
				25	0	2	21.83	22±1
				25	12	2	21.84	22±1
				25	24	2	21.89	22±1
				50	0	2	21.21	22±1
	23130	711	QPSK	1	0	0	22.16	22±1
				1	24	0	22.14	22±1
1				49	0	22.19	22±1	
25				0	1	21.89	22±1	
25				12	1	21.88	22±1	
25				24	1	21.82	22±1	
50				0	1	21.46	22±1	
16QAM			1	0	1	22.63	22±1	
			1	24	1	22.65	22±1	
			1	49	1	22.61	22±1	
			25	0	2	21.46	22±1	
			25	12	2	21.48	22±1	
			25	24	2	21.41	22±1	
			50	0	2	21.06	22±1	

BW (MHz)	Ch	Freq. (MHz)	Mode	UL RB Allocation	UL RB Offset	MPR	Average power (dBm)	Tune up Power tolerant
5MHz	23035	701.5	QPSK	1	0	0	22.42	22±1
				1	12	0	22.41	22±1
				1	24	0	22.46	22±1
				12	0	1	21.78	22±1
				12	6	1	21.77	22±1
				12	11	1	21.69	22±1
			25	0	1	21.26	22±1	
			16QAM	1	0	1	22.34	22±1
				1	12	1	22.35	22±1
				1	24	1	22.38	22±1
				12	0	2	22.03	22±1
				12	6	2	22.08	22±1
	12	11		2	22.01	22±1		
	23095	707.5	QPSK	1	0	0	<b>22.68</b>	22±1
				1	12	0	22.65	22±1
				1	24	0	22.61	22±1
				12	0	1	21.98	22±1
				12	6	1	21.95	22±1
				12	11	1	21.96	22±1
			25	0	1	21.55	22±1	
			16QAM	1	0	1	22.62	22±1
				1	12	1	22.65	22±1
				1	24	1	22.64	22±1
				12	0	2	21.86	22±1
				12	6	2	21.87	22±1
	12	11		2	21.92	22±1		
	25	0	2	21.42	22±1			
23155	713.5	QPSK	1	0	0	22.12	22±1	
			1	12	0	22.13	22±1	
			1	24	0	22.18	22±1	
			12	0	1	21.89	22±1	
			12	6	1	21.87	22±1	
			12	11	1	21.82	22±1	
		25	0	1	21.33	22±1		
		16QAM	1	0	1	22.51	22±1	
			1	12	1	22.52	22±1	
			1	24	1	22.54	22±1	
			12	0	2	21.79	22±1	
			12	6	2	21.75	22±1	
12	11		2	21.76	22±1			
25	0	2	21.24	22±1				

BW (MHz)	Ch	Freq. (MHz)	Mode	UL RB Allocation	UL RB Offset	MPR	Average power (dBm)	Tune up Power tolerant
3MHz	23025	700.5	QPSK	1	0	0	22.28	22±1
				1	7	0	22.29	22±1
				1	14	0	22.22	22±1
				8	0	1	22.53	22±1
				8	4	1	22.52	22±1
				8	7	1	22.57	22±1
			15	0	1	21.36	22±1	
			16QAM	1	0	1	22.59	22±1
				1	7	1	22.54	22±1
				1	14	1	22.56	22±1
				8	0	2	21.61	22±1
				8	4	2	21.65	22±1
	8	7		2	21.62	22±1		
	15	0	2	21.08	22±1			
	23095	707.5	QPSK	1	0	0	22.63	22±1
				1	7	0	22.62	22±1
				1	14	0	22.67	22±1
				8	0	1	22.37	22±1
				8	4	1	22.34	22±1
				8	7	1	22.32	22±1
			15	0	1	21.55	22±1	
			16QAM	1	0	1	22.44	22±1
				1	7	1	22.47	22±1
				1	14	1	22.42	22±1
				8	0	2	21.53	22±1
				8	4	2	21.52	22±1
	8	7		2	21.58	22±1		
	15	0	2	21.07	22±1			
	23025	714.5	QPSK	1	0	0	22.51	22±1
				1	7	0	22.52	22±1
1				14	0	22.56	22±1	
8				0	1	22.23	22±1	
8				4	1	22.21	22±1	
8				7	1	22.27	22±1	
15			0	1	21.81	22±1		
16QAM			1	0	1	22.31	22±1	
			1	7	1	22.32	22±1	
			1	14	1	22.39	22±1	
			8	0	2	21.84	22±1	
			8	4	2	21.85	22±1	
	8	7	2	21.82	22±1			
15	0	2	21.29	22±1				

BW (MHz)	Ch	Freq. (MHz)	Mode	UL RB Allocation	UL RB Offset	MPR	Average power (dBm)	Tune up Power tolerant
1.4MHz	23017	699.7	QPSK	1	0	0	22.43	22±1
				1	2	0	22.45	22±1
				1	5	0	22.41	22±1
				3	0	0	21.87	22±1
				3	1	0	21.89	22±1
				3	2	0	21.82	22±1
			6	0	1	21.56	22±1	
			16QAM	1	0	1	21.65	21.3±1
				1	2	1	21.62	21.3±1
				1	5	1	21.63	21.3±1
				3	0	1	21.32	21.3±1
				3	1	1	20.33	21.3±1
	3	2		1	21.38	21.3±1		
	6	0	2	20.83	21.3±1			
	23095	707.5	QPSK	1	0	0	22.42	22±1
				1	2	0	22.45	22±1
				1	5	0	22.41	22±1
				3	0	0	22.32	22±1
				3	1	0	22.31	22±1
				3	2	0	22.37	22±1
			6	0	1	21.34	22±1	
			16QAM	1	0	1	22.53	22±1
				1	2	1	22.52	22±1
				1	5	1	22.59	22±1
				3	0	1	21.87	22±1
				3	1	1	21.85	22±1
	3	2		1	21.81	22±1		
	6	0	2	21.22	22±1			
	23173	715.3	QPSK	1	0	0	22.14	22±1
				1	2	0	22.15	22±1
1				5	0	22.09	22±1	
3				0	0	21.85	22±1	
3				1	0	21.86	22±1	
3				2	0	21.82	22±1	
6			0	1	21.24	22±1		
16QAM			1	0	1	22.32	22±1	
			1	2	1	22.36	22±1	
			1	5	1	22.37	22±1	
			3	0	1	21.81	22±1	
			3	1	1	21.79	22±1	
	3	2	1	21.78	22±1			
6	0	2	21.22	22±1				

**LTE Band 17:**

BW (MHz)	Ch	Freq. (MHz)	Mode	UL RB Allocation	UL RB Offset	MPR	Average power (dBm)	Tune up Power tolerant
10MHz	23780	709.0	QPSK	1	0	0	22.35	22±1
				1	12	0	22.36	22±1
				1	24	0	22.38	22±1
				12	0	1	21.42	22±1
				12	6	1	22.41	22±1
				12	11	1	22.45	22±1
				25	0	1	21.64	22±1
			16QAM	1	0	1	22.31	22±1
				1	12	1	22.38	22±1
				1	24	1	22.35	22±1
				12	0	2	21.64	22±1
				12	6	2	21.65	22±1
				12	11	2	21.61	22±1
				25	0	2	21.22	22±1
	23790	701.0	QPSK	1	0	0	22.21	22±1
				1	12	0	22.23	22±1
				1	24	0	22.28	22±1
				12	0	1	21.55	22±1
				12	6	1	21.54	22±1
				12	11	1	21.52	22±1
				25	0	1	21.09	22±1
			16QAM	1	0	1	22.14	22±1
				1	12	1	22.13	22±1
				1	24	1	22.15	22±1
				12	0	2	21.78	22±1
				12	6	2	21.74	22±1
				12	11	2	21.75	22±1
				25	0	2	21.39	22±1
23800	711.0	QPSK	1	0	0	22.27	22±1	
			1	12	0	22.26	22±1	
			1	24	0	22.22	22±1	
			12	0	1	21.32	22±1	
			12	6	1	21.35	22±1	
			12	11	1	21.36	22±1	
			25	0	1	21.11	22±1	
		16QAM	1	0	1	22.36	22±1	
			1	12	1	22.35	22±1	
			1	24	1	22.38	22±1	
			12	0	2	21.58	22±1	
			12	6	2	21.57	22±1	
			12	11	2	21.52	22±1	
			25	0	2	21.25	22±1	

BW (MHz)	Ch	Freq. (MHz)	Mode	UL RB Allocation	UL RB Offset	MPR	Average power (dBm)	Tune up Power tolerant
5MHz	23755	706.5	QPSK	1	0	0	22.34	22±1
				1	24	0	22.35	22±1
				1	49	0	22.31	22±1
				25	0	1	21.75	22±1
				25	12	1	21.74	22±1
				25	24	1	21.71	22±1
			50	0	1	21.31	22±1	
			16QAM	1	0	1	22.36	22±1
				1	24	1	22.35	22±1
				1	49	1	22.37	22±1
				25	0	2	21.82	22±1
				25	12	2	21.79	22±1
	25	24		2	21.81	22±1		
	50	0	2	21.44	22±1			
	23790	710.0	QPSK	1	0	0	22.41	22±1
				1	24	0	22.42	22±1
				1	49	0	22.47	22±1
				25	0	1	22.06	22±1
				25	12	1	22.04	22±1
				25	24	1	22.01	22±1
			50	0	1	21.67	22±1	
			16QAM	1	0	1	22.12	22±1
				1	24	1	22.14	22±1
				1	49	1	22.08	22±1
				25	0	2	21.93	22±1
				25	12	2	21.88	22±1
	25	24		2	21.85	22±1		
	50	0	2	21.52	22±1			
	23825	713.5	QPSK	1	0	0	22.63	22±1
				1	24	0	<b>22.65</b>	22±1
1				49	0	22.62	22±1	
25				0	1	22.45	22±1	
25				12	1	22.48	22±1	
25				24	1	22.46	22±1	
50			0	1	21.74	22±1		
16QAM			1	0	1	22.37	22±1	
			1	24	1	22.36	22±1	
			1	49	1	22.32	22±1	
			25	0	2	21.71	22±1	
			25	12	2	21.69	22±1	
	25	24	2	21.66	22±1			
50	0	2	21.23	22±1				

**ERP & EIRP**  
**EIRP for LTE Band 2 (Part 24E)**

Frequency (MHz)	BW (MHz)	Modulation	RB Size/Offset	Substituted level (dBm)	Antenna Polarization	Antenna Gain correction (dBi)	Cable Loss (dB)	Absolute Level (dBm)	Limit (dBm)
1850.7	1.4	QPSK	1/0	12.85	V	7.88	0.85	19.88	33.01
1880	1.4	QPSK	1/0	12.82	V	7.88	0.85	19.85	33.01
1909.3	1.4	QPSK	1/0	12.74	V	7.88	0.85	19.77	33.01
1850.7	1.4	QPSK	1/0	12.76	H	7.88	0.85	19.79	33.01
1880	1.4	QPSK	1/0	12.69	H	7.88	0.85	19.72	33.01
1909.3	1.4	QPSK	1/0	12.66	H	7.88	0.85	19.69	33.01
1850.7	1.4	16-QAM	1/0	11.68	V	7.88	0.85	18.71	33.01
1880	1.4	16-QAM	1/0	11.76	V	7.88	0.85	18.79	33.01
1909.3	1.4	16-QAM	1/0	11.83	V	7.88	0.85	18.86	33.01
1850.7	1.4	16-QAM	1/0	11.44	H	7.88	0.85	18.47	33.01
1880	1.4	16-QAM	1/0	11.54	H	7.88	0.85	18.57	33.01
1909.3	1.4	16-QAM	1/0	11.72	H	7.88	0.85	18.75	33.01
1851.5	3	QPSK	1/0	13.08	V	7.88	0.85	20.11	33.01
1880	3	QPSK	1/0	12.84	V	7.88	0.85	19.87	33.01
1908.5	3	QPSK	1/0	12.78	V	7.88	0.85	19.81	33.01
1851.5	3	QPSK	1/0	12.94	H	7.88	0.85	19.97	33.01
1880	3	QPSK	1/0	12.62	H	7.88	0.85	19.65	33.01
1908.5	3	QPSK	1/0	12.53	H	7.88	0.85	19.56	33.01
1851.5	3	16-QAM	1/0	11.62	V	7.88	0.85	18.65	33.01
1880	3	16-QAM	1/0	12.03	V	7.88	0.85	19.06	33.01
1908.5	3	16-QAM	1/0	11.87	V	7.88	0.85	18.9	33.01
1851.5	3	16-QAM	1/0	11.54	H	7.88	0.85	18.57	33.01
1880	3	16-QAM	1/0	11.93	H	7.88	0.85	18.96	33.01
1908.5	3	16-QAM	1/0	11.63	H	7.88	0.85	18.66	33.01
1852.5	5	QPSK	1/24	12.89	V	7.88	0.85	19.92	33.01
1880	5	QPSK	1/0	13.05	V	7.88	0.85	20.08	33.01
1907.5	5	QPSK	1/24	13.39	V	7.88	0.85	20.42	33.01
1852.5	5	QPSK	1/24	12.65	H	7.88	0.85	19.68	33.01
1880	5	QPSK	1/0	12.86	H	7.88	0.85	19.89	33.01
1907.5	5	QPSK	1/24	13.12	H	7.88	0.85	20.15	33.01
1852.5	5	16-QAM	1/24	12.21	V	7.88	0.85	19.24	33.01

1880	5	16-QAM	1/0	11.85	V	7.88	0.85	18.88	33.01
1907.5	5	16-QAM	1/24	12.31	V	7.88	0.85	19.34	33.01
1852.5	5	16-QAM	1/24	12.04	H	7.88	0.85	19.07	33.01
1880	5	16-QAM	1/0	11.62	H	7.88	0.85	18.65	33.01
1907.5	5	16-QAM	1/24	12.09	H	7.88	0.85	19.12	33.01
1855	10	QPSK	1/0	12.78	V	7.88	0.85	19.81	33.01
1880	10	QPSK	1/0	13.03	V	7.88	0.85	20.06	33.01
1905	10	QPSK	1/49	13.51	V	7.88	0.85	<b>20.54</b>	33.01
1855	10	QPSK	1/0	12.56	H	7.88	0.85	19.59	33.01
1880	10	QPSK	1/0	12.89	H	7.88	0.85	19.92	33.01
1905	10	QPSK	1/49	13.2	H	7.88	0.85	20.23	33.01
1855	10	16-QAM	1/0	12.33	V	7.88	0.85	19.36	33.01
1880	10	16-QAM	1/0	12.08	V	7.88	0.85	19.11	33.01
1905	10	16-QAM	1/49	11.95	V	7.88	0.85	18.98	33.01
1855	10	16-QAM	1/0	12.24	H	7.88	0.85	19.27	33.01
1880	10	16-QAM	1/0	11.84	H	7.88	0.85	18.87	33.01
1905	10	16-QAM	1/49	11.78	H	7.88	0.85	18.81	33.01
1857.5	15	QPSK	1/0	13.42	V	7.88	0.85	20.45	33.01
1880	15	QPSK	1/0	13.01	V	7.88	0.85	20.04	33.01
1902.5	15	QPSK	1/0	13.12	V	7.88	0.85	20.15	33.01
1857.5	15	QPSK	1/0	13.32	H	7.88	0.85	20.35	33.01
1880	15	QPSK	1/0	12.86	H	7.88	0.85	19.89	33.01
1902.5	15	QPSK	1/0	12.94	H	7.88	0.85	19.97	33.01
1857.5	15	16-QAM	1/0	12.08	V	7.88	0.85	19.11	33.01
1880	15	16-QAM	1/0	12.48	V	7.88	0.85	19.51	33.01
1902.5	15	16-QAM	1/0	11.98	V	7.88	0.85	19.01	33.01
1857.5	15	16-QAM	1/0	11.93	H	7.88	0.85	18.96	33.01
1880	15	16-QAM	1/0	12.24	H	7.88	0.85	19.27	33.01
1902.5	15	16-QAM	1/0	11.72	H	7.88	0.85	18.75	33.01
1860	20	QPSK	1/0	13.29	V	7.88	0.85	20.32	33.01
1880	20	QPSK	1/0	12.89	V	7.88	0.85	19.92	33.01
1900	20	QPSK	1/0	13.05	V	7.88	0.85	20.08	33.01
1860	20	QPSK	1/0	12.84	H	7.88	0.85	19.87	33.01
1880	20	QPSK	1/0	12.42	H	7.88	0.85	19.45	33.01
1900	20	QPSK	1/0	11.95	H	7.88	0.85	18.98	33.01
1860	20	16-QAM	1/0	12.05	V	7.88	0.85	19.08	33.01
1880	20	16-QAM	1/0	11.78	V	7.88	0.85	18.81	33.01
1900	20	16-QAM	1/0	12.26	V	7.88	0.85	19.29	33.01



Test Report	16070911-FCC-R5
Page	41 of 152

1860	20	16-QAM	1/0	11.84	H	7.88	0.85	18.87	33.01
1880	20	16-QAM	1/0	11.21	H	7.88	0.85	18.24	33.01
1900	20	16-QAM	1/0	11.68	H	7.88	0.85	18.71	33.01

### EIRP for LTE Band 4 (Part 27)

Frequency (MHz)	BW (MHz)	Modulation	RB Size/Offset	Substituted level (dBm)	Antenna Polarization	Antenna Gain correction (dBi)	Cable Loss (dB)	Absolute Level (dBm)	Limit (dBm)
1710.7	1.4	QPSK	1/0	12.45	V	7.95	0.79	19.61	30
1732.5	1.4	QPSK	1/0	12.85	V	7.95	0.79	20.01	30
1754.3	1.4	QPSK	1/0	12.06	V	7.95	0.79	19.22	30
1710.7	1.4	QPSK	1/0	11.74	H	7.95	0.79	18.9	30
1732.5	1.4	QPSK	1/0	11.98	H	7.95	0.79	19.14	30
1754.3	1.4	QPSK	1/0	11.62	H	7.95	0.79	18.78	30
1710.7	1.4	16-QAM	1/5	12.06	V	7.95	0.79	19.22	30
1732.5	1.4	16-QAM	1/0	12.23	V	7.95	0.79	19.39	30
1754.3	1.4	16-QAM	1/0	11.65	V	7.95	0.79	18.81	30
1710.7	1.4	16-QAM	1/5	11.45	H	7.95	0.79	18.61	30
1732.5	1.4	16-QAM	1/0	11.63	H	7.95	0.79	18.79	30
1754.3	1.4	16-QAM	1/0	11.21	H	7.95	0.79	18.37	30
1711.5	3	QPSK	1/0	12.03	V	7.95	0.79	19.19	30
1732.5	3	QPSK	1/0	13.11	V	7.95	0.79	20.27	30
1753.5	3	QPSK	1/0	12.24	V	7.95	0.79	19.4	30
1711.5	3	QPSK	1/0	11.52	H	7.95	0.79	18.68	30
1732.5	3	QPSK	1/0	12.32	H	7.95	0.79	19.48	30
1753.5	3	QPSK	1/0	11.64	H	7.95	0.79	18.8	30
1711.5	3	16-QAM	1/0	11.48	V	7.95	0.79	18.64	30
1732.5	3	16-QAM	1/0	12.38	V	7.95	0.79	19.54	30
1753.5	3	16-QAM	1/0	11.85	V	7.95	0.79	19.01	30
1711.5	3	16-QAM	1/0	10.36	H	7.95	0.79	17.52	30
1732.5	3	16-QAM	1/0	11.59	H	7.95	0.79	18.75	30
1753.5	3	16-QAM	1/0	10.76	H	7.95	0.79	17.92	30
1712.5	5	QPSK	1/0	12.33	V	7.95	0.79	19.49	30
1732.5	5	QPSK	1/0	12.89	V	7.95	0.79	20.05	30
1752.5	5	QPSK	1/24	11.85	V	7.95	0.79	19.01	30
1712.5	5	QPSK	1/0	11.71	H	7.95	0.79	18.87	30
1732.5	5	QPSK	1/0	11.92	H	7.95	0.79	19.08	30
1752.5	5	QPSK	1/24	10.69	H	7.95	0.79	17.85	30
1712.5	5	16-QAM	1/0	12.76	V	7.95	0.79	19.92	30
1732.5	5	16-QAM	1/0	12.56	V	7.95	0.79	19.72	30
1752.5	5	16-QAM	1/24	11.62	V	7.95	0.79	18.78	30
1712.5	5	16-QAM	1/0	11.54	H	7.95	0.79	18.7	30
1732.5	5	16-QAM	1/0	11.35	H	7.95	0.79	18.51	30

1752.5	5	16-QAM	1/24	10.93	H	7.95	0.79	18.09	30
1715	10	QPSK	1/0	12.21	V	7.95	0.79	19.37	30
1732.5	10	QPSK	1/49	12.33	V	7.95	0.79	19.49	30
1750	10	QPSK	1/0	12.18	V	7.95	0.79	19.34	30
1715	10	QPSK	1/0	11.84	H	7.95	0.79	19	30
1732.5	10	QPSK	1/49	11.92	H	7.95	0.79	19.08	30
1750	10	QPSK	1/0	11.61	H	7.95	0.79	18.77	30
1715	10	16-QAM	1/0	12.35	V	7.95	0.79	19.51	30
1732.5	10	16-QAM	1/49	12.04	V	7.95	0.79	19.2	30
1750	10	16-QAM	1/0	11.48	V	7.95	0.79	18.64	30
1715	10	16-QAM	1/0	11.54	H	7.95	0.79	18.7	30
1732.5	10	16-QAM	1/49	11.26	H	7.95	0.79	18.42	30
1750	10	16-QAM	1/0	10.59	H	7.95	0.79	17.75	30
1717.5	15	QPSK	1/0	12.41	V	7.95	0.79	19.57	30
1732.5	15	QPSK	1/74	12.25	V	7.95	0.79	19.41	30
1747.5	15	QPSK	1/0	12.81	V	7.95	0.79	19.97	30
1717.5	15	QPSK	1/0	11.54	H	7.95	0.79	18.7	30
1732.5	15	QPSK	1/74	11.26	H	7.95	0.79	18.42	30
1747.5	15	QPSK	1/0	11.73	H	7.95	0.79	18.89	30
1717.5	15	16-QAM	1/0	12.46	V	7.95	0.79	19.62	30
1732.5	15	16-QAM	1/74	11.48	V	7.95	0.79	18.64	30
1747.5	15	16-QAM	1/0	11.52	V	7.95	0.79	18.68	30
1717.5	15	16-QAM	1/0	11.82	H	7.95	0.79	18.98	30
1732.5	15	16-QAM	1/74	10.56	H	7.95	0.79	17.72	30
1747.5	15	16-QAM	1/0	10.64	H	7.95	0.79	17.8	30
1720	20	QPSK	1/99	12.03	V	7.95	0.79	19.19	30
1732.5	20	QPSK	1/99	12.18	V	7.95	0.79	19.34	30
1745	20	QPSK	1/0	13.45	V	7.95	0.79	<b>20.61</b>	30
1720	20	QPSK	1/99	11.48	H	7.95	0.79	18.64	30
1732.5	20	QPSK	1/99	11.69	H	7.95	0.79	18.85	30
1745	20	QPSK	1/0	12.52	H	7.95	0.79	19.68	30
1720	20	16-QAM	1/99	12.49	V	7.95	0.79	19.65	30
1732.5	20	16-QAM	1/99	12.53	V	7.95	0.79	19.69	30
1745	20	16-QAM	1/0	12.71	V	7.95	0.79	19.87	30
1720	20	16-QAM	1/99	11.32	H	7.95	0.79	18.48	30
1732.5	20	16-QAM	1/99	11.49	H	7.95	0.79	18.65	30
1745	20	16-QAM	1/0	11.66	H	7.95	0.79	18.82	30

### EIRP for LTE Band 5 (Part 22)

Frequency (MHz)	BW (MHz)	Modulation	RB Size/Offset	Substituted level (dBm)	Antenna Polarization	Antenna Gain correction (dBi)	Cable Loss (dB)	Absolute Level (dBm)	Limit (dBm)
824.7	1.4	QPSK	1/5	10.67	V	6.8	0.44	17.03	34.77
836.5	1.4	QPSK	1/5	10.51	V	6.8	0.44	16.87	34.77
848.3	1.4	QPSK	1/5	10.42	V	6.9	0.44	16.88	34.77
824.7	1.4	QPSK	1/5	9.54	H	6.8	0.44	15.9	34.77
836.5	1.4	QPSK	1/5	9.48	H	6.8	0.44	15.84	34.77
848.3	1.4	QPSK	1/5	9.32	H	6.9	0.44	15.78	34.77
824.7	1.4	16-QAM	1/5	10.62	V	6.8	0.44	16.98	34.77
836.5	1.4	16-QAM	1/5	10.21	V	6.8	0.44	16.57	34.77
848.3	1.4	16-QAM	1/5	10.72	V	6.9	0.44	17.18	34.77
824.7	1.4	16-QAM	1/5	9.62	H	6.8	0.44	15.98	34.77
836.5	1.4	16-QAM	1/5	9.25	H	6.8	0.44	15.61	34.77
848.3	1.4	16-QAM	1/5	9.84	H	6.9	0.44	16.3	34.77
825.5	3	QPSK	1/14	10.52	V	6.8	0.44	16.88	34.77
836.5	3	QPSK	1/0	10.65	V	6.8	0.44	17.01	34.77
847.5	3	QPSK	1/14	10.48	V	6.9	0.44	16.94	34.77
825.5	3	QPSK	1/14	9.63	H	6.8	0.44	15.99	34.77
836.5	3	QPSK	1/0	9.74	H	6.8	0.44	16.1	34.77
847.5	3	QPSK	1/14	9.51	H	6.9	0.44	15.97	34.77
825.5	3	16-QAM	1/14	11.02	V	6.8	0.44	17.38	34.77
836.5	3	16-QAM	1/0	10.63	V	6.8	0.44	16.99	34.77
847.5	3	16-QAM	1/14	10.82	V	6.9	0.44	17.28	34.77
825.5	3	16-QAM	1/14	9.48	H	6.8	0.44	15.84	34.77
836.5	3	16-QAM	1/0	9.23	H	6.8	0.44	15.59	34.77
847.5	3	16-QAM	1/14	9.32	H	6.9	0.44	15.78	34.77
826.5	5	QPSK	1/24	11.71	V	6.8	0.44	18.07	34.77
836.5	5	QPSK	1/24	11.62	V	6.8	0.44	17.98	34.77
846.5	5	QPSK	1/24	11.83	V	6.8	0.44	<b>18.19</b>	34.77
826.5	5	QPSK	1/24	10.65	H	6.8	0.44	17.01	34.77
836.5	5	QPSK	1/24	10.52	H	6.8	0.44	16.88	34.77
846.5	5	QPSK	1/24	10.73	H	6.8	0.44	17.09	34.77
826.5	5	16-QAM	1/24	10.86	V	6.8	0.44	17.22	34.77
836.5	5	16-QAM	1/24	10.77	V	6.8	0.44	17.13	34.77
846.5	5	16-QAM	1/24	10.68	V	6.8	0.44	17.04	34.77

826.5	5	16-QAM	1/24	9.84	H	6.8	0.44	16.2	34.77
836.5	5	16-QAM	1/24	9.62	H	6.8	0.44	15.98	34.77
846.5	5	16-QAM	1/24	9.32	H	6.8	0.44	15.68	34.77
829	10	QPSK	1/49	11.45	V	6.8	0.44	17.81	34.77
836.5	10	QPSK	1/49	11.63	V	6.8	0.44	17.99	34.77
844	10	QPSK	1/49	11.82	V	6.8	0.44	18.18	34.77
829	10	QPSK	1/49	10.48	H	6.8	0.44	16.84	34.77
836.5	10	QPSK	1/49	10.52	H	6.8	0.44	16.88	34.77
844	10	QPSK	1/49	10.65	H	6.8	0.44	17.01	34.77
829	10	16-QAM	1/49	11.09	V	6.8	0.44	17.45	34.77
836.5	10	16-QAM	1/49	10.85	V	6.8	0.44	17.21	34.77
844	10	16-QAM	1/49	10.63	V	6.8	0.44	16.99	34.77
829	10	16-QAM	1/49	10.27	H	6.8	0.44	16.63	34.77
836.5	10	16-QAM	1/49	9.63	H	6.8	0.44	15.99	34.77
844	10	16-QAM	1/49	9.52	H	6.8	0.44	15.88	34.77

### ERP for LTE Band 7 (Part 27)

Frequency (MHz)	BW (MHz)	Modulation	RB Size/Offset	Substituted level (dBm)	Antenna Polarization	Antenna Gain correction (dBi)	Cable Loss (dB)	Absolute Level (dBm)	Limit (dBm)
2502.5	5	QPSK	1/0	10.74	V	8.93	0.83	18.84	30
2535	5	QPSK	1/0	11.46	V	8.93	0.83	19.56	30
2567.5	5	QPSK	1/24	11.69	V	8.93	0.83	19.79	30
2502.5	5	QPSK	1/0	9.55	H	8.93	0.83	17.65	30
2535	5	QPSK	1/0	10.28	H	8.93	0.83	18.38	30
2567.5	5	QPSK	1/24	10.68	H	8.93	0.83	18.78	30
2502.5	5	16-QAM	1/0	11.12	V	8.93	0.83	19.22	30
2535	5	16-QAM	1/0	11.49	V	8.93	0.83	19.59	30
2567.5	5	16-QAM	1/24	10.81	V	8.93	0.83	18.91	30
2502.5	5	16-QAM	1/0	10.62	H	8.93	0.83	18.72	30
2535	5	16-QAM	1/0	10.73	H	8.93	0.83	18.83	30
2567.5	5	16-QAM	1/24	9.65	H	8.93	0.83	17.75	30
2505	10	QPSK	1/0	11.46	V	8.93	0.83	19.56	30
2535	10	QPSK	1/49	11.21	V	8.93	0.83	19.31	30
2565	10	QPSK	1/0	11.32	V	8.93	0.83	19.42	30
2505	10	QPSK	1/0	10.52	H	8.93	0.83	18.62	30
2535	10	QPSK	1/49	10.35	H	8.93	0.83	18.45	30
2565	10	QPSK	1/0	10.12	H	8.93	0.83	18.22	30
2505	10	16-QAM	1/0	11.89	V	8.93	0.83	<b>19.99</b>	30
2535	10	16-QAM	1/49	10.58	V	8.93	0.83	18.68	30
2565	10	16-QAM	1/0	10.62	V	8.93	0.83	18.72	30
2505	10	16-QAM	1/0	10.68	H	8.93	0.83	18.78	30
2535	10	16-QAM	1/49	9.84	H	8.93	0.83	17.94	30
2565	10	16-QAM	1/0	9.88	H	8.93	0.83	17.98	30
2507.5	15	QPSK	1/0	11.31	V	8.93	0.83	19.41	30
2535	15	QPSK	1/74	11.57	V	8.93	0.83	19.67	30
2562.5	15	QPSK	1/0	11.25	V	8.93	0.83	19.35	30
2507.5	15	QPSK	1/0	10.62	H	8.93	0.83	18.72	30
2535	15	QPSK	1/74	10.89	H	8.93	0.83	18.99	30
2562.5	15	QPSK	1/0	10.47	H	8.93	0.83	18.57	30
2507.5	15	16-QAM	1/0	10.96	V	8.93	0.83	19.06	30
2535	15	16-QAM	1/74	11.58	V	8.93	0.83	19.68	30
2562.5	15	16-QAM	1/0	11.43	V	8.93	0.83	19.53	30
2507.5	15	16-QAM	1/0	9.53	H	8.93	0.83	17.63	30
2535	15	16-QAM	1/74	10.52	H	8.93	0.83	18.62	30

2562.5	15	16-QAM	1/0	10.61	H	8.93	0.83	18.71	30
2510	20	QPSK	1/99	10.83	V	8.93	0.83	18.93	30
2535	20	QPSK	1/99	10.92	V	8.93	0.83	19.02	30
2560	20	QPSK	1/0	11.21	V	8.93	0.83	19.31	30
2510	20	QPSK	1/99	9.66	H	8.93	0.83	17.76	30
2535	20	QPSK	1/99	9.82	H	8.93	0.83	17.92	30
2560	20	QPSK	1/0	10.55	H	8.93	0.83	18.65	30
2510	20	16-QAM	1/99	11.74	V	8.93	0.83	19.84	30
2535	20	16-QAM	1/99	11.43	V	8.93	0.83	19.53	30
2560	20	16-QAM	1/0	10.84	V	8.93	0.83	18.94	30
2510	20	16-QAM	1/99	10.56	H	8.93	0.83	18.66	30
2535	20	16-QAM	1/99	10.35	H	8.93	0.83	18.45	30
2560	20	16-QAM	1/0	9.81	H	8.93	0.83	17.91	30

### ERP for LTE Band 12(Part 27)

Frequency (MHz)	BW (MHz)	Modulation	RB Size/Offset	Substituted level (dBm)	Antenna Polarization	Antenna Gain correction (dBi)	Cable Loss (dB)	Absolute Level (dBm)	Limit (dBm)
699.7	1.4	QPSK	1/5	9.82	V	6.9	0.42	16.3	34.77
707.5	1.4	QPSK	1/5	9.71	V	6.8	0.42	16.09	34.77
715.3	1.4	QPSK	1/5	9.53	V	6.8	0.42	15.91	34.77
699.7	1.4	QPSK	1/5	8.62	H	6.9	0.42	15.1	34.77
707.5	1.4	QPSK	1/5	8.51	H	6.8	0.42	14.89	34.77
715.3	1.4	QPSK	1/5	8.23	H	6.8	0.42	14.61	34.77
699.7	1.4	16-QAM	1/5	8.76	V	6.9	0.42	15.24	34.77
707.5	1.4	16-QAM	1/5	9.73	V	6.8	0.42	16.11	34.77
715.3	1.4	16-QAM	1/5	9.93	V	6.8	0.42	<b>16.31</b>	34.77
699.7	1.4	16-QAM	1/5	7.82	H	6.9	0.42	14.3	34.77
707.5	1.4	16-QAM	1/5	8.61	H	6.8	0.42	14.99	34.77
715.3	1.4	16-QAM	1/5	8.77	H	6.8	0.42	15.15	34.77
700.5	3	QPSK	1/14	9.45	V	6.9	0.42	15.93	34.77
707.5	3	QPSK	1/0	9.89	V	6.8	0.42	16.27	34.77
714.5	3	QPSK	1/14	9.64	V	6.8	0.42	16.02	34.77
700.5	3	QPSK	1/14	8.29	H	6.9	0.42	14.77	34.77
707.5	3	QPSK	1/0	8.57	H	6.8	0.42	14.95	34.77
714.5	3	QPSK	1/14	8.68	H	6.8	0.42	15.06	34.77
700.5	3	16-QAM	1/14	9.75	V	6.9	0.42	16.23	34.77
707.5	3	16-QAM	1/0	9.58	V	6.8	0.42	15.96	34.77
714.5	3	16-QAM	1/14	9.38	V	6.8	0.42	15.76	34.77
700.5	3	16-QAM	1/14	8.59	H	6.9	0.42	15.07	34.77
707.5	3	16-QAM	1/0	8.43	H	6.8	0.42	14.81	34.77
714.5	3	16-QAM	1/14	8.23	H	6.8	0.42	14.61	34.77
701.5	5	QPSK	1/24	9.57	V	6.9	0.42	16.05	34.77
707.5	5	QPSK	1/24	9.66	V	6.8	0.42	16.04	34.77
713.5	5	QPSK	1/24	9.31	V	6.8	0.42	15.69	34.77
701.5	5	QPSK	1/24	8.62	H	6.9	0.42	15.1	34.77
707.5	5	QPSK	1/24	8.41	H	6.8	0.42	14.79	34.77
713.5	5	QPSK	1/24	8.23	H	6.8	0.42	14.61	34.77
701.5	5	16-QAM	1/24	9.46	V	6.9	0.42	15.94	34.77
707.5	5	16-QAM	1/24	9.69	V	6.8	0.42	16.07	34.77
713.5	5	16-QAM	1/24	9.53	V	6.8	0.42	15.91	34.77
701.5	5	16-QAM	1/24	8.49	H	6.9	0.42	14.97	34.77
707.5	5	16-QAM	1/24	8.78	H	6.8	0.42	15.16	34.77



713.5	5	16-QAM	1/24	8.23	H	6.8	0.42	14.61	34.77
704	10	QPSK	1/49	9.48	V	6.8	0.42	15.86	34.77
707.5	10	QPSK	1/49	9.39	V	6.8	0.42	15.77	34.77
711	10	QPSK	1/49	9.19	V	6.8	0.42	15.57	34.77
704	10	QPSK	1/49	8.38	H	6.8	0.42	14.76	34.77
707.5	10	QPSK	1/49	8.52	H	6.8	0.42	14.9	34.77
711	10	QPSK	1/49	8.21	H	6.8	0.42	14.59	34.77
704	10	16-QAM	1/49	9.55	V	6.8	0.42	15.93	34.77
707.5	10	16-QAM	1/49	9.61	V	6.8	0.42	15.99	34.77
711	10	16-QAM	1/49	9.48	V	6.8	0.42	15.86	34.77
704	10	16-QAM	1/49	8.62	H	6.8	0.42	15	34.77
707.5	10	16-QAM	1/49	8.73	H	6.8	0.42	15.11	34.77
711	10	16-QAM	1/49	8.54	H	6.8	0.42	14.92	34.77

### ERP for LTE Band 17 (Part 27)

Frequency (MHz)	BW (MHz)	Modulation	RB Size/Offset	Substituted level (dBm)	Antenna Polarization	Antenna Gain correction (dBi)	Cable Loss (dB)	Absolute Level (dBm)	Limit (dBm)
706.5	5	QPSK	1/0	9.31	V	6.8	0.42	15.69	34.77
710	5	QPSK	1/0	9.56	V	6.8	0.42	15.94	34.77
713.5	5	QPSK	1/0	9.27	V	6.8	0.42	15.65	34.77
706.5	5	QPSK	1/0	8.53	H	6.8	0.42	14.91	34.77
710	5	QPSK	1/0	8.67	H	6.8	0.42	15.05	34.77
713.5	5	QPSK	1/0	8.59	H	6.8	0.42	14.97	34.77
706.5	5	16-QAM	1/0	9.44	V	6.8	0.42	15.82	34.77
710	5	16-QAM	1/0	9.05	V	6.8	0.42	15.43	34.77
713.5	5	16-QAM	1/0	9.62	V	6.8	0.42	16	34.77
706.5	5	16-QAM	1/0	8.36	H	6.8	0.42	14.74	34.77
710	5	16-QAM	1/0	8.21	H	6.8	0.42	14.59	34.77
713.5	5	16-QAM	1/0	8.67	H	6.8	0.42	15.05	34.77
709	10	QPSK	1/0	9.89	V	6.8	0.42	<b>16.27</b>	34.77
710	10	QPSK	1/0	9.37	V	6.8	0.42	15.75	34.77
711	10	QPSK	1/0	9.52	V	6.8	0.42	15.9	34.77
709	10	QPSK	1/0	8.76	H	6.8	0.42	15.14	34.77
710	10	QPSK	1/0	8.51	H	6.8	0.42	14.89	34.77
711	10	QPSK	1/0	8.66	H	6.8	0.42	15.04	34.77
709	10	16-QAM	1/0	9.63	V	6.8	0.42	16.01	34.77
710	10	16-QAM	1/0	9.28	V	6.8	0.42	15.66	34.77
711	10	16-QAM	1/0	9.51	V	6.8	0.42	15.89	34.77
709	10	16-QAM	1/0	8.21	H	6.8	0.42	14.59	34.77
710	10	16-QAM	1/0	8.09	H	6.8	0.42	14.47	34.77
711	10	16-QAM	1/0	8.18	H	6.8	0.42	14.56	34.77

### 6.3 Peak-Average Ratio

Temperature	24°C
Relative Humidity	51%
Atmospheric Pressure	1027mbar
Test date :	August 27, 2016
Tested By :	Loren Luo

Requirement(s):

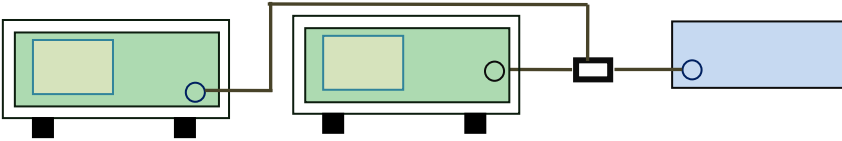
Spec	Item	Requirement	Applicable
§24.232(d) § 27.50(d)	a)	The peak-to-average ratio (PAR) of the transmission may not exceed 13 dB.	<input checked="" type="checkbox"/>
Test Setup			
Test Procedure	<p><b>According with KDB 971168 v02r02</b></p> <p><b>5.7.2 Alternate procedure for PAPR</b></p> <p><b>5.1.2 Peak power measurements with a peak power meter</b></p> <p>The total peak output power may be measured using a broadband peak RF power meter. The power meter must have a video bandwidth that is greater than or equal to the emission bandwidth and utilize a fast-responding diode detector.</p> <p><b>5.2.3 Average power measurement with average power meter</b></p> <p>As an alternative to the use of a spectrum/signal analyzer or EMI receiver to perform a measurement of the total in-band average output power, a wideband RF average power meter with a thermocouple detector or equivalent can be used under certain conditions</p> <p>If the EUT can be configured to transmit continuously (i.e., the burst duty cycle <math>\geq 98\%</math>) and at all times the EUT is transmitting at its maximum output</p>		

Test Report	16070911-FCC-R5
Page	52 of 152

	<p>power level, then a conventional wide-band RF power meter can be used. If the EUT cannot be configured to transmit continuously (i.e., the burst duty cycle &lt; 98%), then there are two options for the use of an average power meter. First, a gated average power meter can be used to perform the measurement if the gating parameters can be adjusted such that the power is measured only over active transmission bursts at maximum output power levels. A conventional average power meter can also be used if the measured burst duty cycle is constant (i.e., duty cycle variations are less than <math>\pm 2</math> percent) by performing the measurement over the on/off burst cycles and then correcting (increasing) the measured level by a factor equal to <math>10\log(1/\text{duty cycle})</math></p>
Remark	
Result	<input checked="" type="checkbox"/> Pass <input type="checkbox"/> Fail

**Test Data**     Yes                       N/A  
**Test Plot**     Yes (See below)             N/A

### LTE Band 2 (part 24E)

BW(MHz)	Frequency (MHz)	Mode	Modulation	Conducted Power (dBm)		Peak-Average Ratio (PAR)
				Peak	Average	
1.4	1880	RB 1/0	QPSK	25.17	22.36	2.81
			16QAM	25.02	21.25	3.77
3	1880	RB 1/0	QPSK	25.13	22.26	2.87
			16QAM	25.04	21.41	3.63
5	1880	RB 1/0	QPSK	25.42	22.47	2.95
			16QAM	25.08	21.36	3.72
10	1880	RB 1/0	QPSK	25.35	22.56	2.79
			16QAM	25.14	21.62	3.52
15	1880	RB 1/0	QPSK	25.33	22.57	2.76
			16QAM	25.47	21.95	3.52
20	1880	RB 1/0	QPSK	25.39	22.18	3.21
			16QAM	25.19	21.37	3.82

### LTE Band 4 (part 27)

BW(MHz)	Frequency (MHz)	Mode	Modulation	Conducted Power (dBm)		Peak-Average Ratio (PAR)
				Peak	Average	
1.4	1732.5	RB 1/0	QPSK	25.53	23.17	2.36
			16QAM	25.12	22.27	2.85
3	1732.5	RB 1/0	QPSK	25.56	23.32	2.24
			16QAM	25.23	22.41	2.82
5	1732.5	RB 1/0	QPSK	25.22	23.13	2.09
			16QAM	25.64	22.53	3.11
10	1732.5	RB 1/0	QPSK	25.72	22.44	3.28
			16QAM	25.21	21.65	3.56
15	1732.5	RB 1/0	QPSK	25.33	22.18	3.15
			16QAM	25.11	21.37	3.74
20	1732.5	RB 1/0	QPSK	25.58	22.67	2.91
			16QAM	25.59	22.52	3.07

### LTE Band 5 (part 27)

BW(MHz)	Frequency (MHz)	Mode	Modulation	Conducted Power (dBm)		Peak-Average Ratio (PAR)
				Peak	Average	
1.4	836.5	RB 1/0	QPSK	25.46	22.34	3.12
			16QAM	25.43	21.79	3.64
3	836.5	RB 1/0	QPSK	25.87	22.37	3.5
			16QAM	25.46	21.88	3.58
5	836.5	RB 1/0	QPSK	25.61	23.12	2.49
			16QAM	24.56	22.47	2.09
10	836.5	RB 1/0	QPSK	25.41	22.47	2.94
			16QAM	25.77	22.82	2.95

### LTE Band 7 (part 27)

BW(MHz)	Frequency (MHz)	Mode	Modulation	Conducted Power (dBm)		Peak-Average Ratio (PAR)
				Peak	Average	
5	2535	RB 1/0	QPSK	25.33	22.54	2.79
			16QAM	25.46	22.56	2.9
10	2535	RB 1/0	QPSK	24.75	22.16	2.59
			16QAM	24.23	21.64	2.59
15	2535	RB 1/0	QPSK	25.34	22.62	2.72
			16QAM	24.35	22.61	1.74
20	2535	RB 1/0	QPSK	24.92	22.13	2.79
			16QAM	24.27	22.54	1.73

### LTE Band 12 (part 27)

BW(MHz)	Frequency (MHz)	Mode	Modulation	Conducted Power (dBm)		Peak-Average Ratio (PAR)
				Peak	Average	
1.4	1732.5	RB 1/0	QPSK	24.24	22.42	1.82
			16QAM	24.52	22.53	1.99
3	1732.5	RB 1/0	QPSK	24.83	22.63	2.2
			16QAM	24.79	22.44	2.35
5	1732.5	RB 1/0	QPSK	25.32	22.68	2.64
			16QAM	25.43	22.62	2.81
10	1732.5	RB 1/0	QPSK	25.13	22.35	2.88
			16QAM	25.17	22.52	2.65

### LTE Band 17 (part 27)

BW(MHz)	Frequency (MHz)	Mode	Modulation	Conducted Power (dBm)		Peak-Average Ratio (PAR)
				Peak	Average	
5	710	RB 1/0	QPSK	25.24	22.41	2.83
			16QAM	24.47	22.12	2.35
10	710	RB 1/0	QPSK	25.09	22.21	2.88
			16QAM	25.12	22.14	2.98

## 6.4 Occupied Bandwidth

Temperature	23°C
Relative Humidity	59%
Atmospheric Pressure	1026mbar
Test date :	August 26, 2016
Tested By :	Loren Luo

### Requirement(s):

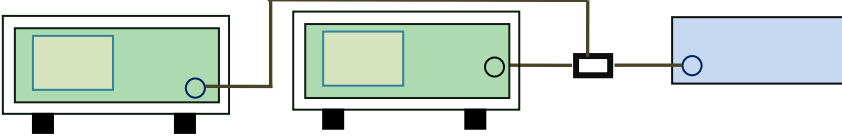
Spec	Item	Requirement	Applicable
§2.1049, §22.917, §22.905 §24.238 §27.53(a)	a)	99% Occupied Bandwidth(kHz)	<input checked="" type="checkbox"/>
	b)	26 dB Bandwidth(kHz)	<input checked="" type="checkbox"/>
Test Setup			
Test Procedure	<ul style="list-style-type: none"> <li>- The EUT was connected to Spectrum Analyzer and Base Station via power divider.</li> <li>- The 99% and 26 dB occupied bandwidth (BW) of the middle channel for the highest RF powers.</li> </ul>		
Remark			
Result	<input checked="" type="checkbox"/> Pass <input type="checkbox"/> Fail		

Test Data     Yes                       N/A

Test Plot     Yes (See below)             N/A



### LTE Band 2 (Part 24E)

BW(MHz)	Channel	Frequency (MHz)	Modulation	99% Occupied Bandwidth (MHz)	26 dB Bandwidth (MHz)
1.4	18607	1850.7	16QAM	1.1005	1.292
			QPSK	1.1022	1.294
1.4	18900	1880	16QAM	1.1039	1.307
			QPSK	1.1034	1.282
1.4	19193	1909.3	16QAM	1.1134	1.429
			QPSK	1.1139	1.390
3	18615	1851.5	16QAM	2.7566	3.142
			QPSK	2.7486	3.119
3	18900	1880	16QAM	2.7547	3.112
			QPSK	2.7483	3.112
3	19185	1908.5	16QAM	2.7711	3.537
			QPSK	2.7598	3.347
5	18625	1852.5	16QAM	4.5229	5.062
			QPSK	4.5328	5.121
5	18900	1880	16QAM	4.5233	5.086
			QPSK	4.5297	5.064
5	19175	1907.5	16QAM	4.5463	5.084
			QPSK	4.5444	5.094
10	18650	1855	16QAM	9.0747	10.295
			QPSK	9.0723	10.278
10	18900	1880	16QAM	9.0820	10.349
			QPSK	9.0844	10.248
10	19150	1905	16QAM	9.0870	10.445
			QPSK	9.0873	10.366
15	18675	1857.5	16QAM	13.5108	15.081
			QPSK	13.4953	15.071
15	18900	1880	16QAM	13.5185	14.998
			QPSK	13.5155	15.027
15	19125	1902.5	16QAM	13.4961	15.064
			QPSK	13.4913	14.963

20	18700	1860	16QAM	17.9676	19.667
			QPSK	17.9240	19.527
20	18900	1880	16QAM	17.9023	19.616
			QPSK	17.9366	19.659
20	19100	1900	16QAM	17.9783	19.613
			QPSK	17.9197	19.680

### LTE Band 4 (Part 27)

BW(MHz)	Channel	Frequency (MHz)	Modulation	99% Occupied Bandwidth (MHz)	26 dB Bandwidth (MHz)
1.4	19957	1710.7	16QAM	1.1051	1.283
			QPSK	1.1012	1.280
1.4	20175	1732.5	16QAM	1.1055	1.284
			QPSK	1.1191	1.284
1.4	20393	1754.3	16QAM	1.1078	1.296
			QPSK	1.1057	1.293
3	19965	1711.5	16QAM	2.7436	3.093
			QPSK	2.7457	3.098
3	20175	1732.5	16QAM	2.7517	3.120
			QPSK	2.7510	3.076
3	20385	1753.5	16QAM	2.7510	3.127
			QPSK	2.7490	3.127
5	19975	1712.5	16QAM	4.5249	5.099
			QPSK	4.5230	5.122
5	20175	1732.5	16QAM	4.5414	5.085
			QPSK	4.5588	5.088
5	20375	1752.5	16QAM	4.5259	5.071
			QPSK	4.5284	5.112
10	20000	1715	16QAM	9.0877	10.382
			QPSK	9.0925	10.227
10	20175	1732.5	16QAM	9.0686	10.327
			QPSK	9.0610	10.207
10	20350	1750	16QAM	9.1042	10.272
			QPSK	9.0922	10.285
15	20025	1717.5	16QAM	13.4480	14.993
			QPSK	13.4387	14.894
15	20175	1732.5	16QAM	13.5025	14.963
			QPSK	13.5127	15.056
15	20325	1747.5	16QAM	13.5386	14.993
			QPSK	13.5181	14.917

20	20050	1720	16QAM	17.8595	19.477
			QPSK	17.8504	19.504
20	20175	1732.5	16QAM	17.9105	19.723
			QPSK	17.9132	19.684
20	20300	1745	16QAM	17.9646	19.640
			QPSK	17.9683	19.611

### LTE Band 5 (Part 22H)

BW(MHz)	Channel	Frequency (MHz)	Modulation	99% Occupied Bandwidth (MHz)	26 dB Bandwidth (MHz)
1.4	20407	824.7	16QAM	1.1065	1.282
			QPSK	1.1020	1.279
1.4	20525	836.5	16QAM	1.1096	1.278
			QPSK	1.1159	1.281
1.4	20643	848.3	16QAM	1.1084	1.305
			QPSK	1.1023	1.287
3	20415	825.5	16QAM	2.7475	3.093
			QPSK	2.7517	3.094
3	20525	836.5	16QAM	2.7422	3.091
			QPSK	2.7426	3.077
3	20635	847.5	16QAM	2.7544	3.117
			QPSK	2.7420	3.128
5	20425	826.5	16QAM	4.5296	5.082
			QPSK	4.5298	5.087
5	20525	836.5	16QAM	4.5263	5.101
			QPSK	4.5117	5.075
5	20625	846.5	16QAM	4.5380	5.084
			QPSK	4.5282	5.098
10	20450	819	16QAM	9.0145	10.112
			QPSK	9.0293	10.149
10	20525	836.5	16QAM	9.1406	10.239
			QPSK	9.1279	10.366
10	20800	844	16QAM	9.0278	10.237
			QPSK	9.0269	10.150

### LTE Band 7 (Part 27) result

BW(MHz)	Channel	Frequency (MHz)	Modulation	99% Occupied Bandwidth (MHz)	26 dB Bandwidth (MHz)
5	20775	2502.5	16QAM	4.5501	5.082
			QPSK	4.5422	5.114
5	21100	2535	16QAM	4.5497	5.101
			QPSK	4.5445	5.119
5	21425	2567.5	16QAM	4.5257	5.099
			QPSK	4.5346	5.085
10	20800	2505	16QAM	9.0882	10.274
			QPSK	9.0761	10.214
10	21100	2535	16QAM	9.1115	10.394
			QPSK	9.1173	10.302
10	21400	2562.5	16QAM	9.1287	10.446
			QPSK	9.1353	10.383
15	20825	2507.5	16QAM	13.4317	15.024
			QPSK	13.4611	14.988
15	21100	2535	16QAM	13.5215	15.013
			QPSK	13.5002	15.058
15	21400	2562.5	16QAM	13.5744	15.087
			QPSK	13.5810	15.112
20	20850	2510	16QAM	17.8852	19.493
			QPSK	17.8292	19.475
20	21100	2535	16QAM	17.9487	19.696
			QPSK	17.9328	19.812
20	21350	2560	16QAM	17.9750	19.695
			QPSK	18.0102	19.556

### LTE Band 12 (Part 27)

BW(MHz)	Channel	Frequency (MHz)	Modulation	99% Occupied Bandwidth (MHz)	26 dB Bandwidth (MHz)
1.4	23017	699.7	16QAM	1.1043	1.280
			QPSK	1.0987	1.283
1.4	23095	707.5	16QAM	1.1006	1.264
			QPSK	1.0994	1.267
1.4	23173	715.3	16QAM	1.1051	1.280
			QPSK	1.1084	1.278
3	23025	700.5	16QAM	2.7387	3.086
			QPSK	2.7444	3.080
3	23095	707.5	16QAM	2.7363	3.085
			QPSK	2.7413	3.098
3	23165	714.5	16QAM	2.7444	3.125
			QPSK	2.7418	3.088
5	23035	701.5	16QAM	4.5329	5.092
			QPSK	4.5183	5.071
5	23095	707.5	16QAM	4.5364	5.123
			QPSK	4.5315	5.079
5	23055	713.5	16QAM	4.5345	5.044
			QPSK	4.5315	5.130
10	23060	704	16QAM	9.0985	10.195
			QPSK	9.0971	10.256
10	23095	707.5	16QAM	9.0662	10.253
			QPSK	9.0828	10.264
10	23130	711	16QAM	9.0796	10.328
			QPSK	9.0855	10.180

### LTE Band 17 (Part 27)

BW(MHz)	Channel	Frequency (MHz)	Modulation	99% Occupied Bandwidth (MHz)	26 dB Bandwidth (MHz)
5	23755	706.5	16QAM	4.5461	5.113
			QPSK	4.5366	5.064
5	23790	710	16QAM	4.5348	5.050
			QPSK	4.5242	5.058
5	23825	713.5	16QAM	4.5407	5.075
			QPSK	4.5359	5.088
10	23780	709	16QAM	9.0778	10.235
			QPSK	9.0356	10.185
10	23790	710	16QAM	9.0522	10.232
			QPSK	9.0703	10.249
10	23800	711	16QAM	9.0966	10.287
			QPSK	9.0774	10.335



**Test Plots**

**LTE Band 2 (Part 24E)**

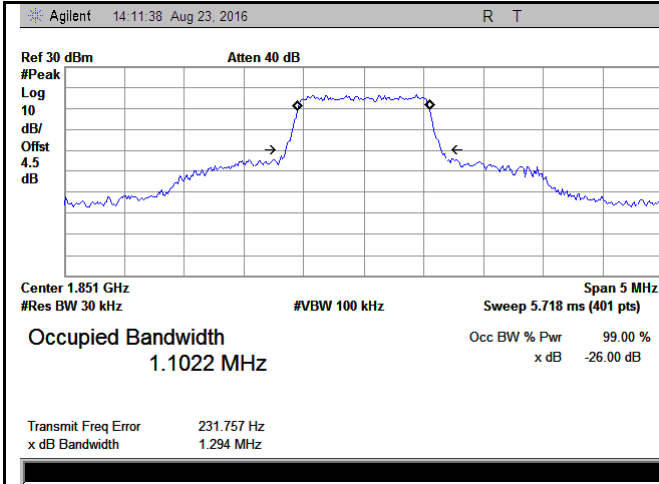

LTE band 2 - Low CH QPSK-1.4

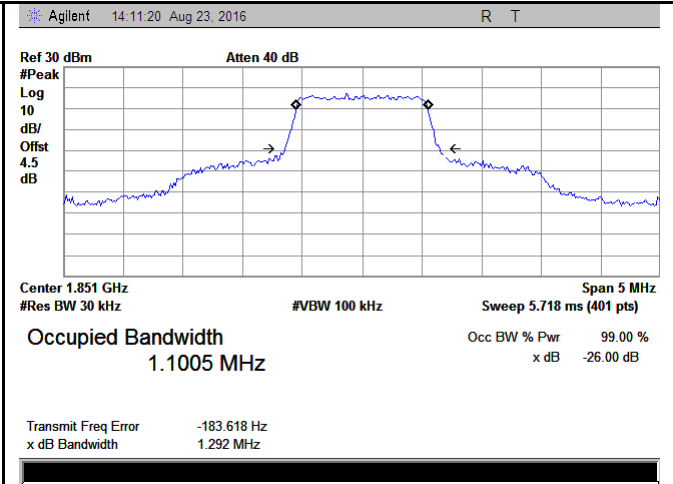

LTE band 2 - Low CH 16QAM-1.4

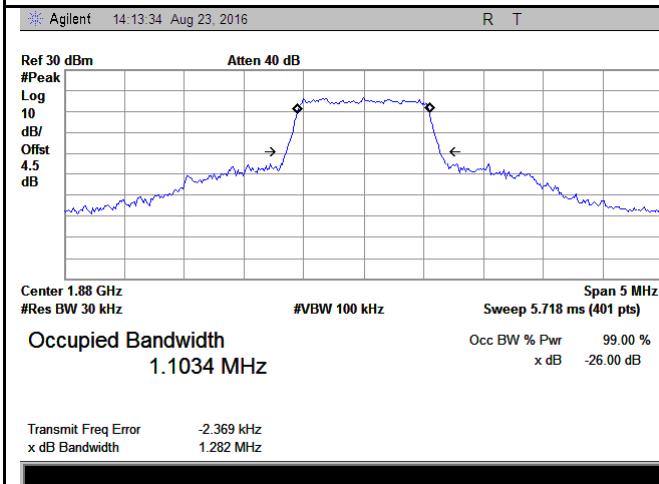

LTE band 2 - Middle CH QPSK-1.4

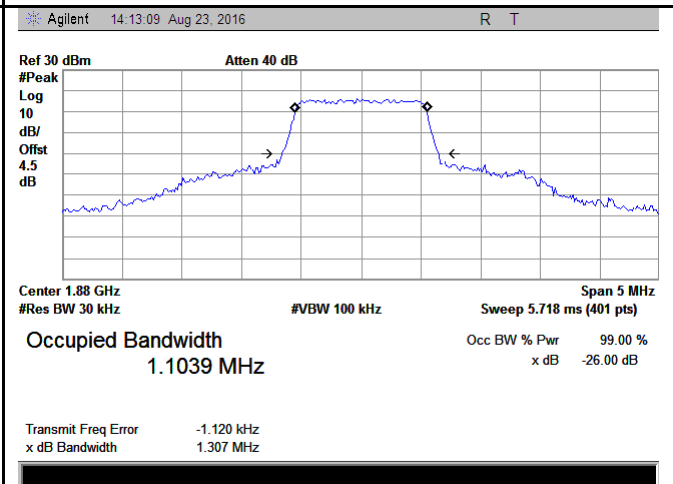

LTE band 2 - Middle CH 16QAM-1.4

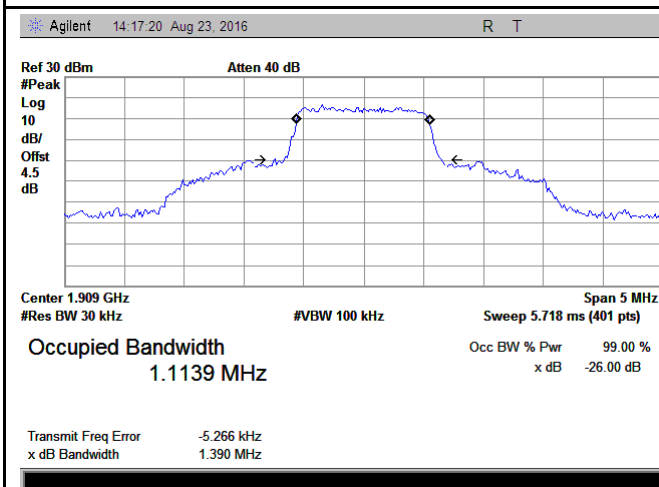

LTE band 2 - High CH QPSK-1.4

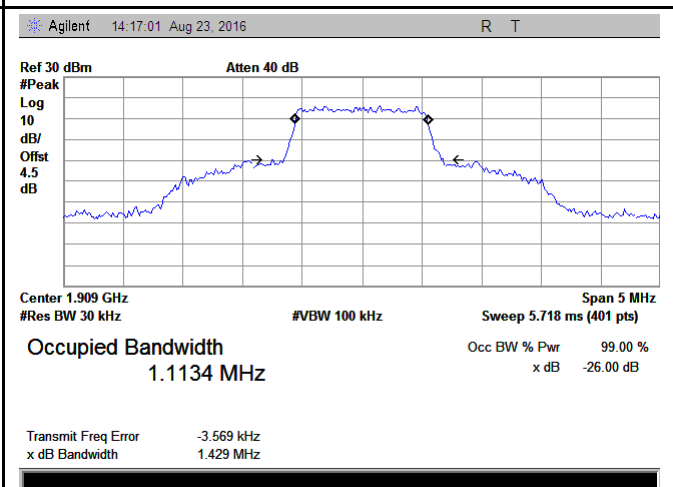

LTE band 2 - High CH 16QAM-1.4

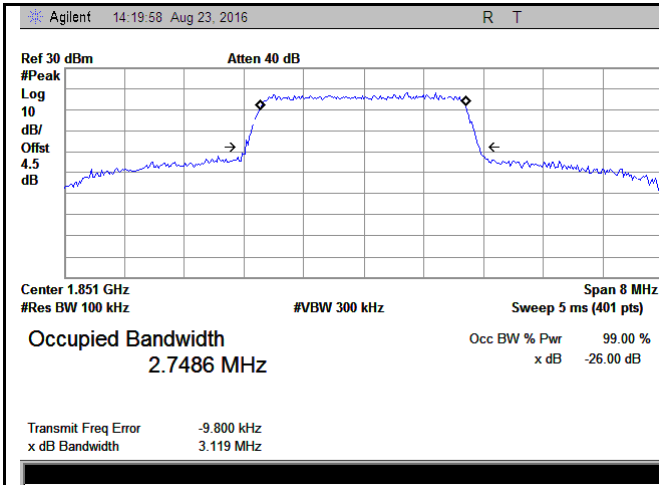

LTE band 2 - Low CH QPSK-3

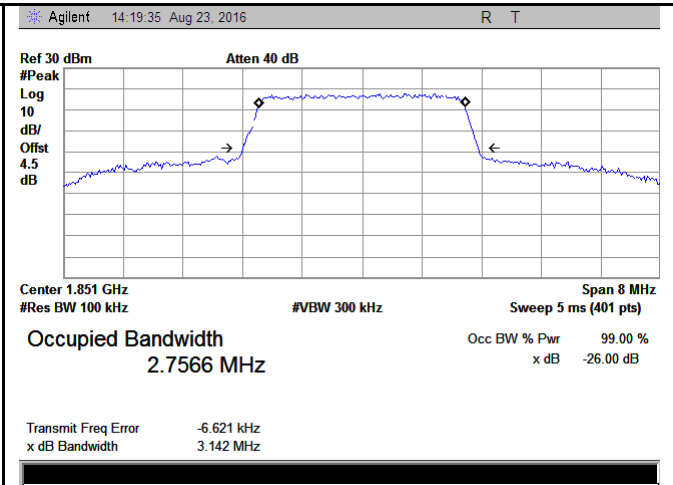

LTE band 2 - Low CH 16QAM-3

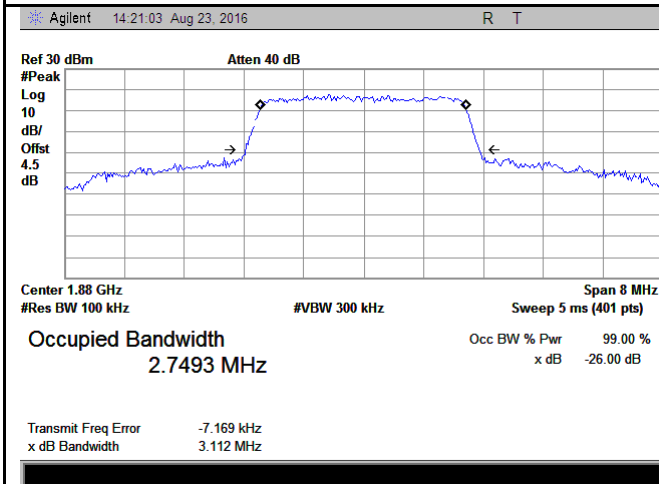

LTE band 2 - Middle CH QPSK-3

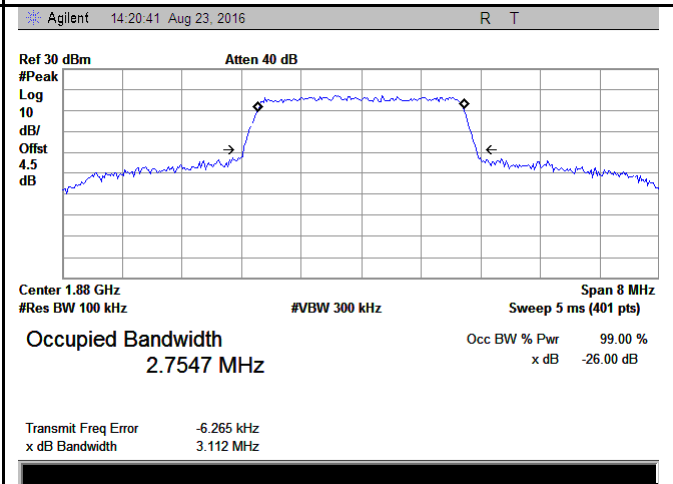

LTE band 2 - Middle CH 16QAM-3

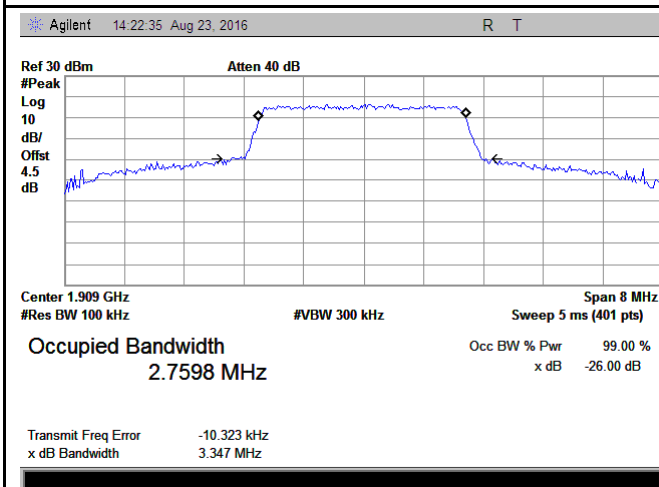

LTE band 2 - High CH QPSK-3

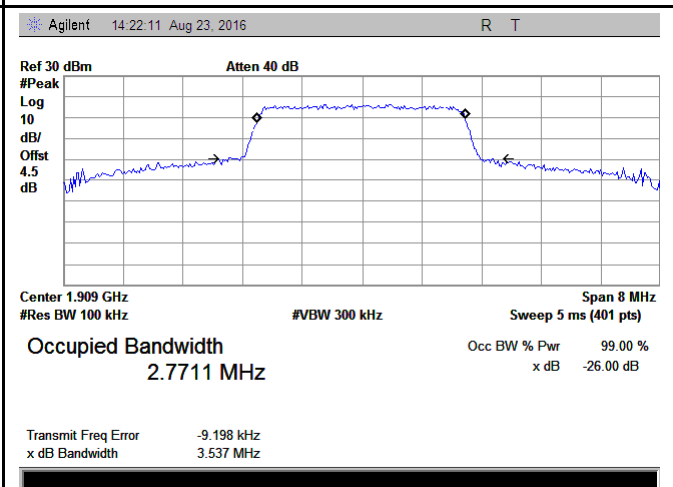

LTE band 2 - High CH 16QAM-3

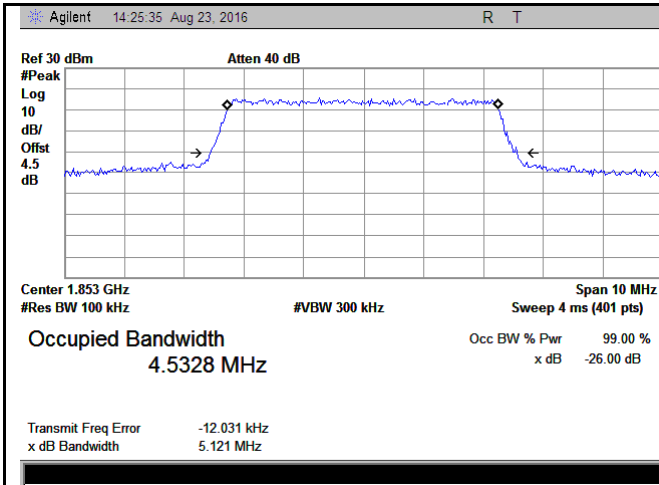

LTE band 2 - Low CH QPSK-5

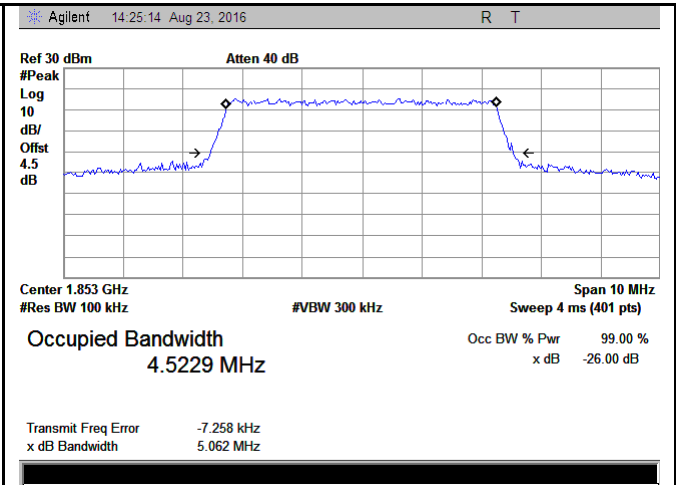

LTE band 2 - Low CH 16QAM-5

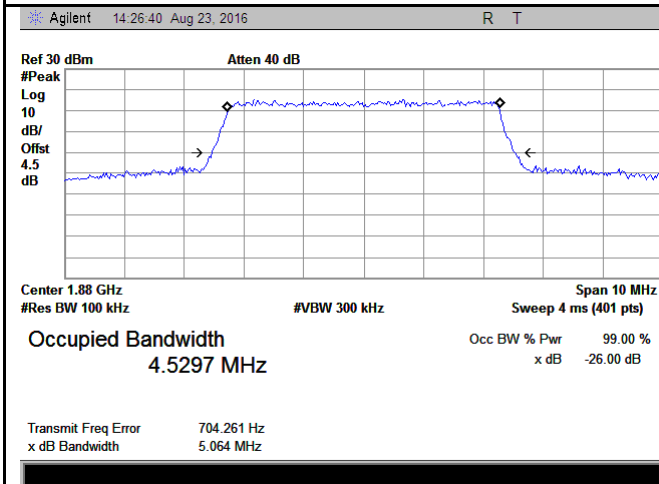

LTE band 2 - Middle CH QPSK-5

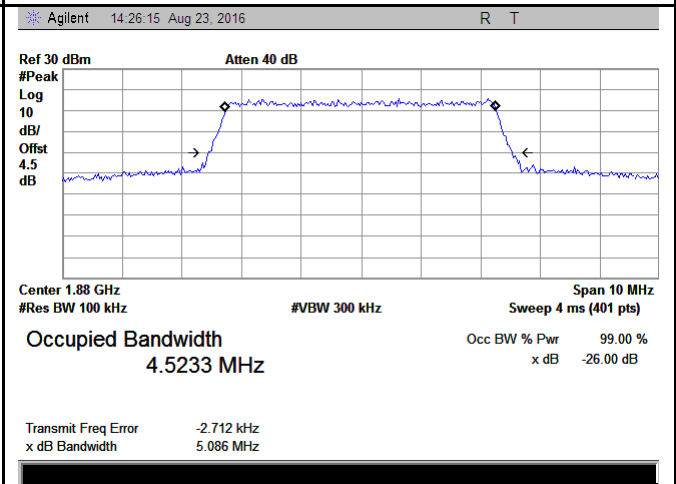

LTE band 2 - Middle CH 16QAM-5

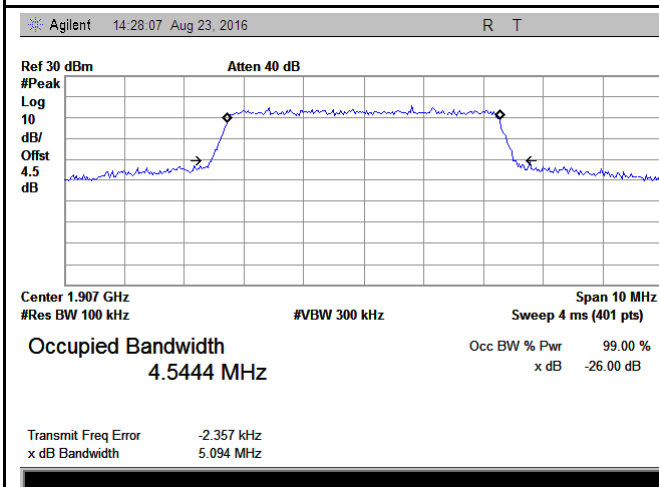

LTE band 2 - High CH QPSK-5

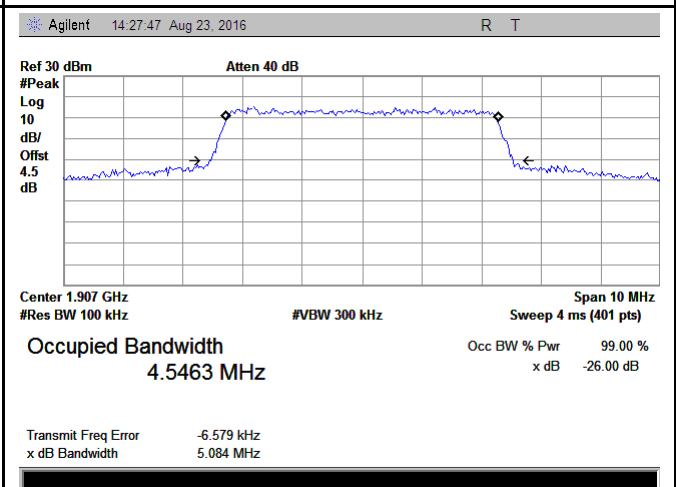

LTE band 2 - High CH 16QAM-5

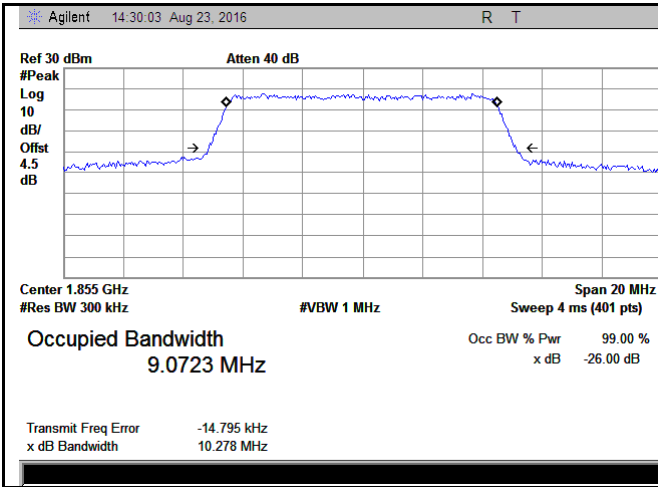

LTE band 2 - Low CH QPSK-10

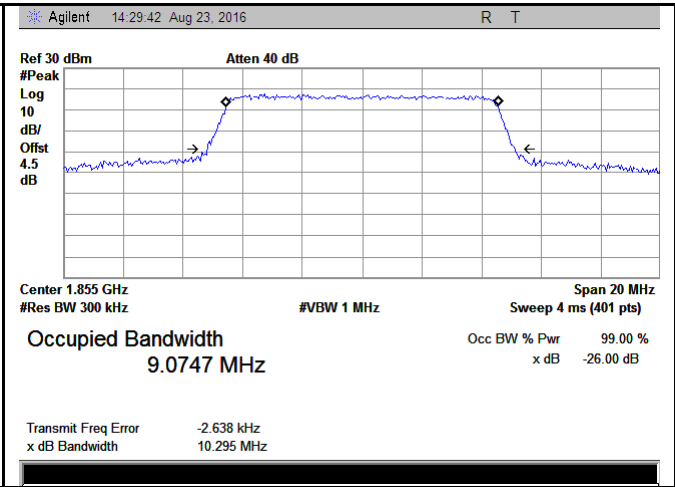

LTE band 2 - Low CH 16QAM-10

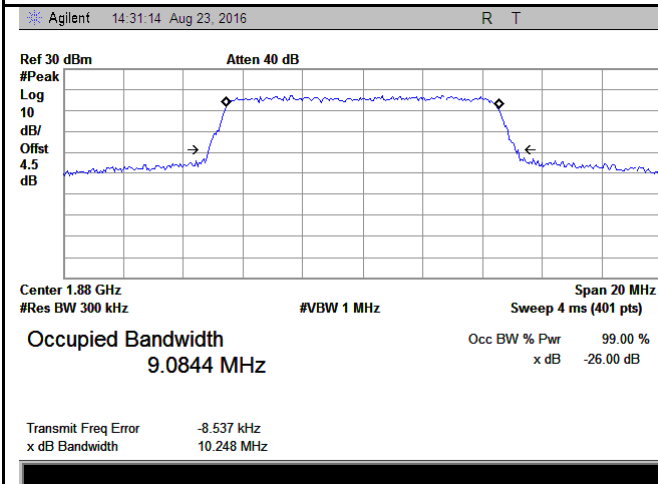

LTE band 2 - Middle CH QPSK-10

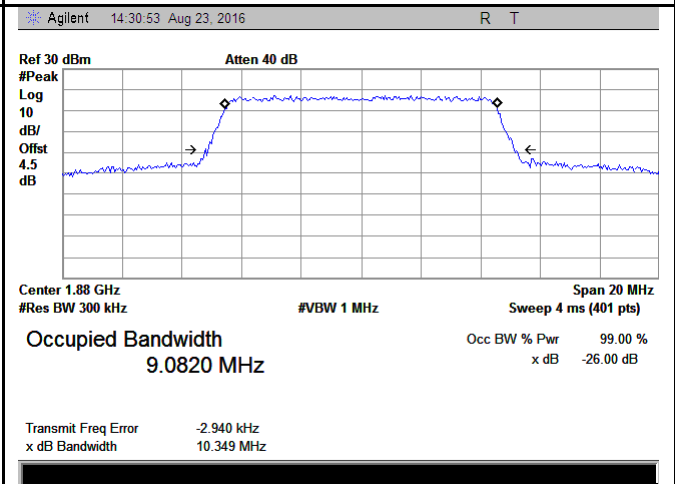

LTE band 2 - Middle CH 16QAM-10

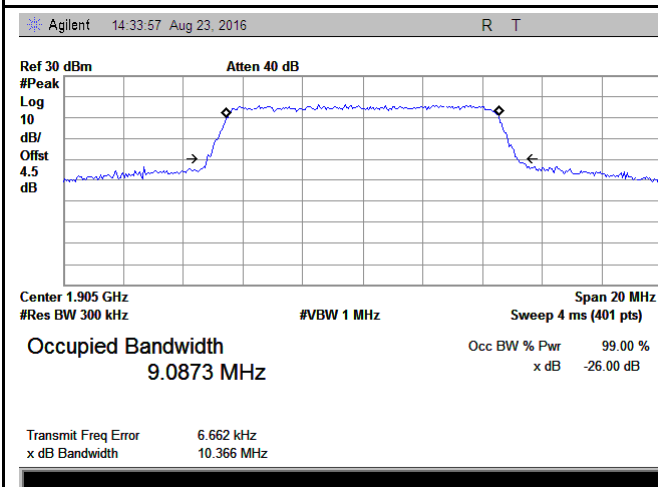

LTE band 2 - High CH QPSK-10

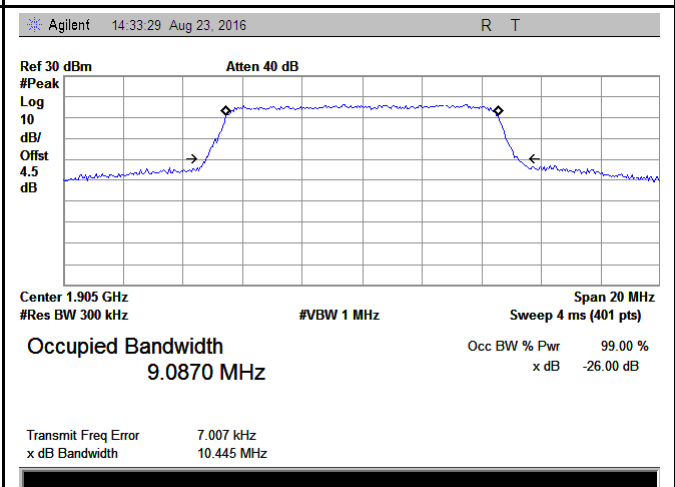

LTE band 2 - High CH 16QAM-10

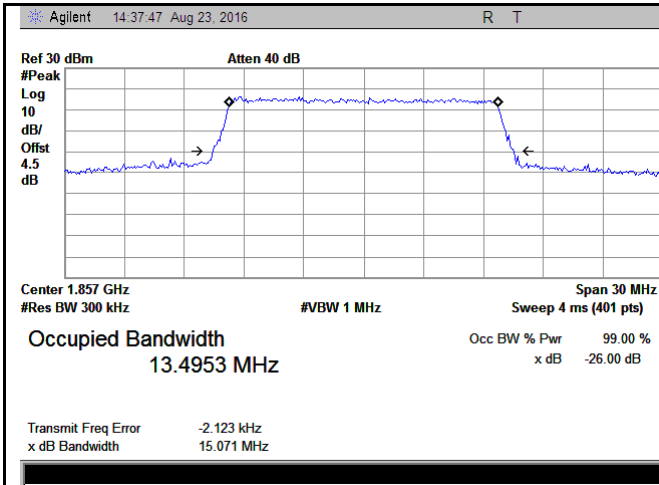

LTE band 2 - Low CH QPSK-15

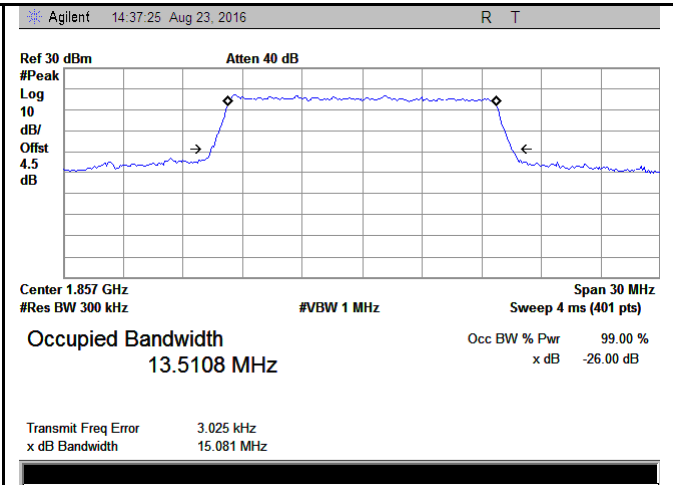

LTE band 2 - Low CH 16QAM-15

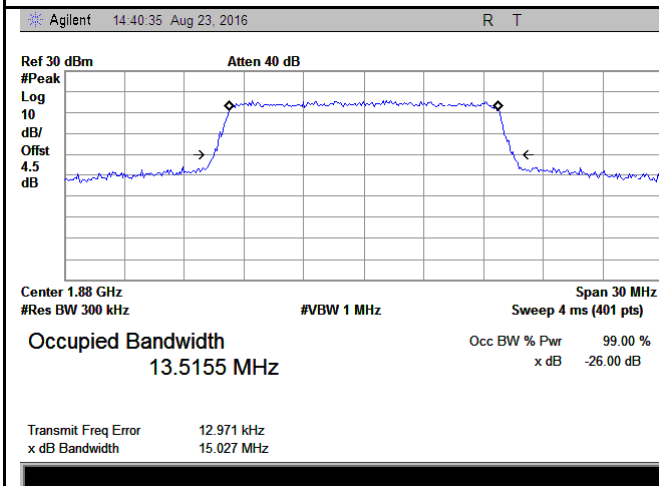

LTE band 2 - Middle CH QPSK-15

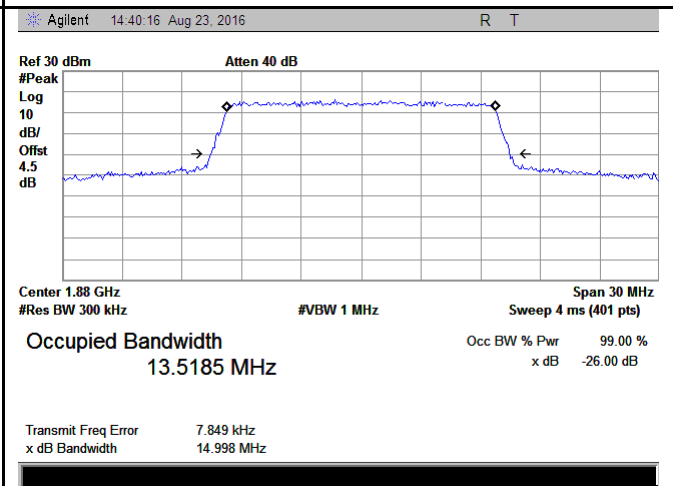

LTE band 2 - Middle CH 16QAM-15

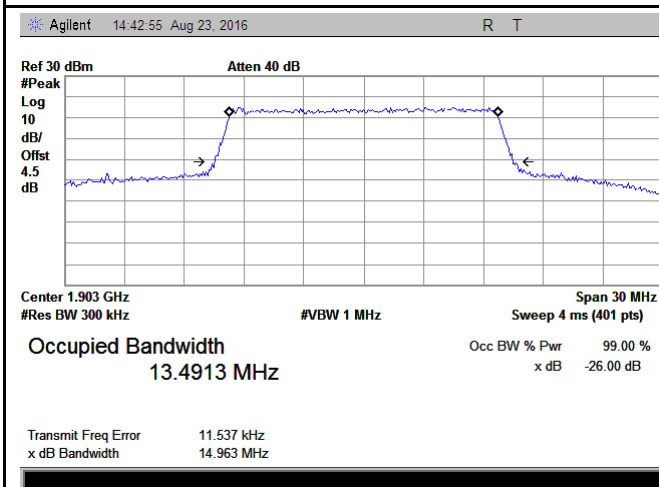

LTE band 2 - High CH QPSK-15

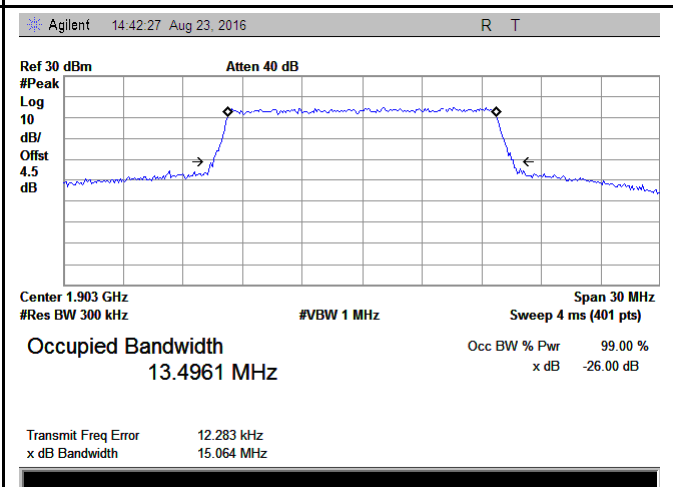

LTE band 2 - High CH 16QAM-15

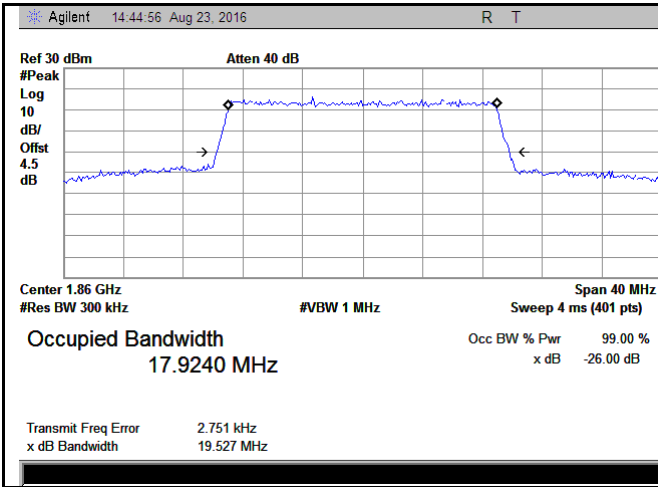

LTE band 2 - Low CH QPSK-20

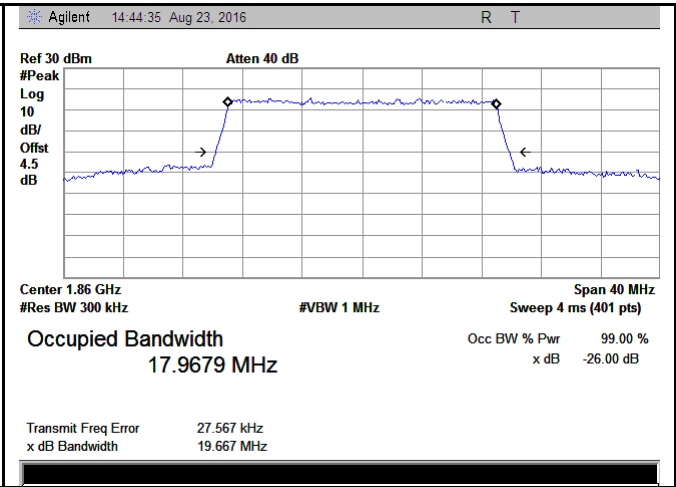

LTE band 2 - Low CH 16QAM-20

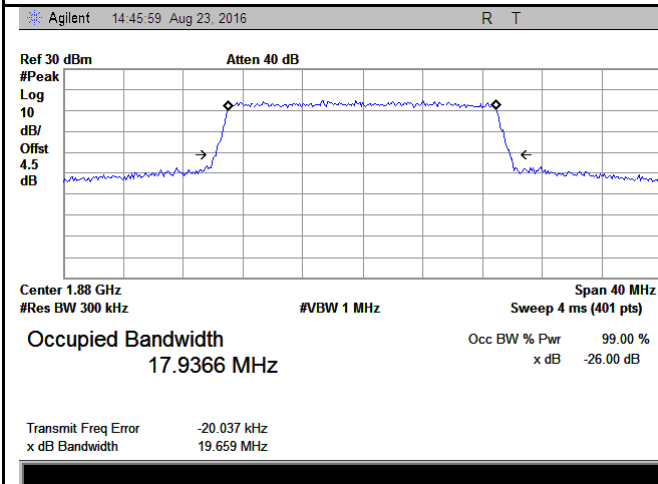

LTE band 2 - Middle CH QPSK-20

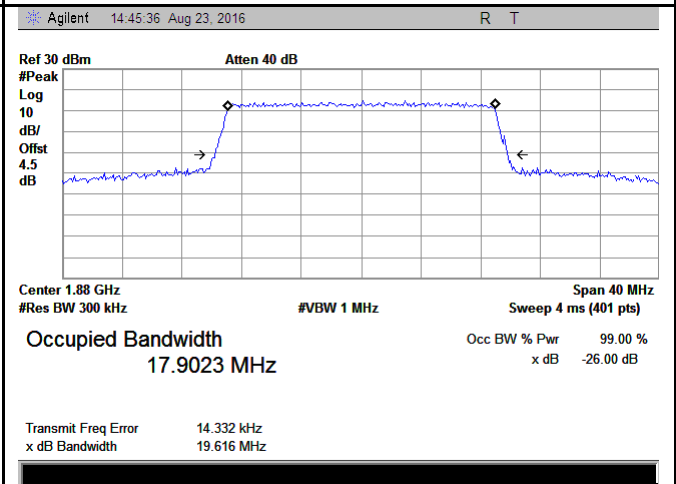

LTE band 2 - Middle CH 16QAM-20

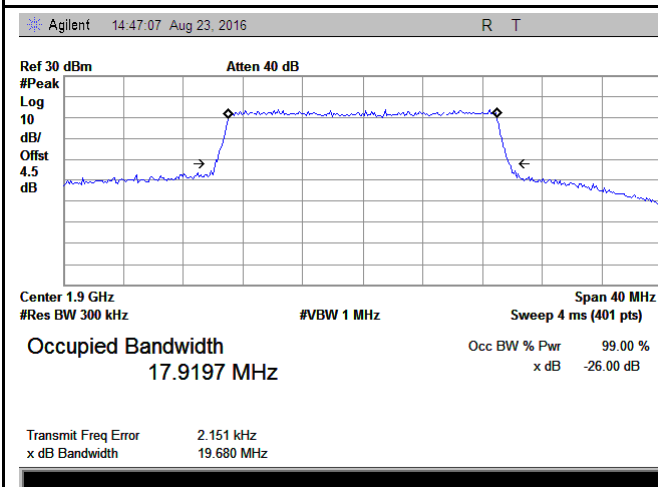

LTE band 2 - High CH QPSK-20

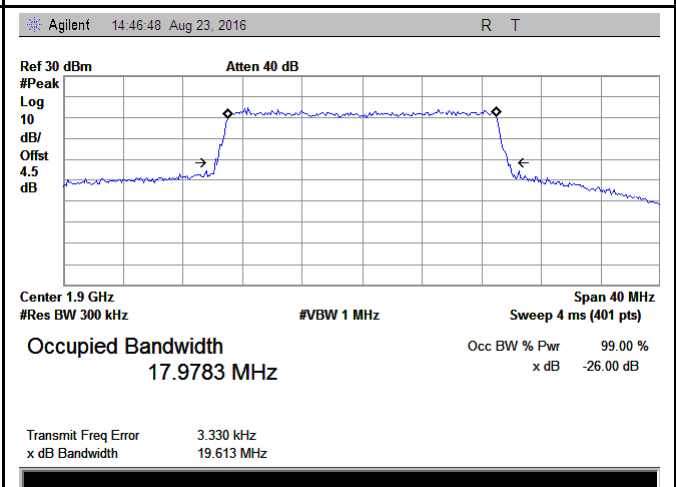

LTE band 2 - High CH 16QAM-20

### LTE Band 4 (Part 27)

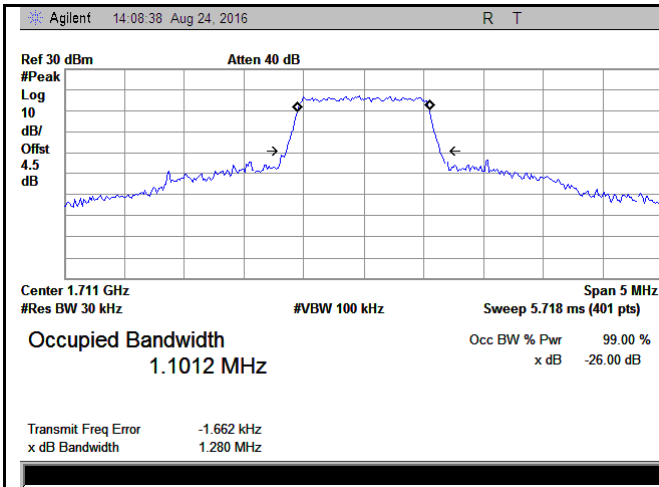

LTE band 4 - Low CH QPSK-1.4

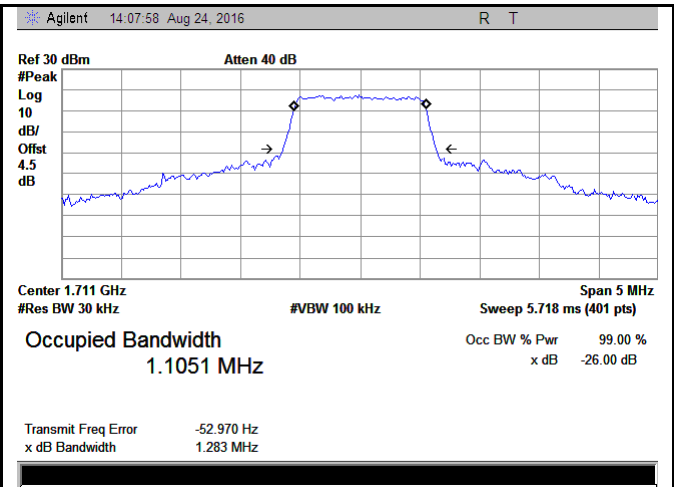

LTE band 4 - Low CH 16QAM-1.4

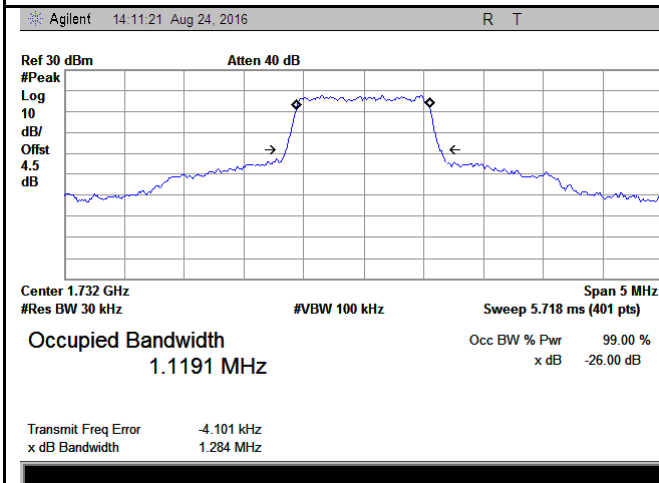

LTE band 4 - Middle CH QPSK-1.4

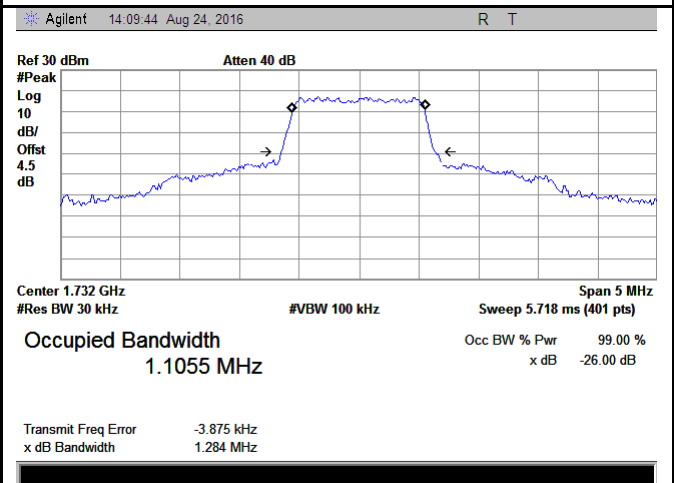

LTE band 4 - Middle CH 16QAM-1.4

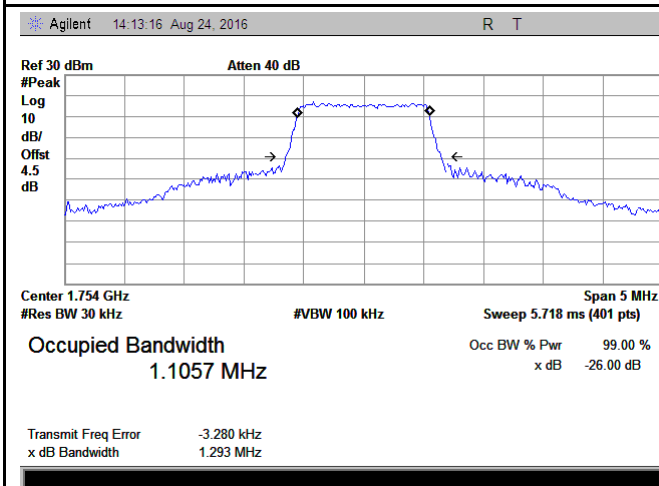

LTE band 4 - High CH QPSK-1.4

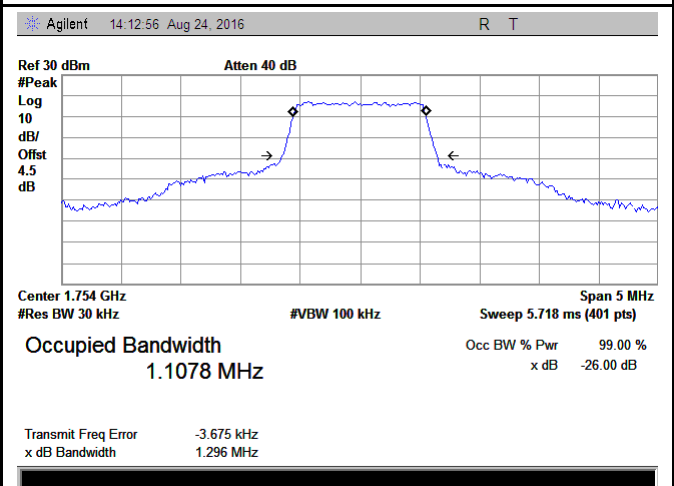

LTE band 4 - High CH 16QAM-1.4

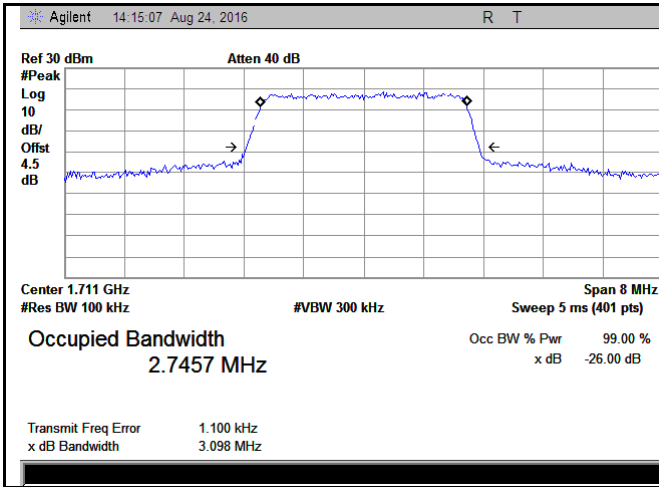

LTE band 4 - Low CH QPSK-3

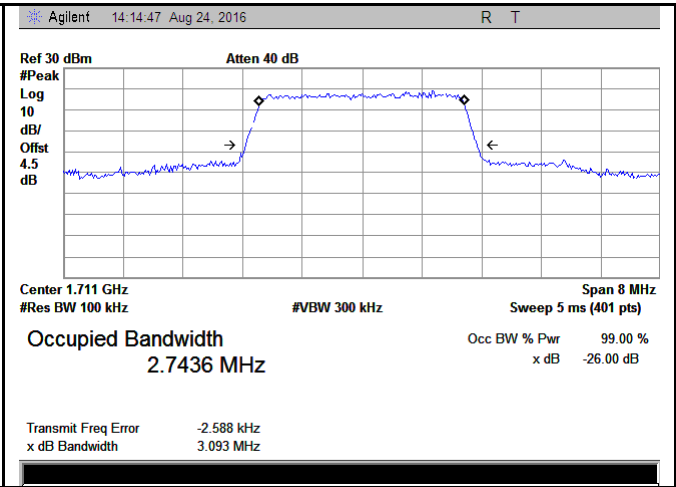

LTE band 4 - Low CH 16QAM-3

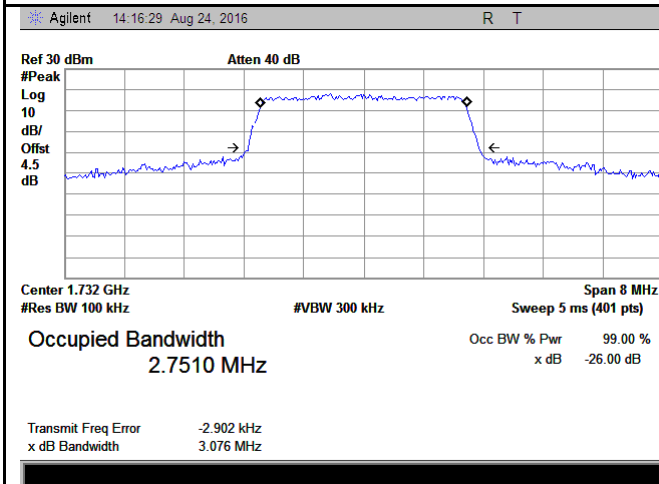

LTE band 4 - Middle CH QPSK-3

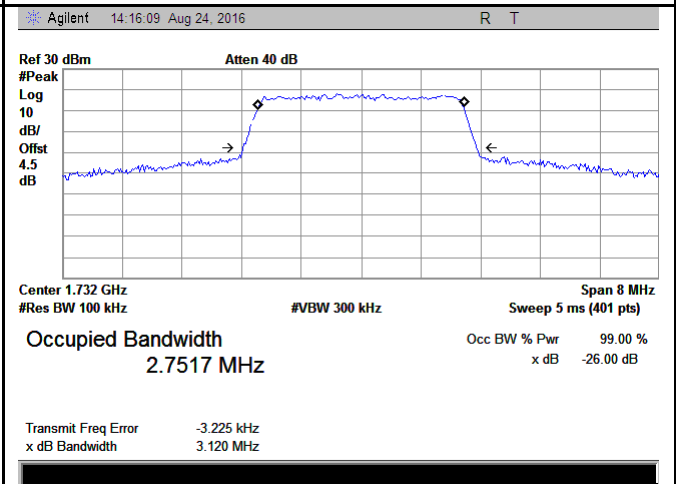

LTE band 4 - Middle CH 16QAM-3

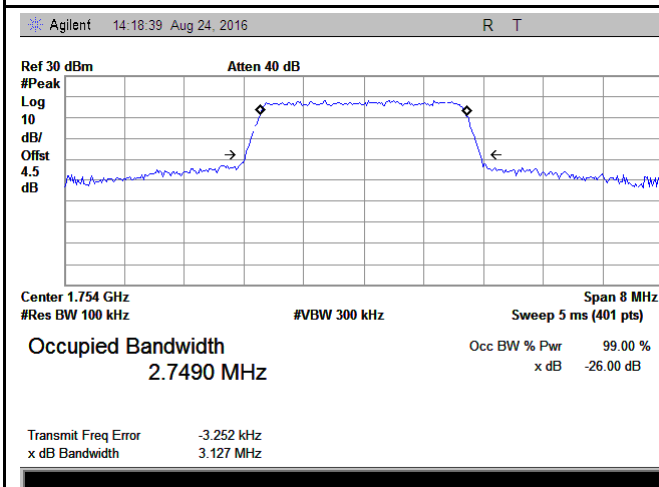

LTE band 4 - High CH QPSK-3

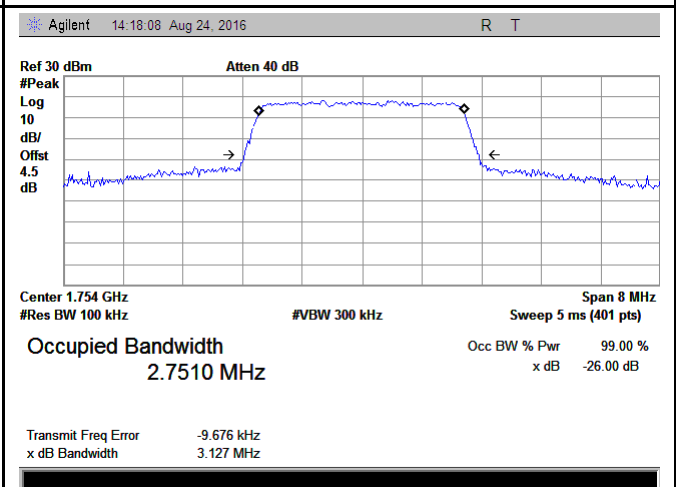

LTE band 4 - High CH 16QAM-3



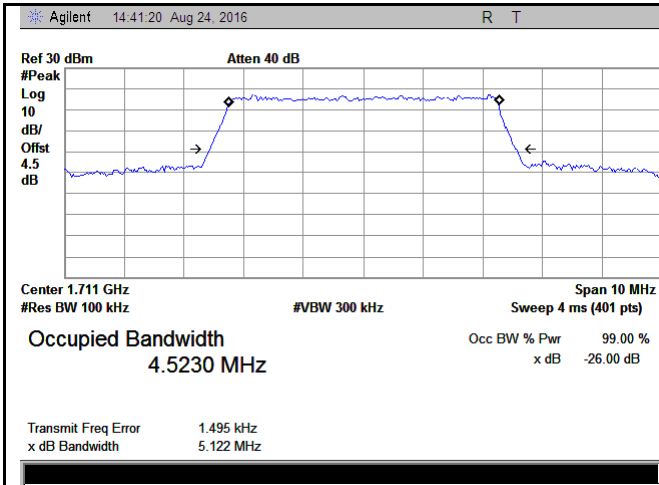

LTE band 4 - Low CH QPSK-5

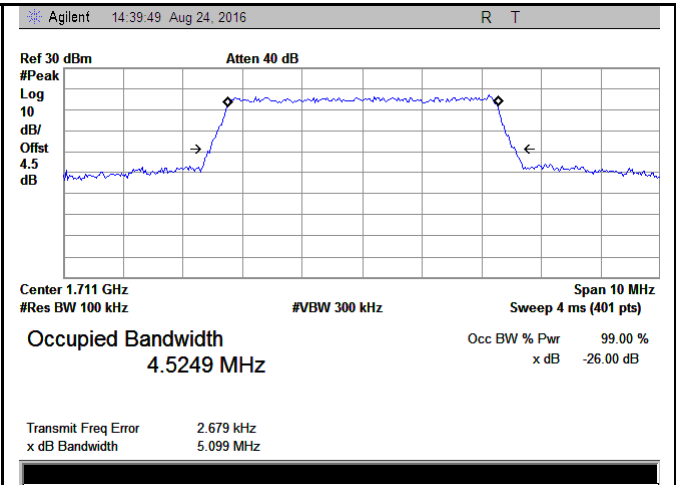

LTE band 4 - Low CH 16QAM-5

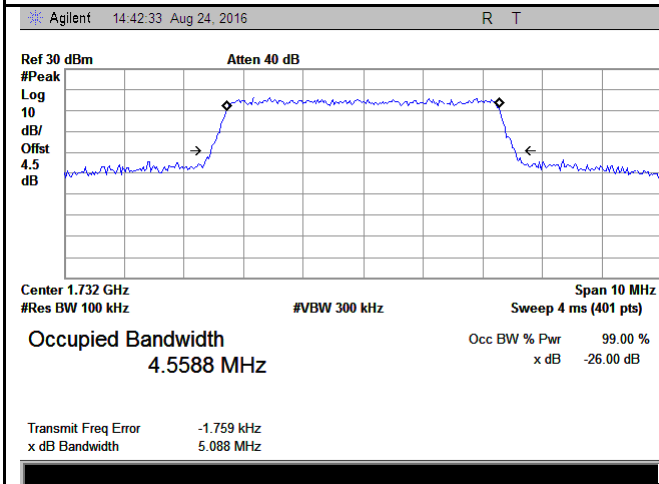

LTE band 4 - Middle CH QPSK-5

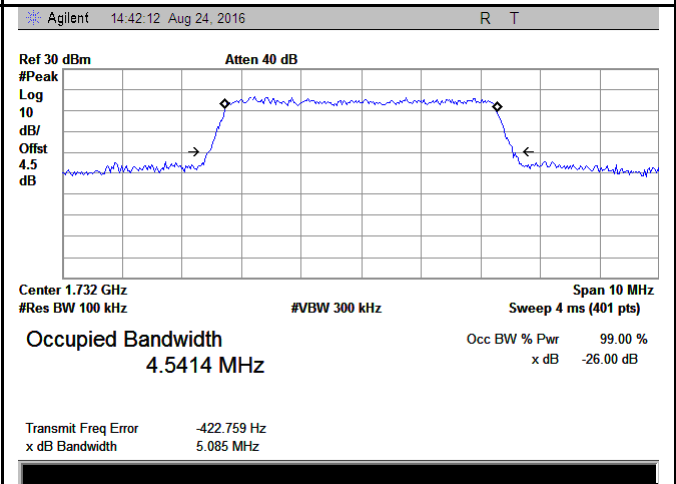

LTE band 4 - Middle CH 16QAM-5

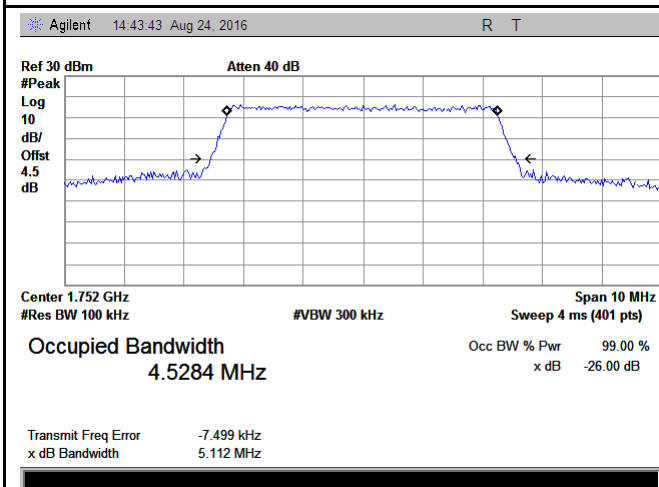

LTE band 4 - High CH QPSK-5

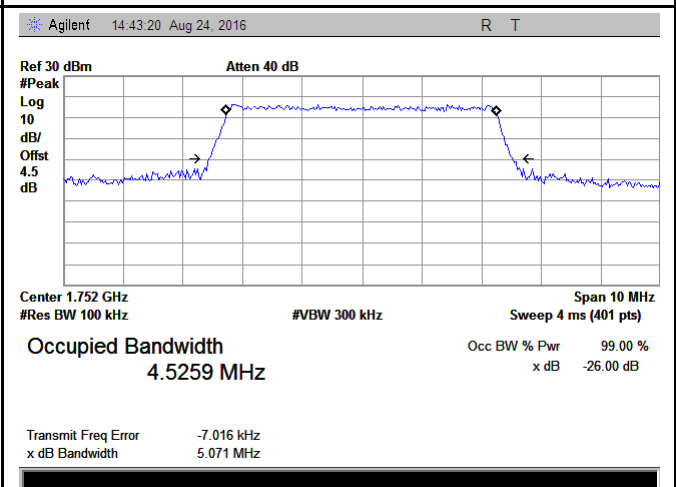

LTE band 4 - High CH 16QAM-5

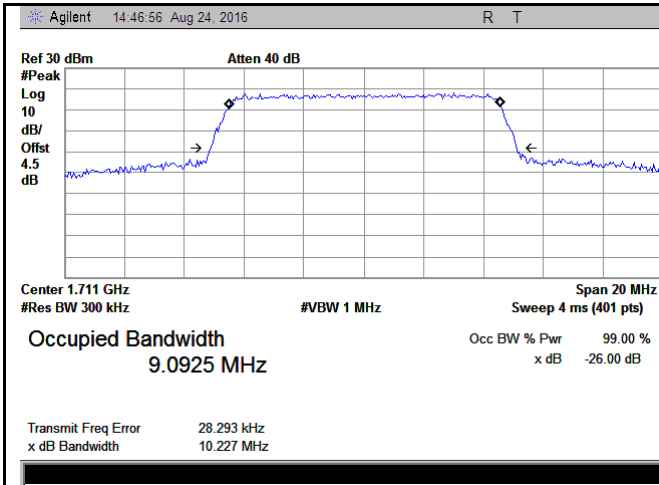

LTE band 4 - Low CH QPSK-10

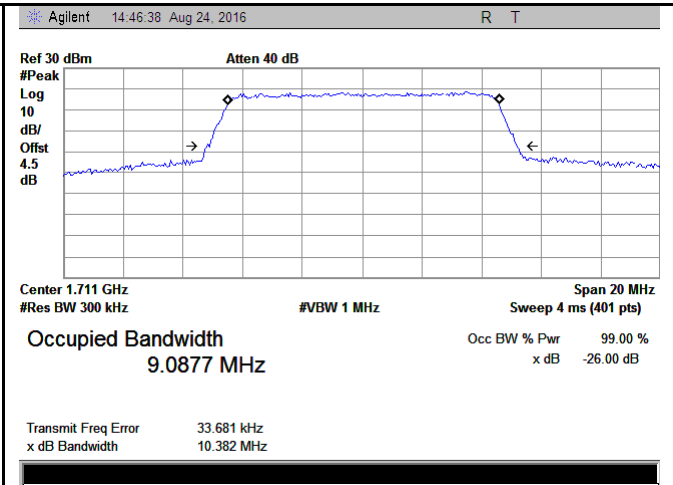

LTE band 4 - Low CH 16QAM-10

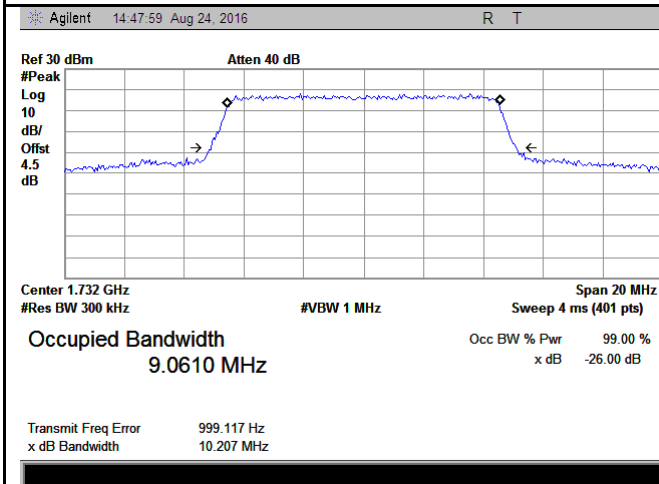

LTE band 4 - Middle CH QPSK-10

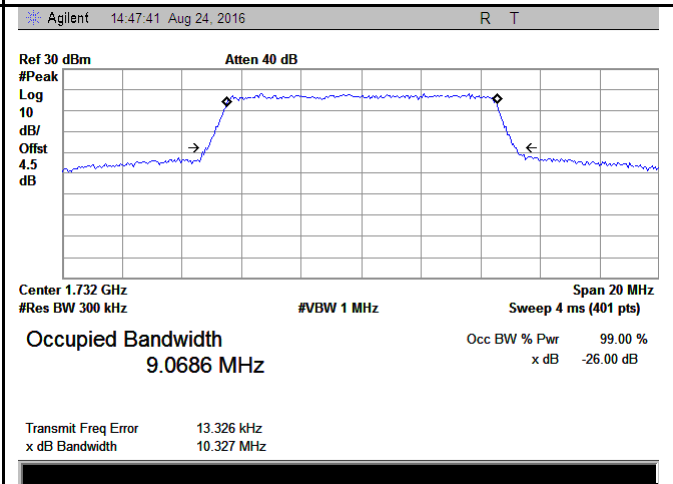

LTE band 4 - Middle CH 16QAM-10

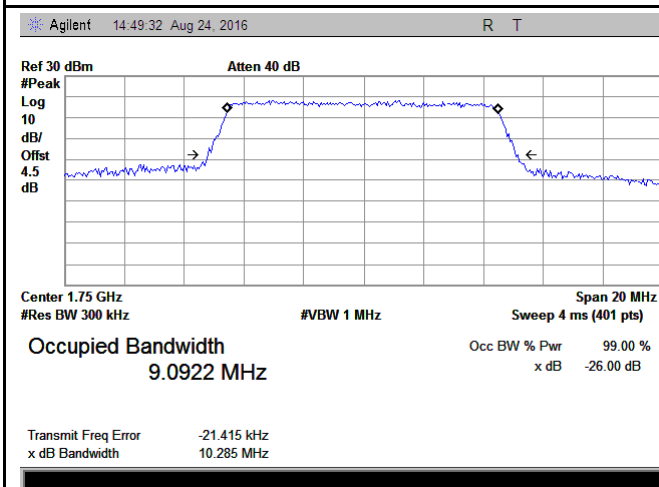

LTE band 4 - High CH QPSK-10

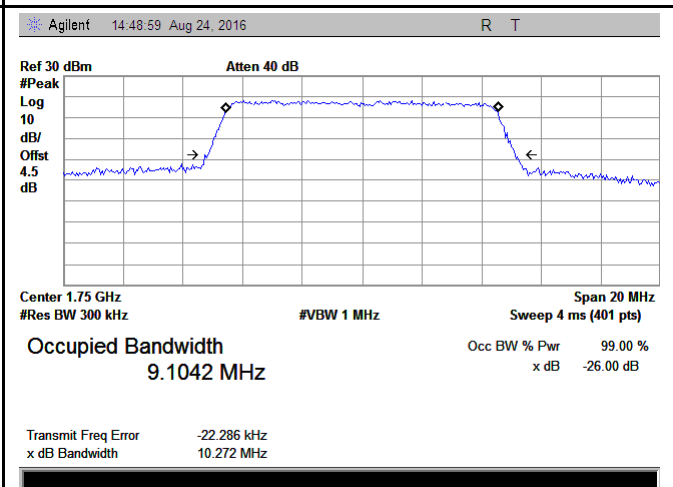

LTE band 4 - High CH 16QAM-10

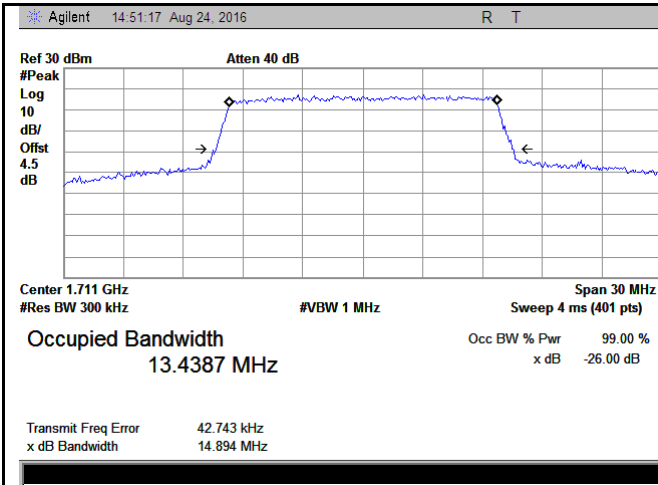

LTE band 4 - Low CH QPSK-15

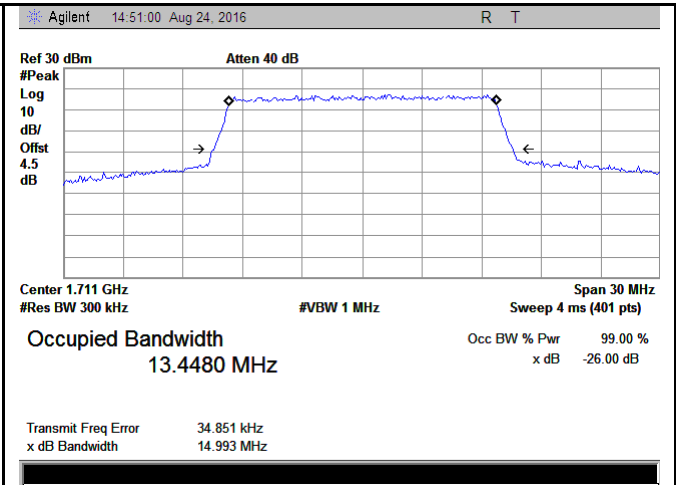

LTE band 4 - Low CH 16QAM-15

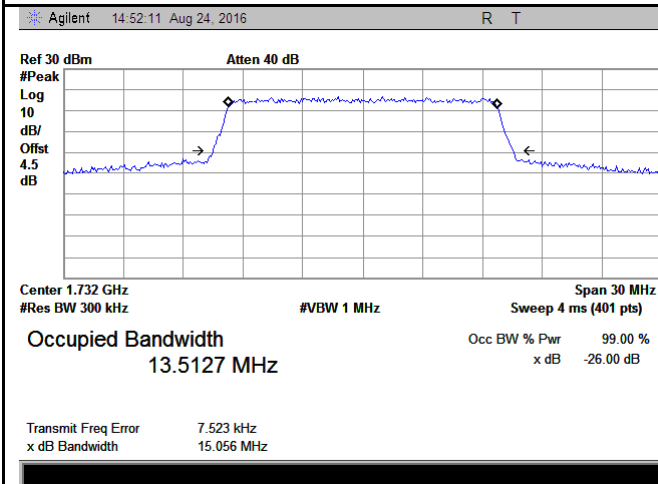

LTE band 4 - Middle CH QPSK-15

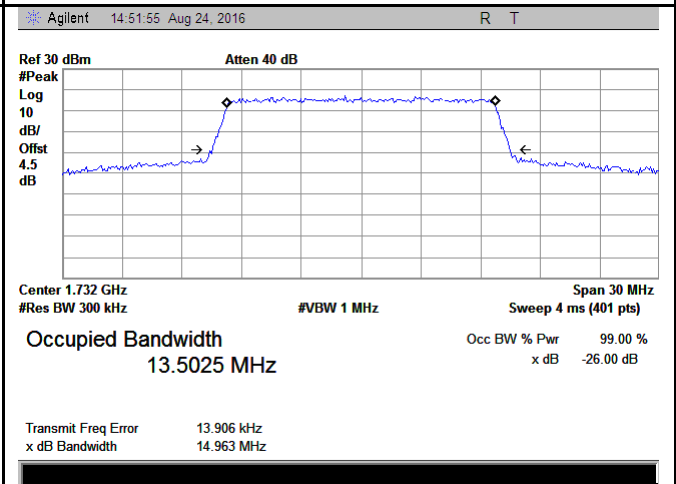

LTE band 4 - Middle CH 16QAM-15

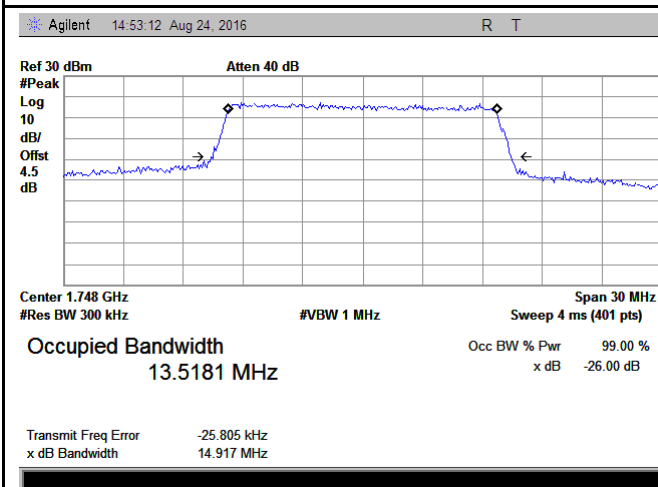

LTE band 4 - High CH QPSK-15

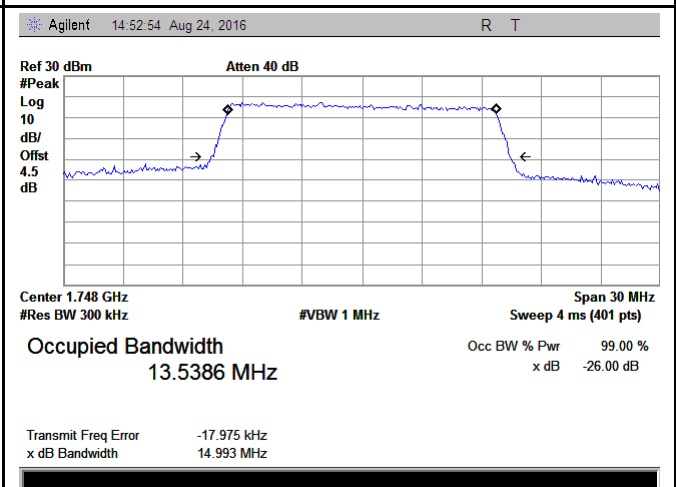

LTE band 4 - High CH 16QAM-15

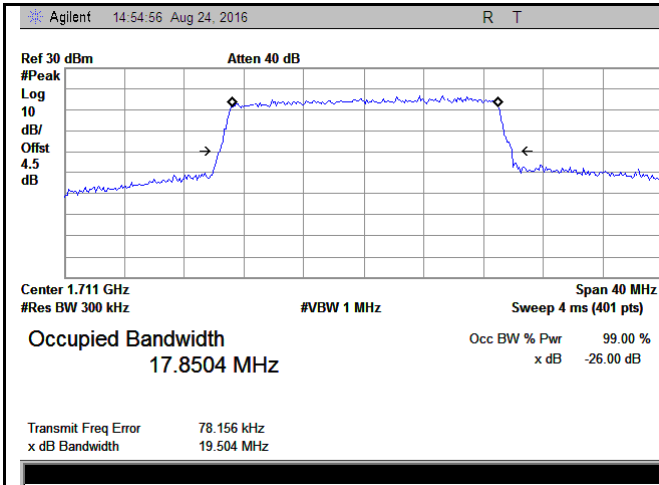

LTE band 4 - Low CH QPSK-20

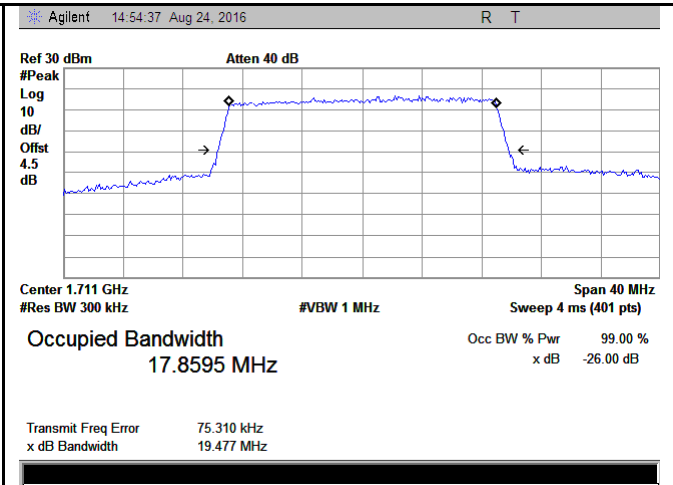

LTE band 4 - Low CH 16QAM-20

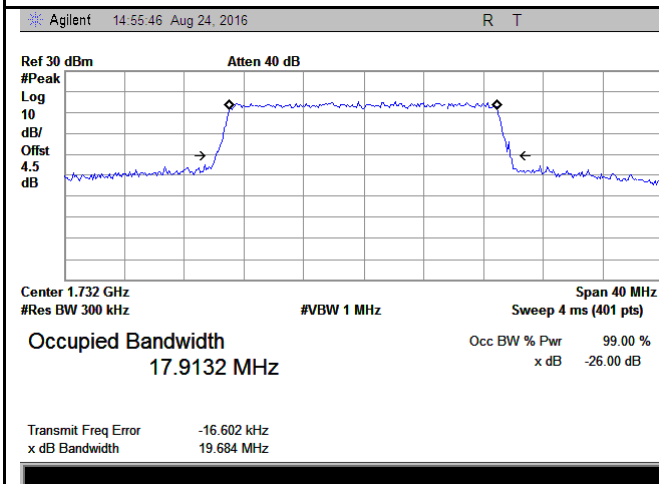

LTE band 4 - Middle CH QPSK-20

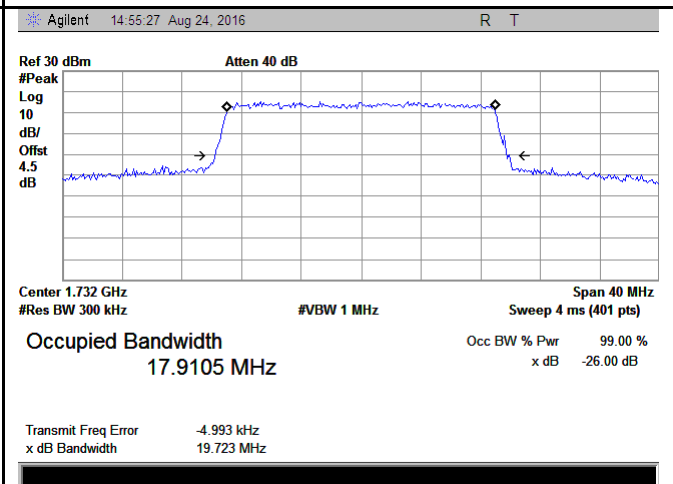

LTE band 4 - Middle CH 16QAM-20

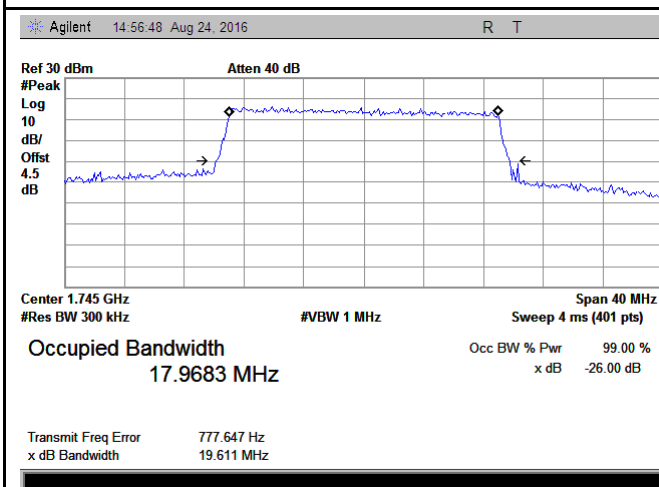

LTE band 4 - High CH QPSK-20

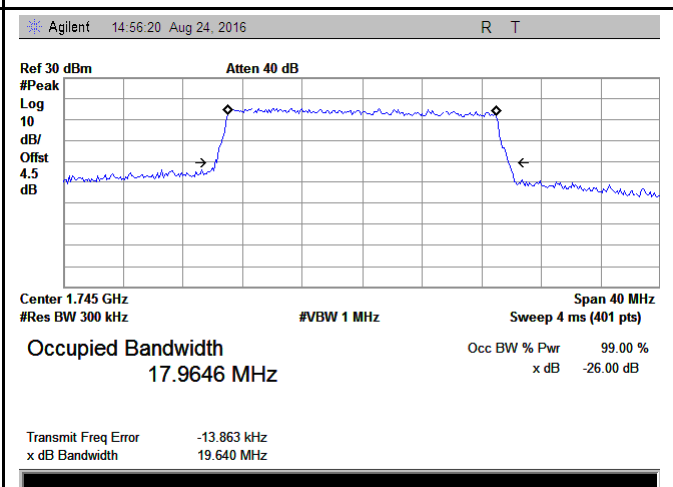

LTE band 4 - High CH 16QAM-20

### LTE Band 5 (Part 22H)

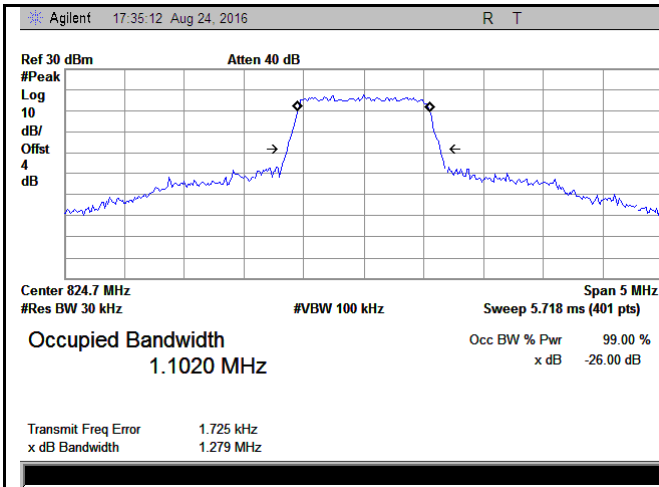

LTE band 5 - Low CH QPSK-1.4

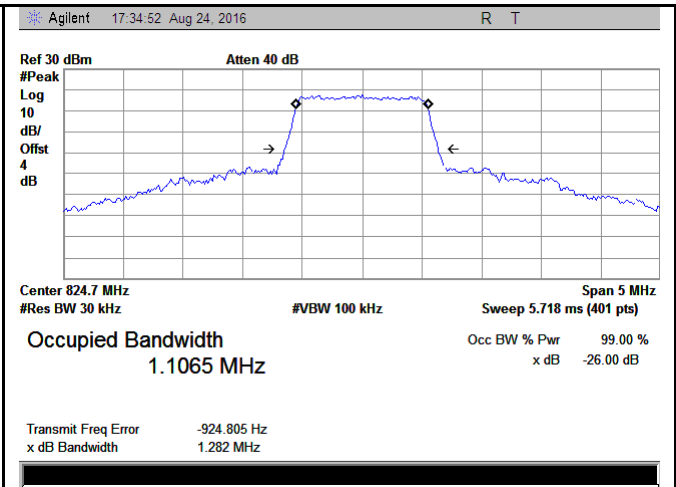

LTE band 5 - Low CH 16QAM-1.4

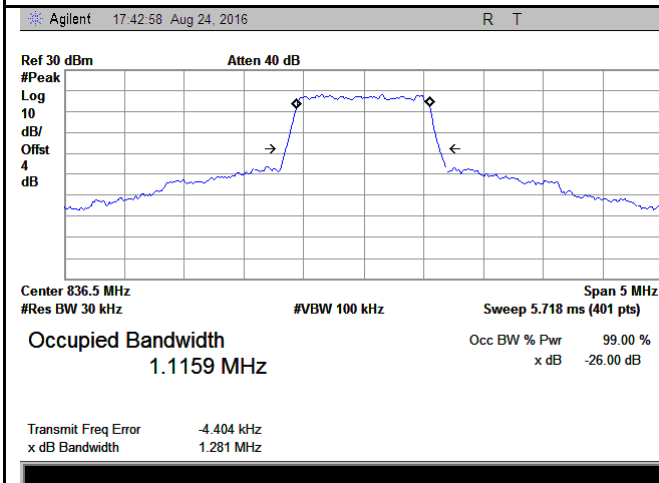

LTE band 5 - Middle CH QPSK-1.4

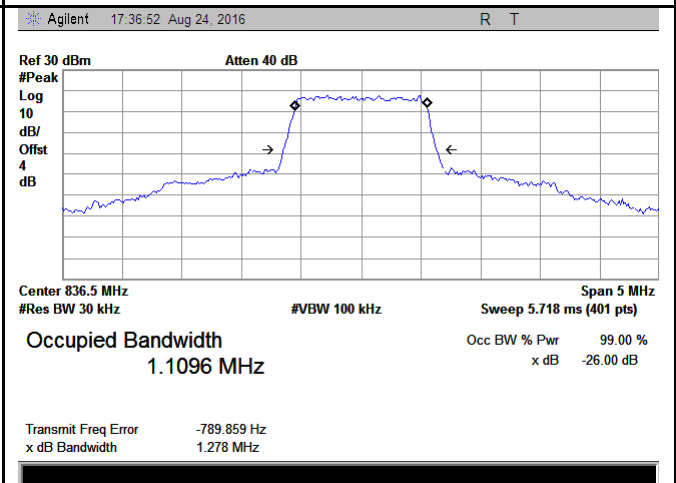

LTE band 5 - Middle CH 16QAM-1.4

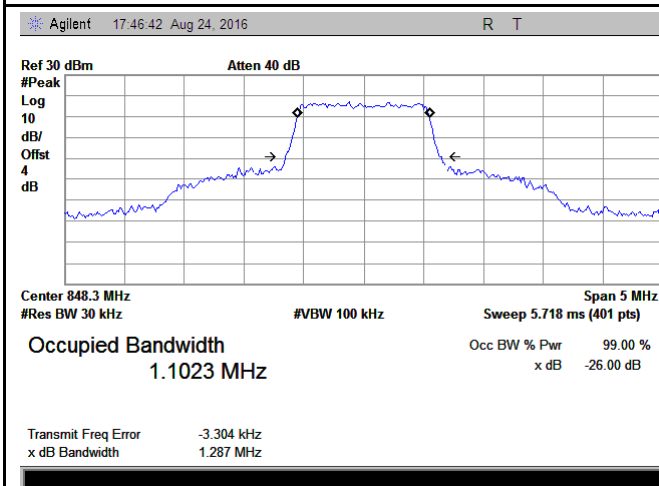

LTE band 5 - High CH QPSK-1.4

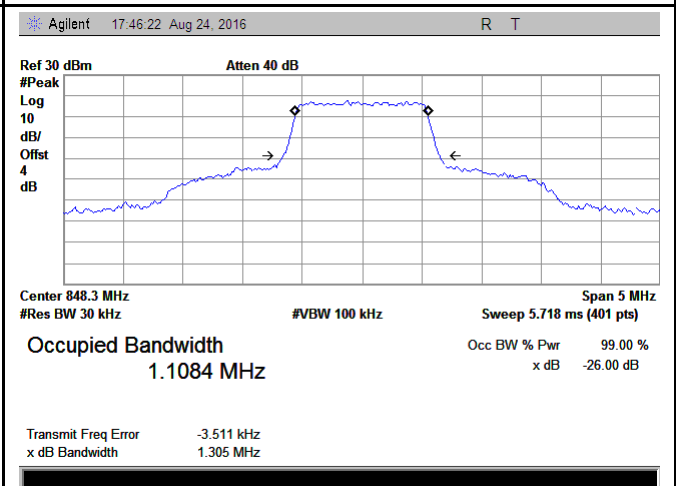

LTE band 5 - High CH 16QAM-1.4

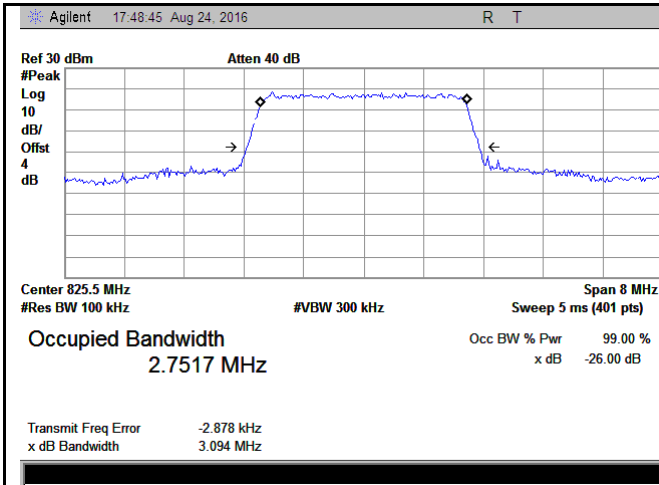

LTE band 5 - Low CH QPSK-3

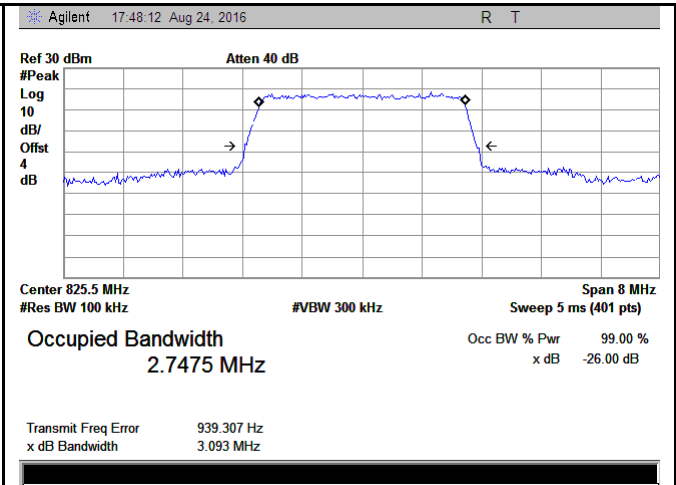

LTE band 5 - Low CH 16QAM-3

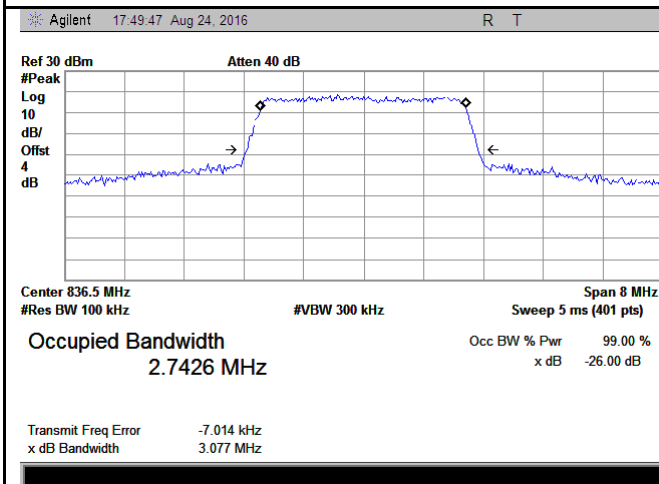

LTE band 5 - Middle CH QPSK-3

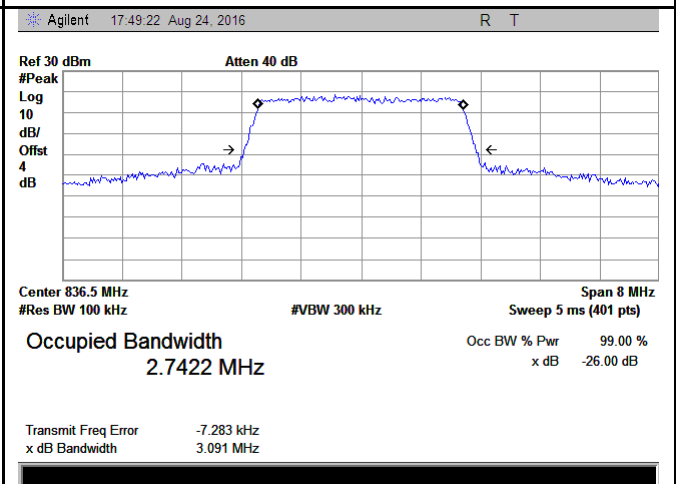

LTE band 5 - Middle CH 16QAM-3

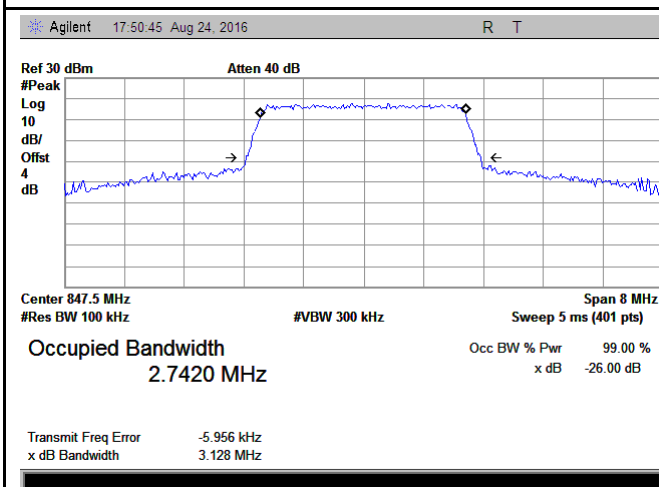

LTE band 5 - High CH QPSK-3

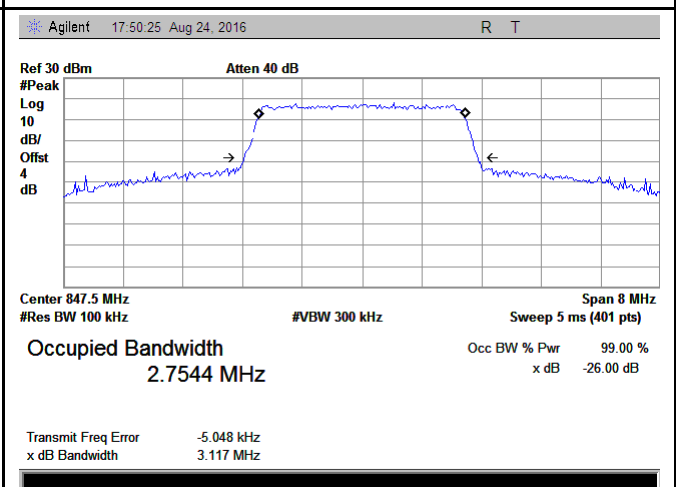

LTE band 5 - High CH 16QAM-3

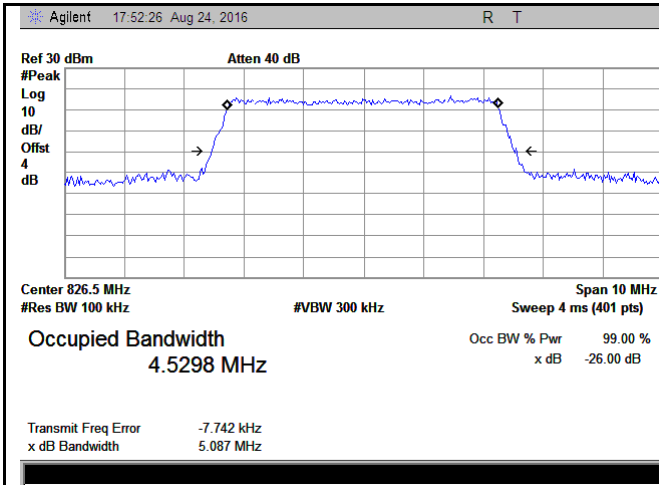

LTE band 5 - Low CH QPSK-5

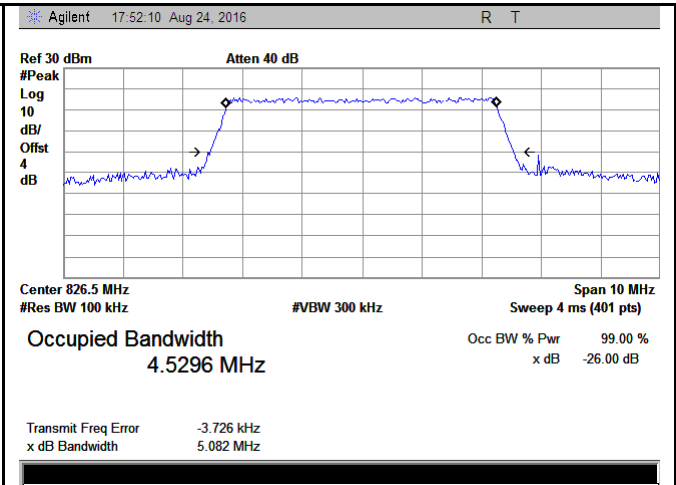

LTE band 5 - Low CH 16QAM-5

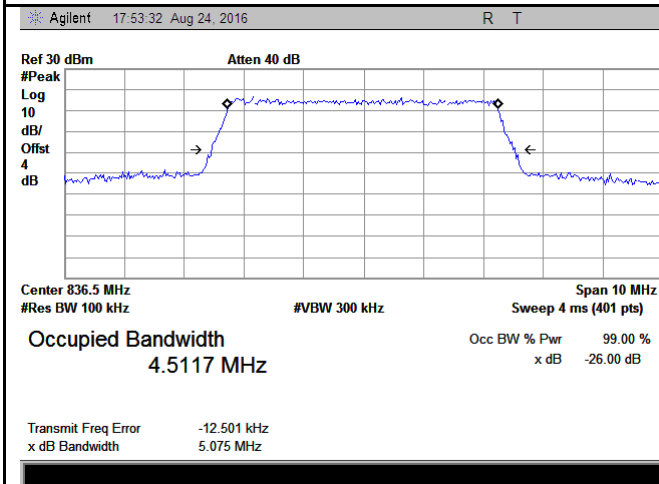

LTE band 5 - Middle CH QPSK-5

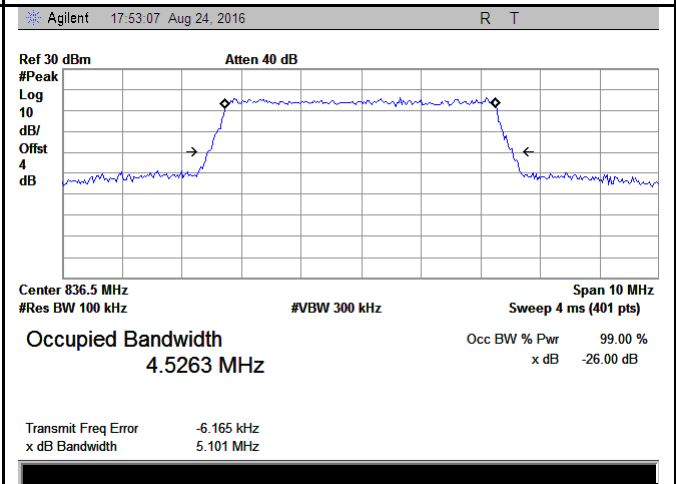

LTE band 5 - Middle CH 16QAM-5

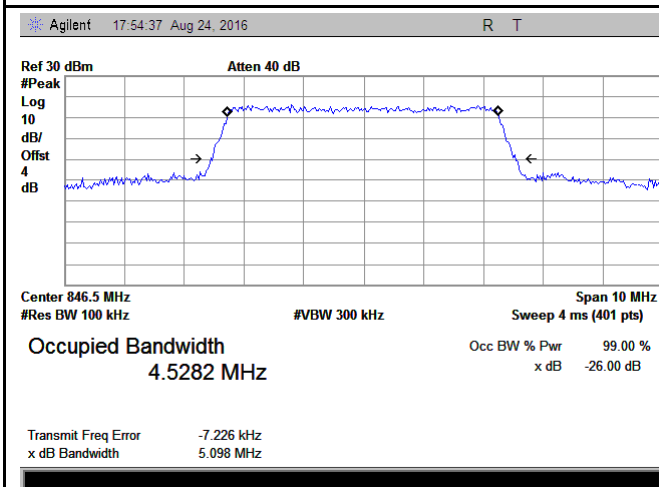

LTE band 5 - High CH QPSK-5

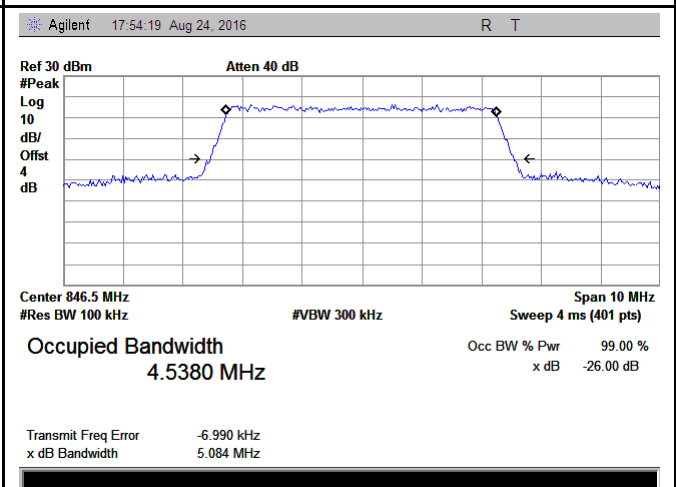

LTE band 5 - High CH 16QAM-5

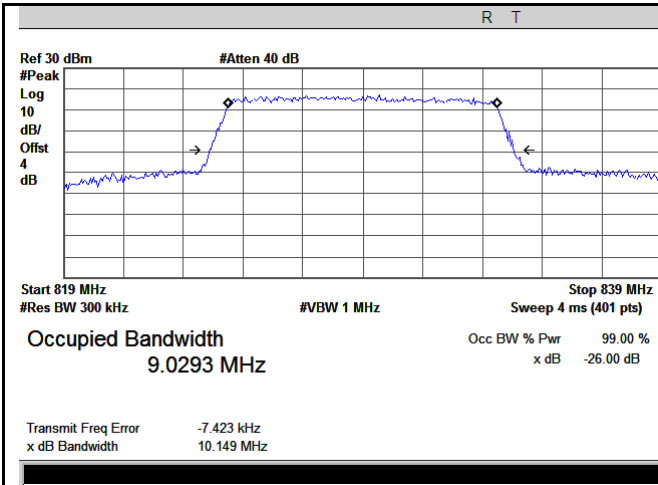

LTE band 5 - Low CH QPSK-10

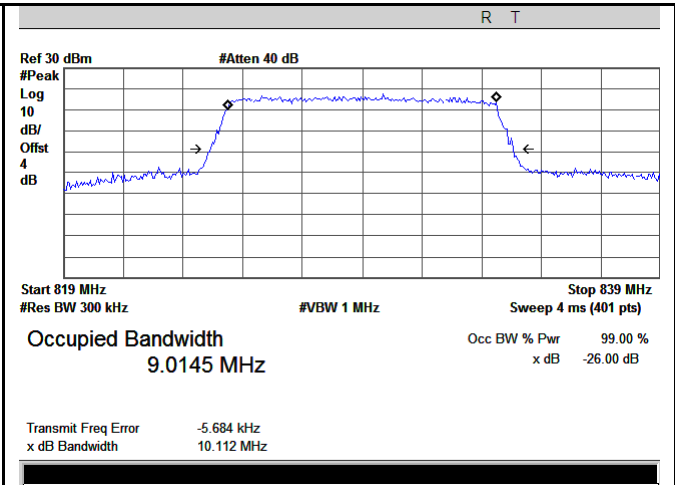

LTE band 5 - Low CH 16QAM-10

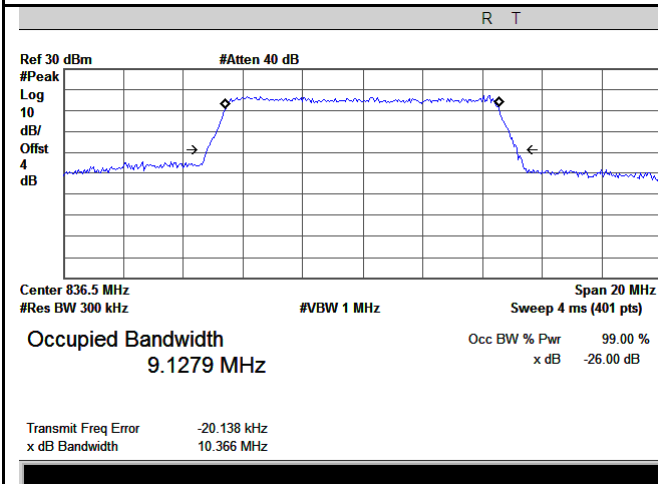

LTE band 5 - Middle CH QPSK-10

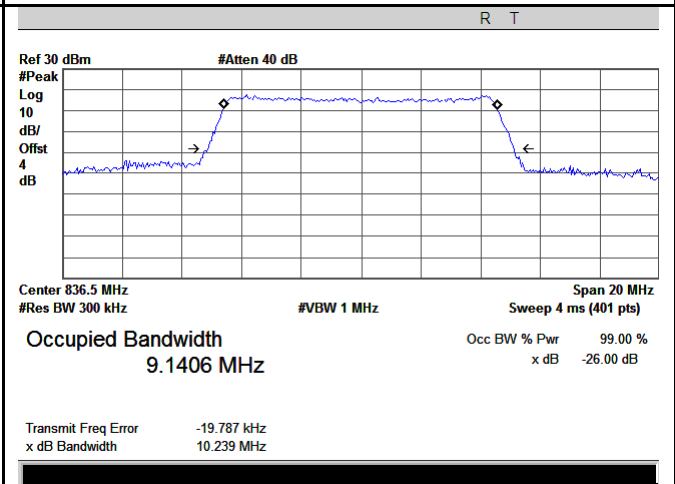

LTE band 5 - Middle CH 16QAM-10

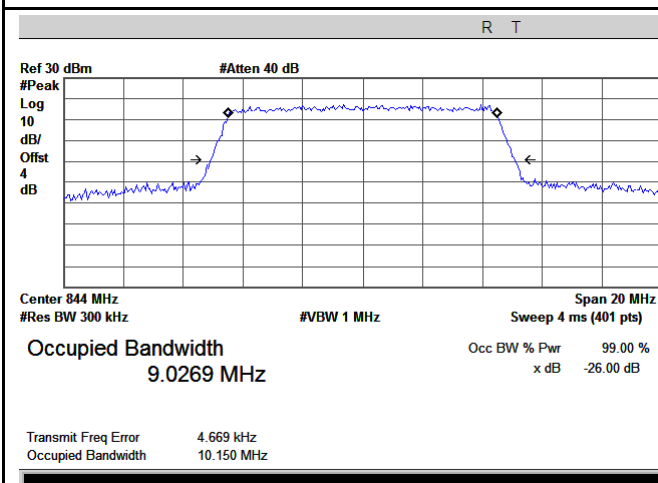

LTE band 5 - High CH QPSK-10

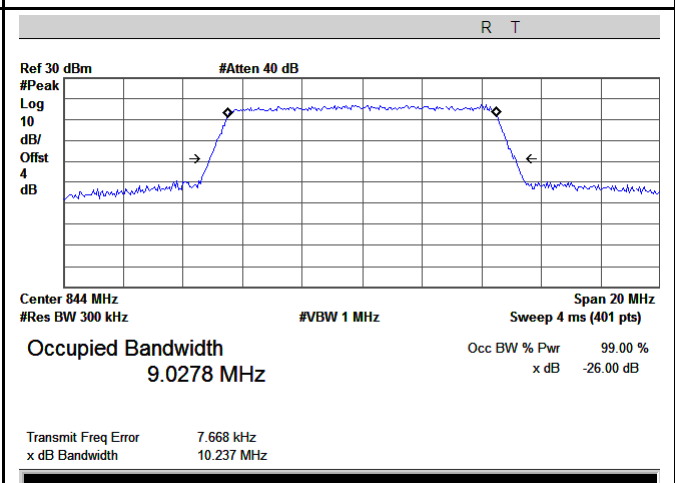

LTE band 5 - High CH 16QAM-10



### LTE Band 7 (Part 27)

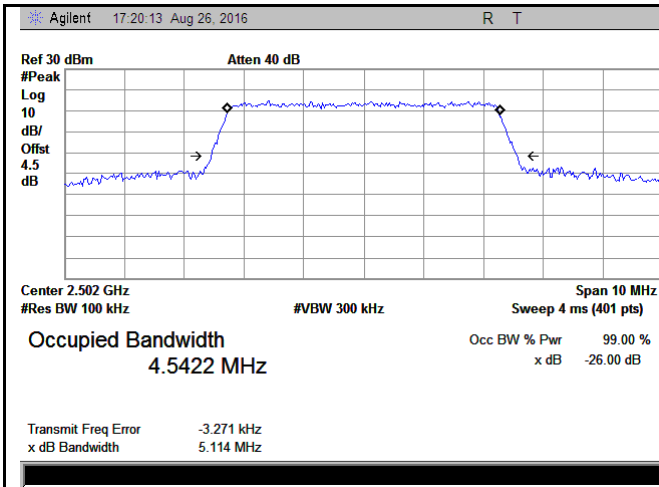

LTE band 7 - Low CH QPSK-5

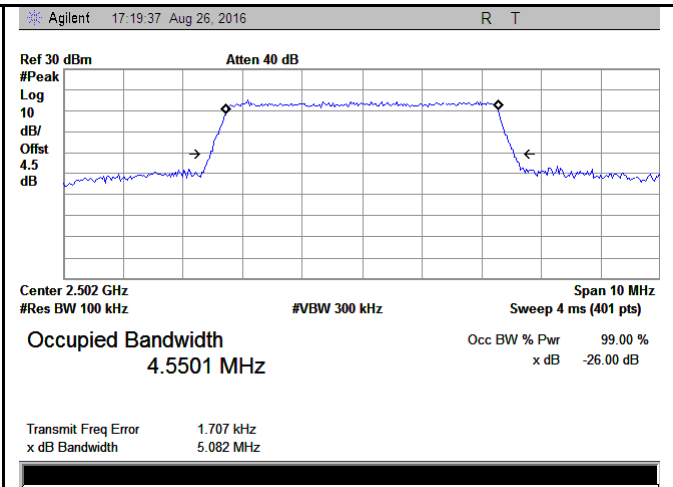

LTE band 7 - Low CH 16QAM-5

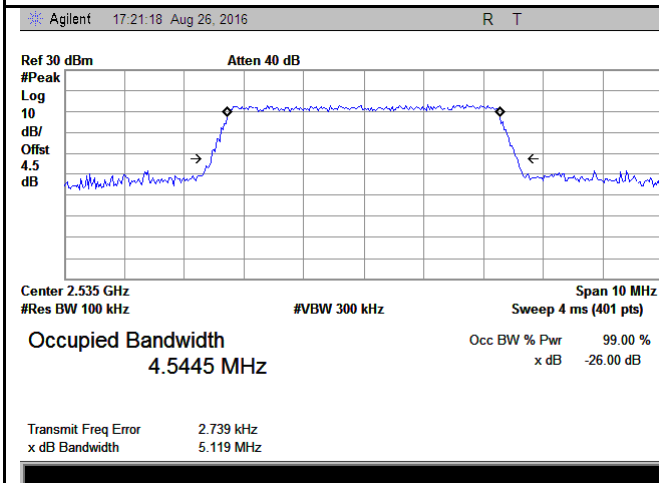

LTE band 7 - Middle CH QPSK-5

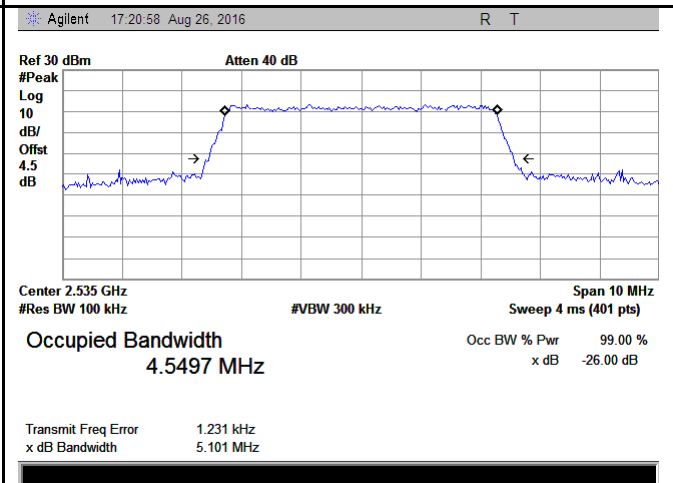

LTE band 7 - Middle CH 16QAM-5

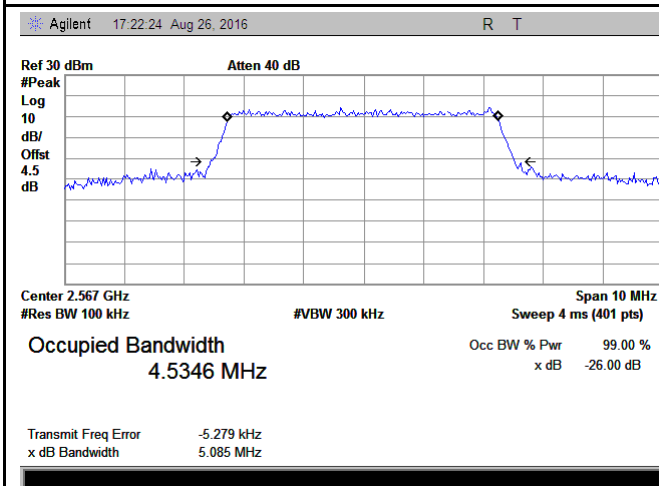

LTE band 7 - High CH QPSK-5

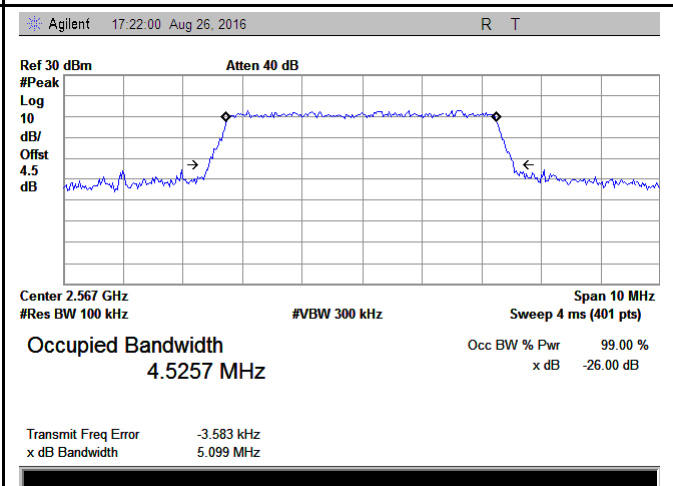

LTE band 7 - High CH 16QAM-5

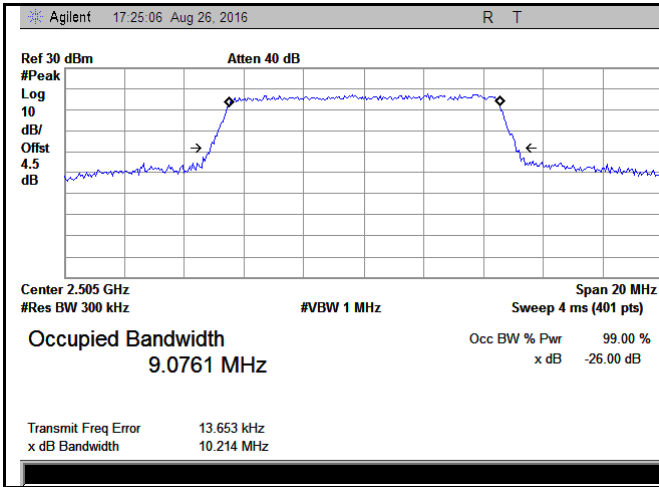

LTE band 7 - Low CH QPSK-10

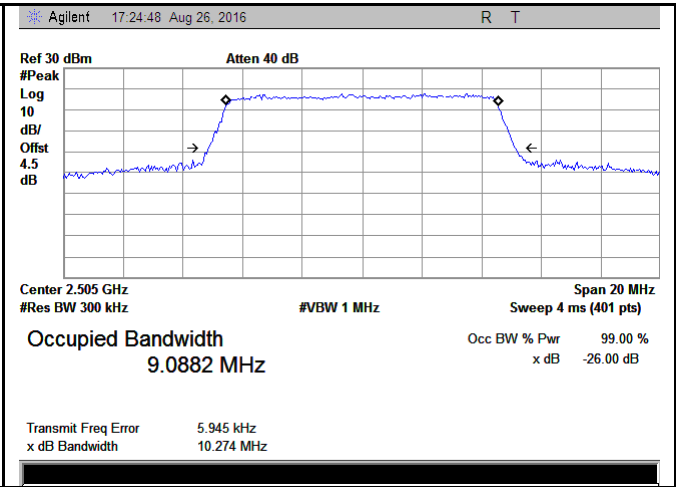

LTE band 7 - Low CH 16QAM-10

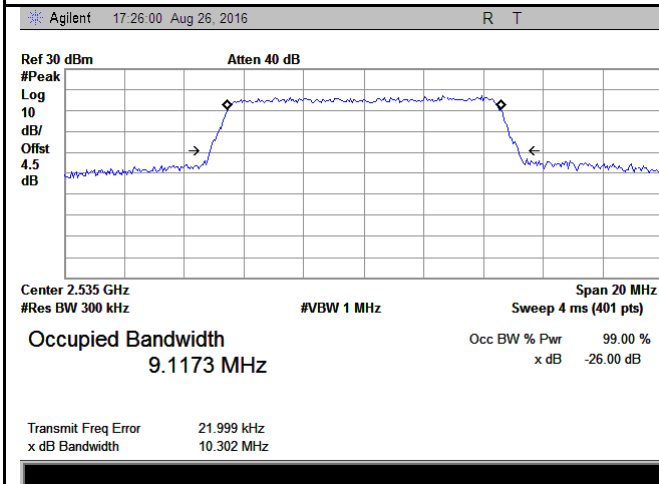

LTE band 7 - Middle CH QPSK-10

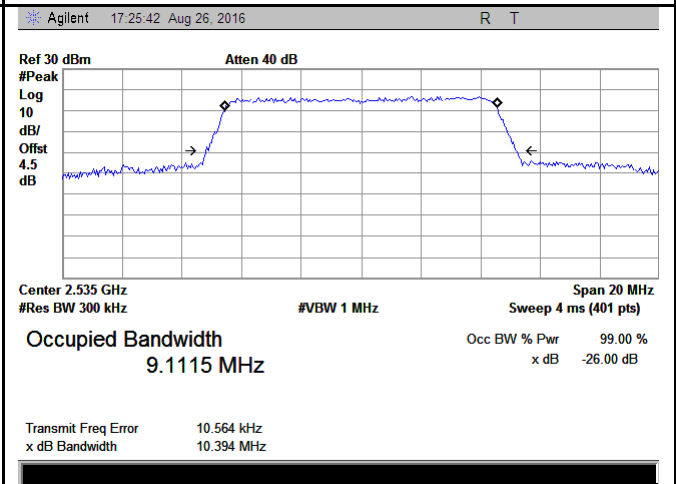

LTE band 7 - Middle CH 16QAM-10

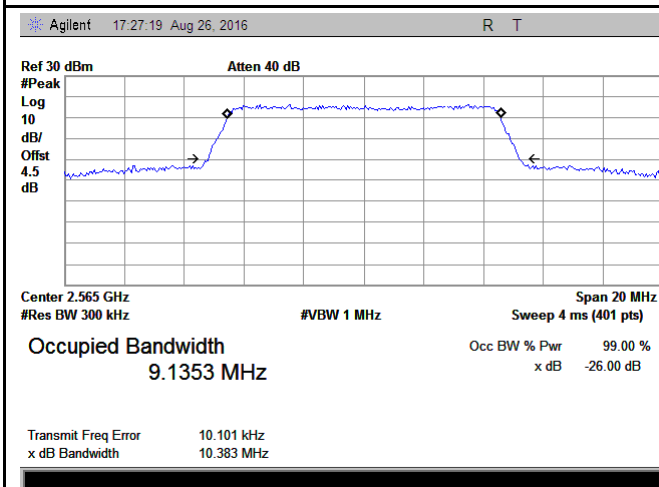

LTE band 7 - High CH QPSK-10

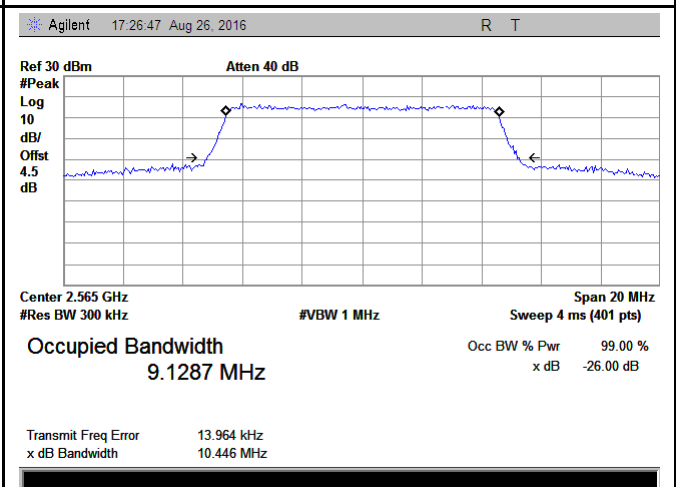

LTE band 7 - High CH 16QAM-10

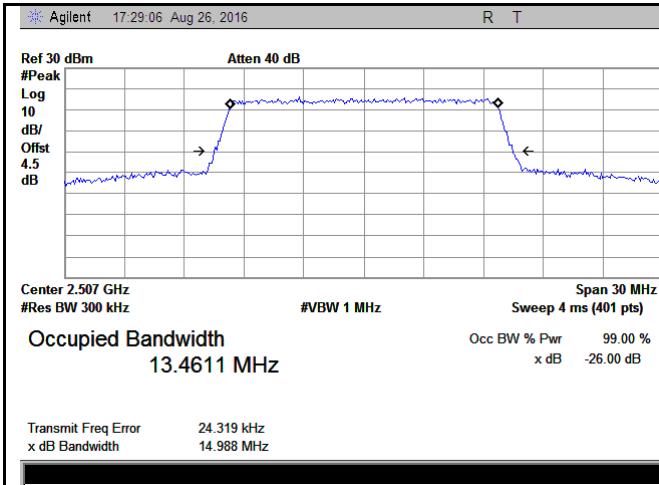

LTE band 7 - Low CH QPSK-15

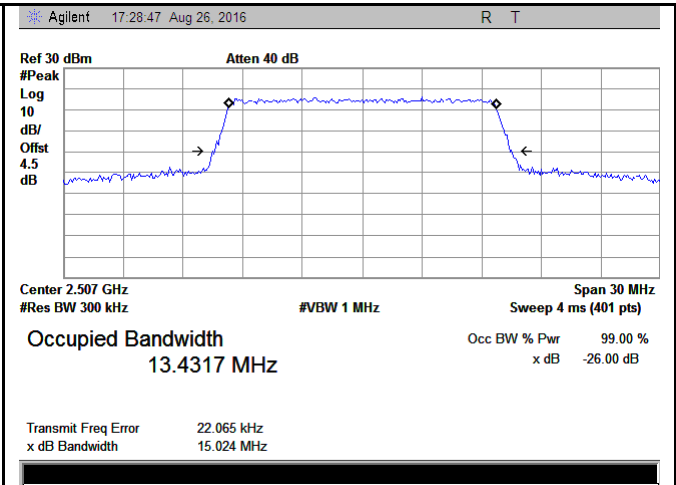

LTE band 7 - Low CH 16QAM-15

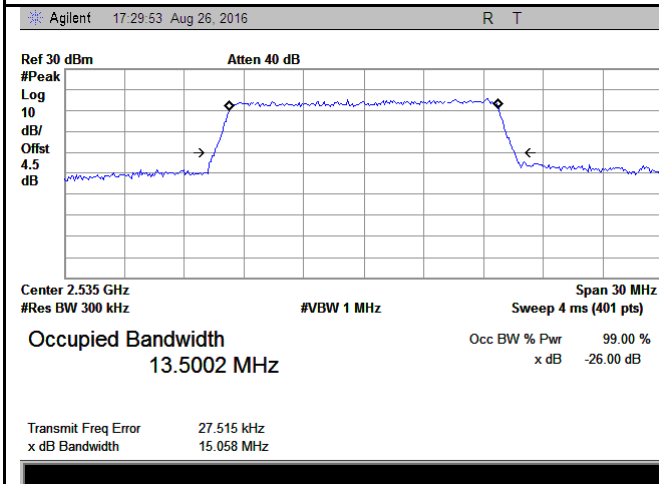

LTE band 7 - Middle CH QPSK-15

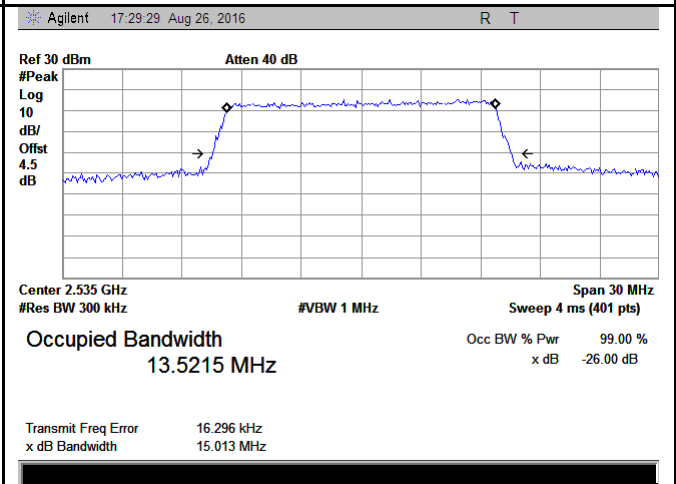

LTE band 7 - Middle CH 16QAM-15

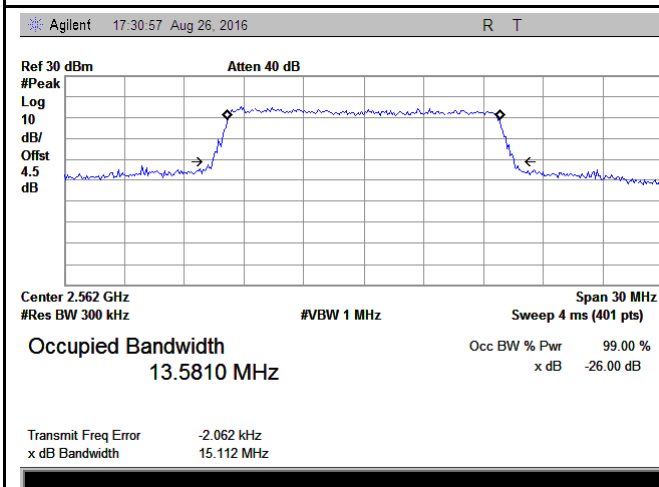

LTE band 7 - High CH QPSK-15

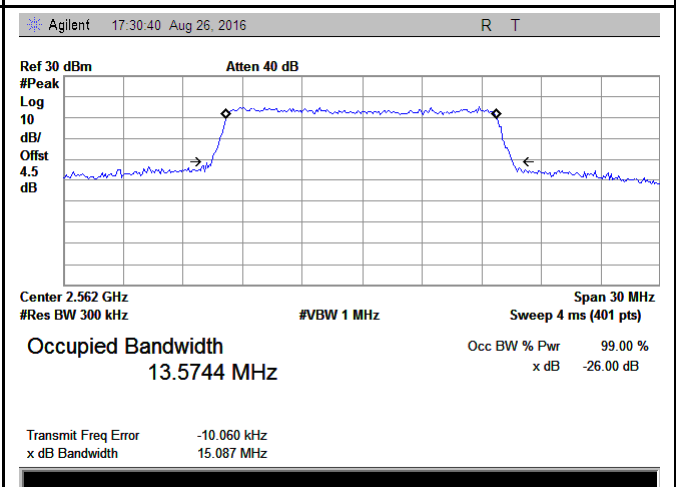

LTE band 7 - High CH 16QAM-15

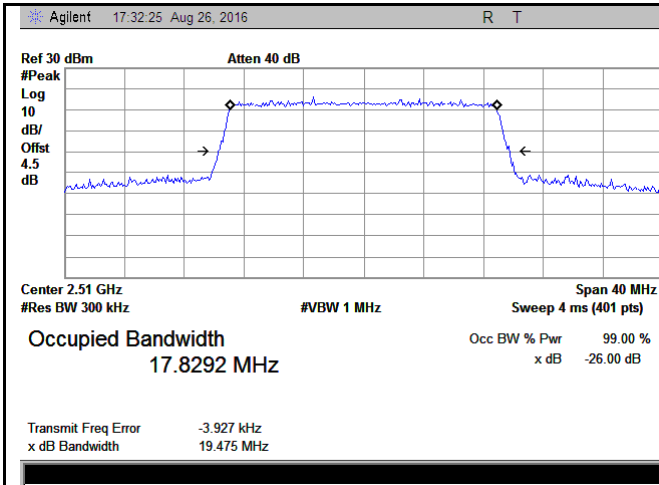

LTE band 7 - Low CH QPSK-20

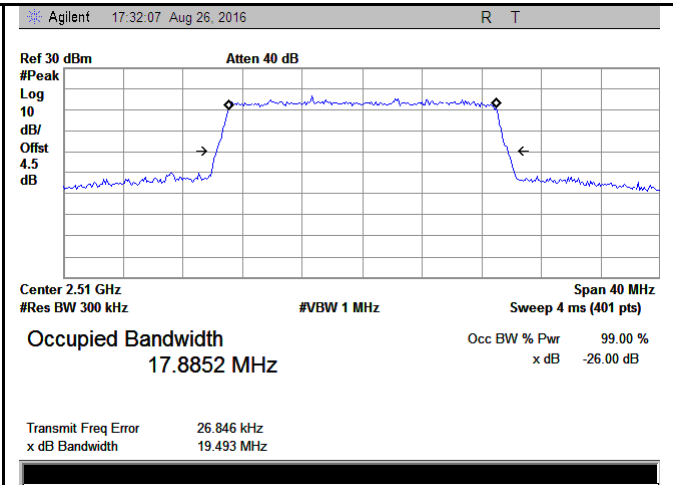

LTE band 7 - Low CH 16QAM-20

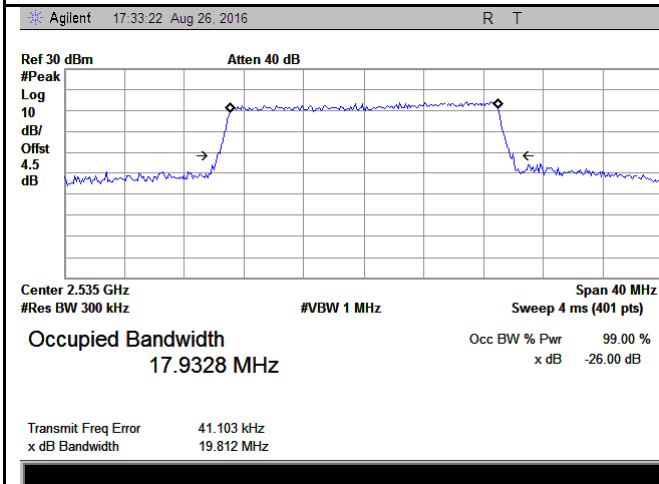

LTE band 7 - Middle CH QPSK-20

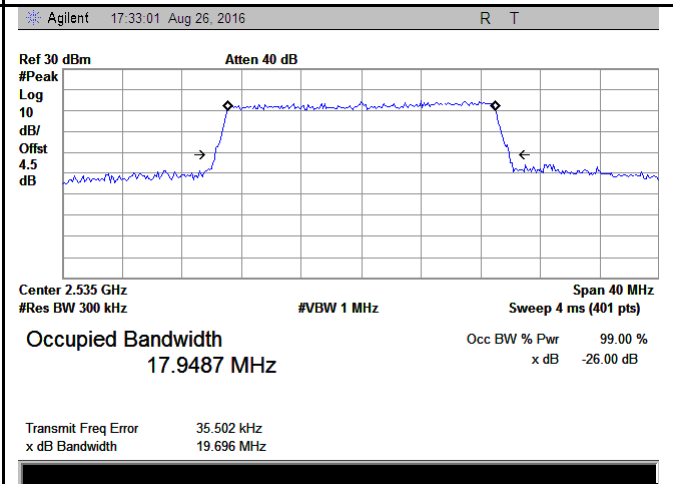

LTE band 7 - Middle CH 16QAM-20

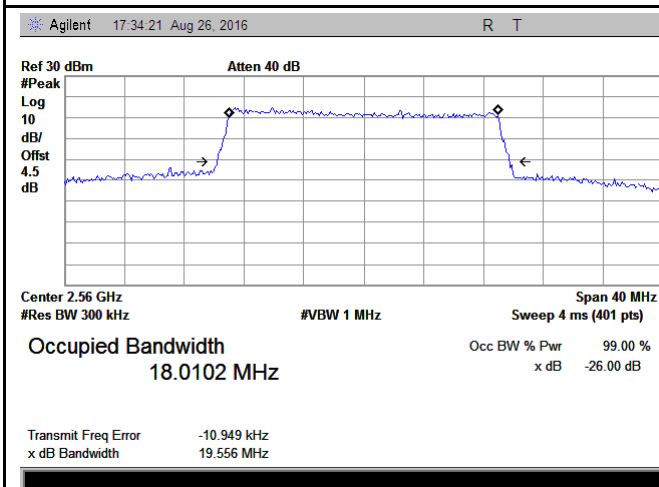

LTE band 7 - High CH QPSK-20

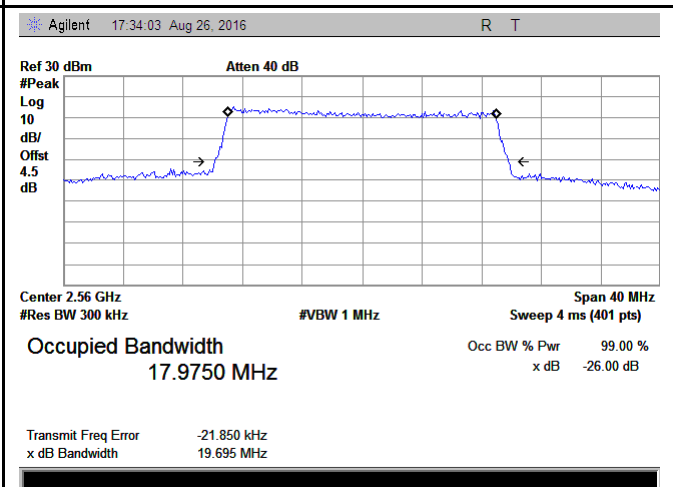

LTE band 7 - High CH 16QAM-20

### LTE Band 12 (Part 27)

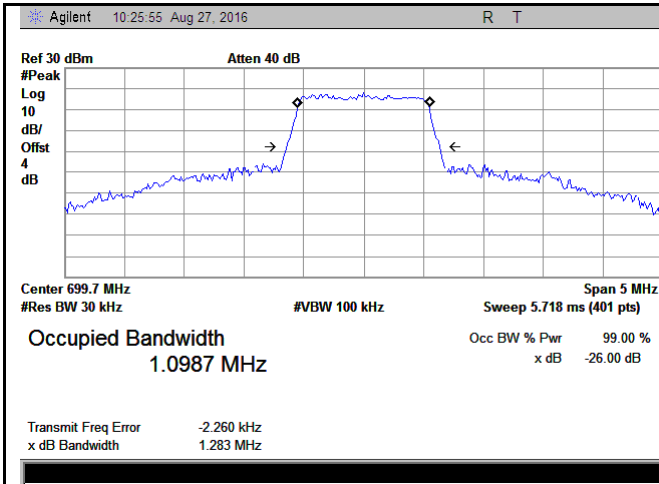

LTE band 12 - Low CH QPSK-1.4

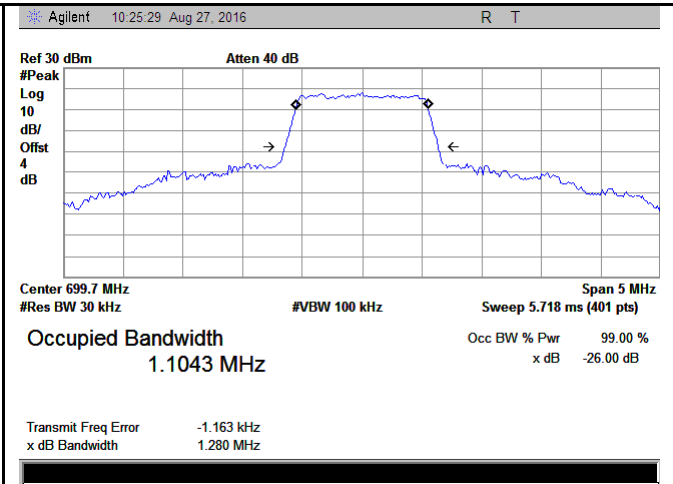

LTE band 12 - Low CH 16QAM-1.4

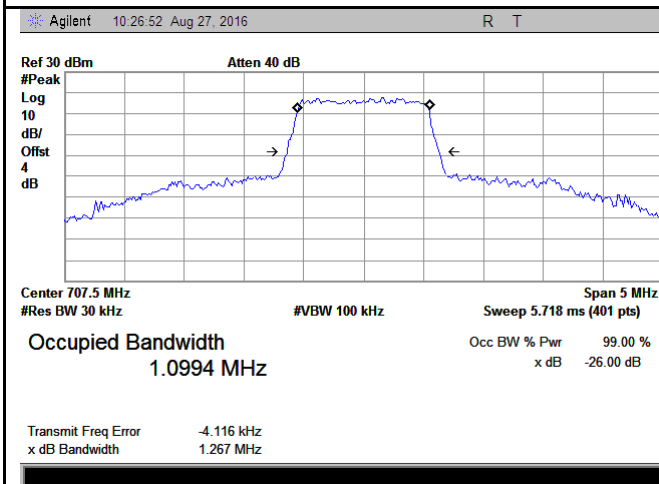

LTE band 12 - Middle CH QPSK-1.4

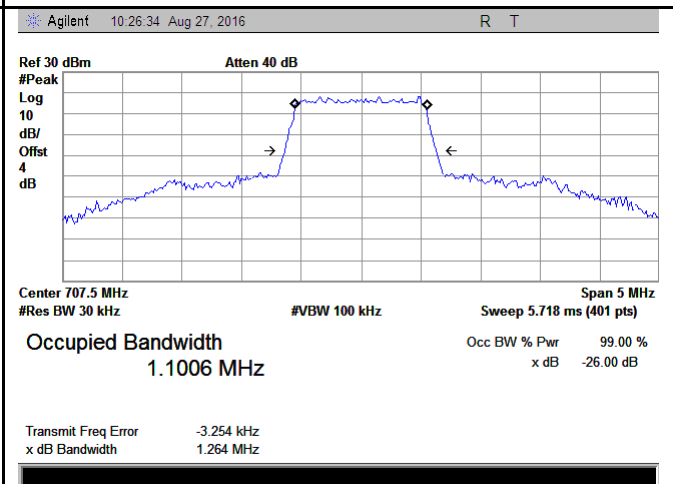

LTE band 12 - Middle CH 16QAM-1.4

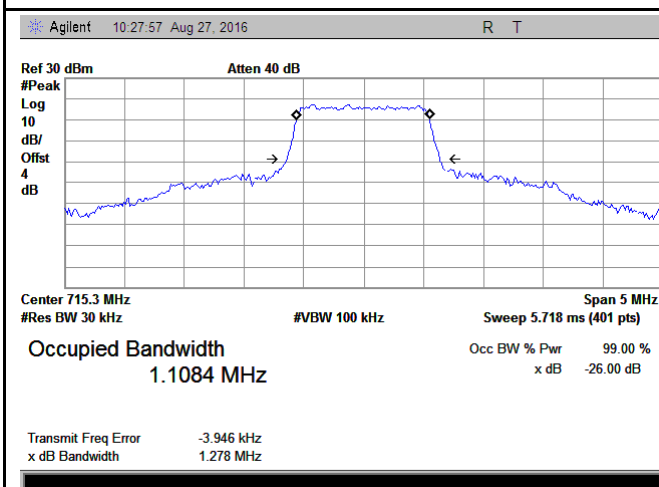

LTE band 12 - High CH QPSK-1.4

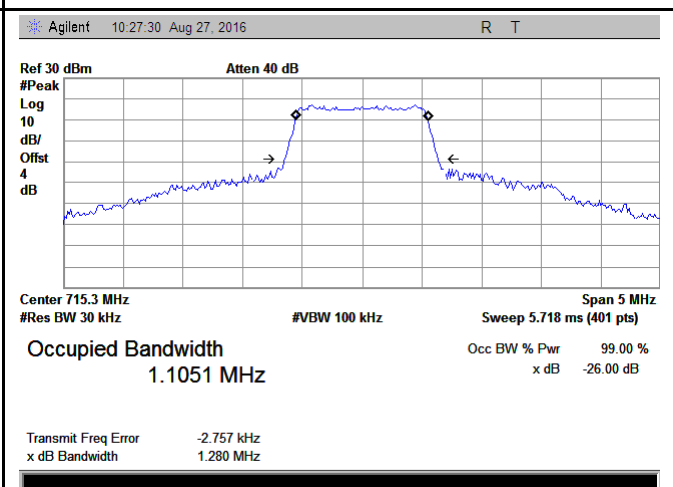

LTE band 12 - High CH 16QAM-1.4

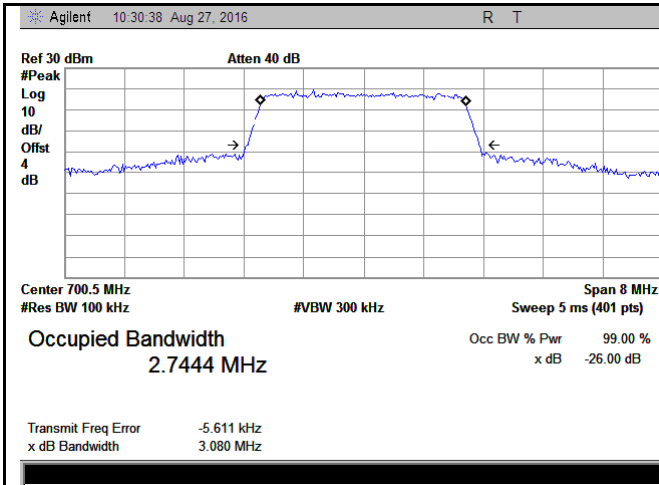

LTE band 12 - Low CH QPSK-3

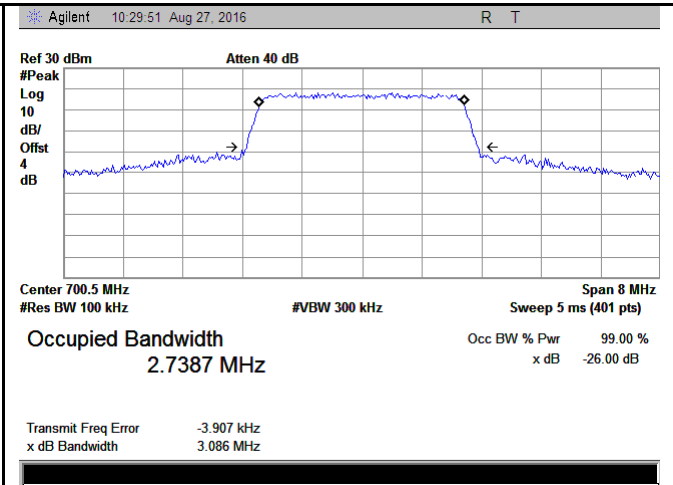

LTE band 12 - Low CH 16QAM-3

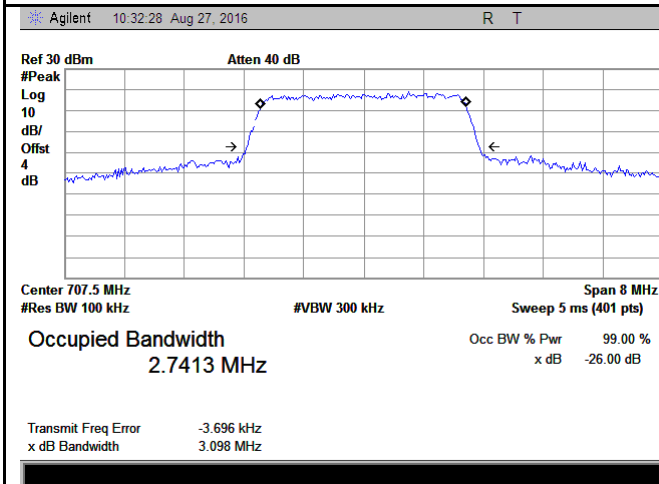

LTE band 12 - Middle CH QPSK-3

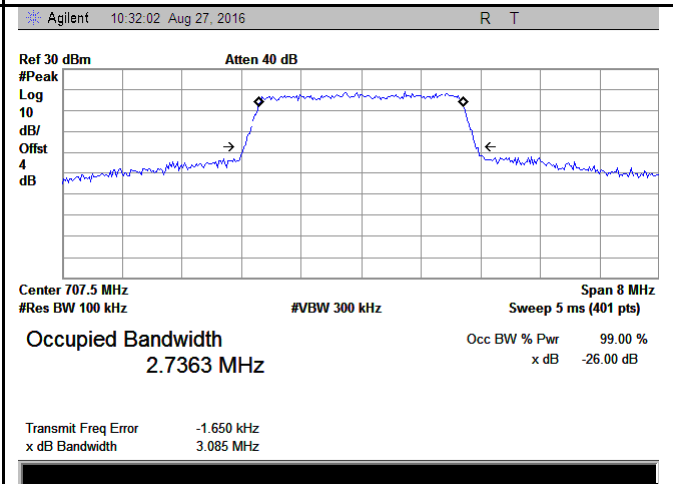

LTE band 12 - Middle CH 16QAM-3

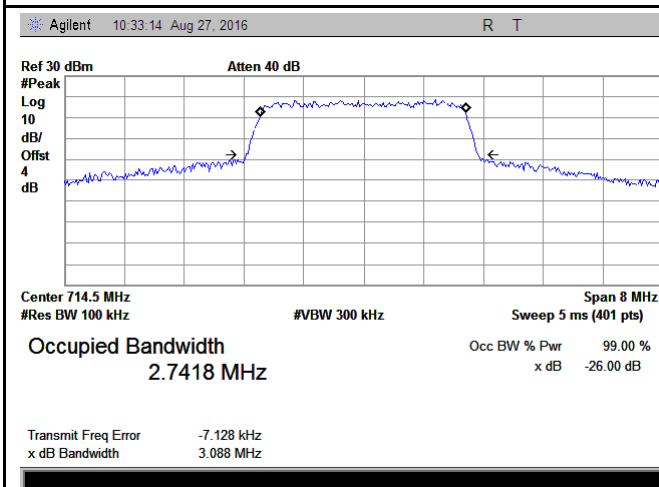

LTE band 12 - High CH QPSK-3

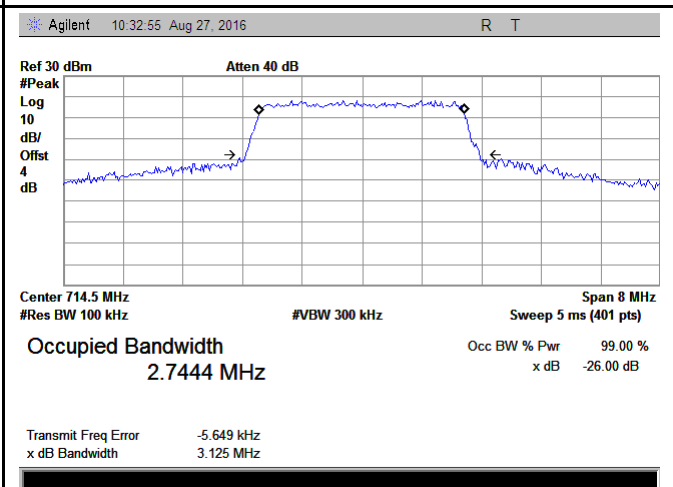

LTE band 12 - High CH 16QAM-3

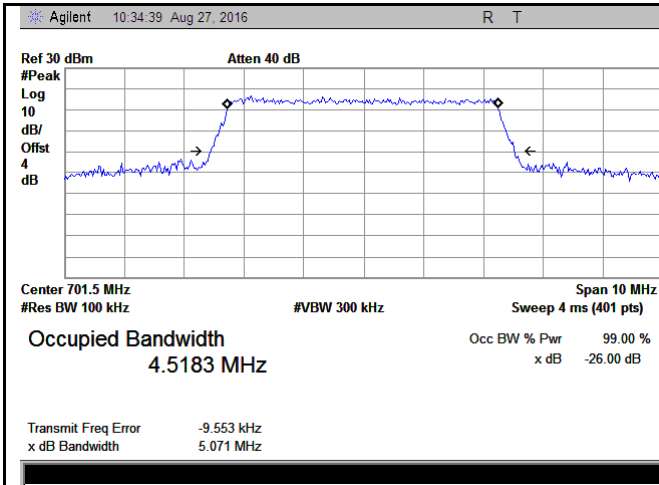

LTE band 12 - Low CH QPSK-5

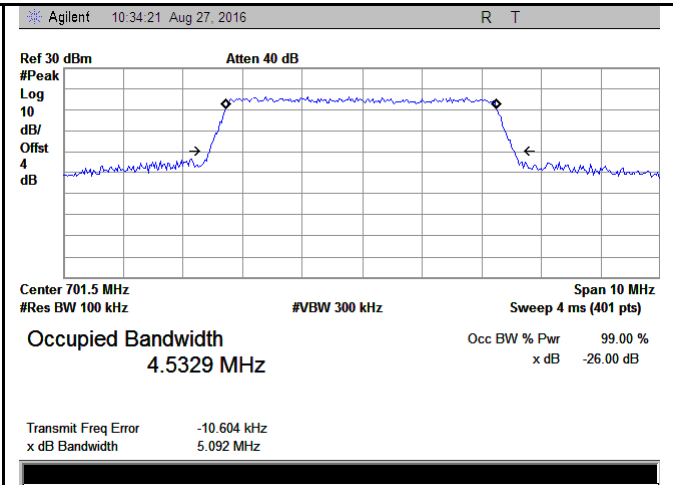

LTE band 12 - Low CH 16QAM-5

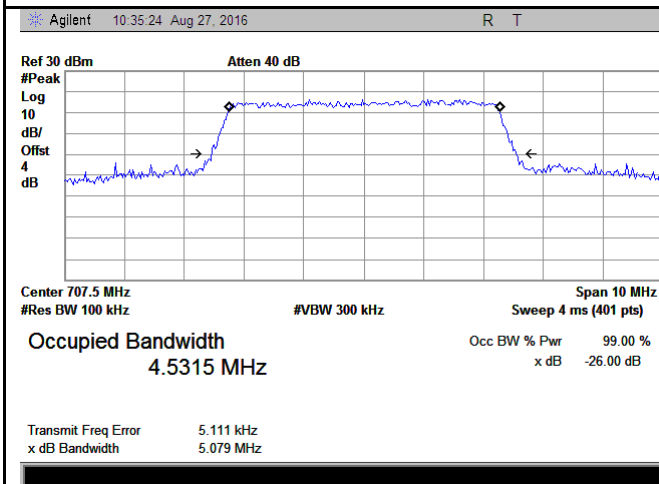

LTE band 12 - Middle CH QPSK-5

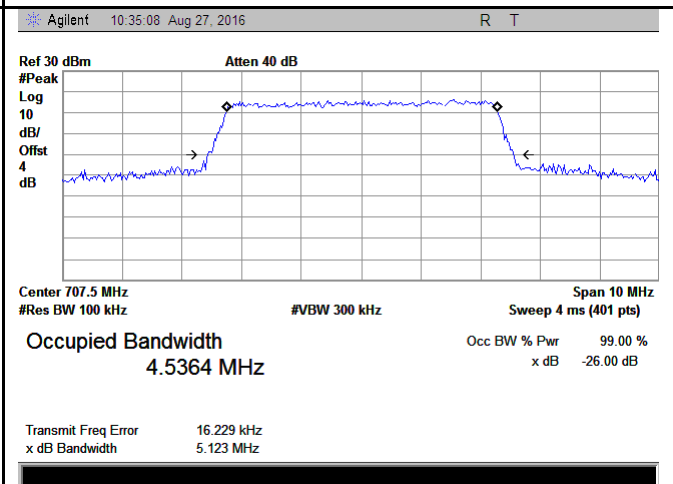

LTE band 12 - Middle CH 16QAM-5

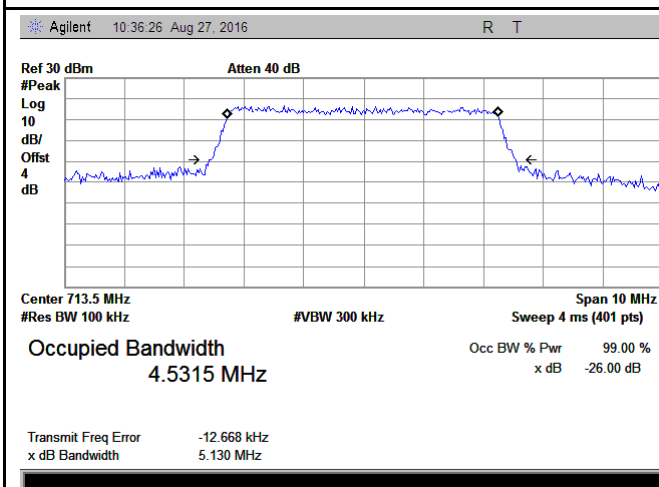

LTE band 12 - High CH QPSK-5

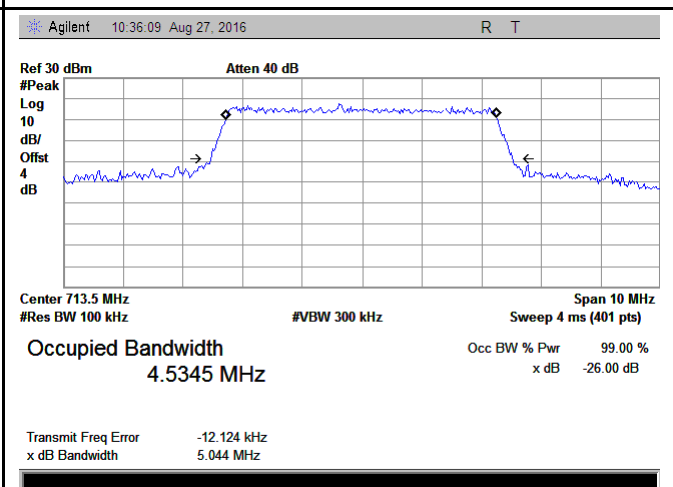

LTE band 12 - High CH 16QAM-5

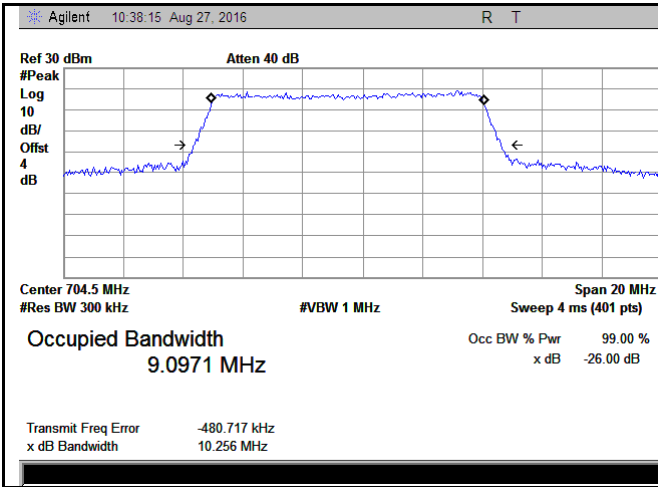

LTE band 12 - Low CH QPSK-10

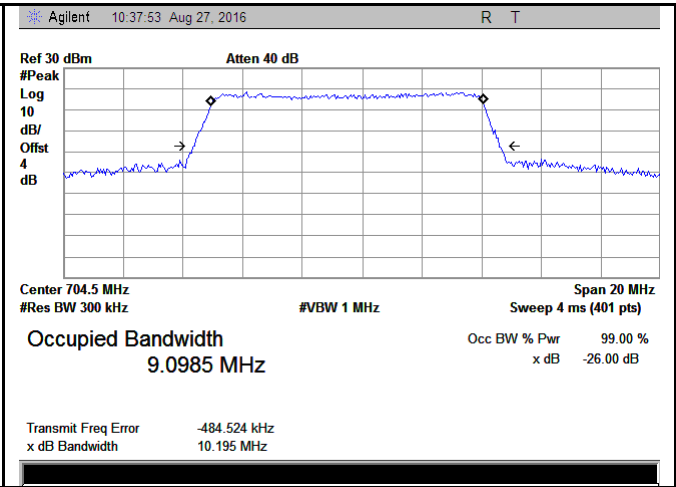

LTE band 12 - Low CH 16QAM-10

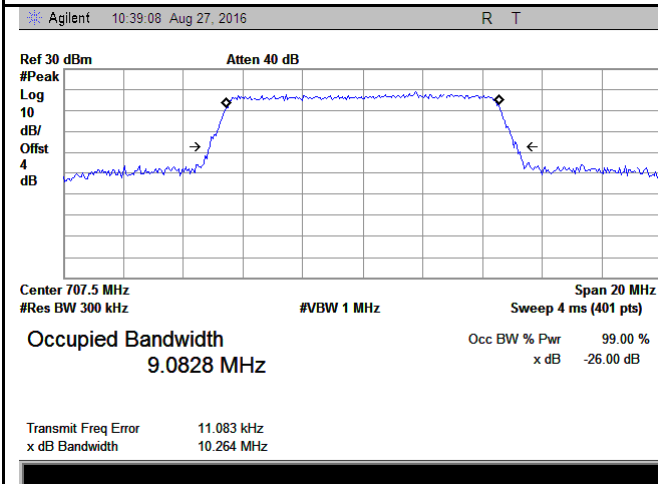

LTE band 12 - Middle CH QPSK-10

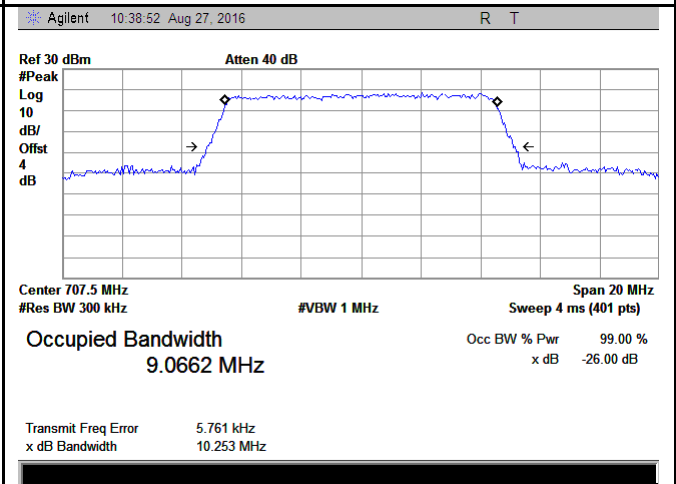

LTE band 12 - Middle CH 16QAM-10

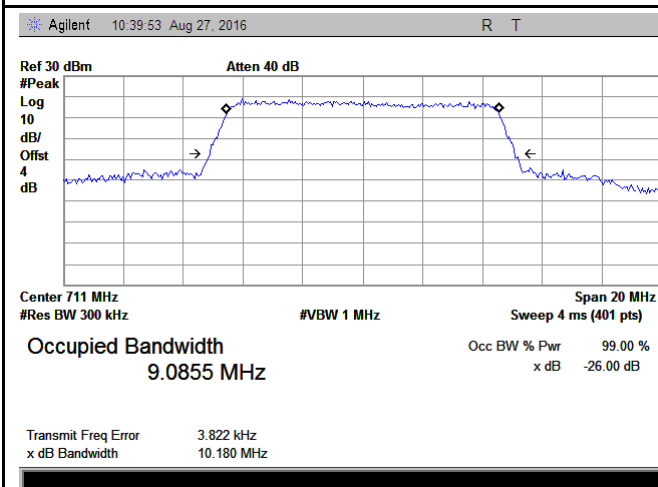

LTE band 12 - High CH QPSK-10

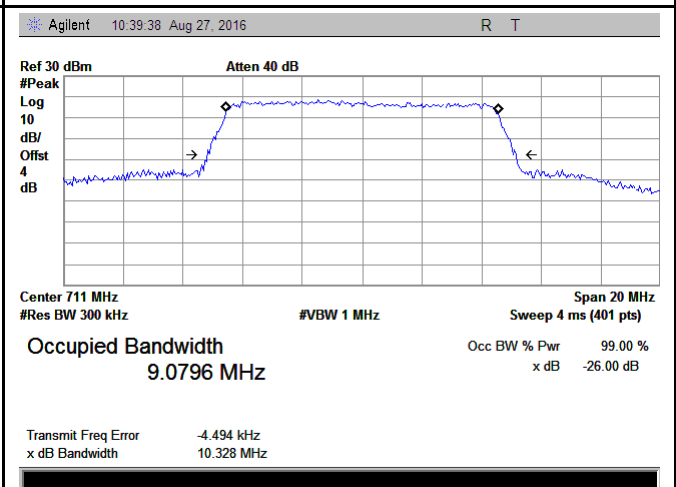

LTE band 12 - High CH 16QAM-10



### LTE Band 17 (Part 27)

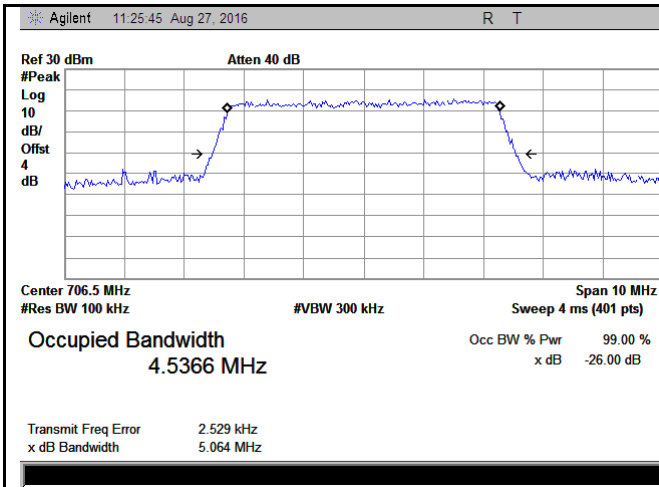

LTE band 17 - Low CH QPSK-5

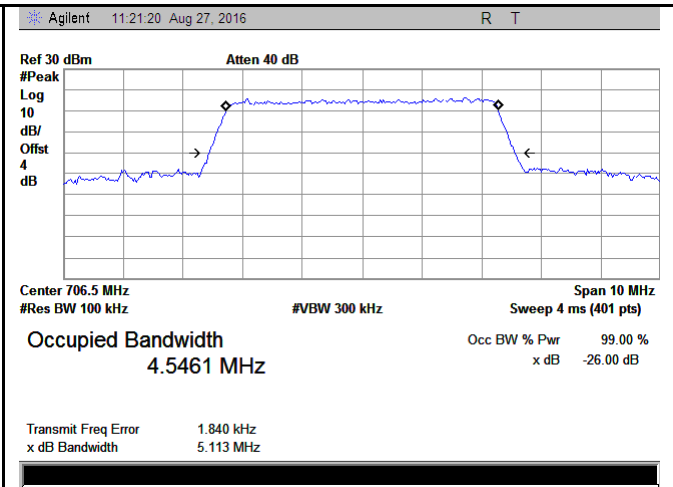

LTE band 17 - Low CH 16QAM-5

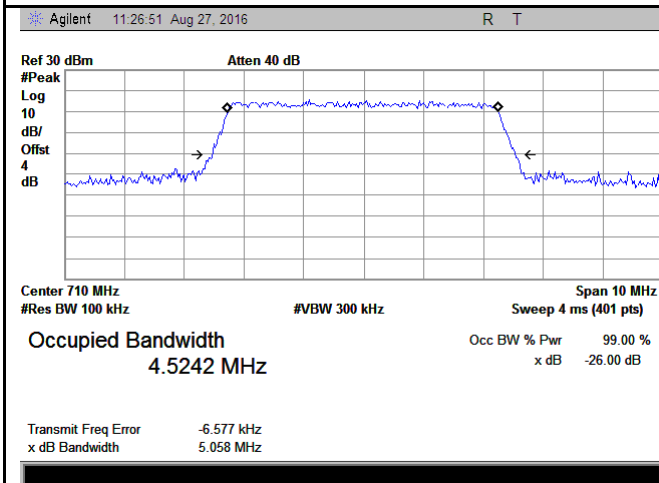

LTE band 17 - Middle CH QPSK-5

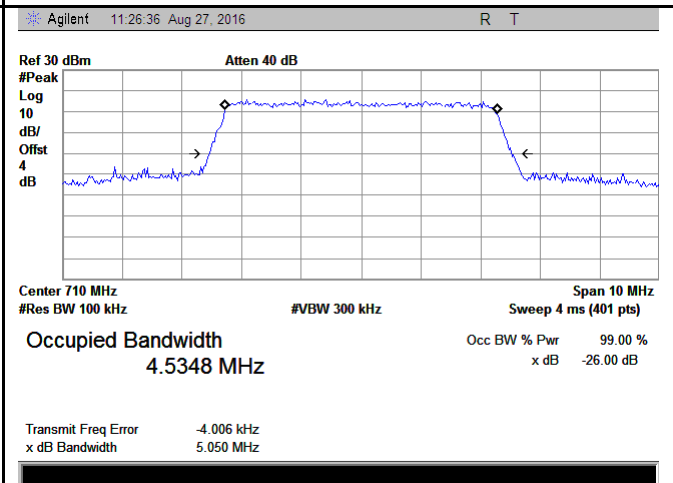

LTE band 17 - Middle CH 16QAM-5

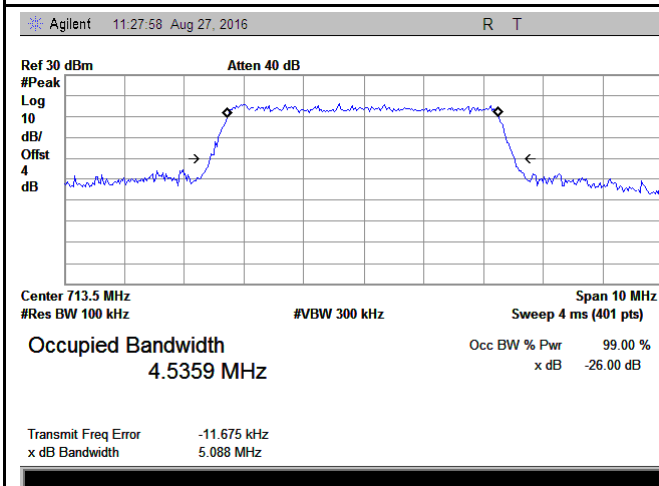

LTE band 17 - High CH QPSK-5

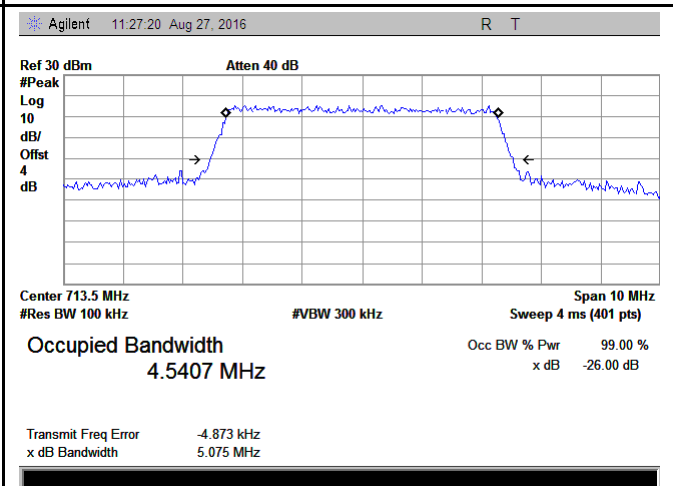

LTE band 17 - High CH 16QAM-5

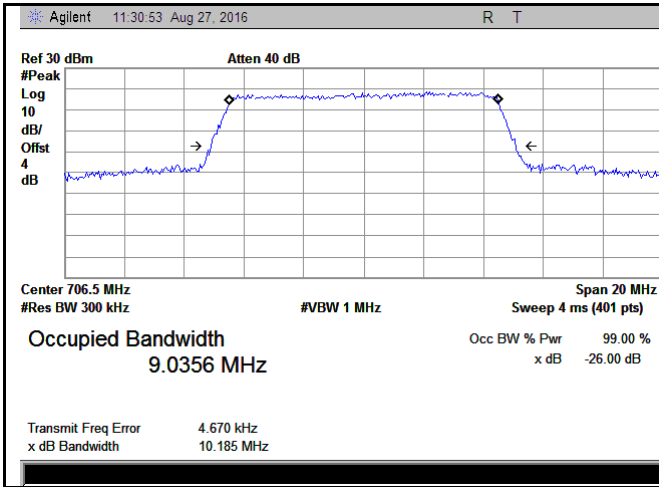

LTE band 17 - Low CH QPSK-10

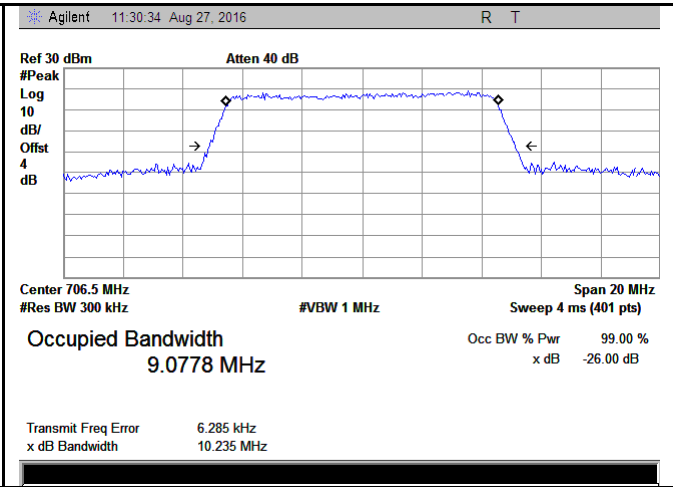

LTE band 17 - Low CH 16QAM-10

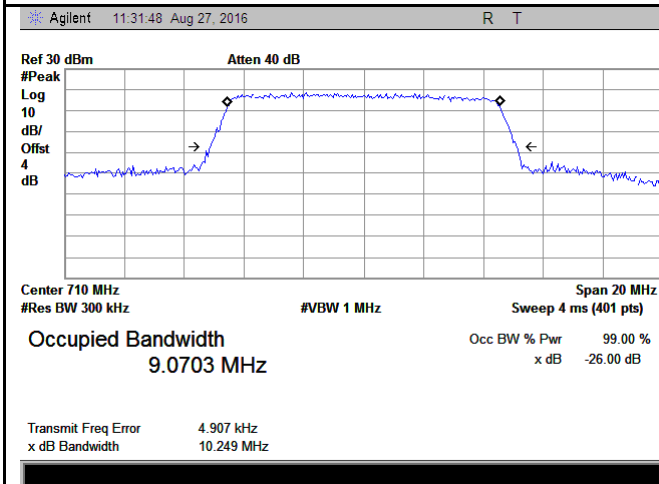

LTE band 17 - Middle CH QPSK-10

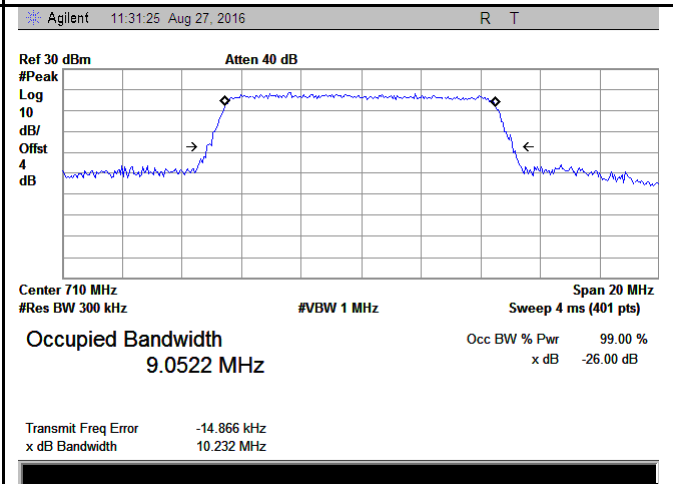

LTE band 17 - Middle CH 16QAM-10

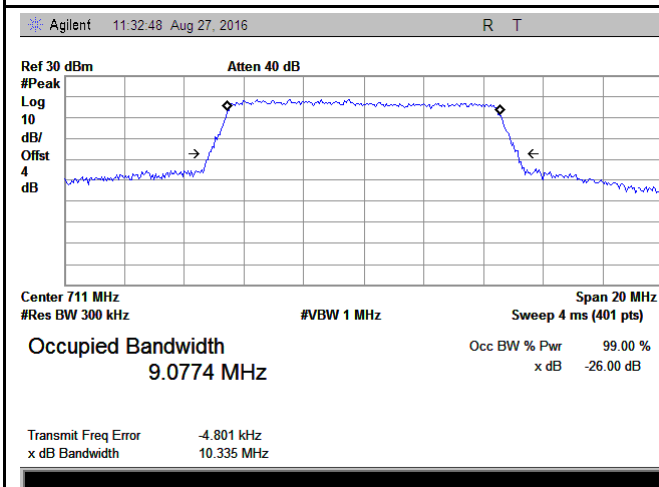

LTE band 17 - High CH QPSK-10

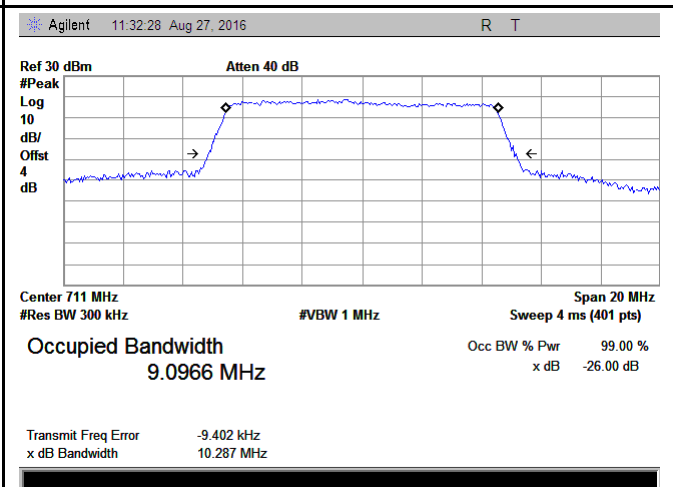

LTE band 17 - High CH 16QAM-10

## 6.5 Spurious Emissions at Antenna Terminals

Temperature	24°C
Relative Humidity	56%
Atmospheric Pressure	1023mbar
Test date :	August 23&27, 2016
Tested By :	Loren Luo

### Requirement(s):

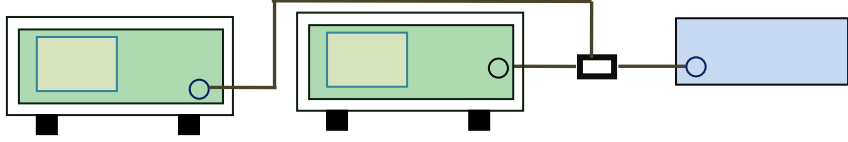
Spec	Item	Requirement	Applicable
§2.1051, §22.917(a)& §24.238(a) § 27.53(h)	a)	The power of any emission outside of the authorized operating frequency ranges must be lower than the transmitter power (P) by a factor of at least $43 + 10 \log (P)$ dB	<input checked="" type="checkbox"/>
Test Setup			
Test Procedure	<ul style="list-style-type: none"> <li>- The EUT was connected to Spectrum Analyzer and Base Station via power divider.</li> <li>- The Band Edges of low and high channels for the highest RF powers were measured.</li> <li>- Setting RBW as roughly BW/100.</li> </ul>		
Remark			
Result	<input checked="" type="checkbox"/> Pass <input type="checkbox"/> Fail		

Test Data     Yes                       N/A  
 Test Plot     Yes (See below)             N/A

**Test Plots 30MHz-5GHz**  
**LTE Band 2 (Part 24E)**

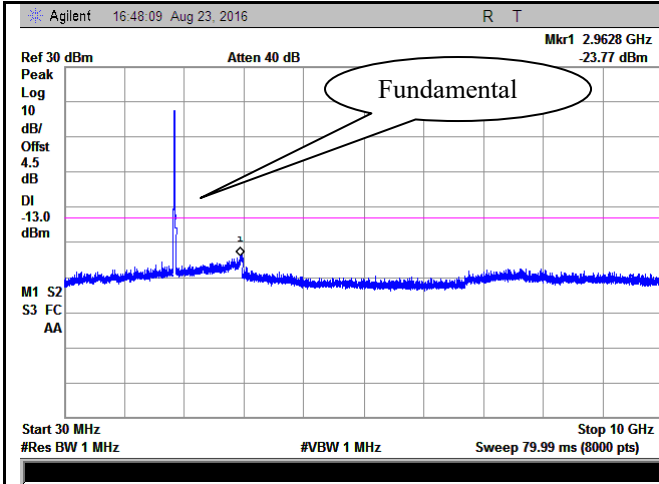

LTE Band 2 - Low Channel-1

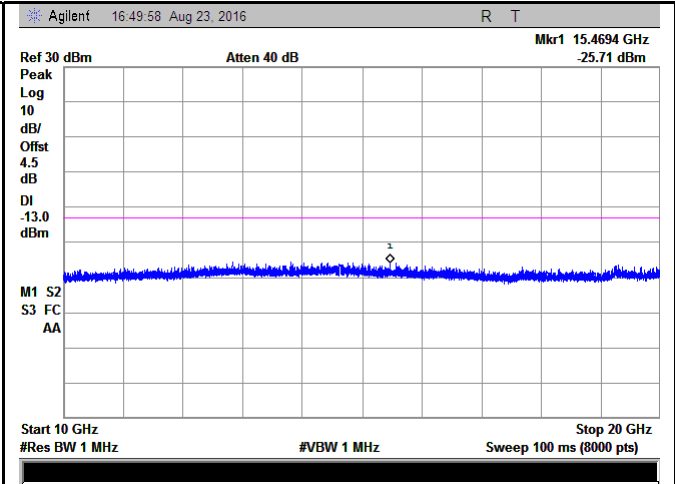

LTE Band 2 - Low Channel-2

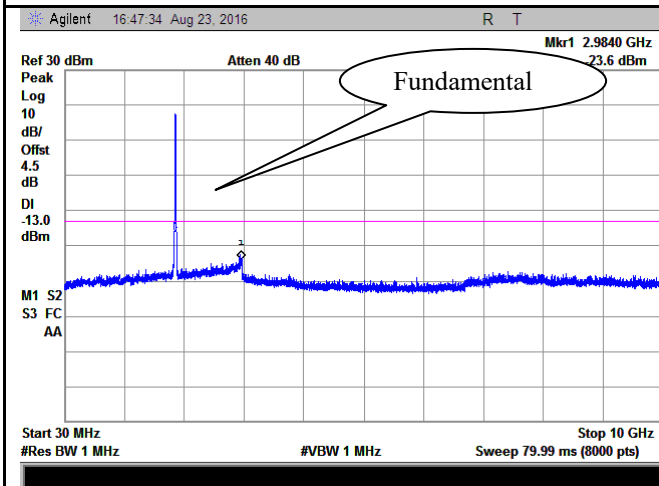

LTE Band 2 Middle Channel-1

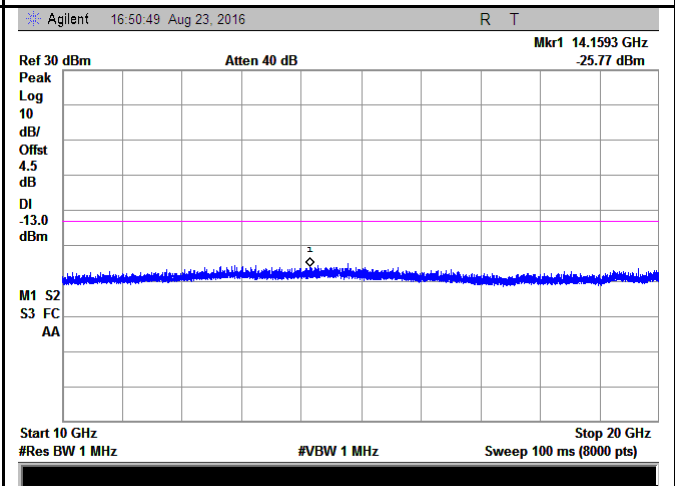

LTE Band 2 Middle Channel-2

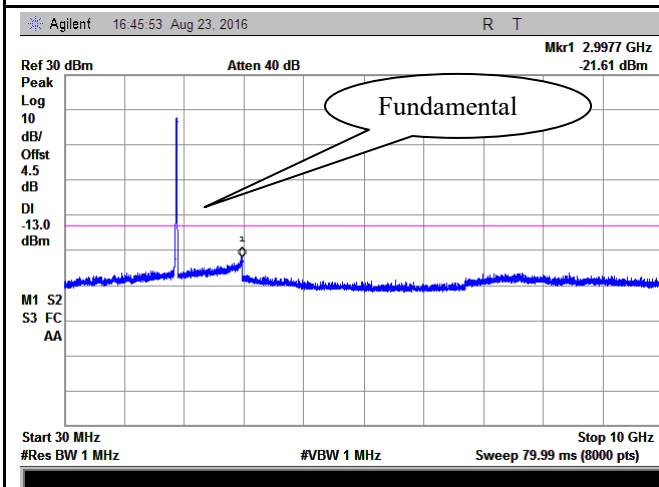

LTE Band 2 - High Channel-1

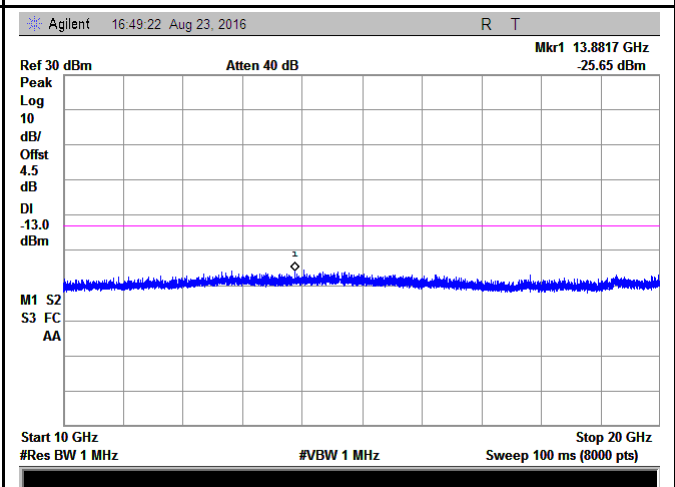

LTE Band 2 - High Channel-2

**LTE Band 4 (Part27) result**

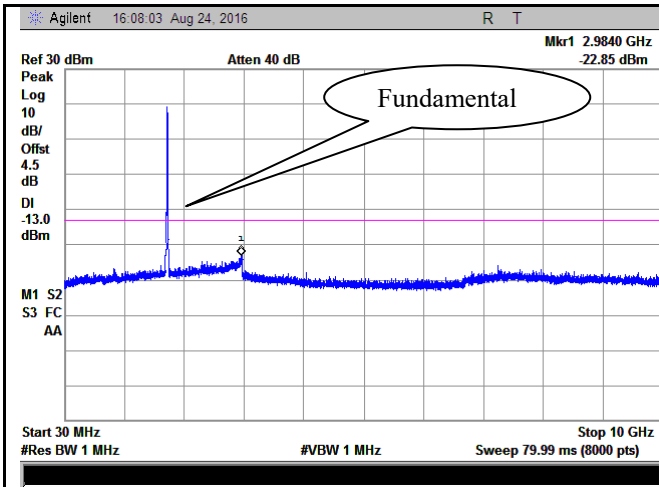

LTE Band 4 - Low Channel-1

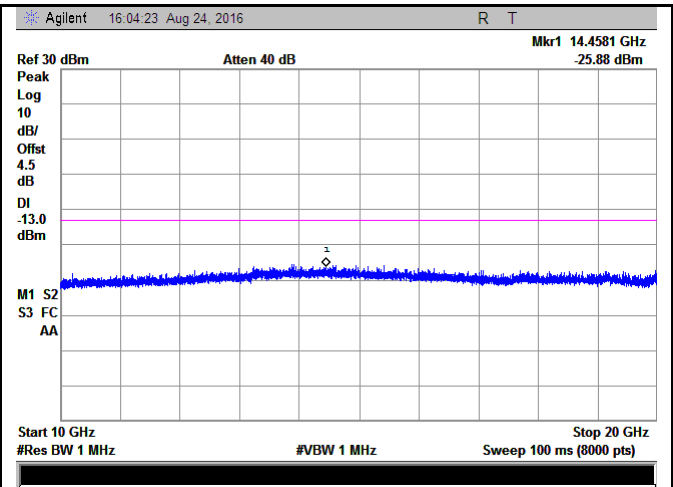

LTE Band 4 - Low Channel-2

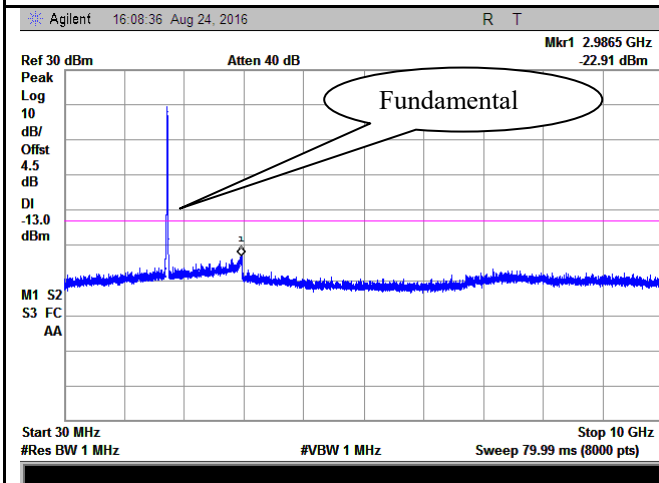

LTE Band 4 - Middle Channel-1

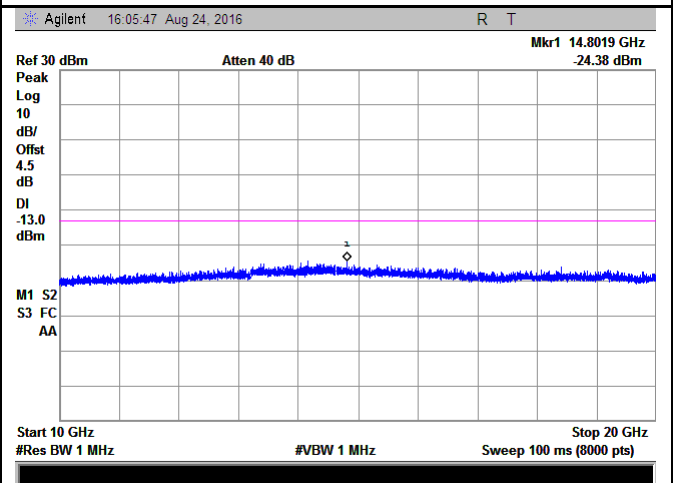

LTE Band 4 - Middle Channel-2

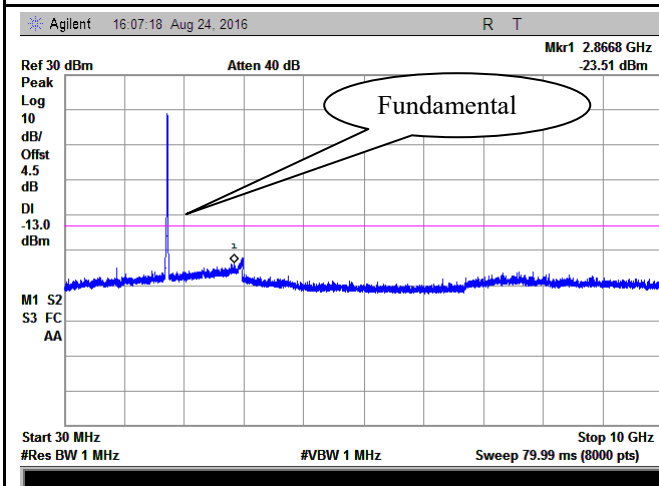

LTE Band 4 - High Channel-1

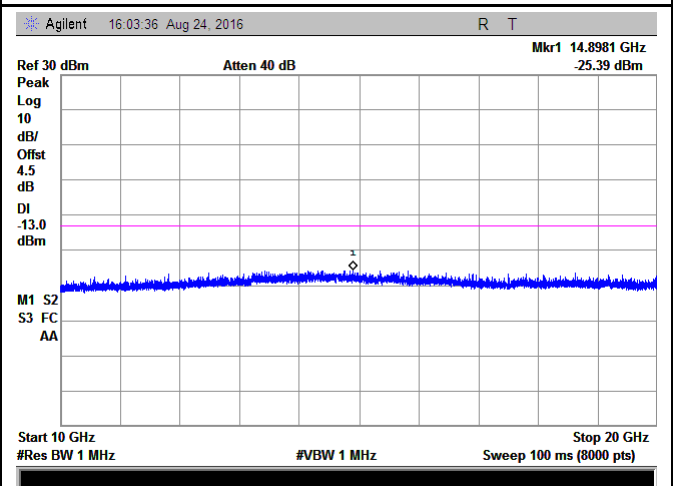

LTE Band 4 - High Channel-2

### LTE Band 5 (Part 22H)

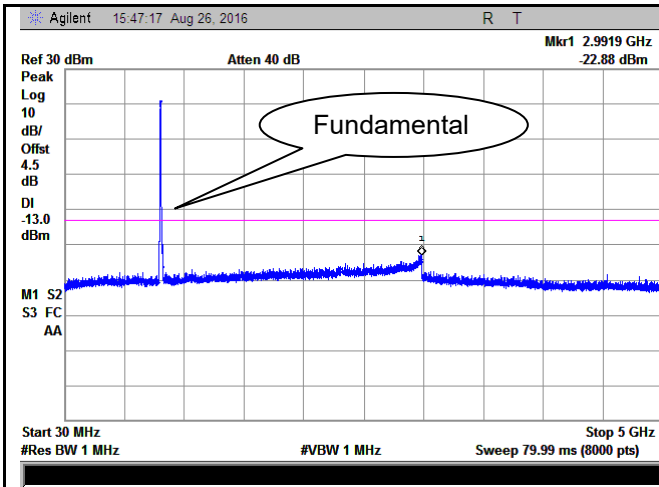

LTE Band 5 - Low Channel-1

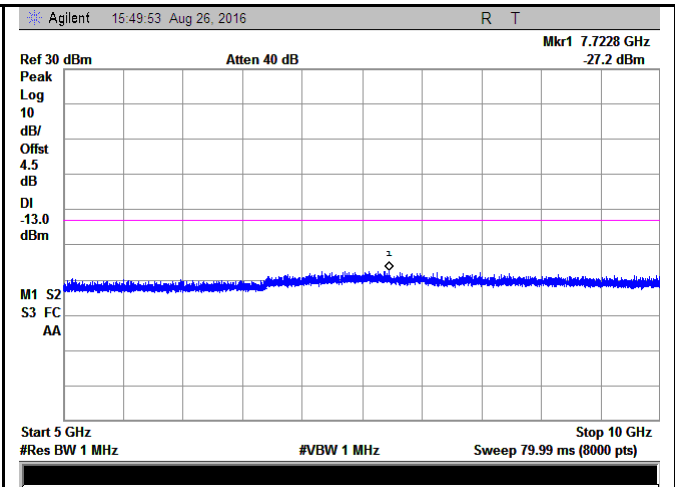

LTE Band 5 - Low Channel-2

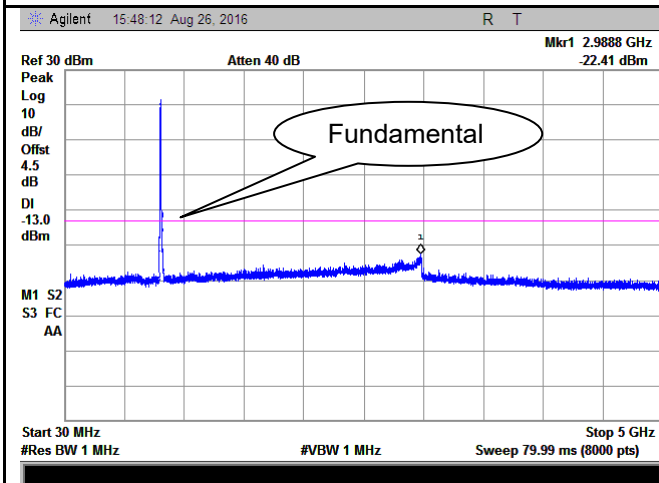

LTE Band 5 - Middle Channel-1

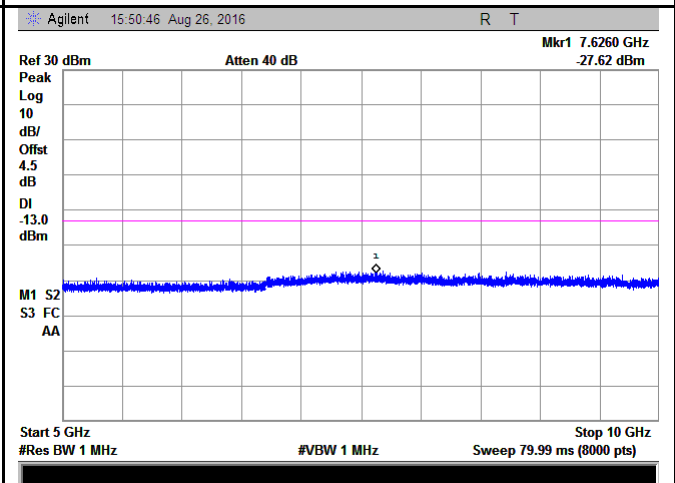

LTE Band 5 - Middle Channel-2

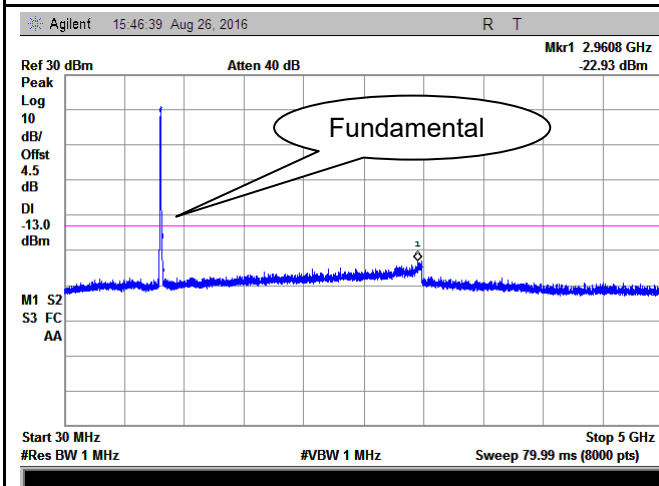

LTE Band 5 - High Channel-1

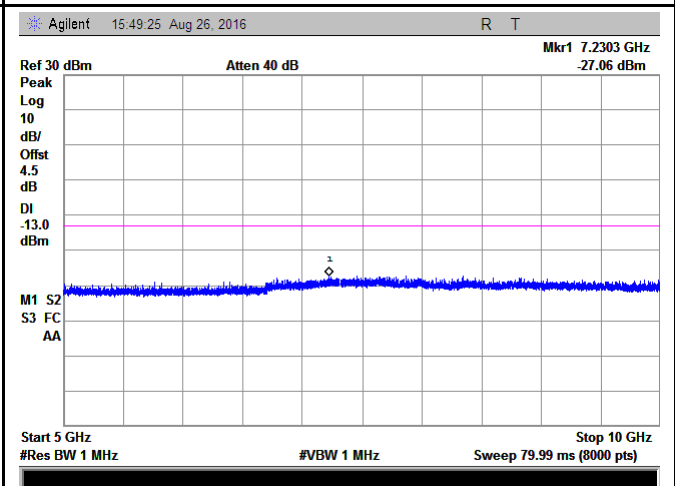

LTE Band 5 - High Channel-2

### LTE Band 7 (Part 27)

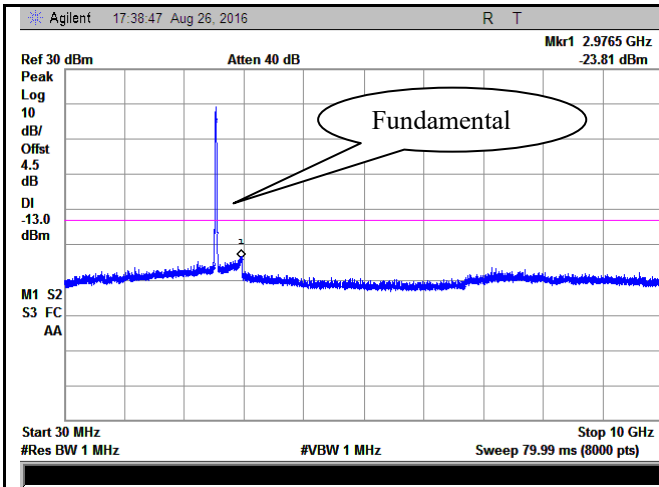

LTE Band 7 - Low Channel-1

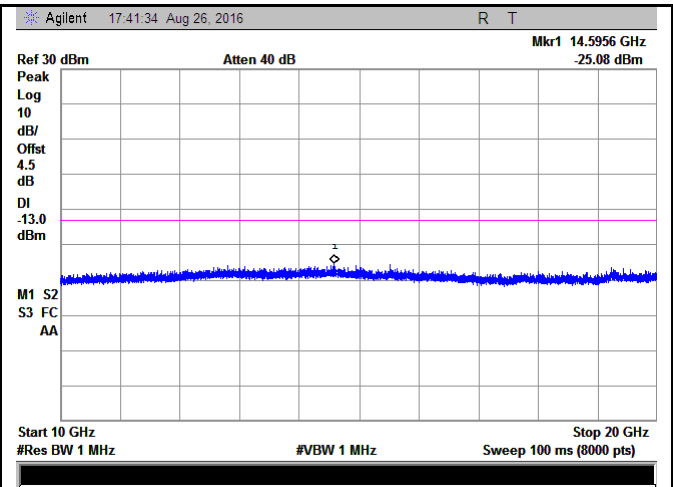

LTE Band 7 - Low Channel-2

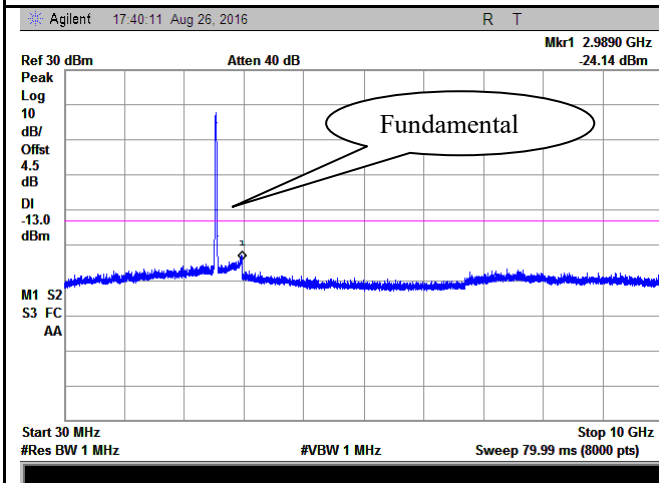

LTE Band 7 - Middle Channel-1

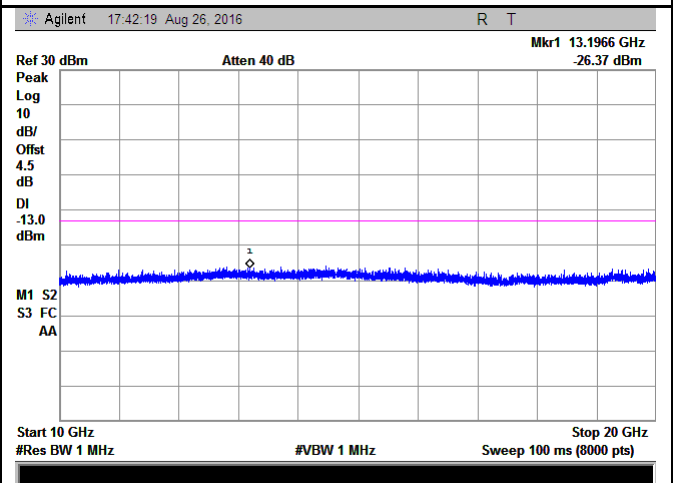

LTE Band 7 - Middle Channel-2

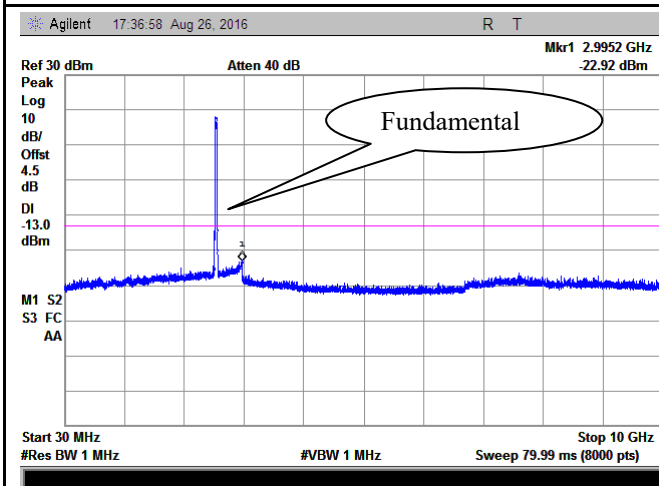

LTE Band 7 - High Channel-1

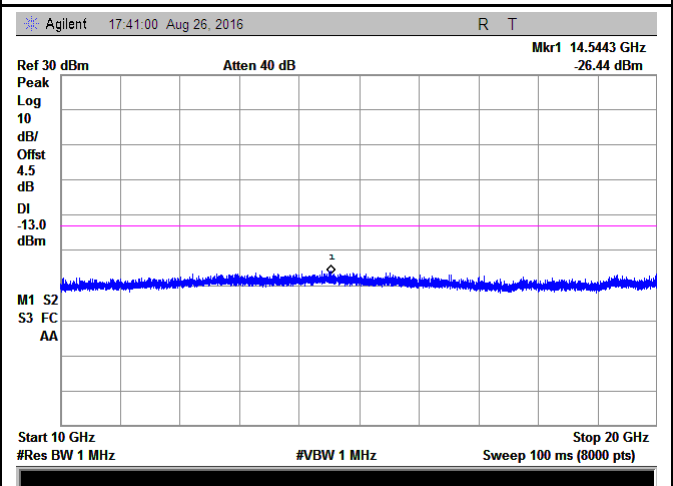

LTE Band 7 - High Channel-2

**LTE Band 12 (Part 27)**

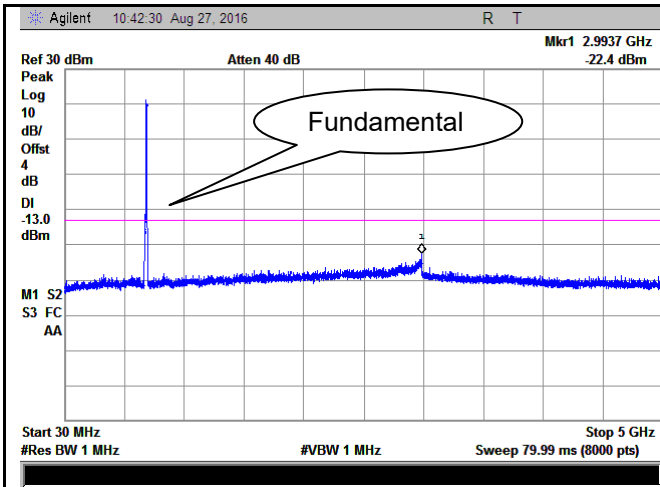

LTE Band 12 - Low Channel-1

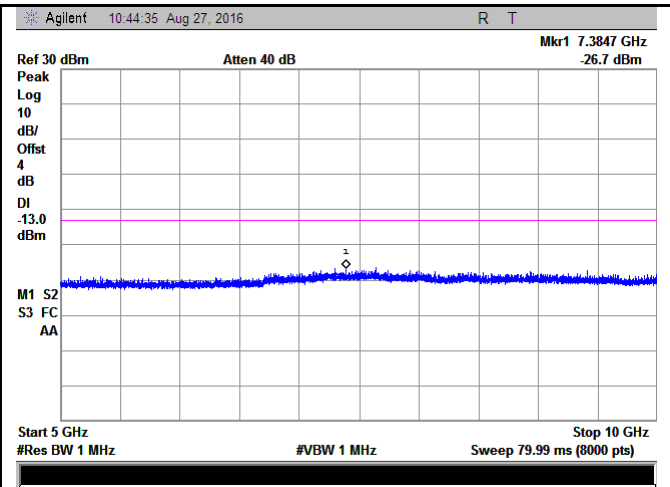

LTE Band 12 - Low Channel-2

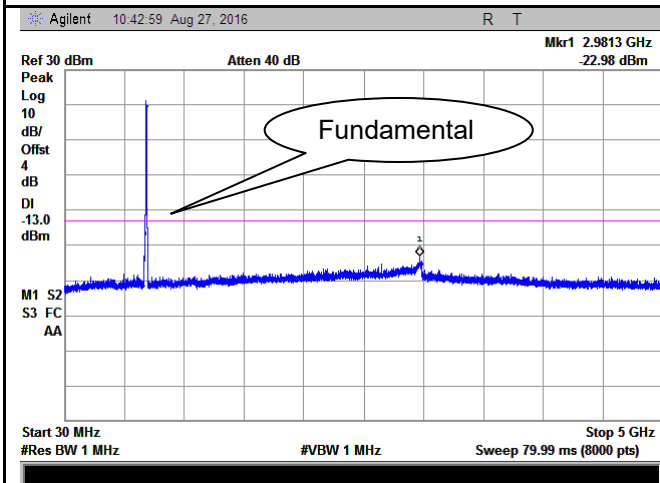

LTE Band 12 - Middle Channel-1

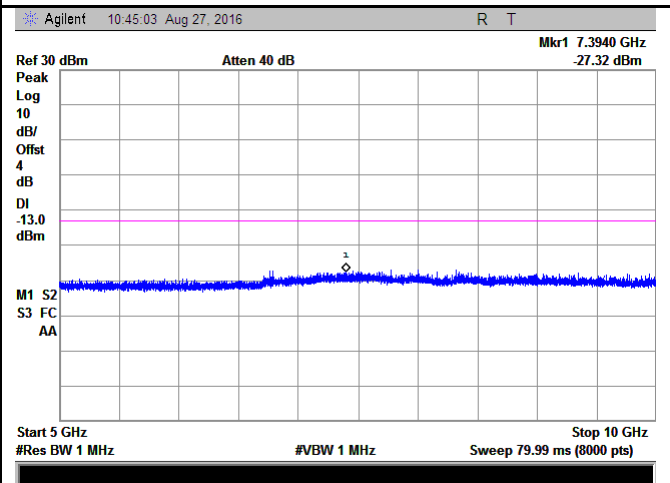

LTE Band 12 - Middle Channel-2

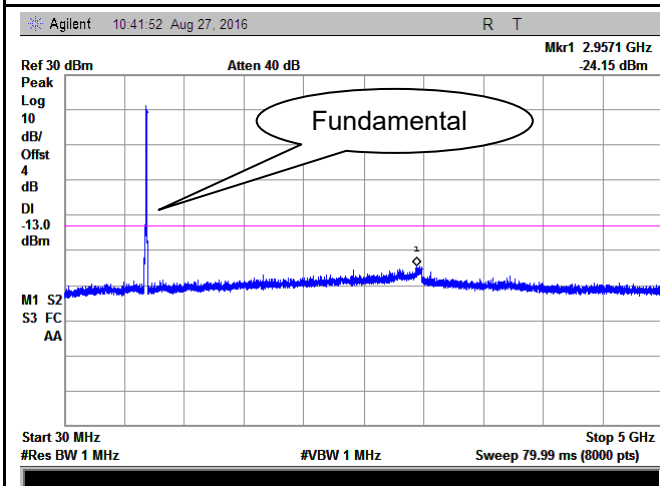

LTE Band 12 - High Channel-1

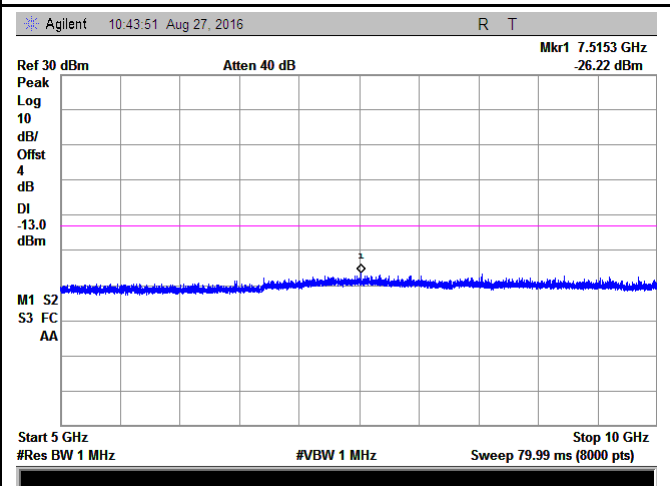

LTE Band 12 - High Channel-2



**LTE Band 17 (Part 27)**

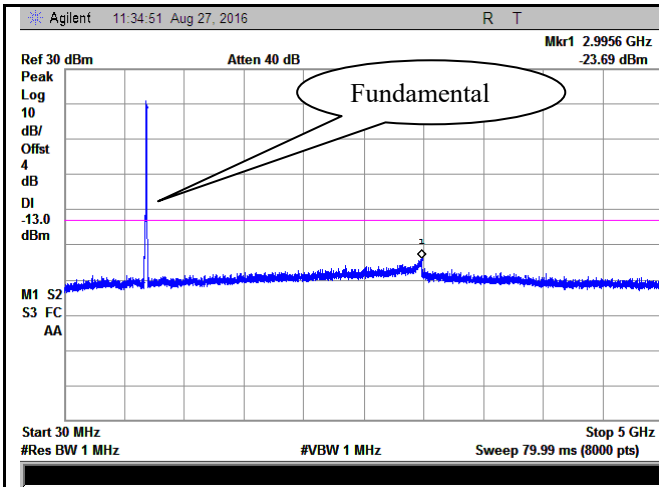

LTE Band 17 - Low Channel-1

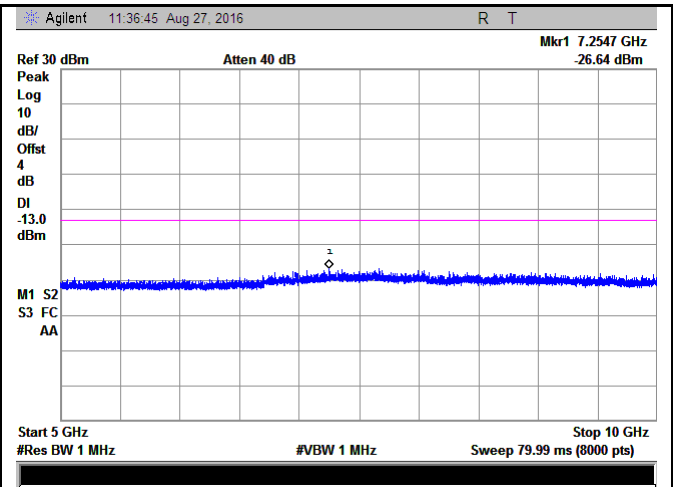

LTE Band 17 - Low Channel-2

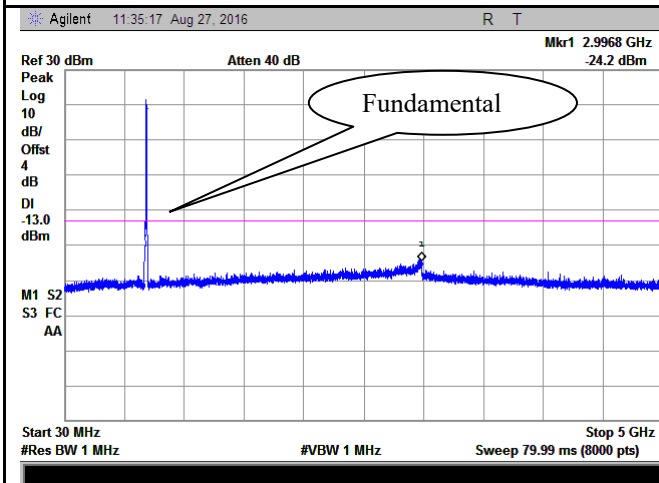

LTE Band 17 - Middle Channel-1

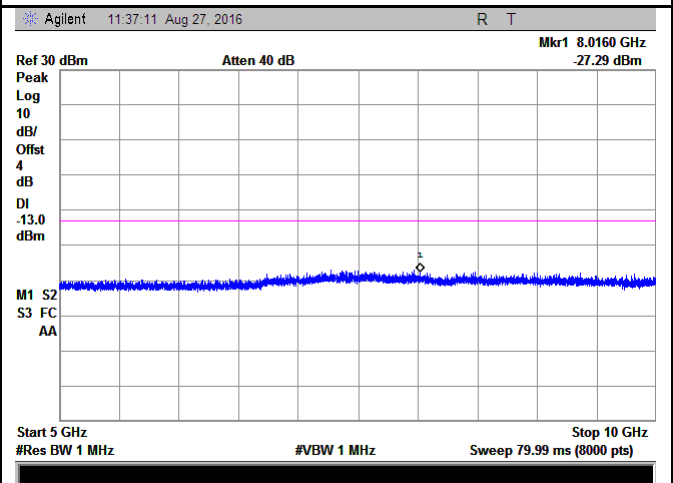

LTE Band 17 - Middle Channel-2

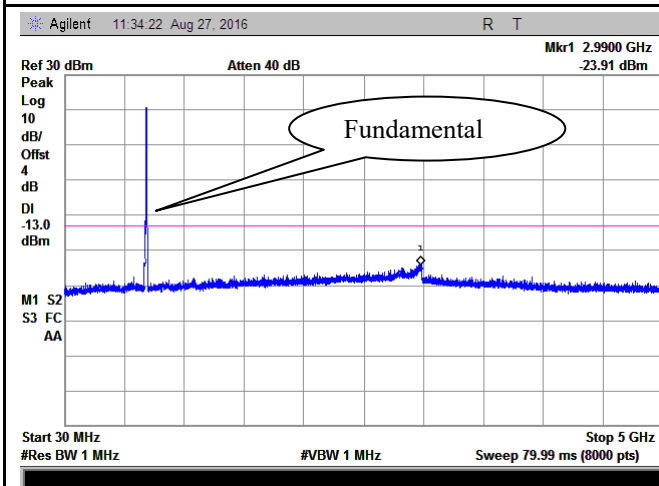

LTE Band 17 - High Channel-1

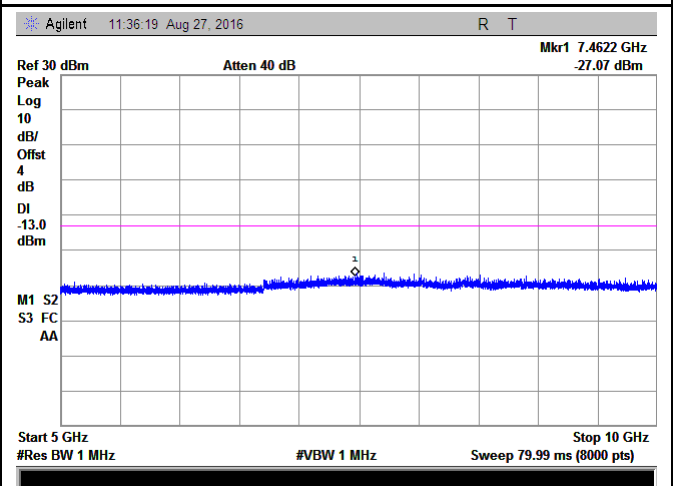

LTE Band 17 - High Channel-2

## 6.6 Spurious Radiated Emissions

Temperature	22°C
Relative Humidity	53%
Atmospheric Pressure	1029mbar
Test date :	August 29, 2016
Tested By :	Loren Luo

### Requirement(s):

Spec	Item	Requirement	Applicable
§2.1053, §22.917 & §24.238 § 27.53(h)	a)	The power of any emission outside of the authorized operating frequency ranges must be attenuated below the transmitter power (P) by a factor of at least $43 + 10 \log (P)$ dB. The spectrum is scanned from 30 MHz up to a frequency including its 10th harmonic.	<input checked="" type="checkbox"/>

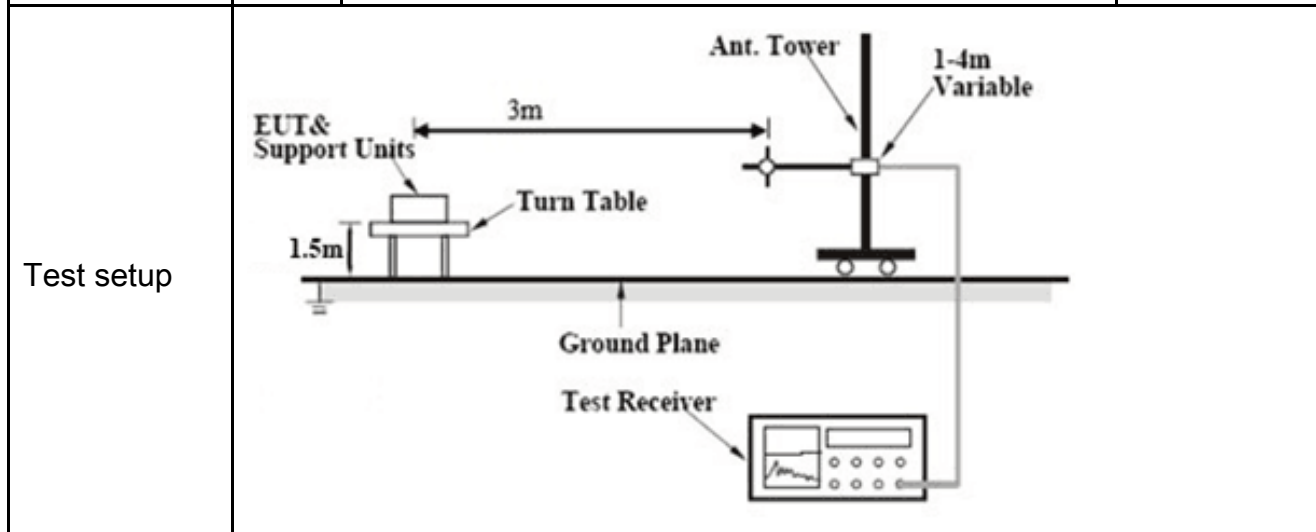

Test Procedure	<ol style="list-style-type: none"> <li>1. The transmitter was placed on a wooden turntable, and it was transmitting into a non-radiating load which was also placed on the turntable.</li> <li>2. The measurement antenna was placed at a distance of 3 meters from the EUT. During the tests, the antenna height and polarization as well as EUT azimuth were varied in order to identify the maximum level of emissions from the EUT. The test was performed by placing the EUT on 3-orthogonal axis.</li> <li>3. Remove the EUT and replace it with substitution antenna. A signal generator was connected to the substitution antenna by a non-radiating cable. The absolute levels of the spurious emissions were measured by the substitution.</li> </ol> <p>Sample Calculation:</p> $\text{EUT Field Strength} = \text{Raw Amplitude (dB}\mu\text{V/m)} - \text{Amplifier Gain (dB)} + \text{Antenna Factor (dB)} + \text{Cable Loss (dB)} + \text{Filter Attenuation (dB, if used)}$
----------------	--

Test Report	16070911-FCC-R5
Page	99 of 152

Remark	
Result	<input checked="" type="checkbox"/> Pass <input type="checkbox"/> Fail

**Test Data**
 Yes
  N/A

**Test Plot**
 Yes (See below)
  N/A

## LTE Band 2 (Part 24E) result

### Low channel

Frequency (MHz)	Substituted level (dBm)	Polarity (H/V)	Antenna Gain Correction (dB)	Cable Loss (dB)	Corrected Reading (dBm)	Limit (dBm)	Margin (dB)
3720	-46.49	V	10.25	2.73	-38.97	-13	-25.97
3720	-47.08	H	10.25	2.73	-39.56	-13	-26.56
51.7	-46.29	V	-4.2	0.11	-50.6	-13	-37.6
203.6	-48.35	H	4.6	0.18	-43.93	-13	-30.93

### Middle channel

Frequency (MHz)	Substituted level (dBm)	Polarity (H/V)	Antenna Gain Correction (dB)	Cable Loss (dB)	Corrected Reading (dBm)	Limit (dBm)	Margin (dB)
3760	-46.2	V	10.25	2.73	-38.68	-13	-25.68
3760	-47.33	H	10.25	2.73	-39.81	-13	-26.81
52.1	-46.09	V	-4.2	0.11	-50.4	-13	-37.4
204.8	-47.89	H	4.6	0.18	-43.47	-13	-30.47

### High channel

Frequency (MHz)	Substituted level (dBm)	Polarity (H/V)	Antenna Gain Correction (dB)	Cable Loss (dB)	Corrected Reading (dBm)	Limit (dBm)	Margin (dB)
3800	-46.16	V	10.36	2.73	-38.53	-13	-25.53
3800	-47.21	H	10.36	2.73	-39.58	-13	-26.58
51.5	-44.38	V	-4.2	0.11	-48.69	-13	-35.69
204.2	-46.79	H	4.6	0.18	-42.37	-13	-29.37

#### Note:

- 1, The testing has been conformed to  $10 \times 1907.5 \text{ MHz} = 19,075 \text{ MHz}$
- 2, All other emissions more than 30 dB below the limit
- 3, X-Axis, Y-Axis and Z-Axis were investigated. The results above show only the worst case.

## LTE Band 4(Part27) result

### Low channel

Frequency (MHz)	Substituted level (dBm)	Polarity (H/V)	Antenna Gain Correction (dB)	Cable Loss (dB)	Corrected Reading (dBm)	Limit (dBm)	Margin (dB)
3440	-45.78	V	10.06	2.52	-38.24	-13	-25.24
3440	-47.29	H	10.06	2.52	-39.75	-13	-26.75
52.1	-46.62	V	-4.2	0.11	-50.93	-13	-37.93
205.6	-48.37	H	4.6	0.18	-43.95	-13	-30.95

### Middle channel

Frequency (MHz)	Substituted level (dBm)	Polarity (H/V)	Antenna Gain Correction (dB)	Cable Loss (dB)	Corrected Reading (dBm)	Limit (dBm)	Margin (dB)
3465	-46.32	V	10.09	2.52	-38.75	-13	-25.75
3465	-47.65	H	10.09	2.52	-40.08	-13	-27.08
52.3	-46.54	V	-4.2	0.11	-50.85	-13	-37.85
205.5	-48.97	H	4.6	0.18	-44.55	-13	-31.55

### High channel

Frequency (MHz)	Substituted level (dBm)	Polarity (H/V)	Antenna Gain Correction (dB)	Cable Loss (dB)	Corrected Reading (dBm)	Limit (dBm)	Margin (dB)
3490	-45.74	V	10.09	2.52	-38.17	-13	-25.17
3490	-47.22	H	10.09	2.52	-39.65	-13	-26.65
52.7	-46.35	V	-4.2	0.11	-50.66	-13	-37.66
205.9	-48.29	H	4.6	0.18	-43.87	-13	-30.87

#### Note:

- 1, The testing has been conformed to  $10 \times 1752.5 \text{ MHz} = 17,525 \text{ MHz}$
- 2, All other emissions more than 30 dB below the limit
- 3, X-Axis, Y-Axis and Z-Axis were investigated. The results above show only the worst case.

## LTE Band 5(Part22H) result

### Low channel

Frequency (MHz)	Substituted level (dBm)	Polarity (H/V)	Antenna Gain Correction (dB)	Cable Loss (dB)	Corrected Reading (dBm)	Limit (dBm)	Margin (dB)
1658	-45.12	V	7.95	0.78	-37.95	-13	-24.95
1658	-45.96	H	7.95	0.78	-38.79	-13	-25.79
50.9	-45.68	V	-4.2	0.11	-49.99	-13	-36.99
203.8	-48.76	H	4.6	0.18	-44.34	-13	-31.34

### Middle channel

Frequency (MHz)	Substituted level (dBm)	Polarity (H/V)	Antenna Gain Correction (dB)	Cable Loss (dB)	Corrected Reading (dBm)	Limit (dBm)	Margin (dB)
1673	-44.46	V	7.95	0.78	-37.29	-13	-24.29
1673	-45.24	H	7.95	0.78	-38.07	-13	-25.07
51.1	-43.98	V	-4.2	0.11	-48.29	-13	-35.29
204.3	-48.64	H	4.6	0.18	-44.22	-13	-31.22

### High channel

Frequency (MHz)	Substituted level (dBm)	Polarity (H/V)	Antenna Gain Correction (dB)	Cable Loss (dB)	Corrected Reading (dBm)	Limit (dBm)	Margin (dB)
1688	-44.67	V	7.95	0.78	-37.5	-13	-24.5
1688	-45.27	H	7.95	0.78	-38.1	-13	-25.1
50.8	-44.29	V	-4.2	0.11	-48.6	-13	-35.6
203.9	-47.89	H	4.6	0.18	-43.47	-13	-30.47

**Note:**

- 1, The testing has been conformed to  $10 \times 846.5 \text{ MHz} = 8,465 \text{ MHz}$
- 2, All other emissions more than 30 dB below the limit
- 3, X-Axis, Y-Axis and Z-Axis were investigated. The results above show only the worst case.

## LTE Band 7(Part27) result

### Low channel

Frequency (MHz)	Substituted level (dBm)	Polarity (H/V)	Antenna Gain Correction (dB)	Cable Loss (dB)	Corrected Reading (dBm)	Limit (dBm)	Margin (dB)
5020	-47.85	V	10.29	0.98	-38.54	-13	-25.54
5020	-48.12	H	10.29	0.98	-38.81	-13	-25.81
51.5	-45.86	V	-4.2	0.11	-50.17	-13	-37.17
204.2	-48.21	H	4.6	0.18	-43.79	-13	-30.79

### Middle channel

Frequency (MHz)	Substituted level (dBm)	Polarity (H/V)	Antenna Gain Correction (dB)	Cable Loss (dB)	Corrected Reading (dBm)	Limit (dBm)	Margin (dB)
5070	-47.56	V	10.3	0.99	-38.25	-13	-25.25
5070	-48.13	H	10.3	0.99	-38.82	-13	-25.82
51.6	-45.67	V	-4.2	0.11	-49.98	-13	-36.98
203.7	-48.39	H	4.6	0.18	-43.97	-13	-30.97

### High channel

Frequency (MHz)	Substituted level (dBm)	Polarity (H/V)	Antenna Gain Correction (dB)	Cable Loss (dB)	Corrected Reading (dBm)	Limit (dBm)	Margin (dB)
5120	-47.83	V	10.32	1	-38.51	-13	-25.51
5120	-48.27	H	10.32	1	-38.95	-13	-25.95
52.1	-45.62	V	-4.2	0.11	-49.93	-13	-36.93
204.7	-47.38	H	4.6	0.18	-42.96	-13	-29.96

**Note:**

- 1, The testing has been conformed to  $10 \times 2567.5 \text{ MHz} = 25,675 \text{ MHz}$
- 2, All other emissions more than 30 dB below the limit
- 3, X-Axis, Y-Axis and Z-Axis were investigated. The results above show only the worst case.

## LTE Band 12(Part27) result

### Low channel

Frequency (MHz)	Substituted level (dBm)	Polarity (H/V)	Antenna Gain Correction (dB)	Cable Loss (dB)	Corrected Reading (dBm)	Limit (dBm)	Margin (dB)
1408	-47.98	V	7.65	0.75	-41.08	-13	-28.08
1408	-48.32	H	7.65	0.75	-41.42	-13	-28.42
570.8	-56.32	V	6.5	0.36	-50.18	-13	-37.18
851.6	-51.26	H	6.8	0.44	-44.9	-13	-31.9

### Middle channel

Frequency (MHz)	Substituted level (dBm)	Polarity (H/V)	Antenna Gain Correction (dB)	Cable Loss (dB)	Corrected Reading (dBm)	Limit (dBm)	Margin (dB)
1415	-47.69	V	7.65	0.75	-40.79	-13	-27.79
1415	-48.11	H	7.65	0.75	-41.21	-13	-28.21
569.7	-55.95	V	6.5	0.36	-49.81	-13	-36.81
848.9	-51.24	H	6.8	0.44	-44.88	-13	-31.88

### High channel

Frequency (MHz)	Substituted level (dBm)	Polarity (H/V)	Antenna Gain Correction (dB)	Cable Loss (dB)	Corrected Reading (dBm)	Limit (dBm)	Margin (dB)
1422	-47.12	V	7.65	0.75	-40.22	-13	-27.22
1422	-47.85	H	7.65	0.75	-40.95	-13	-27.95
569.9	-56.21	V	6.5	0.36	-50.07	-13	-37.07
847.6	-50.47	H	6.8	0.44	-44.11	-13	-31.11

#### Note:

- 1, The testing has been conformed to  $10 \times 715.3 \text{ MHz} = 7,153 \text{ MHz}$
- 2, All other emissions more than 30 dB below the limit
- 3, X-Axis, Y-Axis and Z-Axis were investigated. The results above show only the worst case.



## LTE Band 17(Part27) result

### Low channel

Frequency (MHz)	Substituted level (dBm)	Polarity (H/V)	Antenna Gain Correction (dB)	Cable Loss (dB)	Corrected Reading (dBm)	Limit (dBm)	Margin (dB)
1418	-44.01	V	7.65	0.75	-37.11	-13	-24.11
1418	-44.78	H	7.65	0.75	-37.88	-13	-24.88
51.6	-45.13	V	-4.2	0.11	-49.44	-13	-36.44
204.3	-48.69	H	4.6	0.18	-44.27	-13	-31.27

### Middle channel

Frequency (MHz)	Substituted level (dBm)	Polarity (H/V)	Antenna Gain Correction (dB)	Cable Loss (dB)	Corrected Reading (dBm)	Limit (dBm)	Margin (dB)
1420	-44.02	V	7.65	0.75	-37.12	-13	-24.12
1420	-44.85	H	7.65	0.75	-37.95	-13	-24.95
52.1	-45.32	V	-4.2	0.11	-49.63	-13	-36.63
204.5	-47.98	H	4.6	0.18	-43.56	-13	-30.56

### High channel

Frequency (MHz)	Substituted level (dBm)	Polarity (H/V)	Antenna Gain Correction (dB)	Cable Loss (dB)	Corrected Reading (dBm)	Limit (dBm)	Margin (dB)
1422	-44.11	V	7.65	0.75	-37.21	-13	-24.21
1422	-45.17	H	7.65	0.75	-38.27	-13	-25.27
51.5	-44.98	V	-4.2	0.11	-49.29	-13	-36.29
204.1	-47.53	H	4.6	0.18	-43.11	-13	-30.11

**Note:**

- 1, The testing has been conformed to  $10 \times 713.5 \text{MHz} = 7,135 \text{MHz}$
- 2, All other emissions more than 30 dB below the limit
- 3, X-Axis, Y-Axis and Z-Axis were investigated. The results above show only the worst case.

## 6.7 Band Edge

Temperature	25°C
Relative Humidity	57%
Atmospheric Pressure	1024mbar
Test date :	August 24&27, 2016
Tested By :	Loren Luo

### Requirement(s):

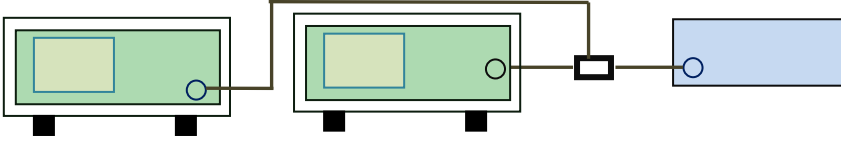
Spec	Item	Requirement	Applicable
§22.917(a) §24.238(a) § 27.53(h)	a)	The power of any emission outside of the authorized operating frequency ranges must be lower than the transmitter power (P) by a factor of at least $43 + 10 \log (P)$ dB.	<input checked="" type="checkbox"/>
Test setup			
Procedure	<ul style="list-style-type: none"> <li>- The EUT was connected to Spectrum Analyzer and Base Station via power divider.</li> <li>- The Band Edges of low and high channels for the highest RF powers were measured. Setting RBW as roughly BW/100.</li> </ul>		
Remark			
Result	<input checked="" type="checkbox"/> Pass <input type="checkbox"/> Fail		

Test Data  Yes       N/A

Test Plot  Yes (See below)       N/A

### LTE Band 2 (Part 24E) result

BW(MHz)	Channel	Frequency (MHz)	Mode	Emission (dBm)	Limit (dBm)
1.4	18607	1849.9	QPSK	-18.73	-13
			16QAM	-19.37	-13
1.4	18900	1910.0	QPSK	-16.67	-13
			16QAM	-16.59	-13
3	18615	1849.9	QPSK	-18.11	-13
			16QAM	-17.11	-13
3	19185	1910.0	QPSK	-18.11	-13
			16QAM	-16.19	-13
5	18625	1849.9	QPSK	-17.56	-13
			16QAM	-18.63	-13
5	19175	1910.0	QPSK	-16.98	-13
			16QAM	-18.48	-13
10	18650	1849.9	QPSK	-19.50	-13
			16QAM	-16.53	-13
10	19150	1910.0	QPSK	-17.35	-13
			16QAM	-16.95	-13
15	18675	1849	QPSK	-18.05	-13
			16QAM	-18.20	-13
15	19125	1910.7	QPSK	-19.16	-13
			16QAM	-19.12	-13
20	18700	1848.8	QPSK	-21.98	-13
			16QAM	-22.41	-13
20	19100	1911	QPSK	-23.65	-13
			16QAM	-21.36	-13

### LTE Band 4 (Part 27) result

BW(MHz)	Channel	Frequency (MHz)	Mode	Emission (dBm)	Limit (dBm)
1.4	19957	1709.9	QPSK	-18.63	-13
			16QAM	-19.14	-13
1.4	20393	1755	QPSK	-18.61	-13
			16QAM	-18	-13
3	19965	1710	QPSK	-14.35	-13
			16QAM	-15.51	-13
3	20385	1755.1	QPSK	-18.18	-13
			16QAM	-18.65	-13
5	19975	1710	QPSK	-13.03	-13
			16QAM	-14.06	-13
5	20375	1755	QPSK	-15.64	-13
			16QAM	-14.68	-13
10	20000	1710	QPSK	-14.13	-13
			16QAM	-15.01	-13
10	20350	1755	QPSK	-16.83	-13
			16QAM	-18.75	-13
15	20025	1710	QPSK	-16.35	-13
			16QAM	-16.11	-13
15	20325	1755	QPSK	-18.26	-13
			16QAM	-18.17	-13
20	20050	1710	QPSK	-20.71	-13
			16QAM	-20.25	-13
20	20300	1755	QPSK	-20.59	-13
			16QAM	-20.06	-13

### LTE Band 5 (Part 22H) result

BW(MHz)	Channel	Frequency (MHz)	Mode	Emission (dBm)	Limit (dBm)
1.4	20407	823.8	QPSK	-24.42	-13
			16QAM	-19.31	-13
1.4	20643	849	QPSK	-18.41	-13
			16QAM	-17.06	-13
3	20415	823.9	QPSK	-15.97	-13
			16QAM	-17.75	-13
3	20635	849	QPSK	-20.45	-13
			16QAM	-18.76	-13
5	20425	823.9	QPSK	-15.55	-13
			16QAM	-16.11	-13
5	20625	849	QPSK	-15.61	-13
			16QAM	-15.52	-13
10	20450	823.9	QPSK	-17.48	-13
			16QAM	-18.79	-13
10	20800	849	QPSK	-16.12	-13
			16QAM	-16.01	-13

### LTE Band 12 (Part 27) result

BW(MHz)	Channel	Frequency (MHz)	Mode	Emission (dBm)	Limit (dBm)
1.4	23017	698	QPSK	-21.97	-13
			16QAM	-21.85	-13
1.4	23173	716	QPSK	-19.77	-13
			16QAM	-19.97	-13
3	23025	698	QPSK	-17.95	-13
			16QAM	-17.14	-13
3	23165	716	QPSK	-15.1	-13
			16QAM	-15.94	-13
5	23035	698	QPSK	-15.12	-13
			16QAM	-15.32	-13
5	23155	716	QPSK	-14.6	-13
			16QAM	-14.83	-13
10	23060	698	QPSK	-15.58	-13
			16QAM	-13.36	-13
10	23130	716	QPSK	-17.61	-13
			16QAM	-17.52	-13

### LTE Band 17 (Part 27) result

BW(MHz)	Channel	Frequency (MHz)	Mode	Emission (dBm)	Limit (dBm)
5	23755	703.9	QPSK	-17.57	-13
			16QAM	-16.04	-13
5	23825	716	QPSK	-17.06	-13
			16QAM	-16.27	-13
10	23780	703.9	QPSK	-21.5	-13
			16QAM	-15.85	-13
10	23800	716	QPSK	-29.25	-13
			16QAM	-26.39	-13

**Test Plots**

**LTE Band 2 (Part 24E)**

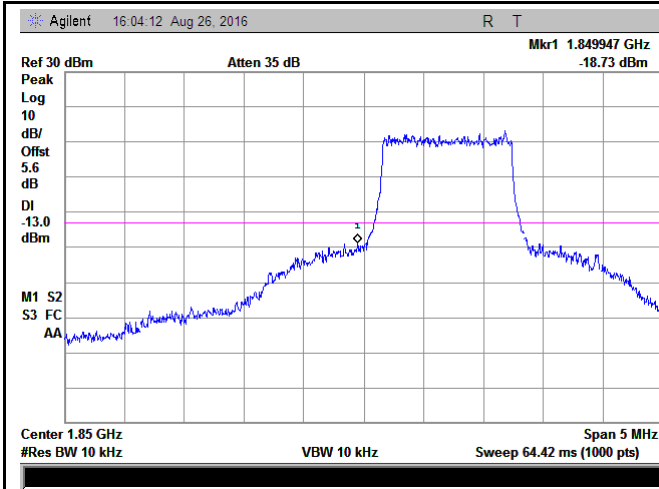

LTE Band 2 - Low Channel QPSK-1.4

Note: Offset=Cable loss (4.5) + 10log  
(12.94/10)=4.5+1.1=5.6dB

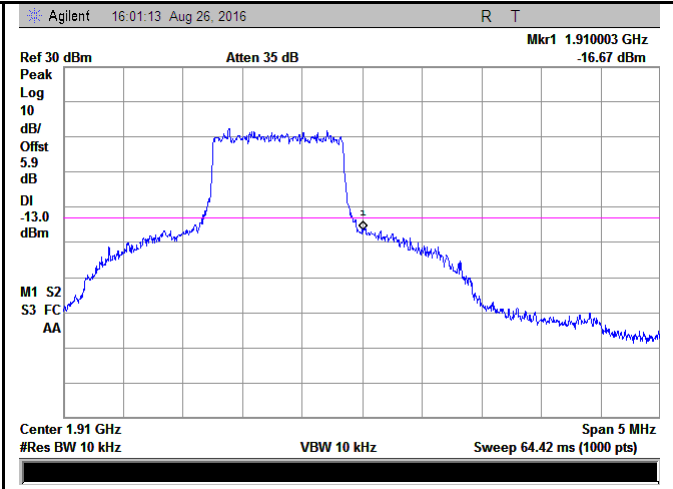

LTE Band 2 - High Channel QPSK-1.4

Note: Offset=Cable loss (4.5) + 10log  
(13.9/10)=4.5+1.4=5.9dB

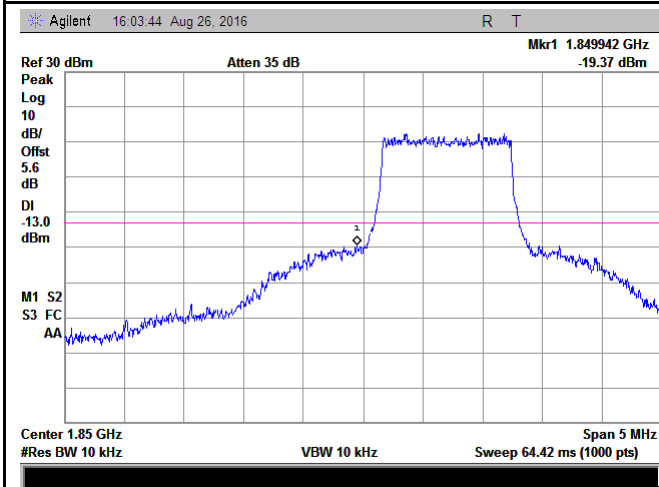

LTE Band 2 - Low Channel 16QAM-1.4

Note: Offset=Cable loss (4.5) + 10log  
(12.92/10)=4.5+1.1=5.6 dB

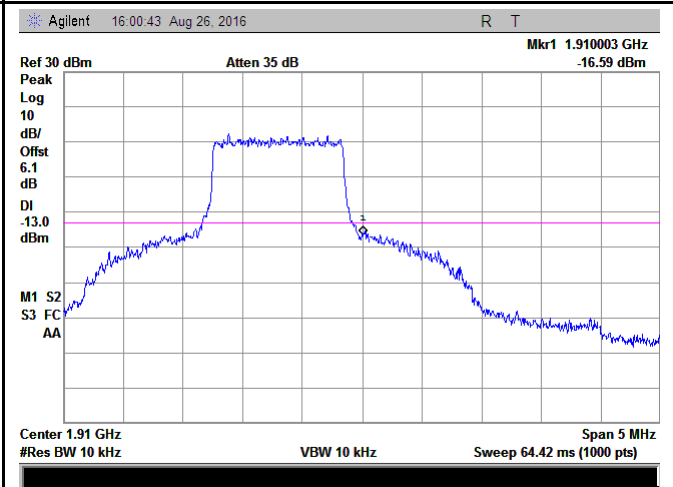

LTE Band 2 - High Channel 16QAM-1.4

Note: Offset=Cable loss (4.5) + 10log  
(14.29/10)=4.5+1.6=6.1 dB

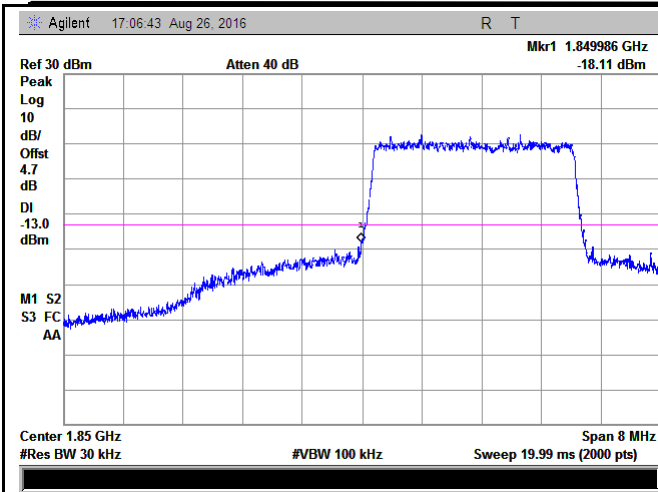

LTE Band 2 - Low Channel QPSK-3

Note: Offset=Cable loss (4.5) + 10log  
(31.19/30)=4.5+0.2=4.7 dB

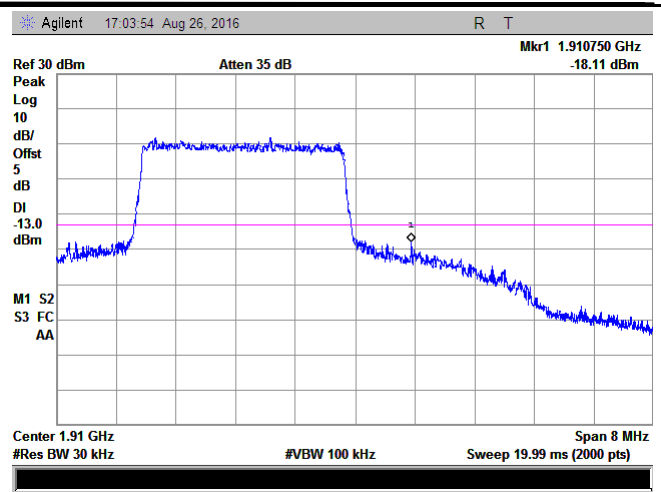

LTE Band 2 - High Channel QPSK-3

Note: Offset=Cable loss (4.5) + 10log  
(33.47/30)=4.5+0.5=5 dB

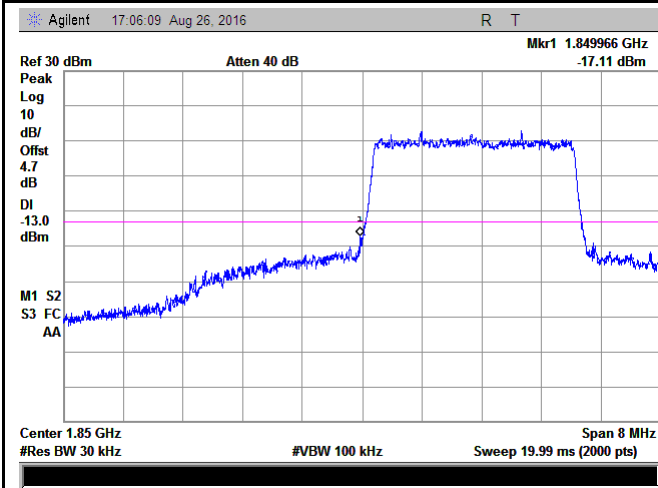

LTE Band 2 - Low Channel 16QAM-3

Note: Offset=Cable loss (4.5) + 10log  
(31.42/30)=4.5+0.2=4.7 dB

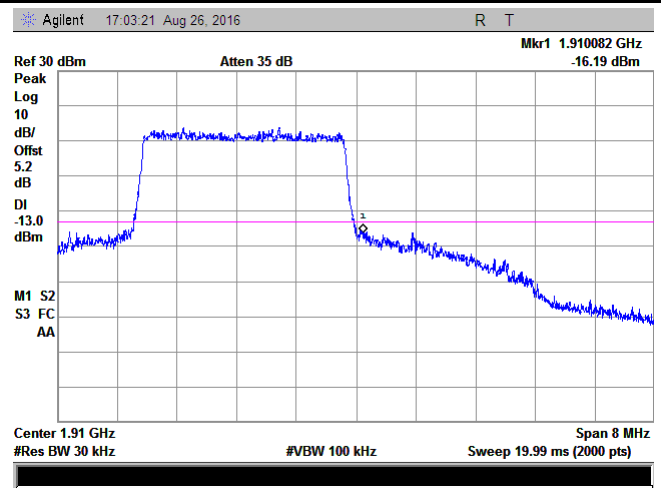

LTE Band 2 - High Channel 16QAM-3

Note: Offset=Cable loss (4.5) + 10log  
(35.37/30)=4.5+0.7=5.2 dB

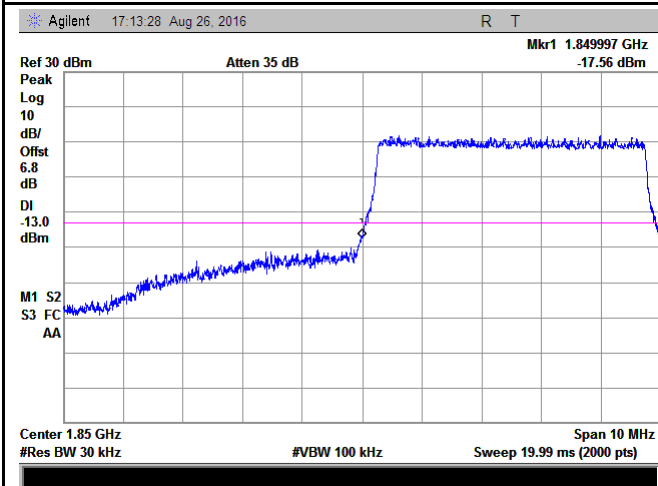

LTE Band 2 - Low Channel QPSK-5

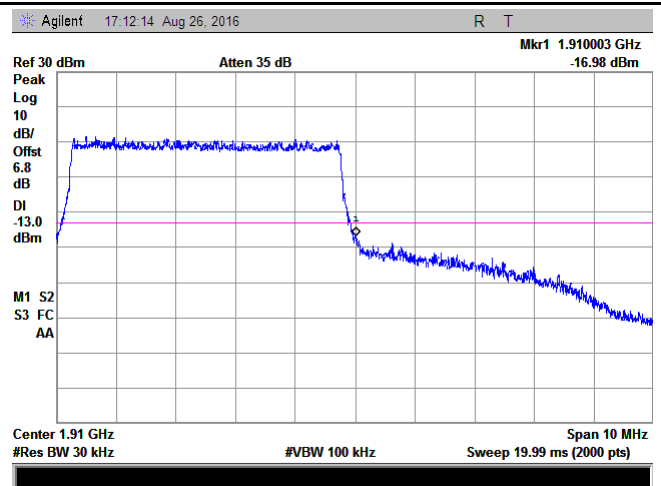

LTE Band 2 - High Channel QPSK-5



Note: Offset=Cable loss (4.5) + 10log  
(51.21/30)=4.5+2.3=6.8 dB

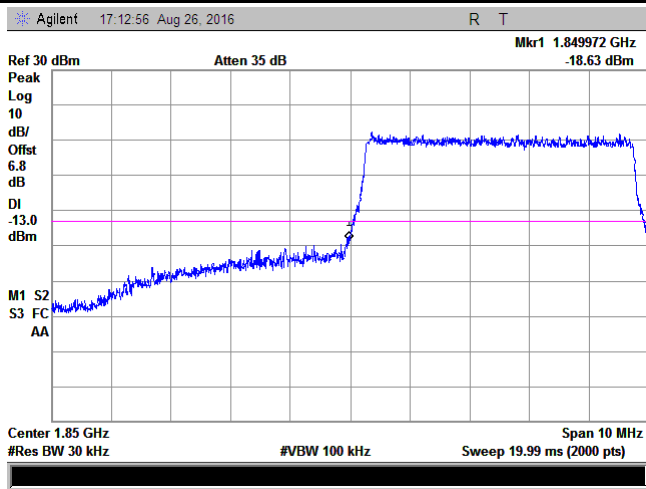

LTE Band 2 - Low Channel 16QAM-5

Note: Offset=Cable loss (4.5) + 10log  
(50.94/30)=4.5+2.3=6.8 dB

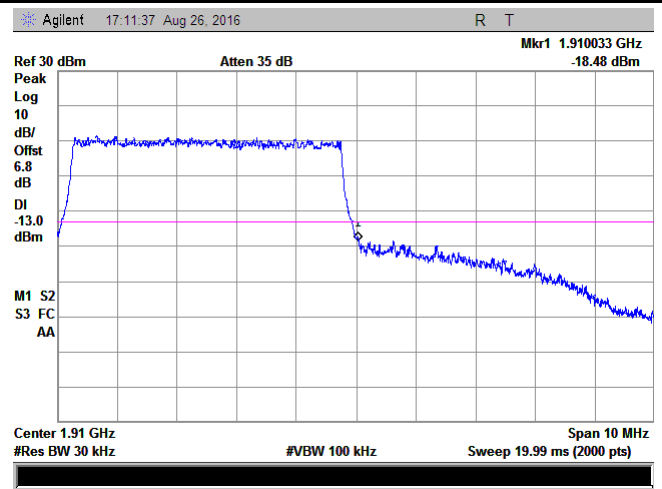

LTE Band 2 - High Channel 16QAM-5

Note: Offset=Cable loss (4.5) + 10log  
(50.62/30)=4.5+2.3=6.8 dB

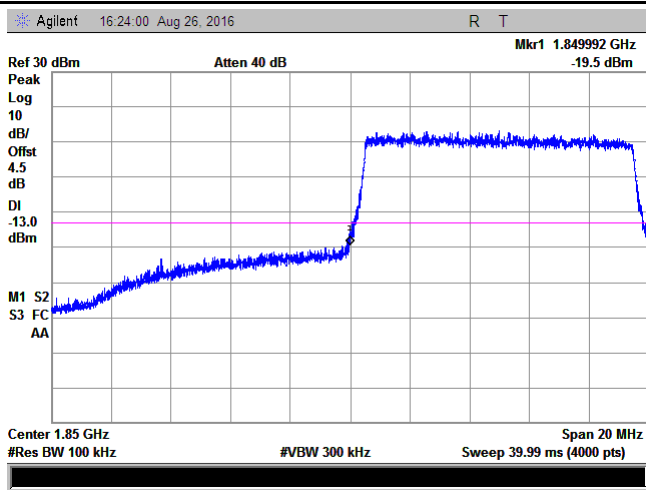

LTE Band 2 - Low Channel QPSK-10

Note: Offset=Cable loss (4.5) + 10log  
(50.84/30)=4.5+2.3=6.8 dB

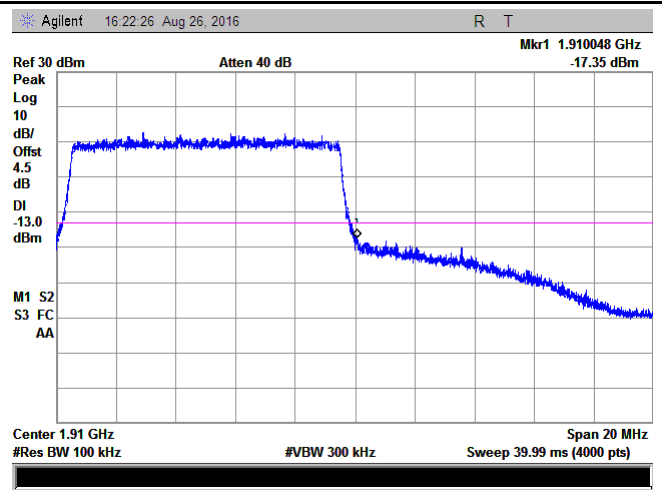

LTE Band 2 - High Channel QPSK-10

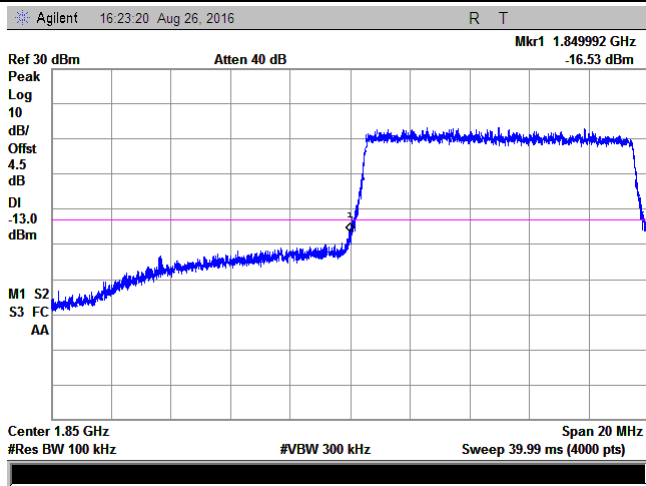

LTE Band 2 - Low Channel 16QAM-10

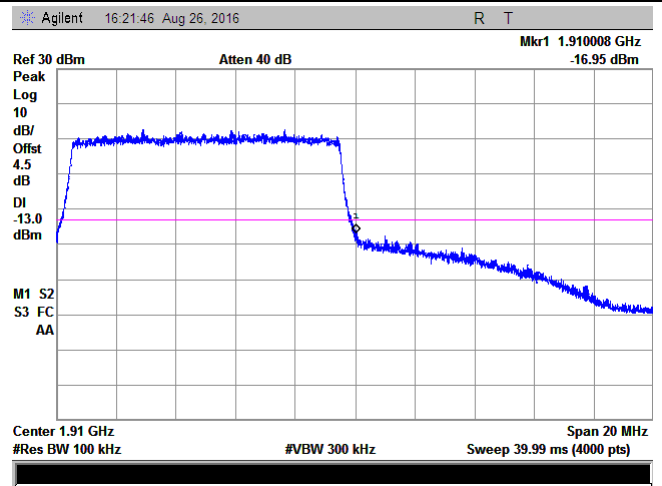

LTE Band 2 - High Channel 16QAM-10

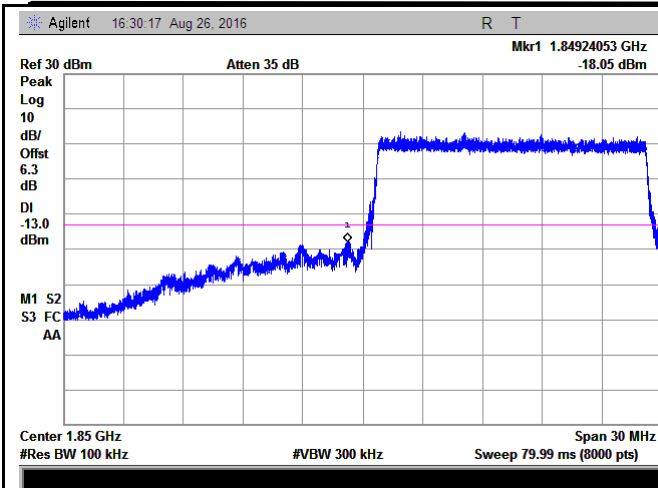

LTE Band 2 - Low Channel QPSK-15

Note: Offset=Cable loss (4.5) + 10log  
(150.71/100)=4.5+1.8=6.3 dB

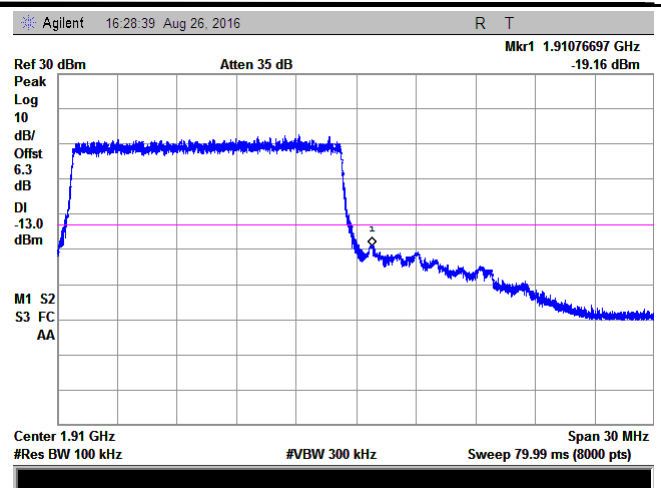

LTE Band 2 - High Channel QPSK-15

Note: Offset=Cable loss (4.5) + 10log  
(149.63/100)=4.5+1.8=6.3 dB

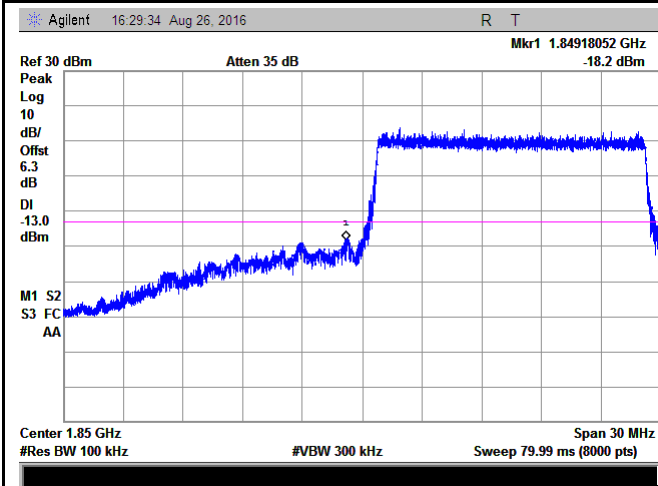

LTE Band 2 - Low Channel 16QAM-15

Note: Offset=Cable loss (4.5) + 10log  
(150.81/100)=4.5+1.8=6.3 dB

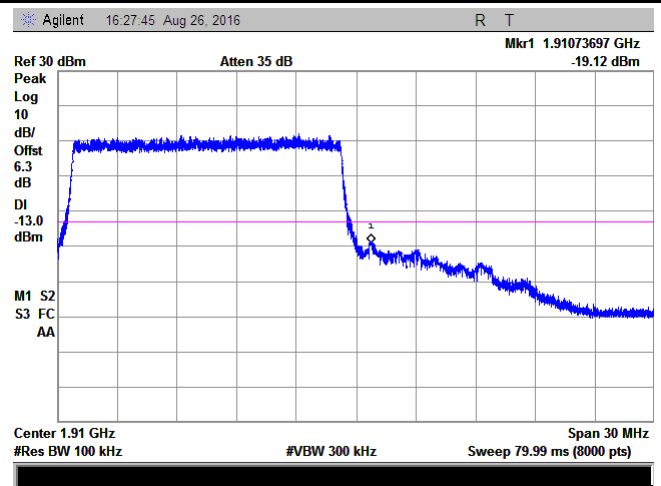

LTE Band 2 - High Channel 16QAM-15

Note: Offset=Cable loss (4.5) + 10log  
(150.64/100)=4.5+1.8=6.3 dB

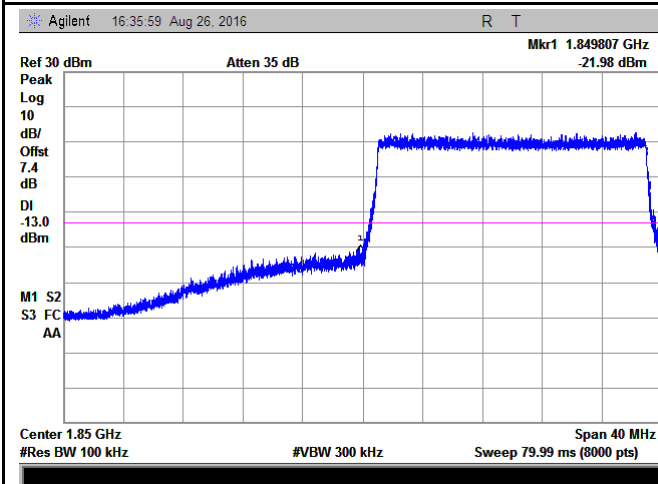

LTE Band 2 - Low Channel QPSK-20

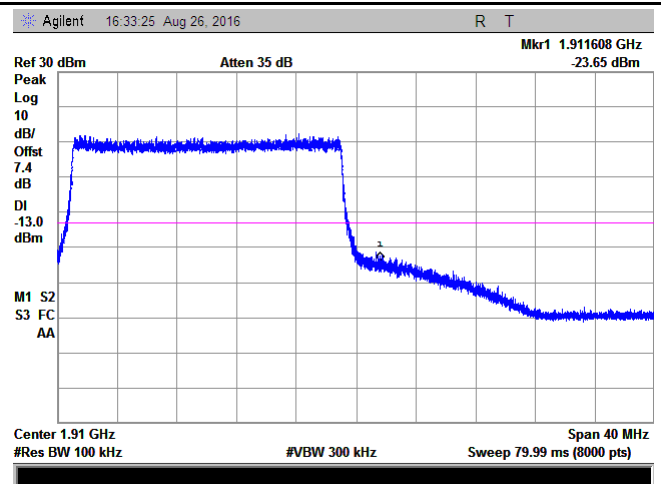

LTE Band 2 - High Channel QPSK-20

Note: Offset=Cable loss (4.5) + 10log  
(195.27/100)=4.5+2.9=7.4 dB

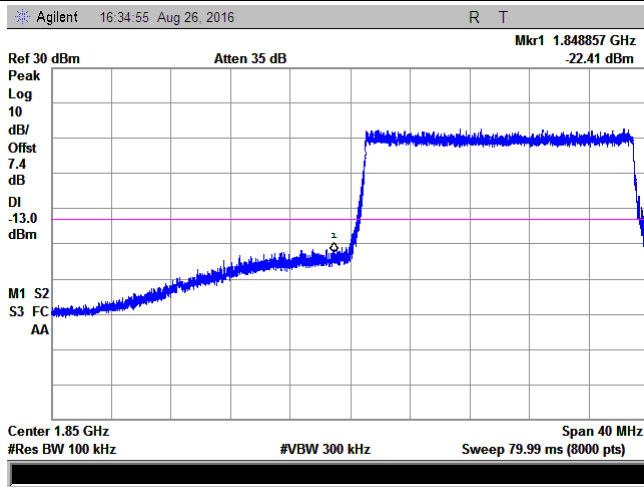

LTE Band 2 - Low Channel 16QAM-20

Note: Offset=Cable loss (4.5) + 10log  
(196.67/100)=4.5+2.9=7.4 dB

Note: Offset=Cable loss (4.5) + 10log  
(196.8/100)=4.5+2.9=7.4 dB

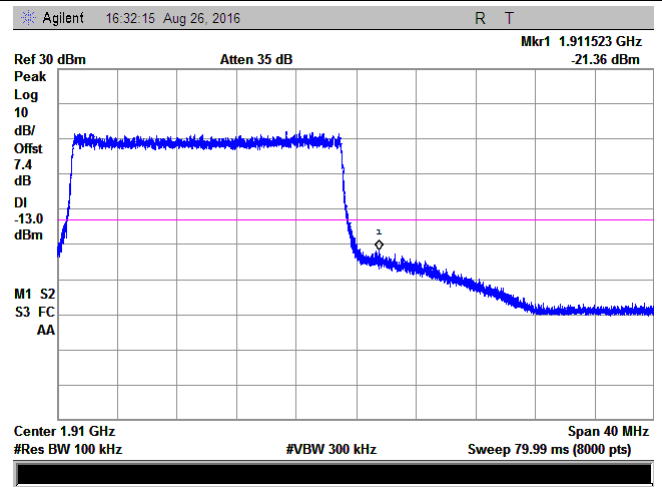

LTE Band 2 - High Channel 16QAM-20

Note: Offset=Cable loss (4.5) + 10log  
(196.13/100)=4.5+2.9=7.4 dB

### LTE Band 4 (Part 27)

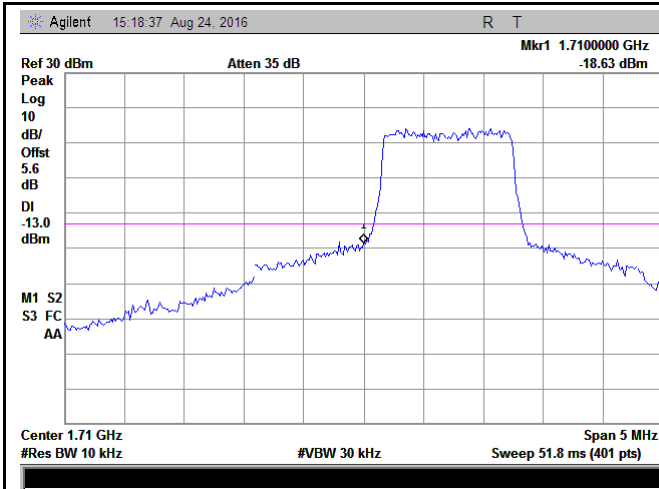

LTE Band 4 - Low Channel QPSK-1.4

Note: Offset=Cable loss (4.5) + 10log  
(12.8/10)=4.5+1.1=5.6 dB

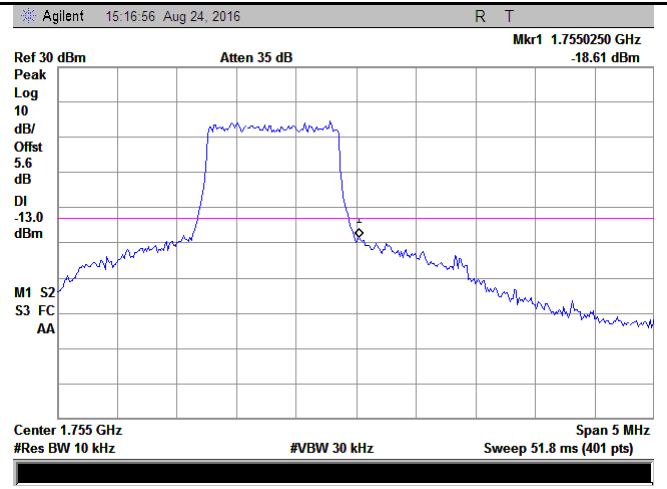

LTE Band 4 - High Channel QPSK-1.4

Note: Offset=Cable loss (4.5) + 10log  
(12.93/10)=4.5+1.1=5.6 dB

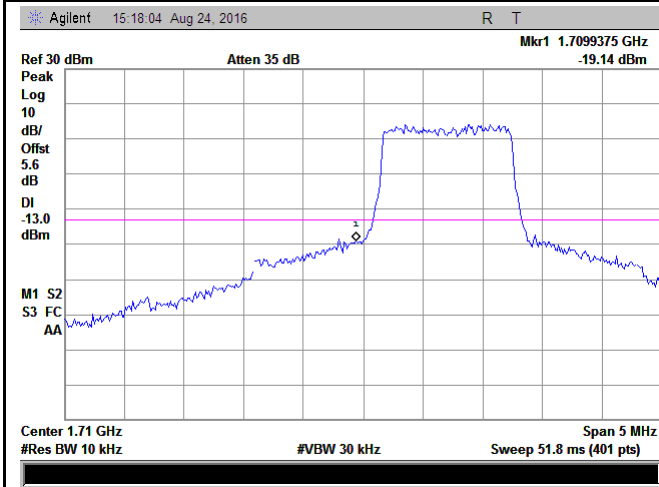

LTE Band 4 - Low Channel 16QAM-1.4

Note: Offset=Cable loss (4.5) + 10log  
(12.83/10)=4.5+1.0=5.5 dB

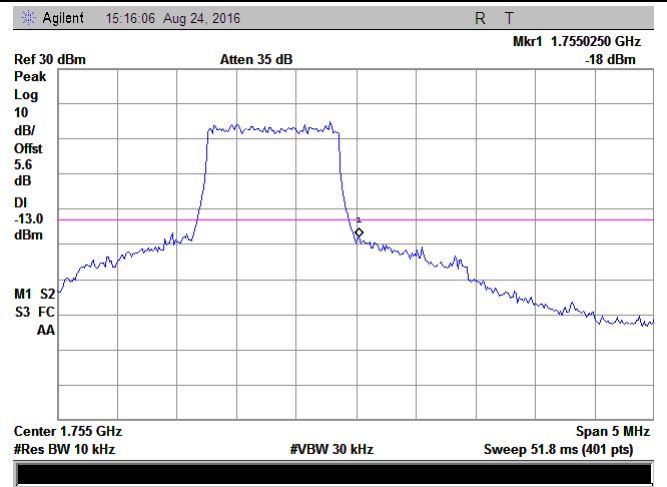

LTE Band 4 - High Channel 16QAM-1.4

Note: Offset=Cable loss (4.5) + 10log  
((12.96/10)=4.5+1.0=5.5 dB

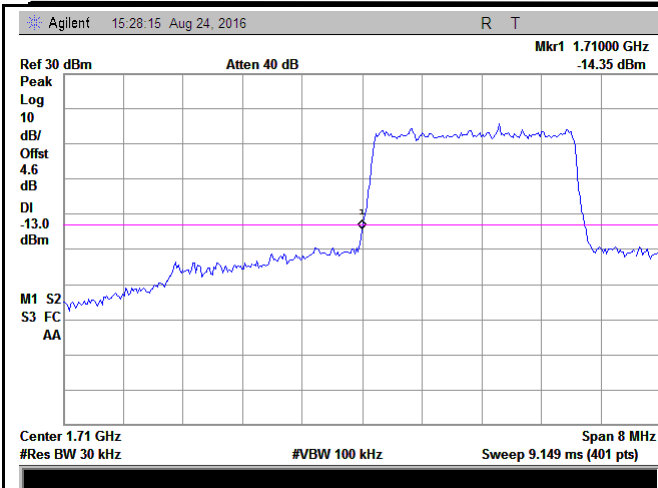

LTE Band 4 - Low Channel QPSK-3

Note: Offset=Cable loss (4.5) + 10log  
(30.98/30)=4.5+0.1=4.6 dB

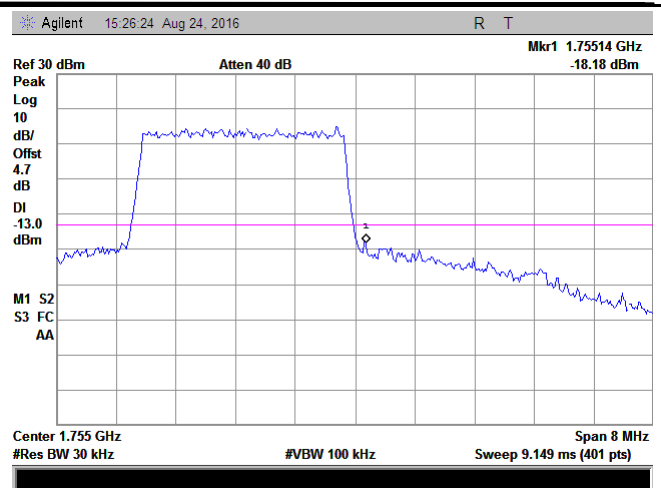

LTE Band 4 - High Channel QPSK-3

Note: Offset=Cable loss (4.5) + 10log  
(31.27/30)=4.5+0.2=4.7 dB

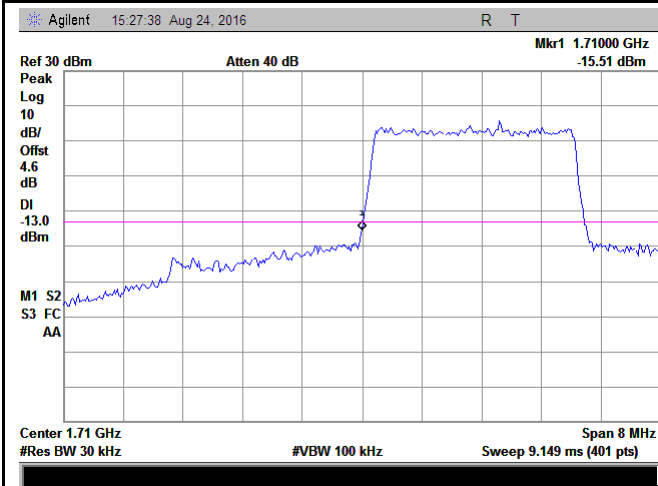

LTE Band 4 - Low Channel 16QAM-3

Note: Offset=Cable loss (4.5) + 10log  
(30.93/30)=4.5+0.1=4.6 dB

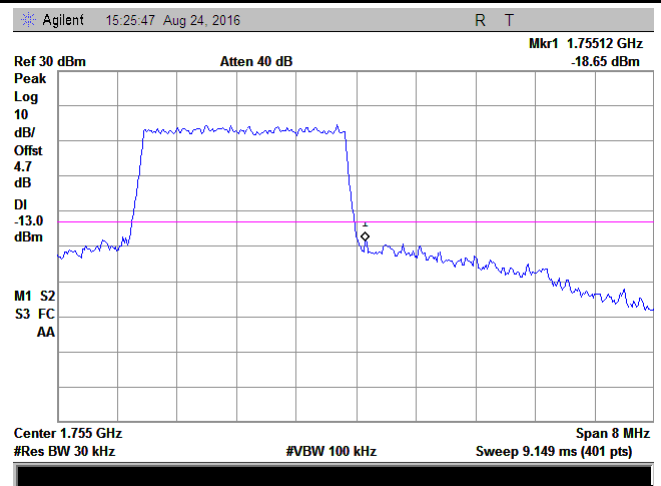

LTE Band 4 - High Channel 16QAM-3

Note: Offset=Cable loss (4.5) + 10log  
(31.27/30)=4.5+0.2=4.7 dB

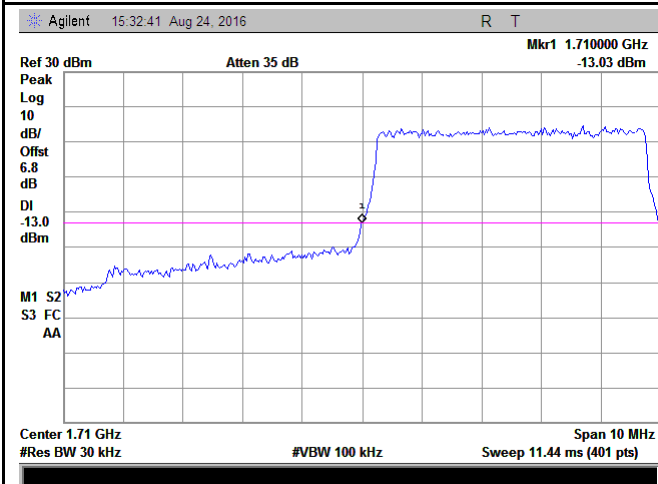

LTE Band 4 - Low Channel QPSK-5

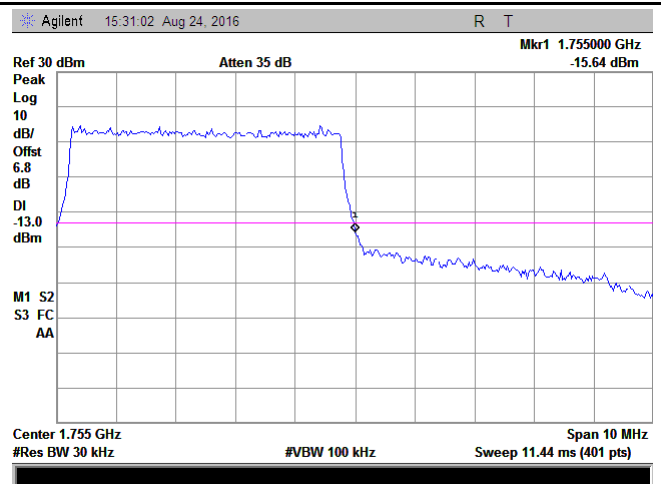

LTE Band 4 - High Channel QPSK-5

Note: Offset=Cable loss (4.5) + 10log  
(51.22/30)=4.5+2.3=6.8 dB

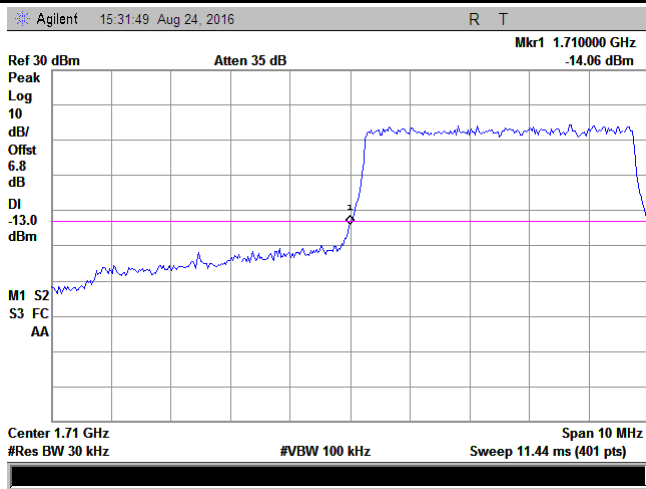

LTE Band 4 - Low Channel 16QAM-5

Note: Offset=Cable loss (4.5) + 10log  
(51.12/30)=4.5+2.3=6.8 dB

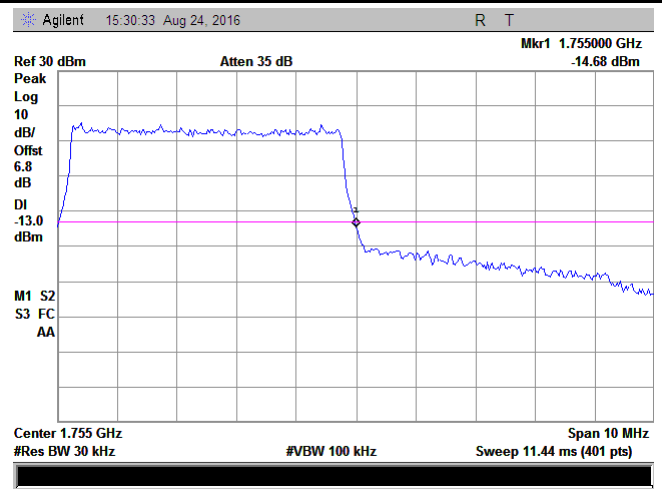

LTE Band 4 - High Channel 16QAM-5

Note: Offset=Cable loss (4.5) + 10log  
(50.99/30)=4.5+2.3=6.8 dB

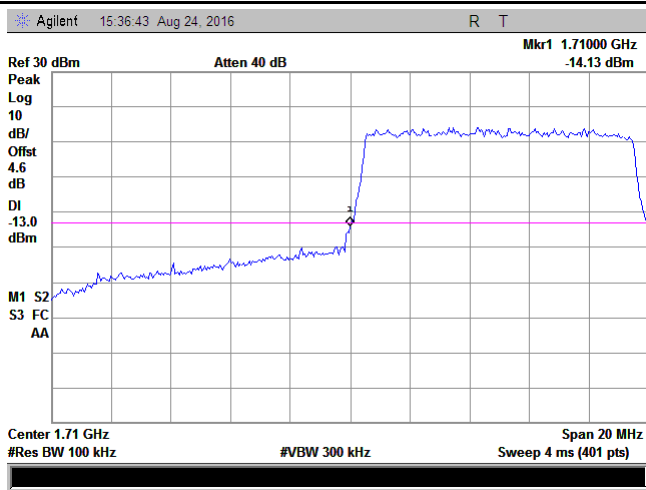

LTE Band 4 - Low Channel QPSK-10

Note: Offset=Cable loss (4.5) + 10log  
(50.71/30)=4.5+2.3=6.8 dB

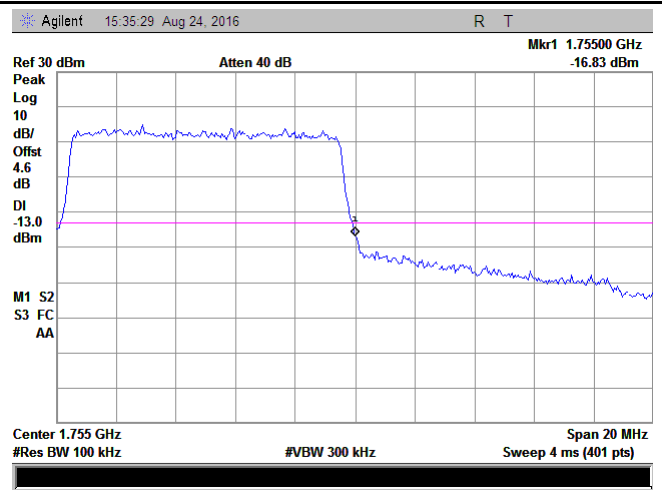

LTE Band 4 - High Channel QPSK-10

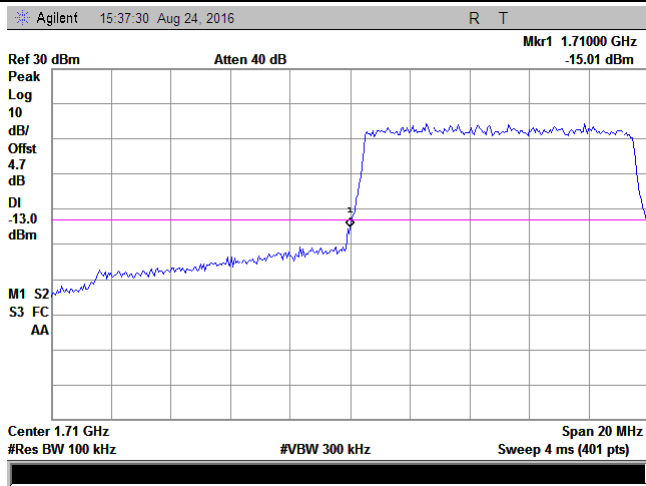

LTE Band 4 - Low Channel 16QAM-10

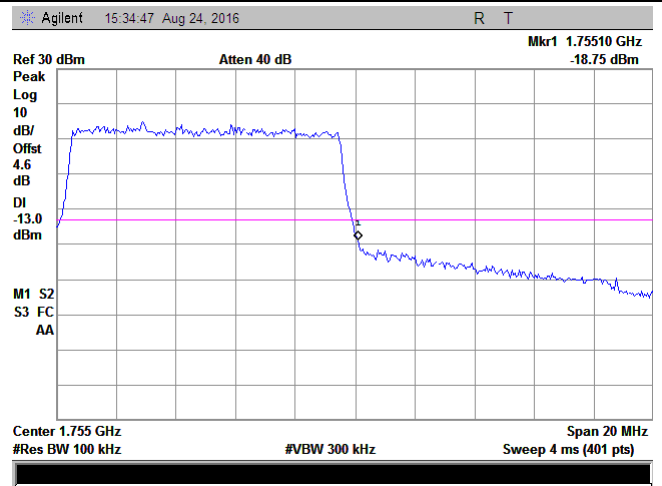

LTE Band 4 - High Channel 16QAM-10

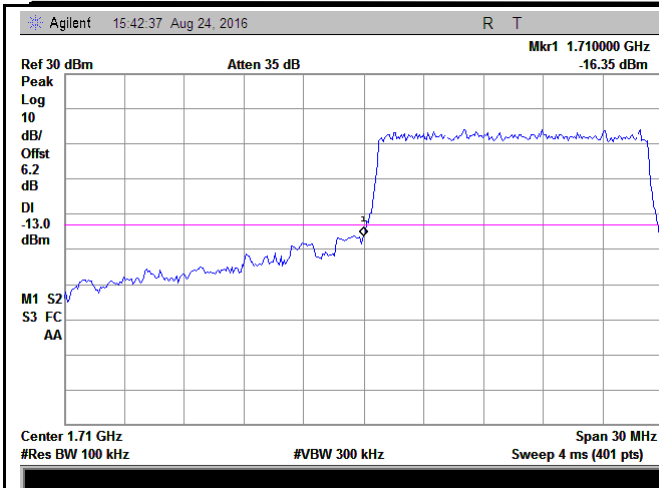

LTE Band 4 - Low Channel QPSK-15

Note: Offset=Cable loss (4.5) + 10log  
(148.94/100)=4.5+1.7=6.2 dB

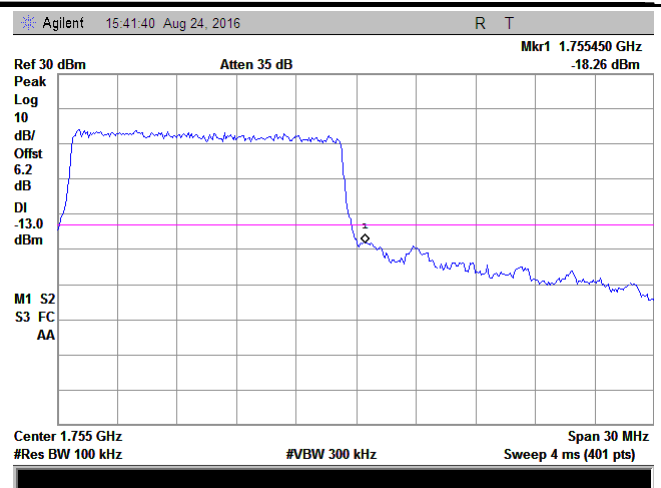

LTE Band 4 - High Channel QPSK-15

Note: Offset=Cable loss (4.5) + 10log  
(149.17/100)=4.5+1.7=6.2

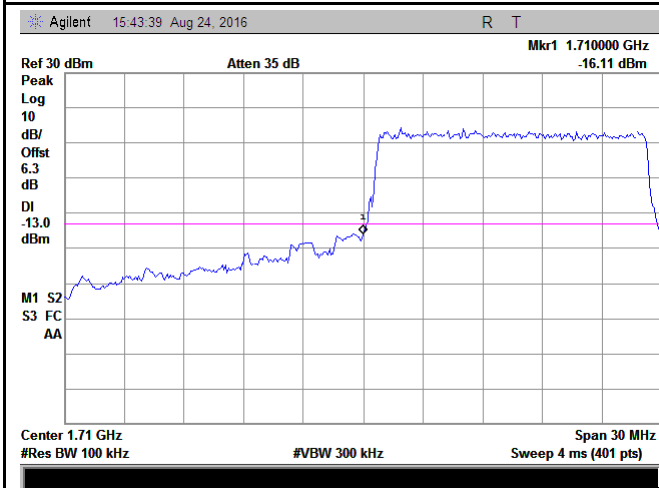

LTE Band 4 - Low Channel 16QAM-15

Note: Offset=Cable loss (4.5) + 10log  
(149.93/100)=4.5+1.8=6.3 dB

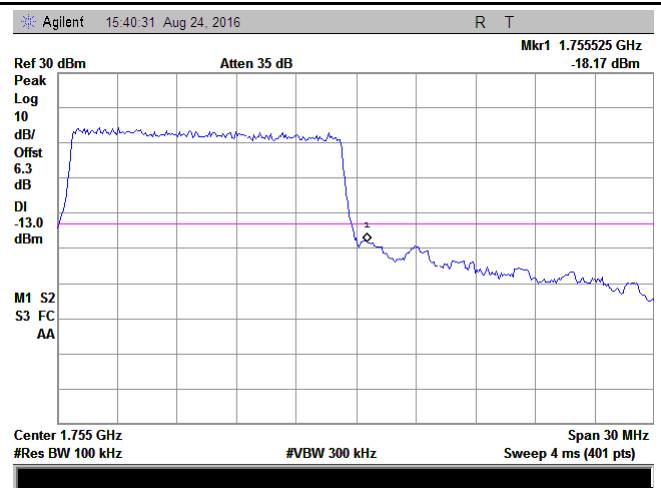

LTE Band 4 - High Channel 16QAM-15

Note: Offset=Cable loss (4.5) + 10log  
(149.93/100)=4.5+1.8=6.3 dB

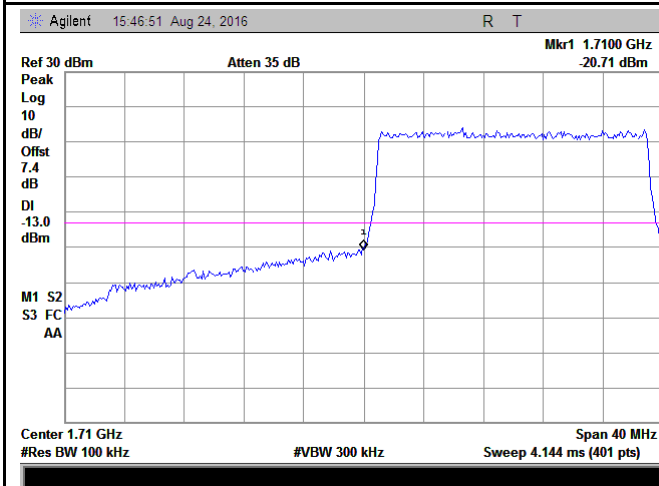

LTE Band 4 - Low Channel QPSK-20

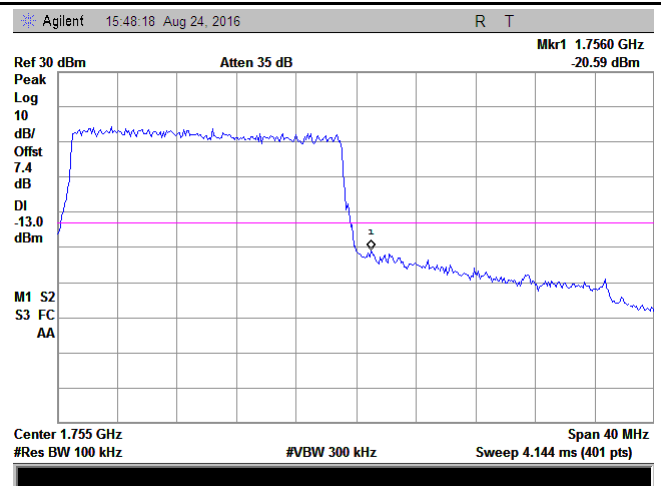

LTE Band 4 - High Channel QPSK-20

Note: Offset=Cable loss (4.5) + 10log  
(195.04/100)=4.5+2.9=7.4 dB

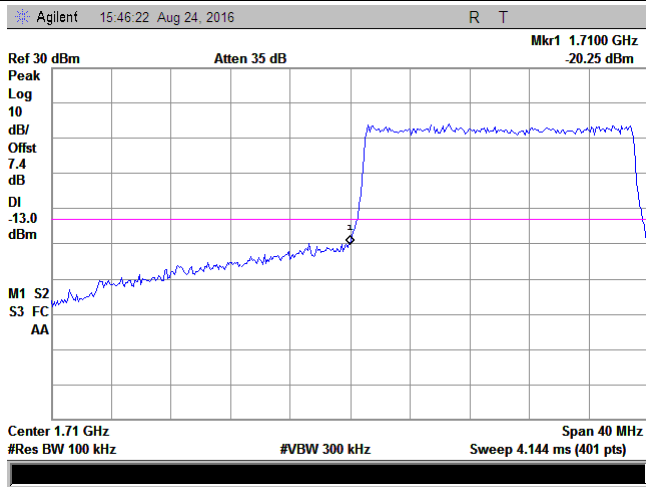

LTE Band 4 - Low Channel 16QAM-20

Note: Offset=Cable loss (4.5) + 10log  
(194.77/100)=4.5+2.9=7.4dB

Note: Offset=Cable loss (4.5) + 10log  
(196.11/100)=4.5+2.9=7.4 dB

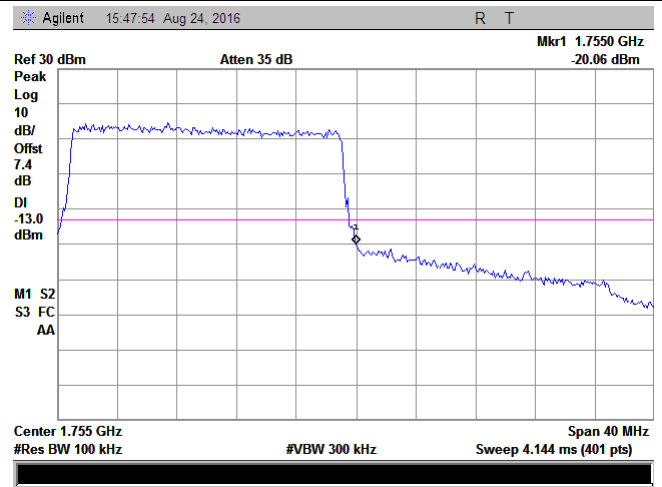

LTE Band 4 - High Channel 16QAM-20

Note: Offset=Cable loss (4.5) + 10log  
(196.4/100)=4.5+2.9=7.4 dB



### LTE Band 5 (Part 22H)

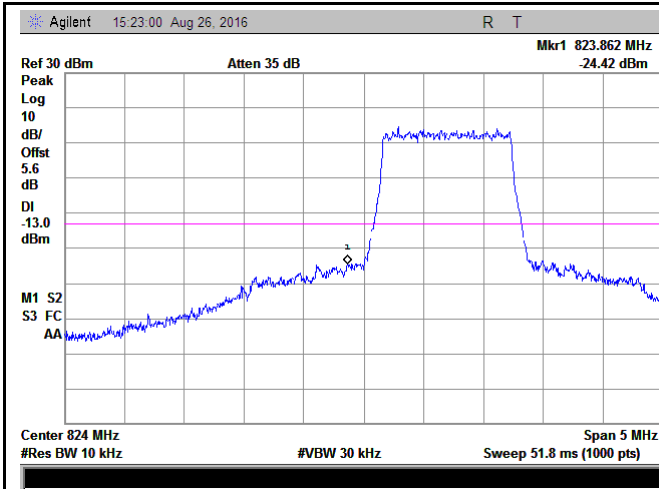

LTE Band 5 - Low Channel QPSK-1.4

Note: Offset=Cable loss (4.5) + 10log  
(12.79/10)=4.5+1.1=5.6 dB

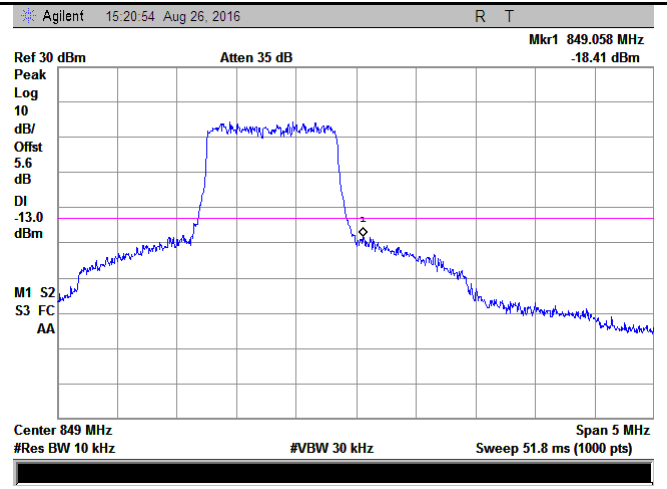

LTE Band 5 - High Channel QPSK-1.4

Note: Offset=Cable loss (4.5) + 10log  
(12.87/10)=4.5+1.1=5.6 dB

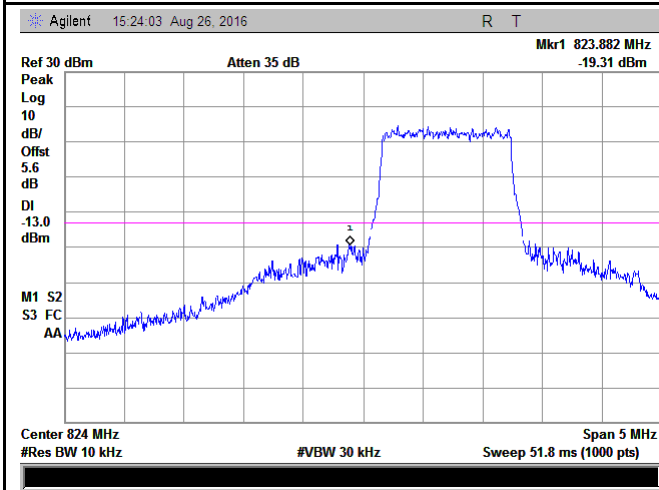

LTE Band 5 - Low Channel 16QAM-1.4

Note: Offset=Cable loss (4.5) + 10log  
(12.82/10)=4.5+1.0=5.5 dB

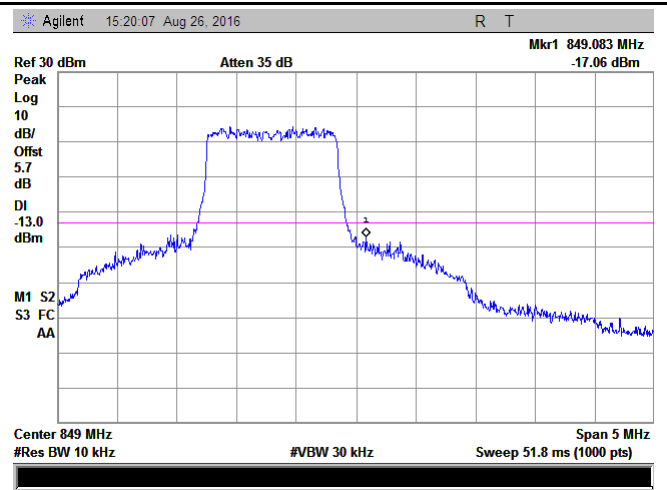

LTE Band 5 - High Channel 16QAM-1.4

Note: Offset=Cable loss (4.5) + 10log  
(13.05/10)=4.5+1.2=5.7 dB

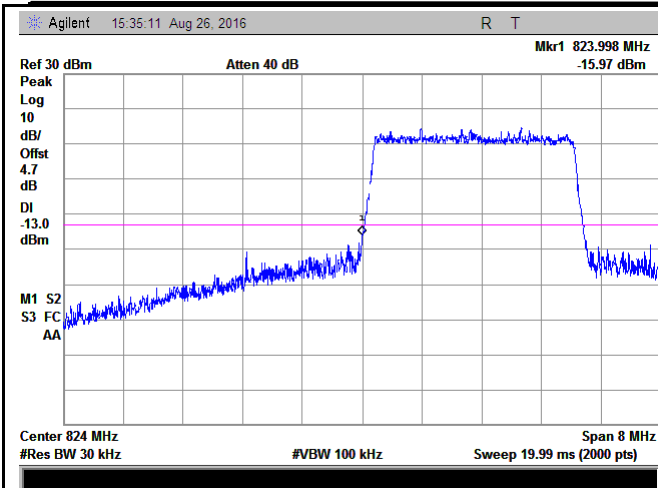

LTE Band 5 - Low Channel QPSK-3

Note: Offset=Cable loss (4.5) + 10log  
(30.94/30)=4.5+0.2=4.7 dB

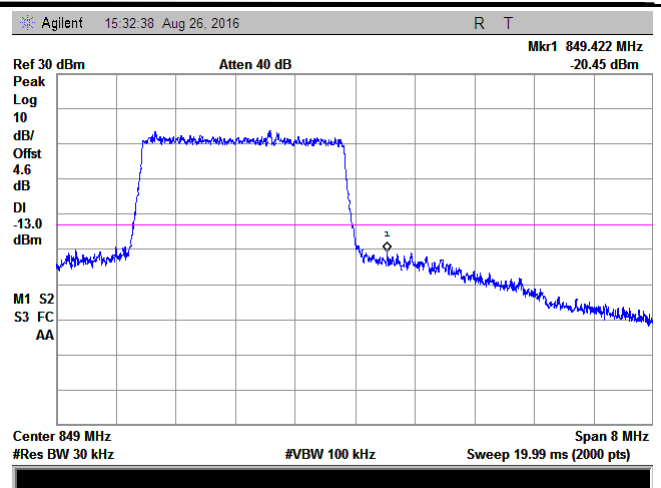

LTE Band 5 - High Channel QPSK-3

Note: Offset=Cable loss (4.5) + 10log  
(31.28/30)=4.5+0.1=4.6 dB

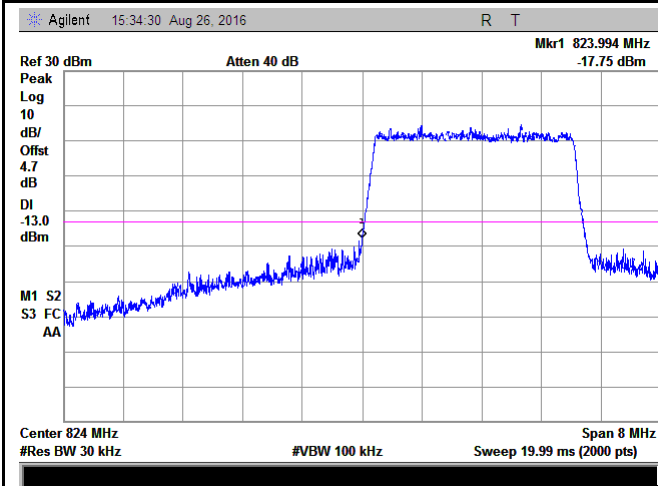

LTE Band 5 - Low Channel 16QAM-3

Note: Offset=Cable loss (4.5) + 10log  
(31.09/30)=4.5+0.2=4.7 dB

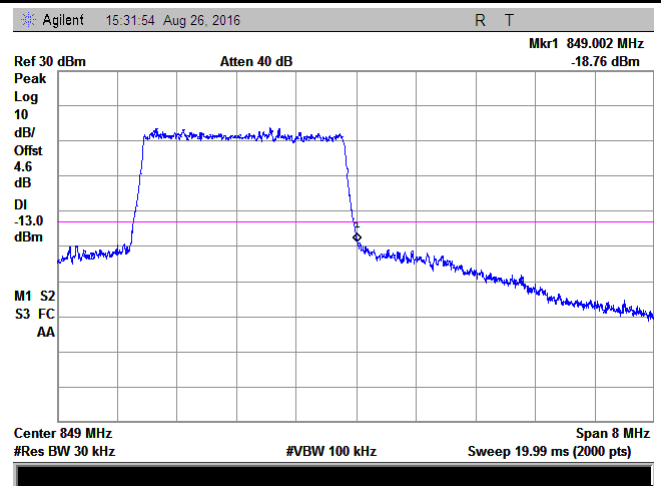

LTE Band 5 - High Channel 16QAM-3

Note: Offset=Cable loss (4.5) + 10log  
(31.17/30)=4.5+0.1=4.6 dB

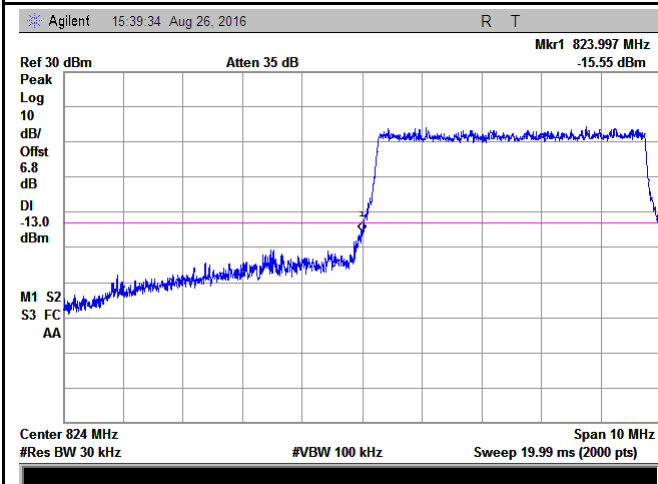

LTE Band 5 - Low Channel QPSK-5

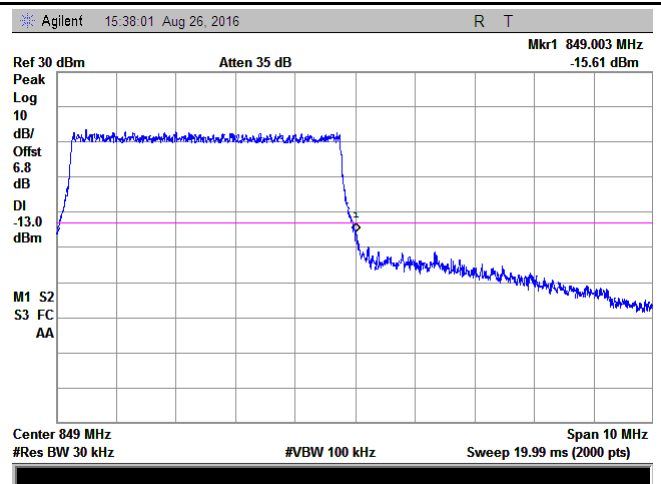

LTE Band 5 - High Channel QPSK-5

Note: Offset=Cable loss (4.5) + 10log  
(50.87/30)=4.5+2.3=6.8 dB

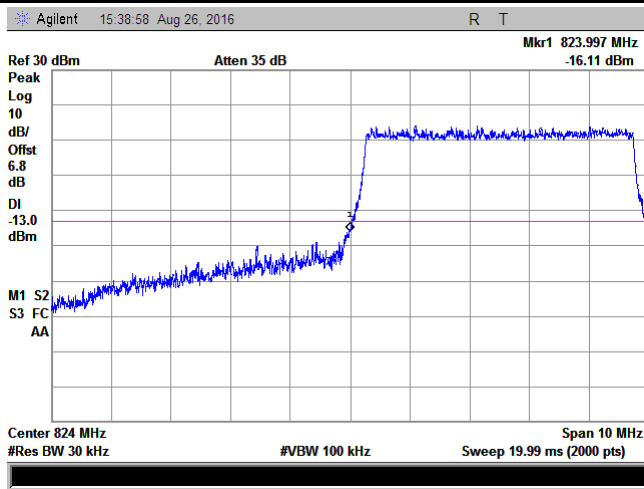

LTE Band 5 - Low Channel 16QAM-5

Note: Offset=Cable loss (4.5) + 10log  
(50.98/30)=4.5+2.3=6.8 dB

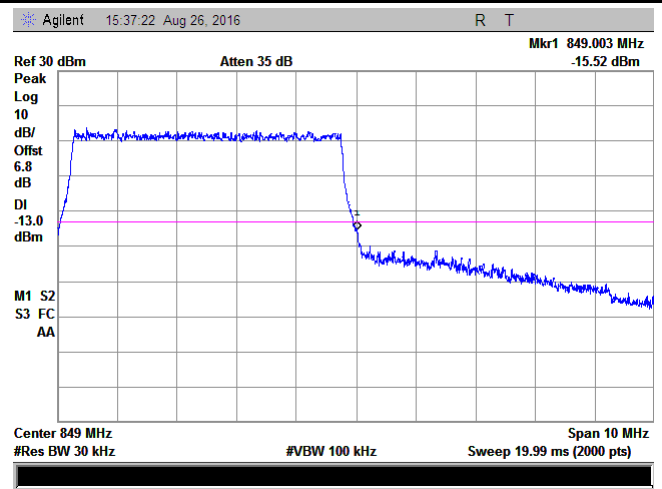

LTE Band 5 - High Channel 16QAM-5

Note: Offset=Cable loss (4.5) + 10log  
(50.82/30)=4.5+2.3=6.8 dB

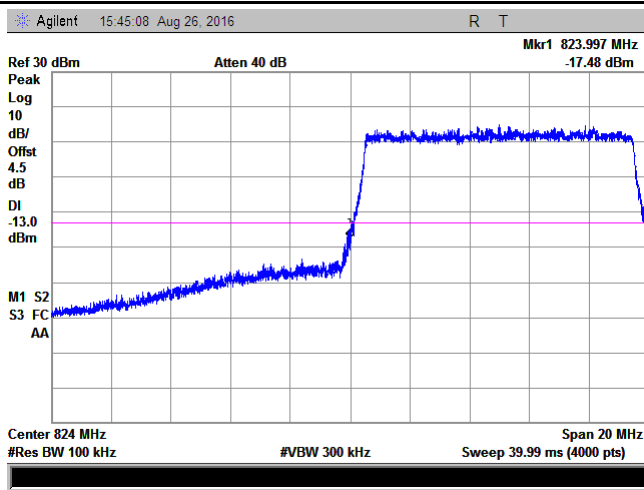

LTE Band 5 - Low Channel QPSK-10

Note: Offset=Cable loss (4.5) + 10log  
(50.84/30)=4.5+2.2=6.7 dB

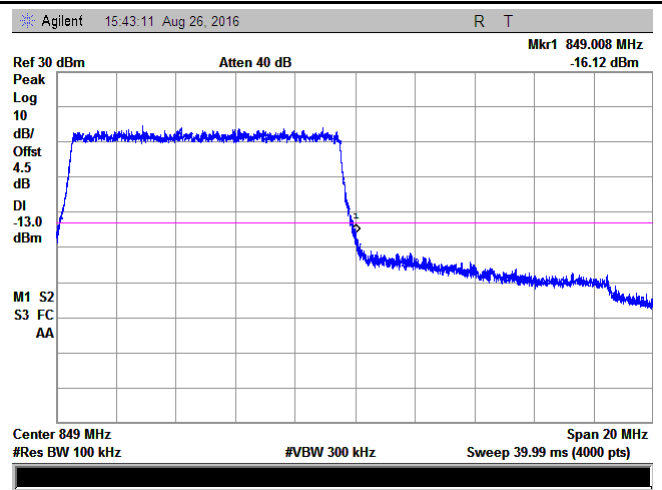

LTE Band 5 - High Channel QPSK-10

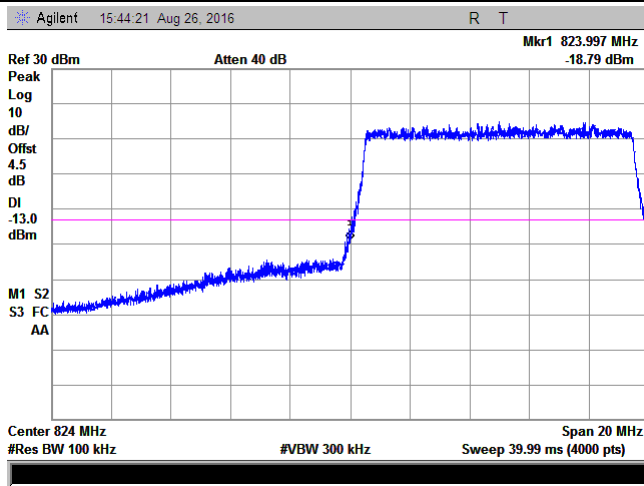

LTE Band 5 - Low Channel 16QAM-10

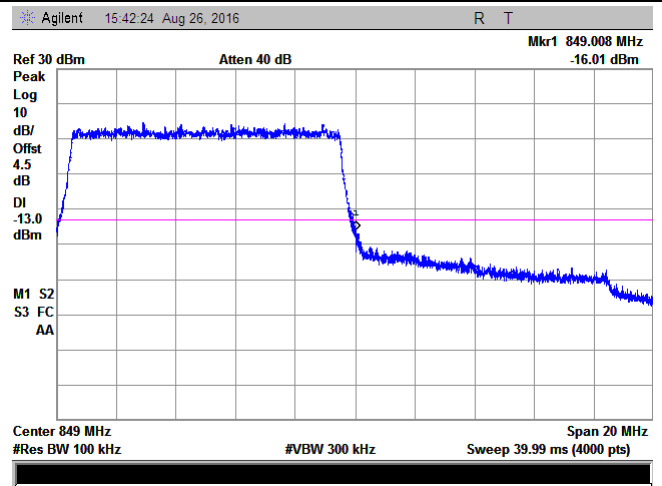

LTE Band 5 - High Channel 16QAM-10

**LTE Band 12 (Part 27)**

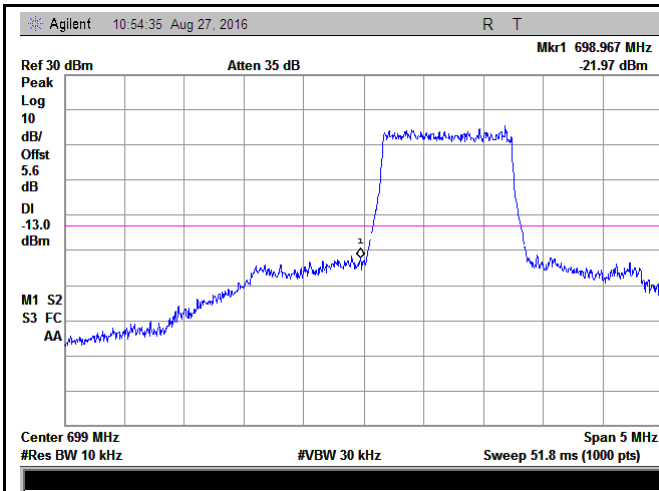

LTE Band 12 - Low Channel QPSK-1.4

Note: Offset=Cable loss (4.5) + 10log  
(12.83/10)=4.5+1.1=5.6 dB

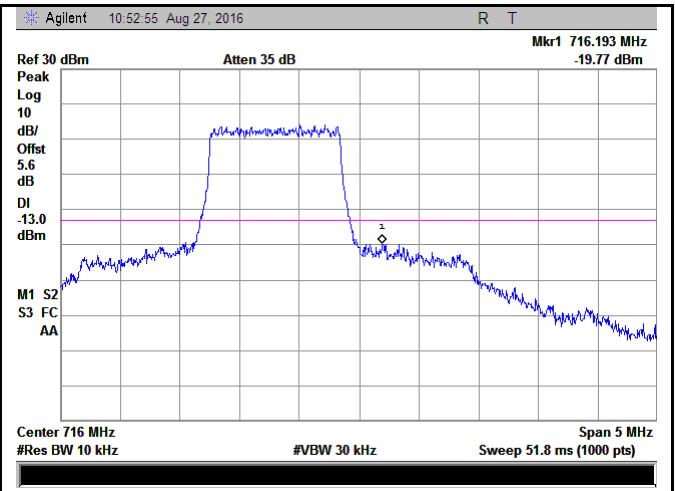

LTE Band 12 - High Channel QPSK-1.4

Note: Offset=Cable loss (4.5) + 10log  
(12.78/10)=4.5+1.1=5.6 dB

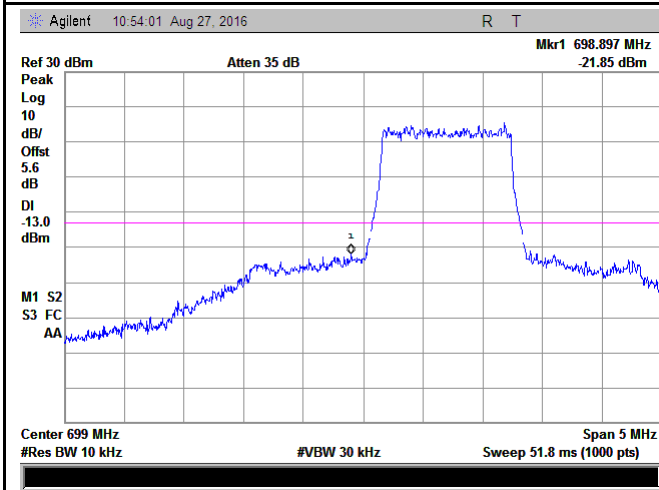

LTE Band 12 - Low Channel 16QAM-1.4

Note: Offset=Cable loss (4.5) + 10log  
(12.8/10)=4.5+1.1=5.6 dB

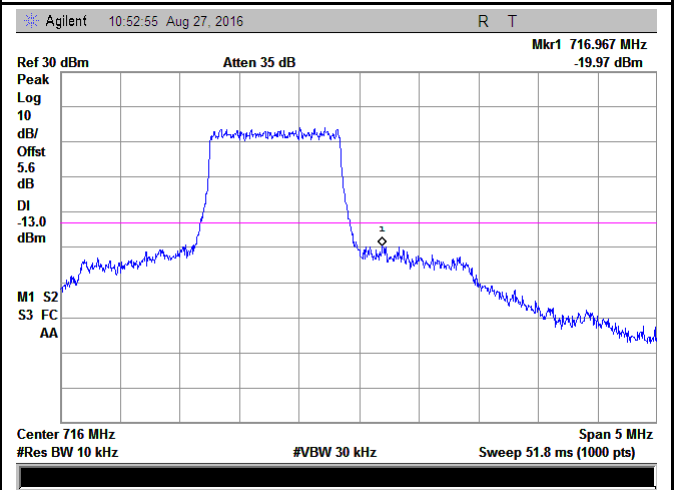

LTE Band 12 - High Channel 16QAM-1.4

Note: Offset=Cable loss (4.5) + 10log  
(12.8/10)=4.5+1.1=5.6 dB

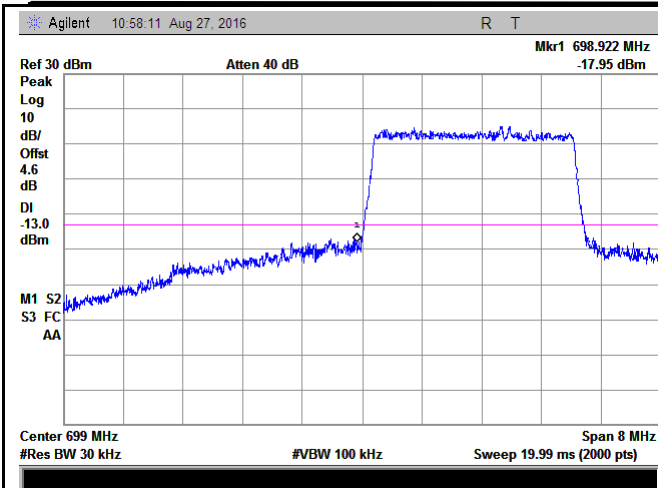

LTE Band 12 - Low Channel QPSK-3

Note: Offset=Cable loss (4.5) + 10log  
(30.8/30)=4.5+0.1=4.6 dB

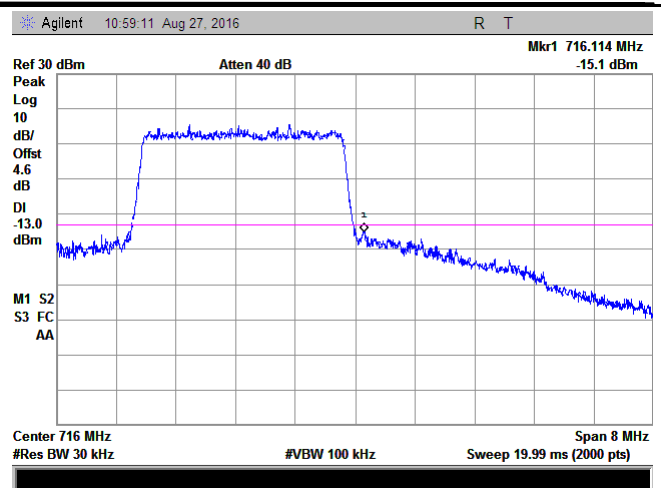

LTE Band 12 - High Channel QPSK-3

Note: Offset=Cable loss (4.5) + 10log  
(30.88/30)=4.5+0.1=4.6 dB

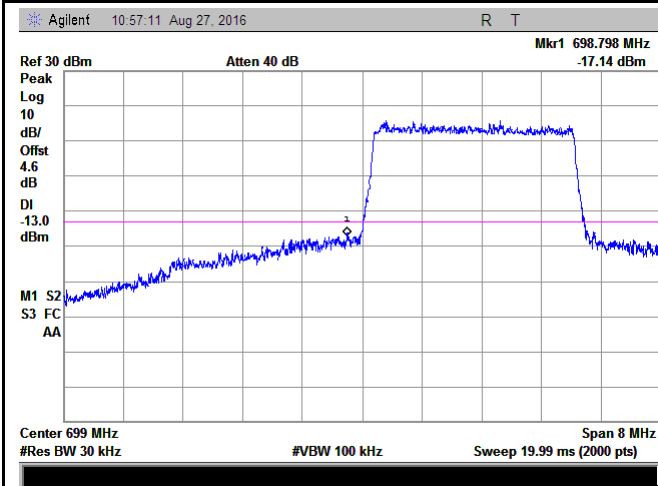

LTE Band 12 - Low Channel 16QAM-3

Note: Offset=Cable loss (4.5) + 10log  
(30.86/30)=4.5+0.1=4.6 dB

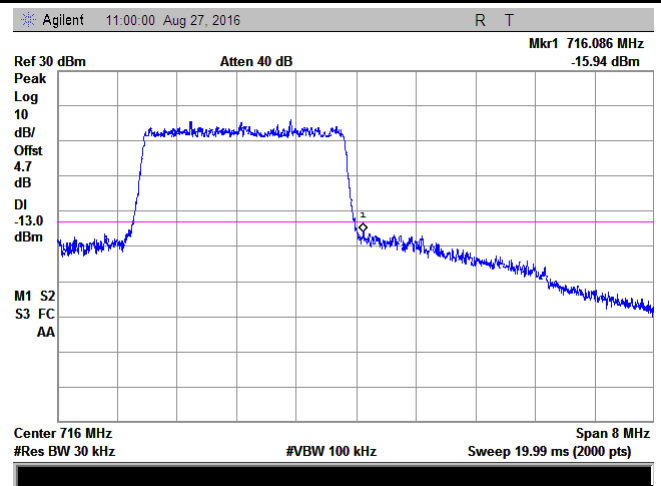

LTE Band 12 - High Channel 16QAM-3

Note: Offset=Cable loss (4.5) + 10log  
(31.25/30)=4.5+0.2=4.7 dB

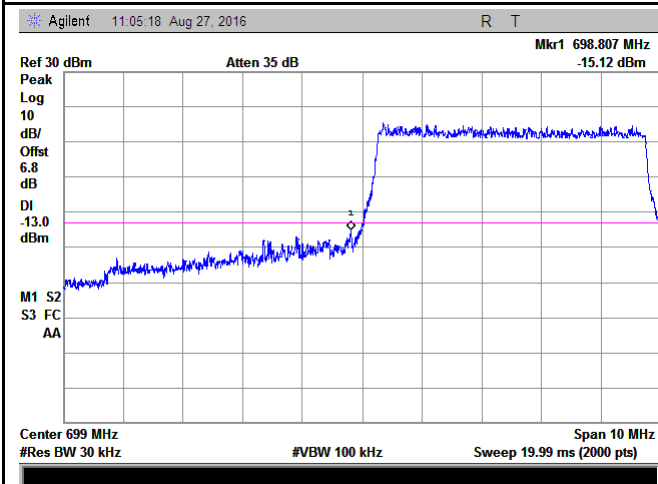

LTE Band 12 - Low Channel QPSK-5

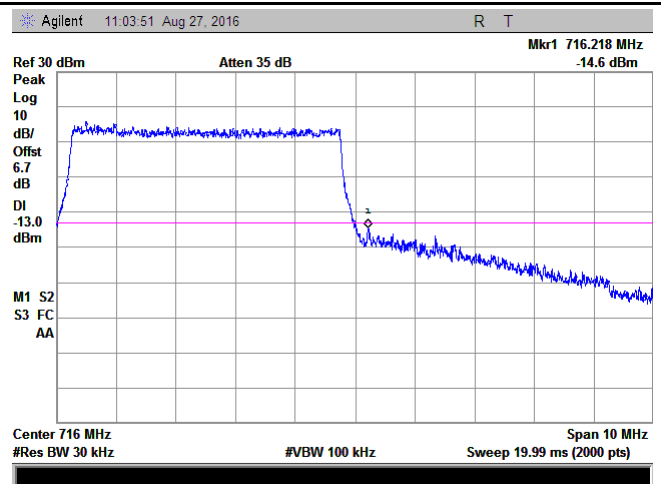

LTE Band 12 - High Channel QPSK-5

Note: Offset=Cable loss (4.5) + 10log  
(50.71/30)=4.5+2.3=6.8 dB

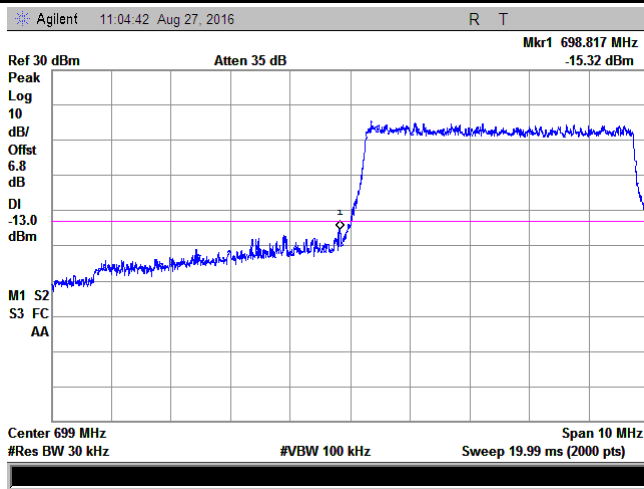

LTE Band 12 - Low Channel 16QAM-5

Note: Offset=Cable loss (4.5) + 10log  
(51.3/30)=4.5+2.2=6.7 dB

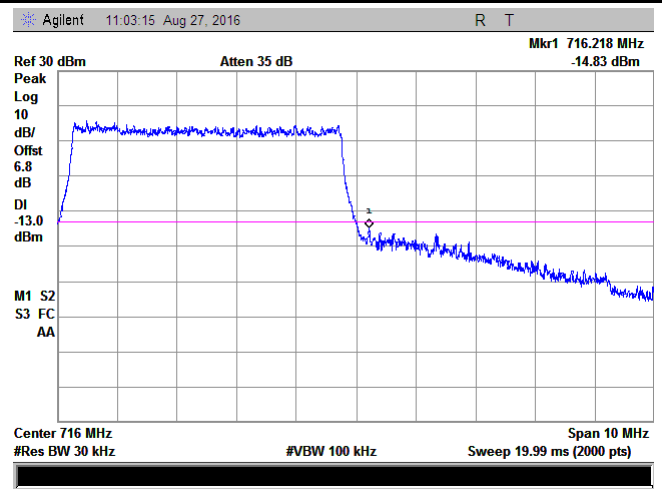

LTE Band 12 - High Channel 16QAM-5

Note: Offset=Cable loss (4.5) + 10log  
(50.92/30)=4.5+2.3=6.8 dB

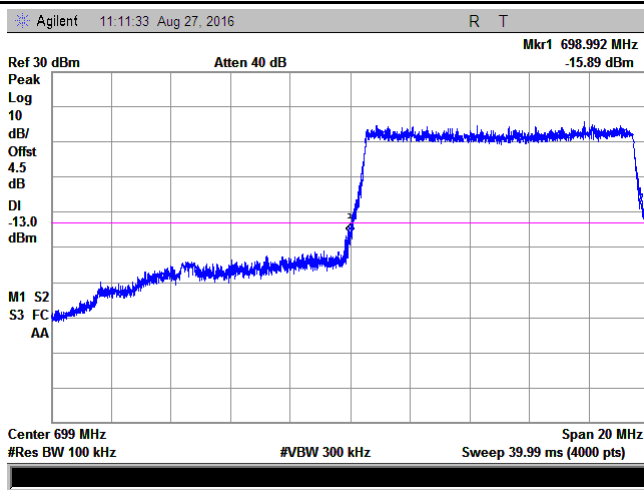

LTE Band 12 - Low Channel QPSK-10

Note: Offset=Cable loss (4.5) + 10log  
(50.44/30)=4.5+2.2=6.7 dB

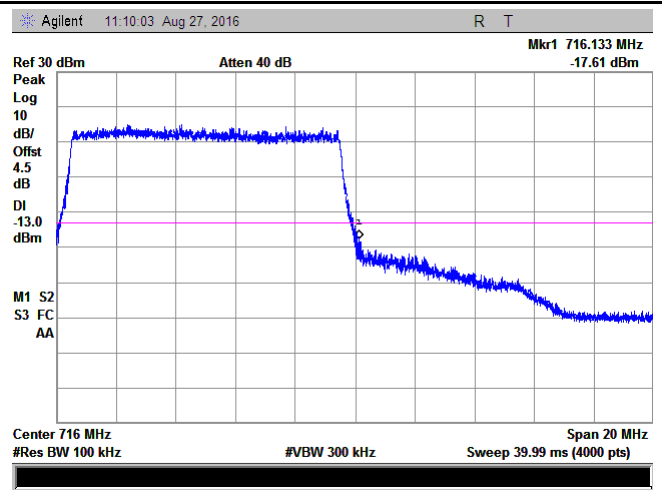

LTE Band 12 - High Channel QPSK-10

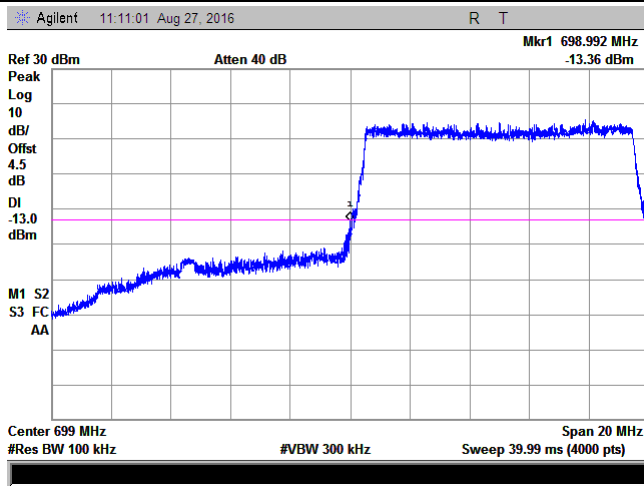

LTE Band 12 - Low Channel 16QAM-10

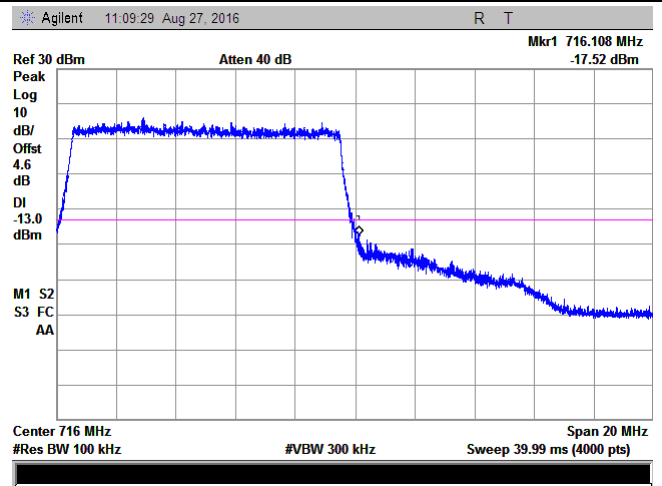

LTE Band 12 - High Channel 16QAM-10

### LTE Band 17 (Part 27)

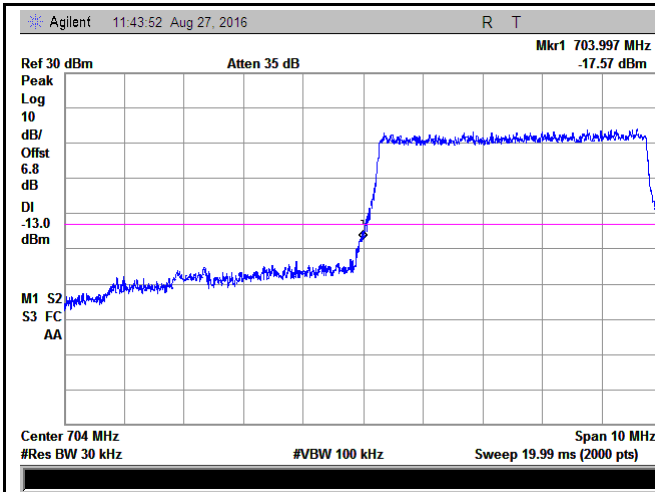

LTE Band 17 - Low Channel QPSK-5

Note: Offset=Cable loss (4.0) + 10log  
(50.64/30)=4.5+2.3=6.8 dB

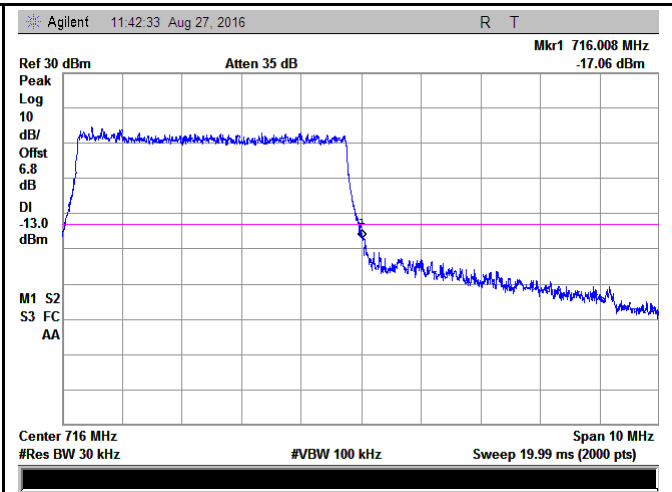

LTE Band 17 - High Channel QPSK-5

Note: Offset=Cable loss (4.0) + 10log  
(50.88/30)=4.5+2.3=6.8 dB

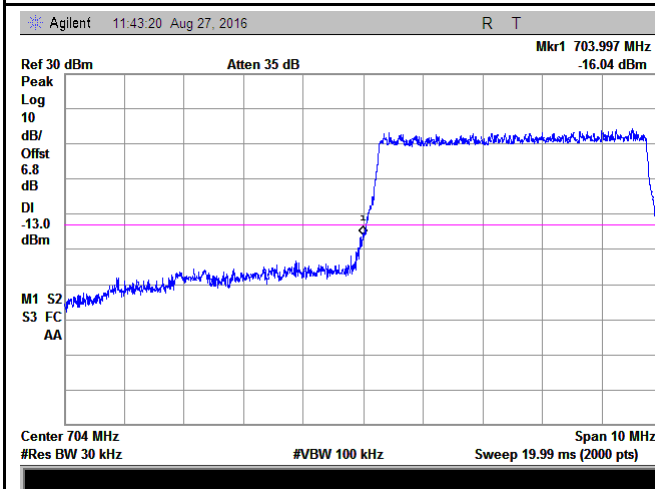

LTE Band 17 - Low Channel 16QAM-5

Note: Offset=Cable loss (4.0) + 10log  
(51.13/30)=4.5+2.3=6.8 dB

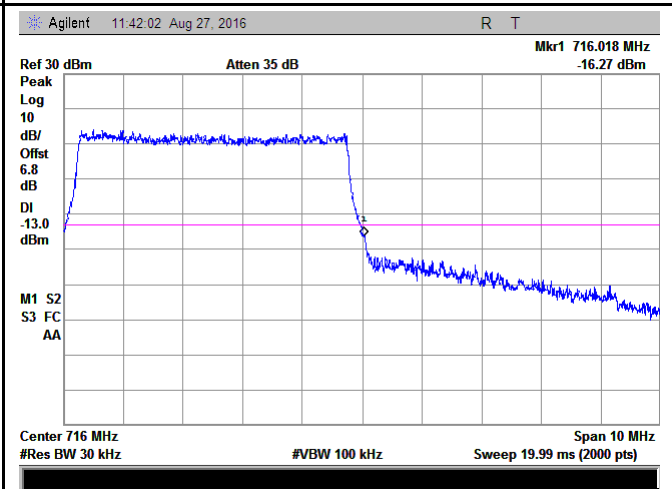

LTE Band 17 - High Channel 16QAM-5

Note: Offset=Cable loss (4.0) + 10log  
(50.75/30)=4.5+2.3=6.8 dB

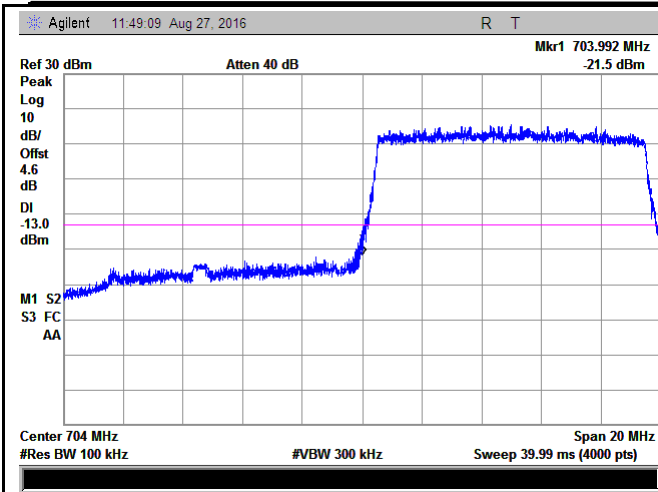

LTE Band 17 - Low Channel QPSK-10

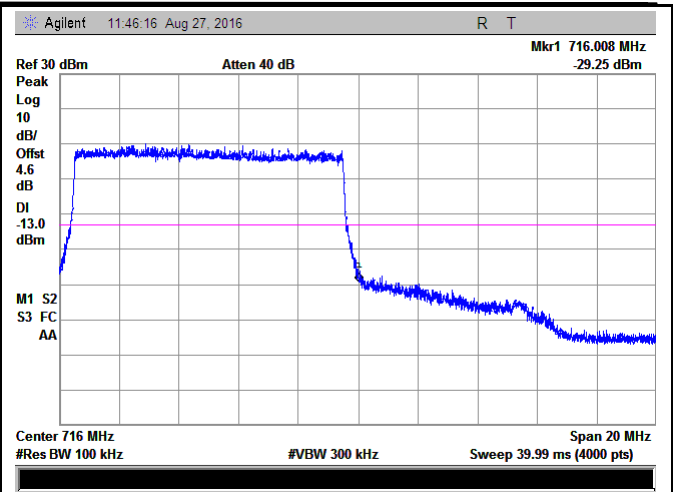

LTE Band 17 - High Channel QPSK-10

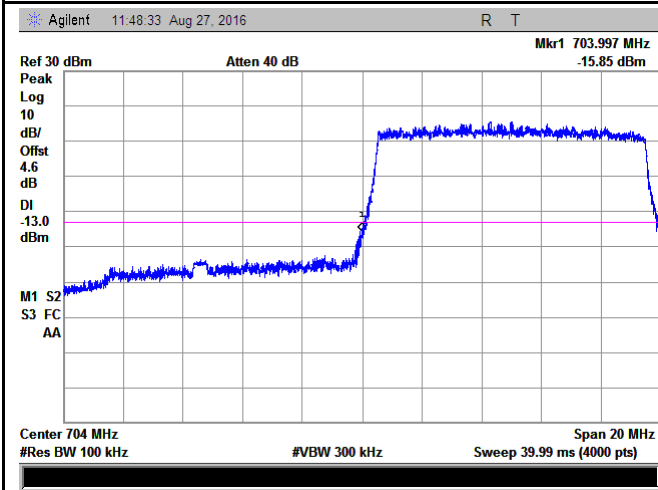

LTE Band 17 - Low Channel 16QAM-10

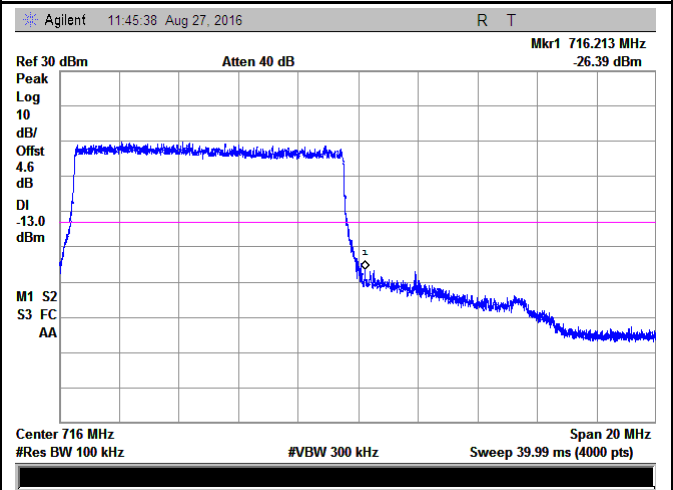

LTE Band 17 - High Channel 16QAM-10



## 6.8 Band Edge 27.53(m)

Temperature	24°C
Relative Humidity	51%
Atmospheric Pressure	1027mbar
Test date :	August 27, 2016
Tested By :	Loren Luo

### Requirement(s):

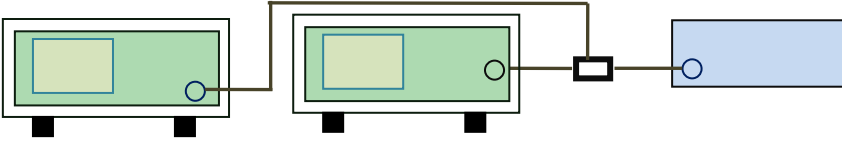
Spec	Requirement	Applicable
§27.53(m)	According to FCC 27.53(m)(4) specified that power of any emission outside of the channel edge must be attenuated below the transmitting power(P) by a factor shall be not less than $43+10\log(P)$ dB at the channel edge, the limit of emission equal to -13dBm. And $55+10\log(P)$ dB at 5.5MHz from the channel edges, the limit of emission equal to -25dBm. In the 1MHz bands immediately outside and adjacent to the frequency block a resolution bandwidth of at least one percent of the emission bandwidth of the fundamental emission of the transmitter may be employed.	<input checked="" type="checkbox"/>
Test Setup		
Test Procedure	<ul style="list-style-type: none"> <li>- The EUT was connected to Spectrum Analyzer and Base Station via power divider.</li> <li>- The 99% and 26 dB occupied bandwidth (BW) of the middle channel for the highest RF powers.</li> </ul>	
Remark		
Result	<input checked="" type="checkbox"/> Pass <input type="checkbox"/> Fail	

Test Data  Yes  N/A  
 Test Plot  Yes (See below)  N/A

### LTE Band 7 (Part 27) result

BW(MHz)	Channel	Frequency (MHz)	Mode	Emission (dBm)	Limit (dBm)
5	20775	2499.9	QPSK	-21.48	-13
			16QAM	-21.61	-13
5	21425	2570	QPSK	-20.84	-13
			16QAM	-22.29	-13
10	20800	2499.9	QPSK	-23.55	-13
			16QAM	-22.34	-13
10	21400	2570	QPSK	-19.25	-13
			16QAM	-19.46	-13
15	20825	2499.9	QPSK	-21.51	-13
			16QAM	-21.53	-13
15	21400	2570	QPSK	-16.16	-13
			16QAM	-15.6	-13
20	20850	2499.9	QPSK	-24.5	-13
			16QAM	-25.54	-13
20	21350	2570	QPSK	-20.3	-13
			16QAM	-18.96	-13

### LTE Band 7 (Part 27)

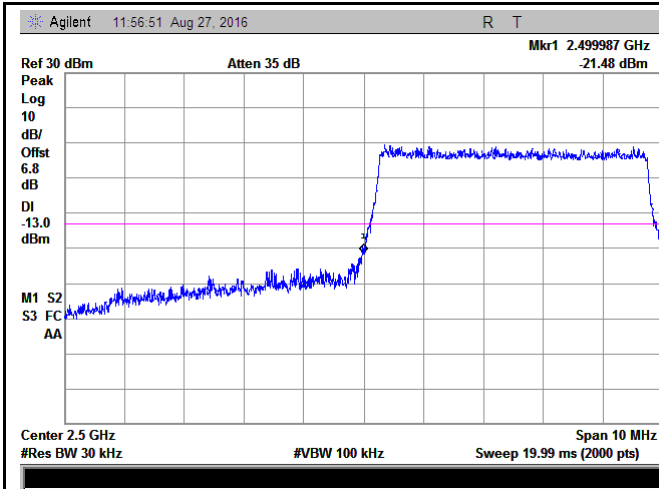

LTE Band 7 - Low Channel QPSK-5

Note: Offset=Cable loss (4.5) + 10log  
(51.14/30)=4.5+2.3=6.8 dB

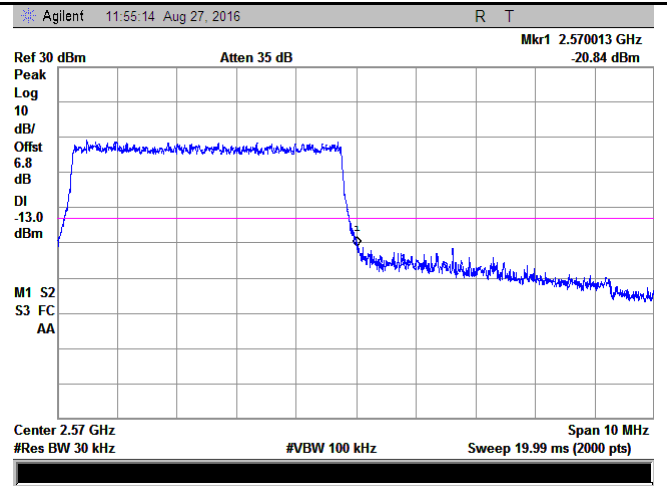

LTE Band 7 - High Channel QPSK-5

Note: Offset=Cable loss (4.5) + 10log  
(50.85/30)=4.5+2.3=6.8 dB

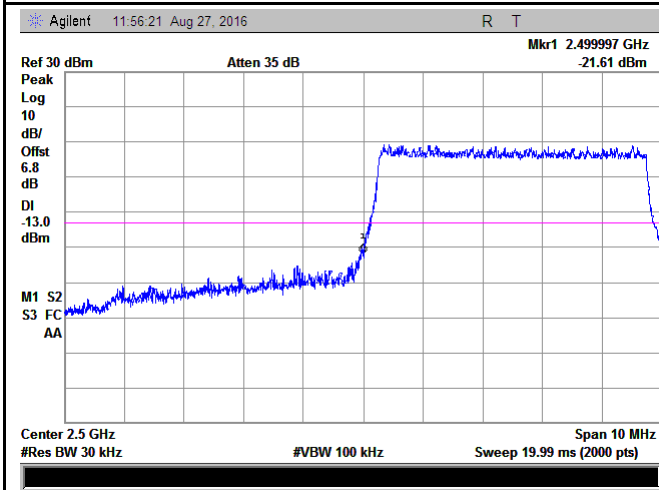

LTE Band 7 - Low Channel 16QAM-5

Note: Offset=Cable loss (4.5) + 10log  
(50.082/30)=4.5+2.3=6.8 dB

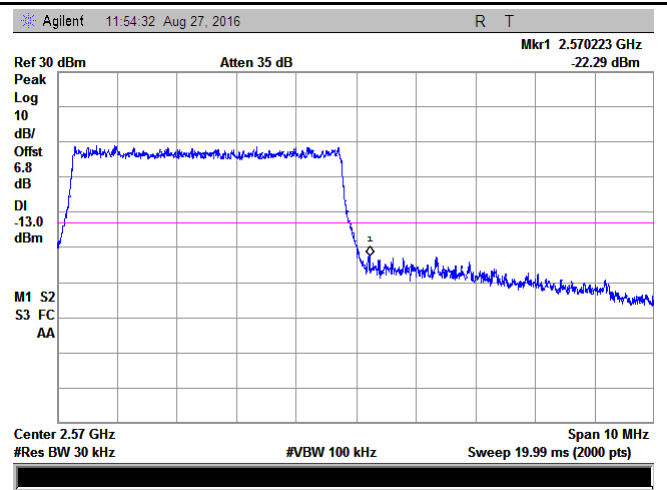

LTE Band 7 - High Channel 16QAM-5

Note: Offset=Cable loss (4.5) + 10log  
(50.099/30)=4.5+2.3=6.8 dB

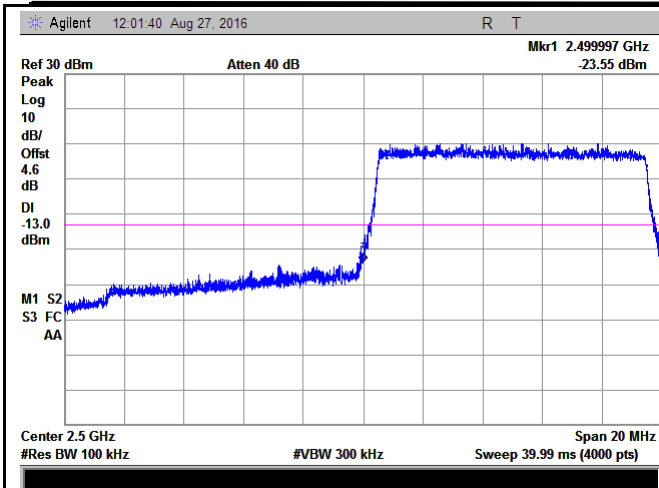

LTE Band 7 - Low Channel QPSK-10

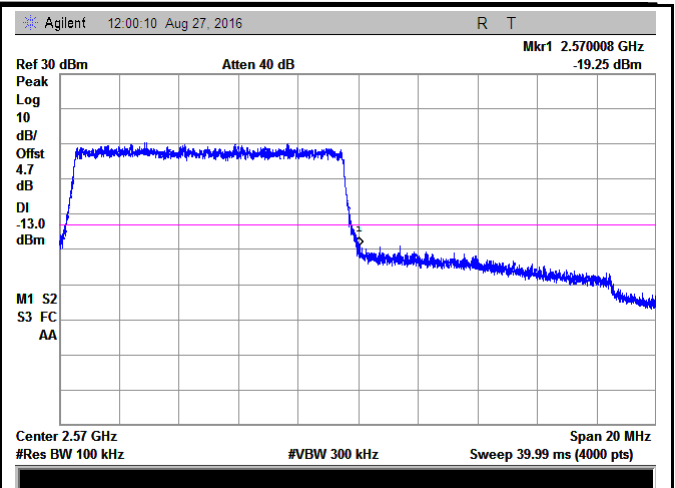

LTE Band 7 - High Channel QPSK-10

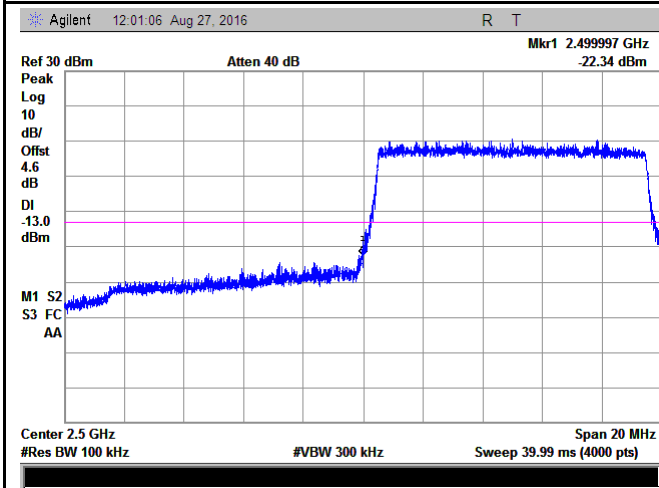

LTE Band 7 - Low Channel 16QAM-10

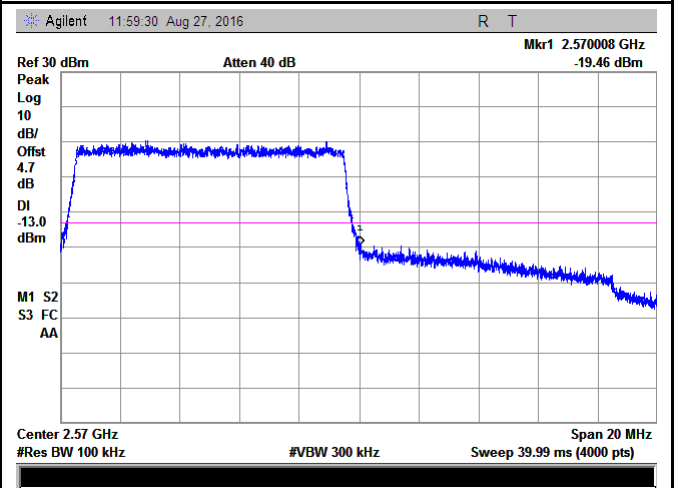

LTE Band 7 - High Channel 16QAM-10

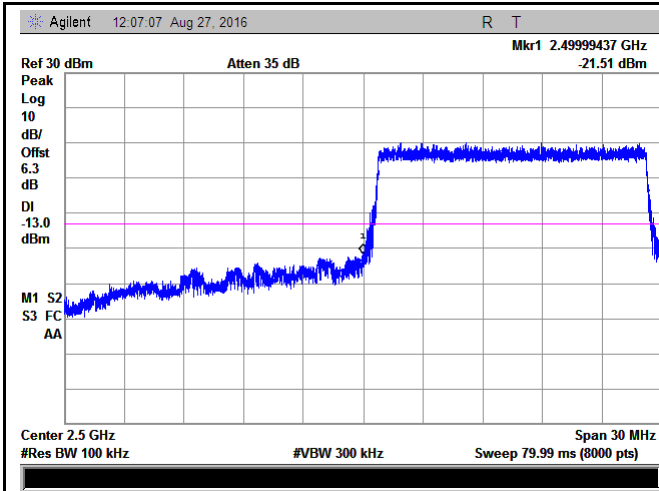

LTE Band 7 - Low Channel QPSK-15

Note: Offset=Cable loss (4.5) + 10log  
(149.88/100)=4.5+1.8=6.3 dB

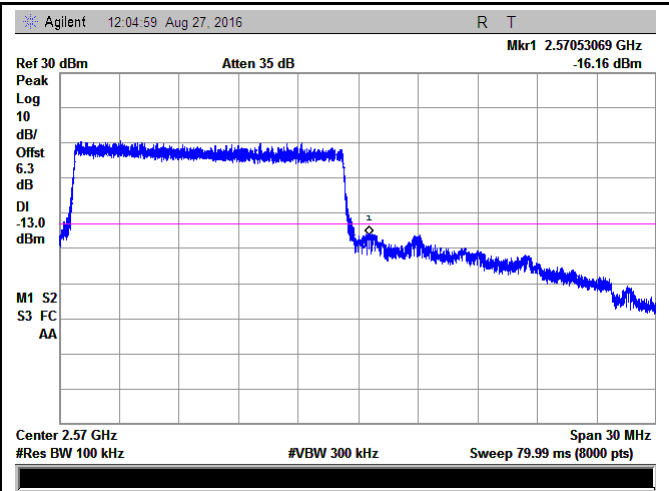

LTE Band 7 - High Channel QPSK-15

Note: Offset=Cable loss (4.5) + 10log  
(151.12/100)=4.5+1.8=6.3 dB

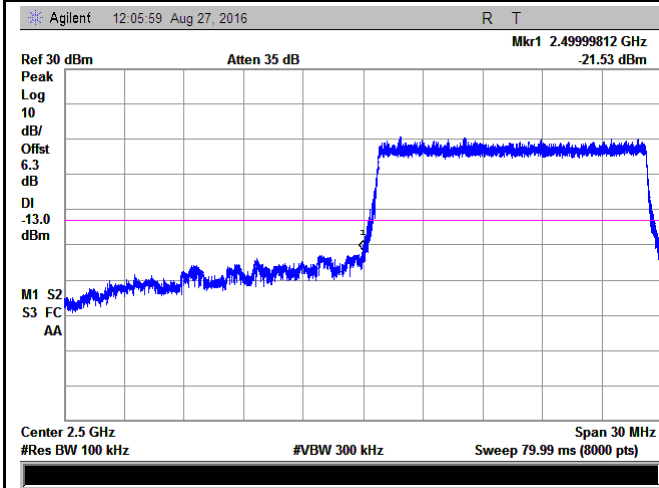

LTE Band 7 - Low Channel 16QAM-15

Note: Offset=Cable loss (4.5) + 10log  
(150.24/100)=4.5+1.8=6.3dB

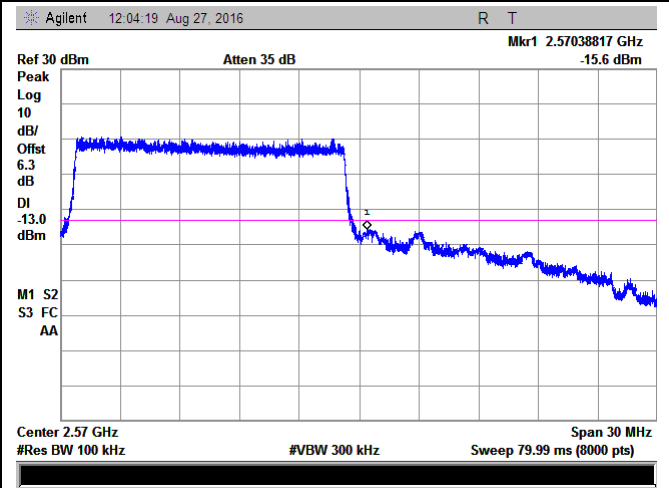

LTE Band 7 - High Channel 16QAM-15

Note: Offset=Cable loss (4.5) + 10log  
(150.87/100)=4.5+1.8=6.3 dB

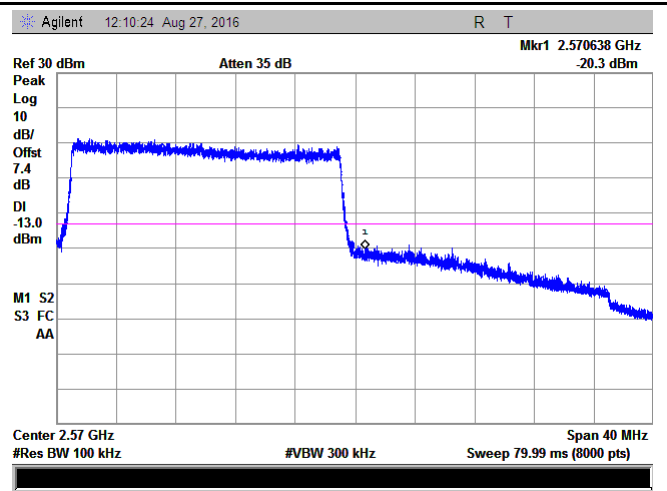
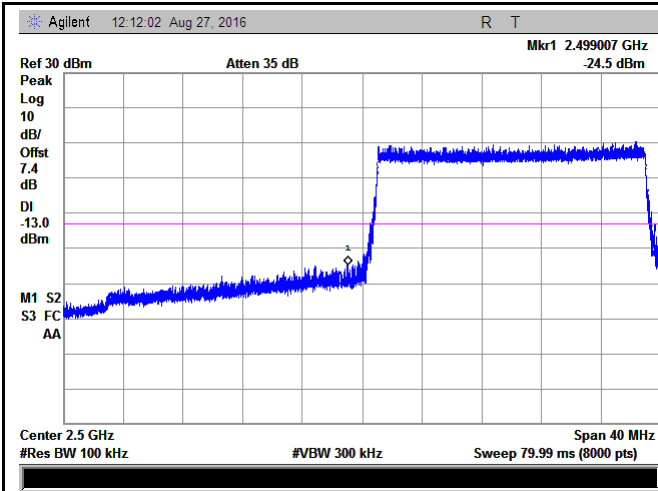

LTE Band 7 - Low Channel QPSK-20

LTE Band 7 - High Channel QPSK-20

Note: Offset=Cable loss (4.5) + 10log  
 (194.75/100)=4.5+2.9=7.4 dB

Note: Offset=Cable loss (4.5) + 10log  
 (195.56/100)=4.5+2.9=7.4dB

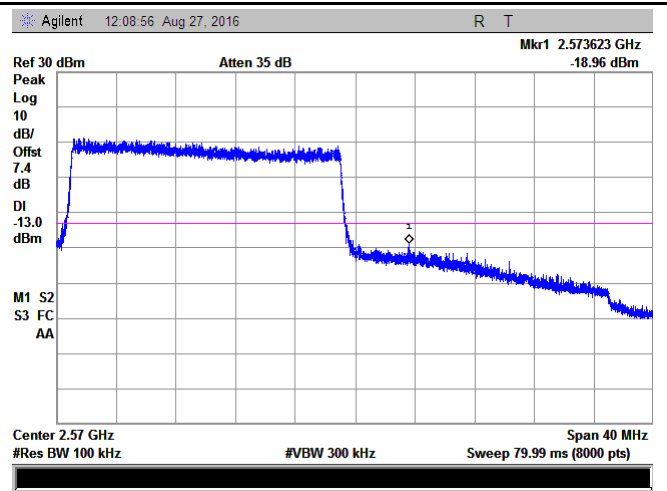
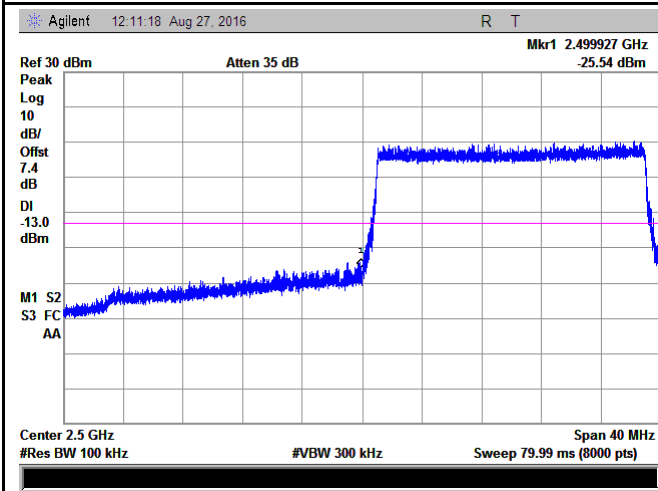

LTE Band 7 - Low Channel 16QAM-20

LTE Band 7 - High Channel 16QAM-20

Note: Offset=Cable loss (4.5) + 10log  
 (194.93/100)=4.5+2.9=7.4 dB

Note: Offset=Cable loss (4.5) + 10log  
 (196.95/100)=4.5+2.9=7.4 dB

## 6.9 Frequency Stability

Temperature	23°C
Relative Humidity	59%
Atmospheric Pressure	1026mbar
Test date :	August 26, 2016
Tested By :	Loren Luo

### Requirement(s):

Spec	Item	Requirement	Applicable																																
§2.1055, §22.355 & §24.235 § 27.5(h); § 27.54	a)	<p>According to §22.355, the carrier frequency of each transmitter in the Public Mobile Services must be maintained within the tolerances given in Table below:</p> <p>Frequency Tolerance for Transmitters in the Public Mobile Services</p> <table border="1"> <thead> <tr> <th>Frequency Range (MHz)</th> <th>Base, fixed (ppm)</th> <th>Mobile ≤ 3 watts (ppm)</th> <th>Mobile ≤ 3 watts (ppm)</th> </tr> </thead> <tbody> <tr> <td>25 to 50</td> <td>20.0</td> <td>20.0</td> <td>50.0</td> </tr> <tr> <td>to 450</td> <td>5.0</td> <td>5.0</td> <td>50.0</td> </tr> <tr> <td>450 to 512</td> <td>2.5</td> <td>5.0</td> <td>5 0</td> </tr> <tr> <td>821 to 896</td> <td>1.5</td> <td>2.5</td> <td>2.5</td> </tr> <tr> <td>928 to 929.</td> <td>5.0</td> <td>N/A</td> <td>N/A</td> </tr> <tr> <td>929 to 960.</td> <td>1.5</td> <td>N/A</td> <td>N/A</td> </tr> <tr> <td>2110 to 2220</td> <td>10.0</td> <td>N/A</td> <td>N/A</td> </tr> </tbody> </table> <p>According to §24.235, the frequency stability shall be sufficient to ensure that the fundamental emissions stay within the authorized frequency block.</p> <p>According to §27.54, The frequency stability shall be sufficient to ensure that the fundamental emissions stay within the authorized bands of operation.</p>	Frequency Range (MHz)	Base, fixed (ppm)	Mobile ≤ 3 watts (ppm)	Mobile ≤ 3 watts (ppm)	25 to 50	20.0	20.0	50.0	to 450	5.0	5.0	50.0	450 to 512	2.5	5.0	5 0	821 to 896	1.5	2.5	2.5	928 to 929.	5.0	N/A	N/A	929 to 960.	1.5	N/A	N/A	2110 to 2220	10.0	N/A	N/A	<input checked="" type="checkbox"/>
		Frequency Range (MHz)	Base, fixed (ppm)	Mobile ≤ 3 watts (ppm)	Mobile ≤ 3 watts (ppm)																														
		25 to 50	20.0	20.0	50.0																														
		to 450	5.0	5.0	50.0																														
		450 to 512	2.5	5.0	5 0																														
		821 to 896	1.5	2.5	2.5																														
		928 to 929.	5.0	N/A	N/A																														
		929 to 960.	1.5	N/A	N/A																														
		2110 to 2220	10.0	N/A	N/A																														

Test setup	
Procedure	<p>A communication link was established between EUT and base station. The frequency error was monitored and measured by base station under variation of ambient temperature and variation of primary supply voltage.</p> <p>Limit: The frequency stability of the transmitter shall be maintained within <math>\pm 0.00025\%</math> (<math>\pm 2.5\text{ppm}</math>) of the center frequency.</p>
Remark	<p>Frequency Stability versus Temperature: The Frequency tolerance of the carrier signal shall be maintained within 2.5ppm of the operating frequency over a temperature variation of <math>-10^{\circ}\text{C}</math> to <math>+55^{\circ}\text{C}</math> at normal supply voltage.</p>
Result	<input checked="" type="checkbox"/> Pass <input type="checkbox"/> Fail

Test Data     Yes                       N/A  
 Test Plot     Yes (See below)             N/A



### LTE Band 2 (Part 24E) result

Middle Channel, $f_0 = 1880$ MHz				
Temperature (°C)	Power Supplied (V <sub>DC</sub> )	Frequency Error (Hz)	Frequency Error (ppm)	Limit (ppm)
-10	3.7	-7	0.0037	2.5
0		-9	0.0048	2.5
10		-10	0.0053	2.5
20		-12	0.0064	2.5
30		-13	0.0069	2.5
40		-8	0.0043	2.5
50		-9	0.0048	2.5
55		-11	0.0059	2.5
25	4.2	-13	0.0069	2.5
	3.5	-13	0.0069	2.5

### LTE Band 4 (Part 27) result

Middle Channel, $f_0 = 1732.5$ MHz				
Temperature (°C)	Power Supplied (V <sub>DC</sub> )	Frequency Error (Hz)	Frequency Error (ppm)	Limit (ppm)
-10	3.7	-10	0.0058	2.5
0		-18	0.0104	2.5
10		-15	0.0087	2.5
20		-11	0.0063	2.5
30		-8	0.0046	2.5
40		-10	0.0058	2.5
50		-12	0.0069	2.5
55		-12	0.0069	2.5
25	4.2	-14	0.0081	2.5
	3.5	-18	0.0104	2.5

### LTE Band 5 (Part 22H) result

Middle Channel, $f_0 = 836.5$ MHz				
Temperature (°C)	Power Supplied (V <sub>DC</sub> )	Frequency Error (Hz)	Frequency Error (ppm)	Limit (ppm)
-10	3.7	-8	0.0096	2.5
0		-6	0.0072	2.5
10		-6	0.0072	2.5
20		-10	0.0120	2.5
30		-12	0.0143	2.5
40		-5	0.0060	2.5
50		-10	0.0120	2.5
55		-5	0.0060	2.5
25	4.2	-7	0.0084	2.5
	3.5	-11	0.0132	2.5

### LTE Band 7 (Part 27) result

Middle Channel, $f_0 = 2535$ MHz				
Temperature (°C)	Power Supplied (V <sub>DC</sub> )	Frequency Error (Hz)	Frequency Error (ppm)	Limit (ppm)
-10	3.7	-10	0.0039	2.5
0		-8	0.0032	2.5
10		-7	0.0028	2.5
20		-9	0.0036	2.5
30		-12	0.0047	2.5
40		-8	0.0032	2.5
50		-9	0.0036	2.5
55		-5	0.0020	2.5
25	4.2	-9	0.0036	2.5
	3.5	-11	0.0043	2.5

### LTE Band 12 (Part 27) result

Middle Channel, $f_0 = 707.5\text{MHz}$				
Temperature (°C)	Power Supplied (V <sub>DC</sub> )	Frequency Error (Hz)	Frequency Error (ppm)	Limit (ppm)
-10	3.7	-8	0.0027	2.5
0		-9	0.0059	2.5
10		-10	0.0037	2.5
20		-12	0.0053	2.5
30		-12	0.0064	2.5
40		-9	0.0048	2.5
50		-8	0.0064	2.5
55		-10	0.0032	2.5
25	4.2	-9	0.0059	2.5
	3.5	-10	0.0053	2.5

### LTE Band 17 (Part 27) result

Middle Channel, $f_0 = 710\text{MHz}$				
Temperature (°C)	Power Supplied (V <sub>DC</sub> )	Frequency Error (Hz)	Frequency Error (ppm)	Limit (ppm)
-10	3.7	8	0.0113	2.5
0		6	0.0085	2.5
10		6	0.0085	2.5
20		5	0.0070	2.5
30		6	0.0085	2.5
40		4	0.0056	2.5
50		10	0.0141	2.5
55		9	0.0127	2.5
25	4.2	12	0.0169	2.5
	3.5	11	0.0155	2.5

## Annex A. TEST INSTRUMENT

Instrument	Model	Serial #	Cal Date	Cal Due	In use
<b>RF Conducted Test</b>					
Agilent ESA-E SERIES SPECTRUM ANALYZER	E4407B	MY45108319	09/16/2015	09/15/2016	<input checked="" type="checkbox"/>
Power Splitter	1#	1#	09/01/2015	08/31/2016	<input checked="" type="checkbox"/>
Universal Radio Communication Tester	CMU200	121393	09/25/2015	09/24/2016	<input checked="" type="checkbox"/>
Wideband Radio Communication Tester	CMW500	120906	03/27/2016	03/26/2017	<input checked="" type="checkbox"/>
Temperature/Humidity Chamber	UHL-270	001	10/09/2015	10/08/2016	<input checked="" type="checkbox"/>
DC Power Supply	E3640A	MY40004013	09/17/2015	09/16/2016	<input checked="" type="checkbox"/>
RF Power Sensor	Dare RPR3006C/P/W	AY554013	09/17/2015	09/16/2016	<input checked="" type="checkbox"/>
<b>Radiated Emissions</b>					
EMI test receiver	ESL6	100262	09/17/2015	09/16/2016	<input checked="" type="checkbox"/>
OPT 010 AMPLIFIER (0.1-1300MHz)	8447E	2727A02430	09/01/2015	08/31/2016	<input checked="" type="checkbox"/>
Microwave Preamplifier (0.5 ~ 18GHz)	PAM-118	443008	09/01/2015	08/31/2016	<input checked="" type="checkbox"/>
Bilog Antenna (30MHz~6GHz)	JB6	A110712	09/21/2015	09/20/2016	<input checked="" type="checkbox"/>
Bilog Antenna (30MHz~2GHz)	JB1	A112017	09/21/2015	09/20/2016	<input checked="" type="checkbox"/>
Double Ridge Horn Antenna (1 ~18GHz)	AH-118	71259	09/24/2015	09/23/2016	<input checked="" type="checkbox"/>
Double Ridge Horn Antenna (1 ~18GHz)	AH-118	71283	09/24/2015	09/23/2016	<input checked="" type="checkbox"/>
SYNTHESIZED SIGNAL GENERATOR	8665B	3744A01293	09/17/2015	09/16/2016	<input checked="" type="checkbox"/>
Tunable Notch Filter	3NF-800/1000-S	AA4	09/01/2015	08/31/2016	<input checked="" type="checkbox"/>

Test Report	16070911-FCC-R5
Page	141 of 152

Tunable Notch Filter	3NF- 1000/2000-S	AM 4	09/01/2015	08/31/2016	<input checked="" type="checkbox"/>
----------------------	---------------------	------	------------	------------	-------------------------------------

**Annex B. EUT And Test Setup Photographs**

**Annex B.i. Photograph: EUT External Photo**



Whole Package View



Adapter - Front View



EUT - Front View



EUT - Rear View



EUT - Top View



EUT - Bottom View



EUT - Left View



EUT - Right View

**Annex B.ii. Photograph: EUT Internal Photo**



Cover Off - Top View 1



Cover Off - Top View 2



Battery - Front View



Battery - Rear View

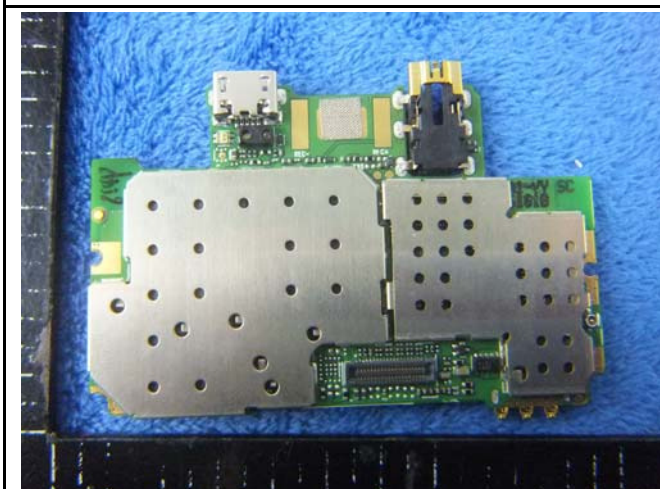

Mainboard with Shielding - Front View

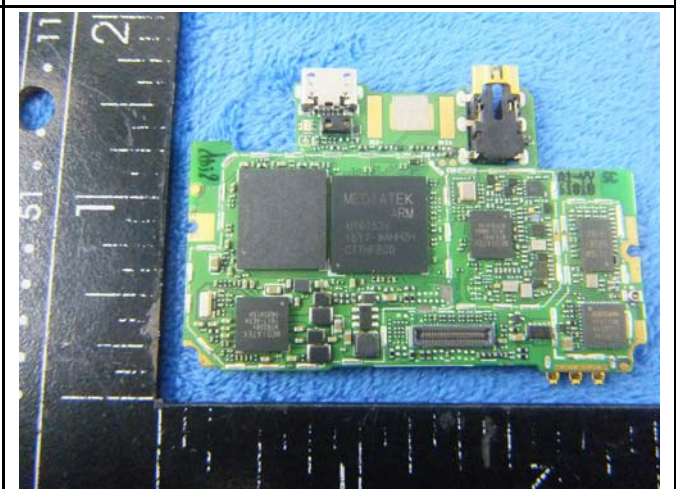

Mainboard without Shielding - Front View





Mainboard with Shielding - Rear View

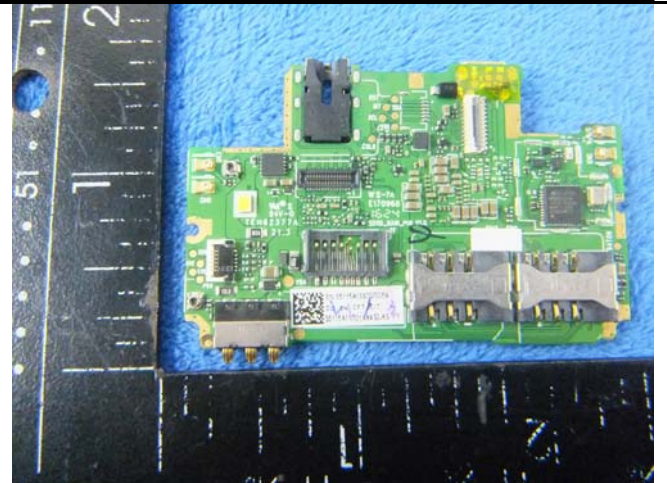

Mainboard without Shielding - Rear View

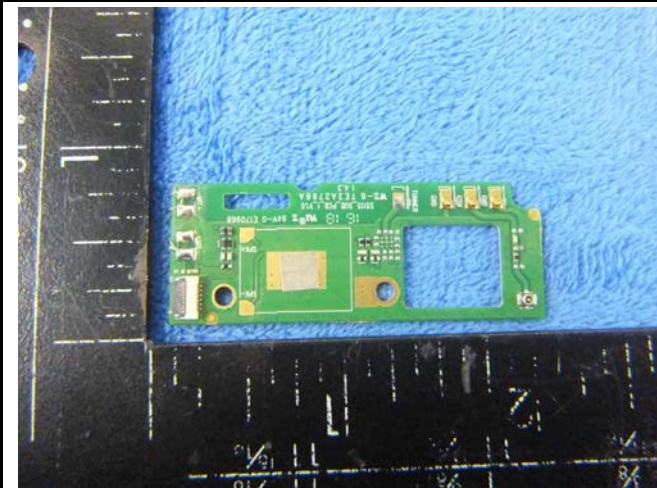

Small Board - Front View

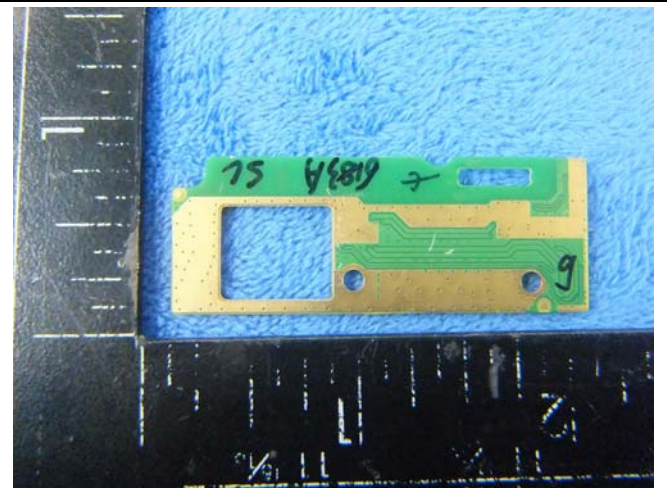

Small Board - Rear View



LCD - Front View



LCD - Rear View

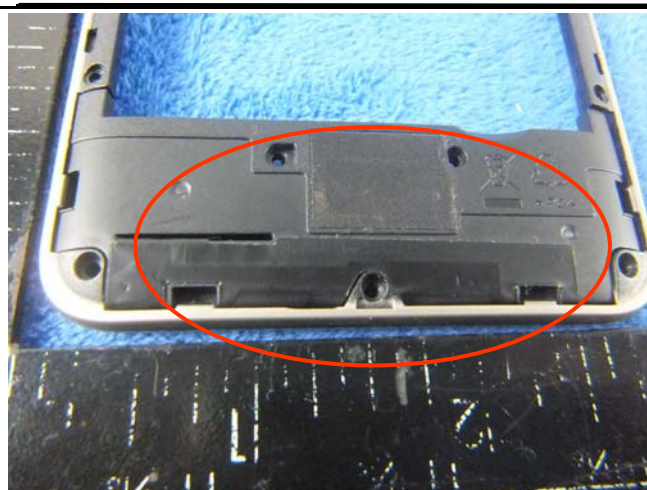

UMTS-FDD/GSM Antenna View

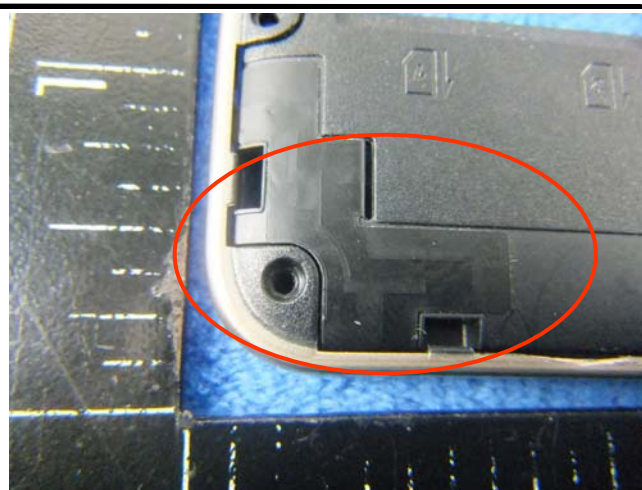

WIFI/BT/BLE/GPS - Antenna View



LTE - Antenna View

**Annex B.iii. Photograph: Test Setup Photo**

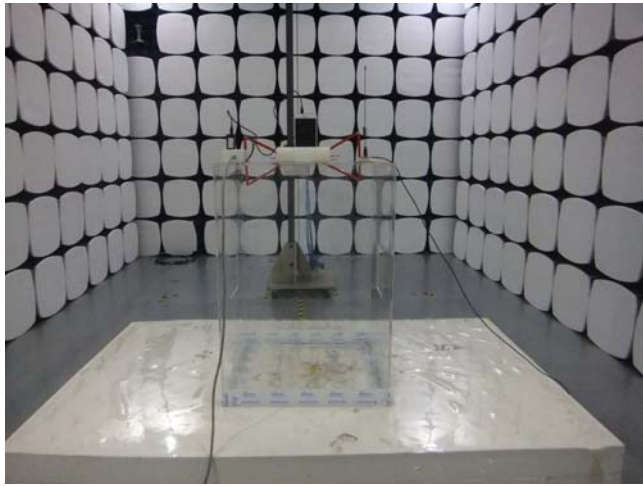

Radiated Spurious Emissions Test Setup Below 1GHz

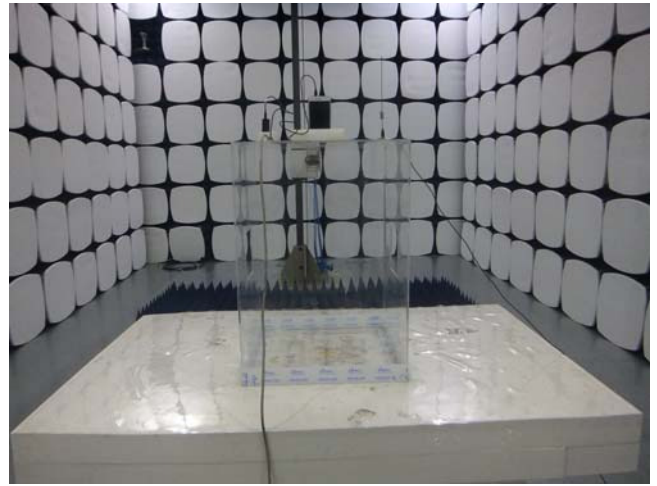

Radiated Spurious Emissions Test Setup Above  
1GHz

## Annex C. TEST SETUP AND SUPPORTING EQUIPMENT

### Annex C.ii. TEST SET UP BLOCK

#### Block Configuration Diagram for Radiated Emissions

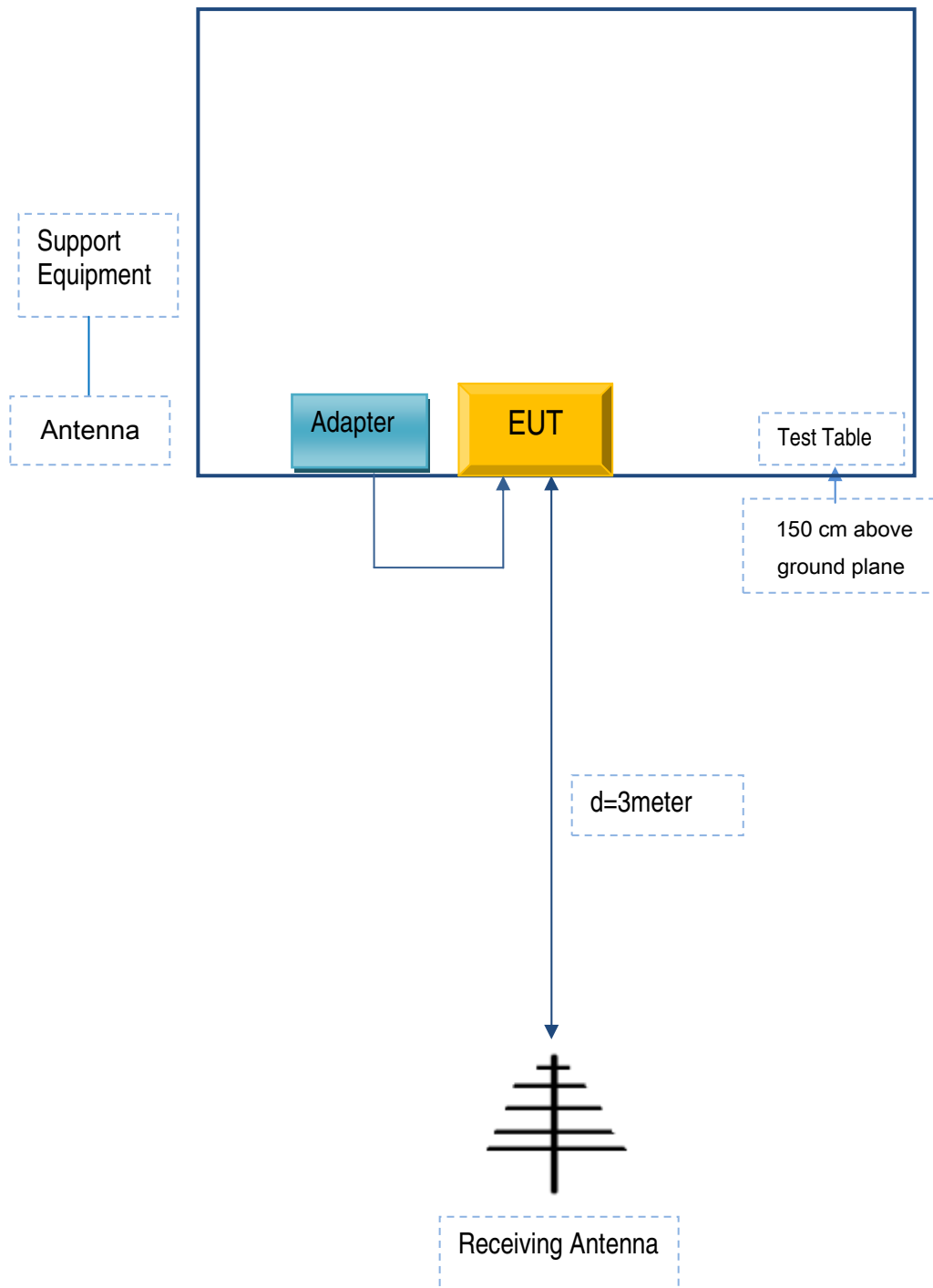

## Annex C. ii. SUPPORTING EQUIPMENT DESCRIPTION

The following is a description of supporting equipment and details of cables used with the EUT.

### Supporting Equipment:

Manufacturer	Equipment Description	Model	Serial No
Verykool USA Inc.	Adapter	TPA-46B050100UU	SL-003

### Supporting Cable:

Cable type	Shield Type	Ferrite Core	Length	Serial No
USB Cable	Un-shielding	No	0.8m	SL-003

Test Report	16070911-FCC-R5
Page	150 of 152

## Annex C.ii. EUT OPERATING CONKITIONS

N/A

Test Report	16070911-FCC-R5
Page	151 of 152

**Annex D. User Manual / Block Diagram / Schematics / Partlist**

**Please see the attachment**

Test Report	16070911-FCC-R5
Page	152 of 152

## Annex E. DECLARATION OF SIMILARITY

N/A