

RF TEST REPORT



Report No.: 16070667-FCC-R5

Supersede Report No.: N/A

Applicant	Verykool USA Inc	
Product Name	Smart Phone	
Model No.	SL5008T	
Serial No.	SL5008	
Test Standard	FCC Part 22(H):2015, FCC Part 24(E):2015, FCC Part 27: 2015; ANSI/TIA-603-D: 2010	
Test Date	June 08 to July 12, 2016	
Issue Date	July13, 2016	
Test Result	<input checked="" type="checkbox"/> Pass <input type="checkbox"/> Fail	
Equipment complied with the specification	<input checked="" type="checkbox"/>	
Equipment did not comply with the specification	<input type="checkbox"/>	
<i>Winnie Zhang</i>	<i>David Huang</i>	
Loren Luo Test Engineer	David Huang Checked By	
This test report may be reproduced in full only Test result presented in this test report is applicable to the tested sample only		

Issued by:

SIEMIC (SHENZHEN-CHINA) LABORATORIES

Zone A, Floor 1, Building 2 Wan Ye Long Technology Park

South Side of Zhoushi Road, Bao' an District, Shenzhen, Guangdong China 518108

Phone: +86 0755 2601 4629801 Email: China@siemic.com.cn

Laboratories Introduction

SIEMIC, headquartered in the heart of Silicon Valley, with superior facilities in US and Asia, is one of the leading independent testing and certification facilities providing customers with one-stop shop services for Compliance Testing and Global Certifications.



In addition to testing and certification, SIEMIC provides initial design reviews and compliance management throughout a project. Our extensive experience with China, Asia Pacific, North America, European, and International compliance requirements, assures the fastest, most cost effective way to attain regulatory compliance for the global markets.

Accreditations for Conformity Assessment

Country/Region	Scope
USA	EMC, RF/Wireless, SAR, Telecom
Canada	EMC, RF/Wireless, SAR, Telecom
Taiwan	EMC, RF, Telecom, SAR, Safety
Hong Kong	RF/Wireless, SAR, Telecom
Australia	EMC, RF, Telecom, SAR, Safety
Korea	EMI, EMS, RF, SAR, Telecom, Safety
Japan	EMI, RF/Wireless, SAR, Telecom
Singapore	EMC, RF, SAR, Telecom
Europe	EMC, RF, SAR, Telecom, Safety

Test Report	16070667-FCC-R5
Page	3 of 123

This page has been left blank intentionally.

CONTENTS

1. REPORT REVISION HISTORY	5
2. CUSTOMER INFORMATION	5
3. TEST SITE INFORMATION.....	5
4. EQUIPMENT UNDER TEST (EUT) INFORMATION.....	6
5. TEST SUMMARY	9
6. MEASUREMENTS, EXAMINATION AND DERIVED RESULTS	10
6.1 RF EXPOSURE (SAR).....	10
6.2 RF OUTPUT POWER.....	11
6.3 PEAK-AVERAGE RATIO.....	42
6.4 OCCUPIED BANDWIDTH.....	47
6.5 SPURIOUS EMISSIONS AT ANTENNA TERMINALS	72
6.6 SPURIOUS RADIATED EMISSIONS.....	77
6.7 BAND EDGE.....	83
6.8 BAND EDGE 27.53(M).....	101
6.9 FREQUENCY STABILITY	107
ANNEX A. TEST INSTRUMENT.....	111
ANNEX B. EUT AND TEST SETUP PHOTOGRAPHS.....	113
ANNEX C. TEST SETUP AND SUPPORTING EQUIPMENT.....	119
ANNEX C.II. EUT OPERATING CONKITIONS.....	121
ANNEX D. USER MANUAL / BLOCK DIAGRAM / SCHEMATICS / PARTLIST	122
ANNEX E. DECLARATION OF SIMILARITY.....	123

1. Report Revision History

Report No.	Report Version	Description	Issue Date
16070667-FCC-R5	NONE	Original	July13, 2016

2. Customer information

Applicant Name	Verykool USA Inc
Applicant Add	3636 Nobel Drive, Suite 325, San Diego, California 92122 United States
Manufacturer	SHENZHEN TOPWELL TECHNOLOGY CO.LTD
Manufacturer Add	T5F, 10Building, Changyuan New Material Port, No.2, Middle Road 1, High Tech Park, Nanshan District, Shenzhen, China

3. Test site information

Lab performing tests	SIEMIC (Shenzhen-China) LABORATORIES
Lab Address	Zone A, Floor 1, Building 2 Wan Ye Long Technology Park South Side of Zhoushi Road, Bao' an District, Shenzhen, Guangdong China 518108
FCC Test Site No.	718246
IC Test Site No.	4842E-1
Test Software	Radiated Emission Program-To Shenzhen v2.0

4. Equipment under Test (EUT) Information

Description of EUT:	Smart Phone
Main Model:	SL5008T
Serial Model:	SL5008
Date EUT received:	June 07, 2016
Test Date(s):	June 08 to July 12, 2016
Equipment Category :	PCE
Antenna Gain:	GSM850: 1.09dBi PCS1900: 2.54dBi UMTS-FDD Band V: 1.14dBi UMTS-FDD Band IV: 2.89dBi UMTS-FDD Band II: 2.95dBi LTE Band 2: 2.71dBi LTE Band 4: 2.92dBi LTE Band 5: 1.34dBi LTE Band 7: 3.23dBi Bluetooth/BLE/WIFI:2.65dBi GPS: 1.42dBi
Antenna Type:	PIFA antenna
Input Power:	Adapter: Model: SL5008 Input: AC 100-240V,50/60Hz;0.2A Output: DC 5.0V,1A Battery: Model: SL5008 Spec: 3.8V,2300mAh(8.74Wh) Charge limited voltage: 4.35V

Type of Modulation:	<p>GSM / GPRS: GMSK EGPRS: GMSK,8PSK UMTS-FDD: QPSK LTE Band: QPSK, 16QAM 802.11b/g/n: DSSS, OFDM Bluetooth: GFSK, π /4DQPSK, 8DPSK BLE: GFSK GPS:BPSK</p>
RF Operating Frequency (ies):	<p>GSM850 TX: 824.2 ~ 848.8 MHz; RX: 869.2 ~ 893.8 MHz PCS1900 TX: 1850.2 ~ 1909.8 MHz; RX: 1930.2 ~ 1989.8 MHz UMTS-FDD Band V TX: 826.4 ~ 846.6 MHz; RX: 871.4 ~ 891.6 MHz UMTS-FDD Band IV TX:1712.4 ~ 1752.6 MHz; RX : 2112.4 ~ 2152.6 MHz UMTS-FDD Band II TX:1852.4 ~ 1907.6 MHz; RX: 1932.4 ~ 1987.6 MHz LTE Band 2 TX: 1852.5 ~ 1907.5 MHz; RX : 1932.5 ~ 1987.5 MHz LTE Band 4 TX: 1712.5 ~ 1752.5 MHz; RX : 2112.5 ~ 2152.5 MHz LTE Band 5 TX: 826.5 ~ 846.5 MHz; RX : 871.5 ~ 891.5 MHz LTE Band 7 TX: 2502.5 ~ 2567.5 MHz; RX : 2622.5 ~ 2687.5 MHz WIFI: 802.11b/g/n(20M): 2412-2462 MHz WIFI: 802.11n(40M): 2422-2452 MHz Bluetooth& BLE: 2402-2480 MHz GPS: 1575.42 MHz</p>
Number of Channels:	<p>GSM 850: 124CH PCS1900: 299CH UMTS-FDD Band V: 102CH UMTS-FDD Band IV: 202CH UMTS-FDD Band II: 277CH WIFI :802.11b/g/n(20M): 11CH WIFI :802.11n(40M): 7CH Bluetooth: 79CH BLE: 40CH GPS:1CH</p>

Maximum Conducted	LTE Band 2: 23.58 dBm
AV Power to Antenna:	LTE Band 4: 23.62 dBm
	LTE Band 5: 23.70 dBm
	LTE Band 7: 23.67 dBm
ERP/EIRP:	LTE Band 2: 26.96 dBm / EIRP
	LTE Band 4: 25.97 dBm / EIRP
	LTE Band 5: 22.95 dBm / EIRP
	LTE Band 7: 26.47 dBm / EIRP
Port:	Earphone Port, USB Port
Trade Name :	N/A
GPRS/EGPRS Multi-slot class	8/10/12
FCC ID:	WA6SL5008T

5. Test Summary

The product was tested in accordance with the following specifications.

All testing has been performed according to below product classification:

FCC Rules	Description of Test	Result
§ 1.1307; § 2.1093	RF Exposure (SAR)	Compliance
§2.1046; § 22.913(a); § 24.232(c); § 27.50(c.10); § 27.50(d.4)	RF Output Power	Compliance
§ 24.232 (d); § 27.50(d)	Peak-Average Ratio	Compliance
§ 2.1047	Modulation Characteristics	N/A
§ 2.1049; § 22.905; § 22.917; § 24.238; § 27.53(a.5)	99% & -26 dB Occupied Bandwidth	Compliance
§ 2.1051; § 22.917(a); § 24.238(a); § 27.53(h)	Spurious Emissions at Antenna Terminal	Compliance
§ 2.1053; § 22.917(a); § 24.238(a); § 27.53(h)	Field Strength of Spurious Radiation	Compliance
§ 22.917(a); § 24.238(a);	Out of band emission, Band Edge	Compliance
§ 27.53(m)	Band Edge 27.53(m)	Compliance
§ 2.1055; § 22.355; § 24.235; § 27.5(h); § 27.54	Frequency stability vs. temperature Frequency stability vs. voltage	Compliance

Note: Testing was performed by configuring EUT to maximum output power status, the declared output power class for different

Measurement Uncertainty

Emissions		
Test Item	Description	Uncertainty
Band Edge and Radiated Spurious Emissions	Confidence level of approximately 95% (in the case where distributions are normal), with a coverage factor of 2 (for EUTs < 0.5m X 0.5m X 0.5m)	+5.6dB/-4.5dB
-	-	-

6. MEASUREMENTS, EXAMINATION AND DERIVED RESULTS

6.1 RF Exposure (SAR)

Test Result: Pass

The EUT is a portable device, thus requires SAR evaluation;

Please refer to RF Exposure Evaluation Report: 16070667-FCC-H.

6.2 RF Output Power

Temperature	25°C
Relative Humidity	54%
Atmospheric Pressure	1002mbar
Test date :	July 02, 2016
Tested By :	Loren Luo

Requirement(s):

Spec	Item	Requirement	Applicable
§22.913 (a)	a)	ERP:38.45dBm	<input checked="" type="checkbox"/>
§24.232 (c)	b)	EIRP:33dBm	<input checked="" type="checkbox"/>
§27.50 (c)	c)	EIRP: 30dBm	<input checked="" type="checkbox"/>

Test Setup

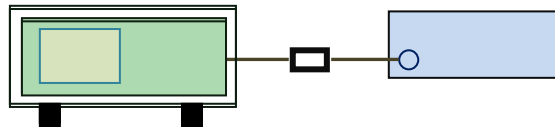

Test Procedure

For Conducted Power:

- The transmitter output port was connected to base station.
- Set EUT at maximum power through base station.
- Select lowest, middle, and highest channels for each band and different test mode.

For ERP/EIRP:

- The transmitter was placed on a wooden turntable, and it was transmitting into a non-radiating load which was also placed on the turntable.
- The measurement antenna was placed at a distance of 3 meters from the EUT. During the tests, the antenna height and polarization as well as EUT azimuth were varied in order to identify the maximum level of emissions from the EUT. The test was performed by placing the EUT on 3-orthogonal axis.
- The frequency range up to tenth harmonic of the fundamental frequency was investigated.

Test Report	16070667-FCC-R5
Page	12 of 123

	<ul style="list-style-type: none"> - Remove the EUT and replace it with substitution antenna. A signal generator was connected to the substitution antenna by a non-radiating cable. The absolute levels of the spurious emissions were measured by the substitution. - Spurious emissions in dB = 10 log (TX power in Watts/0.001) – the absolute level - Spurious attenuation limit in dB = 43 + 10 Log10 (power out in Watts).
Remark	
Result	<input checked="" type="checkbox"/> Pass <input type="checkbox"/> Fail

Test Data Yes N/A
Test Plot Yes (See below) N/A

Conducted Power

LTE Band 2:

BW (MHz)	Ch	Freq. (MHz)	Mode	UL RB Allocation	UL RB Offset	MPR	Average power (dBm)	Tune up Power tolerant
20MHz	18700	1860.0	QPSK	1	0	0	23.39	22.5 ± 1
				1	49	0	23.48	22.5 ± 1
				1	99	0	23.32	22.5 ± 1
				50	0	1	22.37	22.5 ± 1
				50	24	1	22.63	22.5 ± 1
				50	49	1	22.12	22.5 ± 1
			100	0	1	22.32	22.5 ± 1	
			16QAM	1	0	1	22.83	22.5 ± 1
				1	49	1	22.65	22.5 ± 1
				1	99	1	22.32	22.5 ± 1
				50	0	2	21.56	22.5 ± 1
				50	24	2	21.71	22.5 ± 1
				50	49	2	21.35	22.5 ± 1
				100	0	2	21.38	22.5 ± 1
	18900	1880.0		QPSK	1	0	0	23.20
			1		49	0	23.23	22.5 ± 1
			1		99	0	23.37	22.5 ± 1
			50		0	1	22.3	22.5 ± 1
			50		24	1	22.36	22.5 ± 1
			50		49	1	22.53	22.5 ± 1
			100	0	1	22.26	22.5 ± 1	
			16QAM	1	0	1	22.31	22.2 ± 1
				1	49	1	22.25	22.2 ± 1
				1	99	1	22.19	22.2 ± 1
	50	0		2	21.36	22.2 ± 1		
	50	24	2	21.36	22.2 ± 1			
	50	49	2	21.26	22.2 ± 1			
	100	0	2	21.34	22.2 ± 1			
	19100	1900.0	QPSK	1	0	0	23.27	22.5 ± 1
				1	49	0	23.50	22.5 ± 1
1				99	0	23.45	22.5 ± 1	
50				0	1	22.28	22.5 ± 1	
50				24	1	21.93	22.5 ± 1	
50				49	1	22.36	22.5 ± 1	
100				0	1	22.23	22.5 ± 1	
16QAM				1	0	1	22.26	22.3 ± 1
			1	49	1	21.36	22.3 ± 1	
			1	99	1	21.56	22.3 ± 1	
			50	0	2	21.3	22.3 ± 1	
			50	24	2	21.63	22.3 ± 1	
			50	49	2	21.5	22.3 ± 1	
100			0	2	21.26	22.3 ± 1		

BW (MHz)	Ch	Freq. (MHz)	Mode	UL RB Allocation	UL RB Offset	MPR	Average power (dBm)	Tune up Power tolerant
15MHz	18675	1857.5	QPSK	1	0	0	23.16	22.5 ± 1
				1	37	0	23.13	22.5 ± 1
				1	74	0	22.96	22.5 ± 1
				36	0	1	22.33	22.5 ± 1
				36	16	1	23.1	22.5 ± 1
				36	35	1	22.98	22.5 ± 1
				75	0	1	22.31	22.5 ± 1
			16QAM	1	0	1	22.91	22 ± 1
				1	37	1	22.36	22 ± 1
				1	74	1	22.49	22 ± 1
				36	0	2	21.56	22 ± 1
				36	16	2	21.85	22 ± 1
				36	35	2	21.63	22 ± 1
				75	0	2	21.27	22 ± 1
	18900	1880.0	QPSK	1	0	0	23.06	22.1 ± 1
				1	37	0	22.72	22.1 ± 1
				1	74	0	23.02	22.1 ± 1
				36	0	1	22.3	22.1 ± 1
				36	16	1	22.56	22.1 ± 1
				36	35	1	22.23	22.1 ± 1
				75	0	1	22.29	22.1 ± 1
			16QAM	1	0	1	22.21	21.5 ± 1
				1	37	1	21.93	21.5 ± 1
				1	74	1	21.65	21.5 ± 1
				36	0	2	21.4	21.5 ± 1
				36	16	2	21.46	21.5 ± 1
				36	35	2	21.03	21.5 ± 1
				75	0	2	21.33	21.5 ± 1
	19125	1902.5	QPSK	1	0	0	23.23	22.5 ± 1
				1	37	0	22.45	22.5 ± 1
				1	74	0	22.69	22.5 ± 1
				36	0	1	22.34	22.5 ± 1
				36	16	1	22.15	22.5 ± 1
				36	35	1	23.36	22.5 ± 1
				75	0	1	22.33	22.5 ± 1
			16QAM	1	0	1	22.4	21.5 ± 1
1				37	1	22.32	21.5 ± 1	
1				74	1	22.12	21.5 ± 1	
36				0	2	21.36	21.5 ± 1	
36				16	2	21.25	21.5 ± 1	
36				35	2	21.33	21.5 ± 1	
75				0	2	21.27	21.5 ± 1	

BW (MHz)	Ch	Freq. (MHz)	Mode	UL RB Allocation	UL RB Offset	MPR	Average power (dBm)	Tune up Power tolerant
10MHz	18650	1855	QPSK	1	0	0	23.28	22.3±1
				1	24	0	23.16	22.3±1
				1	49	0	23.22	22.3±1
				25	0	1	22.26	22.3±1
				25	12	1	22.32	22.3±1
				25	24	1	22.23	22.3±1
				50	0	1	22.25	22.3±1
			16QAM	1	0	1	22.84	22±1
				1	24	1	22.65	22±1
				1	49	1	22.49	22±1
				25	0	2	22.35	22±1
				25	12	2	22.19	22±1
				25	24	2	21.87	22±1
				50	0	2	21.35	22±1
	18900	1880.0	QPSK	1	0	0	23.28	22.5±1
				1	24	0	23.12	22.5±1
				1	49	0	23.15	22.5±1
				25	0	1	22.16	22.5±1
				25	12	1	22.19	22.5±1
				25	24	1	22.1	22.5±1
				50	0	1	22.18	22.5±1
			16QAM	1	0	1	22.12	22±1
				1	24	1	22.32	22±1
				1	49	1	22.05	22±1
				25	0	2	22.15	22±1
				25	12	2	21.98	22±1
				25	24	2	21.84	22±1
				50	0	2	21.25	22±1
	19150	1905	QPSK	1	0	0	23.21	22.5±1
				1	24	0	23.07	22.5±1
1				49	0	23.2	22.5±1	
25				0	1	22.12	22.5±1	
25				12	1	22.05	22.5±1	
25				24	1	21.97	22.5±1	
50				0	1	22.11	22.5±1	
16QAM			1	0	1	22.11	22±1	
			1	24	1	22.1	22±1	
			1	49	1	21.95	22±1	
			25	0	2	21.69	22±1	
			25	12	2	21.54	22±1	
			25	24	2	21.52	22±1	
			50	0	2	21.18	22±1	

BW (MHz)	Ch	Freq. (MHz)	Mode	UL RB Allocation	UL RB Offset	MPR	Average power (dBm)	Tune up Power tolerant
5MHz	18625	1852.5	QPSK	1	0	0	23.33	22.5 ± 1
				1	12	0	23.56	22.5 ± 1
				1	24	0	23.54	22.5 ± 1
				12	0	1	22.31	22.5 ± 1
				12	6	1	22.28	22.5 ± 1
				12	11	1	22.45	22.5 ± 1
				25	0	1	22.24	22.5 ± 1
			16QAM	1	0	1	22.25	22 ± 1
				1	12	1	22	22 ± 1
				1	24	1	21.92	22 ± 1
				12	0	2	21.65	22 ± 1
				12	6	2	21.23	22 ± 1
				12	11	2	21.45	22 ± 1
				25	0	2	21.45	22 ± 1
	18900	1880.0	QPSK	1	0	0	23.29	22 ± 1
				1	12	0	23.16	22 ± 1
				1	24	0	23.36	22 ± 1
				12	0	1	22.2	22 ± 1
				12	6	1	22.19	22 ± 1
				12	11	1	22.09	22 ± 1
				25	0	1	22.15	22 ± 1
			16QAM	1	0	1	22.25	22 ± 1
				1	12	1	22.36	22 ± 1
				1	24	1	22.21	22 ± 1
				12	0	2	22	22 ± 1
				12	6	2	21.63	22 ± 1
				12	11	2	21.98	22 ± 1
				25	0	2	21.22	22 ± 1
	19175	1907.5	QPSK	1	0	0	23.28	22.5 ± 1
				1	12	0	23.5	22.5 ± 1
1				24	0	23.12	22.5 ± 1	
12				0	1	22.19	22.5 ± 1	
12				6	1	22.32	22.5 ± 1	
12				11	1	22.06	22.5 ± 1	
25				0	1	22.13	22.5 ± 1	
16QAM			1	0	1	22.34	22 ± 1	
			1	12	1	21.9	22 ± 1	
			1	24	1	22.04	22 ± 1	
			12	0	2	21.48	22 ± 1	
			12	6	2	21.53	22 ± 1	
			12	11	2	21.52	22 ± 1	
			25	0	2	21.14	22 ± 1	

BW (MHz)	Ch	Freq. (MHz)	Mode	UL RB Allocation	UL RB Offset	MPR	Average power (dBm)	Tune up Power tolerant
3MHz	18625	1852.5	QPSK	1	0	0	23.14	22.5 ± 1
				1	7	0	23.12	22.5 ± 1
				1	14	0	23.21	22.5 ± 1
				8	0	1	22.25	22.5 ± 1
				8	4	1	22.06	22.5 ± 1
				8	7	1	21.93	22.5 ± 1
			15	0	1	22.26	22.5 ± 1	
			16QAM	1	0	1	22.71	22 ± 1
				1	7	1	22.46	22 ± 1
				1	14	1	22.12	22 ± 1
				8	0	2	21.36	22 ± 1
				8	4	2	21.25	22 ± 1
	8	7		2	21.19	22 ± 1		
	18900	1880.0	QPSK	1	0	0	23.16	22.5 ± 1
				1	7	0	22.94	22.5 ± 1
				1	14	0	22.86	22.5 ± 1
				8	0	1	22.16	22.5 ± 1
				8	4	1	22.09	22.5 ± 1
				8	7	1	22.1	22.5 ± 1
			15	0	1	22.15	22.5 ± 1	
			16QAM	1	0	1	22	22 ± 1
				1	7	1	21.93	22 ± 1
				1	14	1	22.25	22 ± 1
				8	0	2	22.62	22 ± 1
				8	4	2	22.31	22 ± 1
	8	7		2	21.94	22 ± 1		
	19175	1907.5	QPSK	1	0	0	23.23	22.5 ± 1
				1	7	0	23.03	22.5 ± 1
				1	14	0	23.19	22.5 ± 1
				8	0	1	22.14	22.5 ± 1
				8	4	1	22.01	22.5 ± 1
				8	7	1	22.16	22.5 ± 1
			15	0	1	22.14	22.5 ± 1	
			16QAM	1	0	1	22.08	22 ± 1
				1	7	1	21.59	22 ± 1
				1	14	1	21.68	22 ± 1
8				0	2	21.15	22 ± 1	
8				4	2	21.56	22 ± 1	
8	7	2		21.32	22 ± 1			
15	0	2	21.18	22 ± 1				

BW (MHz)	Ch	Freq. (MHz)	Mode	UL RB Allocation	UL RB Offset	MPR	Average power (dBm)	Tune up Power tolerant
1.4MHz	18607	1850.7	QPSK	1	0	0	23.28	22.5±1
				1	2	0	23.3	22.5±1
				1	5	0	23.13	22.5±1
				3	0	0	23.31	22.5±1
				3	1	0	22.68	22.5±1
				3	2	0	22.36	22.5±1
			6	0	1	22.16	22.5±1	
			16QAM	1	0	1	22.21	22±1
				1	2	1	22.06	22±1
				1	5	1	21.94	22±1
				3	0	1	22.31	22±1
				3	1	1	21.87	22±1
	3	2		1	21.64	22±1		
	18900	1880.0	QPSK	1	0	0	23.05	22.7±1
				1	2	0	22.95	22.7±1
				1	5	0	22.63	22.7±1
				3	0	0	23.23	22.7±1
				3	1	0	23.45	22.7±1
				3	2	0	23.58	22.7±1
			6	0	1	22.06	22.7±1	
			16QAM	1	0	1	21.74	21.5±1
				1	2	1	21.65	21.5±1
				1	5	1	21.54	21.5±1
				3	0	1	21.09	21.5±1
				3	1	1	21.36	21.5±1
	3	2		1	21.45	21.5±1		
	19193	1909.3	QPSK	1	0	0	23.25	22.5±1
				1	2	0	23.24	22.5±1
				1	5	0	23.26	22.5±1
				3	0	0	23.26	22.5±1
3				1	0	23.16	22.5±1	
3				2	0	23.05	22.5±1	
6			0	1	22.14	22.5±1		
16QAM			1	0	1	22.01	21.5±1	
			1	2	1	21.95	21.5±1	
			1	5	1	21.36	21.5±1	
			3	0	1	21.16	21.5±1	
			3	1	1	21.45	21.5±1	
	3	2	1	21.58	21.5±1			
6	0	2	21.1	21.5±1				

LTE Band 4:

BW (MHz)	Ch	Freq. (MHz)	Mode	UL RB Allocation	UL RB Offset	MPR	Average power (dBm)	Tune up Power tolerant
20MHz	20050	1720.0	QPSK	1	0	0	23.26	22.5 ± 1
				1	49	0	23.43	22.5 ± 1
				1	99	0	23.5	22.5 ± 1
				50	0	1	22.27	22.5 ± 1
				50	24	1	22.16	22.5 ± 1
				50	49	1	22.48	22.5 ± 1
				100	0	1	22.28	22.5 ± 1
			16QAM	1	0	1	22.65	22 ± 1
				1	49	1	22.19	22 ± 1
				1	99	1	22.1	22 ± 1
				50	0	2	21.63	22 ± 1
				50	24	2	21.58	22 ± 1
				50	49	2	21.41	22 ± 1
				100	0	2	21.34	22 ± 1
	20175	1732.5	QPSK	1	0	0	23.38	22.5 ± 1
				1	49	0	23.21	22.5 ± 1
				1	99	0	23.1	22.5 ± 1
				50	0	1	22.29	22.5 ± 1
				50	24	1	22.3	22.5 ± 1
				50	49	1	22.16	22.5 ± 1
				100	0	1	22.25	22.5 ± 1
			16QAM	1	0	1	22.27	21.5 ± 1
				1	49	1	22.1	21.5 ± 1
				1	99	1	22.35	21.5 ± 1
				50	0	2	22.15	21.5 ± 1
				50	24	2	21.95	21.5 ± 1
				50	49	2	21.62	21.5 ± 1
				100	0	2	21.3	21.5 ± 1
	20300	1745.0	QPSK	1	0	0	23.26	22.5 ± 1
				1	49	0	23.50	22.5 ± 1
1				99	0	22.92	22.5 ± 1	
50				0	1	22.28	22.5 ± 1	
50				24	1	22.36	22.5 ± 1	
50				49	1	22.15	22.5 ± 1	
100				0	1	22.25	22.5 ± 1	
16QAM			1	0	1	22.46	22 ± 1	
			1	49	1	22.29	22 ± 1	
			1	99	1	21.98	22 ± 1	
			50	0	2	21.69	22 ± 1	
			50	24	2	21.56	22 ± 1	
			50	49	2	21.36	22 ± 1	
			100	0	2	21.27	22 ± 1	

BW (MHz)	Ch	Freq. (MHz)	Mode	UL RB Allocation	UL RB Offset	MPR	Average power (dBm)	Tune up Power tolerant
15MHz	20025	1717.5	QPSK	1	0	0	23.21	22.5±1
				1	37	0	23.26	22.5±1
				1	74	0	23.19	22.5±1
				36	0	1	22.31	22.5±1
				36	16	1	22.26	22.5±1
				36	35	1	22.21	22.5±1
				75	0	1	22.32	22.5±1
			16QAM	1	0	1	22.77	22±1
				1	37	1	22.19	22±1
				1	74	1	21.83	22±1
				36	0	2	22.12	22±1
				36	16	2	22.03	22±1
				36	35	2	21.35	22±1
				75	0	2	21.36	22±1
	20175	1732.5	QPSK	1	0	0	23.36	22.5±1
				1	37	0	23.12	22.5±1
				1	74	0	23.13	22.5±1
				36	0	1	22.32	22.5±1
				36	16	1	22.19	22.5±1
				36	35	1	22.67	22.5±1
				75	0	1	22.35	22.5±1
			16QAM	1	0	1	22.16	22±1
				1	37	1	21.58	22±1
				1	74	1	21.64	22±1
				36	0	2	21.63	22±1
				36	16	2	22.36	22±1
				36	35	2	21.37	22±1
				75	0	2	21.34	22±1
	20325	1747.5	QPSK	1	0	0	23.29	22.5±1
				1	37	0	23.22	22.5±1
1				74	0	23.04	22.5±1	
36				0	1	22.35	22.5±1	
36				16	1	22.16	22.5±1	
36				35	1	22.37	22.5±1	
75				0	1	22.34	22.5±1	
16QAM			1	0	1	22.43	22±1	
			1	37	1	22.7	22±1	
			1	74	1	22.51	22±1	
			36	0	2	21.64	22±1	
			36	16	2	21.55	22±1	
			36	35	2	21.36	22±1	
			75	0	2	21.31	22±1	

BW (MHz)	Ch	Freq. (MHz)	Mode	UL RB Allocation	UL RB Offset	MPR	Average power (dBm)	Tune up Power tolerant
10MHz	20000	1715.0	QPSK	1	0	0	23.18	22.5±1
				1	24	0	23.02	22.5±1
				1	49	0	22.94	22.5±1
				25	0	1	22.24	22.5±1
				25	12	1	22.13	22.5±1
				25	24	1	21.87	22.5±1
				50	0	1	22.28	22.5±1
			16QAM	1	0	1	22.73	22±1
				1	24	1	22.26	22±1
				1	49	1	22.09	22±1
				25	0	2	21.65	22±1
				25	12	2	21.56	22±1
				25	24	2	21.53	22±1
				50	0	2	21.34	22±1
	20175	1732.5	QPSK	1	0	0	23.31	22.5±1
				1	24	0	23.16	22.5±1
				1	49	0	23.14	22.5±1
				25	0	1	22.27	22.5±1
				25	12	1	22.15	22.5±1
				25	24	1	22.13	22.5±1
				50	0	1	22.26	22.5±1
			16QAM	1	0	1	22.13	21.3±1
				1	24	1	22.12	21.3±1
				1	49	1	22.06	21.3±1
				25	0	2	22.16	21.3±1
				25	12	2	22.30	21.3±1
				25	24	2	21.63	21.3±1
				50	0	2	21.32	21.3±1
	20350	1750.0	QPSK	1	0	0	23.32	22.5±1
				1	24	0	23.26	22.5±1
1				49	0	23.19	22.5±1	
25				0	1	22.22	22.5±1	
25				12	1	22.16	22.5±1	
25				24	1	22.38	22.5±1	
50				0	1	22.24	22.5±1	
16QAM			1	0	1	22.23	21.3±1	
			1	24	1	22.15	21.3±1	
			1	49	1	22.09	21.3±1	
			25	0	2	21.65	21.3±1	
			25	12	2	21.65	21.3±1	
			25	24	2	21.58	21.3±1	
			50	0	2	21.32	21.3±1	

BW (MHz)	Ch	Freq. (MHz)	Mode	UL RB Allocation	UL RB Offset	MPR	Average power (dBm)	Tune up Power tolerant
5MHz	20000	1715.0	QPSK	1	0	0	23.31	23±1
				1	12	0	23.25	23±1
				1	24	0	23.62	23±1
				12	0	1	22.28	23±1
				12	6	1	22.16	23±1
				12	11	1	22.25	23±1
				25	0	1	22.22	23±1
			16QAM	1	0	1	22.23	21.3±1
				1	12	1	22.13	21.3±1
				1	24	1	22.16	21.3±1
				12	0	2	21.87	21.3±1
				12	6	2	21.82	21.3±1
				12	11	2	21.86	21.3±1
				25	0	2	21.36	21.3±1
	20175	1732.5	QPSK	1	0	0	23.27	22.5±1
				1	12	0	23.19	22.5±1
				1	24	0	23.18	22.5±1
				12	0	1	22.32	22.5±1
				12	6	1	22.26	22.5±1
				12	11	1	22.35	22.5±1
				25	0	1	22.26	22.5±1
			16QAM	1	0	1	22.54	22±1
				1	12	1	22.53	22±1
				1	24	1	22.46	22±1
				12	0	2	22.03	22±1
				12	6	2	22.04	22±1
				12	11	2	22.11	22±1
				25	0	2	21.28	22±1
	20350	1750.0	QPSK	1	0	0	23.31	22.5±1
				1	12	0	23	22.5±1
1				24	0	23.09	22.5±1	
12				0	1	22.3	22.5±1	
12				6	1	22.32	22.5±1	
12				11	1	22.31	22.5±1	
25				0	1	22.24	22.5±1	
16QAM			1	0	1	22.25	21.3±1	
			1	12	1	22.14	21.3±1	
			1	24	1	22.16	21.3±1	
			12	0	2	21.85	21.3±1	
			12	6	2	21.53	21.3±1	
			12	11	2	21.37	21.3±1	
			25	0	2	21.42	21.3±1	

BW (MHz)	Ch	Freq. (MHz)	Mode	UL RB Allocation	UL RB Offset	MPR	Average power (dBm)	Tune up Power tolerant
3MHz	19965	1711.5	QPSK	1	0	0	23.08	22.5±1
				1	7	0	23.1	22.5±1
				1	14	0	23.06	22.5±1
				8	0	1	22.21	22.5±1
				8	4	1	22.19	22.5±1
				8	7	1	21.96	22.5±1
				15	0	1	22.23	22.5±1
			16QAM	1	0	1	22.67	22±1
				1	7	1	22.65	22±1
				1	14	1	22.59	22±1
				8	0	2	21.22	22±1
				8	4	2	21.35	22±1
				8	7	2	21.64	22±1
				15	0	2	21.36	22±1
	20175	1732.5	QPSK	1	0	0	23.24	22.5±1
				1	7	0	23.22	22.5±1
				1	14	0	23.26	22.5±1
				8	0	1	22.19	22.5±1
				8	4	1	22.2	22.5±1
				8	7	1	22.15	22.5±1
				15	0	1	22.21	22.5±1
			16QAM	1	0	1	22.06	21.3±1
				1	7	1	22.01	21.3±1
				1	14	1	21.98	21.3±1
				8	0	2	21.19	21.3±1
				8	4	2	21.11	21.3±1
				8	7	2	21.35	21.3±1
				15	0	2	21.21	21.3±1
	20385	1753.5	QPSK	1	0	0	23.23	22.5±1
				1	7	0	23.2	22.5±1
1				14	0	23.07	22.5±1	
8				0	1	22.15	22.5±1	
8				4	1	22.35	22.5±1	
8				7	1	22.16	22.5±1	
15				0	1	22.23	22.5±1	
16QAM			1	0	1	22.16	21.3±1	
			1	7	1	22.15	21.3±1	
			1	14	1	22.13	21.3±1	
			8	0	2	21.06	21.3±1	
			8	4	2	21.05	21.3±1	
			8	7	2	21.32	21.3±1	
			15	0	2	21.3	21.3±1	

BW (MHz)	Ch	Freq. (MHz)	Mode	UL RB Allocation	UL RB Offset	MPR	Average power (dBm)	Tune up Power tolerant
1.4MHz	19957	1710.7	QPSK	1	0	0	23.12	22.5±1
				1	2	0	23.11	22.5±1
				1	5	0	23.06	22.5±1
				3	0	0	23.28	22.5±1
				3	1	0	23.26	22.5±1
				3	2	0	23.29	22.5±1
			6	0	1	22.19	22.5±1	
			16QAM	1	0	1	21.8	22±1
				1	2	1	21.36	22±1
				1	5	1	21.35	22±1
				3	0	1	21.46	22±1
				3	1	1	21.35	22±1
	3	2		1	21.26	22±1		
	20175	1732.5	QPSK	1	0	0	23.24	22.5±1
				1	2	0	23.26	22.5±1
				1	5	0	23.19	22.5±1
				3	0	0	23.34	22.5±1
				3	1	0	23.26	22.5±1
				3	2	0	23.19	22.5±1
			6	0	1	22.16	22.5±1	
			16QAM	1	0	1	22.07	21.3±1
				1	2	1	21.96	21.3±1
				1	5	1	21.87	21.3±1
				3	0	1	21.56	21.3±1
				3	1	1	21.34	21.3±1
	3	2		1	21.22	21.3±1		
	20393	1754.3	QPSK	1	0	0	23.23	22.5±1
				1	2	0	23.26	22.5±1
				1	5	0	23.16	22.5±1
				3	0	0	23.26	22.5±1
3				1	0	23.15	22.5±1	
3				2	0	23.07	22.5±1	
6			0	1	22.08	22.5±1		
16QAM			1	0	1	22.18	21.3±1	
			1	2	1	22.06	21.3±1	
			1	5	1	22.16	21.3±1	
			3	0	1	21.54	21.3±1	
			3	1	1	21.35	21.3±1	
	3	2	1	21.68	21.3±1			
6	0	2	21.06	21.3±1				

LTE Band 5:

BW (MHz)	Ch	Freq. (MHz)	Mode	UL RB Allocation	UL RB Offset	MPR	Average power (dBm)	Tune up Power tolerant
10MHz	20450	829	QPSK	1	0	0	23.46	22.5 ± 1
				1	24	0	23.35	22.5 ± 1
				1	49	0	23.42	22.5 ± 1
				25	0	1	22.76	22.5 ± 1
				25	12	1	22.36	22.5 ± 1
				25	24	1	22.25	22.5 ± 1
			50	0	1	22.17	22.5 ± 1	
			16QAM	1	0	1	22.69	22 ± 1
				1	24	1	22.45	22 ± 1
				1	49	1	22.64	22 ± 1
				25	0	2	22.03	22 ± 1
				25	12	2	22.1	22 ± 1
				25	24	2	22.04	22 ± 1
				50	0	2	21.88	22 ± 1
	20525	836.5		QPSK	1	0	0	23.5
			1		24	0	23.45	22.5 ± 1
			1		49	0	23.34	22.5 ± 1
			25		0	1	22.72	22.5 ± 1
			25		12	1	22.75	22.5 ± 1
			25		24	1	22.71	22.5 ± 1
			50	0	1	22.66	22.5 ± 1	
			16QAM	1	0	1	23.03	22.5 ± 1
				1	24	1	23	22.5 ± 1
				1	49	1	23.04	22.5 ± 1
				25	0	2	22.03	22.5 ± 1
				25	12	2	22.01	22.5 ± 1
				25	24	2	22.06	22.5 ± 1
				50	0	2	21.68	22.5 ± 1
20600	844	QPSK		1	0	0	23.5	22.5 ± 1
			1	24	0	23.43	22.5 ± 1	
			1	49	0	23.44	22.5 ± 1	
			25	0	1	22.71	22.5 ± 1	
			25	12	1	22.69	22.5 ± 1	
			25	24	1	22.64	22.5 ± 1	
		50	0	1	22.68	22.5 ± 1		
		16QAM	1	0	1	22.64	22 ± 1	
			1	24	1	22.63	22 ± 1	
			1	49	1	22.66	22 ± 1	
			25	0	2	21.73	22 ± 1	
			25	12	2	21.76	22 ± 1	
			25	24	2	21.79	22 ± 1	
			50	0	2	21.86	22 ± 1	

BW (MHz)	Ch	Freq. (MHz)	Mode	UL RB Allocation	UL RB Offset	MPR	Average power (dBm)	Tune up Power tolerant
5MHz	20425	826.5	QPSK	1	0	0	23.5	22.5±1
				1	12	0	23.46	22.5±1
				1	24	0	23.43	22.5±1
				12	0	1	22.7	22.5±1
				12	6	1	22.75	22.5±1
				12	11	1	22.79	22.5±1
				25	0	1	22.72	22.5±1
			16QAM	1	0	1	23.25	22.5±1
				1	12	1	23.26	22.5±1
				1	24	1	23.19	22.5±1
				12	0	2	21.86	22.5±1
				12	6	2	21.82	22.5±1
				12	11	2	21.67	22.5±1
				25	0	2	21.77	22.5±1
	20525	836.5	QPSK	1	0	0	23.36	22.5±1
				1	12	0	23.32	22.5±1
				1	24	0	23.31	22.5±1
				12	0	1	22.7	22.5±1
				12	6	1	22.63	22.5±1
				12	11	1	22.35	22.5±1
				25	0	1	22.68	22.5±1
			16QAM	1	0	1	22.6	22±1
				1	12	1	22.63	22±1
				1	24	1	22.59	22±1
				12	0	2	21.78	22±1
				12	6	2	21.56	22±1
				12	11	2	21.73	22±1
				25	0	2	21.71	22±1
	20625	846.5	QPSK	1	0	0	23.46	22.5±1
				1	12	0	23.36	22.5±1
1				24	0	23.31	22.5±1	
12				0	1	22.65	22.5±1	
12				6	1	22.59	22.5±1	
12				11	1	22.53	22.5±1	
25				0	1	22.7	22.5±1	
16QAM			1	0	1	22.61	22±1	
			1	12	1	22.62	22±1	
			1	24	1	22.55	22±1	
			12	0	2	21.7	22±1	
			12	6	2	21.73	22±1	
			12	11	2	21.68	22±1	
			25	0	2	21.73	22±1	

BW (MHz)	Ch	Freq. (MHz)	Mode	UL RB Allocation	UL RB Offset	MPR	Average power (dBm)	Tune up Power tolerant
3MHz	20415	825.5	QPSK	1	0	0	23.43	22.5 ± 1
				1	7	0	23.45	22.5 ± 1
				1	14	0	23.21	22.5 ± 1
				8	0	1	22.6	22.5 ± 1
				8	4	1	22.59	22.5 ± 1
				8	7	1	22.54	22.5 ± 1
				15	0	1	22.68	22.5 ± 1
			16QAM	1	0	1	23.17	22.5 ± 1
				1	7	1	23.29	22.5 ± 1
				1	14	1	23.05	22.5 ± 1
				8	0	2	21.66	22.5 ± 1
				8	4	2	21.68	22.5 ± 1
				8	7	2	21.89	22.5 ± 1
				15	0	2	21.83	22.5 ± 1
	20525	836.5	QPSK	1	0	0	23.39	22.5 ± 1
				1	7	0	23.45	22.5 ± 1
				1	14	0	23.38	22.5 ± 1
				8	0	1	22.57	22.5 ± 1
				8	4	1	22.36	22.5 ± 1
				8	7	1	22.45	22.5 ± 1
				15	0	1	22.63	22.5 ± 1
			16QAM	1	0	1	22.51	22 ± 1
				1	7	1	22.43	22 ± 1
				1	14	1	22.13	22 ± 1
				8	0	2	21.6	22 ± 1
				8	4	2	21.64	22 ± 1
				8	7	2	21.35	22 ± 1
				15	0	2	21.62	22 ± 1
	20635	847.5	QPSK	1	0	0	23.46	22.5 ± 1
				1	7	0	23.25	22.5 ± 1
1				14	0	23.21	22.5 ± 1	
8				0	1	22.51	22.5 ± 1	
8				4	1	22.5	22.5 ± 1	
8				7	1	22.46	22.5 ± 1	
15				0	1	22.65	22.5 ± 1	
16QAM			1	0	1	22.62	22 ± 1	
			1	7	1	22.53	22 ± 1	
			1	14	1	22.52	22 ± 1	
			8	0	2	21.48	22 ± 1	
			8	4	2	21.63	22 ± 1	
			8	7	2	21.58	22 ± 1	
			15	0	2	21.72	22 ± 1	

BW (MHz)	Ch	Freq. (MHz)	Mode	UL RB Allocation	UL RB Offset	MPR	Average power (dBm)	Tune up Power tolerant
1.4MHz	20407	824.7	QPSK	1	0	0	23.43	22.5 ± 1
				1	2	0	23.45	22.5 ± 1
				1	5	0	23.29	22.5 ± 1
				3	0	0	23.49	22.5 ± 1
				3	1	0	23.47	22.5 ± 1
				3	2	0	23.44	22.5 ± 1
				6	0	1	22.59	22.5 ± 1
			16QAM	1	0	1	22.55	22 ± 1
				1	2	1	22.36	22 ± 1
				1	5	1	22.35	22 ± 1
				3	0	1	21.25	22 ± 1
				3	1	1	21.26	22 ± 1
				3	2	1	21.35	22 ± 1
				6	0	2	21.63	22 ± 1
	20525	836.5	QPSK	1	0	0	23.49	23 ± 1
				1	2	0	23.32	23 ± 1
				1	5	0	23.25	23 ± 1
				3	0	0	23.7	23 ± 1
				3	1	0	23.43	23 ± 1
				3	2	0	23.41	23 ± 1
				6	0	1	22.55	23 ± 1
			16QAM	1	0	1	22.62	22 ± 1
				1	2	1	22.51	22 ± 1
				1	5	1	22.53	22 ± 1
				3	0	1	21.86	22 ± 1
				3	1	1	21.85	22 ± 1
				3	2	1	21.57	22 ± 1
				6	0	2	21.49	22 ± 1
	20643	848.3	QPSK	1	0	0	23.43	22.5 ± 1
				1	2	0	23.46	22.5 ± 1
				1	5	0	23.48	22.5 ± 1
				3	0	0	23.39	22.5 ± 1
				3	1	0	23.34	22.5 ± 1
				3	2	0	23.25	22.5 ± 1
				6	0	1	22.51	22.5 ± 1
			16QAM	1	0	1	22.21	22 ± 1
1				2	1	22.24	22 ± 1	
1				5	1	22.31	22 ± 1	
3				0	1	22.06	22 ± 1	
3				1	1	22.1	22 ± 1	
3				2	1	21.98	22 ± 1	
6				0	2	21.56	22 ± 1	

LTE Band 7:

BW (MHz)	Ch	Freq. (MHz)	Mode	UL RB Allocation	UL RB Offset	MPR	Average power (dBm)	Tune up Power tolerant
20MHz	20850	2510	QPSK	1	0	0	23.41	22.5 ± 1
				1	49	0	23.43	22.5 ± 1
				1	99	0	23.46	22.5 ± 1
				50	0	1	22.26	22.5 ± 1
				50	24	1	22.25	22.5 ± 1
				50	49	1	22.23	22.5 ± 1
				100	0	1	22.11	22.5 ± 1
			16QAM	1	0	1	22.98	22 ± 1
				1	49	1	22.99	22 ± 1
				1	99	1	22.93	22 ± 1
				50	0	2	21.83	22 ± 1
				50	24	2	21.85	22 ± 1
				50	49	2	21.86	22 ± 1
				100	0	2	21.1	22 ± 1
	21100	2535	QPSK	1	0	0	23.04	22.5 ± 1
				1	49	0	23	22.5 ± 1
				1	99	0	22.93	22.5 ± 1
				50	0	1	21.95	22.5 ± 1
				50	24	1	21.99	22.5 ± 1
				50	49	1	21.96	22.5 ± 1
				100	0	1	21.82	22.5 ± 1
			16QAM	1	0	1	21.99	21.3 ± 1
				1	49	1	21.94	21.3 ± 1
				1	99	1	21.97	21.3 ± 1
				50	0	2	21.43	21.3 ± 1
				50	24	2	21.45	21.3 ± 1
				50	49	2	21.49	21.3 ± 1
				100	0	2	20.79	21.3 ± 1
	21350	2560	QPSK	1	0	0	22.4	21.3 ± 1
				1	49	0	22.43	21.3 ± 1
1				99	0	22.39	21.3 ± 1	
50				0	1	21.52	21.3 ± 1	
50				24	1	21.53	21.3 ± 1	
50				49	1	21.5	21.3 ± 1	
100				0	1	21.45	21.3 ± 1	
16QAM			1	0	1	21.76	21.3 ± 1	
			1	49	1	21.75	21.3 ± 1	
			1	99	1	21.78	21.3 ± 1	
			50	0	2	20.65	21.3 ± 1	
			50	24	2	20.63	21.3 ± 1	
			50	49	2	20.69	21.3 ± 1	
			100	0	2	20.44	21.3 ± 1	

BW (MHz)	Ch	Freq. (MHz)	Mode	UL RB Allocation	UL RB Offset	MPR	Average power (dBm)	Tune up Power tolerant
15MHz	20825	1717.5	QPSK	1	0	0	23.43	22.5 ± 1
				1	37	0	23.46	22.5 ± 1
				1	74	0	23.48	22.5 ± 1
				36	0	1	22.34	22.5 ± 1
				36	16	1	22.35	22.5 ± 1
				36	35	1	22.38	22.5 ± 1
				75	0	1	22.18	22.5 ± 1
			16QAM	1	0	1	23.09	22.5 ± 1
				1	37	1	23.06	22.5 ± 1
				1	74	1	23.1	22.5 ± 1
				36	0	2	22.23	22.5 ± 1
				36	16	2	22.3	22.5 ± 1
				36	35	2	22.25	22.5 ± 1
				75	0	2	21.19	21.5 ± 1
	21100	1732.5	QPSK	1	0	0	22.95	22 ± 1
				1	37	0	22.96	22 ± 1
				1	74	0	22.92	22 ± 1
				36	0	1	21.91	22 ± 1
				36	16	1	21.9	22 ± 1
				36	35	1	21.93	22 ± 1
				75	0	1	21.83	22 ± 1
			16QAM	1	0	1	21.81	21.3 ± 1
				1	37	1	21.85	21.3 ± 1
				1	74	1	21.89	21.3 ± 1
				36	0	2	21.43	21.3 ± 1
				36	16	2	21.48	21.3 ± 1
				36	35	2	21.42	21.3 ± 1
				75	0	2	20.83	21.3 ± 1
	21375	1747.5	QPSK	1	0	0	22.39	22 ± 1
				1	37	0	22.35	22 ± 1
1				74	0	22.31	22 ± 1	
36				0	1	21.48	22 ± 1	
36				16	1	21.46	22 ± 1	
36				35	1	21.42	22 ± 1	
75				0	1	21.42	22 ± 1	
16QAM			1	0	1	21.73	21.3 ± 1	
			1	37	1	21.7	21.3 ± 1	
			1	74	1	21.76	21.3 ± 1	
			36	0	2	20.69	21.3 ± 1	
			36	16	2	20.65	21.3 ± 1	
			36	35	2	20.6	21.3 ± 1	
			75	0	2	20.38	21.3 ± 1	

BW (MHz)	Ch	Freq. (MHz)	Mode	UL RB Allocation	UL RB Offset	MPR	Average power (dBm)	Tune up Power tolerant
10MHz	20800	2502	QPSK	1	0	0	23.45	22.5 ± 1
				1	24	0	23.41	22.5 ± 1
				1	49	0	23.43	22.5 ± 1
				25	0	1	22.4	22.5 ± 1
				25	12	1	22.43	22.5 ± 1
				25	24	1	22.35	22.5 ± 1
				50	0	1	22.26	22.5 ± 1
			16QAM	1	0	1	23.11	22.5 ± 1
				1	24	1	23.1	22.5 ± 1
				1	49	1	23.14	22.5 ± 1
				25	0	2	22.55	22.5 ± 1
				25	12	2	22.57	22.5 ± 1
				25	24	2	22.53	22.5 ± 1
				50	0	2	21.27	21.5 ± 1
	21100	2535	QPSK	1	0	0	22.93	22 ± 1
				1	24	0	22.96	22 ± 1
				1	49	0	22.91	22 ± 1
				25	0	1	21.84	22 ± 1
				25	12	1	21.86	22 ± 1
				25	24	1	21.89	22 ± 1
				50	0	1	21.78	22 ± 1
			16QAM	1	0	1	21.73	21.3 ± 1
				1	24	1	21.69	21.3 ± 1
				1	49	1	21.65	21.3 ± 1
				25	0	2	21.03	21.3 ± 1
				25	12	2	21.07	21.3 ± 1
				25	24	2	21.09	21.3 ± 1
				50	0	2	20.81	21.3 ± 1
	21400	2565	QPSK	1	0	0	22.49	22.3 ± 1
				1	24	0	22.46	22.3 ± 1
1				49	0	22.41	22.3 ± 1	
25				0	1	21.44	22.3 ± 1	
25				12	1	21.43	22.3 ± 1	
25				24	1	21.54	22.3 ± 1	
50				0	1	21.38	22.3 ± 1	
16QAM			1	0	1	21.46	21.3 ± 1	
			1	24	1	21.42	21.3 ± 1	
			1	49	1	21.44	21.3 ± 1	
			25	0	2	20.89	21.3 ± 1	
			25	12	2	20.85	21.3 ± 1	
			25	24	2	20.83	21.3 ± 1	
			50	0	2	20.38	21.3 ± 1	

BW (MHz)	Ch	Freq. (MHz)	Mode	UL RB Allocation	UL RB Offset	MPR	Average power (dBm)	Tune up Power tolerant
5MHz	19975	1712.5	QPSK	1	0	0	23.67	22.8±1
				1	12	0	23.64	22.8±1
				1	24	0	23.62	22.8±1
				12	0	1	22.51	22.8±1
				12	6	1	22.5	22.8±1
				12	11	1	22.53	22.8±1
				25	0	1	22.39	22.8±1
			16QAM	1	0	1	22.65	22±1
				1	12	1	22.63	22±1
				1	24	1	22.65	22±1
				12	0	2	21.54	22±1
				12	6	2	21.52	22±1
				12	11	2	21.53	22±1
				25	0	2	21.38	22±1
	20175	1732.5	QPSK	1	0	0	22.83	22±1
				1	12	0	22.81	22±1
				1	24	0	22.76	22±1
				12	0	1	21.87	22±1
				12	6	1	21.86	22±1
				12	11	1	21.85	22±1
				25	0	1	21.77	22±1
			16QAM	1	0	1	22.22	21.3±1
				1	12	1	22.19	21.3±1
				1	24	1	22.26	21.3±1
				12	0	2	21.75	21.3±1
				12	6	2	21.73	21.3±1
				12	11	2	21.71	21.3±1
				25	0	2	20.75	21.3±1
	20375	1752.5	QPSK	1	0	0	22.38	22.3±1
				1	12	0	22.34	22.3±1
1				24	0	22.36	22.3±1	
12				0	1	21.36	22.3±1	
12				6	1	21.37	22.3±1	
12				11	1	21.35	22.3±1	
25				0	1	21.24	22.3±1	
16QAM			1	0	1	21.35	21.3±1	
			1	12	1	21.38	21.3±1	
			1	24	1	21.39	21.3±1	
			12	0	2	20.51	21.3±1	
			12	6	2	20.55	21.3±1	
			12	11	2	20.48	21.3±1	
			25	0	2	20.36	21.3±1	

ERP & EIRP

EIRP for LTE Band 2 (Part 24E)

Frequency (MHz)	BW (MHz)	Modulation	RB Size/Offset	Substituted level (dBm)	Antenna Polarization	Antenna Gain correction (dBi)	Cable Loss (dB)	Absolute Level (dBm)	Limit (dBm)
1850.7	1.4	QPSK	1/0	15.78	V	7.88	0.85	25.40	33.01
1880	1.4	QPSK	1/0	15.73	V	7.88	0.85	25.24	33.01
1909.3	1.4	QPSK	1/0	15.81	V	7.88	0.85	25.37	33.01
1850.7	1.4	QPSK	1/0	14.65	H	7.88	0.85	24.82	33.01
1880	1.4	QPSK	1/0	14.62	H	7.88	0.85	24.75	33.01
1909.3	1.4	QPSK	1/0	14.68	H	7.88	0.85	24.77	33.01
1850.7	1.4	16-QAM	1/0	15.15	V	7.88	0.85	24.46	33.01
1880	1.4	16-QAM	1/0	15.08	V	7.88	0.85	24.4	33.01
1909.3	1.4	16-QAM	1/0	15.12	V	7.88	0.85	24.39	33.01
1850.7	1.4	16-QAM	1/0	14.53	H	7.88	0.85	23.94	33.01
1880	1.4	16-QAM	1/0	14.59	H	7.88	0.85	23.91	33.01
1909.3	1.4	16-QAM	1/0	14.55	H	7.88	0.85	23.97	33.01
1851.5	3	QPSK	1/0	16.06	V	7.88	0.85	25.34	33.01
1880	3	QPSK	1/0	16.02	V	7.88	0.85	25.28	33.01
1908.5	3	QPSK	1/0	16.09	V	7.88	0.85	25.22	33.01
1851.5	3	QPSK	1/0	15.22	H	7.88	0.85	24.76	33.01
1880	3	QPSK	1/0	15.19	H	7.88	0.85	24.67	33.01
1908.5	3	QPSK	1/0	15.27	H	7.88	0.85	24.72	33.01
1851.5	3	16-QAM	1/0	15.98	V	7.88	0.85	24.25	33.01
1880	3	16-QAM	1/0	15.93	V	7.88	0.85	24.18	33.01
1908.5	3	16-QAM	1/0	15.90	V	7.88	0.85	24.21	33.01
1851.5	3	16-QAM	1/0	14.88	H	7.88	0.85	23.79	33.01
1880	3	16-QAM	1/0	14.84	H	7.88	0.85	23.84	33.01
1908.5	3	16-QAM	1/0	14.81	H	7.88	0.85	23.76	33.01
1852.5	5	QPSK	1/24	16.31	V	7.88	0.85	25.45	33.01
1880	5	QPSK	1/0	16.28	V	7.88	0.85	25.38	33.01
1907.5	5	QPSK	1/24	16.34	V	7.88	0.85	25.42	33.01
1852.5	5	QPSK	1/24	15.88	H	7.88	0.85	24.89	33.01
1880	5	QPSK	1/0	15.90	H	7.88	0.85	24.94	33.01
1907.5	5	QPSK	1/24	15.83	H	7.88	0.85	24.91	33.01
1852.5	5	16-QAM	1/24	16.50	V	7.88	0.85	24.39	33.01
1880	5	16-QAM	1/0	16.56	V	7.88	0.85	24.36	33.01

1907.5	5	16-QAM	1/24	16.58	V	7.88	0.85	24.41	33.01
1852.5	5	16-QAM	1/24	15.23	H	7.88	0.85	23.87	33.01
1880	5	16-QAM	1/0	15.15	H	7.88	0.85	23.82	33.01
1907.5	5	16-QAM	1/24	15.09	H	7.88	0.85	23.78	33.01
1855	10	QPSK	1/0	16.35	V	7.88	0.85	25.27	33.01
1880	10	QPSK	1/0	16.30	V	7.88	0.85	25.2	33.01
1905	10	QPSK	1/49	16.39	V	7.88	0.85	25.32	33.01
1855	10	QPSK	1/0	15.82	H	7.88	0.85	24.76	33.01
1880	10	QPSK	1/0	15.92	H	7.88	0.85	24.71	33.01
1905	10	QPSK	1/49	15.87	H	7.88	0.85	24.67	33.01
1855	10	16-QAM	1/0	16.73	V	7.88	0.85	24.44	33.01
1880	10	16-QAM	1/0	16.68	V	7.88	0.85	24.38	33.01
1905	10	16-QAM	1/49	16.70	V	7.88	0.85	24.31	33.01
1855	10	16-QAM	1/0	15.89	H	7.88	0.85	23.85	33.01
1880	10	16-QAM	1/0	15.84	H	7.88	0.85	23.8	33.01
1905	10	16-QAM	1/49	15.83	H	7.88	0.85	23.66	33.01
1857.5	15	QPSK	1/0	16.50	V	7.88	0.85	25.48	33.01
1880	15	QPSK	1/0	16.52	V	7.88	0.85	25.4	33.01
1902.5	15	QPSK	1/0	16.48	V	7.88	0.85	25.41	33.01
1857.5	15	QPSK	1/0	15.78	H	7.88	0.85	24.89	33.01
1880	15	QPSK	1/0	15.81	H	7.88	0.85	24.94	33.01
1902.5	15	QPSK	1/0	15.85	H	7.88	0.85	24.87	33.01
1857.5	15	16-QAM	1/0	16.74	V	7.88	0.85	25.01	33.01
1880	15	16-QAM	1/0	16.79	V	7.88	0.85	26.96	33.01
1902.5	15	16-QAM	1/0	16.75	V	7.88	0.85	24.97	33.01
1857.5	15	16-QAM	1/0	15.91	H	7.88	0.85	24.29	33.01
1880	15	16-QAM	1/0	15.94	H	7.88	0.85	24.34	33.01
1902.5	15	16-QAM	1/0	15.96	H	7.88	0.85	24.27	33.01
1860	20	QPSK	1/0	16.76	V	7.88	0.85	25.45	33.01
1880	20	QPSK	1/0	16.80	V	7.88	0.85	25.39	33.01
1900	20	QPSK	1/0	16.71	V	7.88	0.85	25.4	33.01
1860	20	QPSK	1/0	15.98	H	7.88	0.85	24.89	33.01
1880	20	QPSK	1/0	15.9	H	7.88	0.85	24.95	33.01
1900	20	QPSK	1/0	15.97	H	7.88	0.85	24.84	33.01
1860	20	16-QAM	1/0	16.73	V	7.88	0.85	24.78	33.01
1880	20	16-QAM	1/0	16.69	V	7.88	0.85	24.86	33.01
1900	20	16-QAM	1/0	16.67	V	7.88	0.85	24.82	33.01
1860	20	16-QAM	1/0	15.85	H	7.88	0.85	24.16	33.01

Test Report	16070667-FCC-R5
Page	35 of 123

1880	20	16-QAM	1/0	15.80	H	7.88	0.85	24.11	33.01
1900	20	16-QAM	1/0	15.77	H	7.88	0.85	24.17	33.01

EIRP for LTE Band 4 (Part 27)

Frequency (MHz)	BW (MHz)	Modulation	RB Size/Offset	Substituted level (dBm)	Antenna Polarization	Antenna Gain correction (dBi)	Cable Loss (dB)	Absolute Level (dBm)	Limit (dBm)
1710.7	1.4	QPSK	1/0	15.25	V	7.95	0.79	25.77	30
1732.5	1.4	QPSK	1/0	15.23	V	7.95	0.79	25.85	30
1754.3	1.4	QPSK	1/0	15.2	V	7.95	0.79	25.8	30
1710.7	1.4	QPSK	1/0	14.3	H	7.95	0.79	25.29	30
1732.5	1.4	QPSK	1/0	14.27	H	7.95	0.79	25.34	30
1754.3	1.4	QPSK	1/0	14.35	H	7.95	0.79	25.25	30
1710.7	1.4	16-QAM	1/5	14.79	V	7.95	0.79	24.7	30
1732.5	1.4	16-QAM	1/0	14.82	V	7.95	0.79	24.78	30
1754.3	1.4	16-QAM	1/0	14.76	V	7.95	0.79	24.75	30
1710.7	1.4	16-QAM	1/5	13.87	H	7.95	0.79	24.19	30
1732.5	1.4	16-QAM	1/0	13.93	H	7.95	0.79	24.25	30
1754.3	1.4	16-QAM	1/0	13.9	H	7.95	0.79	24.17	30
1711.5	3	QPSK	1/0	14.15	V	7.95	0.79	25.69	30
1732.5	3	QPSK	1/0	14.09	V	7.95	0.79	25.62	30
1753.5	3	QPSK	1/0	14.05	V	7.95	0.79	25.64	30
1711.5	3	QPSK	1/0	13.17	H	7.95	0.79	25.05	30
1732.5	3	QPSK	1/0	13.25	H	7.95	0.79	25.09	30
1753.5	3	QPSK	1/0	13.2	H	7.95	0.79	25.04	30
1711.5	3	16-QAM	1/0	13.54	V	7.95	0.79	24.83	30
1732.5	3	16-QAM	1/0	13.49	V	7.95	0.79	24.75	30
1753.5	3	16-QAM	1/0	13.58	V	7.95	0.79	24.79	30
1711.5	3	16-QAM	1/0	12.76	H	7.95	0.79	24.28	30
1732.5	3	16-QAM	1/0	12.82	H	7.95	0.79	24.25	30
1753.5	3	16-QAM	1/0	12.8	H	7.95	0.79	24.29	30
1712.5	5	QPSK	1/0	14.31	V	7.95	0.79	26.02	30
1732.5	5	QPSK	1/0	14.29	V	7.95	0.79	25.95	30
1752.5	5	QPSK	1/24	14.35	V	7.95	0.79	25.97	30
1712.5	5	QPSK	1/0	13.58	H	7.95	0.79	25.41	30
1732.5	5	QPSK	1/0	13.62	H	7.95	0.79	25.35	30
1752.5	5	QPSK	1/24	13.55	H	7.95	0.79	25.39	30
1712.5	5	16-QAM	1/0	13.29	V	7.95	0.79	24.95	30
1732.5	5	16-QAM	1/0	13.27	V	7.95	0.79	24.97	30
1752.5	5	16-QAM	1/24	13.33	V	7.95	0.79	24.92	30
1712.5	5	16-QAM	1/0	12.78	H	7.95	0.79	24.39	30
1732.5	5	16-QAM	1/0	12.74	H	7.95	0.79	24.34	30

1752.5	5	16-QAM	1/24	12.8	H	7.95	0.79	24.37	30
1715	10	QPSK	1/0	14.24	V	7.95	0.79	25.71	30
1732.5	10	QPSK	1/49	14.2	V	7.95	0.79	25.65	30
1750	10	QPSK	1/0	14.17	V	7.95	0.79	25.74	30
1715	10	QPSK	1/0	13.66	H	7.95	0.79	25.21	30
1732.5	10	QPSK	1/49	13.69	H	7.95	0.79	25.18	30
1750	10	QPSK	1/0	13.64	H	7.95	0.79	25.25	30
1715	10	16-QAM	1/0	13.62	V	7.95	0.79	24.87	30
1732.5	10	16-QAM	1/49	13.59	V	7.95	0.79	24.84	30
1750	10	16-QAM	1/0	13.57	V	7.95	0.79	24.81	30
1715	10	16-QAM	1/0	12.94	H	7.95	0.79	24.31	30
1732.5	10	16-QAM	1/49	12.97	H	7.95	0.79	24.37	30
1750	10	16-QAM	1/0	12.93	H	7.95	0.79	24.35	30
1717.5	15	QPSK	1/0	14.34	V	7.95	0.79	25.78	30
1732.5	15	QPSK	1/74	14.29	V	7.95	0.79	25.82	30
1747.5	15	QPSK	1/0	14.32	V	7.95	0.79	25.75	30
1717.5	15	QPSK	1/0	13.55	H	7.95	0.79	25.27	30
1732.5	15	QPSK	1/74	13.58	H	7.95	0.79	25.31	30
1747.5	15	QPSK	1/0	13.52	H	7.95	0.79	25.24	30
1717.5	15	16-QAM	1/0	13.16	V	7.95	0.79	25.05	30
1732.5	15	16-QAM	1/74	13.09	V	7.95	0.79	25.08	30
1747.5	15	16-QAM	1/0	13.12	V	7.95	0.79	25.02	30
1717.5	15	16-QAM	1/0	12.46	H	7.95	0.79	24.34	30
1732.5	15	16-QAM	1/74	12.52	H	7.95	0.79	24.42	30
1747.5	15	16-QAM	1/0	12.58	H	7.95	0.79	24.39	30
1720	20	QPSK	1/99	14.37	V	7.95	0.79	25.72	30
1732.5	20	QPSK	1/99	14.36	V	7.95	0.79	25.83	30
1745	20	QPSK	1/0	14.33	V	7.95	0.79	25.68	30
1720	20	QPSK	1/99	13.78	H	7.95	0.79	25.22	30
1732.5	20	QPSK	1/99	13.76	H	7.95	0.79	25.31	30
1745	20	QPSK	1/0	13.74	H	7.95	0.79	25.19	30
1720	20	16-QAM	1/99	12.64	V	7.95	0.79	24.97	30
1732.5	20	16-QAM	1/99	12.61	V	7.95	0.79	25.05	30
1745	20	16-QAM	1/0	12.58	V	7.95	0.79	24.94	30
1720	20	16-QAM	1/99	11.82	H	7.95	0.79	24.3	30
1732.5	20	16-QAM	1/99	11.89	H	7.95	0.79	24.39	30
1745	20	16-QAM	1/0	11.87	H	7.95	0.79	24.34	30

EIRP for LTE Band 5 (Part 22)

Frequency (MHz)	BW (MHz)	Modulation	RB Size/Offset	Substituted level (dBm)	Antenna Polarization	Antenna Gain correction (dBi)	Cable Loss (dB)	Absolute Level (dBm)	Limit (dBm)
824.7	1.4	QPSK	1/5	18.89	V	6.8	0.44	22.87	34.77
836.5	1.4	QPSK	1/5	18.85	V	6.8	0.44	22.92	34.77
848.3	1.4	QPSK	1/5	18.83	V	6.9	0.44	22.95	34.77
824.7	1.4	QPSK	1/5	17.98	H	6.8	0.44	22.29	34.77
836.5	1.4	QPSK	1/5	17.96	H	6.8	0.44	22.33	34.77
848.3	1.4	QPSK	1/5	17.93	H	6.9	0.44	22.37	34.77
824.7	1.4	16-QAM	1/5	18.65	V	6.8	0.44	21.84	34.77
836.5	1.4	16-QAM	1/5	18.62	V	6.8	0.44	21.88	34.77
848.3	1.4	16-QAM	1/5	18.6	V	6.9	0.44	21.92	34.77
824.7	1.4	16-QAM	1/5	17.89	H	6.8	0.44	21.27	34.77
836.5	1.4	16-QAM	1/5	17.86	H	6.8	0.44	21.33	34.77
848.3	1.4	16-QAM	1/5	17.92	H	6.9	0.44	21.41	34.77
825.5	3	QPSK	1/14	18.74	V	6.8	0.44	22.79	34.77
836.5	3	QPSK	1/0	18.79	V	6.8	0.44	22.73	34.77
847.5	3	QPSK	1/14	18.72	V	6.9	0.44	22.91	34.77
825.5	3	QPSK	1/14	17.98	H	6.8	0.44	22.22	34.77
836.5	3	QPSK	1/0	17.96	H	6.8	0.44	22.15	34.77
847.5	3	QPSK	1/14	17.93	H	6.9	0.44	22.27	34.77
825.5	3	16-QAM	1/14	19.16	V	6.8	0.44	22.12	34.77
836.5	3	16-QAM	1/0	19.06	V	6.8	0.44	22.17	34.77
847.5	3	16-QAM	1/14	19.12	V	6.9	0.44	22.28	34.77
825.5	3	16-QAM	1/14	18.79	H	6.8	0.44	21.54	34.77
836.5	3	16-QAM	1/0	18.75	H	6.8	0.44	21.59	34.77
847.5	3	16-QAM	1/14	18.82	H	6.9	0.44	21.61	34.77
826.5	5	QPSK	1/24	18.96	V	6.8	0.44	22.9	34.77
836.5	5	QPSK	1/24	18.91	V	6.8	0.44	22.85	34.77
846.5	5	QPSK	1/24	18.9	V	6.8	0.44	22.87	34.77
826.5	5	QPSK	1/24	18.09	H	6.8	0.44	22.33	34.77
836.5	5	QPSK	1/24	18.12	H	6.8	0.44	22.28	34.77
846.5	5	QPSK	1/24	18.08	H	6.8	0.44	22.24	34.77
826.5	5	16-QAM	1/24	18.75	V	6.8	0.44	22.21	34.77
836.5	5	16-QAM	1/24	18.72	V	6.8	0.44	22.25	34.77
846.5	5	16-QAM	1/24	18.79	V	6.8	0.44	22.19	34.77

826.5	5	16-QAM	1/24	17.88	H	6.8	0.44	21.6	34.77
836.5	5	16-QAM	1/24	17.95	H	6.8	0.44	21.55	34.77
846.5	5	16-QAM	1/24	17.9	H	6.8	0.44	21.58	34.77
829	10	QPSK	1/49	18.73	V	6.8	0.44	22.82	34.77
836.5	10	QPSK	1/49	18.7	V	6.8	0.44	22.85	34.77
844	10	QPSK	1/49	18.69	V	6.8	0.44	22.88	34.77
829	10	QPSK	1/49	18.06	H	6.8	0.44	22.29	34.77
836.5	10	QPSK	1/49	17.9	H	6.8	0.44	22.34	34.77
844	10	QPSK	1/49	18.03	H	6.8	0.44	22.38	34.77
829	10	16-QAM	1/49	19.15	V	6.8	0.44	22.22	34.77
836.5	10	16-QAM	1/49	19.13	V	6.8	0.44	22.28	34.77
844	10	16-QAM	1/49	19.08	V	6.8	0.44	22.31	34.77
829	10	16-QAM	1/49	18.76	H	6.8	0.44	21.65	34.77
836.5	10	16-QAM	1/49	18.79	H	6.8	0.44	21.68	34.77
844	10	16-QAM	1/49	18.74	H	6.8	0.44	21.59	34.77

ERP for LTE Band 7 (Part 27)

Frequency (MHz)	BW (MHz)	Modulation	RB Size/Offset	Substituted level (dBm)	Antenna Polarization	Antenna Gain correction (dBi)	Cable Loss (dB)	Absolute Level (dBm)	Limit (dBm)
2502.5	5	QPSK	1/0	15.47	V	8.93	0.83	26.41	30
2535	5	QPSK	1/0	15.44	V	8.93	0.83	26.46	30
2567.5	5	QPSK	1/24	15.43	V	8.93	0.83	26.39	30
2502.5	5	QPSK	1/0	14.89	H	8.93	0.83	25.76	30
2535	5	QPSK	1/0	14.96	H	8.93	0.83	25.81	30
2567.5	5	QPSK	1/24	14.93	H	8.93	0.83	25.79	30
2502.5	5	16-QAM	1/0	14.39	V	8.93	0.83	25.45	30
2535	5	16-QAM	1/0	14.36	V	8.93	0.83	25.49	30
2567.5	5	16-QAM	1/24	14.31	V	8.93	0.83	25.38	30
2502.5	5	16-QAM	1/0	13.89	H	8.93	0.83	24.91	30
2535	5	16-QAM	1/0	13.84	H	8.93	0.83	24.89	30
2567.5	5	16-QAM	1/24	13.86	H	8.93	0.83	24.93	30
2505	10	QPSK	1/0	13.06	V	8.93	0.83	26.25	30
2535	10	QPSK	1/49	13.05	V	8.93	0.83	26.19	30
2565	10	QPSK	1/0	13.02	V	8.93	0.83	26.23	30
2505	10	QPSK	1/0	12.76	H	8.93	0.83	25.48	30
2535	10	QPSK	1/49	12.72	H	8.93	0.83	25.51	30
2565	10	QPSK	1/0	12.79	H	8.93	0.83	25.46	30
2505	10	16-QAM	1/0	13.62	V	8.93	0.83	25.89	30
2535	10	16-QAM	1/49	13.65	V	8.93	0.83	26.92	30
2565	10	16-QAM	1/0	13.68	V	8.93	0.83	25.86	30
2505	10	16-QAM	1/0	12.94	H	8.93	0.83	25.25	30
2535	10	16-QAM	1/49	12.93	H	8.93	0.83	25.18	30
2565	10	16-QAM	1/0	12.98	H	8.93	0.83	25.21	30
2507.5	15	QPSK	1/0	14.36	V	8.93	0.83	26.33	30
2535	15	QPSK	1/74	14.32	V	8.93	0.83	26.37	30
2562.5	15	QPSK	1/0	14.31	V	8.93	0.83	26.41	30
2507.5	15	QPSK	1/0	13.78	H	8.93	0.83	25.78	30
2535	15	QPSK	1/74	13.76	H	8.93	0.83	25.72	30
2562.5	15	QPSK	1/0	13.72	H	8.93	0.83	25.79	30
2507.5	15	16-QAM	1/0	14.32	V	8.93	0.83	25.75	30
2535	15	16-QAM	1/74	14.29	V	8.93	0.83	25.71	30
2562.5	15	16-QAM	1/0	14.27	V	8.93	0.83	25.78	30

2507.5	15	16-QAM	1/0	13.56	H	8.93	0.83	25.13	30
2535	15	16-QAM	1/74	13.58	H	8.93	0.83	25.18	30
2562.5	15	16-QAM	1/0	13.53	H	8.93	0.83	25.24	30
2510	20	QPSK	1/99	14.62	V	8.93	0.83	26.41	30
2535	20	QPSK	1/99	14.59	V	8.93	0.83	26.45	30
2560	20	QPSK	1/0	14.57	V	8.93	0.83	26.47	30
2510	20	QPSK	1/99	13.89	H	8.93	0.83	25.84	30
2535	20	QPSK	1/99	13.95	H	8.93	0.83	25.86	30
2560	20	QPSK	1/0	13.94	H	8.93	0.83	25.82	30
2510	20	16-QAM	1/99	14.14	V	8.93	0.83	25.83	30
2535	20	16-QAM	1/99	14.11	V	8.93	0.83	25.79	30
2560	20	16-QAM	1/0	14.08	V	8.93	0.83	25.85	30
2510	20	16-QAM	1/99	13.76	H	8.93	0.83	25.21	30
2535	20	16-QAM	1/99	13.8	H	8.93	0.83	25.25	30
2560	20	16-QAM	1/0	13.74	H	8.93	0.83	25.18	30

6.3 Peak-Average Ratio

Temperature	25°C
Relative Humidity	54%
Atmospheric Pressure	1002mbar
Test date :	July 02, 2016
Tested By :	Loren Luo

Requirement(s):

Spec	Item	Requirement	Applicable
§24.232(d) § 27.50(d)	a)	The peak-to-average ratio (PAR) of the transmission may not exceed 13 dB.	<input checked="" type="checkbox"/>

Test Setup	
------------	--

Test Procedure	<p>According with KDB 971168 v02r02</p> <p>5.7.2 Alternate procedure for PAPR</p> <p>5.1.2 Peak power measurements with a peak power meter</p> <p>The total peak output power may be measured using a broadband peak RF power meter. The power meter must have a video bandwidth that is greater than or equal to the emission bandwidth and utilize a fast-responding diode detector.</p> <p>5.2.3 Average power measurement with average power meter</p> <p>As an alternative to the use of a spectrum/signal analyzer or EMI receiver to perform a measurement of the total in-band average output power, a wideband RF average power meter with a thermocouple detector or equivalent can be used under certain conditions</p> <p>If the EUT can be configured to transmit continuously (i.e., the burst duty</p>
----------------	---

Test Report	16070667-FCC-R5
Page	43 of 123

	<p>cycle \geq 98%) and at all times the EUT is transmitting at its maximum output power level, then a conventional wide-band RF power meter can be used. If the EUT cannot be configured to transmit continuously (i.e., the burst duty cycle $<$ 98%), then there are two options for the use of an average power meter. First, a gated average power meter can be used to perform the measurement if the gating parameters can be adjusted such that the power is measured only over active transmission bursts at maximum output power levels. A conventional average power meter can also be used if the measured burst duty cycle is constant (i.e., duty cycle variations are less than \pm 2 percent) by performing the measurement over the on/off burst cycles and then correcting (increasing) the measured level by a factor equal to $10\log(1/\text{duty cycle})$</p>
Remark	
Result	<input checked="" type="checkbox"/> Pass <input type="checkbox"/> Fail

Test Data Yes N/A
 Test Plot Yes (See below) N/A

LTE Band 2 (part 24E)

BW(MHz)	Frequency (MHz)	Mode	Modulation	Conducted Power (dBm)		Peak-Average Ratio (PAR)
				Peak	Average	
1.4	1880	RB 1/0	QPSK	24.56	23.05	1.51
			16QAM	24.32	21.74	2.58
3	1880	RB 1/0	QPSK	25.36	23.16	2.2
			16QAM	24.98	22	2.98
5	1880	RB 1/0	QPSK	25.35	23.29	2.06
			16QAM	24.86	22.25	2.61
10	1880	RB 1/0	QPSK	25.36	23.28	2.08
			16QAM	25.69	22.12	3.57
15	1880	RB 1/0	QPSK	25.38	23.36	2.02
			16QAM	25.34	22.21	3.13
20	1880	RB 1/0	QPSK	24.96	23.4	1.56
			16QAM	24.88	22.31	2.57

LTE Band 4 (part 27)

BW(MHz)	Frequency (MHz)	Mode	Modulation	Conducted Power (dBm)		Peak-Average Ratio (PAR)
				Peak	Average	
1.4	1732.5	RB 1/0	QPSK	25.36	23.24	2.12
			16QAM	24.35	22.07	2.28
3	1732.5	RB 1/0	QPSK	25.25	23.24	2.01
			16QAM	24.39	22.06	2.33
5	1732.5	RB 1/0	QPSK	25.65	23.27	2.38
			16QAM	24.21	22.54	1.67
10	1732.5	RB 1/0	QPSK	25.29	23.31	1.98
			16QAM	25.86	22.13	3.73
15	1732.5	RB 1/0	QPSK	24.68	23.36	1.32
			16QAM	25.35	22.16	3.19
20	1732.5	RB 1/0	QPSK	26.35	23.38	2.97
			16QAM	24.35	22.27	2.08

LTE Band 5 (part 27)

BW(MHz)	Frequency (MHz)	Mode	Modulation	Conducted Power (dBm)		Peak-Average Ratio (PAR)
				Peak	Average	
1.4	836.5	RB 1/0	QPSK	25.35	23.59	1.76
			16QAM	25.24	22.62	2.62
3	836.5	RB 1/0	QPSK	24.52	23.59	0.93
			16QAM	24.13	22.51	1.62
5	836.5	RB 1/0	QPSK	25.31	23.6	1.71
			16QAM	24.65	23.03	1.62
10	836.5	RB 1/0	QPSK	25.1	23.66	1.44
			16QAM	24.8	22.6	2.2

LTE Band 7 (part 27)

BW(MHz)	Frequency (MHz)	Mode	Modulation	Conducted Power (dBm)		Peak-Average Ratio (PAR)
				Peak	Average	
5	2535	RB 1/0	QPSK	25.23	22.83	2.4
			16QAM	24.31	22.22	2.09
10	2535	RB 1/0	QPSK	24.65	22.93	1.72
			16QAM	24.85	21.73	3.12
15	2535	RB 1/0	QPSK	24.88	22.95	1.93
			16QAM	24.32	21.81	2.51
20	2535	RB 1/0	QPSK	25.6	23.04	2.56
			16QAM	24.58	21.99	2.59

LTE Band 17 (part 27)

BW(MHz)	Frequency (MHz)	Mode	Modulation	Conducted Power (dBm)		Peak-Average Ratio (PAR)
				Peak	Average	
5	710	RB 1/0	QPSK	21.52	22.07	-0.55
			16QAM	25.38	21.33	4.05
10	710	RB 1/0	QPSK	25.37	22.15	3.22
			16QAM	25.29	20.96	4.33

6.4 Occupied Bandwidth

Temperature	23°C
Relative Humidity	58%
Atmospheric Pressure	1006mbar
Test date :	July 06, 2016
Tested By :	Loren Luo

Requirement(s):

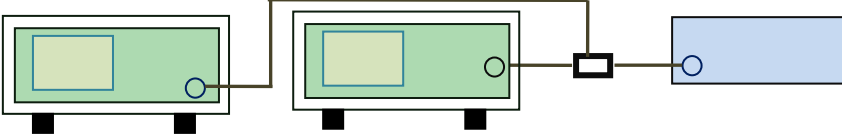
Spec	Item	Requirement	Applicable
§2.1049, §22.917, §22.905 §24.238 §27.53(a)	a)	99% Occupied Bandwidth(kHz)	<input checked="" type="checkbox"/>
	b)	26 dB Bandwidth(kHz)	<input checked="" type="checkbox"/>
Test Setup			
Test Procedure	<ul style="list-style-type: none"> - The EUT was connected to Spectrum Analyzer and Base Station via power divider. - The 99% and 26 dB occupied bandwidth (BW) of the middle channel for the highest RF powers. 		
Remark			
Result	<input checked="" type="checkbox"/> Pass <input type="checkbox"/> Fail		

Test Data Yes N/A

Test Plot Yes (See below) N/A

LTE Band 2 (Part 24E)

BW(MHz)	Channel	Frequency (MHz)	Modulation	99% Occupied Bandwidth (MHz)	26 dB Bandwidth (MHz)
1.4	18607	1850.7	16QAM	1.0956	1.270
			QPSK	1.0903	1.266
1.4	18900	1880	16QAM	1.0950	1.269
			QPSK	1.0958	1.280
1.4	19193	1909.3	16QAM	1.1030	1.267
			QPSK	1.0978	1.260
3	18615	1851.5	16QAM	2.7481	3.109
			QPSK	2.7529	3.107
3	18900	1880	16QAM	2.7503	3.079
			QPSK	2.7482	3.096
3	19185	1908.5	16QAM	2.7535	3.095
			QPSK	2.7502	3.077
5	18625	1852.5	16QAM	4.5283	5.086
			QPSK	4.5385	5.069
5	18900	1880	16QAM	4.5319	5.088
			QPSK	4.5194	5.017
5	19175	1907.5	16QAM	4.5371	5.039
			QPSK	4.5285	5.019
10	18650	1855	16QAM	8.0652	10.345
			QPSK	9.0682	10.270
10	18900	1880	16QAM	9.0729	10.177
			QPSK	9.0658	10.241
10	19150	1905	16QAM	9.0871	10.261
			QPSK	9.0712	10.287
15	18675	1857.5	16QAM	13.4895	14.953
			QPSK	13.5018	15.028
15	18900	1880	16QAM	13.5090	14.919
			QPSK	13.4573	14.922
15	19125	1902.5	16QAM	13.4939	15.008
			QPSK	13.5200	15.023

20	18700	1860	16QAM	17.8701	19.580
			QPSK	17.8546	19.467
20	18900	1880	16QAM	17.9105	19.584
			QPSK	17.9789	19.514
20	19100	1900	16QAM	17.8883	19.480
			QPSK	17.8817	19.740

LTE Band 4 (Part 27)

BW(MHz)	Channel	Frequency (MHz)	Modulation	99% Occupied Bandwidth (MHz)	26 dB Bandwidth (MHz)
1.4	19957	1710.7	16QAM	1.1026	1.289
			QPSK	1.0995	1.288
1.4	20175	1732.5	16QAM	1.1029	1.278
			QPSK	1.1086	1.271
1.4	20393	1754.3	16QAM	1.1070	1.284
			QPSK	1.0974	1.276
3	19965	1711.5	16QAM	2.7517	3.084
			QPSK	2.7535	3.077
3	20175	1732.5	16QAM	2.7443	3.103
			QPSK	2.7507	3.098
3	20385	1753.5	16QAM	2.7484	3.117
			QPSK	2.7503	3.122
5	19975	1712.5	16QAM	4.5250	5.072
			QPSK	4.5360	5.099
5	20175	1732.5	16QAM	4.5480	5.080
			QPSK	4.5331	5.051
5	20375	1752.5	16QAM	4.5245	5.099
			QPSK	4.5172	5.092
10	20000	1715	16QAM	9.0480	10.204
			QPSK	9.0469	10.251
10	20175	1732.5	16QAM	9.0801	10.254
			QPSK	9.0655	10.334
10	20350	1750	16QAM	9.0730	10.337
			QPSK	9.0808	10.396

15	20025	1717.5	16QAM	13.4544	14.903
			QPSK	13.4716	14.872
15	20175	1732.5	16QAM	13.4984	15.000
			QPSK	13.5279	14.985
15	20325	1747.5	16QAM	13.4666	15.001
			QPSK	13.4636	14.944
20	20050	1720	16QAM	17.9213	19.536
			QPSK	17.9226	19.477
20	20175	1732.5	16QAM	17.9574	19.445
			QPSK	17.9482	19.391
20	20300	1745	16QAM	17.9174	19.545
			QPSK	17.9051	19.591

LTE Band 5 (Part 22H)

BW(MHz)	Channel	Frequency (MHz)	Modulation	99% Occupied Bandwidth (MHz)	26 dB Bandwidth (MHz)
1.4	20407	824.7	16QAM	1.1093	1.304
			QPSK	1.0987	1.294
1.4	20525	936.5	16QAM	1.1099	1.279
			QPSK	1.1056	1.267
1.4	20643	949.3	16QAM	1.1041	1.284
			QPSK	1.1052	1.291
3	20415	825.5	16QAM	2.7416	3.119
			QPSK	2.7516	3.124
3	20525	936.5	16QAM	2.7582	3.093
			QPSK	2.7501	3.099
3	20635	847.5	16QAM	2.7590	3.120
			QPSK	2.7568	3.108
5	20425	826.5	16QAM	4.5240	5.099
			QPSK	4.5284	5.070
5	20525	936.5	16QAM	4.5382	5.085
			QPSK	4.5322	5.093
5	20625	846.5	16QAM	4.5222	5.096
			QPSK	4.5346	5.074

10	20450	829	16QAM	9.0908	10.328
			QPSK	9.1010	10.297
10	20525	936.5	16QAM	9.0740	10.249
			QPSK	9.0697	10.286
10	20800	844	16QAM	9.1003	10.305
			QPSK	9.0794	10.217

LTE Band 7 (Part 27) result

BW(MHz)	Channel	Frequency (MHz)	Modulation	99% Occupied Bandwidth (MHz)	26 dB Bandwidth (MHz)
5	20775	2502.5	16QAM	4.5225	5.102
			QPSK	4.5305	5.107
5	21100	2535	16QAM	4.5242	5.084
			QPSK	4.5234	4.987
5	21425	2567.5	16QAM	4.5215	4.997
			QPSK	4.5287	5.048
10	20800	2505	16QAM	9.0724	10.220
			QPSK	9.0428	10.192
10	21100	2535	16QAM	9.0888	10.324
			QPSK	9.0776	10.276
10	21400	2562.5	16QAM	9.0430	10.122
			QPSK	9.0468	10.158
15	20825	2507.5	16QAM	13.5291	15.018
			QPSK	13.5001	15.119
15	21100	2535	16QAM	13.4472	14.897
			QPSK	13.4737	14.929
15	21400	2562.5	16QAM	13.4836	15.011
			QPSK	13.4925	14.904
20	20850	2510	16QAM	17.9575	19.527
			QPSK	17.9237	19.473
20	21100	2535	16QAM	17.8973	19.551
			QPSK	17.9101	19.517
20	21350	2560	16QAM	17.8995	19.459
			QPSK	17.8833	19.515

Test Plots

LTE Band 2 (Part 24E)

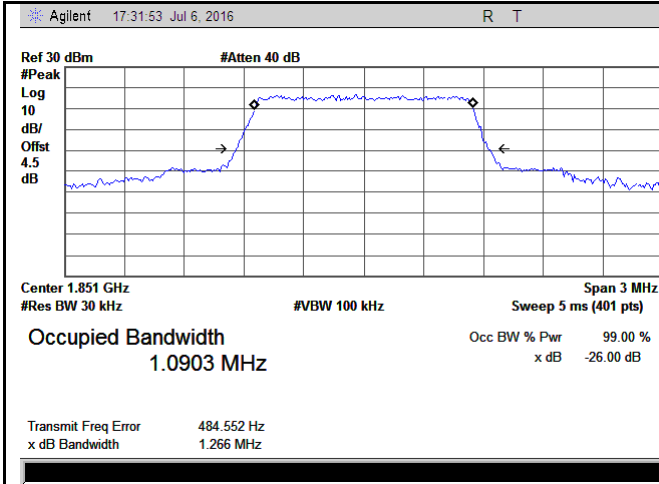

LTE band 2 - Low CH QPSK-1.4

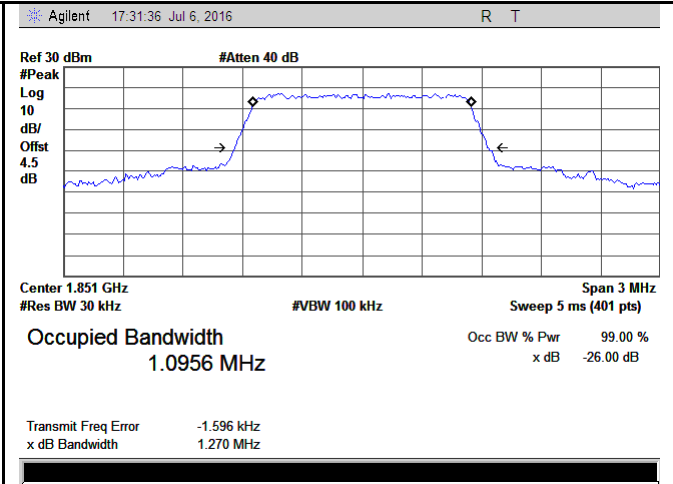

LTE band 2 - Low CH 16QAM-1.4

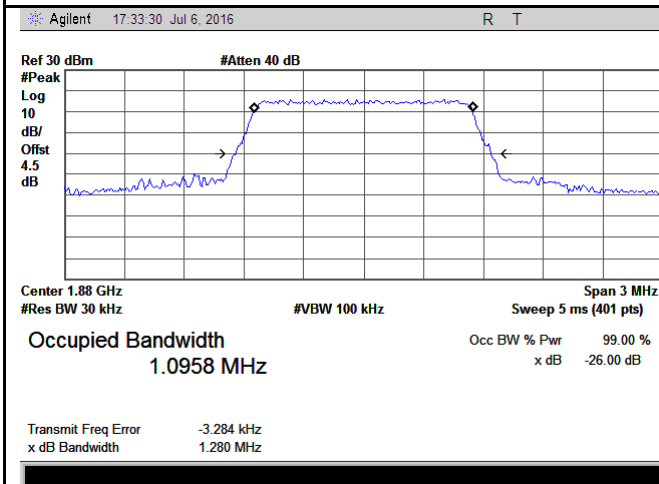

LTE band 2 - Middle CH QPSK-1.4

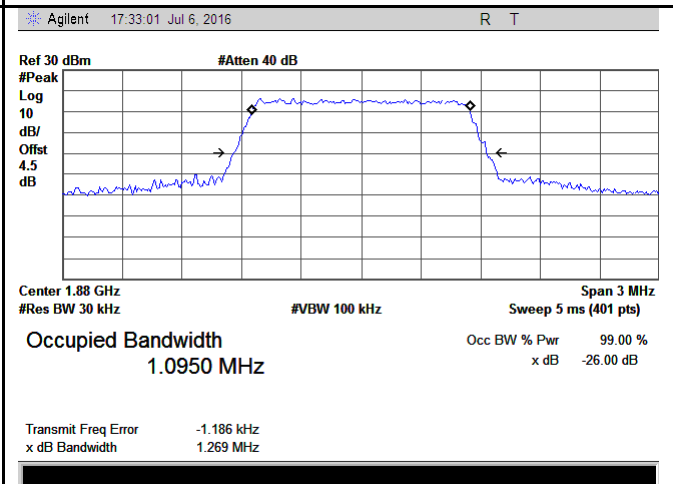

LTE band 2 - Middle CH 16QAM-1.4

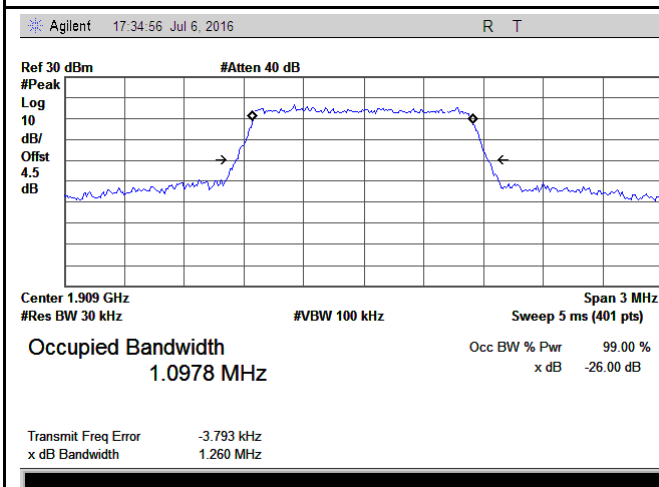

LTE band 2 - High CH QPSK-1.4

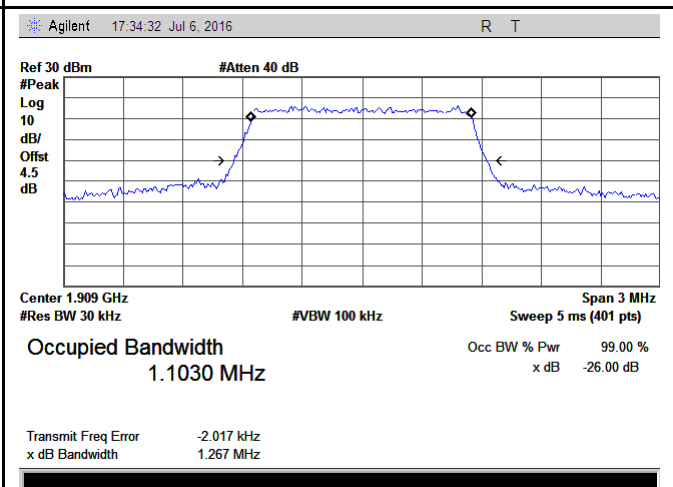

LTE band 2 - High CH 16QAM-1.4

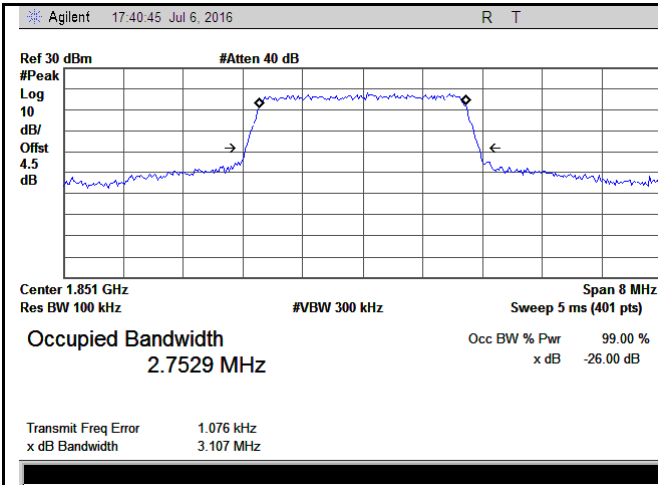

LTE band 2 - Low CH QPSK-3

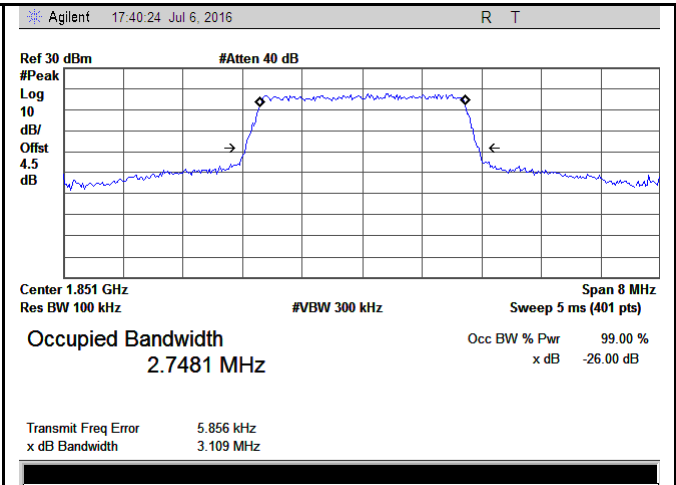

LTE band 2 - Low CH 16QAM-3

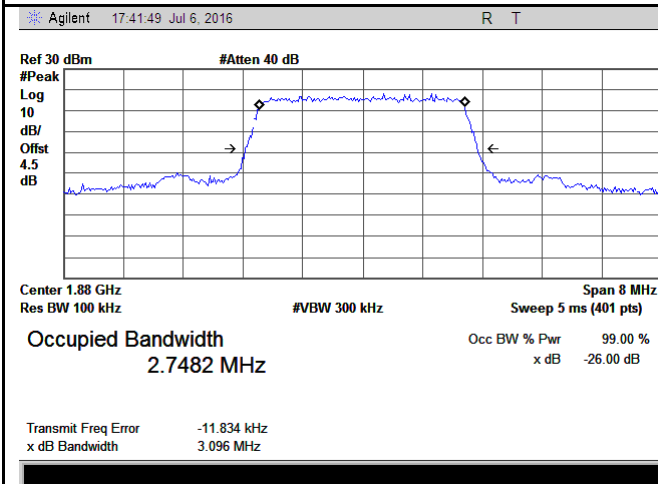

LTE band 2 - Middle CH QPSK-3

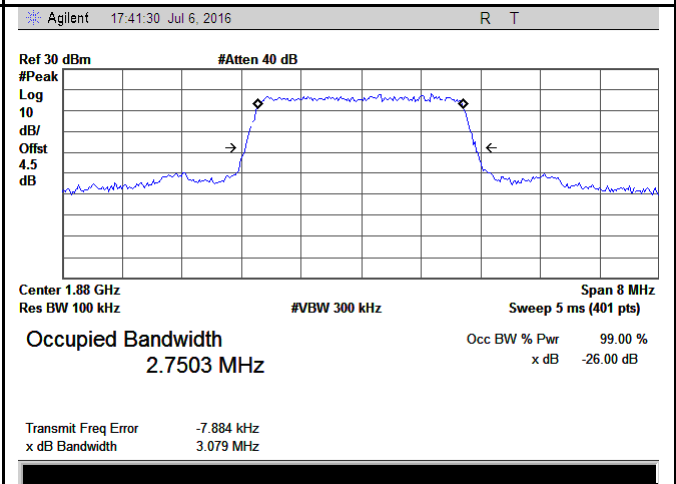

LTE band 2 - Middle CH 16QAM-3

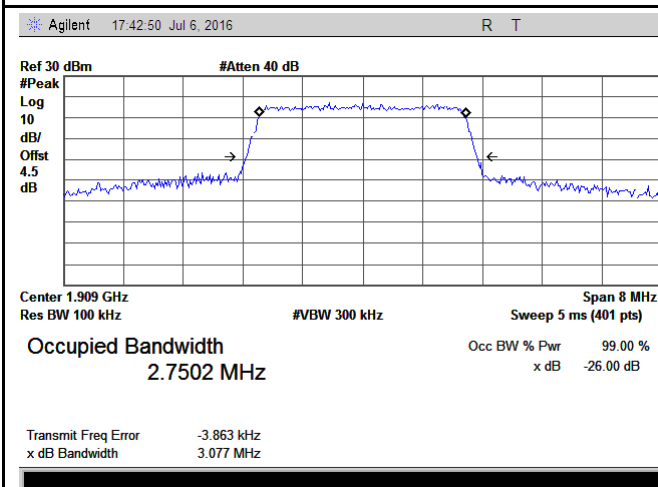

LTE band 2 - High CH QPSK-3

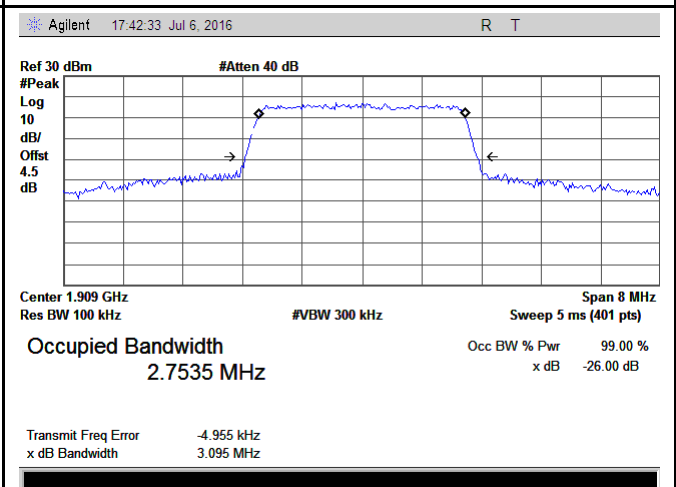

LTE band 2 - High CH 16QAM-3

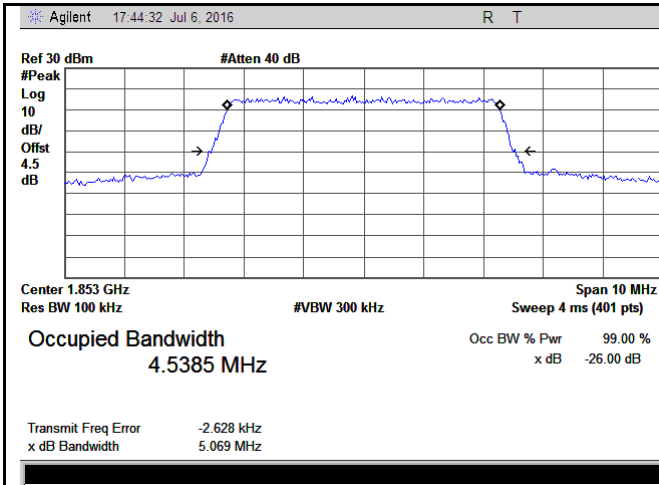

LTE band 2 - Low CH QPSK-5

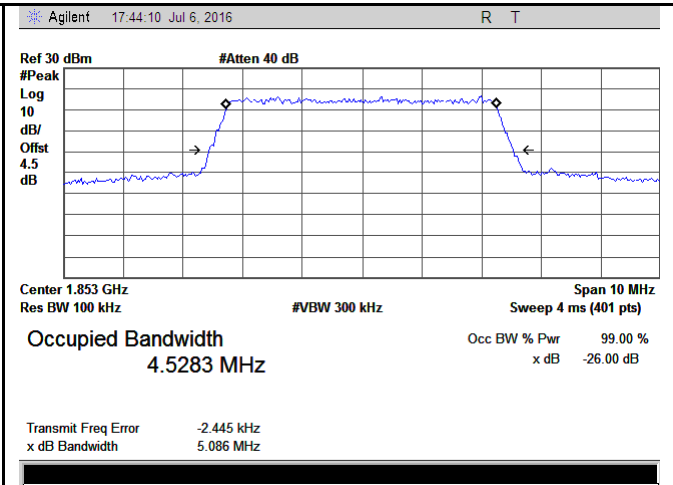

LTE band 2 - Low CH 16QAM-5

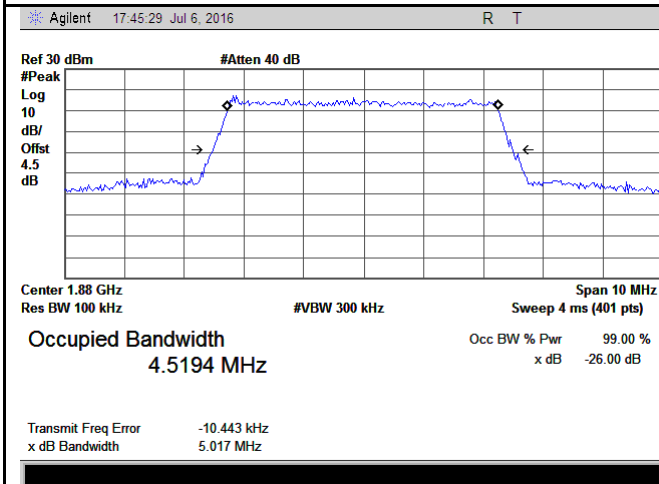

LTE band 2 - Middle CH QPSK-5

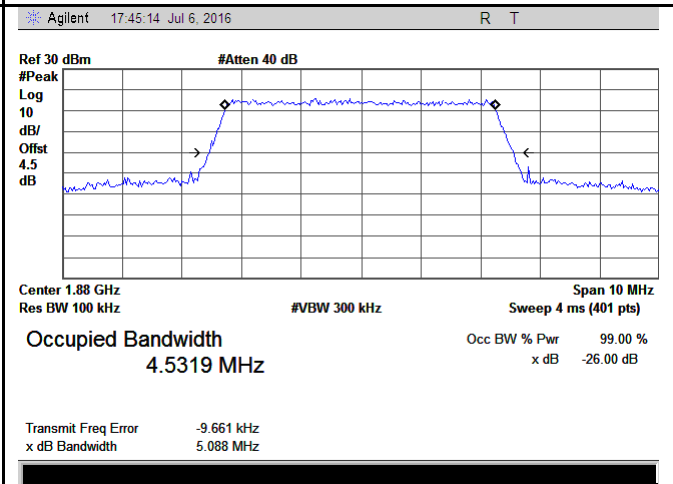

LTE band 2 - Middle CH 16QAM-5

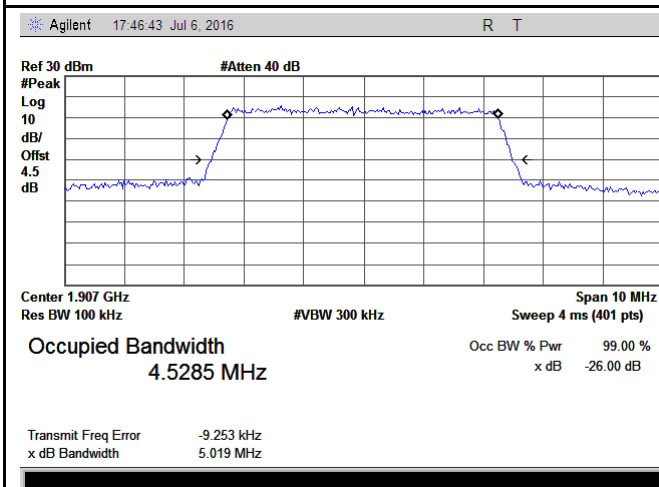

LTE band 2 - High CH QPSK-5

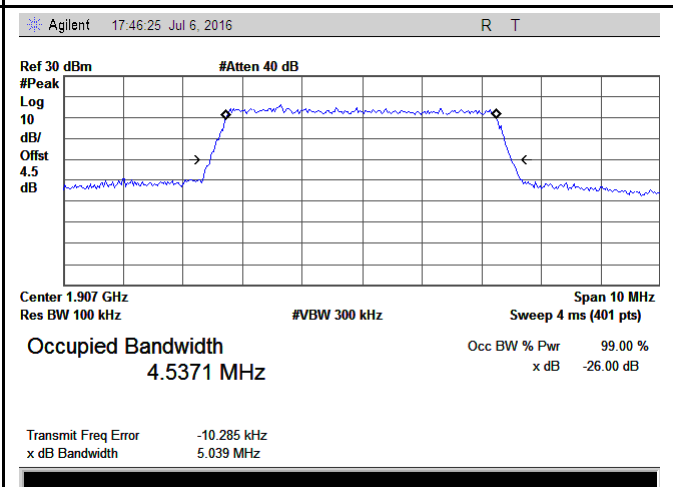

LTE band 2 - High CH 16QAM-5

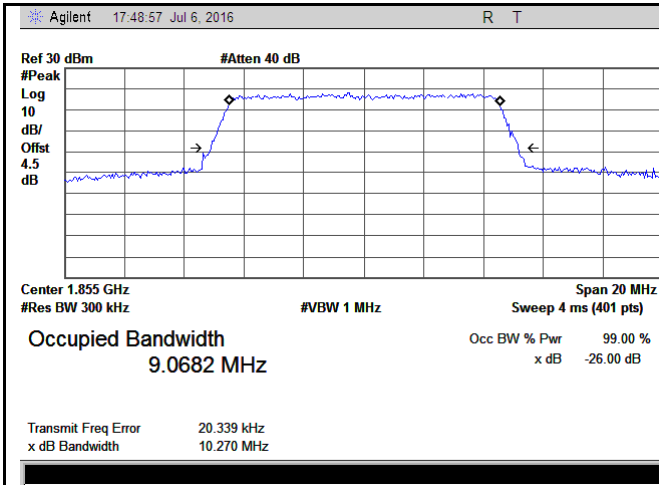

LTE band 2 - Low CH QPSK-10

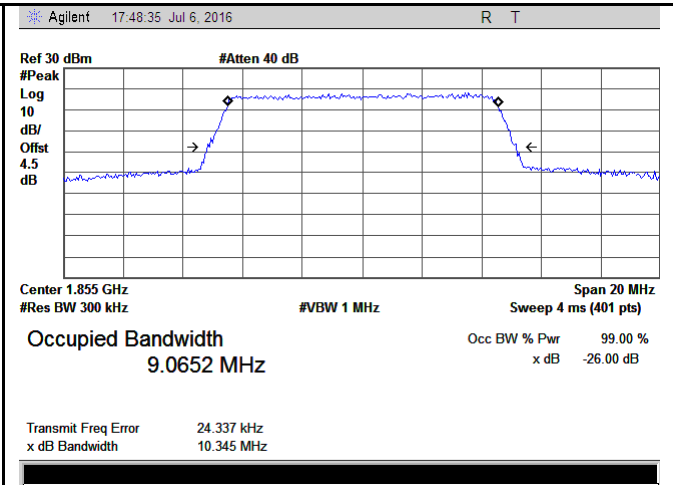

LTE band 2 - Low CH 16QAM-10

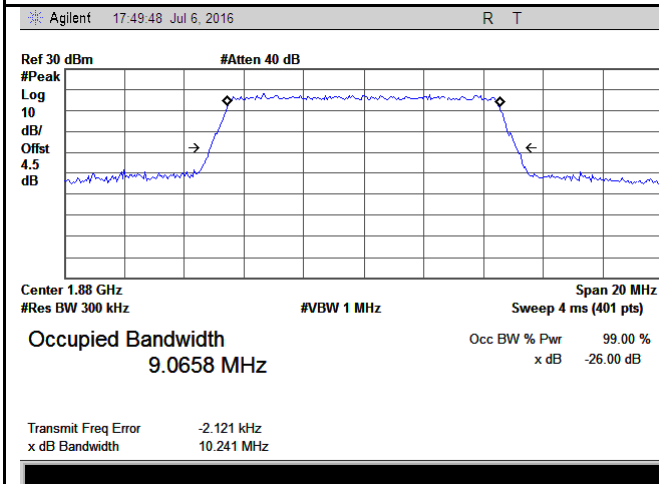

LTE band 2 - Middle CH QPSK-10

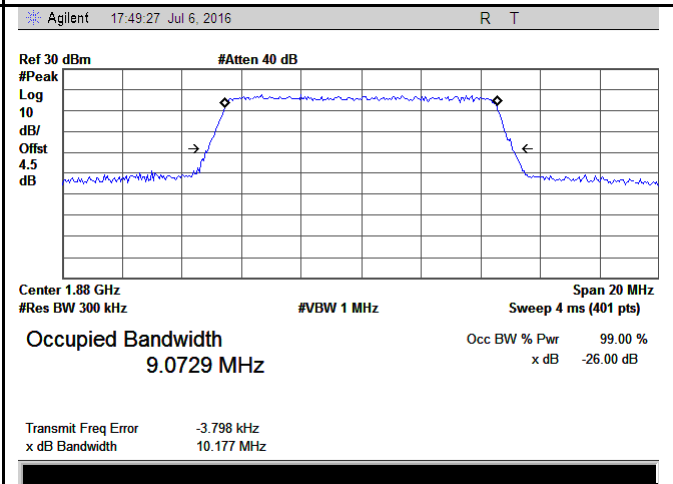

LTE band 2 - Middle CH 16QAM-10

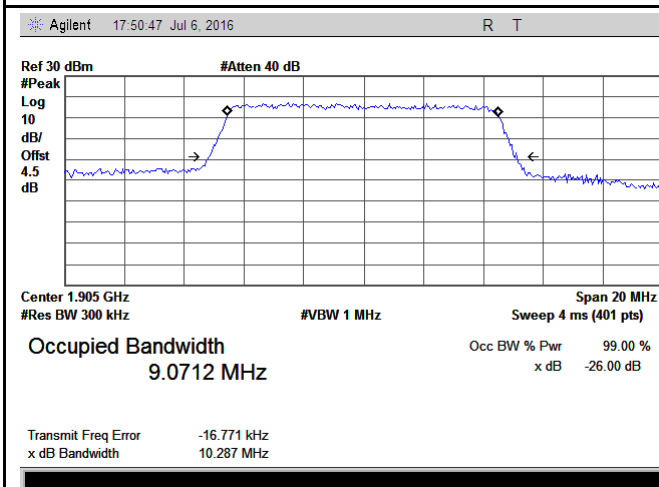

LTE band 2 - High CH QPSK-10

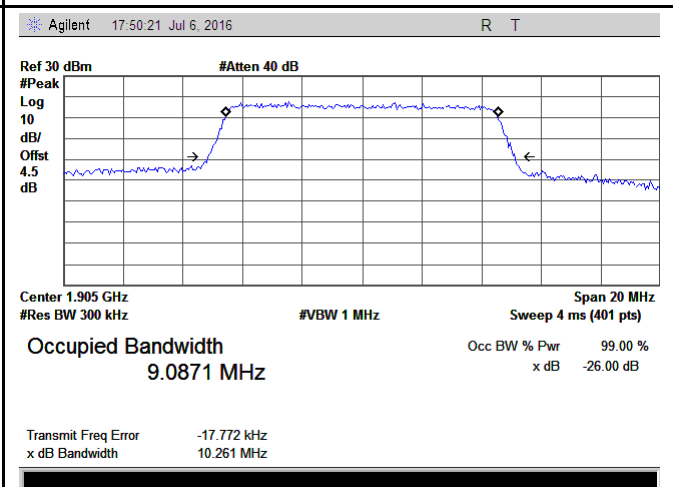

LTE band 2 - High CH 16QAM-10

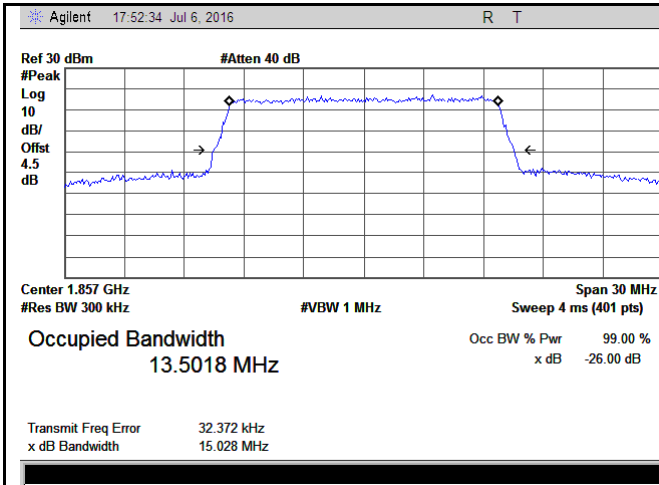

LTE band 2 - Low CH QPSK-15

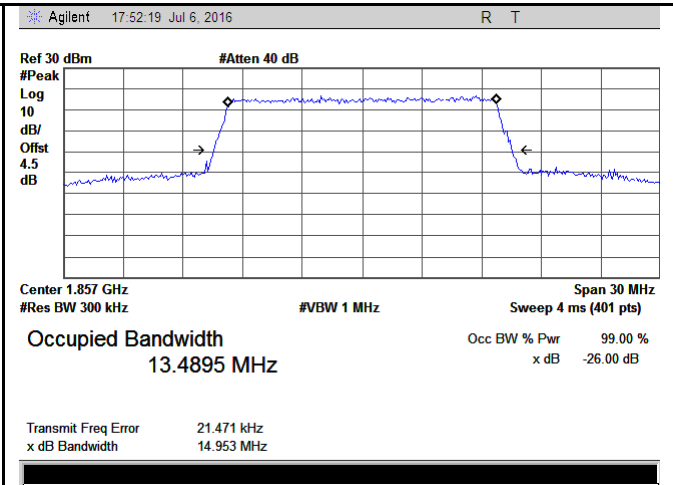

LTE band 2 - Low CH 16QAM-15

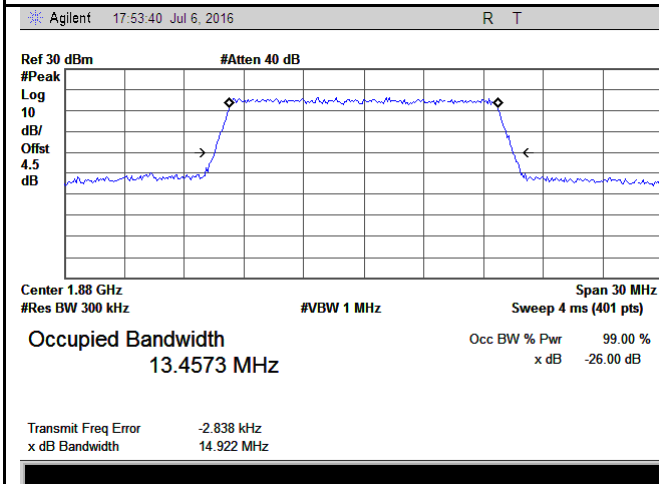

LTE band 2 - Middle CH QPSK-15

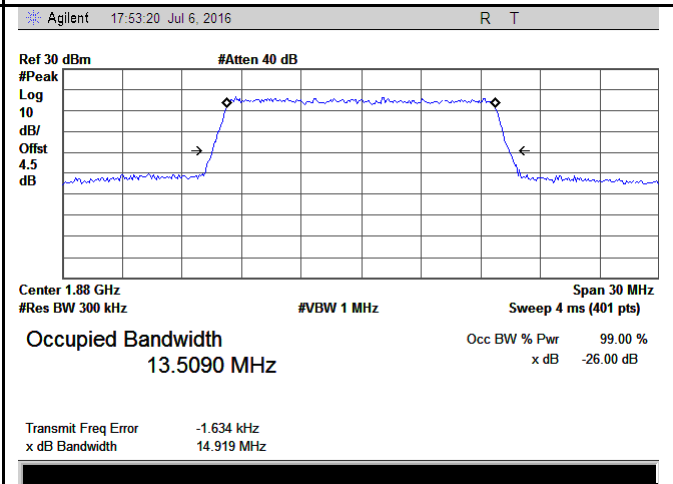

LTE band 2 - Middle CH 16QAM-15

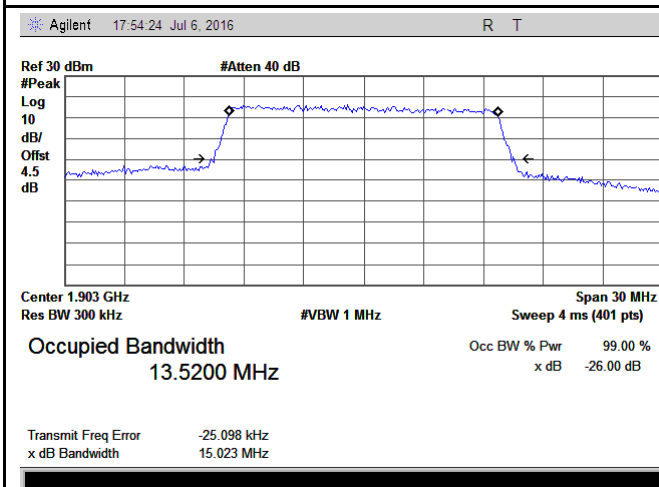

LTE band 2 - High CH QPSK-15

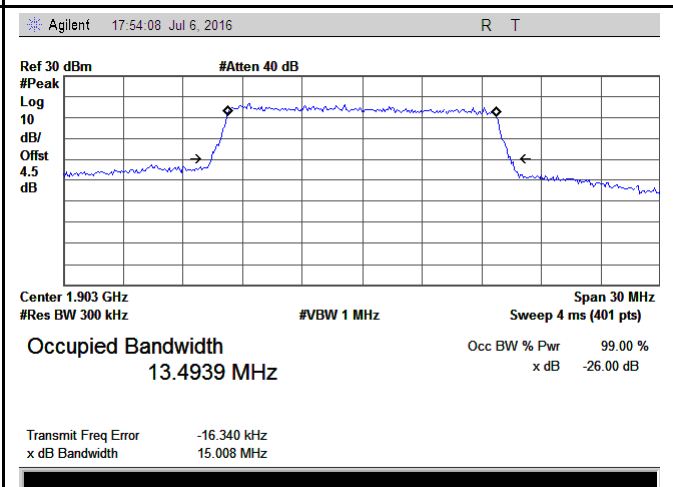

LTE band 2 - High CH 16QAM-15

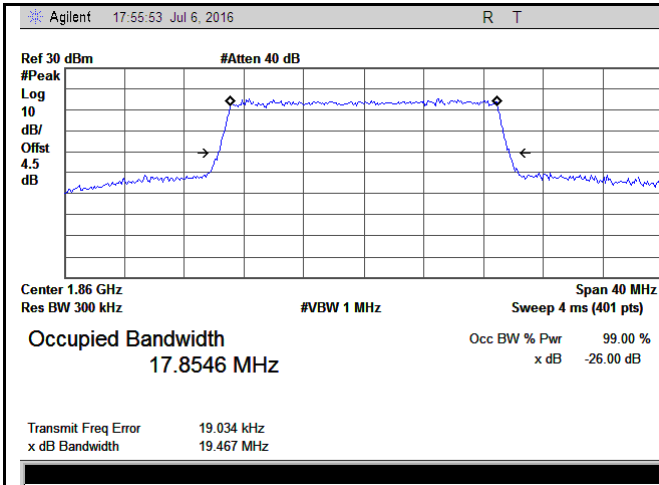

LTE band 2 - Low CH QPSK-20

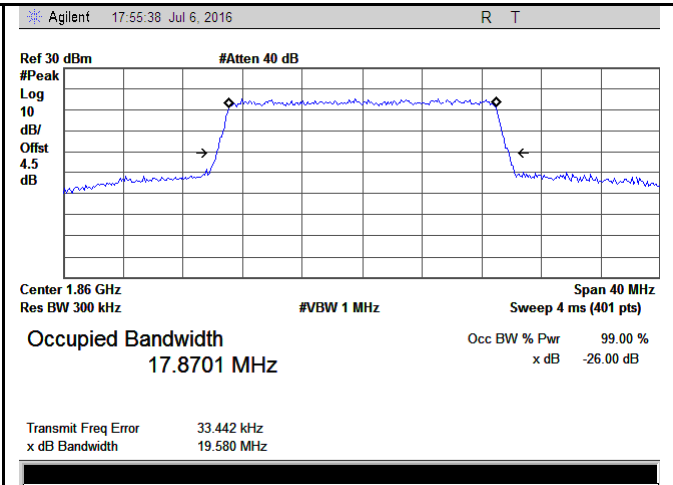

LTE band 2 - Low CH 16QAM-20

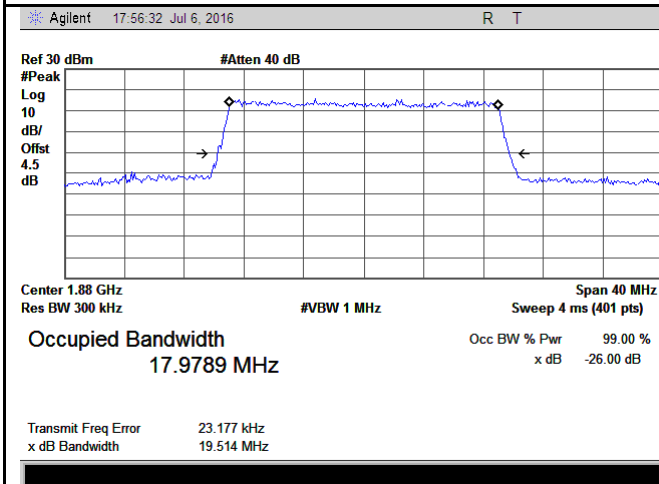

LTE band 2 - Middle CH QPSK-20

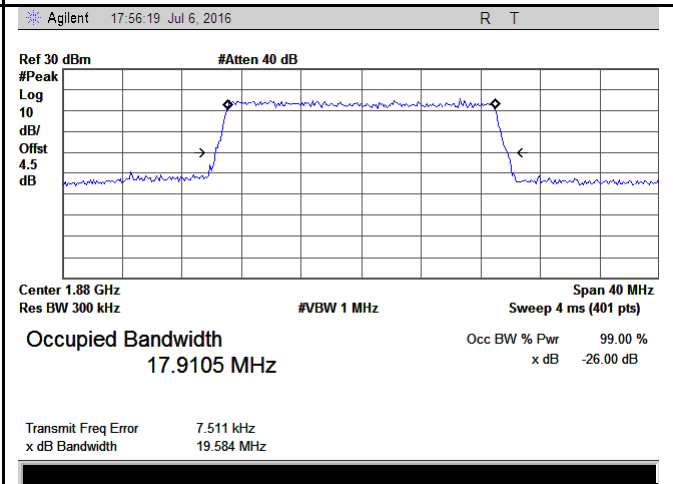

LTE band 2 - Middle CH 16QAM-20

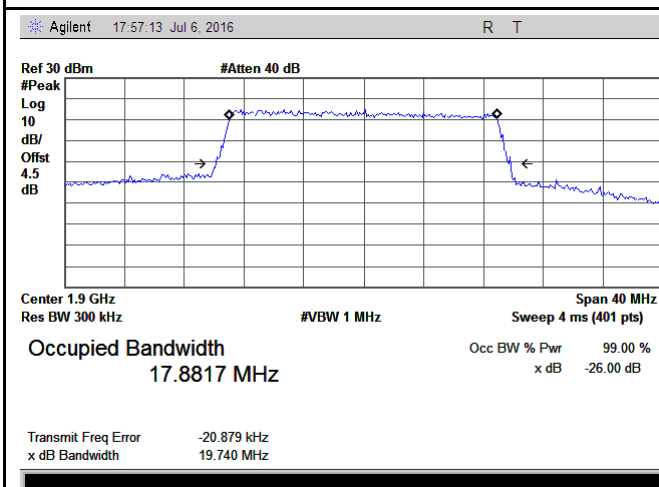

LTE band 2 - High CH QPSK-20

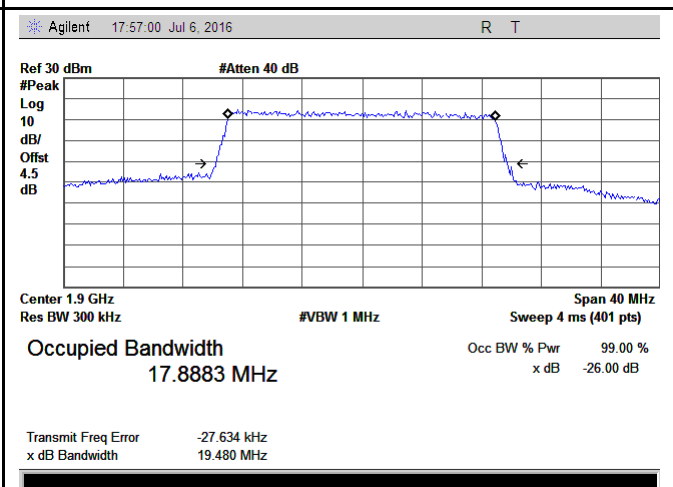

LTE band 2 - High CH 16QAM-20

LTE Band 4 (Part 27)

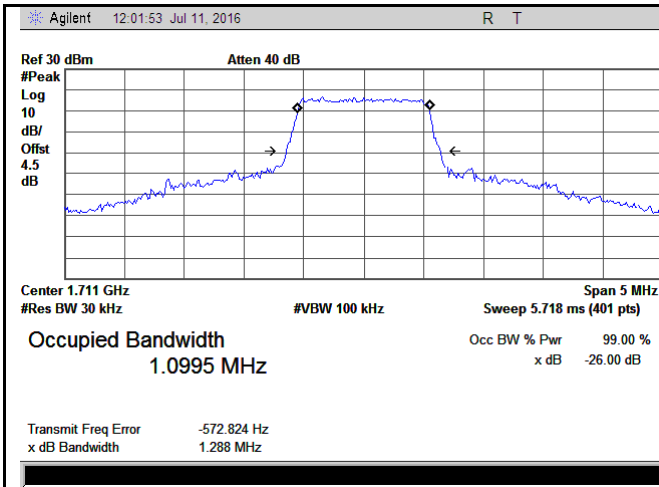

LTE band 4 - Low CH QPSK-1.4

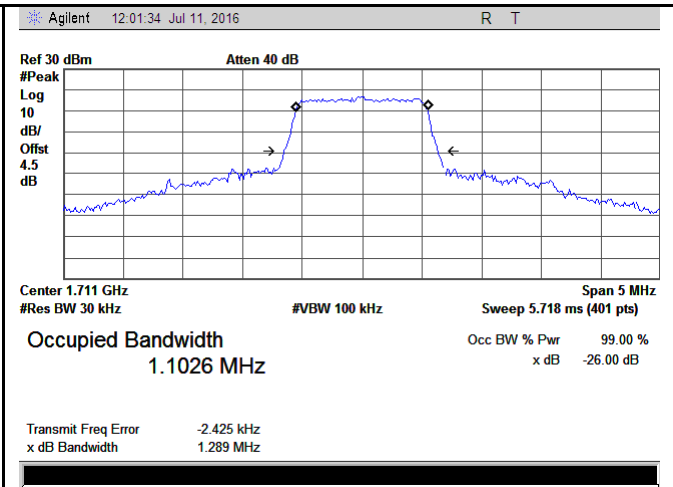

LTE band 4 - Low CH 16QAM-1.4

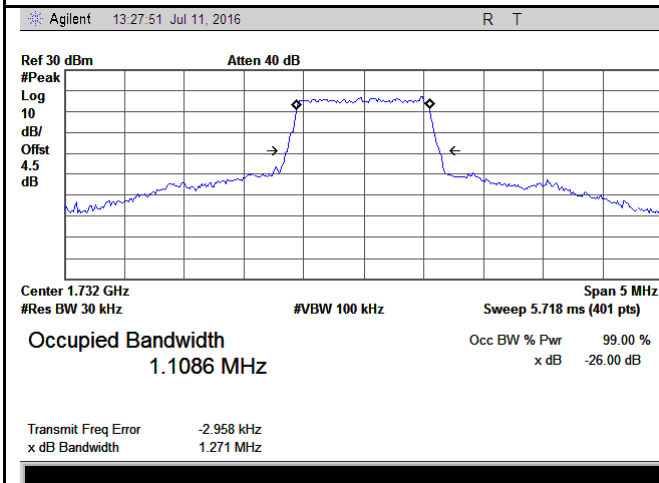

LTE band 4 - Middle CH QPSK-1.4

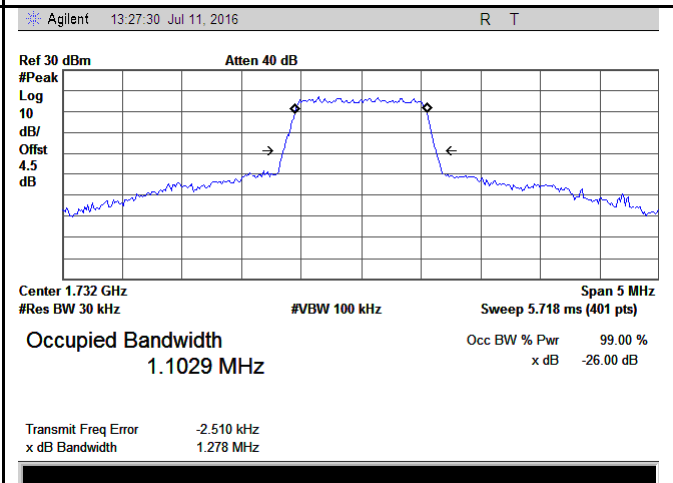

LTE band 4 - Middle CH 16QAM-1.4

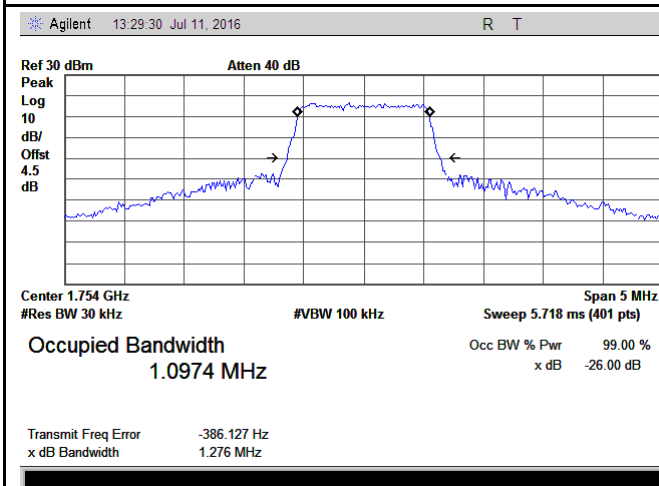

LTE band 4 - High CH QPSK-1.4

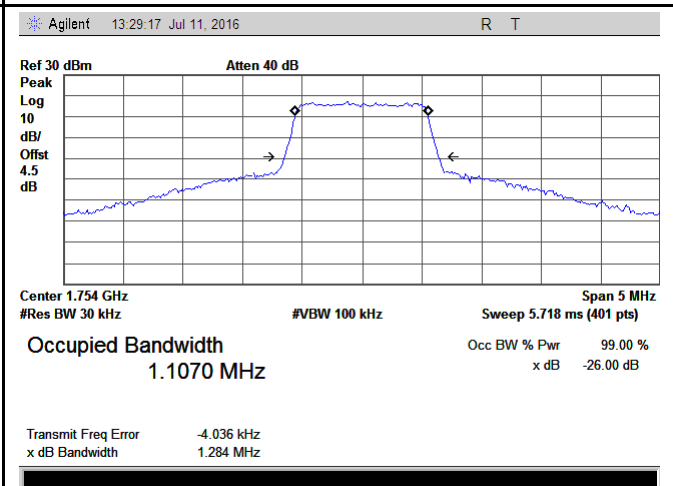

LTE band 4 - High CH 16QAM-1.4

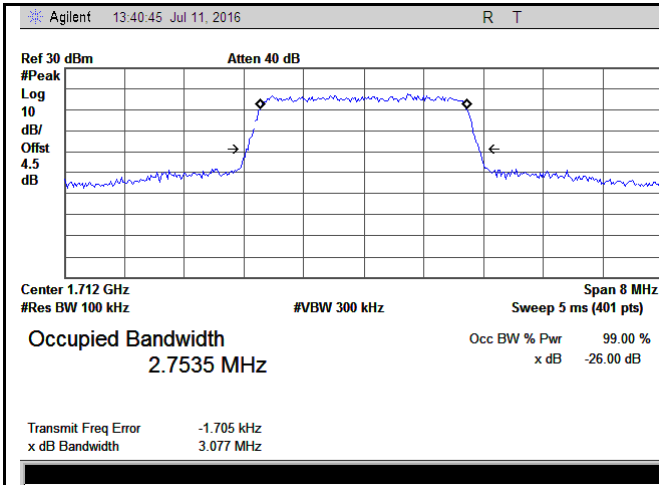

LTE band 4 - Low CH QPSK-3

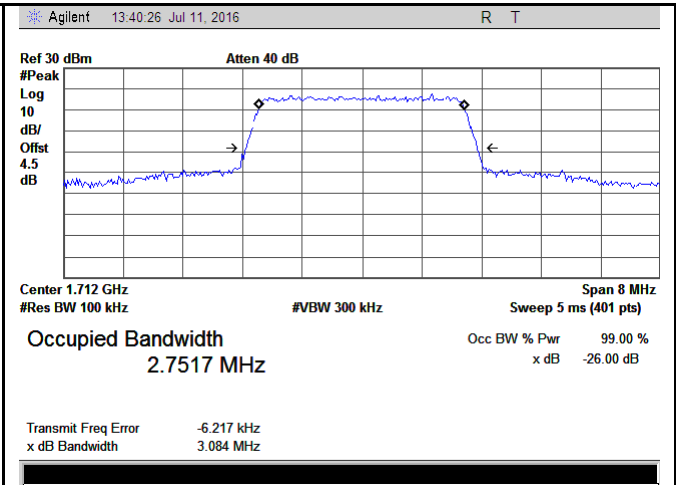

LTE band 4 - Low CH 16QAM-3

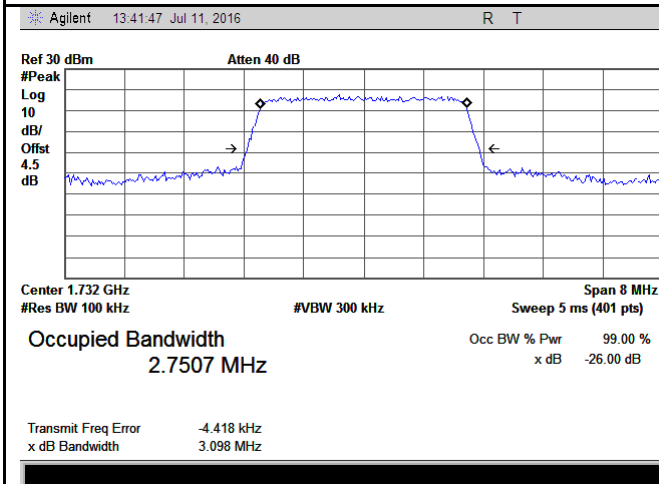

LTE band 4 - Middle CH QPSK-3

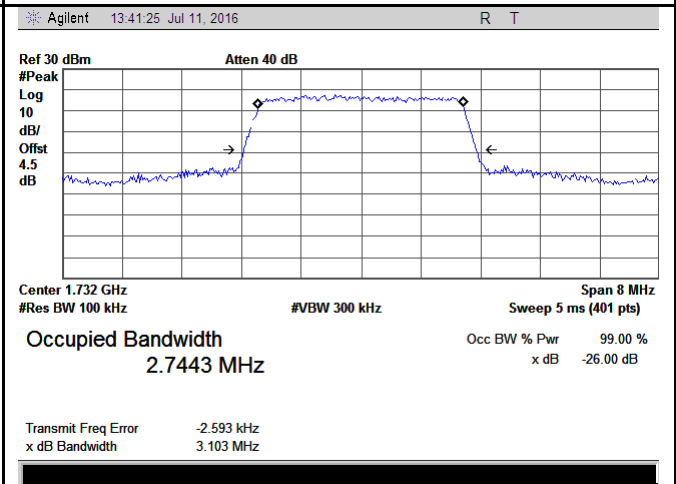

LTE band 4 - Middle CH 16QAM-3

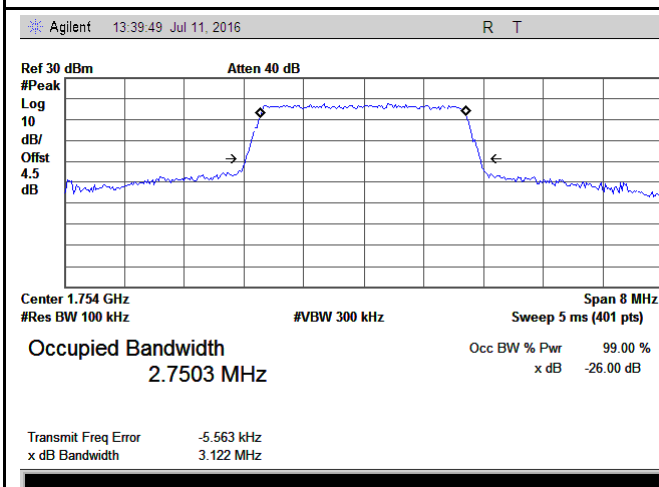

LTE band 4 - High CH QPSK-3

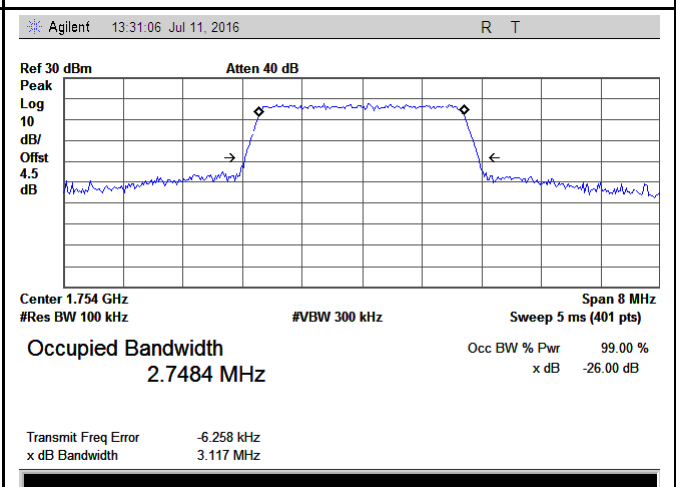

LTE band 4 - High CH 16QAM-3

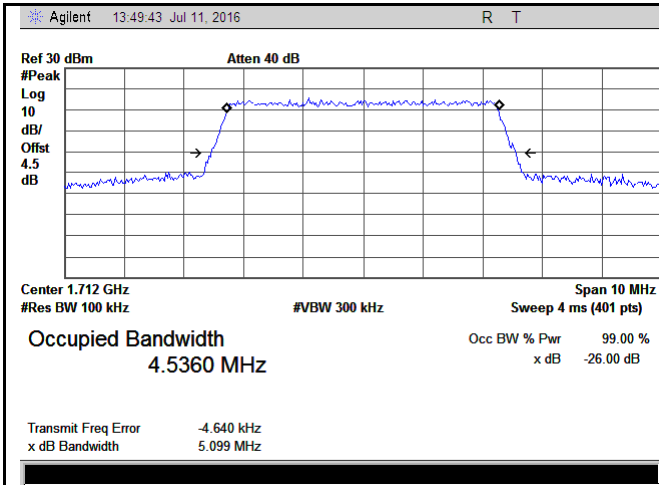

LTE band 4 - Low CH QPSK-5

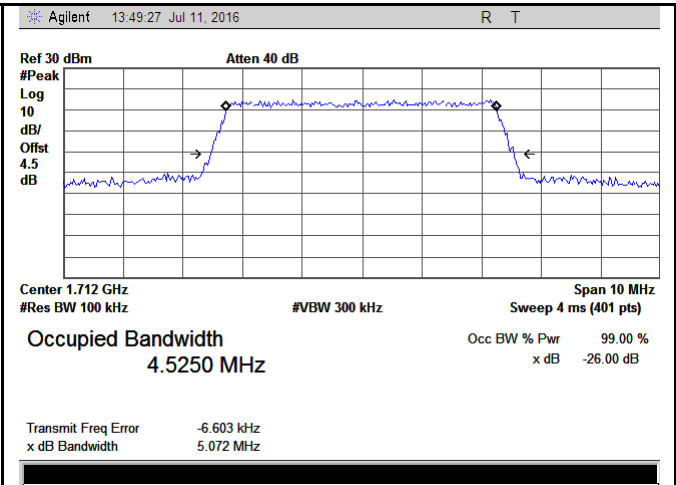

LTE band 4 - Low CH 16QAM-5

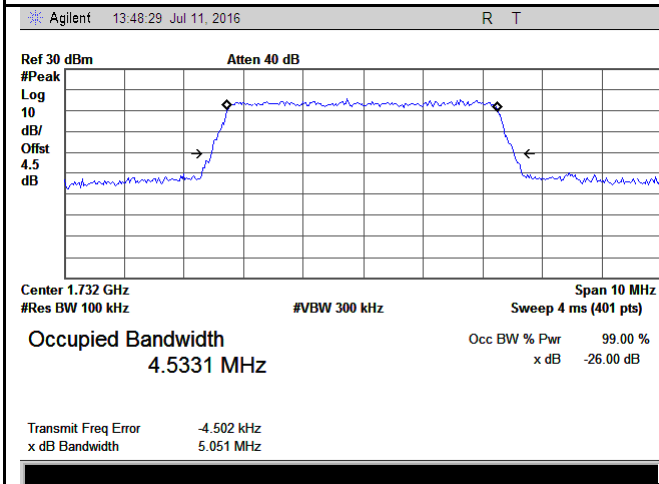

LTE band 4 - Middle CH QPSK-5

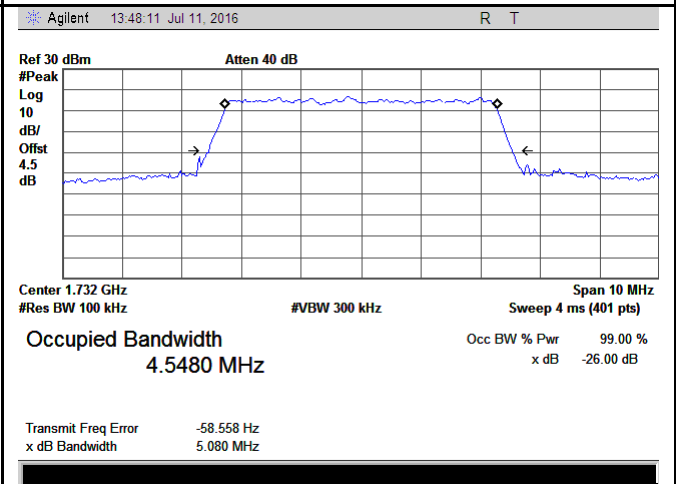

LTE band 4 - Middle CH 16QAM-5

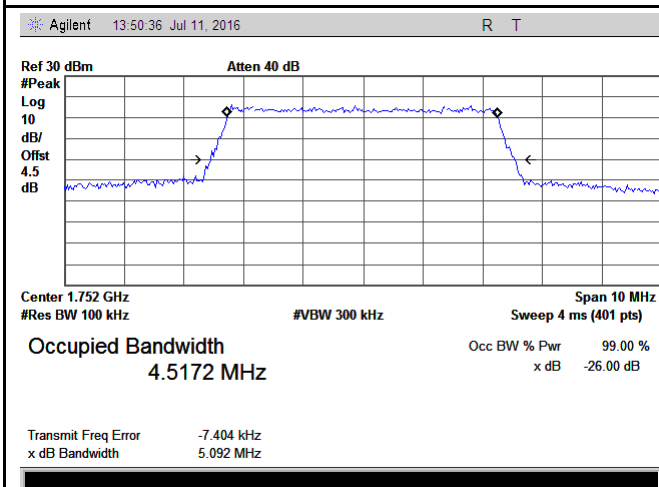

LTE band 4 - High CH QPSK-5

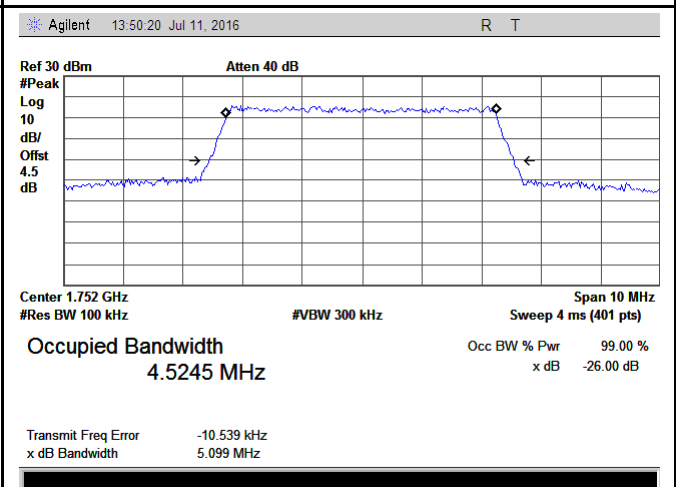

LTE band 4 - High CH 16QAM-5

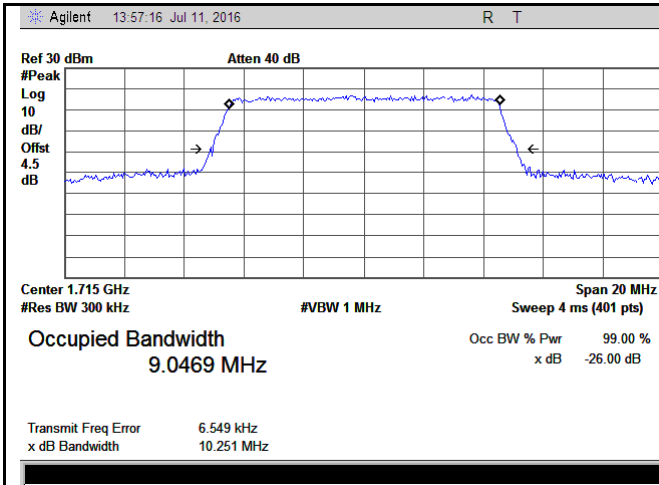

LTE band 4 - Low CH QPSK-10

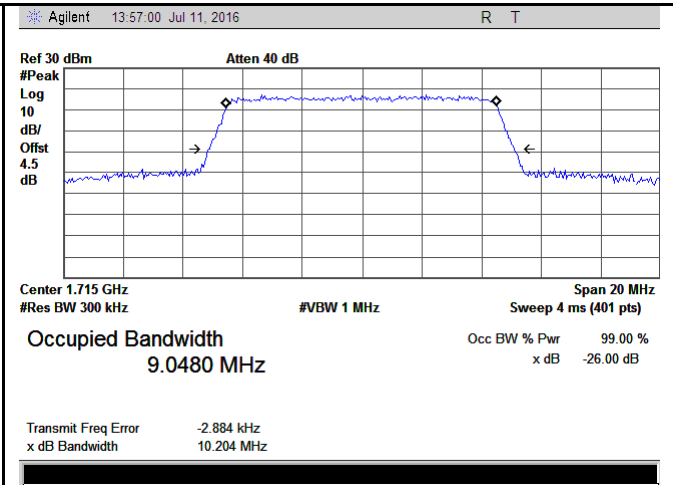

LTE band 4 - Low CH 16QAM-10

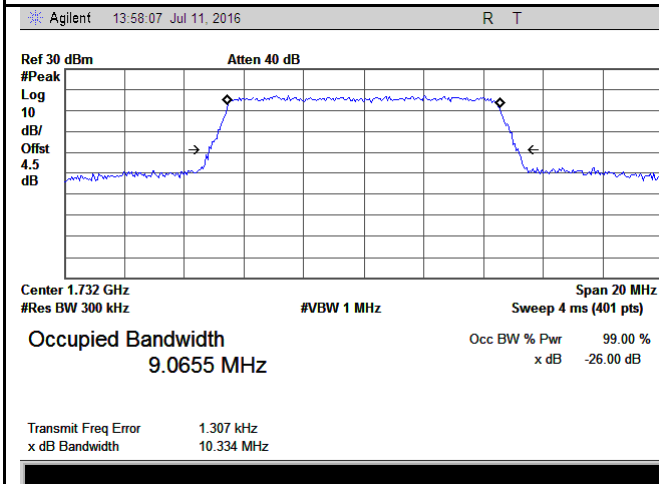

LTE band 4 - Middle CH QPSK-10

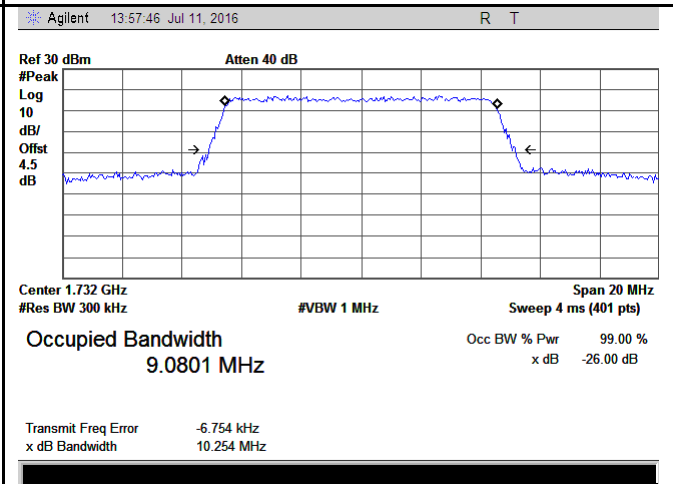

LTE band 4 - Middle CH 16QAM-10

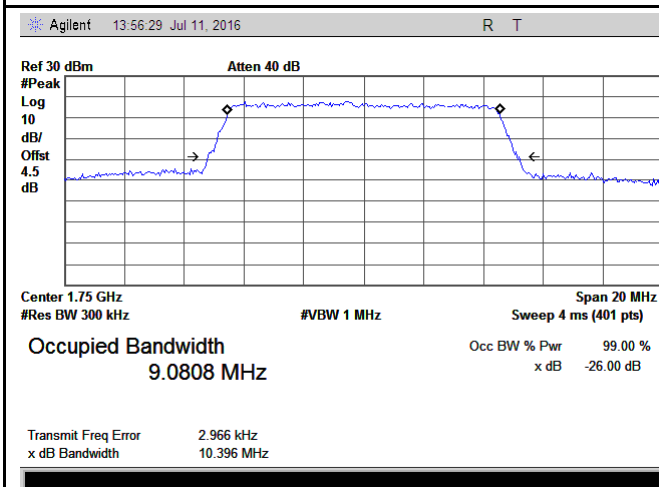

LTE band 4 - High CH QPSK-10

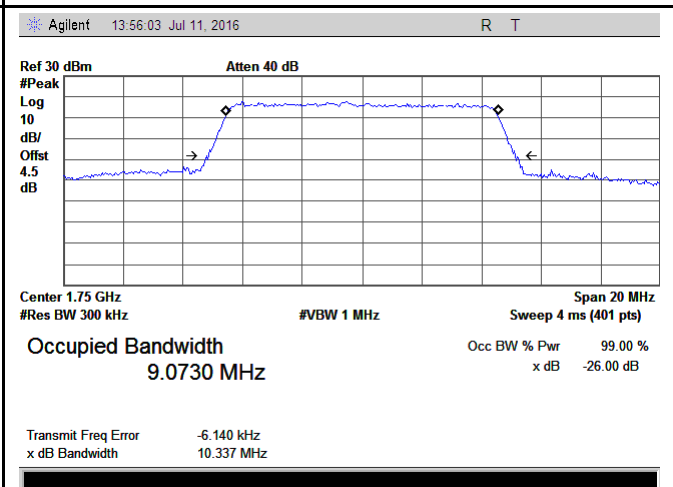

LTE band 4 - High CH 16QAM-10

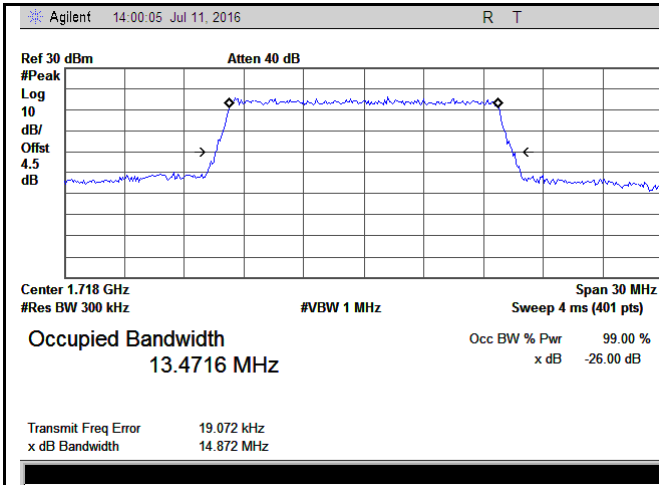

LTE band 4 - Low CH QPSK-15

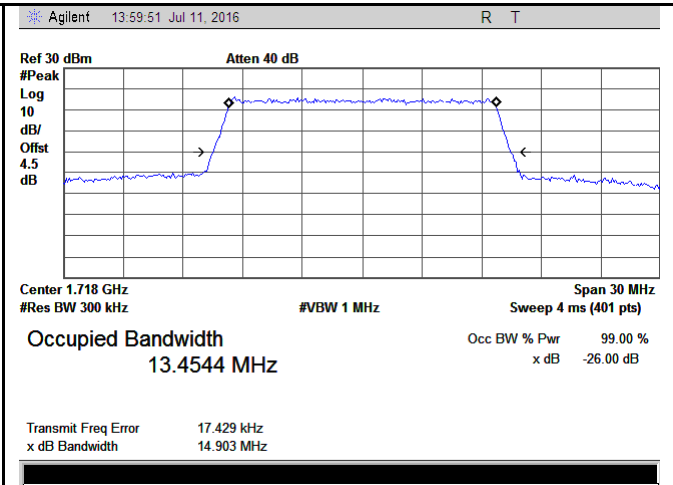

LTE band 4 - Low CH 16QAM-15

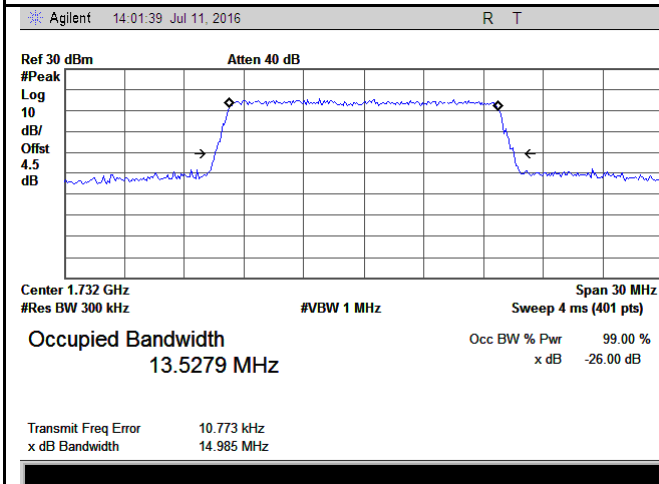

LTE band 4 - Middle CH QPSK-15

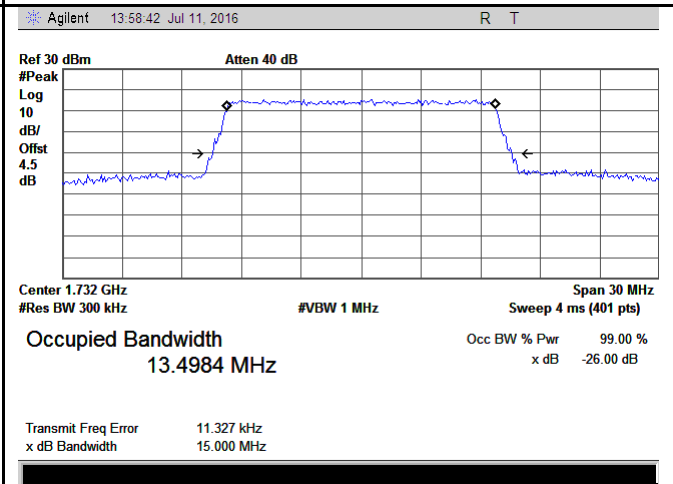

LTE band 4 - Middle CH 16QAM-15

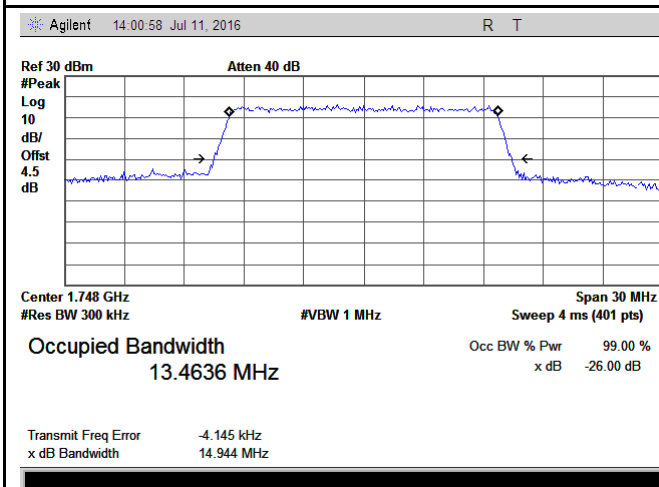

LTE band 4 - High CH QPSK-15

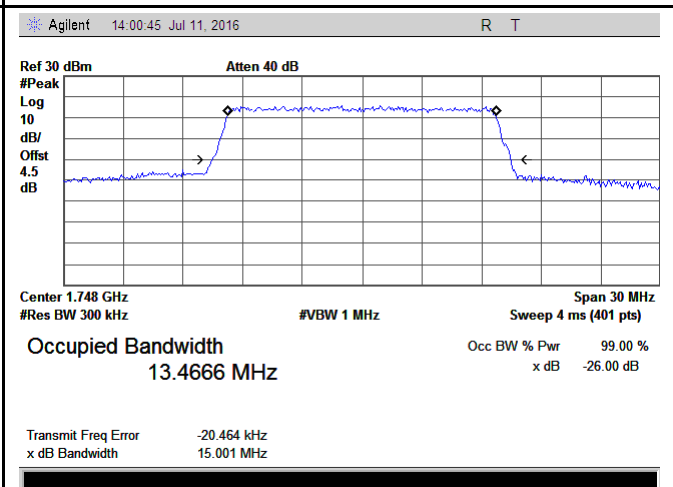

LTE band 4 - High CH 16QAM-15

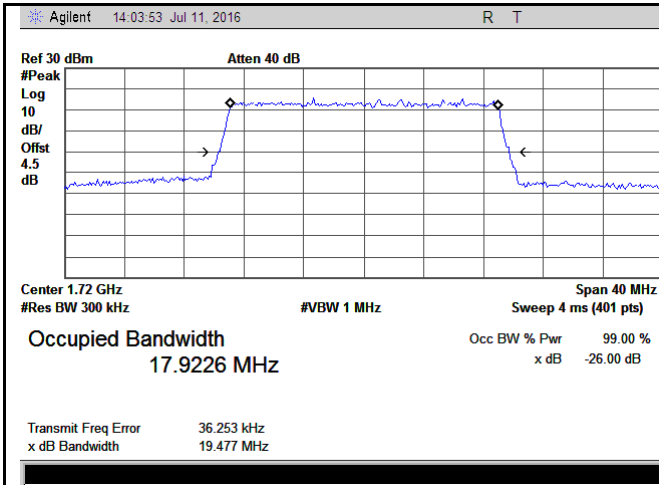

LTE band 4 - Low CH QPSK-20

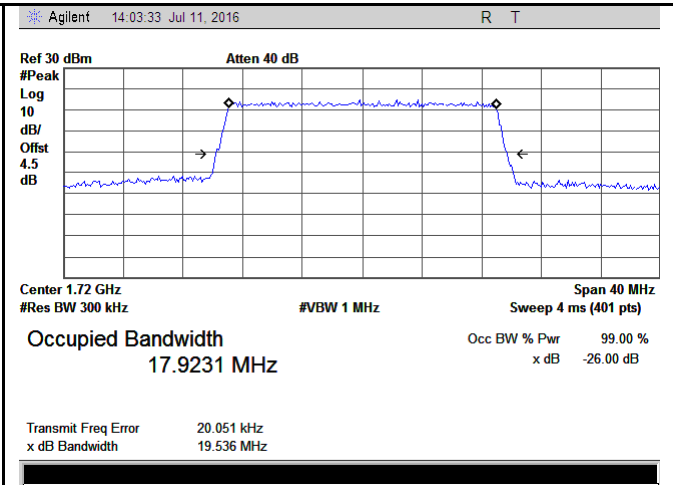

LTE band 4 - Low CH 16QAM-20

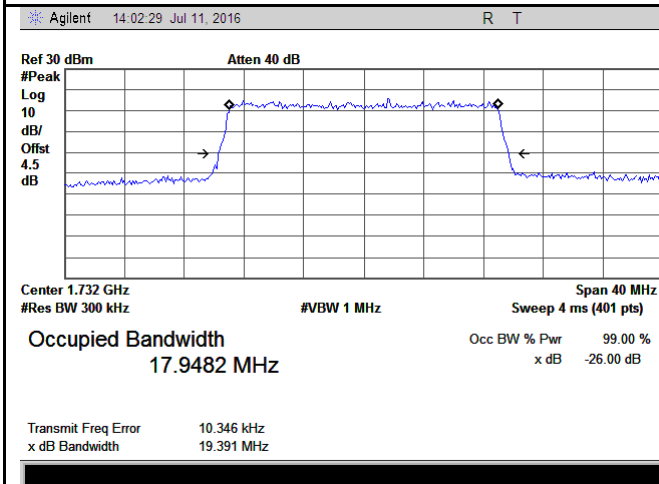

LTE band 4 - Middle CH QPSK-20

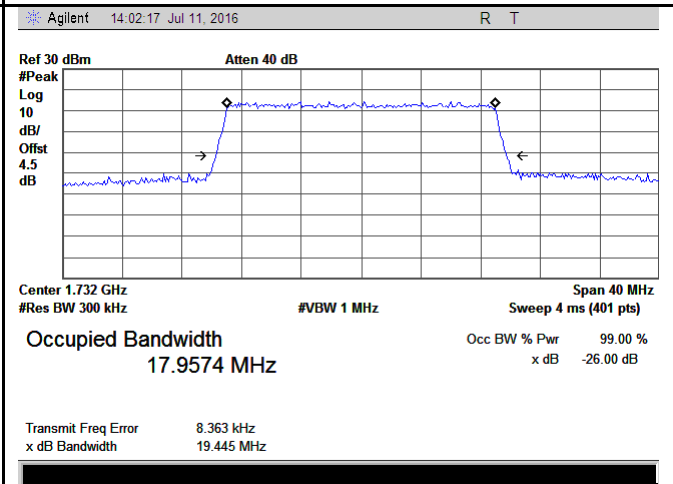

LTE band 4 - Middle CH 16QAM-20

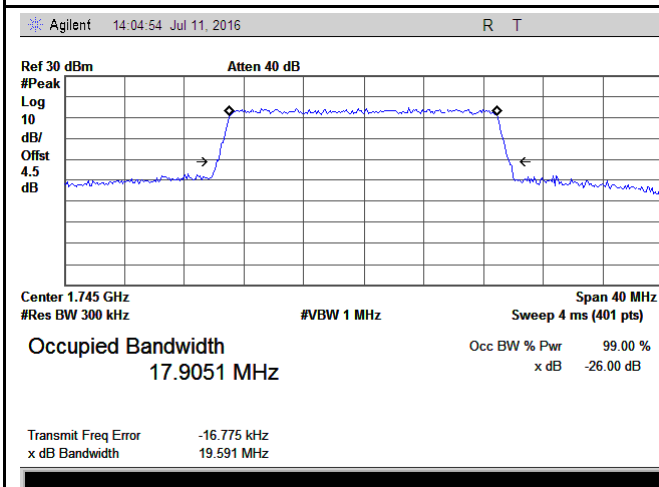

LTE band 4 - High CH QPSK-20

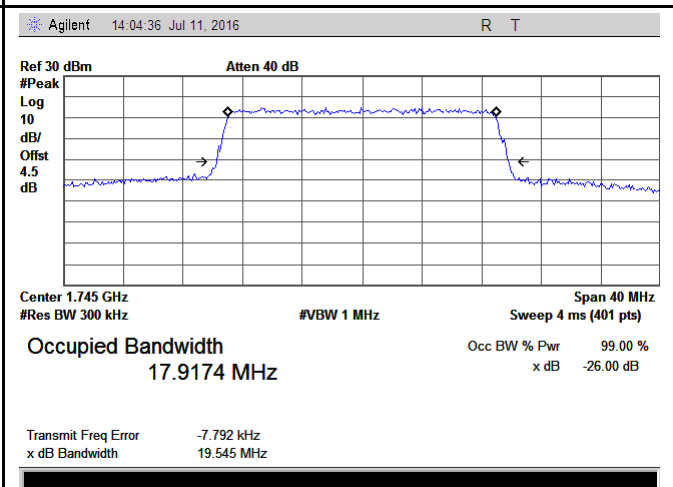

LTE band 4 - High CH 16QAM-20

LTE Band 5 (Part 22H)

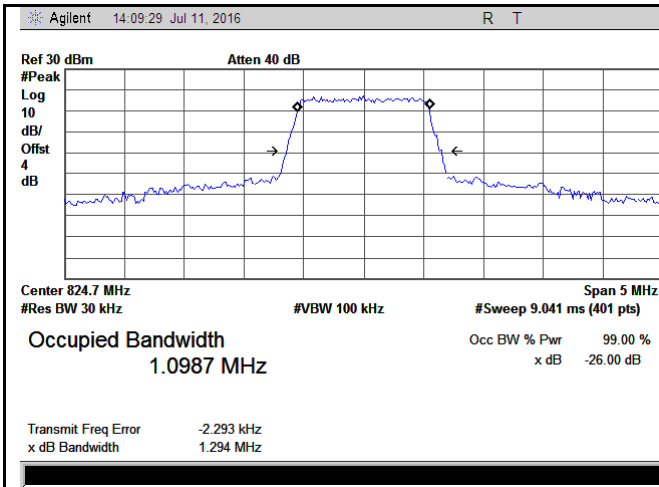

LTE band 5 - Low CH QPSK-1.4

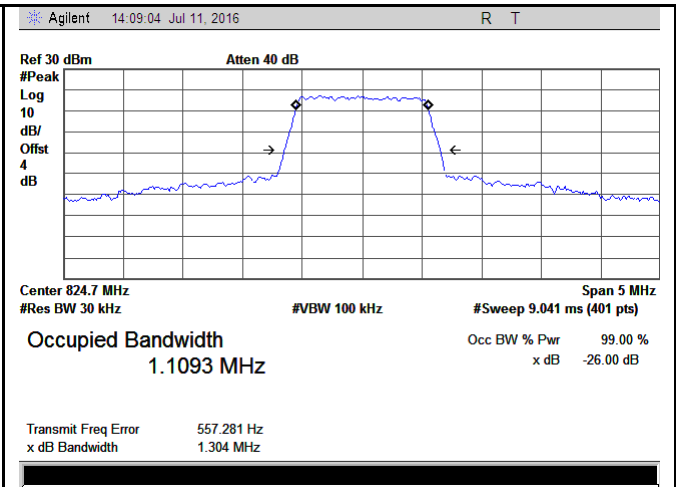

LTE band 5 - Low CH 16QAM-1.4

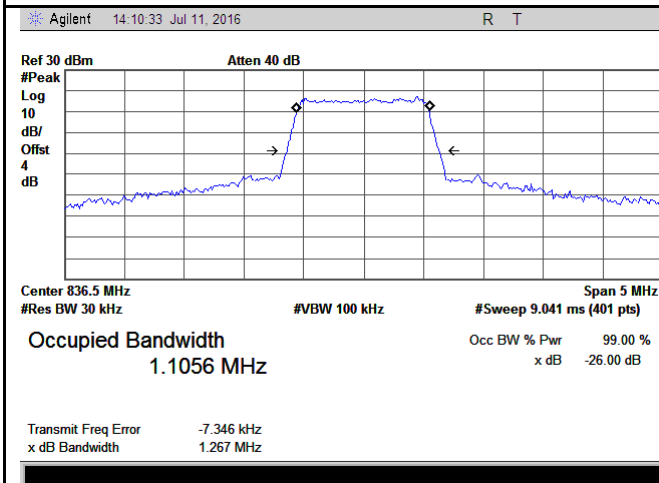

LTE band 5 - Middle CH QPSK-1.4

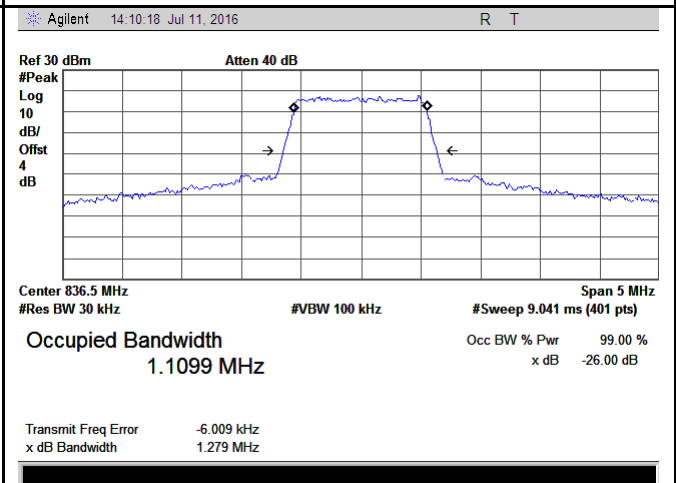

LTE band 5 - Middle CH 16QAM-1.4

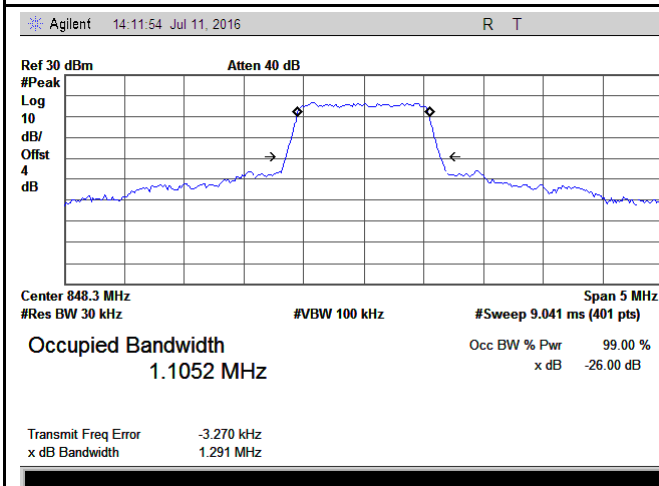

LTE band 5 - High CH QPSK-1.4

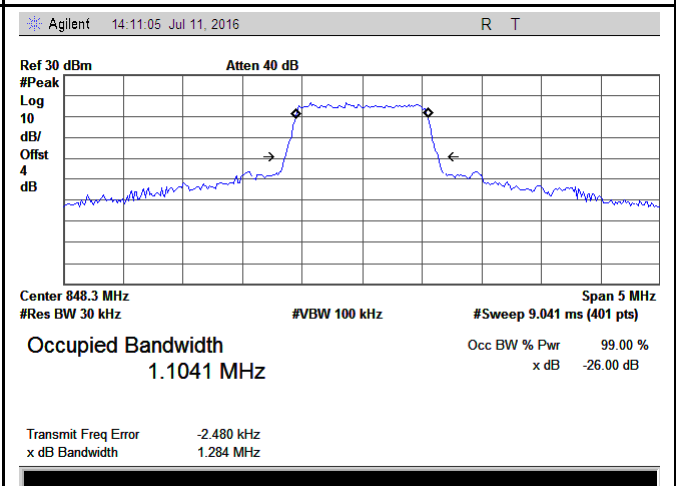

LTE band 5 - High CH 16QAM-1.4

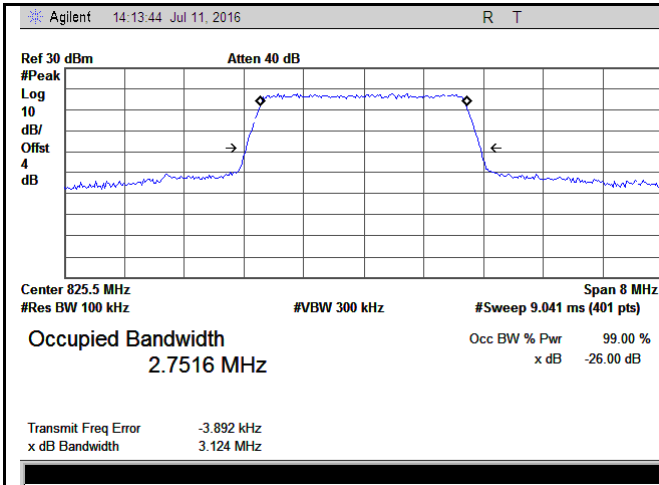

LTE band 5 - Low CH QPSK-3

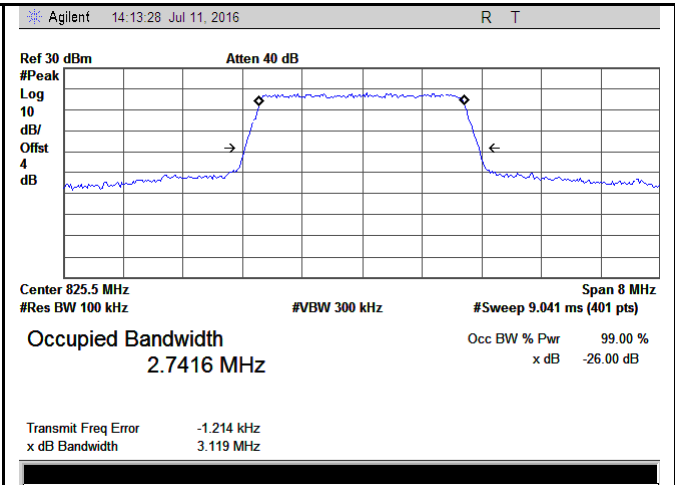

LTE band 5 - Low CH 16QAM-3

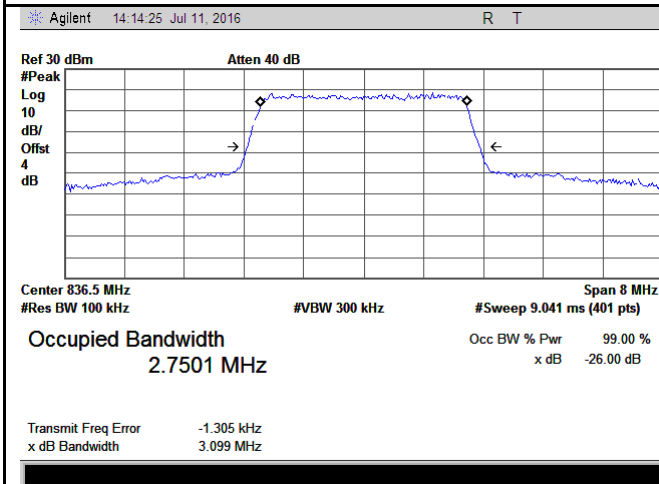

LTE band 5 - Middle CH QPSK-3

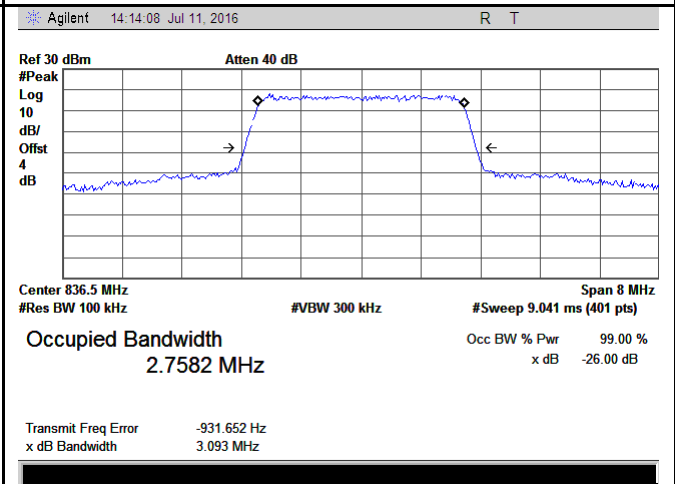

LTE band 5 - Middle CH 16QAM-3

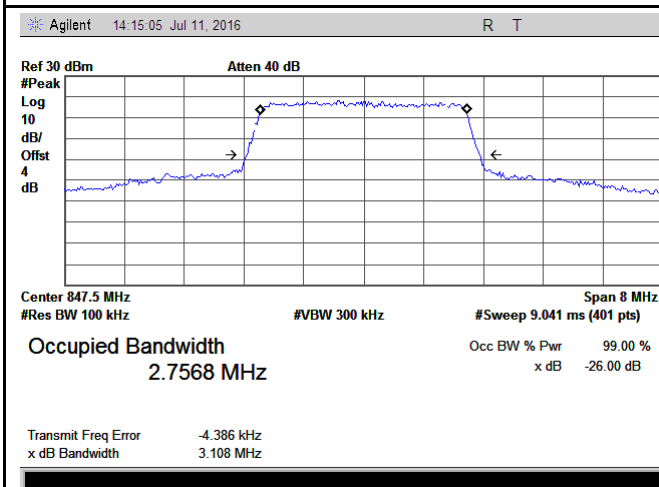

LTE band 5 - High CH QPSK-3

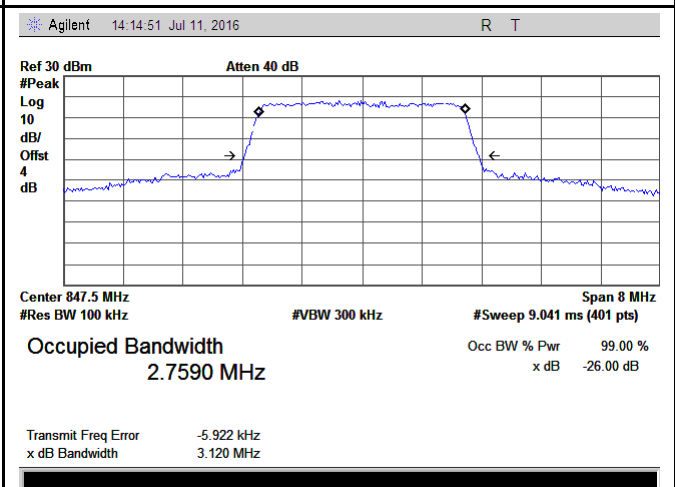

LTE band 5 - High CH 16QAM-3

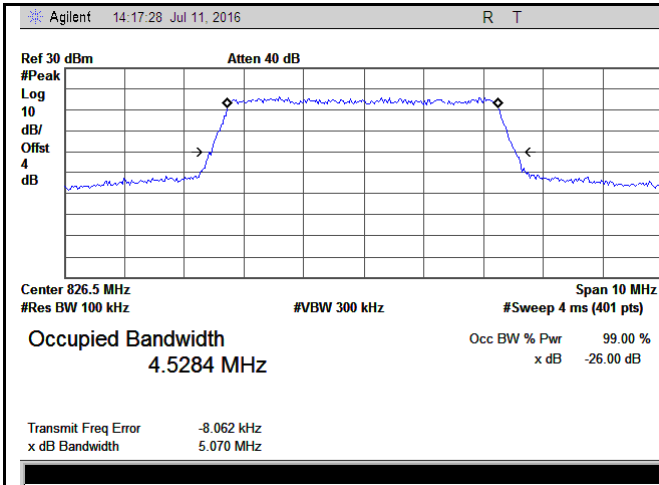

LTE band 5 - Low CH QPSK-5

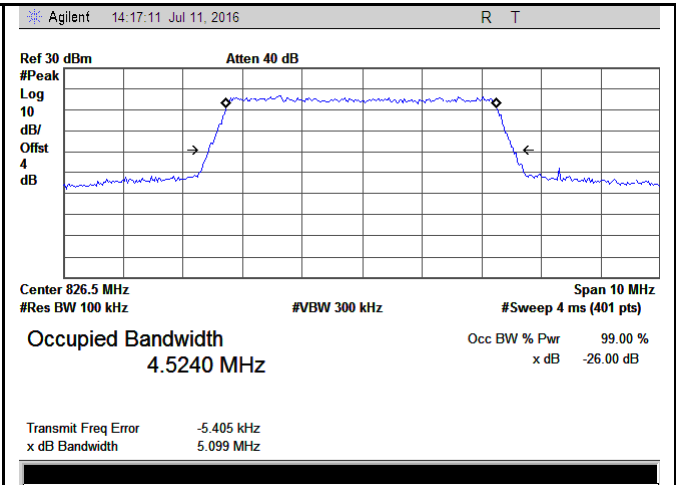

LTE band 5 - Low CH 16QAM-5

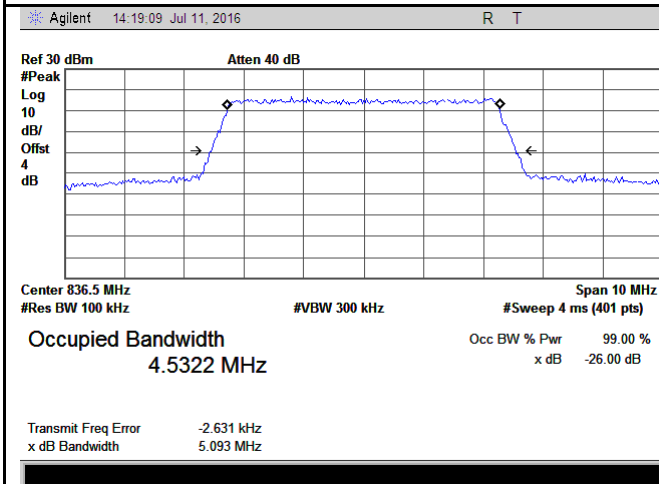

LTE band 5 - Middle CH QPSK-5

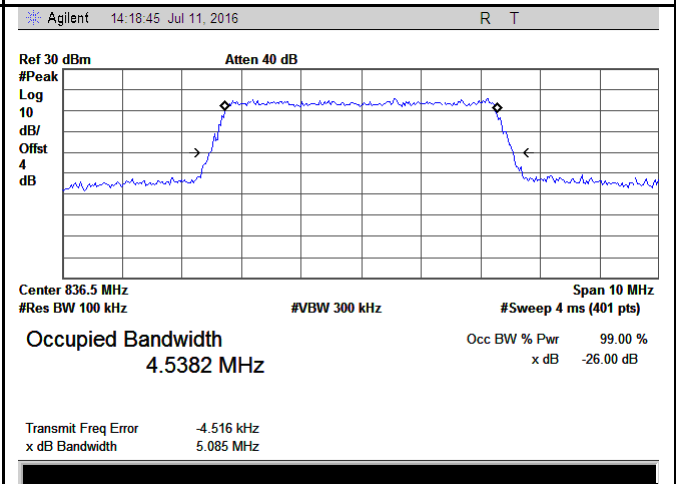

LTE band 5 - Middle CH 16QAM-5

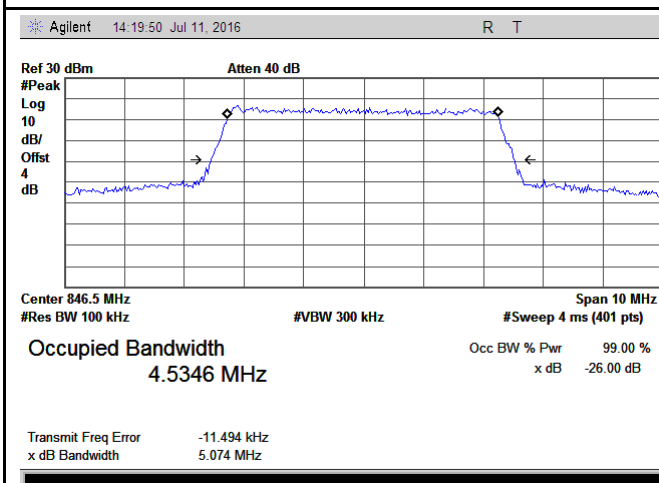

LTE band 5 - High CH QPSK-5

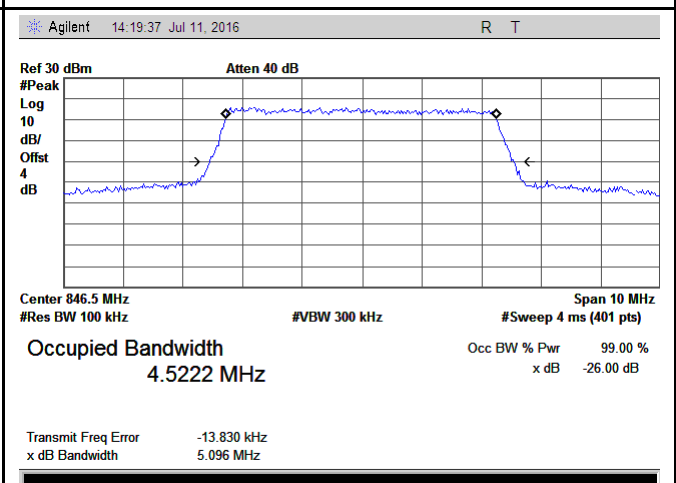

LTE band 5 - High CH 16QAM-5

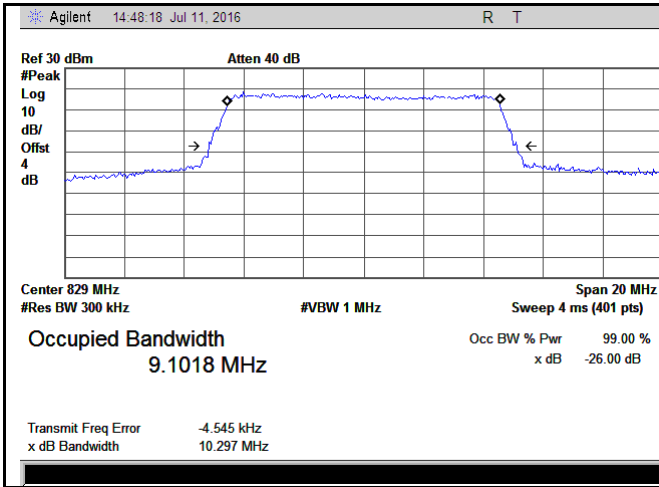

LTE band 5 - Low CH QPSK-10

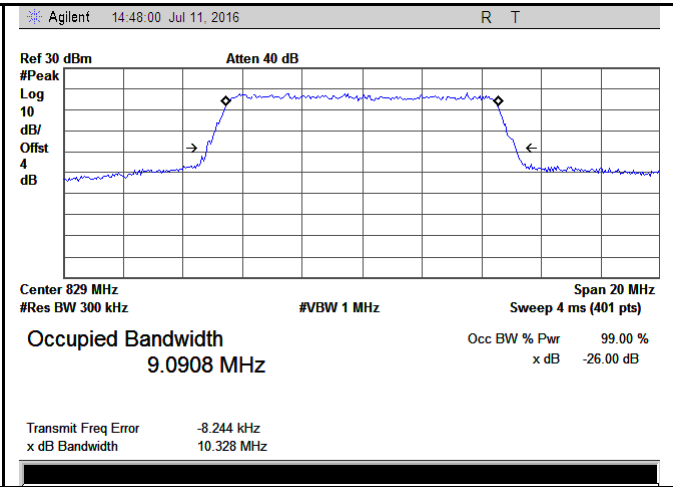

LTE band 5 - Low CH 16QAM-10

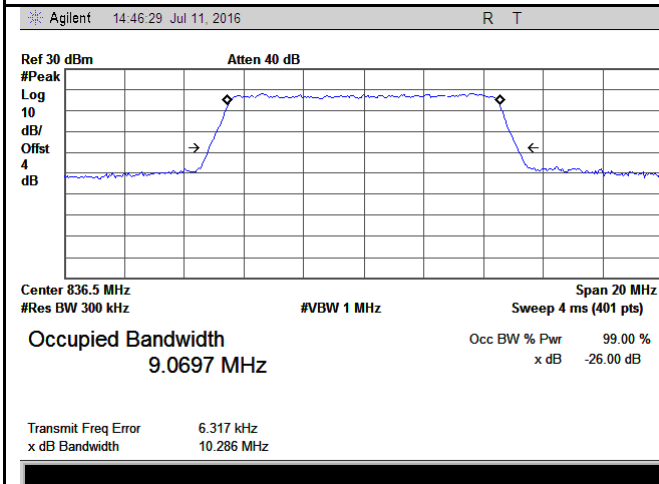

LTE band 5 - Middle CH QPSK-10

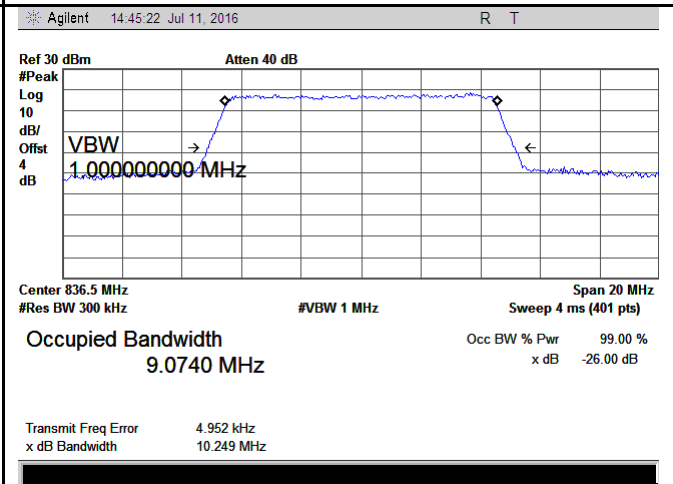

LTE band 5 - Middle CH 16QAM-10

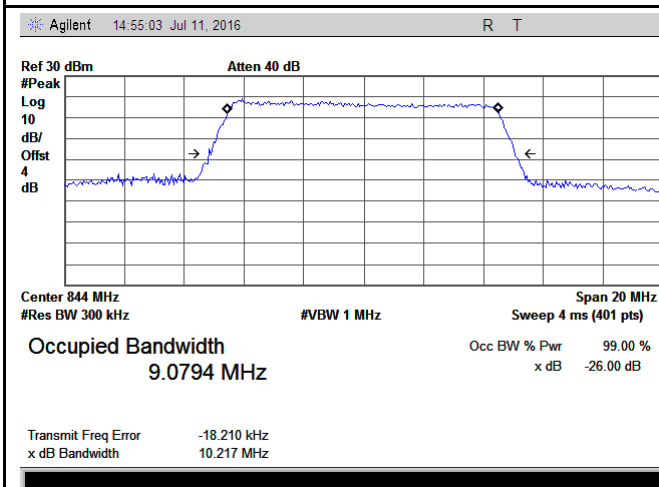

LTE band 5 - High CH QPSK-10

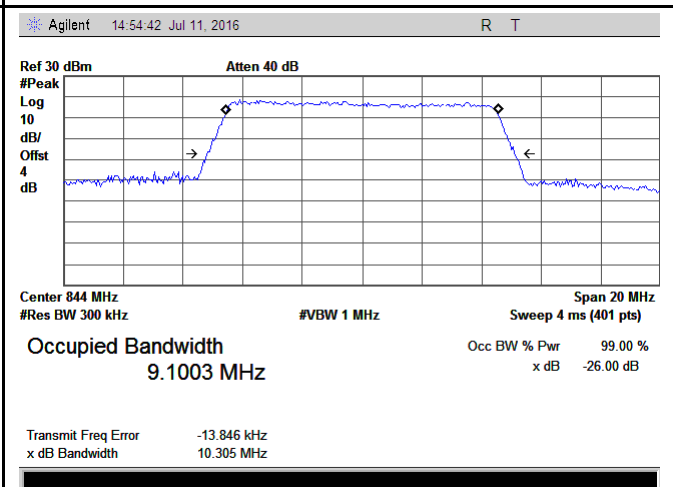

LTE band 5 - High CH 16QAM-10

LTE Band 7 (Part 27)

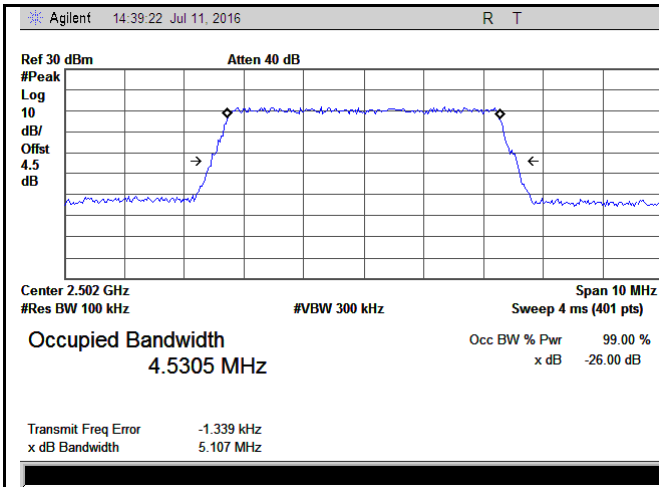

LTE band 7 - Low CH QPSK-5

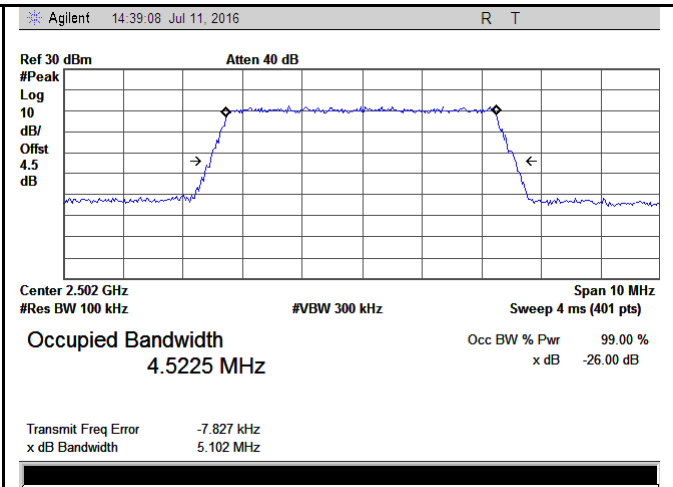

LTE band 7 - Low CH 16QAM-5

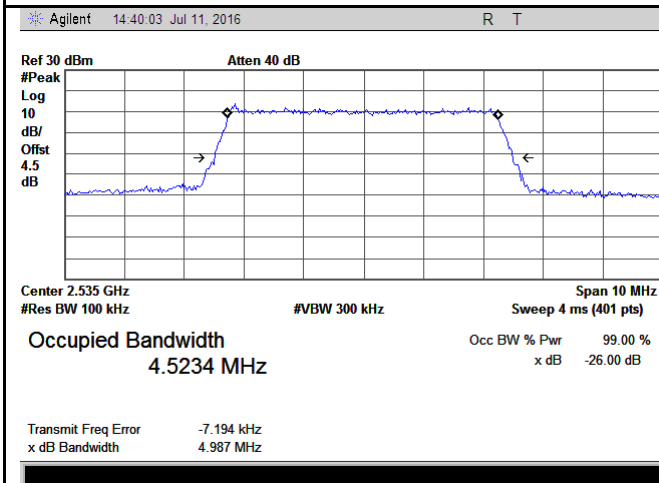

LTE band 7 - Middle CH QPSK-5

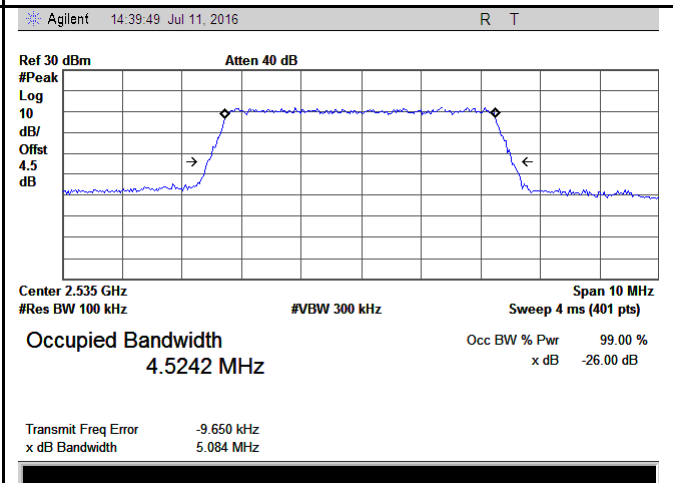

LTE band 7 - Middle CH 16QAM-5

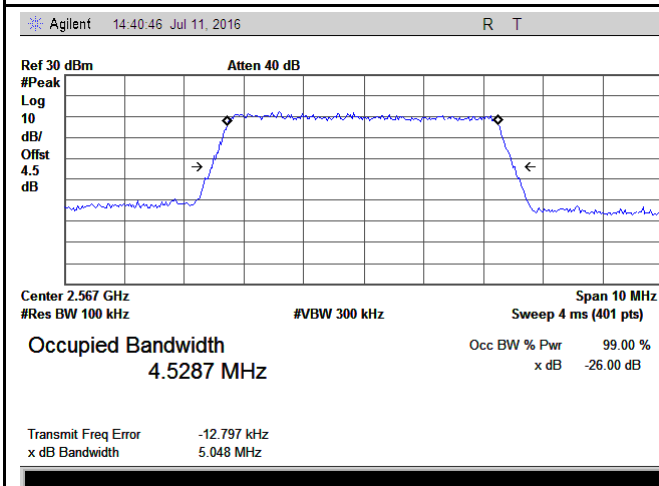

LTE band 7 - High CH QPSK-5

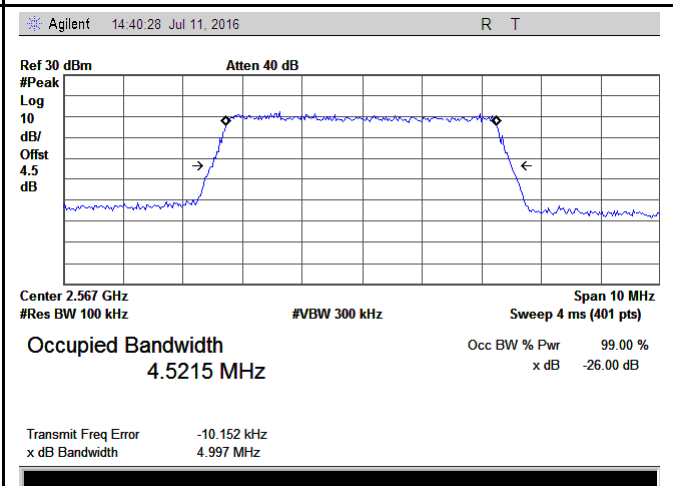

LTE band 7 - High CH 16QAM-5

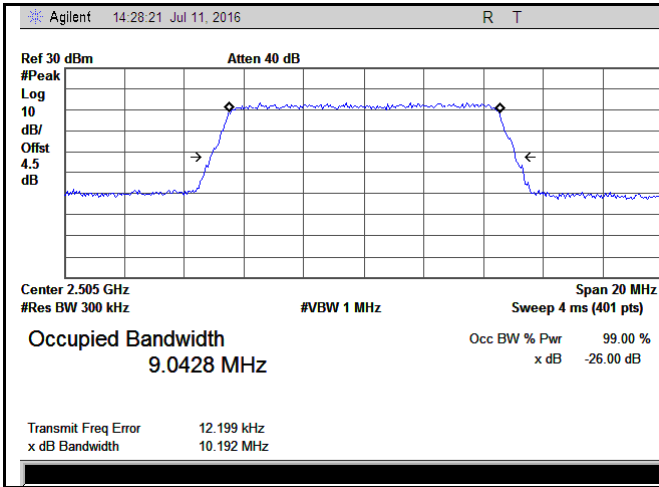

LTE band 7 - Low CH QPSK-10

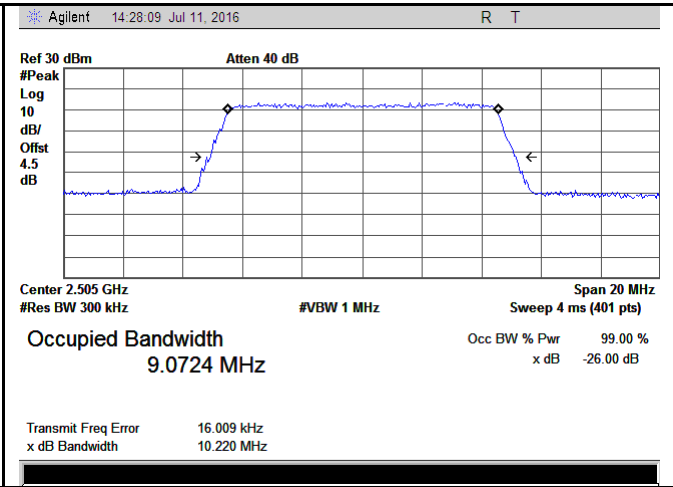

LTE band 7 - Low CH 16QAM-10

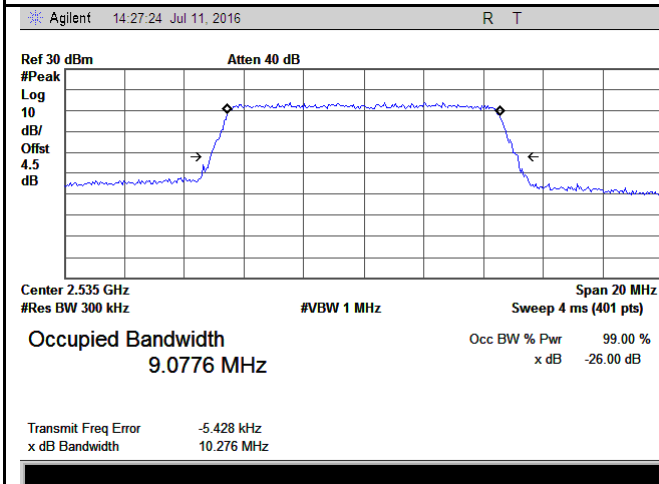

LTE band 7 - Middle CH QPSK-10

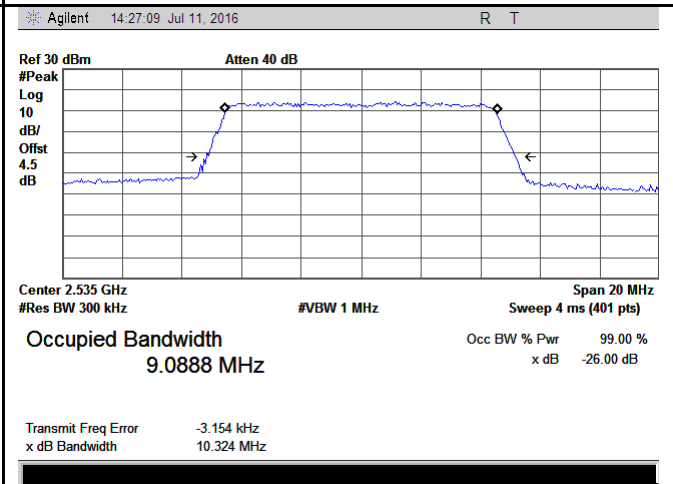

LTE band 7 - Middle CH 16QAM-10

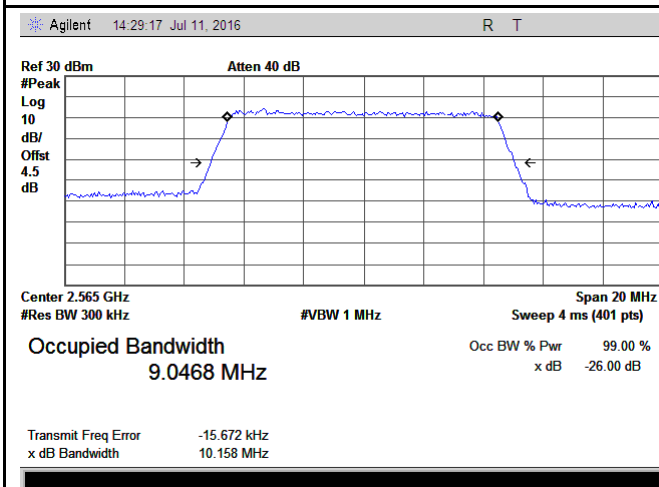

LTE band 7 - High CH QPSK-10

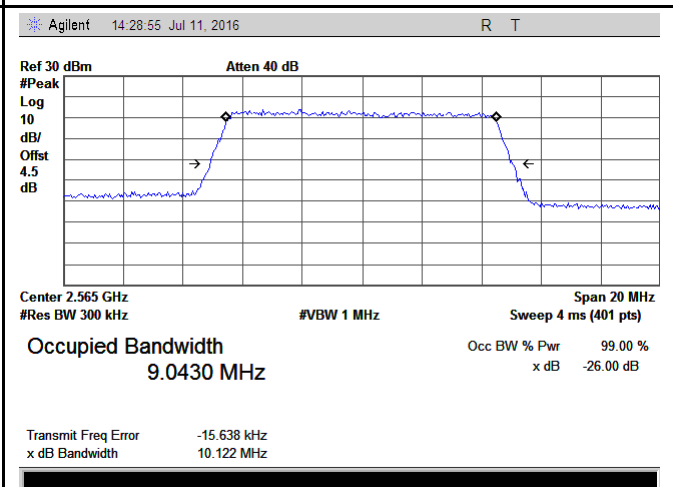

LTE band 7 - High CH 16QAM-10

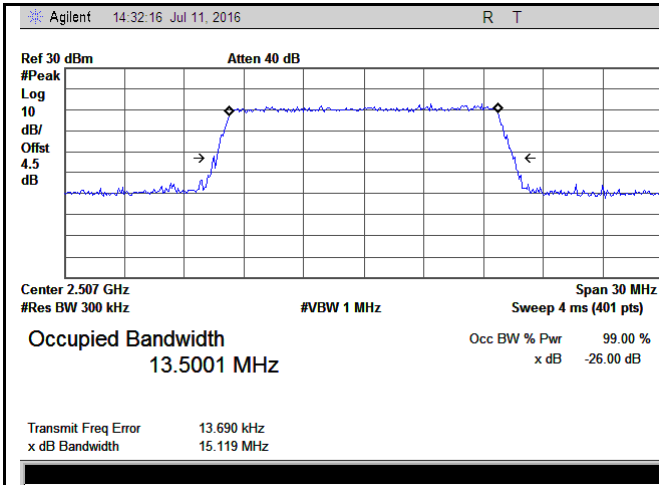

LTE band 7 - Low CH QPSK-15

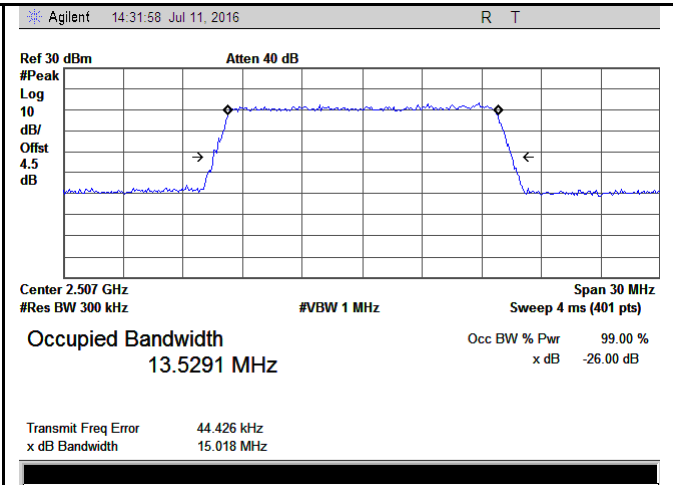

LTE band 7 - Low CH 16QAM-15

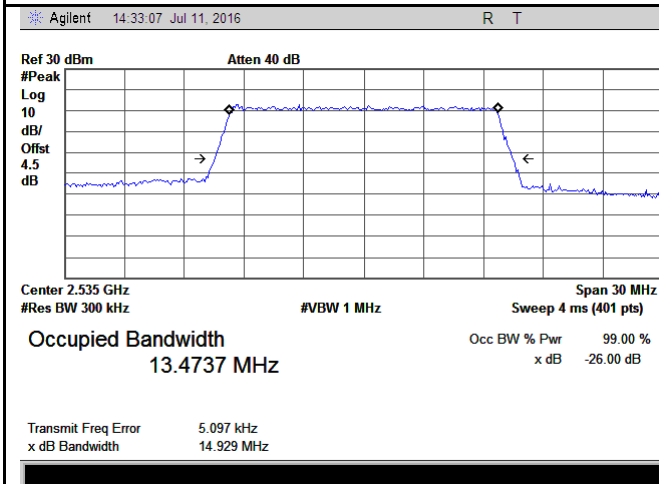

LTE band 7 - Middle CH QPSK-15

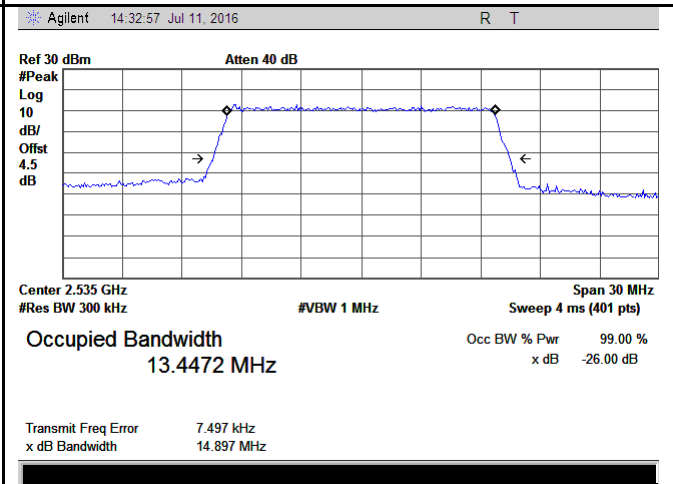

LTE band 7 - Middle CH 16QAM-15

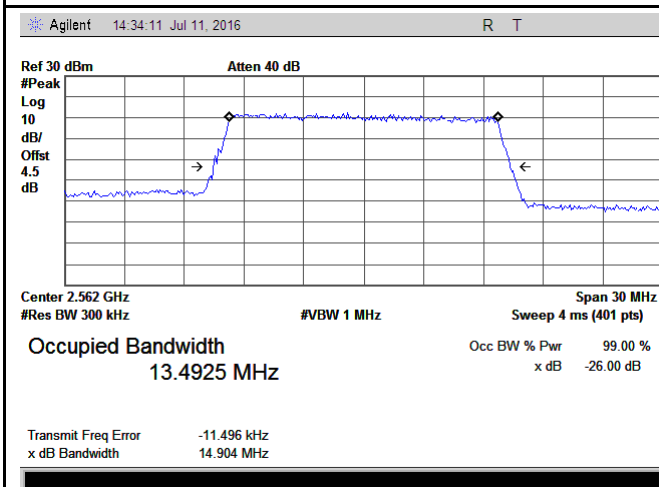

LTE band 7 - High CH QPSK-15

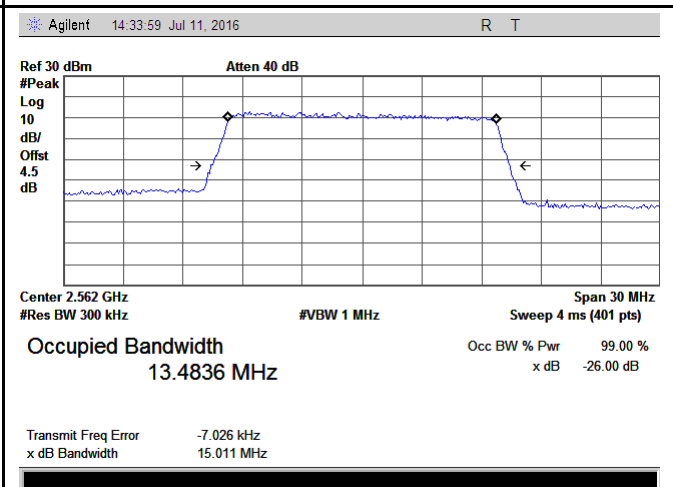

LTE band 7 - High CH 16QAM-15

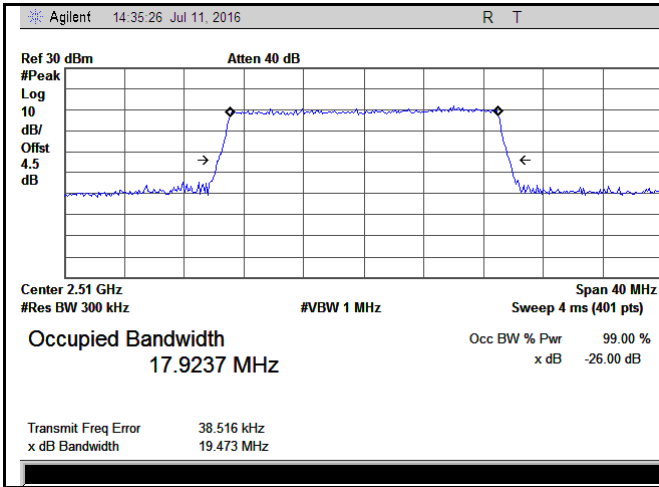

LTE band 7 - Low CH QPSK-20

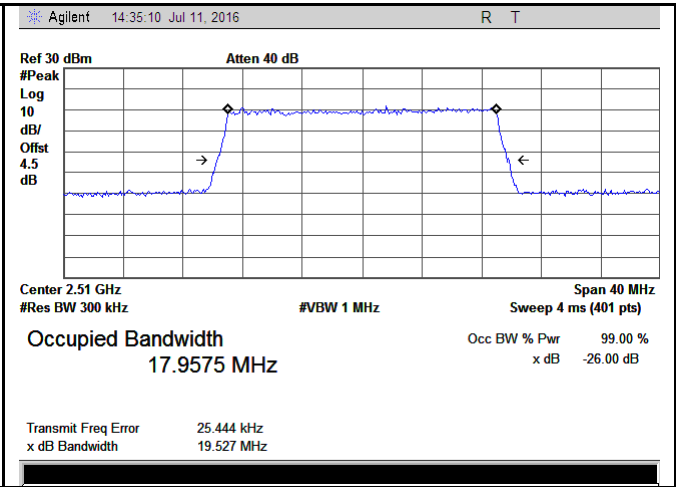

LTE band 7 - Low CH 16QAM-20

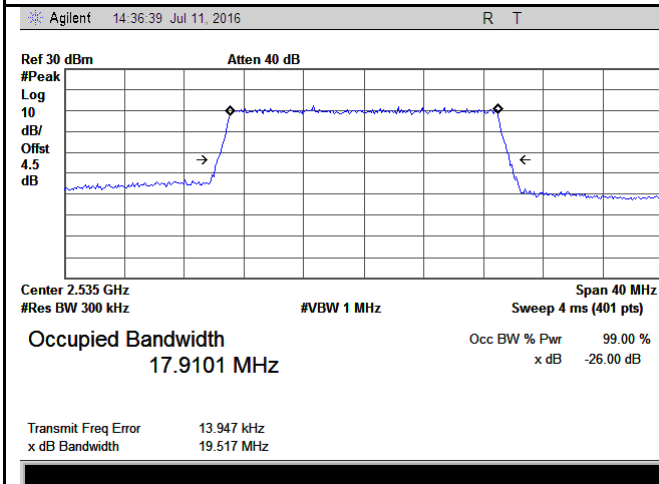

LTE band 7 - Middle CH QPSK-20

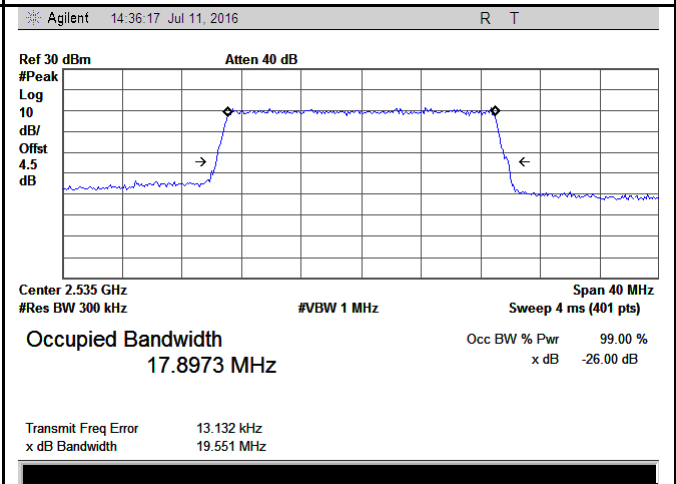

LTE band 7 - Middle CH 16QAM-20

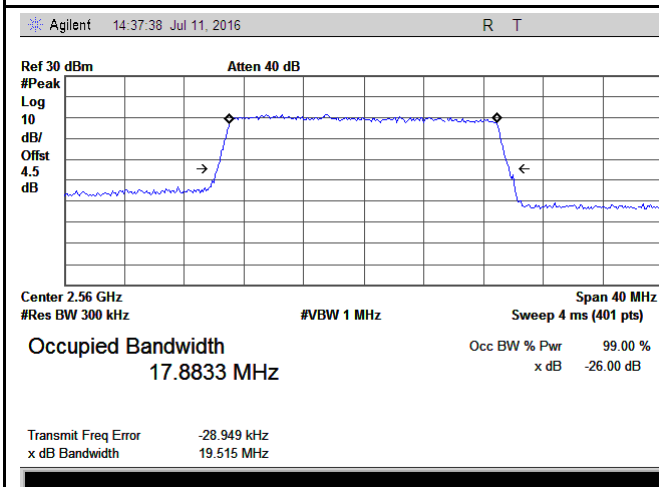

LTE band 7 - High CH QPSK-20

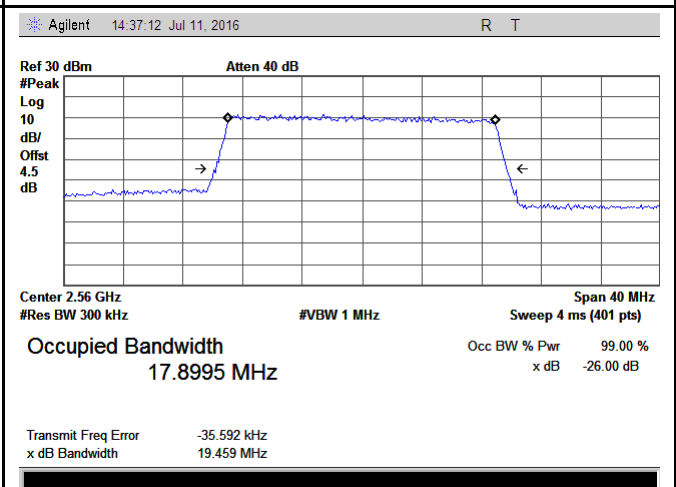

LTE band 7 - High CH 16QAM-20

6.5 Spurious Emissions at Antenna Terminals

Temperature	24°C
Relative Humidity	53%
Atmospheric Pressure	1011mbar
Test date :	July 11, 2016
Tested By :	Loren Luo

Requirement(s):

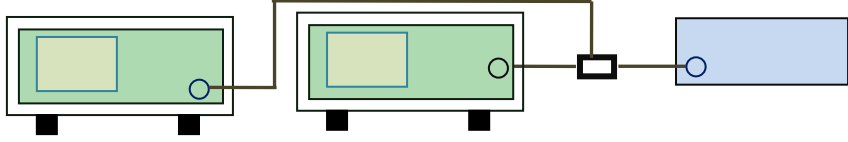
Spec	Item	Requirement	Applicable
§2.1051, §22.917(a)& §24.238(a) § 27.53(h)	a)	The power of any emission outside of the authorized operating frequency ranges must be lower than the transmitter power (P) by a factor of at least $43 + 10 \log(P)$ dB	<input checked="" type="checkbox"/>
Test Setup			
Test Procedure	<ul style="list-style-type: none"> - The EUT was connected to Spectrum Analyzer and Base Station via power divider. - The Band Edges of low and high channels for the highest RF powers were measured. - Setting RBW as roughly BW/100. 		
Remark			
Result	<input checked="" type="checkbox"/> Pass <input type="checkbox"/> Fail		

Test Data Yes N/A
 Test Plot Yes (See below) N/A

Test Plots 30MHz-5GHz
LTE Band 2 (Part 24E)

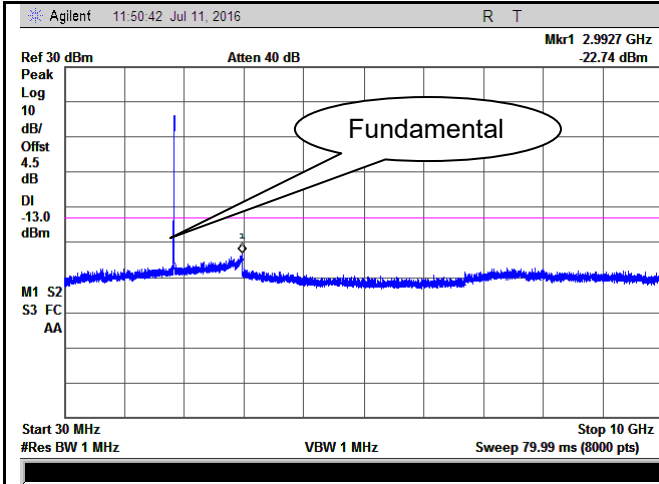

LTE Band 2 - Low Channel-1

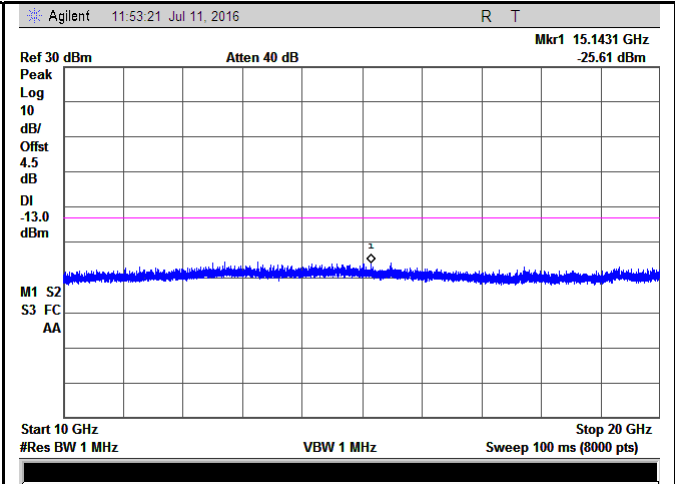

LTE Band 2 - Low Channel-2

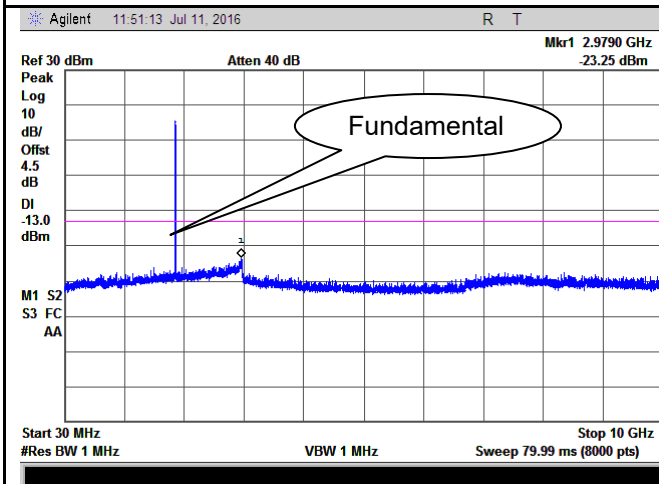

LTE Band 2 Middle Channel-1

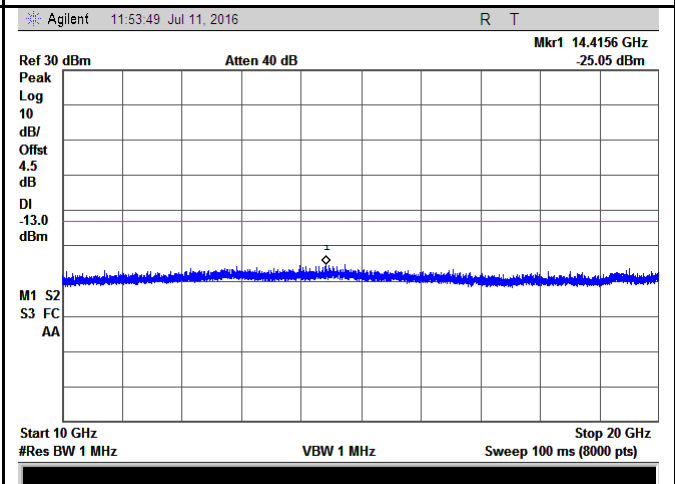

LTE Band 2 Middle Channel-2

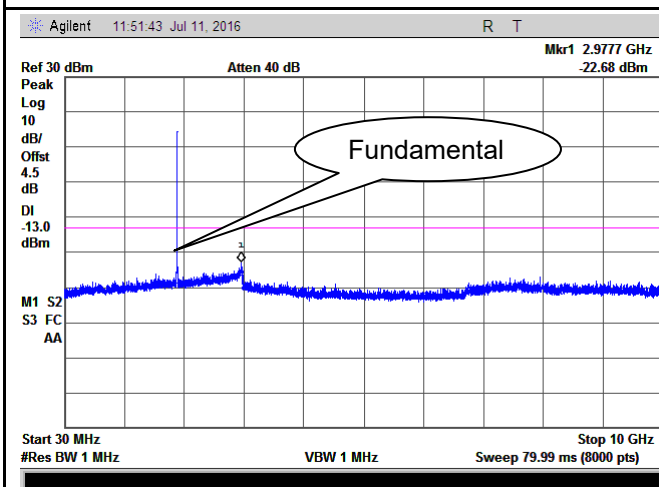

LTE Band 2 - High Channel-1

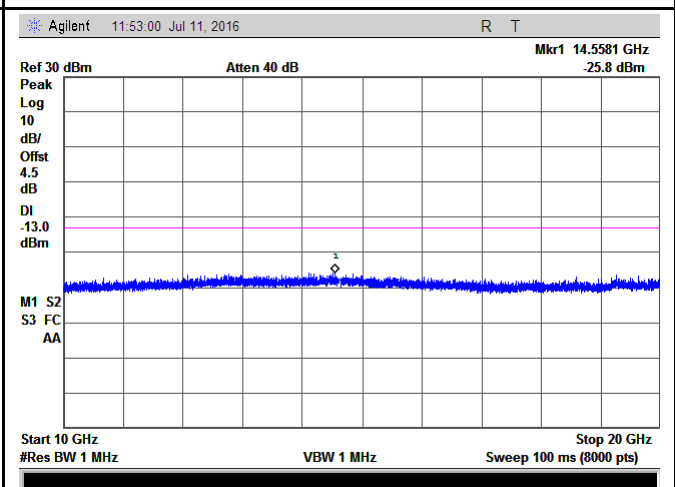

LTE Band 2 - High Channel-2

LTE Band 4 (Part27) result

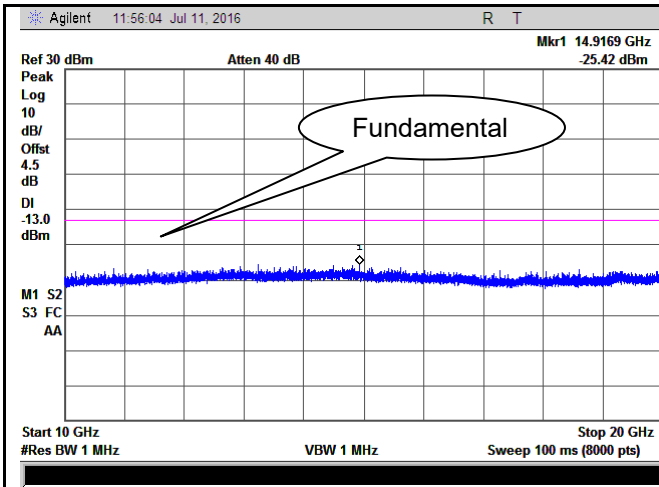

LTE Band 4 - Low Channel-1

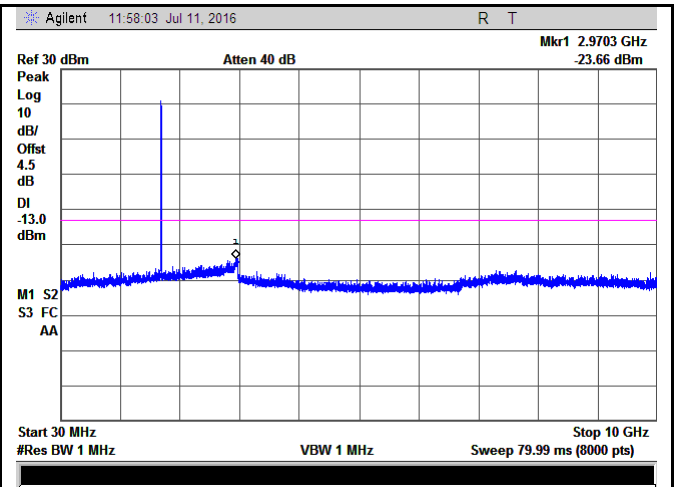

LTE Band 4 - Low Channel-2

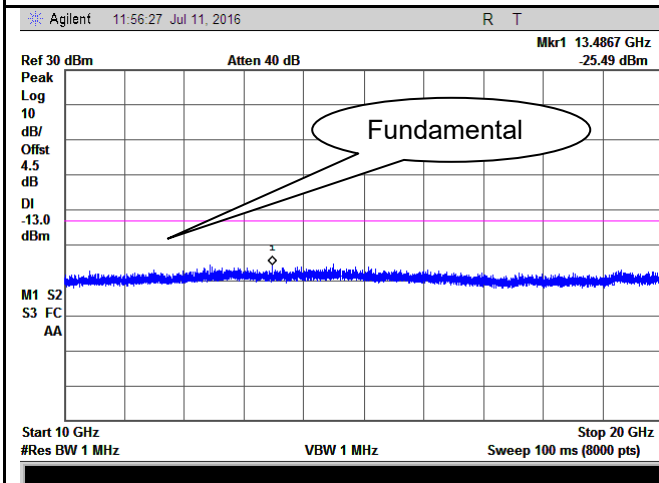

LTE Band 4 - Middle Channel-1

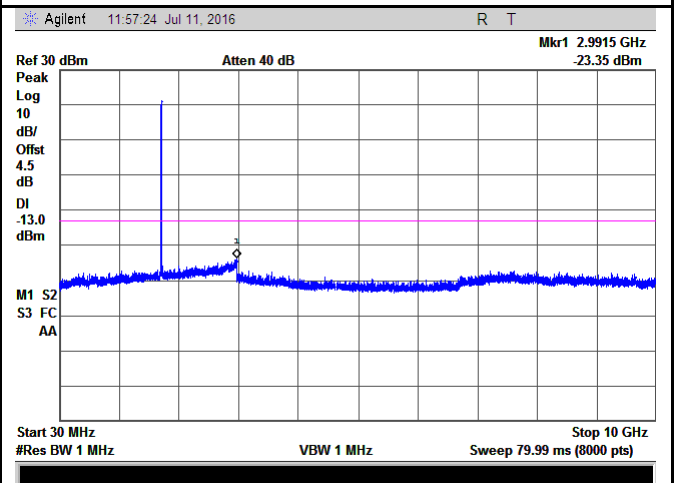

LTE Band 4 - Middle Channel-2

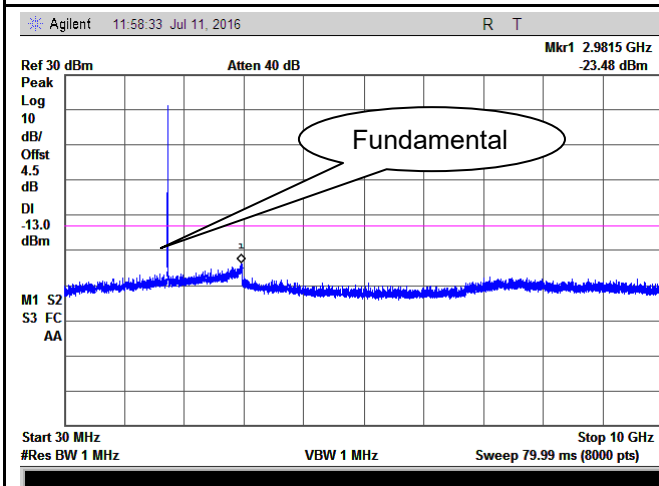

LTE Band 4 - High Channel-1

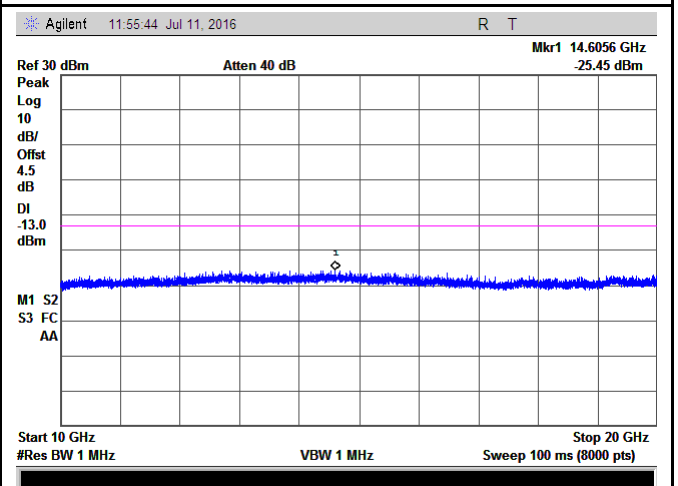

LTE Band 4 - High Channel-2

LTE Band 5 (Part 22H)

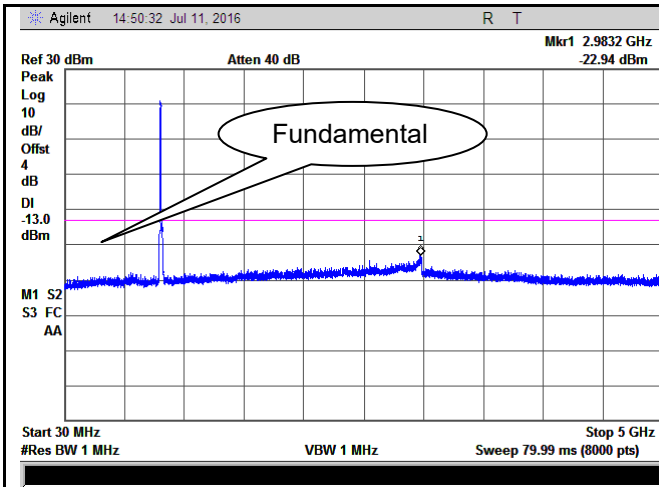

LTE Band 5 - Low Channel-1

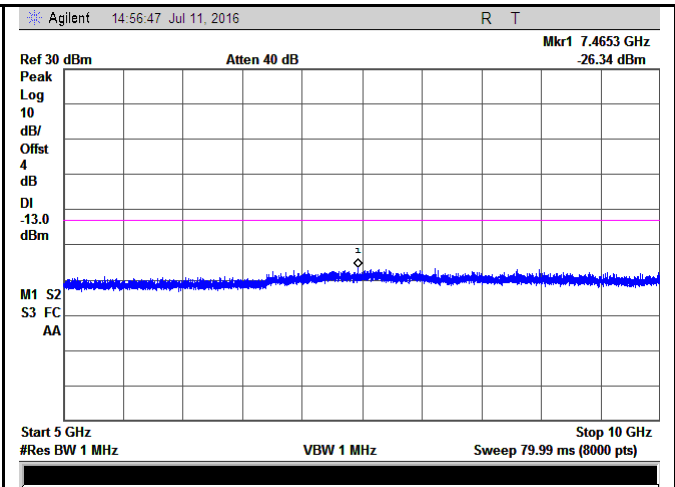

LTE Band 5 - Low Channel-2

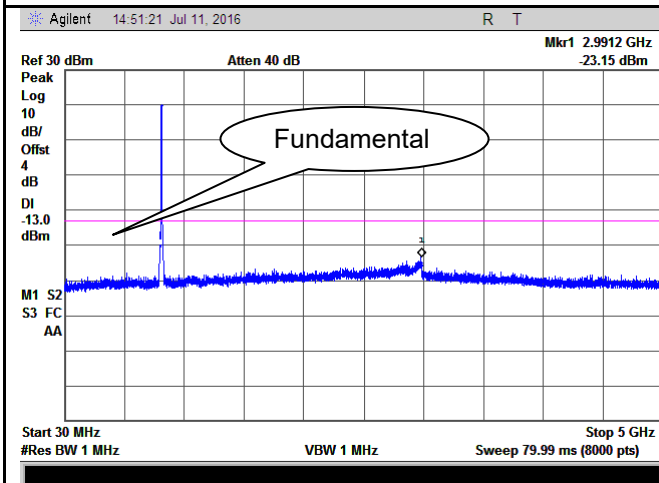

LTE Band 5- Middle Channel-1

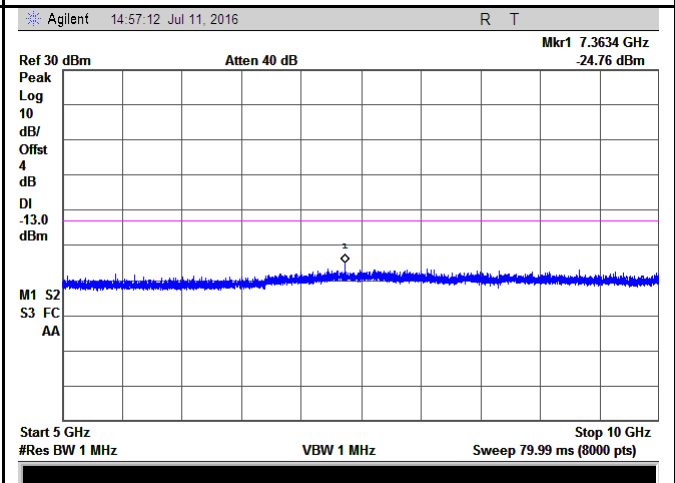

LTE Band 5 - Middle Channel-2

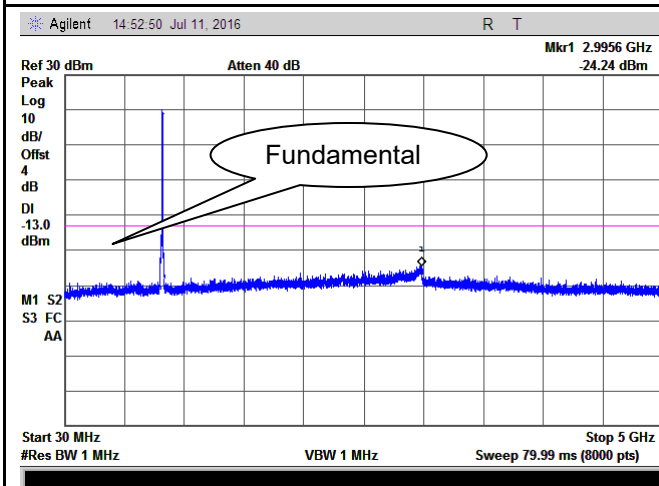

LTE Band 5 - High Channel-1

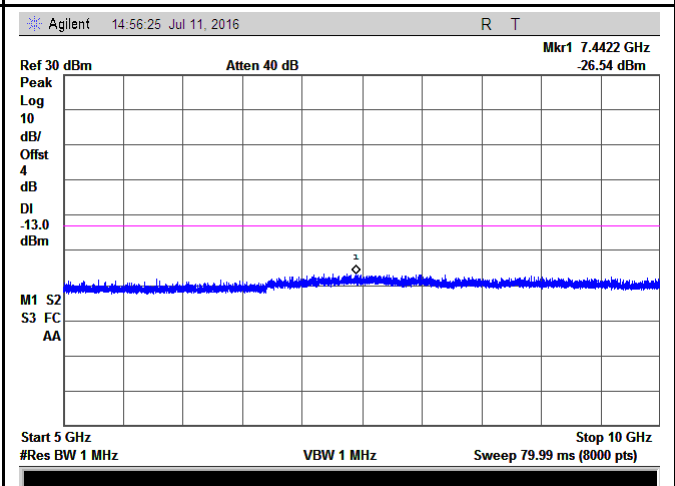

LTE Band 5 - High Channel-2

LTE Band 7 (Part 27)

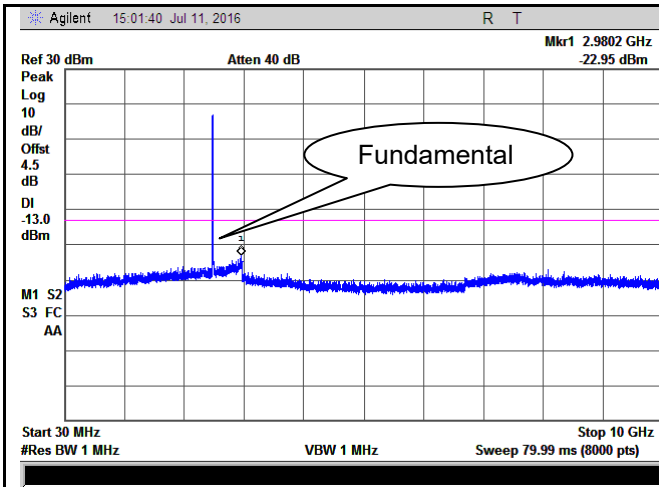

LTE Band 7 - Low Channel-1

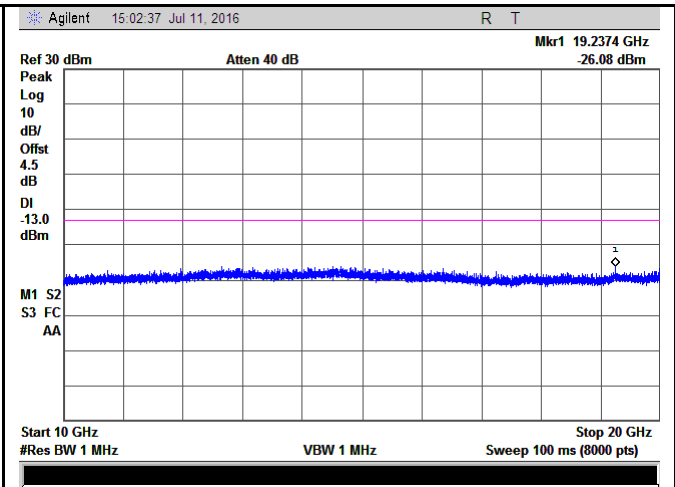

LTE Band 7 - Low Channel-2

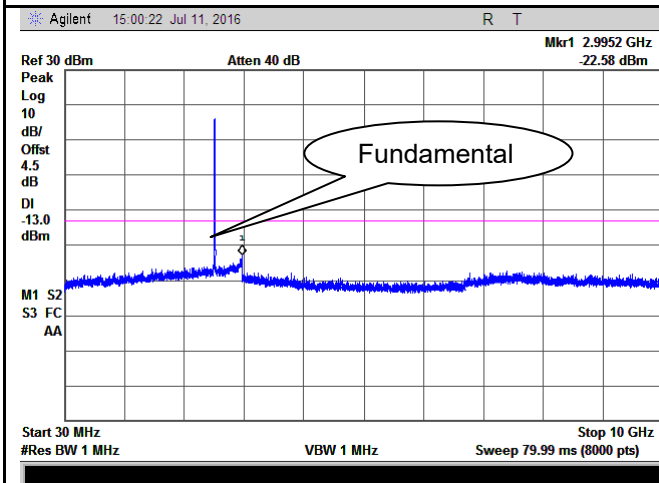

LTE Band 7 - Middle Channel-1

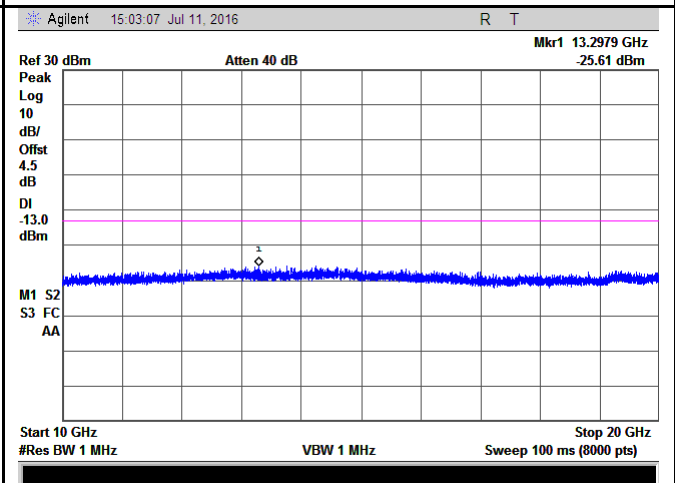

LTE Band 7 - Middle Channel-2

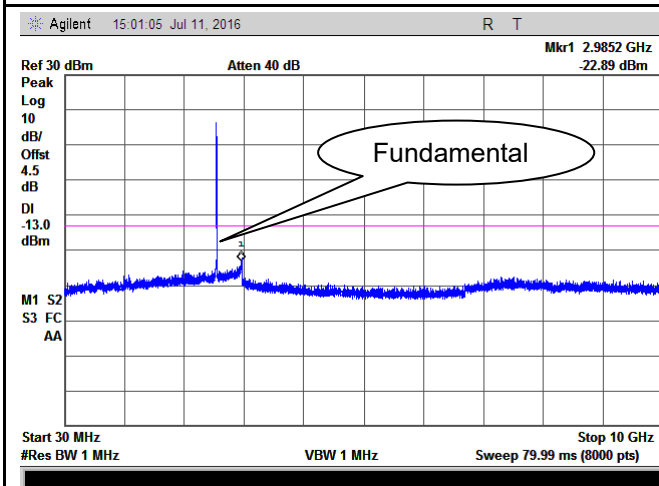

LTE Band 7 - High Channel-1

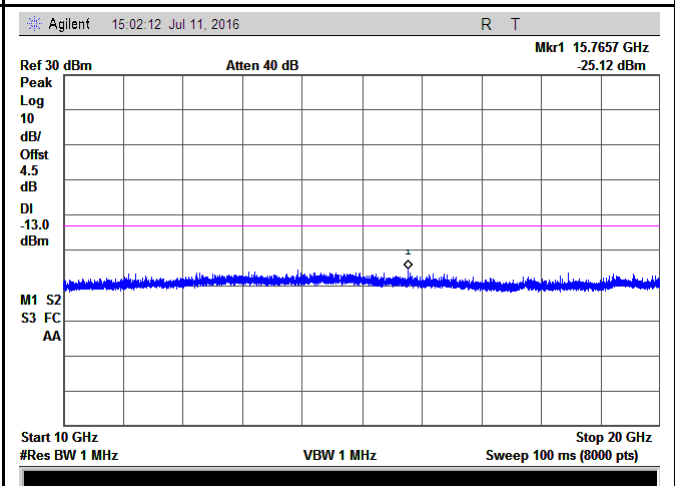

LTE Band 7 - High Channel-2

6.6 Spurious Radiated Emissions

Temperature	25°C
Relative Humidity	54%
Atmospheric Pressure	1002mbar
Test date :	July 02, 2016
Tested By :	Loren Luo

Requirement(s):

Spec	Item	Requirement	Applicable
§2.1053, §22.917 & §24.238 § 27.53(h)	a)	The power of any emission outside of the authorized operating frequency ranges must be attenuated below the transmitter power (P) by a factor of at least $43 + 10 \log (P)$ dB. The spectrum is scanned from 30 MHz up to a frequency including its 10th harmonic.	<input checked="" type="checkbox"/>

Test setup	
------------	--

Test Procedure	<ol style="list-style-type: none"> The transmitter was placed on a wooden turntable, and it was transmitting into a non-radiating load which was also placed on the turntable. The measurement antenna was placed at a distance of 3 meters from the EUT. During the tests, the antenna height and polarization as well as EUT azimuth were varied in order to identify the maximum level of emissions from the EUT. The test was performed by placing the EUT on 3-orthogonal axis. Remove the EUT and replace it with substitution antenna. A signal generator was connected to the substitution antenna by a non-radiating cable. The absolute levels of the spurious emissions were measured by the substitution. Sample Calculation: EUT Field Strength = Raw Amplitude (dBµV/m) – Amplifier Gain (dB) + Antenna
----------------	--

Test Report	16070667-FCC-R5
Page	78 of 123

	Factor (dB) + Cable Loss (dB) + Filter Attenuation (dB, if used)
Remark	
Result	<input checked="" type="checkbox"/> Pass <input type="checkbox"/> Fail

Test Data
 Yes
 N/A

Test Plot
 Yes (See below)
 N/A

LTE Band 2 (Part 24E) result

Low channel

Frequency (MHz)	Substituted level (dBm)	Polarity (H/V)	Antenna Gain Correction (dB)	Cable Loss (dB)	Corrected Reading (dBm)	Limit (dBm)	Margin (dB)
3720	-44.81	V	10.25	2.73	-37.29	-13	-24.29
3720	-44.26	H	10.25	2.73	-36.74	-13	-23.74
78.5	-45.93	V	0.4	0.12	-45.65	-13	-32.65
169.3	-47.84	H	2.9	0.18	-45.12	-13	-32.12

Middle channel

Frequency (MHz)	Substituted level (dBm)	Polarity (H/V)	Antenna Gain Correction (dB)	Cable Loss (dB)	Corrected Reading (dBm)	Limit (dBm)	Margin (dB)
3760	-44.96	V	10.25	2.73	-37.44	-13	-24.44
3760	-44.61	H	10.25	2.73	-37.09	-13	-24.09
78.1	-45.76	V	0.4	0.12	-45.48	-13	-32.48
169.9	-47.69	H	2.9	0.18	-44.97	-13	-31.97

High channel

Frequency (MHz)	Substituted level (dBm)	Polarity (H/V)	Antenna Gain Correction (dB)	Cable Loss (dB)	Corrected Reading (dBm)	Limit (dBm)	Margin (dB)
3800	-44.83	V	10.36	2.73	-37.2	-13	-24.2
3800	-44.47	H	10.36	2.73	-36.84	-13	-23.84
78.4	-45.51	V	0.4	0.12	-45.23	-13	-32.23
170.3	-47.89	H	2.9	0.18	-45.17	-13	-32.17

Note:

- 1, The testing has been conformed to $10 \times 1907.5 \text{ MHz} = 19,075 \text{ MHz}$
- 2, All other emissions more than 30 dB below the limit
- 3, X-Axis, Y-Axis and -Axis were investigated. The results above show only the worst case.

LTE Band 4(Part27) result

Low channel

Frequency (MHz)	Substituted level (dBm)	Polarity (H/V)	Antenna Gain Correction (dB)	Cable Loss (dB)	Corrected Reading (dBm)	Limit (dBm)	Margin (dB)
3440	-46.35	V	10.06	2.52	-38.81	-13	-25.81
3440	-46.59	H	10.06	2.52	-39.05	-13	-26.05
77.9	-45.61	V	0.4	0.12	-45.33	-13	-32.33
178.6	-48.28	H	2.9	0.18	-45.56	-13	-32.56

Middle channel

Frequency (MHz)	Substituted level (dBm)	Polarity (H/V)	Antenna Gain Correction (dB)	Cable Loss (dB)	Corrected Reading (dBm)	Limit (dBm)	Margin (dB)
3465	-46.27	V	10.09	2.52	-38.7	-13	-25.7
3465	-46.42	H	10.09	2.52	-38.85	-13	-25.85
77.5	-45.53	V	0.4	0.12	-45.25	-13	-32.25
178.8	-48.16	H	2.9	0.18	-45.44	-13	-32.44

High channel

Frequency (MHz)	Substituted level (dBm)	Polarity (H/V)	Antenna Gain Correction (dB)	Cable Loss (dB)	Corrected Reading (dBm)	Limit (dBm)	Margin (dB)
3490	-46.55	V	10.09	2.52	-38.98	-13	-25.98
3490	-46.38	H	10.09	2.52	-38.81	-13	-25.81
77.3	-45.49	V	0.4	0.12	-45.21	-13	-32.21
178.5	-48.04	H	2.9	0.18	-45.32	-13	-32.32

Note:

- 1, The testing has been conformed to $10 \times 1752.5 \text{ MHz} = 17,525 \text{ MHz}$
- 2, All other emissions more than 30 dB below the limit
- 3, X-Axis, Y-Axis and -Axis were investigated. The results above show only the worst case.

LTE Band 5(Part22H) result

Low channel

Frequency (MHz)	Substituted level (dBm)	Polarity (H/V)	Antenna Gain Correction (dB)	Cable Loss (dB)	Corrected Reading (dBm)	Limit (dBm)	Margin (dB)
1658	-47.61	V	7.95	0.78	-40.44	-13	-27.44
1658	-46.98	H	7.95	0.78	-39.81	-13	-26.81
80.5	-46.23	V	0.4	0.12	-45.95	-13	-32.95
171.3	-48.75	H	2.9	0.18	-46.03	-13	-33.03

Middle channel

Frequency (MHz)	Substituted level (dBm)	Polarity (H/V)	Antenna Gain Correction (dB)	Cable Loss (dB)	Corrected Reading (dBm)	Limit (dBm)	Margin (dB)
1673	-47.54	V	7.95	0.78	-40.37	-13	-27.37
1673	-47.18	H	7.95	0.78	-40.01	-13	-27.01
79.9	-46.35	V	0.4	0.12	-46.07	-13	-33.07
170.6	-48.61	H	2.9	0.18	-45.89	-13	-32.89

High channel

Frequency (MHz)	Substituted level (dBm)	Polarity (H/V)	Antenna Gain Correction (dB)	Cable Loss (dB)	Corrected Reading (dBm)	Limit (dBm)	Margin (dB)
1688	-47.38	V	7.95	0.78	-40.21	-13	-27.21
1688	-47.02	H	7.95	0.78	-39.85	-13	-26.85
80.7	-46.25	V	0.4	0.12	-45.97	-13	-32.97
171.3	-48.49	H	2.9	0.18	-45.77	-13	-32.77

Note:

- 1, The testing has been conformed to $10 \times 846.5 \text{ MHz} = 8,465 \text{ MHz}$
- 2, All other emissions more than 30 dB below the limit
- 3, X-Axis, Y-Axis and -Axis were investigated. The results above show only the worst case.

LTE Band 7(Part27) result

Low channel

Frequency (MHz)	Substituted level (dBm)	Polarity (H/V)	Antenna Gain Correction (dB)	Cable Loss (dB)	Corrected Reading (dBm)	Limit (dBm)	Margin (dB)
5020	-46.84	V	10.29	0.98	-37.53	-13	-24.53
5020	-46.69	H	10.29	0.98	-37.38	-13	-24.38
79.3	-46.52	V	0.4	0.12	-46.24	-13	-33.24
170.5	-47.87	H	2.9	0.18	-45.15	-13	-32.15

Middle channel

Frequency (MHz)	Substituted level (dBm)	Polarity (H/V)	Antenna Gain Correction (dB)	Cable Loss (dB)	Corrected Reading (dBm)	Limit (dBm)	Margin (dB)
5070	-46.79	V	10.3	0.99	-37.48	-13	-24.48
5070	-46.58	H	10.3	0.99	-37.27	-13	-24.27
79.5	-46.61	V	0.4	0.12	-46.33	-13	-33.33
170.8	-47.76	H	2.9	0.18	-45.04	-13	-32.04

High channel

Frequency (MHz)	Substituted level (dBm)	Polarity (H/V)	Antenna Gain Correction (dB)	Cable Loss (dB)	Corrected Reading (dBm)	Limit (dBm)	Margin (dB)
5120	-46.69	V	10.32	1	-37.37	-13	-24.37
5120	-46.43	H	10.32	1	-37.11	-13	-24.11
79.1	-46.35	V	0.4	0.12	-46.07	-13	-33.07
170.6	-47.98	H	2.9	0.18	-45.26	-13	-32.26

Note:

- 1, The testing has been conformed to $10 \times 2567.5 \text{ MHz} = 25,675 \text{ MHz}$
- 2, All other emissions more than 30 dB below the limit
- 3, X-Axis, Y-Axis and -Axis were investigated. The results above show only the worst case.

6.7 Band Edge

Temperature	24°C
Relative Humidity	53%
Atmospheric Pressure	1011mbar
Test date :	July 11, 2016
Tested By :	Loren Luo

Requirement(s):

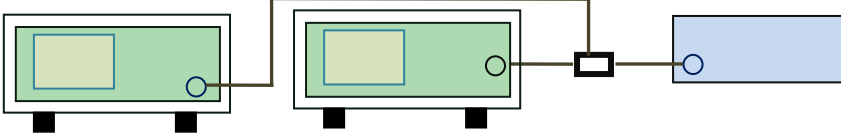
Spec	Item	Requirement	Applicable
§22.917(a) §24.238(a) § 27.53(h)	a)	The power of any emission outside of the authorized operating frequency ranges must be lower than the transmitter power (P) by a factor of at least $43 + 10 \log (P)$ dB.	<input checked="" type="checkbox"/>
Test setup			
Procedure	<ul style="list-style-type: none"> - The EUT was connected to Spectrum Analyzer and Base Station via power divider. - The Band Edges of low and high channels for the highest RF powers were measured. Setting RBW as roughly BW/100. 		
Remark			
Result	<input checked="" type="checkbox"/> Pass <input type="checkbox"/> Fail		

Test Data Yes N/A

Test Plot Yes (See below) N/A

LTE Band 2 (Part 24E) result

BW(MHz)	Channel	Frequency (MHz)	Mode	Emission (dBm)	Limit (dBm)
1.4	18607	1850.7	QPSK	-21.72	-13
			16QAM	-22.64	-13
1.4	18900	1909.3	QPSK	-18.25	-13
			16QAM	-19.74	-13
3	18615	1851.5	QPSK	-16.13	-13
			16QAM	-17.74	-13
3	19185	1908.5	QPSK	-15.76	-13
			16QAM	-16.88	-13
5	18625	1852.5	QPSK	-15.12	-13
			16QAM	-15.79	-13
5	19175	1907.5	QPSK	-17.75	-13
			16QAM	-15.16	-13
10	18650	1855	QPSK	-16.70	-13
			16QAM	-15.54	-13
10	19150	1905	QPSK	-17.03	-13
			16QAM	-16.88	-13
15	18675	1857.5	QPSK	-17.41	-13
			16QAM	-17.18	-13
15	19125	1902.5	QPSK	-16.86	-13
			16QAM	-17.61	-13
20	18700	1860	QPSK	-27.20	-13
			16QAM	-26.94	-13
20	19100	1900	QPSK	-21.36	-13
			16QAM	-26.24	-13

LTE Band 4 (Part 27) result

BW(MHz)	Channel	Frequency (MHz)	Mode	Emission (dBm)	Limit (dBm)
1.4	19957	1710.7	QPSK	-23.08	-13
			16QAM	-23.73	-13
1.4	20393	1754.3	QPSK	-24.68	-13
			16QAM	-24.48	-13
3	19965	1711.5	QPSK	-16.98	-13
			16QAM	-17.35	-13
3	20385	1753.5	QPSK	-18.67	-13
			16QAM	-17.52	-13
5	19975	1712.5	QPSK	-15.38	-13
			16QAM	-17.13	-13
5	20375	1752.5	QPSK	-17.58	-13
			16QAM	-16.11	-13
10	20000	1715	QPSK	-23.25	-13
			16QAM	-21.60	-13
10	20350	1750	QPSK	-19.29	-13
			16QAM	-18.92	-13
15	20025	1717.5	QPSK	-23.11	-13
			16QAM	-24.70	-13
15	20325	1747.5	QPSK	-23.18	-13
			16QAM	-17.85	-13
20	20050	1720	QPSK	-21.34	-13
			16QAM	-27.73	-13
20	20300	1745	QPSK	-23.93	-13
			16QAM	-21.42	-13

LTE Band 5 (Part 22H) result

BW(MHz)	Channel	Frequency (MHz)	Mode	Emission (dBm)	Limit (dBm)
1.4	20407	824.7	QPSK	-18.94	-13
			16QAM	-19.50	-13
1.4	20643	848.3	QPSK	-24.83	-13
			16QAM	-24.21	-13
3	20415	825.5	QPSK	-17.60	-13
			16QAM	-17.53	-13
3	20635	847.5	QPSK	-17.15	-13
			16QAM	-17.68	-13
5	20425	826.5	QPSK	-20.58	-13
			16QAM	-21.97	-13
5	20625	846.5	QPSK	-18.92	-13
			16QAM	-19.14	-13
10	20450	829	QPSK	-23.12	-13
			16QAM	-22.07	-13
10	20800	844	QPSK	-23.55	-13
			16QAM	-25.82	-13

Test Plots

LTE Band 2 (Part 24E)

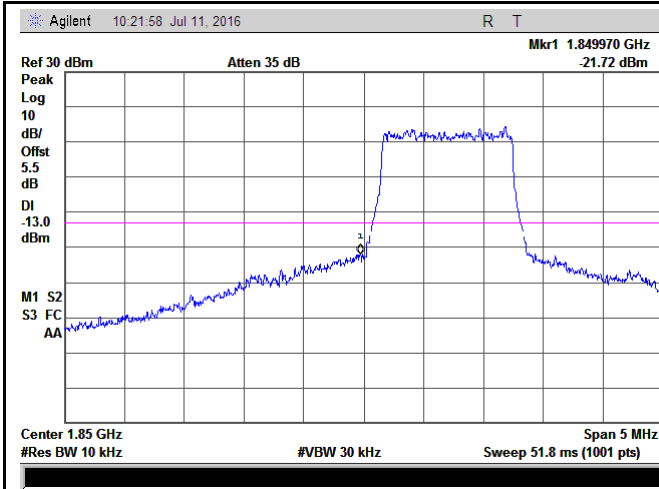

LTE Band 2 - Low Channel QPSK-1.4

Note: Offset=Cable loss (4.5) + 10log
(12.66/10)=4.5+1.0=5.5dB

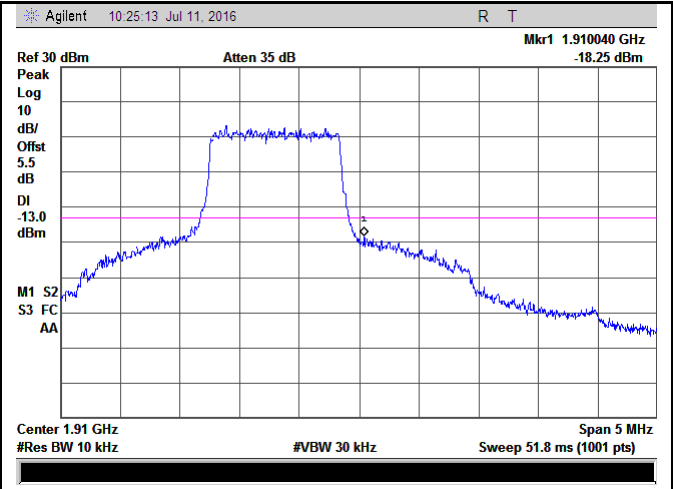

LTE Band 2 - High Channel QPSK-1.4

Note: Offset=Cable loss (4.5) + 10log
(12.60/10)=4.5+1.0=5.5dB

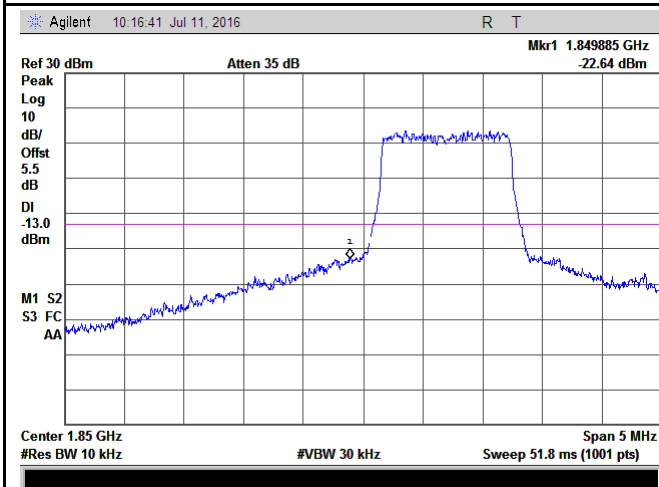

LTE Band 2 - Low Channel 16QAM-1.4

Note: Offset=Cable loss (4.5) + 10log
(12.70/10)=4.5+1.0=5.5 dB

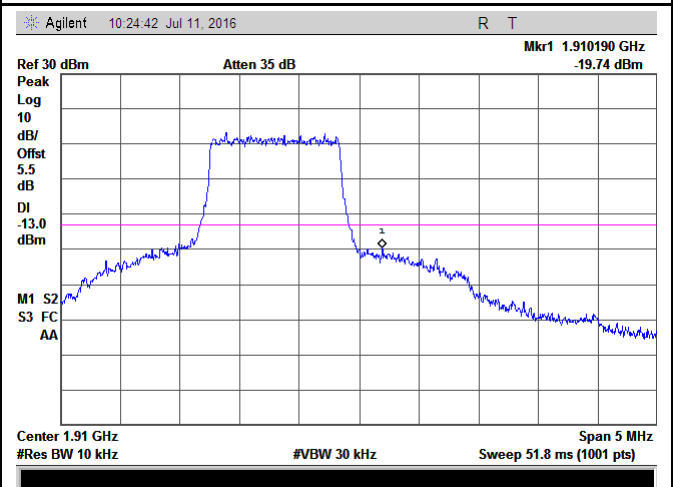

LTE Band 2 - High Channel 16QAM-1.4

Note: Offset=Cable loss (4.5) + 10log
(12.67/10)=4.5+1.0=5.5 dB

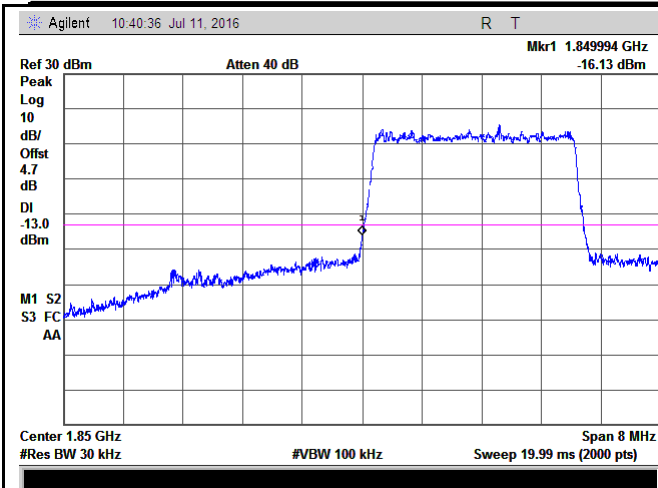

LTE Band 2 - Low Channel QPSK-3

Note: Offset=Cable loss (4.5) + 10log
(31.07/30)=4.5+0.2=4.7 dB

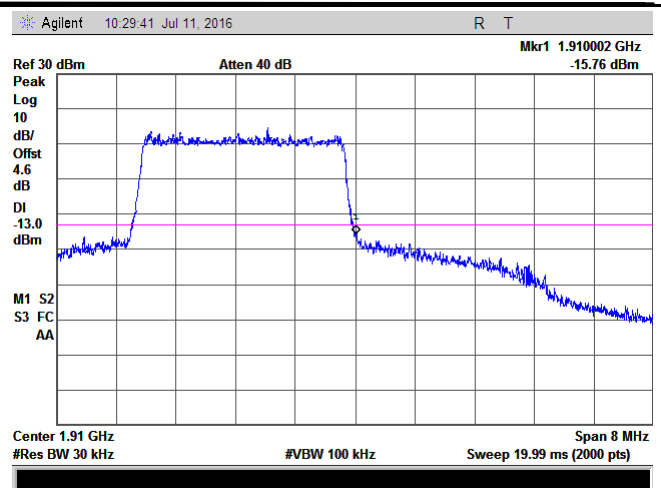

LTE Band 2 - High Channel QPSK-3

Note: Offset=Cable loss (4.5) + 10log
(30.77/30)=4.5+0.1=4.6 dB

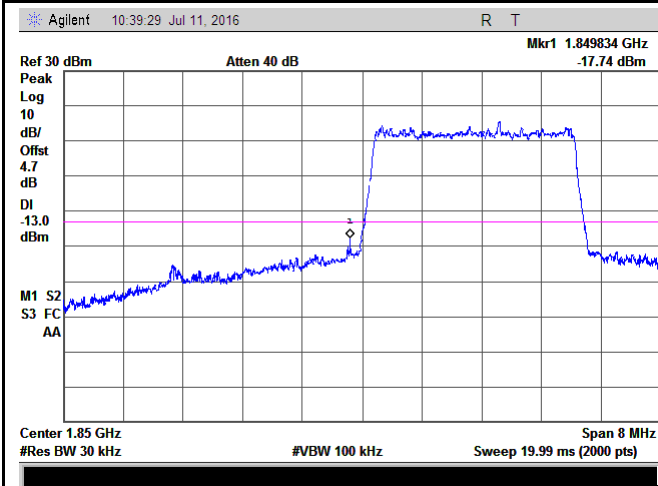

LTE Band 2 - Low Channel 16QAM-3

Note: Offset=Cable loss (4.5) + 10log
(31.09/30)=4.5+0.2=4.7 dB

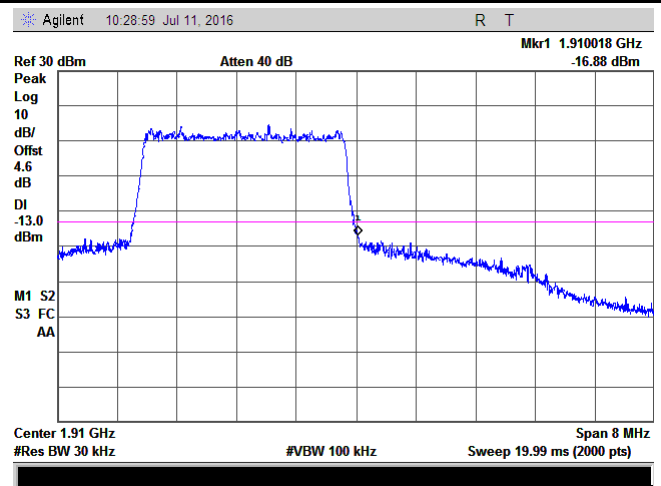

LTE Band 2 - High Channel 16QAM-3

Note: Offset=Cable loss (4.5) + 10log
(30.95/30)=4.5+0.1=4.6 dB

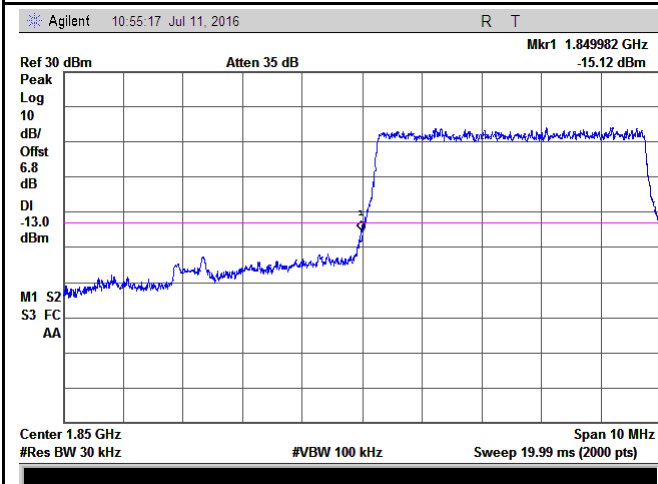

LTE Band 2 - Low Channel QPSK-5

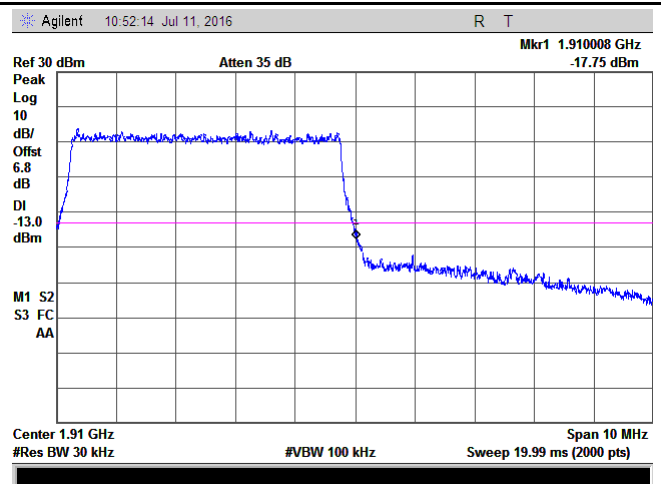

LTE Band 2 - High Channel QPSK-5

Note: Offset=Cable loss (4.5) + 10log
(50.69/30)=4.5+2.3=6.8 dB

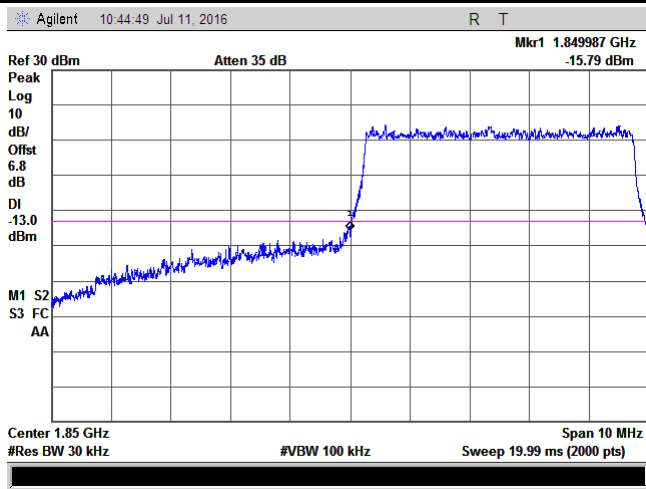

LTE Band 2 - Low Channel 16QAM-5

Note: Offset=Cable loss (4.5) + 10log
(50.19/30)=4.5+2.3=6.8 dB

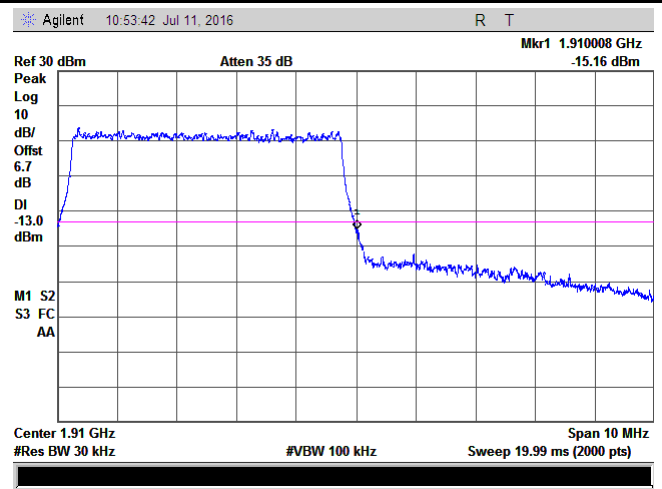

LTE Band 2 - High Channel 16QAM-5

Note: Offset=Cable loss (4.5) + 10log
(50.86/30)=4.5+2.3=6.8 dB

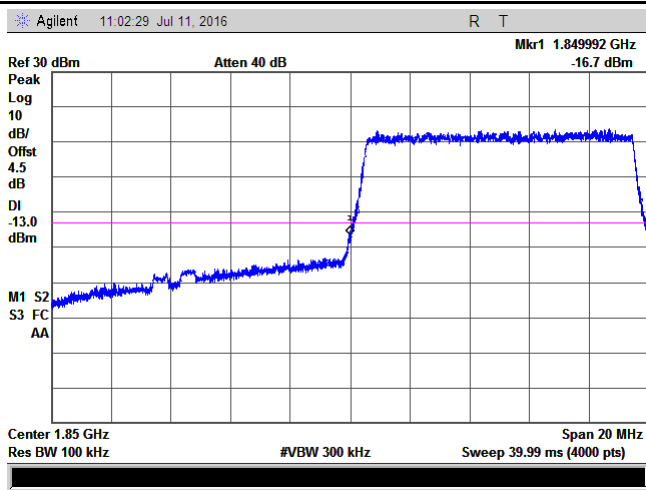

LTE Band 2 - Low Channel QPSK-10

Note: Offset=Cable loss (4.5) + 10log
(50.39/30)=4.5+2.2=6.7 dB

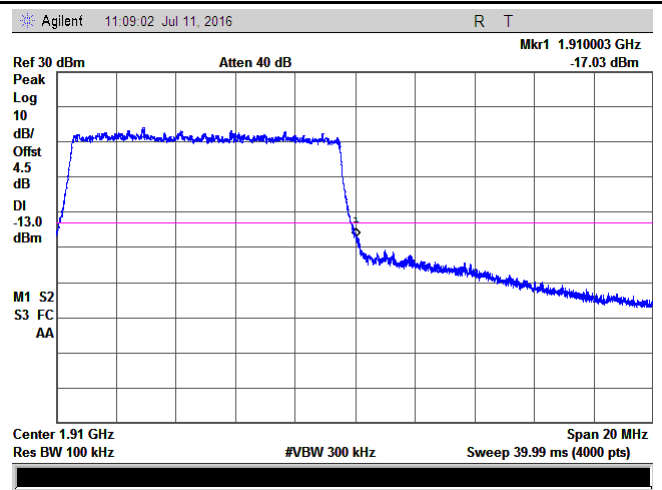

LTE Band 2 - High Channel QPSK-10

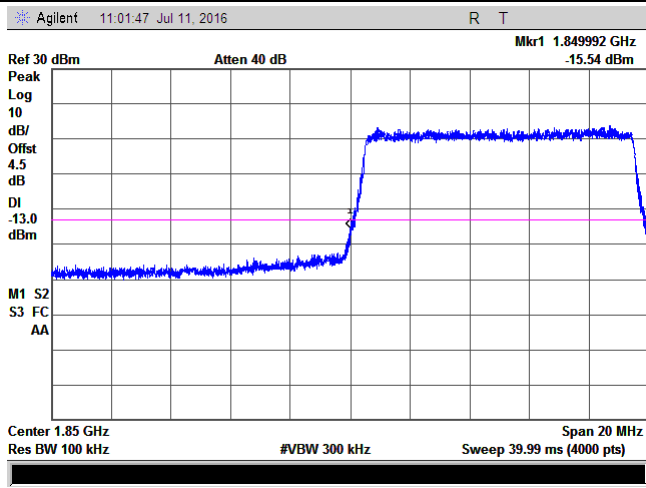

LTE Band 2 - Low Channel 16QAM-10

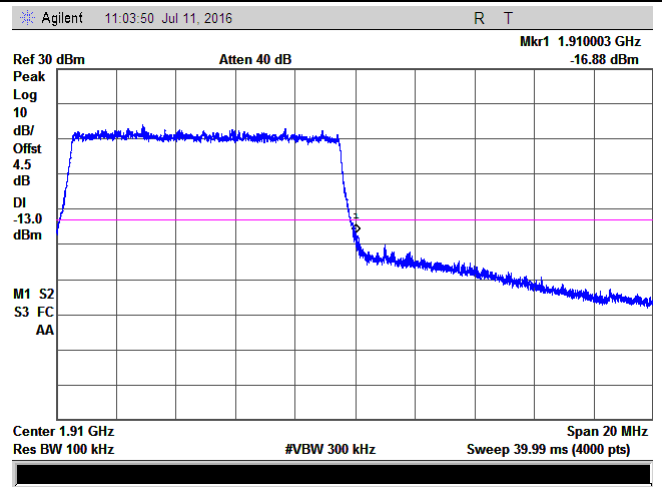

LTE Band 2 - High Channel 16QAM-10

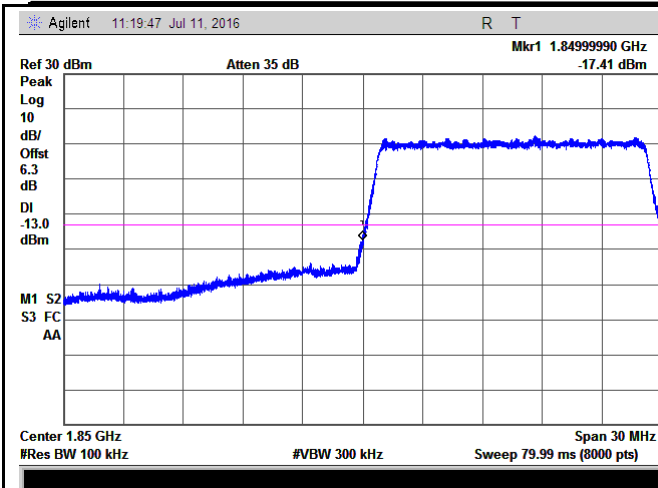

LTE Band 2 - Low Channel QPSK-15

Note: Offset=Cable loss (4.5) + 10log
(150.28/100)=4.5+1.8=6.3 dB

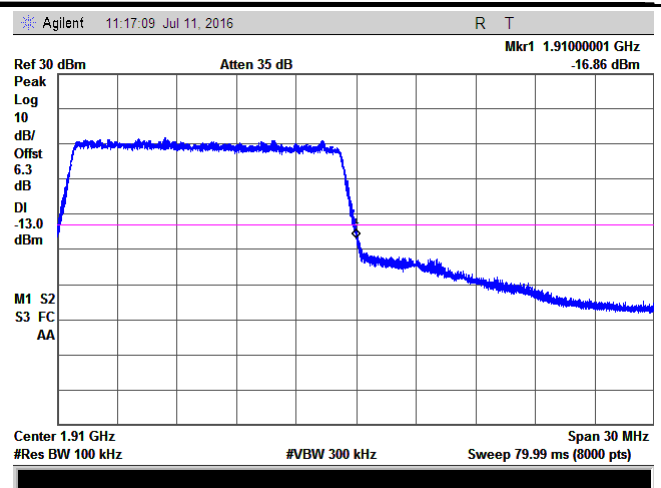

LTE Band 2 - High Channel QPSK-15

Note: Offset=Cable loss (4.5) + 10log
(150.23/100)=4.5+1.8=6.3 dB

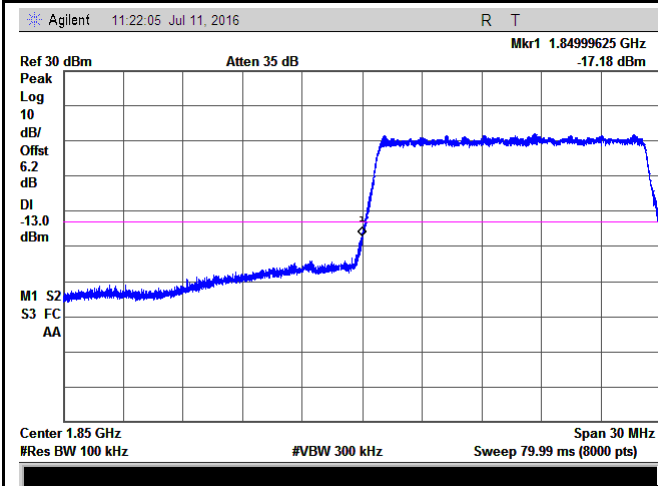

LTE Band 2 - Low Channel 16QAM-15

Note: Offset=Cable loss (4.5) + 10log
(149.5/100)=4.5+1.7=6.2 dB

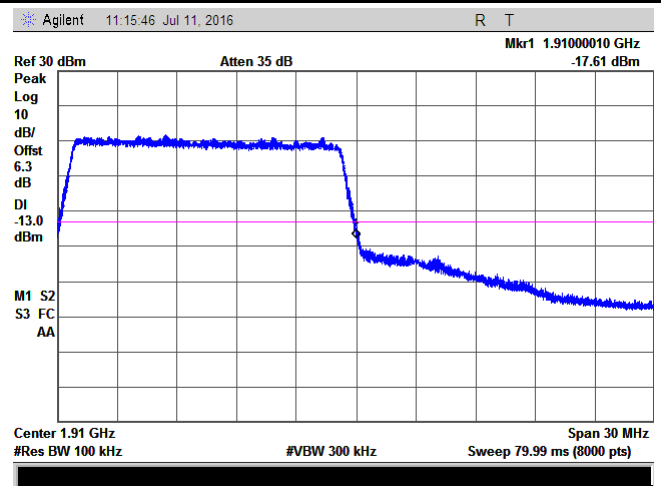

LTE Band 2 - High Channel 16QAM-15

Note: Offset=Cable loss (4.5) + 10log
(150.1/100)=4.5+1.8=6.3 dB

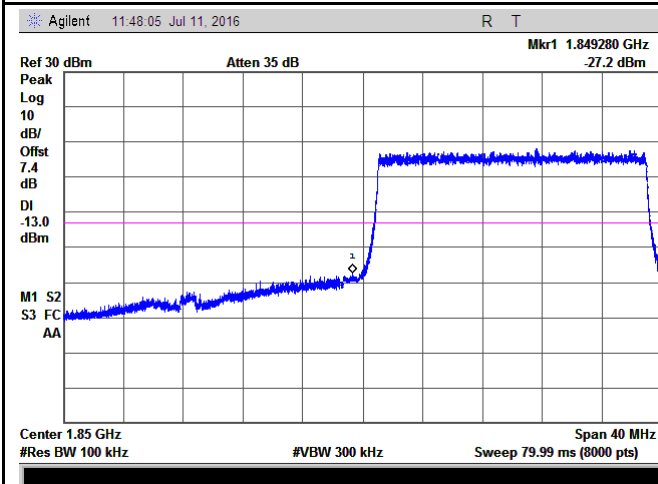

LTE Band 2 - Low Channel QPSK-20

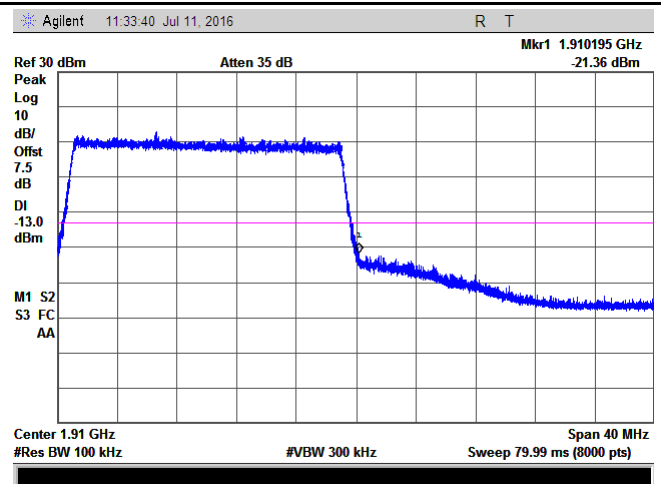

LTE Band 2 - High Channel QPSK-20

Note: Offset=Cable loss (4.5) + 10log
 (194.7/100)=4.5+2.9=7.4 dB

Note: Offset=Cable loss (4.5) + 10log
 (197.4/100)=4.5+3.0=7.5 dB

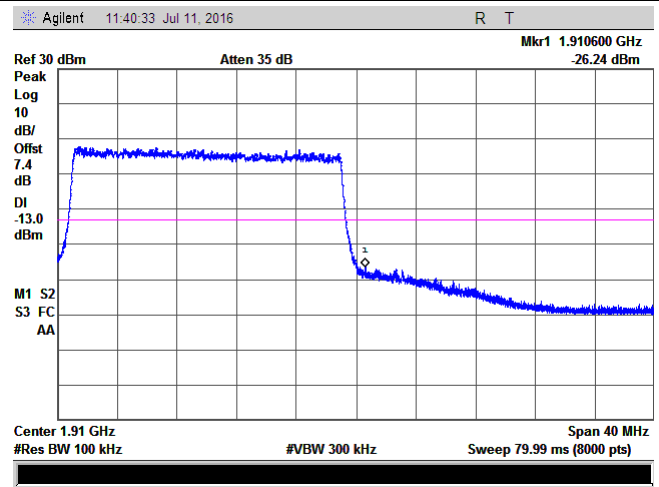
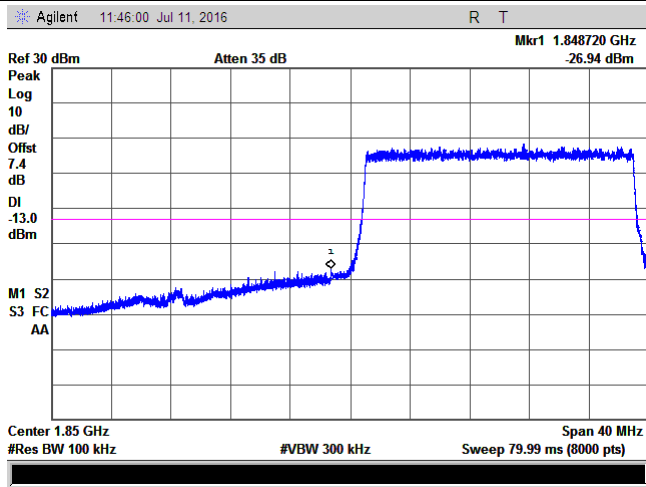

LTE Band 2 - Low Channel 16QAM-20

LTE Band 2 - High Channel 16QAM-20

Note: Offset=Cable loss (4.5) + 10log
 (195.8/100)=4.5+2.9=7.4 dB

Note: Offset=Cable loss (4.5) + 10log
 (194.8/100)=4.5+2.9=7.4 dB

LTE Band 4 (Part 27)

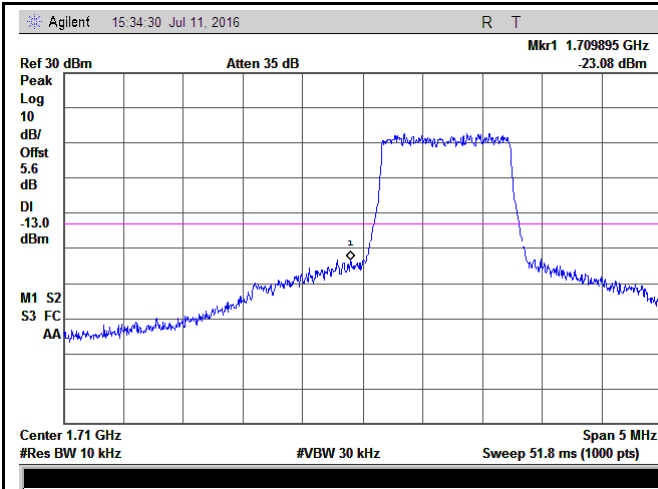

LTE Band 4 - Low Channel QPSK-1.4

Note: Offset=Cable loss (4.5) + 10log
(12.88/10)=4.5+1.1=5.6 dB

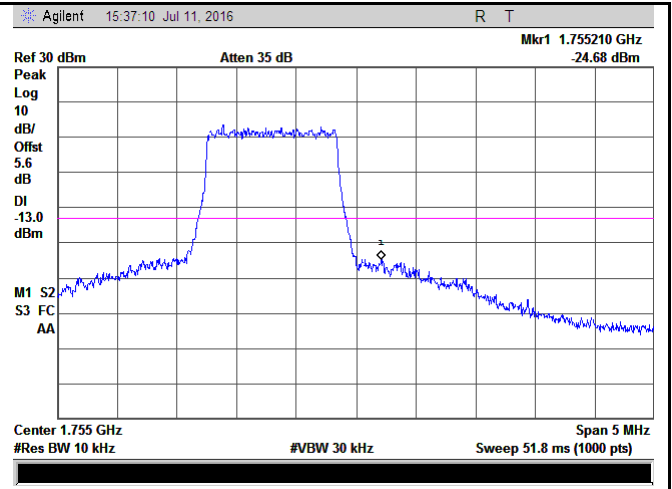

LTE Band 4 - High Channel QPSK-1.4

Note: Offset=Cable loss (4.5) + 10log
(12.76/10)=4.5+1.1=5.6 dB

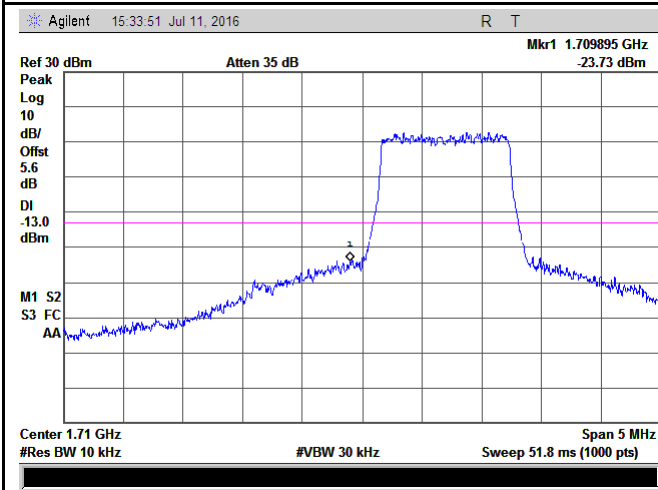

LTE Band 4 - Low Channel 16QAM-1.4

Note: Offset=Cable loss (4.5) + 10log
(12.89/10)=4.5+1.1=5.6 dB

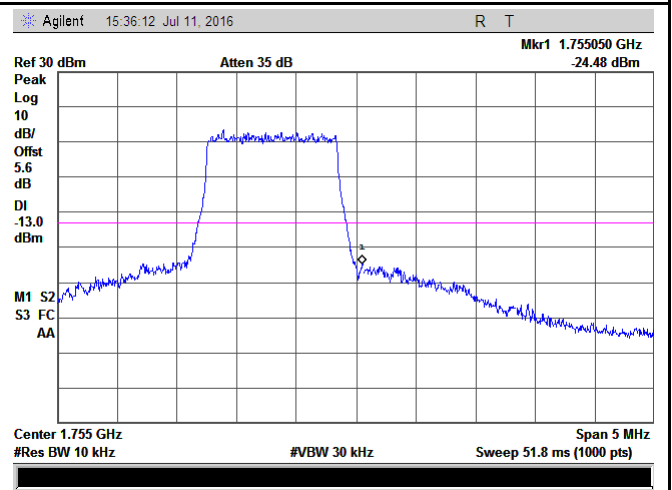

LTE Band 4 - High Channel 16QAM-1.4

Note: Offset=Cable loss (4.5) + 10log
((12.84/10)=4.5+1.1=5.6 dB

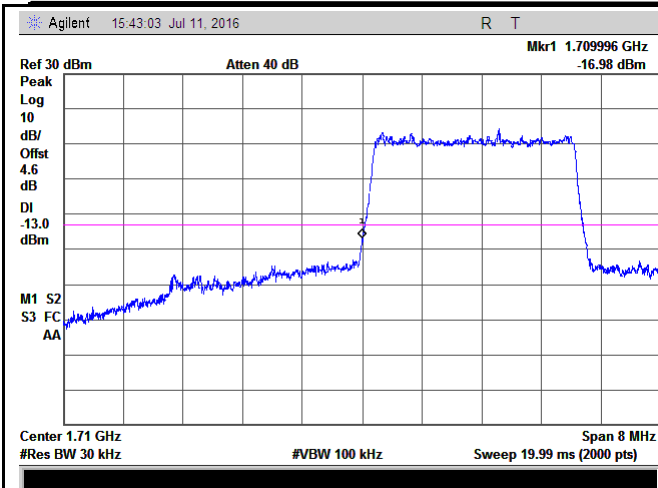

LTE Band 4 - Low Channel QPSK-3

Note: Offset=Cable loss (4.5) + 10log
(30.77/30)=4.5+0.1=4.6 dB

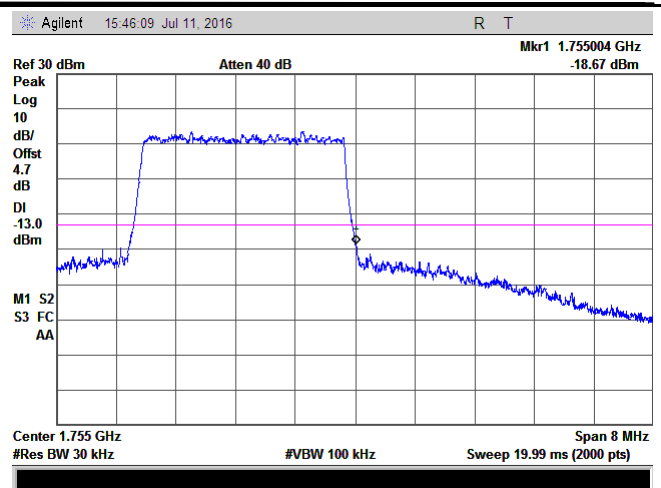

LTE Band 4 - High Channel QPSK-3

Note: Offset=Cable loss (4.5) + 10log
(31.22/30)=4.5+0.2=4.7 dB

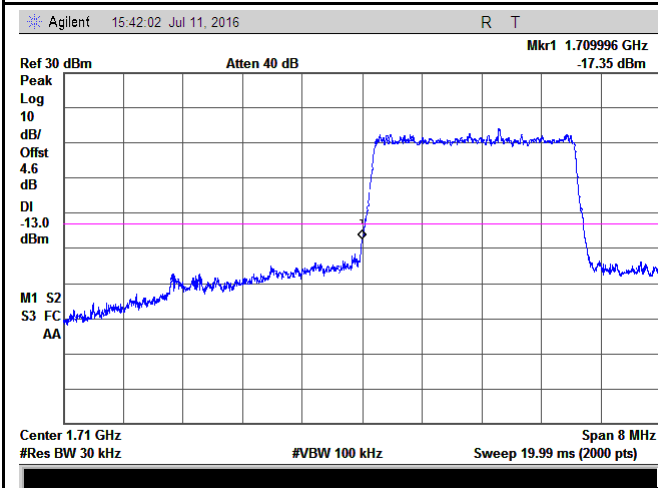

LTE Band 4 - Low Channel 16QAM-3

Note: Offset=Cable loss (4.5) + 10log
(30.84/30)=4.5+0.1=4.6 dB

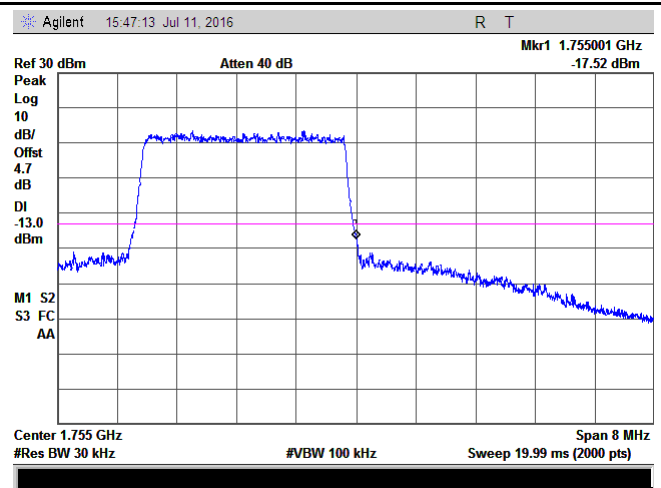

LTE Band 4 - High Channel 16QAM-3

Note: Offset=Cable loss (4.5) + 10log
(31.17/30)=4.5+0.2=4.7 dB

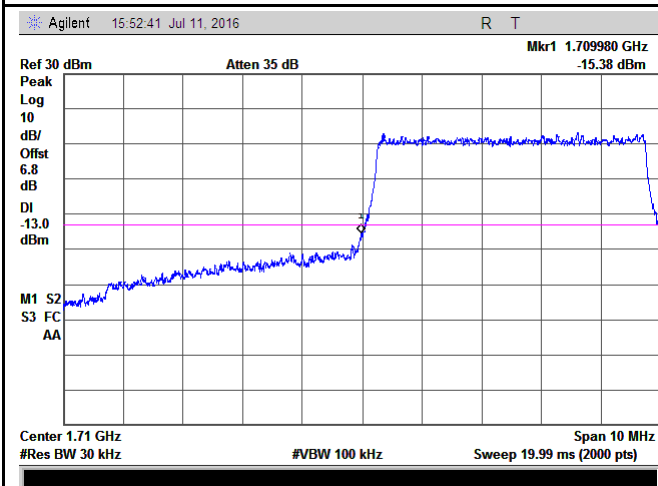

LTE Band 4 - Low Channel QPSK-5

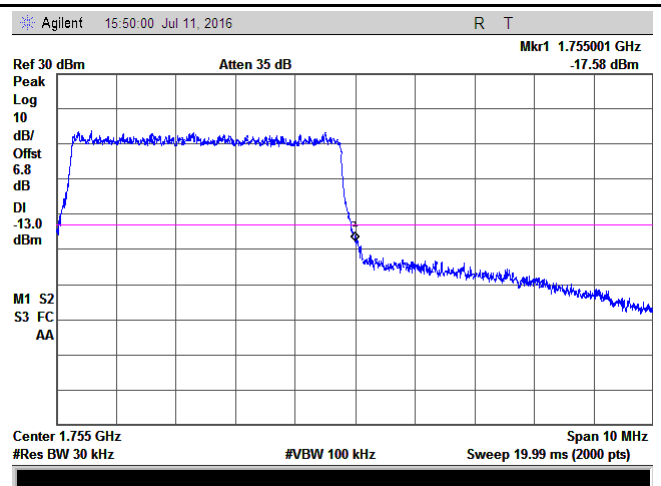

LTE Band 4 - High Channel QPSK-5

Note: Offset=Cable loss (4.5) + 10log
(50.99/30)=4.5+2.43=6.8 dB

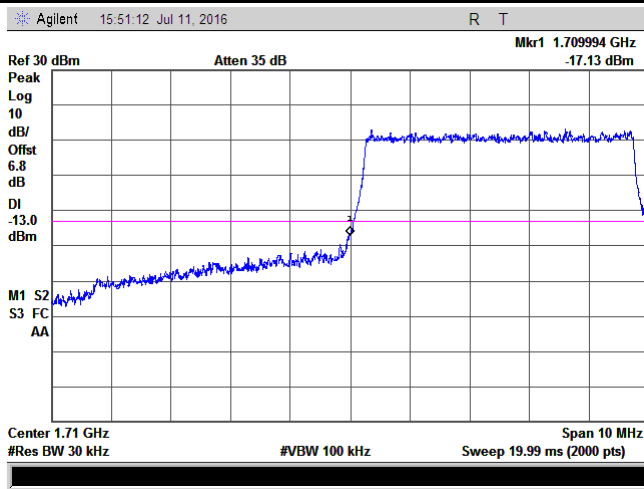

LTE Band 4 - Low Channel 16QAM-5

Note: Offset=Cable loss (4.5) + 10log
(50.92/30)=4.5+2.3=6.8 dB

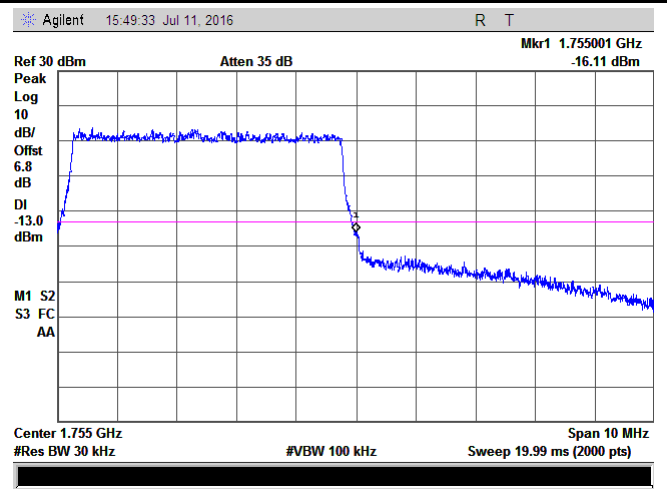

LTE Band 4 - High Channel 16QAM-5

Note: Offset=Cable loss (4.5) + 10log
(50.72/30)=4.5+2.3=6.8 dB

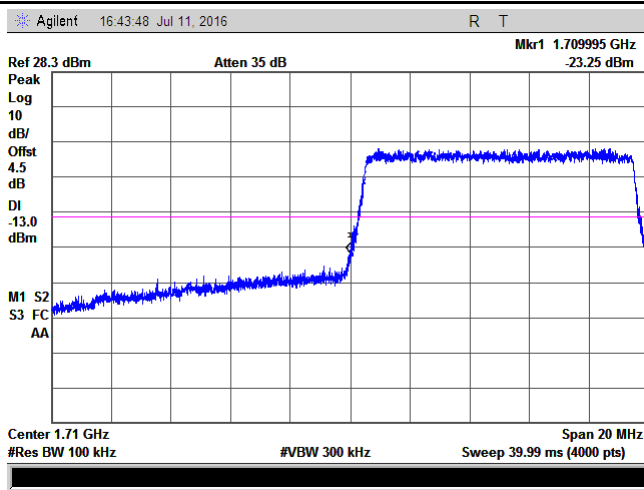

LTE Band 4 - Low Channel QPSK-10

Note: Offset=Cable loss (4.5) + 10log
(50.99/30)=4.5+2.3=6.8 dB

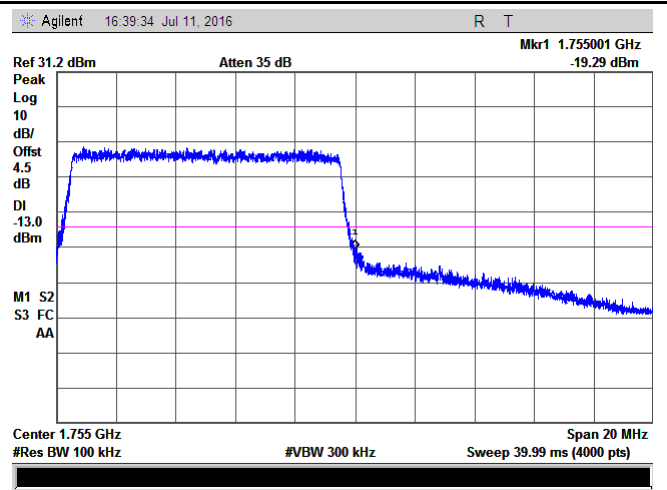

LTE Band 4 - High Channel QPSK-10

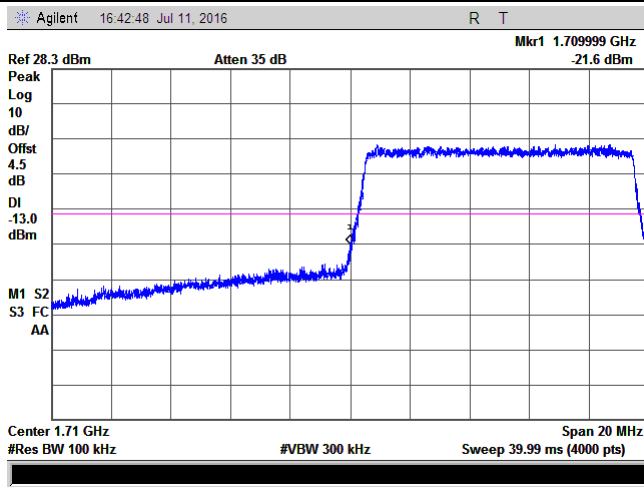

LTE Band 4 - Low Channel 16QAM-10

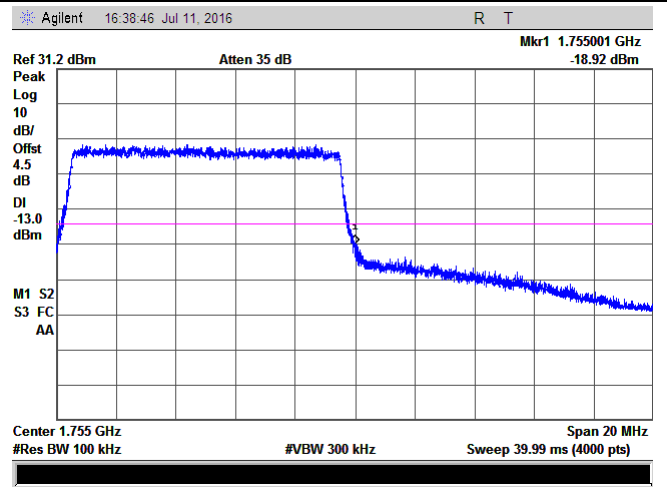

LTE Band 4 - High Channel 16QAM-10

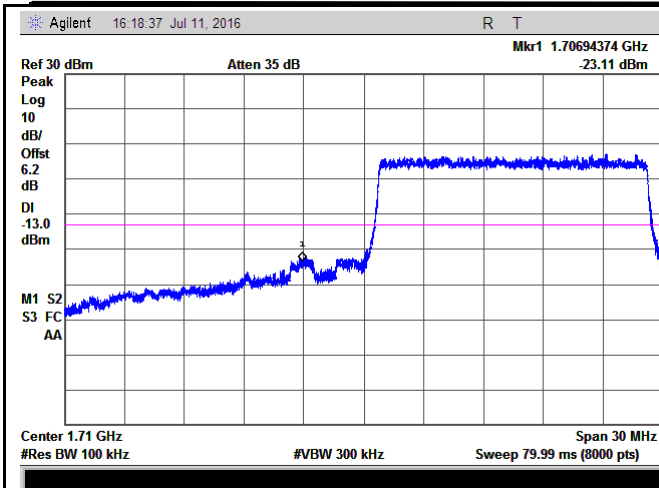

LTE Band 4 - Low Channel QPSK-15

Note: Offset=Cable loss (4.5) + 10log
(148.7/100)=4.5+1.7=6.2 dB

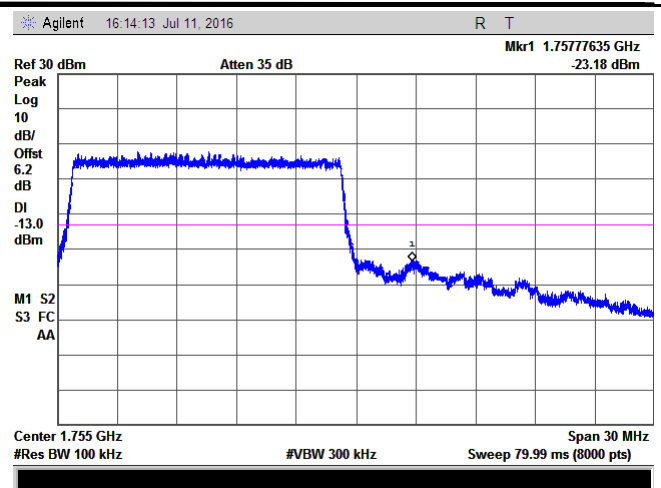

LTE Band 4 - High Channel QPSK-15

Note: Offset=Cable loss (4.5) + 10log
(149.4/100)=4.5+1.7=6.2 dB

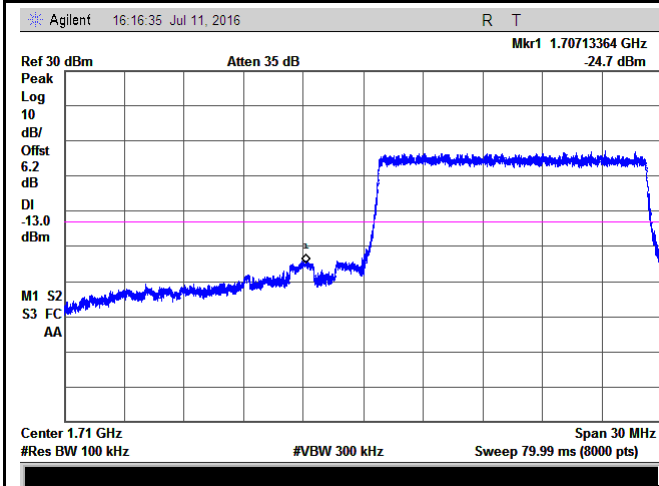

LTE Band 4 - Low Channel 16QAM-15

Note: Offset=Cable loss (4.5) + 10log
(149.0/100)=4.5+1.7=6.2 dB

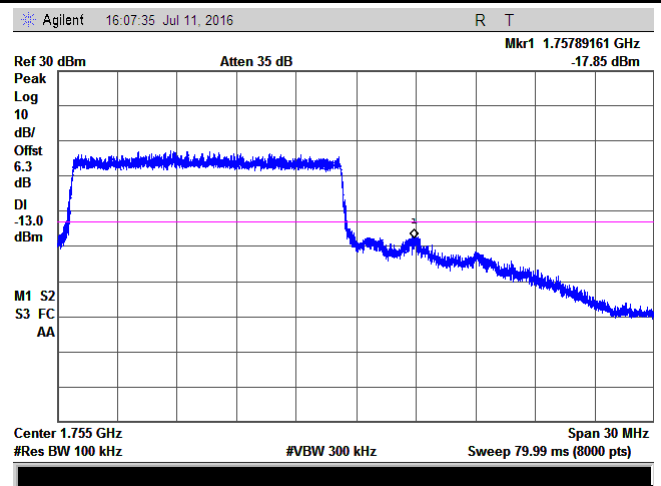

LTE Band 4 - High Channel 16QAM-15

Note: Offset=Cable loss (4.5) + 10log
(150.0/100)=4.5+1.8=6.3 dB

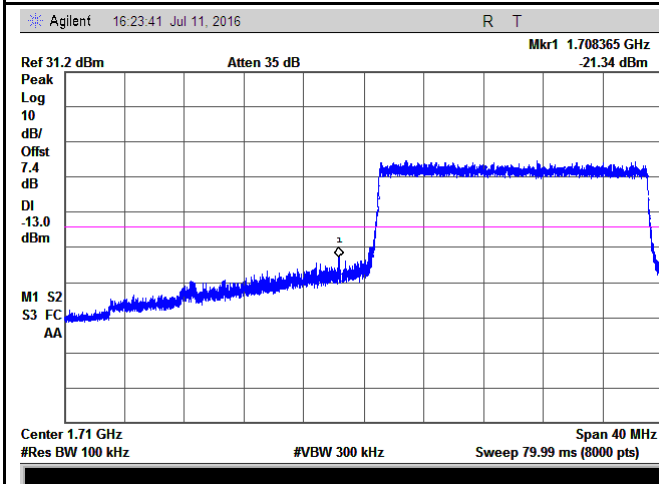

LTE Band 4 - Low Channel QPSK-20

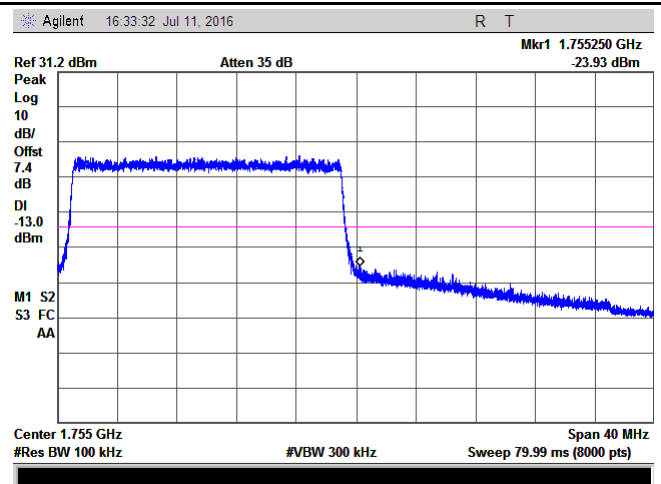

LTE Band 4 - High Channel QPSK-20

Note: Offset=Cable loss (4.5) + 10log
 (194.8/100)=4.5+2.9=7.4 dB

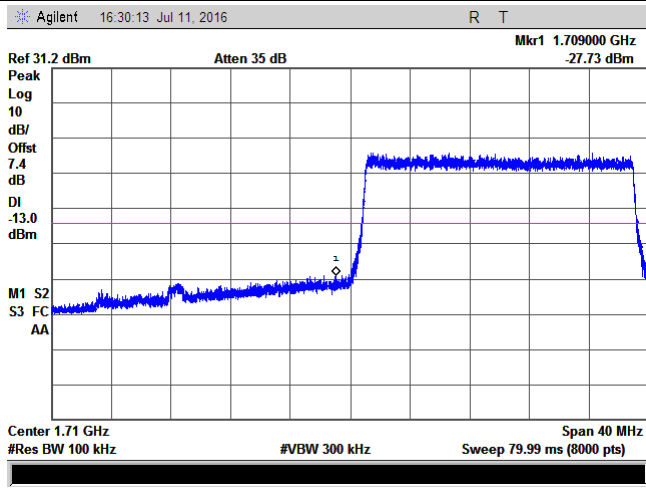

LTE Band 4 - Low Channel 16QAM-20

Note: Offset=Cable loss (4.5) + 10log
 (195.4/100)=4.5+2.9=7.4dB

Note: Offset=Cable loss (4.5) + 10log
 (195.9/100)=4.5+2.9=7.4 dB

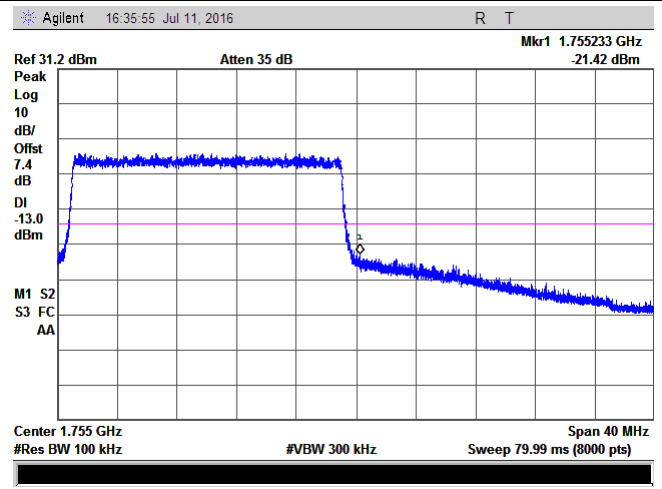

LTE Band 4 - High Channel 16QAM-20

Note: Offset=Cable loss (4.5) + 10log
 (195.5/100)=4.5+2.9=7.4 dB

LTE Band 5 (Part 22H)

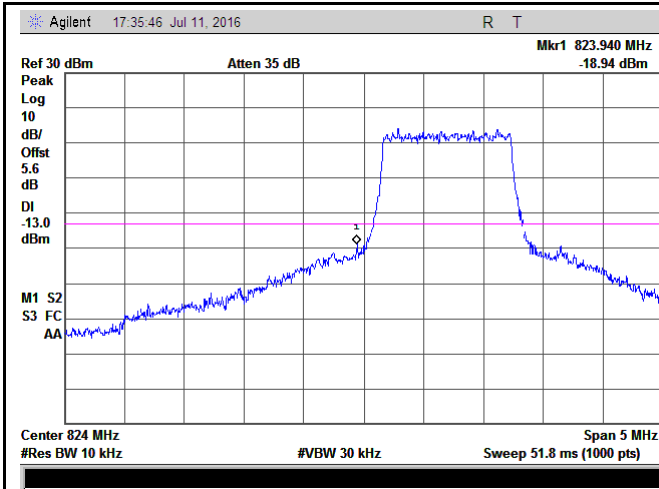

LTE Band 5 - Low Channel QPSK-1.4

Note: Offset=Cable loss (4.5) + 10log
(12.94/10)=4.5+1.1=5.6 dB

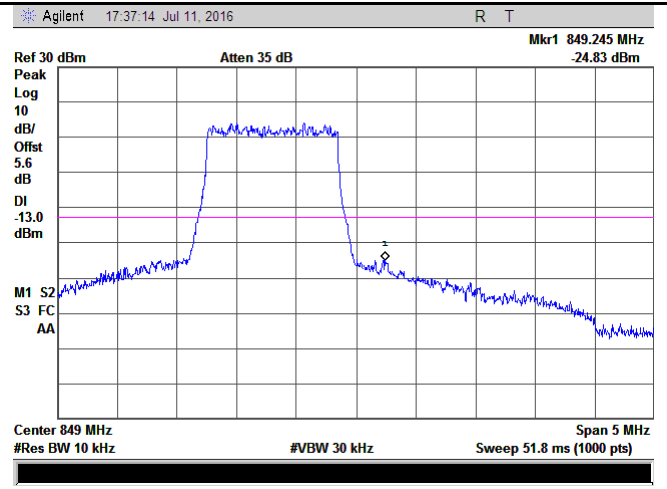

LTE Band 5 - High Channel QPSK-1.4

Note: Offset=Cable loss (4.5) + 10log
(12.91/10)=4.5+1.1=5.6 dB

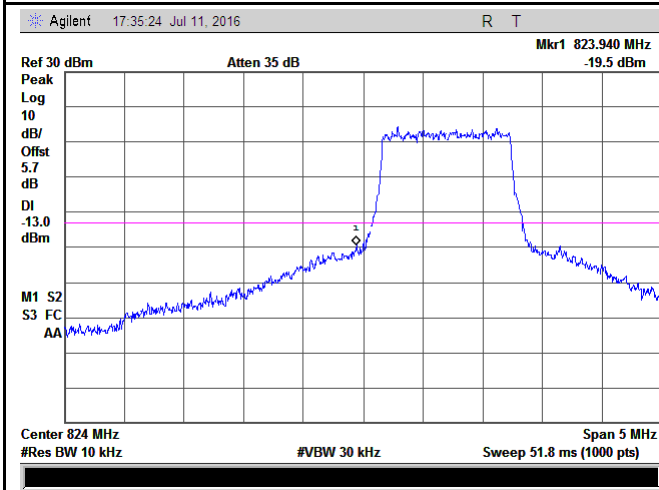

LTE Band 5 - Low Channel 16QAM-1.4

Note: Offset=Cable loss (4.5) + 10log
(13.04/10)=4.5+1.2=5.7 dB

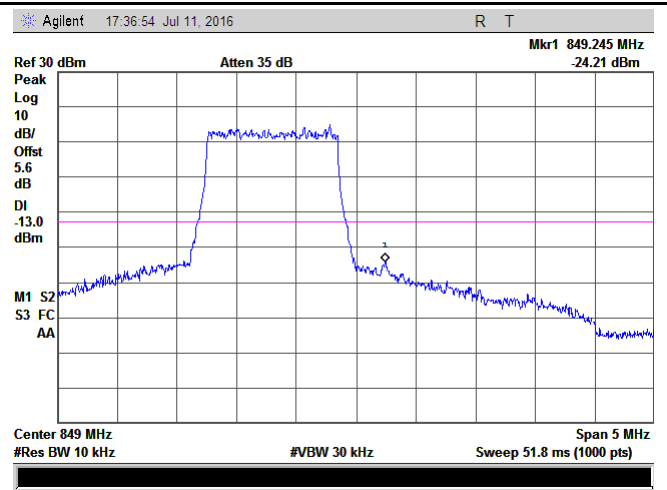

LTE Band 5 - High Channel 16QAM-1.4

Note: Offset=Cable loss (4.5) + 10log
(12.84/10)=4.5+1.1=5.6 dB

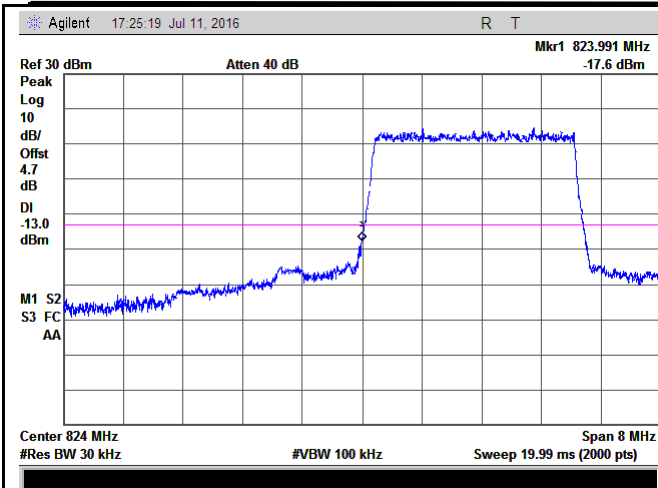

LTE Band 5 - Low Channel QPSK-3

Note: Offset=Cable loss (4.5) + 10log
(30.24/30)=4.5+0.2=4.7 dB

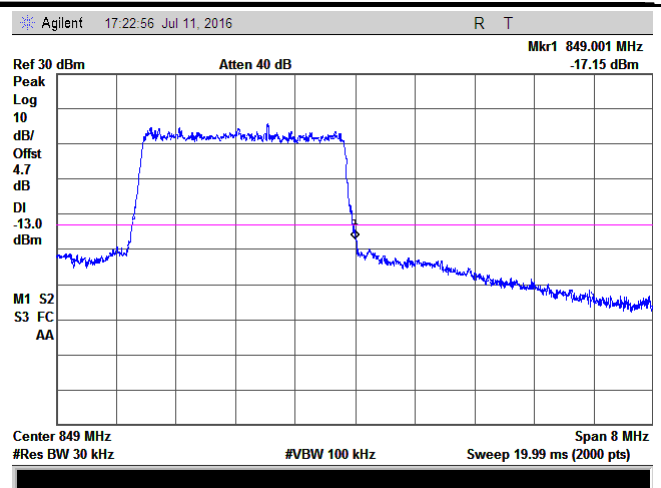

LTE Band 5 - High Channel QPSK-3

Note: Offset=Cable loss (4.5) + 10log
(31.08/30)=4.5+0.2=4.7 dB

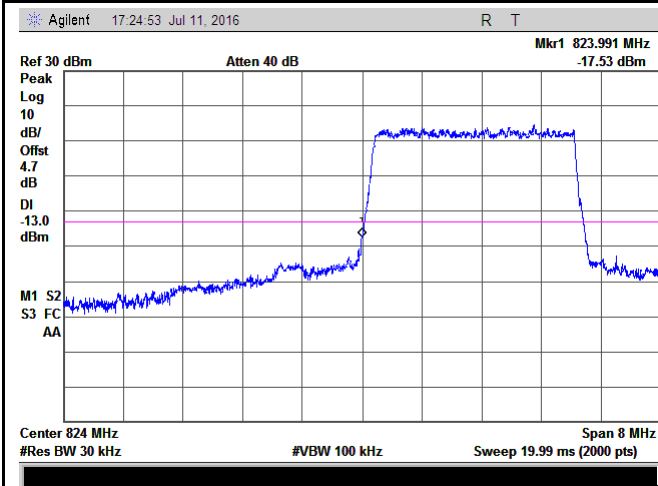

LTE Band 5 - Low Channel 16QAM-3

Note: Offset=Cable loss (4.5) + 10log
(31.19/30)=4.5+0.2=4.7 dB

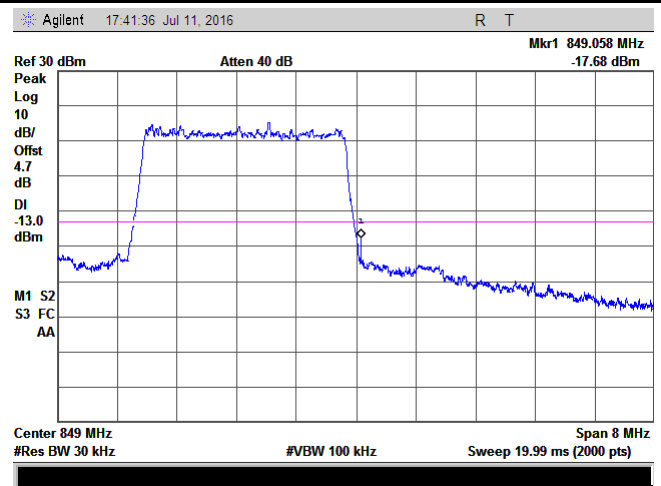

LTE Band 5 - High Channel 16QAM-3

Note: Offset=Cable loss (4.5) + 10log
(31.20/30)=4.5+0.2=4.7 dB

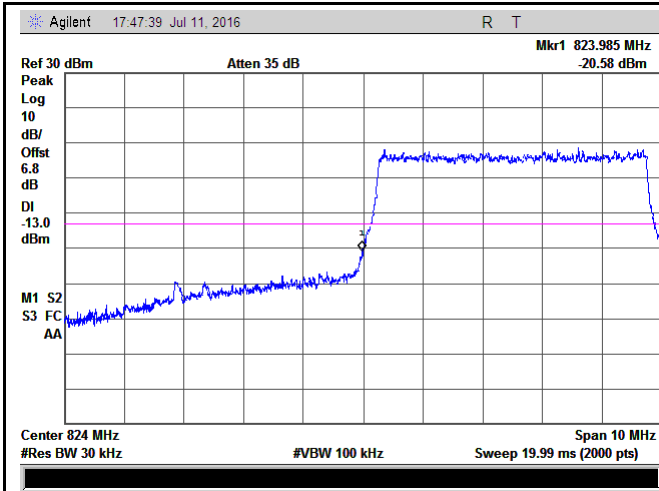

LTE Band 5 - Low Channel QPSK-5

Note: Offset=Cable loss (4.5) + 10log
(50.70/30)=4.5+2.3=6.8 dB

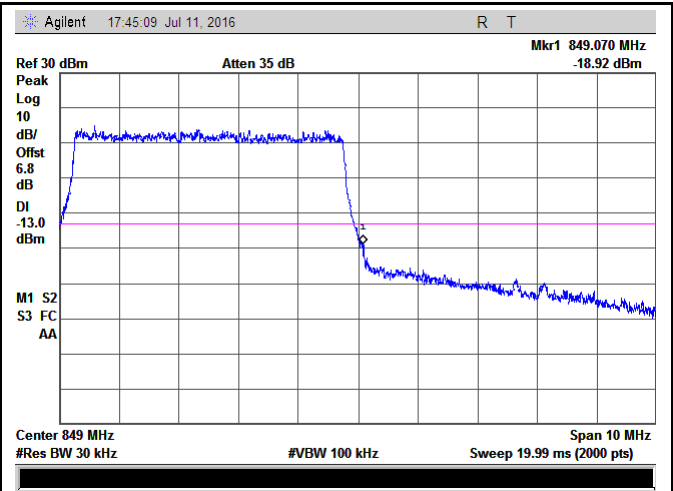

LTE Band 5 - High Channel QPSK-5

Note: Offset=Cable loss (4.5) + 10log
(50.74/30)=4.5+2.3=6.8 dB

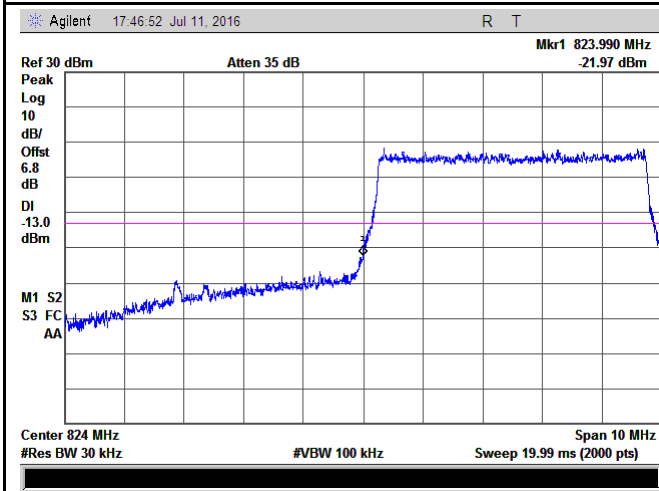

LTE Band 5 - Low Channel 16QAM-5

Note: Offset=Cable loss (4.5) + 10log
(50.99/30)=4.5+2.3=6.8 dB

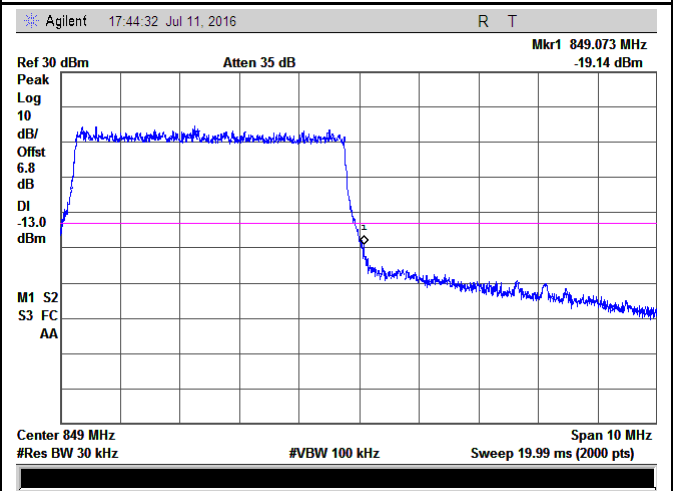

LTE Band 5 - High Channel 16QAM-5

Note: Offset=Cable loss (4.5) + 10log
(50.96/30)=4.5+2.3=6.8 dB

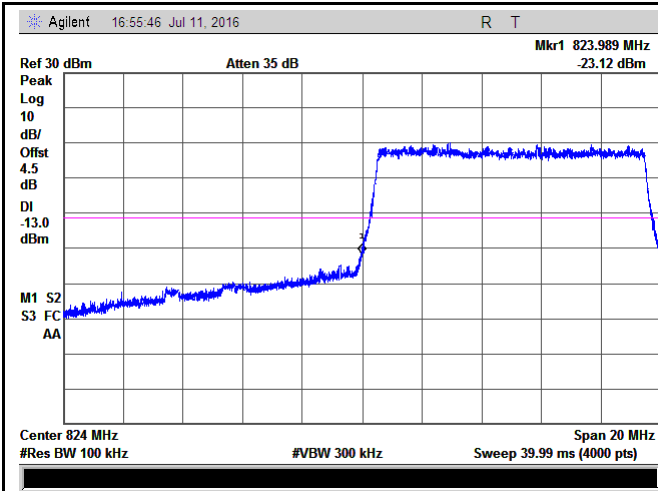

LTE Band 5 - Low Channel QPSK-10

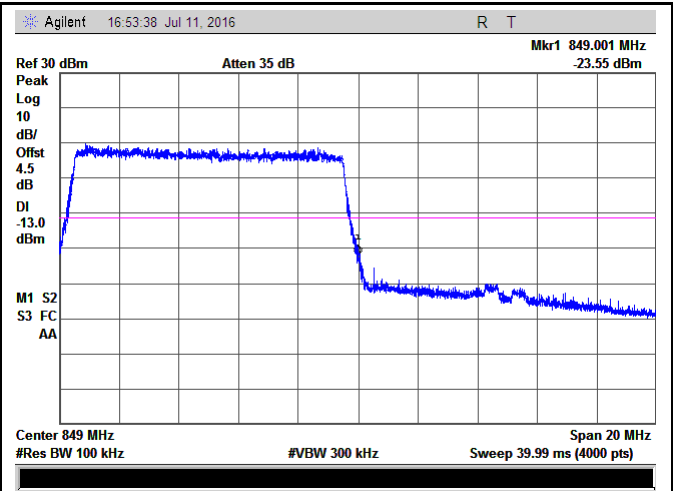

LTE Band 5 - High Channel QPSK-10

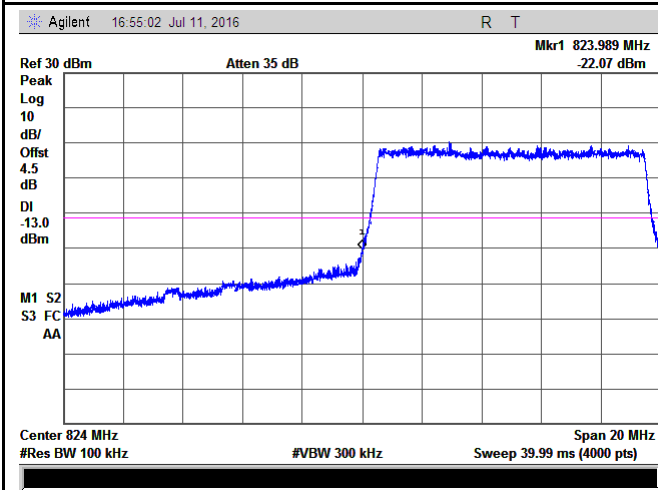

LTE Band 5 - Low Channel 16QAM-10

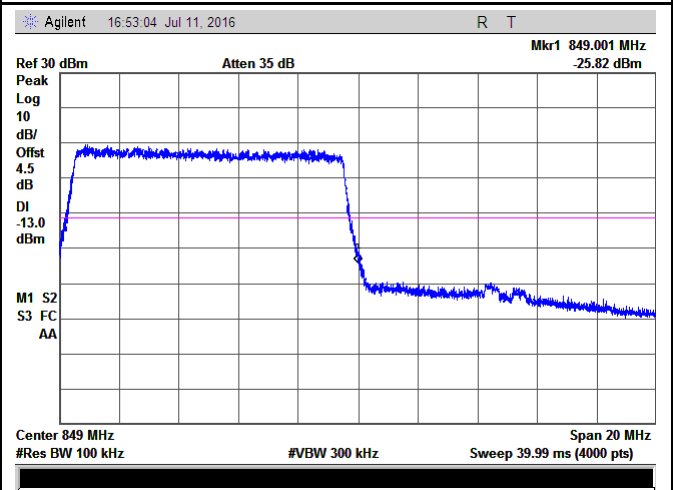

LTE Band 5 - High Channel 16QAM-10

6.8 Band Edge 27.53(m)

Temperature	24°C
Relative Humidity	53%
Atmospheric Pressure	1011mbar
Test date :	July 11, 2016
Tested By :	Loren Luo

Requirement(s):

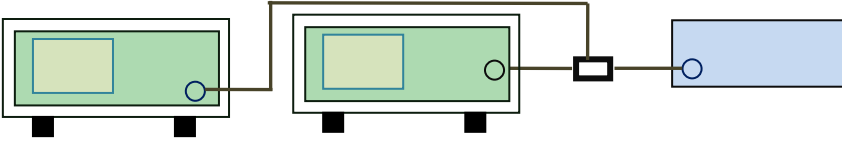
Spec	Requirement	Applicable
§27.53(m)	According to FCC 27.53(m)(4) specified that power of any emission outside of the channel edge must be attenuated below the transmitting power(P) by a factor shall be not less than $43+10\log(P)$ dB at the channel edge, the limit of emission equal to -13dBm. And $55+10\log(P)$ dB at 5.5MHz from the channel edges, the limit of emission equal to -25dBm. In the 1MHz bands immediately outside and adjacent to the frequency block a resolution bandwidth of at least one percent of the emission bandwidth of the fundamental emission of the transmitter may be employed.	<input checked="" type="checkbox"/>
Test Setup		
Test Procedure	<ul style="list-style-type: none"> - The EUT was connected to Spectrum Analyzer and Base Station via power divider. - The 99% and 26 dB occupied bandwidth (BW) of the middle channel for the highest RF powers. 	
Remark		
Result	<input checked="" type="checkbox"/> Pass <input type="checkbox"/> Fail	

Test Data Yes N/A
 Test Plot Yes (See below) N/A

LTE Band 7 (Part 27) result

BW(MHz)	Channel	Frequency (MHz)	Mode	Emission (dBm)	Limit (dBm)
5	20775	2502.5	QPSK	-20.73	-13
			16QAM	-22.92	-13
5	21425	2567.5	QPSK	-21.23	-13
			16QAM	-20.65	-13
10	20800	2505	QPSK	-19.87	-13
			16QAM	-21.62	-13
10	21400	2562.5	QPSK	-23.92	-13
			16QAM	-22.02	-13
15	20825	2507.5	QPSK	-26.53	-13
			16QAM	-20.68	-13
15	21400	2562.5	QPSK	-24.95	-13
			16QAM	-22.88	-13
20	20850	2510	QPSK	-29.06	-13
			16QAM	-27.68	-13
20	21350	2560	QPSK	-21.17	-13
			16QAM	-28.76	-13

LTE Band 7 (Part 27)

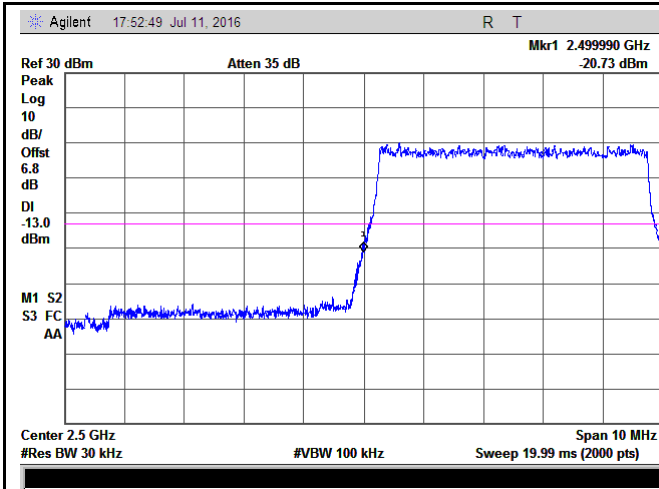

LTE Band 7 - Low Channel QPSK-5

Note: Offset=Cable loss (4.5) + 10log
(51.07/30)=4.5+2.3=6.8 dB

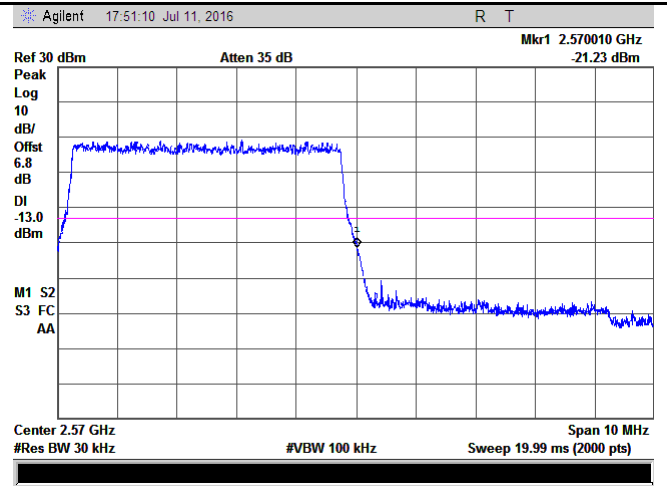

LTE Band 7 - High Channel QPSK-5

Note: Offset=Cable loss (4.5) + 10log
(50.48/30)=4.5+2.3=6.8 dB

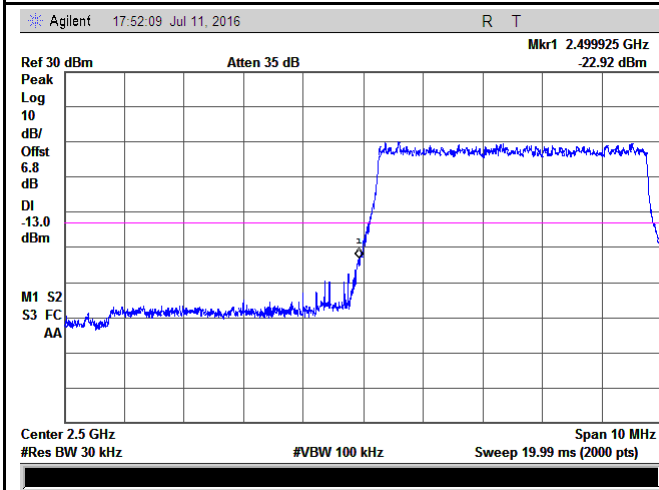

LTE Band 7 - Low Channel 16QAM-5

Note: Offset=Cable loss (4.5) + 10log
(51.02/30)=4.5+2.3=6.8 dB

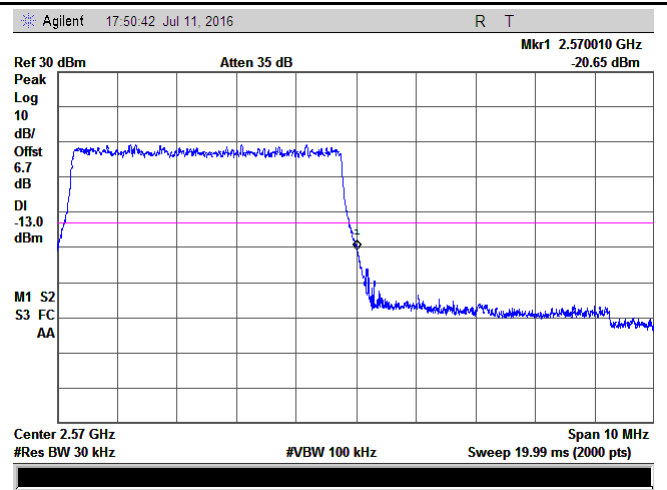

LTE Band 7 - High Channel 16QAM-5

Note: Offset=Cable loss (4.5) + 10log
(19.97/30)=4.5+2.2=6.7 dB

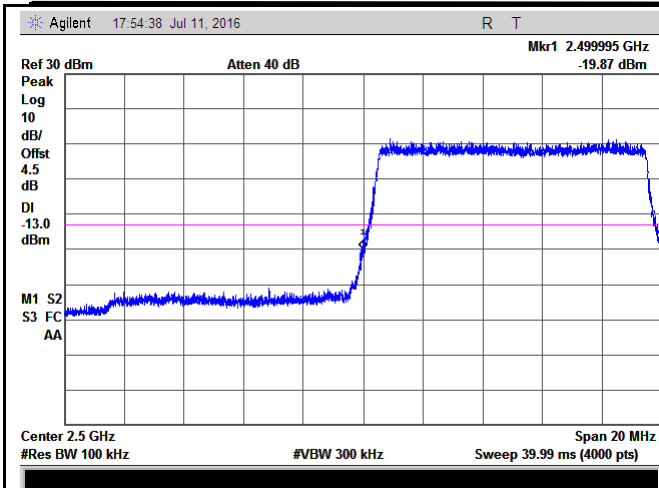

LTE Band 7 - Low Channel QPSK-10

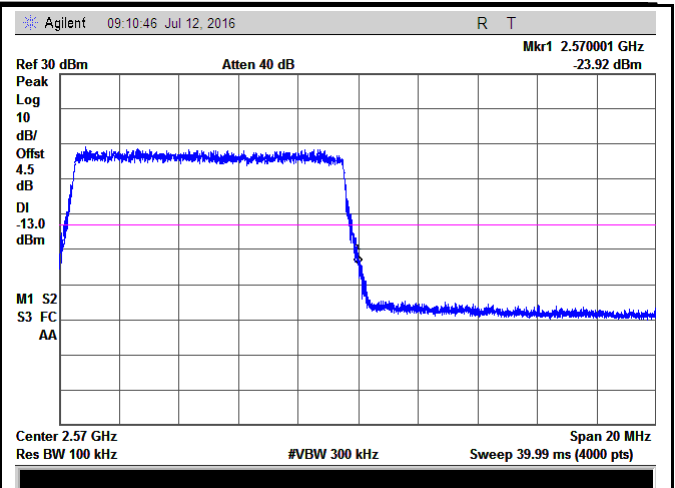

LTE Band 7 - High Channel QPSK-10

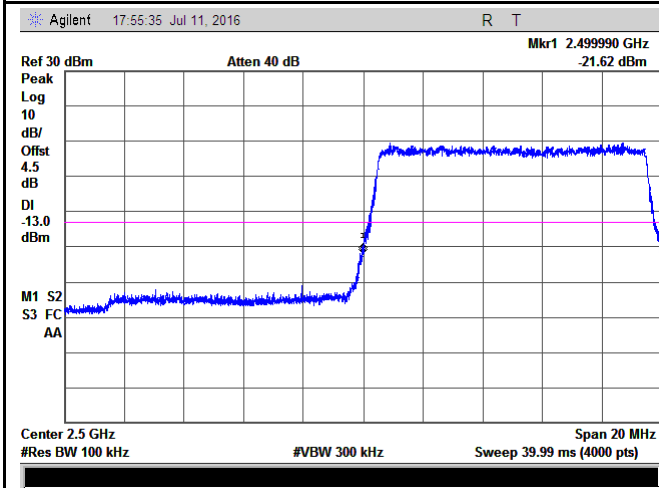

LTE Band 7 - Low Channel 16QAM-10

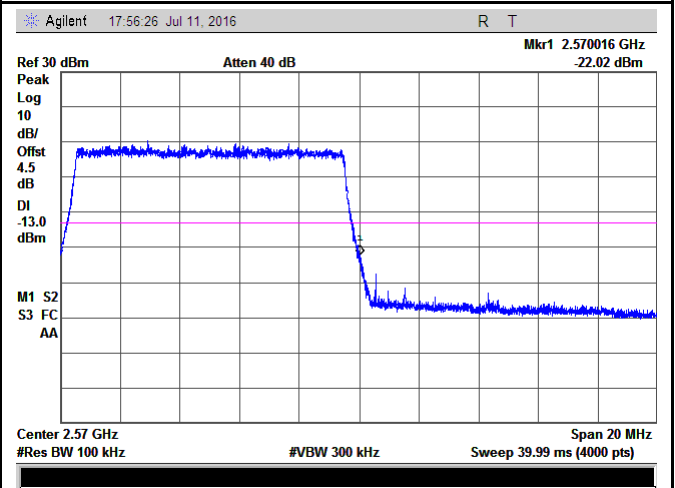

LTE Band 7 - High Channel 16QAM-10

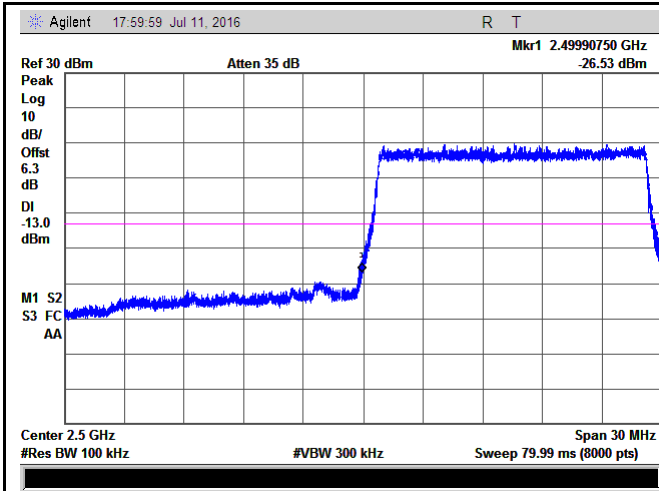

LTE Band 7 - Low Channel QPSK-15

Note: Offset=Cable loss (4.5) + 10log
(151.9/100)=4.5+1.8=6.3 dB

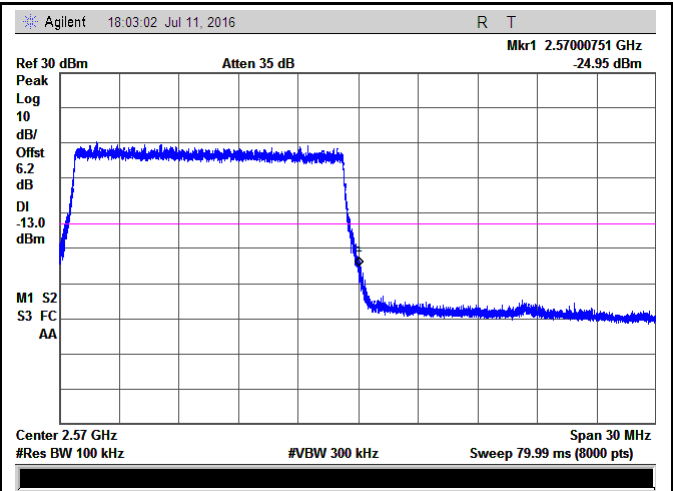

LTE Band 7 - High Channel QPSK-15

Note: Offset=Cable loss (4.5) + 10log
(149.0/100)=4.5+1.7=6.2 dB

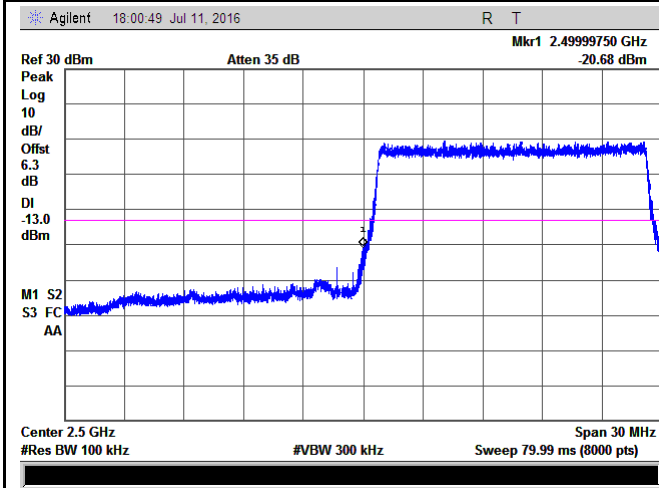

LTE Band 7 - Low Channel 16QAM-15

Note: Offset=Cable loss (4.5) + 10log
(150.2/100)=4.5+1.8=6.3 dB

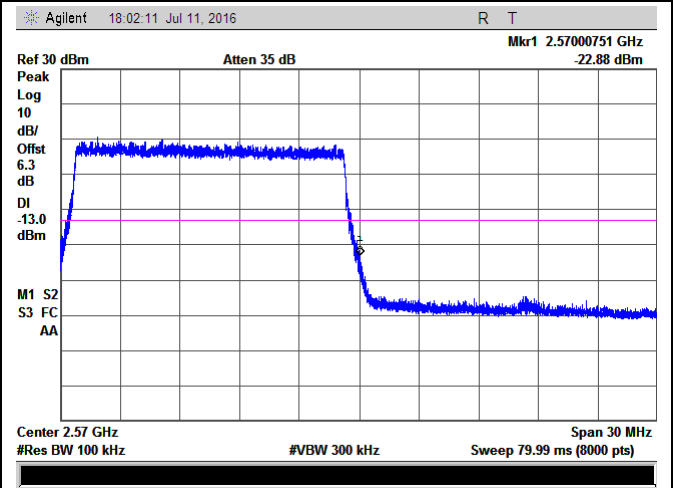

LTE Band 7 - High Channel 16QAM-15

Note: Offset=Cable loss (4.5) + 10log
(150.1/100)=4.5+1.8=6.3 dB

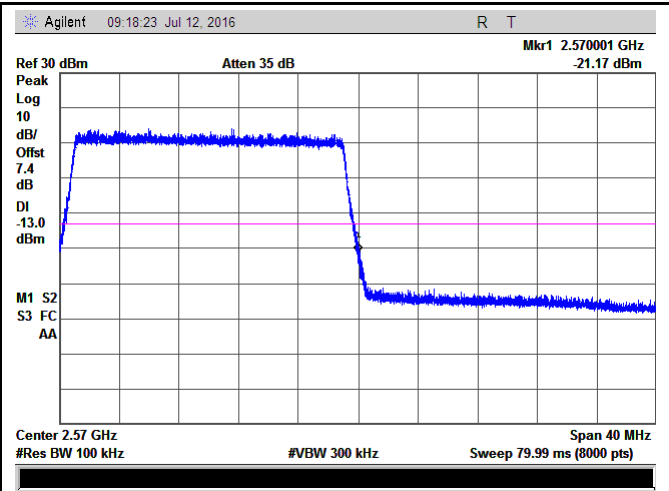
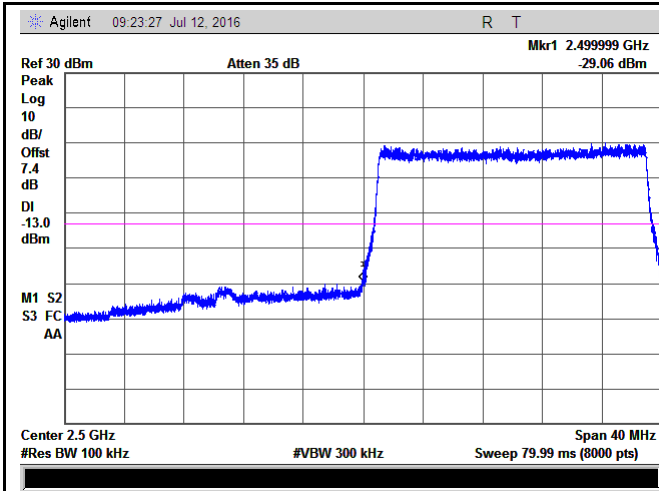

LTE Band 7 - Low Channel QPSK-20

LTE Band 7 - High Channel QPSK-20

Note: Offset=Cable loss (4.5) + 10log
(194.7/100)=4.5+2.9=7.4 dB

Note: Offset=Cable loss (4.5) + 10log
(195.2/100)=4.5+2.9=7.4 dB

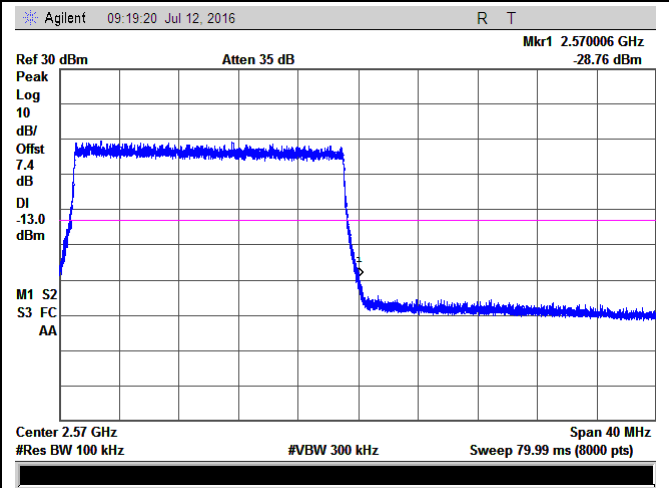
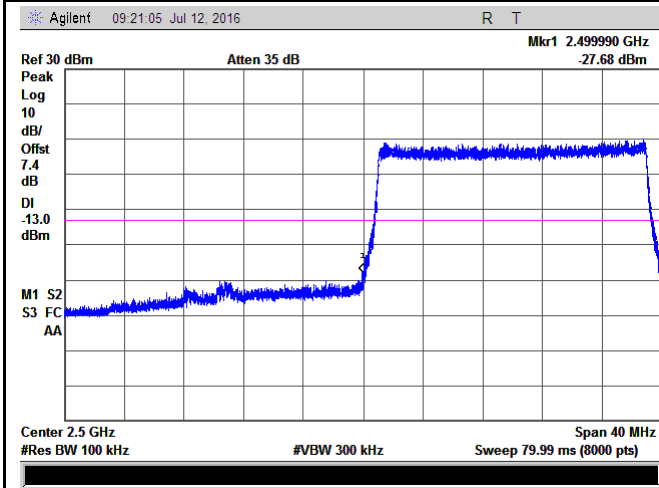

LTE Band 7 - Low Channel 16QAM-20

LTE Band 7 - High Channel 16QAM-20

Note: Offset=Cable loss (4.5) + 10log
(195.3/100)=4.5+2.9=7.4 dB

Note: Offset=Cable loss (4.5) + 10log
(194.6/100)=4.5+2.9=7.4 dB

6.9 Frequency Stability

Temperature	25°C
Relative Humidity	54%
Atmospheric Pressure	1002mbar
Test date :	July 02, 2016
Tested By :	Loren Luo

Requirement(s):

Spec	Item	Requirement	Applicable																																
§2.1055, §22.355 & §24.235 § 27.5(h); § 27.54	a)	According to §22.355, the carrier frequency of each transmitter in the Public Mobile Services must be maintained within the tolerances given in Table below: Frequency Tolerance for Transmitters in the Public Mobile Services	<input checked="" type="checkbox"/>																																
		<table border="1" style="width: 100%; border-collapse: collapse;"> <thead> <tr> <th style="text-align: center;">Frequency Range (MHz)</th> <th style="text-align: center;">Base, fixed (ppm)</th> <th style="text-align: center;">Mobile ≤ 3 watts (ppm)</th> <th style="text-align: center;">Mobile ≤ 3 watts (ppm)</th> </tr> </thead> <tbody> <tr> <td style="text-align: center;">25 to 50</td> <td style="text-align: center;">20.0</td> <td style="text-align: center;">20.0</td> <td style="text-align: center;">50.0</td> </tr> <tr> <td style="text-align: center;">to 450</td> <td style="text-align: center;">5.0</td> <td style="text-align: center;">5.0</td> <td style="text-align: center;">50.0</td> </tr> <tr> <td style="text-align: center;">450 to 512</td> <td style="text-align: center;">2.5</td> <td style="text-align: center;">5.0</td> <td style="text-align: center;">5 0</td> </tr> <tr> <td style="text-align: center;">821 to 896</td> <td style="text-align: center;">1.5</td> <td style="text-align: center;">2.5</td> <td style="text-align: center;">2.5</td> </tr> <tr> <td style="text-align: center;">928 to 929.</td> <td style="text-align: center;">5.0</td> <td style="text-align: center;">N/A</td> <td style="text-align: center;">N/A</td> </tr> <tr> <td style="text-align: center;">929 to 960.</td> <td style="text-align: center;">1.5</td> <td style="text-align: center;">N/A</td> <td style="text-align: center;">N/A</td> </tr> <tr> <td style="text-align: center;">2110 to 2220</td> <td style="text-align: center;">10.0</td> <td style="text-align: center;">N/A</td> <td style="text-align: center;">N/A</td> </tr> </tbody> </table>		Frequency Range (MHz)	Base, fixed (ppm)	Mobile ≤ 3 watts (ppm)	Mobile ≤ 3 watts (ppm)	25 to 50	20.0	20.0	50.0	to 450	5.0	5.0	50.0	450 to 512	2.5	5.0	5 0	821 to 896	1.5	2.5	2.5	928 to 929.	5.0	N/A	N/A	929 to 960.	1.5	N/A	N/A	2110 to 2220	10.0	N/A	N/A
		Frequency Range (MHz)		Base, fixed (ppm)	Mobile ≤ 3 watts (ppm)	Mobile ≤ 3 watts (ppm)																													
		25 to 50		20.0	20.0	50.0																													
		to 450		5.0	5.0	50.0																													
		450 to 512		2.5	5.0	5 0																													
		821 to 896		1.5	2.5	2.5																													
		928 to 929.		5.0	N/A	N/A																													
		929 to 960.		1.5	N/A	N/A																													
2110 to 2220	10.0	N/A	N/A																																
According to §24.235, the frequency stability shall be sufficient to ensure that the fundamental emissions stay within the authorized frequency block.																																			
According to §27.54, The frequency stability shall be sufficient to ensure that the fundamental emissions stay within the authorized bands of operation.																																			

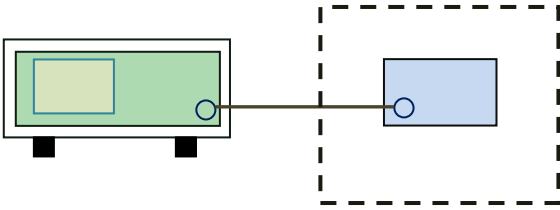
Test setup	
Procedure	<p>A communication link was established between EUT and base station. The frequency error was monitored and measured by base station under variation of ambient temperature and variation of primary supply voltage.</p> <p>Limit: The frequency stability of the transmitter shall be maintained within $\pm 0.00025\%$ ($\pm 2.5\text{ppm}$) of the center frequency.</p>
Remark	<p>Frequency Stability versus Temperature: The Frequency tolerance of the carrier signal shall be maintained within 2.5ppm of the operating frequency over a temperature variation of -10°C to $+55^{\circ}\text{C}$ at normal supply voltage.</p>
Result	<input checked="" type="checkbox"/> Pass <input type="checkbox"/> Fail

Test Data Yes N/A
 Test Plot Yes (See below) N/A

LTE Band 2 (Part 24E) result

Middle Channel, $f_0 = 1880$ MHz				
Temperature (°C)	Power Supplied (V _{DC})	Frequency Error (Hz)	Frequency Error (ppm)	Limit (ppm)
-10	3.7	-5	0.0027	2.5
0		-11	0.0059	2.5
10		-8	0.0043	2.5
20		-10	0.0053	2.5
30		-15	0.0080	2.5
40		-8	0.0043	2.5
50		-11	0.0059	2.5
55		-9	0.0048	2.5
25		4.2	-11	0.0059
	3.5	-13	0.0069	2.5

LTE Band 4 (Part 27) result

Middle Channel, $f_0 = 1732.5$ MHz				
Temperature (°C)	Power Supplied (V _{DC})	Frequency Error (Hz)	Frequency Error (ppm)	Limit (ppm)
-10	3.7	-12	0.0069	2.5
0		-18	0.0104	2.5
10		-15	0.0087	2.5
20		-11	0.0063	2.5
30		-8	0.0046	2.5
40		-10	0.0058	2.5
50		-12	0.0069	2.5
55		-15	0.0087	2.5
25		4.2	-14	0.0081
	3.5	-16	0.0092	2.5

LTE Band 5 (Part 22H) result

Middle Channel, $f_0 = 836.5$ MHz				
Temperature (°C)	Power Supplied (V _{DC})	Frequency Error (Hz)	Frequency Error (ppm)	Limit (ppm)
-10	3.7	-9	0.0108	2.5
0		-7	0.0084	2.5
10		-5	0.0060	2.5
20		-11	0.0132	2.5
30		-10	0.0120	2.5
40		-6	0.0072	2.5
50		-11	0.0132	2.5
55		-8	0.0096	2.5
25	4.2	-10	0.0120	2.5
	3.5	-12	0.0143	2.5

LTE Band 7 (Part 27) result

Middle Channel, $f_0 = 2535$ MHz				
Temperature (°C)	Power Supplied (V _{DC})	Frequency Error (Hz)	Frequency Error (ppm)	Limit (ppm)
-10	3.7	-13	0.0051	2.5
0		-8	0.0032	2.5
10		-10	0.0039	2.5
20		-9	0.0036	2.5
30		-10	0.0039	2.5
40		-10	0.0039	2.5
50		-11	0.0043	2.5
55		-7	0.0028	2.5
25	4.2	-9	0.0036	2.5
	3.5	-11	0.0043	2.5

Annex A. TEST INSTRUMENT

Instrument	Model	Serial #	Cal Date	Cal Due	In use
RF Conducted Test					
Agilent ESA-E SERIES SPECTRUM ANALYZER	E4407B	MY45108319	09/16/2015	09/15/2016	<input checked="" type="checkbox"/>
Power Splitter	1#	1#	09/01/2015	08/31/2016	<input checked="" type="checkbox"/>
Universal Radio Communication Tester	CMU200	121393	09/25/2015	09/24/2016	<input checked="" type="checkbox"/>
Wideband Radio Communication Tester	CMW500	120906	03/28/2015	03/27/2016	<input checked="" type="checkbox"/>
Temperature/Humidity Chamber	UHL-270	001	10/09/2015	10/08/2016	<input checked="" type="checkbox"/>
DC Power Supply	E3640A	MY40004013	09/17/2015	09/16/2016	<input checked="" type="checkbox"/>
RF Power Sensor	Dare RPR3006C/P/W	AY554013	09/17/2015	09/16/2016	<input checked="" type="checkbox"/>
Radiated Emissions					
EMI test receiver	ESL6	100262	09/17/2015	09/16/2016	<input checked="" type="checkbox"/>
OPT 010 AMPLIFIER (0.1-1300MHz)	8447E	2727A02430	09/01/2015	08/31/2016	<input checked="" type="checkbox"/>
Microwave Preamplifier (0.5 ~ 18GHz)	PAM-118	443008	09/01/2015	08/31/2016	<input checked="" type="checkbox"/>
Bilog Antenna (30MHz~6GHz)	JB6	A110712	09/21/2015	09/20/2016	<input checked="" type="checkbox"/>
Bilog Antenna (30MHz~2GHz)	JB1	A112017	09/21/2015	09/20/2016	<input checked="" type="checkbox"/>
Double Ridge Horn Antenna (1 ~18GHz)	AH-118	71259	09/24/2015	09/23/2016	<input checked="" type="checkbox"/>
Double Ridge Horn Antenna (1 ~18GHz)	AH-118	71283	09/24/2015	09/23/2016	<input checked="" type="checkbox"/>
SYNTHESIZED SIGNAL GENERATOR	8665B	3744A01293	09/17/2015	09/16/2016	<input checked="" type="checkbox"/>
Tunable Notch Filter	3NF-800/1000-S	AA4	09/01/2015	08/31/2016	<input checked="" type="checkbox"/>

Test Report	16070667-FCC-R5
Page	112 of 123

Tunable Notch Filter	3NF- 1000/2000-S	AM 4	09/01/2015	08/31/2016	<input checked="" type="checkbox"/>
----------------------	---------------------	------	------------	------------	-------------------------------------

Annex B. EUT And Test Setup Photographs

Annex B.i. Photograph: EUT External Photo

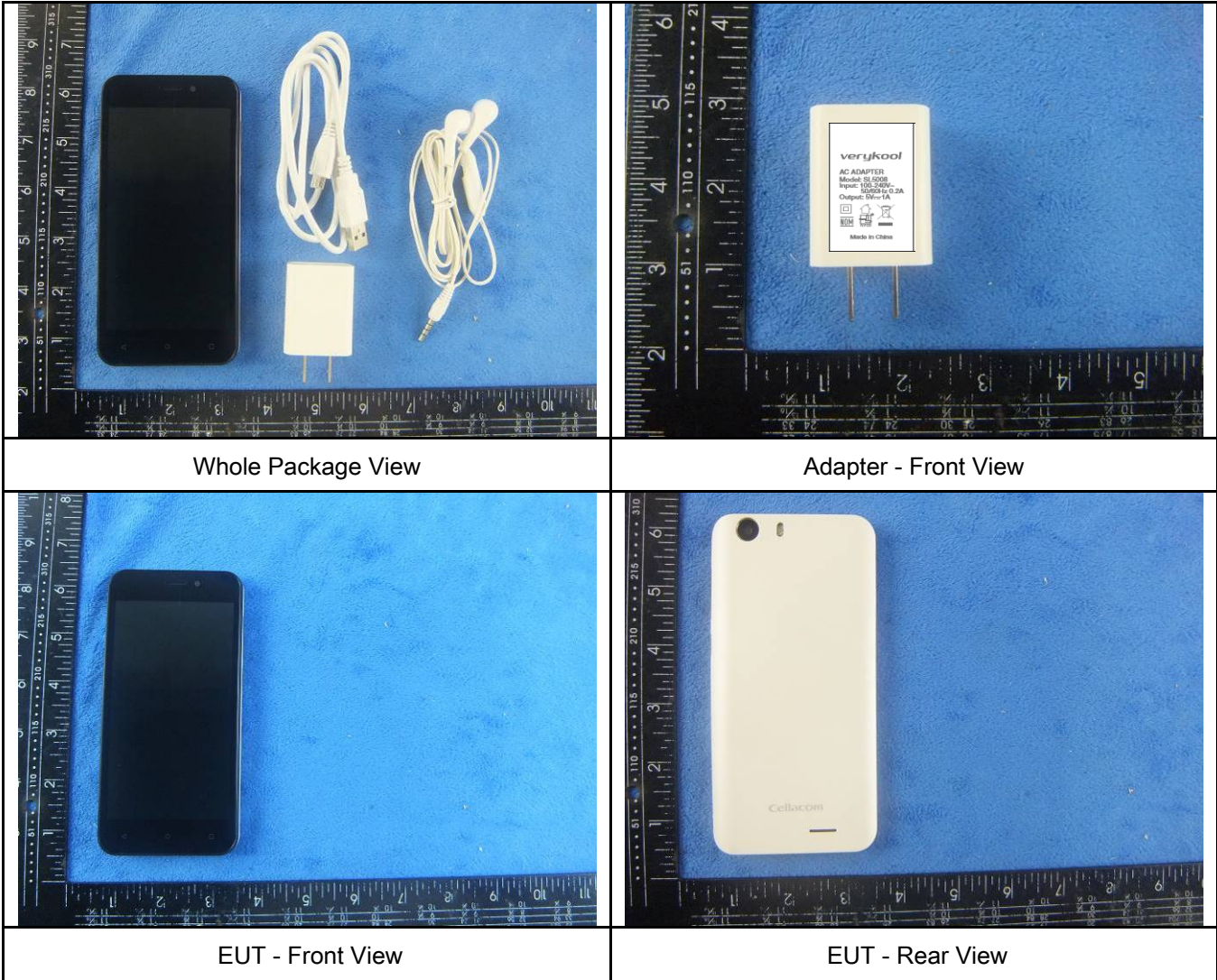

Whole Package View

Adapter - Front View

EUT - Front View

EUT - Rear View



EUT - Top View



EUT - Bottom View

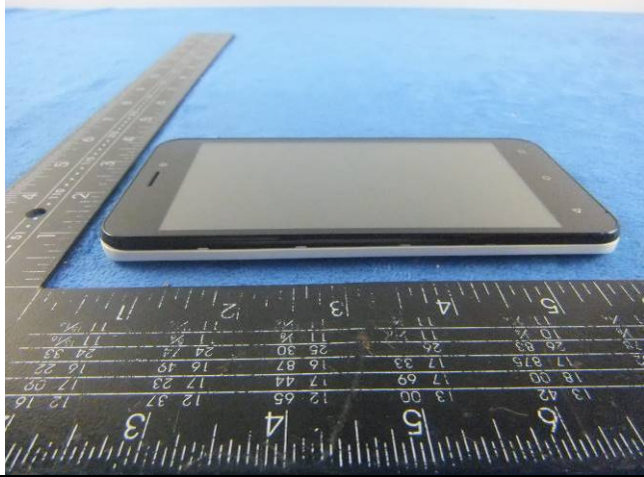

EUT - Left View



EUT - Right View

Annex B.ii. Photograph: EUT Internal Photo



Cover Off - Top View 1



Cover Off - Top View 2

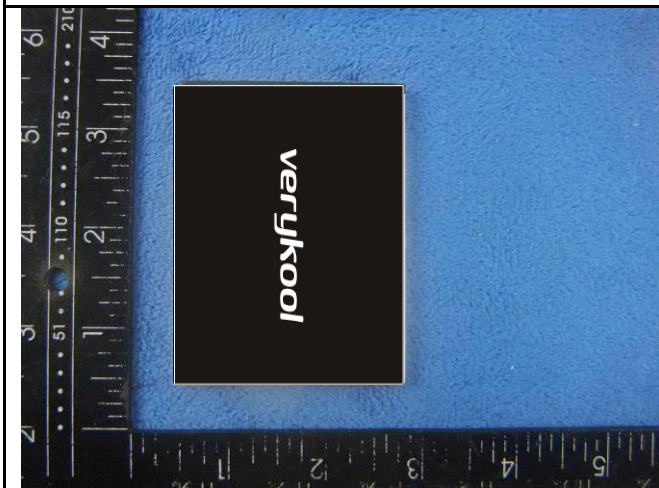

Battery - Front View



Battery - Rear View

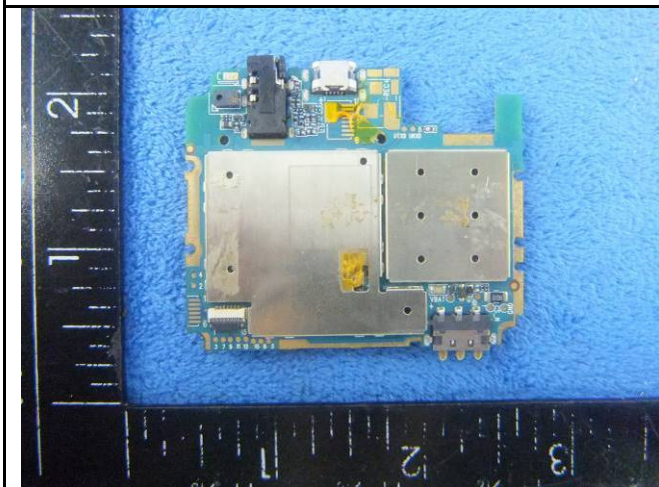

Mainboard with Shielding - Front View



Mainboard without Shielding - Front View

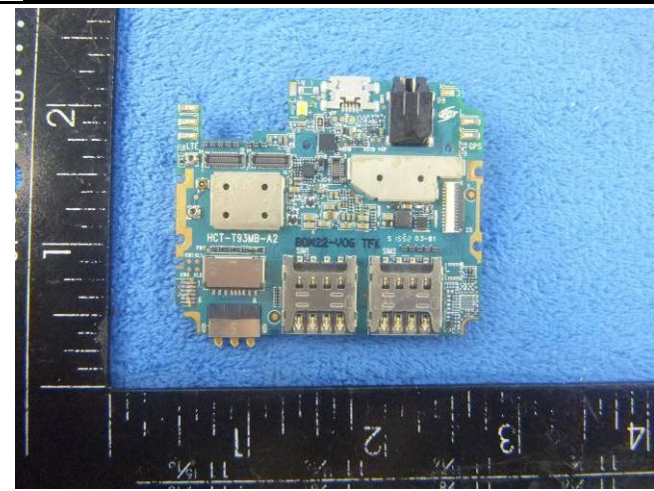

Mainboard with Shielding - Rear View

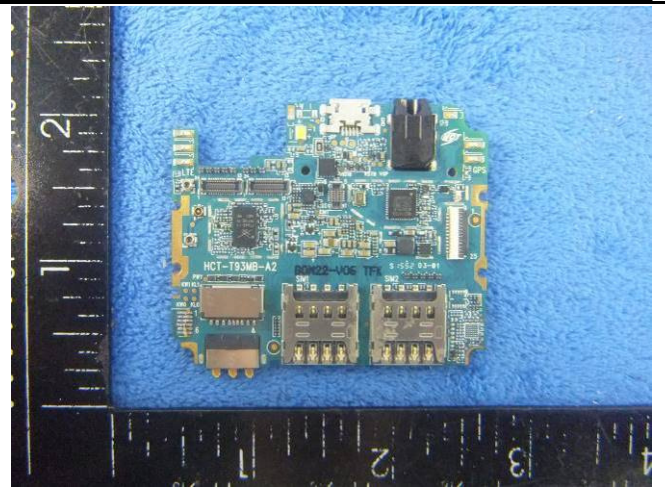

Mainboard without Shielding - Rear View

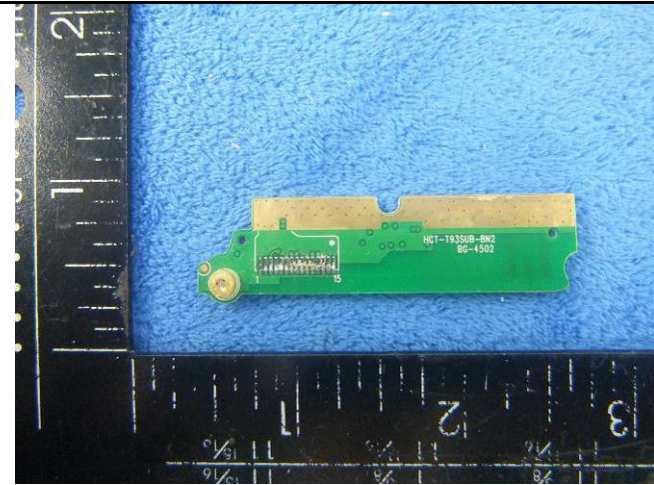

Small Board - Front View

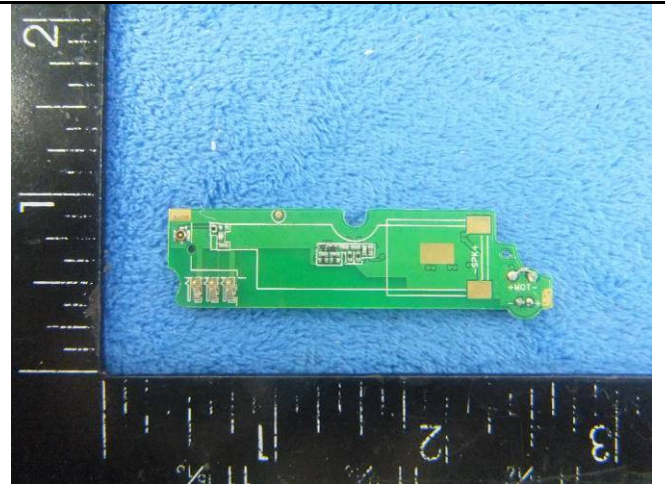

Small Board - Rear View



LCD - Front View



LCD - Rear View



GSM/PCS/UMTS-FDD/LTE Antenna View



WIFI/BT/BLE/GPS - Antenna View

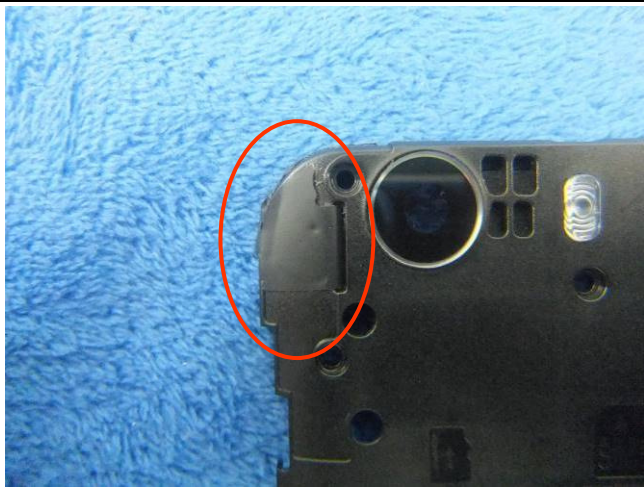

LTE - Antenna View

Annex B.iii. Photograph: Test Setup Photo

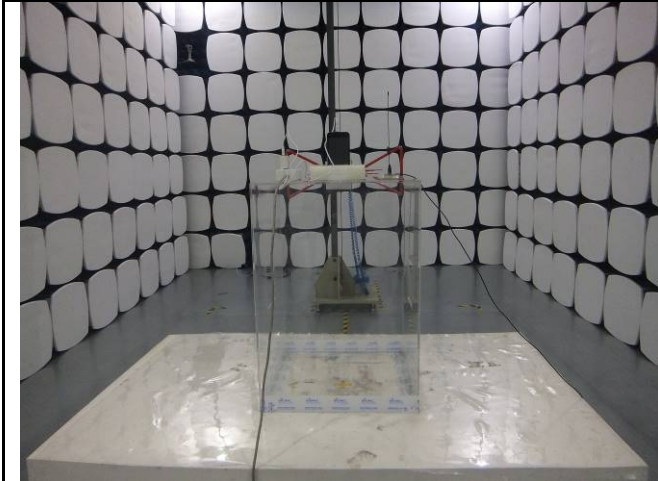

Radiated Spurious Emissions Test Setup Below 1GHz

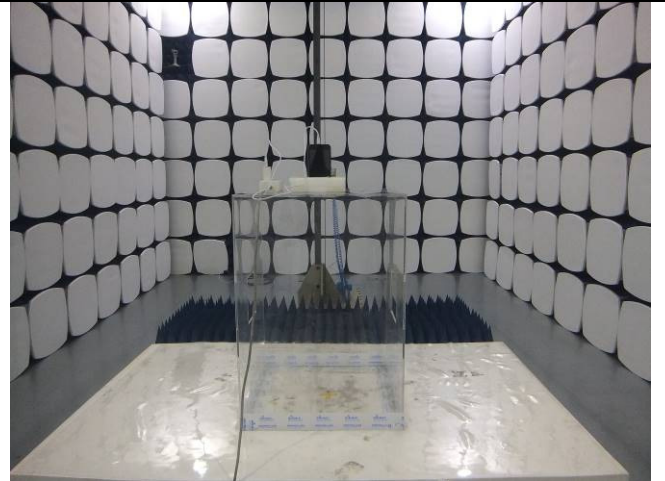

Radiated Spurious Emissions Test Setup Above
1GHz

Annex C. TEST SETUP AND SUPPORTING EQUIPMENT

Annex C.ii. TEST SET UP BLOCK

Block Configuration Diagram for Radiated Emissions

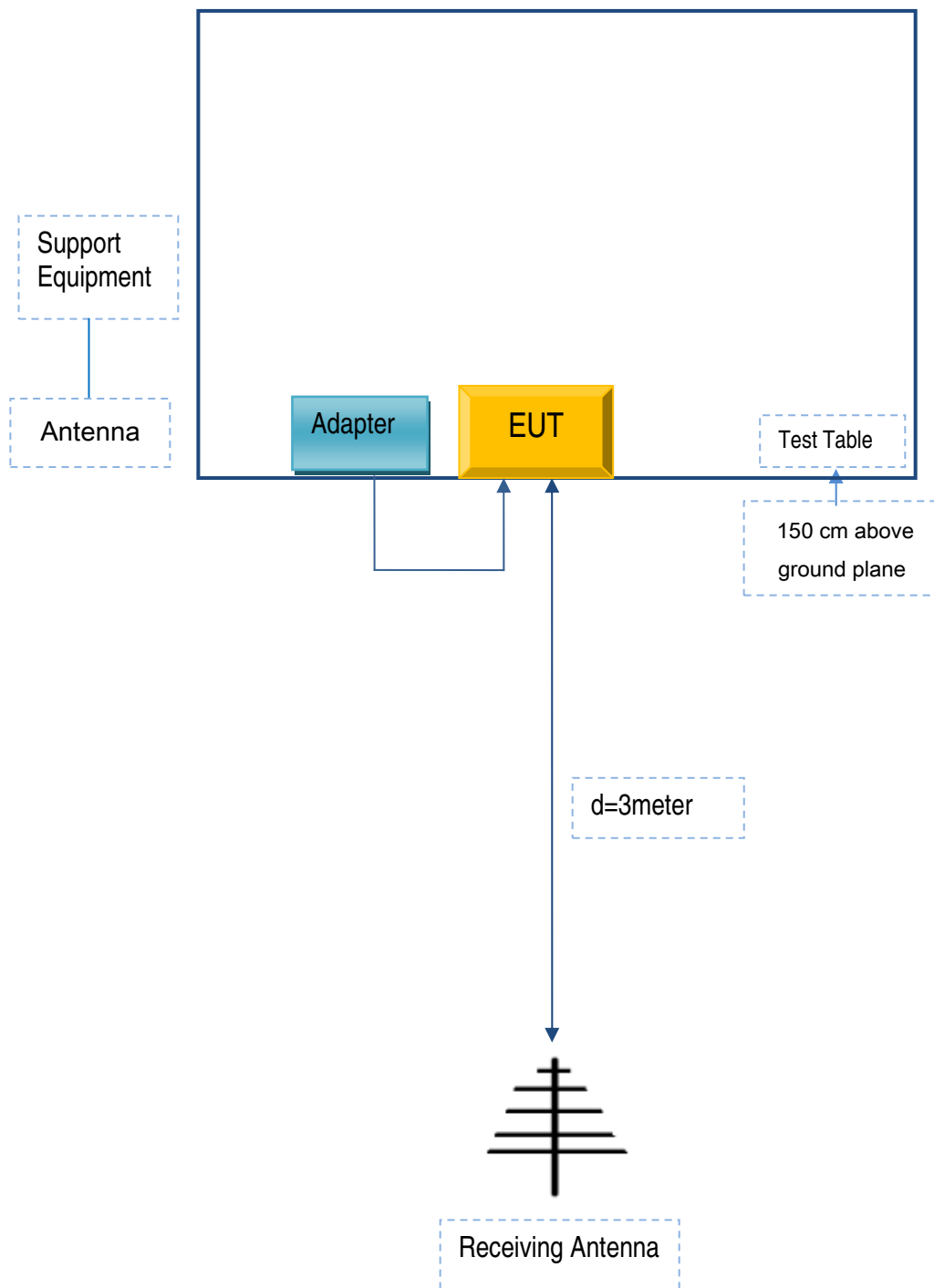

Annex C. ii. SUPPORTING EQUIPMENT DESCRIPTION

The following is a description of supporting equipment and details of cables used with the EUT.

Supporting Equipment:

Manufacturer	Equipment Description	Model	Serial No
Verykool USA Inc	Adapter	SL5008	SL-005

Supporting Cable:

Cable type	Shield Type	Ferrite Core	Length	Serial No
USB Cable	Un-shielding	No	0.8m	SL-005

Test Report	16070667-FCC-R5
Page	121 of 123

Annex C.ii. EUT OPERATING CONKITIONS

N/A

Test Report	16070667-FCC-R5
Page	122 of 123

Annex D. User Manual / Block Diagram / Schematics / Partlist

Please see attachment

Annex E. DECLARATION OF SIMILARITY



Declaration Letter

For our business issue and marketing requirement, we would like to make some change on the model, details are as below:

Model No.:SL5008T and SL5008

We Verykool USA Inc, hereby declare that our product SL5008T and SL5008 share the same PCB and difference are listed as below:

Main Model No.	Serial Model No.	Difference
SL5008T	SL5008	The LTE bands of SL5008T are band II, IV V, VII, for SL5008, band VII will be shield by software based on SL5008T.

Thank you!

Sincerely

Signature: Sunny Choi

Job Title: PM Director