

RF TEST REPORT



Report No.: 15070656-FCC-R5

Supersede Report No.: N/A

Applicant	Verykool USA Inc	
Product Name	Mobile phone	
Model No.	SL4502	
Serial No.	N/A	
Test Standard	FCC Part 22(H), FCC Part 24(E), FCC Part 27: 2014; ANSI/TIA C603 D: 2010	
Test Date	August 06 to September 06, 2015	
Issue Date	September 15, 2015	
Test Result	<input checked="" type="checkbox"/> Pass <input type="checkbox"/> Fail	
Equipment complied with the specification	<input checked="" type="checkbox"/>	
Equipment did not comply with the specification	<input type="checkbox"/>	
<i>Winnie Zhang</i>	<i>David Huang</i>	
Winnie Zhang Test Engineer	David Huang Checked By	
This test report may be reproduced in full only Test result presented in this test report is applicable to the tested sample only		

Issued by:

SIEMIC (SHENZHEN-CHINA) LABORATORIES

Zone A, Floor 1, Building 2 Wan Ye Long Technology Park

South Side of Zhoushi Road, Bao' an District, Shenzhen, Guangdong China 518108

Phone: +86 0755 2601 4629801 Email: China@siemic.com.cn

Laboratories Introduction

SIEMIC, headquartered in the heart of Silicon Valley, with superior facilities in US and Asia, is one of the leading independent testing and certification facilities providing customers with one-stop shop services for Compliance Testing and Global Certifications.



In addition to testing and certification, SIEMIC provides initial design reviews and compliance management throughout a project. Our extensive experience with China, Asia Pacific, North America, European, and International compliance requirements, assures the fastest, most cost effective way to attain regulatory compliance for the global markets.

Accreditations for Conformity Assessment

Country/Region	Scope
USA	EMC, RF/Wireless, SAR, Telecom
Canada	EMC, RF/Wireless, SAR, Telecom
Taiwan	EMC, RF, Telecom, SAR, Safety
Hong Kong	RF/Wireless, SAR, Telecom
Australia	EMC, RF, Telecom, SAR, Safety
Korea	EMI, EMS, RF, SAR, Telecom, Safety
Japan	EMI, RF/Wireless, SAR, Telecom
Singapore	EMC, RF, SAR, Telecom
Europe	EMC, RF, SAR, Telecom, Safety

Test Report	15070656-FCC-R5
Page	3 of 120

This page has been left blank intentionally.

CONTENTS

1. REPORT REVISION HISTORY	5
2. CUSTOMER INFORMATION	5
3. TEST SITE INFORMATION.....	5
4. EQUIPMENT UNDER TEST (EUT) INFORMATION.....	6
5. TEST SUMMARY	8
6. MEASUREMENTS, EXAMINATION AND DERIVED RESULTS	9
6.1 RF EXPOSURE (SAR).....	9
6.2 RF OUTPUT POWER.....	10
6.3 PEAK-AVERAGE RATIO.....	40
6.4 MODULATION CHARACTERISTIC.....	43
6.5 OCCUPIED BANDWIDTH.....	44
6.6 SPURIOUS EMISSIONS AT ANTENNA TERMINALS.....	69
6.7 SPURIOUS RADIATED EMISSIONS.....	74
6.8 BAND EDGE.....	79
6.9 BAND EDGE 27.53(M).....	99
6.10 FREQUENCY STABILITY.....	105
ANNEX A. TEST INSTRUMENT.....	109
ANNEX B. EUT AND TEST SETUP PHOTOGRAPHS.....	110
ANNEX C. TEST SETUP AND SUPPORTING EQUIPMENT.....	116
ANNEX C.II. EUT OPERATING CONKITIONS	118
ANNEX D. USER MANUAL / BLOCK DIAGRAM / SCHEMATICS / PARTLIST	119
ANNEX E. DECLARATION OF SIMILARITY.....	120

1. Report Revision History

Report No.	Report Version	Description	Issue Date
15070656-FCC-R5	NONE	Original	September 15, 2015

2. Customer information

Applicant Name	Verykool USA Inc
Applicant Add	3636 Nobel Drive, Suite 325, San Diego, CA 92122 USA
Manufacturer	HUIZHOU QIAOXING ELECTRONICS TECHNOLOGY CO.,LTD
Manufacturer Add	Room 1906 of VIA Building, No.9966 Shennan Avenue, Yuehai Street in Nanshan District, Shenzhen

3. Test site information

Lab performing tests	SIEMIC (Shenzhen-China) LABORATORIES
Lab Address	Zone A, Floor 1, Building 2 Wan Ye Long Technology Park South Side of Zhoushi Road, Bao' an District, Shenzhen, Guangdong China 518108
FCC Test Site No.	718246
IC Test Site No.	4842E-1
Test Software	Radiated Emission Program-To Shenzhen v2.0

4. Equipment under Test (EUT) Information

Description of EUT:	Mobile phone
Main Model:	SL4502
Serial Model:	N/A
Date EUT received:	August 05, 2015
Test Date(s):	August 06 to September 06, 2015
Equipment Category :	PCE
Antenna Gain:	GSM850: -1 dBi PCS1900: 0 dBi UMTS-FDD Band V: -1 dBi UMTS-FDD Band IV: 0 dBi UMTS-FDD Band II: 0 dBi Bluetooth/BLE: -1 dBi WIFI: -1 dBi LTE Band 2: 0dBi LTE Band 4: 0 dBi LTE Band 5: -1 dBi LTE Band 7: -1 dBi GPS: 0 dBi
Type of Modulation:	GSM / GPRS: GMSK EGPRS: GMSK, 8PSK UMTS-FDD: QPSK, 16QAM 802.11b/g/n: DSSS, OFDM Bluetooth: GFSK, π /4DQPSK, 8DPSK BLE: GFSK LTE Band: QPSK, 16QAM GPS: BPSK
RF Operating Frequency (ies):	GSM850 TX: 824.2 ~ 848.8 MHz; RX: 869.2 ~ 893.8 MHz PCS1900 TX: 1850.2 ~ 1909.8 MHz; RX: 1930.2 ~ 1989.8 MHz

Test Report	15070656-FCC-R5
Page	7 of 120

UMTS-FDD Band V TX: 826.4 ~ 846.6 MHz; RX: 871.4 ~ 891.6 MHz

UMTS-FDD Band IV TX:1712.4 ~ 1752.6 MHz;

RX : 2112.4 ~ 2152.6 MHz

UMTS-FDD Band II TX:1852.4 ~ 1907.6 MHz;

RX: 1932.4 ~ 1987.6 MHz

WIFI:802.11b/g/n(20M): 2412-2462 MHz

WIFI:802.11n(40M): 2422-2472 MHz

Bluetooth& BLE: 2402-2480 MHz

LTE Band 2 TX: 1852.5 ~ 1907.5 MHz; RX : 1932.5 ~ 1987.5 MHz

LTE Band 4 TX: 1712.5 ~ 1752.5 MHz; RX : 2112.5 ~ 2152.5 MHz

LTE Band 5 TX: 826.5 ~ 846.5 MHz; RX : 871.5 ~ 891.5 MHz

LTE Band 7 TX: 2502.5 ~ 2567.5 MHz; RX : 2622.5 ~ 2687.5 MHz

GPS RX:1575.42 MHz

Maximum Conducted
AV Power to Antenna:

LTE Band 2: 23.93 dBm

LTE Band 4: 21.82 dBm

LTE Band 5: 22.63 dBm

LTE Band 7: 22.58 dBm

ERP/EIRP:

LTE Band 2: 17.18 dBm / EIRP

LTE Band 4: 16.92 dBm / EIRP

LTE Band 5: 17.77 dBm / EIRP

LTE Band 7: 16.92 dBm / EIRP

Port:

Power Port, Earphone Port, USB Port

Input Power:

Battery:

Model:Q450

Spec:3.8V,1800mAh(6.84Wh)

Limited Charging Voltage: 4.35V

Adapter:

Model:Q500

Input: 100-240V; 50/60Hz; 0.2A

Output: DC 5.0V,1A

Trade Name :

Verykool

GPRS/EGPRS Multi-slot class

8/10/12

FCC ID:

WA6SL4502

5. Test Summary

The product was tested in accordance with the following specifications.

All testing has been performed according to below product classification:

FCC Rules	Description of Test	Result
§ 1.1307; § 2.1093	RF Exposure (SAR)	Compliance
§2.1046; § 22.913(a); § 24.232(c); § 27.50(c.10); § 27.50(d.4)	RF Output Power	Compliance
§ 24.232 (d); § 27.50(d)	Peak-Average Ratio	Compliance
§ 2.1047	Modulation Characteristics	Compliance
§ 2.1049; § 22.905; § 22.917; § 24.238; § 27.53(a.5)	99% & -26 dB Occupied Bandwidth	Compliance
§ 2.1051; § 22.917(a); § 24.238(a); § 27.53(h)	Spurious Emissions at Antenna Terminal	Compliance
§ 2.1053; § 22.917(a); § 24.238(a); § 27.53(h)	Field Strength of Spurious Radiation	Compliance
§ 22.917(a); § 24.238(a);	Out of band emission, Band Edge	Compliance
§ 27.53(m)	Band Edge 27.53(m)	Compliance
§ 2.1055; § 22.355; § 24.235; § 27.5(h); § 27.54	Frequency stability vs. temperature Frequency stability vs. voltage	Compliance

Note: Testing was performed by configuring EUT to maximum output power status, the declared output power class for different

Measurement Uncertainty

Emissions		
Test Item	Description	Uncertainty
Band Edge and Radiated Spurious Emissions	Confidence level of approximately 95% (in the case where distributions are normal), with a coverage factor of 2 (for EUTs < 0.5m X 0.5m X 0.5m)	+5.6dB/-4.5dB
-	-	-

6. MEASUREMENTS, EXAMINATION AND DERIVED RESULTS

6.1 RF Exposure (SAR)

Test Result: Pass

The EUT is a portable device, thus requires SAR evaluation;

Please refer to RF Exposure Evaluation Report: 15070656-FCC-H.

6.2 RF Output Power

Temperature	23°C
Relative Humidity	55%
Atmospheric Pressure	1003mbar
Test date :	September 03, 2015
Tested By :	Winnie Zhang

Requirement(s):

Spec	Item	Requirement	Applicable
§22.913 (a)	a)	ERP:38.45dBm	<input checked="" type="checkbox"/>
§24.232 (c)	b)	EIRP:33dBm	<input checked="" type="checkbox"/>
§27.50 (c)	c)	EIRP: 30dBm	<input checked="" type="checkbox"/>

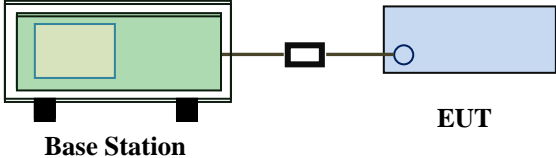
Test Setup	 <p>The diagram illustrates the test setup. On the left is a green rectangular box labeled 'Base Station'. A black cable connects it to a blue rectangular box on the right labeled 'EUT'. The connection point on the EUT is marked with a small circle.</p>
------------	--

Test Procedure	<p>For Conducted Power:</p> <ul style="list-style-type: none"> - The transmitter output port was connected to base station. - Set EUT at maximum power through base station. - Select lowest, middle, and highest channels for each band and different test mode. <p>For ERP/EIRP:</p> <ul style="list-style-type: none"> - The transmitter was placed on a wooden turntable, and it was transmitting into a non-radiating load which was also placed on the turntable. - The measurement antenna was placed at a distance of 3 meters from the EUT. During the tests, the antenna height and polarization as well as EUT azimuth were varied in order to identify the maximum level of emissions from the EUT. The test was performed by placing the EUT on 3-orthogonal axis. - The frequency range up to tenth harmonic of the fundamental frequency was investigated.
----------------	---

Test Report	15070656-FCC-R5
Page	11 of 120

	<ul style="list-style-type: none"> - Remove the EUT and replace it with substitution antenna. A signal generator was connected to the substitution antenna by a non-radiating cable. The absolute levels of the spurious emissions were measured by the substitution. - Spurious emissions in dB = 10 log (TX power in Watts/0.001) – the absolute level - Spurious attenuation limit in dB = 43 + 10 Log10 (power out in Watts).
Remark	
Result	<input checked="" type="checkbox"/> Pass <input type="checkbox"/> Fail

Test Data Yes N/A
Test Plot Yes (See below) N/A

Conducted Power

LTE Band 2:

BW (MHz)	Ch	Freq. (MHz)	Mode	UL RB Allocation	UL RB Offset	MPR	Average power (dBm)	Tune up Power tolerant
20MHz	18700	1860.0	QPSK	1	0	0	21.70	21.3±1
				1	49	0	21.69	21.3±1
				1	99	0	21.88	21.3±1
				50	0	1	20.71	21.3±1
				50	24	1	20.74	21.3±1
				50	49	1	20.79	21.3±1
			100	0	1	20.72	21.3±1	
			16QAM	1	0	1	21.01	21.3±1
				1	49	1	20.98	21.3±1
				1	99	1	21.07	21.3±1
				50	0	2	20.57	21.3±1
				50	24	2	20.89	21.3±1
				50	49	2	20.69	21.3±1
				100	0	2	20.46	21.3±1
	18900	1880.0		QPSK	1	0	0	22.00
			1		49	0	22.24	22±1
			1		99	0	22.35	22±1
			50		0	1	21.03	21.3±1
			50		24	1	21.14	21.3±1
			50		49	1	21.22	21.3±1
			100	0	1	21.12	21.3±1	
			16QAM	1	0	1	21.09	21.3±1
				1	49	1	21.30	21.3±1
				1	99	1	21.44	21.3±1
				50	0	2	21.31	21.3±1
				50	24	2	21.27	21.3±1
	50	49		2	21.34	21.3±1		
	100	0	2	20.38	21.3±1			
	19100	1900.0	QPSK	1	0	0	22.46	22±1
				1	49	0	22.67	22±1
1				99	0	22.23	22±1	
50				0	1	21.57	22±1	
50				24	1	21.61	22±1	
50				49	1	21.72	22±1	
100				0	1	21.59	22±1	
16QAM			1	0	1	21.91	21.3±1	
			1	49	1	22.07	21.3±1	
			1	99	1	21.96	21.3±1	
			50	0	2	21.87	21.3±1	
			50	24	2	21.55	21.3±1	
			50	49	2	21.43	21.3±1	
			100	0	2	20.63	21.3±1	

BW (MHz)	Ch	Freq. (MHz)	Mode	UL RB Allocation	UL RB Offset	MPR	Average power (dBm)	Tune up Power tolerant
15MHz	18675	1857.5	QPSK	1	0	0	21.66	21.3±1
				1	37	0	21.64	21.3±1
				1	74	0	21.71	21.3±1
				36	0	1	20.69	21.3±1
				36	16	1	20.68	21.3±1
				36	35	1	20.71	21.3±1
				75	0	1	20.72	21.3±1
			16QAM	1	0	1	21.18	21.3±1
				1	37	1	21.15	21.3±1
				1	74	1	21.21	21.3±1
				36	0	2	21.17	21.3±1
				36	16	2	21.15	21.3±1
				36	35	2	21.12	21.3±1
				75	0	2	20.35	21.3±1
	18900	1880.0	QPSK	1	0	0	21.98	22±1
				1	37	0	22.18	22±1
				1	74	0	22.28	22±1
				36	0	1	21.12	22±1
				36	16	1	21.16	22±1
				36	35	1	21.27	22±1
				75	0	1	21.21	22±1
			16QAM	1	0	1	21.05	21.3±1
				1	37	1	21.23	21.3±1
				1	74	1	21.36	21.3±1
				36	0	2	21.12	21.3±1
				36	16	2	21.09	21.3±1
				36	35	2	20.48	21.3±1
				75	0	2	20.38	21.3±1
	19125	1902.5	QPSK	1	0	0	22.58	22±1
				1	37	0	22.81	22±1
1				74	0	22.31	22±1	
36				0	1	21.73	22±1	
36				16	1	21.84	22±1	
36				35	1	21.92	22±1	
75				0	1	21.82	22±1	
16QAM			1	0	1	21.88	21.3±1	
			1	37	1	21.95	21.3±1	
			1	74	1	21.63	21.3±1	
			36	0	2	20.94	21.3±1	
			36	16	2	20.74	21.3±1	
			36	35	2	20.51	21.3±1	
			75	0	2	20.75	21.3±1	

BW (MHz)	Ch	Freq. (MHz)	Mode	UL RB Allocation	UL RB Offset	MPR	Average power (dBm)	Tune up Power tolerant
10MHz	18650	1855	QPSK	1	0	0	21.57	21.3±1
				1	24	0	21.55	21.3±1
				1	49	0	21.53	21.3±1
				25	0	1	20.65	21.3±1
				25	12	1	20.61	21.3±1
				25	24	1	20.63	21.3±1
				50	0	1	20.67	21.3±1
			16QAM	1	0	1	21.19	21.3±1
				1	24	1	21.16	21.3±1
				1	49	1	21.11	21.3±1
				25	0	2	20.76	21.3±1
				25	12	2	20.74	21.3±1
				25	24	2	20.59	21.3±1
				50	0	2	20.37	21.3±1
	18900	1880.0	QPSK	1	0	0	21.99	21.3±1
				1	24	0	22.09	21.3±1
				1	49	0	22.08	21.3±1
				25	0	1	21.05	21.3±1
				25	12	1	21.09	21.3±1
				25	24	1	21.16	21.3±1
				50	0	1	21.10	21.3±1
			16QAM	1	0	1	21.49	21.3±1
				1	24	1	21.60	21.3±1
				1	49	1	21.61	21.3±1
				25	0	2	21.17	21.3±1
				25	12	2	21.09	21.3±1
				25	24	2	20.87	21.3±1
				50	0	2	20.45	21.3±1
	19150	1905	QPSK	1	0	0	22.61	22±1
				1	24	0	22.82	22±1
1				49	0	22.15	22±1	
25				0	1	21.67	21.3±1	
25				12	1	21.79	21.3±1	
25				24	1	21.81	21.3±1	
50				0	1	21.76	21.3±1	
16QAM			1	0	1	22.08	21.3±1	
			1	24	1	22.15	21.3±1	
			1	49	1	21.79	21.3±1	
			25	0	2	21.68	21.3±1	
			25	12	2	21.59	21.3±1	
			25	24	2	21.48	21.3±1	
			50	0	2	20.80	21.3±1	

BW (MHz)	Ch	Freq. (MHz)	Mode	UL RB Allocation	UL RB Offset	MPR	Average power (dBm)	Tune up Power tolerant
5MHz	18625	1852.5	QPSK	1	0	0	21.58	21.3±1
				1	12	0	21.59	21.3±1
				1	24	0	21.52	21.3±1
				12	0	1	20.66	21.3±1
				12	6	1	20.64	21.3±1
				12	11	1	20.62	21.3±1
				25	0	1	20.59	21.3±1
			16QAM	1	0	1	21.03	21.3±1
				1	12	1	20.59	21.3±1
				1	24	1	20.58	21.3±1
				12	0	2	20.49	21.3±1
				12	6	2	20.44	21.3±1
				12	11	2	20.42	21.3±1
				25	0	2	20.34	21.3±1
	18900	1880.0	QPSK	1	0	0	22.04	21.3±1
				1	12	0	22.10	21.3±1
				1	24	0	22.13	21.3±1
				12	0	1	21.07	21.3±1
				12	6	1	21.08	21.3±1
				12	11	1	21.14	21.3±1
				25	0	1	21.07	21.3±1
			16QAM	1	0	1	21.40	21.3±1
				1	12	1	21.45	21.3±1
				1	24	1	21.44	21.3±1
				12	0	2	21.13	21.3±1
				12	6	2	21.04	21.3±1
				12	11	2	20.81	21.3±1
				25	0	2	20.31	21.3±1
	19175	1907.5	QPSK	1	0	0	22.75	22±1
				1	12	0	22.84	22±1
1				24	0	22.57	22±1	
12				0	1	21.82	22±1	
12				6	1	21.49	22±1	
12				11	1	21.83	22±1	
25				0	1	21.76	22±1	
16QAM			1	0	1	21.68	21.3±1	
			1	12	1	21.75	21.3±1	
			1	24	1	21.68	21.3±1	
			12	0	2	21.45	21.3±1	
			12	6	2	21.32	21.3±1	
			12	11	2	21.20	21.3±1	
			25	0	2	20.78	21.3±1	

BW (MHz)	Ch	Freq. (MHz)	Mode	UL RB Allocation	UL RB Offset	MPR	Average power (dBm)	Tune up Power tolerant
3MHz	18625	1852.5	QPSK	1	0	0	22.52	22±1
				1	7	0	22.54	22±1
				1	14	0	22.48	22±1
				8	0	1	21.65	21.3±1
				8	4	1	21.64	21.3±1
				8	7	1	21.67	21.3±1
				15	0	1	21.70	21.3±1
			16QAM	1	0	1	22.17	21.3±1
				1	7	1	22.15	21.3±1
				1	14	1	22.10	21.3±1
				8	0	2	22.09	21.3±1
				8	4	2	22.07	21.3±1
				8	7	2	21.97	21.3±1
				15	0	2	20.84	21.3±1
	18900	1880.0	QPSK	1	0	0	23.15	23±1
				1	7	0	23.22	23±1
				1	14	0	23.19	23±1
				8	0	1	22.13	23±1
				8	4	1	22.15	23±1
				8	7	1	22.12	23±1
				15	0	1	22.14	23±1
			16QAM	1	0	1	21.92	21.3±1
				1	7	1	21.97	21.3±1
				1	14	1	21.94	21.3±1
				8	0	2	21.64	21.3±1
				8	4	2	21.37	21.3±1
				8	7	2	21.46	21.3±1
				15	0	2	21.12	21.3±1
	19175	1907.5	QPSK	1	0	0	23.93	23±1
				1	7	0	23.84	23±1
1				14	0	23.44	23±1	
8				0	1	22.81	23±1	
8				4	1	22.79	23±1	
8				7	1	22.77	23±1	
15				0	1	22.83	23±1	
16QAM			1	0	1	22.75	22±1	
			1	7	1	22.74	22±1	
			1	14	1	22.66	22±1	
			8	0	2	22.42	22±1	
			8	4	2	22.38	22±1	
			8	7	2	22.19	22±1	
			15	0	2	21.80	22±1	

BW (MHz)	Ch	Freq. (MHz)	Mode	UL RB Allocation	UL RB Offset	MPR	Average power (dBm)	Tune up Power tolerant
1.4MHz	18607	1850.7	QPSK	1	0	0	22.72	22±1
				1	2	0	22.74	22±1
				1	5	0	22.71	22±1
				3	0	0	22.80	22±1
				3	1	0	22.79	22±1
				3	2	0	22.78	22±1
			6	0	1	21.68	22±1	
			16QAM	1	0	1	21.28	21.3±1
				1	2	1	21.31	21.3±1
				1	5	1	21.27	21.3±1
				3	0	1	21.31	21.3±1
				3	1	1	21.45	21.3±1
	3	2		1	21.79	21.3±1		
	6	0	2	20.65	21.3±1			
	18900	1880.0	QPSK	1	0	0	23.18	23±1
				1	2	0	23.26	23±1
				1	5	0	23.22	23±1
				3	0	0	23.18	23±1
				3	1	0	23.17	23±1
				3	2	0	23.21	23±1
			6	0	1	22.13	23±1	
			16QAM	1	0	1	21.92	21.3±1
				1	2	1	21.99	21.3±1
				1	5	1	21.97	21.3±1
				3	0	1	21.54	21.3±1
				3	1	1	21.57	21.3±1
	3	2		1	21.39	21.3±1		
	6	0	2	21.08	21.3±1			
	19193	1909.3	QPSK	1	0	0	23.15	23±1
				1	2	0	23.06	23±1
1				5	0	23.33	23±1	
3				0	0	23.32	23±1	
3				1	0	23.24	23±1	
3				2	0	23.13	23±1	
6			0	1	22.61	23±1		
16QAM			1	0	1	22.39	22±1	
			1	2	1	22.47	22±1	
			1	5	1	22.38	22±1	
			3	0	1	22.17	22±1	
			3	1	1	22.23	22±1	
	3	2	1	22.19	22±1			
6	0	2	21.57	22±1				

LTE Band 4:

BW (MHz)	Ch	Freq. (MHz)	Mode	UL RB Allocation	UL RB Offset	MPR	Average power (dBm)	Tune up Power tolerant
20MHz	20050	1720.0	QPSK	1	0	0	20.95	21.3±1
				1	49	0	20.97	21.3±1
				1	99	0	20.92	21.3±1
				50	0	1	20.98	21.3±1
				50	24	1	20.91	21.3±1
				50	49	1	20.89	21.3±1
				100	0	1	20.85	21.3±1
			16QAM	1	0	1	21.11	21.3±1
				1	49	1	21.12	21.3±1
				1	99	1	21.04	21.3±1
				50	0	2	20.96	21.3±1
				50	24	2	20.91	21.3±1
				50	49	2	20.89	21.3±1
				100	0	2	20.86	21.3±1
	20175	1732.5	QPSK	1	0	0	20.83	21.3±1
				1	49	0	20.94	21.3±1
				1	99	0	20.87	21.3±1
				50	0	1	20.90	21.3±1
				50	24	1	20.93	21.3±1
				50	49	1	20.96	21.3±1
				100	0	1	20.91	21.3±1
			16QAM	1	0	1	21.42	21.3±1
				1	49	1	21.41	21.3±1
				1	99	1	21.34	21.3±1
				50	0	2	21.12	21.3±1
				50	24	2	21.15	21.3±1
				50	49	2	21.09	21.3±1
				100	0	2	20.89	21.3±1
	20300	1745.0	QPSK	1	0	0	21.00	21.3±1
				1	49	0	20.98	21.3±1
1				99	0	21.29	21.3±1	
50				0	1	20.93	21.3±1	
50				24	1	20.98	21.3±1	
50				49	1	21.12	21.3±1	
100				0	1	21.03	21.3±1	
16QAM			1	0	1	21.22	21.3±1	
			1	49	1	21.23	21.3±1	
			1	99	1	21.54	21.3±1	
			50	0	2	20.94	21.3±1	
			50	24	2	20.92	21.3±1	
			50	49	2	20.96	21.3±1	
			100	0	2	21.02	21.3±1	

BW (MHz)	Ch	Freq. (MHz)	Mode	UL RB Allocation	UL RB Offset	MPR	Average power (dBm)	Tune up Power tolerant
15MHz	20025	1717.5	QPSK	1	0	0	20.98	21.3 ± 1
				1	37	0	20.90	21.3 ± 1
				1	74	0	20.79	21.3 ± 1
				36	0	1	21.01	21.3 ± 1
				36	16	1	20.94	21.3 ± 1
				36	35	1	20.89	21.3 ± 1
				75	0	1	20.95	21.3 ± 1
			16QAM	1	0	1	21.25	21.3 ± 1
				1	37	1	21.43	21.3 ± 1
				1	74	1	21.36	21.3 ± 1
				36	0	2	21.12	21.3 ± 1
				36	16	2	21.14	21.3 ± 1
				36	35	2	21.09	21.3 ± 1
				75	0	2	20.93	21.3 ± 1
	20175	1732.5	QPSK	1	0	0	20.81	21.3 ± 1
				1	37	0	20.94	21.3 ± 1
				1	74	0	20.89	21.3 ± 1
				36	0	1	20.91	21.3 ± 1
				36	16	1	20.96	21.3 ± 1
				36	35	1	21.00	21.3 ± 1
				75	0	1	20.98	21.3 ± 1
			16QAM	1	0	1	21.39	21.3 ± 1
				1	37	1	21.40	21.3 ± 1
				1	74	1	21.33	21.3 ± 1
				36	0	2	21.27	21.3 ± 1
				36	16	2	21.29	21.3 ± 1
				36	35	2	21.18	21.3 ± 1
				75	0	2	20.96	21.3 ± 1
	20325	1747.5	QPSK	1	0	0	20.93	21.3 ± 1
				1	37	0	20.99	21.3 ± 1
1				74	0	21.31	21.3 ± 1	
36				0	1	20.99	21.3 ± 1	
36				16	1	21.06	21.3 ± 1	
36				35	1	21.19	21.3 ± 1	
75				0	1	21.11	21.3 ± 1	
16QAM			1	0	1	21.01	21.3 ± 1	
			1	37	1	21.12	21.3 ± 1	
			1	74	1	21.45	21.3 ± 1	
			36	0	2	21.35	21.3 ± 1	
			36	16	2	21.29	21.3 ± 1	
			36	35	2	21.24	21.3 ± 1	
			75	0	2	21.10	21.3 ± 1	

BW (MHz)	Ch	Freq. (MHz)	Mode	UL RB Allocation	UL RB Offset	MPR	Average power (dBm)	Tune up Power tolerant
10MHz	20000	1715.0	QPSK	1	0	0	20.94	21.3±1
				1	24	0	20.90	21.3±1
				1	49	0	20.82	21.3±1
				25	0	1	21.02	21.3±1
				25	12	1	20.99	21.3±1
				25	24	1	20.97	21.3±1
			50	0	1	20.99	21.3±1	
			16QAM	1	0	1	21.41	21.3±1
				1	24	1	21.47	21.3±1
				1	49	1	21.43	21.3±1
				25	0	2	21.31	21.3±1
				25	12	2	21.27	21.3±1
				25	24	2	21.23	21.3±1
				50	0	2	21.01	21.3±1
	20175	1732.5		QPSK	1	0	0	21.03
			1		24	0	21.09	21.3±1
			1		49	0	21.05	21.3±1
			25		0	1	20.98	21.3±1
			25		12	1	21.03	21.3±1
			25		24	1	21.01	21.3±1
			50	0	1	20.98	21.3±1	
			16QAM	1	0	1	20.85	21.3±1
				1	24	1	20.87	21.3±1
				1	49	1	20.84	21.3±1
				25	0	2	20.61	21.3±1
				25	12	2	20.47	21.3±1
				25	24	2	20.58	21.3±1
50	0	2		20.94	21.3±1			
20350	1750.0	QPSK	1	0	0	21.07	21.3±1	
			1	24	0	21.19	21.3±1	
			1	49	0	21.44	21.3±1	
			25	0	1	21.09	21.3±1	
			25	12	1	21.17	21.3±1	
			25	24	1	21.27	21.3±1	
		50	0	1	21.21	21.3±1		
		16QAM	1	0	1	20.99	21.3±1	
			1	24	1	21.14	21.3±1	
			1	49	1	21.38	21.3±1	
			25	0	2	21.24	21.3±1	
			25	12	2	21.26	21.3±1	
			25	24	2	21.23	21.3±1	
50	0		2	21.22	21.3±1			

BW (MHz)	Ch	Freq. (MHz)	Mode	UL RB Allocation	UL RB Offset	MPR	Average power (dBm)	Tune up Power tolerant
5MHz	20000	1715.0	QPSK	1	0	0	21.04	21.3±1
				1	12	0	20.99	21.3±1
				1	24	0	20.94	21.3±1
				12	0	1	21.08	21.3±1
				12	6	1	21.07	21.3±1
				12	11	1	21.04	21.3±1
				25	0	1	21.04	21.3±1
			16QAM	1	0	1	21.34	21.3±1
				1	12	1	21.36	21.3±1
				1	24	1	21.32	21.3±1
				12	0	2	21.24	21.3±1
				12	6	2	21.21	21.3±1
				12	11	2	21.22	21.3±1
				25	0	2	20.97	21.3±1
	20175	1732.5	QPSK	1	0	0	20.91	21.3±1
				1	12	0	20.96	21.3±1
				1	24	0	20.91	21.3±1
				12	0	1	21.04	21.3±1
				12	6	1	21.06	21.3±1
				12	11	1	21.04	21.3±1
				25	0	1	20.98	21.3±1
			16QAM	1	0	1	20.95	21.3±1
				1	12	1	20.97	21.3±1
				1	24	1	20.93	21.3±1
				12	0	2	20.86	21.3±1
				12	6	2	20.84	21.3±1
				12	11	2	20.88	21.3±1
				25	0	2	20.98	21.3±1
	20350	1750.0	QPSK	1	0	0	21.16	21.3±1
				1	12	0	21.33	21.3±1
1				24	0	21.41	21.3±1	
12				0	1	21.29	21.3±1	
12				6	1	21.38	21.3±1	
12				11	1	21.50	21.3±1	
25				0	1	21.31	21.3±1	
16QAM			1	0	1	21.13	21.3±1	
			1	12	1	21.29	21.3±1	
			1	24	1	21.41	21.3±1	
			12	0	2	21.38	21.3±1	
			12	6	2	21.35	21.3±1	
			12	11	2	21.37	21.3±1	
			25	0	2	21.34	21.3±1	

BW (MHz)	Ch	Freq. (MHz)	Mode	UL RB Allocation	UL RB Offset	MPR	Average power (dBm)	Tune up Power tolerant
3MHz	19965	1711.5	QPSK	1	0	0	21.07	21.3±1
				1	7	0	21.09	21.3±1
				1	14	0	21.03	21.3±1
				8	0	1	21.06	21.3±1
				8	4	1	21.04	21.3±1
				8	7	1	21.02	21.3±1
				15	0	1	21.05	21.3±1
			16QAM	1	0	1	20.86	21.3±1
				1	7	1	20.87	21.3±1
				1	14	1	20.83	21.3±1
				8	0	2	20.89	21.3±1
				8	4	2	20.88	21.3±1
				8	7	2	20.91	21.3±1
				15	0	2	20.95	21.3±1
	20175	1732.5	QPSK	1	0	0	20.98	21.3±1
				1	7	0	21.02	21.3±1
				1	14	0	20.99	21.3±1
				8	0	1	21.00	21.3±1
				8	4	1	21.01	21.3±1
				8	7	1	20.99	21.3±1
				15	0	1	20.98	21.3±1
			16QAM	1	0	1	20.93	21.3±1
				1	7	1	20.92	21.3±1
				1	14	1	20.89	21.3±1
				8	0	2	20.84	21.3±1
				8	4	2	20.74	21.3±1
				8	7	2	20.68	21.3±1
				15	0	2	20.95	21.3±1
	20385	1753.5	QPSK	1	0	0	21.09	21.3±1
				1	7	0	21.26	21.3±1
1				14	0	21.25	21.3±1	
8				0	1	21.36	21.3±1	
8				4	1	21.39	21.3±1	
8				7	1	21.45	21.3±1	
15				0	1	21.42	21.3±1	
16QAM			1	0	1	21.65	21.3±1	
			1	7	1	21.80	21.3±1	
			1	14	1	21.82	21.3±1	
			8	0	2	21.68	21.3±1	
			8	4	2	21.64	21.3±1	
			8	7	2	21.59	21.3±1	
			15	0	2	21.49	21.3±1	

BW (MHz)	Ch	Freq. (MHz)	Mode	UL RB Allocation	UL RB Offset	MPR	Average power (dBm)	Tune up Power tolerant
1.4MHz	19957	1710.7	QPSK	1	0	0	21.10	21.3±1
				1	2	0	21.13	21.3±1
				1	5	0	21.11	21.3±1
				3	0	0	21.11	21.3±1
				3	1	0	21.10	21.3±1
				3	2	0	21.09	21.3±1
			6	0	1	21.07	21.3±1	
			16QAM	1	0	1	20.89	21.3±1
				1	2	1	20.84	21.3±1
				1	5	1	20.88	21.3±1
				3	0	1	20.79	21.3±1
				3	1	1	20.75	21.3±1
	3	2		1	20.86	21.3±1		
	20175	1732.5	QPSK	1	0	0	21.00	21.3±1
				1	2	0	21.06	21.3±1
				1	5	0	21.02	21.3±1
				3	0	0	21.01	21.3±1
				3	1	0	21.04	21.3±1
				3	2	0	21.05	21.3±1
			6	0	1	20.99	21.3±1	
			16QAM	1	0	1	20.93	21.3±1
				1	2	1	21.05	21.3±1
				1	5	1	20.99	21.3±1
				3	0	1	20.94	21.3±1
				3	1	1	20.97	21.3±1
	3	2		1	20.91	21.3±1		
	20393	1754.3	QPSK	1	0	0	21.32	21.3±1
				1	2	0	21.42	21.3±1
				1	5	0	21.43	21.3±1
				3	0	0	21.55	21.3±1
3				1	0	21.54	21.3±1	
3				2	0	21.58	21.3±1	
6			0	1	21.45	21.3±1		
16QAM			1	0	1	21.04	21.3±1	
			1	2	1	21.15	21.3±1	
			1	5	1	21.11	21.3±1	
			3	0	1	21.21	21.3±1	
			3	1	1	21.13	21.3±1	
	3	2	1	21.42	21.3±1			
6	0	2	21.34	21.3±1				

LTE Band 5:

BW (MHz)	Ch	Freq. (MHz)	Mode	UL RB Allocation	UL RB Offset	MPR	Average power (dBm)	Tune up Power tolerant
10MHz	20450	829	QPSK	1	0	0	22.38	22±1
				1	24	0	22.57	22±1
				1	49	0	22.61	22±1
				25	0	1	21.54	21.3±1
				25	12	1	21.51	21.3±1
				25	24	1	21.56	21.3±1
				50	0	1	21.54	21.3±1
			16QAM	1	0	1	21.37	21.3±1
				1	24	1	21.42	21.3±1
				1	49	1	21.40	21.3±1
				25	0	2	21.44	21.3±1
				25	12	2	21.47	21.3±1
				25	24	2	21.49	21.3±1
				50	0	2	20.52	21.3±1
	20525	836.5	QPSK	1	0	0	22.62	22±1
				1	24	0	22.36	22±1
				1	49	0	22.27	22±1
				25	0	1	21.60	21.3±1
				25	12	1	21.55	21.3±1
				25	24	1	21.58	21.3±1
				50	0	1	21.58	21.3±1
			16QAM	1	0	1	21.55	21.3±1
				1	24	1	21.54	21.3±1
				1	49	1	21.52	21.3±1
				25	0	2	21.34	21.3±1
				25	12	2	21.32	21.3±1
				25	24	2	21.29	21.3±1
				50	0	2	20.56	21.3±1
	20600	844	QPSK	1	0	0	22.57	22±1
				1	24	0	22.39	22±1
1				49	0	22.21	22±1	
25				0	1	21.56	21.3±1	
25				12	1	21.49	21.3±1	
25				24	1	21.40	21.3±1	
50				0	1	21.49	21.3±1	
16QAM			1	0	1	22.03	21.3±1	
			1	24	1	21.91	21.3±1	
			1	49	1	21.68	21.3±1	
			25	0	2	21.45	21.3±1	
			25	12	2	21.37	21.3±1	
			25	24	2	21.21	21.3±1	
			50	0	2	20.49	21.3±1	

BW (MHz)	Ch	Freq. (MHz)	Mode	UL RB Allocation	UL RB Offset	MPR	Average power (dBm)	Tune up Power tolerant
5MHz	20425	826.5	QPSK	1	0	0	22.34	22±1
				1	12	0	22.32	22±1
				1	24	0	22.42	22±1
				12	0	1	21.52	22±1
				12	6	1	21.53	22±1
				12	11	1	21.55	22±1
				25	0	1	21.53	22±1
			16QAM	1	0	1	21.81	21.3±1
				1	12	1	21.83	21.3±1
				1	24	1	21.80	21.3±1
				12	0	2	21.67	21.3±1
				12	6	2	21.64	21.3±1
				12	11	2	21.61	21.3±1
				25	0	2	20.46	21.3±1
	20525	836.5	QPSK	1	0	0	22.58	22±1
				1	12	0	22.14	22±1
				1	24	0	22.39	22±1
				12	0	1	21.64	22±1
				12	6	1	21.60	22±1
				12	11	1	21.63	22±1
				25	0	1	21.56	22±1
			16QAM	1	0	1	21.57	21.3±1
				1	12	1	21.51	21.3±1
				1	24	1	21.53	21.3±1
				12	0	2	21.11	21.3±1
				12	6	2	21.14	21.3±1
				12	11	2	21.09	21.3±1
				25	0	2	20.52	21.3±1
	20625	846.5	QPSK	1	0	0	22.45	22±1
				1	12	0	22.36	22±1
1				24	0	22.28	22±1	
12				0	1	21.47	22±1	
12				6	1	21.41	22±1	
12				11	1	21.37	22±1	
25				0	1	21.36	22±1	
16QAM			1	0	1	21.45	21.3±1	
			1	12	1	21.41	21.3±1	
			1	24	1	21.35	21.3±1	
			12	0	2	21.37	21.3±1	
			12	6	2	21.36	21.3±1	
			12	11	2	21.39	21.3±1	
			25	0	2	21.40	21.3±1	

BW (MHz)	Ch	Freq. (MHz)	Mode	UL RB Allocation	UL RB Offset	MPR	Average power (dBm)	Tune up Power tolerant
3MHz	20415	825.5	QPSK	1	0	0	22.58	22±1
				1	7	0	22.55	22±1
				1	14	0	22.45	22±1
				8	0	1	21.52	22±1
				8	4	1	21.48	22±1
				8	7	1	21.49	22±1
				15	0	1	21.48	22±1
			16QAM	1	0	1	21.37	21.3±1
				1	7	1	21.35	21.3±1
				1	14	1	21.31	21.3±1
				8	0	2	21.12	21.3±1
				8	4	2	21.04	21.3±1
				8	7	2	20.92	21.3±1
				15	0	2	20.40	21.3±1
	20525	836.5	QPSK	1	0	0	22.55	22±1
				1	7	0	22.59	22±1
				1	14	0	22.57	22±1
				8	0	1	21.54	22±1
				8	4	1	21.52	22±1
				8	7	1	21.55	22±1
				15	0	1	21.51	22±1
			16QAM	1	0	1	21.49	21.3±1
				1	7	1	21.48	21.3±1
				1	14	1	21.45	21.3±1
				8	0	2	20.89	21.3±1
				8	4	2	20.67	21.3±1
				8	7	2	20.58	21.3±1
				15	0	2	20.46	21.3±1
	20635	847.5	QPSK	1	0	0	22.15	22±1
				1	7	0	22.19	22±1
				1	14	0	22.10	22±1
				8	0	1	21.34	22±1
				8	4	1	21.32	22±1
				8	7	1	21.33	22±1
				15	0	1	21.34	22±1
			16QAM	1	0	1	21.93	21.3±1
1				7	1	21.87	21.3±1	
1				14	1	21.70	21.3±1	
8				0	2	21.65	21.3±1	
8				4	2	21.61	21.3±1	
8				7	2	21.55	21.3±1	
15				0	2	20.42	21.3±1	

BW (MHz)	Ch	Freq. (MHz)	Mode	UL RB Allocation	UL RB Offset	MPR	Average power (dBm)	Tune up Power tolerant
1.4MHz	20407	824.7	QPSK	1	0	0	22.57	22±1
				1	2	0	22.62	22±1
				1	5	0	22.55	22±1
				3	0	0	22.59	22±1
				3	1	0	22.54	22±1
				3	2	0	22.58	22±1
				6	0	1	21.54	22±1
			16QAM	1	0	1	21.37	21.3±1
				1	2	1	21.41	21.3±1
				1	5	1	21.37	21.3±1
				3	0	1	21.12	21.3±1
				3	1	1	21.09	21.3±1
				3	2	1	20.94	21.3±1
				6	0	2	20.45	21.3±1
	20525	836.5	QPSK	1	0	0	22.58	22±1
				1	2	0	22.63	22±1
				1	5	0	22.58	22±1
				3	0	0	22.57	22±1
				3	1	0	22.55	22±1
				3	2	0	22.60	22±1
				6	0	1	21.55	22±1
			16QAM	1	0	1	21.48	21.3±1
				1	2	1	21.53	21.3±1
				1	5	1	21.50	21.3±1
				3	0	1	20.97	21.3±1
				3	1	1	20.91	21.3±1
				3	2	1	20.87	21.3±1
				6	0	2	20.33	21.3±1
	20643	848.3	QPSK	1	0	0	22.21	22±1
				1	2	0	22.27	22±1
				1	5	0	22.21	22±1
				3	0	0	22.39	22±1
				3	1	0	22.36	22±1
				3	2	0	22.35	22±1
				6	0	1	21.28	22±1
			16QAM	1	0	1	20.92	21.3±1
1				2	1	20.99	21.3±1	
1				5	1	20.89	21.3±1	
3				0	1	20.67	21.3±1	
3				1	1	20.64	21.3±1	
3				2	1	20.55	21.3±1	
6				0	2	20.31	21.3±1	

LTE Band 7:

BW (MHz)	Ch	Freq. (MHz)	Mode	UL RB Allocation	UL RB Offset	MPR	Average power (dBm)	Tune up Power tolerant
20MHz	20850	2510	QPSK	1	0	0	21.34	21.3±1
				1	49	0	21.90	21.3±1
				1	99	0	21.64	21.3±1
				50	0	1	20.55	21.3±1
				50	24	1	20.67	21.3±1
				50	49	1	20.90	21.3±1
				100	0	1	20.71	21.3±1
			16QAM	1	0	1	20.40	21.3±1
				1	49	1	20.92	21.3±1
				1	99	1	21.11	21.3±1
				50	0	2	20.45	21.3±1
				50	24	2	20.61	21.3±1
				50	49	2	20.38	21.3±1
				100	0	2	20.39	21.3±1
	21100	2535	QPSK	1	0	0	21.54	21.3±1
				1	49	0	21.73	21.3±1
				1	99	0	22.24	21.3±1
				50	0	1	21.04	21.3±1
				50	24	1	21.31	21.3±1
				50	49	1	21.46	21.3±1
				100	0	1	21.25	21.3±1
			16QAM	1	0	1	21.26	21.3±1
				1	49	1	21.53	21.3±1
				1	99	1	22.03	21.3±1
				50	0	2	21.32	21.3±1
				50	24	2	21.45	21.3±1
				50	49	2	21.28	21.3±1
				100	0	2	20.56	21.3±1
	21350	2560	QPSK	1	0	0	22.58	22±1
				1	49	0	21.82	22±1
1				99	0	21.97	22±1	
50				0	1	21.65	21.3±1	
50				24	1	20.94	21.3±1	
50				49	1	20.84	21.3±1	
100				0	1	21.60	21.3±1	
16QAM			1	0	1	22.19	21.3±1	
			1	49	1	21.54	21.3±1	
			1	99	1	20.63	21.3±1	
			50	0	2	20.46	21.3±1	
			50	24	2	20.42	21.3±1	
			50	49	2	20.39	21.3±1	
			100	0	2	21.01	21.3±1	

BW (MHz)	Ch	Freq. (MHz)	Mode	UL RB Allocation	UL RB Offset	MPR	Average power (dBm)	Tune up Power tolerant
15MHz	20825	1717.5	QPSK	1	0	0	21.30	21.3±1
				1	37	0	21.77	21.3±1
				1	74	0	22.02	21.3±1
				36	0	1	20.59	21.3±1
				36	16	1	20.68	21.3±1
				36	35	1	20.97	21.3±1
				75	0	1	20.78	21.3±1
			16QAM	1	0	1	20.63	21.3±1
				1	37	1	21.06	21.3±1
				1	74	1	21.24	21.3±1
				36	0	2	21.10	21.3±1
				36	16	2	21.02	21.3±1
				36	35	2	20.78	21.3±1
				75	0	2	20.35	21.3±1
	21100	1732.5	QPSK	1	0	0	21.72	21.3±1
				1	37	0	21.86	21.3±1
				1	74	0	22.29	21.3±1
				36	0	1	21.09	21.3±1
				36	16	1	21.13	21.3±1
				36	35	1	21.44	21.3±1
				75	0	1	21.23	21.3±1
			16QAM	1	0	1	21.04	21.3±1
				1	37	1	21.24	21.3±1
				1	74	1	21.70	21.3±1
				36	0	2	21.25	21.3±1
				36	16	2	21.16	21.3±1
				36	35	2	21.07	21.3±1
				75	0	2	20.60	21.3±1
	21375	1747.5	QPSK	1	0	0	22.12	21.3±1
				1	37	0	21.67	21.3±1
1				74	0	20.94	21.3±1	
36				0	1	21.31	21.3±1	
36				16	1	21.11	21.3±1	
36				35	1	20.93	21.3±1	
75				0	1	21.23	21.3±1	
16QAM			1	0	1	21.77	21.3±1	
			1	37	1	21.52	21.3±1	
			1	74	1	20.81	21.3±1	
			36	0	2	20.47	21.3±1	
			36	16	2	20.35	21.3±1	
			36	35	2	20.44	21.3±1	
			75	0	2	20.76	21.3±1	

BW (MHz)	Ch	Freq. (MHz)	Mode	UL RB Allocation	UL RB Offset	MPR	Average power (dBm)	Tune up Power tolerant
10MHz	20800	2502	QPSK	1	0	0	21.29	21.3±1
				1	24	0	21.61	21.3±1
				1	49	0	21.81	21.3±1
				25	0	1	20.42	21.3±1
				25	12	1	20.57	21.3±1
				25	24	1	20.71	21.3±1
				50	0	1	20.57	21.3±1
			16QAM	1	0	1	20.67	21.3±1
				1	24	1	20.93	21.3±1
				1	49	1	21.10	21.3±1
				25	0	2	20.47	21.3±1
				25	12	2	20.42	21.3±1
				25	24	2	20.39	21.3±1
				50	0	2	20.38	21.3±1
	21100	2535	QPSK	1	0	0	21.74	21.3±1
				1	24	0	21.85	21.3±1
				1	49	0	22.02	21.3±1
				25	0	1	21.17	21.3±1
				25	12	1	21.24	21.3±1
				25	24	1	21.38	21.3±1
				50	0	1	21.26	21.3±1
			16QAM	1	0	1	20.74	21.3±1
				1	24	1	20.99	21.3±1
				1	49	1	21.06	21.3±1
				25	0	2	20.68	21.3±1
				25	12	2	20.71	21.3±1
				25	24	2	20.65	21.3±1
				50	0	2	20.59	21.3±1
	21400	2565	QPSK	1	0	0	21.86	21.3±1
				1	24	0	21.17	21.3±1
1				49	0	20.69	21.3±1	
25				0	1	21.05	21.3±1	
25				12	1	20.86	21.3±1	
25				24	1	20.71	21.3±1	
50				0	1	20.87	21.3±1	
16QAM			1	0	1	20.98	21.3±1	
			1	24	1	20.81	21.3±1	
			1	49	1	20.38	21.3±1	
			25	0	2	20.41	21.3±1	
			25	12	2	20.39	21.3±1	
			25	24	2	20.37	21.3±1	
			50	0	2	20.41	21.3±1	

BW (MHz)	Ch	Freq. (MHz)	Mode	UL RB Allocation	UL RB Offset	MPR	Average power (dBm)	Tune up Power tolerant
5MHz	19975	1712.5	QPSK	1	0	0	21.24	21.3±1
				1	12	0	21.39	21.3±1
				1	24	0	21.47	21.3±1
				12	0	1	20.34	21.3±1
				12	6	1	20.45	21.3±1
				12	11	1	20.51	21.3±1
				25	0	1	20.39	21.3±1
			16QAM	1	0	1	20.51	21.3±1
				1	12	1	20.68	21.3±1
				1	24	1	20.73	21.3±1
				12	0	2	20.56	21.3±1
				12	6	2	20.48	21.3±1
				12	11	2	20.42	21.3±1
				25	0	2	20.31	21.3±1
	20175	1732.5	QPSK	1	0	0	21.85	21.3±1
				1	12	0	21.72	21.3±1
				1	24	0	21.94	21.3±1
				12	0	1	21.28	21.3±1
				12	6	1	21.31	21.3±1
				12	11	1	21.39	21.3±1
				25	0	1	21.28	21.3±1
			16QAM	1	0	1	21.16	21.3±1
				1	12	1	21.03	21.3±1
				1	24	1	21.29	21.3±1
				12	0	2	21.13	21.3±1
				12	6	2	20.89	21.3±1
				12	11	2	20.86	21.3±1
				25	0	2	20.62	21.3±1
	20375	1752.5	QPSK	1	0	0	21.38	21.3±1
				1	12	0	20.95	21.3±1
1				24	0	20.85	21.3±1	
12				0	1	20.84	21.3±1	
12				6	1	20.75	21.3±1	
12				11	1	20.64	21.3±1	
25				0	1	20.72	21.3±1	
16QAM			1	0	1	20.78	21.3±1	
			1	12	1	20.46	21.3±1	
			1	24	1	20.42	21.3±1	
			12	0	2	20.39	21.3±1	
			12	6	2	20.35	21.3±1	
			12	11	2	20.33	21.3±1	
			25	0	2	20.31	21.3±1	

ERP & EIRP

EIRP for LTE Band 2 (Part 24E)

Frequency (MHz)	BW (MHz)	Modulation	RB Size/Offset	Substituted level (dBm)	Antenna Polarization	Antenna Gain correction (dBi)	Cable Loss (dB)	Absolute Level (dBm)	Limit (dBm)
1850.7	1.4	QPSK	1/0	9.63	V	7.88	0.85	16.66	33.01
1880	1.4	QPSK	1/0	9.68	V	7.88	0.85	16.71	33.01
1909.3	1.4	QPSK	1/0	9.72	V	7.88	0.85	16.75	33.01
1850.7	1.4	QPSK	1/0	8.93	H	7.88	0.85	15.96	33.01
1880	1.4	QPSK	1/0	8.86	H	7.88	0.85	15.89	33.01
1909.3	1.4	QPSK	1/0	8.71	H	7.88	0.85	15.74	33.01
1850.7	1.4	16-QAM	1/0	9.49	V	7.88	0.85	16.52	33.01
1880	1.4	16-QAM	1/0	9.33	V	7.88	0.85	16.36	33.01
1909.3	1.4	16-QAM	1/0	9.46	V	7.88	0.85	16.49	33.01
1850.7	1.4	16-QAM	1/0	8.69	H	7.88	0.85	15.72	33.01
1880	1.4	16-QAM	1/0	8.71	H	7.88	0.85	15.74	33.01
1909.3	1.4	16-QAM	1/0	8.65	H	7.88	0.85	15.68	33.01
1851.5	3	QPSK	1/0	9.73	V	7.88	0.85	16.76	33.01
1880	3	QPSK	1/0	9.81	V	7.88	0.85	16.84	33.01
1908.5	3	QPSK	1/0	9.79	V	7.88	0.85	16.82	33.01
1851.5	3	QPSK	1/0	8.55	H	7.88	0.85	15.58	33.01
1880	3	QPSK	1/0	8.61	H	7.88	0.85	15.64	33.01
1908.5	3	QPSK	1/0	8.74	H	7.88	0.85	15.77	33.01
1851.5	3	16-QAM	1/0	9.58	V	7.88	0.85	16.61	33.01
1880	3	16-QAM	1/0	9.62	V	7.88	0.85	16.65	33.01
1908.5	3	16-QAM	1/0	9.55	V	7.88	0.85	16.58	33.01
1851.5	3	16-QAM	1/0	8.76	H	7.88	0.85	15.79	33.01
1880	3	16-QAM	1/0	8.65	H	7.88	0.85	15.68	33.01
1908.5	3	16-QAM	1/0	8.71	H	7.88	0.85	15.74	33.01
1852.5	5	QPSK	1/24	10.15	V	7.88	0.85	17.18	33.01
1880	5	QPSK	1/0	10.09	V	7.88	0.85	17.12	33.01
1907.5	5	QPSK	1/24	10.12	V	7.88	0.85	17.15	33.01
1852.5	5	QPSK	1/24	9.37	H	7.88	0.85	16.4	33.01
1880	5	QPSK	1/0	9.41	H	7.88	0.85	16.44	33.01
1907.5	5	QPSK	1/24	9.45	H	7.88	0.85	16.48	33.01
1852.5	5	16-QAM	1/24	9.86	V	7.88	0.85	16.89	33.01
1880	5	16-QAM	1/0	9.93	V	7.88	0.85	16.96	33.01
1907.5	5	16-QAM	1/24	9.97	V	7.88	0.85	17.00	33.01
1852.5	5	16-QAM	1/24	8.52	H	7.88	0.85	15.55	33.01

1880	5	16-QAM	1/0	8.67	H	7.88	0.85	15.7	33.01
1907.5	5	16-QAM	1/24	8.59	H	7.88	0.85	15.62	33.01
1855	10	QPSK	1/0	9.91	V	7.88	0.85	16.94	33.01
1880	10	QPSK	1/0	9.83	V	7.88	0.85	16.86	33.01
1905	10	QPSK	1/49	9.87	V	7.88	0.85	16.9	33.01
1855	10	QPSK	1/0	9.13	H	7.88	0.85	16.16	33.01
1880	10	QPSK	1/0	9.16	H	7.88	0.85	16.19	33.01
1905	10	QPSK	1/49	9.05	H	7.88	0.85	16.08	33.01
1855	10	16-QAM	1/0	9.37	V	7.88	0.85	16.4	33.01
1880	10	16-QAM	1/0	9.42	V	7.88	0.85	16.45	33.01
1905	10	16-QAM	1/49	9.36	V	7.88	0.85	16.39	33.01
1855	10	16-QAM	1/0	8.56	H	7.88	0.85	15.59	33.01
1880	10	16-QAM	1/0	8.61	H	7.88	0.85	15.64	33.01
1905	10	16-QAM	1/49	8.48	H	7.88	0.85	15.51	33.01
1857.5	15	QPSK	1/0	9.95	V	7.88	0.85	16.98	33.01
1880	15	QPSK	1/0	9.99	V	7.88	0.85	17.02	33.01
1902.5	15	QPSK	1/0	9.87	V	7.88	0.85	16.9	33.01
1857.5	15	QPSK	1/0	8.63	H	7.88	0.85	15.66	33.01
1880	15	QPSK	1/0	8.59	H	7.88	0.85	15.62	33.01
1902.5	15	QPSK	1/0	8.62	H	7.88	0.85	15.65	33.01
1857.5	15	16-QAM	1/0	9.83	V	7.88	0.85	16.86	33.01
1880	15	16-QAM	1/0	9.79	V	7.88	0.85	16.82	33.01
1902.5	15	16-QAM	1/0	9.85	V	7.88	0.85	16.88	33.01
1857.5	15	16-QAM	1/0	8.32	H	7.88	0.85	15.35	33.01
1880	15	16-QAM	1/0	8.47	H	7.88	0.85	15.5	33.01
1902.5	15	16-QAM	1/0	8.39	H	7.88	0.85	15.42	33.01
1860	20	QPSK	1/0	9.94	V	7.88	0.85	16.97	33.01
1880	20	QPSK	1/0	9.98	V	7.88	0.85	17.01	33.01
1900	20	QPSK	1/0	10.01	V	7.88	0.85	17.04	33.01
1860	20	QPSK	1/0	9.26	H	7.88	0.85	16.29	33.01
1880	20	QPSK	1/0	9.35	H	7.88	0.85	16.38	33.01
1900	20	QPSK	1/0	9.21	H	7.88	0.85	16.24	33.01
1860	20	16-QAM	1/0	9.83	V	7.88	0.85	16.86	33.01
1880	20	16-QAM	1/0	9.75	V	7.88	0.85	16.78	33.01
1900	20	16-QAM	1/0	9.88	V	7.88	0.85	16.91	33.01
1860	20	16-QAM	1/0	8.49	H	7.88	0.85	15.52	33.01
1880	20	16-QAM	1/0	8.55	H	7.88	0.85	15.58	33.01
1900	20	16-QAM	1/0	8.43	H	7.88	0.85	15.46	33.01

EIRP for LTE Band 4 (Part 27)

Frequency (MHz)	BW (MHz)	Modulation	RB Size/Offset	Substituted level (dBm)	Antenna Polarization	Antenna Gain correction (dBi)	Cable Loss (dB)	Absolute Level (dBm)	Limit (dBm)
1710.7	1.4	QPSK	1/0	9.63	V	7.95	0.79	16.79	30
1732.5	1.4	QPSK	1/0	9.58	V	7.95	0.79	16.74	30
1754.3	1.4	QPSK	1/0	9.61	V	7.95	0.79	16.77	30
1710.7	1.4	QPSK	1/0	8.44	H	7.95	0.79	15.60	30
1732.5	1.4	QPSK	1/0	8.57	H	7.95	0.79	15.73	30
1754.3	1.4	QPSK	1/0	8.49	H	7.95	0.79	15.65	30
1710.7	1.4	16-QAM	1/5	9.51	V	7.95	0.79	16.67	30
1732.5	1.4	16-QAM	1/0	9.48	V	7.95	0.79	16.64	30
1754.3	1.4	16-QAM	1/0	9.45	V	7.95	0.79	16.61	30
1710.7	1.4	16-QAM	1/5	8.33	H	7.95	0.79	15.49	30
1732.5	1.4	16-QAM	1/0	8.41	H	7.95	0.79	15.57	30
1754.3	1.4	16-QAM	1/0	8.39	H	7.95	0.79	15.55	30
1711.5	3	QPSK	1/0	9.74	V	7.95	0.79	16.90	30
1732.5	3	QPSK	1/0	9.68	V	7.95	0.79	16.84	30
1753.5	3	QPSK	1/0	9.63	V	7.95	0.79	16.79	30
1711.5	3	QPSK	1/0	8.79	H	7.95	0.79	15.95	30
1732.5	3	QPSK	1/0	8.72	H	7.95	0.79	15.88	30
1753.5	3	QPSK	1/0	8.68	H	7.95	0.79	15.84	30
1711.5	3	16-QAM	1/0	9.52	V	7.95	0.79	16.68	30
1732.5	3	16-QAM	1/0	9.57	V	7.95	0.79	16.73	30
1753.5	3	16-QAM	1/0	9.61	V	7.95	0.79	16.77	30
1711.5	3	16-QAM	1/0	8.37	H	7.95	0.79	15.53	30
1732.5	3	16-QAM	1/0	8.29	H	7.95	0.79	15.45	30
1753.5	3	16-QAM	1/0	8.33	H	7.95	0.79	15.49	30
1712.5	5	QPSK	1/0	9.56	V	7.95	0.79	16.72	30
1732.5	5	QPSK	1/0	9.62	V	7.95	0.79	16.78	30
1752.5	5	QPSK	1/24	9.51	V	7.95	0.79	16.67	30
1712.5	5	QPSK	1/0	8.37	H	7.95	0.79	15.53	30
1732.5	5	QPSK	1/0	8.42	H	7.95	0.79	15.58	30
1752.5	5	QPSK	1/24	8.36	H	7.95	0.79	15.52	30
1712.5	5	16-QAM	1/0	9.63	V	7.95	0.79	16.79	30
1732.5	5	16-QAM	1/0	9.68	V	7.95	0.79	16.84	30
1752.5	5	16-QAM	1/24	9.62	V	7.95	0.79	16.78	30
1712.5	5	16-QAM	1/0	8.35	H	7.95	0.79	15.51	30
1732.5	5	16-QAM	1/0	8.49	H	7.95	0.79	15.65	30

1752.5	5	16-QAM	1/24	8.37	H	7.95	0.79	15.53	30
1715	10	QPSK	1/0	9.54	V	7.95	0.79	16.70	30
1732.5	10	QPSK	1/49	9.48	V	7.95	0.79	16.64	30
1750	10	QPSK	1/0	9.51	V	7.95	0.79	16.67	30
1715	10	QPSK	1/0	8.37	H	7.95	0.79	15.53	30
1732.5	10	QPSK	1/49	8.45	H	7.95	0.79	15.61	30
1750	10	QPSK	1/0	8.32	H	7.95	0.79	15.48	30
1715	10	16-QAM	1/0	9.74	V	7.95	0.79	16.90	30
1732.5	10	16-QAM	1/49	9.61	V	7.95	0.79	16.77	30
1750	10	16-QAM	1/0	9.68	V	7.95	0.79	16.84	30
1715	10	16-QAM	1/0	8.52	H	7.95	0.79	15.68	30
1732.5	10	16-QAM	1/49	8.57	H	7.95	0.79	15.73	30
1750	10	16-QAM	1/0	8.63	H	7.95	0.79	15.79	30
1717.5	15	QPSK	1/0	9.64	V	7.95	0.79	16.80	30
1732.5	15	QPSK	1/74	9.69	V	7.95	0.79	16.85	30
1747.5	15	QPSK	1/0	9.72	V	7.95	0.79	16.88	30
1717.5	15	QPSK	1/0	8.53	H	7.95	0.79	15.69	30
1732.5	15	QPSK	1/74	8.47	H	7.95	0.79	15.63	30
1747.5	15	QPSK	1/0	8.51	H	7.95	0.79	15.67	30
1717.5	15	16-QAM	1/0	9.76	V	7.95	0.79	16.92	30
1732.5	15	16-QAM	1/74	9.67	V	7.95	0.79	16.83	30
1747.5	15	16-QAM	1/0	9.62	V	7.95	0.79	16.78	30
1717.5	15	16-QAM	1/0	8.59	H	7.95	0.79	15.75	30
1732.5	15	16-QAM	1/74	8.63	H	7.95	0.79	15.79	30
1747.5	15	16-QAM	1/0	8.57	H	7.95	0.79	15.73	30
1720	20	QPSK	1/99	9.59	V	7.95	0.79	16.75	30
1732.5	20	QPSK	1/99	9.46	V	7.95	0.79	16.62	30
1745	20	QPSK	1/0	9.52	V	7.95	0.79	16.68	30
1720	20	QPSK	1/99	8.35	H	7.95	0.79	15.51	30
1732.5	20	QPSK	1/99	8.42	H	7.95	0.79	15.58	30
1745	20	QPSK	1/0	8.37	H	7.95	0.79	15.53	30
1720	20	16-QAM	1/99	9.62	V	7.95	0.79	16.78	30
1732.5	20	16-QAM	1/99	9.58	V	7.95	0.79	16.74	30
1745	20	16-QAM	1/0	9.61	V	7.95	0.79	16.77	30
1720	20	16-QAM	1/99	8.45	H	7.95	0.79	15.61	30
1732.5	20	16-QAM	1/99	8.37	H	7.95	0.79	15.53	30
1745	20	16-QAM	1/0	8.43	H	7.95	0.79	15.59	30

EIRP for LTE Band 5 (Part 22)

Frequency (MHz)	BW (MHz)	Modulation	RB Size/Offset	Substituted level (dBm)	Antenna Polarization	Antenna Gain correction (dBi)	Cable Loss (dB)	Absolute Level (dBm)	Limit (dBm)
824.7	1.4	QPSK	1/5	11.24	V	6.8	0.44	17.60	38.45
836.5	1.4	QPSK	1/5	11.17	V	6.8	0.44	17.53	38.45
848.3	1.4	QPSK	1/5	11.19	V	6.9	0.44	17.65	38.45
824.7	1.4	QPSK	1/5	10.67	H	6.8	0.44	17.03	38.45
836.5	1.4	QPSK	1/5	10.53	H	6.8	0.44	16.89	38.45
848.3	1.4	QPSK	1/5	10.54	H	6.9	0.44	17.00	38.45
824.7	1.4	16-QAM	1/5	10.43	V	6.8	0.44	16.79	38.45
836.5	1.4	16-QAM	1/5	10.57	V	6.8	0.44	16.93	38.45
848.3	1.4	16-QAM	1/5	10.49	V	6.9	0.44	16.95	38.45
824.7	1.4	16-QAM	1/5	9.85	H	6.8	0.44	16.21	38.45
836.5	1.4	16-QAM	1/5	9.69	H	6.8	0.44	16.05	38.45
848.3	1.4	16-QAM	1/5	9.73	H	6.9	0.44	16.19	38.45
825.5	3	QPSK	1/14	11.15	V	6.8	0.44	17.51	38.45
836.5	3	QPSK	1/0	11.09	V	6.8	0.44	17.45	38.45
847.5	3	QPSK	1/14	11.18	V	6.9	0.44	17.64	38.45
825.5	3	QPSK	1/14	10.37	H	6.8	0.44	16.73	38.45
836.5	3	QPSK	1/0	10.24	H	6.8	0.44	16.60	38.45
847.5	3	QPSK	1/14	10.31	H	6.9	0.44	16.77	38.45
825.5	3	16-QAM	1/14	10.59	V	6.8	0.44	16.95	38.45
836.5	3	16-QAM	1/0	10.46	V	6.8	0.44	16.82	38.45
847.5	3	16-QAM	1/14	10.42	V	6.9	0.44	16.88	38.45
825.5	3	16-QAM	1/14	9.52	H	6.8	0.44	15.88	38.45
836.5	3	16-QAM	1/0	9.68	H	6.8	0.44	16.04	38.45
847.5	3	16-QAM	1/14	9.55	H	6.9	0.44	16.01	38.45
826.5	5	QPSK	1/24	11.41	V	6.8	0.44	17.77	38.45
836.5	5	QPSK	1/24	11.37	V	6.8	0.44	17.73	38.45
846.5	5	QPSK	1/24	11.35	V	6.8	0.44	17.71	38.45
826.5	5	QPSK	1/24	10.52	H	6.8	0.44	16.88	38.45
836.5	5	QPSK	1/24	10.61	H	6.8	0.44	16.97	38.45
846.5	5	QPSK	1/24	10.55	H	6.8	0.44	16.91	38.45
826.5	5	16-QAM	1/24	10.72	V	6.8	0.44	17.08	38.45
836.5	5	16-QAM	1/24	10.68	V	6.8	0.44	17.04	38.45
846.5	5	16-QAM	1/24	10.59	V	6.8	0.44	16.95	38.45

826.5	5	16-QAM	1/24	9.86	H	6.8	0.44	16.22	38.45
836.5	5	16-QAM	1/24	9.93	H	6.8	0.44	16.29	38.45
846.5	5	16-QAM	1/24	9.87	H	6.8	0.44	16.23	38.45
829	10	QPSK	1/49	11.23	V	6.8	0.44	17.59	38.45
836.5	10	QPSK	1/49	11.17	V	6.8	0.44	17.53	38.45
844	10	QPSK	1/49	11.28	V	6.8	0.44	17.64	38.45
829	10	QPSK	1/49	10.36	H	6.8	0.44	16.72	38.45
836.5	10	QPSK	1/49	10.41	H	6.8	0.44	16.77	38.45
844	10	QPSK	1/49	10.39	H	6.8	0.44	16.75	38.45
829	10	16-QAM	1/49	10.85	V	6.8	0.44	17.21	38.45
836.5	10	16-QAM	1/49	10.79	V	6.8	0.44	17.15	38.45
844	10	16-QAM	1/49	10.82	V	6.8	0.44	17.18	38.45
829	10	16-QAM	1/49	9.95	H	6.8	0.44	16.31	38.45
836.5	10	16-QAM	1/49	9.99	H	6.8	0.44	16.35	38.45
844	10	16-QAM	1/49	9.86	H	6.8	0.44	16.22	38.45

ERP for LTE Band 7 (Part 27)

Frequency (MHz)	BW (MHz)	Modulation	RB Size/Offset	Substituted level (dBm)	Antenna Polarization	Antenna Gain correction (dBi)	Cable Loss (dB)	Absolute Level (dBm)	Limit (dBm)
2502.5	5	QPSK	1/0	8.76	V	8.93	0.83	16.86	30
2535	5	QPSK	1/0	8.82	V	8.93	0.83	16.92	30
2567.5	5	QPSK	1/24	8.73	V	8.93	0.83	16.83	30
2502.5	5	QPSK	1/0	8.11	H	8.93	0.83	16.21	30
2535	5	QPSK	1/0	8.09	H	8.93	0.83	16.19	30
2567.5	5	QPSK	1/24	8.15	H	8.93	0.83	16.25	30
2502.5	5	16-QAM	1/0	8.63	V	8.93	0.83	16.73	30
2535	5	16-QAM	1/0	8.57	V	8.93	0.83	16.67	30
2567.5	5	16-QAM	1/24	8.69	V	8.93	0.83	16.79	30
2502.5	5	16-QAM	1/0	7.96	H	8.93	0.83	16.06	30
2535	5	16-QAM	1/0	8.05	H	8.93	0.83	16.15	30
2567.5	5	16-QAM	1/24	7.92	H	8.93	0.83	16.02	30
2505	10	QPSK	1/0	8.65	V	8.93	0.83	16.75	30
2535	10	QPSK	1/49	8.71	V	8.93	0.83	16.81	30
2565	10	QPSK	1/0	8.69	V	8.93	0.83	16.79	30
2505	10	QPSK	1/0	8.13	H	8.93	0.83	16.23	30
2535	10	QPSK	1/49	8.07	H	8.93	0.83	16.17	30
2565	10	QPSK	1/0	8.18	H	8.93	0.83	16.28	30
2505	10	16-QAM	1/0	8.43	V	8.93	0.83	16.53	30
2535	10	16-QAM	1/49	8.51	V	8.93	0.83	16.61	30
2565	10	16-QAM	1/0	8.46	V	8.93	0.83	16.56	30
2505	10	16-QAM	1/0	7.89	H	8.93	0.83	15.99	30
2535	10	16-QAM	1/49	7.92	H	8.93	0.83	16.02	30
2565	10	16-QAM	1/0	7.98	H	8.93	0.83	16.08	30
2507.5	15	QPSK	1/0	8.73	V	8.93	0.83	16.83	30
2535	15	QPSK	1/74	8.69	V	8.93	0.83	16.79	30
2562.5	15	QPSK	1/0	8.71	V	8.93	0.83	16.81	30
2507.5	15	QPSK	1/0	8.25	H	8.93	0.83	16.35	30
2535	15	QPSK	1/74	8.17	H	8.93	0.83	16.27	30
2562.5	15	QPSK	1/0	8.23	H	8.93	0.83	16.33	30
2507.5	15	16-QAM	1/0	8.59	V	8.93	0.83	16.69	30
2535	15	16-QAM	1/74	8.53	V	8.93	0.83	16.63	30
2562.5	15	16-QAM	1/0	8.47	V	8.93	0.83	16.57	30

2507.5	15	16-QAM	1/0	8.13	H	8.93	0.83	16.23	30
2535	15	16-QAM	1/74	8.06	H	8.93	0.83	16.16	30
2562.5	15	16-QAM	1/0	8.01	H	8.93	0.83	16.11	30
2510	20	QPSK	1/99	8.69	V	8.93	0.83	16.79	30
2535	20	QPSK	1/99	8.75	V	8.93	0.83	16.85	30
2560	20	QPSK	1/0	8.63	V	8.93	0.83	16.73	30
2510	20	QPSK	1/99	8.25	H	8.93	0.83	16.35	30
2535	20	QPSK	1/99	8.19	H	8.93	0.83	16.29	30
2560	20	QPSK	1/0	8.21	H	8.93	0.83	16.31	30
2510	20	16-QAM	1/99	8.37	V	8.93	0.83	16.47	30
2535	20	16-QAM	1/99	8.42	V	8.93	0.83	16.52	30
2560	20	16-QAM	1/0	8.33	V	8.93	0.83	16.43	30
2510	20	16-QAM	1/99	7.91	H	8.93	0.83	16.01	30
2535	20	16-QAM	1/99	7.85	H	8.93	0.83	15.95	30
2560	20	16-QAM	1/0	7.98	H	8.93	0.83	16.08	30

6.3 Peak-Average Ratio

Temperature	24°C
Relative Humidity	56%
Atmospheric Pressure	1004mbar
Test date :	September 04, 2015
Tested By :	Winnie Zhang

Requirement(s):

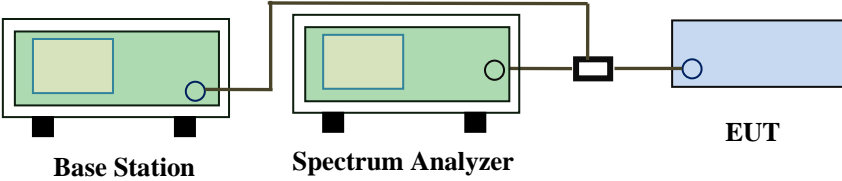
Spec	Item	Requirement	Applicable
§24.232(d) § 27.50(d)	a)	The peak-to-average ratio (PAR) of the transmission may not exceed 13 dB.	<input checked="" type="checkbox"/>
Test Setup	 <p style="text-align: center;">Base Station Spectrum Analyzer EUT</p>		
Test Procedure	<p>According with KDB 971168</p> <ol style="list-style-type: none"> 1. The signal analyzer' s CCDF measurement profile is enabled 2. Frequency = carrier center frequency 3. Measurement BW > Emission bandwidth of signal 4. The signal analyzer was set to collect one million samples to generate the CCDF curve 5. The measurement interval was set depending on the type of signal analyzed. For continuous signals (>98% duty cycle), the measurement interval was set to 1ms. For burst transmissions, the spectrum analyzer is set to use an internal “ RF Burst” trigger that is synced with an incoming pulse and the measurement interval is set to less than the duration of the “ on time” of one burst to ensure that energy is only captured during a time in which the transmitter is operating at maximum power 		
Remark			
Result	<input checked="" type="checkbox"/> Pass <input type="checkbox"/> Fail		

Test Data Yes N/A
 Test Plot Yes (See below) N/A

LTE Band 2 (part 24E)

BW(MHz)	Frequency (MHz)	Mode	Modulation	Conducted Power (dBm)		Peak-Average Ratio (PAR)
				Peak	Average	
1.4	1880	RB 1/0	QPSK	25.51	23.18	2.33
			16QAM	24.87	21.92	2.95
3	1880	RB 1/0	QPSK	25.74	23.15	2.59
			16QAM	25.18	21.92	3.26
5	1880	RB 1/0	QPSK	25.13	22.04	3.09
			16QAM	24.85	21.40	3.45
10	1880	RB 1/0	QPSK	24.64	21.99	2.65
			16QAM	24.36	21.49	2.87
15	1880	RB 1/0	QPSK	24.42	21.98	2.44
			16QAM	24.21	21.05	3.16
20	1880	RB 1/0	QPSK	24.25	22.00	2.25
			16QAM	24.17	21.09	3.08

LTE Band 4 (part 27)

BW(MHz)	Frequency (MHz)	Mode	Modulation	Conducted Power (dBm)		Peak-Average Ratio (PAR)
				Peak	Average	
1.4	1732.5	RB 1/0	QPSK	24.49	21.00	3.49
			16QAM	24.35	20.93	3.42
3	1732.5	RB 1/0	QPSK	24.16	20.98	3.18
			16QAM	24.24	20.93	3.31
5	1732.5	RB 1/0	QPSK	24.33	20.91	3.42
			16QAM	24.41	20.97	3.44
10	1732.5	RB 1/0	QPSK	25.14	21.03	4.11
			16QAM	24.27	20.85	3.42
15	1732.5	RB 1/0	QPSK	24.09	20.81	3.28
			16QAM	25.31	21.39	3.92
20	1732.5	RB 1/0	QPSK	24.25	20.83	3.42
			16QAM	25.14	21.42	3.72

LTE Band 5 (part 27)

BW(MHz)	Frequency (MHz)	Mode	Modulation	Conducted Power (dBm)		Peak-Average Ratio (PAR)
				Peak	Average	
1.4	836.5	RB 1/0	QPSK	26.15	22.58	3.57
			16QAM	26.02	21.48	4.54
3	836.5	RB 1/0	QPSK	26.34	22.55	3.79
			16QAM	26.28	21.49	4.79
5	836.5	RB 1/0	QPSK	26.32	22.58	3.74
			16QAM	26.12	21.57	4.55
10	836.5	RB 1/0	QPSK	26.57	22.62	3.95
			16QAM	26.74	21.55	5.19

LTE Band 7 (part 27)

BW(MHz)	Frequency (MHz)	Mode	Modulation	Conducted Power (dBm)		Peak-Average Ratio (PAR)
				Peak	Average	
5	2535	RB 1/0	QPSK	25.78	21.85	3.93
			16QAM	25.47	21.16	4.31
10	2535	RB 1/0	QPSK	25.28	21.74	3.54
			16QAM	25.07	20.74	4.33
15	2535	RB 1/0	QPSK	25.21	21.72	3.49
			16QAM	25.01	21.04	3.97
20	2535	RB 1/0	QPSK	25.73	21.54	4.19
			16QAM	25.42	21.26	4.16

Test Report	15070656-FCC-R5
Page	43 of 120

6.4 Modulation Characteristic

According to FCC § 2.1047(d), Part 22H&24E& Part 27 there is no specific requirement for digital modulation, therefore modulation characteristic is not presented.

6.5 Occupied Bandwidth

Temperature	24°C
Relative Humidity	56%
Atmospheric Pressure	1004mbar
Test date :	September 04, 2015
Tested By :	Winnie Zhang

Requirement(s):

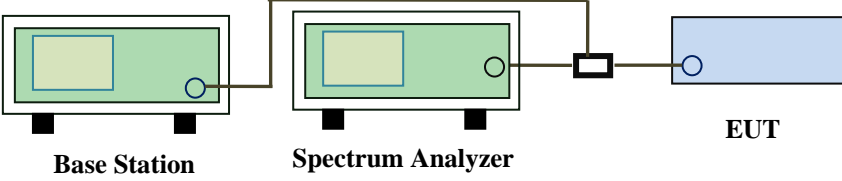
Spec	Item	Requirement	Applicable
§2.1049, §22.917, §22.905 §24.238 §27.53(a)	a)	99% Occupied Bandwidth(kHz)	<input checked="" type="checkbox"/>
	b)	26 dB Bandwidth(kHz)	<input checked="" type="checkbox"/>
Test Setup	 <p>The diagram illustrates the test setup. On the left is a green box labeled 'Base Station'. A line connects it to a central green box labeled 'Spectrum Analyzer'. From the Spectrum Analyzer, a line goes to a small black box representing a power divider. From the power divider, two lines branch out: one goes back to the Base Station, and the other goes to a blue box on the right labeled 'EUT'.</p>		
Test Procedure	<ul style="list-style-type: none"> - The EUT was connected to Spectrum Analyzer and Base Station via power divider. - The 99% and 26 dB occupied bandwidth (BW) of the middle channel for the highest RF powers. 		
Remark			
Result	<input checked="" type="checkbox"/> Pass <input type="checkbox"/> Fail		

Test Data Yes N/A

Test Plot Yes (See below) N/A

LTE Band 2 (Part 24E)

BW(MHz)	Channel	Frequency (MHz)	Modulation	99% Occupied Bandwidth (MHz)	26 dB Bandwidth (MHz)
1.4	18607	1850.7	16QAM	1.0932	1.258
			QPSK	1.0929	1.265
1.4	18900	1880	16QAM	1.0953	1.273
			QPSK	1.1108	1.301
1.4	19193	1909.3	16QAM	1.1064	1.307
			QPSK	1.0998	1.311
3	18615	1851.5	16QAM	2.7445	3.102
			QPSK	2.7460	3.071
3	18900	1880	16QAM	2.7436	3.125
			QPSK	2.7451	3.057
3	19185	1908.5	16QAM	2.7411	3.093
			QPSK	2.7581	3.099
5	18625	1852.5	16QAM	4.5203	5.003
			QPSK	4.5105	5.070
5	18900	1880	16QAM	4.5207	5.081
			QPSK	4.5199	5.091
5	19175	1907.5	16QAM	4.5373	5.089
			QPSK	4.5192	5.041
10	18650	1855	16QAM	9.0966	10.067
			QPSK	9.0804	10.123
10	18900	1880	16QAM	9.0869	10.207
			QPSK	9.0774	10.218
10	19150	1905	16QAM	9.0501	10.112
			QPSK	9.0824	10.259
15	18675	1857.5	16QAM	13.5193	14.770
			QPSK	13.5054	14.811
15	18900	1880	16QAM	13.5157	14.5157
			QPSK	13.4991	14.849
15	19125	1902.5	16QAM	13.4417	14.689
			QPSK	13.4970	14.822

20	18700	1860	16QAM	17.9460	19.405
			QPSK	17.8531	19.259
20	18900	1880	16QAM	17.9436	19.274
			QPSK	17.9015	19.380
20	19100	1900	16QAM	17.8420	19.170
			QPSK	17.8529	19.438

LTE Band 4 (Part 27)

BW(MHz)	Channel	Frequency (MHz)	Modulation	99% Occupied Bandwidth (MHz)	26 dB Bandwidth (MHz)
1.4	19957	1710.7	16QAM	1.0999	1.272
			QPSK	1.0985	1.270
1.4	20175	1732.5	16QAM	1.0917	1.263
			QPSK	1.0945	1.272
1.4	20393	1754.3	16QAM	1.0974	1.271
			QPSK	1.1089	1.260
3	19965	1711.5	16QAM	2.7355	3.030
			QPSK	2.7285	3.055
3	20175	1732.5	16QAM	2.7377	3.050
			QPSK	2.7402	3.081
3	20385	1753.5	16QAM	2.7264	3.061
			QPSK	2.7376	3.069
5	19975	1712.5	16QAM	4.5119	5.038
			QPSK	4.5149	5.072
5	20175	1732.5	16QAM	4.5196	4.994
			QPSK	4.4945	5.004
5	20375	1752.5	16QAM	4.5402	5.121
			QPSK	4.5128	5.021
10	20000	1715	16QAM	9.0812	10.120
			QPSK	9.0904	10.319
10	20175	1732.5	16QAM	9.0549	10.099
			QPSK	9.0865	10.152
10	20350	1750	16QAM	9.0608	10.124
			QPSK	9.0685	10.288

15	20025	1717.5	16QAM	13.4615	14.638
			QPSK	13.5028	14.773
15	20175	1732.5	16QAM	13.4575	14.951
			QPSK	13.4354	14.751
15	20325	1747.5	16QAM	13.4814	14.847
			QPSK	13.4647	14.737
20	20050	1720	16QAM	17.9117	19.338
			QPSK	17.8927	19.141
20	20175	1732.5	16QAM	17.8812	19.274
			QPSK	17.8561	19.403
20	20300	1745	16QAM	17.9125	19.349
			QPSK	17.9118	19.211

LTE Band 5 (Part 22H)

BW(MHz)	Channel	Frequency (MHz)	Modulation	99% Occupied Bandwidth (MHz)	26 dB Bandwidth (MHz)
1.4	20407	824.7	16QAM	1.1010	1.278
			QPSK	1.1023	1.275
1.4	20525	936.5	16QAM	1.0932	1.257
			QPSK	1.0955	1.277
1.4	20643	949.3	16QAM	1.1005	1.275
			QPSK	1.0952	1.267
3	20415	825.5	16QAM	2.7433	3.042
			QPSK	2.7437	3.081
3	20525	936.5	16QAM	2.7365	3.053
			QPSK	2.7380	3.068
3	20635	847.5	16QAM	2.7296	3.039
			QPSK	2.7405	3.065
5	20425	826.5	16QAM	4.5116	5.035
			QPSK	4.5227	5.003
5	20525	936.5	16QAM	4.5139	5.041
			QPSK	4.5129	5.052
5	20625	846.5	16QAM	4.5285	5.095
			QPSK	4.5122	5.017

10	20450	829	16QAM	9.1213	10.31
			QPSK	9.1134	10.142
10	20525	936.5	16QAM	9.0231	10.054
			QPSK	9.0237	10.032
10	20800	844	16QAM	9.1345	10.322
			QPSK	9.1356	10.169

LTE Band 7 (Part 27) result

BW(MHz)	Channel	Frequency (MHz)	Modulation	99% Occupied Bandwidth (MHz)	26 dB Bandwidth (MHz)
5	20775	2502.5	16QAM	4.5137	5.056
			QPSK	4.5303	5.026
5	21100	2535	16QAM	4.5346	5.076
			QPSK	4.5235	5.041
5	21425	2567.5	16QAM	4.5427	5.068
			QPSK	4.5320	5.209
10	20800	2505	16QAM	9.0404	10.048
			QPSK	9.0335	10.144
10	21100	2535	16QAM	9.0881	11.415
			QPSK	9.0797	10.267
10	21400	2562.5	16QAM	9.1243	10.709
			QPSK	9.1466	12.732
15	20825	2507.5	16QAM	13.4800	14.728
			QPSK	13.4837	14.992
15	21100	2535	16QAM	13.5166	14.805
			QPSK	13.5155	14.866
15	21400	2562.5	16QAM	13.5266	18.388
			QPSK	13.5245	19.321
20	20850	2510	16QAM	17.7984	19.136
			QPSK	17.8397	20.301
20	21100	2535	16QAM	17.9484	19.426
			QPSK	17.9263	19.427
20	21350	2560	16QAM	17.8946	22.793
			QPSK	17.9518	20.677

Test Plots

LTE Band 2 (Part 24E)

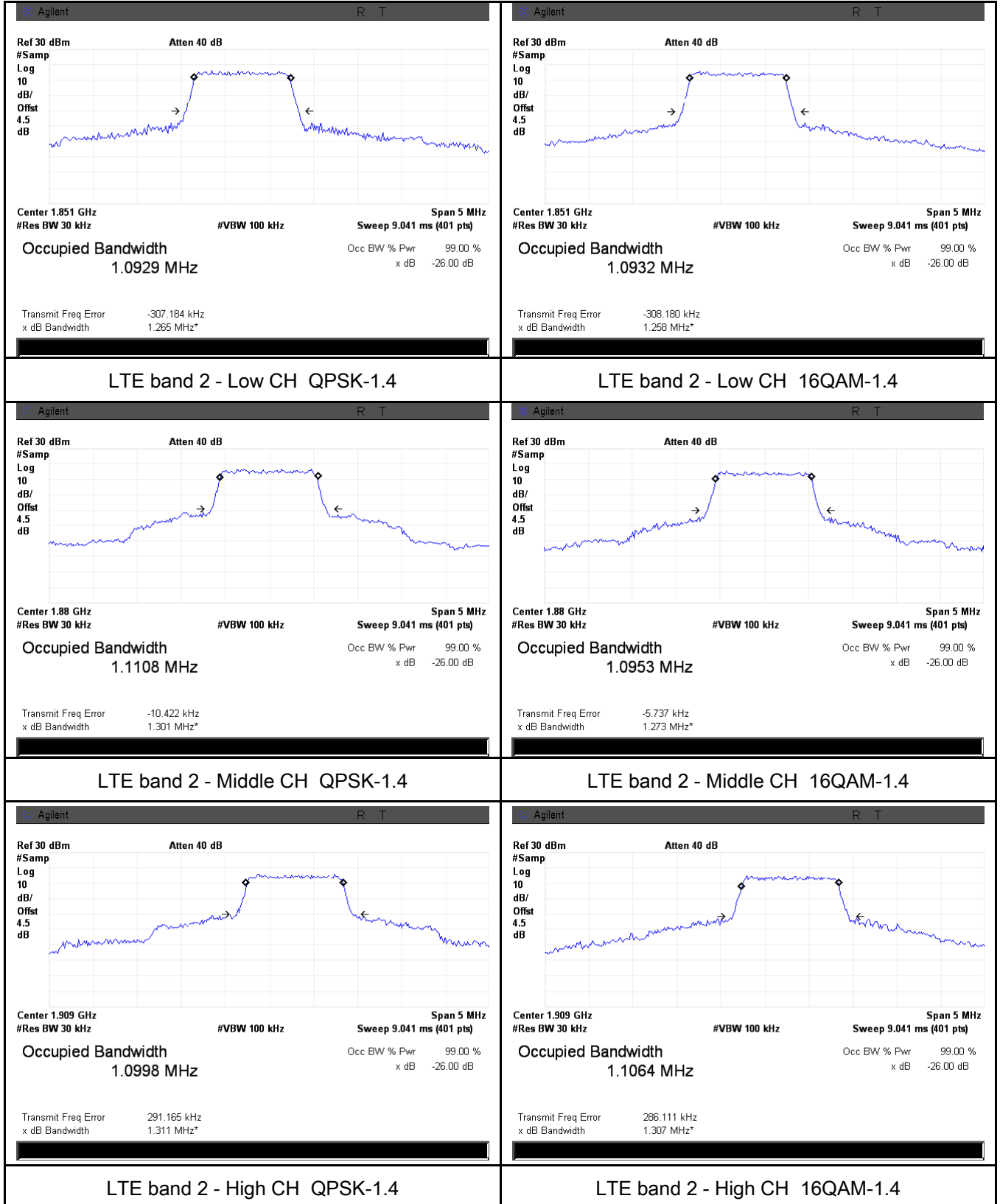

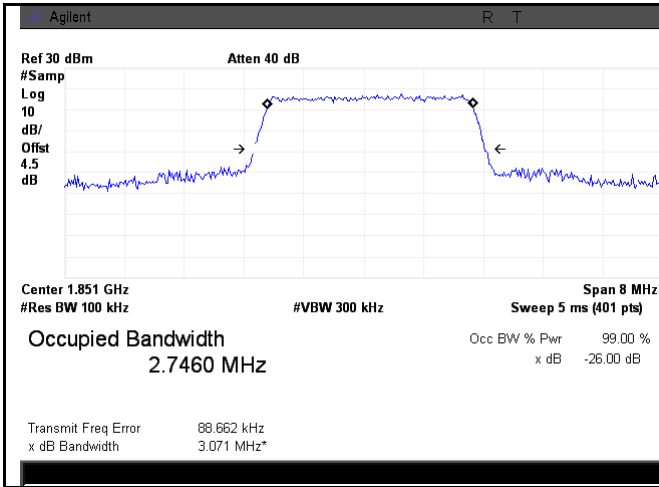

LTE band 2 - Low CH QPSK-3

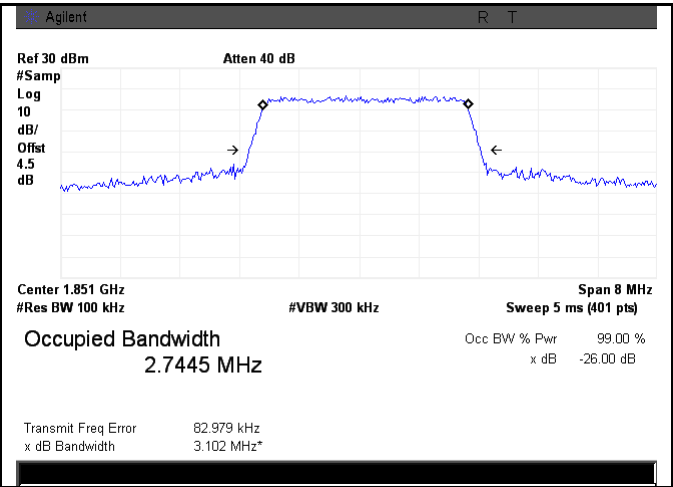

LTE band 2 - Low CH 16QAM-3

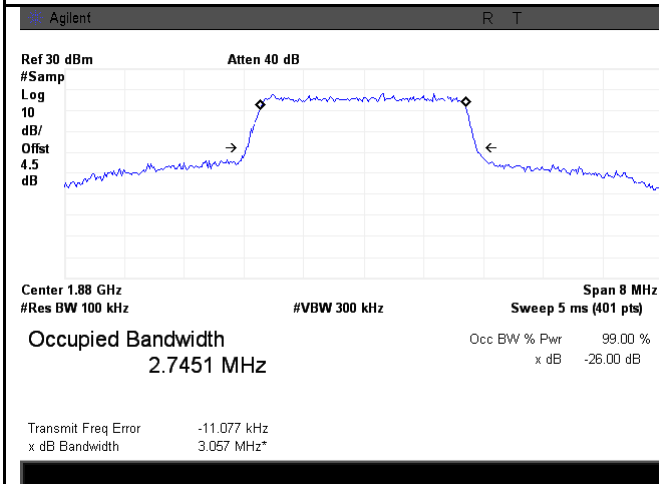

LTE band 2 - Middle CH QPSK-3

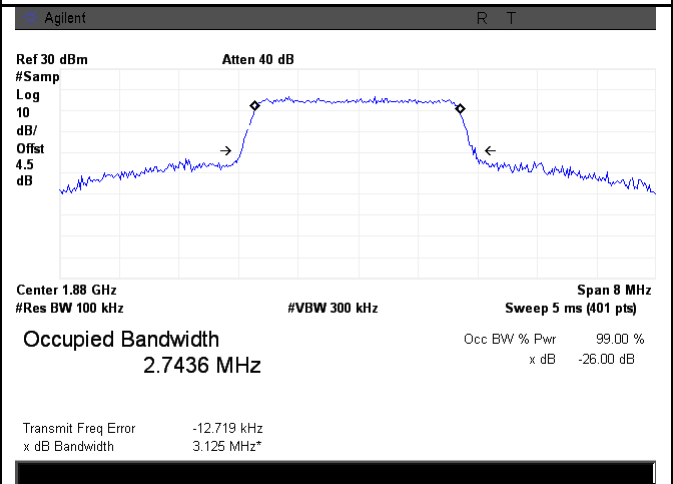

LTE band 2 - Middle CH 16QAM-3

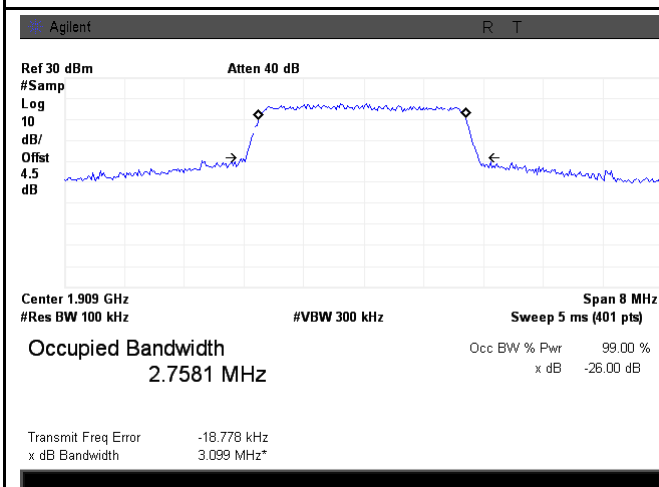

LTE band 2 - High CH QPSK-3

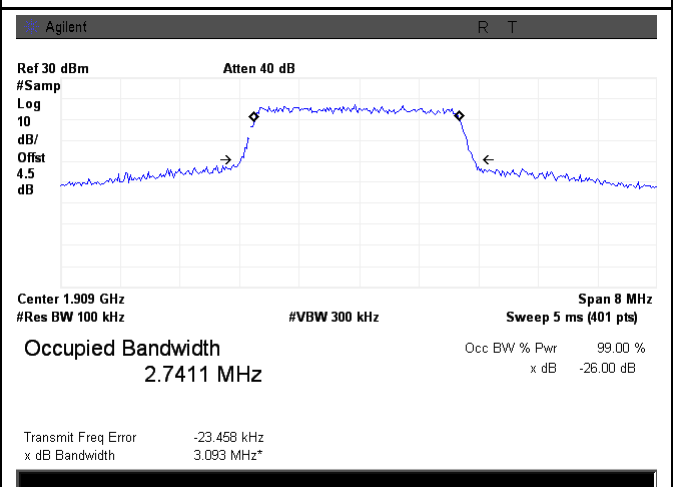

LTE band 2 - High CH 16QAM-3

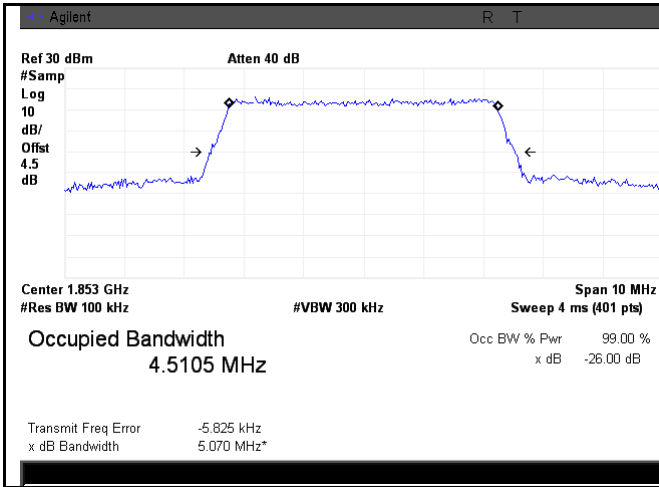

LTE band 2 - Low CH QPSK-5

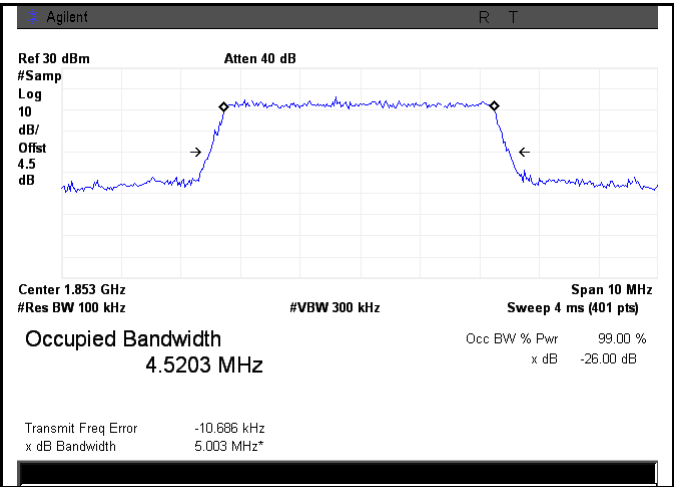

LTE band 2 - Low CH 16QAM-5

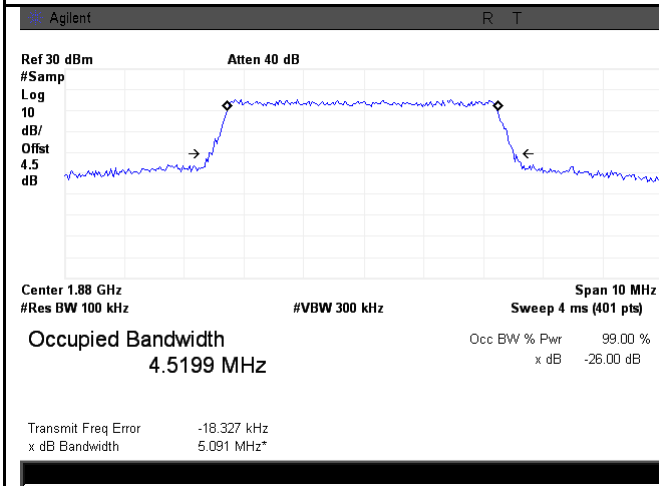

LTE band 2 - Middle CH QPSK-5

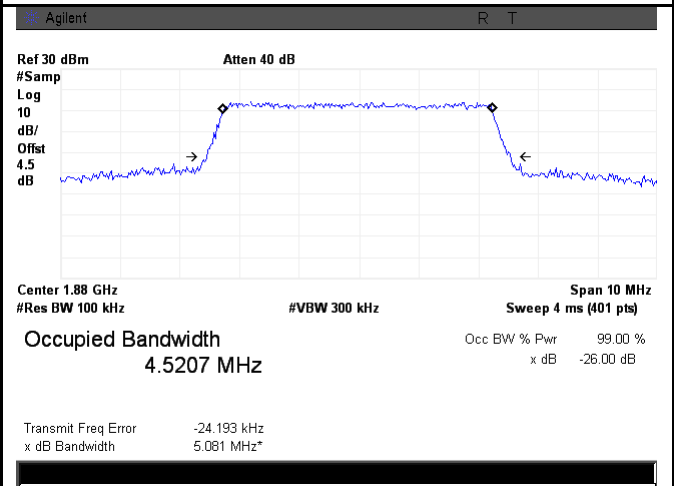

LTE band 2 - Middle CH 16QAM-5

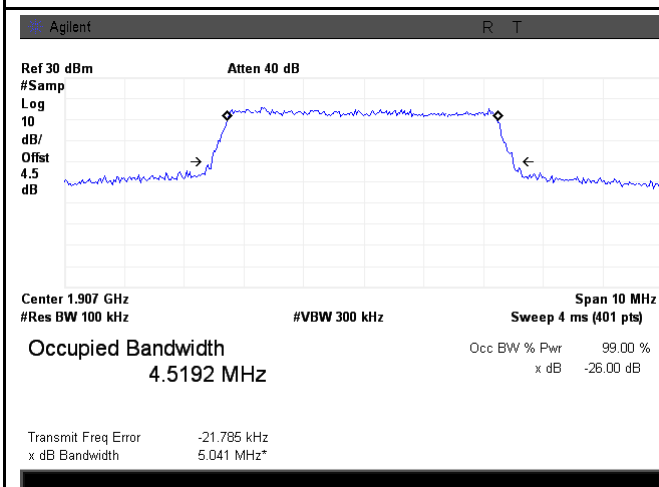

LTE band 2 - High CH QPSK-5

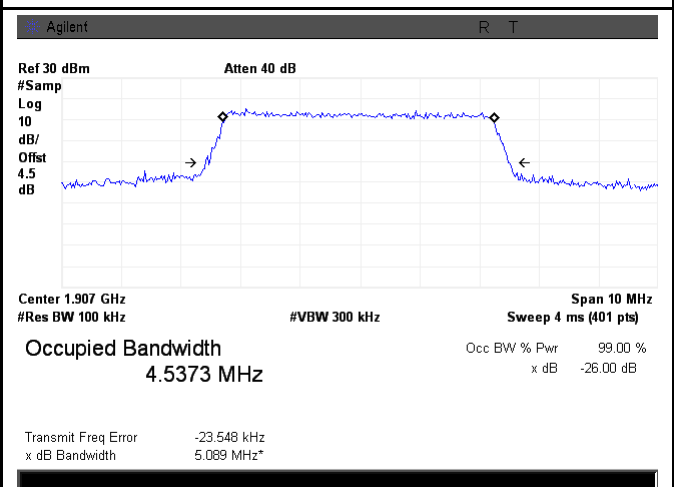

LTE band 2 - High CH 16QAM-5

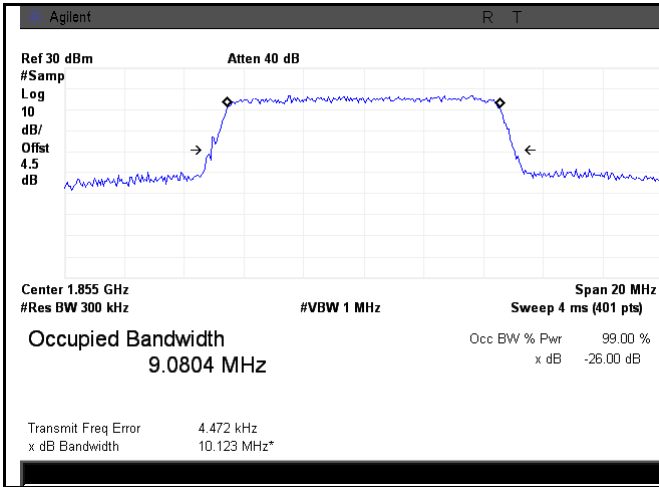

LTE band 2 - Low CH QPSK-10

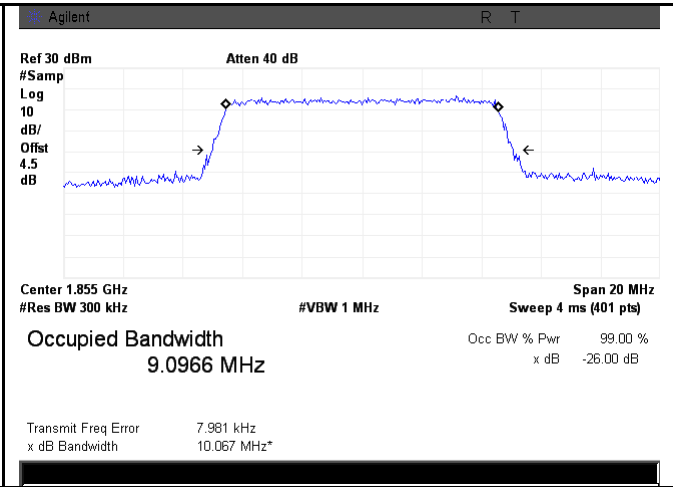

LTE band 2 - Low CH 16QAM-10

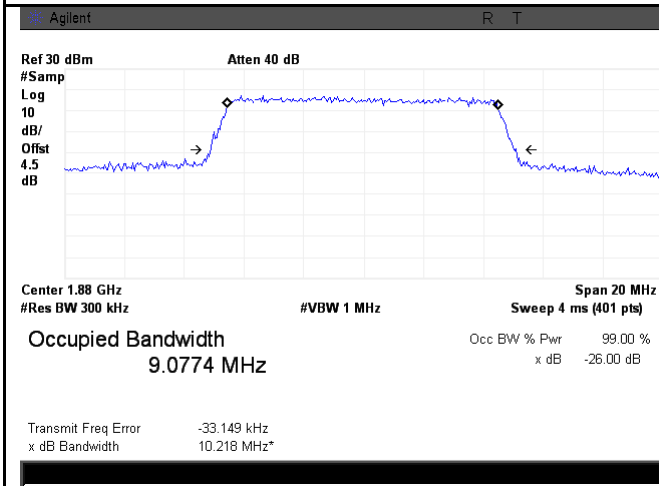

LTE band 2 - Middle CH QPSK-10

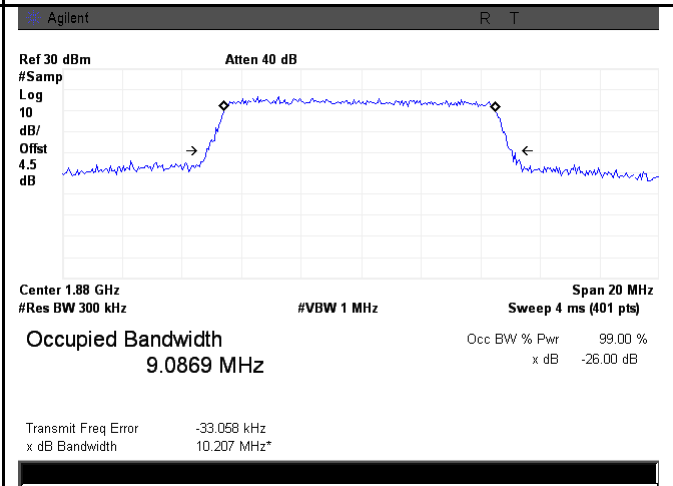

LTE band 2 - Middle CH 16QAM-10

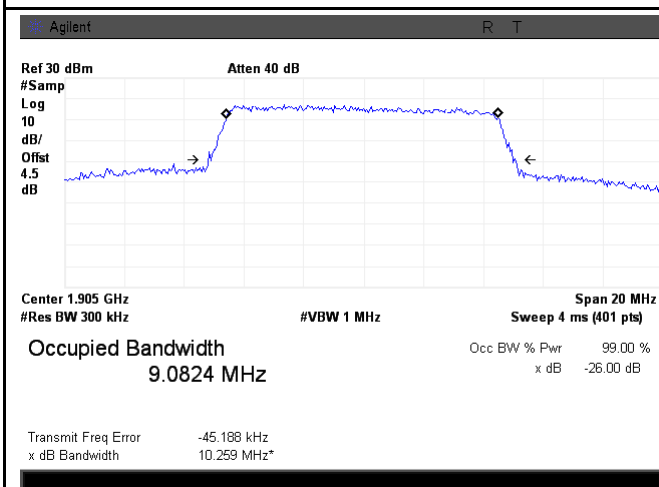

LTE band 2 - High CH QPSK-10

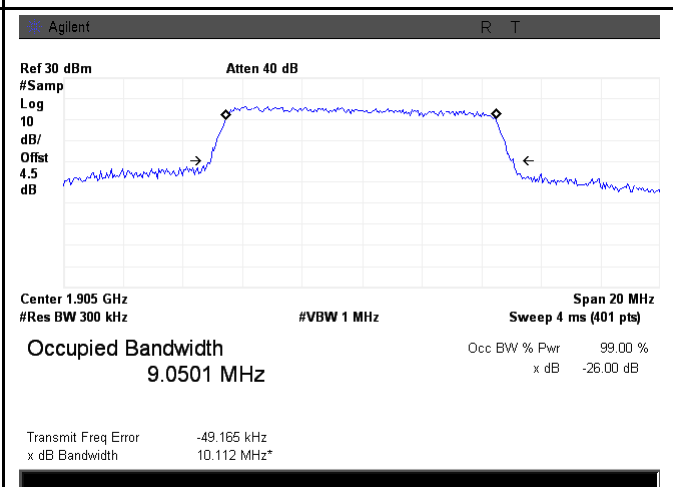

LTE band 2 - High CH 16QAM-10

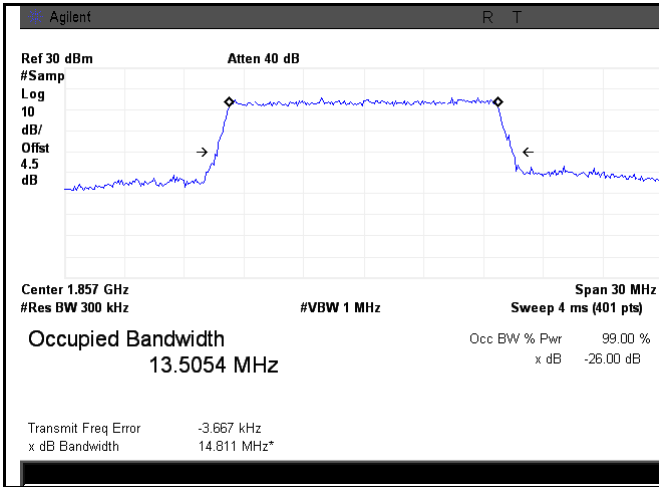

LTE band 2 - Low CH QPSK-15

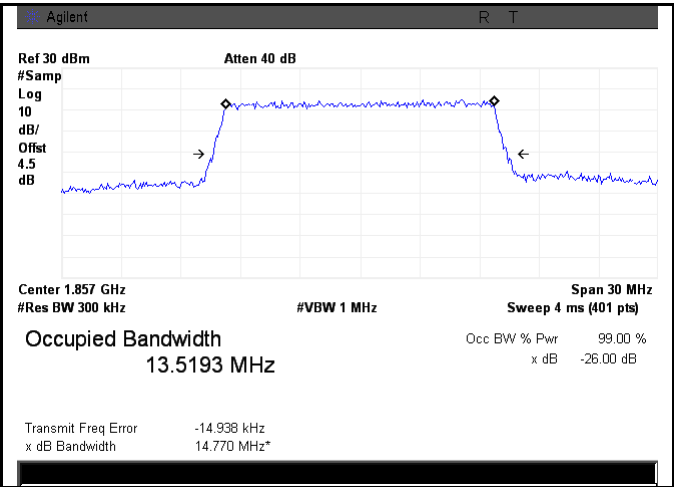

LTE band 2 - Low CH 16QAM-15

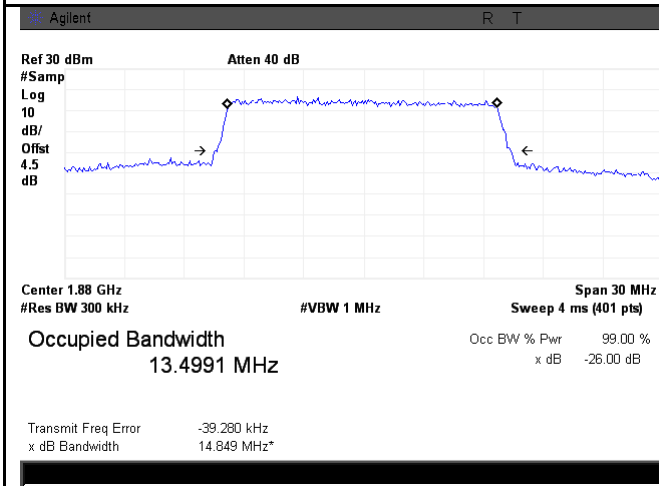

LTE band 2 - Middle CH QPSK-15

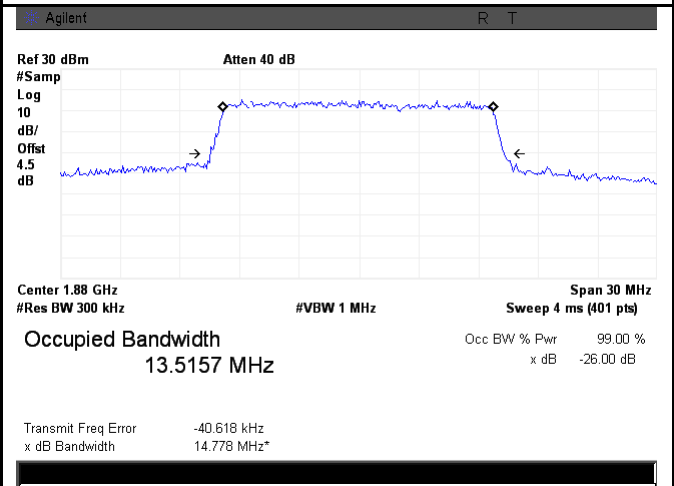

LTE band 2 - Middle CH 16QAM-15

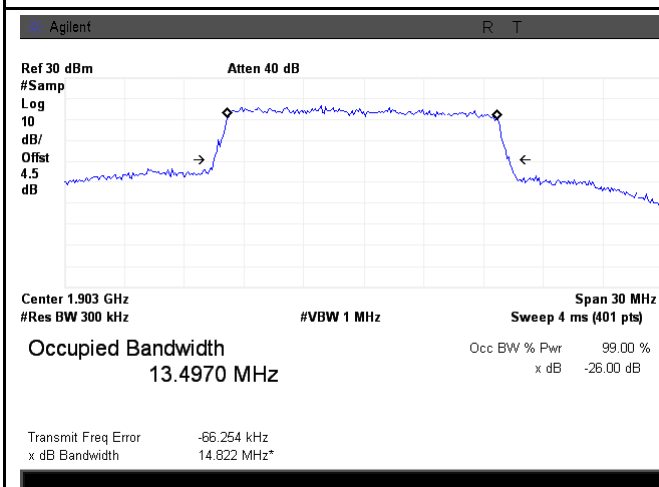

LTE band 2 - High CH QPSK-15

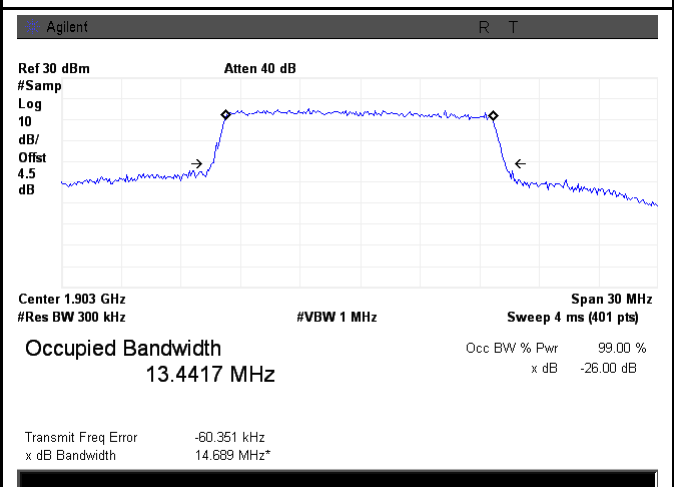

LTE band 2 - High CH 16QAM-15

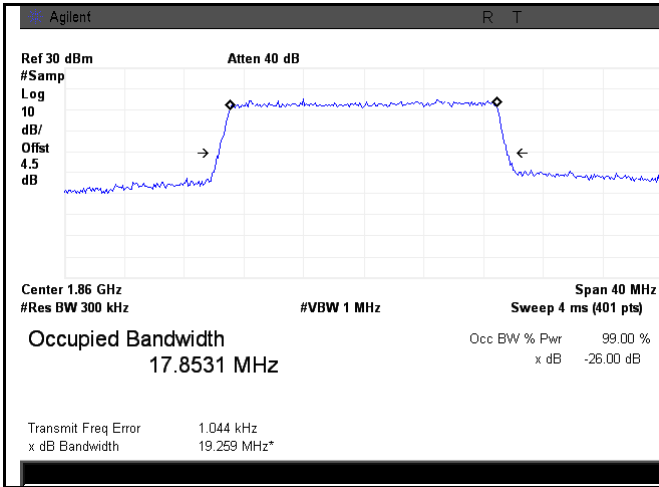

LTE band 2 - Low CH QPSK-20

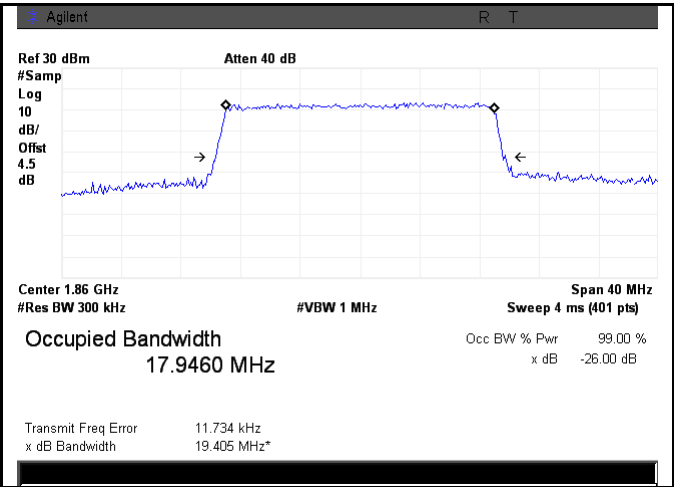

LTE band 2 - Low CH 16QAM-20

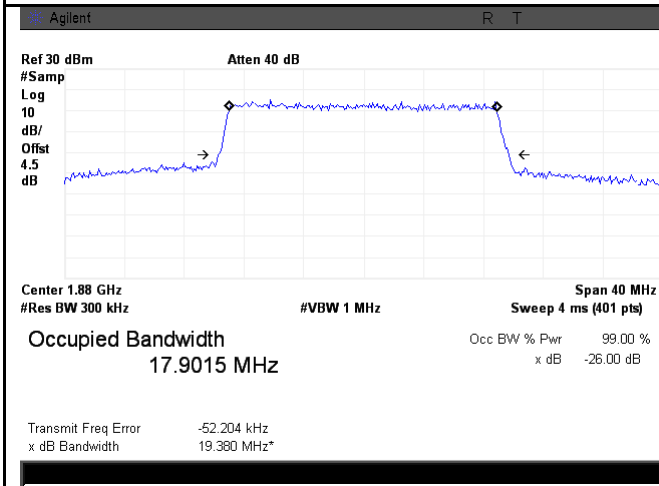

LTE band 2 - Middle CH QPSK-20

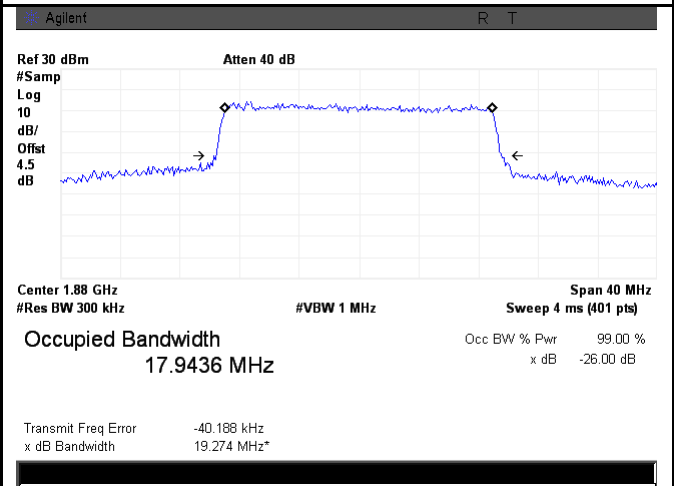

LTE band 2 - Middle CH 16QAM-20

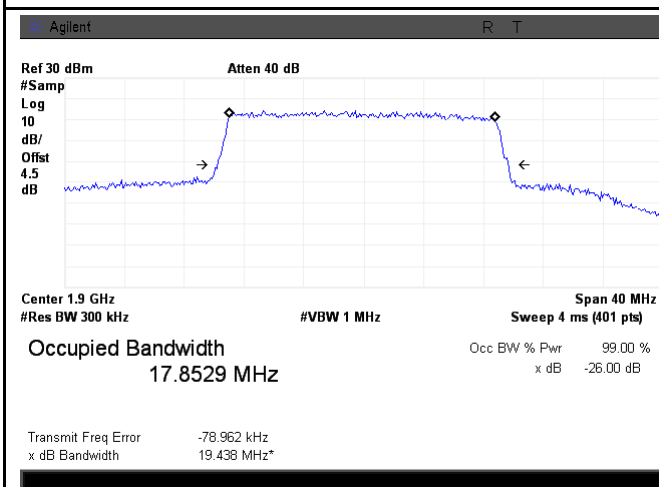

LTE band 2 - High CH QPSK-20

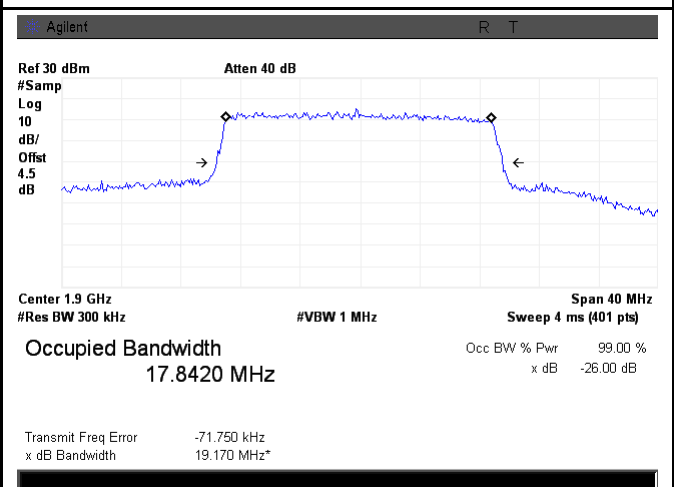

LTE band 2 - High CH 16QAM-20

LTE Band 4 (Part 27)

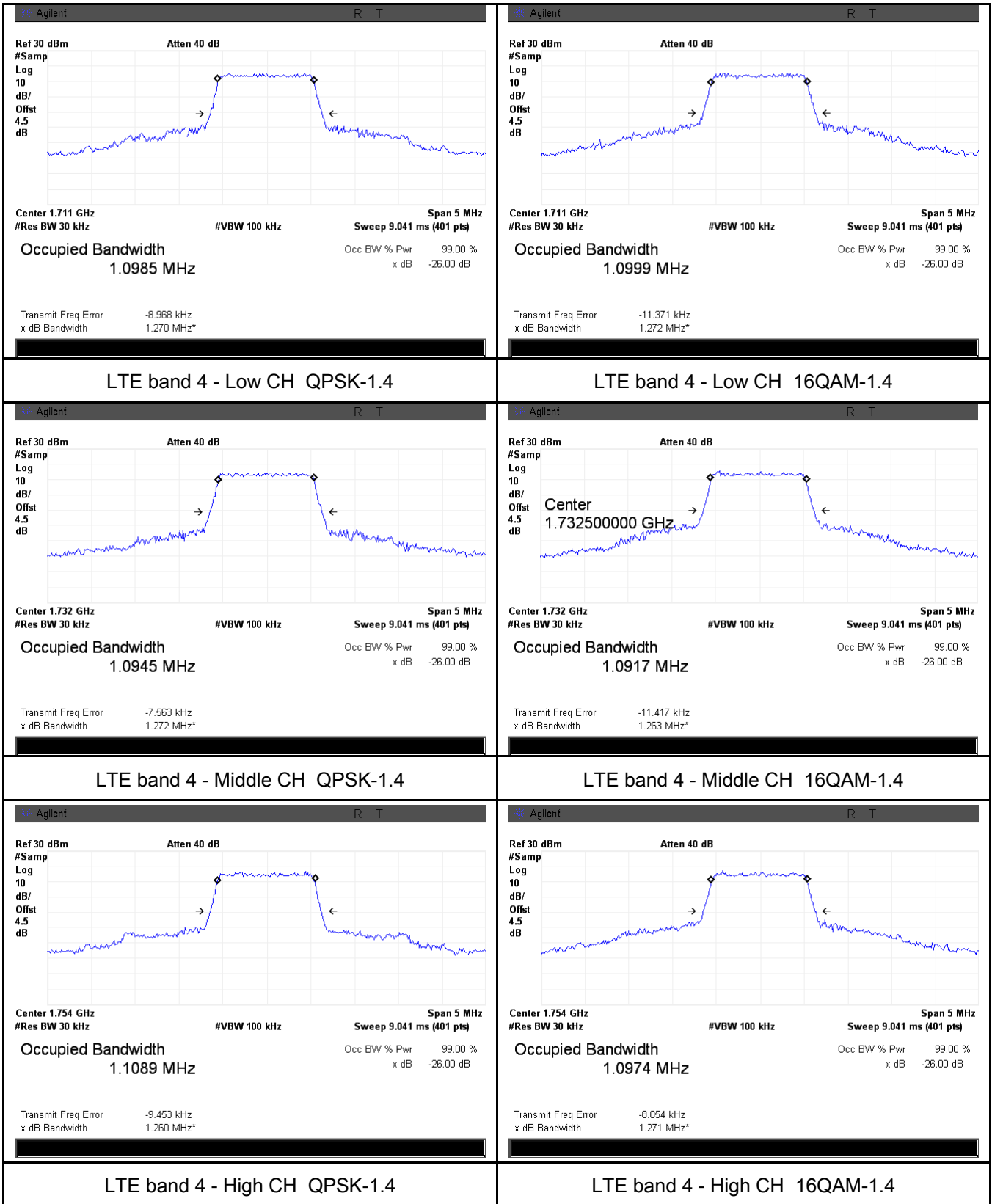

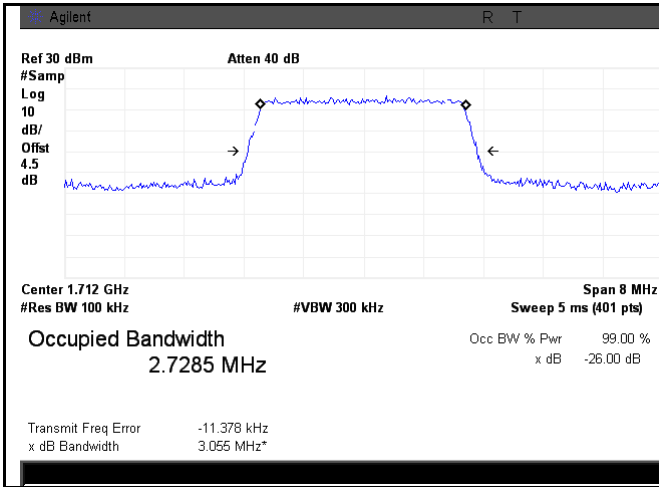

LTE band 4 - Low CH QPSK-3

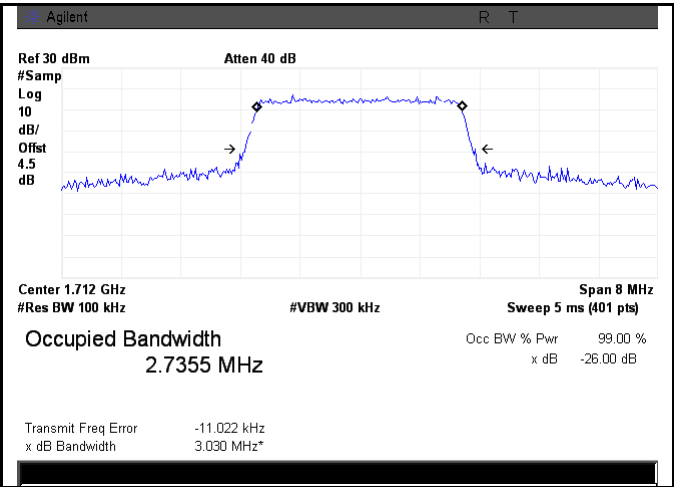

LTE band 4 - Low CH 16QAM-3

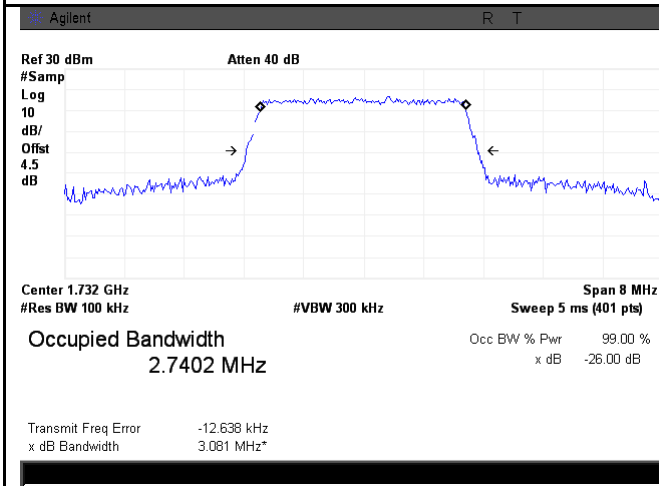

LTE band 4 - Middle CH QPSK-3

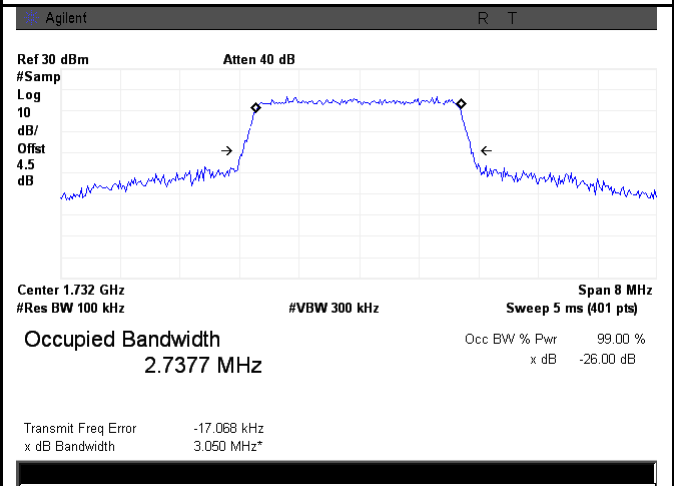

LTE band 4 - Middle CH 16QAM-3

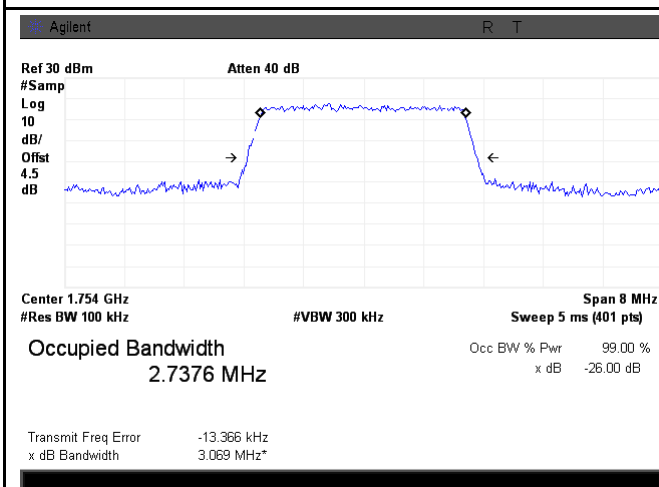

LTE band 4 - High CH QPSK-3

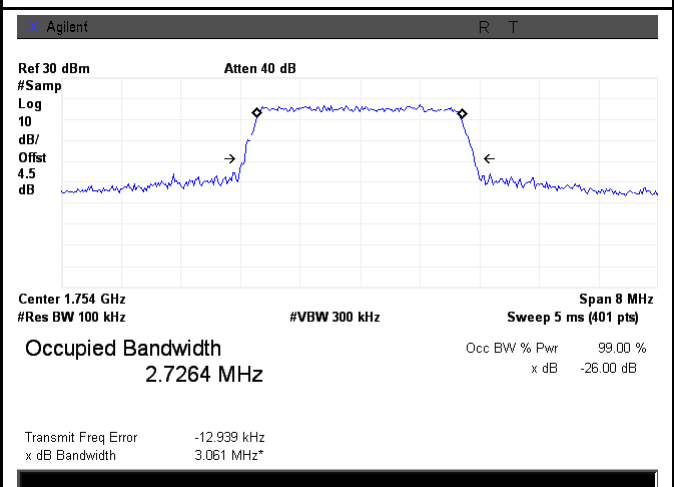

LTE band 4 - High CH 16QAM-3

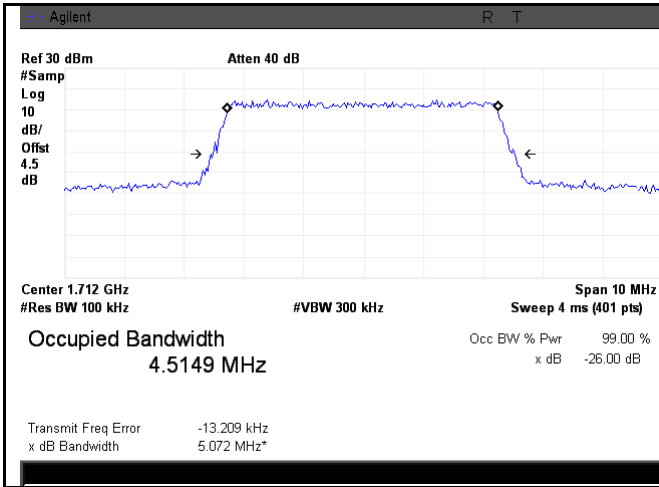

LTE band 4 - Low CH QPSK-5

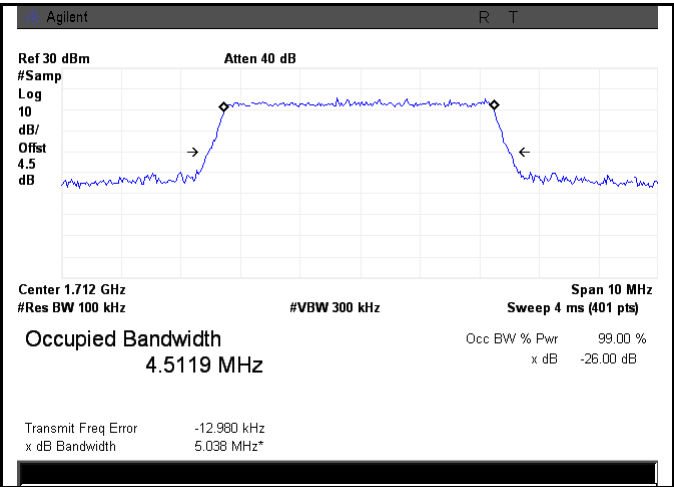

LTE band 4 - Low CH 16QAM-5

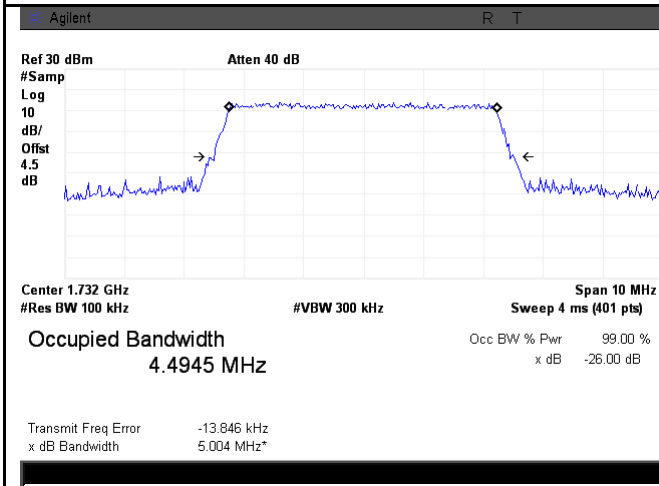

LTE band 4 - Middle CH QPSK-5

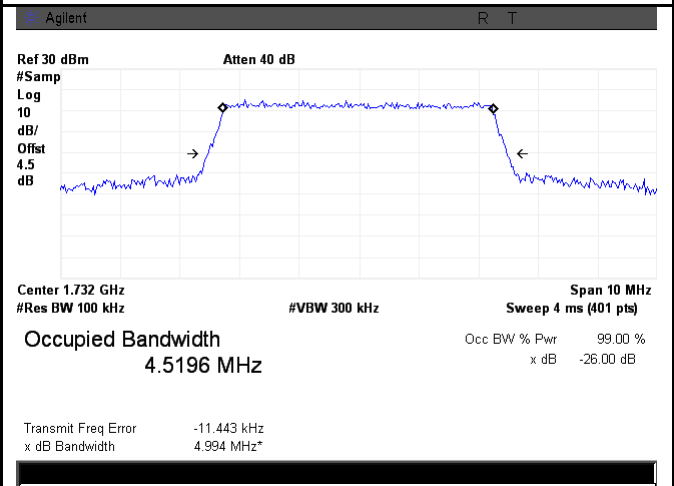

LTE band 4 - Middle CH 16QAM-5

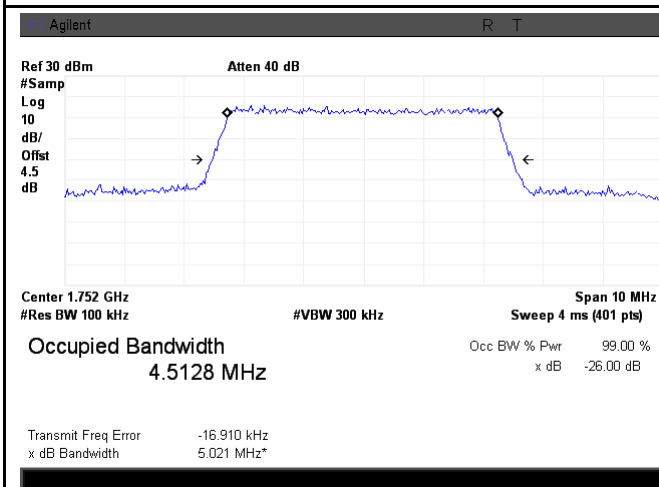

LTE band 4 - High CH QPSK-5

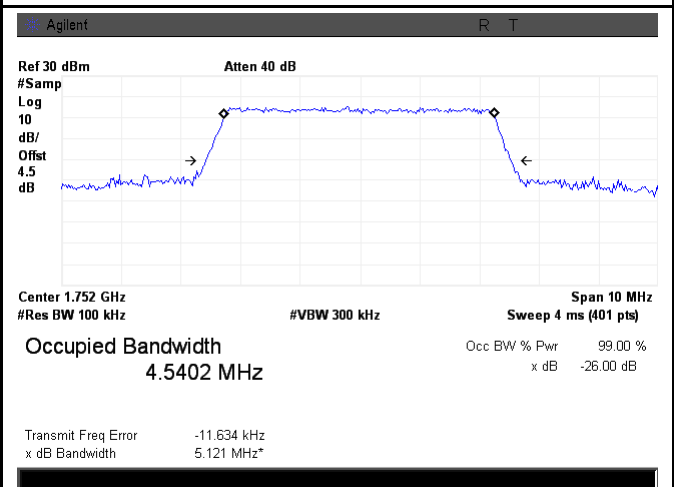

LTE band 4 - High CH 16QAM-5

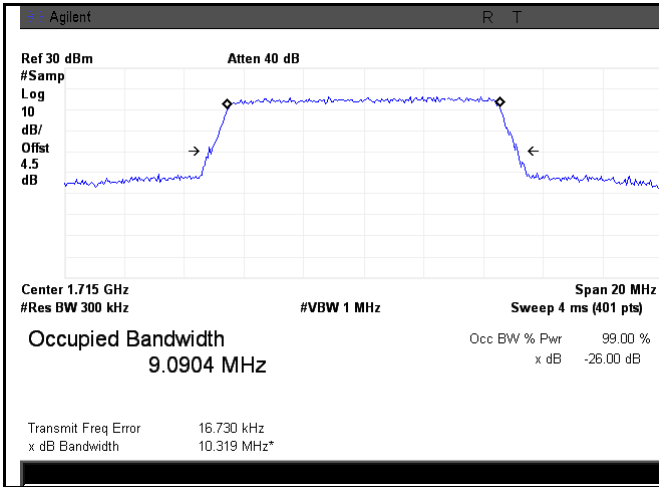

LTE band 4 - Low CH QPSK-10

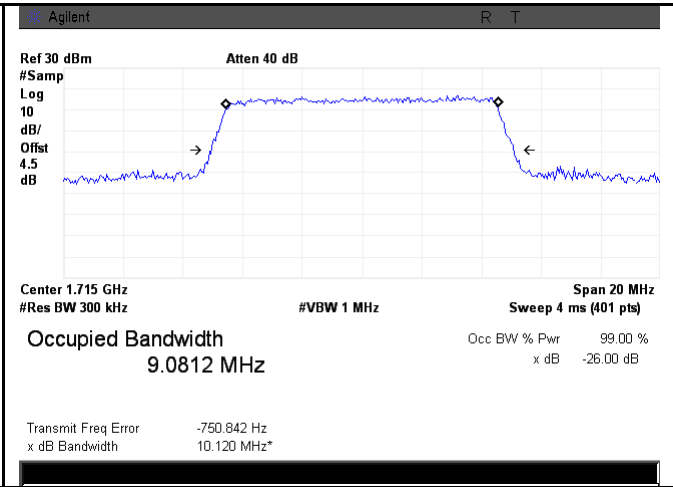

LTE band 4 - Low CH 16QAM-10

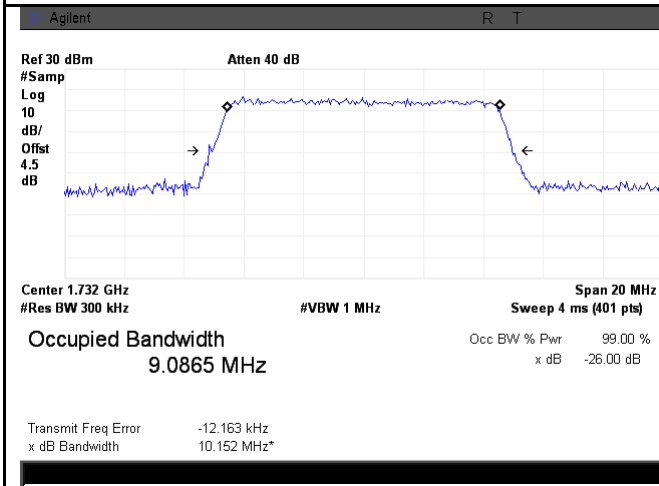

LTE band 4 - Middle CH QPSK-10

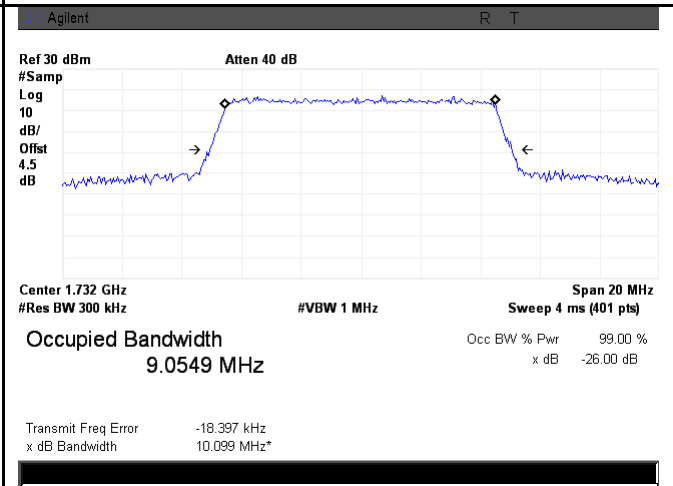

LTE band 4 - Middle CH 16QAM-10

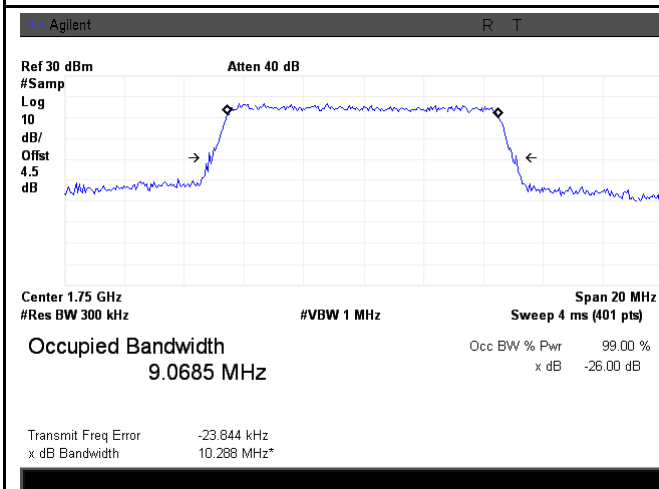

LTE band 4 - High CH QPSK-10

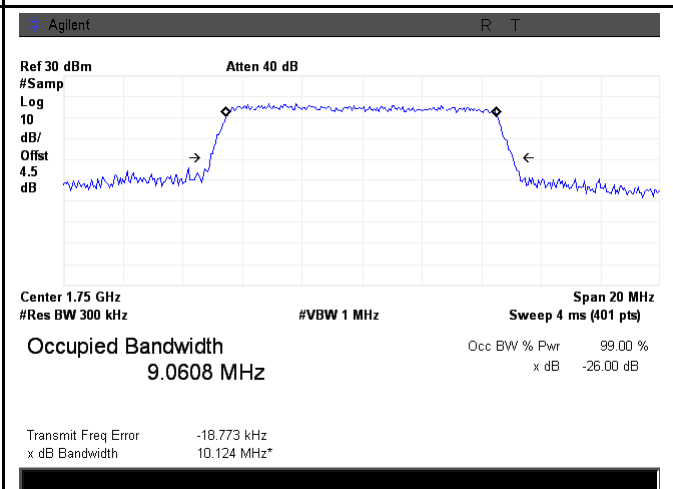

LTE band 4 - High CH 16QAM-10

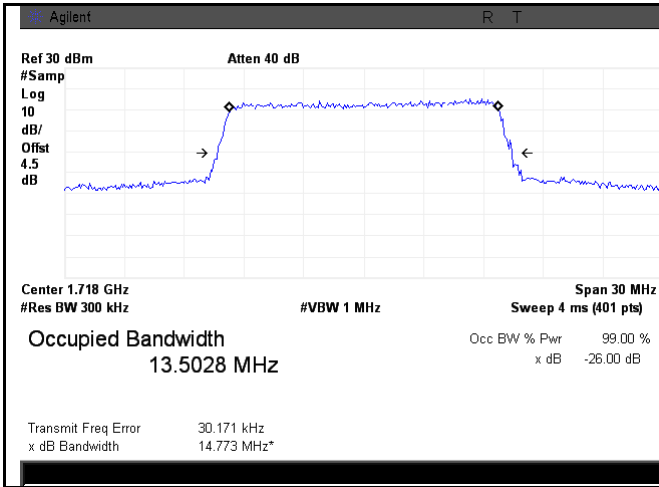

LTE band 4 - Low CH QPSK-15

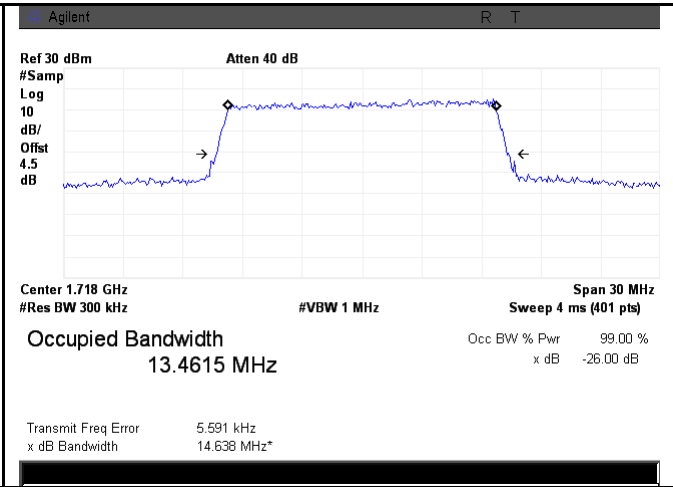

LTE band 4 - Low CH 16QAM-15

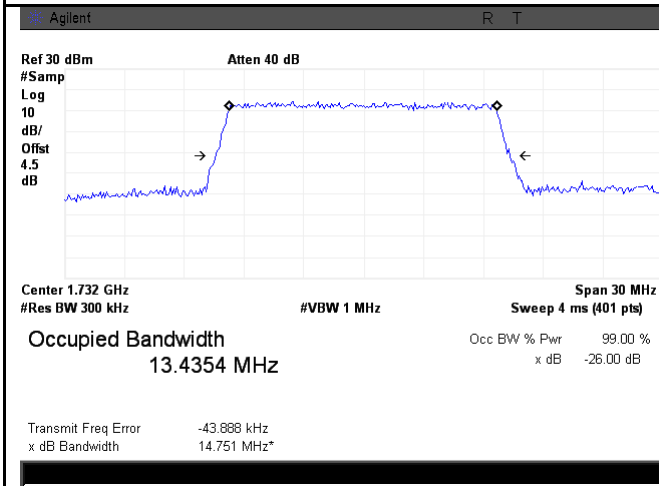

LTE band 4 - Middle CH QPSK-15

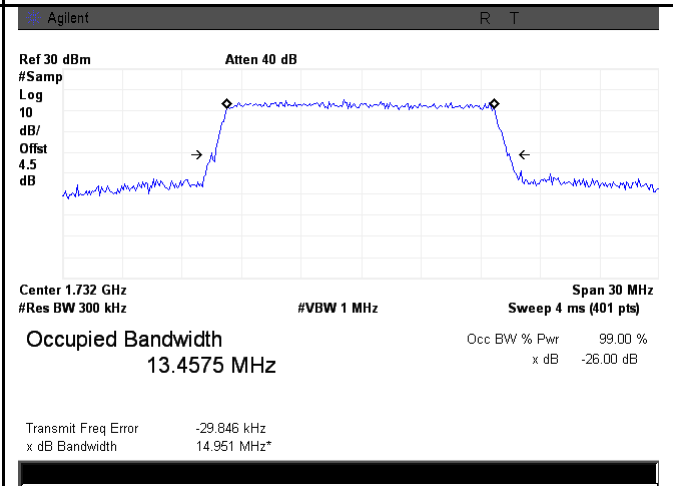

LTE band 4 - Middle CH 16QAM-15

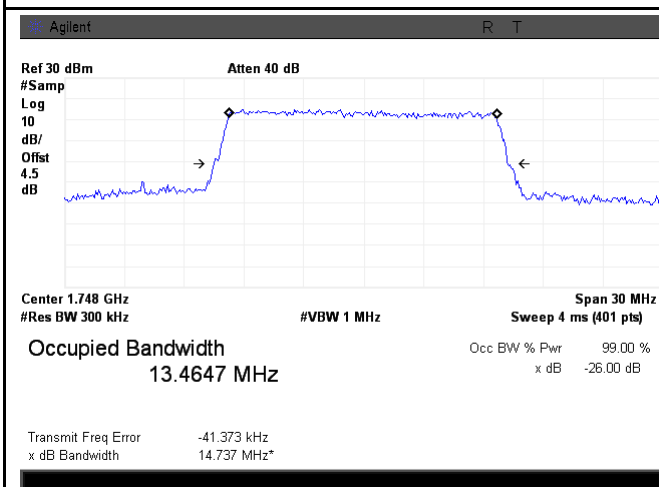

LTE band 4 - High CH QPSK-15

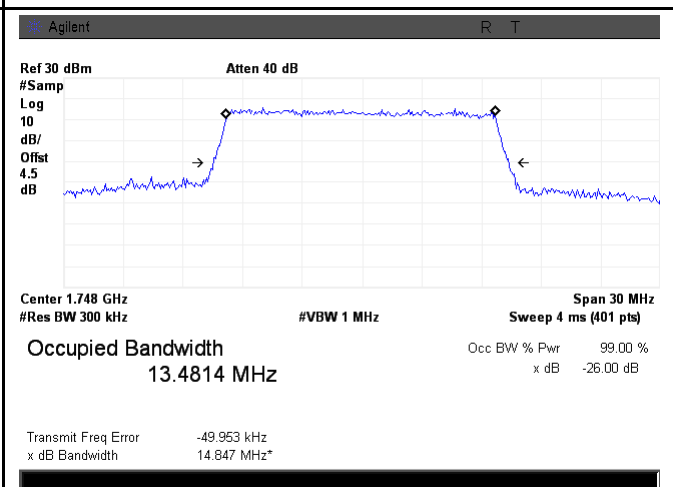

LTE band 4 - High CH 16QAM-15

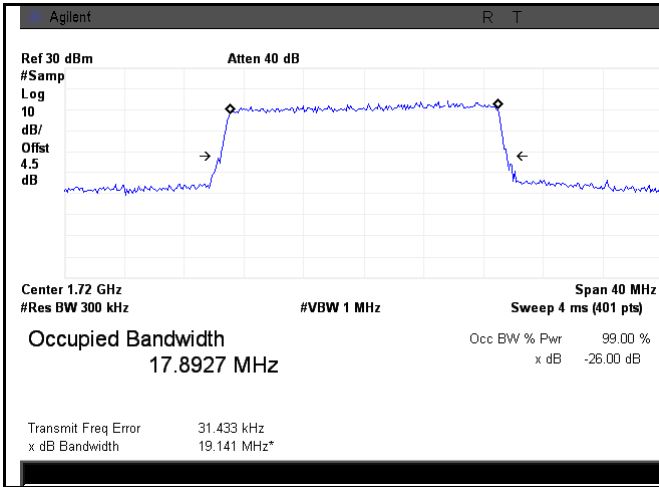

LTE band 4 - Low CH QPSK-20

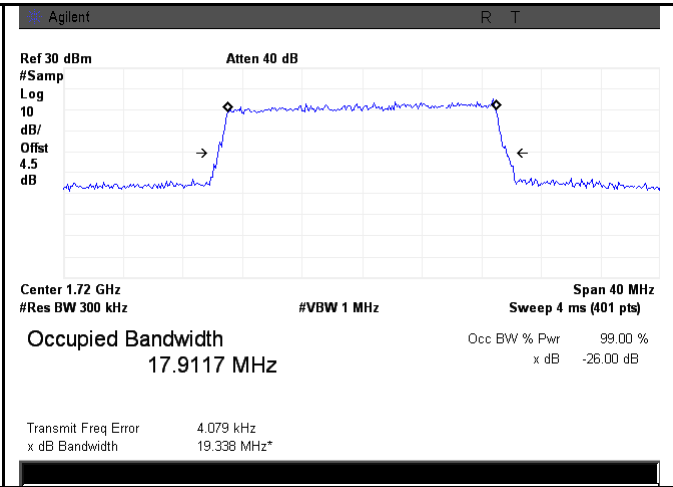

LTE band 4 - Low CH 16QAM-20

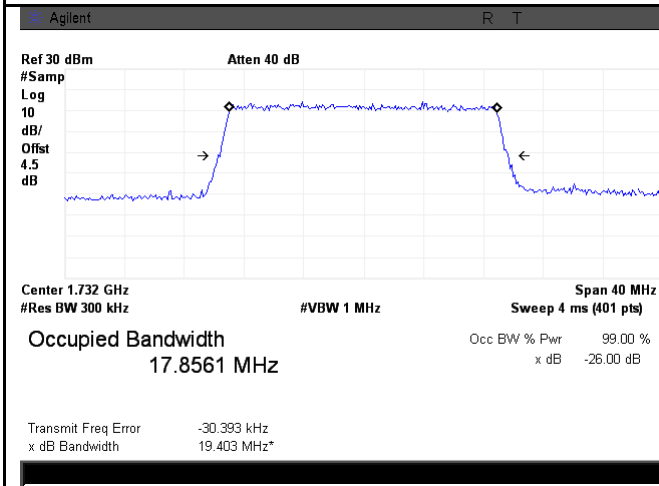

LTE band 4 - Middle CH QPSK-20

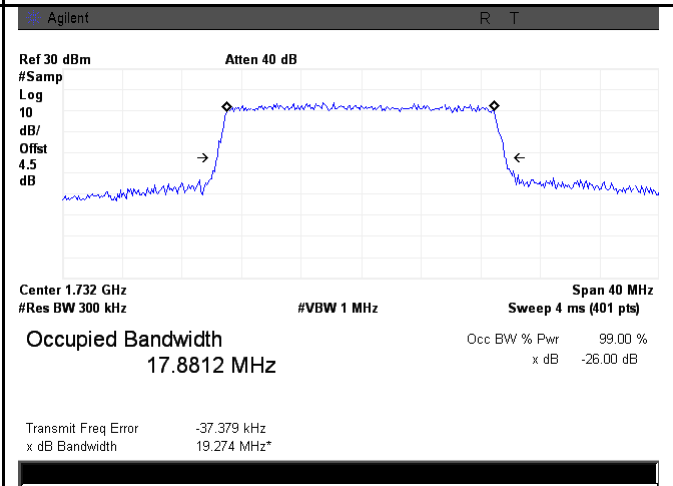

LTE band 4 - Middle CH 16QAM-20

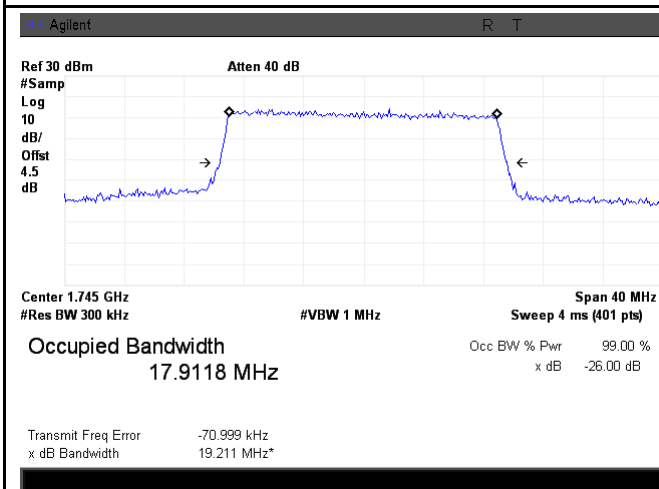

LTE band 4 - High CH QPSK-20

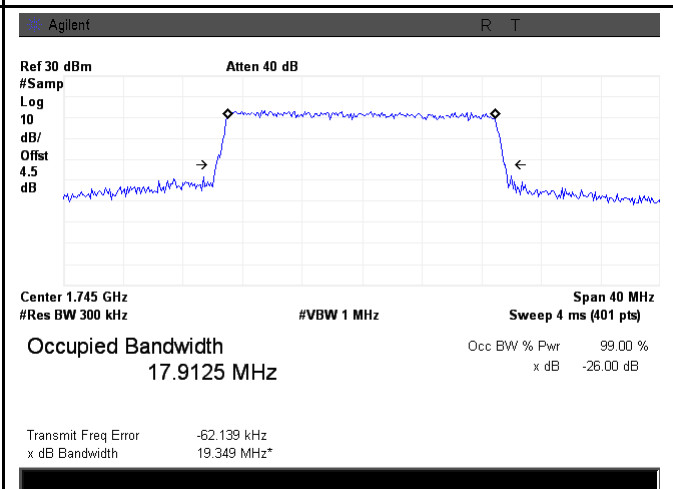

LTE band 4 - High CH 16QAM-20

LTE Band 5 (Part 22H)

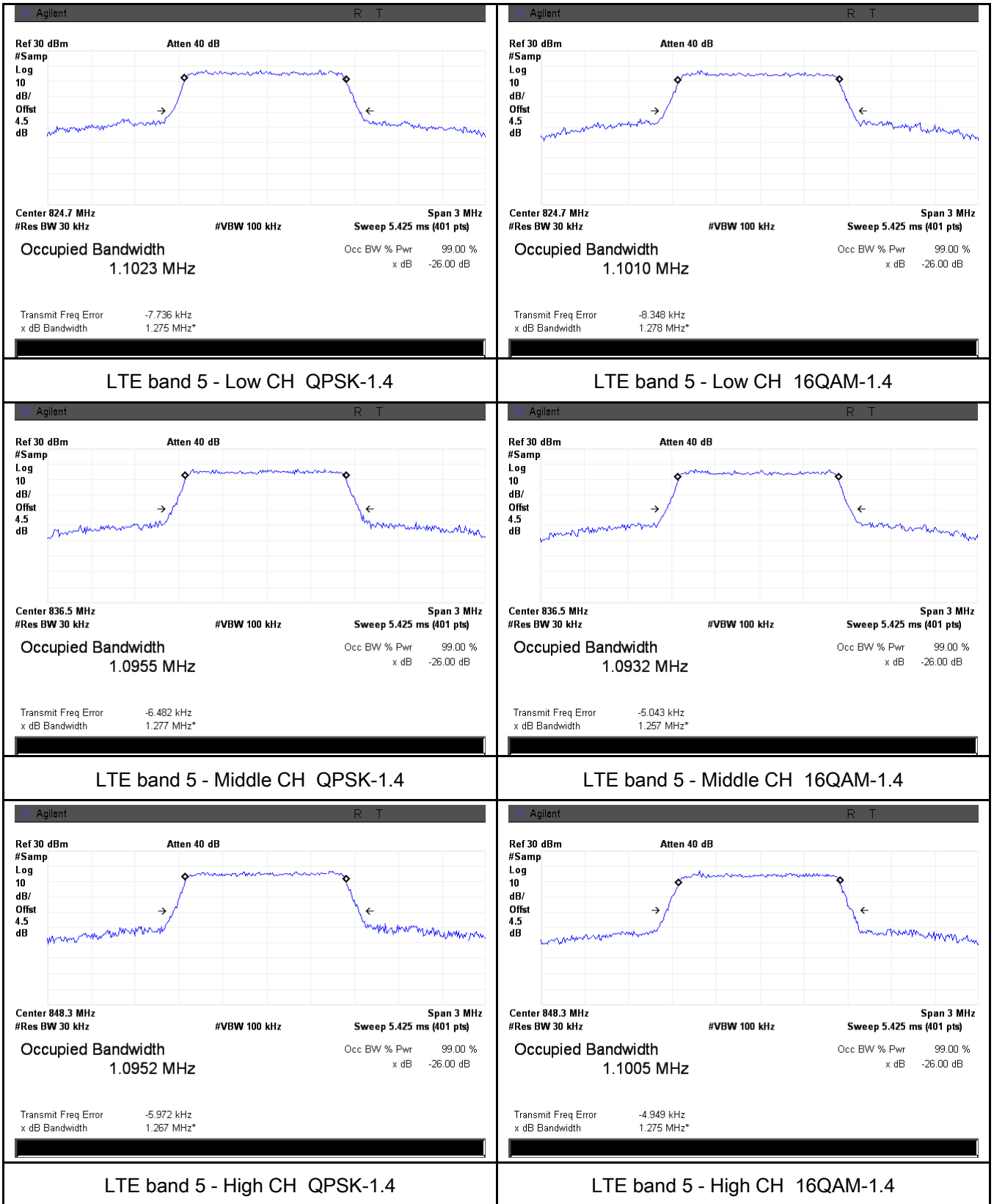

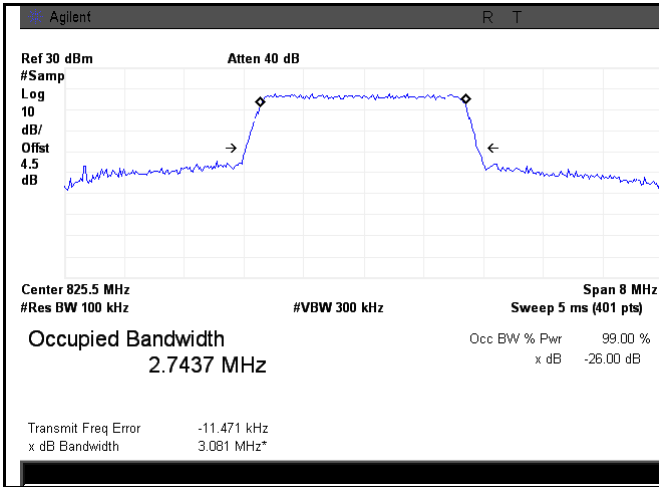

LTE band 5 - Low CH QPSK-3

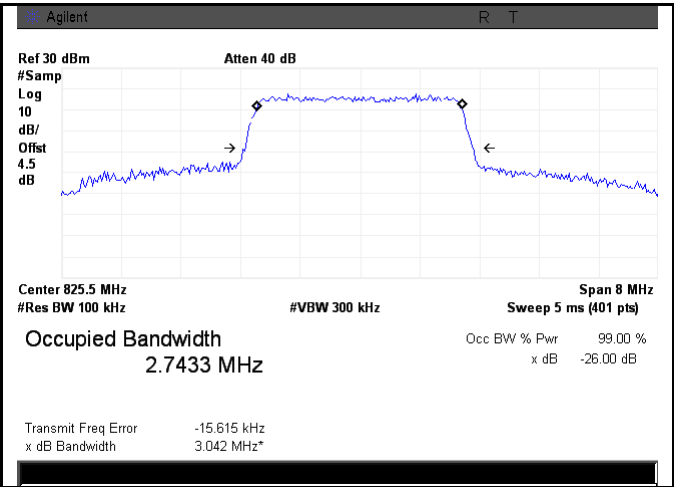

LTE band 5 - Low CH 16QAM-3

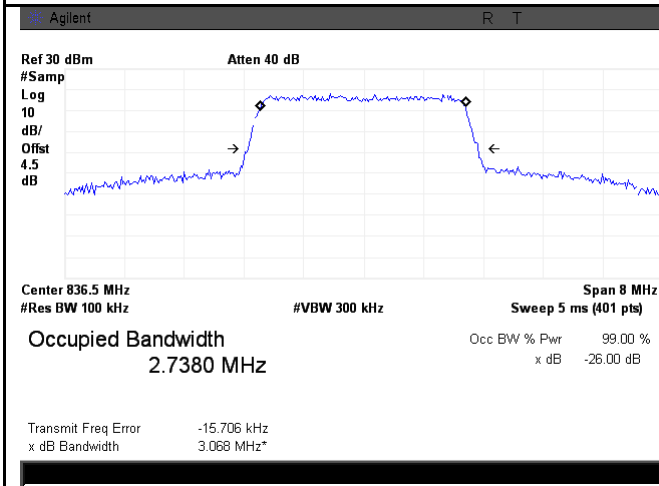

LTE band 5 - Middle CH QPSK-3

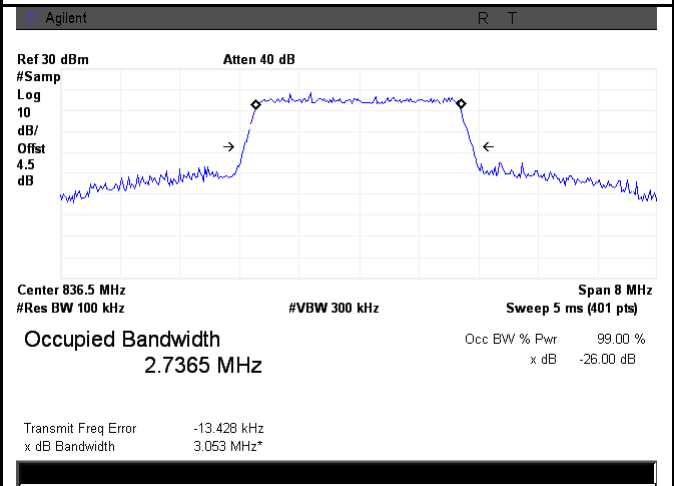

LTE band 5 - Middle CH 16QAM-3

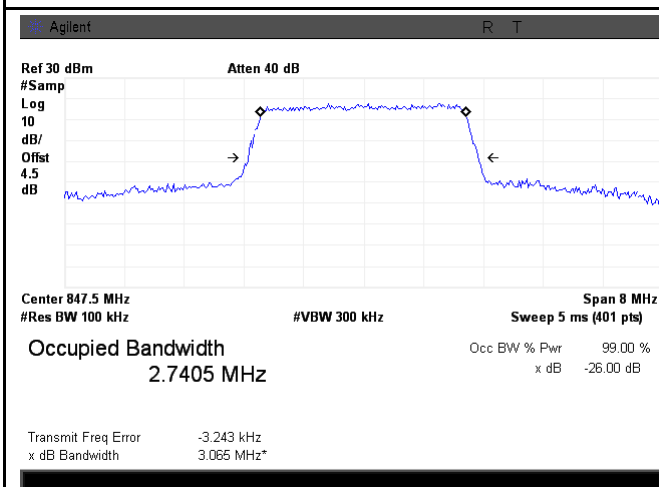

LTE band 5 - High CH QPSK-3

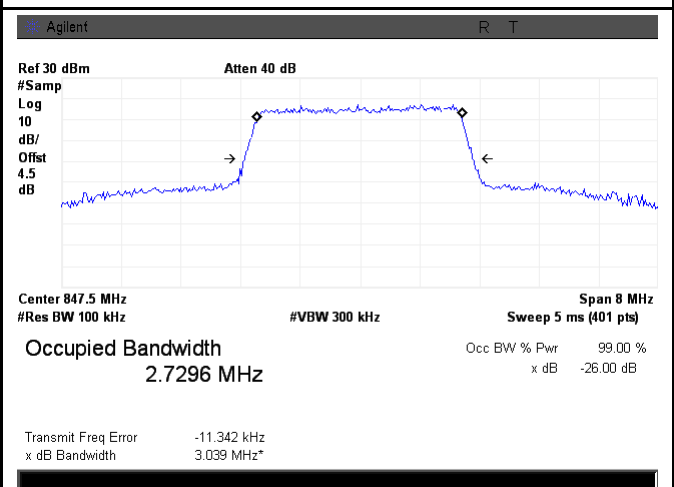

LTE band 5 - High CH 16QAM-3

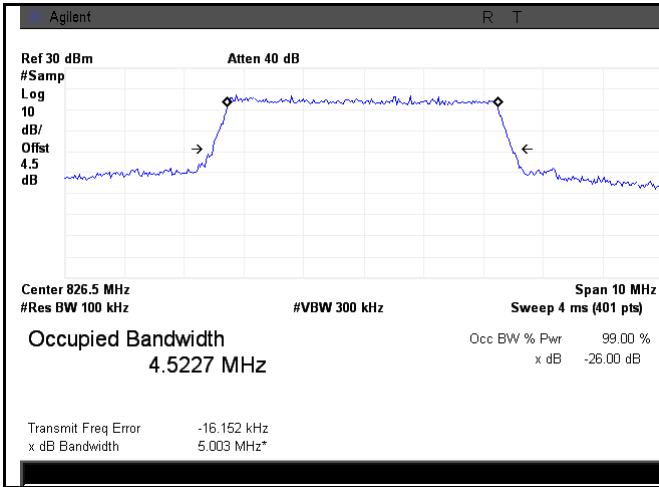

LTE band 5 - Low CH QPSK-5

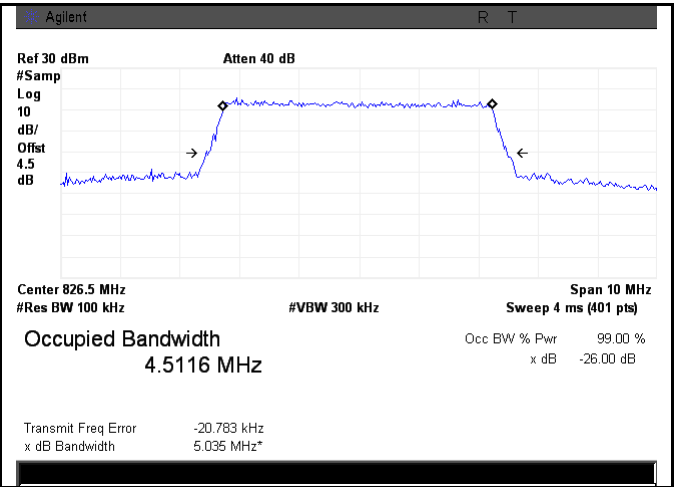

LTE band 5 - Low CH 16QAM-5

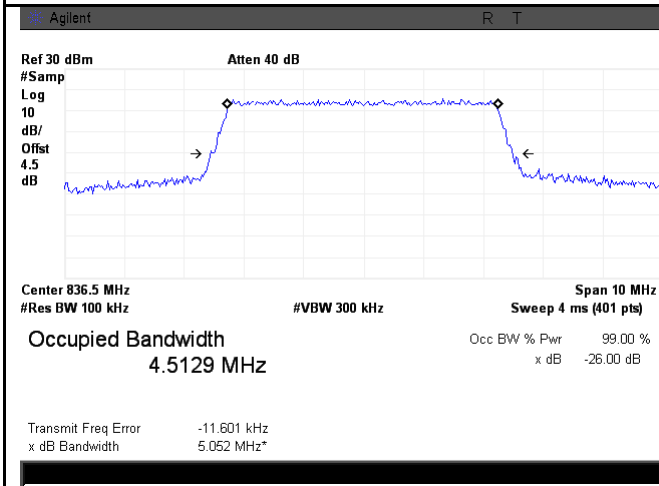

LTE band 5 - Middle CH QPSK-5

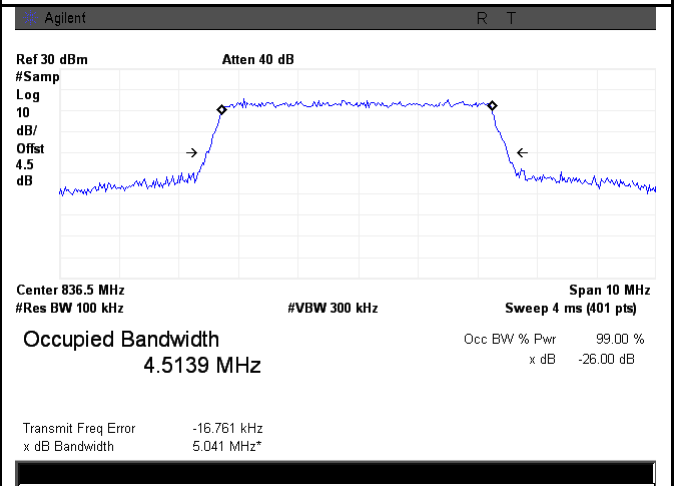

LTE band 5 - Middle CH 16QAM-5

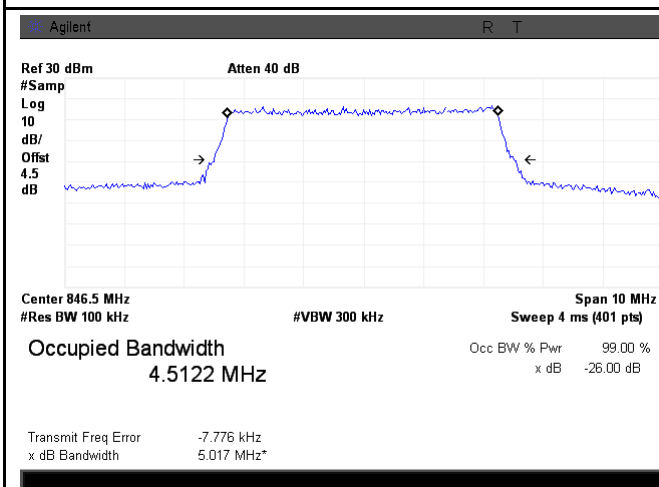

LTE band 5 - High CH QPSK-5

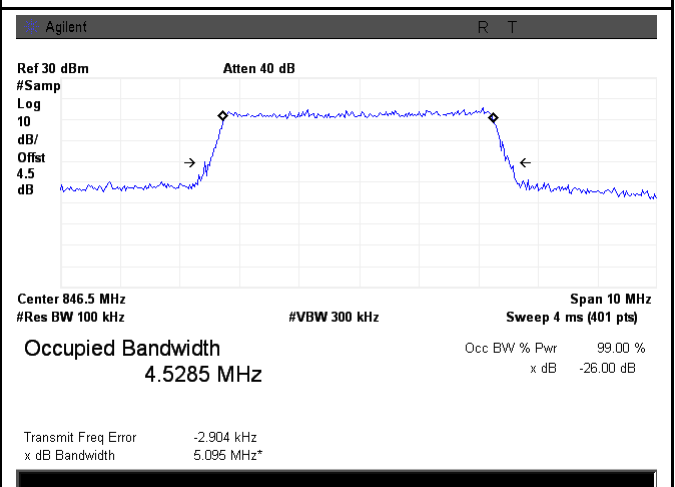

LTE band 5 - High CH 16QAM-5

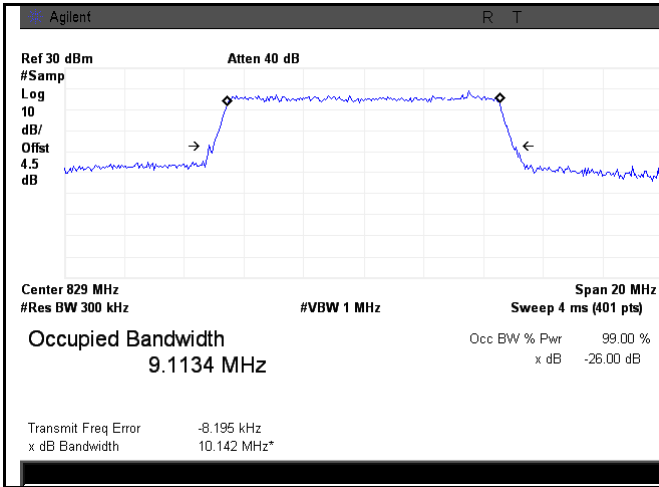

LTE band 5 - Low CH QPSK-10

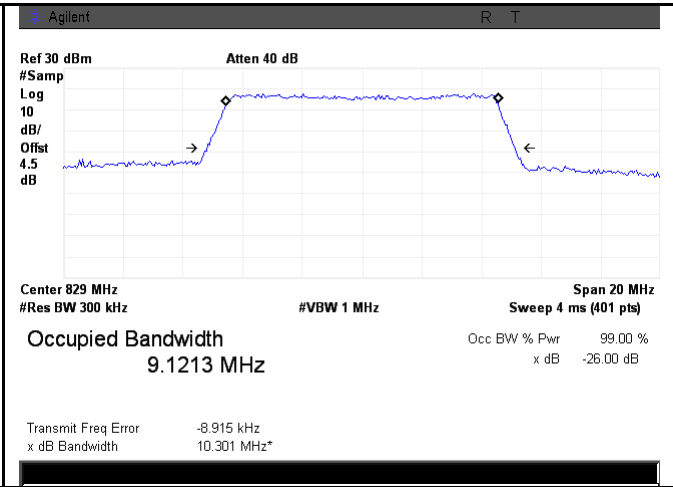

LTE band 5 - Low CH 16QAM-10

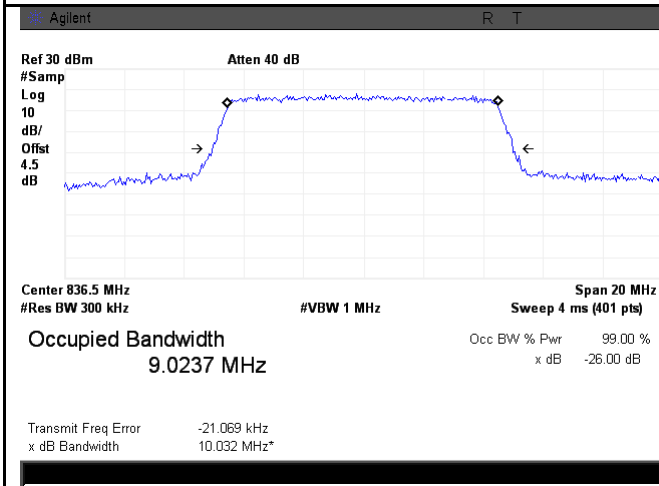

LTE band 5 - Middle CH QPSK-10

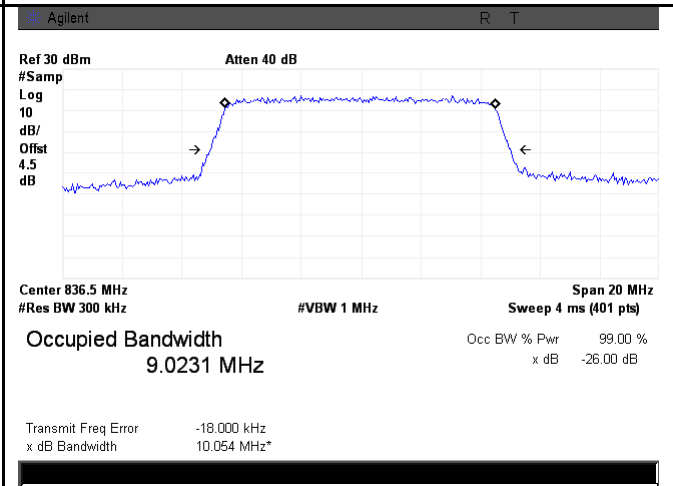

LTE band 5 - Middle CH 16QAM-10

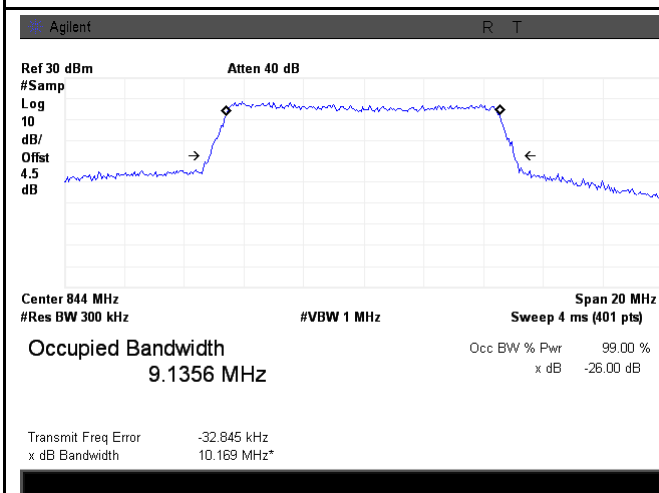

LTE band 5 - High CH QPSK-10

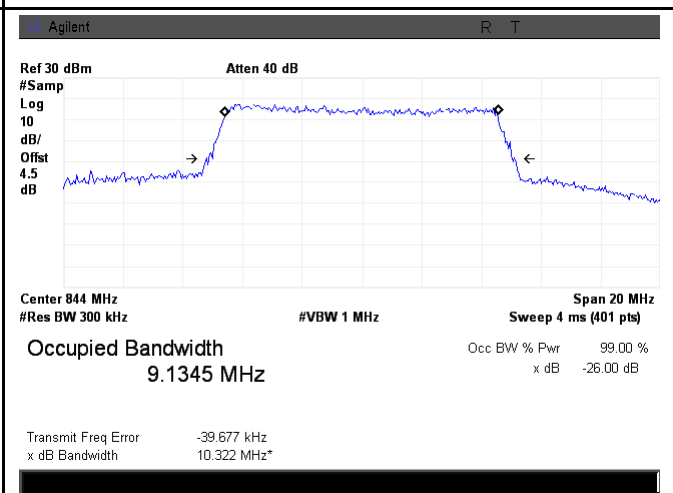

LTE band 5 - High CH 16QAM-10

LTE Band 7 (Part 27)

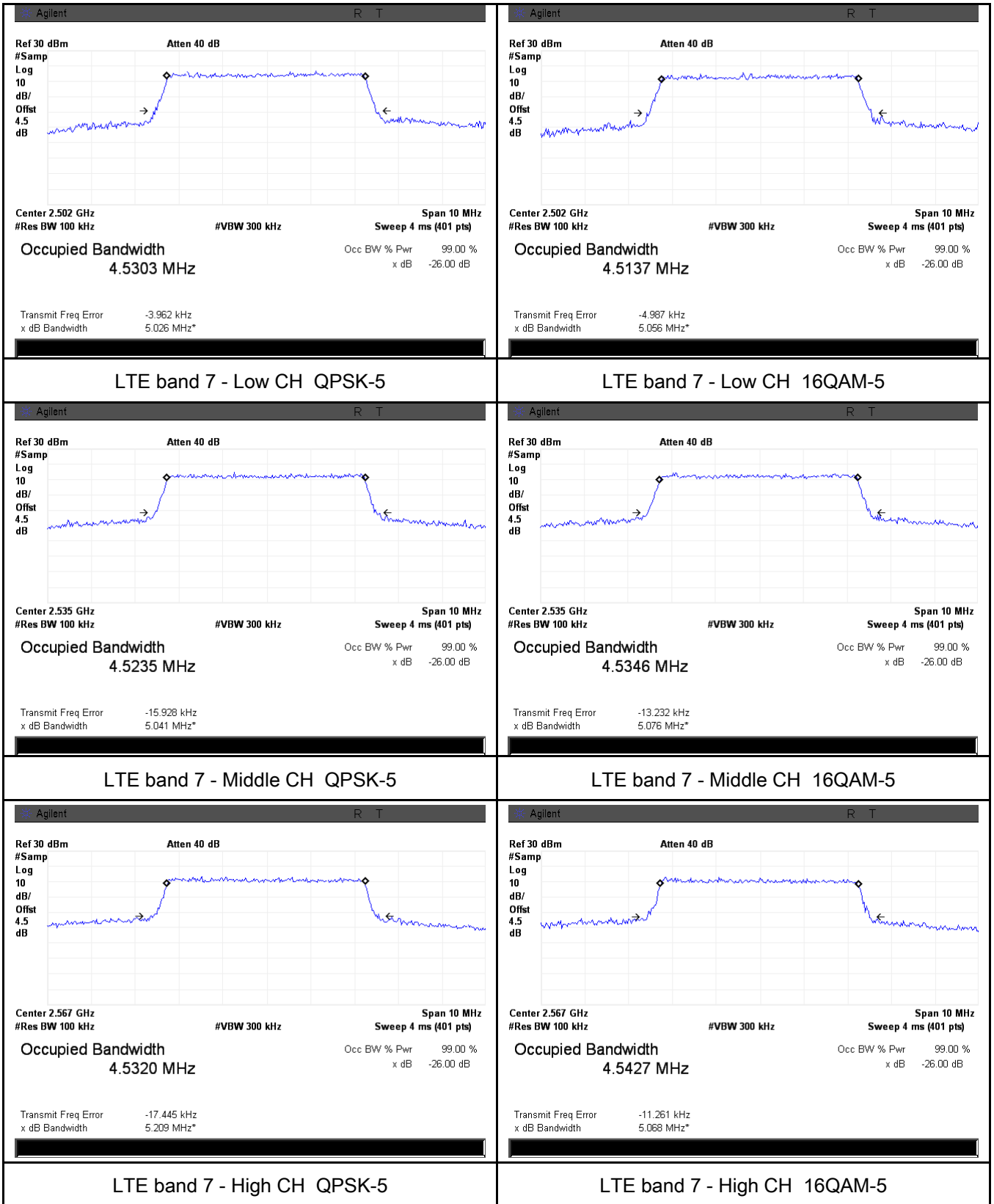

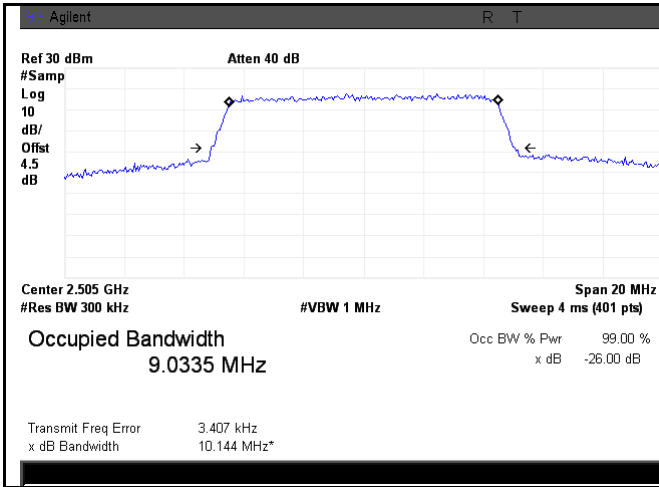

LTE band 7 - Low CH QPSK-10

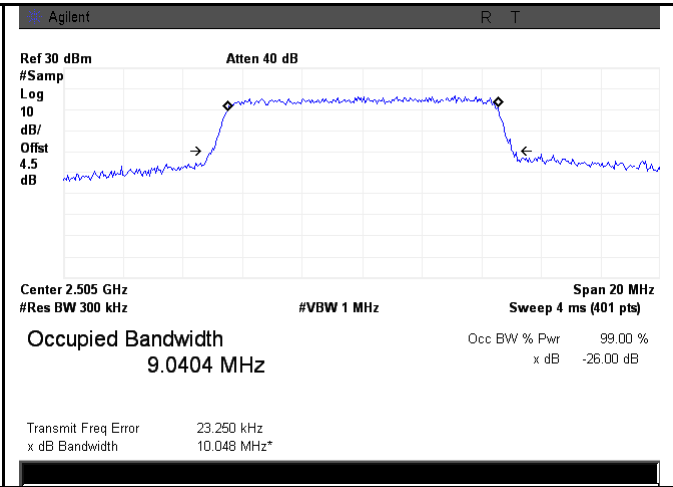

LTE band 7 - Low CH 16QAM-10

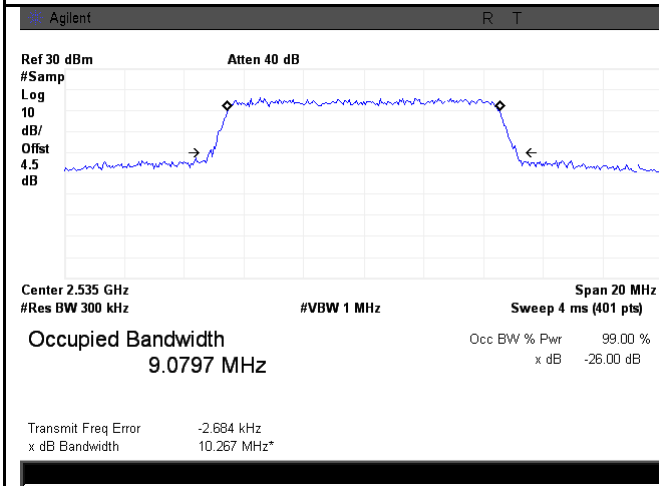

LTE band 7 - Middle CH QPSK-10

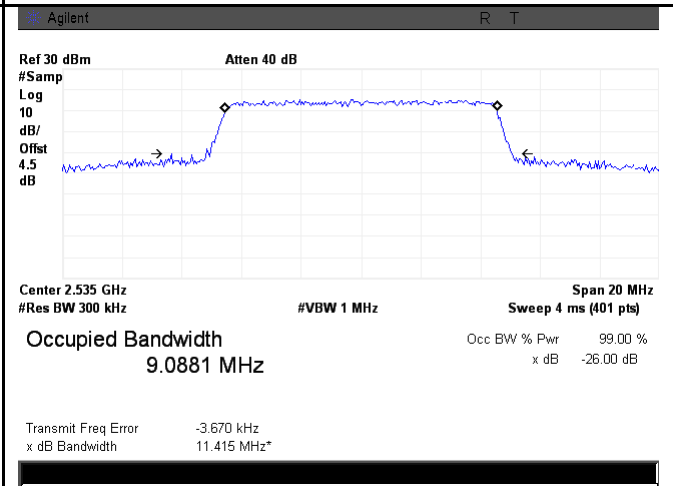

LTE band 7 - Middle CH 16QAM-10

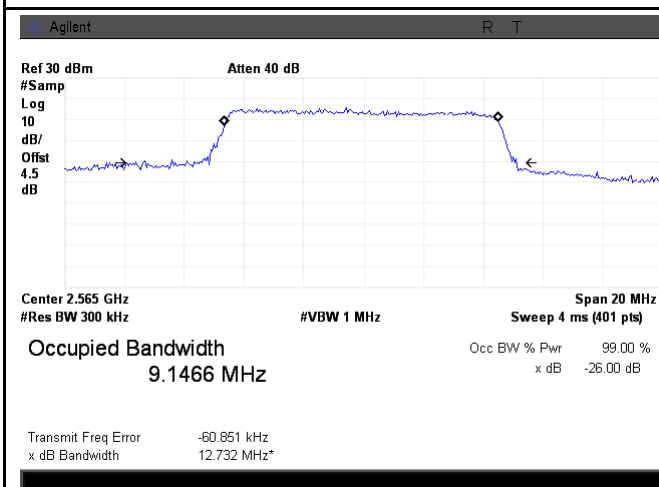

LTE band 7 - High CH QPSK-10

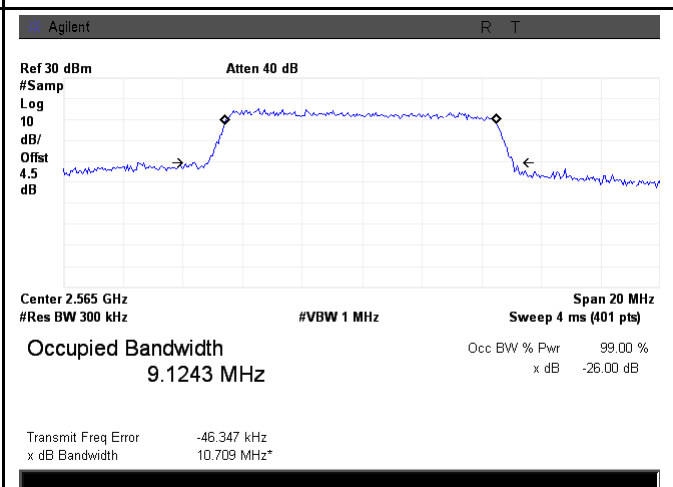

LTE band 7 - High CH 16QAM-10

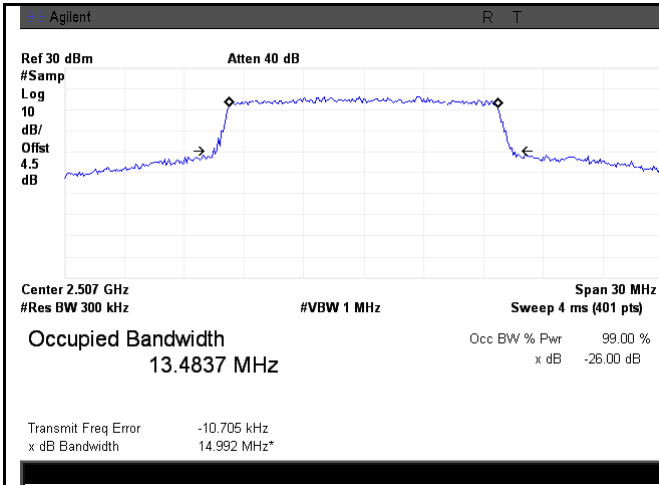

LTE band 7 - Low CH QPSK-15

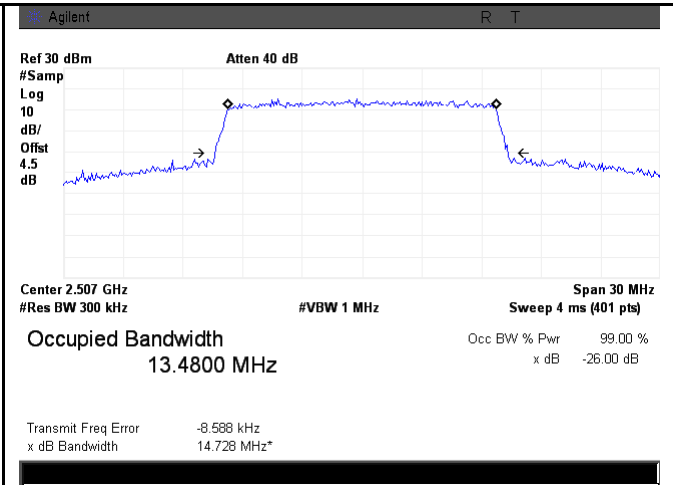

LTE band 7 - Low CH 16QAM-15

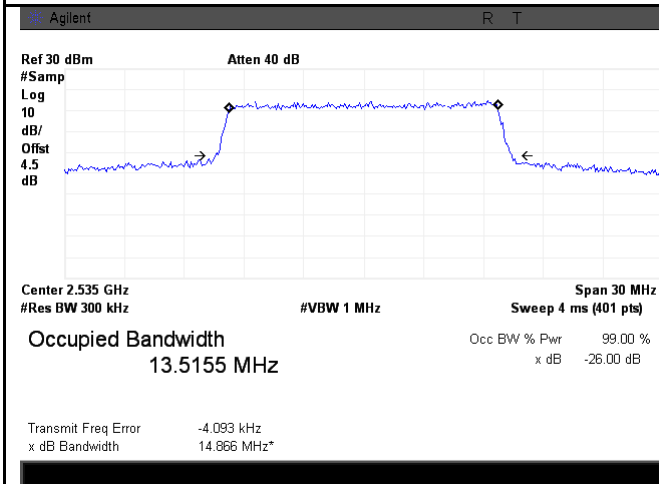

LTE band 7 - Middle CH QPSK-15

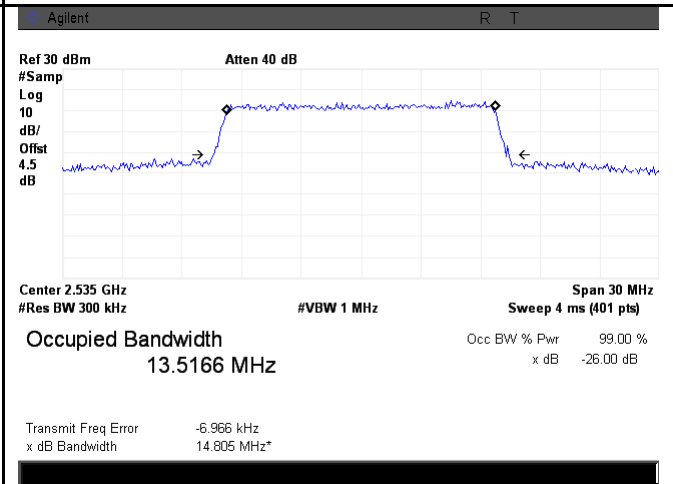

LTE band 7 - Middle CH 16QAM-15

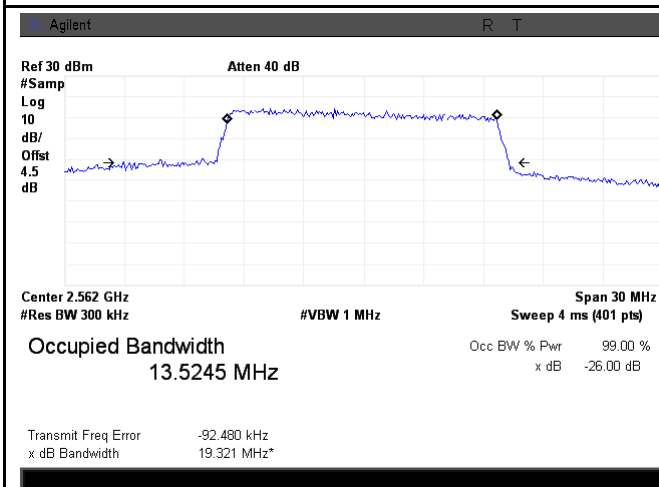

LTE band 7 - High CH QPSK-15

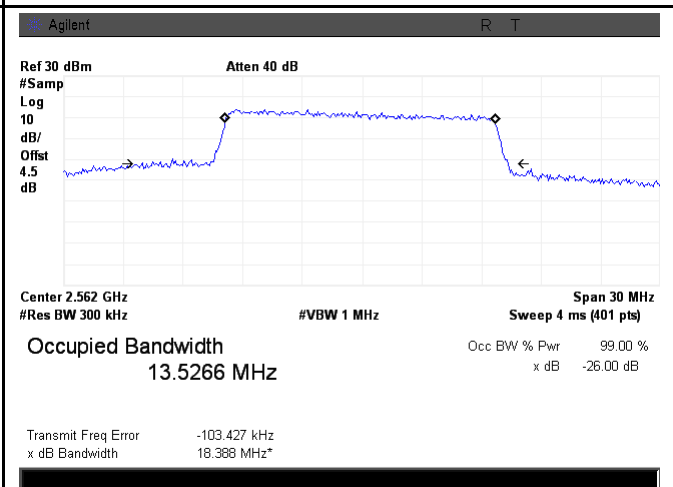

LTE band 7 - High CH 16QAM-15

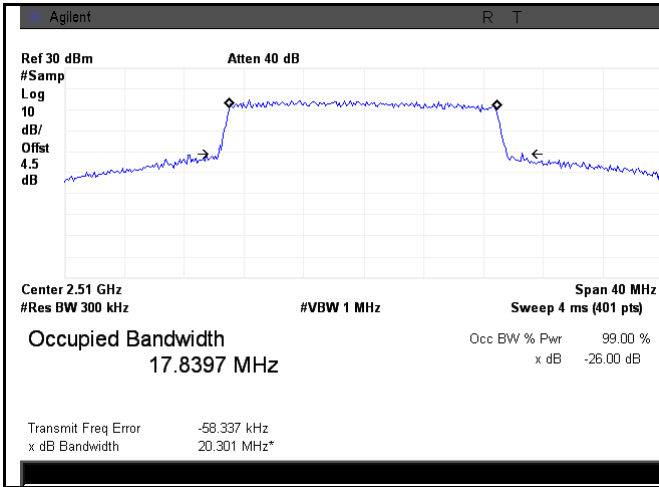

LTE band 7 - Low CH QPSK-20

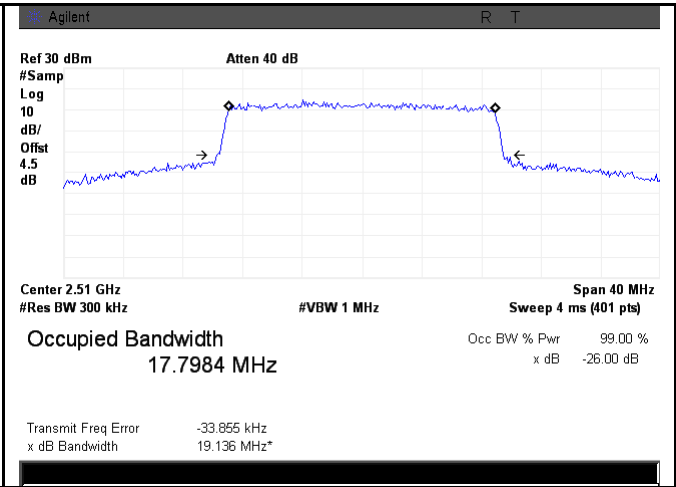

LTE band 7 - Low CH 16QAM-20

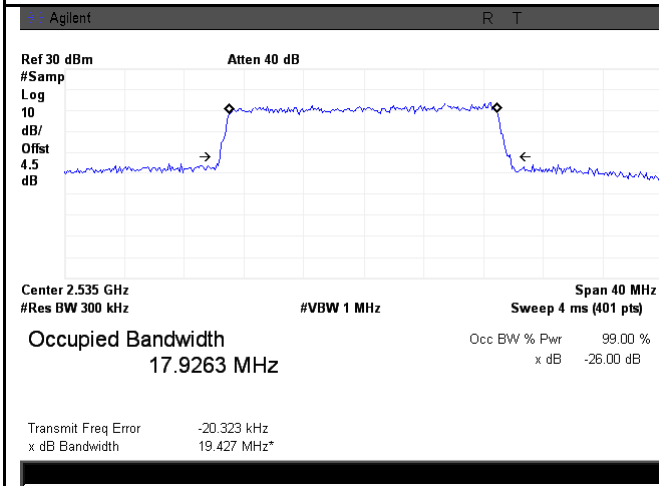

LTE band 7 - Middle CH QPSK-20

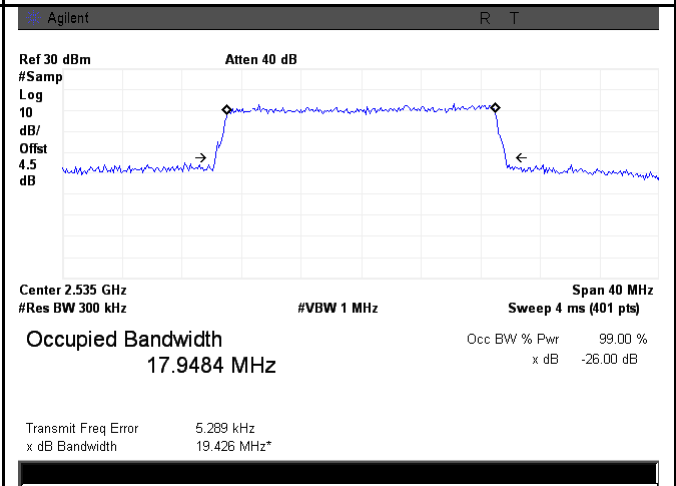

LTE band 7 - Middle CH 16QAM-20

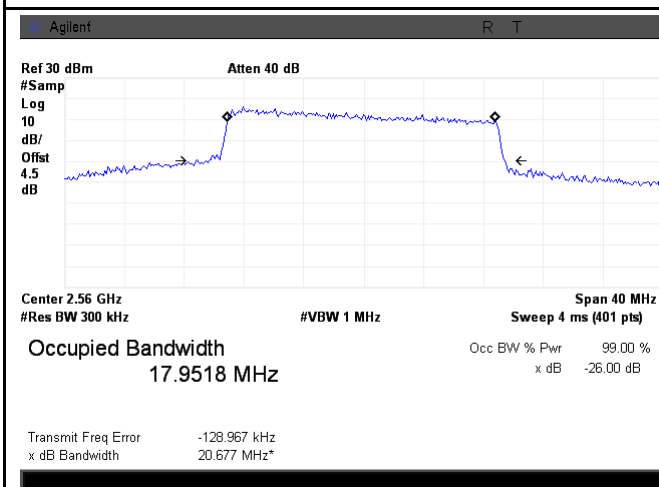

LTE band 7 - High CH QPSK-20

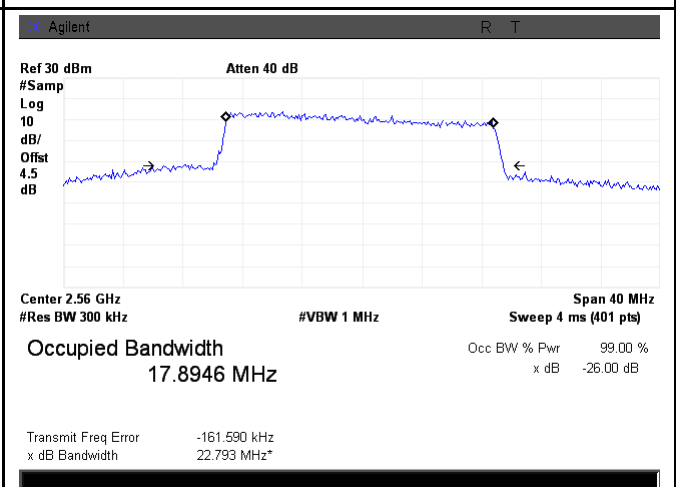

LTE band 7 - High CH 16QAM-20

6.6 Spurious Emissions at Antenna Terminals

Temperature	24°C
Relative Humidity	56%
Atmospheric Pressure	1004mbar
Test date :	September 04, 2015
Tested By :	Winnie Zhang

Requirement(s):

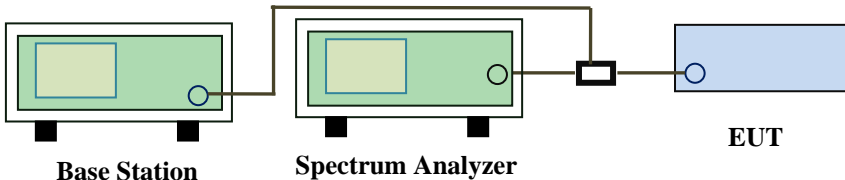
Spec	Item	Requirement	Applicable
§2.1051, §22.917(a)& §24.238(a) § 27.53(h)	a)	The power of any emission outside of the authorized operating frequency ranges must be lower than the transmitter power (P) by a factor of at least $43 + 10 \log (P)$ dB	<input checked="" type="checkbox"/>
Test Setup	 <p>The diagram shows a Base Station (green box) connected to a Spectrum Analyzer (green box) and an EUT (blue box) via a power divider. The Base Station and Spectrum Analyzer are connected to the power divider, which then splits the signal to the Spectrum Analyzer and the EUT.</p>		
Test Procedure	<ul style="list-style-type: none"> - The EUT was connected to Spectrum Analyzer and Base Station via power divider. - The Band Edges of low and high channels for the highest RF powers were measured. - Setting RBW as roughly BW/100. 		
Remark			
Result	<input checked="" type="checkbox"/> Pass <input type="checkbox"/> Fail		

Test Data Yes N/A
 Test Plot Yes (See below) N/A

Test Plots 30MHz-5GHz
LTE Band 2 (Part 24E)

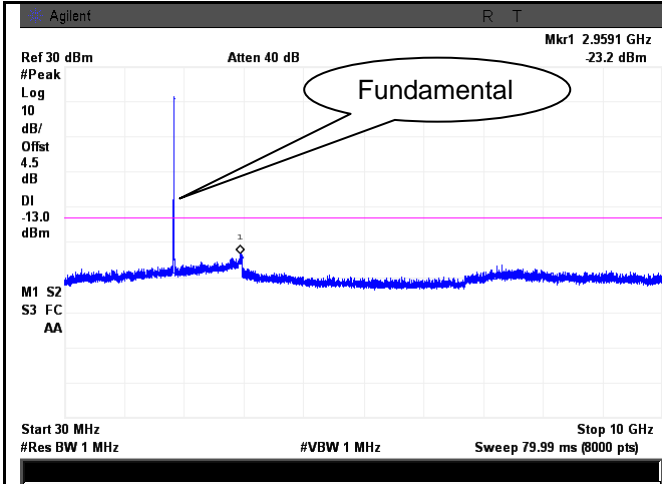

LTE Band 2 - Low Channel-1

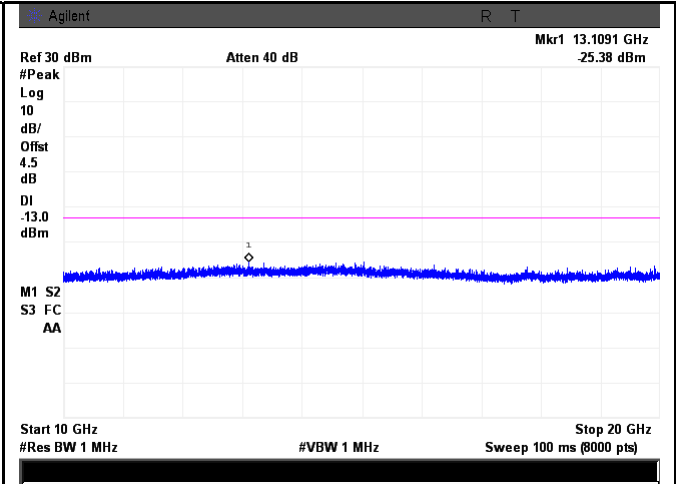

LTE Band 2 - Low Channel-2

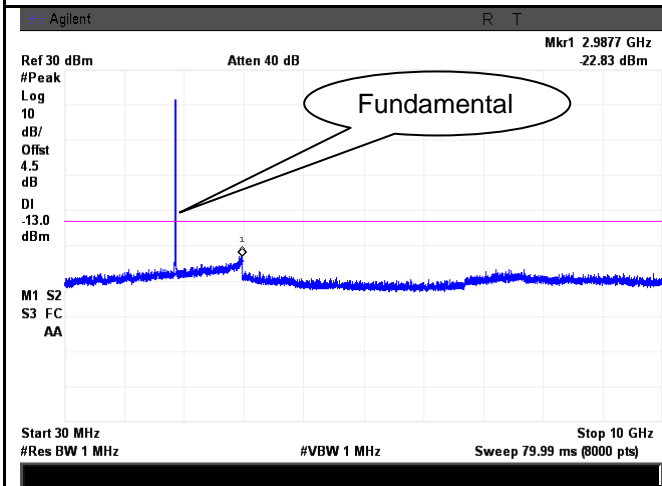

LTE Band 2 Middle Channel-1

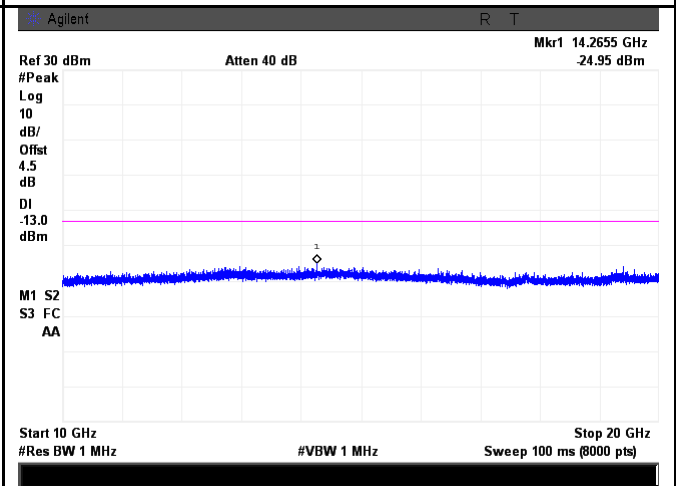

LTE Band 2 Middle Channel-2

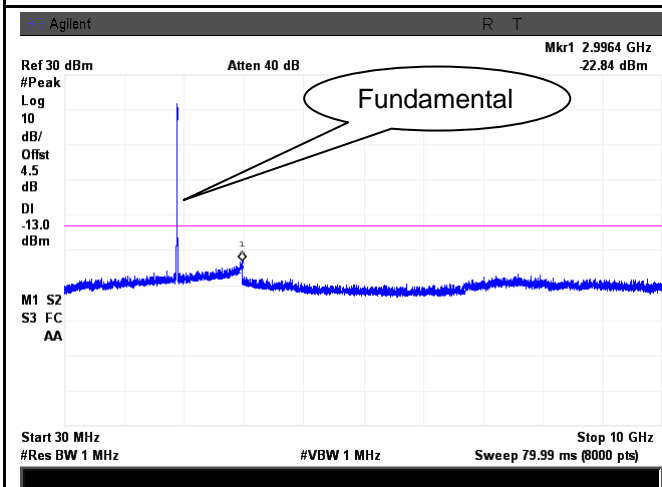

LTE Band 2 - High Channel-1

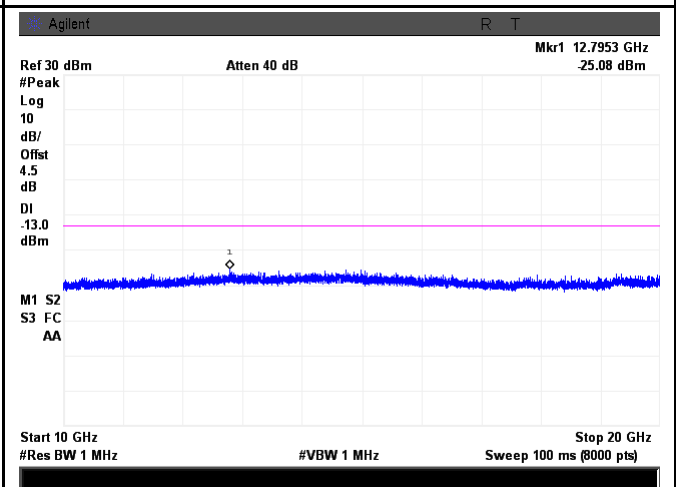

LTE Band 2 - High Channel-2

LTE Band 4 (Part27) result

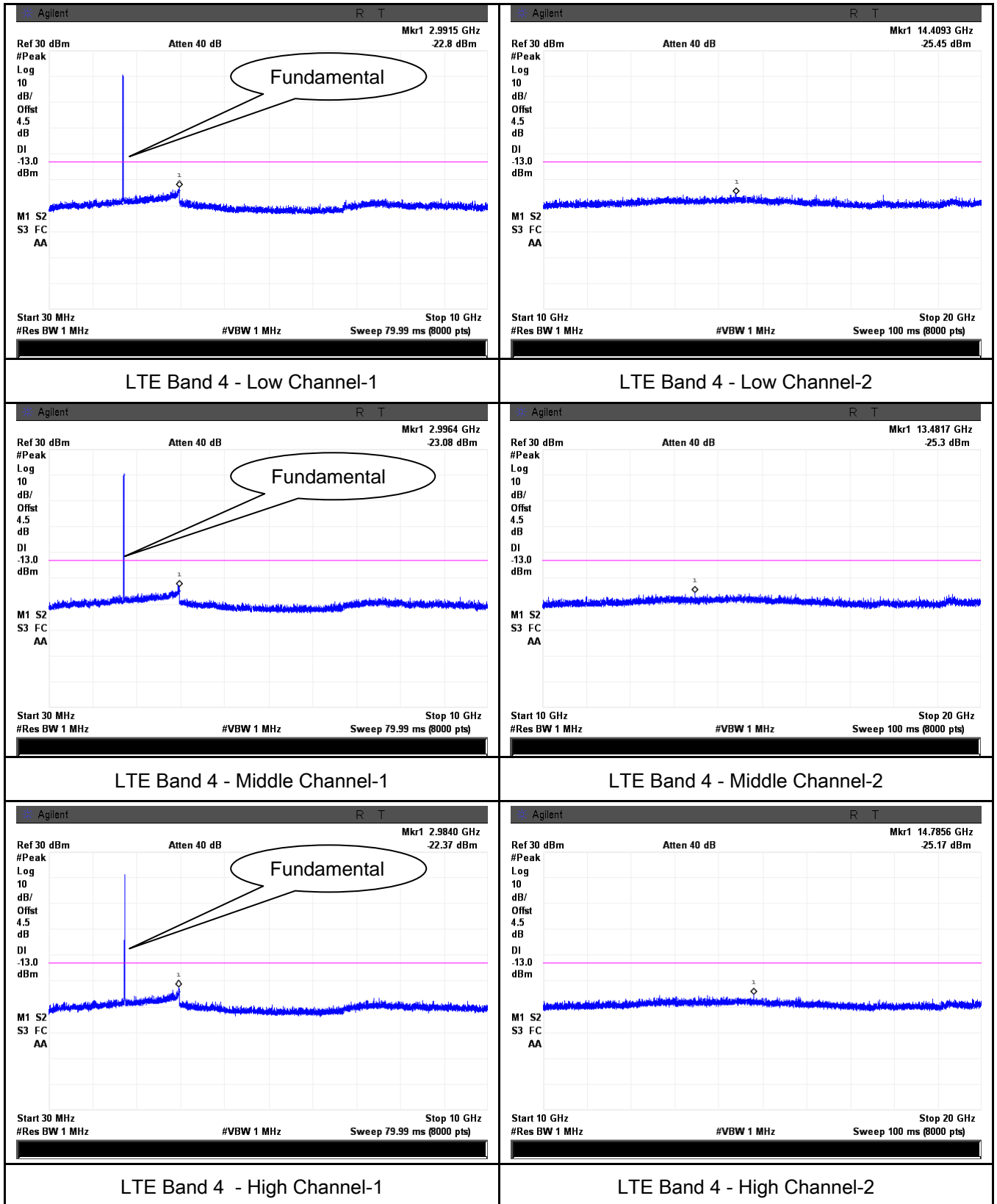

LTE Band 5 (Part 22H)

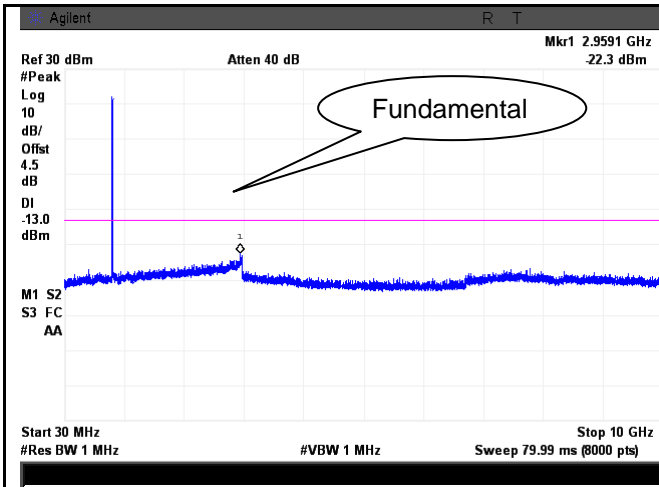

LTE Band 5 - Low Channel-1

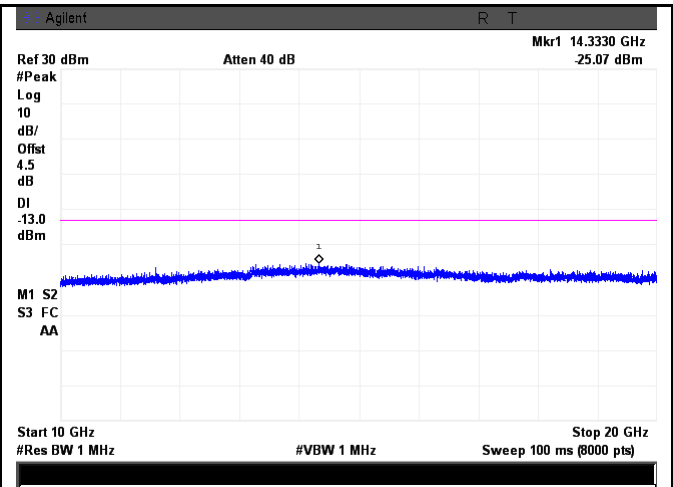

LTE Band 5 - Low Channel-2

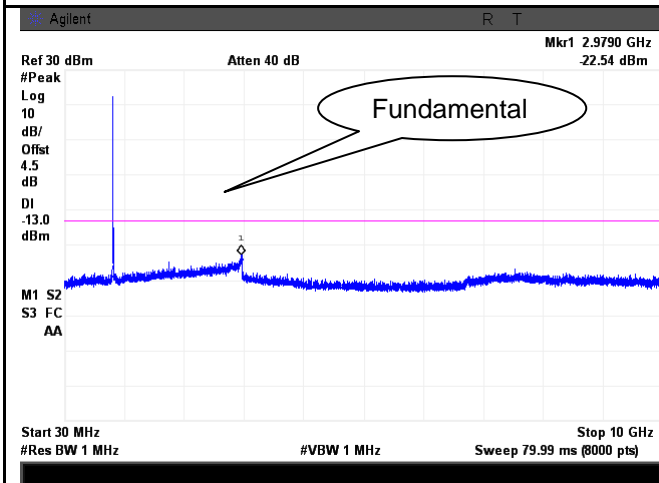

LTE Band 5 - Middle Channel-1

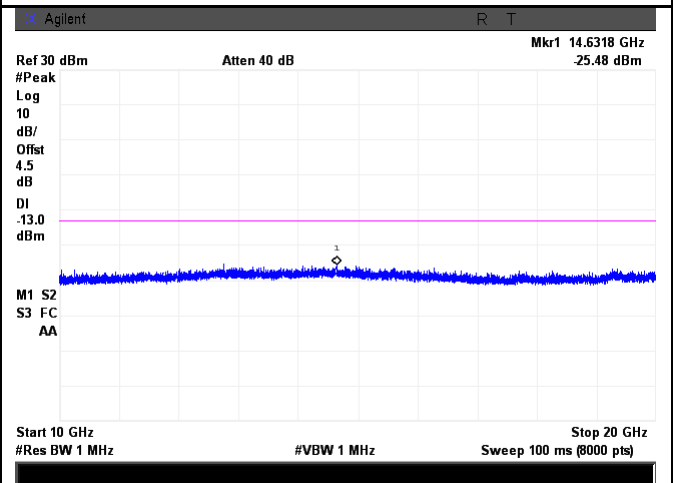

LTE Band 5 - Middle Channel-2

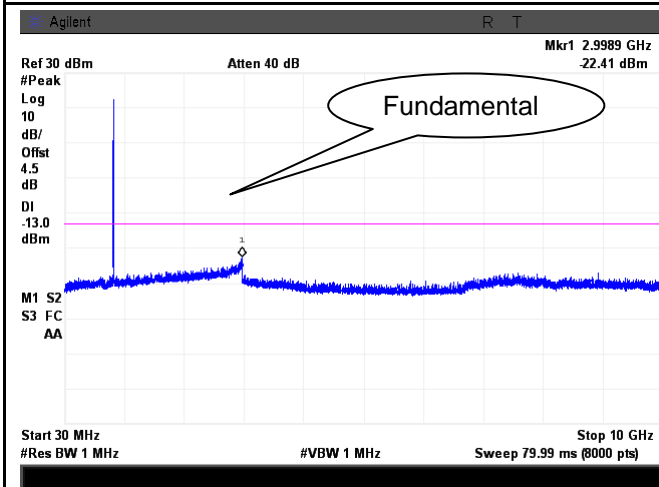

LTE Band 5 - High Channel-1

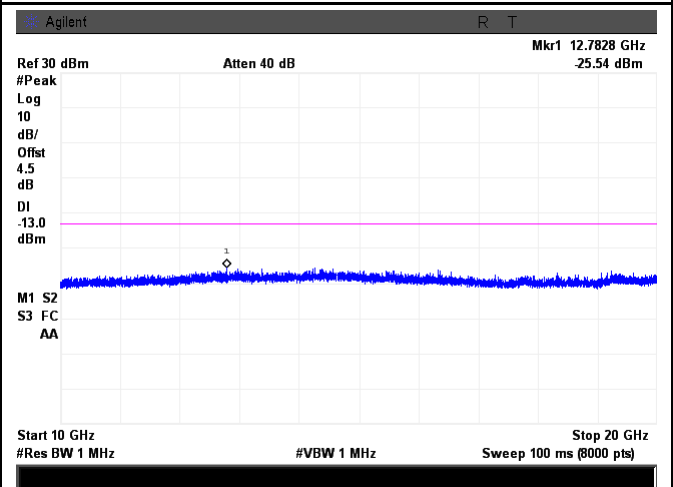

LTE Band 5 - High Channel-2

LTE Band 7 (Part 27)

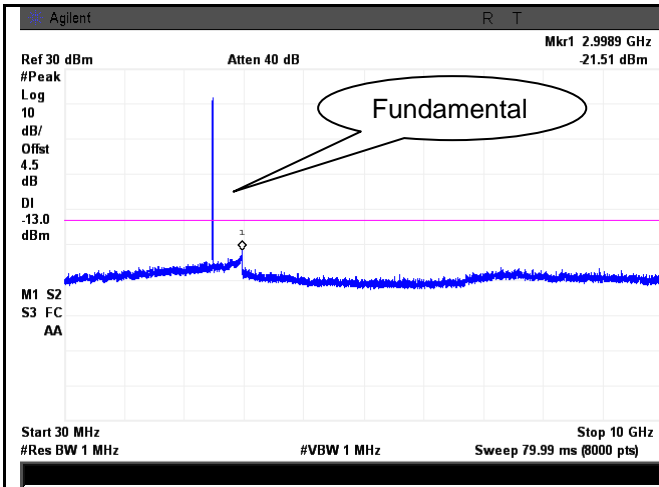

LTE Band 7 - Low Channel-1

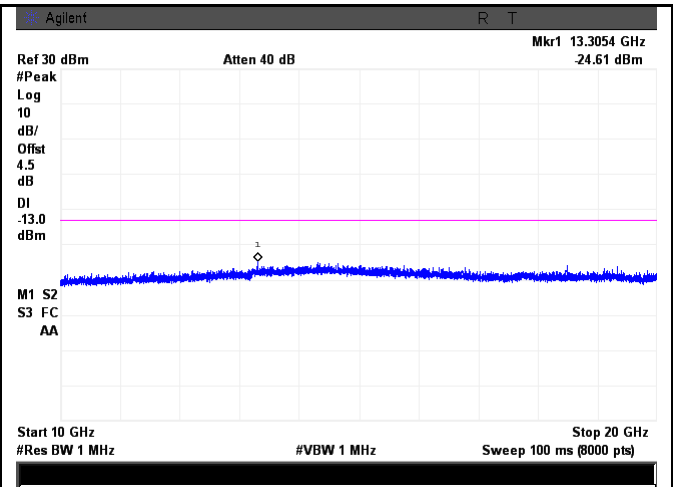

LTE Band 7 - Low Channel-2

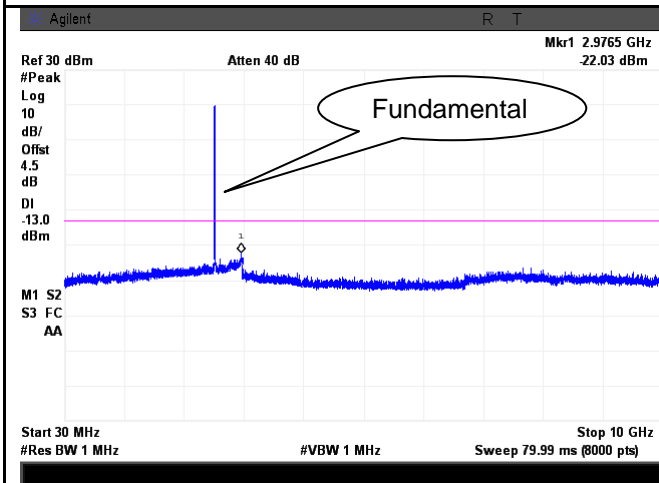

LTE Band 7 - Middle Channel-1

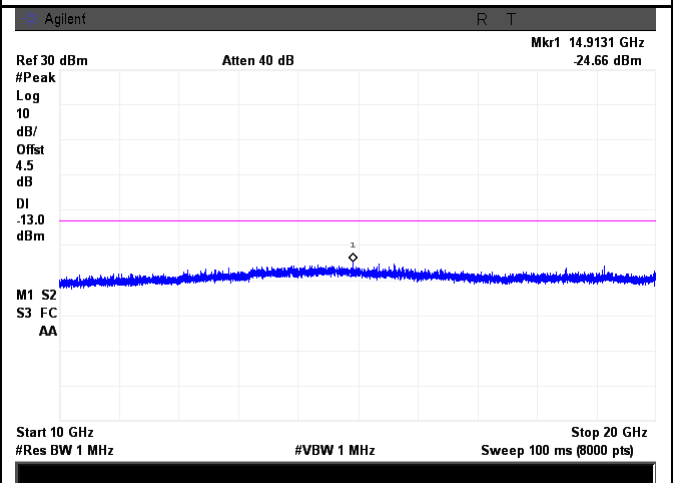

LTE Band 7 - Middle Channel-2

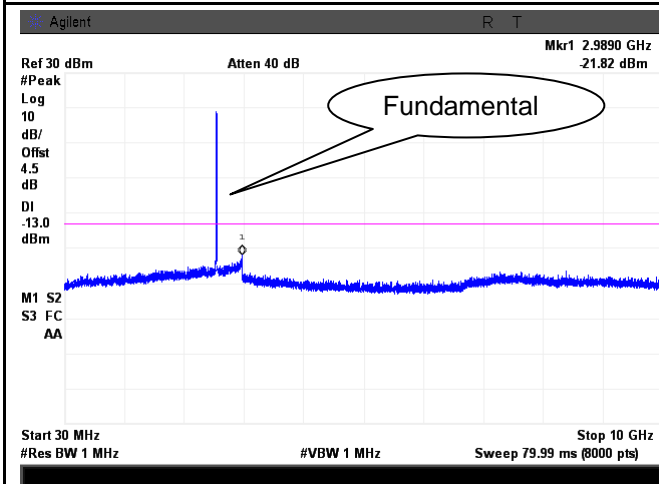

LTE Band 7 - High Channel-1

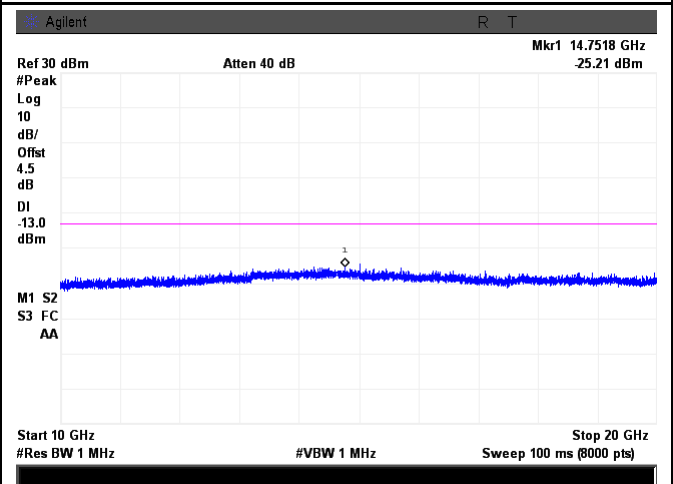

LTE Band 7 - High Channel-2

6.7 Spurious Radiated Emissions

Temperature	24°C
Relative Humidity	56%
Atmospheric Pressure	1004mbar
Test date :	September 04, 2015
Tested By :	Winnie Zhang

Requirement(s):

Spec	Item	Requirement	Applicable
§2.1053, §22.917 & §24.238 § 27.53(h)	a)	The power of any emission outside of the authorized operating frequency ranges must be attenuated below the transmitter power (P) by a factor of at least $43 + 10 \log (P)$ dB. The spectrum is scanned from 30 MHz up to a frequency including its 10th harmonic.	<input checked="" type="checkbox"/>

Test setup	
------------	--

Test Procedure	<ol style="list-style-type: none"> The transmitter was placed on a wooden turntable, and it was transmitting into a non-radiating load which was also placed on the turntable. The measurement antenna was placed at a distance of 3 meters from the EUT. During the tests, the antenna height and polarization as well as EUT azimuth were varied in order to identify the maximum level of emissions from the EUT. The test was performed by placing the EUT on 3-orthogonal axis. Remove the EUT and replace it with substitution antenna. A signal generator was connected to the substitution antenna by a non-radiating cable. The absolute levels of the spurious emissions were measured by the substitution. Sample Calculation: EUT Field Strength = Raw Amplitude (dBµV/m) – Amplifier Gain (dB) + Antenna Factor (dB) + Cable Loss (dB) + Filter Attenuation (dB, if used)
----------------	---

Remark	
Result	<input checked="" type="checkbox"/> Pass <input type="checkbox"/> Fail

Test Data Yes N/A

Test Plot Yes (See below) N/A

LTE Band 2 (Part 24E) result

Low channel

Frequency (MHz)	Substituted level (dBm)	Polarity (H/V)	Antenna Gain Correction (dB)	Cable Loss (dB)	Corrected Reading (dBm)	Limit (dBm)	Margin (dB)
3720	-48.22	V	10.25	2.73	-40.7	-13	-27.7
3720	-49.57	H	10.25	2.73	-42.05	-13	-29.05
262.9	-46.83	V	5.5	0.24	-41.57	-13	-28.57
174.5	-48.65	H	3.9	0.19	-44.94	-13	-31.94

Middle channel

Frequency (MHz)	Substituted level (dBm)	Polarity (H/V)	Antenna Gain Correction (dB)	Cable Loss (dB)	Corrected Reading (dBm)	Limit (dBm)	Margin (dB)
3760	-48.35	V	10.25	2.73	-40.83	-13	-27.83
3760	-49.62	H	10.25	2.73	-42.1	-13	-29.1
262.3	-46.75	V	5.5	0.24	-41.49	-13	-28.49
174.8	-48.47	H	3.9	0.19	-44.76	-13	-31.76

High channel

Frequency (MHz)	Substituted level (dBm)	Polarity (H/V)	Antenna Gain Correction (dB)	Cable Loss (dB)	Corrected Reading (dBm)	Limit (dBm)	Margin (dB)
3800	-48.29	V	10.36	2.73	-40.66	-13	-27.66
3800	-49.53	H	10.36	2.73	-41.9	-13	-28.9
262.5	-46.67	V	5.5	0.24	-41.41	-13	-28.41
174.6	-48.51	H	3.9	0.19	-44.8	-13	-31.8

LTE Band 4(Part27) result

Low channel

Frequency (MHz)	Substituted level (dBm)	Polarity (H/V)	Antenna Gain Correction (dB)	Cable Loss (dB)	Corrected Reading (dBm)	Limit (dBm)	Margin (dB)
3440	-46.83	V	10.06	2.52	-39.29	-13	-26.29
3440	-48.57	H	10.06	2.52	-41.03	-13	-28.03
263.1	-45.61	V	5.5	0.24	-40.35	-13	-27.35
175.6	-47.49	H	3.9	0.19	-43.78	-13	-30.78

Middle channel

Frequency (MHz)	Substituted level (dBm)	Polarity (H/V)	Antenna Gain Correction (dB)	Cable Loss (dB)	Corrected Reading (dBm)	Limit (dBm)	Margin (dB)
3465	-46.59	V	10.09	2.52	-39.02	-13	-26.02
3465	-48.35	H	10.09	2.52	-40.78	-13	-27.78
263.5	-45.91	V	5.5	0.24	-40.65	-13	-27.65
175.2	-47.36	H	3.9	0.19	-43.65	-13	-30.65

High channel

Frequency (MHz)	Substituted level (dBm)	Polarity (H/V)	Antenna Gain Correction (dB)	Cable Loss (dB)	Corrected Reading (dBm)	Limit (dBm)	Margin (dB)
3490	-46.43	V	10.09	2.52	-38.86	-13	-25.86
3490	-48.27	H	10.09	2.52	-40.7	-13	-27.7
263.8	-45.81	V	5.5	0.24	-40.55	-13	-27.55
175.4	-47.65	H	3.9	0.19	-43.94	-13	-30.94

LTE Band 5(Part22H) result

Low channel

Frequency (MHz)	Substituted level (dBm)	Polarity (H/V)	Antenna Gain Correction (dB)	Cable Loss (dB)	Corrected Reading (dBm)	Limit (dBm)	Margin (dB)
1658	-45.82	V	7.95	0.78	-38.65	-13	-25.65
1658	-46.39	H	7.95	0.78	-39.22	-13	-26.22
260.5	-46.15	V	5.5	0.24	-40.89	-13	-27.89
179.1	-48.52	H	3.9	0.19	-44.81	-13	-31.81

Middle channel

Frequency (MHz)	Substituted level (dBm)	Polarity (H/V)	Antenna Gain Correction (dB)	Cable Loss (dB)	Corrected Reading (dBm)	Limit (dBm)	Margin (dB)
1673	-45.67	V	7.95	0.78	-38.5	-13	-25.5
1673	-46.22	H	7.95	0.78	-39.05	-13	-26.05
260.8	-46.38	V	5.5	0.24	-41.12	-13	-28.12
179.5	-48.41	H	3.9	0.19	-44.7	-13	-31.7

High channel

Frequency (MHz)	Substituted level (dBm)	Polarity (H/V)	Antenna Gain Correction (dB)	Cable Loss (dB)	Corrected Reading (dBm)	Limit (dBm)	Margin (dB)
1688	-45.35	V	7.95	0.78	-38.18	-13	-25.18
1688	-46.42	H	7.95	0.78	-39.25	-13	-26.25
260.4	-46.66	V	5.5	0.24	-41.4	-13	-28.4
179.6	-48.59	H	3.9	0.19	-44.88	-13	-31.88

LTE Band 7(Part27) result

Low channel

Frequency (MHz)	Substituted level (dBm)	Polarity (H/V)	Antenna Gain Correction (dB)	Cable Loss (dB)	Corrected Reading (dBm)	Limit (dBm)	Margin (dB)
5020	-49.51	V	10.29	0.98	-40.2	-13	-27.2
5020	-50.69	H	10.29	0.98	-41.38	-13	-28.38
261.5	-46.55	V	5.5	0.24	-41.29	-13	-28.29
173.2	-48.63	H	3.9	0.19	-44.92	-13	-31.92

Middle channel

Frequency (MHz)	Substituted level (dBm)	Polarity (H/V)	Antenna Gain Correction (dB)	Cable Loss (dB)	Corrected Reading (dBm)	Limit (dBm)	Margin (dB)
5070	-49.48	V	10.3	0.99	-40.17	-13	-27.17
5070	-50.35	H	10.3	0.99	-41.04	-13	-28.04
261.3	-46.71	V	5.5	0.24	-41.45	-13	-28.45
173.9	-48.59	H	3.9	0.19	-44.88	-13	-31.88

High channel

Frequency (MHz)	Substituted level (dBm)	Polarity (H/V)	Antenna Gain Correction (dB)	Cable Loss (dB)	Corrected Reading (dBm)	Limit (dBm)	Margin (dB)
5120	-49.53	V	10.32	1	-40.21	-13	-27.21
5120	-50.48	H	10.32	1	-41.16	-13	-28.16
261.7	-46.61	V	5.5	0.24	-41.35	-13	-28.35
173.4	-48.49	H	3.9	0.19	-44.78	-13	-31.78

6.8 Band Edge

Temperature	24°C
Relative Humidity	56%
Atmospheric Pressure	1004mbar
Test date :	September 04, 2015
Tested By :	Winnie Zhang

Requirement(s):

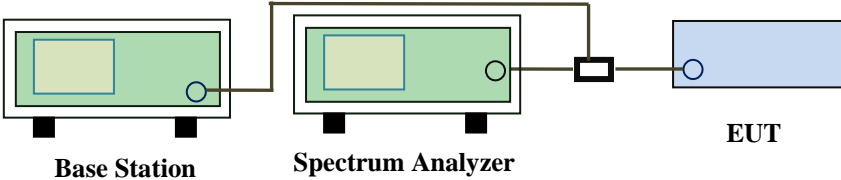
Spec	Item	Requirement	Applicable
§22.917(a) §24.238(a) § 27.53(h)	a)	The power of any emission outside of the authorized operating frequency ranges must be lower than the transmitter power (P) by a factor of at least $43 + 10 \log (P)$ dB.	<input checked="" type="checkbox"/>
Test setup	 <p>The diagram shows a Base Station (green box) connected to a Spectrum Analyzer (green box) and an EUT (blue box) via a power divider (black box). The Base Station and Spectrum Analyzer are connected to the power divider, which then splits the signal to the EUT.</p>		
Procedure	<ul style="list-style-type: none"> - The EUT was connected to Spectrum Analyzer and Base Station via power divider. - The Band Edges of low and high channels for the highest RF powers were measured. Setting RBW as roughly BW/100. 		
Remark			
Result	<input checked="" type="checkbox"/> Pass <input type="checkbox"/> Fail		

Test Data Yes N/A

Test Plot Yes (See below) N/A

LTE Band 2 (Part 24E) result

BW(MHz)	Channel	Frequency (MHz)	Mode	Emission (dBm)	Limit (dBm)
1.4	18607	1850.7	QPSK	-23.51	-13
			16QAM	-23.45	-13
1.4	18900	1909.3	QPSK	-15.97	-13
			16QAM	-17.84	-13
3	18615	1851.5	QPSK	-22.87	-13
			16QAM	-23.70	-13
3	19185	1908.5	QPSK	-15.79	-13
			16QAM	-16.28	-13
5	18625	1852.5	QPSK	-16.18	-13
			16QAM	-16.67	-13
5	19175	1907.5	QPSK	-16.73	-13
			16QAM	-17.33	-13
10	18650	1855	QPSK	-15.98	-13
			16QAM	-19.32	-13
10	19150	1905	QPSK	-16.61	-13
			16QAM	-18.50	-13
15	18675	1857.5	QPSK	-19.62	-13
			16QAM	-20.94	-13
15	19125	1902.5	QPSK	-17.83	-13
			16QAM	-22.51	-13
20	18700	1860	QPSK	-22.68	-13
			16QAM	-23.86	-13
20	19100	1900	QPSK	-22.34	-13
			16QAM	-22.91	-13

LTE Band 4 (Part 27) result

BW(MHz)	Channel	Frequency (MHz)	Mode	Emission (dBm)	Limit (dBm)
1.4	19957	1710.7	QPSK	-25.70	-13
			16QAM	-21.84	-13
1.4	20393	1754.3	QPSK	-24.73	-13
			16QAM	-20.59	-13
3	19965	1711.5	QPSK	-18.02	-13
			16QAM	-21.13	-13
3	20385	1753.5	QPSK	-18.50	-13
			16QAM	-18.20	-13
5	19975	1712.5	QPSK	-15.74	-13
			16QAM	-17.32	-13
5	20375	1752.5	QPSK	-16.72	-13
			16QAM	-16.51	-13
10	20000	1715	QPSK	-17.35	-13
			16QAM	-18.17	-13
10	20350	1750	QPSK	-20.09	-13
			16QAM	-17.45	-13
15	20025	1717.5	QPSK	-21.68	-13
			16QAM	-21.40	-13
15	20325	1747.5	QPSK	-20.57	-13
			16QAM	-20.57	-13
20	20050	1720	QPSK	-25.19	-13
			16QAM	-24.40	-13
20	20300	1745	QPSK	-25.82	-13
			16QAM	-24.07	-13

LTE Band 5 (Part 22H) result

BW(MHz)	Channel	Frequency (MHz)	Mode	Emission (dBm)	Limit (dBm)
1.4	20407	824.7	QPSK	-16.51	-13
			16QAM	-19.32	-13
1.4	20643	848.3	QPSK	-21.57	-13
			16QAM	-23.71	-13
3	20415	825.5	QPSK	-15.50	-13
			16QAM	-16.27	-13
3	20635	847.5	QPSK	-17.62	-13
			16QAM	-18.73	-13
5	20425	826.5	QPSK	-14.60	-13
			16QAM	-14.85	-13
5	20625	846.5	QPSK	-14.38	-13
			16QAM	-15.63	-13
10	20450	829	QPSK	-15.16	-13
			16QAM	-16.64	-13
10	20800	844	QPSK	-17.63	-13
			16QAM	-16.71	-13

Test Plots

LTE Band 2 (Part 24E)

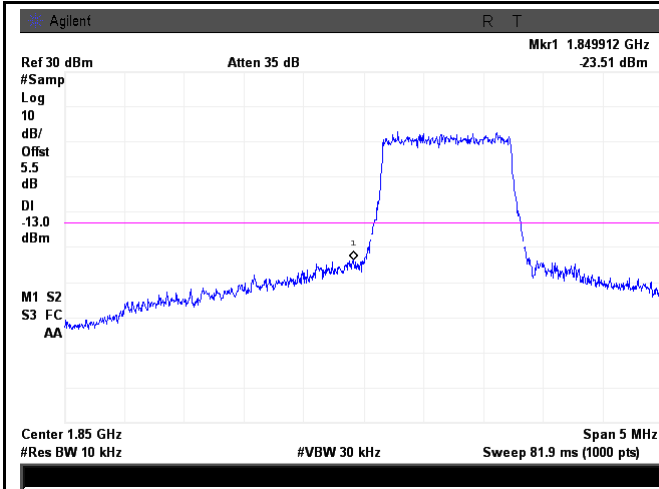

LTE Band 2 - Low Channel QPSK-1.4

Note: Offset=Cable loss (4.5) + 10log
(12.65/10)=4.5+1.0=5.5 dB

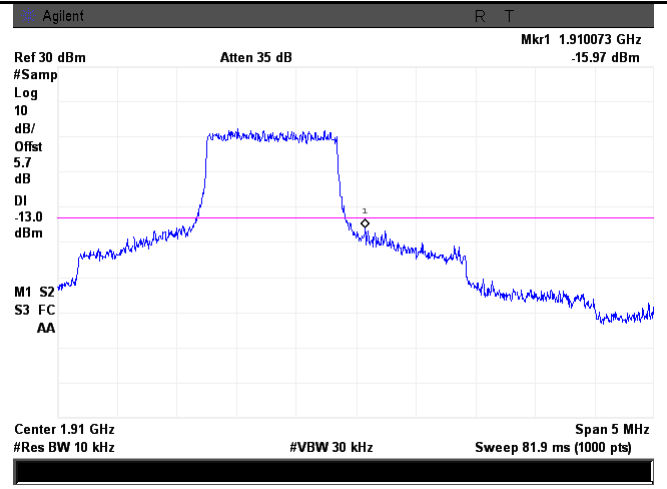

LTE Band 2 - High Channel QPSK-1.4

Note: Offset=Cable loss (4.5) + 10log
(13.11/10)=4.5+1.2=5.7 dB

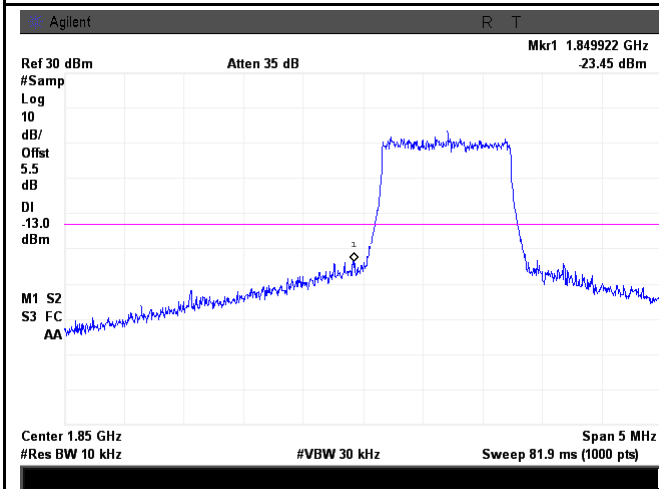

LTE Band 2 - Low Channel 16QAM-1.4

Note: Offset=Cable loss (4.5) + 10log
(12.58/10)=4.5+1.0=5.5 dB

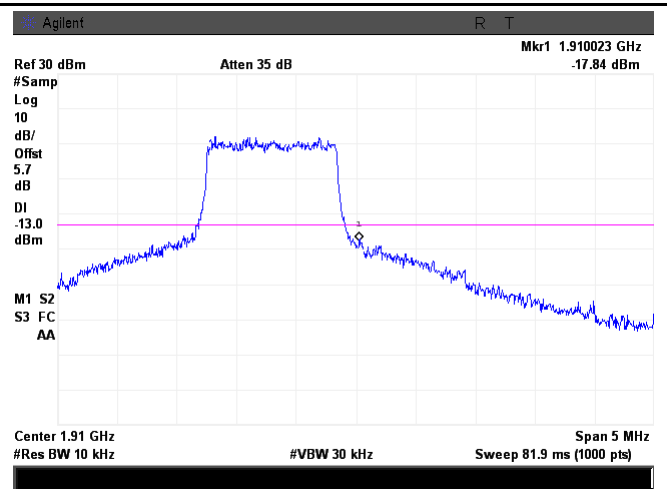

LTE Band 2 - High Channel 16QAM-1.4

Note: Offset=Cable loss (4.5) + 10log
(13.07/10)=4.5+1.2=5.7 dB

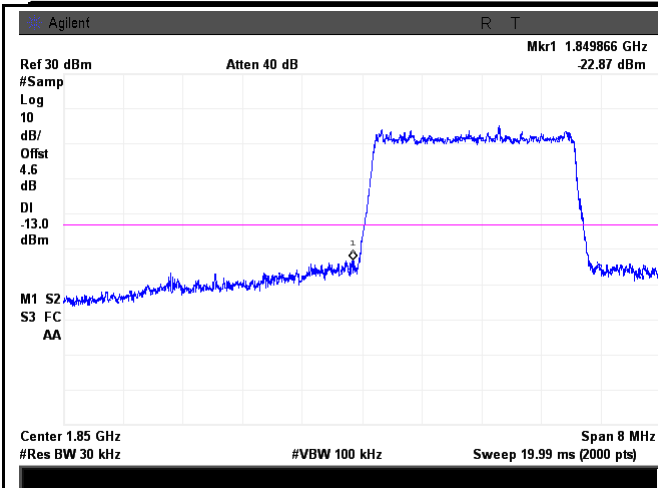

LTE Band 2 - Low Channel QPSK-3

Note: Offset=Cable loss (4.5) + 10log
(30.71/30)=4.5+0.1=4.6 dB

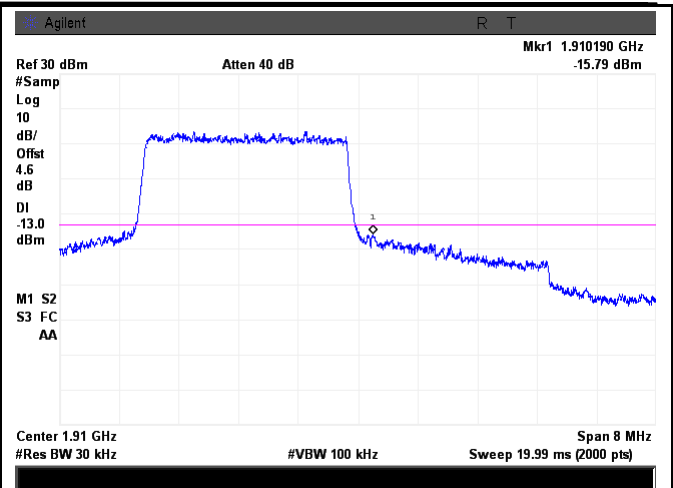

LTE Band 2 - High Channel QPSK-3

Note: Offset=Cable loss (4.5) + 10log
(30.99/30)=4.5+0.1=4.6 dB

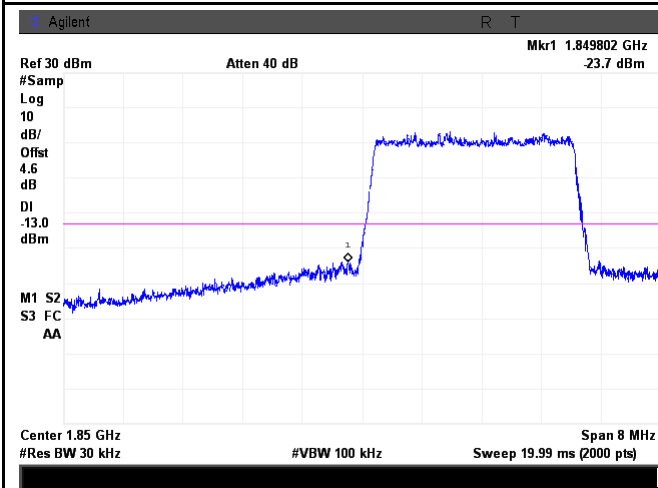

LTE Band 2 - Low Channel 16QAM-3

Note: Offset=Cable loss (4.5) + 10log
(31.02/30)=4.5+0.1=4.6 dB

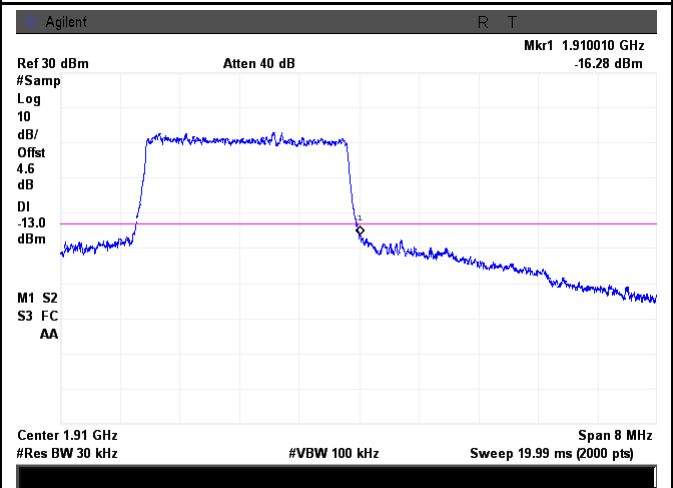

LTE Band 2 - High Channel 16QAM-3

Note: Offset=Cable loss (4.5) + 10log
(30.93/30)=4.5+0.1=4.6 dB

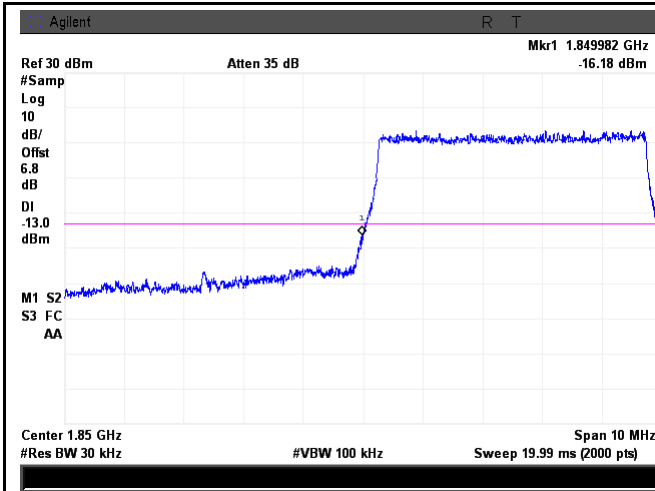

LTE Band 2 - Low Channel QPSK-5

Note: Offset=Cable loss (4.5) + 10log
(50.70/30)=4.5+2.3=6.8 dB

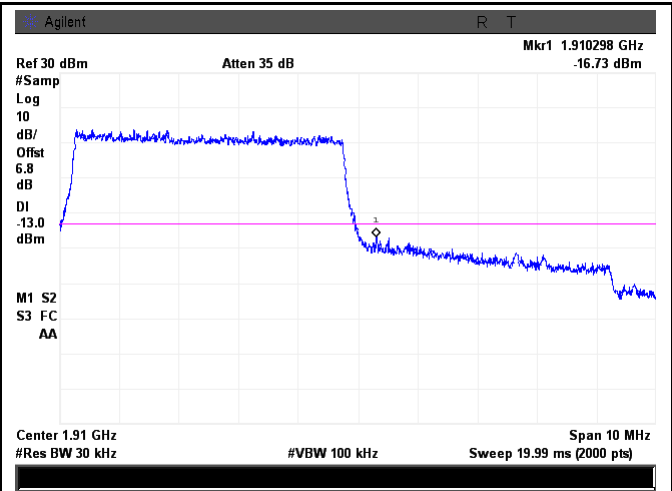

LTE Band 2 - High Channel QPSK-5

Note: Offset=Cable loss (4.5) + 10log
(50.41/30)=4.5+2.3=6.8 dB

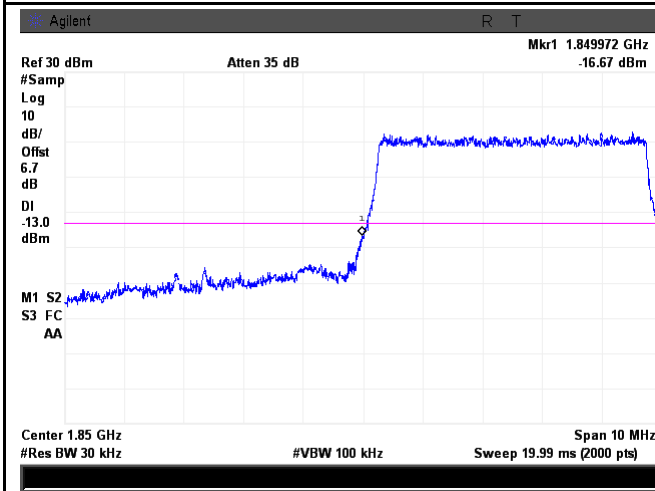

LTE Band 2 - Low Channel 16QAM-5

Note: Offset=Cable loss (4.5) + 10log
(50.03/30)=4.5+2.2=6.7 dB

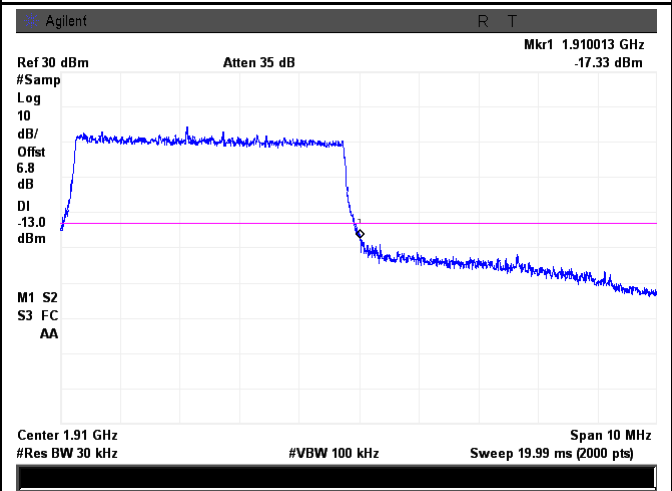

LTE Band 2 - High Channel 16QAM-5

Note: Offset=Cable loss (4.5) + 10log
(50.89/30)=4.5+2.3=6.8 dB

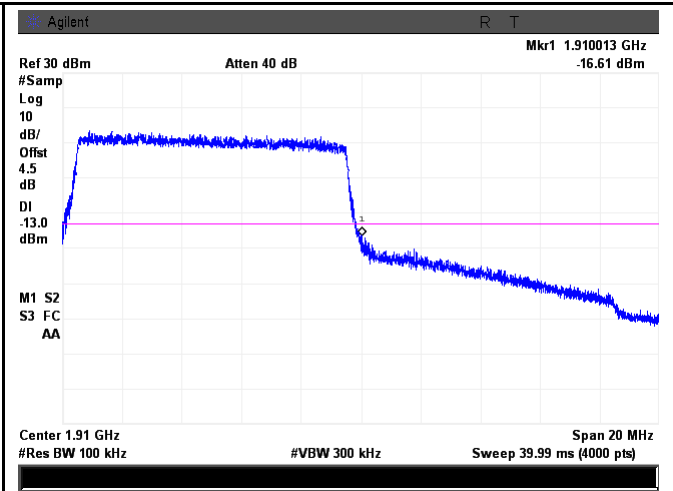
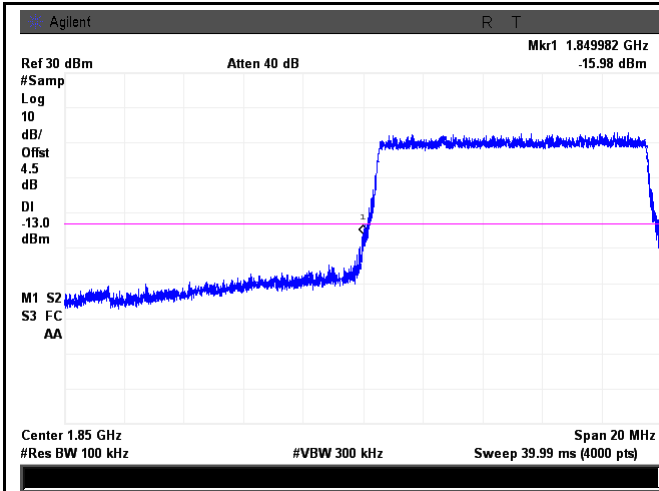

LTE Band 2 - Low Channel QPSK-10

LTE Band 2 - High Channel QPSK-10

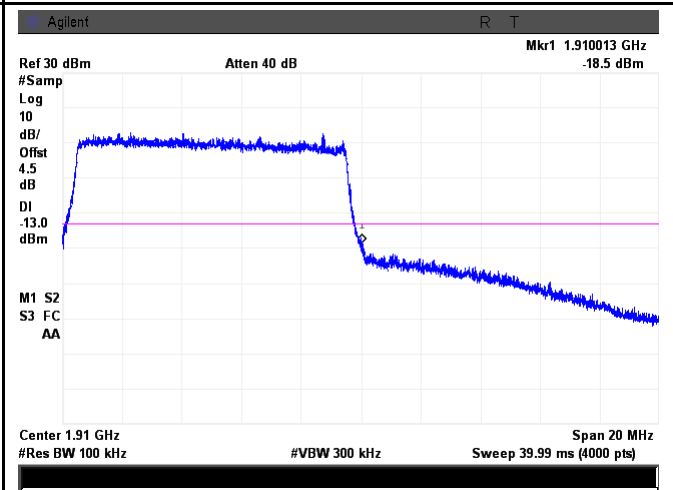
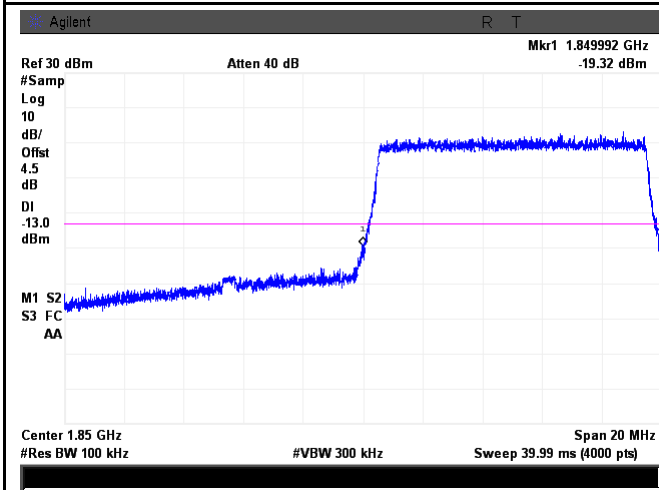

LTE Band 2 - Low Channel 16QAM-10

LTE Band 2 - High Channel 16QAM-10

Note: Offset=Cable loss (4.5) + 10log
(100.67/100)=4.5+0.0=4.5 dB

Note: Offset=Cable loss (4.5) + 10log
(101.12/100)=4.5+0.0=4.5 dB

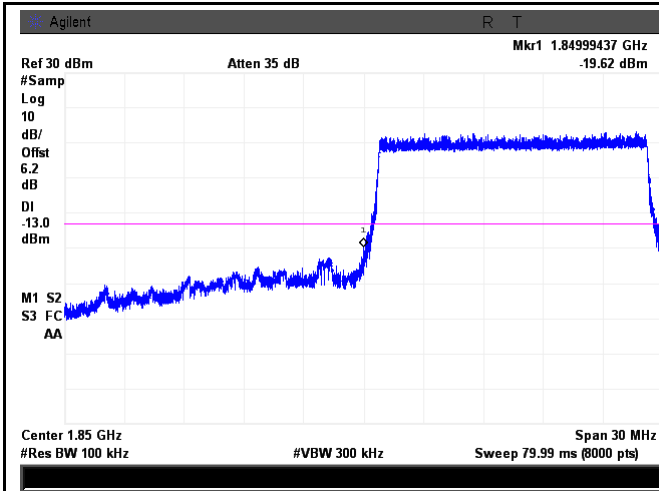

LTE Band 2 - Low Channel QPSK-15

Note: Offset=Cable loss (4.5) + 10log
 (148.11/100)=4.5+1.7=6.2dB

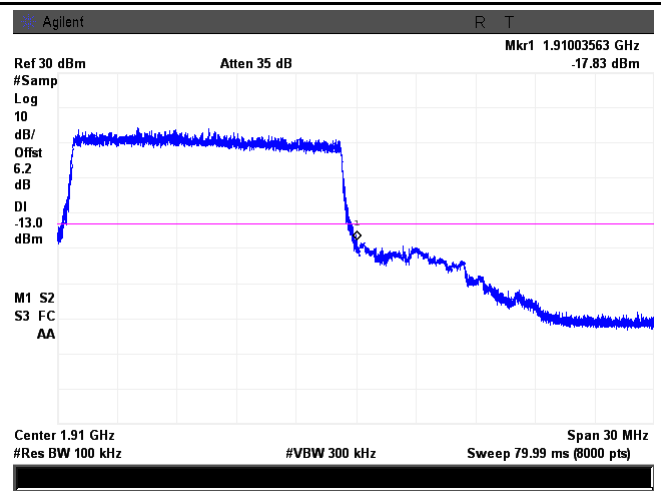

LTE Band 2 - High Channel QPSK-15

Note: Offset=Cable loss (4.5) + 10log
 (148.22/100)=4.5+1.7=6.2 dB

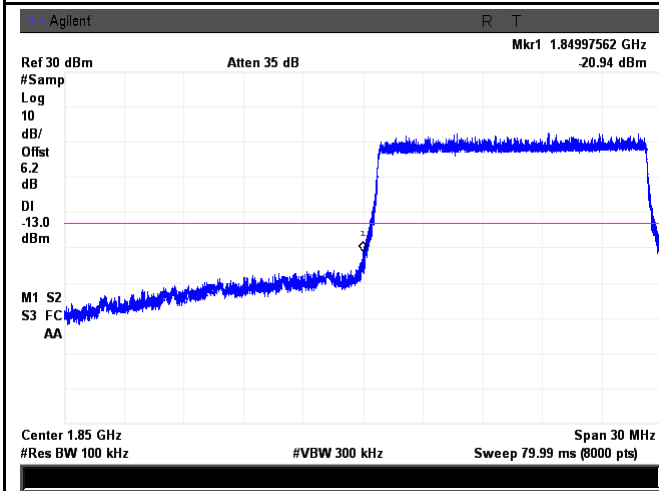

LTE Band 2 - Low Channel 16QAM-15

Note: Offset=Cable loss (4.5) + 10log
 (147.7/100)=4.5+1.7=6.2 dB

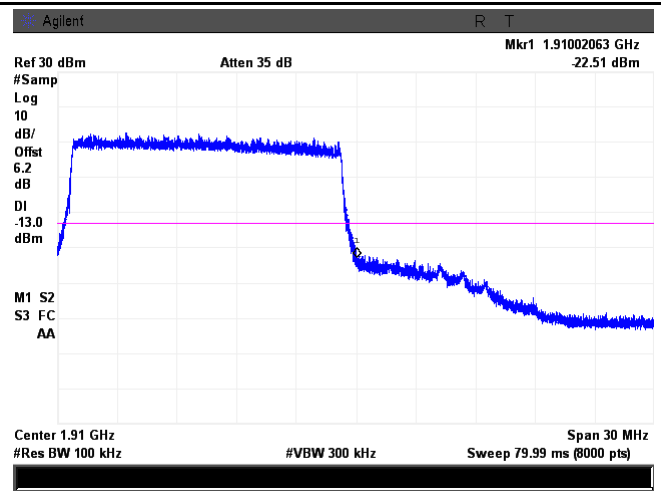

LTE Band 2 - High Channel 16QAM-15

Note: Offset=Cable loss (4.5) + 10log
 (146.89/100)=4.5+1.7=6.2 dB

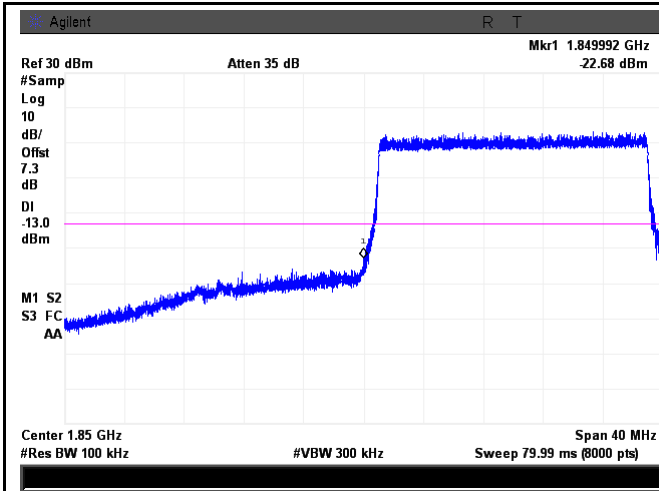

LTE Band 2 - Low Channel QPSK-20

Note: Offset=Cable loss (4.5) + 10log
 (192.59/100)=4.5+2.8=7.3 dB

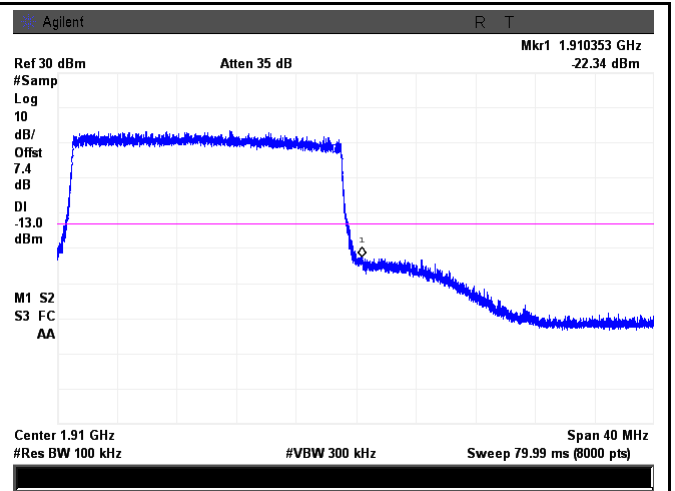

LTE Band 2 - High Channel QPSK-20

Note: Offset=Cable loss (4.5) + 10log
 (194.38/100)=4.5+2.9=7.4 dB

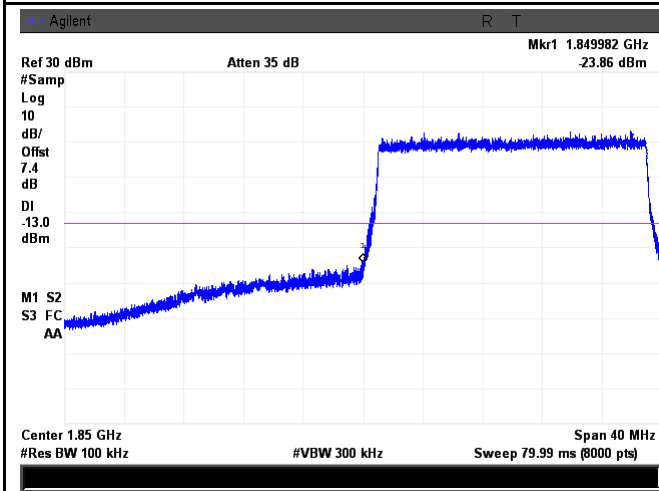

LTE Band 2 - Low Channel 16QAM-20

Note: Offset=Cable loss (4.5) + 10log
 (194.05/100)=4.5+2.9=7.4 dB

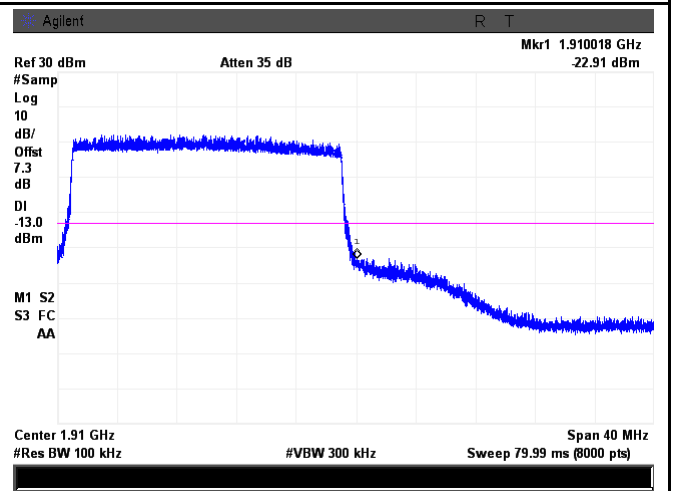

LTE Band 2 - High Channel 16QAM-20

Note: Offset=Cable loss (4.5) + 10log
 (191.7/100)=4.5+2.8=7.3 dB

LTE Band 4 (Part 27)

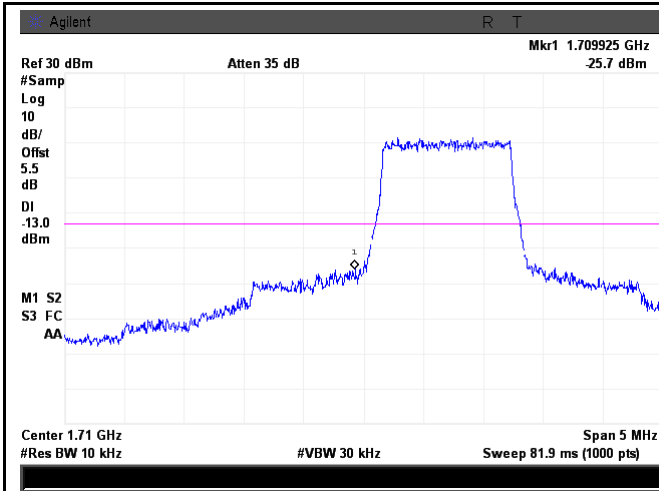

LTE Band 4 - Low Channel QPSK-1.4

Note: Offset=Cable loss (4.5) + 10log
(12.7/10)=4.5+1.0=5.5 dB

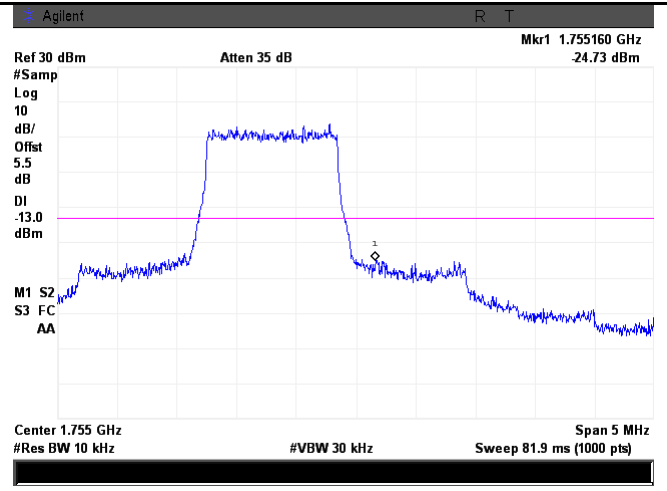

LTE Band 4 - High Channel QPSK-1.4

Note: Offset=Cable loss (4.5) + 10log
(12.6/10)=4.5+1.0=5.5 dB

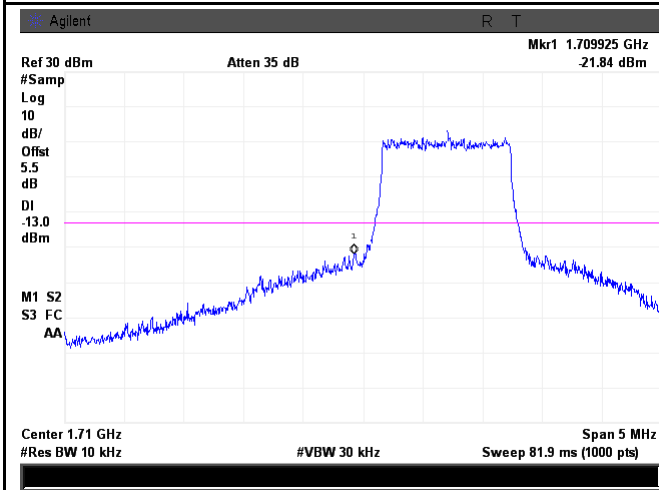

LTE Band 4 - Low Channel 16QAM-1.4

Note: Offset=Cable loss (4.5) + 10log
(12.72/10)=4.5+1.0=5.5 dB

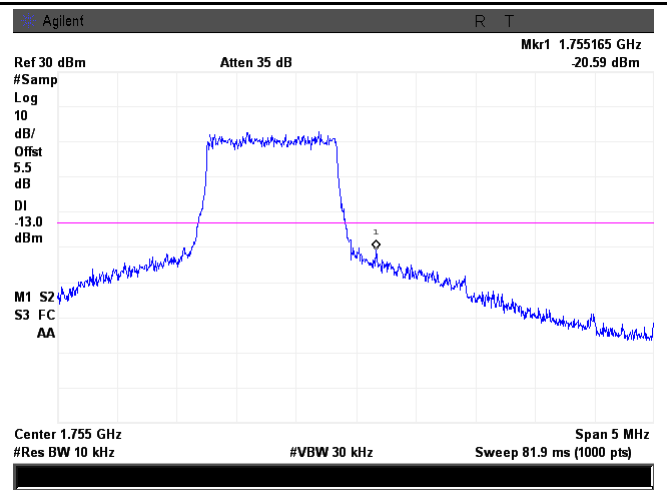

LTE Band 4 - High Channel 16QAM-1.4

Note: Offset=Cable loss (4.5) + 10log
(12.71/10)=4.5+1.0=5.5 dB

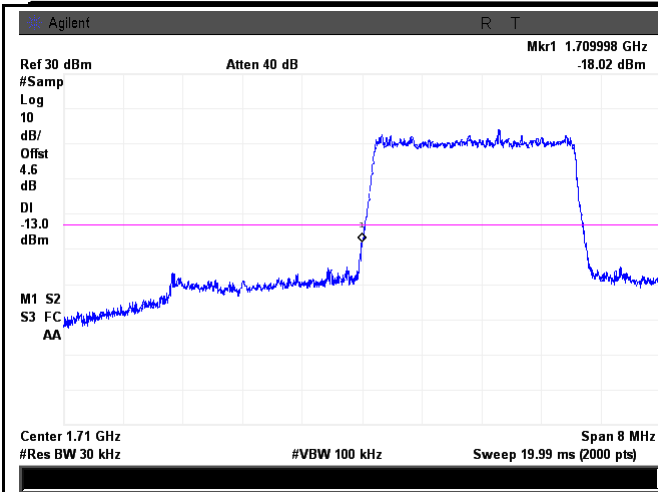

LTE Band 4 - Low Channel QPSK-3

Note: Offset=Cable loss (4.5) + 10log
(30.55/30)=4.5+0.1=4.6 dB

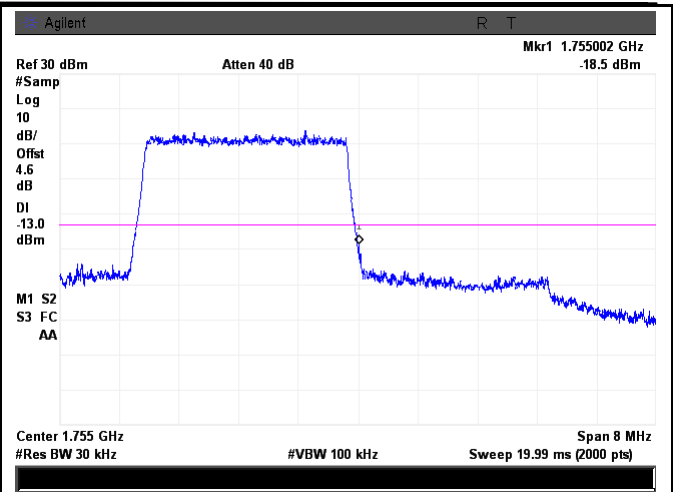

LTE Band 4 - High Channel QPSK-3

Note: Offset=Cable loss (4.5) + 10log
(30.69/30)=4.5+0.1=4.6 dB

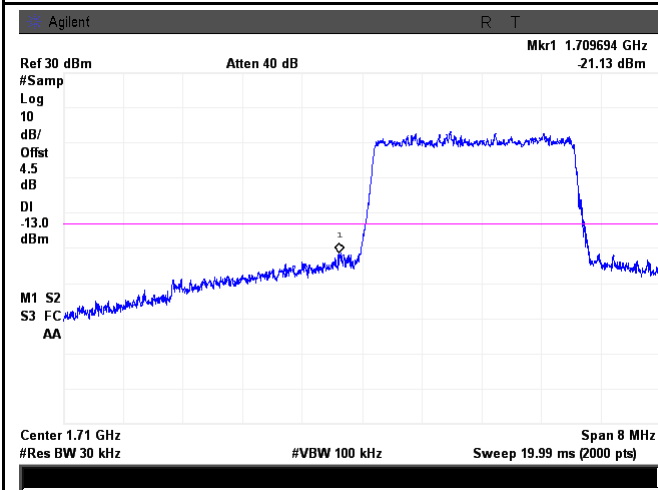

LTE Band 4 - Low Channel 16QAM-3

Note: Offset=Cable loss (4.5) + 10log
(30.3/30)=4.5+0.0=4.5 dB

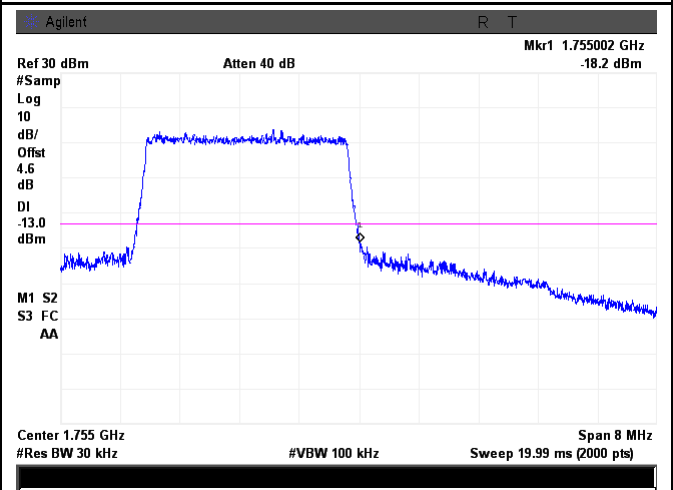

LTE Band 4 - High Channel 16QAM-3

Note: Offset=Cable loss (4.5) + 10log
(30.61/30)=4.5+0.1=4.6 dB

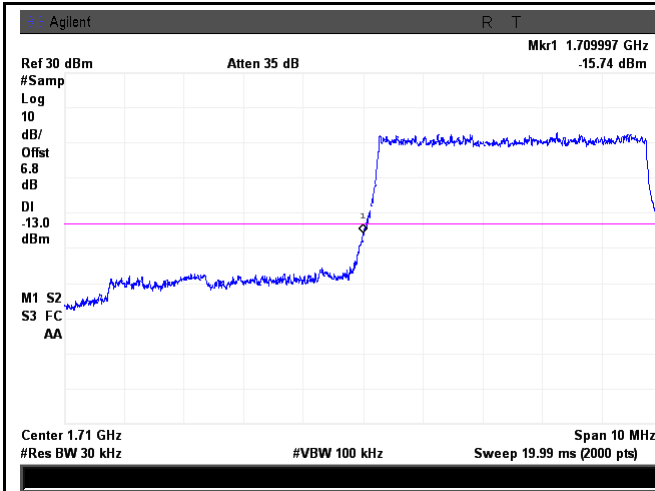

LTE Band 4 - Low Channel QPSK-5

Note: Offset=Cable loss (4.5) + 10log
(50.72/30)=4.5+2.3=6.8 dB

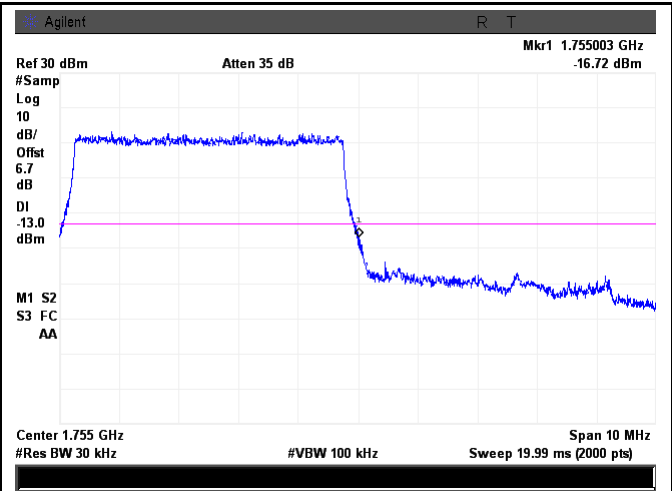

LTE Band 4 - High Channel QPSK-5

Note: Offset=Cable loss (4.5) + 10log
(50.21/30)=4.5+2.2=6.7 dB

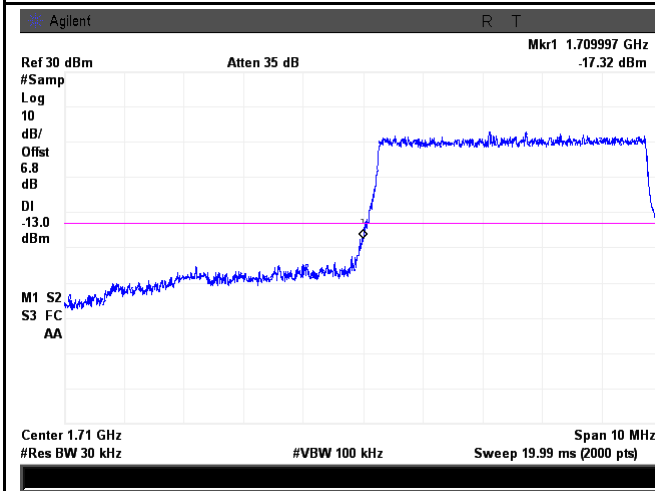

LTE Band 4 - Low Channel 16QAM-5

Note: Offset=Cable loss (4.5) + 10log
(50.38/30)=4.5+2.3=6.8dB

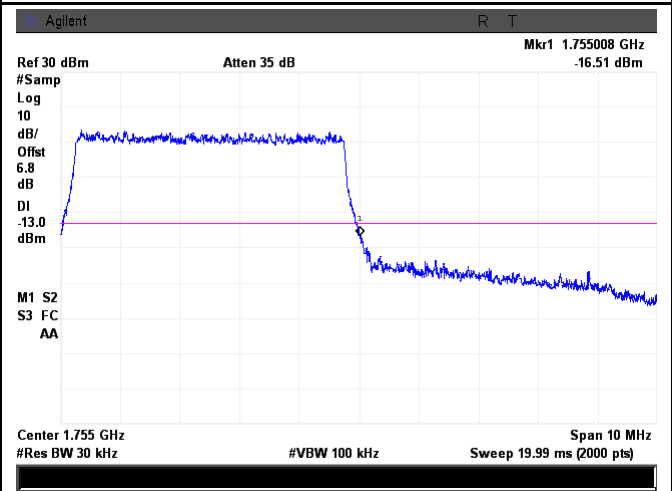

LTE Band 4 - High Channel 16QAM-5

Note: Offset=Cable loss (4.5) + 10log
(51.21/30)=4.5+2.3=6.8 dB

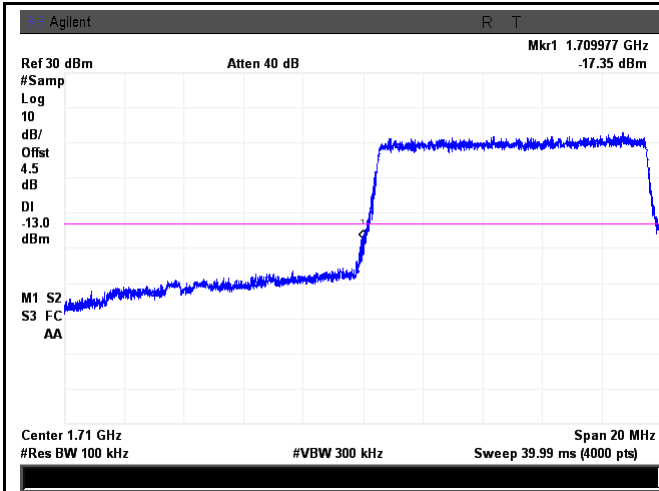

LTE Band 4 - Low Channel QPSK-10

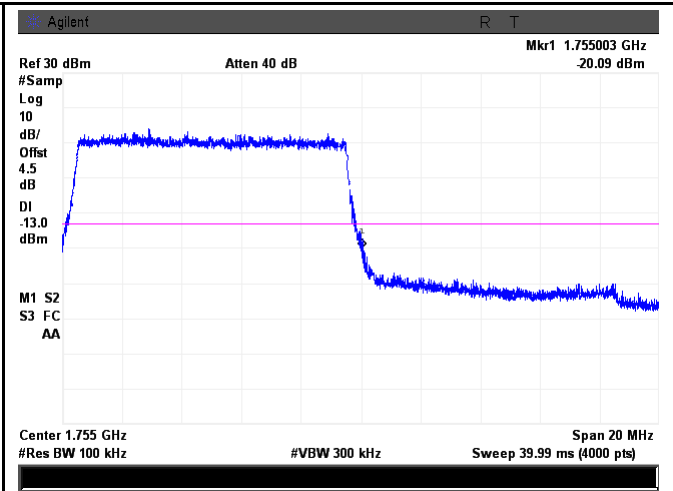

LTE Band 4 - High Channel QPSK-10

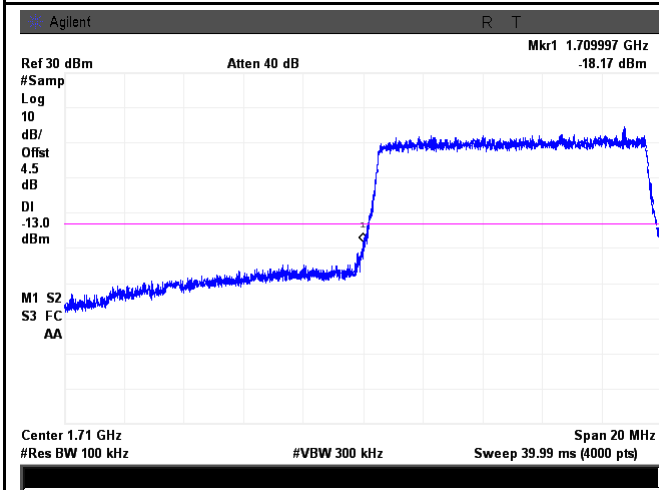

LTE Band 4 - Low Channel 16QAM-10

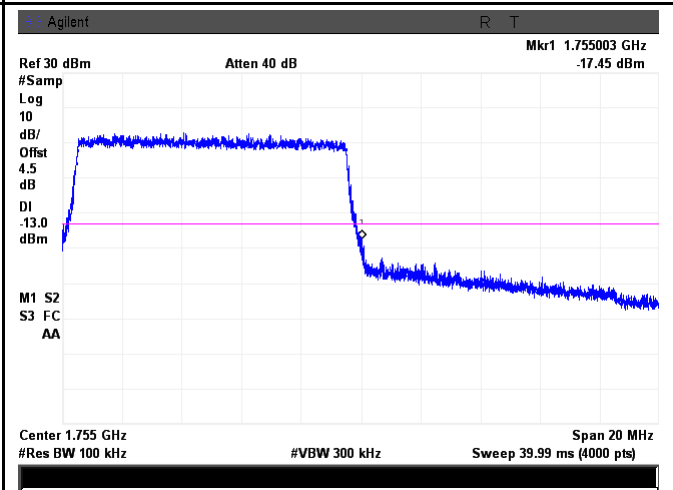

LTE Band 4 - High Channel 16QAM-10

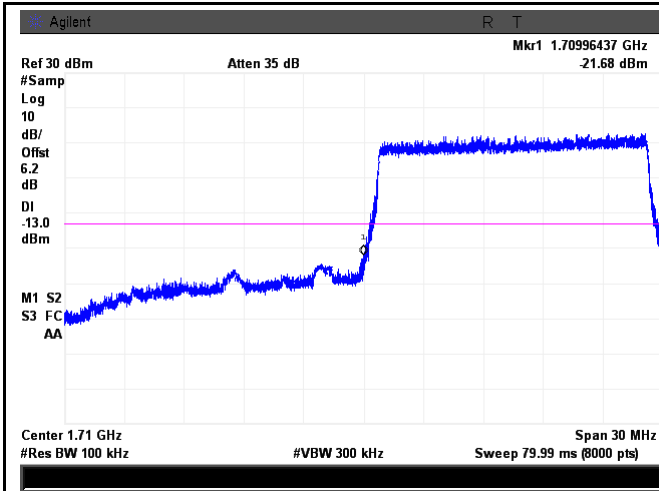

LTE Band 4 - Low Channel QPSK-15

Note: Offset=Cable loss (4.5) + 10log
 (147.73/100)=4.5+1.7=6.2 dB

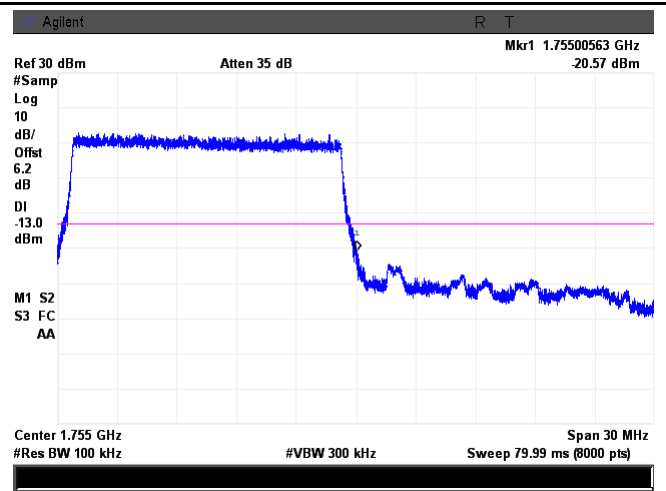

LTE Band 4 - High Channel QPSK-15

Note: Offset=Cable loss (4.5) + 10log
 (147.37/100)=4.5+1.7=6.2 dB

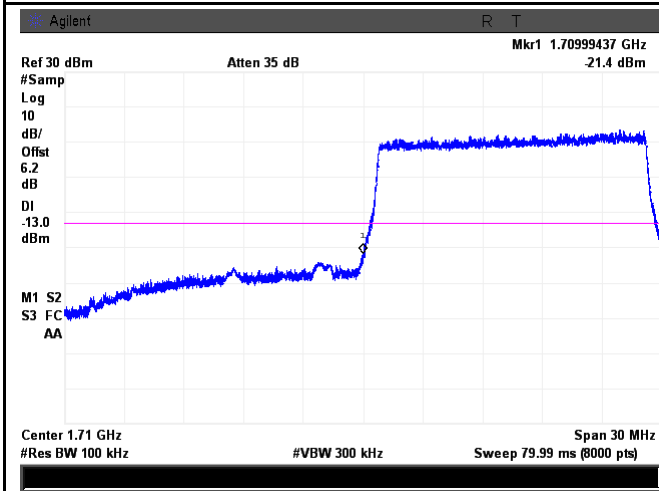

LTE Band 4 - Low Channel 16QAM-15

Note: Offset=Cable loss (4.5) + 10log
 (146.38/100)=4.5+1.7=6.2 dB

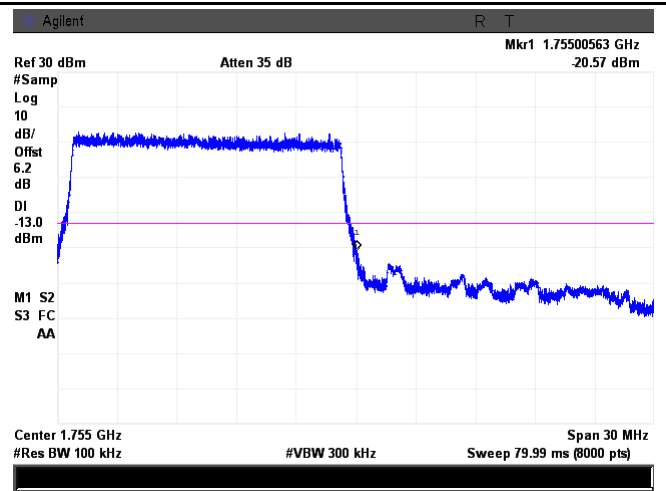

LTE Band 4 - High Channel 16QAM-15

Note: Offset=Cable loss (4.5) + 10log
 (148.47/100)=4.5+1.7=6.2 dB

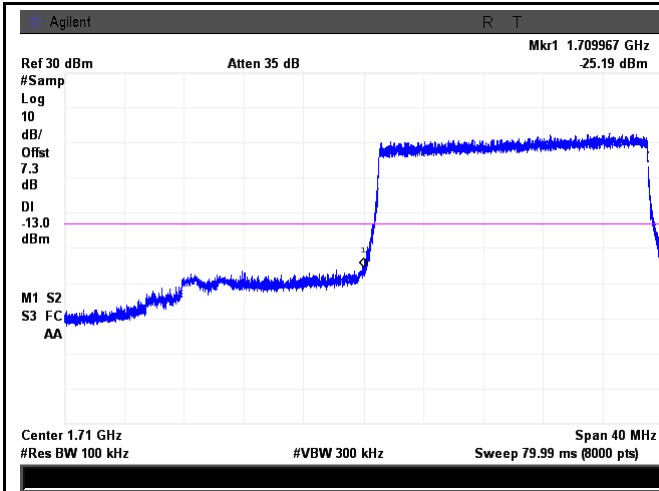

LTE Band 4 - Low Channel QPSK-20

Note: Offset=Cable loss (4.5) + 10log
(191.41/100)=4.5+2.8=7.3 dB

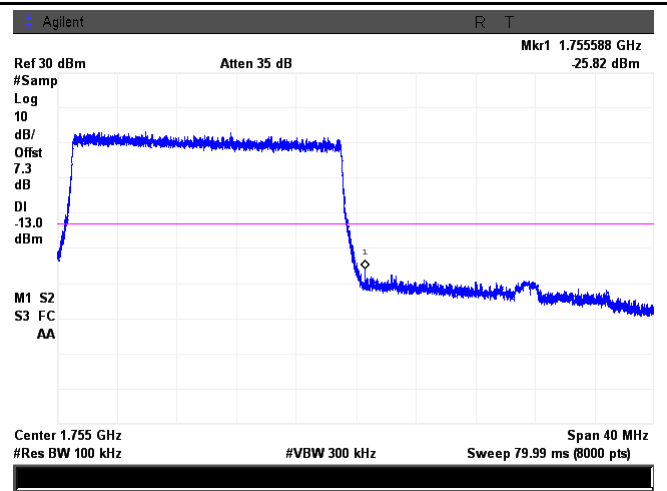

LTE Band 4 - High Channel QPSK-20

Note: Offset=Cable loss (4.5) + 10log
(192.11/100)=4.5+2.8=7.3 dB

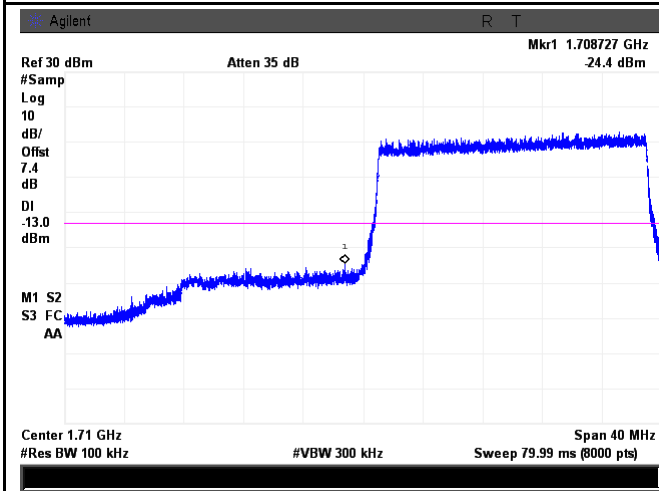

LTE Band 4 - Low Channel 16QAM-20

Note: Offset=Cable loss (4.5) + 10log
(193.38/100)=4.5+2.9=7.4 dB

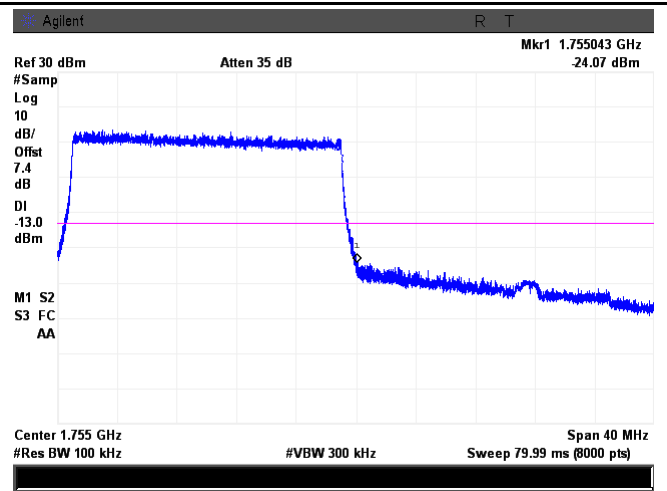

LTE Band 4 - High Channel 16QAM-20

Note: Offset=Cable loss (4.5) + 10log
(193.49/100)=4.5+2.9=7.4 dB

LTE Band 5 (Part 22H)

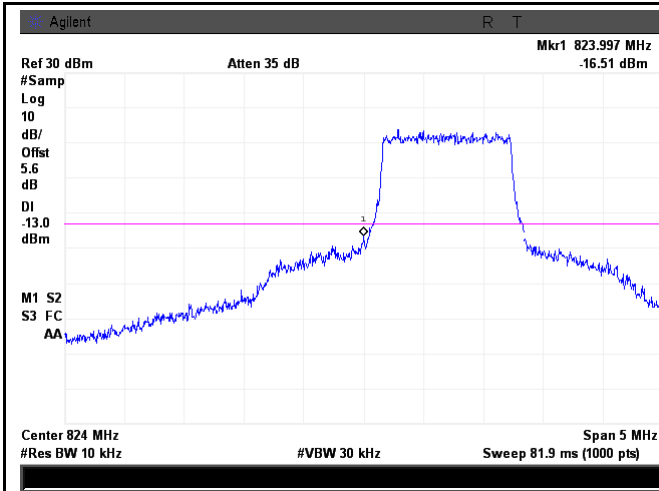

LTE Band 5 - Low Channel QPSK-1.4

Note: Offset=Cable loss (4.5) + 10log
(12.75/10)=4.5+1.1=5.6 dB

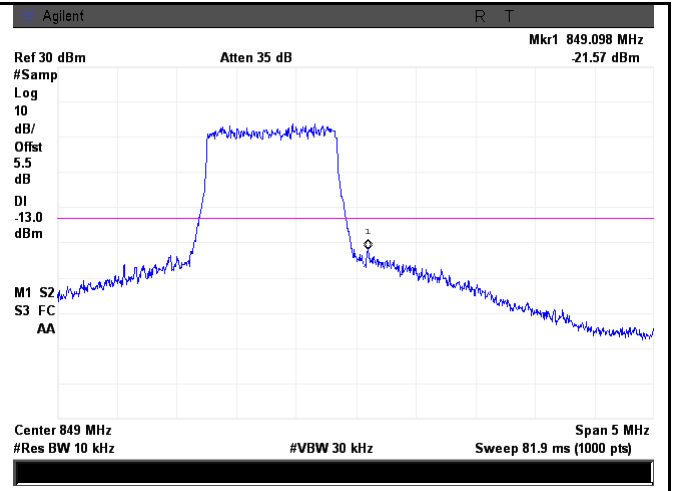

LTE Band 5 - High Channel QPSK-1.4

Note: Offset=Cable loss (4.5) + 10log
(12.67/10)=4.5+1.0=5.5 dB

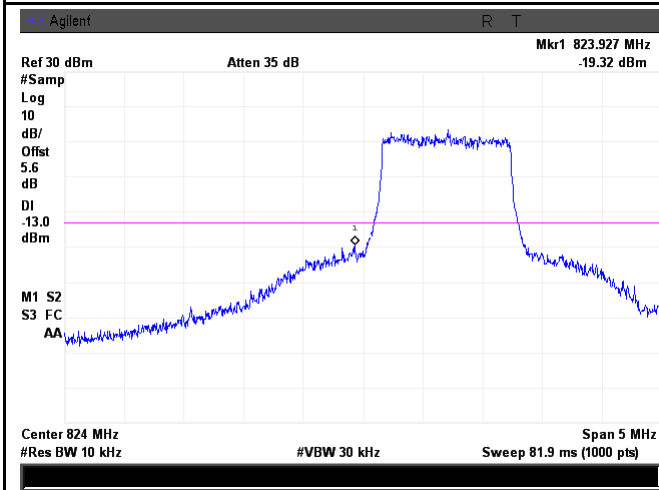

LTE Band 5 - Low Channel 16QAM-1.4

Note: Offset=Cable loss (4.5) + 10log
(12.78/10)=4.5+1.1=5.6 dB

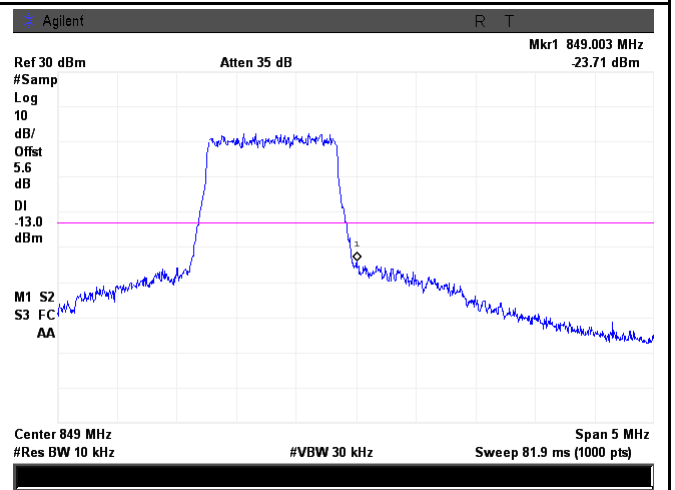

LTE Band 5 - High Channel 16QAM-1.4

Note: Offset=Cable loss (4.5) + 10log
(12.75/10)=4.5+1.1=5.6 dB

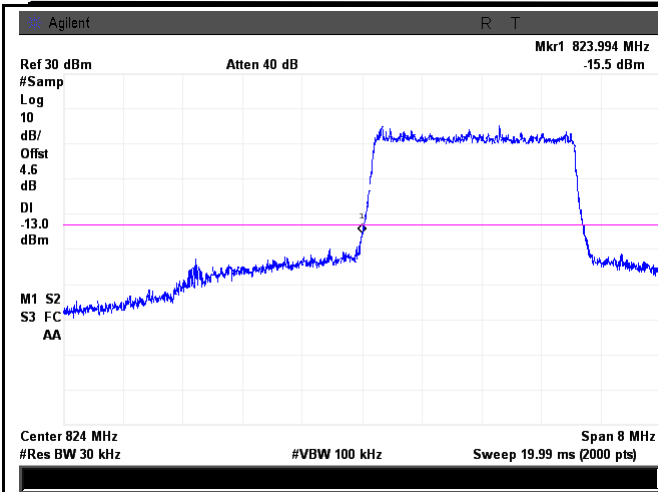

LTE Band 5 - Low Channel QPSK-3

Note: Offset=Cable loss (4.5) + 10log
(30.81/30)=4.5+0.1=4.6 dB

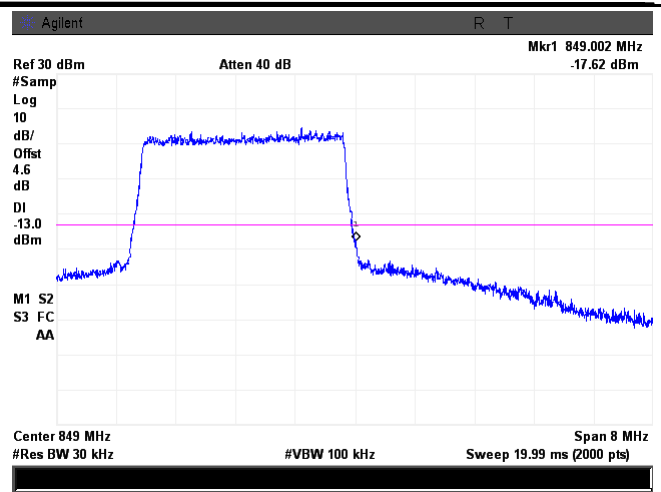

LTE Band 5 - High Channel QPSK-3

Note: Offset=Cable loss (4.5) + 10log
(30.65/30)=4.5+0.1=4.6 dB

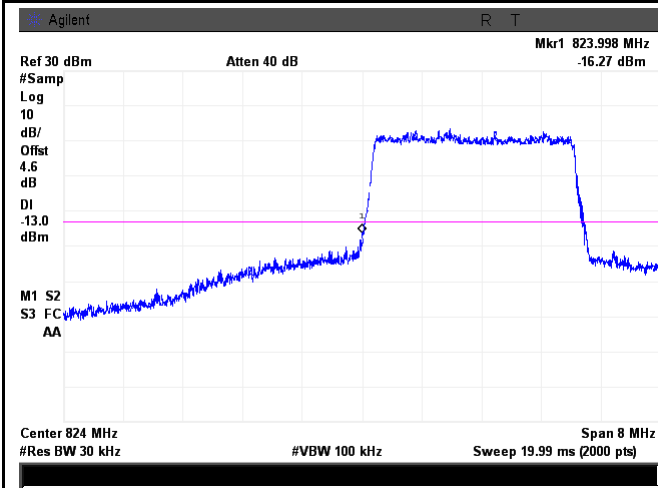

LTE Band 5 - Low Channel 16QAM-3

Note: Offset=Cable loss (4.5) + 10log
(30.42/30)=4.5+0.1=4.6 dB

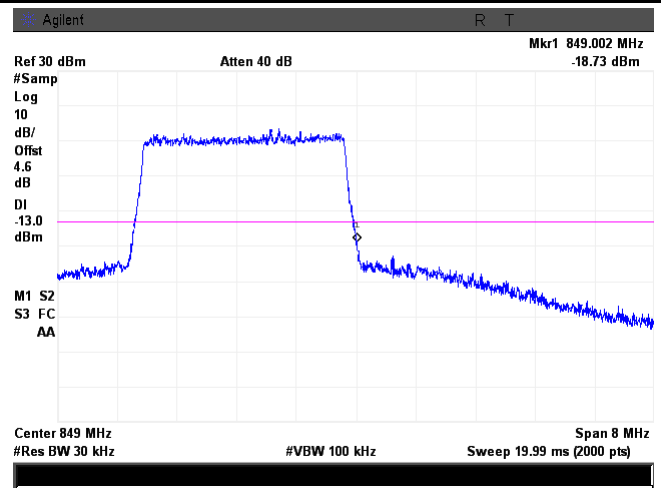

LTE Band 5 - High Channel 16QAM-3

Note: Offset=Cable loss (4.5) + 10log
(30.39/30)=4.5+0.1=4.6 dB

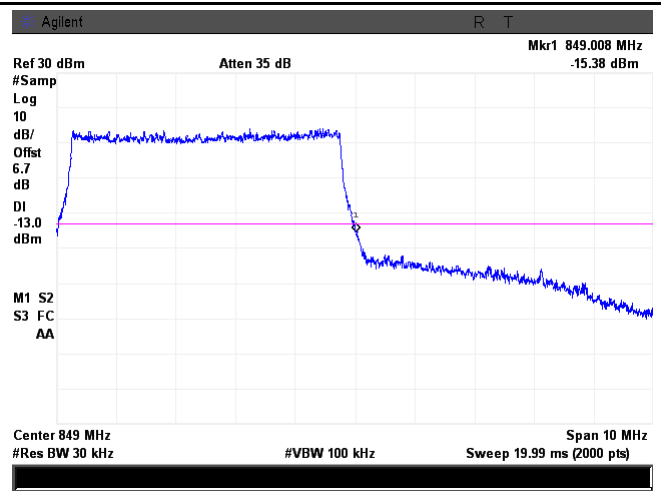
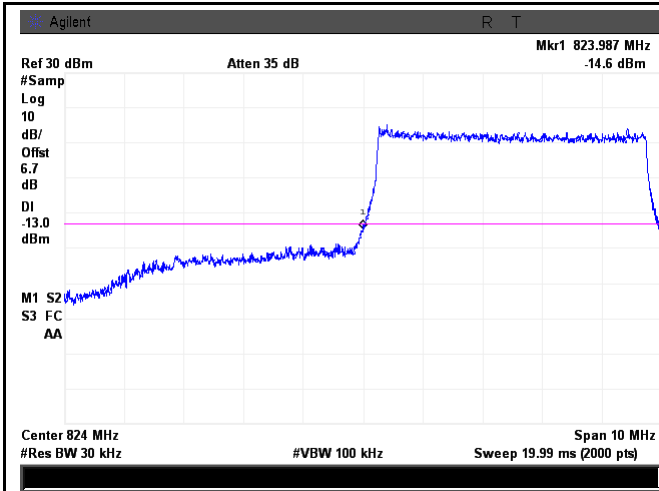

LTE Band 5 - Low Channel QPSK-5

LTE Band 5 - High Channel QPSK-5

Note: Offset=Cable loss (4.5) + 10log
 (50.03/30)=4.5+2.2=6.7 dB

Note: Offset=Cable loss (4.5) + 10log
 (50.17/30)=4.5+2.2=6.7 dB

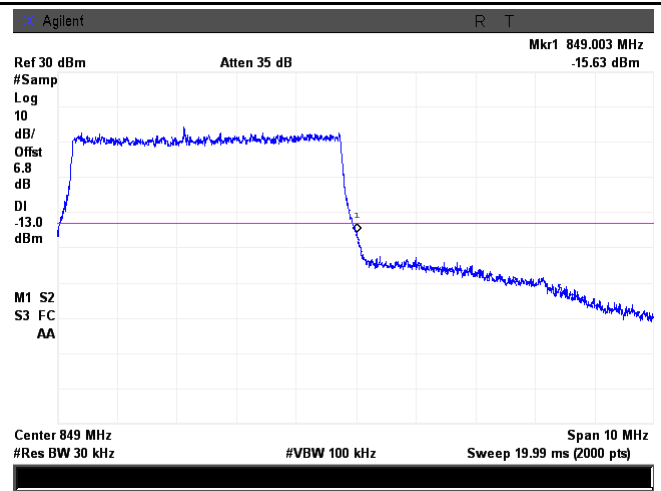
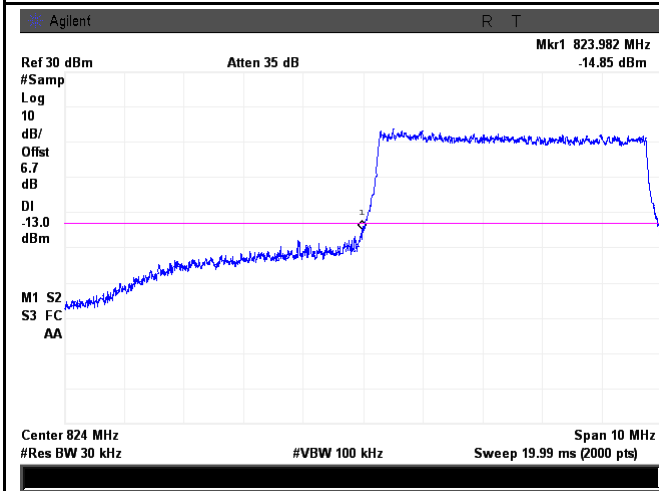

LTE Band 5 - Low Channel 16QAM-5

LTE Band 5 - High Channel 16QAM-5

Note: Offset=Cable loss (4.5) + 10log
 (50.35/30)=4.5+2.2=6.7 dB

Note: Offset=Cable loss (4.5) + 10log
 (50.95/30)=4.5+2.3=6.8 dB

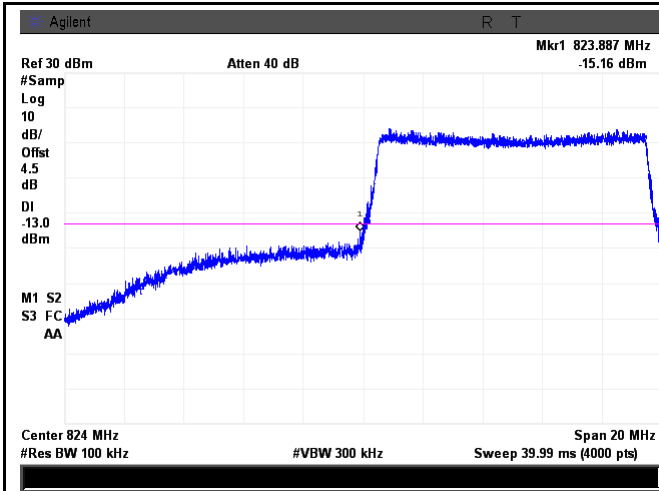

LTE Band 5 - Low Channel QPSK-10

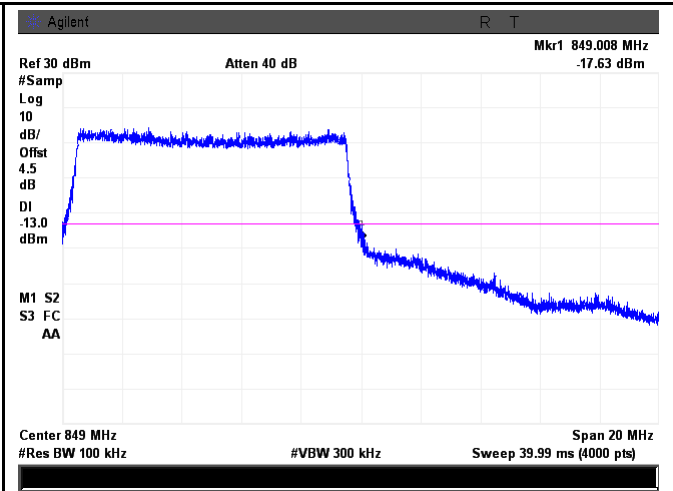

LTE Band 5 - High Channel QPSK-10

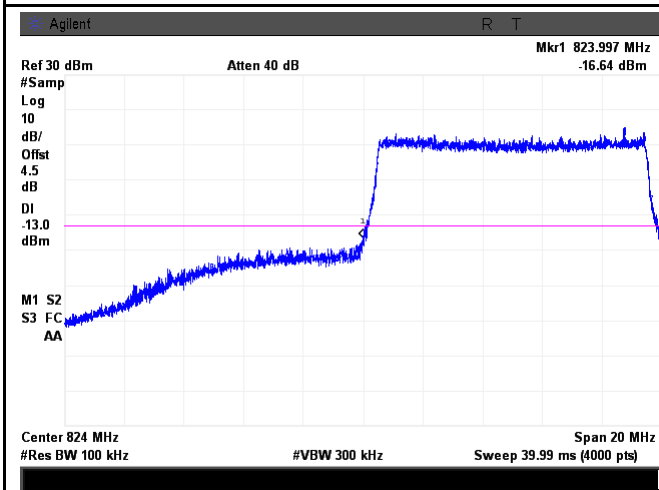

LTE Band 5 - Low Channel 16QAM-10

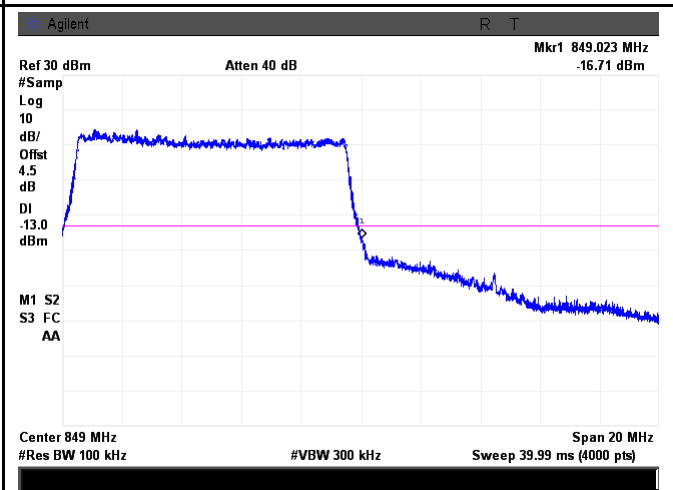

LTE Band 5 - High Channel 16QAM-10

6.9 Band Edge 27.53(m)

Temperature	24°C
Relative Humidity	56%
Atmospheric Pressure	1004mbar
Test date :	September 04, 2015
Tested By :	Winnie Zhang

Requirement(s):

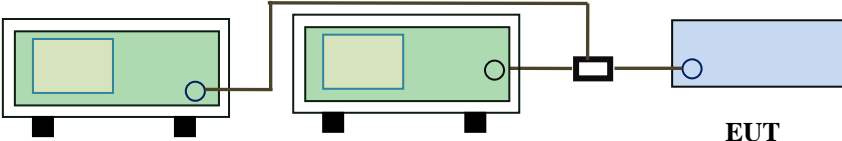
Spec	Requirement	Applicable
§27.53(m)	According to FCC 27.53(m)(4) specified that power of any emission outside of the channel edge must be attenuated below the transmitting power(P) by a factor shall be not less than $43+10\log(P)$ dB at the channel edge, the limit of emission equal to -13dBm. And $55+10\log(P)$ dB at 5.5MHz from the channel edges, the limit of emission equal to -25dBm. In the 1MHz bands immediately outside and adjacent to the frequency block a resolution bandwidth of at least one percent of the emission bandwidth of the fundamental emission of the transmitter may be employed.	<input checked="" type="checkbox"/>
Test Setup	 <p style="text-align: center;">Base Station Spectrum Analyzer EUT</p>	
Test Procedure	<ul style="list-style-type: none"> - The EUT was connected to Spectrum Analyzer and Base Station via power divider. - The 99% and 26 dB occupied bandwidth (BW) of the middle channel for the highest RF powers. 	
Remark		
Result	<input checked="" type="checkbox"/> Pass <input type="checkbox"/> Fail	

Test Data Yes N/A
 Test Plot Yes (See below) N/A

LTE Band 7 (Part 27) result

BW(MHz)	Channel	Frequency (MHz)	Mode	Emission (dBm)	Limit (dBm)
5	20775	2502.5	QPSK	-15.36	-13
			16QAM	-15.59	-13
5	21425	2567.5	QPSK	-15.20	-13
			16QAM	-17.18	-13
10	20800	2505	QPSK	-14.55	-13
			16QAM	-19.66	-13
10	21400	2562.5	QPSK	-17.06	-13
			16QAM	-16.77	-13
15	20825	2507.5	QPSK	-16.04	-13
			16QAM	-18.91	-13
15	21400	2562.5	QPSK	-17.49	-13
			16QAM	-14.73	-13
20	20850	2510	QPSK	-15.18	-13
			16QAM	-16.18	-13
20	21350	2560	QPSK	-17.03	-13
			16QAM	-16.01	-13

LTE Band 7 (Part 27)

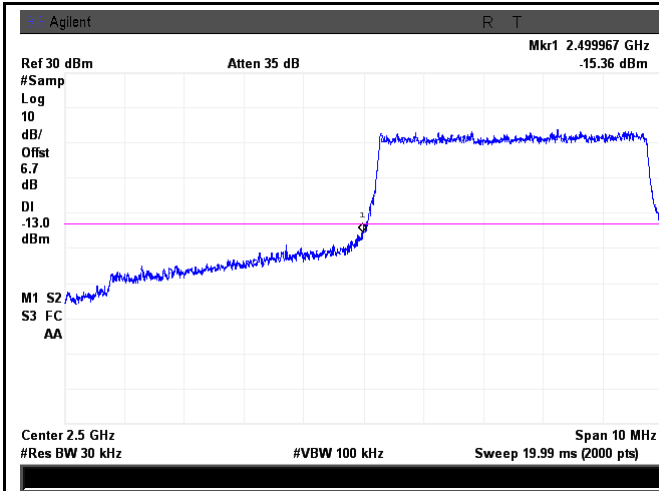

LTE Band 7 - Low Channel QPSK-5

Note: Offset=Cable loss (4.5) + 10log
(50.26/30)=4.5+2.2=6.7 dB

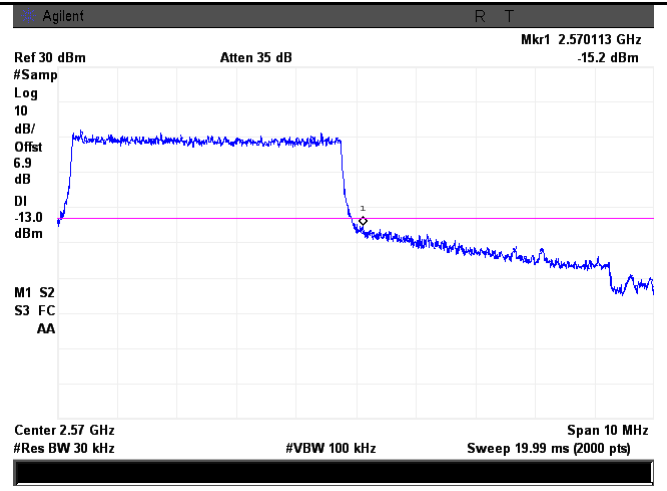

LTE Band 7 - High Channel QPSK-5

Note: Offset=Cable loss (4.5) + 10log
(52.09/30)=4.5+2.4=6.9 dB

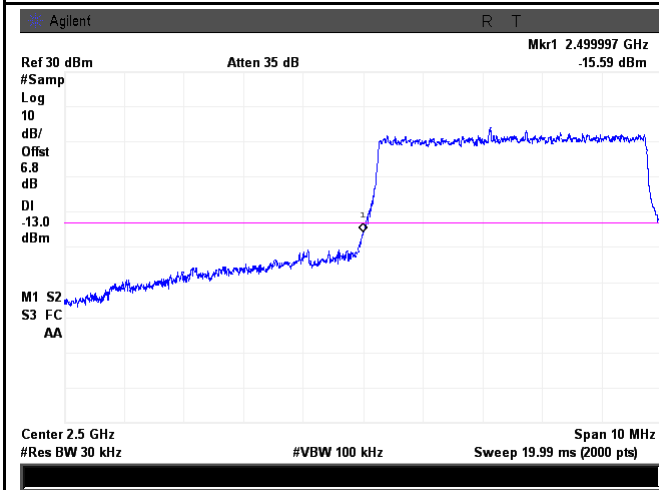

LTE Band 7 - Low Channel 16QAM-5

Note: Offset=Cable loss (4.5) + 10log
(50.56/30)=4.5+2.3=6.8 dB

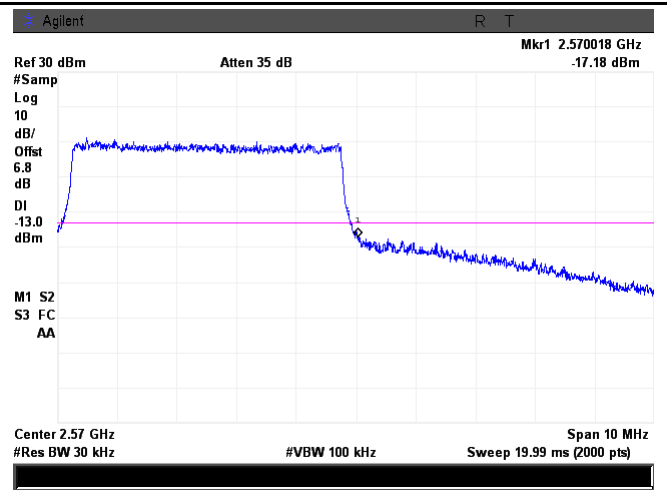

LTE Band 7 - High Channel 16QAM-5

Note: Offset=Cable loss (4.5) + 10log
(50.68/30)=4.5+2.3=6.8 dB

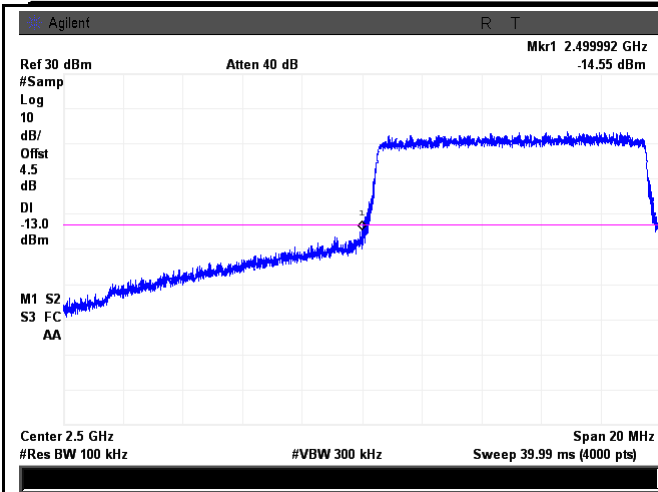

LTE Band 7 - Low Channel QPSK-10

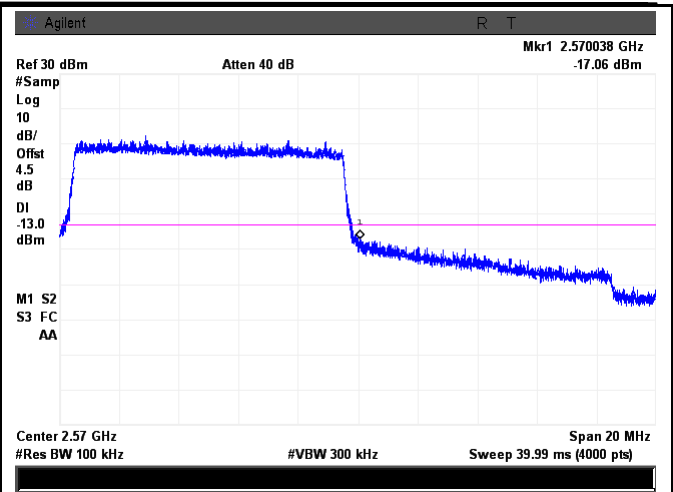

LTE Band 7 - High Channel QPSK-10

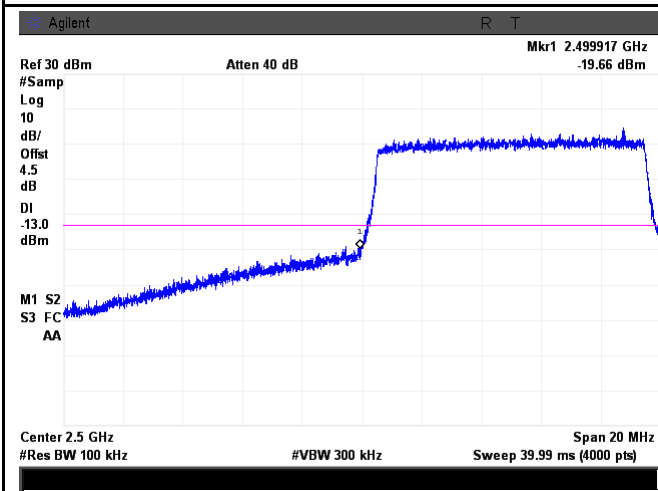

LTE Band 7 - Low Channel 16QAM-10

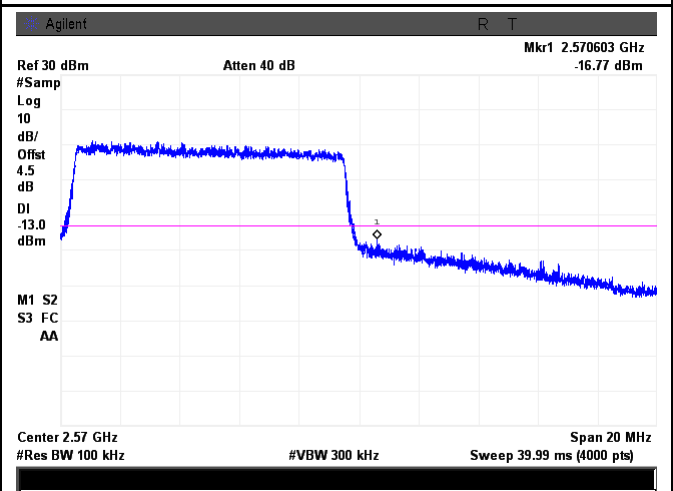

LTE Band 7 - High Channel 16QAM-10

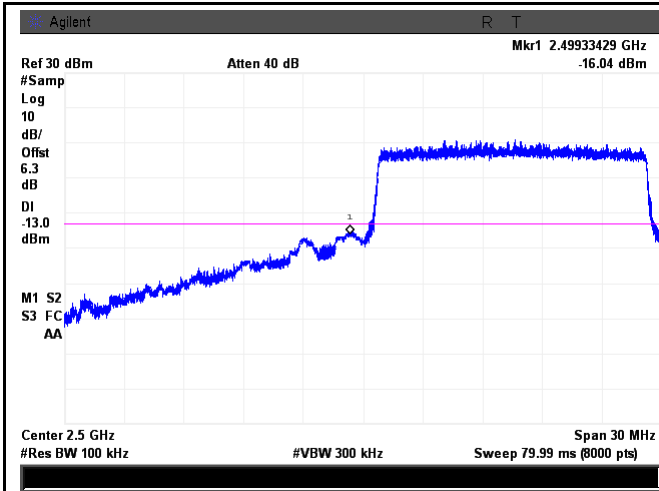

LTE Band 7 - Low Channel QPSK-15

Note: Offset=Cable loss (4.5) + 10log
(149.92/100)=4.5+1.8=6.3 dB

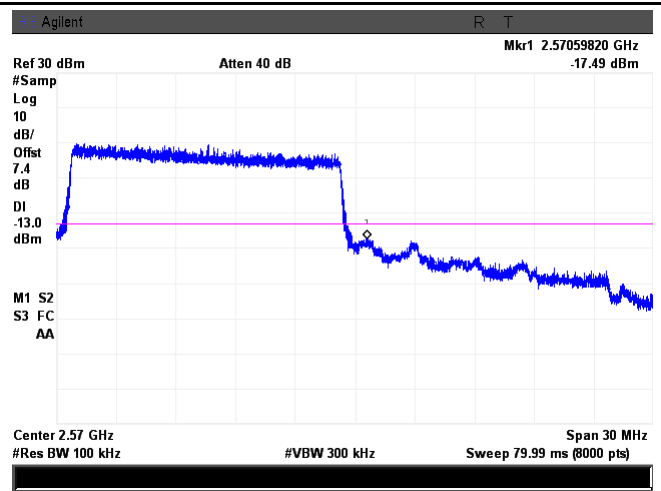

LTE Band 7 - High Channel QPSK-15

Note: Offset=Cable loss (4.5) + 10log
(193.21/100)=4.5+2.9=7.4 dB

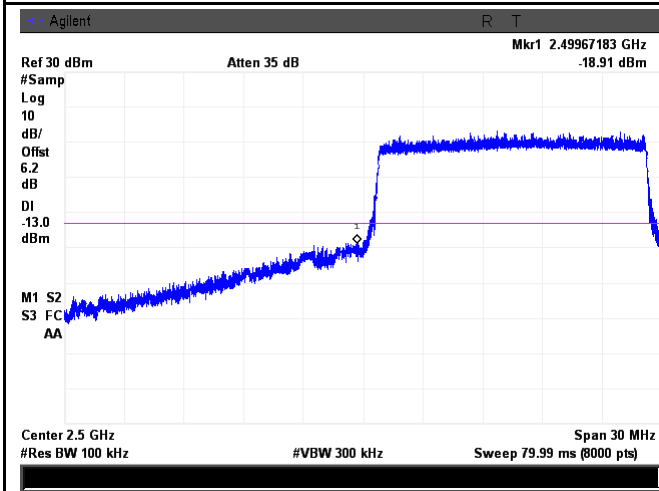

LTE Band 7 - Low Channel 16QAM-15

Note: Offset=Cable loss (4.5) + 10log
(147.28/100)=4.5+1.7=6.2 dB

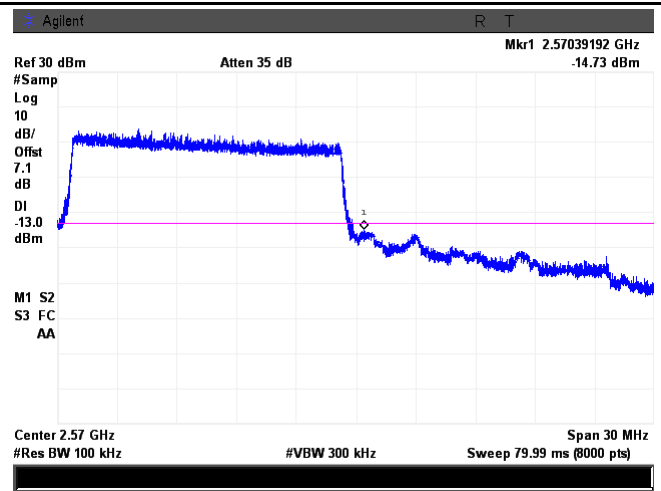

LTE Band 7 - High Channel 16QAM-15

Note: Offset=Cable loss (4.5) + 10log
(183.88/100)=4.5+2.6=7.1 dB

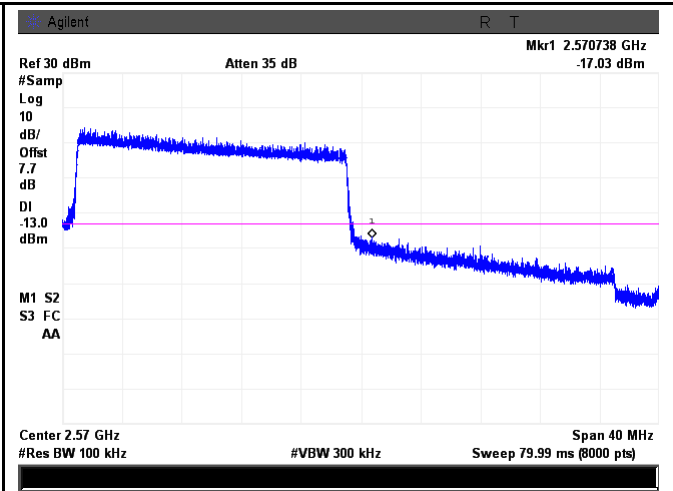
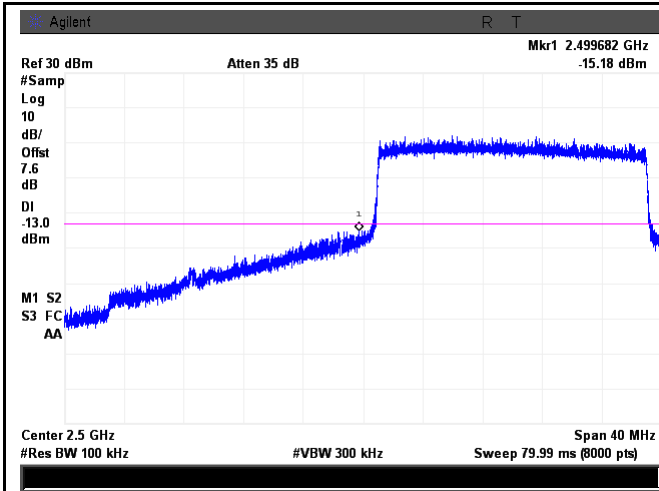

LTE Band 7 - Low Channel QPSK-20

LTE Band 7 - High Channel QPSK-20

Note: Offset=Cable loss (4.5) + 10log
(203.01/100)=4.5+3.1=7.6dB

Note: Offset=Cable loss (4.5) + 10log
(206.77/100)=4.5+3.2=7.7dB

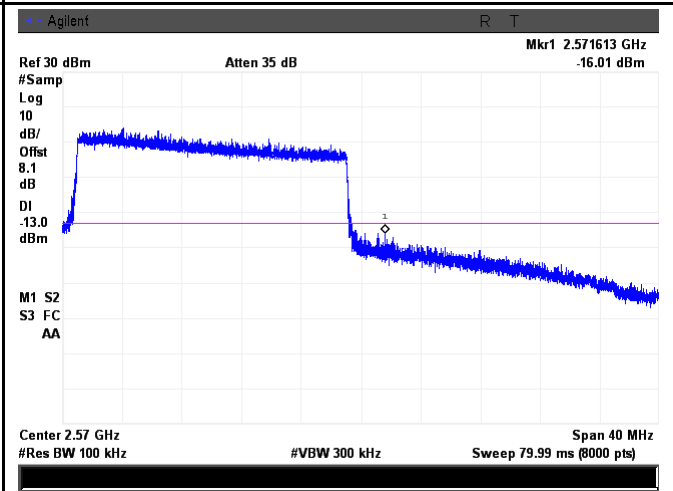
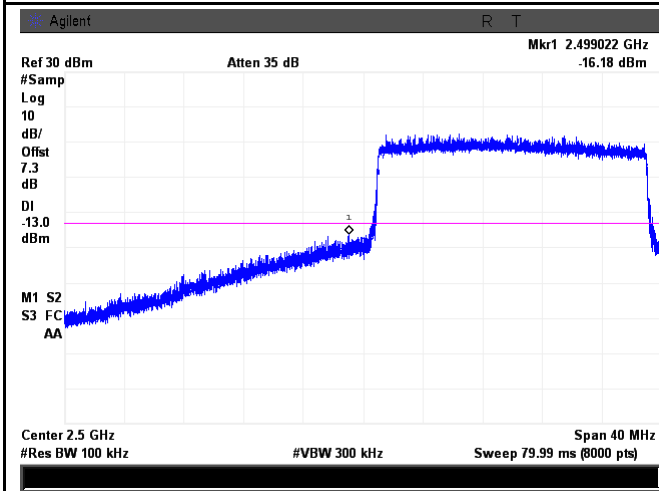

LTE Band 7 - Low Channel 16QAM-20

LTE Band 7 - High Channel 16QAM-20

Note: Offset=Cable loss (4.5) + 10log
(191.36/100)=4.5+2.8=7.3 dB

Note: Offset=Cable loss (4.5) + 10log
(227.93/100)=4.5+3.6=8.1 dB

6.10 Frequency Stability

Temperature	24°C
Relative Humidity	56%
Atmospheric Pressure	1004mbar
Test date :	September 04, 2015
Tested By :	Winnie Zhang

Requirement(s):

Spec	Item	Requirement	Applicable																																
§2.1055, §22.355 & §24.235 § 27.5(h); § 27.54	a)	<p>According to §22.355, the carrier frequency of each transmitter in the Public Mobile Services must be maintained within the tolerances given in Table below:</p> <p>Frequency Tolerance for Transmitters in the Public Mobile Services</p> <table border="1"> <thead> <tr> <th>Frequency Range (MHz)</th> <th>Base, fixed (ppm)</th> <th>Mobile ≤ 3 watts (ppm)</th> <th>Mobile ≤ 3 watts (ppm)</th> </tr> </thead> <tbody> <tr> <td>25 to 50</td> <td>20.0</td> <td>20.0</td> <td>50.0</td> </tr> <tr> <td>to 450</td> <td>5.0</td> <td>5.0</td> <td>50.0</td> </tr> <tr> <td>450 to 512</td> <td>2.5</td> <td>5.0</td> <td>5 0</td> </tr> <tr> <td>821 to 896</td> <td>1.5</td> <td>2.5</td> <td>2.5</td> </tr> <tr> <td>928 to 929.</td> <td>5.0</td> <td>N/A</td> <td>N/A</td> </tr> <tr> <td>929 to 960.</td> <td>1.5</td> <td>N/A</td> <td>N/A</td> </tr> <tr> <td>2110 to 2220</td> <td>10.0</td> <td>N/A</td> <td>N/A</td> </tr> </tbody> </table>	Frequency Range (MHz)	Base, fixed (ppm)	Mobile ≤ 3 watts (ppm)	Mobile ≤ 3 watts (ppm)	25 to 50	20.0	20.0	50.0	to 450	5.0	5.0	50.0	450 to 512	2.5	5.0	5 0	821 to 896	1.5	2.5	2.5	928 to 929.	5.0	N/A	N/A	929 to 960.	1.5	N/A	N/A	2110 to 2220	10.0	N/A	N/A	<input checked="" type="checkbox"/>
		Frequency Range (MHz)	Base, fixed (ppm)	Mobile ≤ 3 watts (ppm)	Mobile ≤ 3 watts (ppm)																														
		25 to 50	20.0	20.0	50.0																														
		to 450	5.0	5.0	50.0																														
		450 to 512	2.5	5.0	5 0																														
		821 to 896	1.5	2.5	2.5																														
		928 to 929.	5.0	N/A	N/A																														
		929 to 960.	1.5	N/A	N/A																														
2110 to 2220	10.0	N/A	N/A																																
<p>According to §24.235, the frequency stability shall be sufficient to ensure that the fundamental emissions stay within the authorized frequency block.</p>																																			
<p>According to §27.54, The frequency stability shall be sufficient to ensure that the fundamental emissions stay within the authorized bands of operation.</p>																																			

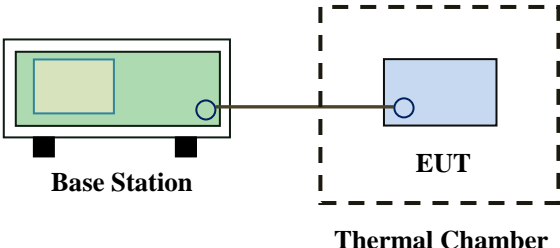
<p>Test setup</p>	 <p>The diagram illustrates the test setup. On the left, a green rectangular box labeled 'Base Station' is shown with a smaller green box inside it. A horizontal line connects the right side of the Base Station to the left side of a blue rectangular box labeled 'EUT'. The EUT is enclosed within a dashed-line rectangular box labeled 'Thermal Chamber'.</p>
<p>Procedure</p>	<p>A communication link was established between EUT and base station. The frequency error was monitored and measured by base station under variation of ambient temperature and variation of primary supply voltage.</p> <p>Limit: The frequency stability of the transmitter shall be maintained within $\pm 0.00025\%$ ($\pm 2.5\text{ppm}$) of the center frequency.</p>
<p>Remark</p>	<p>Frequency Stability versus Temperature: The Frequency tolerance of the carrier signal shall be maintained within 2.5ppm of the operating frequency over a temperature variation of -10°C to $+55^{\circ}\text{C}$ at normal supply voltage.</p>
<p>Result</p>	<p><input checked="" type="checkbox"/> Pass <input type="checkbox"/> Fail</p>

Test Data Yes N/A

Test Plot Yes (See below) N/A

LTE Band 2 (Part 24E) result

Middle Channel, $f_0 = 1880$ MHz				
Temperature (°C)	Power Supplied (V _{DC})	Frequency Error (Hz)	Frequency Error (ppm)	Limit (ppm)
-10	3.7	-7	0.0037	2.5
0		-10	0.0053	2.5
10		-7	0.0037	2.5
20		-5	0.0027	2.5
30		-13	0.0069	2.5
40		-8	0.0043	2.5
50		-11	0.0059	2.5
55		-9	0.0048	2.5
25	4.2	-11	0.0059	2.5
	3.5	-12	0.0064	2.5

LTE Band 4 (Part 27) result

Middle Channel, $f_0 = 1732.5$ MHz				
Temperature (°C)	Power Supplied (V _{DC})	Frequency Error (Hz)	Frequency Error (ppm)	Limit (ppm)
-10	3.7	-20	0.0115	2.5
0		-16	0.0092	2.5
10		-14	0.0081	2.5
20		-17	0.0098	2.5
30		-12	0.0069	2.5
40		-15	0.0087	2.5
50		-11	0.0063	2.5
55		-17	0.0098	2.5
25	4.2	-18	0.0104	2.5
	3.5	-19	0.0110	2.5

LTE Band 5 (Part 22H) result

Middle Channel, $f_0 = 1732.5$ MHz				
Temperature (°C)	Power Supplied (V _{DC})	Frequency Error (Hz)	Frequency Error (ppm)	Limit (ppm)
-10	3.7	6	0.0072	2.5
0		5	0.0060	2.5
10		7	0.0084	2.5
20		9	0.0108	2.5
30		11	0.0132	2.5
40		10	0.0120	2.5
50		13	0.0155	2.5
55		8	0.0096	2.5
25	4.2	5	0.0060	2.5
	3.5	6	0.0072	2.5

LTE Band 7 (Part 27) result

Middle Channel, $f_0 = 2535$ MHz				
Temperature (°C)	Power Supplied (V _{DC})	Frequency Error (Hz)	Frequency Error (ppm)	Limit (ppm)
-10	3.7	9	0.0036	2.5
0		11	0.0043	2.5
10		13	0.0051	2.5
20		8	0.0032	2.5
30		15	0.0059	2.5
40		10	0.0039	2.5
50		13	0.0051	2.5
55		7	0.0028	2.5
25	4.2	11	0.0043	2.5
	3.5	14	0.0055	2.5

Annex A. TEST INSTRUMENT

Instrument	Model	Serial #	Cal Date	Cal Due	In use
RF Conducted Test					
Agilent ESA-E SERIES SPECTRUM ANALYZER	E4407B	MY45108319	09/17/2014	09/16/2015	<input checked="" type="checkbox"/>
Power Splitter	1#	1#	09/01/2015	08/31/2016	<input checked="" type="checkbox"/>
Universal Radio Communication Tester	CMU200	121393	09/26/2014	09/25/2015	<input checked="" type="checkbox"/>
Wideband Radio Communication Tester	CMW500	120906	03/29/2014	03/28/2015	<input checked="" type="checkbox"/>
Temperature/Humidity Chamber	UHL-270	001	10/10/2014	10/09/2015	<input checked="" type="checkbox"/>
DC Power Supply	E3640A	MY40004013	09/18/2014	09/17/2015	<input checked="" type="checkbox"/>
Radiated Emissions					
EMI test receiver	ESL6	100262	09/18/2014	09/17/2015	<input checked="" type="checkbox"/>
OPT 010 AMPLIFIER (0.1-1300MHz)	8447E	2727A02430	09/01/2015	08/31/2016	<input checked="" type="checkbox"/>
Microwave Preamplifier (0.5 ~ 18GHz)	PAM-118	443008	09/01/2015	08/31/2016	<input checked="" type="checkbox"/>
Bilog Antenna (30MHz~6GHz)	JB6	A110712	09/22/2014	09/21/2015	<input checked="" type="checkbox"/>
Bilog Antenna (30MHz~2GHz)	JB1	A112017	09/22/2014	09/21/2015	<input checked="" type="checkbox"/>
Double Ridge Horn Antenna (1 ~18GHz)	AH-118	71259	09/25/2014	09/24/2015	<input checked="" type="checkbox"/>
Double Ridge Horn Antenna (1 ~18GHz)	AH-118	71283	09/25/2014	09/24/2015	<input checked="" type="checkbox"/>
SYNTHESIZED SIGNAL GENERATOR	8665B	3744A01293	09/18/2014	09/17/2015	<input checked="" type="checkbox"/>
Tunable Notch Filter	3NF-800/1000-S	AA4	09/01/2015	08/31/2016	<input checked="" type="checkbox"/>
Tunable Notch Filter	3NF-1000/2000-S	AM 4	09/01/2015	08/31/2016	<input checked="" type="checkbox"/>

Annex B. EUT And Test Setup Photographs

Annex B.i. Photograph: EUT External Photo





EUT - Left View



EUT - Right View

Annex B.ii. Photograph: EUT Internal Photo



Cover Off - Top View 1



Cover Off - Top View 2

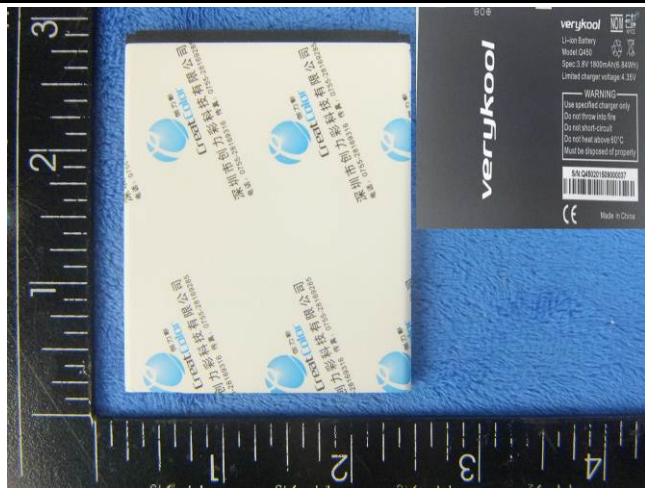

Battery - Front View



Battery - Rear View

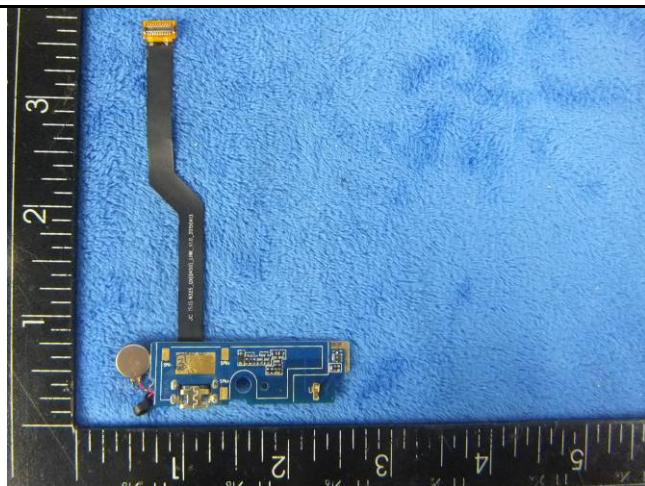

Small Mainboard - Front View

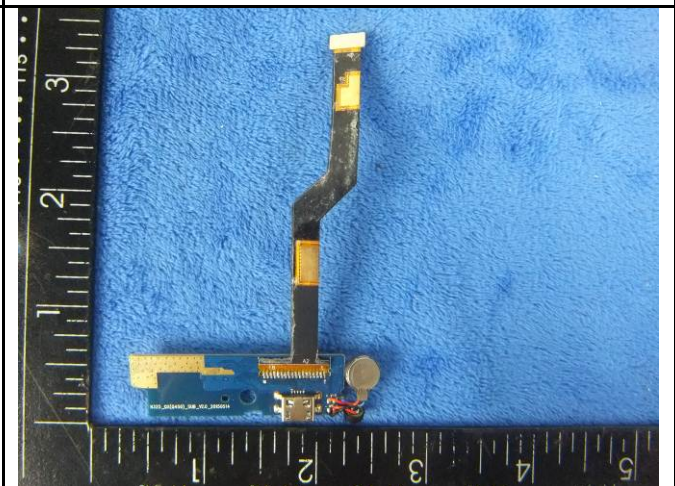

Small Mainboard - Rear View

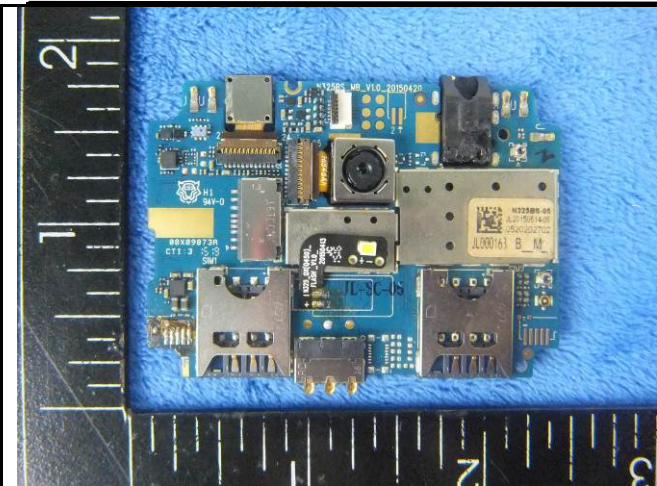

Mainboard With Shielding – Front View

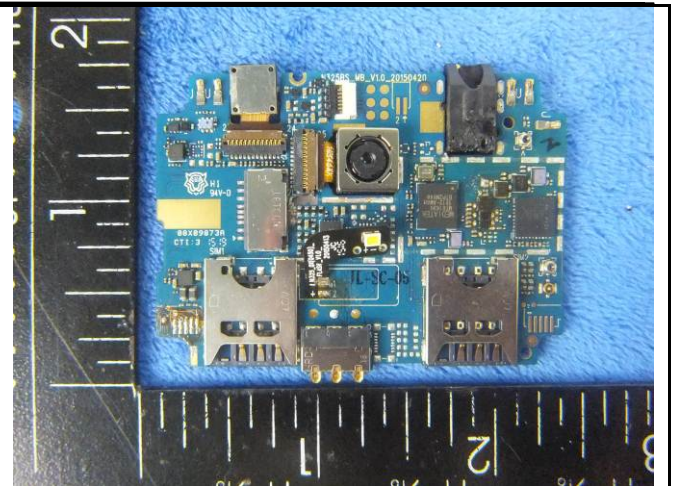

Mainboard Without Shielding - Front View

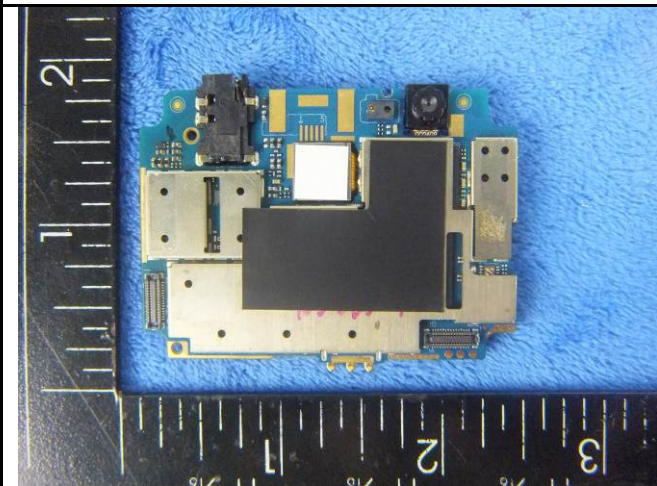

Mainboard With Shielding – Rear View

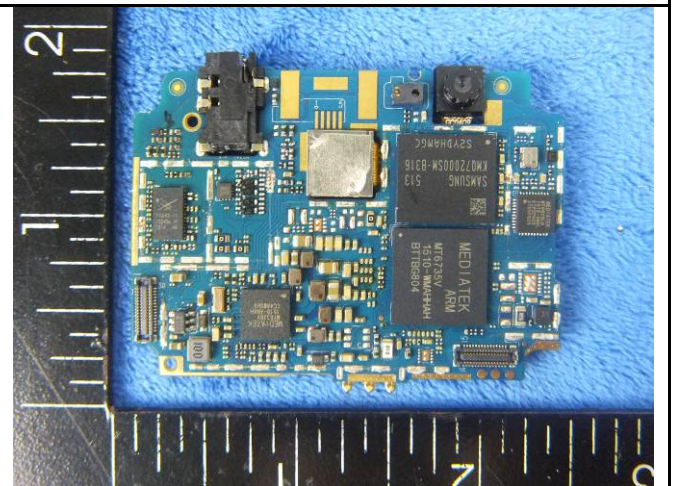

Mainboard Without Shielding - Rear View



LCD – Front View



LCD – Rear View

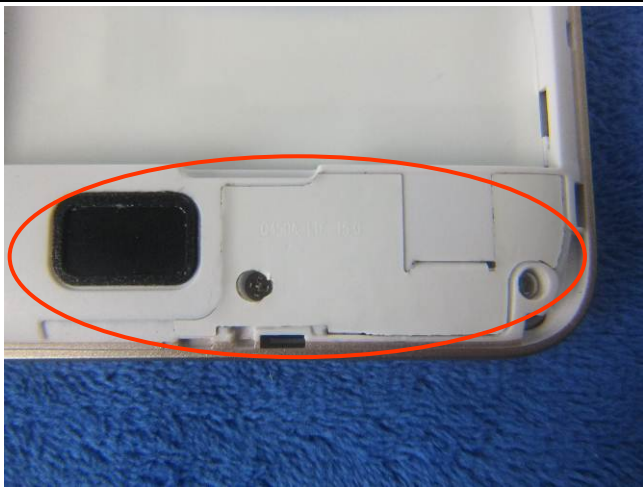

GSM/PCS/UMTS-FDD/LTE Antenna View



WIFI/BT/BLE - Antenna View

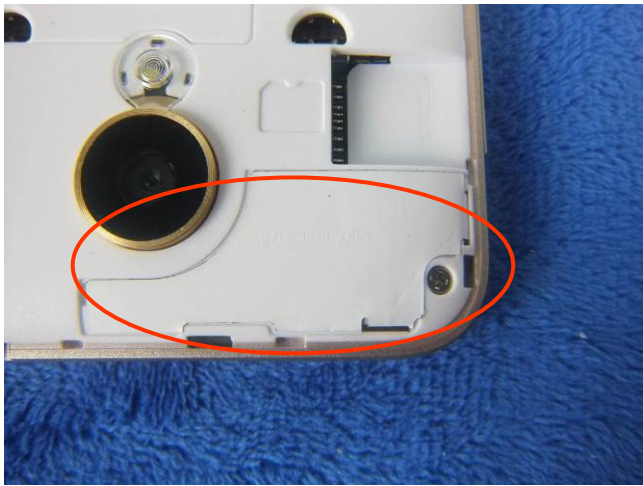

GPS - Antenna View



Annex B.iii. Photograph: Test Setup Photo

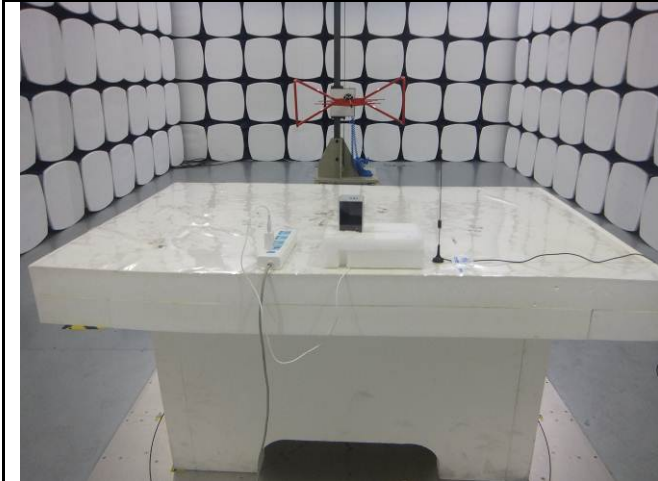

Radiated Spurious Emissions Test Setup Below 1GHz



Radiated Spurious Emissions Test Setup Above
1GHz

Annex C. TEST SETUP AND SUPPORTING EQUIPMENT

Annex C.ii. TEST SET UP BLOCK

Block Configuration Diagram for Radiated Emissions

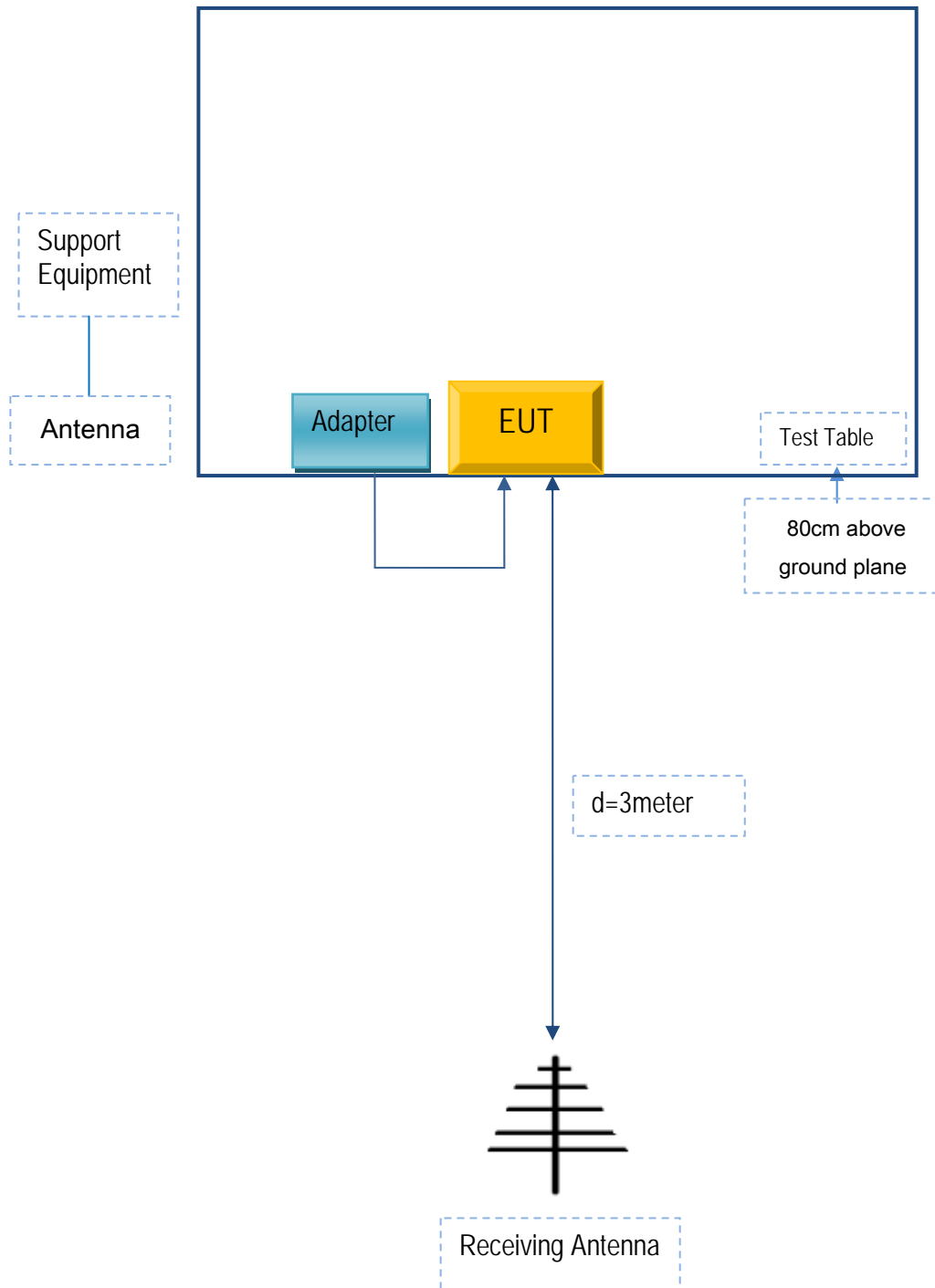

Annex C. ii. SUPPORTING EQUIPMENT DESCRIPTION

The following is a description of supporting equipment and details of cables used with the EUT.

Manufacturer	Equipment Description	Model	Calibration Date	Calibration Due Date
N/A	N/A	N/A	N/A	N/A

Test Report	15070656-FCC-R5
Page	118 of 120

Annex C.ii. EUT OPERATING CONKITIONS

N/A

Test Report	15070656-FCC-R5
Page	119 of 120

Annex D. User Manual / Block Diagram / Schematics / Partlist

Please see attachment

Test Report	15070656-FCC-R5
Page	120 of 120

Annex E. DECLARATION OF SIMILARITY

N/A