

# HAC RF EMISSION TEST REPORT



Report No.: 15070221-HAC-RF

Supersede Report No.: NONE

Applicant	Verykool USA Inc	
Product Name	Smart phone	
Model No.	SL4500	
Standards	FCC 47 CFR 20.19, ANSI C63.19:2011	
Test Date	April 15, 2015~ May 12, 2015	
Issue Date	May 12, 2015	
HAC RF Emission Test Result	E-Field(dBv/m)	M Rating
	13.83dBv/m	M4
Test Result	PASS	
Equipment complied with the specification	<input checked="" type="checkbox"/>	
Equipment did not comply with the specification	<input type="checkbox"/>	
<i>Huke . wang</i>	<i>Chris You</i>	
<b>Huke Wang</b> Test Engineer	<b>Chris You</b> Checked By	
<p>This test report may be reproduced in full only</p> <p>Test result presented in this test report is applicable to the tested sample only</p>		

Issued by:

**SIEMIC (SHENZHEN-CHINA) LABORATORIES**

Zone A, Floor 1, Building 2 Wan Ye Long Technology Park

South Side of Zhoushi Road, Bao'an District, Shenzhen, Guangdong China 518108

Phone: +86 0755 2601 4629801 Email: [China@siemic.com.cn](mailto:China@siemic.com.cn)

## Laboratory Introduction

SIEMIC, headquartered in the heart of Silicon Valley, with superior facilities in US and Asia, is one of the leading independent testing and certification facilities providing customers with one-stop shop services for Compliance Testing and Global Certifications.



In addition to [testing](#) and [certification](#), SIEMIC provides initial design reviews and [compliance management](#) through out a project. Our extensive experience with [China](#), [Asia Pacific](#), [North America](#), [European, and international](#) compliance requirements, assures the fastest, most cost effective way to attain regulatory compliance for the [global markets](#).

### Accreditations for Conformity Assessment

Country/Region	Scope
USA	EMC, RF/Wireless, SAR, Telecom
Canada	EMC, RF/Wireless, SAR, Telecom
Taiwan	EMC, RF, Telecom, SAR, Safety
Hong Kong	RF/Wireless, SAR, Telecom
Australia	EMC, RF, Telecom, SAR, Safety
Korea	EMI, EMS, RF, SAR, Telecom, Safety
Japan	EMI, RF/Wireless, SAR, Telecom
Singapore	EMC, RF, SAR, Telecom
Europe	EMC, RF, SAR, Telecom, Safety

Test Report	15070097-HAC-RF
Page	3 of 59

---

This page has been left blank intentionally.

**CONTENTS**

1	TECHNICAL DETAILS .....	5
2	TEST CONDITION .....	6
3	MODULATION INTERFERENCE FACTOR (MIF).....	7
4	HAC RF EMISSION TEST PROCEDURE.....	9
5	SYSTEM VALIDATION.....	11
6	LIST OF EQUIPMENTS .....	12
7	HAC RF EMISSIONS MEASUREMENT UNCERTAINTY .....	13
8	RF CONDUCTED POWER & TESTED MODE JUSTIFICATION.....	14
9	HAC RF EMISSIONS TEST RESULTS .....	15
	ANNEX A SYSTEM CHECK .....	16
	ANNEX B TEST PLOTS .....	18
	ANNEX B TEST SETUP PHOTO.....	34
	ANNEX C CALIBRATION REPORT .....	35

# 1 TECHNICAL DETAILS

Purpose	Compliance testing of SL4500 with HAC RF Emission.
Applicant / Client	Verykool USA Inc 3636 Nobel Drive, Suite 325, San Diego, CA 92122 USA
Manufacturer	Shenzhen BVC Technology Co., LTD Floor 1, Building A2, Dingbaohong Industrial Park, Industrial 2nd Road, Shiyan Subdistrict Office, Baoan District, Shenzhen, Guangdong, PRC
Laboratory performing the tests	SIEMIC(Shenzhen-China) Laboratories Zone A, Floor 1, Building 2, Wan Ye Long Technology Park, South Side of Zhoushi Road, Bao'an District, Shenzhen 518108, Guangdong, P.R.C. Tel: +(86) 0755-26014629 VIP Line: 950-4038-0435
Test report reference number	15070221-HAC-RF
Date EUT received	Mar-30-2015
Standard applied	CFR 20.19 , ANSI C63.19:2011
Dates of test (from – to)	Feb 15 <sup>th</sup> , 2015
No of Units:	1
Equipment Category:	PCE
Trade Name:	verykool
Model Name:	SL4500
RF Operating Frequency (ies)	GSM850 TX : 824.2 ~ 848.8 MHz; RX : 869.2 ~ 893.8 MHz PCS1900 TX : 1850.2 ~ 1909.8 MHz; RX : 1930.2 ~ 1989.8 MHz UMTS-FDD Band 5 TX : 826.4 ~ 846.6 MHz; RX : 871.4 ~ 891.6 MHz UMTS-FDD Band 2 TX :1852.4 ~ 1907.6 MHz; RX : 1932.4 ~ 1987.6 MHz UMTS-FDD Band 4 TX :1712.4 ~ 1752.6 MHz; RX : 2112.4 ~ 2152.6 MHz LTE Band 2 TX: 1852.5 ~ 1907.5 MHz; RX : 1932.5 ~ 1987.5 MHz LTE Band 4 TX: 1712.5 ~ 1752.5 MHz; RX : 2112.5 ~ 2152.5 MHz LTE Band 12 TX: 701.5 ~ 713.5 MHz; RX : 731.5 ~ 743.5 MHz LTE Band 17 TX: 706.5 ~ 713.5 MHz; RX : 736.5 ~ 743.5 MHz BT & BLE:2402~ 2480MHz(TX/RX) WIFI:802.11b/g/n(20M): 2412-2462 MHz(TX/RX)
Antenna Type:	PIFA Antenna
Modulation:	GSM / GPRS : GMSK EGPRS: 8PSK WCDMA:QPSK LTE: QPSK, 16QAM Wifi: CCK, OFDM Bluetooth: GFSK, $\pi/4$ -DQPSK, 8DPSK BLE:GFSK
FCC ID:	WA6SL4500
IC ID:	NA

## 2 Test Condition

### Ambient Condition

Temperature: 20 ~ 24 C

Humidity : < 60 %

### Testing Configuration

The device was controlled by using a base station emulator R&S CMU200. Communication between the device and the emulator was established by air link. The power control bits was set to "Always Up" from the emulator to radiate maximum output power during all testing

Measurements were performed on the low, middle and high channels of all bands

### List of Air Interfaces/Bands & Operating Modes

Air-Interface	Band (MHz)	Type	C63.19/ Tested	Simultaneous Transmissions Note: Not to be test	Concurred single transmission	Reduced power 20.19(c)(1)	Voice Over Digital Transport (Data)
GSM	850	VO	YES	Yes, with Bluetooth/wifi	NA	NA	NA
	1900					NA	NA
	GPRS/EDGE	DT	No	NA	NA	NA	NA
WCDAMA	Band II , Band IV , Band V R99	VO	Yes	Yes, with Bluetooth/wifi	NA	NA	NA
	HSDPA	DT	NO	NA	NA	NA	NA
WIFI	2.4G	DT	NO	Yes, with WWAN	NA	NA	Yes
BT	2.4G	DT	NO	Yes, with WWAN	NA	NA	NA
LTE	Band 2 (1900)	DT	NO	Yes, with Bluetooth/wifi	NA	NA	Yes
	Band 4 (1700)	DT	NO	Yes, with Bluetooth/wifi	NA	NA	Yes
	Band 12 (700)	DT	NO	Yes, with Bluetooth/wifi	NA	NA	Yes
	Band 17 (700)	DT	NO	Yes, with Bluetooth/wifi	NA	NA	Yes

VO Voice CMRS/PTSN Service Only  
V/D Voice CMRS/PSTN and Data Service  
DT Digital Transport

Note: \* HAC Rating was not base on concurrent voice and data modes, Noncurrent mode was found to represent worst Case rating.

### 3 Modulation Interference Factor (MIF)

The HAC Standard ANSI C63.19-2011 defines a new scaling using the Modulation Interference Factor (MIF) which replaces the need for the Articulation Weighting Factor (AWF) during the evaluation and is applicable to any modulation scheme.

The Modulation Interference factor (MIF, in dB) is added to the measured average E-field (in dBV/m) and converts it to the RF Audio Interference level (in dBV/m). This level considers the audible amplitude modulation components in the RF E-field. CW fields without amplitude modulation are assumed to not interfere with the hearing aid electronics. Modulations without time slots and low fluctuations at low frequencies have low MIF values, TDMA modulations with narrow transmission and repetition rates of few 100 Hz have high MIF values and give similar classifications as ANSI C63-2007.

#### Definitions

COMHAC E-field probes have a bandwidth <10 kHz and can therefore not evaluate the RF envelope in the full audio band. OPENHAC is therefore using the "indirect" measurement method according to ANSI C63.19-2011 which is the primary method. These near field probes read the averaged E-field measurement. Especially for the new high peak-to-average (PAR) signal types, the probes shall be linearized by probe modulation response (PMR) calibration in order to not overestimate the field reading.

The evaluation method or the MIF is defined in ANSI C63.19-2011 section D.7. An RMS demodulated RF signal is fed to a spectral filter (similar to an A weighting filter) and forwarded to a temporal filter acting as a quasi-peak detector. The averaged output of these filtering is called to a 1 kHz 80% AM signal as reference. MIF measurement requires additional instrumentation and is not well suited for evaluation by the end user with reasonable uncertainty

It may alternatively be determined through analysis and simulation, because it is constraint and characteristic for a communication signal. OPENHAC uses well defined signals for PMR calibration. The MIF of these signals has been determined by simulation and is automatically applied.

MIF values were not tested by a probe or as specified in the standards but are based on analysis provided by SATIMO for all the air interfaces (GSM, WCDMA, CDMA). For GSM, CDMA2000, WCDMA, the data included in this report are for the worst case operating modes.

Communication System Name	
UMTS-FDD(WCDMA)	-20.00
GSM-FDD(TDMA,GMSK)	+3.50
CDMA2000(1XRTT, RC3)	-19.00
CDMA2000(RC1;1/8th frame rate);	+3.3

A PMR calibrated probe is linearized for the selected waveform over the full dynamic range within the uncertainty specified in its calibration certificate. COMHAC E-field probes have a bandwidth <10 kHz and can therefore not evaluate the RF envelope in the full audio band. OPENHAC is therefore using the "indirect" measurement method according to ANSI C63.19-2011 which is the primary method. These near field probes read the averaged E-field measurement. Especially for the new high peak-to-average (PAR) signal types, the probes shall be linearized by PMR calibration in order to not overestimate the field reading.

The evaluation method for the MIF is defined in ANSI C63.19-2011 section D.7. An RMS demodulated RF

Test Report	15070097-HAC-RF
Page	8 of 59

signal is fed to a spectral filter (similar to an A weighting filter) and forwarded to a temporal filter acting as a quasi-peak detector. The averaged output of these filtering is scaled to a 1 kHz 80% AM signal as reference. MIF measurement requires additional instrumentation and is not well suited for evaluation by the end user with reasonable uncertainty. It may alternatively be determined through analysis and simulation, because it is constant and characteristic for a communication signal. OPENHAC uses well-defined signals for PMR calibration. The MIF of these signals has been determined by simulation and is automatically applied. The MIF measurement uncertainty is estimated as follows, for modulation frequencies from slotted waveforms with fundamental frequency and at least 2 harmonics within 10 kHz:

- 0.2 dB for MIF -7 to +5 dB,*
- 0.5 dB for MIF -13 to +11 dB*
- 1 dB for MIF > -20 dB*

The modulation interference factors obtained were applied to readings taken of the actual wireless device in order to obtain an accurate audio interference level reading using the formula:

$$\text{Audio Interference Level [dB(V/m)]} = 20 * \log[\text{Raw Field Value (V/m)}] + \text{MIF (dB)}$$



## 4 HAC RF Emission Test Procedure

The following are step-by-step test procedures.

- a) Confirm proper operation of the field probe, probe measurement system and other instrumentation and the positioning system.
- b) Position the WD in its intended test position.
- c) Set the WD to transmit a fixed and repeatable combination of signal power and modulation characteristic that is representative of the worst case (highest interference potential) encountered in normal use. Transiently occurring start-up, changeover, or termination conditions, or other operations likely to occur less than 1% of the time during normal operation, may be excluded from consideration.
- d) The center sub-grid shall be centered on the T-Coil mode perpendicular measurement point or the acoustic output, as appropriate. Locate the field probe at the initial test position in the 50 mm by 50 mm grid, which is contained in the measurement plane, refer to illustrated in Figure 1. If the field alignment method is used, align the probe for maximum field reception.
- e) Record the reading at the output of the measurement system
- f) Scan the entire 50 mm by 50 mm region in equally spaced increments and record the reading at each measurement point. The distance between measurement points shall be sufficient to assure the identification of the maximum reading.
- g) Identify the five contiguous sub-grids around the center sub-grid whose maximum reading is the lowest of all available choices. This eliminates the three sub-grids with the maximum readings. Thus, the six areas to be used to determine the WD's highest emissions are identified.
- h) Identify the maximum reading within the non-excluded sub-grids identified in step g).
- i) Convert the highest field reading within identified in step h) to RF audio interference level, in V/m, by taking the square root of the reading and then dividing it by the measurement system transfer function, established in 5.5.1.1 Convert this result to dB(V/m) by taking the base-10 logarithm and multiplying by 20. Indirect measurement method Replacing step i), the RF audio interference level in dB (V/m) is obtained by adding the MIF (in dB) to the maximum steady-state rms field-strength reading, in dB(V/m), from step h). Use this result to determine the category rating
- j) Compare this RF audio interference level with the categories in Clause 8 (ANSI C63.19-2011) and record the resulting WD category rating
- k) For the T-Coil mode M-rating assessment, determine whether the chosen perpendicular measurement point is contained in an included sub-grid of the first scan. If so, then a second scan is not necessary. The first scan and resultant category rating may be used for the T-Coil mode M rating. Otherwise, repeat step a) through step i), with the grid shifted so that it is centered on the perpendicular measurement point. Record the WD category rating.



**Test flowchart Per ANSI-PC63.19 2011**

**Test Instructions**

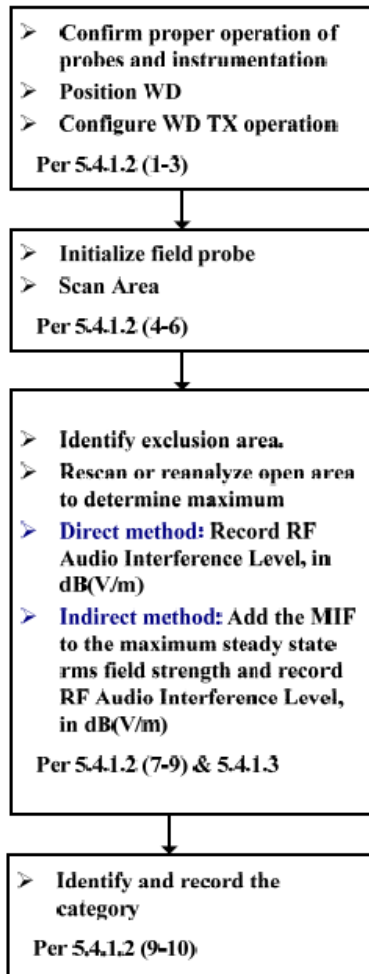

Figure 5.3—WD near-field emission scan flowchart

## 5 System Validation

The test setup was validated when first configured and verified periodically thereafter to ensure proper function. The procedure provided in this section is a validation procedure using dipole antennas for which the field levels were computed by numeric modeling.

### Procedure

Place a dipole antenna meeting the requirements given in ANSI C63.19-2011 in the normally occupied by the WD. The dipole antenna serves as a known source for an electrical and magnetic output. Position the E-field probe so that the following occurs:

- The probes and their cables are parallel to the coaxial feed of the dipole antenna
- The probe cables and the coaxial feed of the dipole antenna approach the measurement area from opposite directions
- The center point of the probe element(s) is 15 mm from the closest surface of the dipole elements.

Scan the length of the dipole with the E-field probe and record the two maximum values found near the dipole ends. Average the two readings and compare the reading to the expected value in the calibration certificate or the expected value in this standard.

Setup diagram

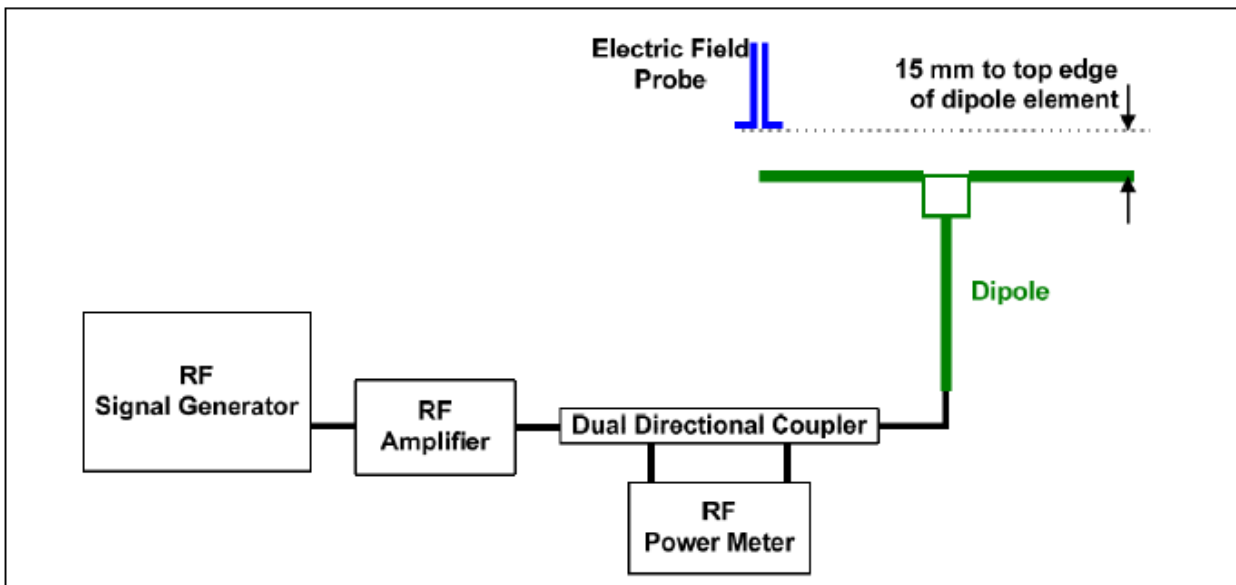

### 5.1 System Validation Results

Calibration Dipole	F(MHz)	Input Power (mW)	Measured Results	E-field Target Values (V/m) (From SATIMO)	Deviation1) (%)
DHA31	835	100	226.10	220.4	2.58
DHA32	1880	100	163.17	153.4	6.36

Note: performed at 04/15/2015

## 6 List of Equipments

Name of Equipment	Manufacturer	Type/Model	Serial Number	Calibration Due
P C	Compaq	PV 3.06GHz	375052-AA1	N/A
Signal Generator	Agilent	8665B-008	3744A01304	5/17/2015
MultiMeter	Keithley	MiltiMeter 2000	1259033	08/13/2015
S-Parameter Network Analyzer	Agilent	8753ES	US38161019	08/04/2015
Wireless Communication Test Set	R & S	CMU200	111078	07/22/2015
Power Meter	HP	437B	3038A03648	5/17/2015
COMOHAC E-Field Probe	SATIMO	SCE	SN 31/10 EPH25	08/14/2015
Communication Antenna	SATIMO	ANTA30	SN 31/10 ANTA30	N/A
Mobile Phone POSITIONING DEVICE	SATIMO	MSH63	SN 31/10 MSH63	N/A
COMOHAC Broadband Dipole 800-950	SATIMO	COMOHAC Broadband Dipole 800-950MHz	SN 24/11 DHA31	10/28/2015
COMOHAC Broadband Dipole 1700-2000	SATIMO	COMOHAC Broadband Dipole 1700-2000MHz	SN 24/11 DHB32	10/28/2015
PHANTOM TABLE	SATIMO	N/A	N/A	N/A
6 AXIS ROBOT	KUKA	KR5	949319	N/A
High Power Solid State Amplifier (80MHz-1000MHz)	Instruments for Industry	CMC150	M631-0408	N/A
Medium Power Solid State Amplifier (0.8-4.2GHz)	Instruments for Industry	S41-25	M629-0408	N/A
Wave Tube Amplifier 4-8 GHz at 20Watt	Hughes Aircraft Company	1277H02F000	81	N/A

## 7 HAC RF Emissions Measurement Uncertainty

Uncertainty Component	Tolerances (dB) / %	Probability Distribution	Divisor	Ci	Uncertainty (dB)	Uncertainty (%)
<b>Measurement System Related</b>						
RF Reflections	0.1 dB	R	$\sqrt{3}$	1	0.06	N/A
Field Probe Conv. Factor	0.2 dB	R	$\sqrt{3}$	1	0.12	N/A
Field Probe Anisotropy	0.25 dB	R	$\sqrt{3}$	1	0.14	N/A
Positioning Accuracy	0.1 dB	R	$\sqrt{3}$	1	0.06	N/A
Probe Cable Placement	0.1 dB	R	$\sqrt{3}$	1	0.06	N/A
System Repeatability	0.2 dB	R	$\sqrt{3}$	1	0.12	N/A
EUT Repeatability	0.1 dB	N	1	1	0.10	N/A
<i>Combined Standard Uncertainty :</i>					0.26	6.36 %
<b>Test Sample Related</b>						
Device Positioning Vertical	4.7 %	R	$\sqrt{3}$	0.67	N/A	1.8 %
Device Positioning Lateral	1.0 %	R	$\sqrt{3}$	1	N/A	0.6 %
Device Holder	2.4 %	R	$\sqrt{3}$	1	N/A	1.4 %
Test Sample	0.3 %	N	1	1	N/A	0.3 %
Power drift	5 %	R	$\sqrt{3}$	1	N/A	1.7 %
<b>PMF Calculation</b>						
Power Sensor	1.0 %	R	$\sqrt{3}$	1	N/A	0.6 %
Dual Directional Coupler	1.0 %	R	$\sqrt{3}$	1	N/A	0.6 %
<b>Phantom and setup Related</b>						
Phantom Thickness	2.4 %	R	$\sqrt{3}$	0.67	N/A	0.9 %
Combined Standard Uncertainty					7.1 %	
Expanded Standard Uncertainty (K=2, confidence 95%)					14.2 %	

## 8 RF Conducted Power & Tested Mode Justification

### RF Conducted power

Mobile phone radio output power measurement

1. The transmitter output port was connected to base station emulator.
2. Establish communication link between emulator and EUT and set EUT to operate at maximum output power all the time.
3. Select lowest, middle, and highest channels for each band and different possible test mode.
4. Measure the conducted peak burst power and conducted average burst power from EUT antenna port.

Burst Average Power (dBm);						
Band	GSM850			GSM1900		
Channel	128	190	251	512	661	810
Frequency (MHz)	824.2	836.6	848.8	1850.2	1880	1909.8
GSM Voice (1 uplink),GMSK	33.85	33.89	33.84	30.99	30.96	30.68

### WCDMA BAND V

Band/ Time Slot configuration	Channel	Frequency	Average power (dBm)
ARM VOCIE (R99)	4132	826.4	22.59
	4175	835	22.58
	4232	846.4	22.65

### WCDMA Band II :

Band/ Time Slot configuration	Channel	Frequency	Average power (dBm)
ARM VOCIE (R99)	9262	1852.4	21.55
	9400	1880.0	21.64
	9538	1907.6	21.45

### WCDMA Band IV :

Band/ Time Slot configuration	Channel	Frequency	Average power (dBm)
ARM VOCIE (R99)	1313	1712.4	21.22
	1413	1732	21.79
	1512	1752.6	21.25

## 9 HAC RF Emissions Test Results

### 8.1 RF Emissions Measurement Criteria

WD RF audio interference level categories in logarithmic units

Emission Categories	E-field emissions	
	< 960 MHz	> 960 MHz
Category M1	50 to 55 dB (V/m)	40 to 45 dB (V/m)
Category M2	45 to 50 dB (V/m)	35 to 40 dB (V/m)
Category M3	40 to 45 dB (V/m)	30 to 35 dB (V/m)
Category M4	<40 dB (V/m)	<30 dB (V/m)

### 8.2 HAC (RF Emissions) Test Results

Operating Mode	Channel No.	Frequency(MHz)	Peak E Field (dBV/m)	M rating	Plots
GSM850	128	824.2	8.81	M4	1#
	192	836.6	8.89	M4	2#
	251	848.8	8.85	M4	3#
GSM1900	512	1850.2	1.37	M4	4#
	661	1880.0	1.36	M4	5#
	810	1909.8	1.19	M4	6#
WCDMA Band V	4132	826.4	8.40	M4	7#
	4175	835	8.39	M4	8#
	4232	846.4	8.79	M4	9#
WCDMA Band II	9262	1852.4	3.20	M4	10#
	9400	1880.0	3.11	M4	11#
	9538	1907.6	2.50	M4	12#
WCDMA Band IV	1313	1712.4	12.55	M4	13#
	1413	1732	12.65	M4	14#
	1512	1752.6	13.83	M4	15#

# Annex A System Check

CW850  
 Band  
 Frequency (MHz): 835.000000  
 Input power: 20dBm

### Surface HAC

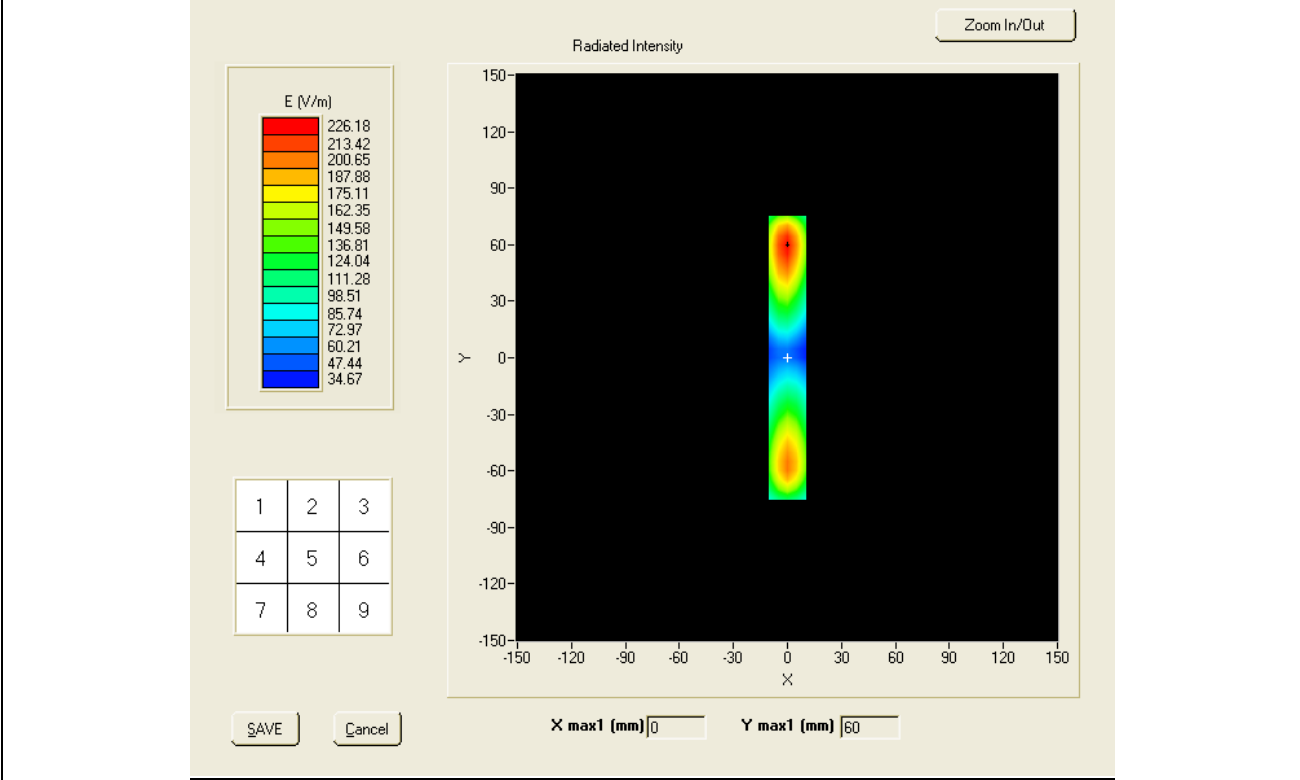

Probe Modulation Factor = 1.000000  
Maximum value of total field = 226.10 V/m



CW1900  
 Band  
 Frequency (MHz): 1880.00000  
 Input power: 20dBm

**Surface HAC**

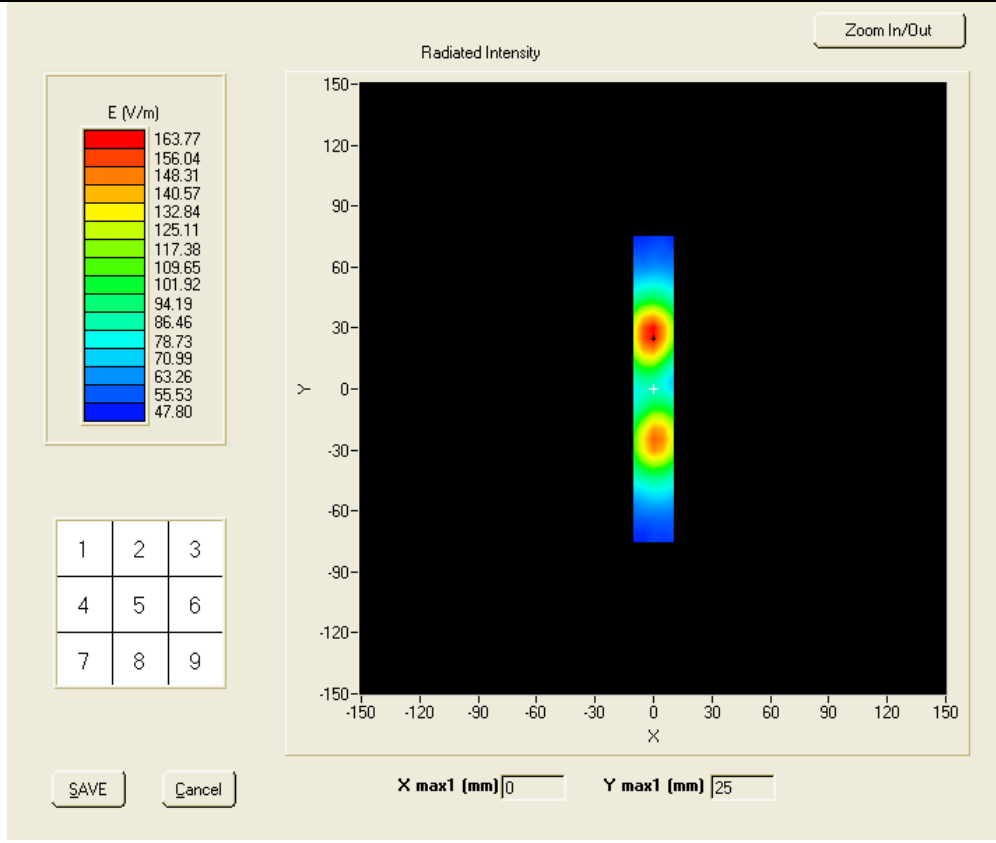

**Probe Modulation Factor = 1.000000**  
**Maximum value of total field = 163.17 V/m**

## Annex B Test plots

Test Item 1
GSM850
low Band
Frequency (MHz): 824.200000
E-Field
Grid size (mm x mm): 50.0, 50.0
Step (mm): 5

### Surface HAC

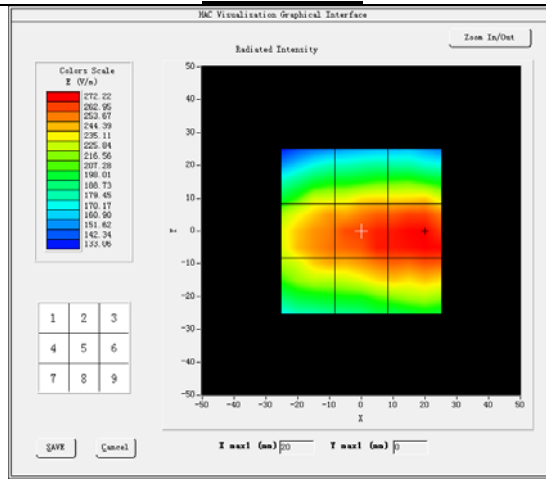

Maximum value of total field = 8.81 dB (V/m)

**Hearing Aid Near-Field Category: M4**

### E in dB (V/m)

Grid 1: 7.38	Grid 2: 7.74	Grid 3: 7.83
Grid 4: 8.39	<b>Grid 5: 8.81</b>	<b>Grid 6: 8.91</b>
Grid 7: 8.17	<b>Grid 8: 8.56</b>	<b>Grid 9: 8.69</b>

Test Item 2
GSM850
Middle Band
Frequency (MHz): 836.600000
E-Field
Grid size (mm x mm): 50.0, 50.0
Step (mm): 5

**Surface HAC**

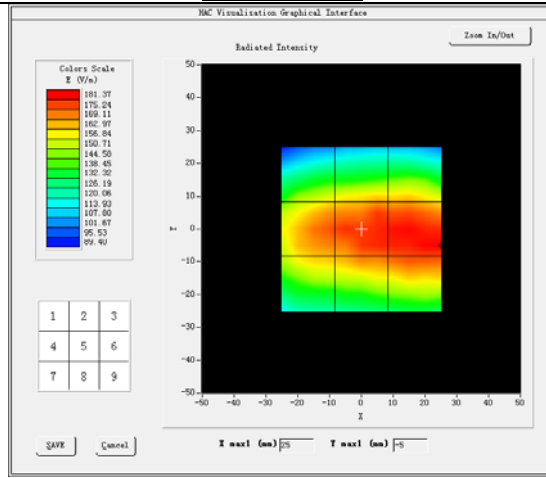

Maximum value of total field = 8.89 dB (V/m)  
**Hearing Aid Near-Field Category: M4**

**E in dB (V/m)**

Grid 1: 7.58	Grid 2: 7.90	Grid 3: 7.92
Grid 4: 8.65	<b>Grid 5: 8.89</b>	<b>Grid 6: 8.99</b>
Grid 7: 8.08	<b>Grid 8: 8.59</b>	<b>Grid 9: 8.75</b>

Test Item 3
GSM850
High Band
Frequency (MHz): 848.800000
E-Field
Grid size (mm x mm): 50.0, 50.0
Step (mm): 5

**Surface HAC**

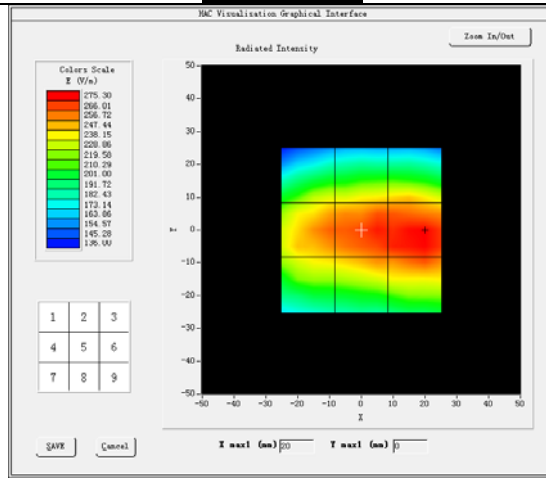

Maximum value of total field = 8.85 dB (V/m)

**Hearing Aid Near-Field Category: M4**

**E in dB (V/m)**

Grid 1: 7.52	Grid 2: 7.84	Grid 3: 7.97
Grid 4: 8.53	<b>Grid 5: 8.85</b>	<b>Grid 6: 9.03</b>
Grid 7: 8.00	<b>Grid 8: 8.47</b>	<b>Grid 9: 8.76</b>

Test Item 4
PCS1900
Low Band
Frequency (MHz): 1850.2000
E-Field
Grid size (mm x mm): 50.0, 50.0
Step (mm): 5

**Surface HAC**

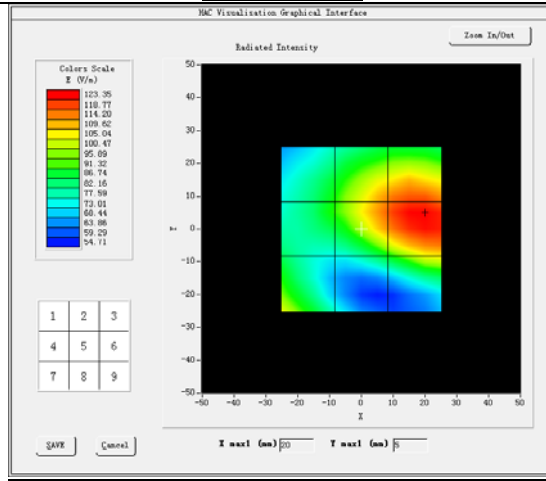

Maximum value of total field = 1.37 dB (V/m)

**Hearing Aid Near-Field Category: M4**

**E in dB (V/m)**

Grid 1: - 0.85	Grid 2: 1.07	Grid 3: 1.36
Grid 4: - 0.69	Grid 5: 1.37	Grid 6: 1.82
Grid 7: 0.19	Grid 8: - 0.85	Grid 9: 0.53

Test Item 5
PCS1900
Middle Band
Frequency (MHz): 1880.0000
E-Field
Grid size (mm x mm): 50.0, 50.0
Step (mm): 5

**Surface HAC**

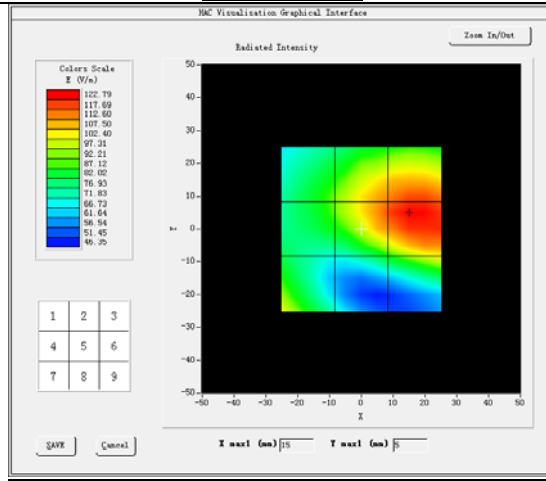

Maximum value of total field = 1.36 dB (V/m)

**Hearing Aid Near-Field Category: M4**

**E in dB (V/m)**

Grid 1: - 0.81	Grid 2: 0.93	Grid 3: 1.35
Grid 4: - 0.77	Grid 5: 1.36	Grid 6: 1.75
Grid 7: - 0.02	Grid 8: - 1.13	Grid 9: 0.27

Test Item 6
PCS1900
Middle Band
Frequency (MHz): 1909.8000
E-Field
Grid size (mm x mm): 50.0, 50.0
Step (mm): 5

**Surface HAC**

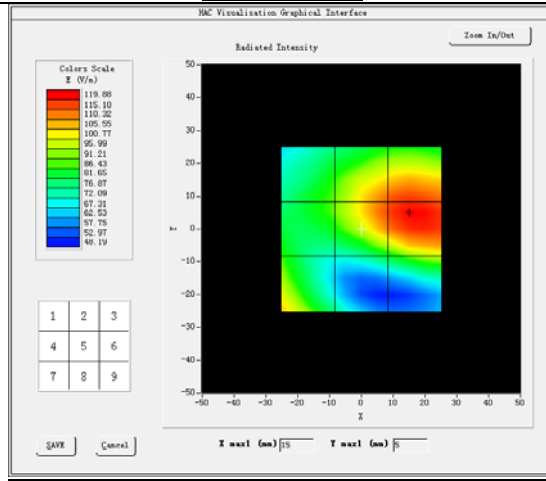

Maximum value of total field = 1.19 dB (V/m)  
**Hearing Aid Near-Field Category: M4**

**E in dB (V/m)**

Grid 1: - 1.00	Grid 2: 0.99	Grid 3: 1.18
Grid 4: - 0.91	Grid 5: 1.19	Grid 6: 1.55
Grid 7: 0.34	Grid 8: - 1.52	Grid 9: - 0.23

Test Item 7
WCDMA Band V
low Band
Frequency (MHz): 826.400000
E-Field
Grid size (mm x mm): 50.0, 50.0
Step (mm): 5

**Surface HAC**

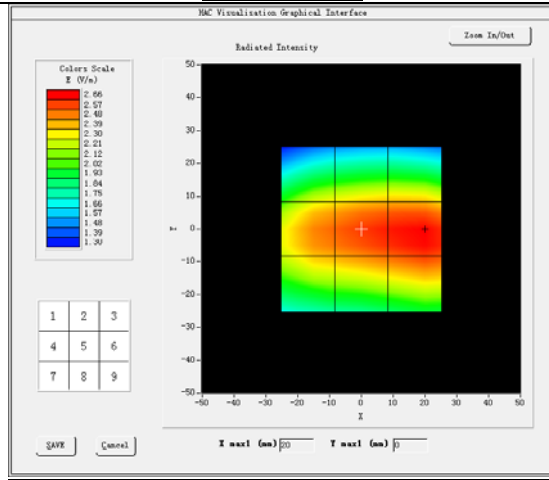

Maximum value of total field = 8.40 dB (V/m)  
**Hearing Aid Near-Field Category: M4**

**E in dB (V/m)**

Grid 1: 6.99	Grid 2: 7.32	Grid 3: 7.33
Grid 4: 8.03	<b>Grid 5: 8.40</b>	<b>Grid 6: 8.53</b>
Grid 7: 7.69	<b>Grid 8: 8.06</b>	<b>Grid 9: 8.27</b>



Test Item 8
WCDMA Band V
Middle Band
Frequency (MHz): 835.00000
E-Field
Grid size (mm x mm): 50.0, 50.0
Step (mm): 5

**Surface HAC**

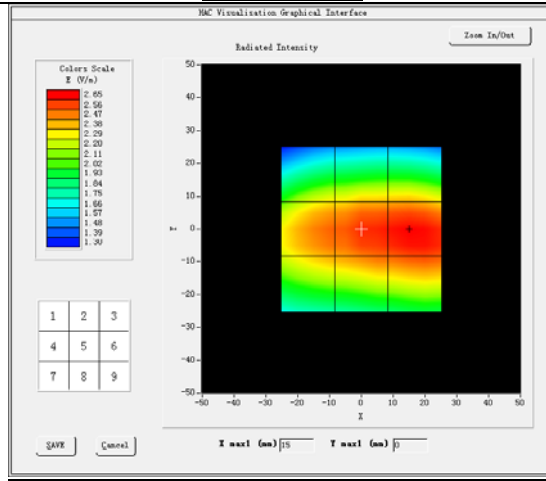

Maximum value of total field = 8.39 dB (V/m)

**Hearing Aid Near-Field Category: M4**

**E in dB (V/m)**

Grid 1: 7.01	Grid 2: 7.31	Grid 3: 7.35
Grid 4: 8.02	<b>Grid 5: 8.39</b>	<b>Grid 6: 8.49</b>
Grid 7: 7.70	<b>Grid 8: 8.05</b>	<b>Grid 9: 8.21</b>

Test Item 9
WCDMA Band V
High Band
Frequency (MHz): 846.400000
E-Field
Grid size (mm x mm): 50.0, 50.0
Step (mm): 5

**Surface HAC**

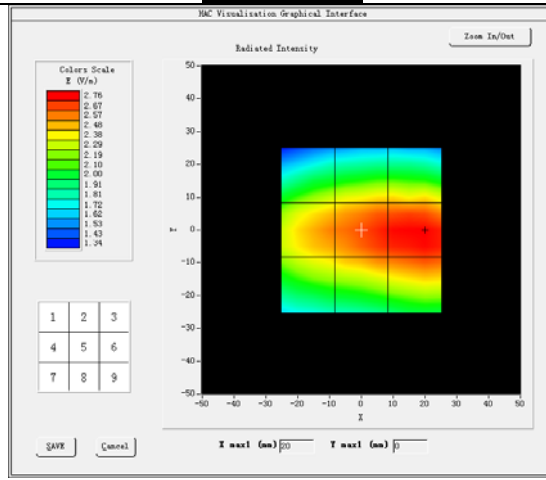

Maximum value of total field = 8.79 dB (V/m)

**Hearing Aid Near-Field Category: M4**

**E in dB (V/m)**

Grid 1: 7.28	Grid 2: 7.71	Grid 3: 7.70
Grid 4: 8.23	<b>Grid 5: 8.79</b>	<b>Grid 6: 8.86</b>
Grid 7: 7.80	<b>Grid 8: 8.39</b>	<b>Grid 9: 8.59</b>

Test Item 10
WCDMA Band II
Low Band
Frequency (MHz): 1852.4000
E-Field
Grid size (mm x mm): 50.0, 50.0
Step (mm): 5

**Surface HAC**

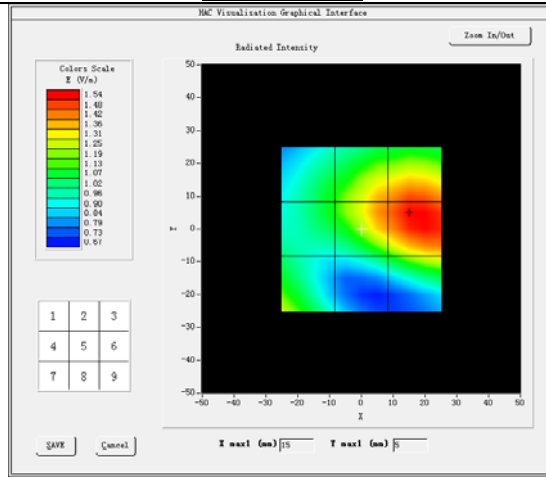

Maximum value of total field = 3.20 dB (V/m)  
**Hearing Aid Near-Field Category: M4**

**E in dB (V/m)**

Grid 1: 1.08	Grid 2: 2.91	Grid 3: 3.36
Grid 4: 1.17	Grid 5: 3.20	Grid 6: 3.81
Grid 7: 1.91	Grid 8: 1.11	Grid 9: 2.47

Test Item 11
WCDMA Band II
Middle Band
Frequency (MHz): 1880.0000
E-Field
Grid size (mm x mm): 50.0, 50.0
Step (mm): 5

**Surface HAC**

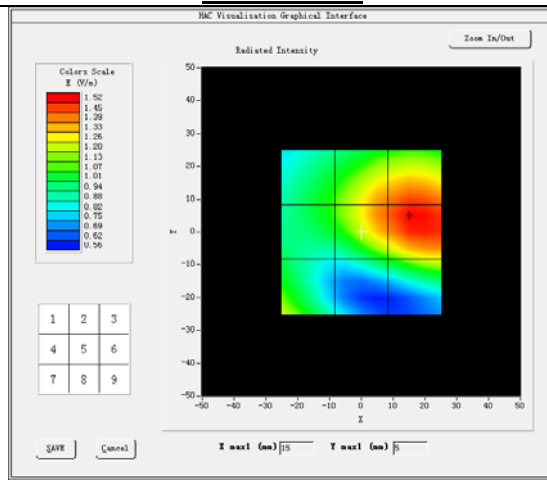

Maximum value of total field = 3.11 dB (V/m)  
**Hearing Aid Near-Field Category: M4**

**E in dB (V/m)**

Grid 1: 0.84	Grid 2: 2.88	Grid 3: 3.27
Grid 4: 0.88	Grid 5: 3.11	Grid 6: 3.67
Grid 7: 1.60	Grid 8: 0.68	Grid 9: 2.03

Test Item 12
WCDMA Band II
Middle Band
Frequency (MHz): 1907.6000
E-Field
Grid size (mm x mm): 50.0, 50.0
Step (mm): 5

**Surface HAC**

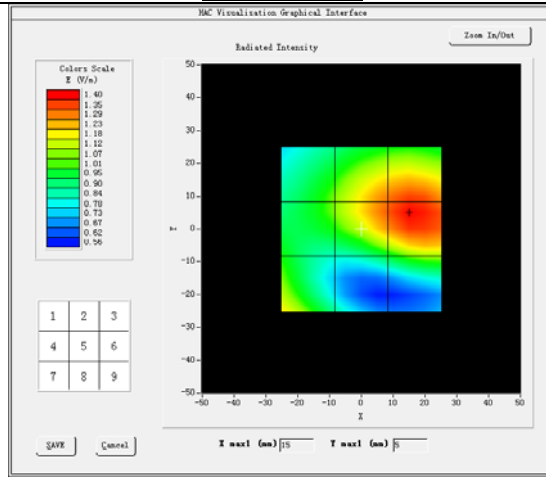

Maximum value of total field = 2.50 dB (V/m)  
**Hearing Aid Near-Field Category: M4**

**E in dB (V/m)**

Grid 1: 0.54	Grid 2: 2.27	Grid 3: 2.58
Grid 4: 0.62	Grid 5: 2.50	Grid 6: 2.94
Grid 7: 1.48	Grid 8: - 0.13	Grid 9: 0.93

Test Item 13
WCDMA Band IV
low Band
Frequency (MHz): 1712.400000
E-Field
Grid size (mm x mm): 50.0, 50.0
Step (mm): 5

**Surface HAC**

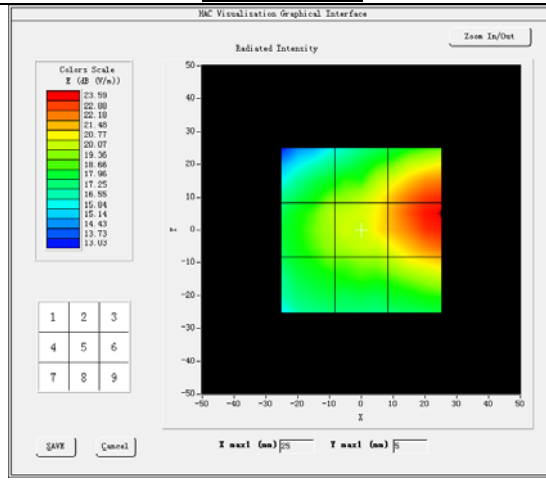

Maximum value of total field = 12.55 dB (V/m)  
**Hearing Aid Near-Field Category: M4**

**E in dB (V/m)**

Grid 1: 10.39	Grid 2: 12.27	Grid 3: 14.20
Grid 4: 11.08	Grid 5: 12.55	Grid 6: 14.61
Grid 7: 10.36	Grid 8: 11.13	Grid 9: 12.76

Test Item 14
WCDMA Band IV
Middle Band
Frequency (MHz): 1732.00000
E-Field
Grid size (mm x mm): 50.0, 50.0
Step (mm): 5

**Surface HAC**

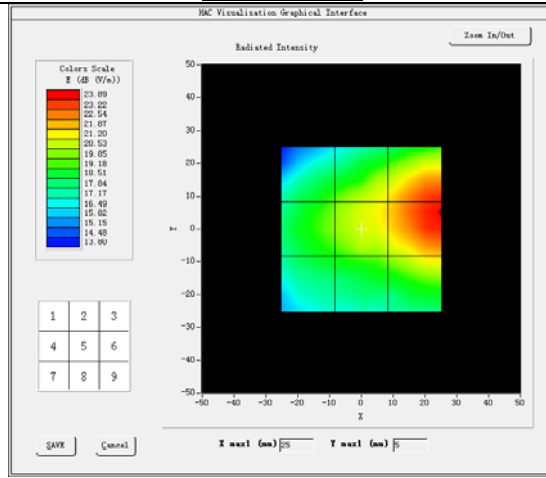

Maximum value of total field = 12.65 dB (V/m)  
**Hearing Aid Near-Field Category: M4**

**E in dB (V/m)**

Grid 1: 10.56	Grid 2: 12.39	Grid 3: 14.49
Grid 4: 10.98	Grid 5: 12.65	Grid 6: 14.91
Grid 7: 10.22	Grid 8: 11.24	Grid 9: 12.74

Test Item 15
WCDMA Band IV
High Band
Frequency (MHz): 1752.60000
E-Field
Grid size (mm x mm): 50.0, 50.0
Step (mm): 5

**Surface HAC**

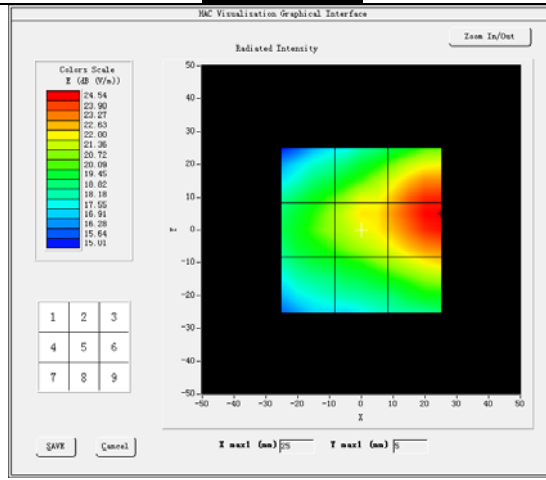

Maximum value of total field = 13.83 dB (V/m)

**Hearing Aid Near-Field Category: M4**

**E in dB (V/m)**

Grid 1: 11.49	Grid 2: 13.35	Grid 3: 15.23
Grid 4: 12.10	Grid 5: 13.83	Grid 6: 15.62
Grid 7: 11.07	Grid 8: 12.36	Grid 9: 13.77



Test Report	15070097-HAC-RF
Page	33 of 59

---

## Annex B Test Setup Photo

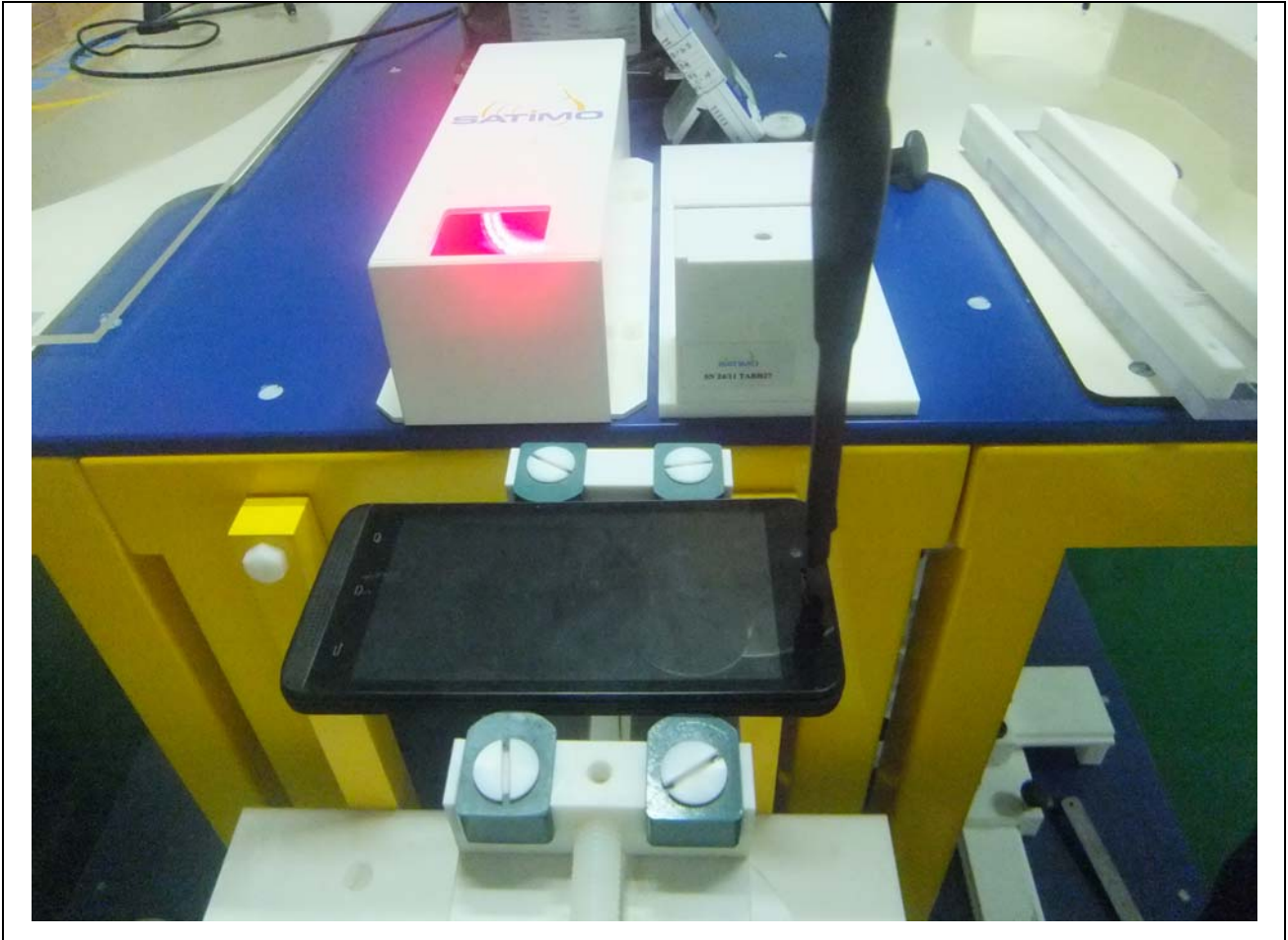

Test Report	15070097-HAC-RF
Page	35 of 59

## Annex C Calibration Report



## COMOHAC E-Field Probe Calibration Report

Ref : ACR.227.9.14.SATU.A

### SIEMIC TESTING AND CERTIFICATION SERVICES

775 MONTAGUE EXPRESSWAY

MILPITAS, CA 95035, USA

**SATIMO COMOHAC E-FIELD PROBE**

SERIAL NO.: SN 31/10 EPH25

Calibrated at SATIMO US  
2105 Barrett Park Dr. - Kennesaw, GA 30144



08/14/2014

#### *Summary:*

This document presents the method and results from an accredited COMOHAC E-Field Probe calibration performed in SATIMO USA using the CALIBAIR test bench, for use with a SATIMO COMOHAC system only. All calibration results are traceable to national metrology institutions.



	<i>Name</i>	<i>Function</i>	<i>Date</i>	<i>Signature</i>
<i>Prepared by :</i>	Jérôme LUC	Product Manager	8/15/2014	<i>JS</i>
<i>Checked by :</i>	Jérôme LUC	Product Manager	8/15/2014	<i>JS</i>
<i>Approved by :</i>	Kim RUTKOWSKI	Quality Manager	8/15/2014	<i>Kim Rutkowski</i>

	<i>Customer Name</i>
<i>Distribution :</i>	SIEMIC Testing and Certification Services

<i>Issue</i>	<i>Date</i>	<i>Modifications</i>
A	8/15/2014	Initial release

**TABLE OF CONTENTS**

1	Device Under Test .....	4
2	Product Description .....	4
2.1	General Information .....	4
3	Measurement Method .....	4
3.1	Linearity .....	4
3.2	Sensitivity .....	4
3.3	Isotropy .....	5
3.4	Probe Modulation Response .....	5
4	Measurement Uncertainty .....	5
5	Calibration Measurement Results .....	5
5.1	Sensitivity in air .....	6
5.2	Linearity .....	7
5.3	Isotropy .....	7
6	List of Equipment .....	8

## 1 DEVICE UNDER TEST

Device Under Test	
Device Type	COMOHAC E FIELD PROBE
Manufacturer	Satimo
Model	SCE
Serial Number	SN 31/10 EPH25
Product Condition (new / used)	Used
Frequency Range of Probe	0.7GHz-2.5GHz
Resistance of Three Dipoles at Connector	Dipole 1: R1=1.378 MΩ Dipole 2: R2=1.257 MΩ Dipole 3: R3=1.402 MΩ

A yearly calibration interval is recommended.

## 2 PRODUCT DESCRIPTION

### 2.1 GENERAL INFORMATION

Satimo's COMOHAC E field Probes are built in accordance to the ANSI C63.19 and IEEE 1309 standards.



Figure 1 – Satimo COMOHAC E field Probe

Probe Length	330 mm
Length of Individual Dipoles	3.3 mm
Maximum external diameter	8 mm
Probe Tip External Diameter	5 mm
Distance between dipoles / probe extremity	3 mm

## 3 MEASUREMENT METHOD

All methods used to perform the measurements and calibrations comply with the ANSI C63.19 and IEEE 1309 standards.

### 3.1 LINEARITY

The linearity was determined using a standard dipole with the probe positioned 10 mm above the dipole. The input power of the dipole was adjusted from -15 to 36 dBm using a 1dB step (to cover the range 2V/m to 1000A/m).

### 3.2 SENSITIVITY

The sensitivity factors of the three dipoles were determined using the waveguide method outlined in the fore mentioned standards.

### 3.3 ISOTROPY

The axial isotropy was evaluated by exposing the probe to a reference wave from a standard dipole. The probe was rotated along its main axis from 0 - 360 degrees in 15 degree steps.

### 3.4 PROBE MODULATION RESPONSE

The modulation factor was determined by illuminating the probe with a reference wave from a standard dipole 10 mm away, applying first a CW signal and then a modulated signal (both at same power level). The modulation factor is the ratio, in linear units, of the CW to modulated signal reading.

## 4 MEASUREMENT UNCERTAINTY

The guidelines outlined in the IEEE 1528 and IEC/CEI 62209 standards were followed to generate the measurement uncertainty associated with an E-field probe calibration using the waveguide technique. All uncertainties listed below represent an expanded uncertainty expressed at approximately the 95% confidence level using a coverage factor of k=2, traceable to the Internationally Accepted Guides to Measurement Uncertainty.

Uncertainty analysis of the probe calibration in waveguide					
ERROR SOURCES	Uncertainty value (%)	Probability Distribution	Divisor	ci	Standard Uncertainty (%)
Incident or forward power	3.00%	Rectangular	$\sqrt{3}$	1	1.732%
Reflected power	3.00%	Rectangular	$\sqrt{3}$	1	1.732%
Field homogeneity	3.00%	Rectangular	$\sqrt{3}$	1	1.732%
Field probe positioning	5.00%	Rectangular	$\sqrt{3}$	1	2.887%
Field probe linearity	3.00%	Rectangular	$\sqrt{3}$	1	1.732%
<b>Combined standard uncertainty</b>					4.509%
<b>Expanded uncertainty 95 % confidence level k = 2</b>					9.0%

## 5 CALIBRATION MEASUREMENT RESULTS

Calibration Parameters	
Lab Temperature	21 °C
Lab Humidity	45 %



5.1 SENSITIVITY IN AIR

Normx dipole 1 ( $\mu\text{V}/(\text{V}/\text{m})^2$ )	Normy dipole 2 ( $\mu\text{V}/(\text{V}/\text{m})^2$ )	Normz dipole 3 ( $\mu\text{V}/(\text{V}/\text{m})^2$ )
5.29	4.14	4.23

DCP dipole 1 (mV)	DCP dipole 2 (mV)	DCP dipole 3 (mV)
120	113	106

Calibration curves

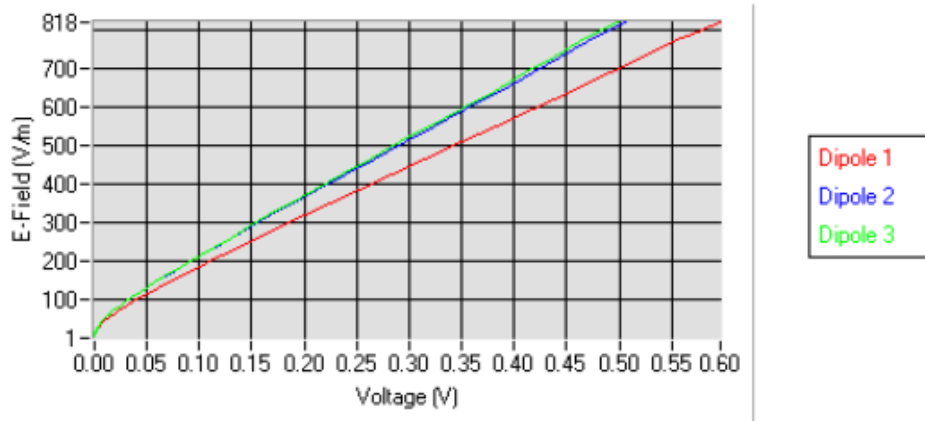



5.2 LINEARITY

Linearity

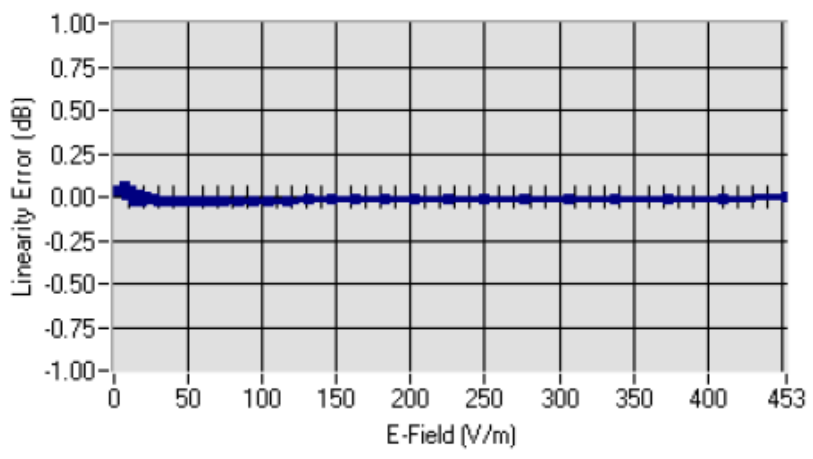

Linearity:  $\pm 1.44\%$  ( $\pm 0.06\text{dB}$ )

5.3 ISOTROPY

Isotropy curve

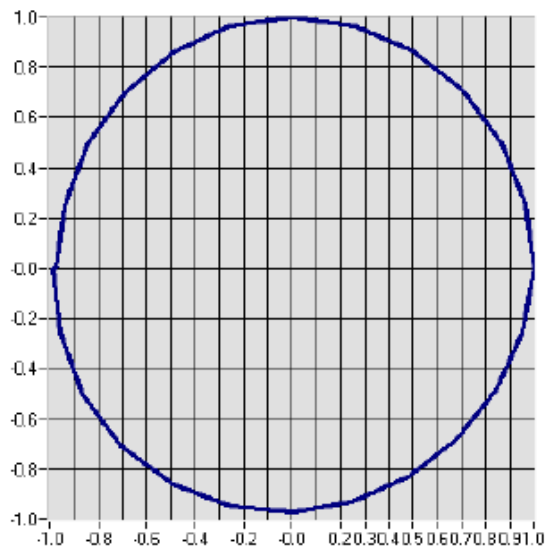

Isotropy:  $\pm 2.19\%$  ( $\pm 0.10\text{dB}$ )

**6 LIST OF EQUIPMENT**

Equipment Summary Sheet				
Equipment Description	Manufacturer / Model	Identification No.	Current Calibration Date	Next Calibration Date
HAC positioning ruler	Satimo	TABH12 SN 42/09	Validated. No cal required.	Validated. No cal required.
COMOHAC Test Bench	Version 2	NA	Validated. No cal required.	Validated. No cal required.
Network Analyzer	Rhode & Schwarz ZVA	SN100132	02/2013	02/2016
Reference Probe	Satimo	EPH28 SN 08/11	10/2013	10/2014
Reference Probe	Satimo	HPH38 SN31/10	10/2013	10/2014
Multimeter	Keithley 2000	1188656	12/2013	12/2016
Signal Generator	Agilent E4438C	MY49070581	12/2013	12/2016
Amplifier	Aethercomm	SN 046	Characterized prior to test. No cal required.	Characterized prior to test. No cal required.
Power Meter	HP E4418A	US38261498	12/2013	12/2016
Power Sensor	HP ECP-E26A	US37181460	12/2013	12/2016
Directional Coupler	Narda 4216-20	01386	Characterized prior to test. No cal required.	Characterized prior to test. No cal required.
Waveguide	Mega Industries	069Y7-158-13-712	Validated. No cal required.	Validated. No cal required.
Waveguide Transition	Mega Industries	069Y7-158-13-701	Validated. No cal required.	Validated. No cal required.
Waveguide Termination	Mega Industries	069Y7-158-13-701	Validated. No cal required.	Validated. No cal required.
Temperature / Humidity Sensor	Control Company	11-661-9	8/2012	8/2015



## HAC Reference Dipole Calibration Report

Ref: ACR.301.3.13.SATU.A

### **SIEMIC TESTING AND CERTIFICATION SERVICES**

**SUITE 311, BUILDING 1, SECTION 30 ,NO.2 KEFA ROAD,  
SCIENCE AND TECHNOLOGY PARK  
NAN SHAN DISTRICT, SHENZHEN 518057 , GUANGDONG  
,P.R.C.**

### **SATIMO COMOHAC REFERENCE DIPOLE**

**FREQUENCY: 800-950MHZ  
SERIAL NO.: SN 24/11 DHA31**

**Calibrated at SATIMO US  
2105 Barrett Park Dr. • Kennesaw, GA 30144**





**10/28/2014**

#### *Summary:*

This document presents the method and results from an accredited HAC reference dipole calibration performed in SATIMO USA using the COMOHAC test bench. All calibration results are traceable to national metrology institutions.



	<i>Name</i>	<i>Function</i>	<i>Date</i>	<i>Signature</i>
<i>Prepared by :</i>	Jérôme LUC	Product Manager	10/28/2014	
<i>Checked by :</i>	Jérôme LUC	Product Manager	10/28/2014	
<i>Approved by :</i>	Kim RUTKOWSKI	Quality Manager	10/28/2014	

	<i>Customer Name</i>
<i>Distribution :</i>	SIEMIC Testing and Certification Services

<i>Issue</i>	<i>Date</i>	<i>Modifications</i>
A	10/28/2013	Initial release

Test Report	15070097-HAC-RF
Page	46 of 59



**TABLE OF CONTENTS**

1 Introduction..... 4

2 Device Under Test..... 4

3 Product Description ..... 4

    3.1 General Information ..... 4

4 Measurement Method ..... 4

    4.1 Return Loss Requirements ..... 5

    4.2 Reference Dipole Calibration ..... 5

5 Measurement Uncertainty ..... 5

    5.1 Return Loss ..... 5

    5.2 Validation Measurement ..... 5

6 Calibration Measurement Results ..... 6

    6.1 Return Loss ..... 6

    6.2 Validation measurement ..... 6

7 List of Equipment ..... 8



**1 INTRODUCTION**

This document contains a summary of the requirements set forth by the ANSI C63.19 standard for reference dipoles used for HAC measurement system validations and the measurements that were performed to verify that the product complies with the fore mentioned standards.

**2 DEVICE UNDER TEST**

Device Under Test	
Device Type	COMOHAC 800-950 MHz REFERENCE DIPOLE
Manufacturer	Satimo
Model	SIDB835
Serial Number	SN 24/11 DHA31
Product Condition (new / used)	Used

A yearly calibration interval is recommended.

**3 PRODUCT DESCRIPTION**

**3.1 GENERAL INFORMATION**

Satimo’s COMOHAC Validation Dipoles are built in accordance to the ANSI C63.19 standard. The product is designed for use with the COMOHAC system only.

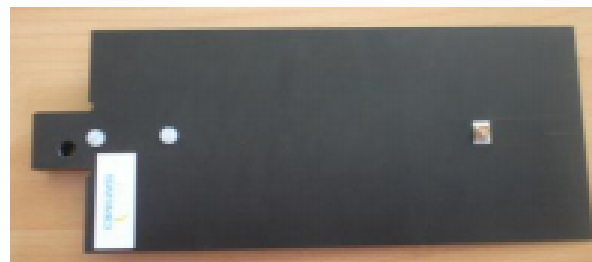

Figure 1 – Satimo COMOHAC Validation Dipole

**4 MEASUREMENT METHOD**

The ANSI C63.19 standard outlines the requirements for reference dipoles to be used for system validation measurements. The following measurements were performed to verify that the product complies with the fore mentioned standard.



#### 4.1 RETURN LOSS REQUIREMENTS

The dipole used for HAC system validation measurements and checks must have a return loss of -10 dB or better. The return loss measurement shall be performed in free space.

#### 4.2 REFERENCE DIPOLE CALIBRATION

The IEEE ANSI C63-19 standard states that the dipole used for validation measurements and checks must be scanned with the E and H field probe, with the dipole 10 mm below the probe. The E and H field strength plots are compared to the simulation results obtained by SATIMO.

### 5 MEASUREMENT UNCERTAINTY

All uncertainties listed below represent an expanded uncertainty expressed at approximately the 95% confidence level using a coverage factor of k=2, traceable to the Internationally Accepted Guides to Measurement Uncertainty.

#### 5.1 RETURN LOSS

The following uncertainties apply to the return loss measurement:

Frequency band	Expanded Uncertainty on Gain
400-6000MHz	0.1 dB

#### 5.2 VALIDATION MEASUREMENT

The guideline outlined in the IEEE ANSI C63.19 standard was followed to generate the measurement uncertainty for validation measurements.

Uncertainty analysis of the probe calibration in waveguide					
ERROR SOURCES	Uncertainty value (%)	Probability Distribution	Divisor	Uncertainty (dB)	Standard Uncertainty (%)
RF reflections	0.1	R	$\sqrt{3}$	0.06	
Field probe conv. Factor	0.4	R	$\sqrt{3}$	0.23	
Field probe anisotropy	0.25	R	$\sqrt{3}$	0.14	
Positioning accuracy	0.2	R	$\sqrt{3}$	0.12	
Probe cable placement	0.1	R	$\sqrt{3}$	0.06	
System repeatability	0.2	R	$\sqrt{3}$	0.12	
EUT repeatability	0.4	N	1	0.40	
Combined standard uncertainty				0.52	
Expanded uncertainty 95 % confidence level k = 2				1.00	13.0





## 6 CALIBRATION MEASUREMENT RESULTS

### 6.1 RETURN LOSS

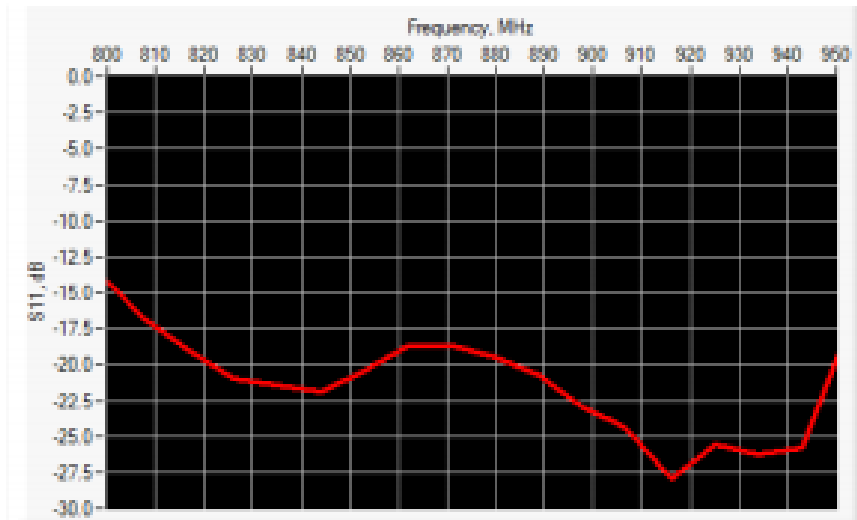

Frequency (MHz)	Worst Case Return Loss (dB)	Requirement (dB)
800-950 MHz	-14.60	-10

### 6.2 VALIDATION MEASUREMENT

The IEEE ANSI C63.19 standard states that the system validation measurements must be performed using a reference dipole meeting the fore mentioned return loss requirements. The system validations measurement results are then compared to SATIMO’s simulated results.

#### Measurement Condition

Software Version	OpenHAC V2
HAC positioning ruler	SN 42/09 TABH12
E-Field probe	SN 08/11 EPH28
H-Field probe	SN 31/10 HPH38
Distance between dipole and sensor center	10 mm
E-field scan size	X=150mm/Y=20mm
H-field scan size	X=40mm/Y=20mm
Scan resolution	dx=5mm/dy=5mm
Frequency	835 MHz
Input power	20 dBm
Lab Temperature	21°C
Lab Humidity	45%



**Measurement Result**

	Measured	Internal Requirement
<b>E field (V/m)</b>	218.70	220.4
<b>H field (A/m)</b>	0.45	0.445

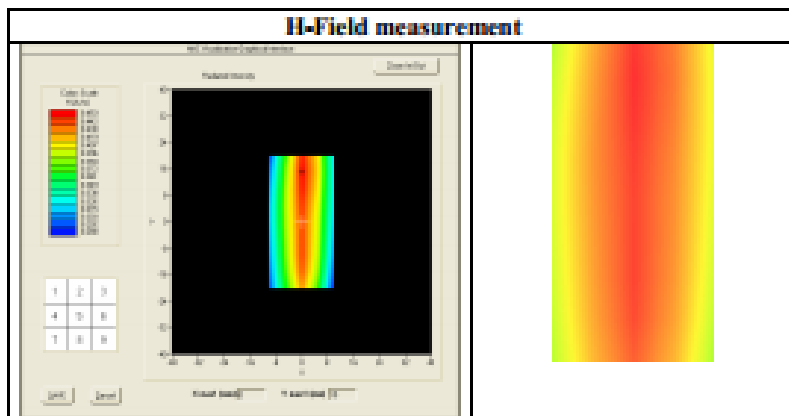
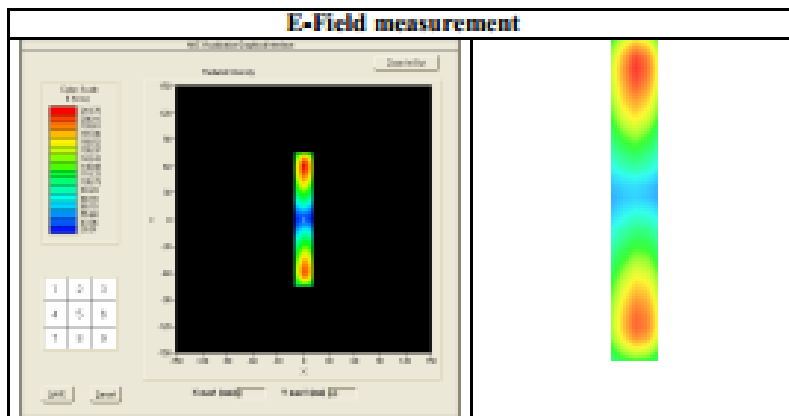



## 7 LIST OF EQUIPMENT

Equipment Summary Sheet				
Equipment Description	Manufacturer / Model	Identification No.	Current Calibration Date	Next Calibration Date
HAC positioning ruler	Satimo	TABH12 SN 42/09	Validated. No cal required.	Validated. No cal required.
COMOHAC Test Bench	Version 2	NA	Validated. No cal required.	Validated. No cal required.
Network Analyzer	Rhode & Schwarz ZVA	SN100132	02/2013	02/2016
Reference Probe	Satimo	EPH28 SN 08/11	Characterized prior to test. No cal required.	Characterized prior to test. No cal required.
Reference Probe	Satimo	HPH38 SN31/10	Characterized prior to test. No cal required.	Characterized prior to test. No cal required.
Multimeter	Keithley 2000	1188656	11/2013	11/2016
Signal Generator	Agilent E4438C	MY49070581	12/2013	12/2016
Amplifier	Aethercomm	SN 046	Characterized prior to test. No cal required.	Characterized prior to test. No cal required.
Power Meter	HP E4418A	US38261498	11/2013	11/2016
Power Sensor	HP ECP-E26A	US37181460	11/2013	11/2016
Directional Coupler	Narda 4216-20	01386	Characterized prior to test. No cal required.	Characterized prior to test. No cal required.
Temperature and Humidity Sensor	Control Company	11-661-8	3/2014	3/2016



## HAC Reference Dipole Calibration Report

Ref : ACR.301.4.13.SATUA

### **SIEMIC TESTING AND CERTIFICATION SERVICES**

**SUITE 311, BUILDING 1, SECTION 30 ,NO.2 KEFA ROAD,  
SCIENCE AND TECHNOLOGY PARK  
NAN SHAN DISTRICT, SHENZHEN 518057 , GUANGDONG  
,P.R.C.**

### **SATIMO COMOHAC REFERENCE DIPOLE**

**FREQUENCY: 1700-2000MHZ**

**SERIAL NO.: SN 24/11 DHB32**

**Calibrated at SATIMO US**

**2105 Barrett Park Dr. - Kennesaw, GA 30144**



**10/28/2014**

#### *Summary:*

This document presents the method and results from an accredited HAC reference dipole calibration performed in SATIMO USA using the COMOHAC test bench. All calibration results are traceable to national metrology institutions.



	<i>Name</i>	<i>Function</i>	<i>Date</i>	<i>Signature</i>
<i>Prepared by :</i>	Jérôme LUC	Product Manager	10/28/2014	<i>JS</i>
<i>Checked by :</i>	Jérôme LUC	Product Manager	10/28/2014	<i>JS</i>
<i>Approved by :</i>	Kim RUTKOWSKI	Quality Manager	10/28/2014	<i>Kim Rutkowski</i>

	<i>Customer Name</i>
<i>Distribution :</i>	SIEMIC Testing and Certification Services

<i>Issue</i>	<i>Date</i>	<i>Modifications</i>
A	10/28/2013	Initial release



**TABLE OF CONTENTS**

1 Introduction.....4

2 Device Under Test.....4

3 Product Description .....4

    3.1 General Information ..... 4

4 Measurement Method .....4

    4.1 Return Loss Requirements ..... 5

    4.2 Reference Dipole Calibration ..... 5

5 Measurement Uncertainty .....5

    5.1 Return Loss ..... 5

    5.2 Validation Measurement ..... 5

6 Calibration Measurement Results.....6

    6.1 Return Loss ..... 6

    6.2 Validation measurement ..... 6

7 List of Equipment .....8

## 1 INTRODUCTION

This document contains a summary of the requirements set forth by the ANSI C63.19 standard for reference dipoles used for HAC measurement system validations and the measurements that were performed to verify that the product complies with the fore mentioned standards.

## 2 DEVICE UNDER TEST

Device Under Test	
Device Type	COMOHAC 1700-2000 MHz REFERENCE DIPOLE
Manufacturer	Satimo
Model	SIDB1900
Serial Number	SN 24/11 DHB32
Product Condition (new / used)	Used

A yearly calibration interval is recommended.

## 3 PRODUCT DESCRIPTION

### 3.1 GENERAL INFORMATION

Satimo's COMOHAC Validation Dipoles are built in accordance to the ANSI C63.19 standard. The product is designed for use with the COMOHAC system only.



Figure 1 – Satimo COMOHAC Validation Dipole

## 4 MEASUREMENT METHOD

The ANSI C63.19 standard outlines the requirements for reference dipoles to be used for system validation measurements. The following measurements were performed to verify that the product complies with the fore mentioned standard.

#### 4.1 RETURN LOSS REQUIREMENTS

The dipole used for HAC system validation measurements and checks must have a return loss of -10 dB or better. The return loss measurement shall be performed in free space.

#### 4.2 REFERENCE DIPOLE CALIBRATION

The IEEE ANSI C63-19 standard states that the dipole used for validation measurements and checks must be scanned with the E and H field probe, with the dipole 10 mm below the probe. The E and H field strength plots are compared to the simulation results obtained by SATIMO.

### 5 MEASUREMENT UNCERTAINTY

All uncertainties listed below represent an expanded uncertainty expressed at approximately the 95% confidence level using a coverage factor of  $k=2$ , traceable to the Internationally Accepted Guides to Measurement Uncertainty.

#### 5.1 RETURN LOSS

The following uncertainties apply to the return loss measurement:

Frequency band	Expanded Uncertainty on Gain
400-6000MHz	0.1 dB

#### 5.2 VALIDATION MEASUREMENT

The guideline outlined in the IEEE ANSI C63.19 standard was followed to generate the measurement uncertainty for validation measurements.

Uncertainty analysis of the probe calibration in waveguide					
ERROR SOURCES	Uncertainty value (%)	Probability Distribution	Divisor	Uncertainty (dB)	Standard Uncertainty (%)
RF reflections	0.1	R	$\sqrt{3}$	0.06	
Field probe corr. Factor	0.4	R	$\sqrt{3}$	0.23	
Field probe anisotropy	0.25	R	$\sqrt{3}$	0.14	
Positioning accuracy	0.2	R	$\sqrt{3}$	0.12	
Probe cable placement	0.1	R	$\sqrt{3}$	0.06	
System repeatability	0.2	R	$\sqrt{3}$	0.12	
EUT repeatability	0.4	N	1	0.40	
<b>Combined standard uncertainty</b>				<b>0.52</b>	
<b>Expanded uncertainty 95 % confidence level <math>k = 2</math></b>				<b>1.00</b>	<b>13.0</b>





## 6 CALIBRATION MEASUREMENT RESULTS

### 6.1 RETURN LOSS

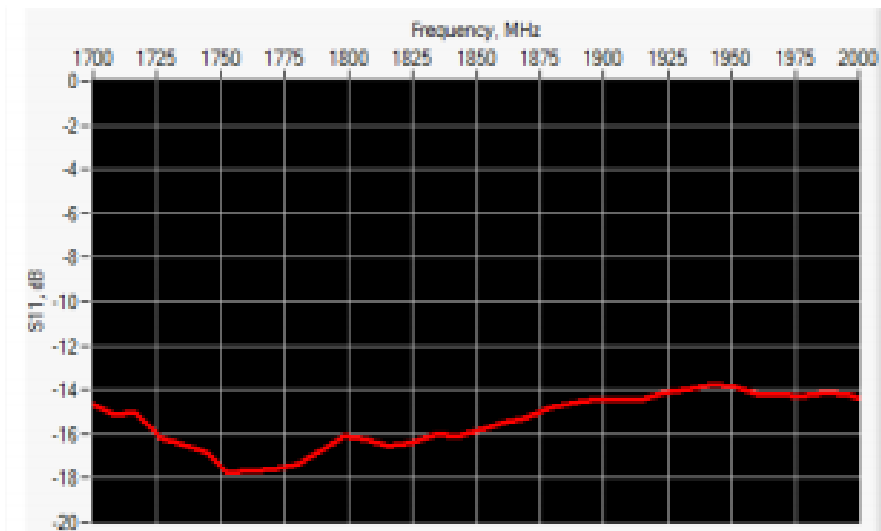

Frequency (MHz)	Worst Case Return Loss (dB)	Requirement (dB)
1700-2000 MHz	-13.72	-10

### 6.2 VALIDATION MEASUREMENT

The IEEE ANSI C63.19 standard states that the system validation measurements must be performed using a reference dipole meeting the fore mentioned return loss requirements. The system validations measurement results are then compared to SATIMO's simulated results.

#### Measurement Condition

Software Version	OpenHAC V2
HAC positioning ruler	SN 42/09 TABH12
E-Field probe	SN 08/11 EPH28
H-Field probe	SN 31/10 HPH38
Distance between dipole and sensor center	10 mm
E-field scan size	X=150mm/Y=20mm
H-field scan size	X=40mm/Y=20mm
Scan resolution	dx=5mm/dy=5mm
Frequency	1900 MHz
Input power	20 dBm
Lab Temperature	21°C
Lab Humidity	45%

**Measurement Result**

	<b>Measured</b>	<b>Internal Requirement</b>
<b>E field (V/m)</b>	<b>147.65</b>	<b>153.4</b>
<b>H field (A/m)</b>	<b>0.47</b>	<b>0.445</b>

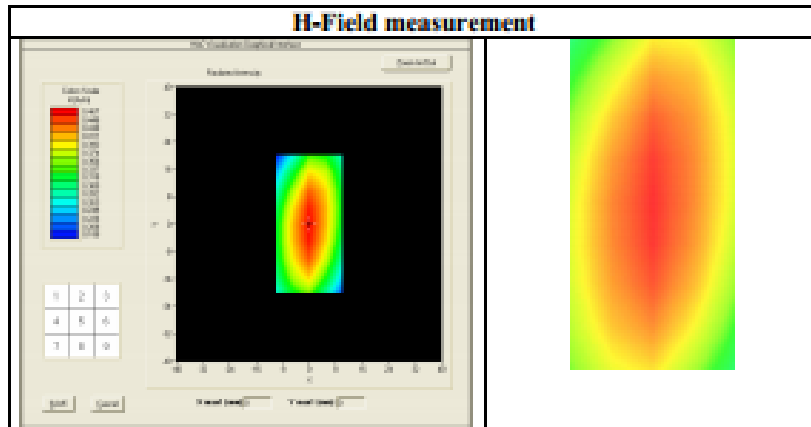
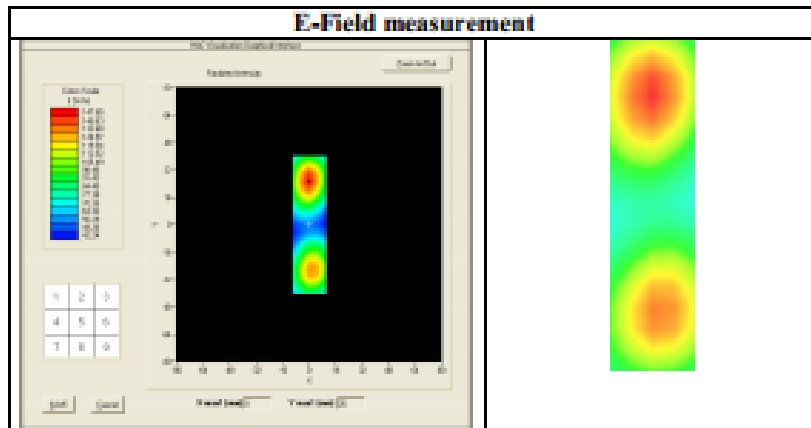



## 7 LIST OF EQUIPMENT

Equipment Summary Sheet				
Equipment Description	Manufacturer / Model	Identification No.	Current Calibration Date	Next Calibration Date
HAC positioning ruler	Satimo	TABH12 SN 42/09	Validated. No cal required.	Validated. No cal required.
COMOHAC Test Bench	Version 2	NA	Validated. No cal required.	Validated. No cal required.
Network Analyzer	Rhode & Schwarz ZVA	SN100132	02/2013	02/2016
Reference Probe	Satimo	EPH28 SN 08/11	Characterized prior to test. No cal required.	Characterized prior to test. No cal required.
Reference Probe	Satimo	HPH38 SN31/10	Characterized prior to test. No cal required.	Characterized prior to test. No cal required.
Multimeter	Keithley 2000	1188656	11/2013	11/2016
Signal Generator	Agilent E4438C	MY49070581	12/2013	12/2016
Amplifier	Aethercomm	SN 046	Characterized prior to test. No cal required.	Characterized prior to test. No cal required.
Power Meter	HP E4418A	US38261496	11/2013	11/2016
Power Sensor	HP ECP-E26A	US37181460	11/2013	11/2016
Directional Coupler	Narda 4216-20	01386	Characterized prior to test. No cal required.	Characterized prior to test. No cal required.
Temperature and Humidity Sensor	Control Company	11-661-9	3/2014	3/2016