

RF TEST REPORT



Report No.: 15071133-FCC-R2

Supersede Report No.: N/A

Applicant	Verykool USA Inc	
Product Name	Mobile Phone	
Model No.	SL4050	
Serial No.	N/A	
Test Standard	FCC Part 15.247: 2014, ANSI C63.10: 2013	
Test Date	November 25 to December 15, 2015	
Issue Date	December 17, 2015	
Test Result	<input checked="" type="checkbox"/> Pass <input type="checkbox"/> Fail	
Equipment complied with the specification	<input checked="" type="checkbox"/>	
Equipment did not comply with the specification	<input type="checkbox"/>	
<i>Winnie Zhang</i>	<i>David Huang</i>	
Winnie Zhang Test Engineer	David Huang Checked By	
This test report may be reproduced in full only Test result presented in this test report is applicable to the tested sample only		

Issued by:

SIEMIC (SHENZHEN-CHINA) LABORATORIES

Zone A, Floor 1, Building 2 Wan Ye Long Technology Park

South Side of Zhoushi Road, Bao' an District, Shenzhen, Guangdong China 518108

Phone: +86 0755 2601 4629801 Email: China@siemic.com.cn

Laboratories Introduction

SIEMIC, headquartered in the heart of Silicon Valley, with superior facilities in US and Asia, is one of the leading independent testing and certification facilities providing customers with one-stop shop services for Compliance Testing and Global Certifications.



In addition to testing and certification, SIEMIC provides initial design reviews and compliance management throughout a project. Our extensive experience with China, Asia Pacific, North America, European, and International compliance requirements, assures the fastest, most cost effective way to attain regulatory compliance for the global markets.

Accreditations for Conformity Assessment

Country/Region	Scope
USA	EMC, RF/Wireless, SAR, Telecom
Canada	EMC, RF/Wireless, SAR, Telecom
Taiwan	EMC, RF, Telecom, SAR, Safety
Hong Kong	RF/Wireless, SAR, Telecom
Australia	EMC, RF, Telecom, SAR, Safety
Korea	EMI, EMS, RF, SAR, Telecom, Safety
Japan	EMI, RF/Wireless, SAR, Telecom
Singapore	EMC, RF, SAR, Telecom
Europe	EMC, RF, SAR, Telecom, Safety

Test Report	15071133-FCC-R2
Page	3 of 59

This page has been left blank intentionally.

CONTENTS

1. REPORT REVISION HISTORY	5
2. CUSTOMER INFORMATION	5
3. TEST SITE INFORMATION.....	5
4. EQUIPMENT UNDER TEST (EUT) INFORMATION.....	6
5. TEST SUMMARY	9
6. MEASUREMENTS, EXAMINATION AND DERIVED RESULTS	10
6.1 ANTENNA REQUIREMENT.....	10
6.2 CHANNEL SEPARATION	11
6.3 20DB BANDWIDTH	15
6.4 PEAK OUTPUT POWER.....	19
6.5 NUMBER OF HOPPING CHANNEL.....	23
6.6 TIME OF OCCUPANCY (DWEEL TIME)	25
6.7 BAND EDGE.....	29
6.8 AC POWER LINE CONDUCTED EMISSIONS.....	37
6.9 RADIATED EMISSIONS.....	43
ANNEX A. TEST INSTRUMENT.....	48
ANNEX B. EUT AND TEST SETUP PHOTOGRAPHS.....	49
ANNEX C. TEST SETUP AND SUPPORTING EQUIPMENT.....	54
ANNEX D. USER MANUAL / BLOCK DIAGRAM / SCHEMATICS / PARTLIST	58
ANNEX E. DECLARATION OF SIMILARITY.....	59

1. Report Revision History

Report No.	Report Version	Description	Issue Date
15071133-FCC-R2	NONE	Original	December 17, 2015

2. Customer information

Applicant Name	Verykool USA Inc
Applicant Add	3636 Nobel Drive, Suite 325, San Diego, CA 92122 USA
Manufacturer	HUAWO TECHNOLOGY LIMITED
Manufacturer Add	9A,Gongkan building,Technology south 8th road,High-Tech Park,Nanshan district,Shenzhen

3. Test site information

Lab performing tests	SIEMIC (Shenzhen-China) LABORATORIES
Lab Address	Zone A, Floor 1, Building 2 Wan Ye Long Technology Park South Side of Zhoushi Road, Bao' an District, Shenzhen, Guangdong China 518108
FCC Test Site No.	718246
IC Test Site No.	4842E-1
Test Software	Radiated Emission Program-To Shenzhen v2.0

4. Equipment under Test (EUT) Information

Description of EUT:	Mobile Phone
Main Model:	SL4050
Serial Model:	N/A
Date EUT received:	November 24,2015
Test Date(s):	November 25 to December 15, 2015
Equipment Category :	DSS
Antenna Gain:	<p>GSM850: 3.9dBi PCS1900: 4.47dBi UMTS-FDD Band V: 3.9dBi UMTS-FDD Band II: 4.47dBi UMTS-FDD Band IV: 3.15dBi Bluetooth/BLE:5.49dBi WIFI: 5.35dBi LTE Band 2: 3.9dBi LTE Band 4: 5.2dBi LTE Band 5: 3.9dBi LTE Band 7: 4.0dBi GPS: 3.97dBi</p>
Type of Modulation:	<p>GSM / GPRS: GMSK EGPRS: GMSK, 8PSK UMTS-FDD: QPSK, 16QAM 802.11b/g/n: DSSS, OFDM Bluetooth: GFSK, π /4DQPSK, 8DPSK BLE: GFSK LTE Band: QPSK, 16QAM GPS:BPSK</p>
RF Operating Frequency (ies):	<p>GSM850 TX: 824.2 ~ 848.8 MHz; RX: 869.2 ~ 893.8 MHz PCS1900 TX: 1850.2 ~ 1909.8 MHz; RX: 1930.2 ~ 1989.8 MHz UMTS-FDD Band V TX: 826.4 ~ 846.6 MHz; RX: 871.4 ~ 891.6 MHz</p>

UMTS-FDD Band II TX:1852.4 ~ 1907.6 MHz;
 RX: 1932.4 ~ 1987.6 MHz
 UMTS-FDD Band IV TX:1712.4 ~ 1752.6 MHz;
 WIFI:802.11b/g/n(20M): 2412-2462 MHz
 WIFI:802.11n(40M): 2422-2452 MHz
 Bluetooth& BLE: 2402-2480 MHz
 LTE Band 2 TX: 1852.5 ~ 1907.5 MHz; RX : 1932.5 ~ 1987.5 MHz
 LTE Band 4 TX: 1712.5 ~ 1752.5 MHz; RX : 2112.5 ~ 2152.5 MHz
 LTE Band 5 TX: 826.5 ~ 846.5 MHz; RX : 871.5 ~ 891.5 MHz
 LTE Band 7 TX: 2502.5 ~ 2567.5 MHz; RX : 2622.5 ~ 2687.5 MHz
 GPS RX:1575.42 MHz

Max. Output Power: 8.290dBm

Number of Channels: GSM 850: 124CH
 PCS1900: 299CH
 UMTS-FDD Band V : 102CH
 UMTS-FDD Band II : 277CH
 UMTS-FDD Band IV: 202CH
 WIFI :802.11b/g/n(20M): 11CH
 WIFI :802.11n(40M): 7CH
 Bluetooth: 79CH
 BLE: 40CH
 GPS:1CH

Input Power: Battery:
 Model:395254
 Standard Voltage:DC3.7V
 Rated Capacity:1400mAh,5.18Wh
 Limited charger coltage:4.2V
 Adapter:
 Model:DU050050USB01
 Input: AC100-240V; 50/60Hz; 0.2A
 Output: DC 5.0V,500mA

Port: Power Port, Earphone Port, USB Port

Trade Name : veryKool

Test Report	15071133-FCC-R2
Page	8 of 59

GPRS/EGPRS Multi-slot class 8/10/12

FCC ID: WA6SL4050

5. Test Summary

The product was tested in accordance with the following specifications.

All testing has been performed according to below product classification:

FCC Rules	Description of Test	Result
§15.203	Antenna Requirement	Compliance
§15.247(a)(1)	Channel Separation	Compliance
§15.247(a)(1)	20 dB Bandwidth	Compliance
§15.247(b)(1)	Peak Output Power	Compliance
§15.247(a)(1)(iii)	Number of Hopping Channel	Compliance
§15.247(a)(1)(iii)	Time of Occupancy (Dwell Time)	Compliance
§15.247(d)	Band Edge	Compliance
§15.207(a)	AC Line Conducted Emissions	Compliance
§15.205, §15.209, §15.247(d)	Radiated Emissions	Compliance

Measurement Uncertainty

Emissions		
Test Item	Description	Uncertainty
Band Edge and Radiated Spurious Emissions	Confidence level of approximately 95% (in the case where distributions are normal), with a coverage factor of 2 (for EUTs < 0.5m X 0.5m X 0.5m)	+5.6dB/-4.5dB
-	-	-

6. Measurements, Examination And Derived Results

6.1 Antenna Requirement

Applicable Standard

According to § 15.203, an intentional radiator shall be designed to ensure that no antenna other than that furnished by the responsible party shall be used with the device. The use of a permanently attached antenna or of an antenna that uses a unique coupling to the intentional radiator shall be considered sufficient to comply with the provisions of this section. The manufacturer may design the unit so that a broken antenna can be replaced by the user, but the user of a standard antenna jack or electrical connector is prohibited. The structure and application of the EUT were analyzed to determine compliance with section §15.203 of the rules. §15.203 state that the subject device must meet the following criteria:

- a. Antenna must be permanently attached to the unit.
- b. Antenna must use a unique type of connector to attach to the EUT.

Unit must be professionally installed, and installer shall be responsible for verifying that the correct antenna is employed with the unit.

And according to FCC 47 CFR section 15.247 (b), if the transmitting antennas of directional gain greater than 6dBi are used, the power shall be reduced by the amount in dB that the directional gain of the antenna exceeds 6 dBi.

Antenna Connector Construction

The EUT has 3 antennas:

A permanently attached PIFA antenna for Bluetooth/BLE/WIFI/GPS, the gain is 5.49dBi for Bluetooth and BLE, the gain is 5.35dBi for WIFI, the gain is 3.97dBi for GPS.

A permanently attached PIFA antenna for GSM /UMTS, the gain is 3.9dBi for GSM850, 4.47dBi for PCS1900, 3.9dBi for UMTS-FDD Band V, 4.47dBi for UMTS-FDD Band II, 3.15dBi for UMTS-FDD Band IV .

A permanently attached PIFA antenna for LTE, the gain is 3.9dBi for LTE Band 2, the gain is 5.2dBi for LTE Band 4, the gain is 3.9dBi for LTE Band 5, the gain is 4.0dBi for LTE Band 7.

The antenna meets up with the ANTENNA REQUIREMENT.

Result: Compliance.

6.2 Channel Separation

Temperature	24°C
Relative Humidity	53%
Atmospheric Pressure	1011mbar
Test date :	December 11, 2015
Tested By :	Winnie Zhang

Requirement(s):

Spec	Item	Requirement	Applicable
§ 15.247(a)(1)	a)	Channel Separation < 20dB BW and 20dB BW < 25KHz ; Channel Separation Limit=25KHz Chanel Separation < 20dB BW and 20dB BW > 25kHz ; Channel Separation Limit=2/3 20dB BW	<input checked="" type="checkbox"/>

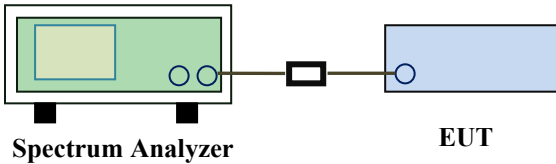
Test Setup	 <p>The diagram shows a green Spectrum Analyzer on the left connected by a black cable to a blue EUT on the right. The Spectrum Analyzer has two small circles on its front panel, and the EUT has one small circle on its front panel.</p>
------------	---

Test Procedure	<p>The test follows FCC Public Notice DA 00-705 Measurement Guidelines. Use the following spectrum analyzer settings:</p> <ul style="list-style-type: none"> - The EUT must have its hopping function enabled - Span = wide enough to capture the peaks of two adjacent channels - Resolution (or IF) Bandwidth (RBW) ≥ 1% of the span - Video (or Average) Bandwidth (VBW) ≥ RBW - Sweep = auto - Detector function = peak - Trace = max hold - Allow the trace to stabilize. Use the marker-delta function to determine the separation between the peaks of the adjacent channels. The limit is specified in one of the subparagraphs of this Section. Submit this plot.
----------------	--

Remark	
Result	<input checked="" type="checkbox"/> Pass <input type="checkbox"/> Fail

Test Data Yes N/A

Test Plot Yes (See below) N/A

Channel Separation measurement result

Type/ Modulation	CH	CH Freq (MHz)	CH Separation (MHz)	Limit (MHz)	Result
CH Separation GFSK	Low Channel	2402	1.005	0.687	Pass
	Adjacency Channel	2403			
	Mid Channel	2440	1.005	0.689	Pass
	Adjacency Channel	2441			
	High Channel	2480	1.005	0.690	Pass
	Adjacency Channel	2479			
CH Separation $\pi/4$ DQPSK	Low Channel	2402	1.005	0.871	Pass
	Adjacency Channel	2403			
	Mid Channel	2440	1.005	0.871	Pass
	Adjacency Channel	2441			
	High Channel	2480	1.005	0.874	Pass
	Adjacency Channel	2479			
CH Separation 8DPSK	Low Channel	2402	1.005	0.868	Pass
	Adjacency Channel	2403			
	Mid Channel	2440	1.005	0.869	Pass
	Adjacency Channel	2441			
	High Channel	2480	1.005	0.871	Pass
	Adjacency Channel	2479			

Test Plots

Channel Separation measurement result

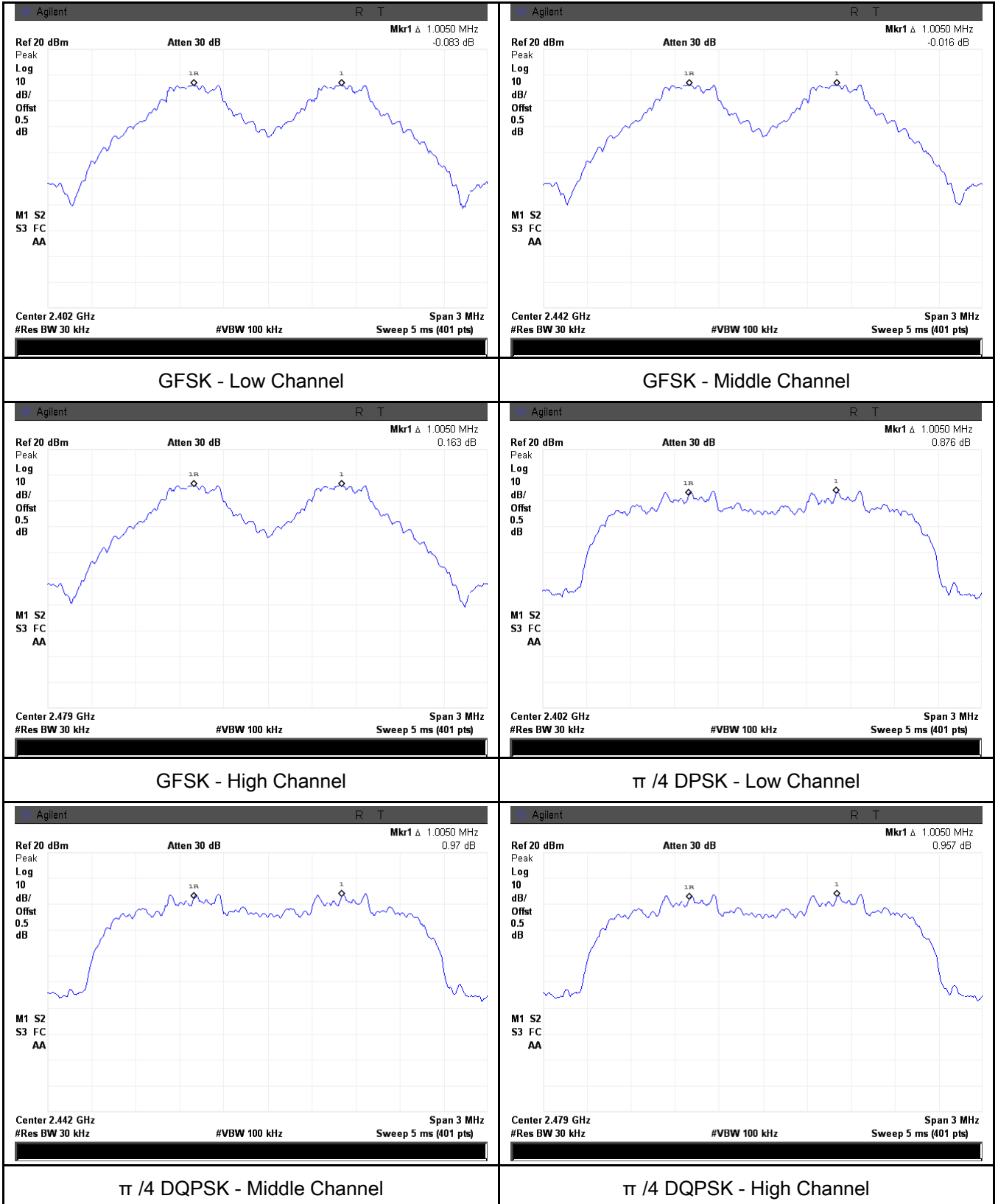

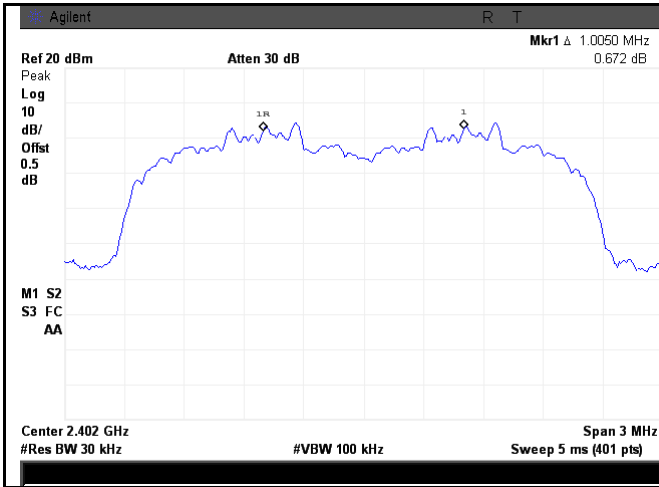

8DPSK - Low Channel

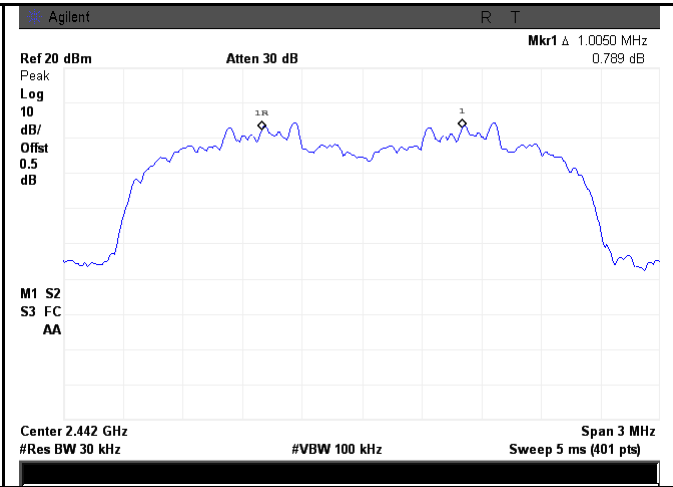

8DPSK - Middle Channel

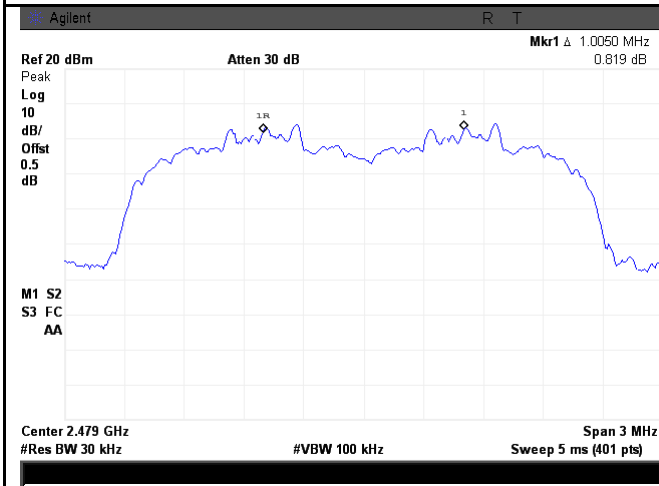

8DPSK - High Channel

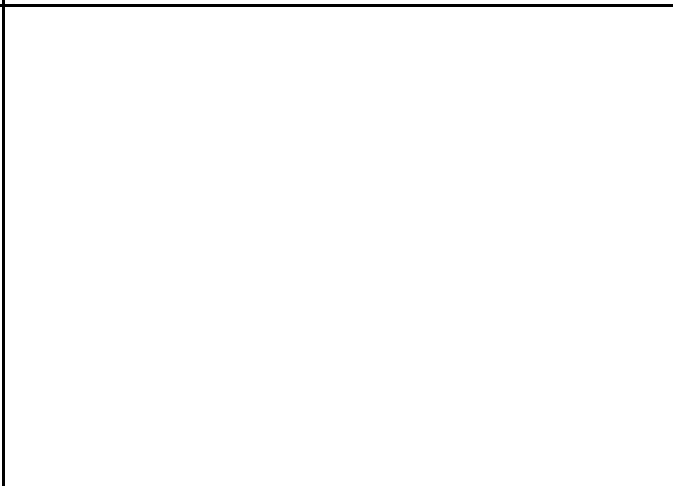

6.3 20dB Bandwidth

Temperature	24°C
Relative Humidity	53%
Atmospheric Pressure	1011mbar
Test date :	December 11, 2015
Tested By :	Winnie Zhang

Requirement(s):

Spec	Item	Requirement	Applicable
§15.247(a) (1)	a)	Frequency hopping systems shall have hopping channel carrier frequencies separated by a minimum of 25 kHz or the 20 dB bandwidth of the hopping channel, whichever is greater.	<input checked="" type="checkbox"/>

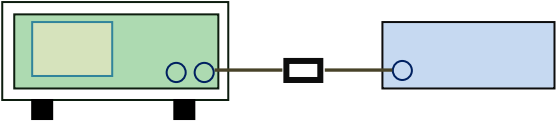
Test Setup	 <p style="text-align: center;">Spectrum Analyzer EUT</p>
------------	--

Test Procedure	<p>The test follows FCC Public Notice DA 00-705 Measurement Guidelines. Use the following spectrum analyzer settings:</p> <ul style="list-style-type: none"> - Span = approximately 2 to 3 times the 20 dB bandwidth, centered on a hopping channel - RBW \geq 1% of the 20 dB bandwidth - VBW \geq RBW - Sweep = auto - Detector function = peak - Trace = max hold. - The EUT should be transmitting at its maximum data rate. Allow the trace to stabilize. Use the marker-to-peak function to set the marker to the peak of the emission. Use the marker-delta function to measure 20 dB down one side of the emission. Reset the marker-delta function, and move the marker to the other side of the emission, until it is (as close as possible to) even with the reference
----------------	--

	marker level. The marker-delta reading at this point is the 20 dB bandwidth of the emission. If this value varies with different modes of operation (e.g., data rate, modulation format, etc.), repeat this test for each variation. The limit is specified in one of the subparagraphs of this Section. Submit this plot(s).
Remark	
Result	<input checked="" type="checkbox"/> Pass <input type="checkbox"/> Fail

Test Data Yes N/A

Test Plot Yes (See below) N/A

Measurement result

Modulation	CH	CH Freq (MHz)	20dB Bandwidth (MHz)	99% Occupied Bandwidth (MHz)
GFSK	Low	2402	1.030	0.8937
	Mid	2441	1.033	0.8936
	High	2480	1.035	0.8932
$\pi/4$ DQPSK	Low	2402	1.307	1.1691
	Mid	2441	1.307	1.1686
	High	2480	1.311	1.1693
8-DPSK	Low	2402	1.302	1.1755
	Mid	2441	1.304	1.1779
	High	2480	1.306	1.1773

Test Plots

20dB Bandwidth measurement result

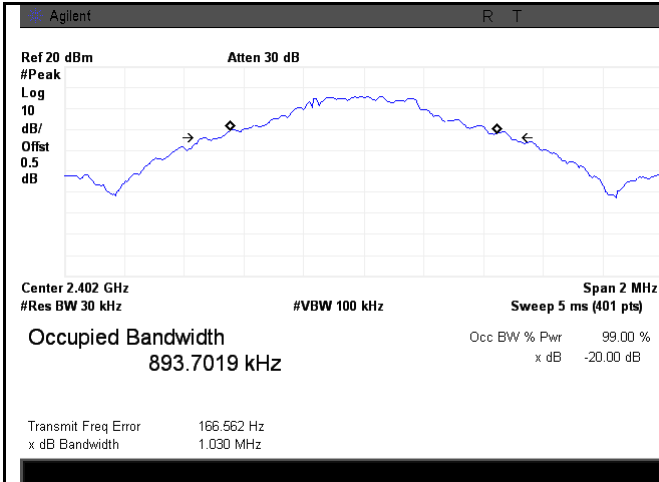

GFSK - Low Channel

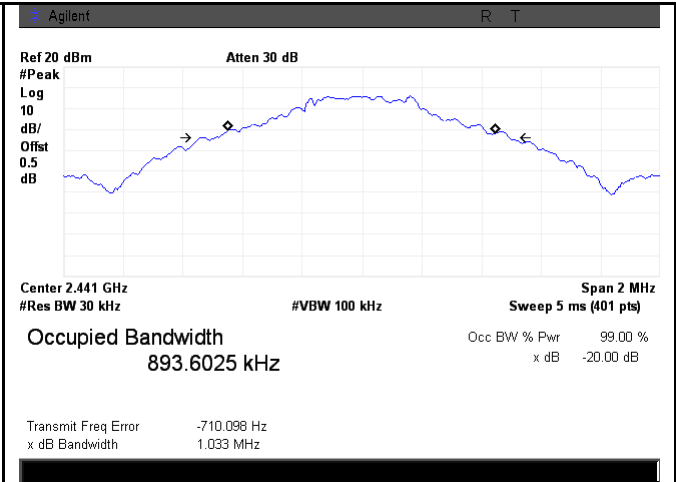

GFSK - Middle Channel

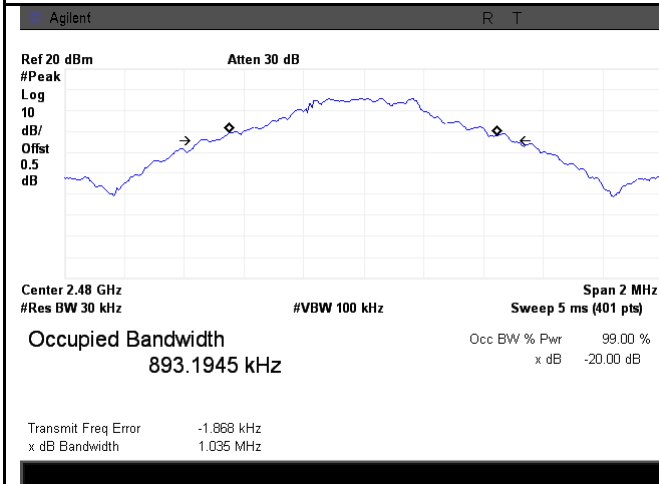

GFSK - High Channel

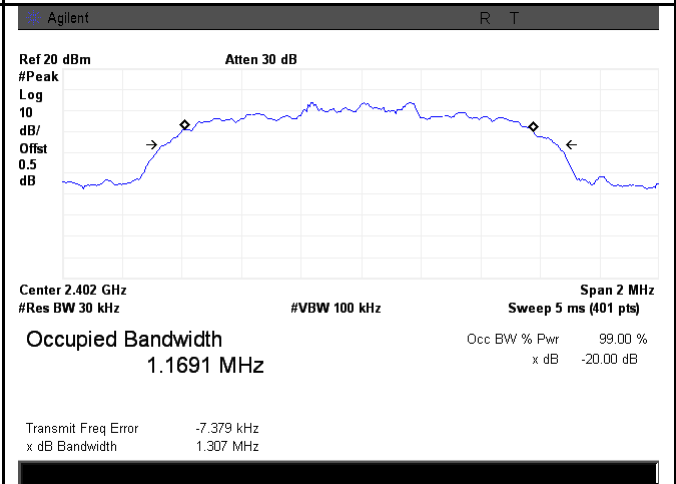

$\pi/4$ DPSK - Low Channel

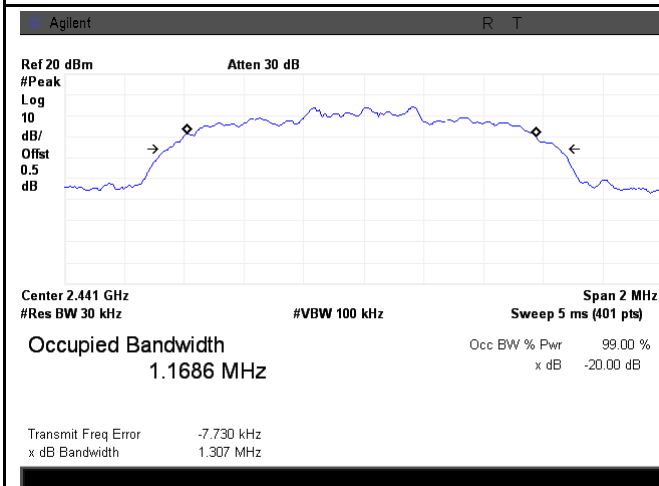

$\pi/4$ DQPSK - Middle Channel

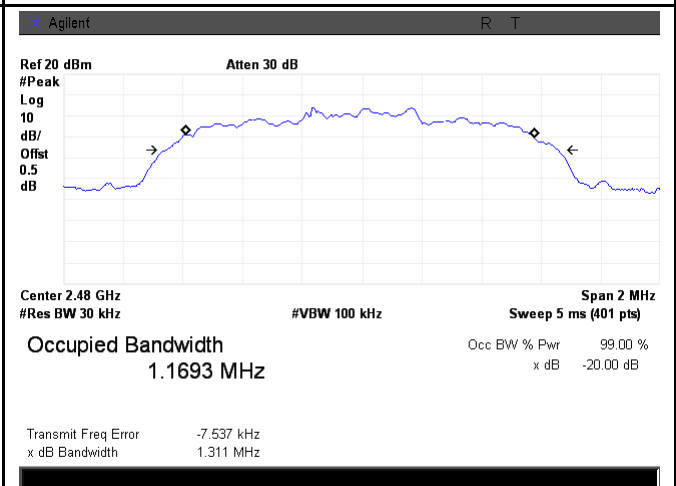

$\pi/4$ DQPSK - High Channel

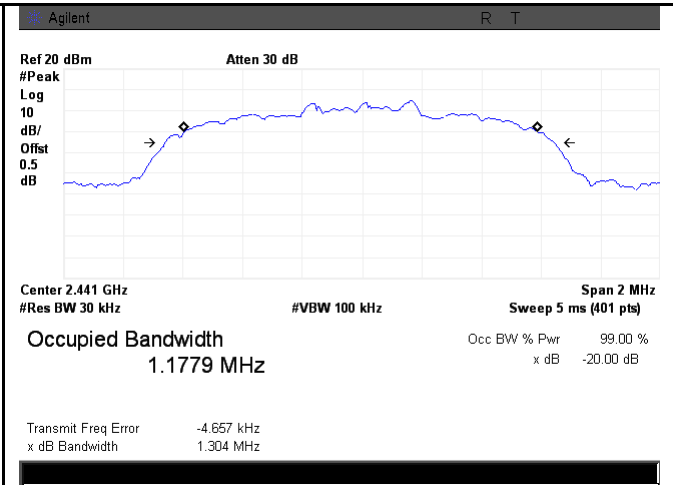
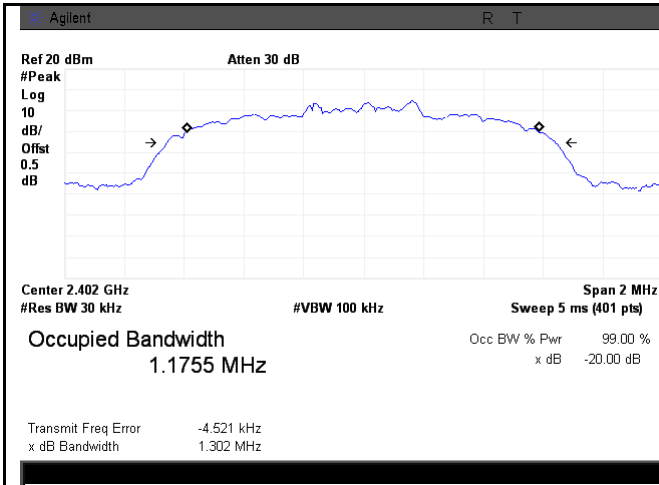

8DPSK - Low Channel

8DPSK - Middle Channel

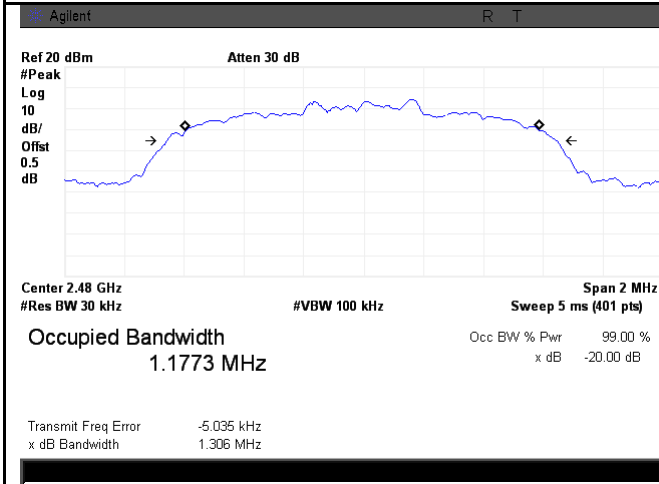

8DPSK - High Channel

6.4 Peak Output Power

Temperature	24°C
Relative Humidity	53%
Atmospheric Pressure	1011mbar
Test date :	December 11, 2015
Tested By :	Winnie Zhang

Requirement(s):

Spec	Item	Requirement	Applicable
§15.247(b) (3),RSS210 (A8.4)	a)	FHSS in 2400-2483.5MHz with ≥ 75 channels: ≤ 1 Watt	<input checked="" type="checkbox"/>
	b)	FHSS in 5725-5850MHz: ≤ 1 Watt	<input type="checkbox"/>
	c)	For all other FHSS in the 2400-2483.5MHz band: ≤ 0.125 Watt.	<input checked="" type="checkbox"/>
	d)	FHSS in 902-928MHz with ≥ 50 channels: ≤ 1 Watt	<input type="checkbox"/>
	e)	FHSS in 902-928MHz with ≥ 25 & <50 channels: ≤ 0.25 Watt	<input type="checkbox"/>
	f)	DTS in 902-928MHz, 2400-2483.5MHz ≤ 1 Watt	<input type="checkbox"/>

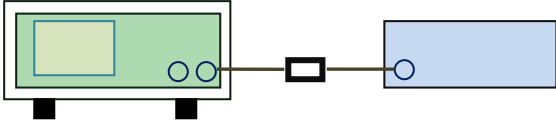
Test Setup	 <p style="text-align: center;">Spectrum Analyzer EUT</p>
------------	--

Test Procedure	<p>The test follows FCC Public Notice DA 00-705 Measurement Guidelines. Use the following spectrum analyzer settings:</p> <ul style="list-style-type: none"> - Span = approximately 5 times the 20 dB bandwidth, centered on a hopping channel - RBW > the 20 dB bandwidth of the emission being measured - VBW \geq RBW - Sweep = auto - Detector function = peak - Trace = max hold - Allow the trace to stabilize.
----------------	--

	<ul style="list-style-type: none"> - Use the marker-to-peak function to set the marker to the peak of the emission. The indicated level is the peak output power (see the note above regarding external attenuation and cable loss). The limit is specified in one of the subparagraphs of this Section. Submit this plot. A peak responding power meter may be used instead of a spectrum analyzer.
Remark	
Result	<input checked="" type="checkbox"/> Pass <input type="checkbox"/> Fail

Test Data Yes N/A
 Test Plot Yes (See below) N/A

Peak Output Power measurement result

Type	Modulation	CH	Freq (MHz)	Conducted Power (dBm)	Limit (mW)	Result
Output power	GFSK	Low	2402	8.270	125	Pass
		Mid	2441	8.290	125	Pass
		High	2480	8.020	125	Pass
	$\pi/4$ DQPSK	Low	2402	7.437	125	Pass
		Mid	2441	7.494	125	Pass
		High	2480	7.241	125	Pass
	8-DPSK	Low	2402	7.579	125	Pass
		Mid	2441	7.674	125	Pass
		High	2480	7.403	125	Pass

Test Plots

Output Power measurement result

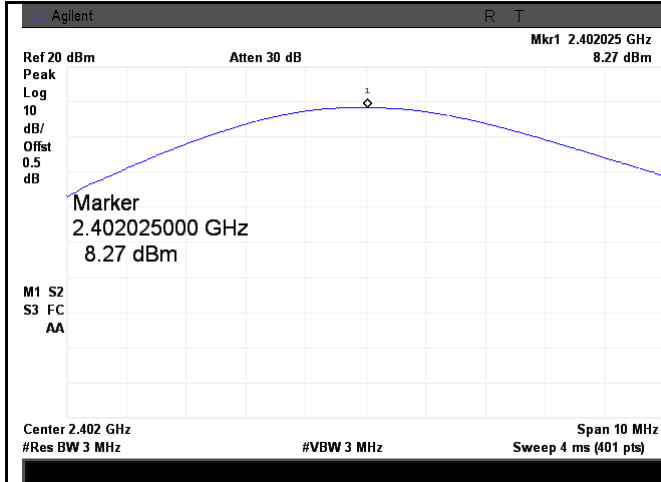

GFSK Output power - Low CH 2402

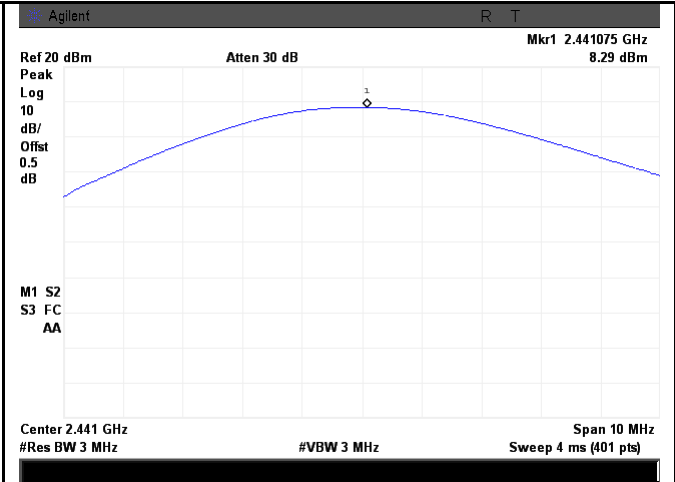

GFSK Output power - Mid CH 2441

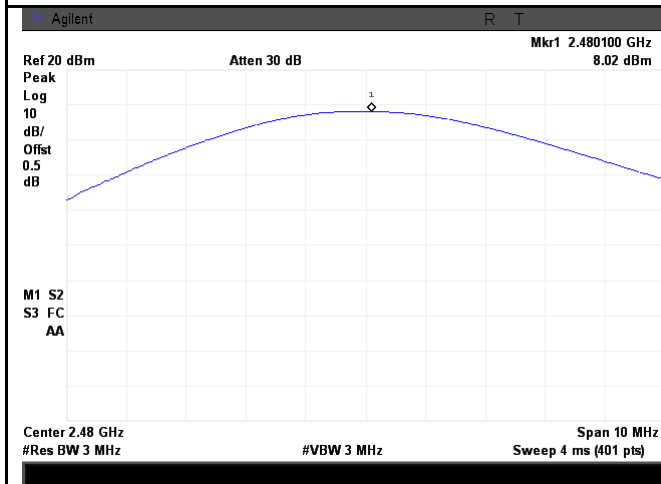

GFSK Output power - High CH 2480

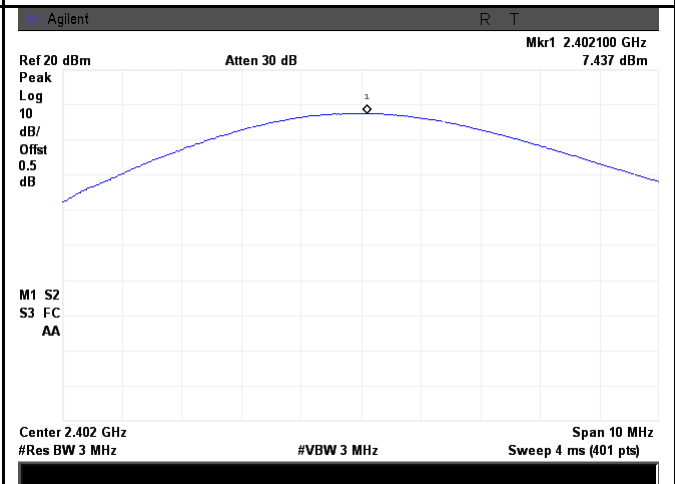

$\pi/4$ DQPSK Output power - Low CH 2402

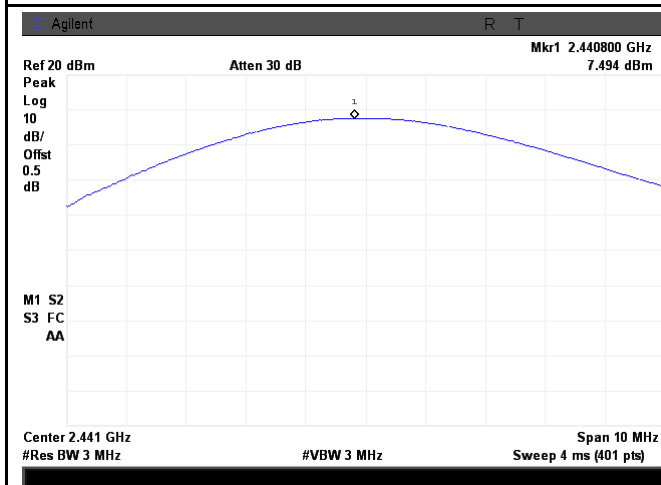

$\pi/4$ DQPSK Output power - Mid CH 2441

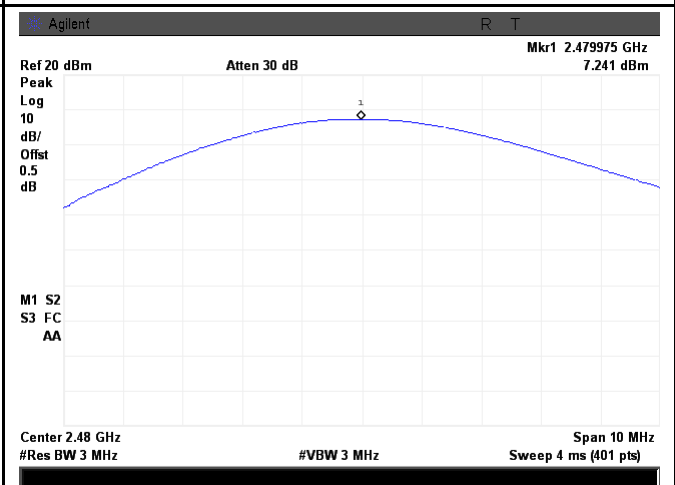

$\pi/4$ DQPSK Output power - High CH 2480

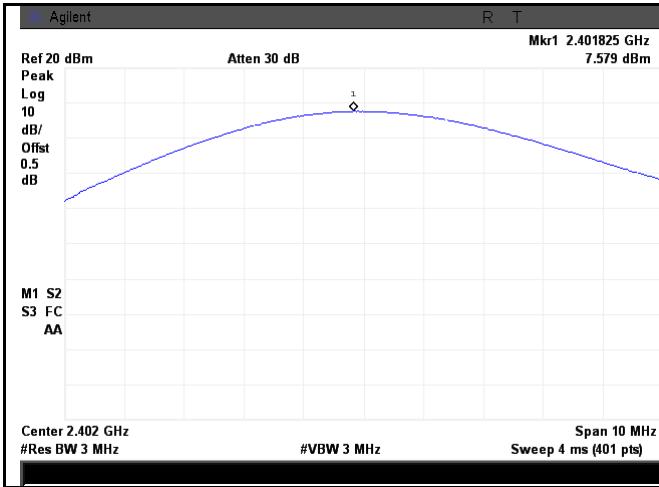

8DPSK Output power - Low CH 2402

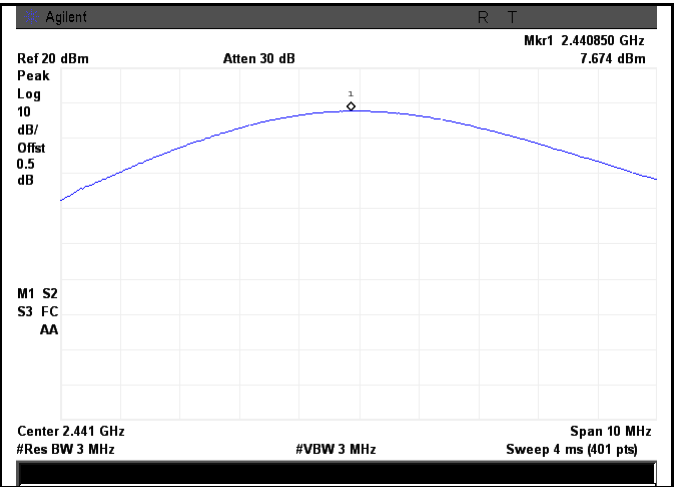

8DPSK Output power - Mid CH 2441

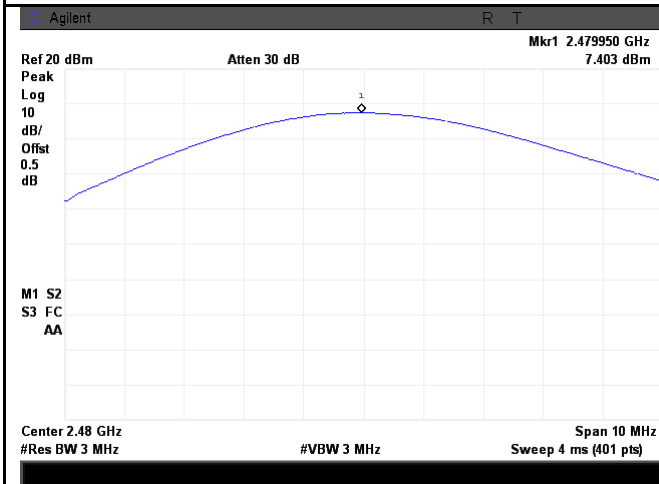

8DPSK Output power - High CH 2480

6.5 Number of Hopping Channel

Temperature	24°C
Relative Humidity	53%
Atmospheric Pressure	1011mbar
Test date :	December 11, 2015
Tested By :	Winnie Zhang

Requirement(s):

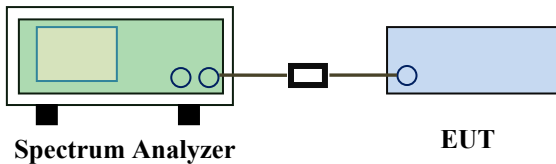
Spec	Item	Requirement	Applicable
§15.247(a) (1)(iii)	a)	FHSS in 2400-2483.5MHz ≥ 15 channels	<input checked="" type="checkbox"/>
Test Setup	 <p style="text-align: center;">Spectrum Analyzer EUT</p>		
Test Procedure	<p>The test follows FCC Public Notice DA 00-705 Measurement Guidelines. <u>Use the following spectrum analyzer settings:</u> The EUT must have its hopping function enabled.</p> <ul style="list-style-type: none"> - Span = the frequency band of operation - RBW ≥ 1% of the span - VBW ≥ RBW - Sweep = auto - Detector function = peak - Trace = max hold - Allow trace to fully stabilize. - It may prove necessary to break the span up to sections, in order to clearly show all of the hopping frequencies. The limit is specified in one of the subparagraphs of this Section. Submit this plot(s). 		
Remark			
Result	<input checked="" type="checkbox"/> Pass <input type="checkbox"/> Fail		

Test Data Yes N/A
 Test Plot Yes (See below) N/A

Number of Hopping Channel measurement result

Type	Modulation	Frequency Range	Number of Hopping Channel	Limit
Number of Hopping Channel	GFSK	2400-2483.5	79	15
	$\pi/4$ DQPSK	2400-2483.5	79	15
	8-DPSK	2400-2483.5	79	15

Test Plots

Number of Hopping Channels measurement result

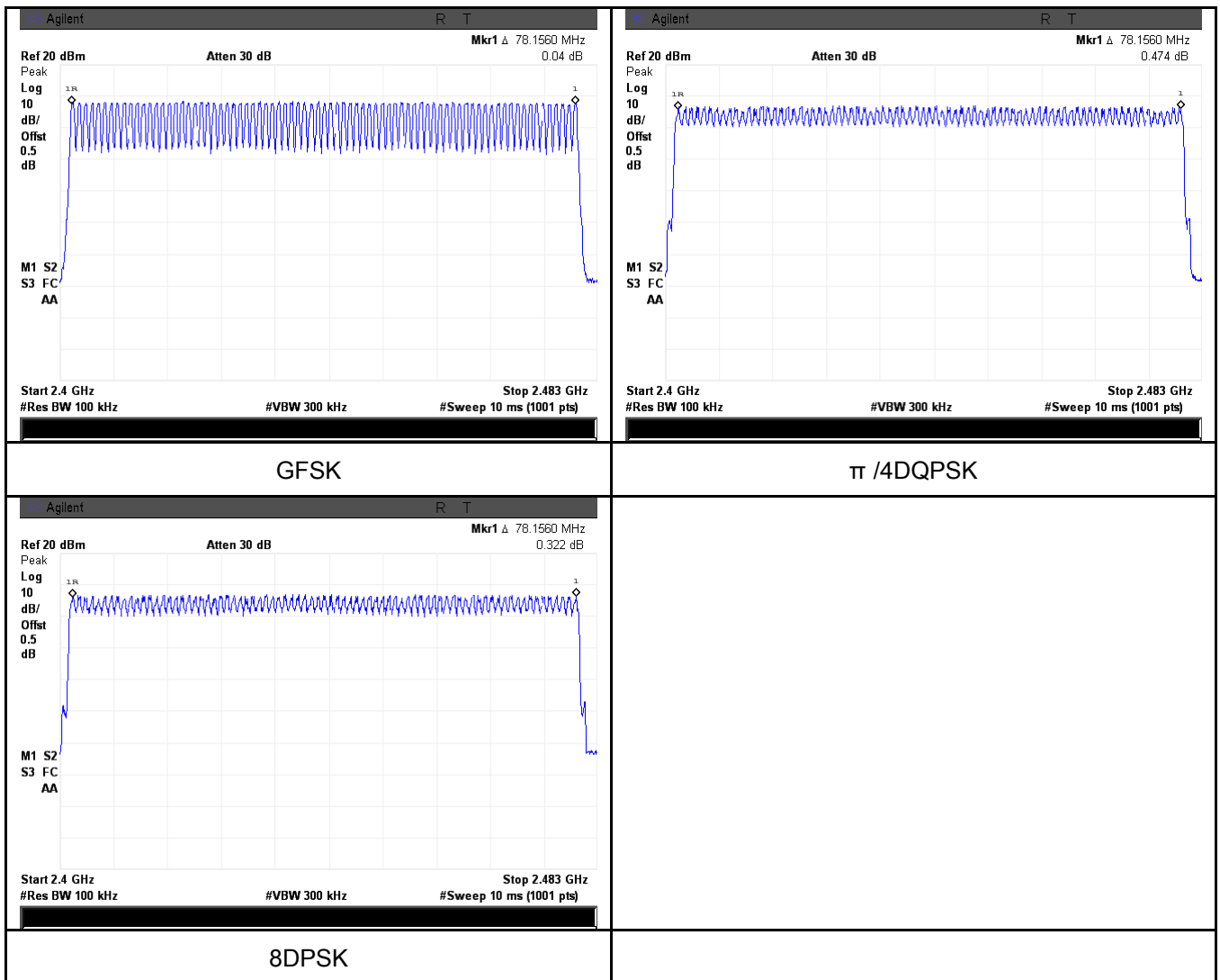

6.6 Time of Occupancy (Dwell Time)

Temperature	24°C
Relative Humidity	53%
Atmospheric Pressure	1011mbar
Test date :	December 11, 2015
Tested By :	Winnie Zhang

Requirement(s):

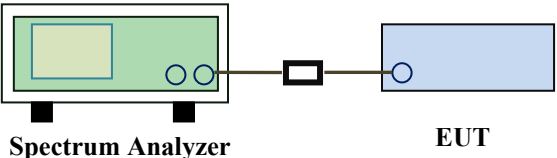
Spec	Item	Requirement	Applicable
§15.247(a) (1)(iii)	a)	Dwell Time < 0.4s	<input checked="" type="checkbox"/>
Test Setup	 <p style="text-align: center;">Spectrum Analyzer EUT</p>		
Test Procedure	<p>The test follows FCC Public Notice DA 00-705 Measurement Guidelines. <u>Use the following spectrum analyzer</u></p> <ul style="list-style-type: none"> - Span = zero span, centered on a hopping channel - RBW = 1 MHz - VBW ≥ RBW - Sweep = as necessary to capture the entire dwell time per hopping channel - Detector function = peak - Trace = max hold - use the marker-delta function to determine the dwell time 		
Remark			
Result	<input checked="" type="checkbox"/> Pass <input type="checkbox"/> Fail		

Test Data Yes N/A

Test Plot Yes (See below) N/A

Dwell Time measurement result

Type	Modulation	CH	Pulse Width (ms)	Dwell Time (ms)	Limit (ms)	Result
Dwell Time	GFSK	Low	2.90	309.333	400	Pass
		Mid	2.89	308.267	400	Pass
		High	2.89	308.267	400	Pass
	π /4 DQPSK	Low	2.91	310.400	400	Pass
		Mid	2.91	310.400	400	Pass
		High	2.91	310.400	400	Pass
	8-DPSK	Low	2.91	310.400	400	Pass
		Mid	2.90	309.333	400	Pass
		High	2.90	309.333	400	Pass

Note: Dwell time=Pulse Time (ms) × (1600 ÷ 6 ÷ 79) ×31.6

Test Plots

Dwell Time measurement result

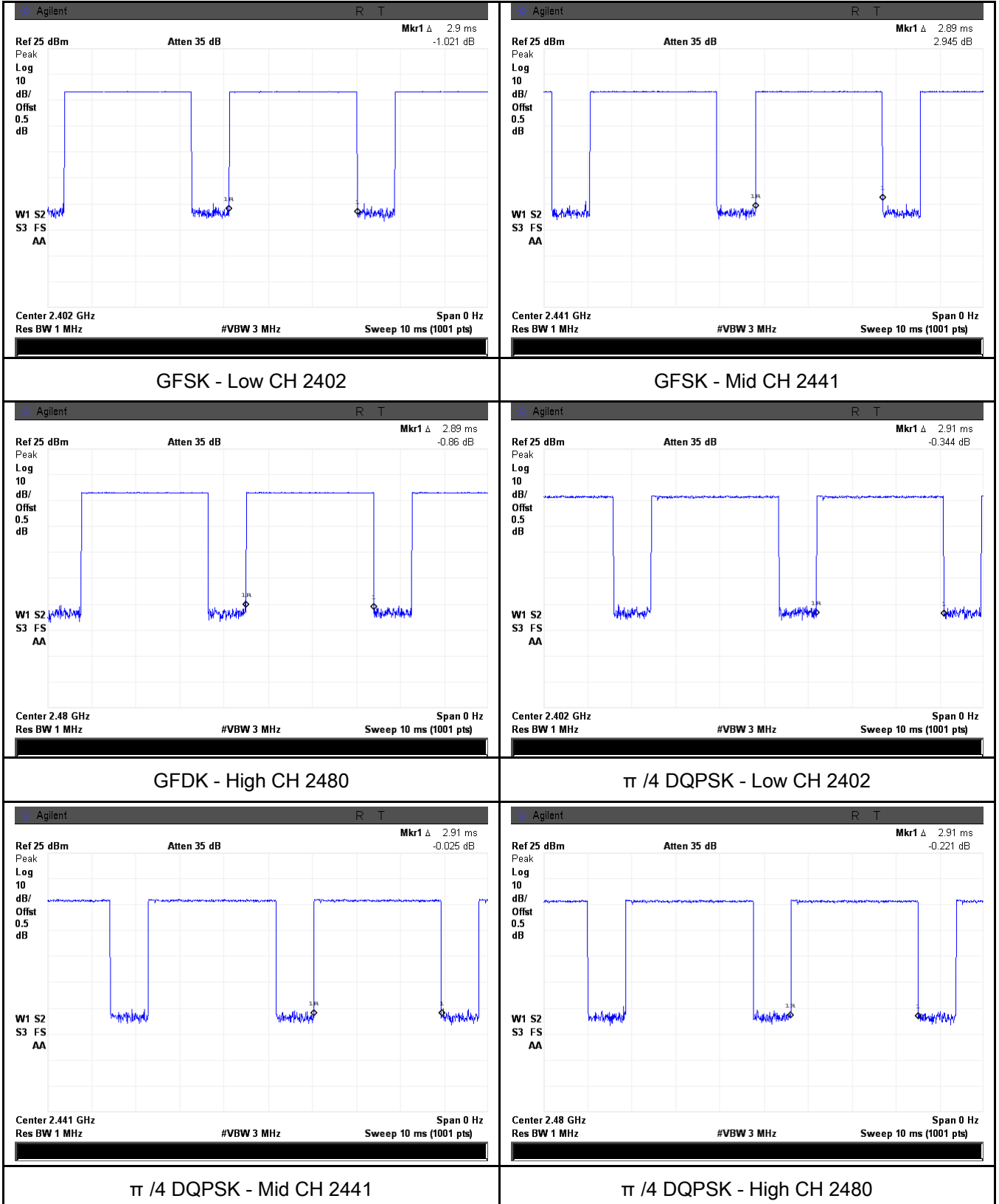

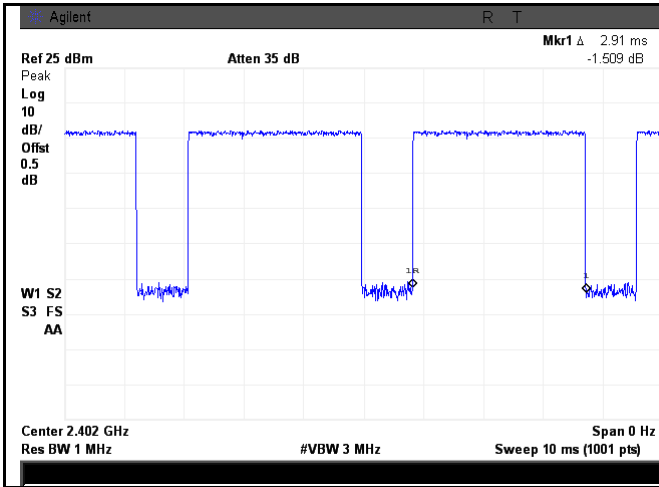

8DPSK - Low CH 2402

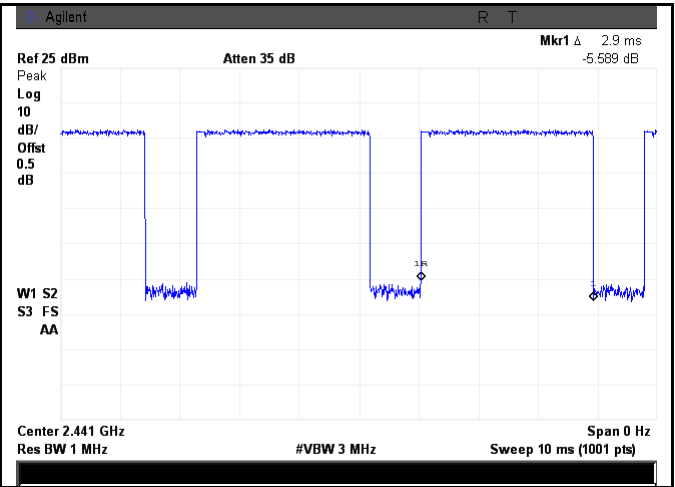

8DPSK - Mid CH 2441

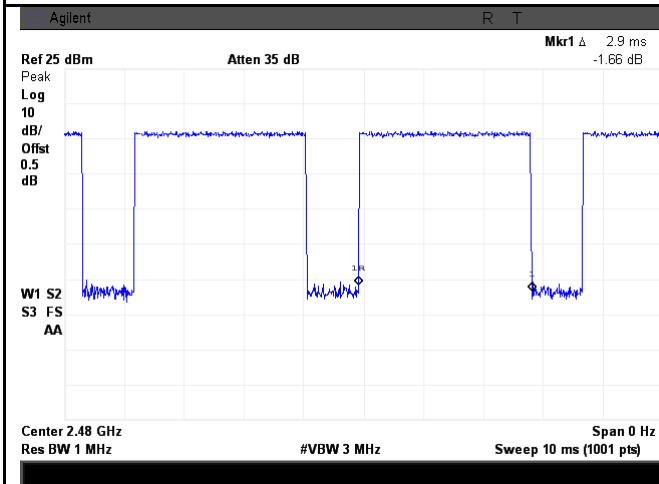

8DPSK - High CH 2480

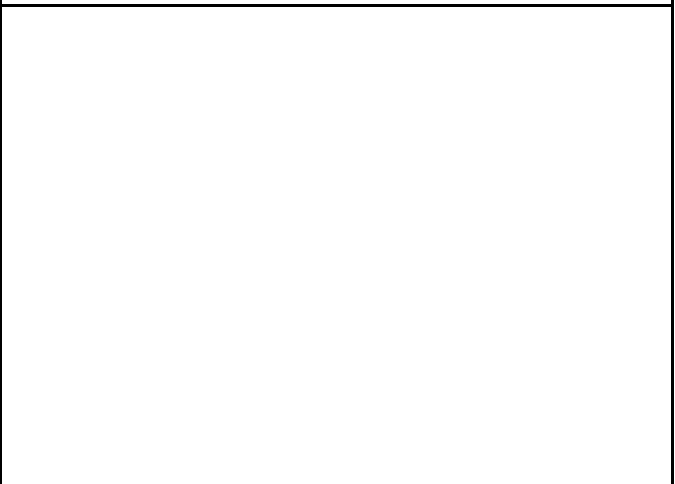

6.7 Band Edge

Temperature	23°C
Relative Humidity	52%
Atmospheric Pressure	1010mbar
Test date :	December 10, 2015
Tested By :	Winnie Zhang

Requirement(s):

Spec	Item	Requirement	Applicable
§15.247(a) (1)(iii)	a)	In any 100 kHz bandwidth outside the frequency band in which the spread spectrum or digitally modulated intentional radiator is operating, the radio frequency power that is produced by the intentional radiator shall be at least 20 dB below that in the 100 kHz bandwidth within the band that contains the highest level of the desired power, based on either an RF conducted or a radiated measurement, provided the transmitter demonstrates compliance with the peak conducted power limits.	<input checked="" type="checkbox"/>

Test Setup	
------------	--

Test Procedure	<p>The test follows FCC Public Notice DA 00-705 Measurement Guidelines. Radiated Method Only</p> <ul style="list-style-type: none"> - 1. Check the calibration of the measuring instrument using either an internal calibrator or a known signal from an external generator. - 2. Position the EUT without connection to measurement instrument. Put it on the Rotated table and turn on the EUT and make it operate in transmitting mode. Then set it to Low Channel and High Channel within its operating range,
----------------	--

	<p>and make sure the instrument is operated in its linear range.</p> <ul style="list-style-type: none"> - 3. First, set both RBW and VBW of spectrum analyzer to 100 kHz with a convenient frequency span including 100kHz bandwidth from band edge, check the emission of EUT, if pass then set Spectrum Analyzer as below: <ul style="list-style-type: none"> a. The resolution bandwidth and video bandwidth of test receiver/spectrum analyzer is 120 kHz for Quasiy Peak detection at frequency below 1GHz. b. The resolution bandwidth of test receiver/spectrum analyzer is 1MHz and video bandwidth is 3MHz with Peak detection for Peak measurement at frequency above 1GHz. c. The resolution bandwidth of test receiver/spectrum analyzer is 1MHz and the video bandwidth is 10Hz with Peak detection for Average Measurement as below at frequency above 1GHz. - 4. Measure the highest amplitude appearing on spectral display and set it as a reference level. Plot the graph with marking the highest point and edge frequency. - 5. Repeat above procedures until all measured frequencies were complete.
Remark	
Result	<input checked="" type="checkbox"/> Pass <input type="checkbox"/> Fail

Test Data Yes N/A
 Test Plot Yes (See below) N/A

Test Plots

GFSK Mode:

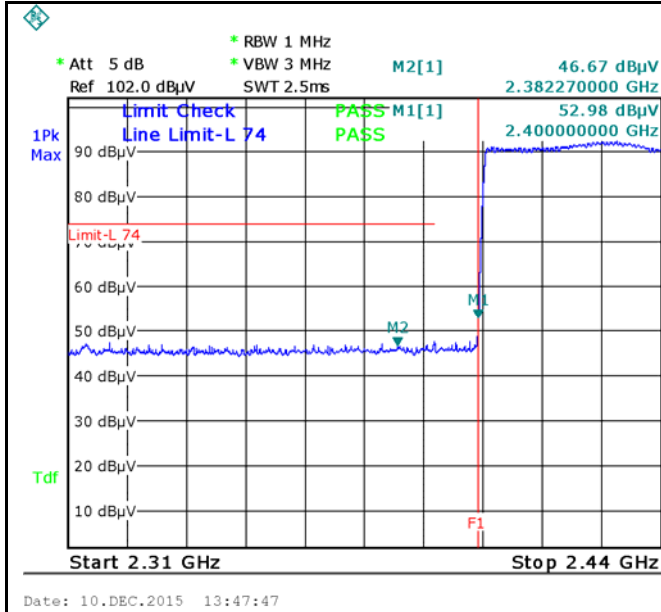

GFSK-Hopping Left Side-PK
Note: F1 is frequency 2400MHz

Note: (no need if PK value less than the AV limit)

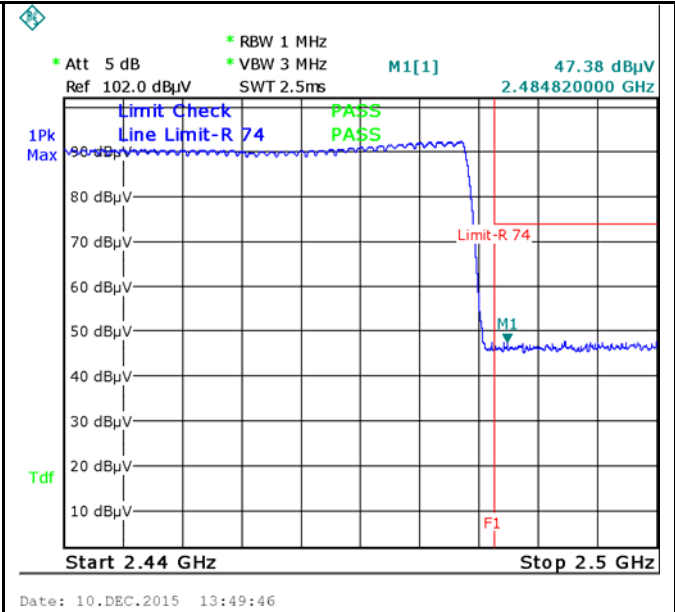

GFSK-Hopping Right Side-PK
Note: F1 is frequency 2483.5MHz

Note: (no need if PK value less than the AV limit)

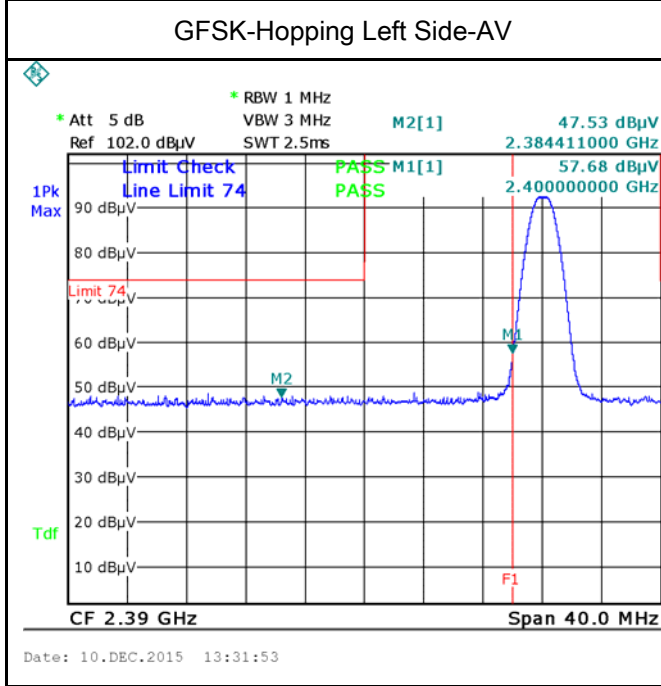

GFSK-Left Side-PK
Note: F1 is frequency 2400MHz

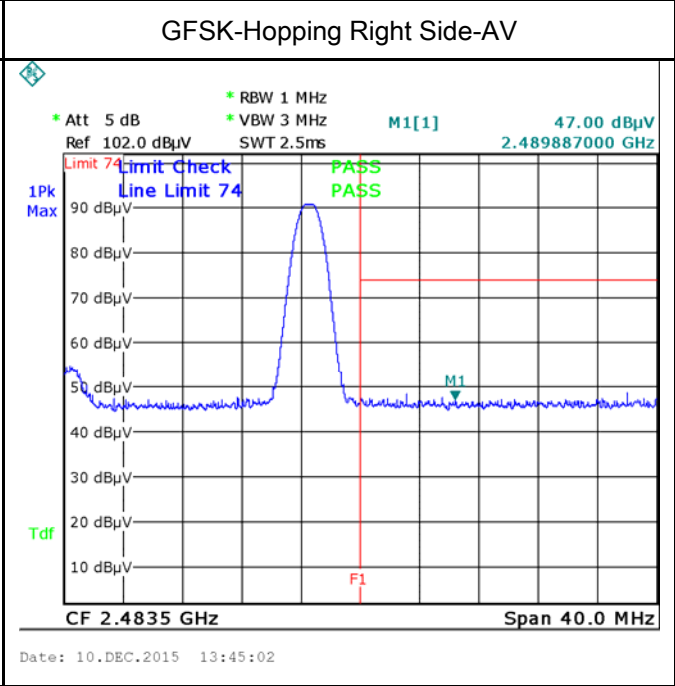

GFSK-Right Side-PK
Note: F1 is frequency 2483.5MHz

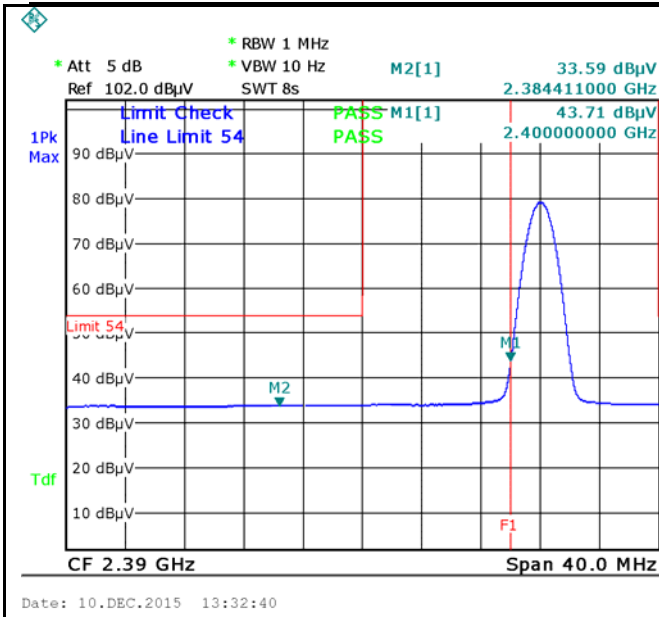

Note: (no need if PK value less than the AV limit)

GFSK-Left Side-AV

GFSK-Right Side-AV

$\pi/4$ DQPSK Mode:

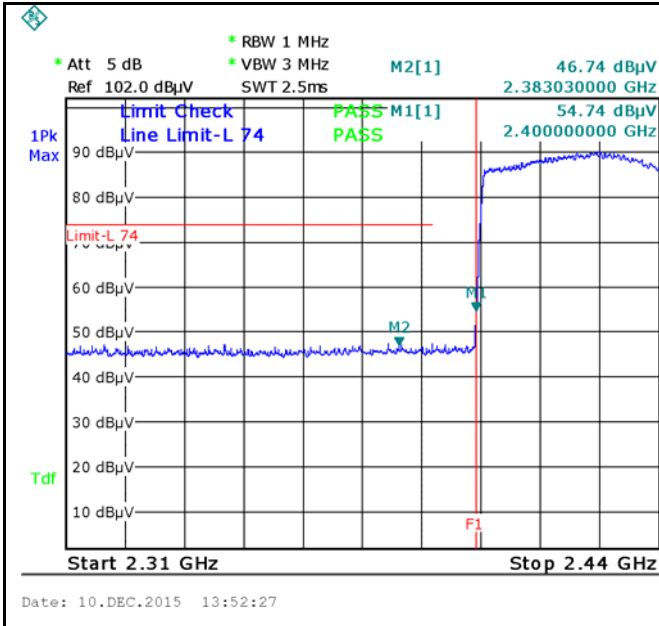

$\pi/4$ DQPSK-Hopping Left Side-PK

Note: F1 is frequency 2400MHz

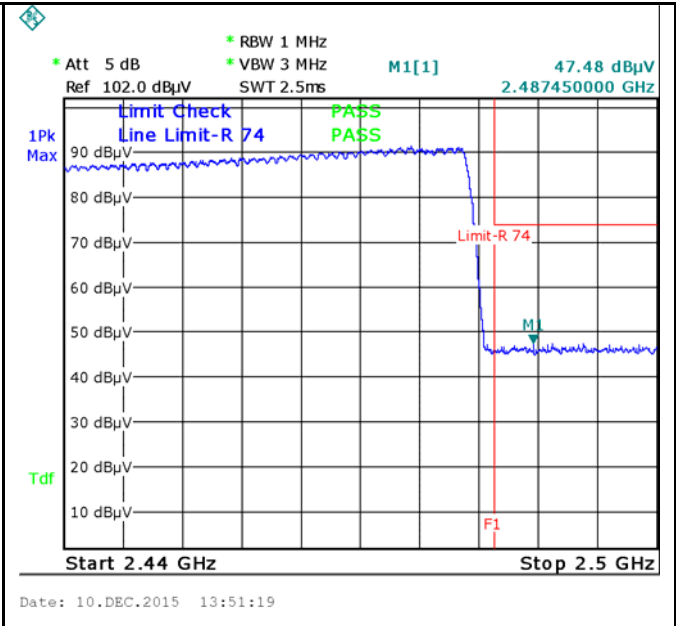

$\pi/4$ DQPSK-Hopping Right Side-PK

Note: F1 is frequency 2483.5MHz

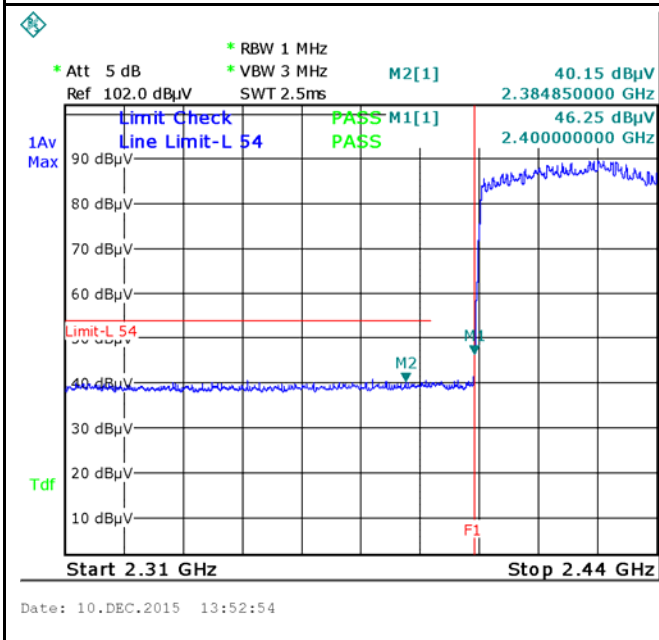

$\pi/4$ DQPSK-Hopping Left-AV

Note: (no need if PK value less than the AV limit)

$\pi/4$ DQPSK-Hopping Right-AV

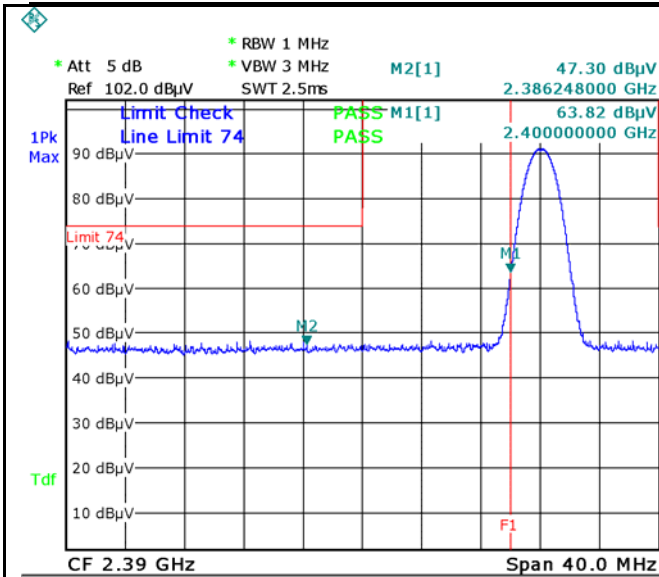

Date: 10.DEC.2015 13:35:50

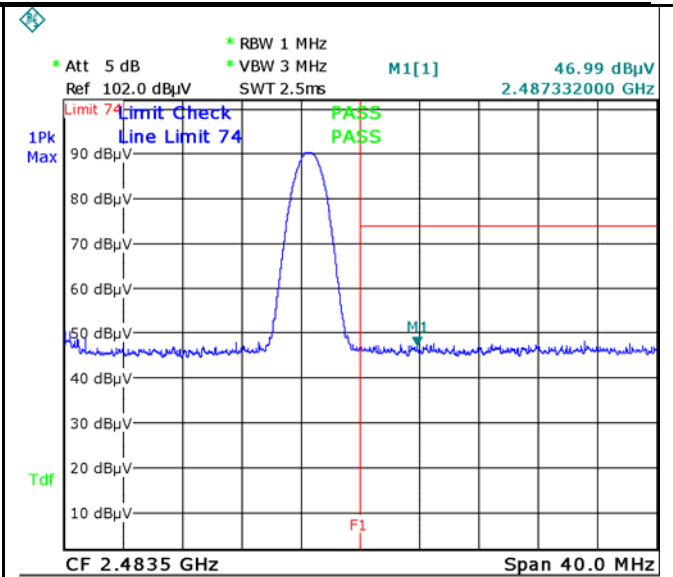

Date: 10.DEC.2015 13:42:50

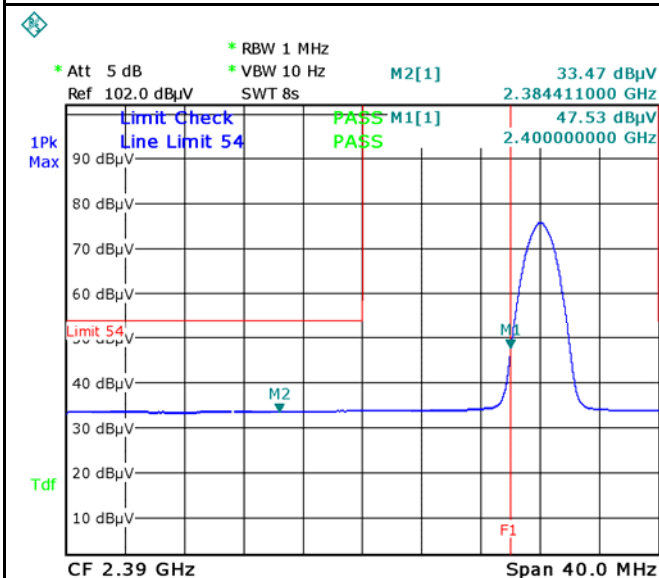

Date: 10.DEC.2015 13:35:22

π /4 DQPSK-Right Side-PK
Note: F1 is frequency 2483.5MHz

Note: (no need if PK value less than the AV limit)

Note: (no need if PK value less than the AV limit)

π /4 DQPSK-Left Side-AV

π /4 DQPSK-Right Side-AV

8-DPSK Mode:

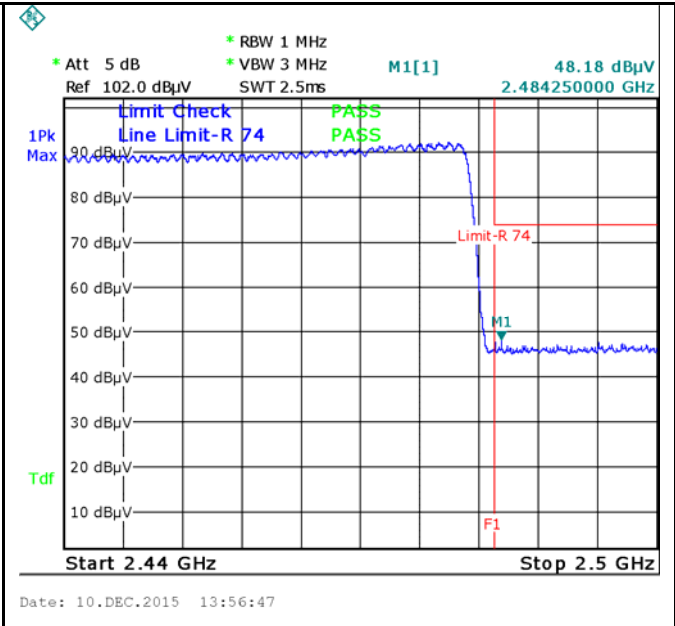
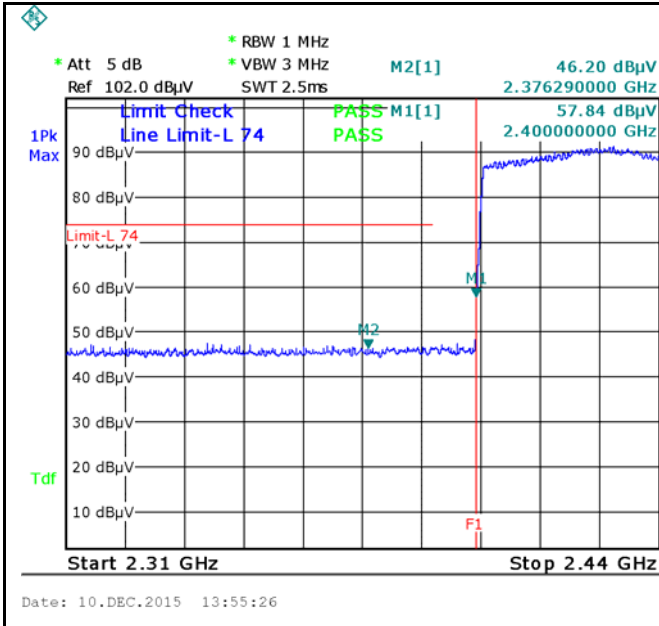

8DPSK-Hopping Left Side-PK

Note: F1 is frequency 2400MHz

8DPSK-Hopping Right Side-PK

Note: F1 is frequency 2483.5MHz

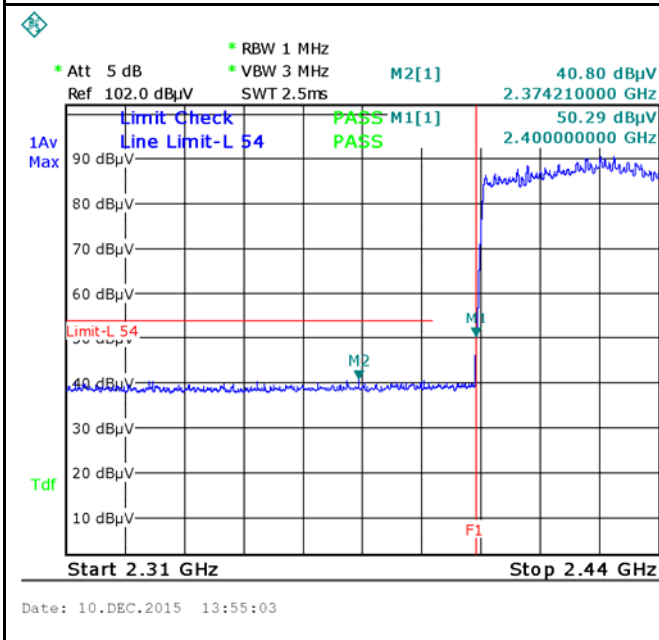

Note: (no need if PK value less than the AV limit)

8DPSK-Hopping Left-AV

8DPSK-Hopping Right-AV

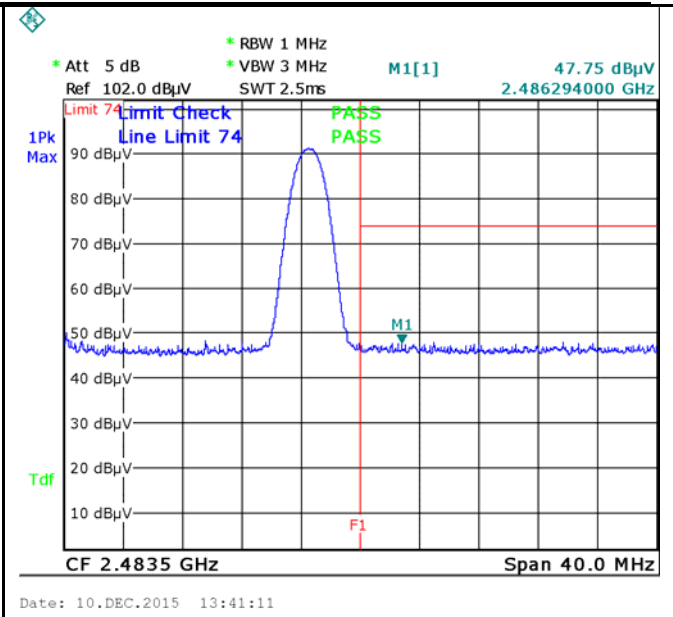
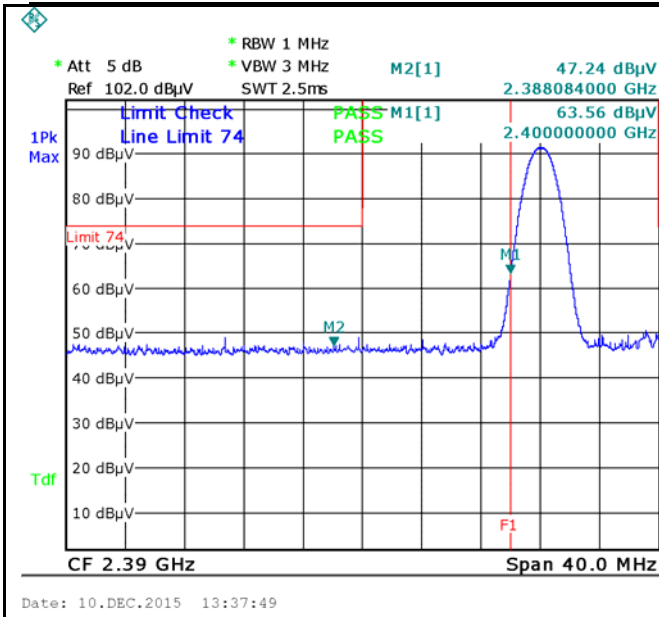

8DPSK-Left Side-PK

Note: F1 is frequency 2400MHz

8DPSK-Right Side-PK

Note: F1 is frequency 2483.5MHz

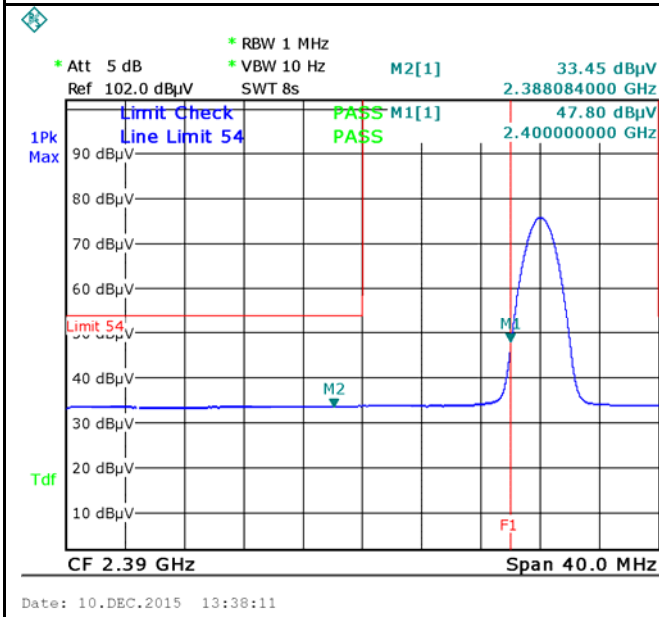

Note: (no need if PK value less than the AV limit)

8DPSK-Left Side-AV

8DPSK-Right Side-AV

6.8 AC Power Line Conducted Emissions

Temperature	22°C
Relative Humidity	51%
Atmospheric Pressure	1009mbar
Test date :	December 09, 2015
Tested By :	Winnie Zhang

Requirement(s):

Spec	Item	Requirement	Applicable														
47CFR§15.207, RSS210 (A8.1)	a)	For Low-power radio-frequency devices that is designed to be connected to the public utility (AC) power line, the radio frequency voltage that is conducted back onto the AC power line on any frequency or frequencies, within the band 150 kHz to 30 MHz, shall not exceed the limits in the following table, as measured using a 50 [μ]H/50 ohms line impedance stabilization network (LISN). The lower limit applies at the boundary between the frequencies ranges.	<input checked="" type="checkbox"/>														
		<table border="1"> <thead> <tr> <th rowspan="2">Frequency ranges (MHz)</th> <th colspan="2">Limit (dBμV)</th> </tr> <tr> <th>QP</th> <th>Average</th> </tr> </thead> <tbody> <tr> <td>0.15 ~ 0.5</td> <td>66 – 56</td> <td>56 – 46</td> </tr> <tr> <td>0.5 ~ 5</td> <td>56</td> <td>46</td> </tr> <tr> <td>5 ~ 30</td> <td>60</td> <td>50</td> </tr> </tbody> </table>		Frequency ranges (MHz)	Limit (dBμV)		QP	Average	0.15 ~ 0.5	66 – 56	56 – 46	0.5 ~ 5	56	46	5 ~ 30	60	50
		Frequency ranges (MHz)			Limit (dBμV)												
				QP	Average												
0.15 ~ 0.5	66 – 56	56 – 46															
0.5 ~ 5	56	46															
5 ~ 30	60	50															

Test Setup	<p>Note: 1.Support units were connected to second LISN. 2.Both of LISNs (AMN) are 80cm from EUT and at least 80cm from other units and other metal planes support units.</p>
------------	--

Procedure	<ol style="list-style-type: none"> The EUT and supporting equipment were set up in accordance with the requirements of the standard on top of a 1.5m x 1m x 0.8m high, non-metallic table. The power supply for the EUT was fed through a 50W/50mH EUT LISN, connected to filtered mains. The RF OUT of the EUT LISN was connected to the EMI test receiver via a low-loss
-----------	---

Test Report	15071133-FCC-R2
Page	38 of 59

	coaxial cable. 4. All other supporting equipment were powered separately from another main supply. 5. The EUT was switched on and allowed to warm up to its normal operating condition. 6. A scan was made on the NEUTRAL line (for AC mains) or Earth line (for DC power) over the required frequency range using an EMI test receiver. 7. High peaks, relative to the limit line, The EMI test receiver was then tuned to the selected frequencies and the necessary measurements made with a receiver bandwidth setting of 10 kHz. 8. Step 7 was then repeated for the LIVE line (for AC mains) or DC line (for DC power).
Remark	
Result	<input checked="" type="checkbox"/> Pass <input type="checkbox"/> Fail

Test Data Yes N/A

Test Plot Yes (See below) N/A

Test Mode: Bluetooth Mode

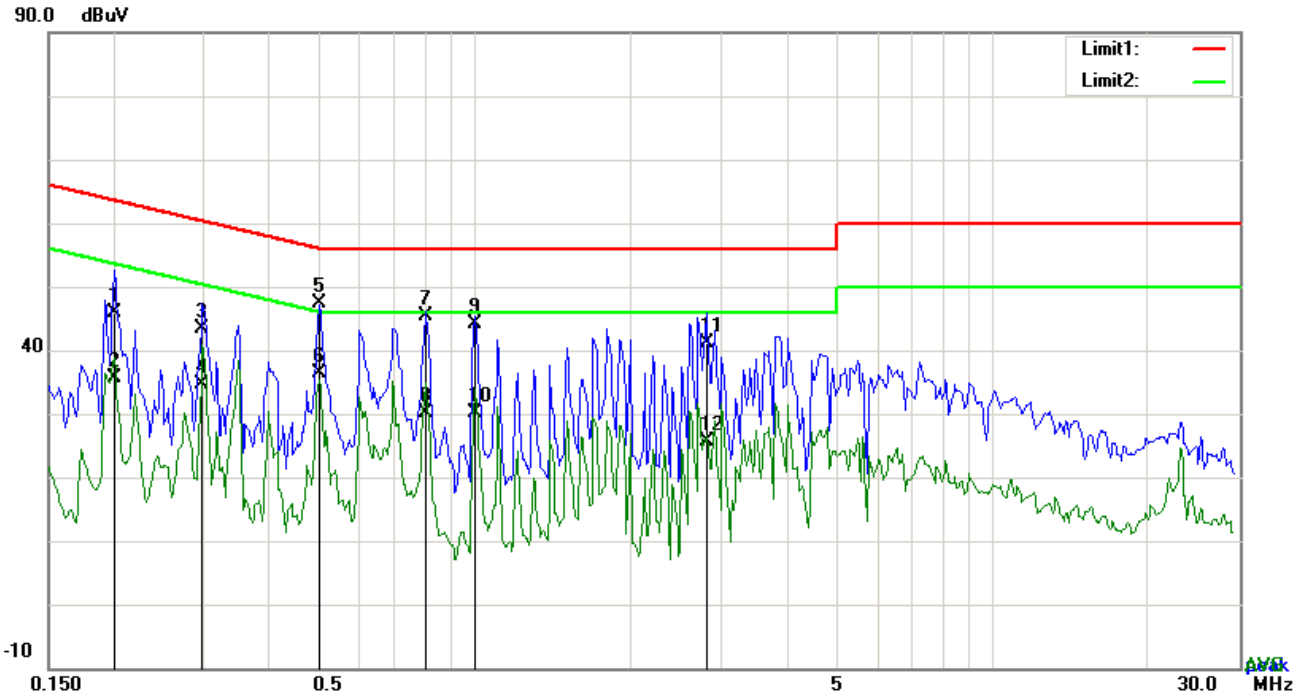

Test Data

Phase Line Plot at 120Vac, 60Hz

No.	P/L	Frequency	Reading	Detector	Corrected	Result	Limit	Margin
		(MHz)	(dBuV)		(dB}	(dBuV)	(dBuV)	(dB)
1	L1	0.2007	32.79	QP	13.01	45.80	63.58	-17.78
2	L1	0.2007	22.63	AVG	13.01	35.64	53.58	-17.94
3	L1	0.2982	30.69	QP	12.65	43.34	60.29	-16.95
4	L1	0.2982	21.89	AVG	12.65	34.54	50.29	-15.75
5	L1	0.5010	35.43	QP	11.90	47.33	56.00	-8.67
6	L1	0.5010	24.58	AVG	11.90	36.48	46.00	-9.52
7	L1	0.8013	33.73	QP	11.60	45.33	56.00	-10.67
8	L1	0.8013	18.63	AVG	11.60	30.23	46.00	-15.77
9	L1	1.0002	32.82	QP	11.40	44.22	56.00	-11.78
10	L1	1.0002	18.63	AVG	11.40	30.03	46.00	-15.97
11	L1	2.7981	29.70	QP	11.40	41.10	56.00	-14.90
12	L1	2.7981	14.25	AVG	11.40	25.65	46.00	-20.35

Test Mode: Bluetooth Mode

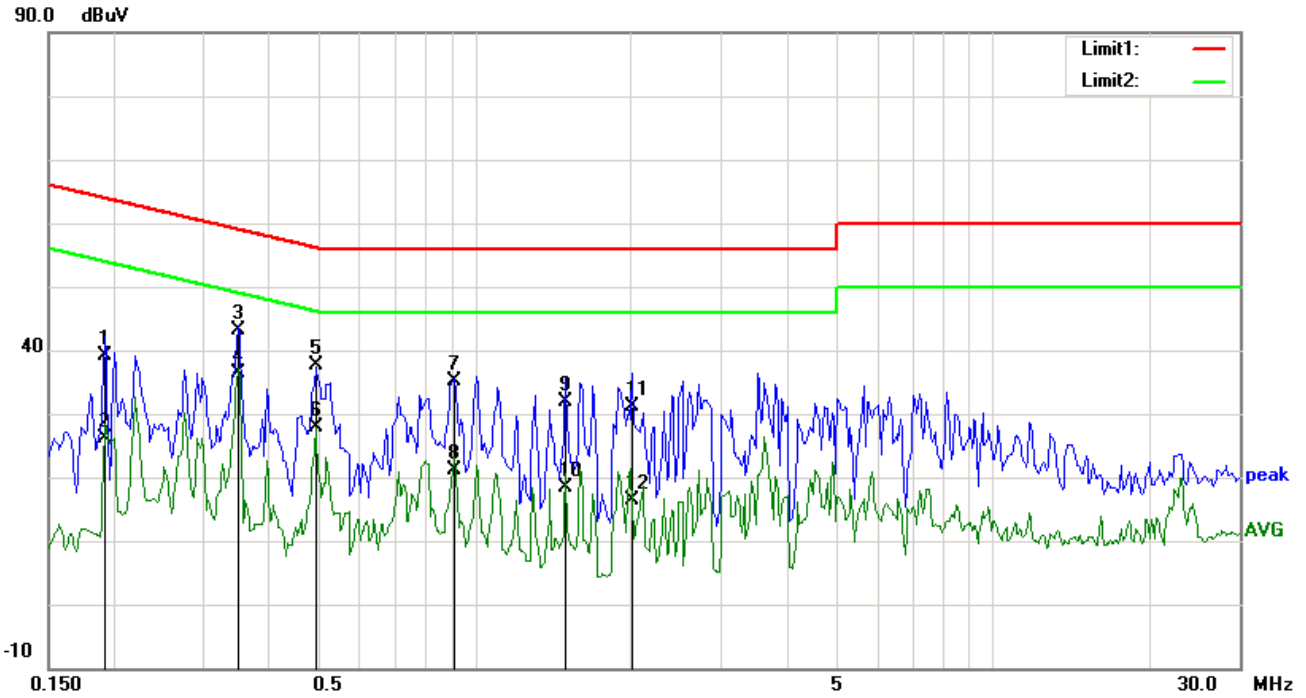

Test Data

Phase Neutral Plot at 120Vac, 60Hz

No.	P/L	Frequency	Reading	Detector	Corrected	Result	Limit	Margin
		(MHz)	(dBuV)		(dB)	(dBuV)	(dBuV)	(dB)
1	N	0.1929	26.02	QP	13.04	39.06	63.91	-24.85
2	N	0.1929	13.09	AVG	13.04	26.13	53.91	-27.78
3	N	0.3489	30.56	QP	12.46	43.02	58.99	-15.97
4	N	0.3489	23.88	AVG	12.46	36.34	48.99	-12.65
5	N	0.4932	25.64	QP	11.93	37.57	56.11	-18.54
6	N	0.4932	15.83	AVG	11.93	27.76	46.11	-18.35
7	N	0.9144	23.54	QP	11.49	35.03	56.00	-20.97
8	N	0.9144	9.58	AVG	11.49	21.07	46.00	-24.93
9	N	1.4994	20.51	QP	11.46	31.97	56.00	-24.03
10	N	1.4994	6.82	AVG	11.46	18.28	46.00	-27.72
11	N	2.0181	19.63	QP	11.53	31.16	56.00	-24.84
12	N	2.0181	4.87	AVG	11.53	16.40	46.00	-29.60

Test Mode:	Bluetooth Mode
-------------------	-----------------------

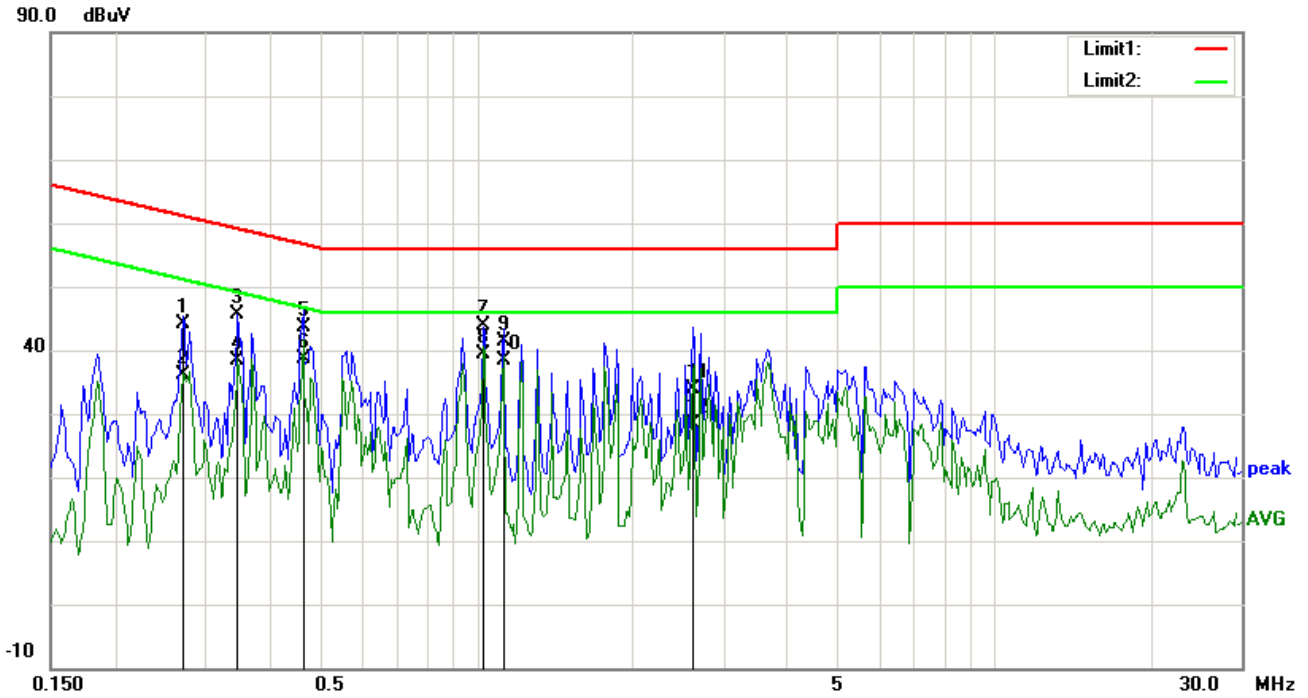

Test Data

Phase Line Plot at 240Vac, 60Hz

No.	P/L	Frequency	Reading	Detector	Corrected	Result	Limit	Margin
		(MHz)	(dBuV)		(dB}	(dBuV)	(dBuV)	(dB)
1	L1	0.2709	31.34	QP	12.75	44.09	61.09	-17.00
2	L1	0.2709	23.38	AVG	12.75	36.13	51.09	-14.96
3	L1	0.3450	33.20	QP	12.48	45.68	59.08	-13.40
4	L1	0.3450	25.91	AVG	12.48	38.39	49.08	-10.69
5	L1	0.4620	31.56	QP	12.04	43.60	56.66	-13.06
6	L1	0.4620	26.53	AVG	12.04	38.57	46.66	-8.09
7	L1	1.0314	32.48	QP	11.40	43.88	56.00	-12.12
8	L1	1.0314	27.88	AVG	11.40	39.28	46.00	-6.72
9	L1	1.1250	29.98	QP	11.40	41.38	56.00	-14.62
10	L1	1.1250	26.96	AVG	11.40	38.36	46.00	-7.64
11	L1	2.6187	22.51	QP	11.40	33.91	56.00	-22.09
12	L1	2.6187	17.00	AVG	11.40	28.40	46.00	-17.60

Test Mode:	Bluetooth Mode
-------------------	-----------------------

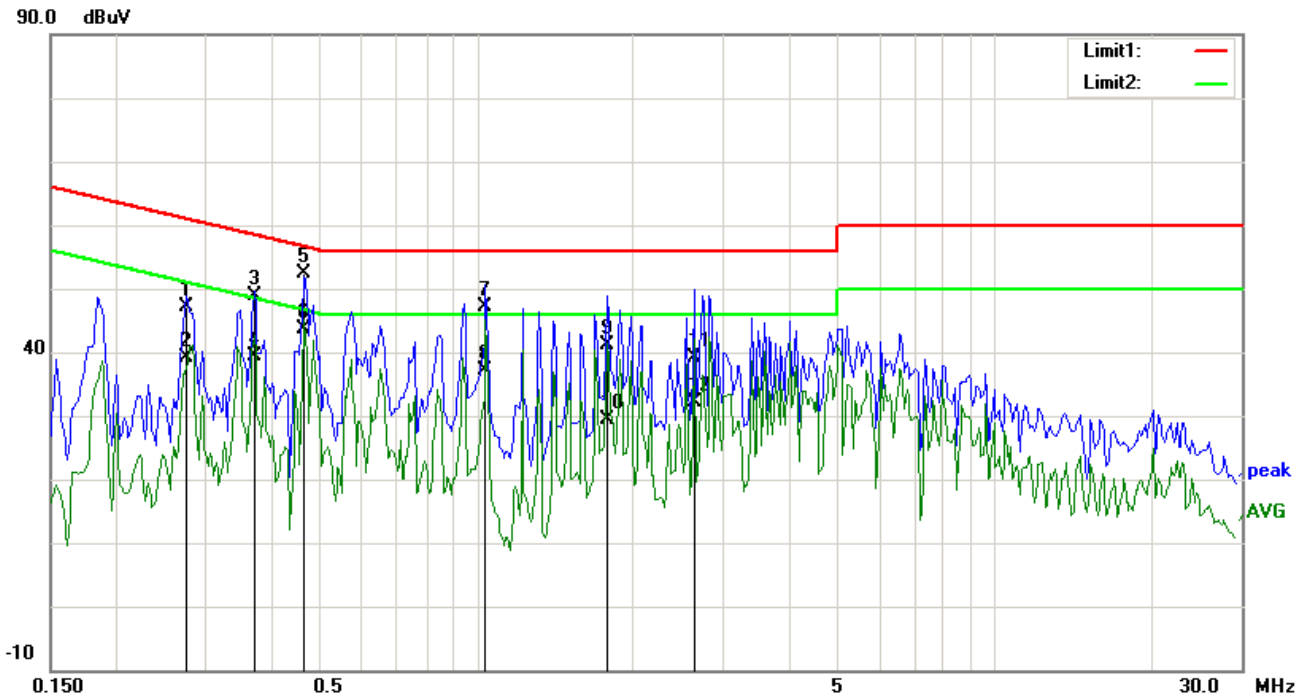

Test Data

Phase Neutral Plot at 240Vac, 60Hz

No.	P/L	Frequency	Reading	Detector	Corrected	Result	Limit	Margin
		(MHz)	(dBuV)		(dB)	(dBuV)	(dBuV)	(dB)
1	N	0.2748	34.47	QP	12.74	47.21	60.97	-13.76
2	N	0.2748	26.37	AVG	12.74	39.11	50.97	-11.86
3	N	0.3723	36.63	QP	12.37	49.00	58.45	-9.45
4	N	0.3723	27.07	AVG	12.37	39.44	48.45	-9.01
5	N	0.4659	40.24	QP	12.03	52.27	56.59	-4.32
6	N	0.4659	31.49	AVG	12.03	43.52	46.59	-3.07
7	N	1.0392	35.80	QP	11.40	47.20	56.00	-8.80
8	N	1.0392	25.63	AVG	11.40	37.03	46.00	-8.97
9	N	1.7841	29.51	QP	11.50	41.01	56.00	-14.99
10	N	1.7841	17.92	AVG	11.50	29.42	46.00	-16.58
11	N	2.6343	27.44	QP	11.60	39.04	56.00	-16.96
12	N	2.6343	20.56	AVG	11.60	32.16	46.00	-13.84

6.9 Radiated Emissions

Temperature	22°C
Relative Humidity	51%
Atmospheric Pressure	1009mbar
Test date :	December 09, 2015
Tested By :	Winnie Zhang

Requirement(s):

Spec	Item	Requirement	Applicable										
47CFR§15.205, §15.209, §15.247(d)	a)	<p>Except higher limit as specified elsewhere in other section, the emissions from the low-power radio-frequency devices shall not exceed the field strength levels specified in the following table and the level of any unwanted emissions shall not exceed the level of the fundamental emission. The tighter limit applies at the band edges</p> <table border="1"> <thead> <tr> <th>Frequency range (MHz)</th> <th>Field Strength ($\mu\text{V}/\text{m}$)</th> </tr> </thead> <tbody> <tr> <td>30 – 88</td> <td>100</td> </tr> <tr> <td>88 – 216</td> <td>150</td> </tr> <tr> <td>216 960</td> <td>200</td> </tr> <tr> <td>Above 960</td> <td>500</td> </tr> </tbody> </table>	Frequency range (MHz)	Field Strength ($\mu\text{V}/\text{m}$)	30 – 88	100	88 – 216	150	216 960	200	Above 960	500	<input checked="" type="checkbox"/>
Frequency range (MHz)	Field Strength ($\mu\text{V}/\text{m}$)												
30 – 88	100												
88 – 216	150												
216 960	200												
Above 960	500												

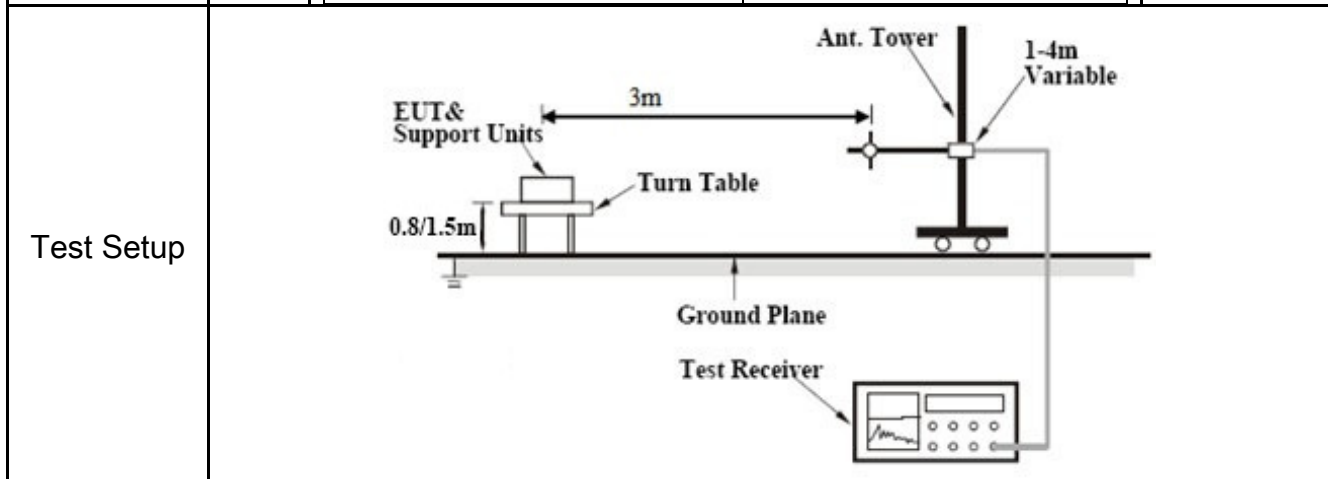

Procedure	<ol style="list-style-type: none"> 1. The EUT was switched on and allowed to warm up to its normal operating condition. 2. The test was carried out at the selected frequency points obtained from the EUT characterization. Maximization of the emissions, was carried out by rotating the EUT, changing the antenna polarization, and adjusting the antenna height in the following manner: <ol style="list-style-type: none"> a. Vertical or horizontal polarization (whichever gave the higher emission level over a full rotation of the EUT) was chosen.
-----------	--

	<p>b. The EUT was then rotated to the direction that gave the maximum emission.</p> <p>c. Finally, the antenna height was adjusted to the height that gave the maximum emission.</p> <p>3. The resolution bandwidth and video bandwidth of test receiver/spectrum analyzer is 120 kHz for Quasiy Peak detection at frequency below 1GHz.</p> <p>4. The resolution bandwidth of test receiver/spectrum analyzer is 1MHz and video bandwidth is 3MHz with Peak detection for Peak measurement at frequency above 1GHz. The resolution bandwidth of test receiver/spectrum analyzer is 1MHz and the video bandwidth is 10Hz with Peak detection for Average Measurement as below at frequency above 1GHz.</p> <p>5. Steps 2 and 3 were repeated for the next frequency point, until all selected frequency points were measured.</p>
Remark	
Result	<input checked="" type="checkbox"/> Pass <input type="checkbox"/> Fail

Test Data Yes N/A

Test Plot Yes (See below) N/A

Test Mode: Bluetooth Mode

Below 1GHz

80.0 dBuV/m

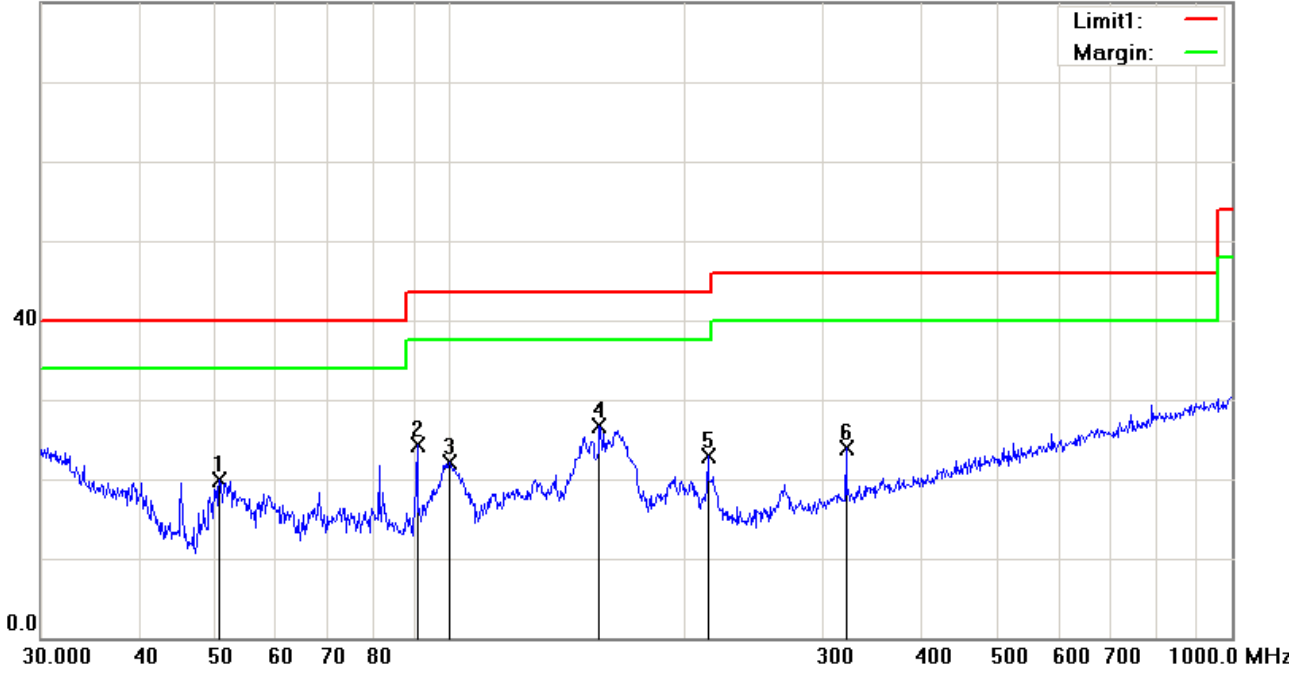

Test Data

Horizontal Polarity Plot @3m

No.	P/L	Frequency (MHz)	Reading (dBuV/m)	Detector	Corrected (dB/m)	Result (dBuV/m)	Limit (dBuV/m)	Margin (dB)	Height (cm)	Degree ()
1	H	50.7637	33.16	peak	-13.26	19.90	40.00	-20.10	100	0
2	H	90.8554	37.51	peak	-13.15	24.36	43.50	-19.14	100	0
3	H	99.8777	32.88	peak	-10.83	22.05	43.50	-21.45	100	164
4	H	155.3644	34.98	peak	-8.33	26.65	43.50	-16.85	100	115
5	H	213.7634	31.71	peak	-8.87	22.84	43.50	-20.66	100	29
6	H	321.0608	30.14	peak	-6.29	23.85	46.00	-22.15	100	96

Below 1GHz

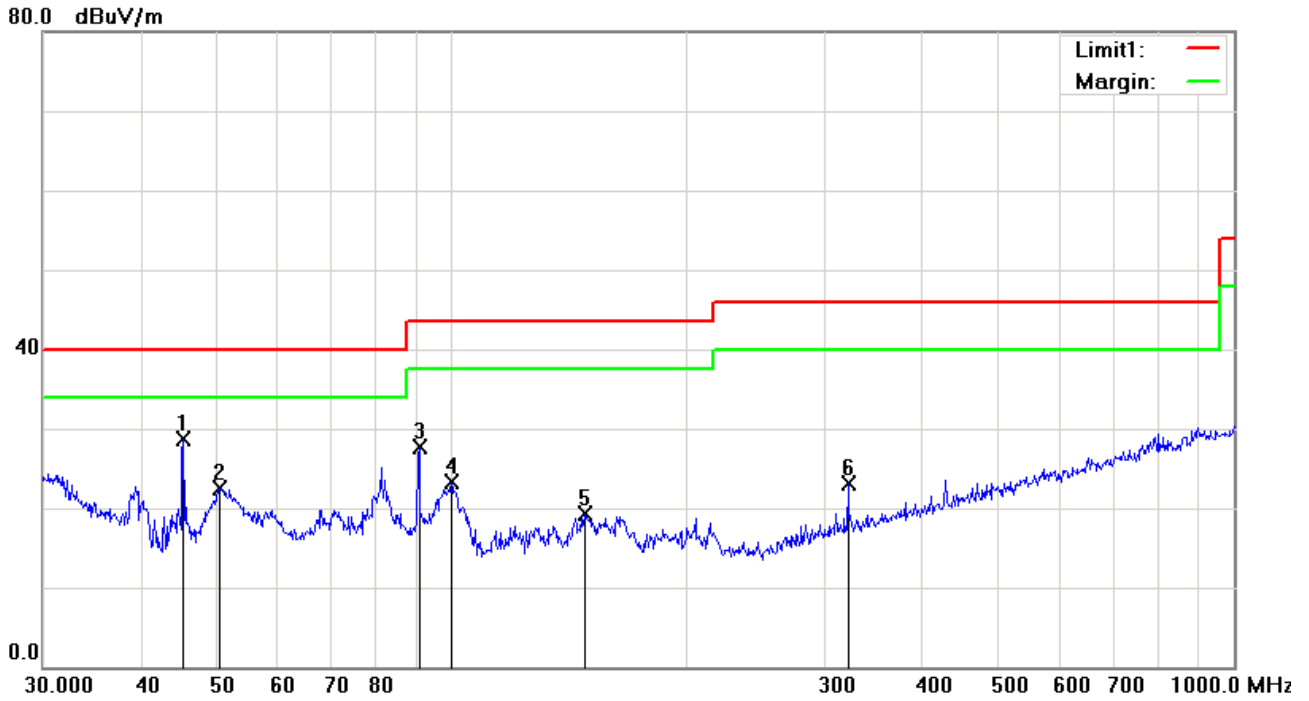

Test Data

Vertical Polarity Plot @3m

No.	P/L	Frequency (MHz)	Reading (dBuV/m)	Detector	Corrected (dB/m)	Result (dBuV/m)	Limit (dBuV/m)	Margin (dB)	Height (cm)	Degree ()
1	V	45.3755	39.85	peak	-11.12	28.73	40.00	-11.27	100	76
2	V	50.4089	35.81	peak	-13.22	22.59	40.00	-17.41	100	129
3	V	90.8554	40.76	peak	-13.15	27.61	43.50	-15.89	100	170
4	V	99.8777	34.16	peak	-10.83	23.33	43.50	-20.17	100	211
5	V	147.9214	27.66	peak	-8.42	19.24	43.50	-24.26	100	61
6	V	321.0608	29.44	peak	-6.29	23.15	46.00	-22.85	100	159

Above 1GHz

Test Mode:	Transmitting Mode
-------------------	--------------------------

Mode: GFSK (Worst Case)

Low Channel (2402 MHz)

Frequency (MHz)	S.A. Reading (dBμV)	Detector (PK/AV)	Polarity (H/V)	Ant. Factor (dB/m)	Cable Loss (dB)	Pre-Amp. Gain (dB)	Cord. Amp. (dBμV/m)	Limit (dBμV/m)	Margin (dB)
4804	38.63	AV	V	33.83	6.86	31.72	47.6	54	-6.4
4804	38.28	AV	H	33.83	6.86	31.72	47.25	54	-6.75
4804	46.82	PK	V	33.83	6.86	31.72	55.79	74	-18.21
4804	46.59	PK	H	33.83	6.86	31.72	55.56	74	-18.44

Middle Channel (2441 MHz)

Frequency (MHz)	S.A. Reading (dBμV)	Detector (PK/AV)	Polarity (H/V)	Ant. Factor (dB/m)	Cable Loss (dB)	Pre-Amp. Gain (dB)	Cord. Amp. (dBμV/m)	Limit (dBμV/m)	Margin (dB)
4882	38.59	AV	V	33.86	6.82	31.82	47.45	54	-6.55
4882	38.22	AV	H	33.86	6.82	31.82	47.08	54	-6.92
4882	46.76	PK	V	33.86	6.82	31.82	55.62	74	-18.38
4882	46.51	PK	H	33.86	6.82	31.82	55.37	74	-18.63

High Channel (2480 MHz)

Frequency (MHz)	S.A. Reading (dBμV)	Detector (PK/AV)	Polarity (H/V)	Ant. Factor (dB/m)	Cable Loss (dB)	Pre-Amp. Gain (dB)	Cord. Amp. (dBμV/m)	Limit (dBμV/m)	Margin (dB)
4960	38.55	AV	V	33.9	6.76	31.92	47.29	54	-6.71
4960	38.31	AV	H	33.9	6.76	31.92	47.05	54	-6.95
4960	46.79	PK	V	33.9	6.76	31.92	55.53	74	-18.47
4960	46.43	PK	H	33.9	6.76	31.92	55.17	74	-18.83

Note:

- 1, The testing has been conformed to $10 \times 2480 \text{MHz} = 24,800 \text{MHz}$
- 2, All other emissions more than 30 dB below the limit

Annex A. TEST INSTRUMENT

Instrument	Model	Serial #	Cal Date	Cal Due	In use
AC Line Conducted					
EMI test receiver	ESCS30	8471241027	09/17/2015	09/16/2016	<input checked="" type="checkbox"/>
Line Impedance	LI-125A	191106	09/25/2015	09/24/2016	<input checked="" type="checkbox"/>
Line Impedance	LI-125A	191107	09/25/2015	09/24/2016	<input checked="" type="checkbox"/>
LISN	ISN T800	34373	09/25/2015	09/24/2016	<input checked="" type="checkbox"/>
Double Ridge Horn Antenna (1 ~18GHz)	AH-118	71283	09/24/2015	09/23/2016	<input checked="" type="checkbox"/>
Transient Limiter	LIT-153	531118	09/01/2015	08/31/2016	<input checked="" type="checkbox"/>
RF conducted test					
Agilent ESA-E SERIES	E4407B	MY45108319	09/17/2015	09/16/2016	<input checked="" type="checkbox"/>
Power Splitter	1#	1#	09/01/2015	08/31/2016	<input checked="" type="checkbox"/>
DC Power Supply	E3640A	MY40004013	09/17/2015	09/16/2016	<input checked="" type="checkbox"/>
Radiated Emissions					
EMI test receiver	ESL6	100262	09/17/2015	09/16/2016	<input checked="" type="checkbox"/>
Positioning Controller	UC3000	MF780208282	11/20/2014	11/19/2015	<input checked="" type="checkbox"/>
OPT 010 AMPLIFIER (0.1-1300MHz)	8447E	2727A02430	09/01/2015	08/31/2016	<input checked="" type="checkbox"/>
Microwave Preamplifier (1 ~ 26.5GHz)	8449B	3008A02402	03/25/2015	03/24/2016	<input checked="" type="checkbox"/>
Bilog Antenna (30MHz~6GHz)	JB6	A110712	09/21/2015	09/20/2016	<input checked="" type="checkbox"/>
Double Ridge Horn Antenna (1 ~18GHz)	AH-118	71283	09/24/2015	09/23/2016	<input checked="" type="checkbox"/>
Universal Radio Communication Tester	CMU200	121393	09/25/2015	09/23/2016	<input checked="" type="checkbox"/>

Annex B. EUT And Test Setup Photographs

Annex B.i. Photograph: EUT External Photo

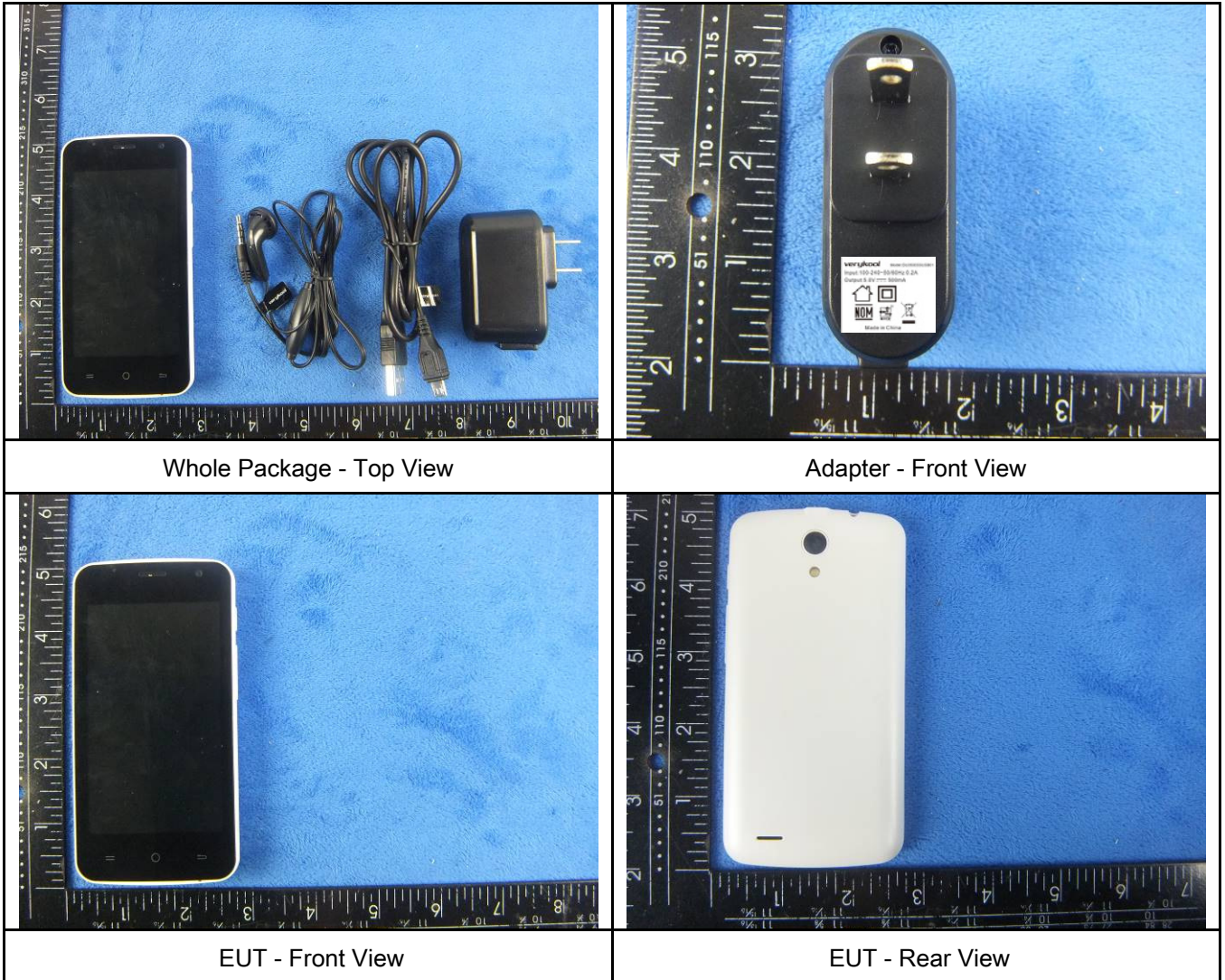



EUT - Top View



EUT - Bottom View



EUT - Left View

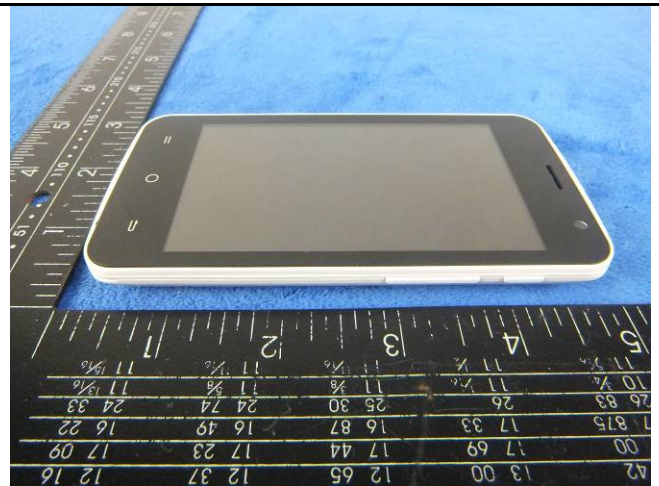

EUT - Right View

Annex B.ii. Photograph: EUT Internal Photo



Cover Off - Top View 1



Cover Off - Top View 2

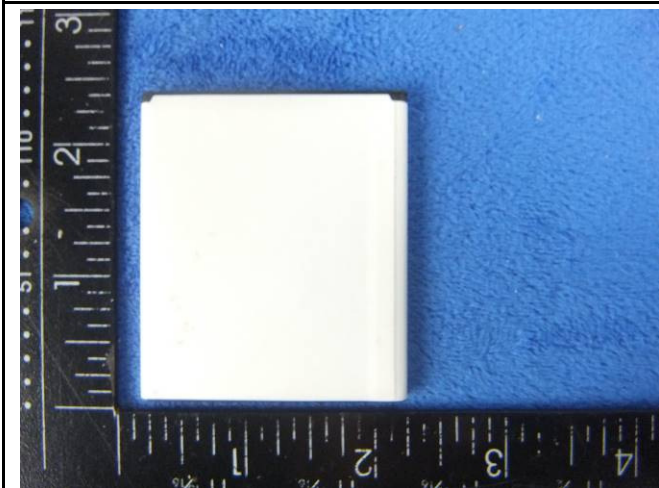

Battery - Front View



Battery - Rear View

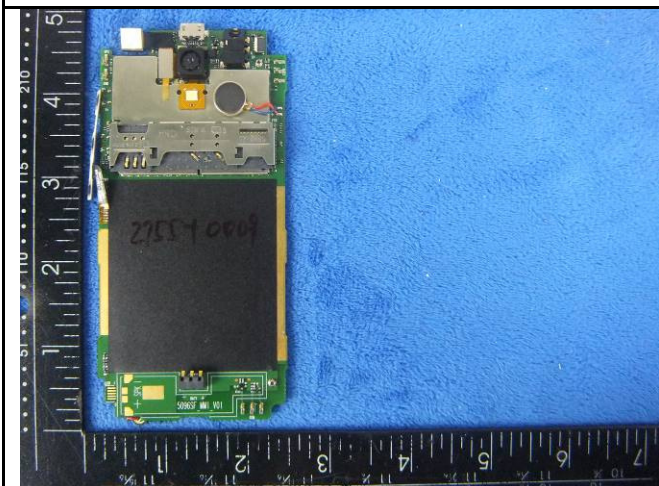

Mainboard with Shielding - Front View

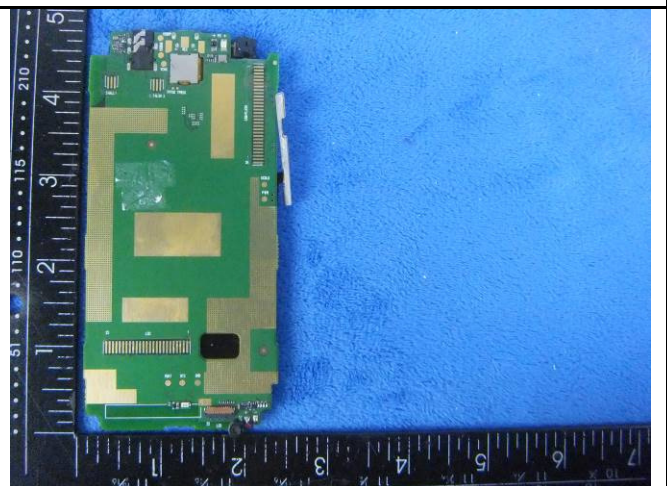

Mainboard with Shielding - Rear View

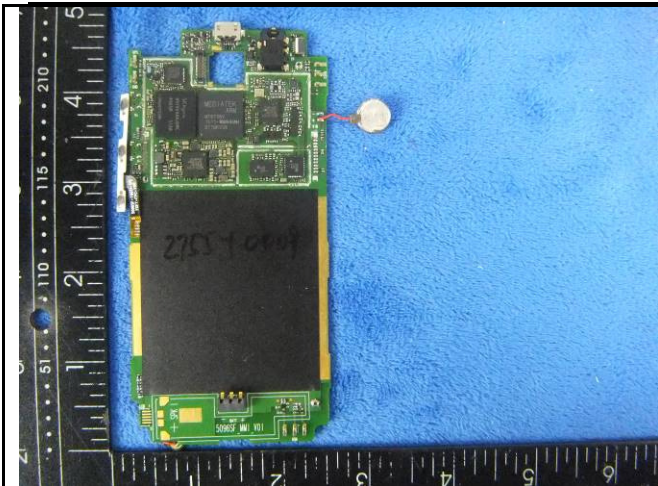

Mainboard without shielding - Front View

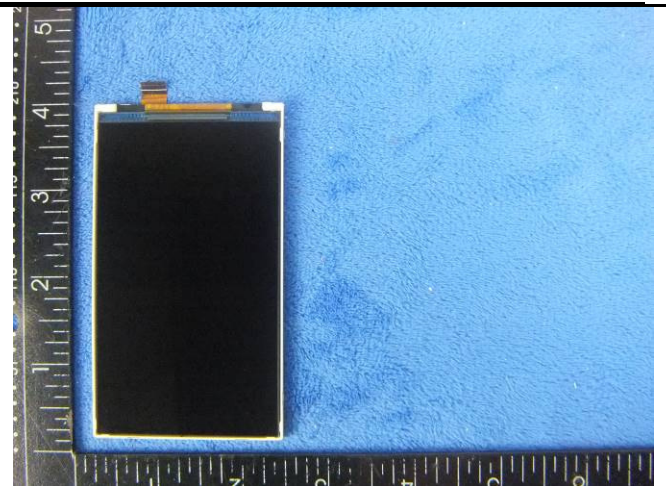

LCD - Front View



LCD - Rear View

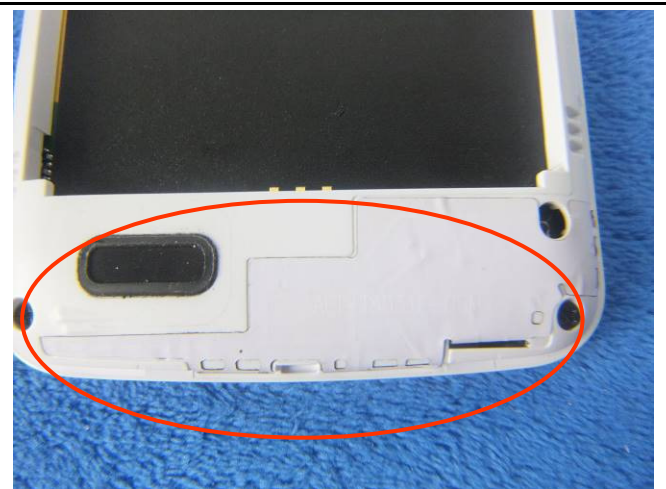

GSM/PCS/UMTS-FDD/LTE - Antenna View



WIFI/BT/BLE/GPS - Antenna View



LTE - Antenna View

Annex B.iii. Photograph: Test Setup Photo



Conducted Emissions Test Setup Front View



Conducted Emissions Test Setup Side View

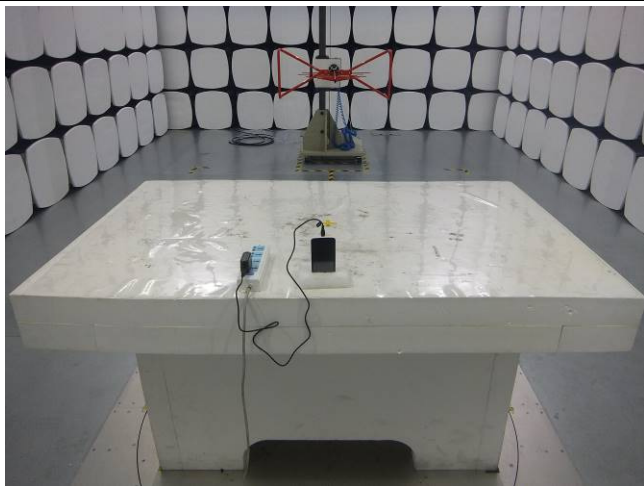

Radiated Spurious Emissions Test Setup Below 1GHz

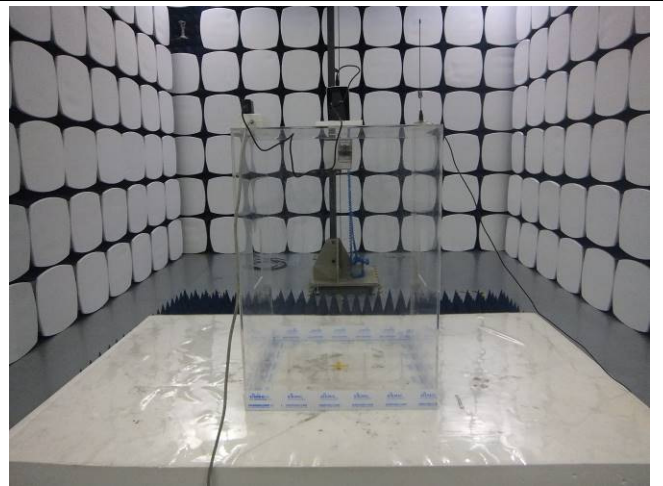

Radiated Spurious Emissions Test Setup Above
1GHz

Annex C. TEST SETUP AND SUPPORTING EQUIPMENT

Annex C.ii. TEST SET UP BLOCK

Block Configuration Diagram for AC Line Conducted Emissions

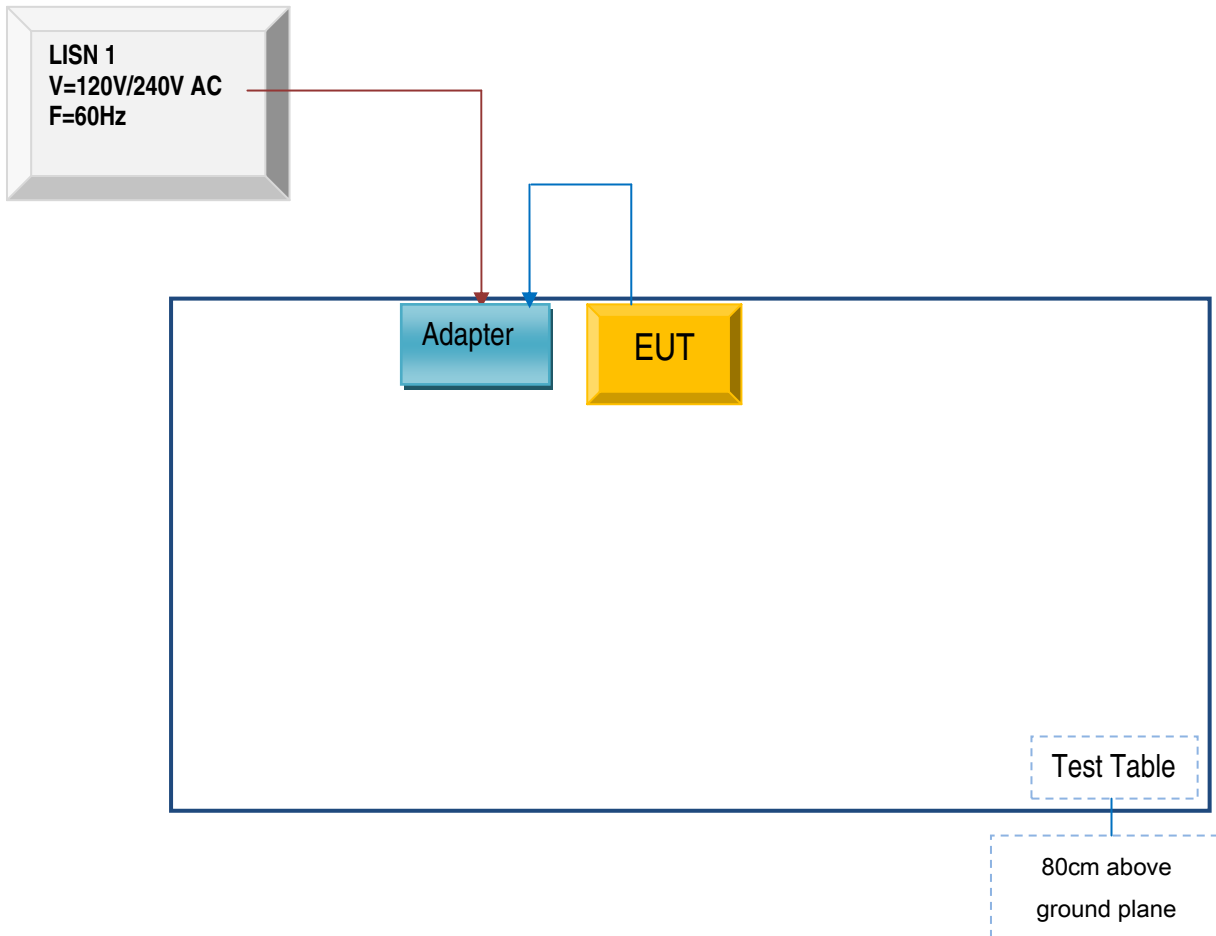

Block Configuration Diagram for Radiated Emissions (Below 1GHz) .

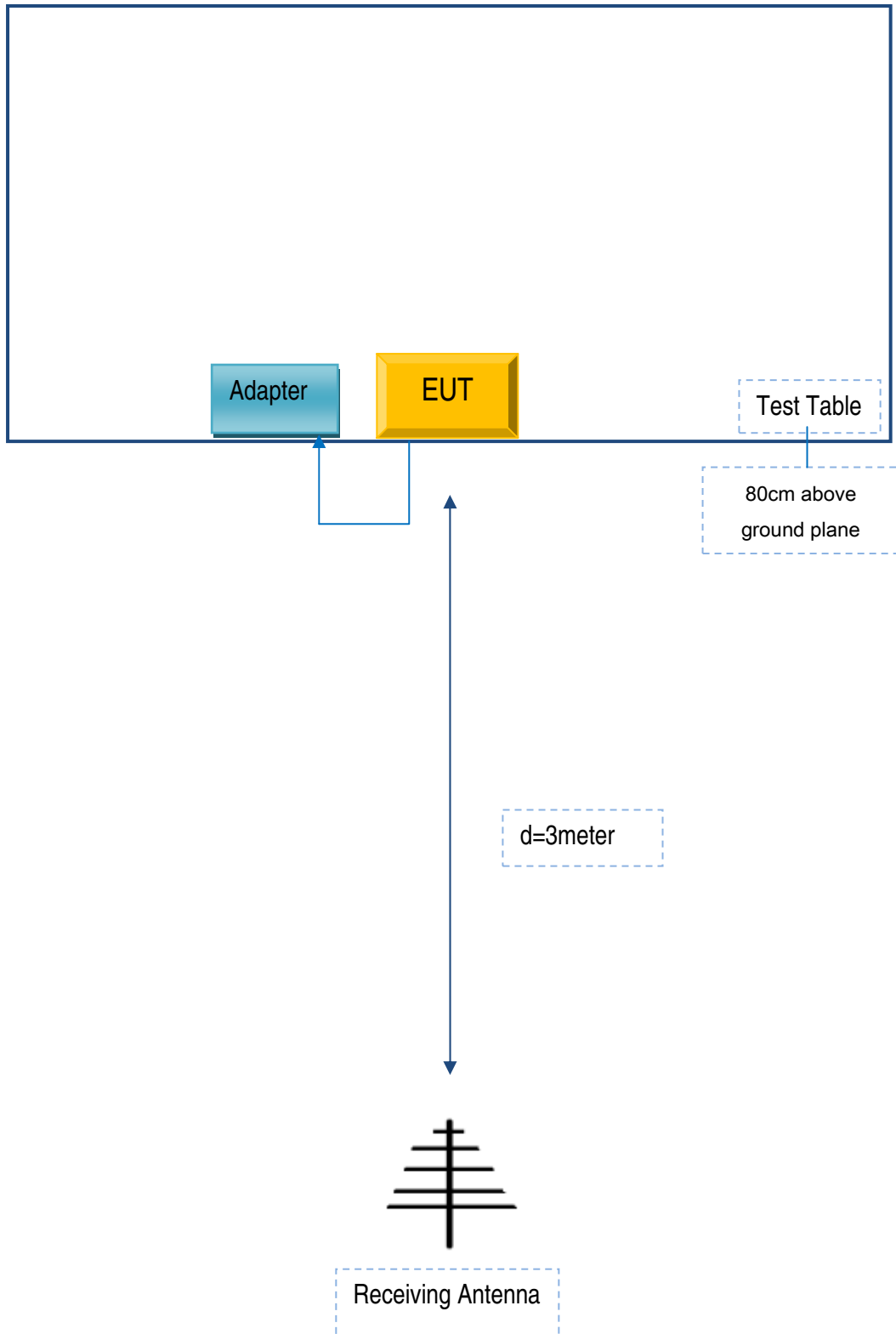

Block Configuration Diagram for Radiated Emissions (Above 1GHz) .

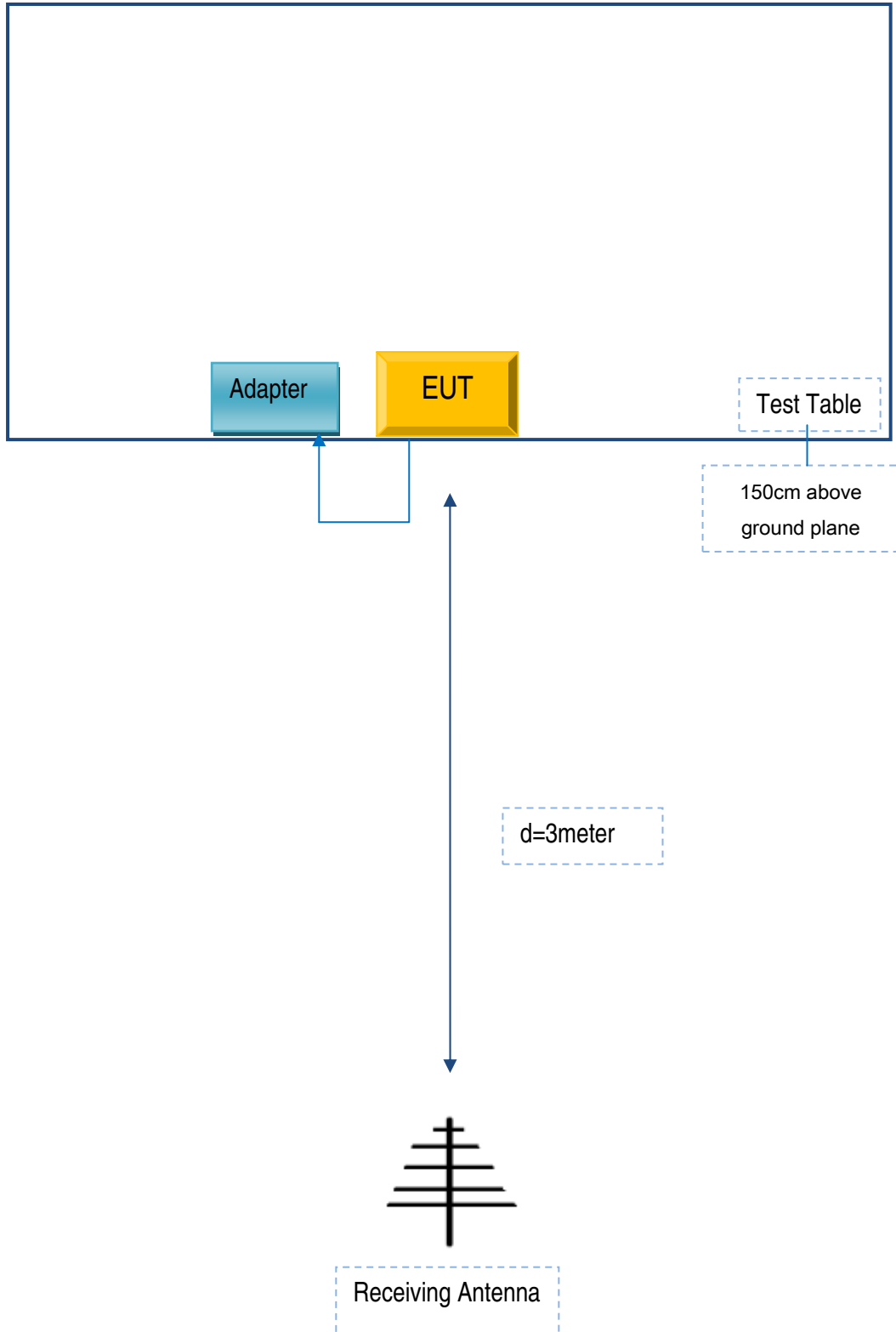

Annex C. ii. SUPPORTING EQUIPMENT DESCRIPTION

The following is a description of supporting equipment and details of cables used with the EUT.

Manufacturer	Equipment Description	Model	Calibration Date	Serial No	Calibration Due Date
Verykool USA Inc	Adapter	DU050050USB01	N/A	CN15010435	N/A

Supporting Cable:

Cable type	Shield Type	Ferrite Core	Length	Serial No	Calibration Date	Calibration Due Date
USB Cable	Un-shielding	No	0.8m	JX1502736	N/A	N/A

Test Report	15071133-FCC-R2
Page	58 of 59

Annex D. User Manual / Block Diagram / Schematics / Partlist

Please see attachment

Test Report	15071133-FCC-R2
Page	59 of 59

Annex E. DECLARATION OF SIMILARITY

N/A