



Report No.: SZ12050058H01

HAC TEST REPORT



Issued to

Verykool USA Inc

For

3G Mobile Phone

Model Name : S757
 Trade Name : verykool
 Brand Name : verykool
 FCC ID : WA6S757
 Standard : ANSI C 63.19:2007
 HAC Level : H-Field: M3
 E-Field: M4
 Test date : 2012-05-30
 Issue date : 2012-06-08

by

Shenzhen MORLAB Communication Technology Co., Ltd.



Tested by Samuel Peng
 Samuel Peng
 Date 2012.6.8

Approved by Zeng Dexin
 Zeng Dexin
 Date 2012.6.8

Review by Li Lei
 Li Lei
 Date 2012.6.8



The report refers only to the sample tested and does not apply to the bulk. This report is issued in confidence to the client and it will be strictly treated as such by the Shenzhen MORLAB Communication Technology Co., Ltd. It may not be reproduced in its entirety or in part and it may not be used for advertising. The client to whom the report is issued may, however, show or send it, or a certified copy thereof prepared by the Shenzhen MORLAB Telecommunication Co., Ltd to his customer. Supplier or others persons directly concerned. Shenzhen MORLAB Telecommunication Co., Ltd will not, without the consent of the client enter into any discussion of correspondence with any third party concerning the contents of the report. In the event of the improper use of the report, Shenzhen MORLAB Telecommunication Co., Ltd reserves the rights to withdraw it and to adopt any other remedies which may be appropriate.

Contents

1.1. Identification of the Responsible Testing Laboratory	3
1.2. Identification of the Responsible Testing Location	3
1.3. Accreditation Certificate	3
1.4. List of Test Equipments	3
2. TECHNICAL INFORMATION	4
2.1. Identification of Applicant.....	4
2.2. Identification of Manufacturer	4
2.3. Equipment Under Test (EUT).....	4
2.3.1. Photographs of the EUT	4
2.3.2. Identification of all used EUTs.....	5
2.4. Applied Reference Documents	5
2.5. Test Environment/Conditions	6
2.6. Operational Conditions During Test	7
2.6.1. INTRODUCTION.....	7
2.6.2. ANSI/IEEE PC 63.19 PERFORMANCE CATEGORIES	8
2.6.3. Description of Test System	10
2.6.4. TEST PROCEDURE	14
2.6.5. SYSTEM CHECK.....	16
2.6.6. Uncertainty Estimation Table	18
2.6.7. OVERALL MEASUREMENT SUMMARY	19
2.6.8. TEST DATA.....	21
ANNEX A ACCREDITATION CERTIFICATE	71
ANNEX B PHOTOGRAPHS OF THE EUT.....	72

1.1. Identification of the Responsible Testing Laboratory

Company Name: Shenzhen Morlab Communications Technology Co., Ltd.
Department: Morlab Laboratory
Address: 3/F, Electronic Testing Building, Shahe Road, Nanshan District, Shenzhen, 518055 P. R. China
Responsible Test Lab Manager: Mr. Shu Luan
Telephone: +86 755 86130268
Facsimile: +86 755 86130218

1.2. Identification of the Responsible Testing Location

Name: Shenzhen Morlab Communications Technology Co., Ltd. Morlab Laboratory
Address: 3/F, Electronic Testing Building, Shahe Road, Nanshan District, Shenzhen, 518055 P. R. China

1.3. Accreditation Certificate

Accredited Testing Laboratory: No. CNAS L1659

1.4. List of Test Equipments

No.	Instrument	Type
1	PC	Dell (Pentium IV 2.4GHz, SN:X10-23533)
2	Network Emulator	Rohde&Schwarz (CMU200, SN:105894)
3	Voltmeter	Keithley (2000, SN:1000572)
4	Synthesizer	Rohde&Schwarz (SML_03, SN:101868)
5	Amplifier	Nucl udes (ALB216, SN:10800)
6	Power Meter	Rohde&Schwarz (NRVD, SN:101066)
7	Audio DAQ	NI (MonDAQ, SN:MonNumero)
8	E-FIELD PROBE	SN: SN 41/08 EPH17
9	H-FIELD PROBE	SN: SN 41/08 HPH18
10	T-COIL PROBE	SN: SN 39/08 TCP11
11	800-950 MHZ DIPOLE	SN: SN 36/08 DHA16
12	1700-2000 MHZ DIPOLE	SN: SN 36/08 DHB16
13	HAC holder	SN02_EPH02 (SN:SN_3608_SUPH16)

2. Technical Information

Note: the following data is based on the information by the applicant.

2.1. Identification of Applicant

Company Name: Verykool USA Inc
Address: 4350 Executive Dr. #100, San Diego

2.2. Identification of Manufacturer

Company Name: Verykool Wireless Technology Ltd.
Address: Room 1701, Reward Building C, No.203, 2nd Section of WangJing, Li Ze
Zhong Yuan, ChaoYang District, Beijing, P.R. of China 100102

2.3. Equipment Under Test (EUT)

Brand Name: verykool
Type Name: verykool
Marking Name: S757
Hardware Version: (N.A)
Software Version: (N.A)
Frequency Bands: GSM850MHz PCS 1900MHz
WCDMA 850MHz WCDMA 1900MHz
Tx Frequencies 824.20 - 848.80 MHz (GSM 850)
1850.20 - 1909.80 MHz (GSM 1900)
824MHz-849MHz(WCDMA 850)
1850MHz-1910MHz(WCDMA 1900)
Antenna type: Fixed Internal Antenna
Development Stage: Identical prototype
Battery Model: BL-05
Battery specification: 2300mAh 3.7V
Development Stage: Identical prototype
Classification: Licensed Transmitter Held to Ear
EUT Type: GSM850MHz PCS 1900MHz
WCDMA 850MHz WCDMA 1900MHz
GSM 850, 975, 38, 124, BT/WIFI Off
HAC Test GSM 1900, 512, 698, 885, BT/WIFI Off
Configurations: WCDMA 850, 4132, 4182, 4233, BT/WIFI Off
WCDMA 1900, 9262, 9400, 9538, BT/WIFI Off

2.3.1. Photographs of the EUT

Please see for photographs of the EUT.

2.3.2. Identification of all used EUTs

The EUT identity consists of numerical and letter characters, the letter character indicates the test sample, and the following two numerical characters indicate the software version of the test sample.

EUT Identity	Hardware Version	Software Version
1#	(N.A)	(N.A)

2.4. Applied Reference Documents

Leading reference documents for testing:

No.	Identity	Document Title
1	ANSI C 63.19:2007	American National Standard Methods of Measurement of Compatibility between Wireless Communications Devices and Hearing Aids

Note: Test report, reference KDB 285076 documents.

2.5. Test Environment/Conditions

Normal Temperature (NT):	20 ... 25 °C
Relative Humidity:	30 ... 75 %
Air Pressure:	980 ... 1020 hPa
Extreme Voltage of the EUT:	Normal Voltage (NV) = 3.70V
	Low Voltage (LV) = 3.60V
	High Voltage (HV) = 4.20V
Test frequency:	GSM 850MHz PCS 1900MHz WCDMA 850MHz, WCDMA 1900MHz
Operation mode:	Call established
Power Level:	GSM 850 MHz Maximum output power(level 5)
	PCS 1900 MHz Maximum output power(level 0)
	WCDMA Maximum output power

During HAC test, EUT is in Traffic Mode (Channel Allocated) at Normal Voltage Condition. A communication link is set up with a System Simulator (SS) by air link, and a call is established. The Absolute Radio Frequency Channel Number (ARFCN) is allocated to 25, 190 and 251 respectively in the case of GSM 850 MHz, or to 512, 661 and 810 respectively in the case of PCS 1900 MHz or is allocated to 4132, 4182 and 4233 respectively in the case of WCDMA 850MHz and is allocated to 9262, 9400 and 9538 respectively in the case of WCDMA 1900MHz. The EUT is commanded to operate at maximum transmitting power.

2.6.Operational Conditions During Test

2.6.1. INTRODUCTION

On July 10,2003,the Federal Communications Commission (FCC) adopted new rules requiring wireless manufacturers and service providers to provide digital wireless phones that are compatible with hearing aids. The FCC has modified the exemption for wireless phones under the Hearing Aid Compatibility Act of 1998 (HAC Act) in WT Docket 01-309 RM-8658 to extend the benefits of wireless telecommunications to individuals with hearing disabilities. These benefits encompass business, social and emergency communications, which increase the value of the wireless network for everyone. An estimated more than 10% of the population in the United States show signs of hearing impairment and of that fraction, almost 80% use hearing aids. Approximately 500 million people worldwide suffer from hearing loss.

Compatibility Tests involved:

The standard calls for wireless communications devices to be measured for:

- RF Electric-field emissions.
- RF Magnetic- field emissions.
- T-coil mode, magnetic-signal strength in the audio band.
- T-coil mode, magnetic-signal frequency response through the audio band.
- T-coil mode, magnetic-signal and noise articulation index.

The hearing aid must be measured for:

- RF immunity in microphone mode
- RF immunity in T-coil mode

In the following tests and results, this report includes the evaluation for a wireless communications device

2.6.2. ANSI/IEEE PC 63.19 PERFORMANCE CATEGORIES

4.3.2.1. RF EMISSIONS

The ANSI Standard presents performance requirements for acceptable interoperability of hearing with wireless communications devices. When these parameters are met, a hearing aid operates acceptably in close proximity to a wireless communications device.

850MHz Limit:

Category	AWF (dB)	Limits for E-Field Emission (V/m)	Limits for H-Field Emission (A/m)
M1	0	631.0 - 1122.0	1.91 - 3.39
	-5	473.2 - 841.4	1.43 - 2.54
M2	0	354.8 - 631.0	1.07 - 1.91
	-5	266.1 - 473.2	0.80 - 1.43
M3	0	199.5 - 354.8	0.6 - 1.07
	-5	149.6 - 266.1	0.45 - 0.80
M4	0	<199.5	<0.60
	-5	<149.6	<0.45

Hearing aid and WD near-field categories as defined in ANSI PC 63.19. During testing, the hearing aid must maintain an input-referenced interference level of less than 55dB a gain compression of less than 6dB.

1900MHz Limit:

Category	AWF (dB)	Limits for E-Field Emission (V/m)	Limits for H-Field Emission (A/m)
M1	0	199.5 - 354.8	0.6 - 1.07
	-5	149.6 - 266.1	0.45 - 0.8
M2	0	112.2 - 199.5	0.34 - 0.6
	-5	84.1 - 149.6	0.25 - 0.45
M3	0	63.1 - 112.2	0.19 - 0.34
	-5	47.3 - 84.1	0.15 - 0.25
M4	0	<63.1	<0.19
	-5	<47.3	<0.15

4.3.2.2. Articulation Weighing Factor (AWF)

Standard	Technology	AWF
T1/T1P1/3GPP	UMTS(WCDMA)	0
IS-95	CDMA	0
iden	GSM(22and 11Hz)	0
J-STD-007	GSM(217Hz)	-5

AWF has been developed from information presented to the committee regarding the interference potential of the various modulation types according to ANSI PC 63.19

2.6.3. Description of Test System

4.3.3.1. COMO HAC E-FIELD PROBE



Serial Number:	SN 41/08 EPH17
Frequency:	100MHz – 3GHz
Probe length:	330mm
Length of one dipole:	3.3mm
Maximum external diameter:	8mm
Probe extremity diameter:	6mm
Distance between dipoles/probe extremity:	3mm
Resistance of the three dipole (at the connector):	Dipole 1:R1=2.1807 MΩ Dipole 2:R1=2.0612 MΩ Dipole 3:R3=2.1892 MΩ
Connector (HIROSE series SR30)	6 wire male (Hirose SR30series)

CALIBRATION TEST EQUIPMENT

TYPE	IDENTIFICATION
Calibration bench	SATIMO AIR CALIBRATION SOFTWARE
Multimeter	Keithley 2000

MEASUREMENT PROCEDURE

Probe calibration is realized by using the waveguide method. The probe was inserted in a waveguide loading by a 50 load. By controlling the input power in the waveguide, we are able to create a know EField value in the waveguide. ,

Keithley configuration:

Rate = Medium; Filter =ON; RDGS=10; FILTER TYPE =MOVING AVERAGE; RANGE AUTO

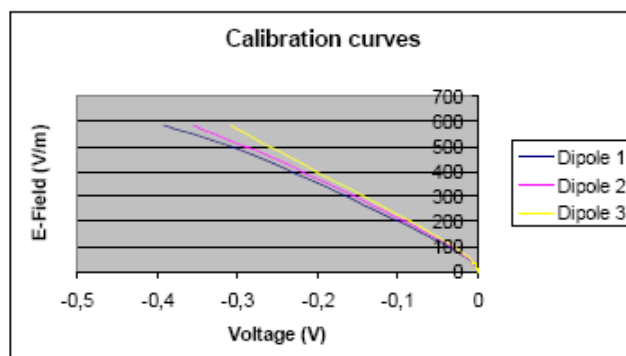

The following tables represent the calibration curves linearization by curve segment in CW signal.

4.3.3.2. COMO HAC H-FIELD PROBE



Serial Number:	SN 41/08 HPH18
Frequency:	100MHz – 3GHz
Probe length:	330mm
Length of one dipole:	3.3mm
Maximum external diameter:	8mm
Probe extremity diameter:	6mm
Distance between dipoles/probe extremity:	3mm
Resistance of the three dipole (at the connector):	Dipole 1:R1=2.1650 MΩ Dipole 2:R1=2.2176 MΩ Dipole 3:R3=2.4084 MΩ
Connector (HIROSE series SR30)	6 wire male (Hirose SR30series)

CALIBRATION TEST EQUIPMENT

TYPE	IDENTIFICATION
Calibration bench	SATIMO AIR CALIBRATION SOFTWARE
Multimeter	Keithley 2000

MEASUREMENT PROCEDURE

Probe calibration is realized by using the waveguide method. The probe was inserted in a waveguide loading by a 50 load. By controlling the input power in the waveguide, we are able to create a know HField value in the waveguide.

Keithley configuration:

Rate = Medium; Filter =ON; RDGS=10; FILTER TYPE =MOVING AVERAGE; RANGE AUTO

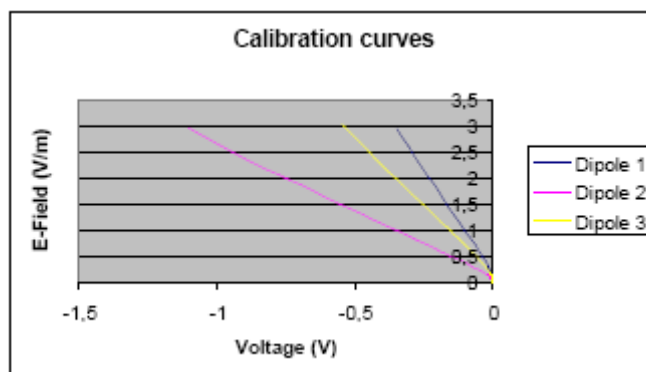

The following tables represent the calibration curves linearization by curve segment in CW signal.

4.3.3.3. COMOHAC T-COIL PROBE



Serial Number:	SN 39/08 TCP11
Dimensions:	6.55mm length*2.29mm diameter
DC resistance:	860.6Ω
Wire size:	51 AWG
Inductance:	132.1 mH at 1kHz
Sensitivity:	-60.22 dB (V/A/m) at 1kHz

SENSITIVITY

Probe coil sensitivity relative to sensitivity at 1000 Hz

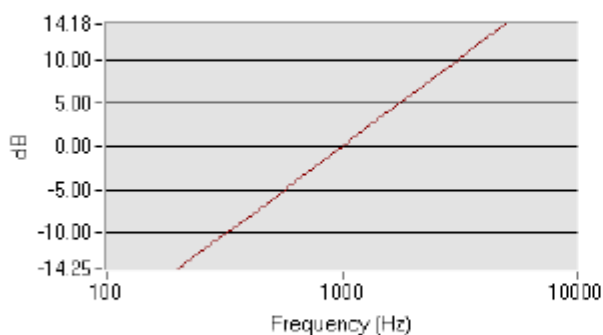

T-Coil probe sensitivity (dB V/(A/m))

Frequency (Hz)	H (dB (V/(A/m)))
200	-73,92940009
250	-72,011119983
315	-70,06378892
400	-67,88880017
500	-66,00059991
630	-64,07318901
800	-62,00820026
1000	-60,22
1250	-58,29179974
1600	-56,20760035
2000	-54,31940009
2500	-52,36119983
3150	-50,38378892
4000	-48,50880017
5000	-46,44059991

LINEARITY

Linearity = 0.27 dB

Power (dB) relative to 1 A/m	0	-10	-20	-30	-40	-50
H (dB (V/(A/m)))	0	-9,95	-19,95	-30	-39,9	-49,73

4.3.3.4. System Hardware

The HAC positioning ruler is used to position the phone properly with the regard to the position of the probe during a measurement. The positioning system is made of a dedicated frame that can be fixed on the table. The tip of the probe is positioned on a reference point located on the top of the positioning ruler. The distance between this reference point and the cross located on the ruler being known, the speaker of the phone is positioned on this cross in order to make sure both probe and phone are positioned properly.

During the measurement, the HAC ruler has to be removed so that it does not interfere with the measurement.

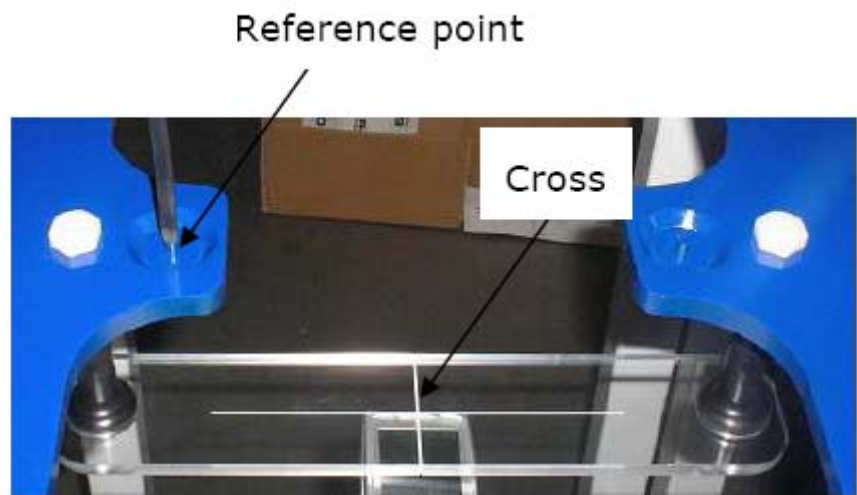

HAC positioning ruler

2.6.4. TEST PROCEDURE

4.3.4.1. RF EMISSIONS

Per ANSI C 63.19 2007:

Test Instructions

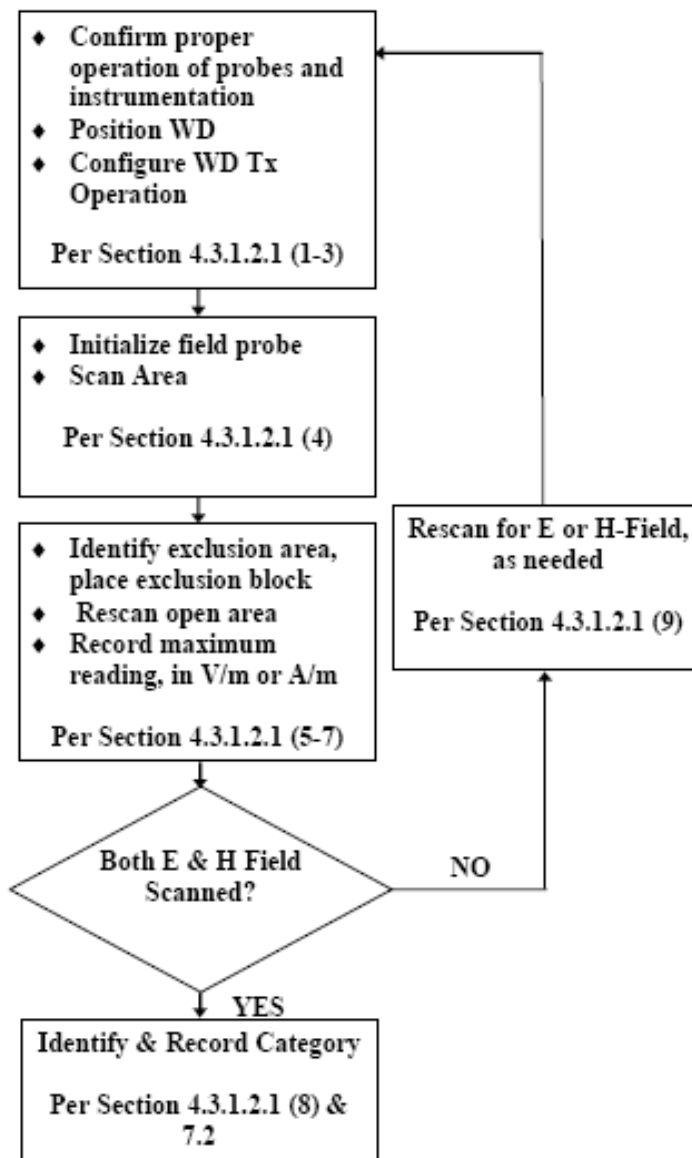

4.3.4.2. TEST Setup



WD reference and plane for RF emission measurements

4.3.4.3. RF Emission Test Procedure

The following illustrate a typical RF emissions test scan over a wireless communications device:

1. Proper operation of the field probe, probe measurement system, other instrumentation, and the positioning system was confirmed.
2. WD is positioned in its intended test position, acoustic output point of the device perpendicular to the field probe.
3. The WD operation for maximum rated RF output power was configured and confirmed with the base station simulator, at the test channel and other normal operating parameters as intended for the test. The battery was ensured to be fully charged before each test.
4. The center sub-grid was centered over the center of the acoustic output (also audio band magnetic output, if applicable). The WD audio output was positioned tangent (as physically possible) to the measurement plane.
5. A surface calibration was performed before each setup change to ensure repeatable spacing and proper maintenance of the measurement plane using the HAC Phantom.
6. The measurement system measured the field strength at the reference location.

2.6.5. SYSTEM CHECK

4.3.5.1. System Check Parameters

The input signal was an unmodulated continuous wave. The following points were taken into consideration in performing this check:

- Average Input Power $P = 100\text{mW RMS}$ (20dBm RMS) after adjustment for return loss
- The test fixture must meet the 2 wavelength separation criterion
- The proper measurement of the 1 cm probe to dipole separation, which is measured from top surface of the dipole to the calibration reference point of the sensor, defined by the probe manufacturer is shown in the following diagram:

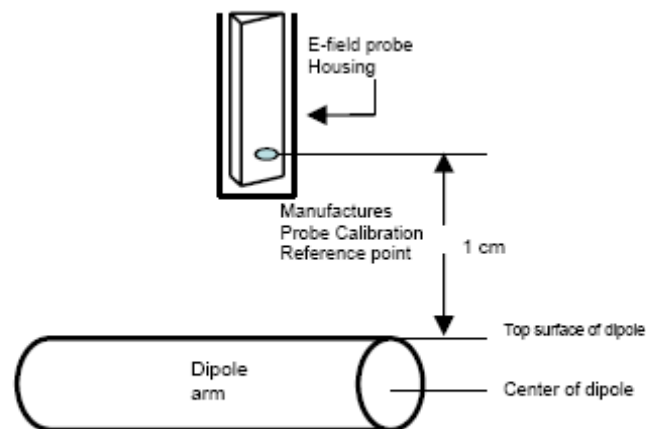

Figure 15
Separation Distance from Dipole to Field Probe

RF power was recorded using both an average reading meter and a peak reading meter. Readings of the probe are provided by the measurement system.

To assure proper operation of the near-field measurement probe the input power to the dipole shall be commensurate with the full rated output power of the wireless device (e.g. - for a cellular phone wireless device the average peak antenna input power will be on the order of 100mW (i.e. - 20dBm) RMS after adjustment for any mismatch.

4.3.5.2 Validation Procedure

A dipole antenna meeting the requirements given in PC63.19 was placed in the position normally occupied by the WD.

The length of the dipole was scanned with both E-field and H-field probes and the maximum values for each were recorded.

Using the near-field measurement system, scan the antenna over the radiating dipole and record the greatest field reading observed. Due to the nature of E-fields about free-space dipoles, the two E-field peaks measured over the dipole are averaged to compensate for non-parallelity of the setup see manufacturer method on dipole calibration certificates, Field strength measurements shall be made only when the probe is stationary.

RF power was recorded using both an average and a peak power reading meter.

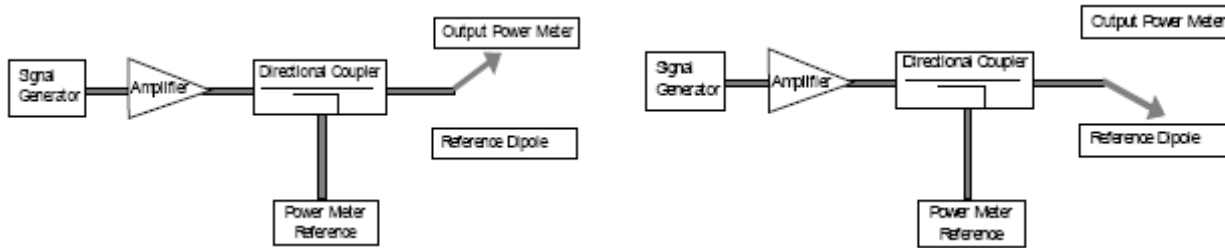

Setup for Desired Output Power to Dipole

Setup to Dipole

Using this setup configuration, the signal generator was adjusted for the desired output power (100mW) at a specified frequency. The reference power from the coupled port of the directional coupler is recorded. Next, the output cable is connected to the reference dipole,

4.3.5.3. Test System Validation

Validation Results (1W forward input power), System checks the specific test data please see page 49-56

Frequency	Input Power (dBm)	E-field Result (V/m)	Target Field (V/m)
900 MHz	20.0	207	205
1800MHz	20.0	161.52	165
Frequency	Input Power (dBm)	H-field Result (A/m)	Target Field (A/m)
900 MHz	20.0	0.442	0.448
1800MHz	20.0	0.447	0.452

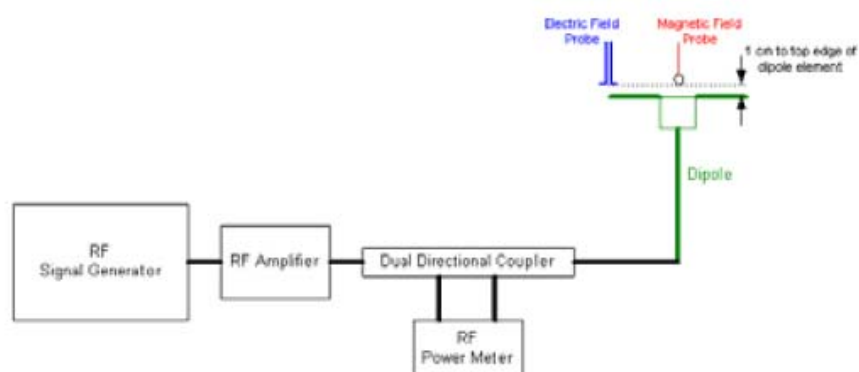

System Check Setup

2.6.6. Uncertainty Estimation Table

a	b	c	d	e= f(d,k)	f	g	h= c*f/e	i= c*g/e	k
Uncertainty Component	Sec.	Tol (+- %)	Prob. Dist.	Div.	Ci (1g)	Ci (10g)	1g Ui (+-%)	10g Ui (+-%)	V i
Measurement System									
Probe calibration	E.2.1	7.0	N	1	1	1	7.00	7.00	
Axial Isotropy	E.2.2	2.5	R	$\sqrt{3}$			1.02	1.02	
Hemispherical Isotropy	E.2.2	4.0	R	$\sqrt{3}$			1.63	1.63	
Boundary effect	E.2.3	1.0	R	$\sqrt{3}$	1	1	0.58	0.58	
Linearity	E.2.4	5.0	R	$\sqrt{3}$	1	1	2.89	2.89	
System detection limits	E.2.5	1.0	R	$\sqrt{3}$	1	1	0.58	0.58	
Readout Electronics	E.2.6	0.02	N	1	1	1	0.02	0.02	
Reponse Time	E.2.7	3.0	R	$\sqrt{3}$	1	1	1.73	1.73	
Integration Time	E.2.8	2.0	R	$\sqrt{3}$	1	1	1.15	1.15	
RF ambient Conditions	E.6.1	3.0	R	$\sqrt{3}$	1	1	1.73	1.73	
Probe positioner Mechanical Tolerance	E.6.2	2.0	R	$\sqrt{3}$	1	1	1.15	1.15	
Probe positioning with respect to Phantom Shell	E.6.3	0.05	R	$\sqrt{3}$	1	1	0.03	0.03	
Extrapolation, interpolation and integration Algorithms for Max. SAR Evaluation	E.5.2	5.0	R	$\sqrt{3}$	1	1	2.89	2.89	
Test sample Related									
Test sample positioning	E.4.2.1	0.03	N	1	1	1	0.03	0.03	N - 1
Device Holder Uncertainty	E.4.1.1	5.00	N	1	1	1	5.00	5.00	
Output power Variation - drift measurement	6.6.2	5.78	R		1	1	3.34	3.34	

2.6.7. OVERALL MEASUREMENT SUMMARY

2.6.7.1 E-FIELD EMISSIONS

Band	Mode	Channel	Peak E Field (V/m)	M Rating	Output power (dBm)
E-FIELD EMISSIONS					
GSM850	GSM	128	48.77	M4	33.59
GSM850	GSM	189	57.19	M4	33.47
GSM850	GSM	250	60.25	M4	31.08
GSM1900	GSM	513	46.70	M4	29.28
GSM1900	GSM	661	46.25	M4	29.33
GSM1900	GSM	809	41.78	M4	29.47

2.6.7.2 H-FIELD EMISSIONS

Band	Mode	Channel	Peak E Field (A/m)	M Rating	Output power (dBm)
H-FIELD EMISSIONS					
GSM850	GSM	128	0.11	M4	33.59
GSM850	GSM	189	0.28	M4	33.47
GSM850	GSM	250	0.11	M4	31.08
GSM1900	GSM	513	0.20	M3	29.28
GSM1900	GSM	661	0.19	M3	29.33
GSM1900	GSM	809	0.24	M3	29.47

2.6.7.3 E-FIELD EMISSIONS

Band	Mode	Channel	Peak E Field (V/m)	M Rating	Output power (dBm)
E-FIELD EMISSIONS					
WCDMA850	WCDMA	4132	127.15	M4	21.85
WCDMA850	WCDMA	4182	125.11	M4	21.73
WCDMA850	WCDMA	4233	111.53	M4	21.80
WCDMA1900	WCDMA	9262	32.43	M4	21.45
WCDMA1900	WCDMA	9400	37.32	M4	21.37
WCDMA1900	WCDMA	9538	41.10	M4	21.39

2.6.7.4 H-FIELD EMISSIONS

Band	Mode	Channel	Peak E Field (A/m)	M Rating	Output power (dBm)
H-FIELD EMISSIONS					
WCDMA850	WCDMA	128	0.25	M4	21.85
WCDMA850	WCDMA	189	0.27	M4	21.73
WCDMA850	WCDMA	250	0.25	M4	21.80
WCDMA1900	WCDMA	513	0.08	M4	21.45
WCDMA1900	WCDMA	661	0.10	M4	21.37
WCDMA1900	WCDMA	809	0.11	M4	21.39

2.6.8. TEST DATA

<u>FREQUENCY</u>	<u>PARAMETERS</u>
<u>GSM850</u>	<p><u>Measurement 1</u>: Efield on Low Channel</p> <p><u>Measurement 2</u>: Hfield on Low Channel</p> <p><u>Measurement 3</u>: Efield on Middle Channel</p> <p><u>Measurement 4</u>: Hfield on Middle Channel</p> <p><u>Measurement 5</u>: Efield on High Channel</p> <p><u>Measurement 6</u>: Hfield on High Channel</p>
<u>GSM1900</u>	<p><u>Measurement 7</u>: Efield on Low Channel</p> <p><u>Measurement 8</u>: Hfield on Low Channel</p> <p><u>Measurement 9</u>: Efield on Middle Channel</p> <p><u>Measurement 10</u>: Hfield on Middle Channel</p> <p><u>Measurement 11</u>: Efield on High Channel</p> <p><u>Measurement 12</u>: Hfield on High Channel</p>
<u>WCDMA850</u>	<p><u>Measurement 13</u>: Efield on Low Channel</p> <p><u>Measurement 14</u>: Hfield on Low Channel</p> <p><u>Measurement 15</u>: Efield on Middle Channel</p> <p><u>Measurement 16</u>: Hfield on Middle Channel</p> <p><u>Measurement 17</u>: Efield on High Channel</p> <p><u>Measurement 18</u>: Hfield on High Channel</p>
<u>WCDMA 1900</u>	<p><u>Measurement 19</u>: Efield on Low Channel</p> <p><u>Measurement 20</u>: Hfield on Low Channel</p>

Measurement 21: Efield on Middle Channel

Measurement 22: Hfield on Middle Channel

Measurement 23: Efield on High Channel

Measurement 24: Hfield on High Channel

MEASUREMENT 1

A. Experimental conditions.

Grid size (mm x mm)	50.0, 50.0
Step (mm)	5
Band	GSM850
Channel	Low
Signal	GSM
Date of measurement	30/5/2012

B. HAC Measurement Results

Lower Band (Channel 128):

Frequency (MHz): 824.200000

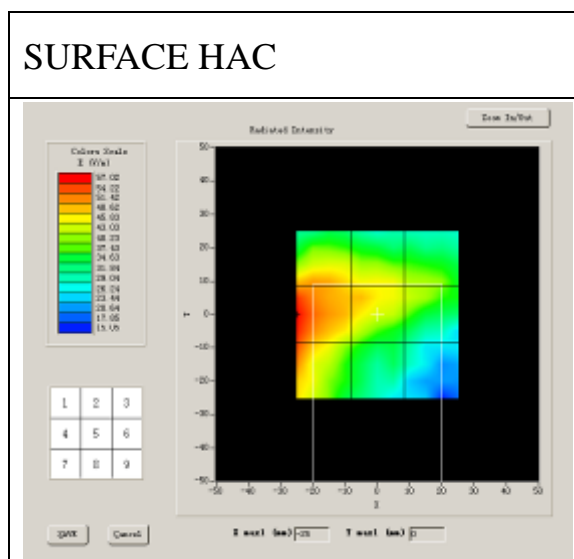

Probe Modulation Factor = 2.840000

Maximum value of total field = 48.77 V/m

Hearing Aid Near-Field Category: M4 (AWF -5 dB)

E in V/m

Grid 1: 50.28	Grid 2: 45.93	Grid 3: 41.75
Grid 4: 57.02	Grid 5: 48.77	Grid 6: 43.15
Grid 7: 54.81	Grid 8: 39.99	Grid 9: 30.51

MEASUREMENT 2

A. Experimental conditions.

Grid size (mm x mm)	50.0, 50.0
Step (mm)	5
Band	GSM850
Channel	Low
Signal	GSM
Date of measurement	30/5/2012

B. HAC Measurement Results

Lower Band (Channel 128):

Frequency (MHz): 824.200000

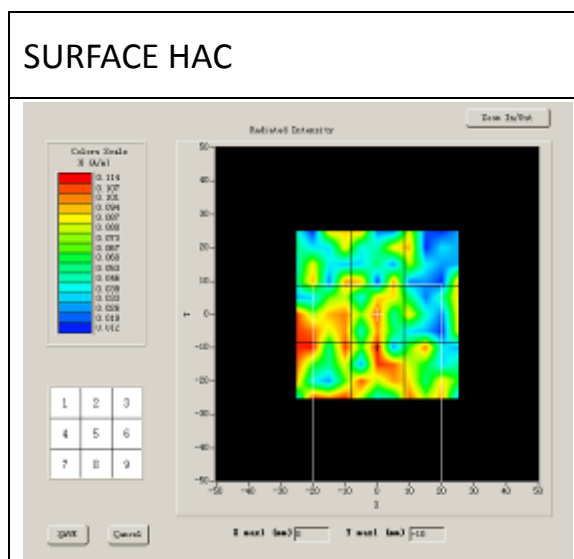

Probe Modulation Factor = 2.840000

Maximum value of total field = 0.11 A/m

Hearing Aid Near-Field Category: M4 (AWF -5 dB)

H in A/m

Grid 1: 0.10	Grid 2: 0.10	Grid 3: 0.09
Grid 4: 0.12	Grid 5: 0.11	Grid 6: 0.10
Grid 7: 0.12	Grid 8: 0.12	Grid 9: 0.10

MEASUREMENT 3

A. Experimental conditions.

Grid size (mm x mm)	50.0, 50.0
Step (mm)	5
Band	GSM850
Channel	Middle
Signal	GSM
Date of measurement	30/5/2012

B. HAC Measurement Results

Middle Band (Channel 189):

Frequency (MHz): 836.400000

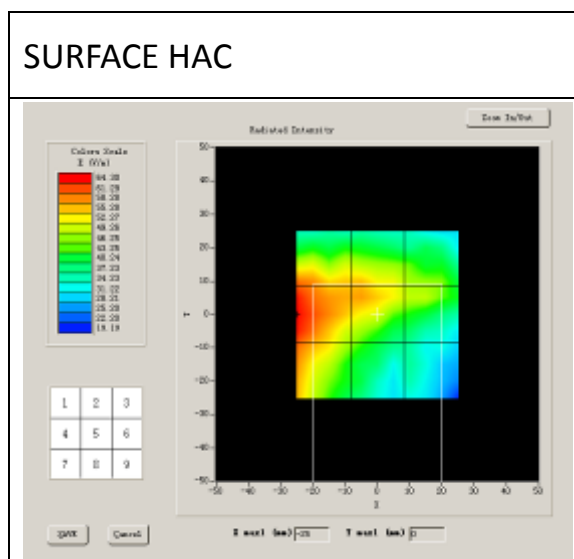

Probe Modulation Factor = 2.840000

Maximum value of total field = 57.19 V/m

Hearing Aid Near-Field Category: M4 (AWF -5 dB)

E in V/m

Grid 1: 59.27	Grid 2: 55.38	Grid 3: 47.16
Grid 4: 64.33	Grid 5: 57.19	Grid 6: 49.22
Grid 7: 61.11	Grid 8: 45.80	Grid 9: 35.94

MEASUREMENT 4

A. Experimental conditions.

Grid size (mm x mm)	50.0, 50.0
Step (mm)	5
Band	GSM850
Channel	Middle
Signal	GSM
Date of measurement	30/5/2012

B. HAC Measurement Results

Middle Band (Channel 189):

Frequency (MHz): 836.400000

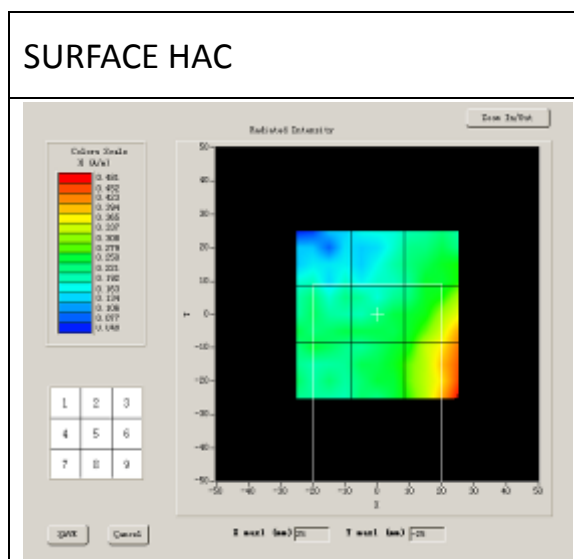

Probe Modulation Factor = 2.840000

Maximum value of total field = 0.28 A/m

Hearing Aid Near-Field Category: M4 (AWF -5 dB)

H in A/m

Grid 1: 0.19	Grid 2: 0.22	Grid 3: 0.28
Grid 4: 0.24	Grid 5: 0.26	Grid 6: 0.42
Grid 7: 0.25	Grid 8: 0.29	Grid 9: 0.48

MEASUREMENT 5

A. Experimental conditions.

Grid size (mm x mm)	50.0, 50.0
Step (mm)	5
Band	GSM850
Channel	High
Signal	GSM
Date of measurement	30/5/2012

B. HAC Measurement Results

Higher Band (Channel 250):

Frequency (MHz): 848.600000

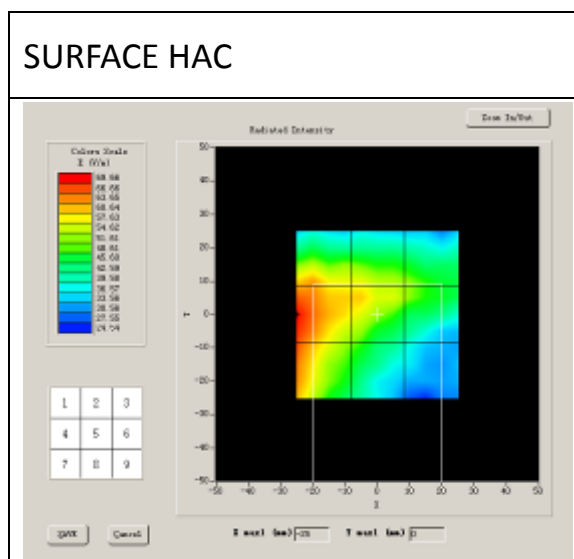

Probe Modulation Factor = 2.840000

Maximum value of total field = 60.25 V/m

Hearing Aid Near-Field Category: M4 (AWF -5 dB)

E in V/m

Grid 1: 62.46	Grid 2: 56.88	Grid 3: 51.47
Grid 4: 69.67	Grid 5: 60.25	Grid 6: 52.49
Grid 7: 66.93	Grid 8: 50.99	Grid 9: 38.22

MEASUREMENT 6

A. Experimental conditions.

Grid size (mm x mm)	50.0, 50.0
Step (mm)	5
Band	GSM850
Channel	High
Signal	GSM
Date of measurement	30/5/2012

B. HAC Measurement Results

Higher Band (Channel 250):

Frequency (MHz): 848.600000

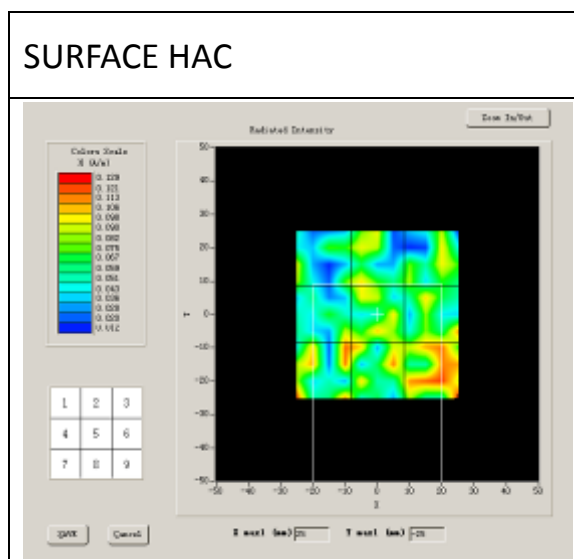

Probe Modulation Factor = 2.840000

Maximum value of total field = 0.11 A/m

Hearing Aid Near-Field Category: M4 (AWF -5 dB)

H in A/m

Grid 1: 0.10	Grid 2: 0.11	Grid 3: 0.10
Grid 4: 0.11	Grid 5: 0.11	Grid 6: 0.11
Grid 7: 0.13	Grid 8: 0.12	Grid 9: 0.13

MEASUREMENT 7

A. Experimental conditions.

Grid size (mm x mm)	50.0, 50.0
Step (mm)	5
Band	GSM1900
Channel	Low
Signal	GSM
Date of measurement	30/5/2012

B. HAC Measurement Result

Lower Band (Channel 513):

Frequency (MHz): 1850.400000

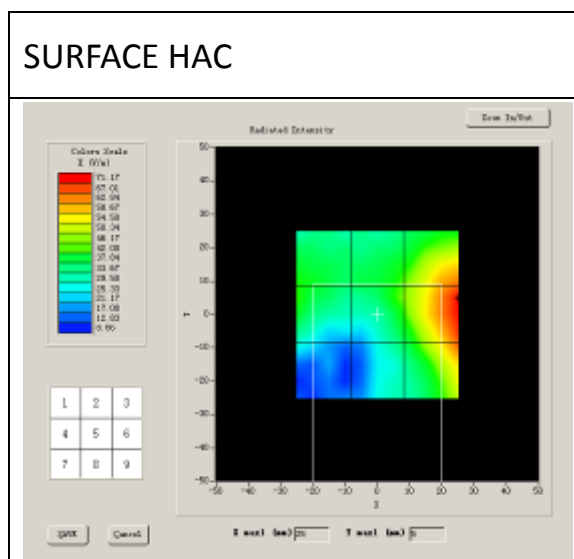

Probe Modulation Factor = 2.840000

Maximum value of total field = 46.70 V/m

Hearing Aid Near-Field Category: M4 (AWF -5 dB)

E in V/m

Grid 1: 41.54	Grid 2: 44.89	Grid 3: 63.39
Grid 4: 43.08	Grid 5: 46.70	Grid 6: 71.67
Grid 7: 29.02	Grid 8: 37.13	Grid 9: 66.61

MEASUREMENT 8

A. Experimental conditions.

Grid size (mm x mm)	50.0, 50.0
Step (mm)	5
Band	GSM1900
Channel	Low
Signal	GSM
Date of measurement	30/5/2012

B. HAC Measurement Results

Lower Band (Channel 513):

Frequency (MHz): 1850.400000

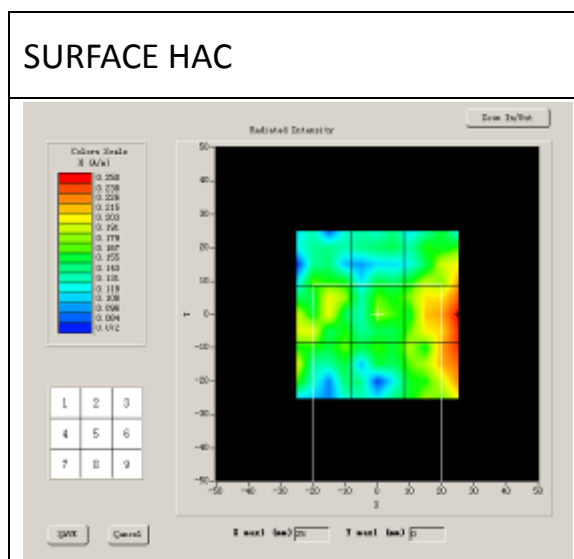

Probe Modulation Factor = 2.840000

Maximum value of total field = 0.20 A/m

Hearing Aid Near-Field Category: M3 (AWF -5 dB)

H in A/m

Grid 1: 0.18	Grid 2: 0.16	Grid 3: 0.22
Grid 4: 0.20	Grid 5: 0.19	Grid 6: 0.25
Grid 7: 0.20	Grid 8: 0.18	Grid 9: 0.24

MEASUREMENT 9

A. Experimental conditions.

Grid size (mm x mm)	50.0, 50.0
Step (mm)	5
Band	GSM1900
Channel	Middle
Signal	GSM
Date of measurement	30/5/2012

B. HAC Measurement Results

Middle Band (Channel 661):

Frequency (MHz): 1880.000000

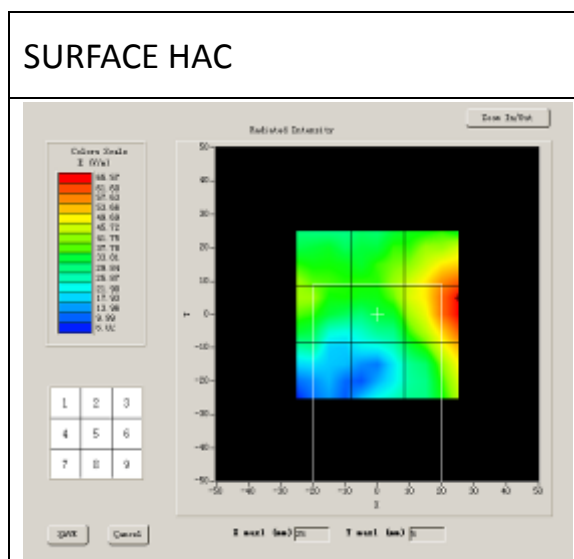

Probe Modulation Factor = 2.840000

Maximum value of total field = 46.25 V/m

Hearing Aid Near-Field Category: M4 (AWF -5 dB)

E in V/m

Grid 1: 42.57	Grid 2: 45.24	Grid 3: 60.13
Grid 4: 43.43	Grid 5: 46.25	Grid 6: 66.25
Grid 7: 31.25	Grid 8: 34.11	Grid 9: 56.36

MEASUREMENT 10

A. Experimental conditions.

Grid size (mm x mm)	50.0, 50.0
Step (mm)	5
Band	GSM1900
Channel	Middle
Signal	GSM
Date of measurement	30/5/2012

B. HAC Measurement Results

Middle Band (Channel 661):

Frequency (MHz): 1880.000000

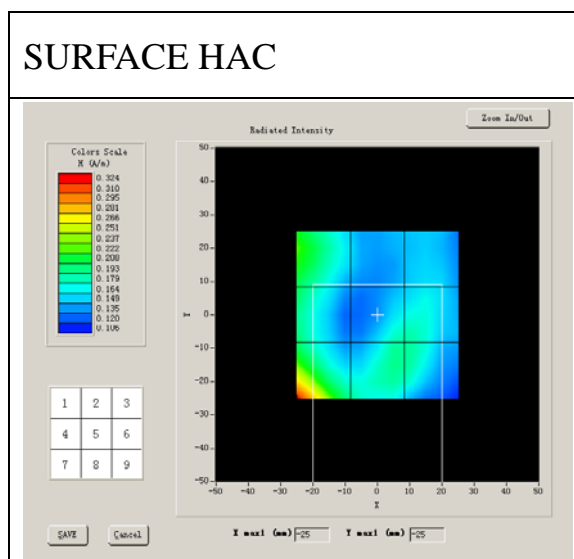

Probe Modulation Factor = 2.840000

Maximum value of total field = 0.19 A/m

Hearing Aid Near-Field Category: M3 (AWF -5 dB)

H in A/m

Grid 1: 0.23	Grid 2: 0.15	Grid 3: 0.15
Grid 4: 0.20	Grid 5: 0.18	Grid 6: 0.18
Grid 7: 0.32	Grid 8: 0.19	Grid 9: 0.18

MEASUREMENT 11

A. Experimental conditions.

Grid size (mm x mm)	50.0, 50.0
Step (mm)	5
Band	GSM1900
Channel	High
Signal	GSM
Date of measurement	30/5/2012

B. HAC Measurement Results

Higher Band (Channel 809):

Frequency (MHz): 1909.600000

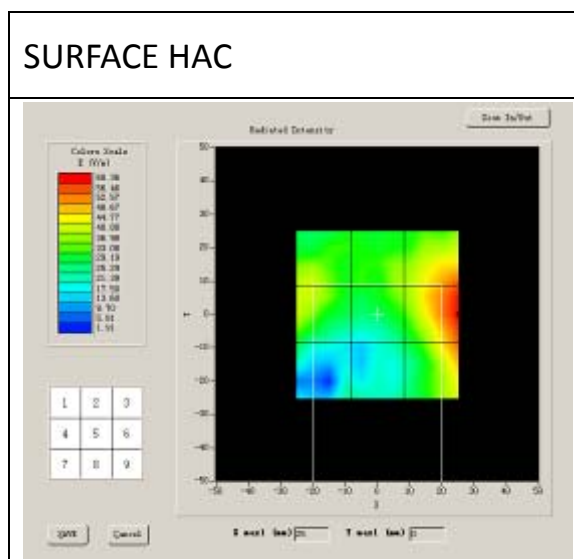

Probe Modulation Factor = 2.840000

Maximum value of total field = 41.78 V/m

Hearing Aid Near-Field Category: M4 (AWF -5 dB)

E in V/m

Grid 1: 41.49	Grid 2: 39.07	Grid 3: 55.48
Grid 4: 41.78	Grid 5: 39.01	Grid 6: 60.63
Grid 7: 30.04	Grid 8: 28.48	Grid 9: 55.32

MEASUREMENT 12

A. Experimental conditions.

Grid size (mm x mm)	50.0, 50.0
Step (mm)	5
Band	GSM1900
Channel	High
Signal	GSM
Date of measurement	30/5/2012

B. HAC Measurement Results

Higher Band (Channel 809):

Frequency (MHz): 1909.600000

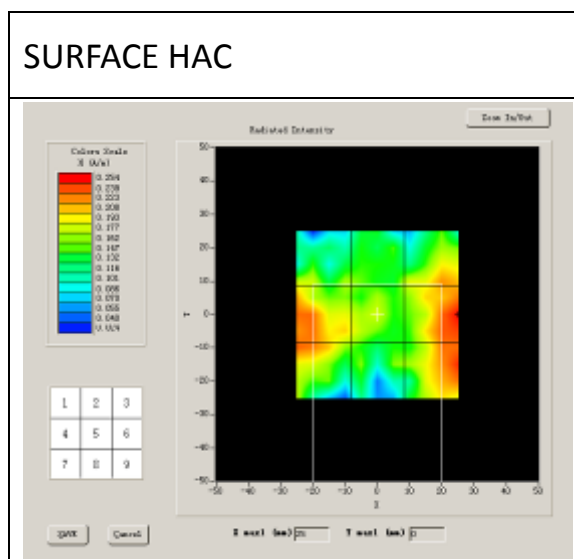

Probe Modulation Factor = 2.840000

Maximum value of total field = 0.24 A/m

Hearing Aid Near-Field Category: M3 (AWF -5 dB)

H in A/m

Grid 1: 0.18	Grid 2: 0.18	Grid 3: 0.22
Grid 4: 0.24	Grid 5: 0.19	Grid 6: 0.25
Grid 7: 0.23	Grid 8: 0.17	Grid 9: 0.25

MEASUREMENT 13

A. Experimental conditions.

Grid size (mm x mm)	50.0, 50.0
Step (mm)	5
Band	WCDMA850
Channel	Low
Signal	CDMA
Date of measurement	30/5/2012

B. HAC Measurement Results

Frequency (MHz): 826.000000

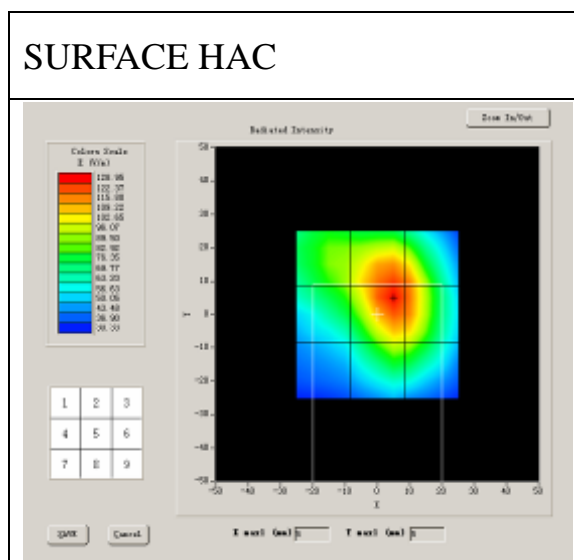

Probe Modulation Factor = 2.820000

Maximum value of total field = 127.15 V/m

Hearing Aid Near-Field Category: M4 (AWF 0 dB)

Grid 1: 95.56	Grid 2: 123.28	Grid 3: 115.84
Grid 4: 94.44	Grid 5: 127.15	Grid 6: 117.89
Grid 7: 61.72	Grid 8: 100.06	Grid 9: 95.92

MEASUREMENT 14

A. Experimental conditions.

Grid size (mm x mm)	50.0, 50.0
Step (mm)	5
Band	WCDMA850
Channel	Low
Signal	CDMA
Date of measurement	30/5/2012

B. HAC Measurement Results

Frequency (MHz): 826.000000

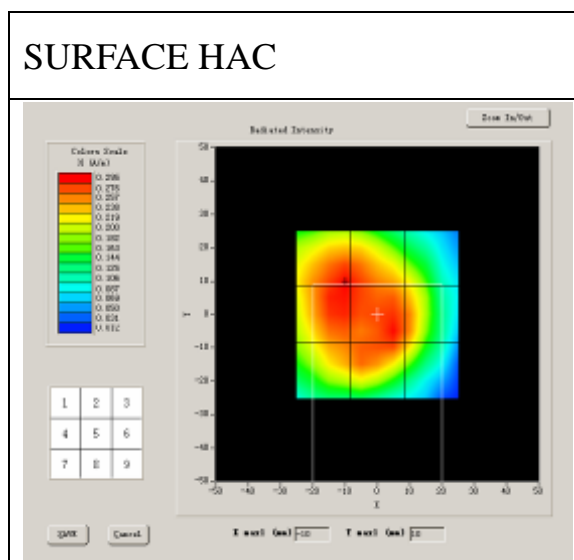

Probe Modulation Factor = 2.800000

Maximum value of total field = 0.25 A/m

Hearing Aid Near-Field Category: M4 (AWF 0 dB)

Grid 1: 0.29	Grid 2: 0.29	Grid 3: 0.22
Grid 4: 0.29	Grid 5: 0.25	Grid 6: 0.26
Grid 7: 0.26	Grid 8: 0.29	Grid 9: 0.24

MEASUREMENT 15

A. Experimental conditions.

Grid size (mm x mm)	50.0, 50.0
Step (mm)	5
Band	WCDMA850
Channel	Middle
Signal	CDMA
Date of measurement	30/5/2012

B. HAC Measurement Results

Frequency (MHz): 835.000000

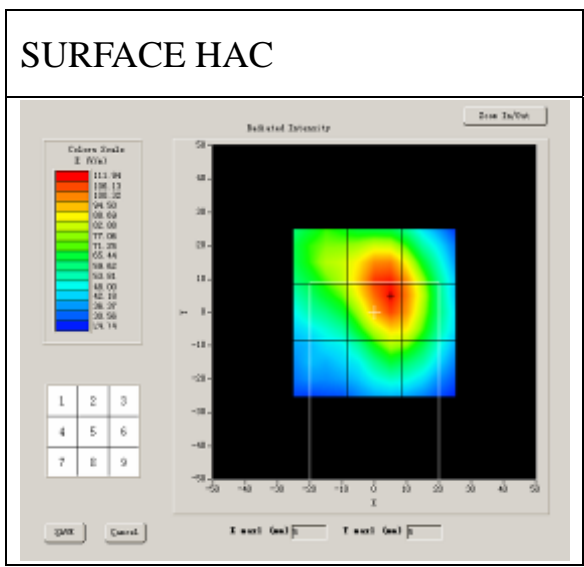

Probe Modulation Factor = 2.820000

Maximum value of total field = 125.11 V/m

Hearing Aid Near-Field Category: M4 (AWF 0 dB)

Grid 1: 85.80	Grid 2: 110.26	Grid 3: 98.59
Grid 4: 84.37	Grid 5: 125.11	Grid 6: 101.20
Grid 7: 53.22	Grid 8: 85.00	Grid 9: 81.75

MEASUREMENT 16

A. Experimental conditions.

Grid size (mm x mm)	50.0, 50.0
Step (mm)	5
Band	WCDMA850
Channel	Middle
Signal	CDMA
Date of measurement	30/5/2012

B. HAC Measurement Results

Frequency (MHz): 835.000000

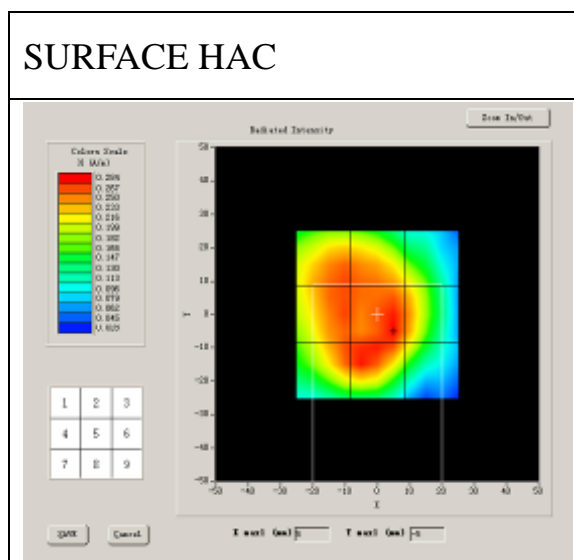

Probe Modulation Factor = 2.800000

Maximum value of total field = 0.27 A/m

Hearing Aid Near-Field Category: M4 (AWF 0dB)

Grid 1: 0.27	Grid 2: 0.26	Grid 3: 0.21
Grid 4: 0.27	Grid 5: 0.27	Grid 6: 0.25
Grid 7: 0.28	Grid 8: 0.28	Grid 9: 0.22

MEASUREMENT 17

A. Experimental conditions.

Grid size (mm x mm)	50.0, 50.0
Step (mm)	5
Band	WCDMA850
Channel	High
Signal	CDMA
Date of measurement	30/5/2012

B. HAC Measurement Results

Frequency (MHz): 846.000000

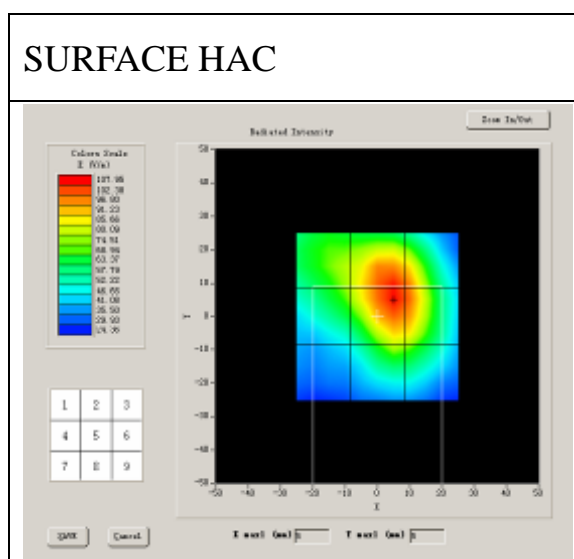

Probe Modulation Factor = 2.820000

Maximum value of total field = 111.53 V/m

Hearing Aid Near-Field Category: M4 (AWF 0 dB)

Grid 1: 80.29	Grid 2: 106.04	Grid 3: 96.56
Grid 4: 79.17	Grid 5: 111.25	Grid 6: 99.51
Grid 7: 48.36	Grid 8: 81.39	Grid 9: 77.14

MEASUREMENT 18

A. Experimental conditions.

Grid size (mm x mm)	50.0, 50.0
Step (mm)	5
Band	WCDMA850
Channel	High
Signal	CDMA
Date of measurement	30/5/2012

B. HAC Measurement Results

Frequency (MHz): 846.000000

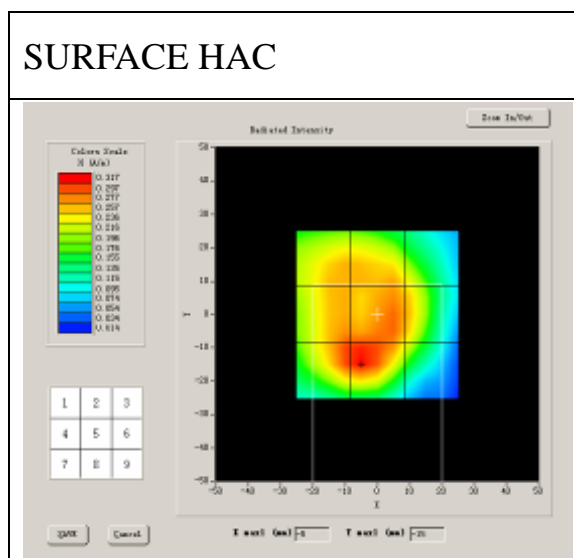

Probe Modulation Factor = 2.800000

Maximum value of total field = 0.25 A/m

Hearing Aid Near-Field Category: M4 (AWF 0 dB)

Grid 1: 0.26	Grid 2: 0.27	Grid 3: 0.23
Grid 4: 0.28	Grid 5: 0.25	Grid 6: 0.26
Grid 7: 0.32	Grid 8: 0.32	Grid 9: 0.23

MEASUREMENT 19

A. Experimental conditions.

Grid size (mm x mm)	50.0, 50.0
Step (mm)	5
Band	WCDMA 1900
Channel	Low
Signal	CDMA
Date of measurement	30/5/2012

B. HAC Measurement Results

Frequency (MHz): 1852.000000

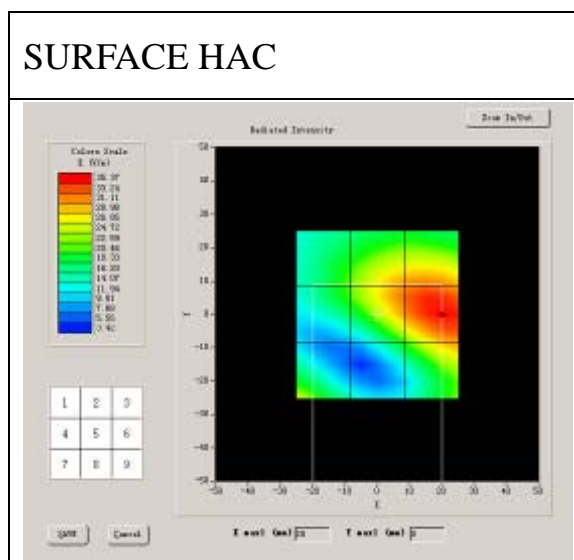

Probe Modulation Factor = 2.840000

Maximum value of total field = 32.43 V/m

Hearing Aid Near-Field Category: M4 (AWF 0 dB)

E in V/m

Grid 1: 22.09	Grid 2: 30.23	Grid 3: 30.91
Grid 4: 22.20	Grid 5: 32.43	Grid 6: 35.47
Grid 7: 25.13	Grid 8: 21.79	Grid 9: 30.79

MEASUREMENT 20

A. Experimental conditions.

Grid size (mm x mm)	50.0, 50.0
Step (mm)	5
Band	WCDMA 1900
Channel	Low
Signal	CDMA
Date of measurement	30/5/2012

B. HAC Measurement Results

Frequency (MHz): 1852.000000

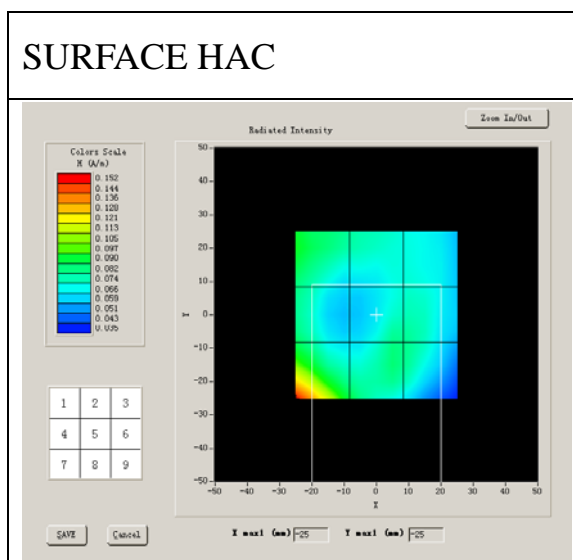

Probe Modulation Factor = 2.840000

Maximum value of total field = 0.08 A/m

Hearing Aid Near-Field Category: M4 (AWF 0 dB)

H in A/m

Grid 1: 0.09	Grid 2: 0.08	Grid 3: 0.07
Grid 4: 0.08	Grid 5: 0.08	Grid 6: 0.08
Grid 7: 0.15	Grid 8: 0.08	Grid 9: 0.08

MEASUREMENT 21

A. Experimental conditions.

Grid size (mm x mm)	50.0, 50.0
Step (mm)	5
Band	WCDMA 1900
Channel	Middle
Signal	CDMA
Date of measurement	30/5/2012

B. HAC Measurement Results

Frequency (MHz): 1880.000000

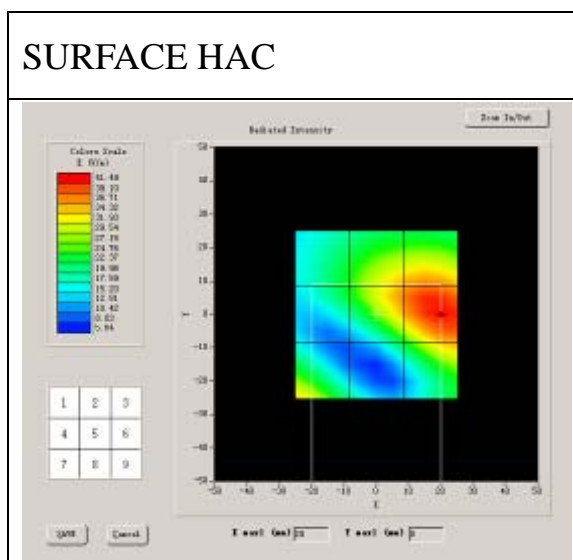

Probe Modulation Factor = 2.840000

Maximum value of total field = 37.32 V/m

Hearing Aid Near-Field Category: M4 (AWF 0 dB)

E in V/m

Grid 1: 24.60	Grid 2: 34.67	Grid 3: 36.36
Grid 4: 24.61	Grid 5: 37.32	Grid 6: 41.61
Grid 7: 33.36	Grid 8: 24.69	Grid 9: 36.01

MEASUREMENT 22

A. Experimental conditions.

Grid size (mm x mm)	50.0, 50.0
Step (mm)	5
Band	WCDMA 1900
Channel	Middle
Signal	CDMA
Date of measurement	30/5/2012

B. HAC Measurement Results

Frequency (MHz): 1880.000000

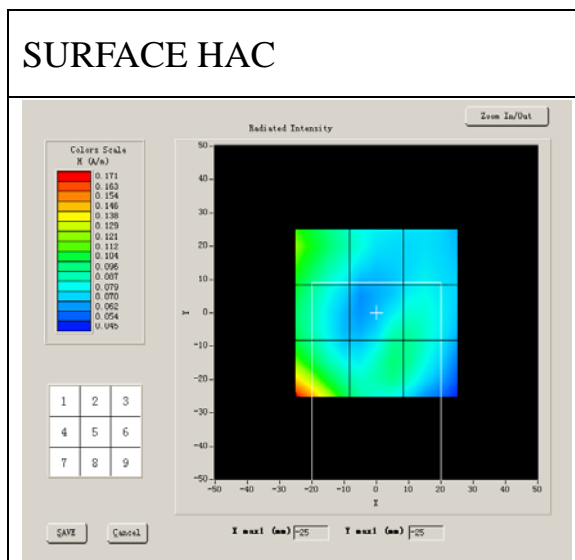

Probe Modulation Factor = 2.840000

Maximum value of total field = 0.10 A/m

Hearing Aid Near-Field Category: M4 (AWF 0 dB)

H in A/m

Grid 1: 0.12	Grid 2: 0.08	Grid 3: 0.08
Grid 4: 0.11	Grid 5: 0.09	Grid 6: 0.09
Grid 7: 0.17	Grid 8: 0.10	Grid 9: 0.09

MEASUREMENT 23

A. Experimental conditions.

Grid size (mm x mm)	50.0, 50.0
Step (mm)	5
Band	WCDMA 1900
Channel	High
Signal	CDMA
Date of measurement	30/5/2012

B. HAC Measurement Results

Frequency (MHz): 1907.000000

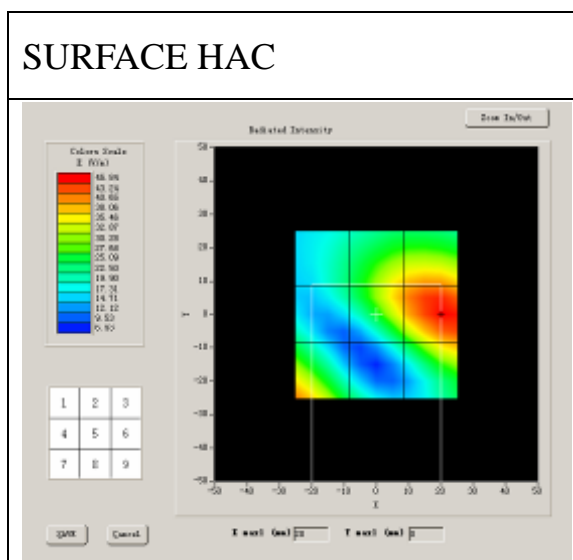

Probe Modulation Factor = 2.840000

Maximum value of total field = 41.10 V/m

Hearing Aid Near-Field Category: M4 (AWF 0 dB)

E in V/m

Grid 1: 23.66	Grid 2: 37.57	Grid 3: 39.65
Grid 4: 23.56	Grid 5: 40.15	Grid 6: 46.02
Grid 7: 41.10	Grid 8: 25.84	Grid 9: 40.25

MEASUREMENT 24

A. Experimental conditions.

Grid size (mm x mm)	50.0, 50.0
Step (mm)	5
Band	WCDMA 1900
Channel	High
Signal	CDMA
Date of measurement	30/5/2012

B. HAC Measurement Results

Frequency (MHz): 1907.000000

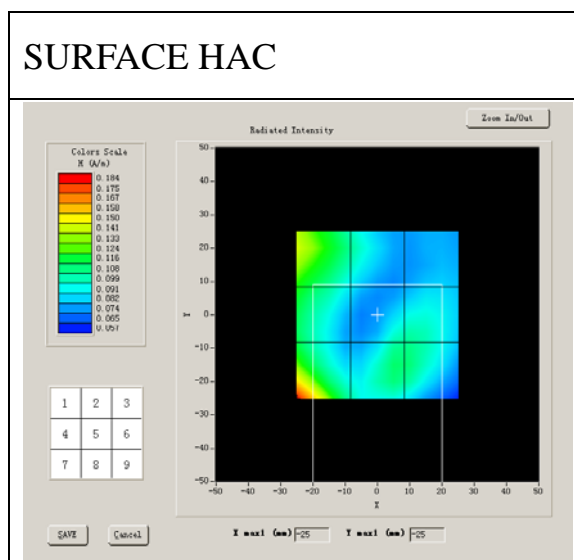

Probe Modulation Factor = 2.840000

Maximum value of total field = 0.11 A/m

Hearing Aid Near-Field Category: M4 (AWF 0 dB)

H in A/m

Grid 1: 0.14	Grid 2: 0.10	Grid 3: 0.08
Grid 4: 0.12	Grid 5: 0.10	Grid 6: 0.10
Grid 7: 0.18	Grid 8: 0.11	Grid 9: 0.11

Annex A Accreditation Certificate

 
China National Accreditation Service for Conformity Assessment
LABORATORY ACCREDITATION CERTIFICATE
(No. CNAS L1659)
<i>China National Accreditation Service for Conformity Assessment has accredited</i>
Shenzhen Electronic Product Quality Testing Center
<u>Electronic Testing Building, Shahe Road, Xili, Nanshan District,</u> <u>Shenzhen, Guangdong, China</u>
<i>to ISO/IEC 17025:2005 General Requirements for the Competence of Testing and Calibration Laboratories(CNAS-CL01 Accreditation Criteria for the Competence of Testing and Calibration Laboratories) for the competence in the field of testing and calibration.</i>
<i>The scope of accreditation is detailed in the attached schedule bearing the same accreditation number as above. The schedule forms an integral part of this certificate.</i>
Date of Issue: 2009-09-29
Date of Expiry: 2012-09-28
Date of Initial Accreditation: 1999-08-03

Signed on behalf of China National Accreditation Service for Conformity Assessment
<small>China National Accreditation Service for Conformity Assessment(CNAS) is authorized by Certification and Accreditation Administration of the People's Republic of China (CNCA) to operate the national accreditation systems for conformity assessment. CNAS is the signatory to International Laboratory Accreditation Cooperation Multilateral Recognition Arrangement (ILAC MRA), and the signatory to Asia Pacific Laboratory Accreditation Cooperation Multilateral Recognition Arrangement (APLAC MRA).</small>

Annex B Photographs of the EUT

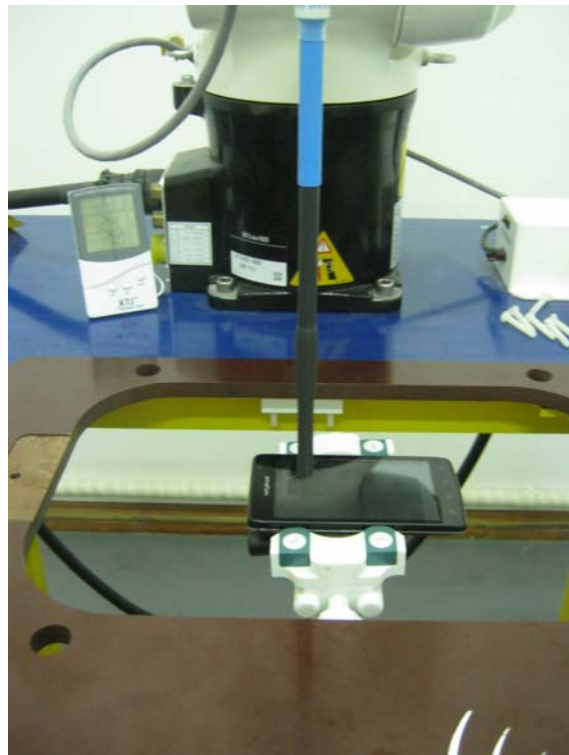
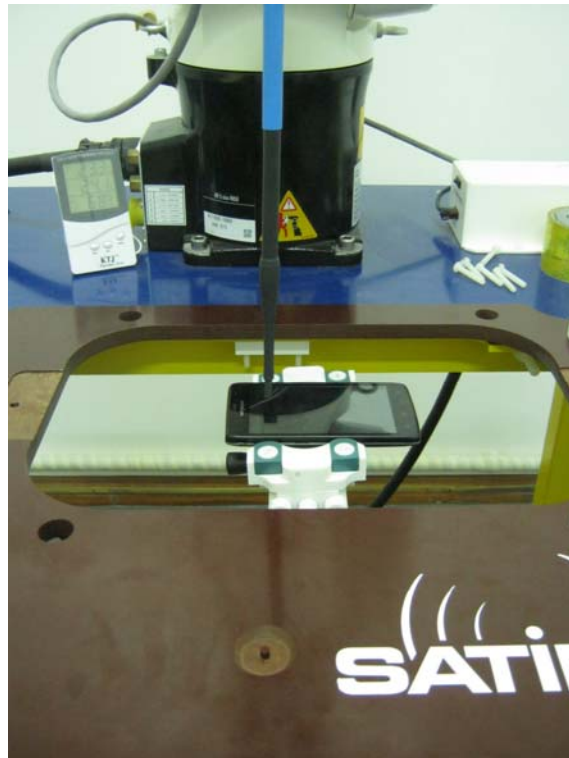

System Performance Check (E-field)

A. Experimental conditions.

Grid size (mm x mm)	50.0, 50.0
Step (mm)	5
Band	850 MHz
Channel	
Signal	CW
Date of measurement	30/5/2012

B. HAC Measurement Results

Frequency (MHz): 850.000000

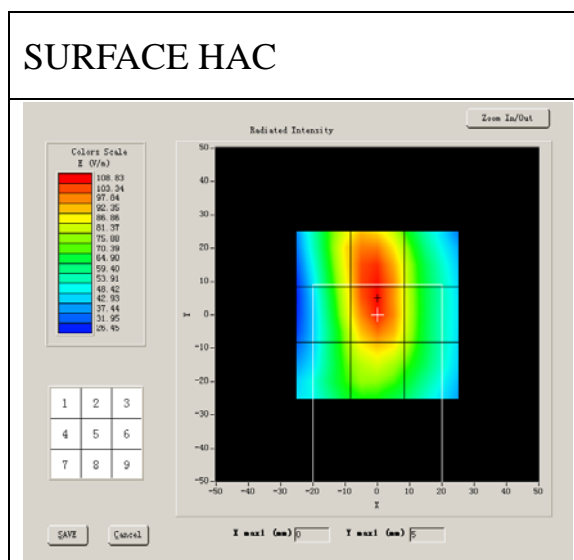

Probe Modulation Factor = 2.820000

Maximum value of total field = 205 V/m

E in V/m

Grid 1: 194.51	Grid 2: 198.12	Grid 3: 177.56
Grid 4: 192.69	Grid 5: 205.00	Grid 6: 178.98
Grid 7: 181.13	Grid 8: 194.18	Grid 9: 176.51

System Performance Check (H-field)

A. Experimental conditions.

Grid size (mm x mm)	50.0, 50.0
Step (mm)	5
Band	850 MHz
Channel	
Signal	CW
Date of measurement	30/5/2012

B. HAC Measurement Results

Frequency (MHz): 850.000000

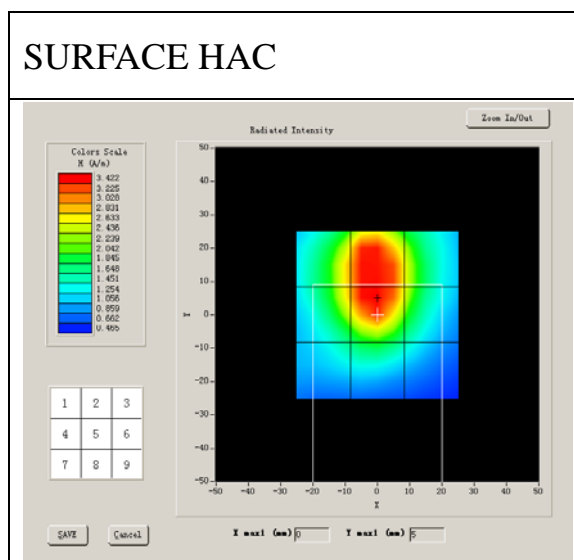

Probe Modulation Factor = 2.800000

Maximum value of total field = 0.448 A/m

H in A/m

Grid 1: 0.302	Grid 2: 0.421	Grid 3: 0.336
Grid 4: 0.381	Grid 5: 0.449	Grid 6: 0.332
Grid 7: 0.370	Grid 8: 0.400	Grid 9: 0.239

System Performance Check (E-field)

A. Experimental conditions.

Grid size (mm x mm)	50.0, 50.0
Step (mm)	5
Band	1800 MHz
Channel	
Signal	CW
Date of measurement	30/5/2012

B. HAC Measurement Results

Frequency (MHz): 1800.000000

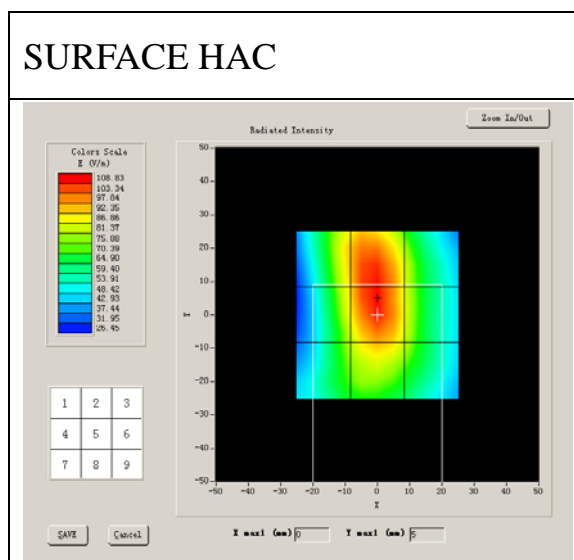

Probe Modulation Factor = 2.820000

Maximum value of total field = 161.52V/m

E in V/m

Grid 1: 145.51	Grid 2: 158.33	Grid 3: 136.11
Grid 4: 151.64	Grid 5: 161.52	Grid 6: 142.95
Grid 7: 141.52	Grid 8: 148.62	Grid 9: 126.77

System Performance Check (H-field)

A. Experimental conditions.

Grid size (mm x mm)	50.0, 50.0
Step (mm)	5
Band	1800 MHz
Channel	
Signal	CW
Date of measurement	30/5/2012

B. HAC Measurement Results

Frequency (MHz): 1800.000000

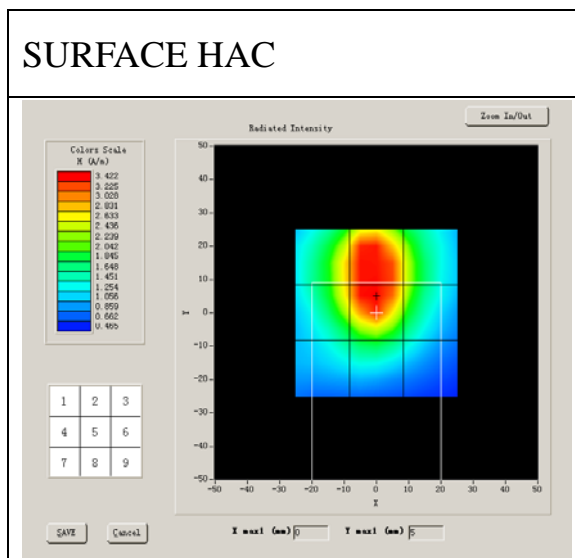

Probe Modulation Factor = 2.800000

Maximum value of total field = 0.447 A/m

H in A/m

Grid 1: 0.424	Grid 2: 0.434	Grid 3: 0.384
Grid 4: 0.437	Grid 5: 0.447	Grid 6: 0.415
Grid 7: 0.432	Grid 8: 0.415	Grid 9: 0.361