



FCC 47 CFR PART 22 SUBPART H

TEST REPORT

For

Applicant: verykool USA INC.

Address: 4350 Executive Dr. #100, San Diego, CA 92121

Product Name: Mobile Phone

Model Name: S729

Brand Name: verykool

FCC ID: WA6S729

Report No.: DPH120925F06

Date of Issue: October 16, 2012

Issued by: Super Test Service Technology Co., Ltd.

Address: Room 506, Hongyu Commercial Building, Gushu 2nd Road,
Baoan District, Shenzhen, China

Tel: 0755-61196328

Fax: 0755-61196328

The report consists 48 pages in total. It may be duplicated completely for legal use with the approval of the applicant. It should not be reproduced except in full, without the written approval of our laboratory. The client should not use it to claim product endorsement by STS. The test results in the report only apply to the tested sample. The test report shall be invalid without all the signatures of testing engineers, reviewer and approver.

TABLE OF CONTENTS

1. VERIFICATION OF CONFORMITY 4

2. GENERAL INFORMATION 5

2.1 Product Information 5

2.2 Objective 6

2.3 Test Standards and Results 6

2.4 Environmental Conditions 6

3. TEST FACILITY 7

4. TEST EQUIPMENT LIST 8

5. 47 CFR Part 2, Part 22H Requirements 9

5.1 General Information 9

6. CONDUCTED RF OUTPUT POWER 12

6.1 Requirement 12

6.2 Test Procedure 12

6.3 Test Result 12

7. OCCUPIED BANDWIDTH 13

7.1 Occupied Bandwidth Definition 13

7.2 Test Procedure 13

7.3 Test Result 13

8. CONDUCTED SPURIOUS EMISSION 16

8.1 Requirement 16

8.2 Test Procedure 16

8.3 Test Result 17

9. TRANSMITTER RADIATED POWER (EIRP/ERP) 31

9.1 Requirement 31

9.2 Test Procedure 31

9.3 Test Result 31

10. RADIATED SPURIOUS EMISSION 32

10.1 Requirement 32

10.2 Test Procedure 32

10.3 Test Result 32

11. FREQUENCY STABILITY 35

11.1 Frequency Stability Requirement 35

11.2 Test Procedure 35

11.3 Test Result..... 36

APPENDIX 1 37

PHOTOGRAPHS OF TEST SETUP 37

APPENDIX 2..... 39

PHOTOGRAPHS OF EUT 39

Revision History		
Issue	Date	Reason for Revision
1.0	October 16, 2012	First edition

1. VERIFICATION OF CONFORMITY

Equipment Under Test:	Mobile Phone
Brand Name:	verykool
Model Number:	S729
Series Model Name:	N/A
Difference description:	N/A
FCC ID:	WA6S729
Applicant:	verykool USA INC.
	4350 Executive Dr. #100, San Diego, CA 92121
Manufacturer:	Shenzhen Ginwave Technologies Ltd.
	4/F, R2-A, High-Tech Industrial Park, Shenzhen 518057, China
Technical Standards:	47 CFR Part 2 47 CFR Part 22 Subpart H
File Number:	DPH120925F06
Date of test:	September 22 ~ October 15, 2012
Deviation:	None
Condition of Test Sample:	Normal
Test Result:	PASS

The above equipment was tested by STS. for compliance with the requirement set forth in FCC rules and the Technical Standards mentioned above. This said equipment in the configuration described in this report shows the maximum emission levels emanating from equipment and the level of the immunity endurance of the equipment are within the compliance requirements.

The test results of this report relate only to the tested sample identified in this report.

Tested by (+ signature):

Rex Luo

Rex Luo
Test Engineer



Approved by (+ signature):

Joe Jia

Joe Jia
Manager

2. GENERAL INFORMATION

2.1 Product Information

EUT1- Mobile Phone	
Description:	Mobile Phone
Brand Name:	verykool
Model Name:	S729
Hardware Version:	GW-MX06M_V1.0
Software Version:	N/A
Frequency:	GW-S729_B01-S01_V03_20120515
Ancillary Equipment – Power Supply	
Description:	Travel Charger
Model Name:	NBT-050B-B050UA
Brand Name:	Verykool
Rated Input:	AC 100-240V, 50/60Hz, 0.2A
Rated Output:	DC 5V, 500mA
Length USB cable:	1.0m
Ancillary Equipment – Battery	
Description:	Lithium-ion Battery
Model Name:	454060A
Brand Name:	Verykool
Capacitance:	1150 mAh
Rated Voltage:	3.7V
Charge Limit:	4.2V

NOTE:

1. The EUT is a Mobile Station, here only WCDMA 850MHz band was tested in this report.
2. The transmitter (Tx) frequency arrangement of the WCDMA 850MHz band for the EUT can be represented with a formula $F(n)=826.4+0.2*(n-4132)$, $4132 \leq n \leq 4233$.
3. The normal, high and low voltage supply for the Battery of the EUT is separately 3.7V, 4.2V and 3.6V, which are specified by the applicant.
4. Please refer to Appendix 2 for the photographs of the EUT. For a more detailed features description about the EUT, please refer to User's Manual.

2.2 Objective

The objective of the report is to perform tests according to 47 CFR Part 2, Part 22 for FCC ID Certification:

No.	Identity	Document Title
1	47 CFR Part 2 (10-1-05 Edition)	Frequency Allocations and Radio Treaty Matters; General Rules and Regulations
2	47 CFR Part 22 (10-1-05 Edition)	Public Mobile Services

2.3 Test Standards and Results

Test items and the results are as bellow:

No.	Rules	Test Type	Result	Date of Test
1	§2.1046	Conducted RF Output Power at Antenna Terminal	PASS	2012-09-22
2	§2.1049	Occupied Bandwidth	PASS	2012-09-22
3	§2.1051 §2.1057 §22.917	Conducted Spurious Emission at Antenna Terminal	PASS	2012-09-22
4	§2.1051 §2.1057 §22.917	Band Edge	PASS	2012-09-29
5	§22.913	Transmitter Radiated Power (EIPR/ERP)	PASS	2012-09-29
6	§2.1053 §2.1057 §22.917	Radiated Spurious Emission	PASS	2012-09-29
7	§2.1055 §22.355	Frequency Stability	PASS	2012-09-29

Note: 1. The test result judgment is decided by the limit of measurement standard
2. The information of measurement uncertainty is available upon the customer's request.

2.4 Environmental Conditions

During the measurement the environmental conditions were within the listed ranges:

- Temperature: 15-35°C
- Humidity: 30-60 %
- Atmospheric pressure: 86-106 kPa

3. TEST FACILITY

Test Site:	Most Technology Service Co.,Ltd
Location:	No.5, Langshan 2nd Rd., North Hi-Tech Industrial park, Nanshan, Shenzhen, Guangdong ,China
Description:	<p>There is one 3m semi-anechoic an area test sites and two line conducted labs for final test. The Open Area Test Sites and the Line Conducted labs are constructed and calibrated to meet the FCC requirements in documents ANSI C63.4:2009 and CISPR 16 requirements.</p> <p>The FCC Registration Number is 490827.</p> <p>The IC Registration Number is 46405-7103.</p> <p>The CNAS Registration Number is CNAS L3573.</p>
Site Filing:	The site description is on file with the Federal Communications Commission, 7435 Oakland Mills Road, Columbia, MD 21046.
Instrument Tolerance:	All measuring equipment is in accord with ANSI C63.4:2009 and CISPR 16 requirements that meet industry regulatory agency and accreditation agency requirement.
Ground Plane:	Two conductive reference ground planes were used during the Line Conducted Emission, one in vertical and the other in horizontal. The dimensions of these ground planes are as below. The vertical ground plane was placed distancing 40 cm to the rear of the wooden test table on where the EUT and the support equipment were placed during test. The horizontal ground plane projected 50 cm beyond the footprint of the EUT system and distanced 80 cm to the wooden test table. For Radiated Emission Test, one horizontal conductive ground plane extended at least 1m beyond the periphery of the EUT and the largest measuring antenna, and covered the entire area between the EUT and the antenna.

4. TEST EQUIPMENT LIST

Instrumentation: The following list contains equipment used at Most for testing. The equipment conforms to the CISPR 16-1 / ANSI C63.2 Specifications for Electromagnetic Interference and Field Strength Instrumentation from 10 kHz to 1.0 GHz or above.

No.	Equipment	Manufacturer	Model No.	S/N	Calibration date	Calibration due date
1	Test Receiver	Rohde & Schwarz	ESCI	100492	2012/4/22	2013/4/21
2	Test Receiver	Rohde & Schwarz	ESPI	101202	2012/4/22	2013/4/21
3	Bi-Log Antenna	Sunol	JB3	A121206	2012/3/15	2013/3/14
4	Test Antenna – Bi-Log	Schwarzbeck	VULB 9163	---	2012/3/15	2013/3/14
5	Horn Antenna	ETS	3115	---	2012/3/15	2013/3/14
6	Test Antenna - Horn	Schwarzbeck	BBHA 9120C	--	2012/3/15	2013/3/14
7	Cable	Resenberger	N/A	NO.1	N/A	N/A
8	Cable	SchwarzBeck	N/A	NO.2	N/A	N/A
9	Cable	SchwarzBeck	N/A	NO.3	N/A	N/A
10	Power Splitter	Weinschel	1506A	NW521	N/A	N/A
11	Spectrum Analyzer	Agilent	4408B	MY41440460	2012/4/22	2013/4/21
12	Coaxial Switch	Anritsu Corp	MP59B	6200283933	N/A	N/A
13	Signal Generator	IFR	2032	203002/100	2012/4/22	2013/4/21
14	System Simulator	ROHDE&SCHWARZ	CMU200	0304789	2012/4/22	2013/4/21
15	Telecommunication Antenna	European Antennas	PSA 75301R/170	0304213	2012/3/15	2013/3/14
16	Temperature Chamber	Guangzhou Gongwen	GDS-250	N/A	N/A	N/A
17	DC Power Supply	Good Will	GPS-3030DD	EF920938	2012/4/22	2013/4/21
18	Full-Anechoic Chamber	Albatross	9m*6m*6m	(n.a.)	2012/4/16	2013/4/15

NOTE: Equipments listed above have been calibrated and are in the period of validation.

5. 47 CFR Part 2, Part 22H Requirements

5.1 General Information

5.1.1 Conducted Related Tests

Based on ANSI/TIA-603-C-2004

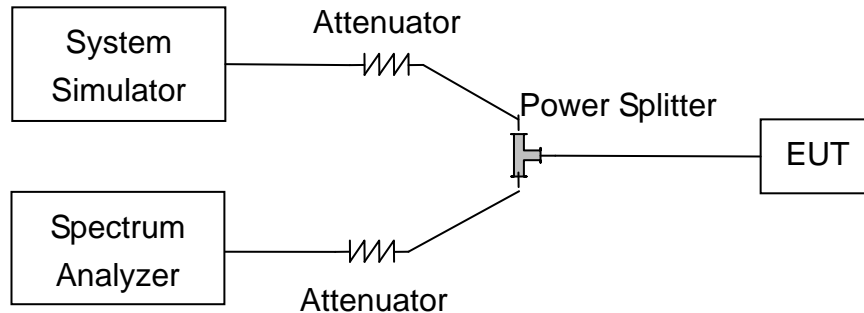

1. The EUT is coupled to the Spectrum Analyzer and the System Simulator with the suitable Attenuators through the Power Splitter; the path loss is calibrated to correct the reading.
 2. The EUT is configured here as MS + Battery.
 3. Set the spectrum analyzer to measure peak hold with the required settings.
 4. Set the signal generator to a known output power and record the path loss in dB (LOSS) for frequencies up to the tenth harmonic of the EUT's carrier frequency. $LOSS = \text{Generator Output Power (dBm)} - \text{Analyzer reading (dBm)}$.
 5. Replace the signal generator with the EUT.
 6. Adjust the settings of the Digital Radio communication Tester (DRT) to set the EUT to its maximum power at the required channel.
 7. Set the spectrum analyzer to measure peak hold with the required settings. Offset the spectrum analyzer reference level by the path loss measured above.
 8. Measure and record all spurious emissions up to the tenth harmonic of the carrier frequency.
 9. Measurements are to be performed with the EUT set to the low, middle and high channel of each frequency band.
 10. If necessary steps 6 and 7 may be performed with the spectrum analyzer set to average detector.
- Note: Step 4 above is performed prior to testing and LOSS is recorded by test software. Steps 3, 7, and 8 above are performed with test software.

5.1.2 Radiated Power and Spurious Emission Tests

Based on ANSI/TIA-603-C-2004

Setup 1:

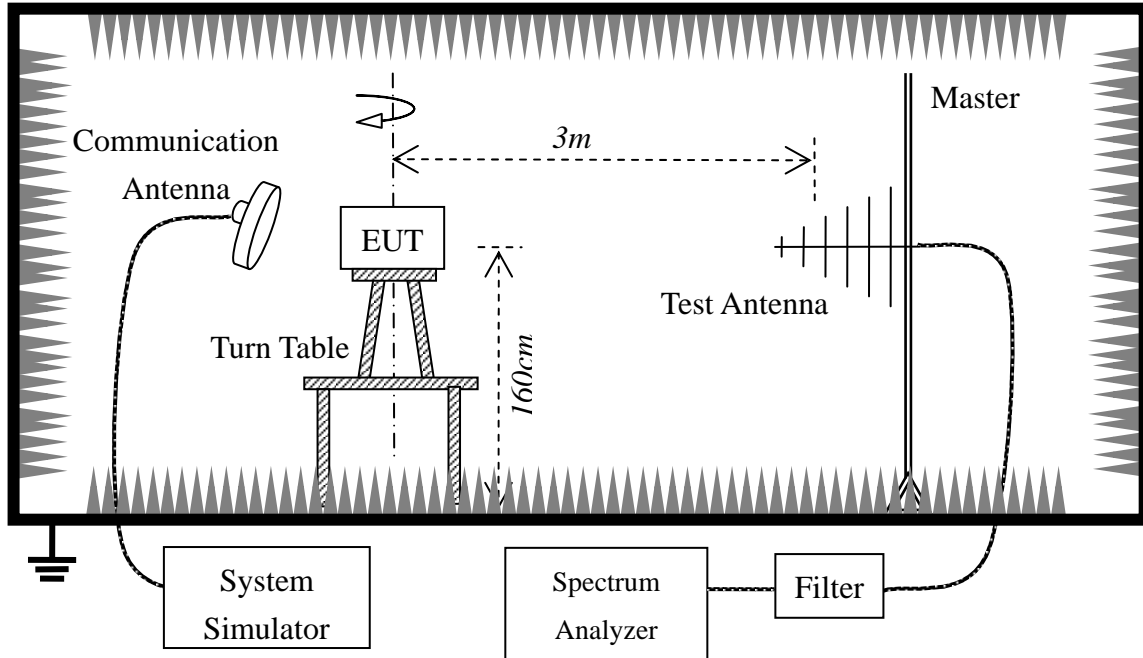

Setup 2:

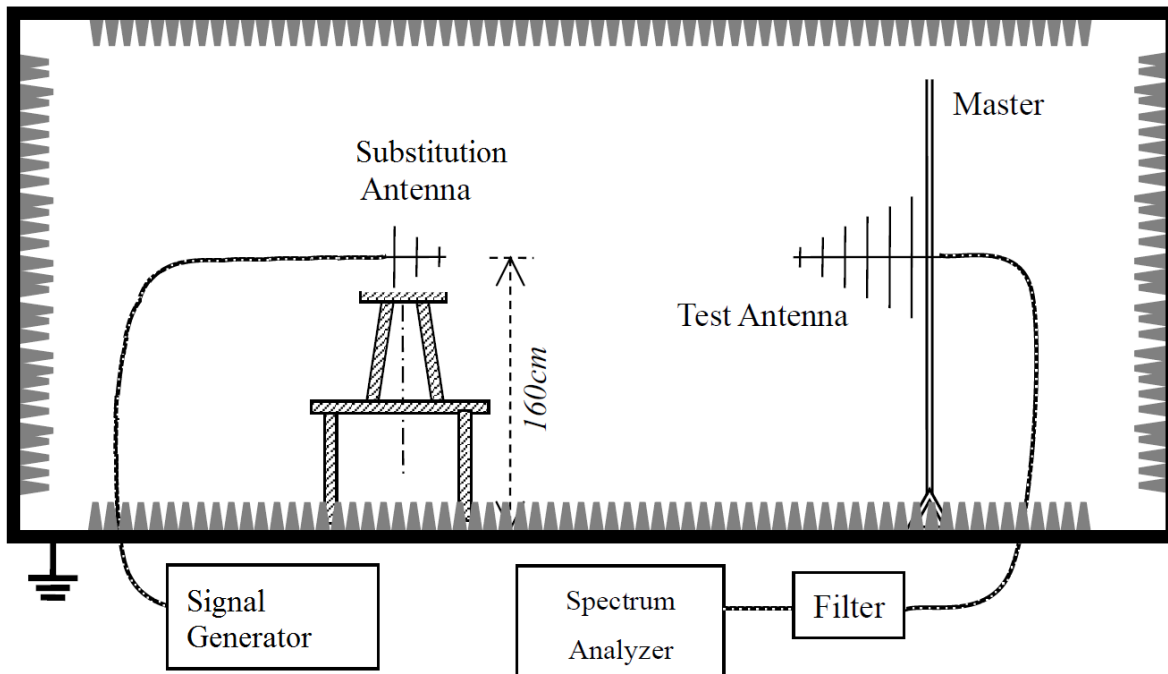

1. The test is performed in a full-Anechoic Chamber, the air loss of the site and the factors of the test system are using the substitution method.
2. Connect the equipment as shown in setup 1.
3. Adjust the setting of System Simulator to set the EUT to its maximum power at the require channel.

4. Set the Spectrum Analyzer to the channel frequency, set the analyzer to measure peak hold with the required setting.
5. Rotate the EUT 360 degree, recorded the peak level in dBm(LVL).
6. The EUT is substituted by a half wave dipole or known gain antenna. The center of the antenna should be at the same location as the center of the EUT's antenna.
7. Connect the antenna to a signal generator and adjust the output power level of the signal generator (SGP) to get same received power recorded in step 5 on the Spectrum Analyze.
8. Determine the ERP using the following equation:

$$\text{ERP(dBm)} = \text{SGP(dBm)} + \text{Gain(dB)} - \text{Cable Loss(dB)}$$
9. Determine the EIRP using the following equation:

$$\text{EIRP(dBm)} = \text{ERP(dBm)} + 2.14(\text{dB})$$
10. Measurements are to be performed with the EUT set to the low, middle and high channel of each frequency band.

5.1.3 Frequency Stability Test

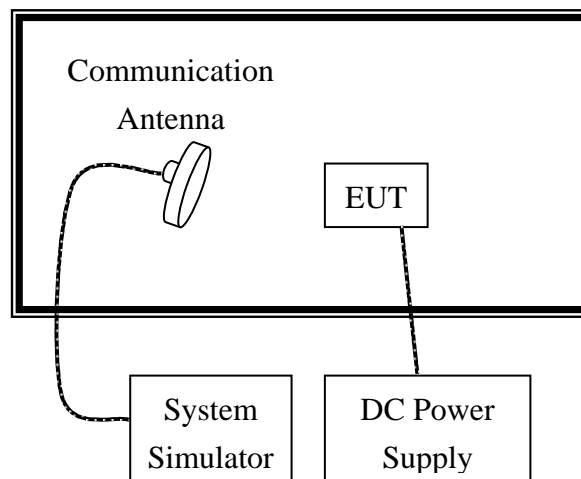

1. The test is performed in a Temperature Chamber.
2. The EUT is configured as MS + DC Power Supply.

6. CONDUCTED RF OUTPUT POWER

6.1 Requirement

According to FCC §2.1046 (a), for transmitters other than single sideband, independent sideband and controlled carrier radiotelephone, power output shall be measured at the RF output terminals when the transmitter is adjusted in accordance with the tune-up procedure to give the values of current and voltage on the circuit elements specified in §2.1033 (c)(8). The electrical characteristics of the radio frequency load attached to the output terminals when this test is made shall be stated.

6.2 Test Procedure

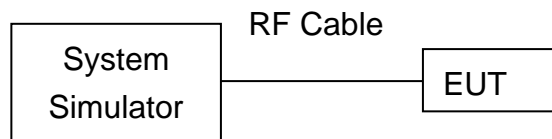

1. The EUT was connected with System Simulator and a communication link was established between the EUT and a System Simulator Perform. The EUT operated at maximum output power.
2. Set and send continuously up power control commands to the EUT and start transmitting data.
3. The low, middle and the high channels are selected to perform tests respectively. Set the Channel to 4132 as the low channel.
4. Measured and recorded the output power of the EUT.
5. Set the Channel to 4175 as the middle channel, then repeat step 4.
6. Set the Channel to 4233 as the high channel, then repeat step 4.

6.3 Test Result

3GPP Release Version	Item	BAND	WCDMA BAND V		
		ARFCN	4132	4175	4233
		subtest	dBm		
99	5.2(WCDMA)	non	23.15	23.49	23.29
6	HSDPA	1	23.11	23.43	23.21
		2	23.09	23.42	23.23
		3	22.68	22.98	22.84
		4	22.62	23.04	22.86
6	HSUPA	1	22.93	23.37	23.15
		2	21.19	21.61	21.34
		3	22.18	22.63	22.31
		4	21.17	21.53	21.34
		5	23.15	23.44	23.24

Note: The sample was tested according to Release 6 of 3GPP TS 34.121.

7. OCCUPIED BANDWIDTH

7.1 Occupied Bandwidth Definition

According to FCC §2.1049, the occupied bandwidth is the frequency bandwidth such that, below its lower and above its upper frequency limits, the mean powers radiated are each equal to 0.5 percent of the total mean power radiated by a given emission.

Occupied bandwidth is also known as the 99% emission bandwidth, or 20dB bandwidth ($10 \cdot \log 1\%$ is equal to 20dB) taking the total RF output power as reference.

7.2 Test Procedure

1. Perform test system setup as section 5.1.1
2. The resolution bandwidth of the Spectrum Analyzer is set to at least one percent of the emission bandwidth, e.g. for GSM modulated signal (here used): $RBW=VBW=3$ kHz, for CDMA modulated signal: $RBW=VBW=30$ kHz.
3. The low, middle and the high channels are selected to perform tests respectively. Set the Channel to 4132 as the low channel.
4. Measurement and record the 99% occupied bandwidth.
5. Set the Channel to 4175 as middle channel, then repeat step 4.
6. Set the Channel to 4233 as high channel, then repeat step 4.

7.3 Test Result

A. Test Verdict:

Test Mode	Channel	Frequency (MHz)	Measured Occupied Bandwidth (kHz)
WCDMA 850	4175	835.00	4.1480
HSDPA 850	4175	835.00	4.1417
HSUPA 850	4175	835.00	4.1588

B. Test Plots:

WCDMA 850MHz:

- 1. Plot when the Channel set to 4175

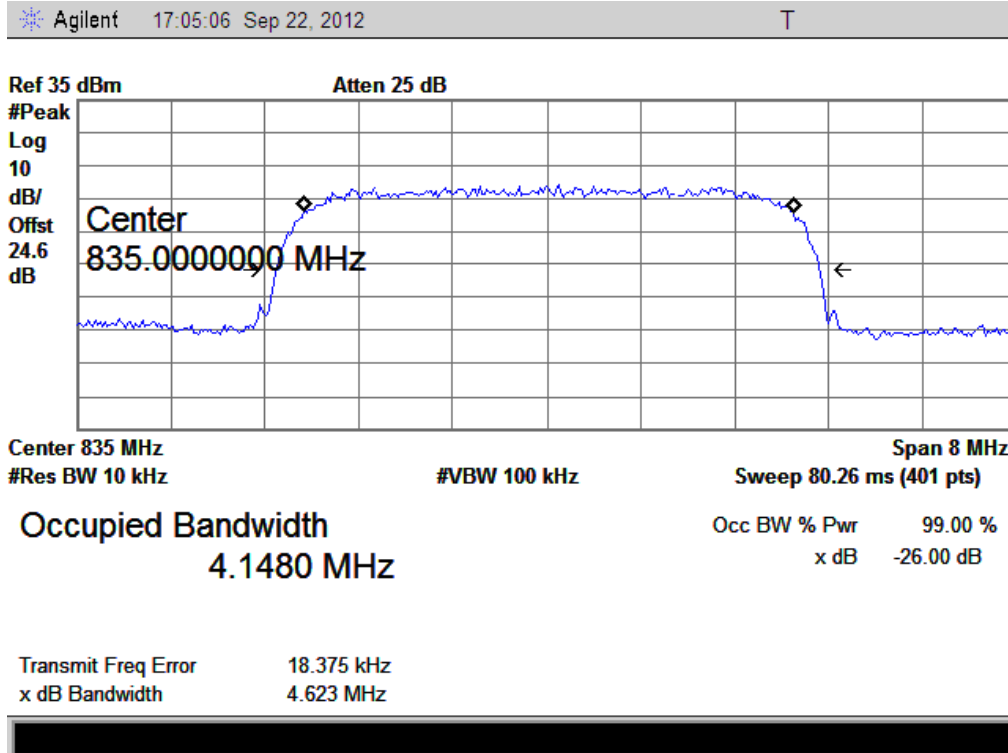

HSDPA 850MHz:

- 1. Plot when the Channel set to 4175

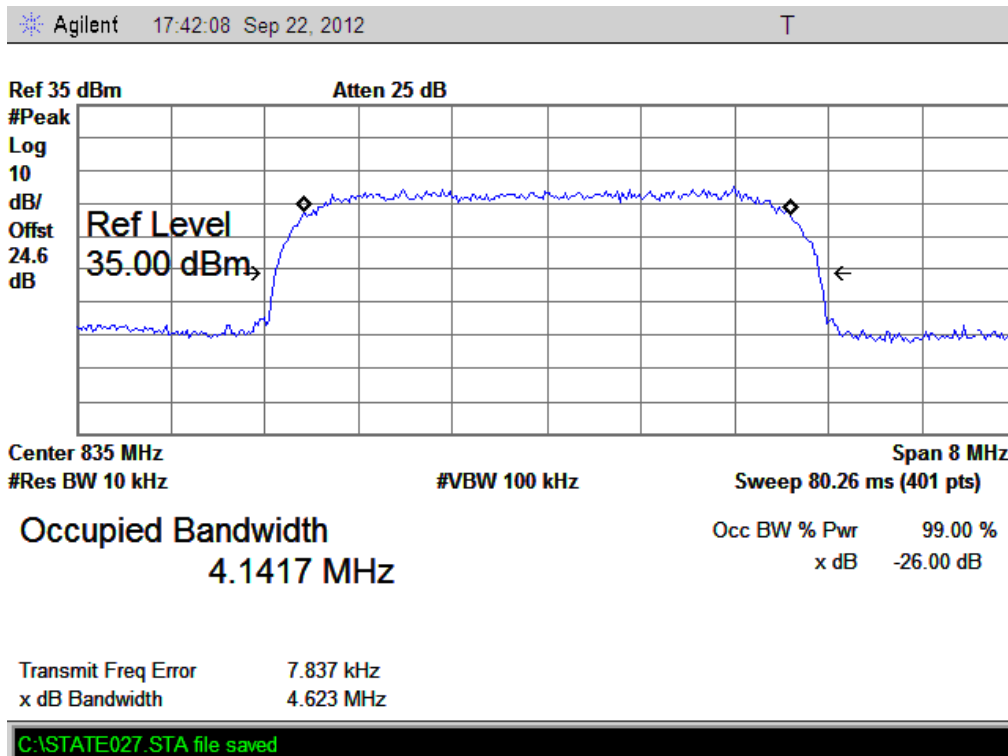

HSUPA 850MHz:

- 1. Plot when the Channel set to 4175:

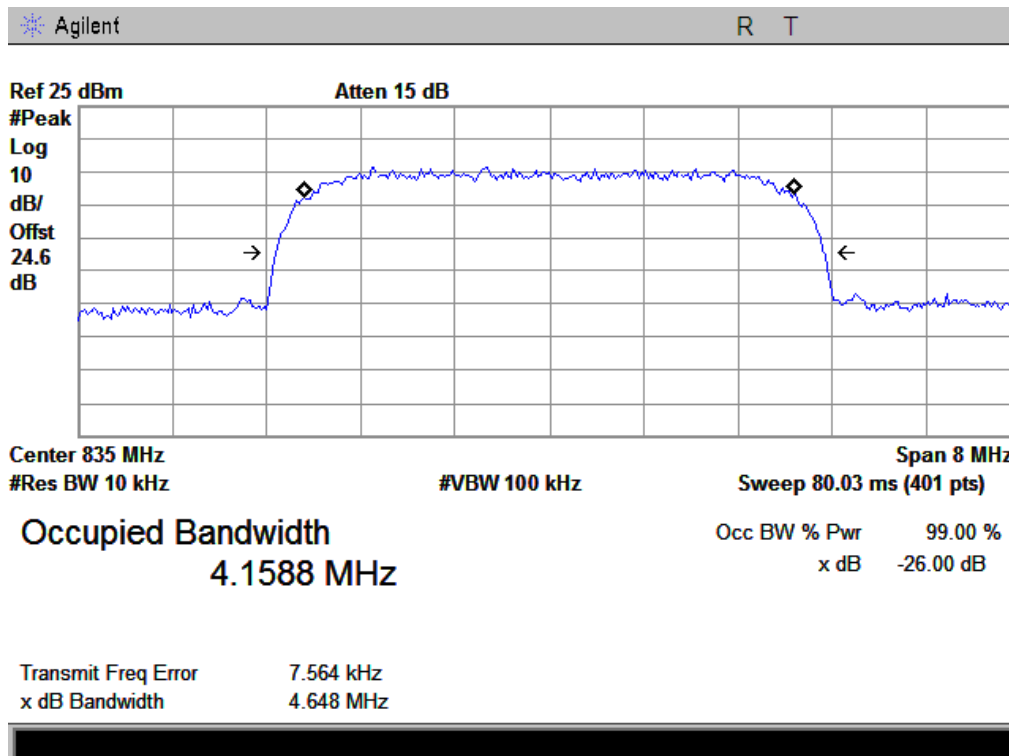

8. CONDUCTED SPURIOUS EMISSION

8.1 Requirement

According to FCC §22.917(a), the power of any emission outside of the authorized operating frequency ranges must be attenuated below the transmitting power (P) by a factor of at least $43+10*\log(P)$ dB. This calculated to be -13dBm.

According to FCC §22.917 (a), in the 1MHz bands immediately outside and adjacent to the frequency block a resolution bandwidth of at least one percent of the emission bandwidth of the fundamental emission of the transmitter may be employed. Thus the 26dB emission bandwidth is measurement for showing compliance at the band-edge.

8.2 Test Procedure

1. Perform test system setup as section 5.1.1.
2. Make a limit line whose value is -13dBm on the Spectrum Analyzer.
3. The lowest, middle and the highest channels are selected to perform tests respectively. Set the Channel to 4132 as the lowest channel.
4. Set the RBW of the Spectrum Analyzer to 1MHz, and the measuring frequency range from 9kHz to 10th harmonic of the fundamental frequency (here used 26.5GHz); mark the fundamental frequency and the harmonics thereof; finally record the harmonics and the plot. Note, the measuring frequency range can be divided into several parts to perform tests.
5. In the 1MHz bands immediately outside and adjacent to the frequency block, the RBW of the Spectrum Analyzer was set to at least one percent of the emission bandwidth of the fundamental emission of the transmitter, e.g. for GSM modulated signal (here used): RBW=3kHz, for CDMA modulated signal: RBW=30kHz.
6. Set the Channel to 4175 as the middle channel, then repeat step 4.
7. Set the Channel to 4233 as the highest channel, then repeat step 4 and 5.

8.3 Test Result

Table for the Harmonics and Plots for the Spurious Emission

1. Table for the Harmonics:

NOTE: “---” in the table following means that the emission power was too small to be measured and was at least 12dB below the limit.

No.	Frequency (MHz)	Emission Power (dBm)	Limit (dBm)
WCDMA 850MHz-Channel set to 4132 (826.40MHz)			
1	1652.80	---	-13
2	2479.20	---	-13
3	3305.60	---	-13
4	4132.00	---	-13
5	4958.40	---	-13
6	5784.80	---	-13
7	6611.20	---	-13
8	7437.60	---	-13
9	8264.00	---	-13
WCDMA 850MHz-Channel set to 4175 (835.00MHz)			
1	1670.00	---	-13
2	2505.00	---	-13
3	3340.00	---	-13
4	4175.00	---	-13
5	5010.00	---	-13
6	5845.00	---	-13
7	6680.00	---	-13
8	7515.00	---	-13
9	1670.00	---	-13
WCDMA 850MHz-Channel set to 4233 (846.60MHz)			
1	1693.20	---	-13
2	2539.80	---	-13
3	3386.40	---	-13
4	4233.00	---	-13
5	5079.60	---	-13
6	5926.20	---	-13
7	6772.80	---	-13
8	7619.40	---	-13
9	8466.00	---	-13
HSDPA 850MHz-Channel set to 4132 (826.40MHz)			
1	1652.80	---	-13
2	2479.20	---	-13
3	3305.60	---	-13
4	4132.00	---	-13
5	4958.40	---	-13
6	5784.80	---	-13
7	6611.20	---	-13
8	7437.60	---	-13
9	8264.00	---	-13
HSDPA 850MHz-Channel set to 4175 (835.00MHz)			
1	1670.00	---	-13
2	2505.00	---	-13
3	3340.00	---	-13

4	4175.00	---	-13
5	5010.00	---	-13
6	5845.00	---	-13
7	6680.00	---	-13
8	7515.00	---	-13
9	1670.00	---	-13
HSDPA 850MHz-Channel set to 4233 (846.60MHz)			
1	1693.20	---	-13
2	2539.80	---	-13
3	3386.40	---	-13
4	4233.00	---	-13
5	5079.60	---	-13
6	5926.20	---	-13
7	6772.80	---	-13
8	7619.40	---	-13
9	8466.00	---	-13
HSUPA 850MHz-Channel set to 4132 (826.40MHz)			
1	1652.80	---	-13
2	2479.20	---	-13
3	3305.60	---	-13
4	4132.00	---	-13
5	4958.40	---	-13
6	5784.80	---	-13
7	6611.20	---	-13
8	7437.60	---	-13
9	8264.00	---	-13
HSUPA 850MHz-Channel set to 4175 (835.00MHz)			
1	1670.00	---	-13
2	2505.00	---	-13
3	3340.00	---	-13
4	4175.00	---	-13
5	5010.00	---	-13
6	5845.00	---	-13
7	6680.00	---	-13
8	7515.00	---	-13
9	1670.00	---	-13
HSUPA 850MHz-Channel set to 4233 (846.60MHz)			
1	1693.20	---	-13
2	2539.80	---	-13
3	3386.40	---	-13
4	4233.00	---	-13
5	5079.60	---	-13
6	5926.20	---	-13
7	6772.80	---	-13
8	7619.40	---	-13
9	8466.00	---	-13

2. Plot for Spurious Emission:

The measuring frequency range was from 9 kHz to 9GHz.

NOTE: The marker points are the Mobile Phone transmitting frequencies which should be ignored.

WCDMA 850MHz:

1) Plot when the Channel set to 4123:

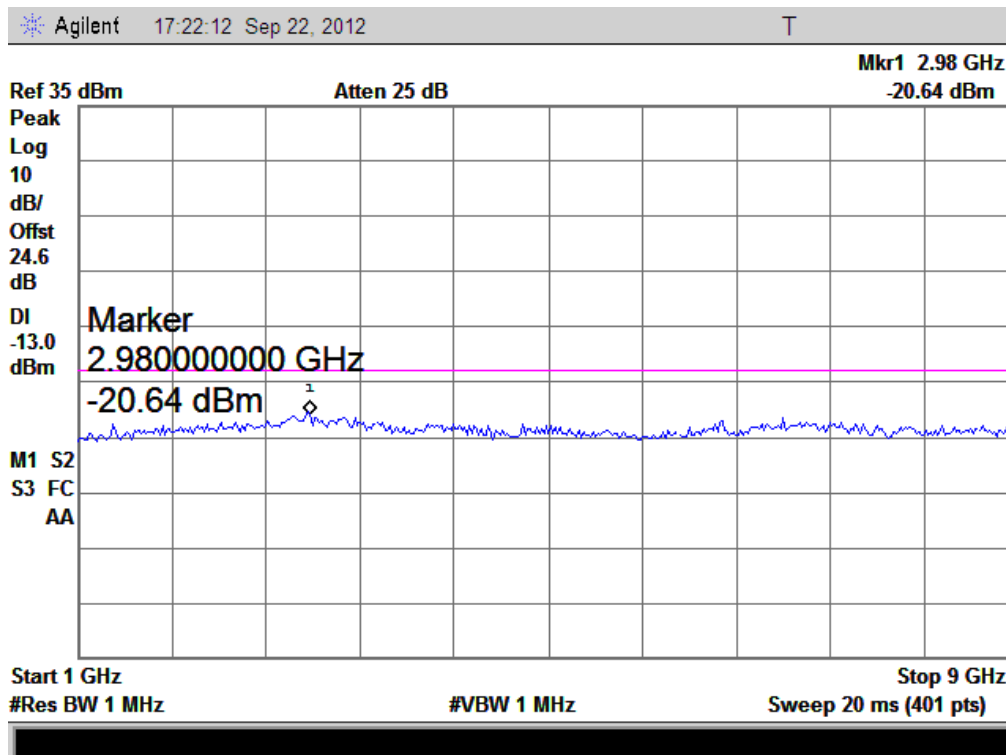
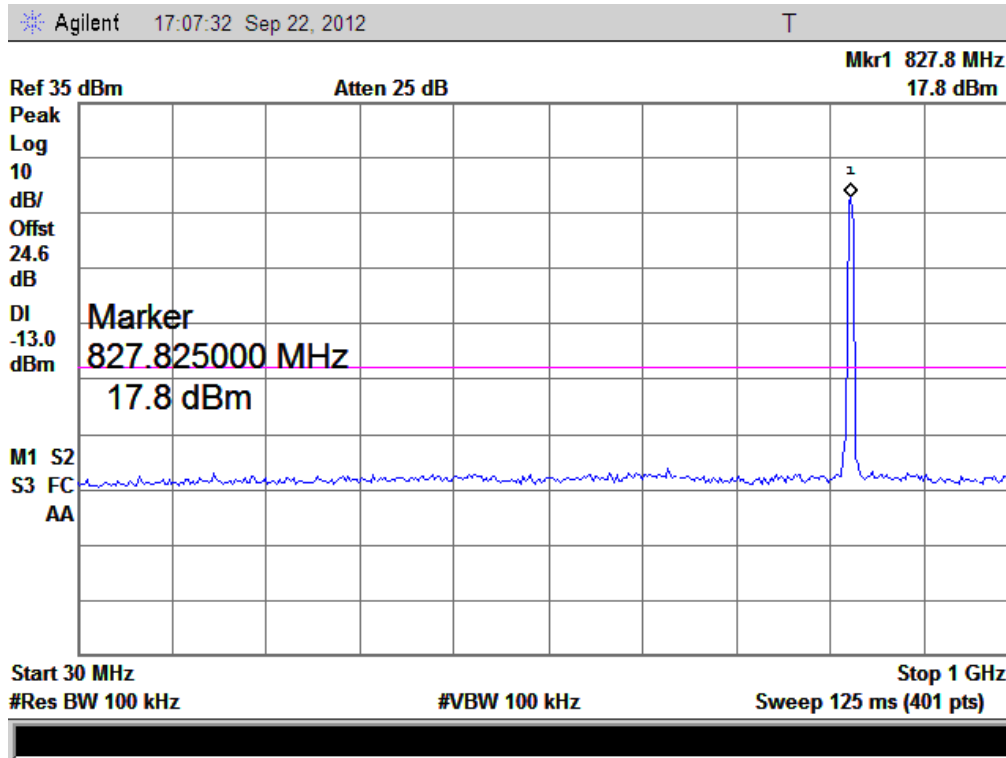

2) Plot when the Channel set to 4175:

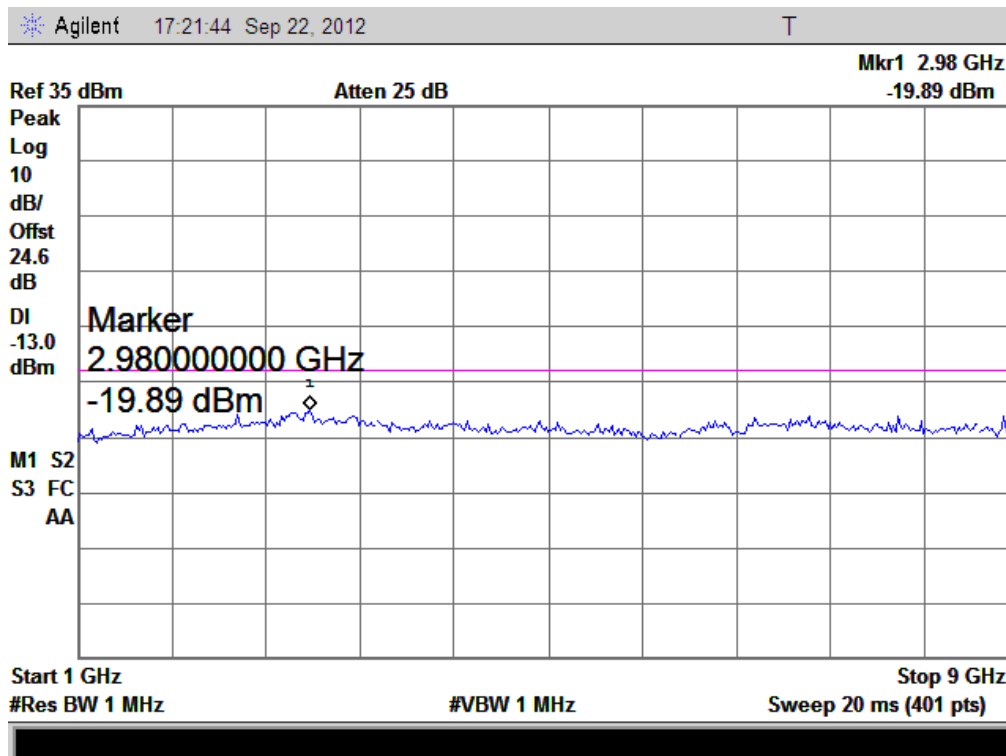
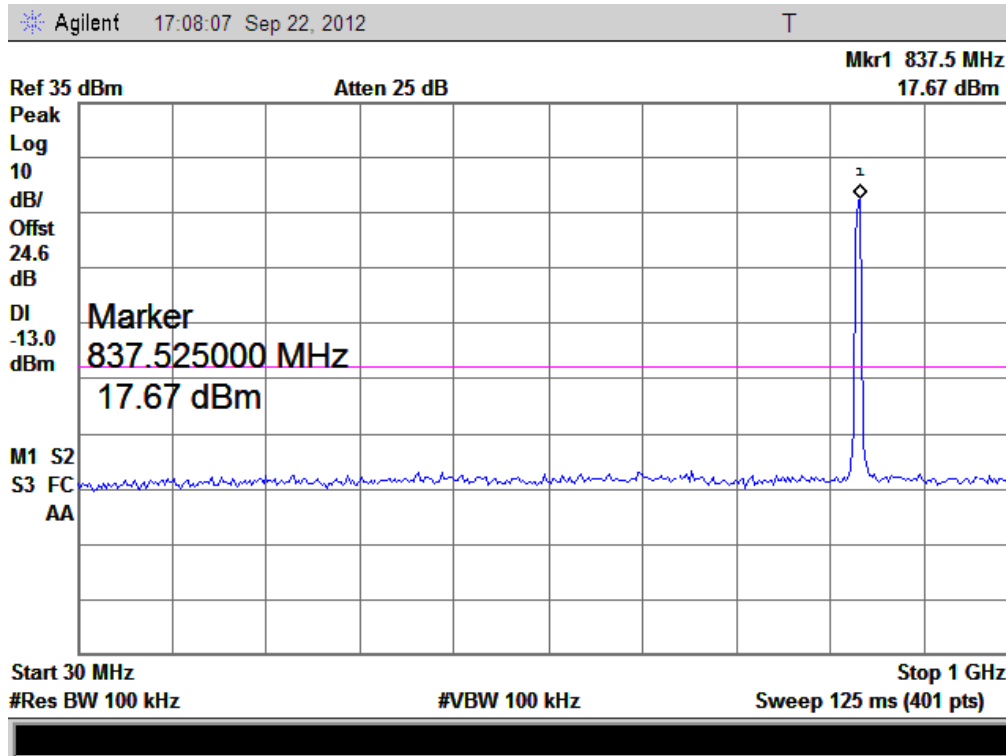

3) Plot when the Channel set to 4233:

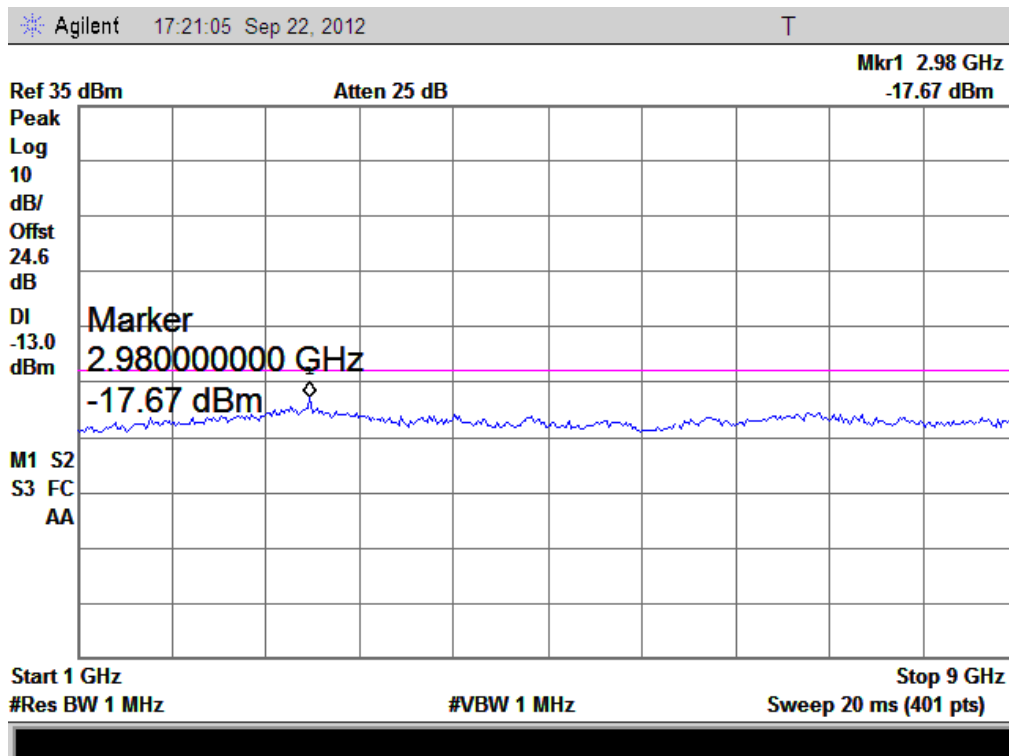
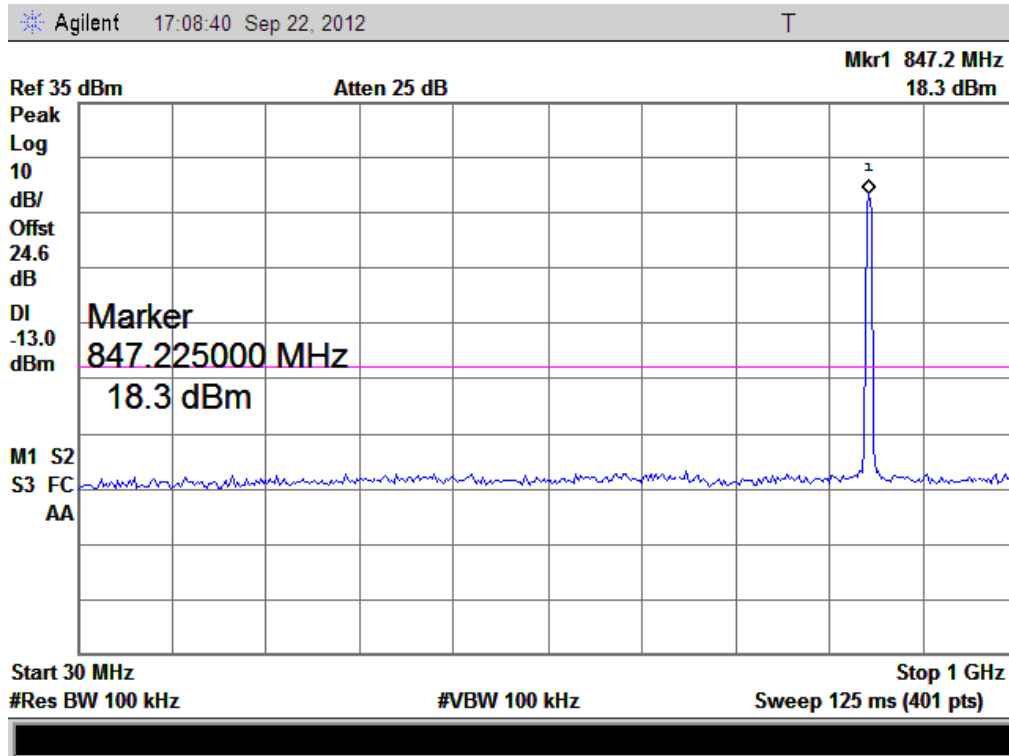

HSDPA 850MHz:

1) Plot when the Channel set to 4123:

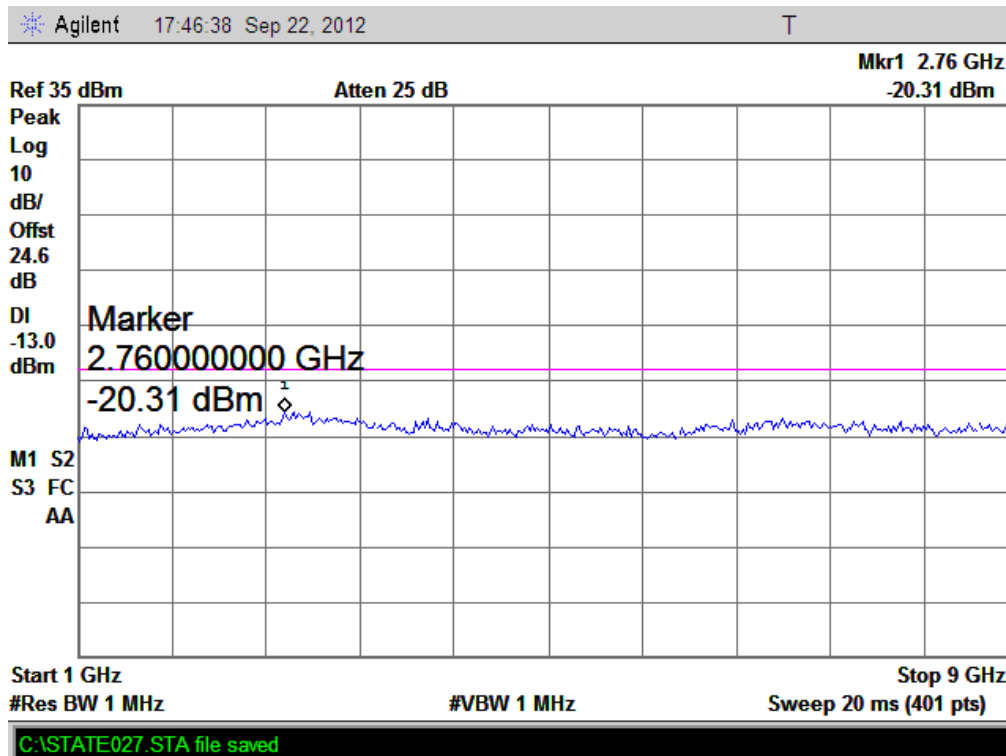
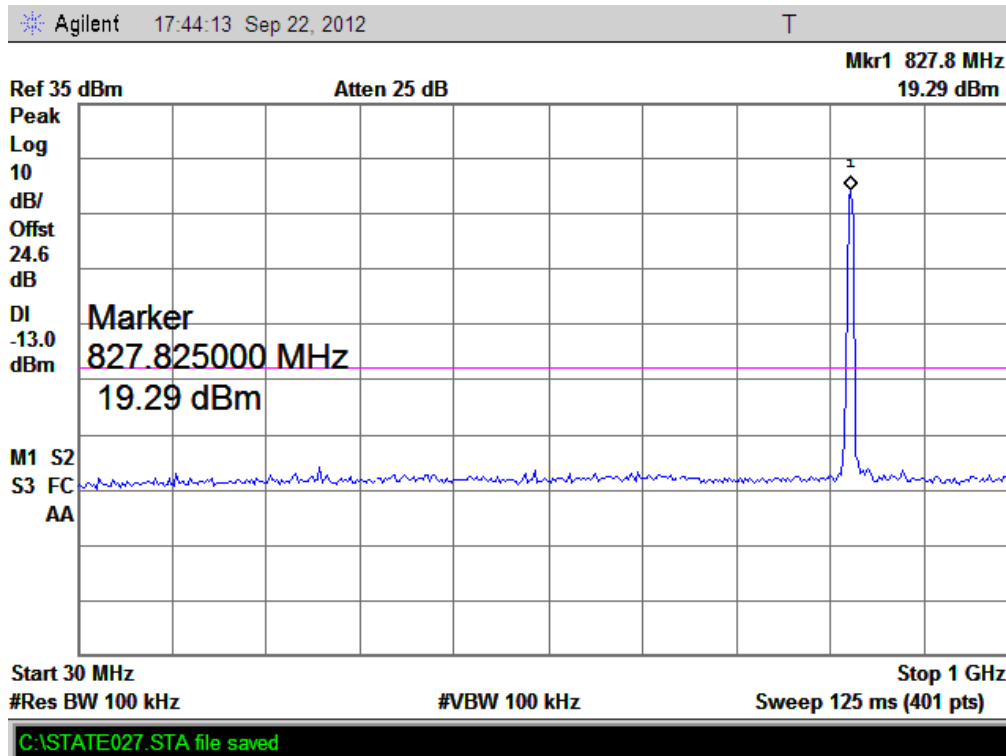

2) Plot when the Channel set to 4175:

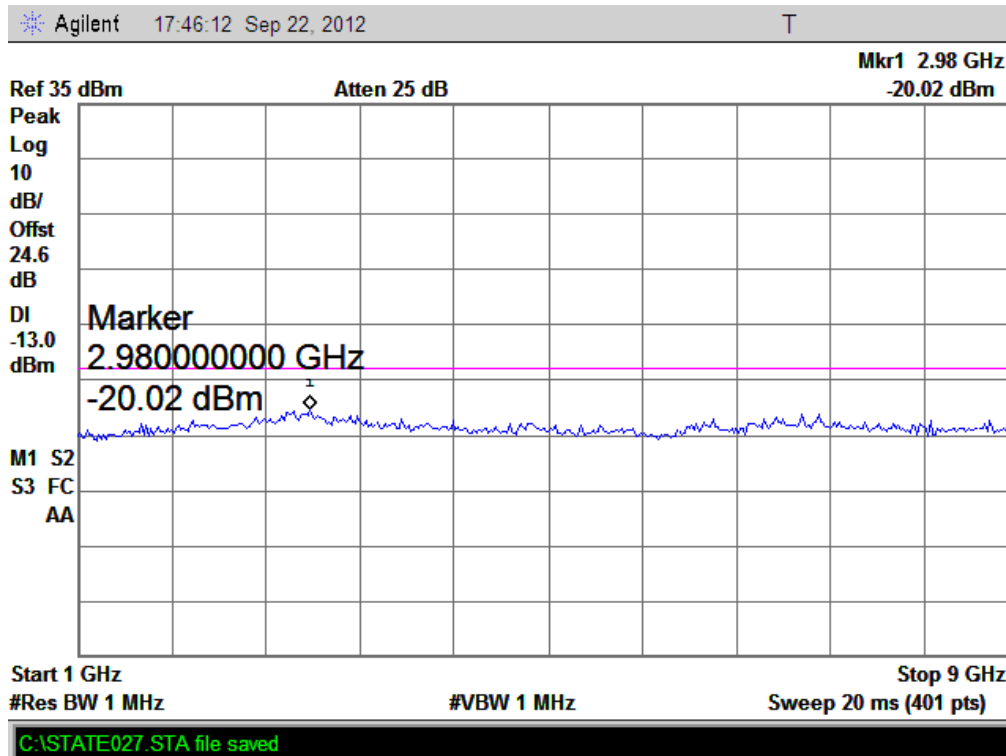
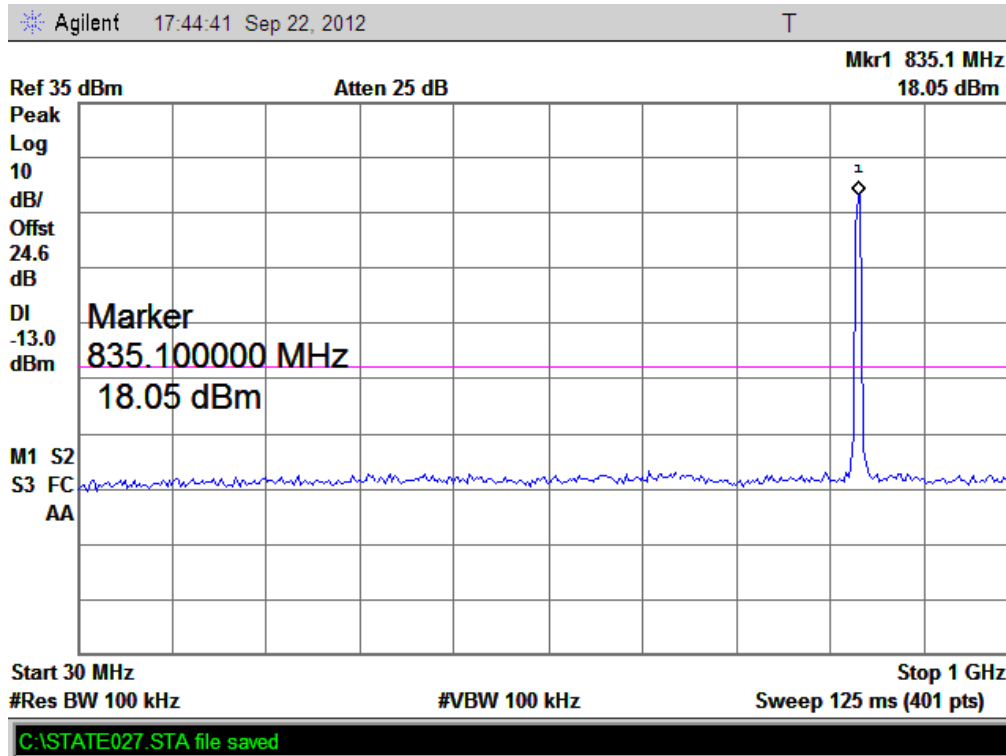

3) Plot when the Channel set to 4233:

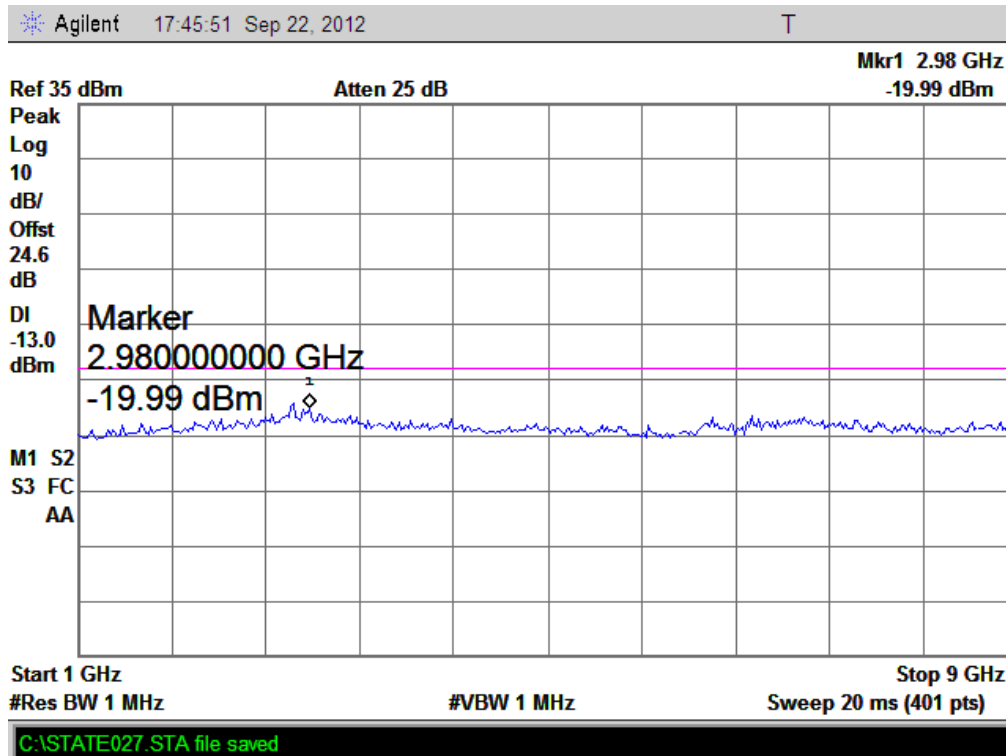
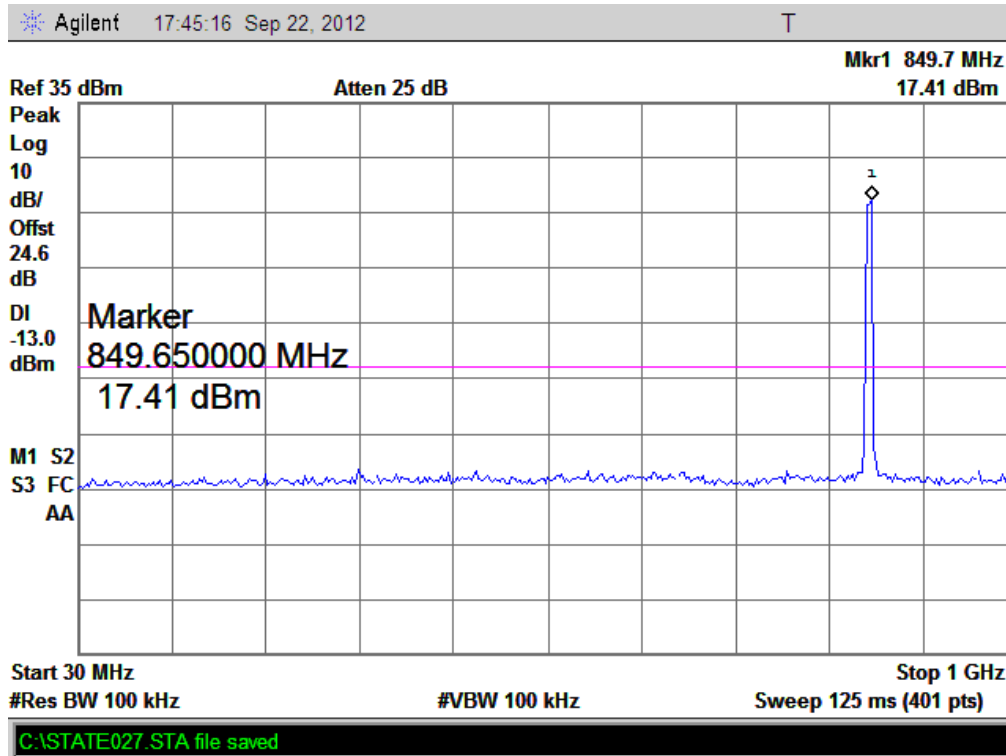

HSUPA 850MHz:

1) Plot when the Channel set to 4123:

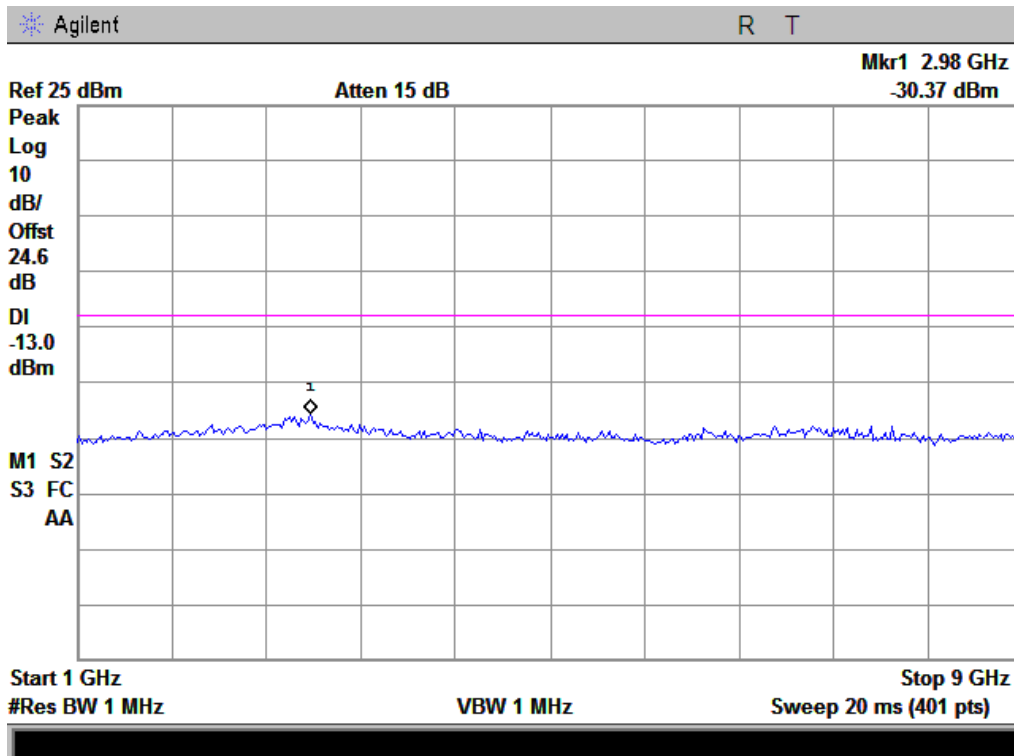
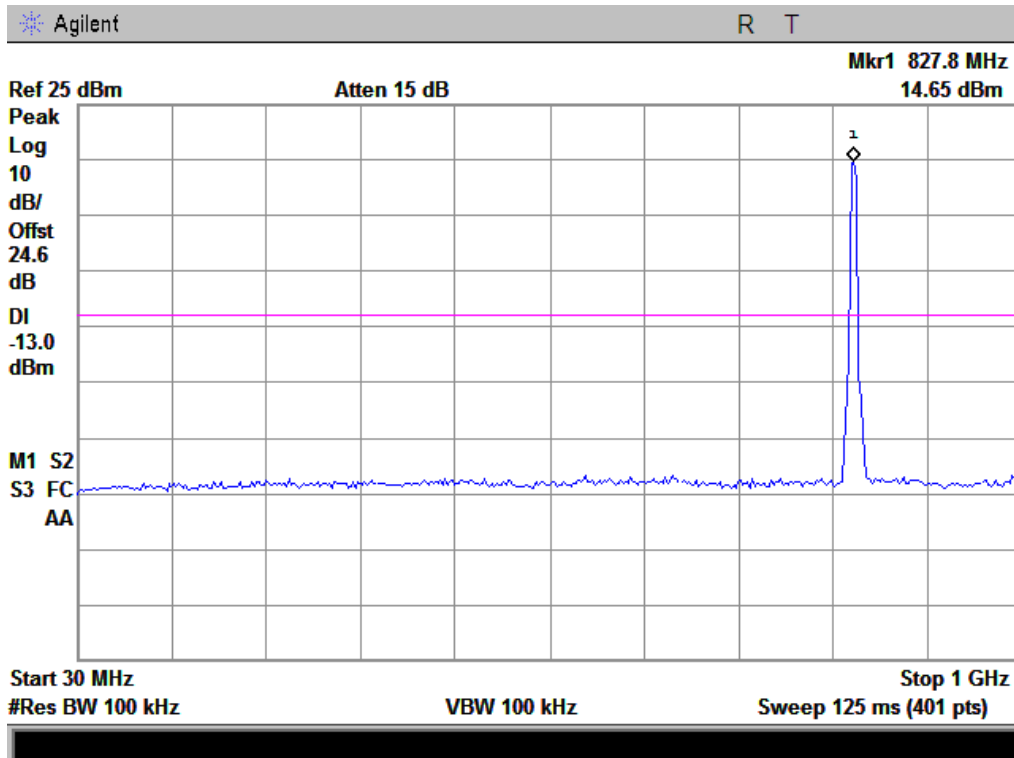

2) Plot when the Channel set to 4175:

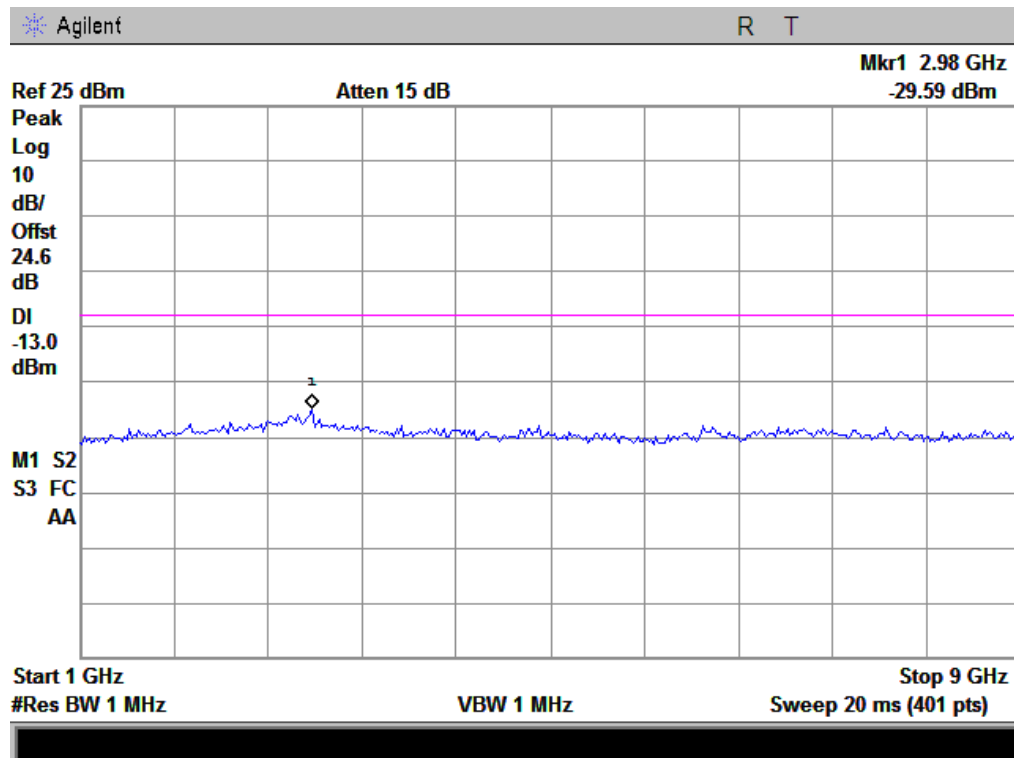
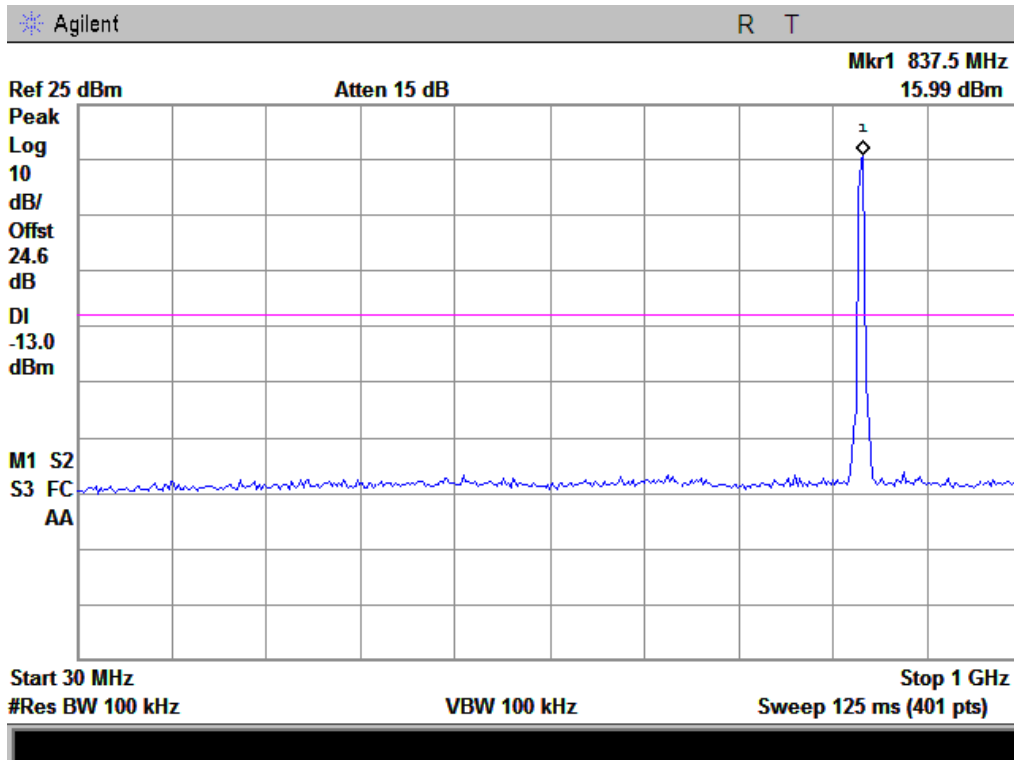

3) Plot when the Channel set to 4233:

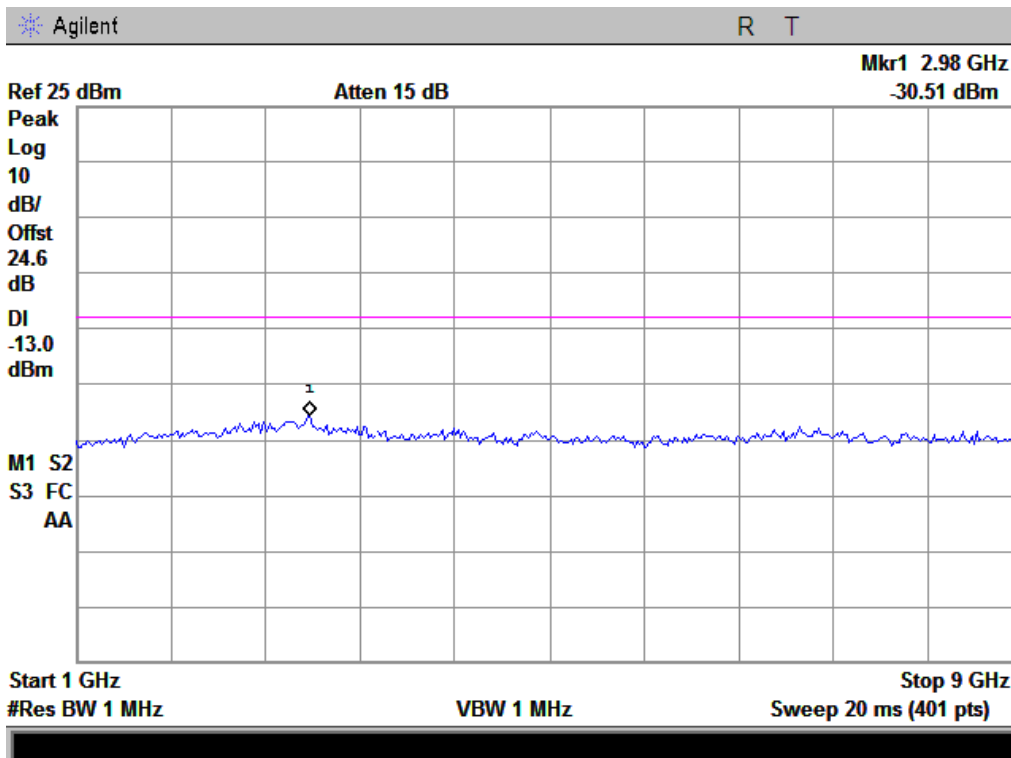
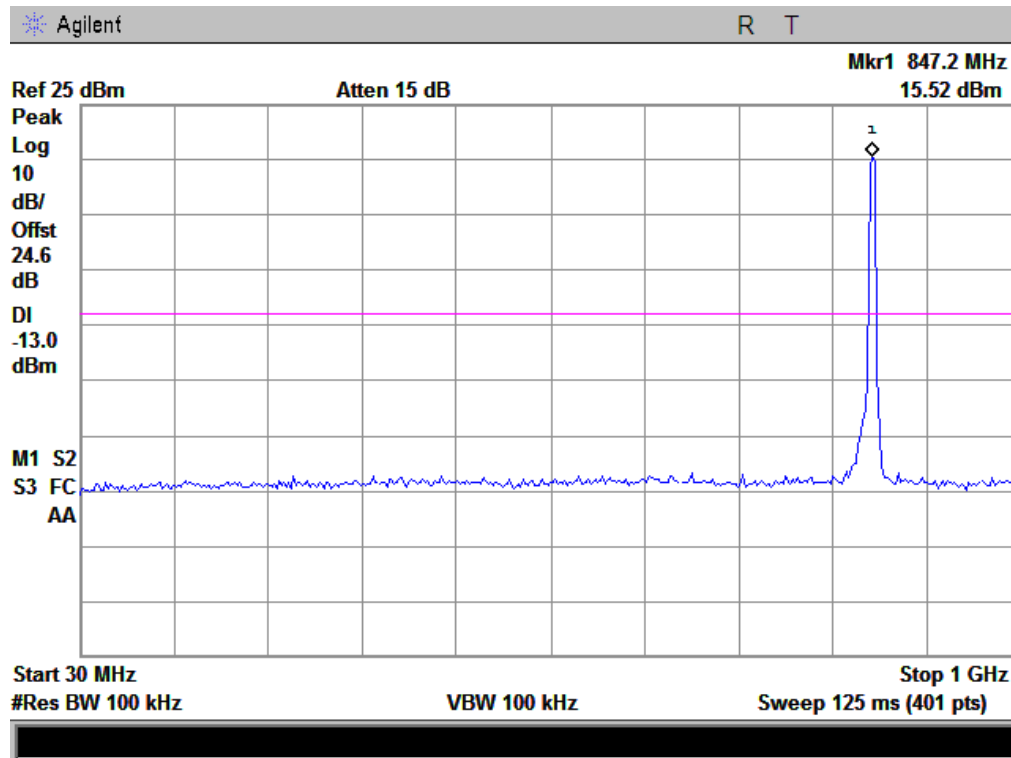

3. Plot for Band-edge

WCDMA 850MHz

1) Plot when the Channel set to 4123:

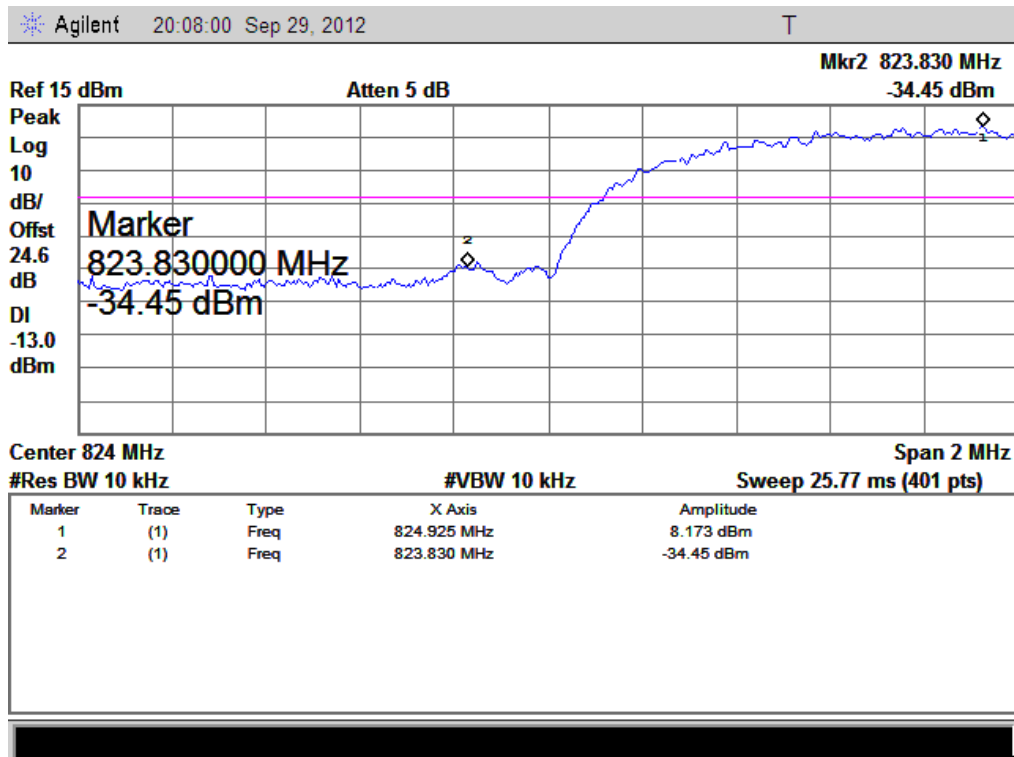

2) Plot when the Channel set to 4233:

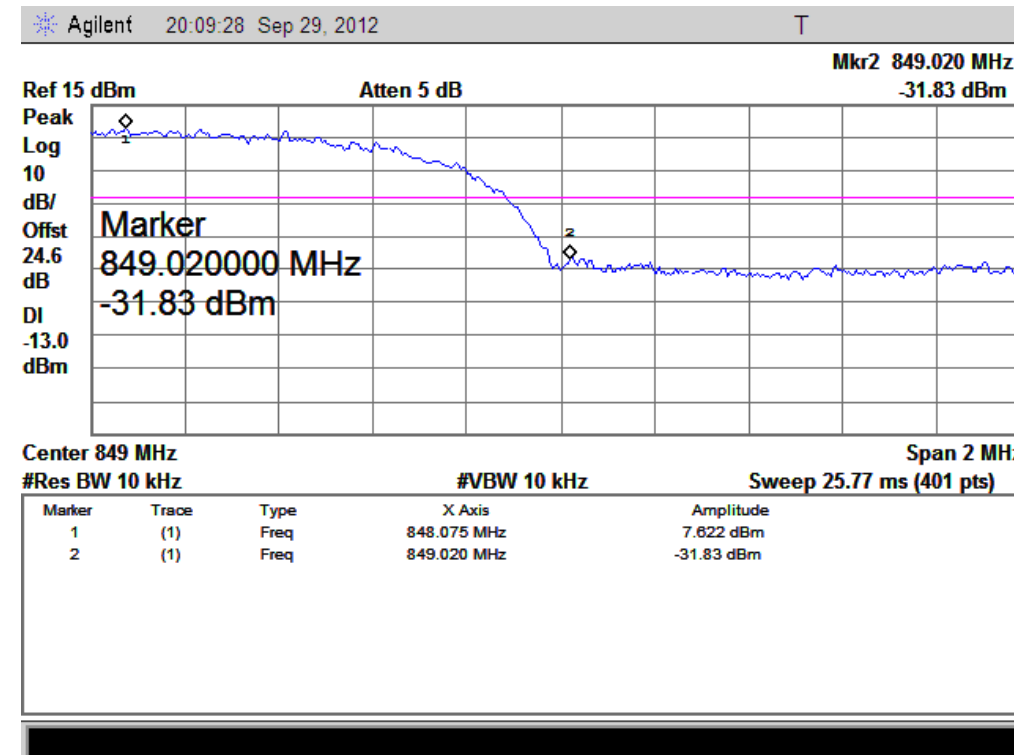

HSDPA 850MHz

1) Plot when the Channel set to 4123:

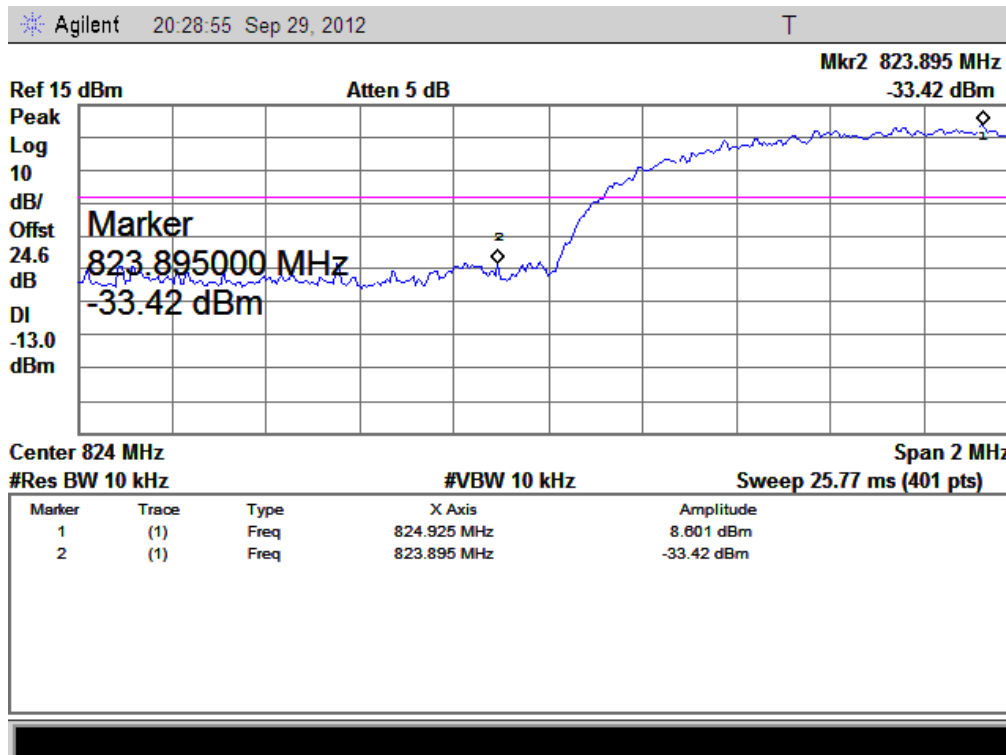

2) Plot when the Channel set to 4233:

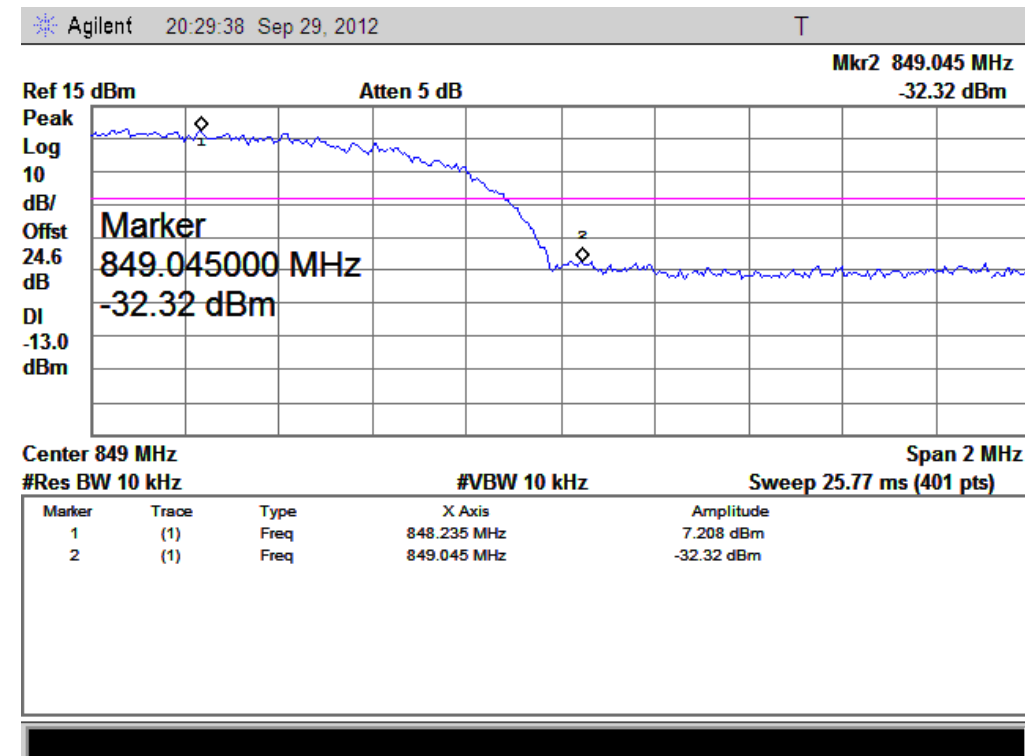

HSUPA 850MHz

1) Plot when the Channel set to 4123:

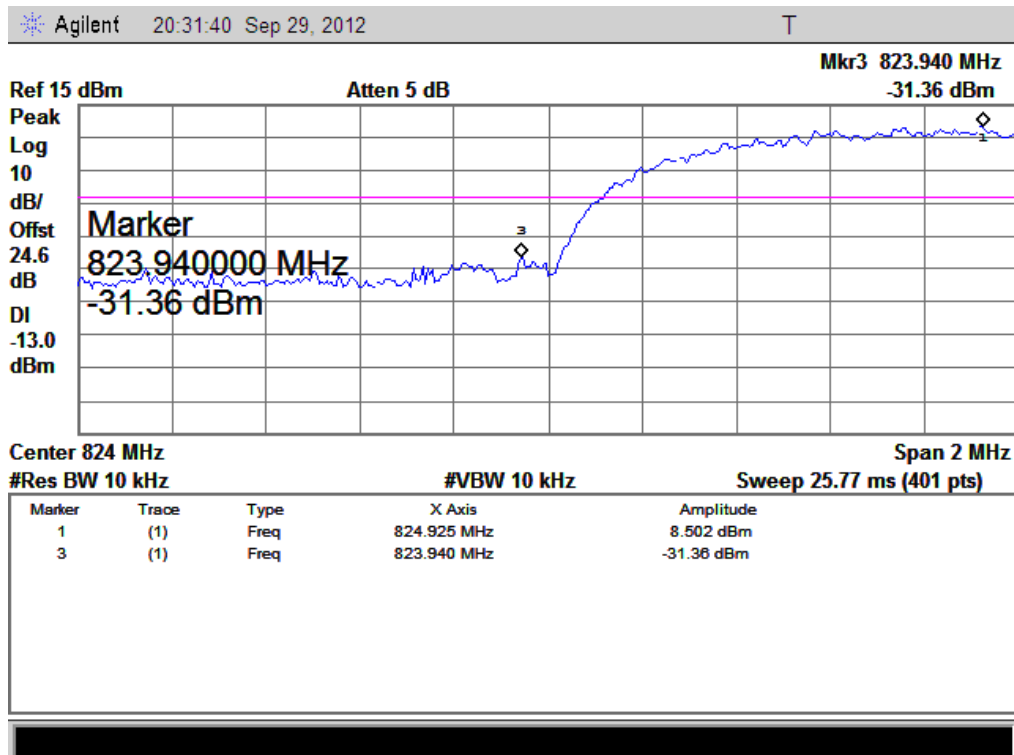

2) Plot when the Channel set to 4233:

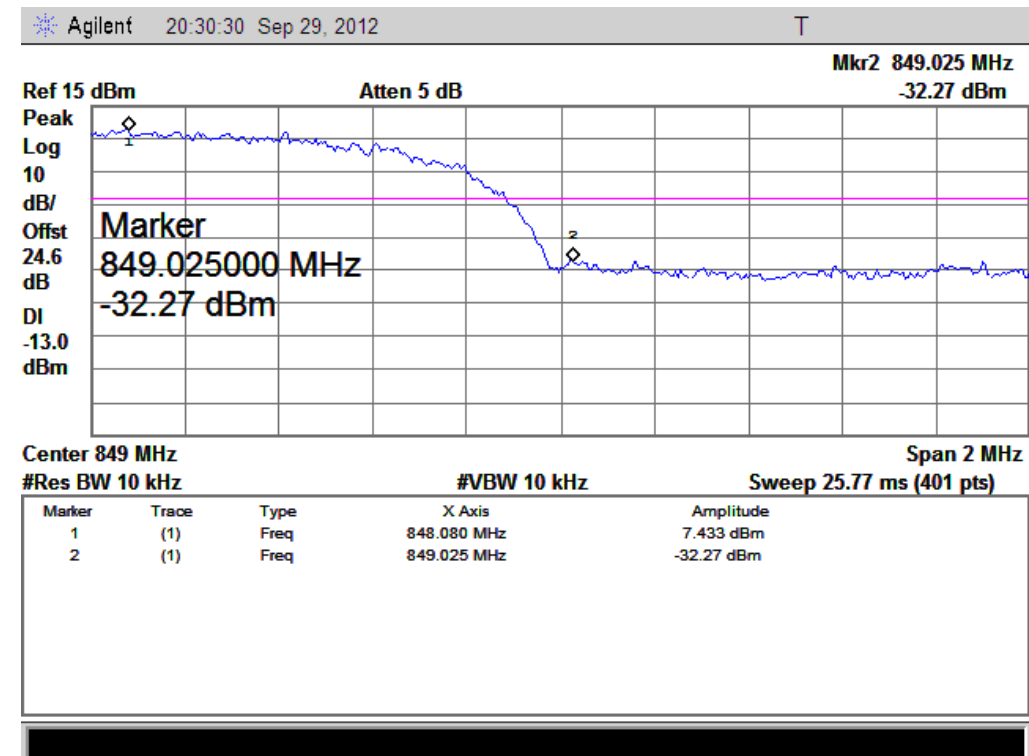

9. TRANSMITTER RADIATED POWER (EIRP/ERP)

9.1 Requirement

According to FCC §22.913, the ERP of Cellular mobile transmitters must not exceed 7 Watts (38.5dBm).

9.2 Test Procedure

See the section 5.1.2.

9.3 Test Result

Test Mode	Channel	Frequency (MHz)	Measured ERP		Limit ERP		Result
			dBm	W	dBm	W	
WCDMA 850MHz	4132	826.40	21.37	0.137	< 38.5	< 7	PASS
	4175	835.00	20.93	0.124	< 38.5	< 7	PASS
	4233	846.60	21.16	0.131	< 38.5	< 7	PASS
HSDPA 850MHz	4132	826.40	20.12	0.103	< 38.5	< 7	PASS
	4175	835.00	20.57	0.114	< 38.5	< 7	PASS
	4233	846.60	20.43	0.110	< 38.5	< 7	PASS
HSUPA 850MHz	4132	826.40	20.38	0.109	< 38.5	< 7	PASS
	4175	835.00	20.62	0.115	< 38.5	< 7	PASS
	4233	846.60	21.04	0.127	< 38.5	< 7	PASS

10. RADIATED SPURIOUS EMISSION

10.1 Requirement

According to FCC §22.917(a), the power of any emission outside of the authorized operating frequency ranges must be attenuated below the transmitting power (P) by a factor of at least $43+10*\log(P)$ dB. This calculated to be -13dBm.

10.2 Test Procedure

See the section 5.1.2.

10.3 Test Result

The measurement frequency range is from 30MHz to the 10th harmonic of the fundamental frequency. The both horizontal and vertical polarizations of the Test Antenna are used to find the maximum radiated power. The lowest, middle and highest channels are tested to verify the out of band emissions.

Table for the Harmonics

No.	Frequency (MHz)	Emission Power (dBm)		Limit (dBm)
		Test Antenna Vertical	Test Antenna Horizontal	
WCDMA 850MHz-Channel set to 4132 (826.40MHz)				
1	1652.80	---	---	-13
2	2479.20	---	---	-13
3	3305.60	---	---	-13
4	4132.00	---	---	-13
5	4958.40	---	---	-13
6	5784.80	---	---	-13
7	6611.20	---	---	-13
8	7437.60	---	---	-13
9	8264.00	---	---	-13
WCDMA 850MHz-Channel set to 4175 (835.00MHz)				
1	1670.00	---	---	-13
2	2505.00	---	---	-13
3	3340.00	---	---	-13
4	4175.00	---	---	-13
5	5010.00	---	---	-13
6	5845.00	---	---	-13
7	6680.00	---	---	-13
8	7515.00	---	---	-13
9	1670.00	---	---	-13
WCDMA 850MHz-Channel set to 4233 (846.60MHz)				
1	1652.80	---	---	-13
2	2479.20	---	---	-13
3	3305.60	---	---	-13
4	4132.00	---	---	-13
5	4958.40	---	---	-13
6	5784.80	---	---	-13
7	6611.20	---	---	-13
8	7437.60	---	---	-13
9	8264.00	---	---	-13

No.	Frequency (MHz)	Emission Power (dBm)		Limit (dBm)
		Test Antenna Vertical	Test Antenna Horizontal	
HSDPA 850MHz-Channel set to 4132 (826.40MHz)				
1	1652.80	---	---	-13
2	2479.20	---	---	-13
3	3305.60	---	---	-13
4	4132.00	---	---	-13
5	4958.40	---	---	-13
6	5784.80	---	---	-13
7	6611.20	---	---	-13
8	7437.60	---	---	-13
9	8264.00	---	---	-13
HSDPA 850MHz-Channel set to 4175 (835.00MHz)				
1	1670.00	---	---	-13
2	2505.00	---	---	-13
3	3340.00	---	---	-13
4	4175.00	---	---	-13
5	5010.00	---	---	-13
6	5845.00	---	---	-13
7	6680.00	---	---	-13
8	7515.00	---	---	-13
9	1670.00	---	---	-13
HSDPA 850MHz-Channel set to 4233 (846.60MHz)				
1	1652.80	---	---	-13
2	2479.20	---	---	-13
3	3305.60	---	---	-13
4	4132.00	---	---	-13
5	4958.40	---	---	-13
6	5784.80	---	---	-13
7	6611.20	---	---	-13
8	7437.60	---	---	-13
9	8264.00	---	---	-13
HSUPA 850MHz-Channel set to 4132 (826.40MHz)				
1	1652.80	---	---	-13
2	2479.20	---	---	-13
3	3305.60	---	---	-13
4	4132.00	---	---	-13
5	4958.40	---	---	-13
6	5784.80	---	---	-13
7	6611.20	---	---	-13
8	7437.60	---	---	-13
9	8264.00	---	---	-13
HSUPA 850MHz-Channel set to 4175 (835.00MHz)				
1	1670.00	---	---	-13
2	2505.00	---	---	-13
3	3340.00	---	---	-13
4	4175.00	---	---	-13
5	5010.00	---	---	-13
6	5845.00	---	---	-13
7	6680.00	---	---	-13
8	7515.00	---	---	-13
9	1670.00	---	---	-13
HSUPA 850MHz-Channel set to 4233 (846.60MHz)				

No.	Frequency (MHz)	Emission Power (dBm)		Limit (dBm)
		Test Antenna Vertical	Test Antenna Horizontal	
1	1652.80	---	---	-13
2	2479.20	---	---	-13
3	3305.60	---	---	-13
4	4132.00	---	---	-13
5	4958.40	---	---	-13
6	5784.80	---	---	-13
7	6611.20	---	---	-13
8	7437.60	---	---	-13
9	8264.00	---	---	-13

NOTE: “---” in the table following means that the emission power was too small to be measured and was at least 12dB below the limit.

11. FREQUENCY STABILITY

11.1 Frequency Stability Requirement

According to FCC §22.355, the frequency stability shall be sufficient to ensure that the fundamental emission stays within the authorized frequency block.

According to FCC §2.1055, the test conditions are:

(a) Temperature:

The temperature is varied from -30°C to $+50^{\circ}\text{C}$ at intervals of not more than 10°C .

(b) Primary Supply Voltage:

For hand carried battery powered equipment, the primary supply voltage is reduced to the battery operating end point which shall be specified by the manufacture. The supply voltage shall be measured at the input to the cable normally provided with the equipment, or at the power supply terminals if cables are not normally provided.

11.2 Test Procedure

1. Perform test system setup as section 5.1.3.
2. Set the voltage of the DC Power Supply to normal supply voltage (here used 3.7V) and the temperature of the Temperature Chamber to vary from -30°C to $+50^{\circ}\text{C}$ at intervals of 10°C .
3. At each temperature level, the EUT is powered off and kept in the Temperature Chamber for two hours.
4. After sufficient stabilization, turn on the EUT, command it via the System Simulator (SS) to operate at the maximum output power i.e. Power Control Level, and then establish a communication link between the EUT and the SS.
5. The low, middle and the high channels are selected to perform tests respectively. Set the channel to 4132 as the low channel.
6. The frequency deviation is measured (directly read from the SS, which can report the parameter) within three minutes.
7. Set the channel to 4175 as the middle channel, then repeat step 5.
8. Set the TCH channel to 4233 as the high channel, then repeat step 5.
9. Adjust the temperature of the Temperature Chamber as specified in step 2, then repeat step 3 to 7.
10. Set the voltage of the DC Power Supply to high extreme supply voltage (here used 4.2V) and the temperature of the Temperature Chamber to normal (here used $+22^{\circ}\text{C}$), then repeat step 3 to 8.
11. Set the voltage of the DC Power Supply to low extreme supply voltage (here used 3.6V) and the temperature of the Temperature Chamber to normal (here used $+22^{\circ}\text{C}$), then repeat step 3 to 8.

11.3 Test Result

Band	Test Conditions		Frequency Deviation (Hz) at Channels Used			
	Voltage	Temperature	4132	4175	4233	Limit (± 2.5 ppm)
WCDMA 850	V-nor	-30°C	-35.19	-29.24	15.62	(a) ± 2066 Hz for 4132 Channel (b) ± 2091 Hz for 4175 Channel (a) ± 2116 Hz for 4233 Channel
		-20°C	-24.75	-21.24	-20.95	
		-10°C	14.59	-10.59	-19.73	
		0°C	-22.86	-22.24	19.26	
		+10°C	-31.99	-35.15	-30.62	
		+20°C	-27.07	5.75	-36.25	
		+30°C	13.24	2.40	-26.56	
		+40°C	-25.42	-25.22	-34.68	
	+50°C	17.20	-29.44	-22.05		
	V-high	+22°C	-36.27	-2.51	-35.95	
V-low	+22°C	-32.66	10.75	-31.98		

Result: PASS

Band	Test Conditions		Frequency Deviation (Hz) at Channels Used			
	Voltage	Temperature	4132	4175	4233	Limit (± 2.5 ppm)
HSDPA 850	V-nor	-30°C	-34.89	-27.14	-18.99	(c) ± 2066 Hz for 4132 Channel (d) ± 2091 Hz for 4175 Channel (b) ± 2116 Hz for 4233 Channel
		-20°C	-24.45	-0.66	17.58	
		-10°C	-20.99	-21.31	-19.14	
		0°C	16.46	10.34	-19.85	
		+10°C	-31.69	-33.05	-30.03	
		+20°C	-26.77	-27.65	-35.66	
		+30°C	-19.64	-24.30	-25.97	
		+40°C	-25.12	-23.12	-35.09	
	+50°C	-23.43	-27.34	-21.46		
	V-high	+22°C	29.87	-19.39	-35.36	
V-low	+22°C	-32.36	-22.65	-32.06		

Result: PASS

Band	Test Conditions		Frequency Deviation (Hz) at Channels Used			
	Voltage	Temperature	4132	4175	4233	Limit (± 2.5 ppm)
HSUPA 850	V-nor	-30°C	-24.59	-25.04	-8.37	(e) ± 2066 Hz for 4132 Channel (f) ± 2091 Hz for 4175 Channel (c) ± 2116 Hz for 4233 Channel
		-20°C	-34.15	-21.24	18.17	
		-10°C	-20.69	-19.21	-18.55	
		0°C	19.76	-12.44	10.44	
		+10°C	-31.39	-30.95	-29.44	
		+20°C	-26.47	-25.55	-35.07	
		+30°C	10.24	-12.44	12.35	
		+40°C	-24.82	-21.02	-25.50	
	+50°C	-23.30	-25.24	-14.87		
	V-high	+22°C	-26.27	-27.29	-14.77	
V-low	+22°C	-22.06	-20.55	12.87		

Result: PASS

APPENDIX 1
PHOTOGRAPHS OF TEST SETUP

CONDUCTED TEST SETUP

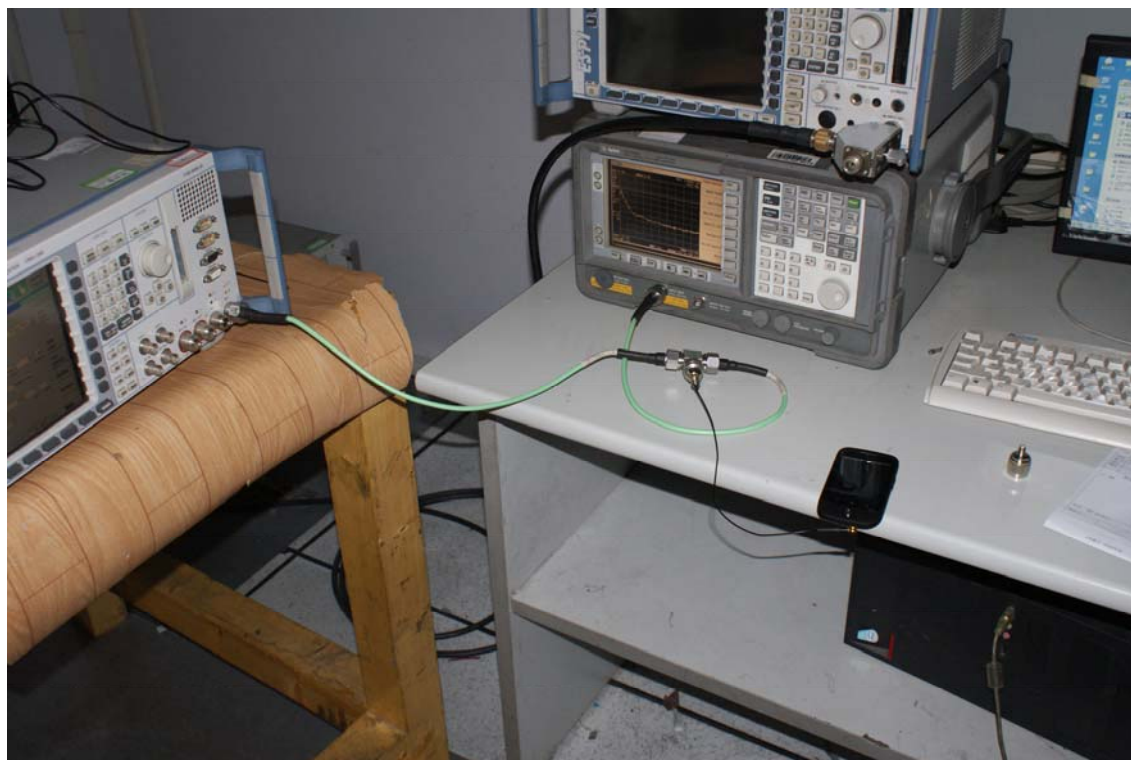

RADIATED EMISSION TEST SETUP

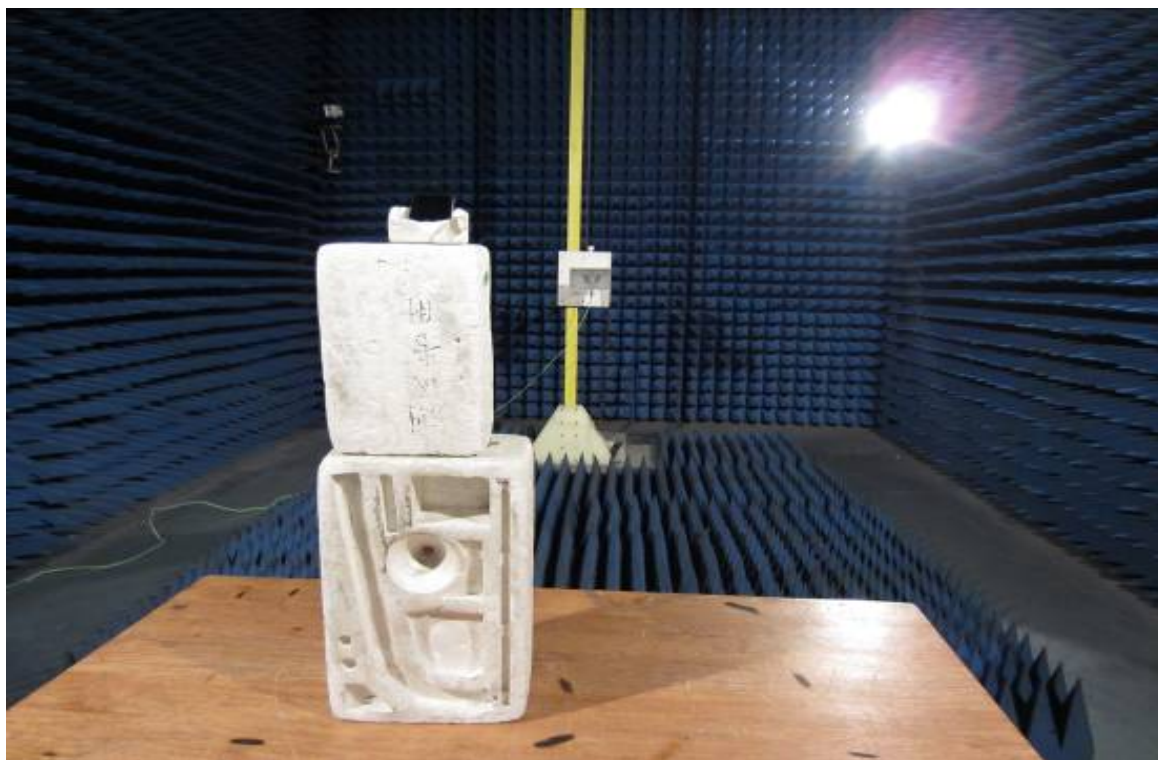

**APPENDIX 2
PHOTOGRAPHS OF EUT**

FRONT VIEW OF SAMPLE



BACK VIEW OF SAMPLE



LEFT VIEW OF SAMPLE



RIGHT VIEW OF SAMPLE



UP VIEW OF SAMPLE



DOWN VIEW OF SAMPLE



PHOTO OF HEADPHONE



PHOTO OF ADAPTER



PHOTO OF BATTERY



PHOTO OF USB CABLE



INTERNAL PHOTO OF SAMPLE - 1



INTERNAL PHOTO OF SAMPLE -2



INTERNAL PHOTO OF SAMPLE - 3

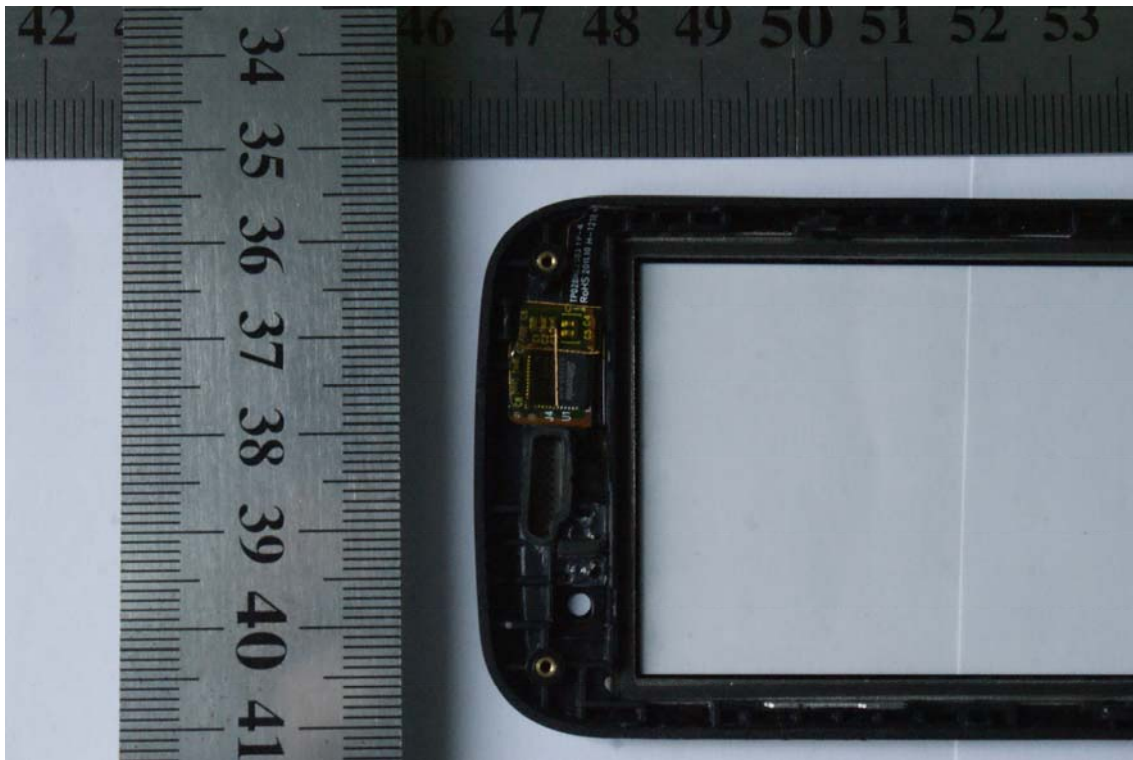

INTERNAL PHOTO OF SAMPLE - 4

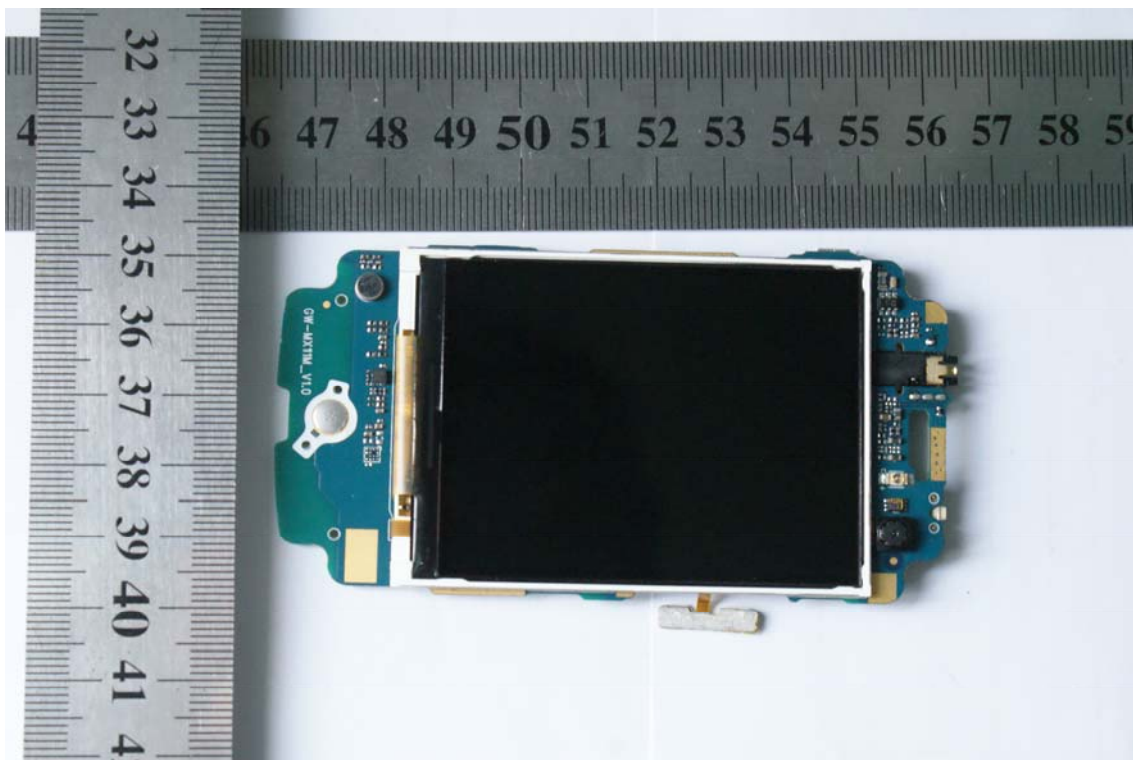

INTERNAL PHOTO OF SAMPLE - 5

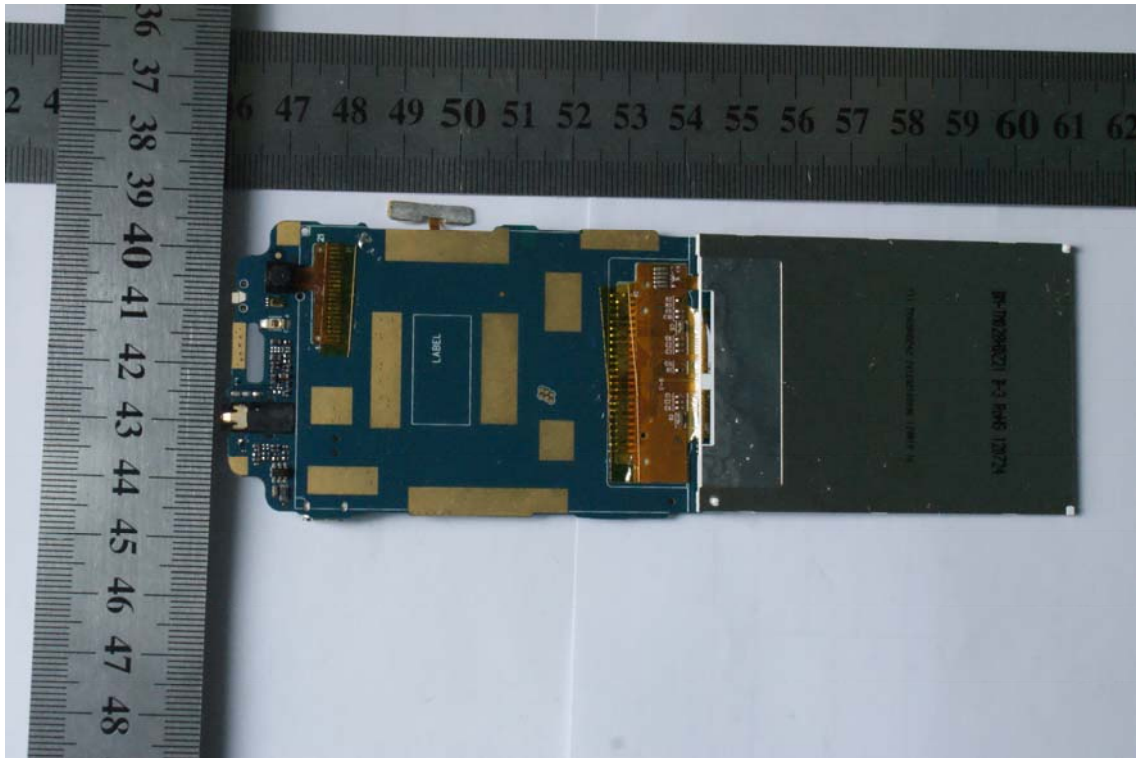

INTERNAL PHOTO OF SAMPLE - 6

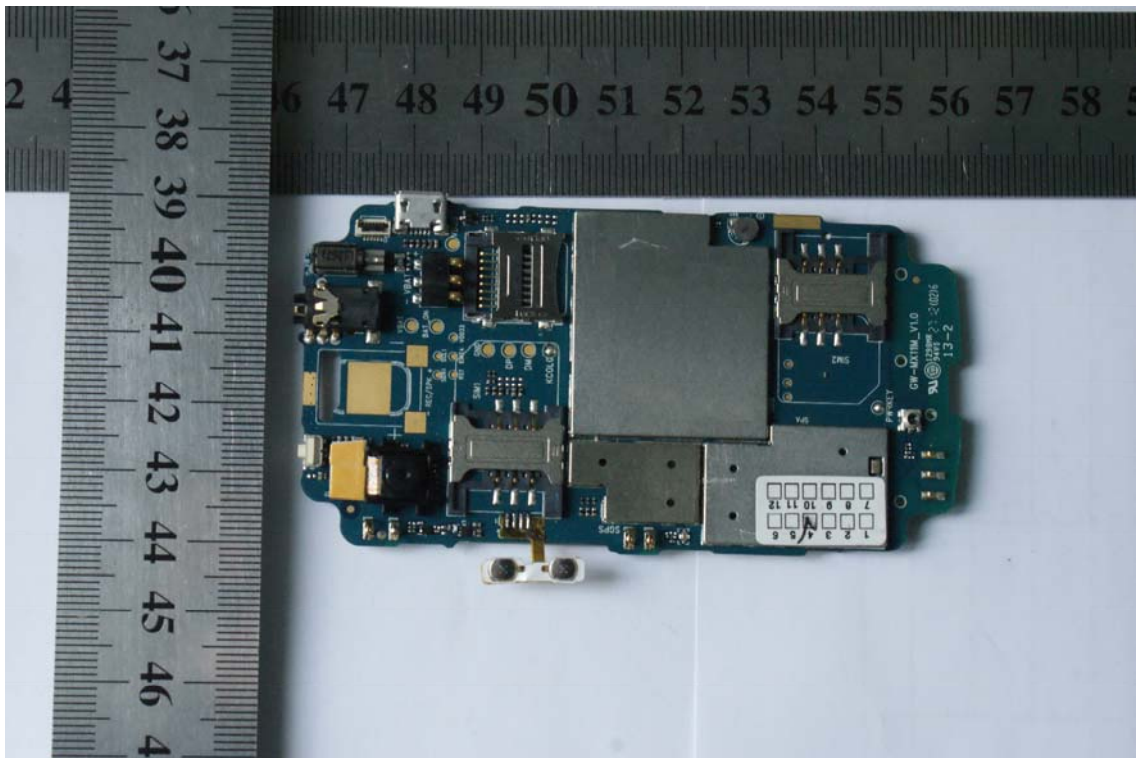

INTERNAL PHOTO OF SAMPLE – 7

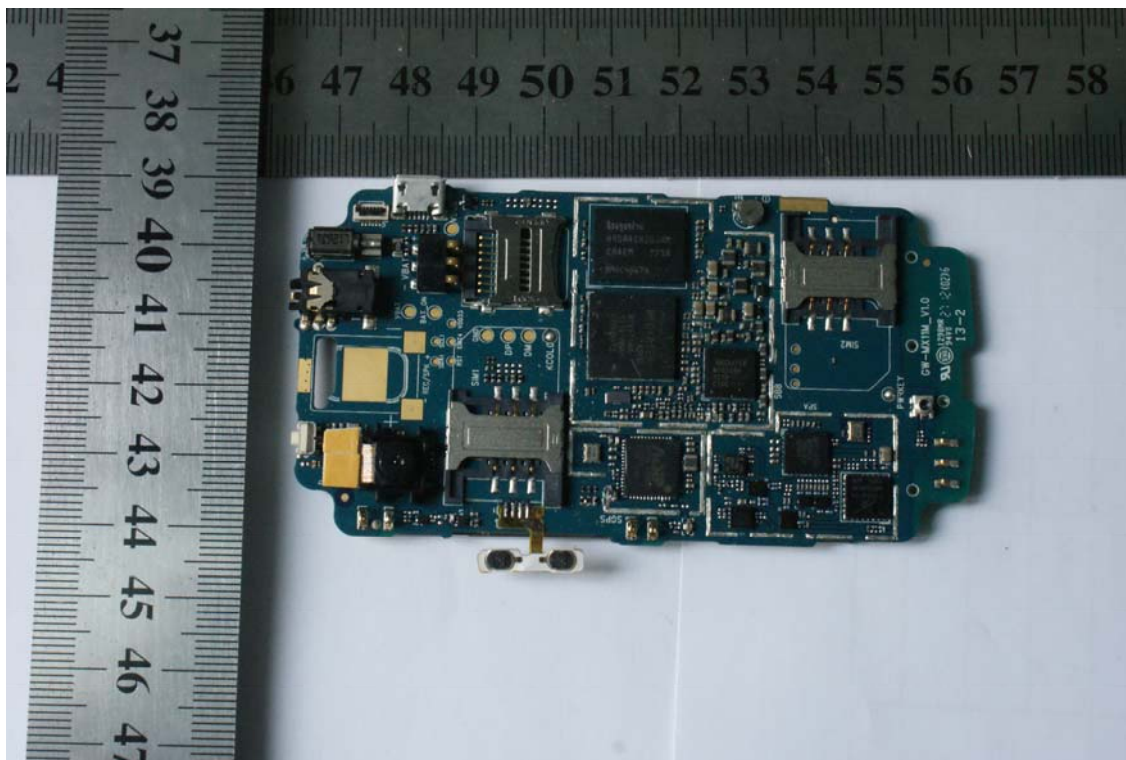

-----END OF REPORT-----