



TEST REPORT

Report Reference No...... : **TRE1712002903** R/C.....: 23847
FCC ID..... : **WA6S5701**
Applicant's name..... : **Verykool USA Inc**
Address..... : 3636 Nobel Drive,Suite 325, San Diego,CA 92122 USA
Manufacturer..... : HUAWO TECHNOLOGY LIMITED
Address..... : 3 floor west,B building,New world shopping plaza,Gushu 2nd road,
Xixiang street,Baoan District,Shenzhen,China
Test item description : **Mobile Phone**
Trade Mark : Verykool
Model/Type reference..... : s5702
Listed Model(s) : s5701
Standard : **FCC CFR Title 47 Part 15 Subpart C Section 15.247**
Date of receipt of test sample..... : Dec.05, 2017
Date of testing..... : Dec.05, 2017 - Dec.25, 2017
Date of issue..... : Dec.26, 2017
Result..... : **PASS**

Compiled by
(position+printedname+signature)....: File administrators Candy Liu *Candy Liu*
Supervised by
(position+printedname+signature)....: Project Engineer : Edward Pan *Edward Pan*
Approved by
(position+printedname+signature)....: RF Manager Hans Hu *Hans Hu*

Testing Laboratory Name : **Shenzhen Huatongwei International Inspection Co., Ltd.**
Address..... : 1/F, Bldg 3, Hongfa Hi-tech Industrial Park, Genyu Road, Tianliao,
Gongming, Shenzhen, China

Shenzhen Huatongwei International Inspection Co., Ltd. All rights reserved.
This publication may be reproduced in whole or in part for non-commercial purposes as long as the Shenzhen Huatongwei International Inspection Co., Ltd. is acknowledged as copyright owner and source of the material. Shenzhen Huatongwei International Inspection Co., Ltd. takes no responsibility for and will not assume liability for damages resulting from the reader's interpretation of the reproduced material due to its placement and context.
The test report merely correspond to the test sample.

Contents

1.	<u>TEST STANDARDS AND REPORT VERSION</u>	3
1.1.	Test Standards	3
1.2.	Report version	3
2.	<u>TEST DESCRIPTION</u>	4
3.	<u>SUMMARY</u>	5
3.1.	Client Information	5
3.2.	Product Description	5
3.3.	Operation state	6
3.4.	EUT configuration	6
3.5.	Modifications	6
4.	<u>TEST ENVIRONMENT</u>	7
4.1.	Address of the test laboratory	7
4.2.	Test Facility	7
4.3.	Environmental conditions	8
4.4.	Statement of the measurement uncertainty	8
4.5.	Equipments Used during the Test	9
7.	<u>TEST CONDITIONS AND RESULTS</u>	11
7.1.	Antenna requirement	11
7.2.	Conducted Emissions (AC Main)	12
7.3.	Conducted Peak Output Power	15
7.4.	Power Spectral Density	16
7.5.	6dB bandwidth	22
7.6.	Restricted band	28
7.7.	Band edge and Spurious Emissions (conducted)	45
7.8.	Spurious Emissions (radiated)	62
8.	<u>TEST SETUP PHOTOS</u>	69
9.	<u>EXTERANAL AND INTERNAL PHOTOS</u>	70

1. TEST STANDARDS AND REPORT VERSION

1.1. Test Standards

The tests were performed according to following standards:

[FCC Rules Part 15.247](#): Frequency Hopping, Direct Spread Spectrum and Hybrid Systems that are in operation within the bands of 902-928 MHz, 2400-2483.5 MHz, and 5725-5850 MHz.

[ANSI C63.10:2013](#): American National Standard for Testing Unlicensed Wireless Devices

[KDB 558074 D01 DTS Meas Guidance v04](#): Guidance for Performing Compliance Measurements on Digital Transmission Systems (DTS) Operating under §15.247

1.2. Report version

Version No.	Date of issue	Description
00	Dec.26, 2017	Original

2. TEST DESCRIPTION

Test Item	FCC Rule	Result	Test Engineer
Antenna requirement	15.203/15.247(c)	Pass	William Wang
Line Conducted Emissions (AC Main)	15.207	Pass	William Wang
Conducted Peak Output Power	15.247(b)(3)	Pass	Baozhu Hu
Power Spectral Density	15.247(e)	Pass	Baozhu Hu
6dB Bandwidth	15.247(a)(2)	Pass	Baozhu Hu
Restricted band	15.247(d)/15.205	Pass	Baozhu Hu
Spurious Emissions	15.247(d)/15.209	Pass	Baozhu Hu

Note: The measurement uncertainty is not included in the test result.

3. SUMMARY

3.1. Client Information

Applicant:	Verykool USA Inc
Address:	3636 Nobel Drive, Suite 325, San Diego, CA 92122 USA
Manufacturer:	HUAWO TECHNOLOGY LIMITED
Address:	3 floor west, B building, New world shopping plaza, Gushu 2nd road, Xixiang street, Baoan District, Shenzhen, China

3.2. Product Description

Name of EUT:	Mobile Phone
Trade Mark:	Verykool
Model No.:	s5702
Listed Model(s):	s5701
IMEI 1 :	352484079998752
IMEI 2 :	352484079999874
Power supply:	DC 3.8V
Adapter information:	Input: 100-240Va.c., 50/60Hz, 0.2A Output: 5Vd.c., 1000mA
Hardware version:	MF0MCCRA1-1
Software version:	s5072_VK_Movi_Dual_SW_V1.0
WIFI	
Supported type:	802.11b/802.11g/802.11n(HT20)/802.11n(HT40)
Modulation:	DSSS for 802.11b OFDM for 802.11g/802.11n(HT20)/802.11n(HT40)
Operation frequency:	2412MHz~2462MHz for 802.11b/802.11g/802.11n(HT20) 2422MHz~2452MHz for 802.11n(HT40)
Channel number:	11 for 802.11b/802.11g/802.11n(HT20) 7 for 802.11n(HT40)
Channel separation:	5MHz
Antenna type:	Integral antenna
Antenna gain:	-1.2dBi

3.3. Operation state

➤ **Test frequency list**

According to section 15.31(m), regards to the operating frequency range over 10 MHz, must select three channel which were tested. the Lowest frequency, the middle frequency, and the highest frequency of channel were selected to perform the test, please see the above gray bottom.

802.11b/g/n(HT20)		802.11n(HT40)	
Channel	Frequency (MHz)	Channel	Frequency (MHz)
01	2412	01	-
02	2417	02	-
03	2422	03	2422
04	2427	04	2427
05	2432	05	2432
06	2437	06	2437
07	2442	07	2442
08	2447	08	2447
09	2452	09	2452
10	2457	10	-
11	2462	11	-

➤ **Test mode**

For RF test items
The engineering test program was provided and enabled to make EUT continuous transmit (duty cycle>98%).
For AC power line conducted emissions:
The EUT was set to connect with the WLAN AP under large package sizes transmission.
For Radiated suprious emissions test item:
The engineering test program was provided and enabled to make EUT continuous transmit(duty cycle>98%). The EUT in each of three orthogonal axis emissions had been tested ,but only the worst case (X axis) data Recorded in the report.

3.4. EUT configuration

The following peripheral devices and interface cables were connected during the measurement:

- - supplied by the manufacturer
- - supplied by the lab

○	/	Manufacturer:	/
		Model No.:	/
○	/	Manufacturer:	/
		Model No.:	/

3.5. Modifications

No modifications were implemented to meet testing criteria.

4. TEST ENVIRONMENT

4.1. Address of the test laboratory

Laboratory: Shenzhen Huatongwei International Inspection Co., Ltd.

Address: 1/F, Bldg 3, Hongfa Hi-tech Industrial Park, Genyu Road, Tianliao, Gongming, Shenzhen, China

4.2. Test Facility

CNAS-Lab Code: L1225

Shenzhen Huatongwei International Inspection Co., Ltd. has been assessed and proved to be in compliance with CNAS-CL01 Accreditation Criteria for Testing and Calibration Laboratories (identical to ISO/IEC17025: 2005 General Requirements) for the Competence of Testing and Calibration Laboratories.

A2LA-Lab Cert. No.: 3902.01

Shenzhen Huatongwei International Inspection Co., Ltd. EMC Laboratory has been accredited by A2LA for technical competence in the field of electrical testing, and proved to be in compliance with ISO/IEC 17025: 2005 General Requirements for the Competence of Testing and Calibration Laboratories and any additional program requirements in the identified field of testing.

FCC-Registration No.: 762235

Shenzhen Huatongwei International Inspection Co., Ltd. EMC Laboratory has been registered and fully described in a report filed with the FCC (Federal Communications Commission). The acceptance letter from the FCC is maintained in our files.

IC-Registration No.:5377B-1

Two 3m Alternate Test Site of Shenzhen Huatongwei International Inspection Co., Ltd. has been registered by Certification and Engineering Bureau of Industry Canada for the performance of radiated measurements with Registration No.: 5377B-1.

ACA

Shenzhen Huatongwei International Inspection Co., Ltd. EMC Laboratory can also perform testing for the Australian C-Tick mark as a result of our A2LA accreditation.

4.3. Environmental conditions

During the measurement the environmental conditions were within the listed ranges:

Temperature:	15~35°C
Relative Humidity:	30~60 %
Air Pressure:	950~1050mba

4.4. Statement of the measurement uncertainty

The data and results referenced in this document are true and accurate. The reader is cautioned that there may be errors in calibration limits of the equipment and facilities. The measurement uncertainty was calculated for all measurements listed in this test report according to TR-100028-01 "Electromagnetic compatibility and Radio spectrum Matters (ERM); Uncertainties in the measurement of mobile radio equipment characteristics; Part 1" and TR-100028-02 "Electromagnetic compatibility and Radio spectrum Matters (ERM); Uncertainties in the measurement of mobile radio equipment characteristics; Part 2" and is documented in the Shenzhen Huatongwei International Inspection Co., Ltd. quality system according to ISO/IEC 17025. Furthermore, component and process variability of devices similar to that tested may result in additional deviation. The manufacturer has the sole responsibility of continued compliance of the device.

Here after the best measurement capability for Shenzhen Huatongwei International Inspection Co., Ltd. is reported:

Test Items	Measurement Uncertainty	Notes
Transmitter power conducted	0.57 dB	(1)
Transmitter power Radiated	2.20 dB	(1)
Conducted spurious emissions 9kHz~40GHz	1.60 dB	(1)
Radiated spurious emissions 9kHz~40GHz	2.20 dB	(1)
Conducted Emissions 9kHz~30MHz	3.39 dB	(1)
Radiated Emissions 30~1000MHz	4.24 dB	(1)
Radiated Emissions 1~18GHz	5.16 dB	(1)
Radiated Emissions 18~40GHz	5.54 dB	(1)

(1) This uncertainty represents an expanded uncertainty expressed at approximately the 95% confidence level using a coverage factor of $k=1.96$.

4.5. Equipments Used during the Test

Conducted Emissions						
Item	Test Equipment	Manufacturer	Model No.	Serial No.	Last Cal. (mm-dd-yy)	Next Cal. (mm-dd-yy)
1	EMI Test Receiver	R&S	ESCI	101247	11/11/2017	11/10/2018
2	Artificial Mains	SCHWARZBECK	NNLK 8121	573	11/11/2017	11/10/2018
3	Pulse Limiter	R&S	ESH3-Z2	101488	11/11/2017	11/10/2018
4	Test Software	R&S	ES-K1	N/A	N/A	N/A
5	RF Connection Cable	HUBER+SUHNER	EF400	N/A	11/21/2017	11/20/2018
6	Single Balanced Telecom Pair ISN	FCC	FCC-TLISN-T2-02	20371	11/11/2017	11/10/2018
7	Two Balanced Telecom Pairs ISN	FCC	FCC-TLISN-T4-02	20373	11/11/2017	11/10/2018
8	Four Balanced Telecom Pairs ISN	FCC	FCC-TLISN-T8-02	20375	11/11/2017	11/10/2018
9	V-Network	R&S	ESH3-Z6	100211	11/11/2017	11/10/2018
10	V-Network	R&S	ESH3-Z6	100210	11/11/2017	11/10/2018
11	2-Line V-Network	R&S	ESH3-Z5	100049	11/11/2017	11/10/2018

5.

Radiated Emissions						
Item	Test Equipment	Manufacturer	Model No.	Serial No.	Last Cal. (mm-dd-yy)	Next Cal. (mm-dd-yy)
1	EMI Test Receiver	R&S	ESCI	101247	11/11/2017	11/10/2018
2	Loop Antenna	R&S	HFH2-Z2	100020	11/20/2017	11/19/2018
3	Ultra-Broadband Antenna	SCHWARZBECK	VULB9163	538	4/5/2017	4/4/2018
4	Horn Antenna	SCHWARZBECK	9120D	1011	3/27/2017	3/26/2018
5	Horn Antenna	SCHWARZBECK	BBHA9170	25841	3/27/2017	3/26/2018
6	Preamplifier	SCHWARZBECK	BBV 9743	9743-0022	10/18/2017	10/17/2018
7	Broadband Preamplifier	SCHWARZBECK	BBV 9718	9718-248	10/18/2017	10/17/2018
8	High pass filter	Compliance Direction systems	BSU-6	34202	11/11/2017	11/10/2018
9	Turntable	MATURO	TT2.0	/	N/A	N/A
10	Antenna Mast	MATURO	TAM-4.0-P	/	N/A	N/A
11	EMI Test Software	R&S	ESK1	N/A	N/A	N/A
12	EMI Test Software	Audix	E3	N/A	N/A	N/A

13	RF Connection Cable	HUBER+SUHNER	3m 3GHz S	N/A	11/21/2017	11/20/2018
14	RF Connection Cable	HUBER+SUHNER	3m 3GHz RG	N/A	11/21/2017	11/20/2018
15	RF Connection Cable	HUBER+SUHNER	6m 18GHz S	N/A	11/21/2017	11/20/2018

6.

RF Conducted Method						
Item	Test Equipment	Manufacturer	Model No.	Serial No.	Last Cal. (mm-dd-yy)	Next Cal. (mm-dd-yy)
1	Spectrum Analyzer	R&S	FSV40	100048	11/11/2017	11/10/2018
2	OSP	R&S	OSP120	101317	N/A	N/A
3	OSP	R&S	OSP-B157	100890	N/A	N/A
4	Signal generator	R&S	SMB100A	177956	11/11/2017	11/10/2018
5	Vector signal generator	R&S	SMBV100A	260790	7/20/2017	7/19/2018
6	EXA Signal Analyzer	Agilent	N9020A	184247	9/22/2017	9/21/2018
7	Power Meter	Agilent	U2021XA	178231	9/22/2017	9/21/2018
8	DAQ Device	Agilent	U2531A	132812	9/22/2017	9/21/2018

The Cal.Interval was one year.

7. TEST CONDITIONS AND RESULTS

7.1. Antenna requirement

REQUIREMENT:

FCC CFR Title 47 Part 15 Subpart C Section 15.203:

An intentional radiator shall be designed to ensure that no antenna other than that furnished by the responsible party shall be used with the device. The use of a permanently attached antenna or of an antenna that uses a unique coupling to the intentional radiator, the manufacturer may design the unit so that a broken antenna can be replaced by the user, but the use of a standard antenna jack or electrical connector is prohibited.

FCC CFR Title 47 Part 15 Subpart C Section 15.247(c) (1)(i):

(i) Systems operating in the 2400~2483.5 MHz band that is used exclusively for fixed. Point-to-point operations may employ transmitting antennas with directional gain greater than 6 dBi provided the maximum conducted output power of the intentional radiator is reduced by 1 dB for every 3 dB that the directional gain of the antenna exceeds 6 dBi.

TEST RESULTS

Passed **Not Applicable**

The directional gain of the antenna less than 6 dBi, please refer to the below antenna photo.

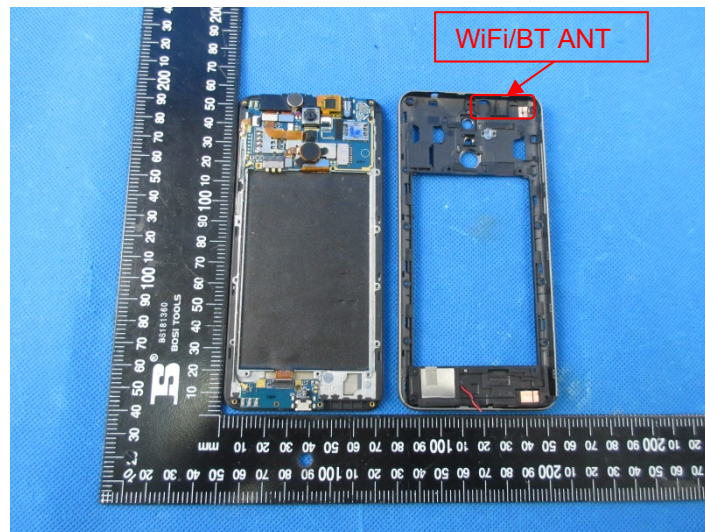

7.2. Conducted Emissions (AC Main)

LIMIT

FCC CFR Title 47 Part 15 Subpart C Section 15.207:

Frequency range (MHz)	Limit (dBuV)	
	Quasi-peak	Average
0.15-0.5	66 to 56*	56 to 46*
0.5-5	56	46
5-30	60	50

* Decreases with the logarithm of the frequency.

TEST CONFIGURATION

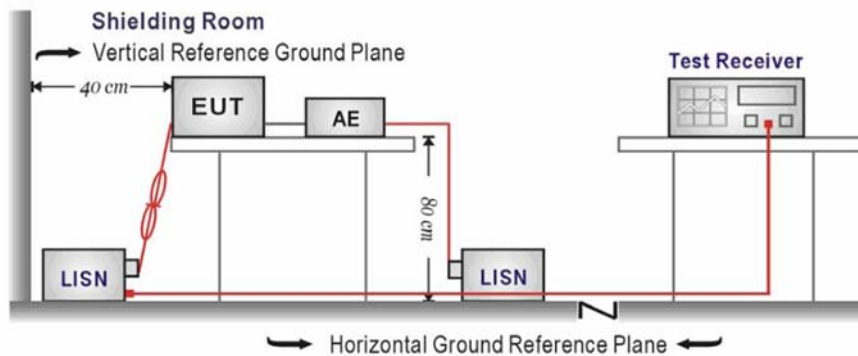

TEST PROCEDURE

1. The EUT was setup according to ANSI C63.10:2013 requirements.
2. The EUT was placed on a platform of nominal size, 1 m by 1.5 m, raised 80 cm above the conducting ground plane. The vertical conducting plane was located 40 cm to the rear of the EUT. All other surfaces of EUT were at least 80 cm from any other grounded conducting surface.
3. The EUT and simulators are connected to the main power through a line impedances stabilization network (LISN). The LISN provides a 50 ohm /50uH coupling impedance for the measuring equipment.
4. The peripheral devices are also connected to the main power through a LISN. (Please refer to the block diagram of the test setup and photographs)
5. Each current-carrying conductor of the EUT power cord, except the ground (safety) conductor, was individually connected through a LISN to the input power source.
6. The excess length of the power cord between the EUT and the LISN receptacle were folded back and forth at the center of the lead to form a bundle not exceeding 40 cm in length.
7. Conducted Emissions were investigated over the frequency range from 0.15MHz to 30MHz using a receiver bandwidth of 9 kHz.
8. During the above scans, the emissions were maximized by cable manipulation.

TEST MODE:

Please refer to the clause 3.3

TEST RESULTS

Passed Not Applicable

Note:

- 1) Transd=Cable lose+ Pulse Limiter Factor + Artificial Mains Factor
- 2) Margin= Limit -Level

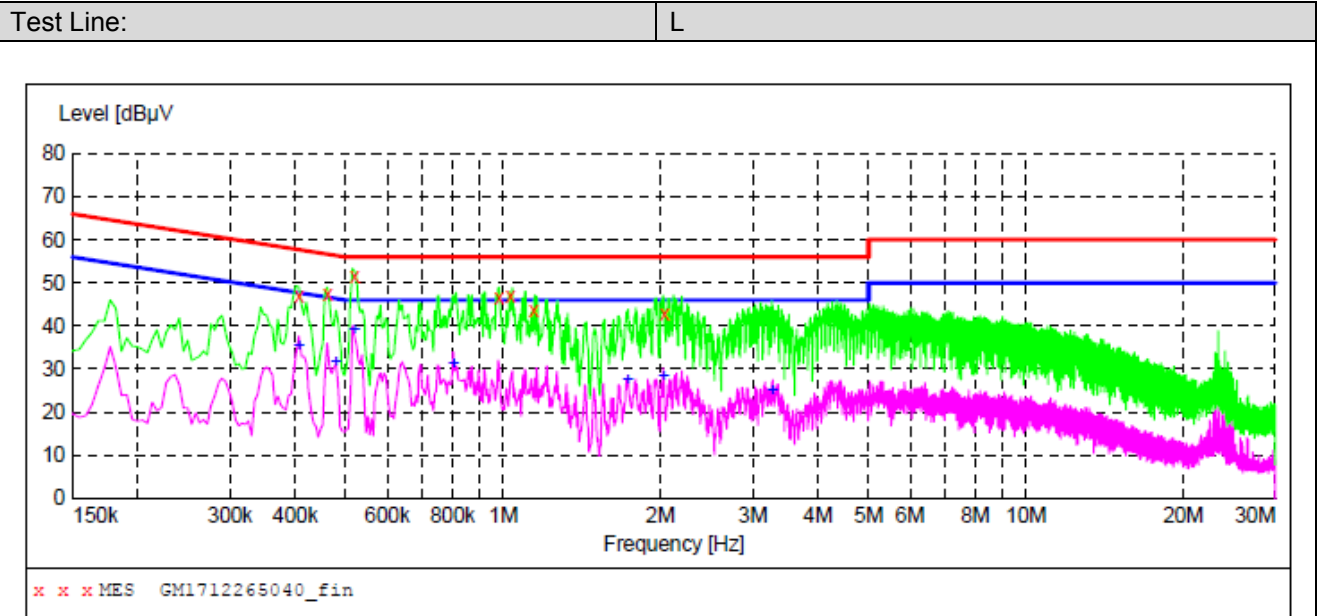

MEASUREMENT RESULT: "GM1712265040_fin"

26/12/2017 13:37

Frequency MHz	Level dBµV	Transd dB	Limit dBµV	Margin dB	Detector	Line	PE
0.406500	46.90	9.9	58	10.8	QP	L1	GND
0.460500	47.20	9.9	57	9.5	QP	L1	GND
0.519000	51.60	10.0	56	4.4	QP	L1	GND
0.982500	46.70	10.1	56	9.3	QP	L1	GND
1.032000	46.90	10.1	56	9.1	QP	L1	GND
1.144500	43.80	10.1	56	12.2	QP	L1	GND
2.031000	42.90	10.1	56	13.1	QP	L1	GND

MEASUREMENT RESULT: "GM1712265040_fin2"

26/12/2017 13:37

Frequency MHz	Level dB和廣	Transd dB	Limit dB和廣	Margin dB	Detector	Line	PE
0.406500	35.30	9.9	48	12.4	AV	L1	GND
0.478500	31.80	9.9	46	14.6	AV	L1	GND
0.519000	39.20	10.0	46	6.8	AV	L1	GND
0.802500	31.30	10.0	46	14.7	AV	L1	GND
1.729500	27.40	10.1	46	18.6	AV	L1	GND
2.026500	28.10	10.1	46	17.9	AV	L1	GND
3.273000	25.00	10.1	46	21.0	AV	L1	GND

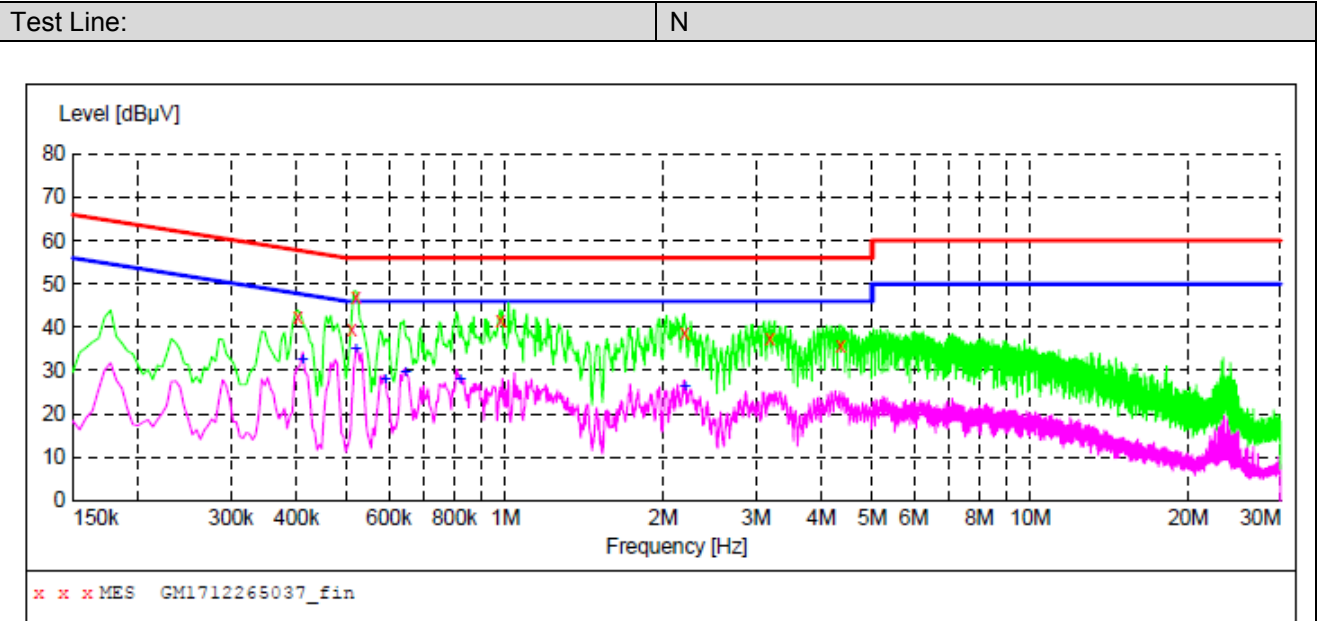

MEASUREMENT RESULT: "GM1712265037_fin"

26/12/2017 13:30

Frequency MHz	Level dBµV	Transd dB	Limit dBµV	Margin dB	Detector	Line	PE
0.402000	42.50	9.9	58	15.3	QP	N	GND
0.510000	39.60	10.0	56	16.4	QP	N	GND
0.519000	47.10	10.0	56	8.9	QP	N	GND
0.978000	41.60	10.1	56	14.4	QP	N	GND
2.193000	38.80	10.1	56	17.2	QP	N	GND
3.183000	37.50	10.1	56	18.5	QP	N	GND
4.339500	35.90	10.2	56	20.1	QP	N	GND

MEASUREMENT RESULT: "GM1712265037_fin2"

26/12/2017 13:30

Frequency MHz	Level dBµV	Transd dB	Limit dBµV	Margin dB	Detector	Line	PE
0.411000	32.30	9.9	48	15.3	AV	N	GND
0.519000	35.10	10.0	46	10.9	AV	N	GND
0.591000	28.10	10.0	46	17.9	AV	N	GND
0.645000	29.50	10.0	46	16.5	AV	N	GND
0.820500	28.10	10.0	46	17.9	AV	N	GND
2.197500	26.40	10.1	46	19.6	AV	N	GND

7.3. Conducted Peak Output Power

LIMIT

FCC CFR Title 47 Part 15 Subpart C Section 15.247 (b)(3): **30dBm**:

TEST CONFIGURATION

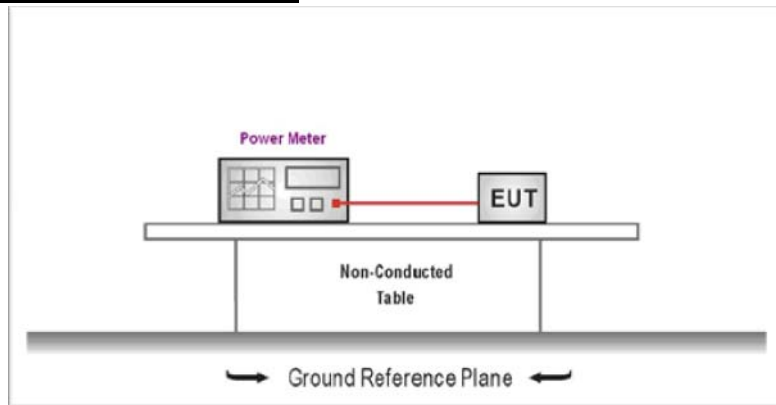

TEST PROCEDURE

1. The EUT was tested according to ANSI C63.10: 2013 and KDB 558074 D01 for compliance to FCC 47 CFR 15.247 requirements.
2. The maximum peak conducted output power may be measured using a broadband peak RF power meter.
3. The power meter shall have a video bandwidth that is greater than or equal to the DTS bandwidth and shall utilize a fast-responding diode detector
4. Record the measurement data.

TEST MODE:

Please refer to the clause 3.3

TEST RESULTS

Passed Not Applicable

Type	Channel	Output power (dBm)	Limit (dBm)	Result
802.11b	01	18.34	≤30.00	Pass
	06	18.43		
	11	18.23		
802.11g	01	16.81	≤30.00	Pass
	06	16.75		
	11	16.81		
802.11n(HT20)	01	15.49	≤30.00	Pass
	06	15.41		
	11	15.42		
802.11n(HT40)	03	14.98	≤30.00	Pass
	06	14.20		
	09	14.85		

7.4. Power Spectral Density

LIMIT

FCC CFR Title 47 Part 15 Subpart C Section 15.247 (e):For digitally modulated systems, the power spectral density conducted from the intentional radiator to the antenna shall not be greater than 8 dBm in any 3 kHz band during any time interval of continuous transmission.

TEST CONFIGURATION

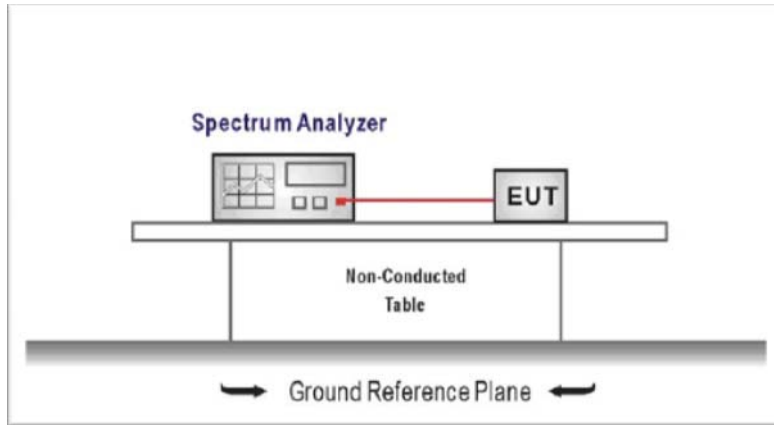

TEST PROCEDURE

1. Connect the antenna port(s) to the spectrum analyzer input,
2. Configure the spectrum analyzer as shown below:
Center frequency=DTS channel center frequency
Span =1.5 times the DTS bandwidth
RBW = 3 kHz ≤ RBW ≤ 100 kHz, VBW ≥ 3 × RBW
Sweep time = auto couple
Detector = peak
Trace mode = max hold
3. Place the radio in continuous transmit mode, allow the trace to stabilize, view the transmitter wave form on the spectrum analyzer.
4. Use the peak marker function to determine the maximum amplitude level within the RBW.
5. If measured value exceeds limit, reduce RBW (no less than 3 kHz) and repeat.

TEST MODE:

Please refer to the clause 3.3



TEST RESULTS

Passed Not Applicable

Type	Channel	Power Spectral Density (dBm/30KHz)	Limit (dBm/3KHz)	Result
802.11b	01	6.33	≤8.00	Pass
	06	2.49		
	11	1.97		
802.11g	01	-6.94	≤8.00	Pass
	06	-6.99		
	11	-6.81		
802.11n(HT20)	01	-7.97	≤8.00	Pass
	06	-7.40		
	11	-7.63		
802.11n(HT40)	03	-11.83	≤8.00	Pass
	06	-12.61		
	09	-12.19		

Test plot as follows:

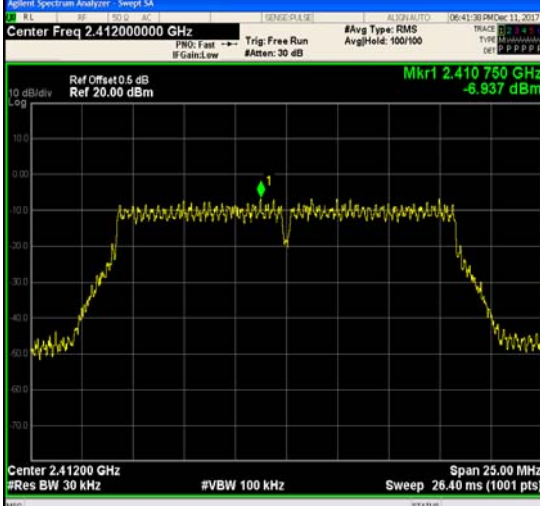
Type:		802.11 b	
CH01			<p>Agilent Spectrum Analyzer - Sweep SA</p> <p>Center Freq 2.41200000 GHz</p> <p>Ref Offset 0.5 dB Ref 20.00 dBm</p> <p>Mkr1 2.412 992 GHz 6.330 dBm</p> <p>Center 2.412000 GHz #Res BW 30 kHz</p> <p>Span 16.00 MHz #VBW 100 kHz Sweep 16.93 ms (1001 pts)</p> <p>Frequency</p> <p>Auto Tune</p> <p>Center Freq 2.412000000 GHz</p> <p>Start Freq 2.404000000 GHz</p> <p>Stop Freq 2.420000000 GHz</p> <p>CF Step 1.600000 MHz</p> <p>Auto Man</p> <p>Freq Offset 0 Hz</p>
CH06			<p>Agilent Spectrum Analyzer - Sweep SA</p> <p>Center Freq 2.43700000 GHz</p> <p>Ref Offset 0.5 dB Ref 20.00 dBm</p> <p>Mkr1 2.435 976 GHz 2.489 dBm</p> <p>Center 2.437000 GHz #Res BW 30 kHz</p> <p>Span 16.00 MHz #VBW 100 kHz Sweep 16.93 ms (1001 pts)</p> <p>Frequency</p> <p>Auto Tune</p> <p>Center Freq 2.437000000 GHz</p> <p>Start Freq 2.429000000 GHz</p> <p>Stop Freq 2.445000000 GHz</p> <p>CF Step 1.600000 MHz</p> <p>Auto Man</p> <p>Freq Offset 0 Hz</p>
CH11			<p>Agilent Spectrum Analyzer - Sweep SA</p> <p>Center Freq 2.46200000 GHz</p> <p>Ref Offset 0.5 dB Ref 20.00 dBm</p> <p>Mkr1 2.462 464 GHz 1.985 dBm</p> <p>Center 2.462000 GHz #Res BW 30 kHz</p> <p>Span 16.00 MHz #VBW 100 kHz Sweep 16.93 ms (1001 pts)</p> <p>Frequency</p> <p>Auto Tune</p> <p>Center Freq 2.462000000 GHz</p> <p>Start Freq 2.454000000 GHz</p> <p>Stop Freq 2.470000000 GHz</p> <p>CF Step 1.600000 MHz</p> <p>Auto Man</p> <p>Freq Offset 0 Hz</p>

Type:		802.11 g	
CH01			<p>Frequency</p> <p>Auto Tune</p> <p>Center Freq 2.412000000 GHz</p> <p>Start Freq 2.399500000 GHz</p> <p>Stop Freq 2.424500000 GHz</p> <p>CF Step 2.500000 MHz Auto Man</p> <p>Freq Offset 0 Hz</p>
CH06			<p>Frequency</p> <p>Auto Tune</p> <p>Center Freq 2.437000000 GHz</p> <p>Start Freq 2.424500000 GHz</p> <p>Stop Freq 2.449500000 GHz</p> <p>CF Step 2.500000 MHz Auto Man</p> <p>Freq Offset 0 Hz</p>
CH11			<p>Frequency</p> <p>Auto Tune</p> <p>Center Freq 2.462000000 GHz</p> <p>Start Freq 2.449500000 GHz</p> <p>Stop Freq 2.474500000 GHz</p> <p>CF Step 2.500000 MHz Auto Man</p> <p>Freq Offset 0 Hz</p>

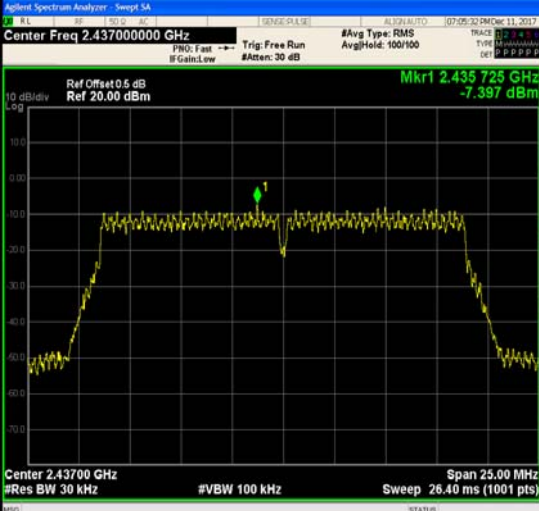
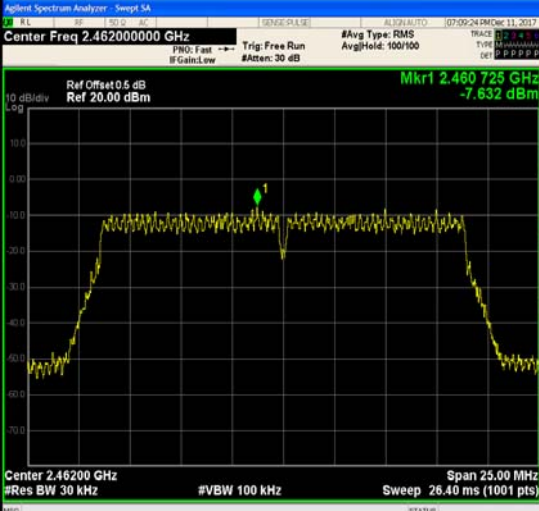
Type:		802.11n(HT20)	
CH01			<p>Frequency</p> <p>Auto Tune</p> <p>Center Freq 2.41200000 GHz</p> <p>Start Freq 2.399500000 GHz</p> <p>Stop Freq 2.424500000 GHz</p> <p>CF Step 2.500000 MHz Auto Man</p> <p>Freq Offset 0 Hz</p>
CH06			<p>Frequency</p> <p>Auto Tune</p> <p>Center Freq 2.437000000 GHz</p> <p>Start Freq 2.424500000 GHz</p> <p>Stop Freq 2.449500000 GHz</p> <p>CF Step 2.500000 MHz Auto Man</p> <p>Freq Offset 0 Hz</p>
CH11			<p>Frequency</p> <p>Auto Tune</p> <p>Center Freq 2.462000000 GHz</p> <p>Start Freq 2.449500000 GHz</p> <p>Stop Freq 2.474500000 GHz</p> <p>CF Step 2.500000 MHz Auto Man</p> <p>Freq Offset 0 Hz</p>

Type:	802.11n(HT40)	
CH03	<p>Agilent Spectrum Analyzer - Swept SA Center Freq 2.422000000 GHz #Avg Type: RMS AvgHold: 64/100 Ref Offset 0.5 dB Ref 20.00 dBm Mkr1 2.430 690 GHz -11.831 dBm Center 2.42200 GHz Span 55.00 MHz #Res BW 30 kHz #VBW 100 kHz Sweep 58.00 ms (1001 pts)</p>	<p>Frequency</p> <p>Auto Tune</p> <p>Center Freq 2.422000000 GHz</p> <p>Start Freq 2.394500000 GHz</p> <p>Stop Freq 2.449500000 GHz</p> <p>CF Step 5.500000 MHz Auto Man</p> <p>Freq Offset 0 Hz</p>
CH06	<p>Agilent Spectrum Analyzer - Swept SA Center Freq 2.437000000 GHz #Avg Type: RMS AvgHold: 66/100 Ref Offset 0.5 dB Ref 20.00 dBm Mkr1 2.434 470 GHz -12.612 dBm Center 2.43700 GHz Span 55.00 MHz #Res BW 30 kHz #VBW 100 kHz Sweep 58.00 ms (1001 pts)</p>	<p>Frequency</p> <p>Auto Tune</p> <p>Center Freq 2.437000000 GHz</p> <p>Start Freq 2.409500000 GHz</p> <p>Stop Freq 2.464500000 GHz</p> <p>CF Step 5.500000 MHz Auto Man</p> <p>Freq Offset 0 Hz</p>
CH09	<p>Agilent Spectrum Analyzer - Swept SA Center Freq 2.452000000 GHz #Avg Type: RMS AvgHold: 66/100 Ref Offset 0.5 dB Ref 20.00 dBm Mkr1 2.458 600 GHz -12.188 dBm Center 2.45200 GHz Span 55.00 MHz #Res BW 30 kHz #VBW 100 kHz Sweep 58.00 ms (1001 pts)</p>	<p>Frequency</p> <p>Auto Tune</p> <p>Center Freq 2.452000000 GHz</p> <p>Start Freq 2.424500000 GHz</p> <p>Stop Freq 2.479500000 GHz</p> <p>CF Step 5.500000 MHz Auto Man</p> <p>Freq Offset 0 Hz</p>

7.5. 6dB bandwidth

LIMIT

FCC CFR Title 47 Part 15 Subpart C Section 15.247 (a)(2):For digital modulation systems, the minimum 6 dB bandwidth shall be at least 500 kHz.

TEST CONFIGURATION

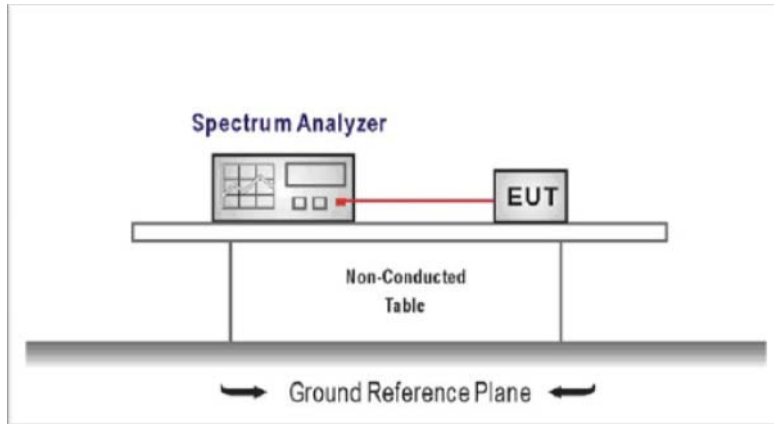

TEST PROCEDURE

1. Connect the antenna port(s) to the spectrum analyzer input.
2. Configure the spectrum analyzer as shown below (enter all losses between the transmitter output and the spectrum analyzer).
Center Frequency = DTS channel center frequency
Span = 2 x DTS bandwidth
RBW = 100 kHz, VBW \geq 3 x RBW
Sweep time = auto couple
Detector = Peak
Trace mode = max hold
3. Place the radio in continuous transmit mode, allow the trace to stabilize, view the transmitter wave form on the spectrum analyzer.
4. Measure the maximum width of the emission that is constrained by the frequencies associated with the two outermost amplitude points (upper and lower frequencies) that are attenuated by 6 dB relative to the maximum level measured in the fundamental emission, and record the pertinent measurements.

TEST MODE:

Please refer to the clause 3.3

TEST RESULTS

Passed Not Applicable

Type	Channel	6dB Bandwidth (MHz)	Limit (kHz)	Result
802.11b	01	10.06	≥500	Pass
	06	10.04		
	11	10.03		
802.11g	01	16.40	≥500	Pass
	06	16.37		
	11	16.37		
802.11n(HT20)	01	17.61	≥500	Pass
	06	17.62		
	11	17.62		
802.11n(HT40)	03	36.04	≥500	Pass
	06	35.87		
	09	35.92		

Test plot as follows:

Type:		802.11 b	
CH01		<p>Agilent Spectrum Analyzer - Occupied BW</p> <p>Center Freq: 2.412000000 GHz</p> <p>Center Freq: 2.412000000 GHz</p> <p>Trig: Free Run</p> <p>Avg/Hold: 500/500</p> <p>Radio Std: None</p> <p>Radio Device: BTS</p> <p>Ref Offset: 0.5 dB</p> <p>Ref: 20.50 dBm</p> <p>Mkr1: 2.4105 GHz</p> <p>6.6331 dBm</p> <p>Center: 2.412 GHz</p> <p>#Res BW: 100 kHz</p> <p>#VBW: 300 kHz</p> <p>Span: 30 MHz</p> <p>Sweep: 2.933 ms</p> <p>Occupied Bandwidth: 12.725 MHz</p> <p>Total Power: 22.7 dBm</p> <p>Transmit Freq Error: 71.893 kHz</p> <p>OBW Power: 99.00 %</p> <p>x dB Bandwidth: 10.06 MHz</p> <p>x dB: -6.00 dB</p>	<p>Frequency</p> <p>Center Freq: 2.412000000 GHz</p> <p>CF Step: 3.000000 MHz</p> <p>Freq Offset: 0 Hz</p>
CH06		<p>Agilent Spectrum Analyzer - Occupied BW</p> <p>Center Freq: 2.437000000 GHz</p> <p>Center Freq: 2.437000000 GHz</p> <p>Trig: Free Run</p> <p>Avg/Hold: 500/500</p> <p>Radio Std: None</p> <p>Radio Device: BTS</p> <p>Ref Offset: 0.5 dB</p> <p>Ref: 20.50 dBm</p> <p>Mkr1: 2.4385 GHz</p> <p>6.6121 dBm</p> <p>Center: 2.437 GHz</p> <p>#Res BW: 100 kHz</p> <p>#VBW: 300 kHz</p> <p>Span: 30 MHz</p> <p>Sweep: 2.933 ms</p> <p>Occupied Bandwidth: 12.687 MHz</p> <p>Total Power: 22.8 dBm</p> <p>Transmit Freq Error: 49.727 kHz</p> <p>OBW Power: 99.00 %</p> <p>x dB Bandwidth: 10.04 MHz</p> <p>x dB: -6.00 dB</p>	<p>Frequency</p> <p>Center Freq: 2.437000000 GHz</p> <p>CF Step: 3.000000 MHz</p> <p>Freq Offset: 0 Hz</p>
CH11		<p>Agilent Spectrum Analyzer - Occupied BW</p> <p>Center Freq: 2.462000000 GHz</p> <p>Center Freq: 2.462000000 GHz</p> <p>Trig: Free Run</p> <p>Avg/Hold: 500/500</p> <p>Radio Std: None</p> <p>Radio Device: BTS</p> <p>Ref Offset: 0.5 dB</p> <p>Ref: 20.50 dBm</p> <p>Mkr1: 2.46251 GHz</p> <p>6.6509 dBm</p> <p>Center: 2.462 GHz</p> <p>#Res BW: 100 kHz</p> <p>#VBW: 300 kHz</p> <p>Span: 30 MHz</p> <p>Sweep: 2.933 ms</p> <p>Occupied Bandwidth: 12.620 MHz</p> <p>Total Power: 22.7 dBm</p> <p>Transmit Freq Error: 28.269 kHz</p> <p>OBW Power: 99.00 %</p> <p>x dB Bandwidth: 10.03 MHz</p> <p>x dB: -6.00 dB</p>	<p>Frequency</p> <p>Center Freq: 2.462000000 GHz</p> <p>CF Step: 3.000000 MHz</p> <p>Freq Offset: 0 Hz</p>

Type:		802.11 g	
CH01		<p>Agilent Spectrum Analyzer - Occupied BW Center Freq 2.412000000 GHz Center Freq: 2.412000000 GHz Trig: Free Run Avg/Hold: 500/500 Radio Std: None Radio Device: BTS</p> <p>Ref Offset 0.5 dB Ref 20.50 dBm Mkr1 2.41326 GHz -1.6740 dBm</p> <p>Center 2.412 GHz #Res BW 100 kHz #VBW 300 kHz Span 30 MHz Sweep 2.933 ms</p> <p>Occupied Bandwidth 16.502 MHz Total Power 16.3 dBm</p> <p>Transmit Freq Error 5.024 kHz OBW Power 99.00 % x dB Bandwidth 16.40 MHz x dB -6.00 dB</p>	<p>Frequency</p> <p>Center Freq 2.412000000 GHz</p> <p>CF Step 3.000000 MHz Auto Man</p> <p>Freq Offset 0 Hz</p>
CH06		<p>Agilent Spectrum Analyzer - Occupied BW Center Freq 2.437000000 GHz Center Freq: 2.437000000 GHz Trig: Free Run Avg/Hold: 500/500 Radio Std: None Radio Device: BTS</p> <p>Ref Offset 0.5 dB Ref 20.50 dBm Mkr1 2.43826 GHz -1.8074 dBm</p> <p>Center 2.437 GHz #Res BW 100 kHz #VBW 300 kHz Span 30 MHz Sweep 2.933 ms</p> <p>Occupied Bandwidth 16.484 MHz Total Power 16.1 dBm</p> <p>Transmit Freq Error 2.952 kHz OBW Power 99.00 % x dB Bandwidth 16.37 MHz x dB -6.00 dB</p>	<p>Frequency</p> <p>Center Freq 2.437000000 GHz</p> <p>CF Step 3.000000 MHz Auto Man</p> <p>Freq Offset 0 Hz</p>
CH11		<p>Agilent Spectrum Analyzer - Occupied BW Center Freq 2.462000000 GHz Center Freq: 2.462000000 GHz Trig: Free Run Avg/Hold: 500/500 Radio Std: None Radio Device: BTS</p> <p>Ref Offset 0.5 dB Ref 20.50 dBm Mkr1 2.46326 GHz -1.7143 dBm</p> <p>Center 2.462 GHz #Res BW 100 kHz #VBW 300 kHz Span 30 MHz Sweep 2.933 ms</p> <p>Occupied Bandwidth 16.499 MHz Total Power 16.2 dBm</p> <p>Transmit Freq Error -5.923 kHz OBW Power 99.00 % x dB Bandwidth 16.37 MHz x dB -6.00 dB</p>	<p>Frequency</p> <p>Center Freq 2.462000000 GHz</p> <p>CF Step 3.000000 MHz Auto Man</p> <p>Freq Offset 0 Hz</p>

Type:		802.11n(HT20)	
CH01		<p>Agilent Spectrum Analyzer - Occupied BW</p> <p>Center Freq 2.412000000 GHz</p> <p>Center Freq: 2.412000000 GHz</p> <p>Mkr1 2.41326 GHz -3.0254 dBm</p> <p>Occupied Bandwidth 17.645 MHz</p> <p>Total Power 14.9 dBm</p> <p>Transmit Freq Error 16.026 kHz</p> <p>OBW Power 99.00 %</p> <p>x dB Bandwidth 17.61 MHz</p> <p>x dB -6.00 dB</p>	<p>Frequency</p> <p>Center Freq 2.412000000 GHz</p> <p>CF Step 3.000000 MHz</p> <p>Freq Offset 0 Hz</p>
CH06		<p>Agilent Spectrum Analyzer - Occupied BW</p> <p>Center Freq 2.437000000 GHz</p> <p>Center Freq: 2.437000000 GHz</p> <p>Mkr1 2.43829 GHz -3.2623 dBm</p> <p>Occupied Bandwidth 17.647 MHz</p> <p>Total Power 14.8 dBm</p> <p>Transmit Freq Error 2.998 kHz</p> <p>OBW Power 99.00 %</p> <p>x dB Bandwidth 17.62 MHz</p> <p>x dB -6.00 dB</p>	<p>Frequency</p> <p>Center Freq 2.437000000 GHz</p> <p>CF Step 3.000000 MHz</p> <p>Freq Offset 0 Hz</p>
CH11		<p>Agilent Spectrum Analyzer - Occupied BW</p> <p>Center Freq 2.462000000 GHz</p> <p>Center Freq: 2.462000000 GHz</p> <p>Mkr1 2.46326 GHz -3.2475 dBm</p> <p>Occupied Bandwidth 17.668 MHz</p> <p>Total Power 14.9 dBm</p> <p>Transmit Freq Error 7.787 kHz</p> <p>OBW Power 99.00 %</p> <p>x dB Bandwidth 17.62 MHz</p> <p>x dB -6.00 dB</p>	<p>Frequency</p> <p>Center Freq 2.462000000 GHz</p> <p>CF Step 3.000000 MHz</p> <p>Freq Offset 0 Hz</p>

Type:		802.11n(HT40)	
CH03		<p>Agilent Spectrum Analyzer - Occupied BW</p> <p>Center Freq: 2.422000000 GHz</p> <p>Center Freq: 2.422000000 GHz</p> <p>Trig: Free Run</p> <p>Avg/Hold: 500/500</p> <p>Radio Std: None</p> <p>Radio Device: BTS</p> <p>Frequency</p> <p>Center Freq: 2.422000000 GHz</p> <p>CF Step: 6.000000 MHz</p> <p>Freq Offset: 0 Hz</p> <p>Occupied Bandwidth: 35.991 MHz</p> <p>Total Power: 14.7 dBm</p> <p>Transmit Freq Error: 23.977 kHz</p> <p>OBW Power: 99.00 %</p> <p>x dB Bandwidth: 36.04 MHz</p> <p>x dB: -6.00 dB</p> <p>Mkr1: 2.42452 GHz</p> <p>-6.6813 dBm</p>	
CH06		<p>Agilent Spectrum Analyzer - Occupied BW</p> <p>Center Freq: 2.437000000 GHz</p> <p>Center Freq: 2.437000000 GHz</p> <p>Trig: Free Run</p> <p>Avg/Hold: 500/500</p> <p>Radio Std: None</p> <p>Radio Device: BTS</p> <p>Frequency</p> <p>Center Freq: 2.437000000 GHz</p> <p>CF Step: 6.000000 MHz</p> <p>Freq Offset: 0 Hz</p> <p>Occupied Bandwidth: 35.977 MHz</p> <p>Total Power: 13.9 dBm</p> <p>Transmit Freq Error: 20.349 kHz</p> <p>OBW Power: 99.00 %</p> <p>x dB Bandwidth: 35.87 MHz</p> <p>x dB: -6.00 dB</p> <p>Mkr1: 2.43952 GHz</p> <p>-7.3878 dBm</p>	
CH09		<p>Agilent Spectrum Analyzer - Occupied BW</p> <p>Center Freq: 2.452000000 GHz</p> <p>Center Freq: 2.452000000 GHz</p> <p>Trig: Free Run</p> <p>Avg/Hold: 500/500</p> <p>Radio Std: None</p> <p>Radio Device: BTS</p> <p>Frequency</p> <p>Center Freq: 2.452000000 GHz</p> <p>CF Step: 6.000000 MHz</p> <p>Freq Offset: 0 Hz</p> <p>Occupied Bandwidth: 35.982 MHz</p> <p>Total Power: 14.6 dBm</p> <p>Transmit Freq Error: 8.003 kHz</p> <p>OBW Power: 99.00 %</p> <p>x dB Bandwidth: 35.92 MHz</p> <p>x dB: -6.00 dB</p> <p>Mkr1: 2.45452 GHz</p> <p>-6.7638 dBm</p>	

7.6. Restricted band

LIMIT

FCC CFR Title 47 Part 15 Subpart C Section 15.247 (d): In any 100 kHz bandwidth outside the frequency band in which the spread spectrum or digitally modulated intentional radiator is operating, Radiated Emissions which fall in the restricted bands, as defined in §15.205(a), must also comply with the Radiated Emissions limits specified in §15.209(a) (see §15.205(c)).

TEST CONFIGURATION

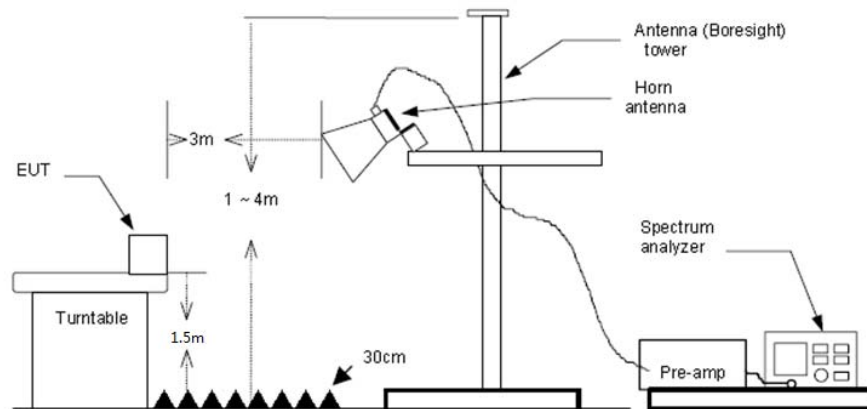

TEST PROCEDURE

- 1) The EUT was setup and tested according to ANSI C63.10:2013 for compliance to FCC 47CFR 15.247 requirements.
- 2) The EUT is placed on a turn table which is 1.5 meter above ground. The turn table is rotated 360 degrees to determine the position of the maximum emission level.
- 3) The EUT was positioned such that the distance from antenna to the EUT was 3 meters.
- 4) The antenna is scanned from 1 meter to 4 meters to find out the maximum emission level. This is repeated for both horizontal and vertical polarization of the antenna. In order to find the maximum emission, all of the interface cables were manipulated according to ANSI C63.10:2013 on radiated measurement.
- 5) The receiver set as follow:
 RBW=1MHz, VBW=3MHz PEAK detector for Peak value.
 RBW=1MHz, VBW=3MHz RMS detector for Average value.

TEST MODE:

Please refer to the clause 3.3

TEST RESULTS

Passed Not Applicable

Note:

- 1) Final level= Read level + Antenna Factor+ Cable Loss- Preamp Factor

802.11b-2412MHz Peak:

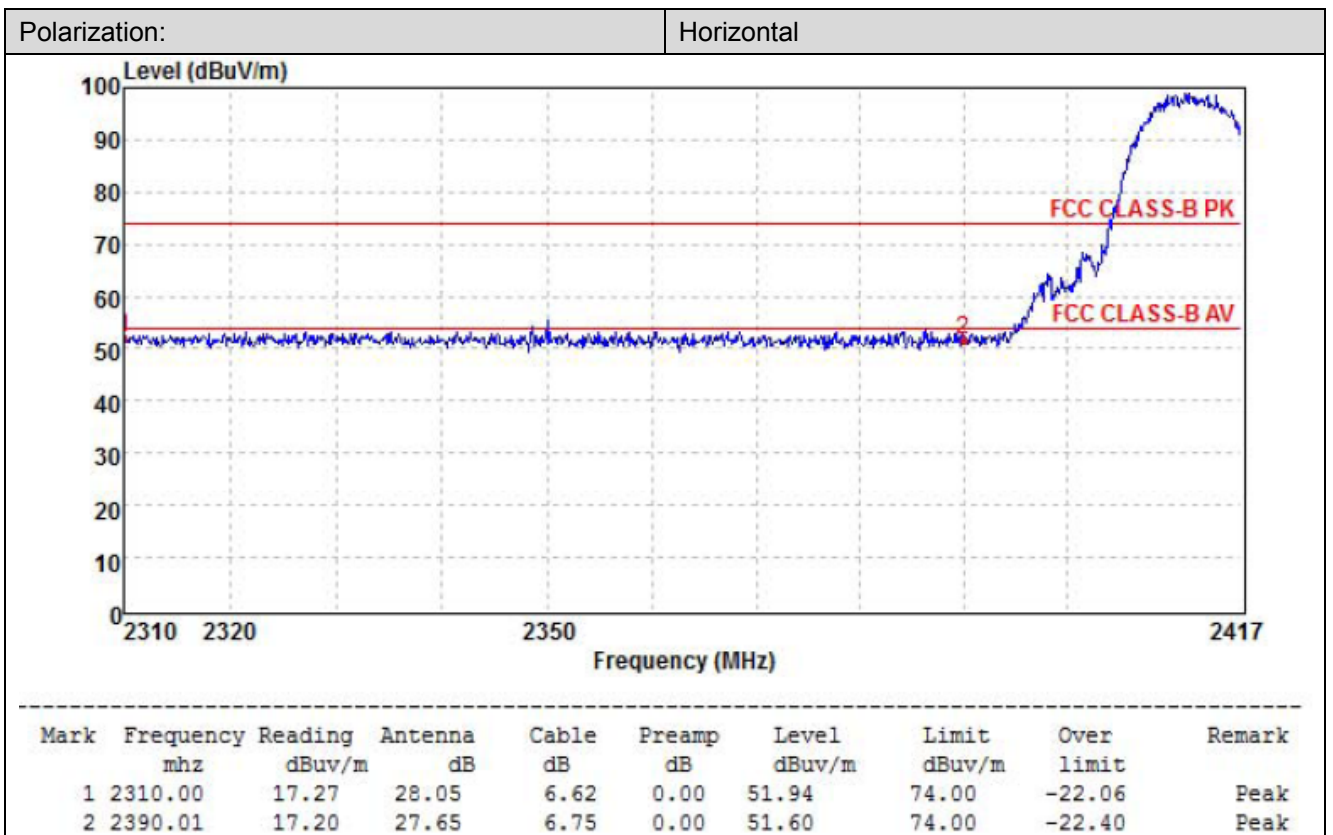
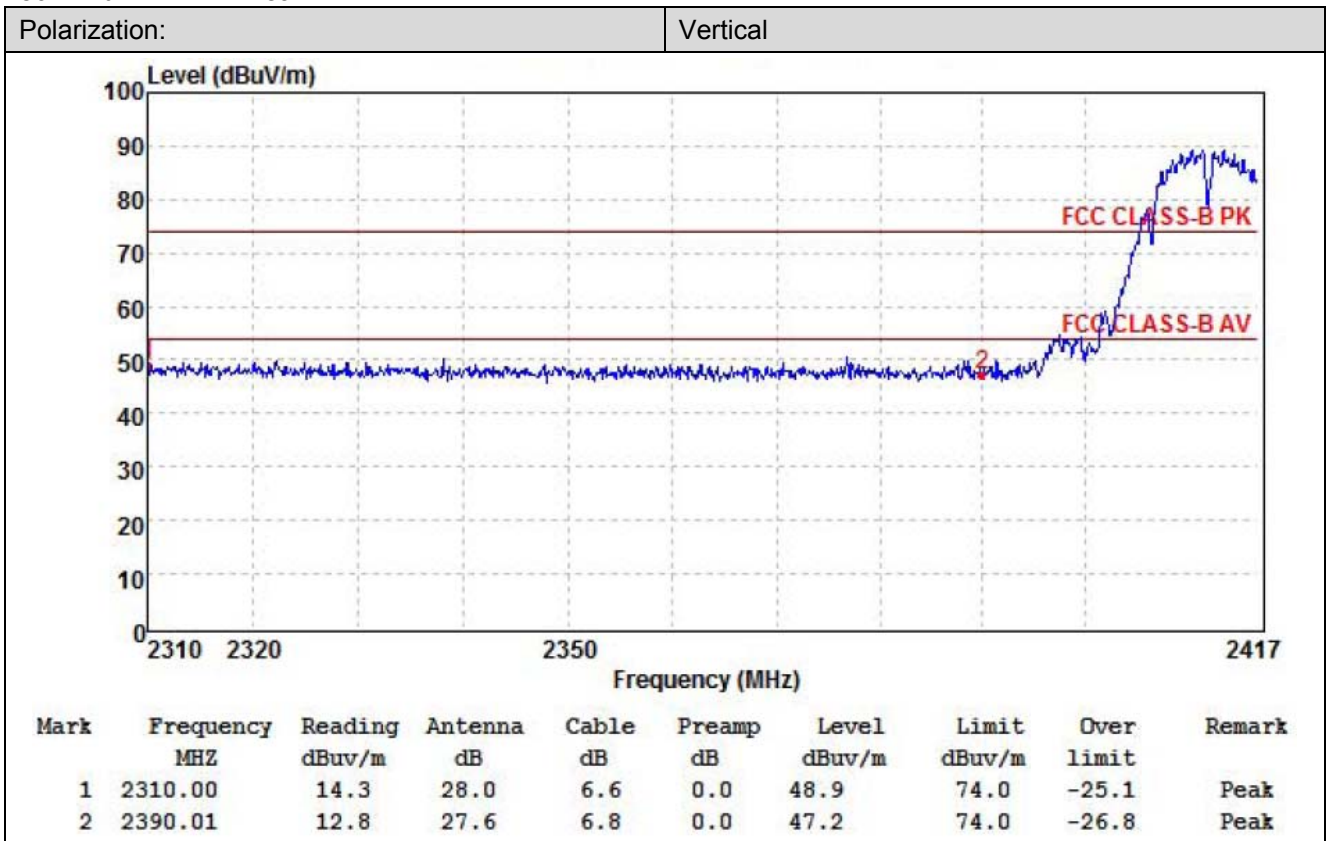

802.11b-2412MHz Average:

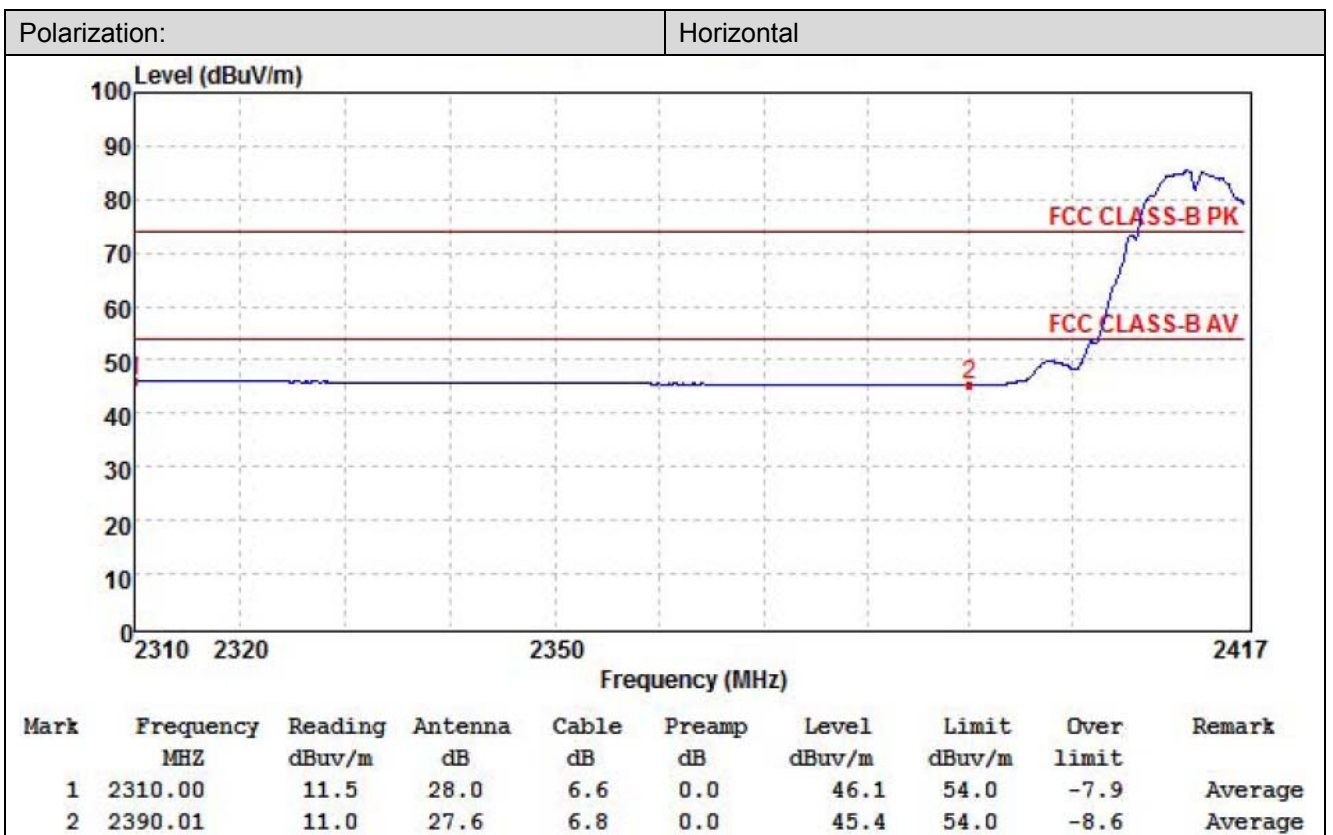
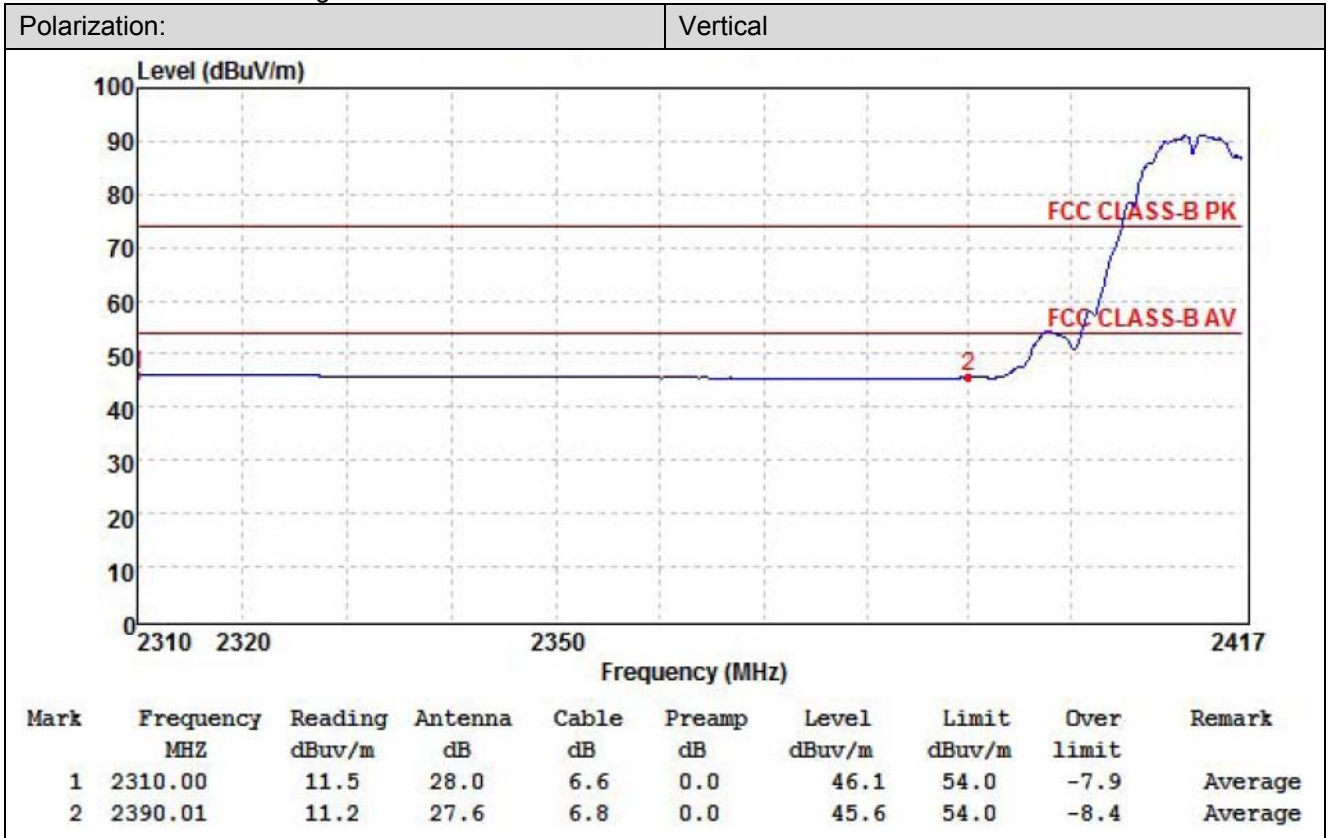

802.11b-2462MHz Peak:

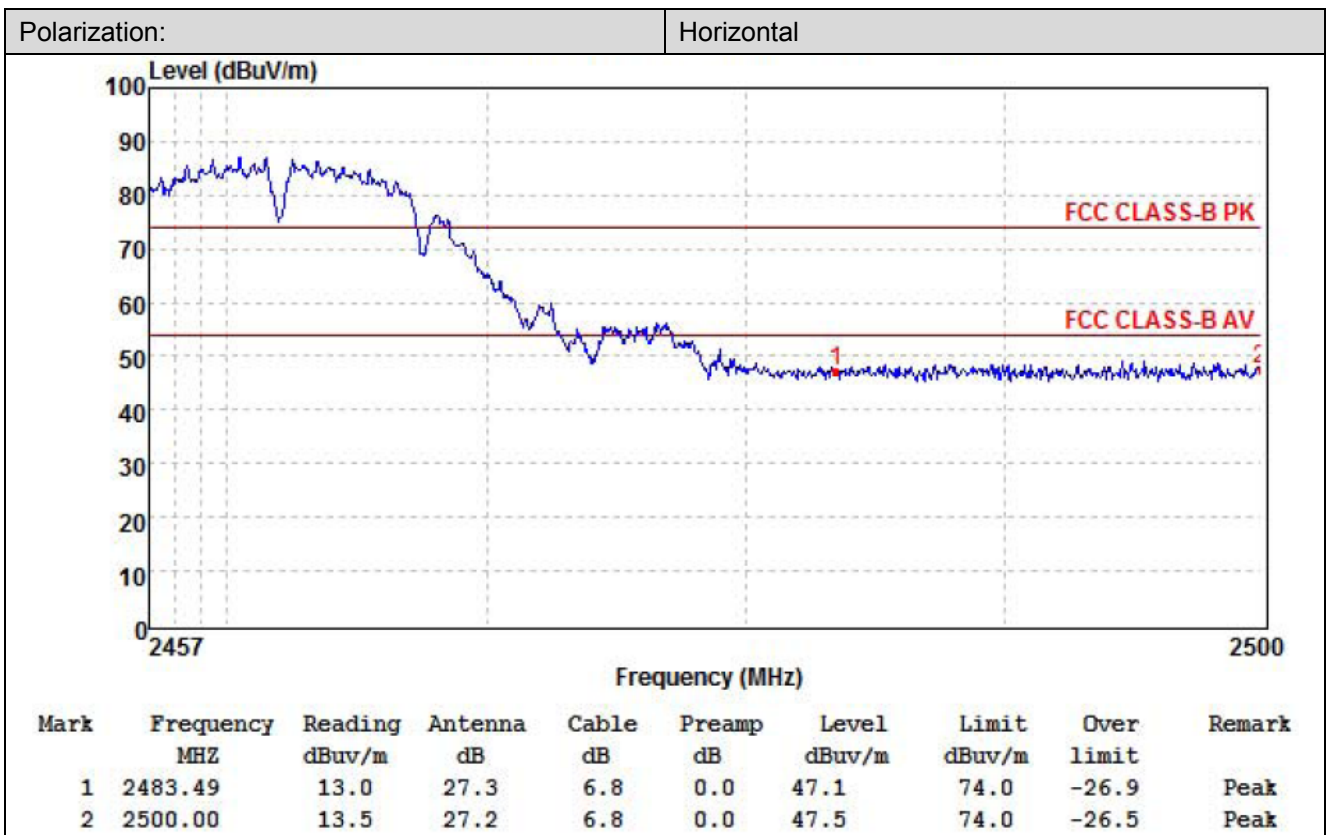
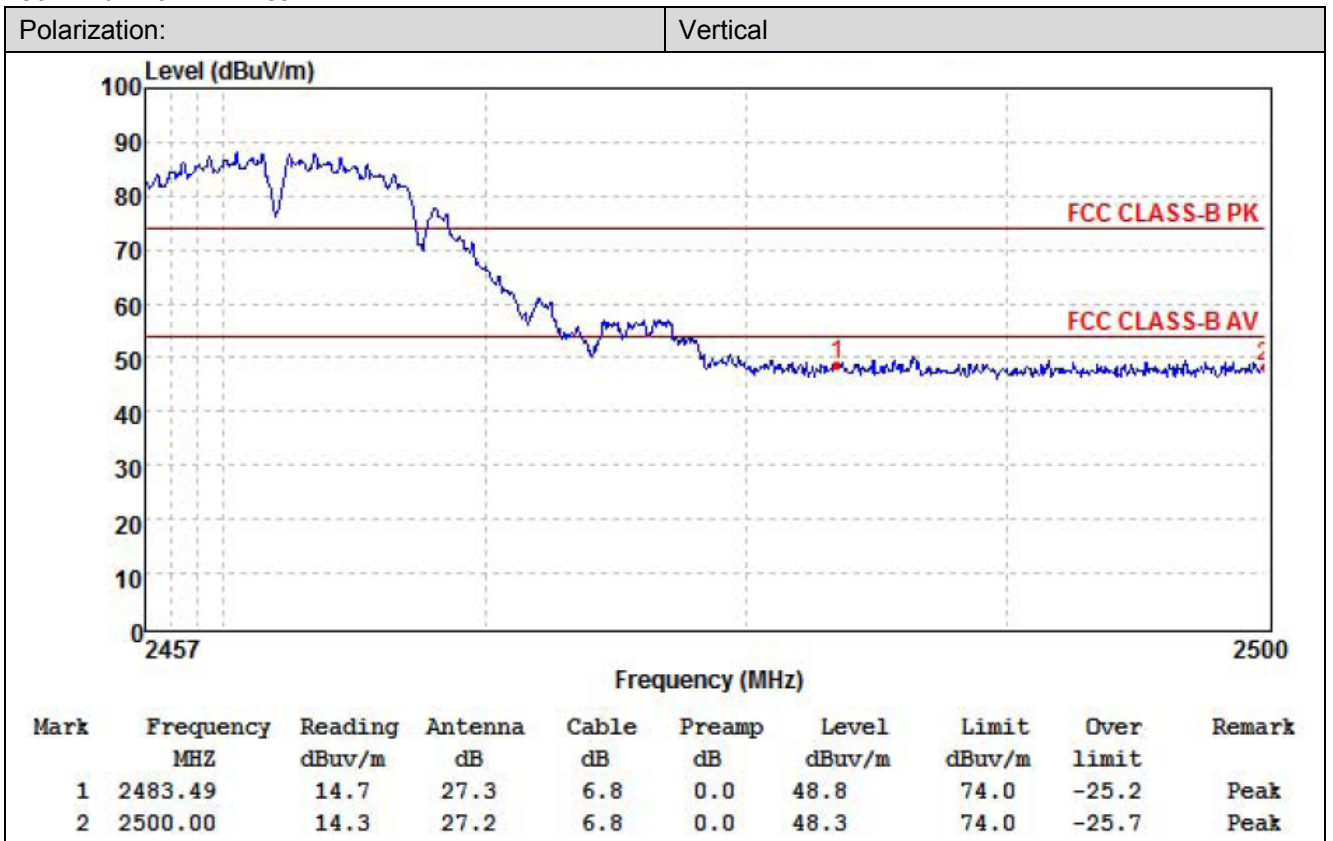

802.11b-2462MHz Average:

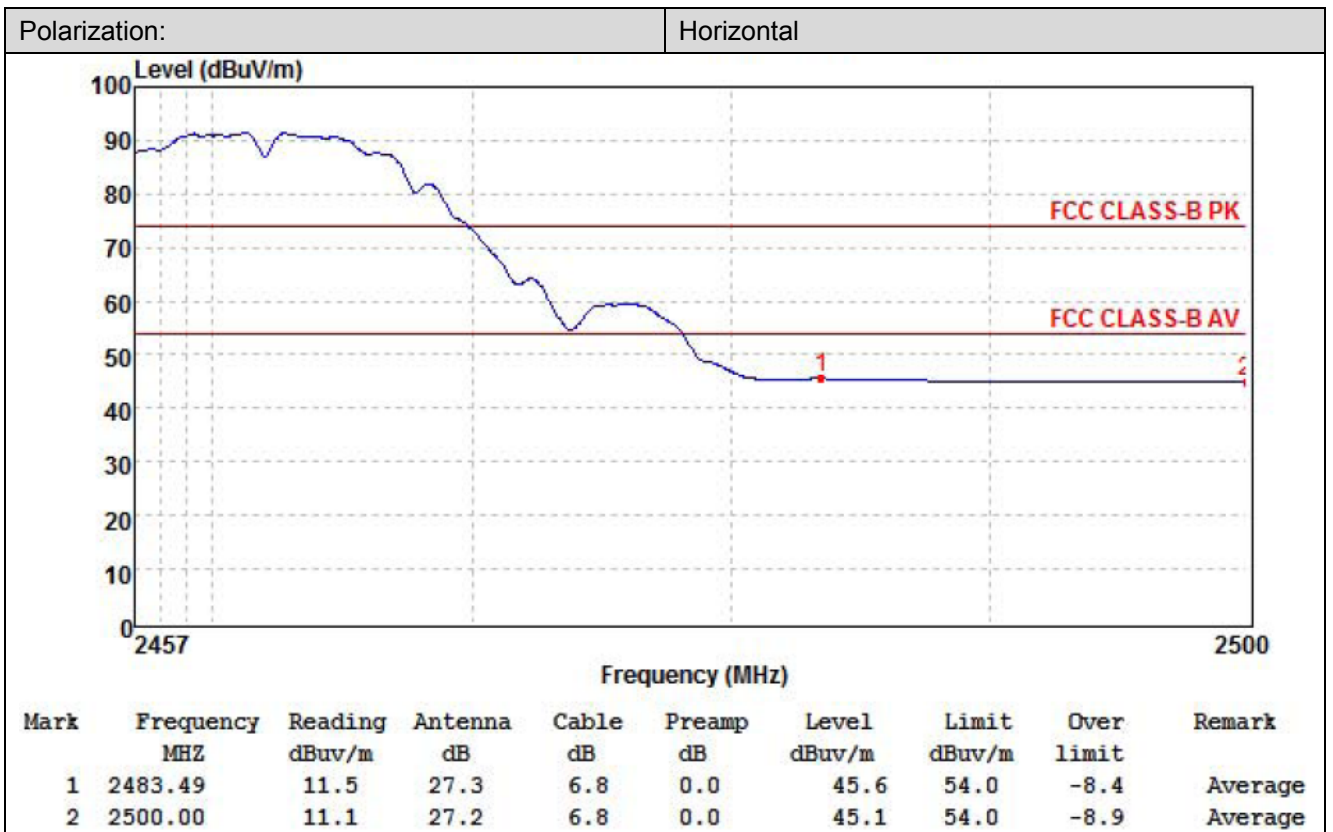
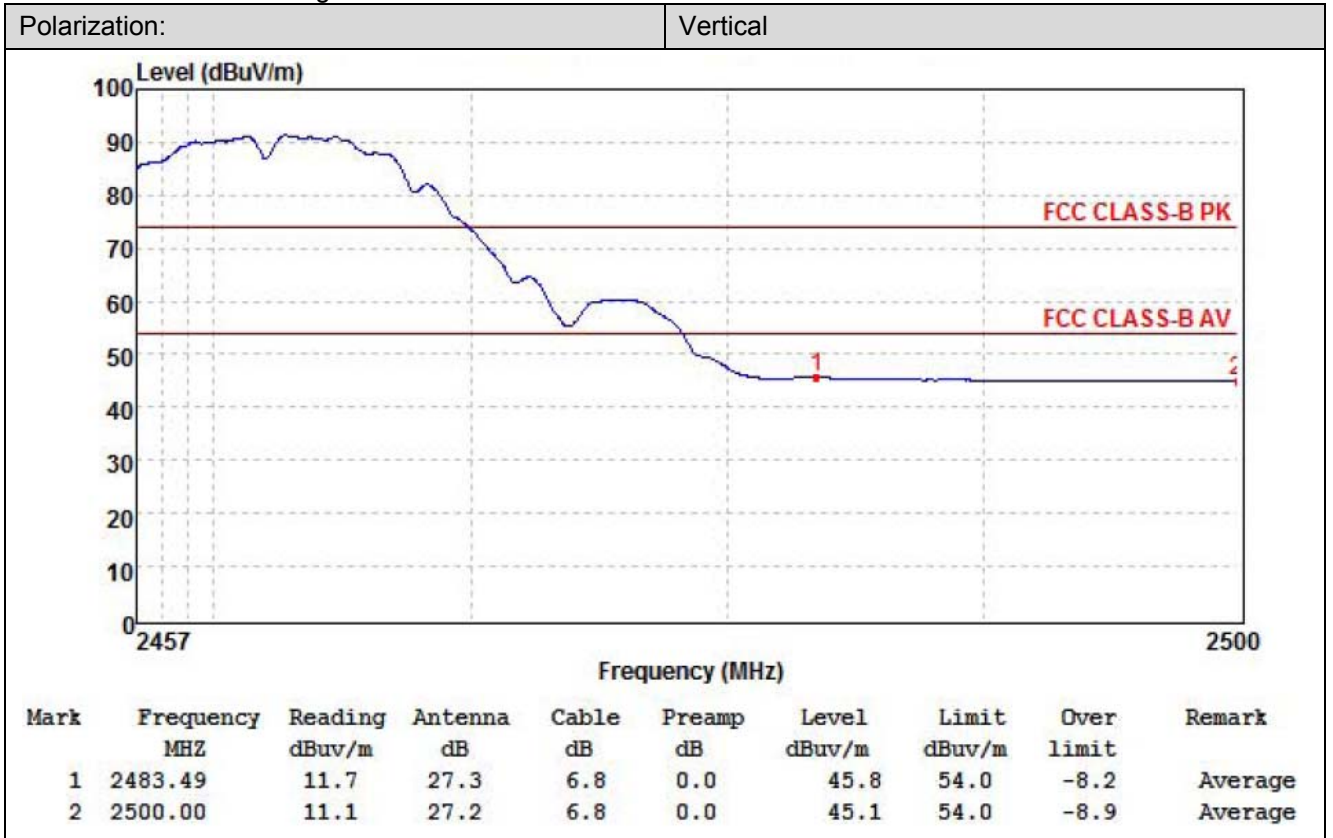

802.11g-2412MHz Peak:

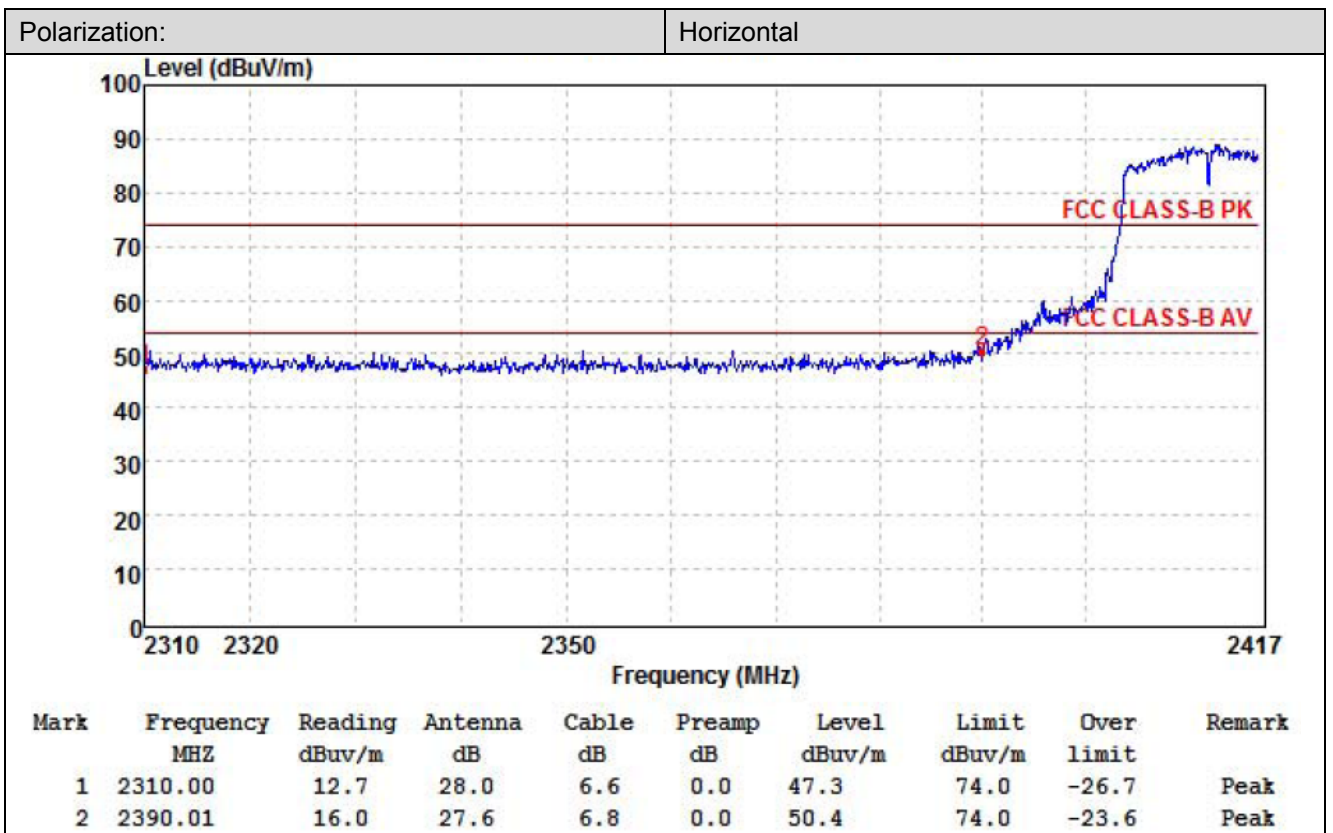
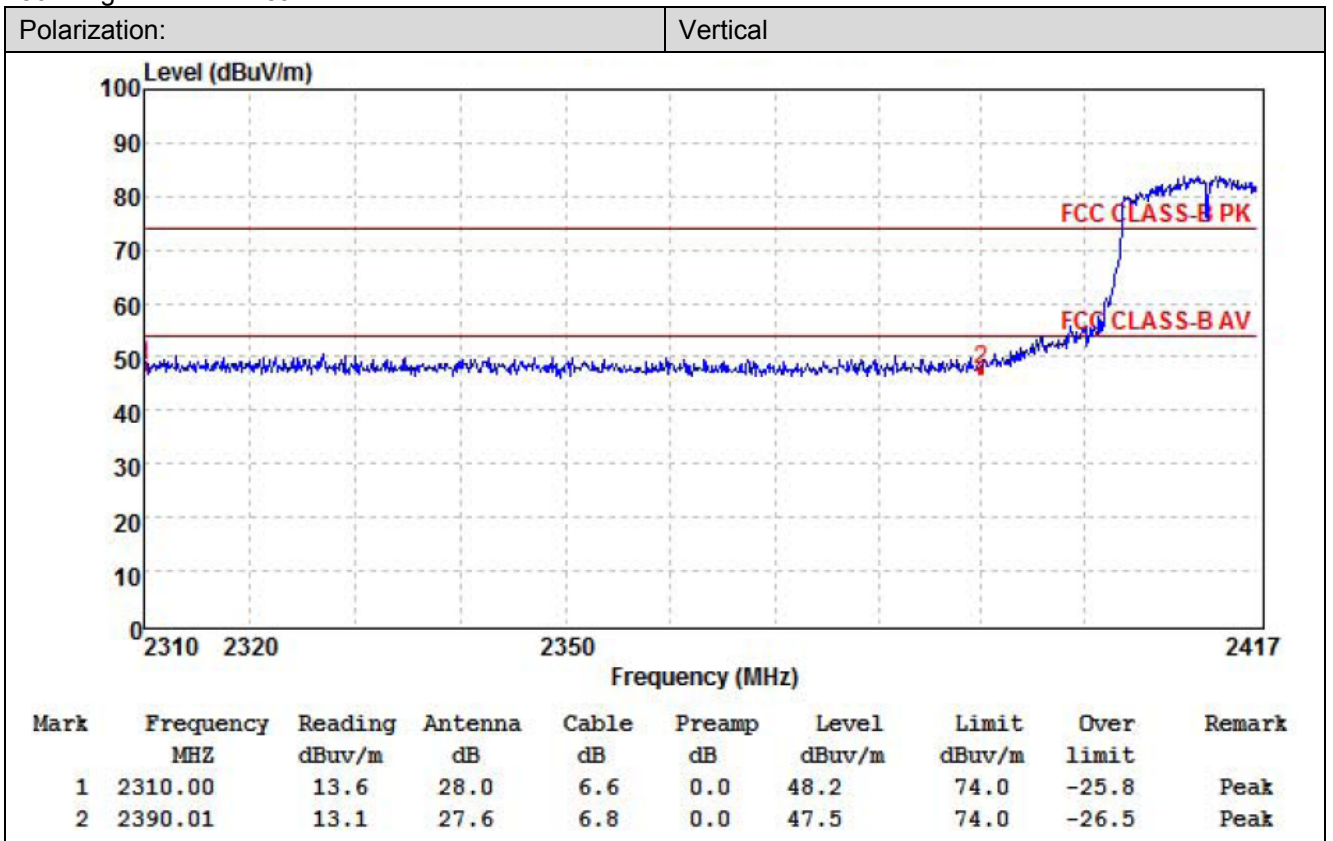

802.11g-2412MHz Average:

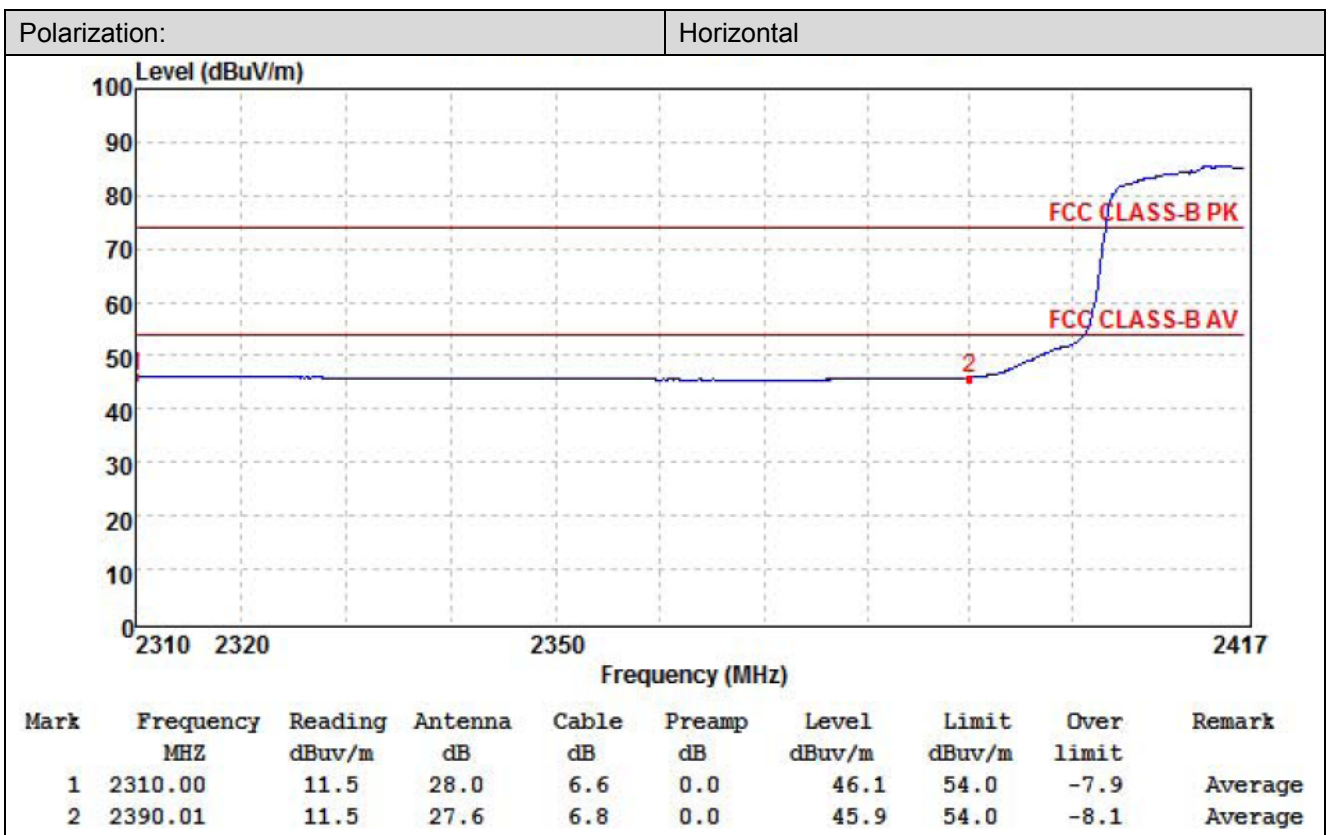
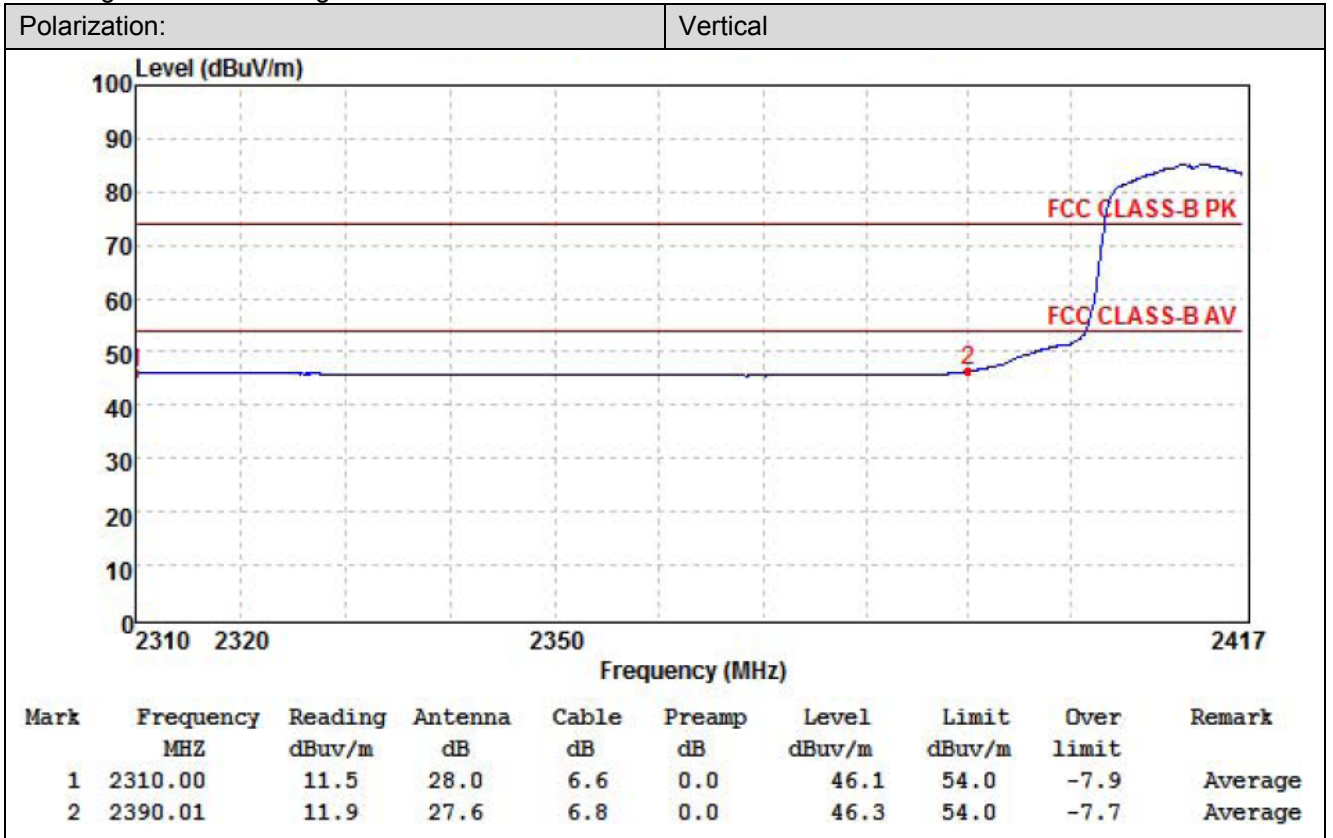

802.11g-2462MHz Peak:

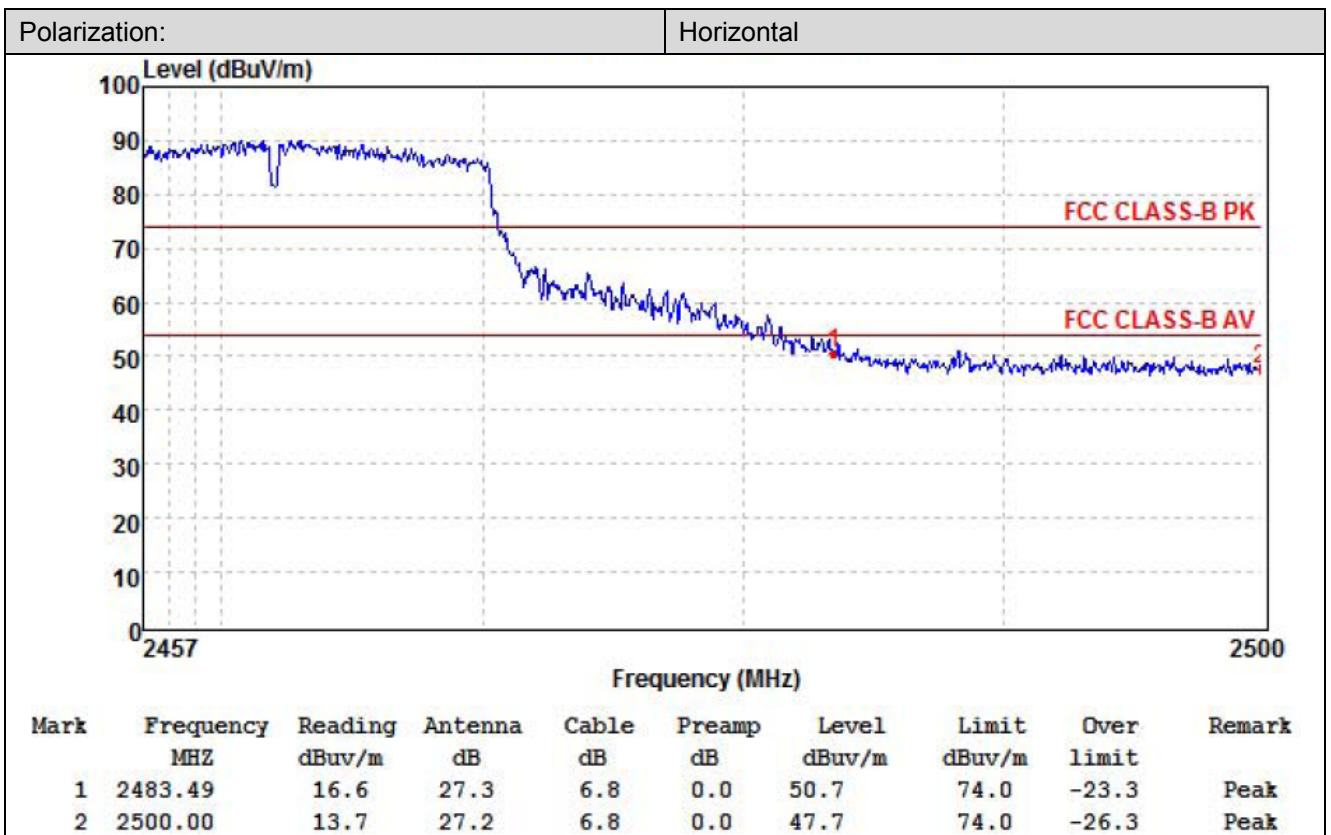
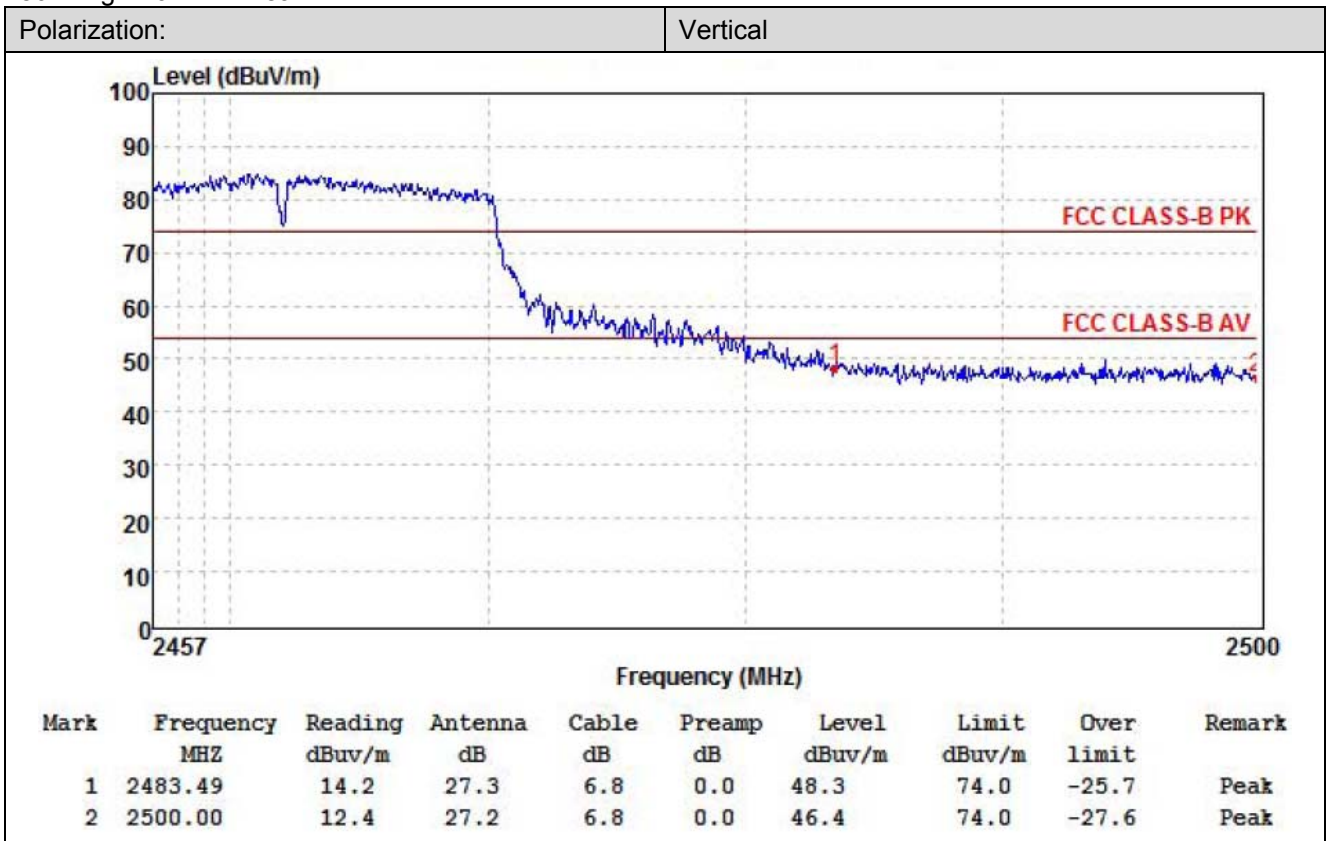

802.11g-2462MHz Average:

