

UMTS-FDD Band IV (Part 27)

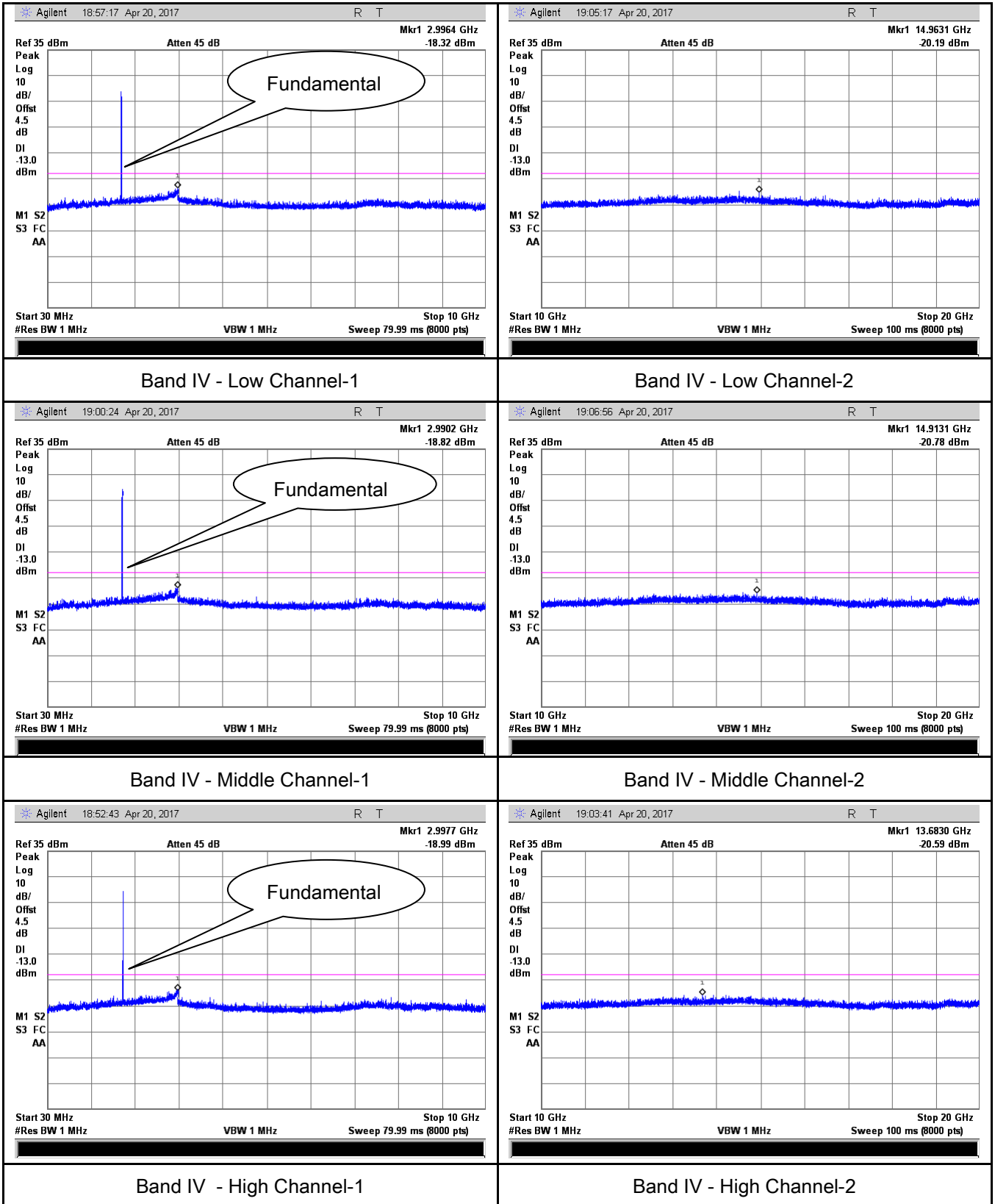

HSDPA:

UMTS-FDD Band V (Part 22H)

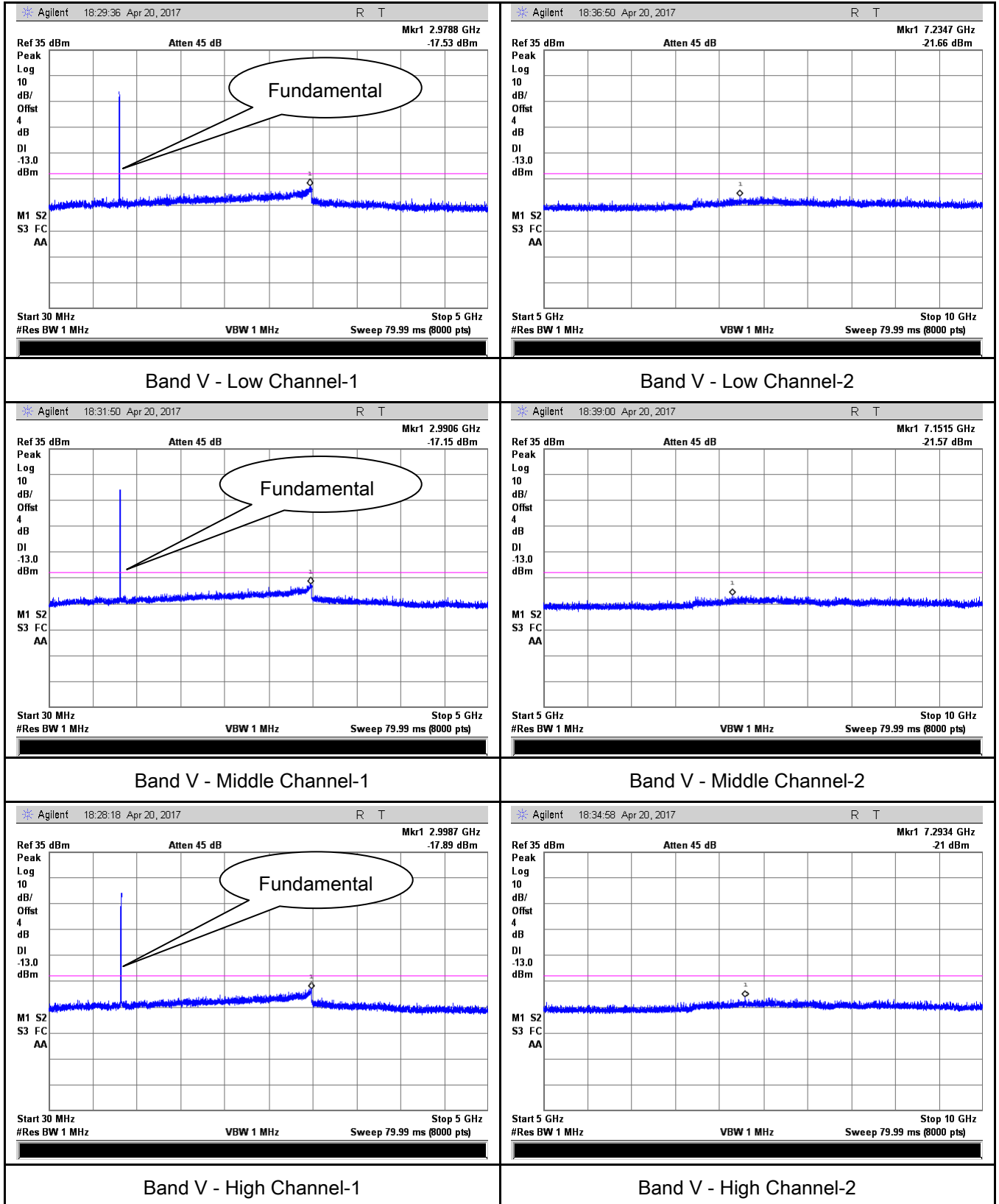

UMTS-FDD Band II (Part 24E)

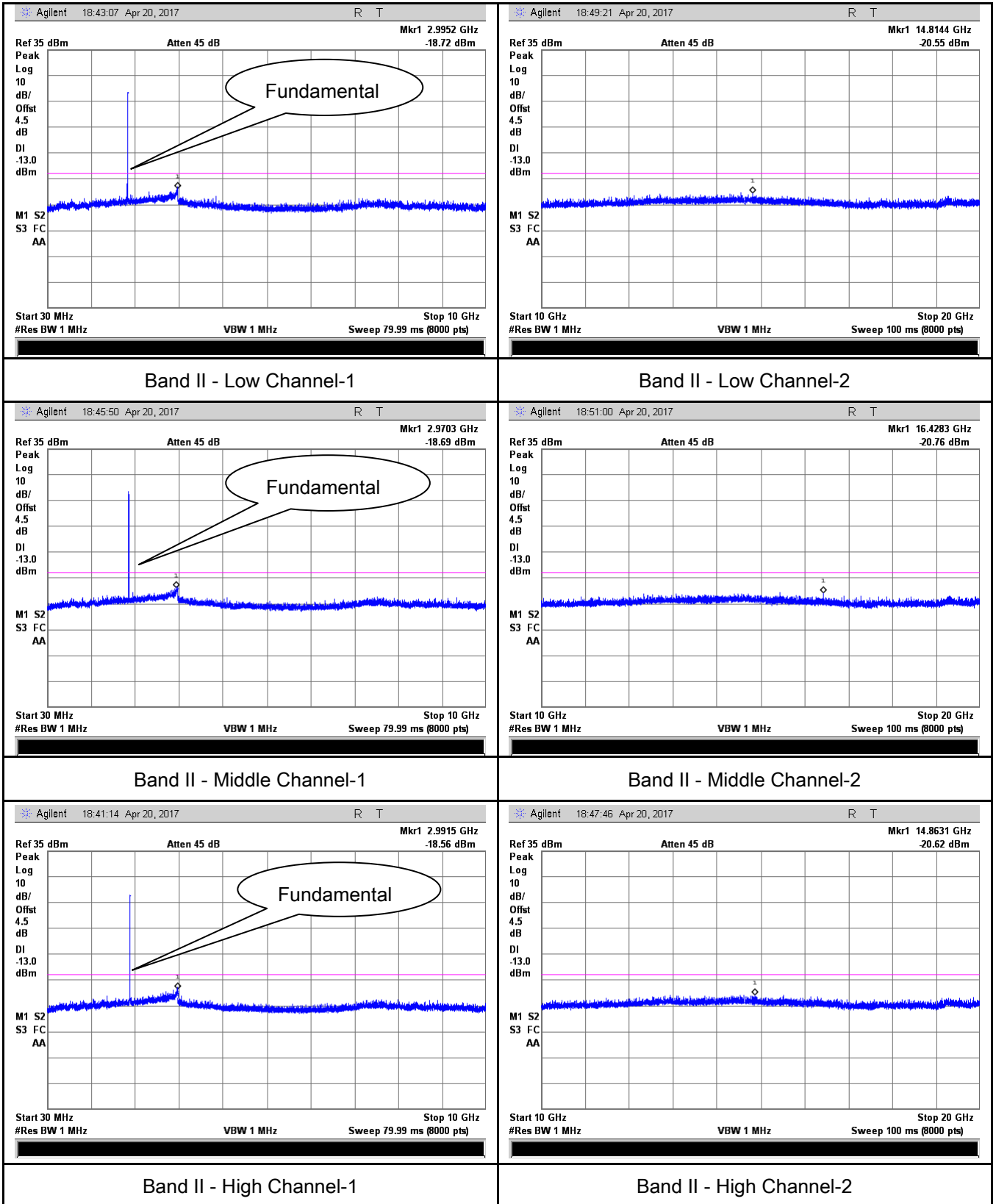

UMTS-FDD Band IV (Part 27)

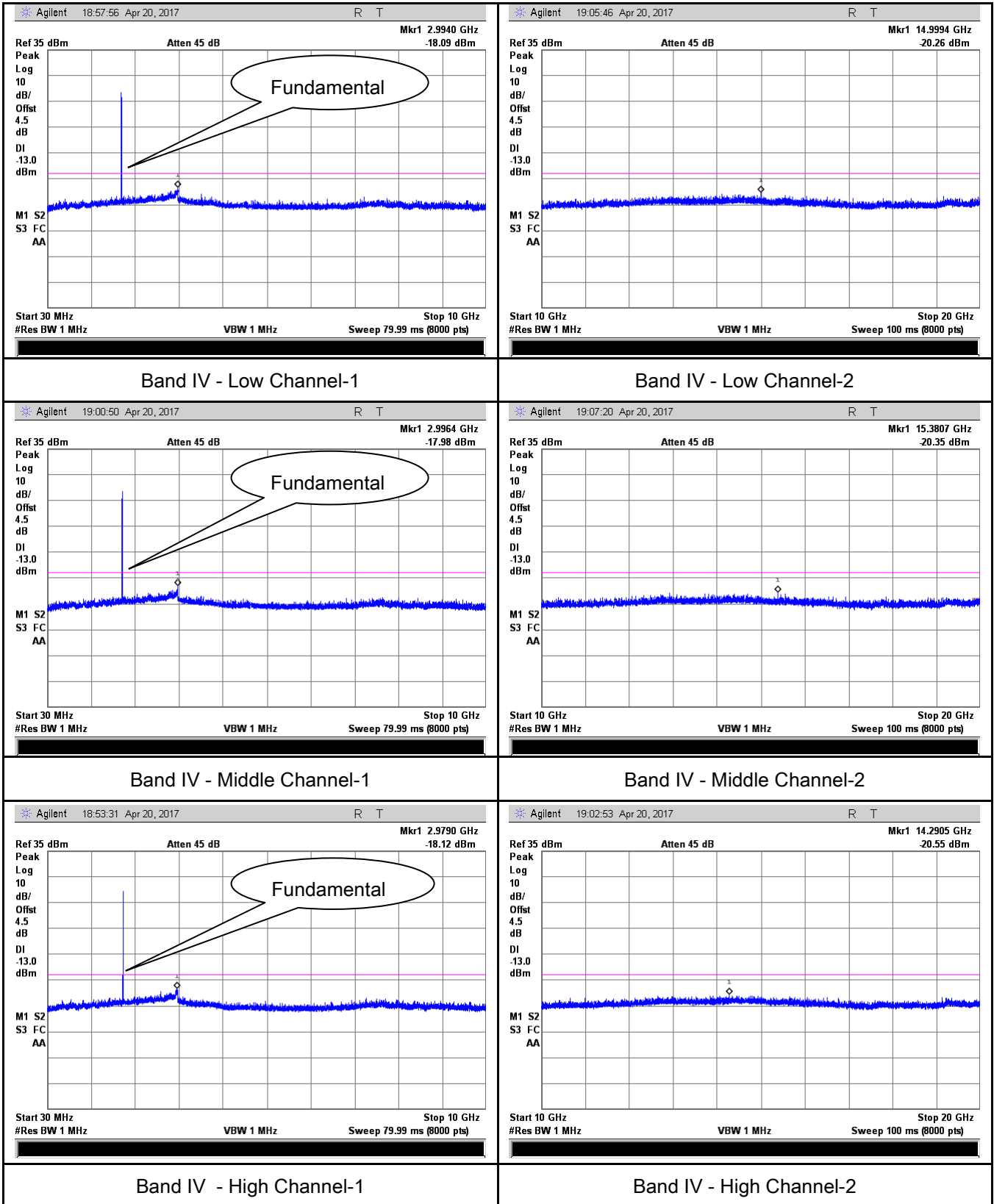

6.6 Spurious Radiated Emissions

Temperature	24 °C
Relative Humidity	52%
Atmospheric Pressure	1019mbar
Test date :	April 19, 2017
Tested By :	Loren Luo

Requirement(s):

Spec	Item	Requirement	Applicable
§2.1053, §22.917 & §24.238 § 27.53(h)	a)	The power of any emission outside of the authorized operating frequency ranges must be attenuated below the transmitter power (P) by a factor of at least $43 + 10 \log (P)$ dB. The spectrum is scanned from 30 MHz up to a frequency including its 10th harmonic.	<input checked="" type="checkbox"/>

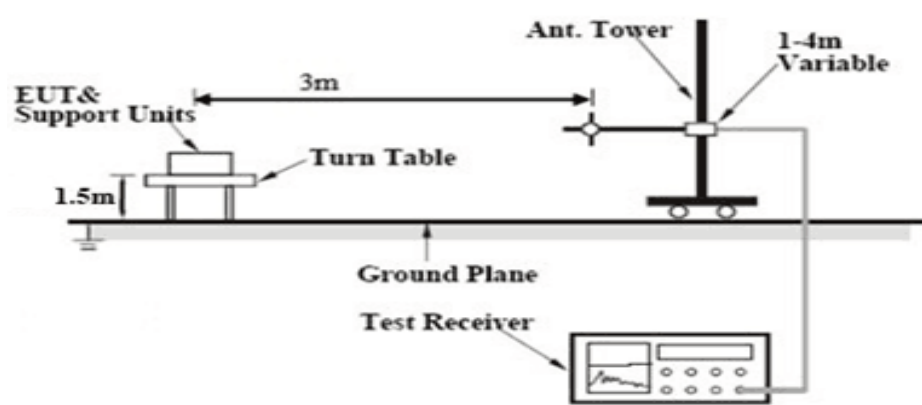
Test setup	
------------	--

Test Procedure	<ol style="list-style-type: none"> The transmitter was placed on a wooden turntable, and it was transmitting into a non-radiating load which was also placed on the turntable. The measurement antenna was placed at a distance of 3 meters from the EUT. During the tests, the antenna height and polarization as well as EUT azimuth were varied in order to identify the maximum level of emissions from the EUT. The test was performed by placing the EUT on 3-orthogonal axis. Remove the EUT and replace it with substitution antenna. A signal generator was connected to the substitution antenna by a non-radiating cable. The absolute levels of the spurious emissions were measured by the substitution. Sample Calculation: EUT Field Strength = Raw Amplitude (dBμV/m) – Amplifier Gain (dB) + Antenna Factor (dB) + Cable Loss (dB) + Filter Attenuation (dB, if used)
----------------	--

Remark	
Result	<input checked="" type="checkbox"/> Pass <input type="checkbox"/> Fail

Test Data Yes N/A
Test Plot Yes (See below) N/A

Cellular Band (Part 22H) result

Low channel

Frequency (MHz)	Substituted level (dBm)	Polarity (H/V)	Antenna Gain Correction (dB)	Cable Loss (dB)	Corrected Reading (dBm)	Limit (dBm)	Margin (dB)
1648.4	-44.12	V	7.95	0.78	-36.95	-13	-23.95
1648.4	-44.65	H	7.95	0.78	-37.48	-13	-24.48
330.2	-52.93	V	6.4	0.26	-46.79	-13	-33.79
611.7	-53.62	H	6.8	0.37	-47.19	-13	-34.19

Middle channel

Frequency (MHz)	Substituted level (dBm)	Polarity (H/V)	Antenna Gain Correction (dB)	Cable Loss (dB)	Corrected Reading (dBm)	Limit (dBm)	Margin (dB)
1673.2	-44.38	V	7.95	0.78	-37.21	-13	-24.21
1673.2	-44.57	H	7.95	0.78	-37.4	-13	-24.4
330.8	-53.05	V	6.4	0.26	-46.91	-13	-33.91
611.3	-53.42	H	6.8	0.37	-46.99	-13	-33.99

High channel

Frequency (MHz)	Substituted level (dBm)	Polarity (H/V)	Antenna Gain Correction (dB)	Cable Loss (dB)	Corrected Reading (dBm)	Limit (dBm)	Margin (dB)
1697.6	-43.95	V	7.95	0.78	-36.78	-13	-23.78
1697.6	-44.29	H	7.95	0.78	-37.12	-13	-24.12
330.5	-53.25	V	6.4	0.26	-47.11	-13	-34.11
611.2	-53.18	H	6.8	0.37	-46.75	-13	-33.75

Note:

- 1, The testing has been conformed to $10 \times 848.8 \text{ MHz} = 8,488 \text{ MHz}$
- 2, All other emissions more than 30 dB below the limit
- 3, GSM voice, GPRS and EGPRS mode were investigated. The results above show only the worse cases
- 4, X-Axis, Y-Axis and Z-Axis were investigated. The results above show only the worst case.

PCS Band (Part24E) result

Low channel

Frequency (MHz)	Substituted level (dBm)	Polarity (H/V)	Antenna Gain Correction (dB)	Cable Loss (dB)	Corrected Reading (dBm)	Limit (dBm)	Margin (dB)
3700.4	-48.11	V	10.25	2.73	-40.59	-13	-27.59
3700.4	-48.69	H	10.25	2.73	-41.17	-13	-28.17
329.1	-53.46	V	6.4	0.26	-47.32	-13	-34.32
610.8	-54.05	H	6.8	0.37	-47.62	-13	-34.62

Middle channel

Frequency (MHz)	Substituted level (dBm)	Polarity (H/V)	Antenna Gain Correction (dB)	Cable Loss (dB)	Corrected Reading (dBm)	Limit (dBm)	Margin (dB)
3760	-48.25	V	10.25	2.73	-40.73	-13	-27.73
3760	-48.98	H	10.25	2.73	-41.46	-13	-28.46
329.5	-53.42	V	6.4	0.26	-47.28	-13	-34.28
610.6	-53.91	H	6.8	0.37	-47.48	-13	-34.48

High channel

Frequency (MHz)	Substituted level (dBm)	Polarity (H/V)	Antenna Gain Correction (dB)	Cable Loss (dB)	Corrected Reading (dBm)	Limit (dBm)	Margin (dB)
3819.6	-48.19	V	10.36	2.73	-40.56	-13	-27.56
3819.6	-49.03	H	10.36	2.73	-41.4	-13	-28.4
329.9	-53.66	V	6.4	0.26	-47.52	-13	-34.52
610.3	-52.78	H	6.8	0.37	-46.35	-13	-33.35

Note:

- 1, The testing has been conformed to $10 \times 1909.8 \text{ MHz} = 19,098 \text{ MHz}$
- 2, All other emissions more than 30 dB below the limit
- 3, GSM voice, GPRS and EGPRS mode were investigated. The results above show only the worse cases
- 4, X-Axis, Y-Axis and Z-Axis were investigated. The results above show only the worst case.

UMTS-FDD Band V (Part 22H)

Low channel

Frequency (MHz)	Substituted level (dBm)	Polarity (H/V)	Antenna Gain Correction (dB)	Cable Loss (dB)	Corrected Reading (dBm)	Limit (dBm)	Margin (dB)
1652.8	-47.15	V	7.95	0.78	-39.98	-13	-26.98
1652.8	-46.23	H	7.95	0.78	-39.06	-13	-26.06
322.3	-53.27	V	6.4	0.26	-47.13	-13	-34.13
607.8	-53.59	H	6.8	0.37	-47.16	-13	-34.16

Middle channel

Frequency (MHz)	Substituted level (dBm)	Polarity (H/V)	Antenna Gain Correction (dB)	Cable Loss (dB)	Corrected Reading (dBm)	Limit (dBm)	Margin (dB)
1670	-46.95	V	7.95	0.78	-39.78	-13	-26.78
1670	-46.17	H	7.95	0.78	-39	-13	-26
322.6	-52.86	V	6.4	0.26	-46.72	-13	-33.72
607.4	-53.04	H	6.8	0.37	-46.61	-13	-33.61

High channel

Frequency (MHz)	Substituted level (dBm)	Polarity (H/V)	Antenna Gain Correction (dB)	Cable Loss (dB)	Corrected Reading (dBm)	Limit (dBm)	Margin (dB)
1693.2	-46.92	V	7.95	0.78	-39.75	-13	-26.75
1693.2	-45.87	H	7.95	0.78	-38.7	-13	-25.7
322.5	-52.79	V	6.4	0.26	-46.65	-13	-33.65
607.1	-53.36	H	6.8	0.37	-46.93	-13	-33.93

Note:

1, The testing has been conformed to $10 \times 846.6 \text{ MHz} = 8,466 \text{ MHz}$

2, All other emissions more than 30 dB below the limit

3, RMC, HSUPA and HSDPA mode were investigated. The results above show only the worse cases

4, X-Axis, Y-Axis and Z-Axis were investigated. The results above show only the worst case.

UMTS-FDD Band II (Part 24E)

Low channel

Frequency (MHz)	Substituted level (dBm)	Polarity (H/V)	Antenna Gain Correction (dB)	Cable Loss (dB)	Corrected Reading (dBm)	Limit (dBm)	Margin (dB)
3704.8	-49.88	V	10.25	2.73	-42.36	-13	-29.36
3704.8	-49.71	H	10.25	2.73	-42.19	-13	-29.19
327.2	-53.65	V	6.4	0.26	-47.51	-13	-34.51
606.5	-53.55	H	6.8	0.37	-47.12	-13	-34.12

Middle channel

Frequency (MHz)	Substituted level (dBm)	Polarity (H/V)	Antenna Gain Correction (dB)	Cable Loss (dB)	Corrected Reading (dBm)	Limit (dBm)	Margin (dB)
3760	-49.67	V	10.25	2.73	-42.15	-13	-29.15
3760	-49.72	H	10.25	2.73	-42.2	-13	-29.2
327.7	-53.68	V	6.4	0.26	-47.54	-13	-34.54
606.8	-53.46	H	6.8	0.37	-47.03	-13	-34.03

High channel

Frequency (MHz)	Substituted level (dBm)	Polarity (H/V)	Antenna Gain Correction (dB)	Cable Loss (dB)	Corrected Reading (dBm)	Limit (dBm)	Margin (dB)
3815.2	-49.62	V	10.36	2.73	-41.99	-13	-28.99
3815.2	-49.56	H	10.36	2.73	-41.93	-13	-28.93
327.5	-53.72	V	6.4	0.26	-47.58	-13	-34.58
606.3	-53.81	H	6.8	0.37	-47.38	-13	-34.38

Note:

1, The testing has been conformed to $10 \times 1907.6 \text{MHz} = 19,076 \text{MHz}$

2, All other emissions more than 30 dB below the limit

3, RMC, HSUPA and HSDPA mode were investigated. The results above show only the worse cases

4, X-Axis, Y-Axis and Z-Axis were investigated. The results above show only the worst case

UMTS-FDD Band IV (Part 27)

Low channel

Frequency (MHz)	Substituted level (dBm)	Polarity (H/V)	Antenna Gain Correction (dB)	Cable Loss (dB)	Corrected Reading (dBm)	Limit (dBm)	Margin (dB)
3424.8	-44.81	V	10.07	2.52	-37.26	-13	-24.26
3424.8	-47.95	H	10.07	2.52	-40.4	-13	-27.4
326.3	-56.54	V	6.4	0.26	-50.4	-13	-37.4
740.5	-52.13	H	7.1	0.42	-45.45	-13	-32.45

Middle channel

Frequency (MHz)	Substituted level (dBm)	Polarity (H/V)	Antenna Gain Correction (dB)	Cable Loss (dB)	Corrected Reading (dBm)	Limit (dBm)	Margin (dB)
3480	-45.47	V	10.09	2.52	-37.9	-13	-24.9
3480	-46.75	H	10.09	2.52	-39.18	-13	-26.18
326.6	-56.11	V	6.4	0.26	-49.97	-13	-36.97
740.1	-52.35	H	7.1	0.42	-45.67	-13	-32.67

High channel

Frequency (MHz)	Substituted level (dBm)	Polarity (H/V)	Antenna Gain Correction (dB)	Cable Loss (dB)	Corrected Reading (dBm)	Limit (dBm)	Margin (dB)
3505.2	-44.96	V	10.09	2.52	-37.39	-13	-24.39
3505.2	-46.81	H	10.09	2.52	-39.24	-13	-26.24
326.9	-56.64	V	6.4	0.26	-50.5	-13	-37.5
740.7	-52.37	H	7.1	0.42	-45.69	-13	-32.69

Note:

- 1, The testing has been conformed to $10 \times 1752.6 \text{ MHz} = 17,526 \text{ MHz}$
- 2, All other emissions more than 30 dB below the limit
- 3, RMC, HSUPA and HSDPA mode were investigated. The results above show only the worse cases.
- 4, X-Axis, Y-Axis and Z-Axis were investigated. The results above show only the worst case.

6.7 Band Edge

Temperature	25 °C
Relative Humidity	53%
Atmospheric Pressure	1020mbar
Test date :	April 20, 2017
Tested By :	Loren Luo

Requirement(s):

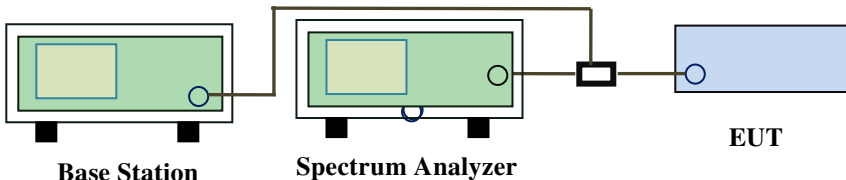
Spec	Item	Requirement	Applicable
§22.917(a) §24.238(a) § 27.53(h)	a)	The power of any emission outside of the authorized operating frequency ranges must be lower than the transmitter power (P) by a factor of at least $43 + 10 \log (P)$ dB.	<input checked="" type="checkbox"/>
Test setup	 <p>The diagram shows a Base Station (green box) and a Spectrum Analyzer (green box) connected to an EUT (blue box) through a power divider (black box). The Base Station and Spectrum Analyzer are connected to the power divider, which then splits the signal to the EUT.</p>		
Procedure	<ul style="list-style-type: none"> - The EUT was connected to Spectrum Analyzer and Base Station via power divider. - The Band Edges of low and high channels for the highest RF powers were measured. Setting RBW as roughly BW/100. 		
Remark			
Result	<input checked="" type="checkbox"/> Pass <input type="checkbox"/> Fail		

Test Data Yes N/A

Test Plot Yes (See below) N/A

GSM Voice:

Cellular Band (Part 22H) result

Frequency (MHz)	Emission (dBm)	Limit (dBm)
823.977	-18.374	-13
849.003	-17.703	-13

PCS Band (Part24E) result

Frequency (MHz)	Emission (dBm)	Limit (dBm)
1849.995	-15.875	-13
1910.004	-14.402	-13

GPRS:

Cellular Band (Part 22H) result

Frequency (MHz)	Emission (dBm)	Limit (dBm)
823.997	-18.564	-13
849.020	-17.499	-13

PCS Band (Part24E) result

Frequency (MHz)	Emission (dBm)	Limit (dBm)
1849.994	-16.438	-13
1910.018	-14.261	-13

EGPRS (MCS1):

Cellular Band (Part 22H) result

Frequency (MHz)	Emission (dBm)	Limit (dBm)
823.996	-17.150	-13
849.020	-14.978	-13

PCS Band (Part24E) result

Frequency (MHz)	Emission (dBm)	Limit (dBm)
1849.996	-15.317	-13
1910.016	-16.181	-13

RCM:

UMTS-FDD Band V (Part 22H)

Frequency (MHz)	Emission (dBm)	Limit (dBm)
823.70	-31.482	-13
849.06	-30.284	-13

UMTS-FDD Band II (Part 24E)

Frequency (MHz)	Emission (dBm)	Limit (dBm)
1849.70	-25.636	-13
1910.26	-26.683	-13

UMTS-FDD Band IV (Part 27)

Frequency (MHz)	Emission (dBm)	Limit (dBm)
1709.69	-31.351	-13
1755.27	-31.818	-13

HSUPA:

UMTS-FDD Band V (Part 22H)

Frequency (MHz)	Emission (dBm)	Limit (dBm)
823.73	-31.604	-13
849.27	-31.740	-13

UMTS-FDD Band II (Part 24E)

Frequency (MHz)	Emission (dBm)	Limit (dBm)
1849.88	-26.321	-13
1910.27	-30.552	-13

UMTS-FDD Band IV (Part 27)

Frequency (MHz)	Emission (dBm)	Limit (dBm)
1708.71	-30.921	-13
1755.22	-30.003	-13

HSDPA:

UMTS-FDD Band V (Part 22H)

Frequency (MHz)	Emission (dBm)	Limit (dBm)
823.67	-32.231	-13
849.27	-32.293	-13

UMTS-FDD Band II (Part 24E)

Frequency (MHz)	Emission (dBm)	Limit (dBm)
1849.69	-31.026	-13
1910.51	-30.794	-13

UMTS-FDD Band IV (Part 27)

Frequency (MHz)	Emission (dBm)	Limit (dBm)
1709.99	-31.777	-13
1756.19	-30.596	-13

**GSM Voice:
Test Plots**

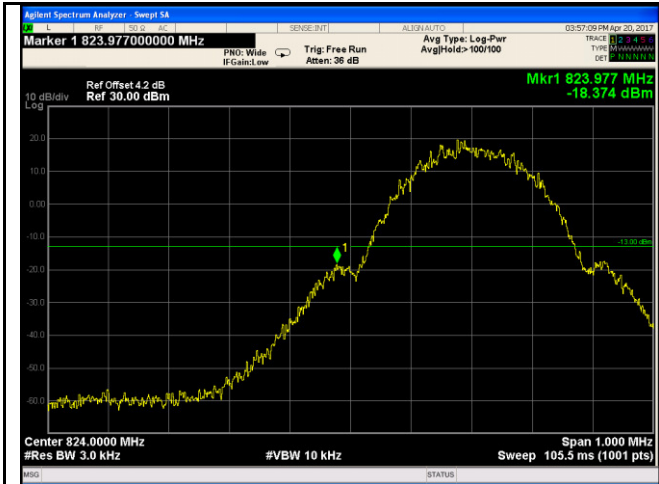

Cellular Band - Low Channel

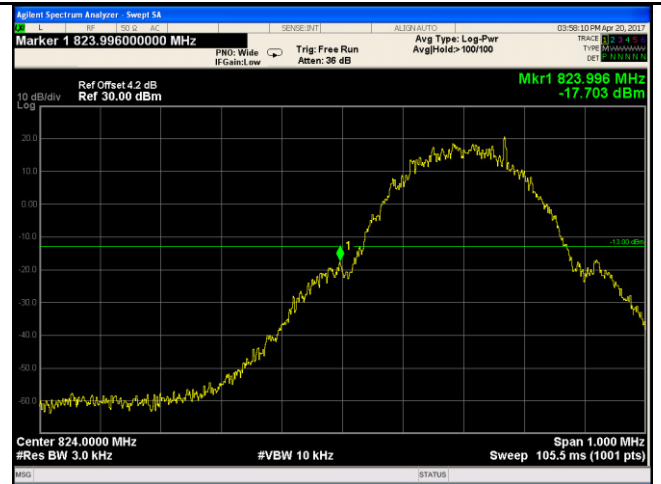

Cellular Band - High Channel

Note: Offset=Cable loss (4.0) + 10log
(3.16/3)=4.0+0.2=4.2dB

Note: Offset=Cable loss (4.0) + 10log
(3.18/3)=4.0+0.2=4.2dB

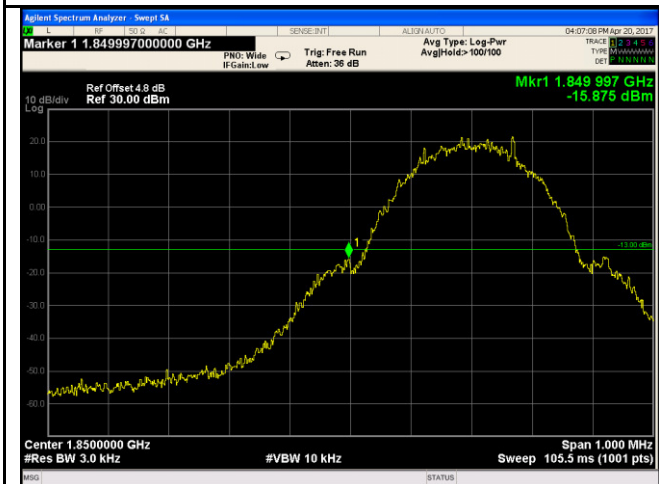

PCS Band - Low Channel

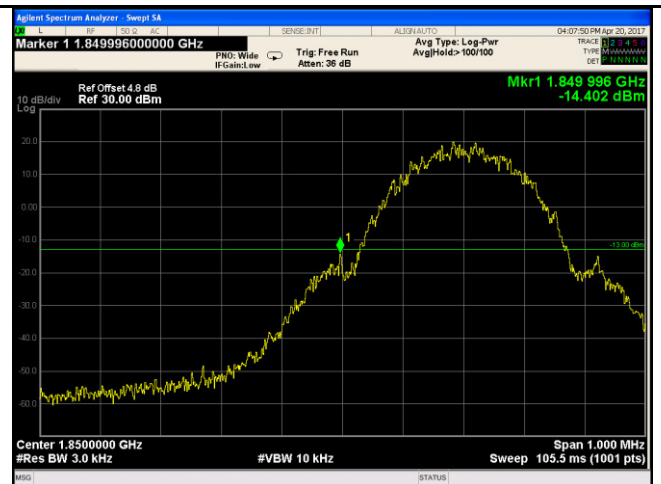

PCS Band - High Channel

Note: Offset=Cable loss (4.0) + 10log
(3.17/3)=4.5+0.3=4.8dB

Note: Offset=Cable loss (4.0) + 10log
(3.18/3)=4.5+0.3=4.8dB

GPRS:

Test Plots

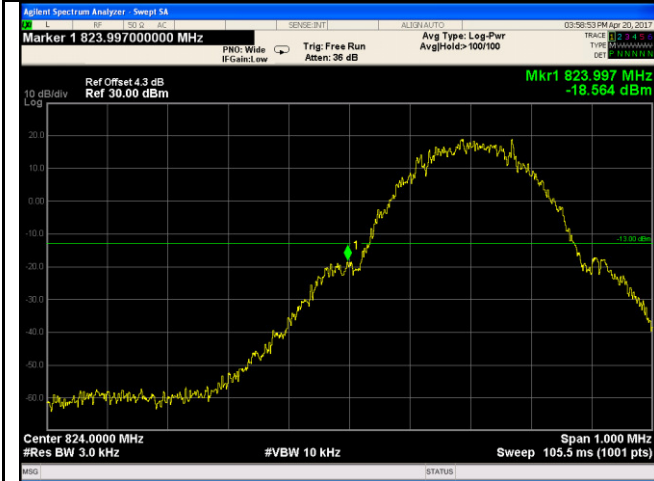

Cellular Band - Low Channel

Note: Offset=Cable loss (4.0) + 10log
(3.15/3)=4.0+0.3=4.3dB

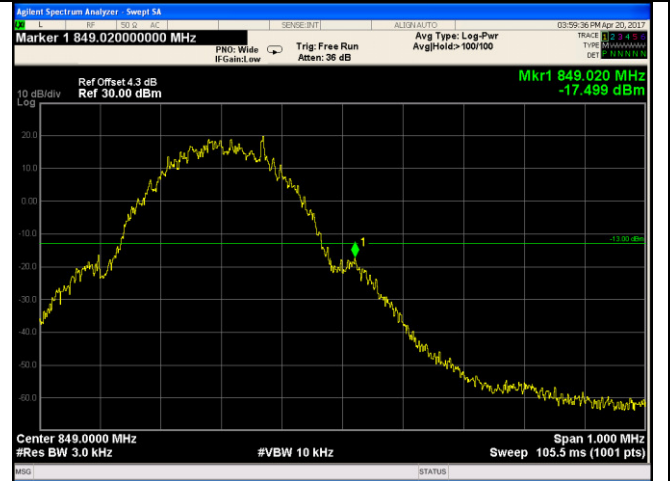

Cellular Band - High Channel

Note: Offset=Cable loss (4.0) + 10log
(3.15/3)=4.0+0.3=4.3dB

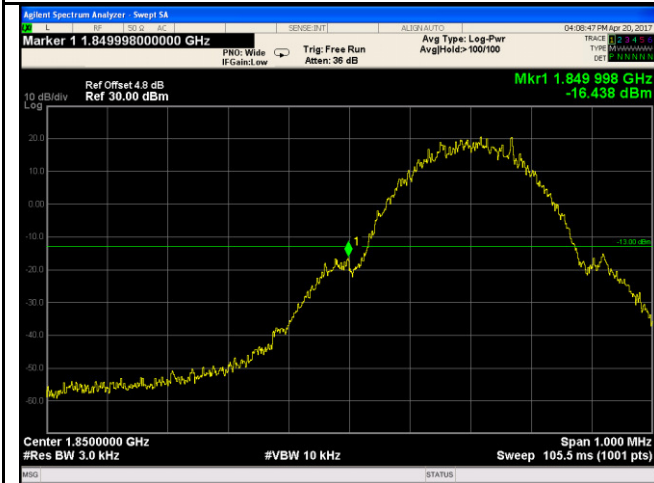

PCS Band - Low Channel

Note: Offset=Cable loss (4.5) + 10log
(3.18/3)=4.5+0.3=4.8dB

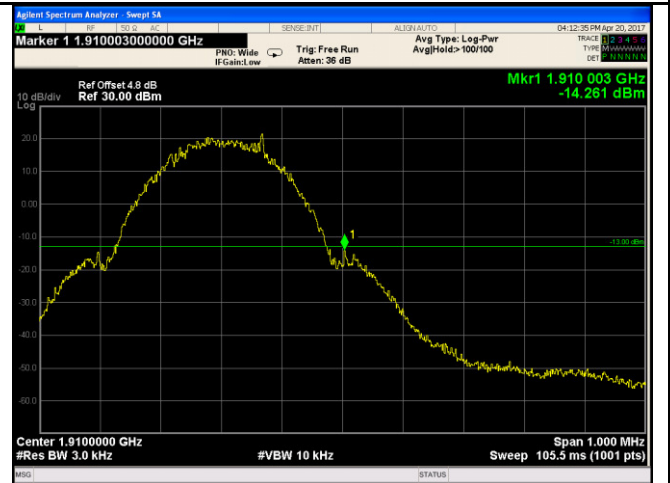

PCS Band - High Channel

Note: Offset=Cable loss (4.5) + 10log
(3.17/3)=4.5+0.3=4.8dB

EGPRS (MCS5):
Test Plots



Cellular Band - Low Channel

Note: Offset=Cable loss (4.0) + 10log
(3.17/3)=4.0+0.2=4.2dB

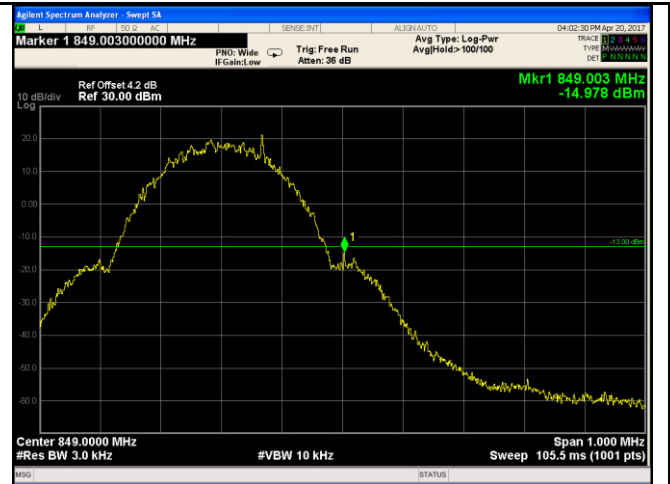

Cellular Band - High Channel

Note: Offset=Cable loss (4.0) + 10log
(3.14/3)=4.0+0.2=4.2dB

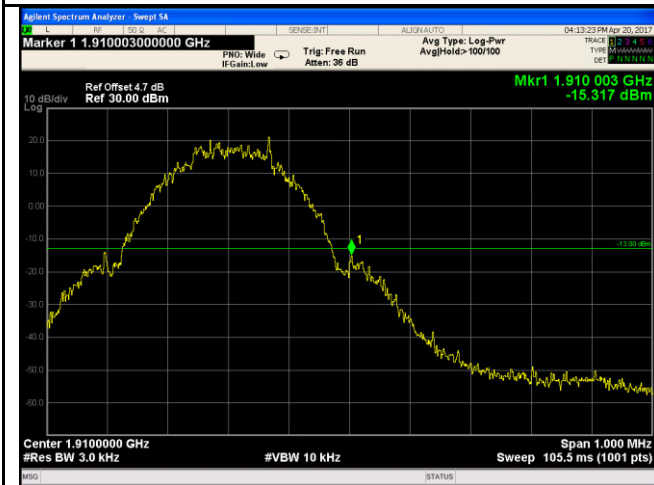

PCS Band - Low Channel

Note: Offset=Cable loss (4.5) + 10log
(3.18/3)=4.5+0.2=4.7dB



PCS Band - High Channel

Note: Offset=Cable loss (4.5) + 10log
(3.19/3)=4.5+0.3=4.8dB

RMC:

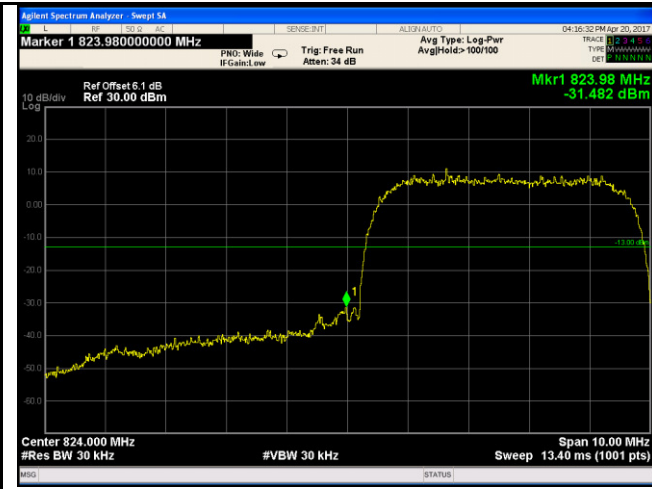

UMTS-FDD Band V - Low Channel

Note: Offset=Cable loss (4.0) + 10log
(48.54/30)=4.0+2.1=6.1 dB

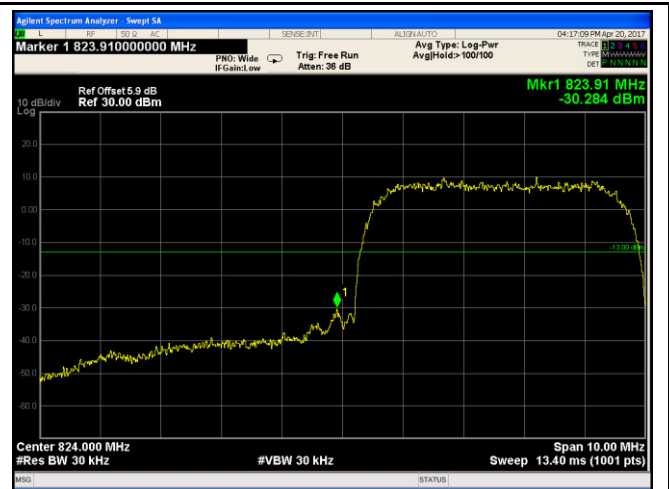

UMTS-FDD Band V - High Channel

Note: Offset=Cable loss (4.0) + 10log
(46.64/30)=4.0+1.9=5.9 dB

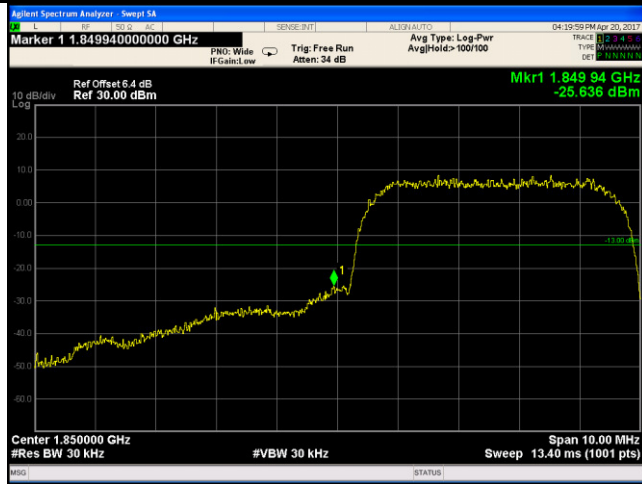

UMTS-FDD Band II - Low Channel

Note: Offset=Cable loss (4.5) + 10log
(46.99/30)=4.5+1.9=6.4 dB

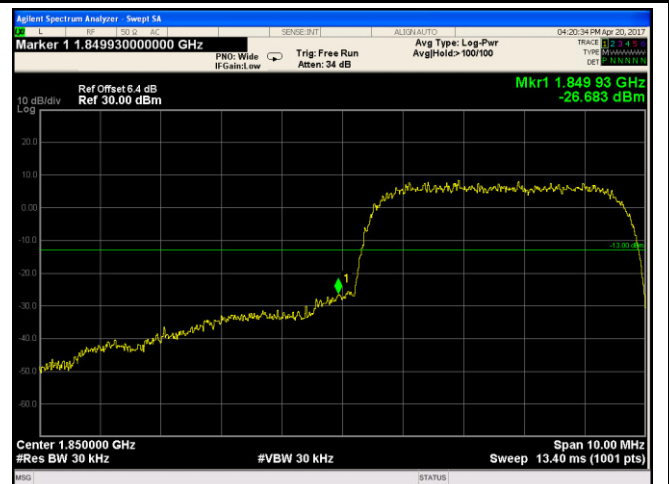

UMTS-FDD Band II - High Channel

Note: Offset=Cable loss (4.5) + 10log
(46.85/30)=4.5+1.9=6.4 dB

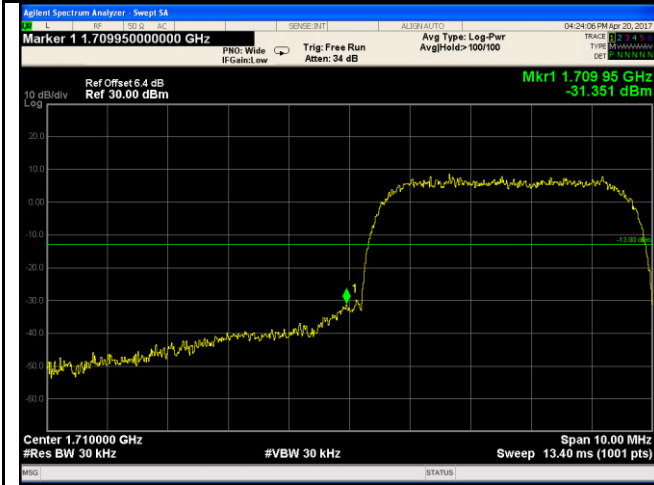

UMTS-FDD Band IV - Low Channel

Note: Offset=Cable loss (4.5) + 10log
(46.84/30)=4.5+1.9=6.4 dB

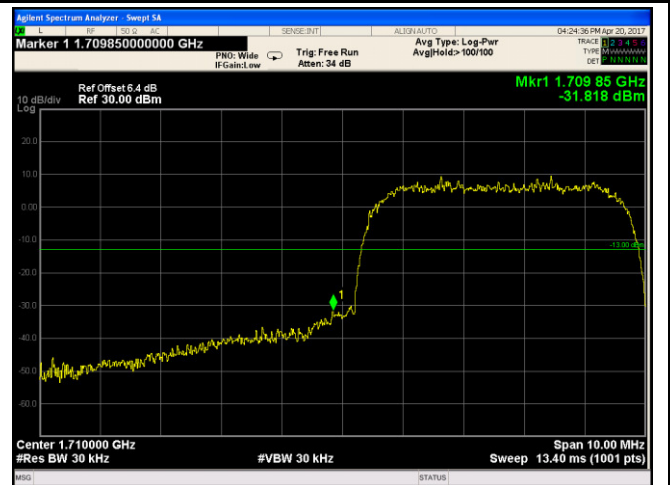

UMTS-FDD Band IV - High Channel

Note: Offset=Cable loss (4.0) + 10log
(46.76/30)=4.5+1.9=6.4 dB

HSUPA:

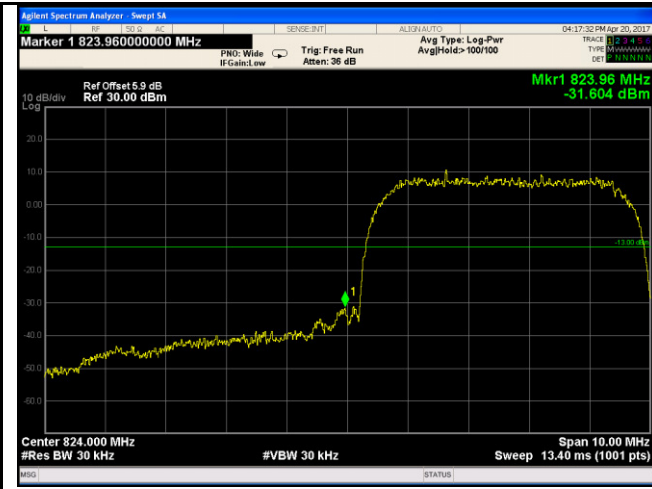

UMTS-FDD Band V - Low Channel

Note: Offset=Cable loss (4.0) + 10log
(46.83/30)=4.0+1.9=5.9 dB

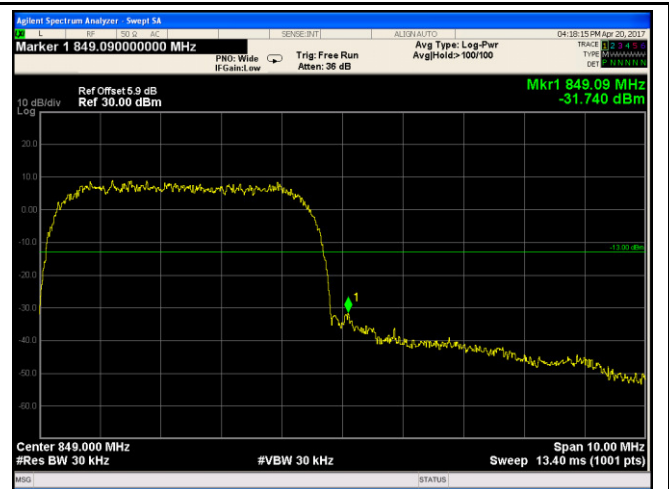

UMTS-FDD Band V - High Channel

Note: Offset=Cable loss (4.0) + 10log
(46.77/30)=4.0+1.9=5.9 dB



UMTS-FDD Band II - Low Channel

Note: Offset=Cable loss (4.5) + 10log
(46.65/30)=4.5+1.9=6.4 dB

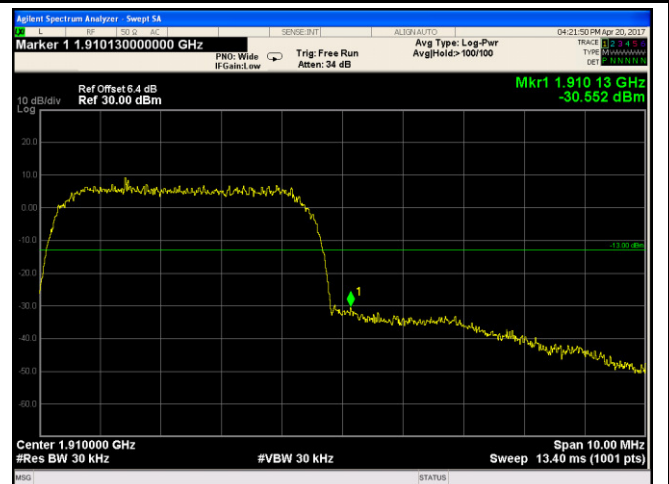

UMTS-FDD Band II - High Channel

Note: Offset=Cable loss (4.5) + 10log
(46.80/30)=4.5+1.9=6.4 dB

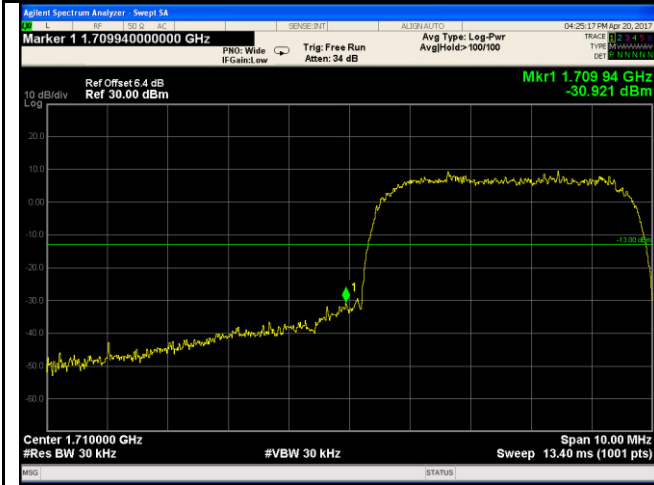

UMTS-FDD Band IV - Low Channel

Note: Offset=Cable loss (4.5) + 10log
(46.73/30)=4.5+1.9=6.4 dB



UMTS-FDD Band IV - High Channel

Note: Offset=Cable loss (4.5) + 10log
(47.16/30)=4.5+1.9=6.4 dB

HSDPA:

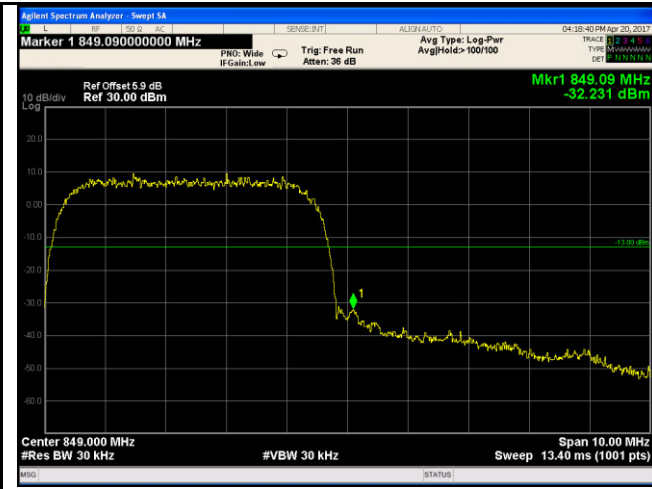

UMTS-FDD Band V - Low Channel

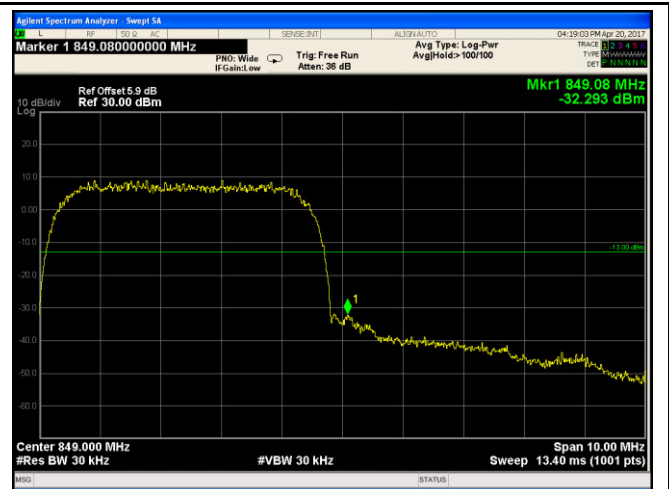

UMTS-FDD Band V - High Channel

Note: Offset=Cable loss (4.0) + 10log
(46.87/30)=4.0+1.9=5.9 dB

Note: Offset=Cable loss (4.0) + 10log
(46.87/30)=4.0+1.9=5.9 dB

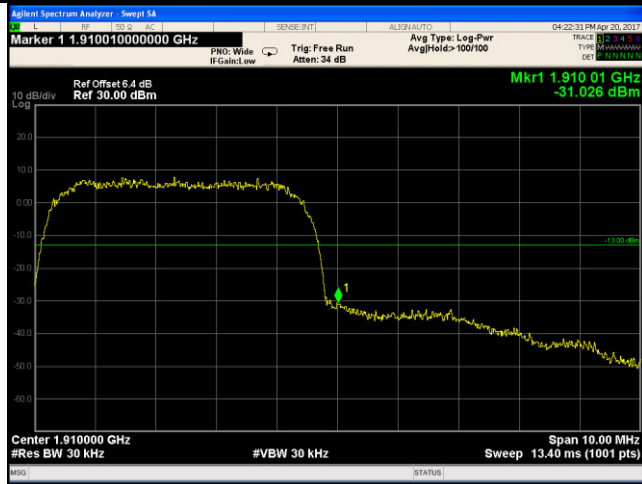

UMTS-FDD Band II - Low Channel

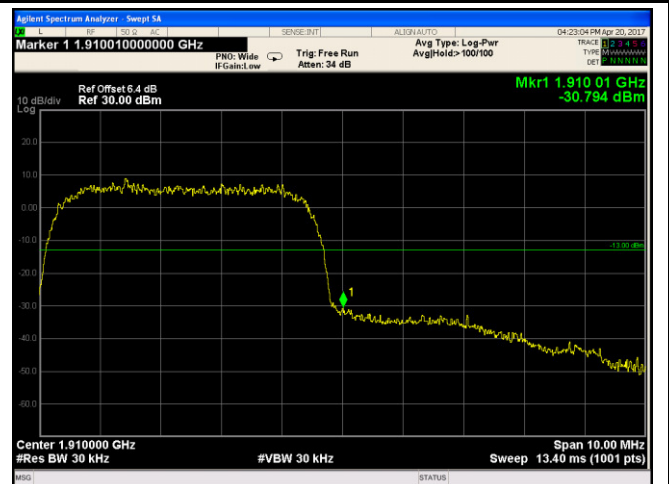

UMTS-FDD Band II - High Channel

Note: Offset=Cable loss (4.5) + 10log
(46.81/30)=4.5+1.9=6.4 dB

Note: Offset=Cable loss (4.5) + 10log
(46.83/30)=4.5+1.9=6.4 dB

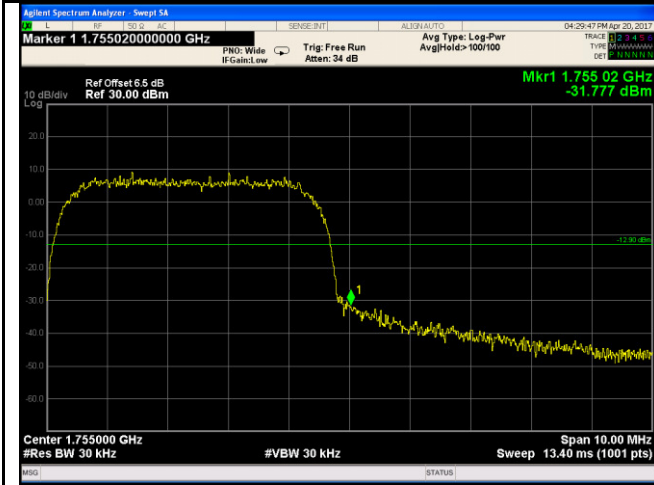

UMTS-FDD Band IV - Low Channel

Note: Offset=Cable loss (4.5) + 10log
(46.74/30)=4.5+2.0=6.5 dB

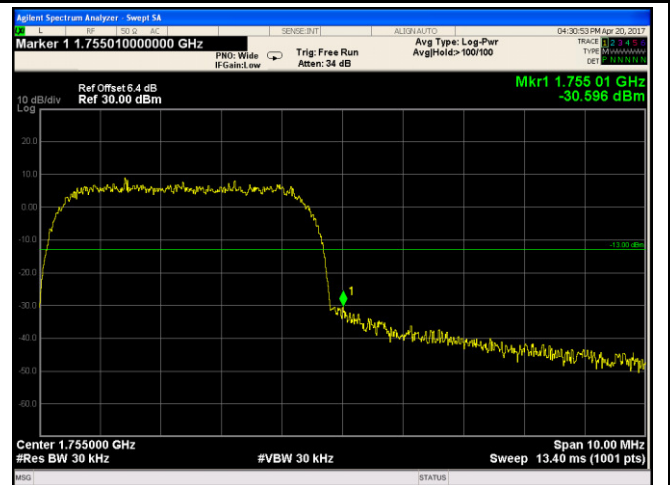

UMTS-FDD Band IV - High Channel

Note: Offset=Cable loss (4.5) + 10log
(46.70/30)=4.5+1.9=6.4 dB

6.8 Frequency Stability

Temperature	24 °C
Relative Humidity	52%
Atmospheric Pressure	1019mbar
Test date :	April 19, 2017
Tested By :	Loren Luo

Requirement(s):

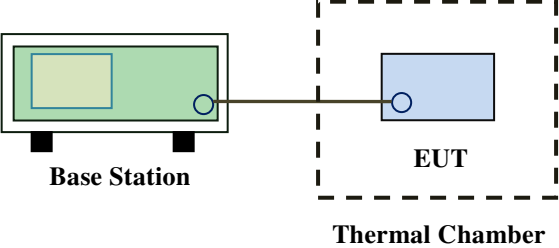
Spec	Item	Requirement	Applicable																																
§2.1055, §22.355 & §24.235 § 27.5(h); § 27.54	a)	According to §22.355, the carrier frequency of each transmitter in the Public Mobile Services must be maintained within the tolerances given in Table below: Frequency Tolerance for Transmitters in the Public Mobile Services <table border="1" data-bbox="459 1137 1265 1637"> <thead> <tr> <th>Frequency Range (MHz)</th> <th>Base, fixed (ppm)</th> <th>Mobile ≤ 3 watts (ppm)</th> <th>Mobile ≤ 3 watts (ppm)</th> </tr> </thead> <tbody> <tr> <td>25 to 50</td> <td>20.0</td> <td>20.0</td> <td>50.0</td> </tr> <tr> <td>50 to 450</td> <td>5.0</td> <td>5.0</td> <td>50.0</td> </tr> <tr> <td>450 to 512</td> <td>2.5</td> <td>5.0</td> <td>10.0</td> </tr> <tr> <td>821 to 896</td> <td>1.5</td> <td>2.5</td> <td>2.5</td> </tr> <tr> <td>928 to 929</td> <td>5.0</td> <td>N/A</td> <td>N/A</td> </tr> <tr> <td>929 to 960</td> <td>1.5</td> <td>N/A</td> <td>N/A</td> </tr> <tr> <td>2110 to 2220</td> <td>10.0</td> <td>N/A</td> <td>N/A</td> </tr> </tbody> </table>	Frequency Range (MHz)	Base, fixed (ppm)	Mobile ≤ 3 watts (ppm)	Mobile ≤ 3 watts (ppm)	25 to 50	20.0	20.0	50.0	50 to 450	5.0	5.0	50.0	450 to 512	2.5	5.0	10.0	821 to 896	1.5	2.5	2.5	928 to 929	5.0	N/A	N/A	929 to 960	1.5	N/A	N/A	2110 to 2220	10.0	N/A	N/A	<input checked="" type="checkbox"/>
		Frequency Range (MHz)	Base, fixed (ppm)	Mobile ≤ 3 watts (ppm)	Mobile ≤ 3 watts (ppm)																														
25 to 50	20.0	20.0	50.0																																
50 to 450	5.0	5.0	50.0																																
450 to 512	2.5	5.0	10.0																																
821 to 896	1.5	2.5	2.5																																
928 to 929	5.0	N/A	N/A																																
929 to 960	1.5	N/A	N/A																																
2110 to 2220	10.0	N/A	N/A																																
According to §24.235, the frequency stability shall be sufficient to ensure that the fundamental emissions stay within the authorized frequency block.																																			
Test setup		 <p style="text-align: center;"> Base Station EUT Thermal Chamber </p>																																	

Test Report	17070263-FCC-R1
Page	82 of 104

Procedure	<p>A communication link was established between EUT and base station. The frequency error was monitored and measured by base station under variation of ambient temperature and variation of primary supply voltage.</p> <p>Limit: The frequency stability of the transmitter shall be maintained within $\pm 0.00025\%$ ($\pm 2.5\text{ppm}$) of the center frequency.</p>
Remark	
Result	<input checked="" type="checkbox"/> Pass <input type="checkbox"/> Fail

Test Data Yes N/A

Test Plot Yes (See below) N/A

GSM Voice:

Cellular Band (Part 22H) result

Middle Channel, $f_0 = 836.6$ MHz				
Temperature (°C)	Power Supplied (V _{DC})	Frequency Error (Hz)	Frequency Error (ppm)	Limit (ppm)
-10	3.7	20	0.0239	2.5
0		16	0.0191	2.5
10		15	0.0179	2.5
20		18	0.0215	2.5
30		19	0.0227	2.5
40		17	0.0203	2.5
50		15	0.0179	2.5
55		20	0.0239	2.5
25	4.2	16	0.0191	2.5
	3.5	18	0.0215	2.5

PCS Band (Part 24E) result

Middle Channel, $f_0 = 1880$ MHz				
Temperature (°C)	Power Supplied (V _{DC})	Frequency Error (Hz)	Frequency Error (ppm)	Limit (ppm)
-10	3.7	14	0.0074	2.5
0		16	0.0085	2.5
10		13	0.0069	2.5
20		18	0.0096	2.5
30		17	0.0090	2.5
40		15	0.0080	2.5
50		12	0.0064	2.5
55		14	0.0074	2.5
25	4.2	19	0.0101	2.5
	3.5	15	0.0080	2.5

RMC:

UMTS-FDD Band V (Part 22H)

Middle Channel, $f_0 = 835$ MHz				
Temperature (°C)	Power Supplied (V _{DC})	Frequency Error (Hz)	Frequency Error (ppm)	Limit (ppm)
-10	3.7	16	0.0192	2.5
0		15	0.0180	2.5
10		14	0.0168	2.5
20		19	0.0228	2.5
30		12	0.0144	2.5
40		18	0.0216	2.5
50		17	0.0204	2.5
55		11	0.0132	2.5
25	4.2	16	0.0192	2.5
	3.5	13	0.0156	2.5

UMTS-FDD Band II (Part 24E)

Middle Channel, $f_0 = 1880$ MHz				
Temperature (°C)	Power Supplied (V _{DC})	Frequency Error (Hz)	Frequency Error (ppm)	Limit (ppm)
-10	3.7	16	0.0085	2.5
0		12	0.0064	2.5
10		15	0.0080	2.5
20		11	0.0059	2.5
30		12	0.0064	2.5
40		15	0.0080	2.5
50		11	0.0059	2.5
55		13	0.0069	2.5
25	4.2	16	0.0085	2.5
	3.5	14	0.0074	2.5

UMTS-FDD Band IV (Part 27)

Middle Channel, $f_0 = 1733$ MHz				
Temperature (°C)	Power Supplied (V _{DC})	Frequency Error (Hz)	Frequency Error (ppm)	Limit (ppm)
-10	3.7	16	0.0192	2.5
0		18	0.0216	2.5
10		19	0.0228	2.5
20		17	0.0204	2.5
30		13	0.0156	2.5
40		17	0.0204	2.5
50		15	0.0180	2.5
55		14	0.0168	2.5
25		4.2	19	0.0228
	3.5	15	0.0180	2.5

Annex A. TEST INSTRUMENT

Instrument	Model	Serial #	Cal Date	Cal Due	In use
RF Conducted Test					
Agilent ESA-E SERIES SPECTRUM ANALYZER	E4407B	MY45108319	09/15/2016	09/14/2017	<input checked="" type="checkbox"/>
Power Splitter	1#	1#	08/31/2016	08/30/2017	<input checked="" type="checkbox"/>
Universal Radio Communication Tester	CMU200	121393	09/24/2016	09/23/2017	<input checked="" type="checkbox"/>
Temperature/Humidity Chamber	UHL-270	001	10/08/2016	10/07/2017	<input checked="" type="checkbox"/>
DC Power Supply	E3640A	MY40004013	09/16/2016	09/15/2017	<input checked="" type="checkbox"/>
RF Power Sensor	Dare RPR3006C/P/W	AY554013	09/16/2016	09/15/2017	<input checked="" type="checkbox"/>
Radiated Emissions					
EMI test receiver	ESL6	100262	09/16/2016	09/15/2017	<input checked="" type="checkbox"/>
OPT 010 AMPLIFIER (0.1-1300MHz)	8447E	2727A02430	08/31/2016	08/30/2017	<input checked="" type="checkbox"/>
Microwave Preamplifier (1 ~ 26.5GHz)	8449B	3008A02402	03/23/2017	03/22/2018	<input checked="" type="checkbox"/>
Bilog Antenna (30MHz~6GHz)	JB6	A110712	09/20/2016	09/19/2017	<input checked="" type="checkbox"/>
Bilog Antenna (30MHz~2GHz)	JB1	A112017	09/20/2016	09/19/2017	<input checked="" type="checkbox"/>
Double Ridge Horn Antenna (1 ~18GHz)	AH-118	71259	09/23/2016	09/22/2017	<input checked="" type="checkbox"/>
Double Ridge Horn Antenna (1 ~18GHz)	AH-118	71283	09/23/2016	09/22/2017	<input checked="" type="checkbox"/>
SYNTHESIZED SIGNAL GENERATOR	8665B	3744A01293	09/16/2016	09/15/2017	<input checked="" type="checkbox"/>
Power Amplifier	SMC150D	R1553-0313	03/08/2017	03/07/2018	<input checked="" type="checkbox"/>
Power Amplifier	S41-25D	R1553-0314	05/27/2016	05/26/2017	<input checked="" type="checkbox"/>
Tunable Notch Filter	3NF-800/1000-S	AA4	08/31/2016	08/30/2017	<input checked="" type="checkbox"/>



Test Report	17070263-FCC-R1
Page	87 of 104

Tunable Notch Filter	3NF- 1000/2000-S	AM 4	08/31/2016	08/30/2017	<input checked="" type="checkbox"/>
----------------------	---------------------	------	------------	------------	-------------------------------------

Annex B. EUT And Test Setup Photographs

Annex B.i. Photograph: EUT External Photo

Whole Package View



Adapter - Front View

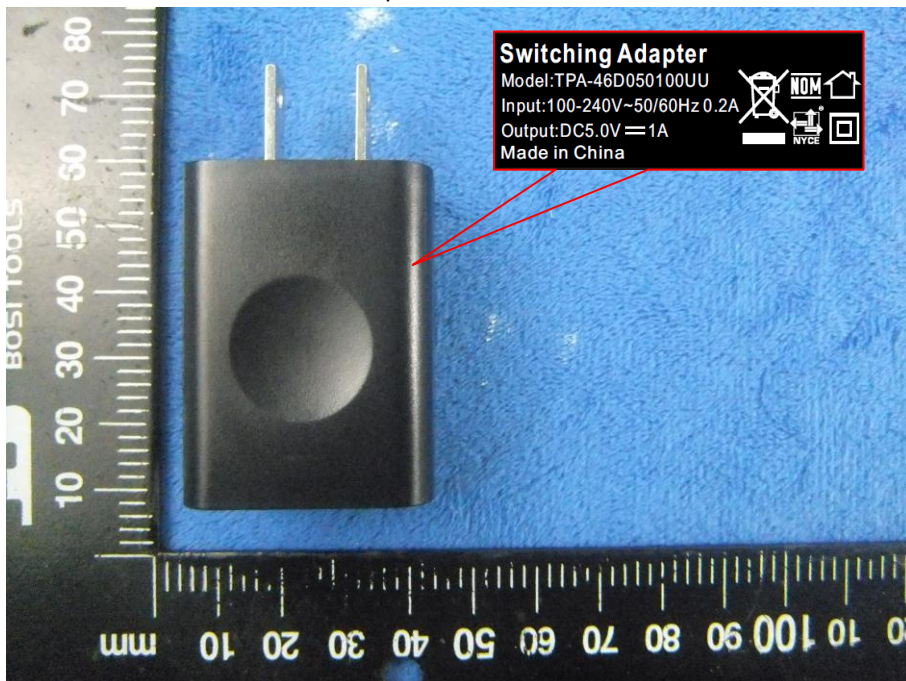

EUT - Front View



EUT - Rear View



EUT - Top View



EUT - Bottom View

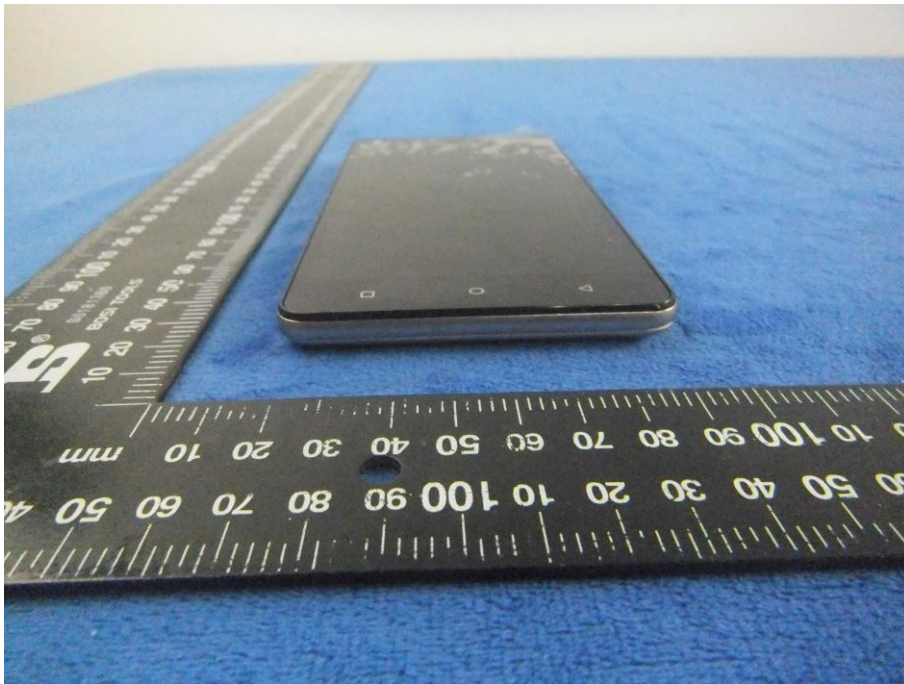

EUT - Left View



EUT - Right View

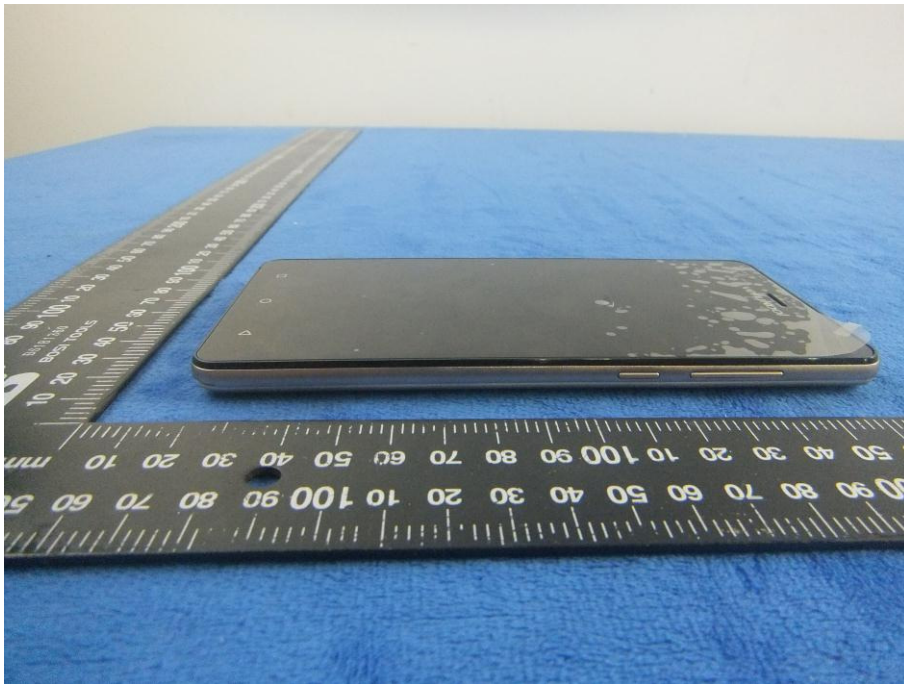

Annex B.ii. Photograph: EUT Internal Photo

Cover Off - Top View 1



Cover Off - Top View 2



Battery - Front View



Battery - Rear View



Mainboard – Front View

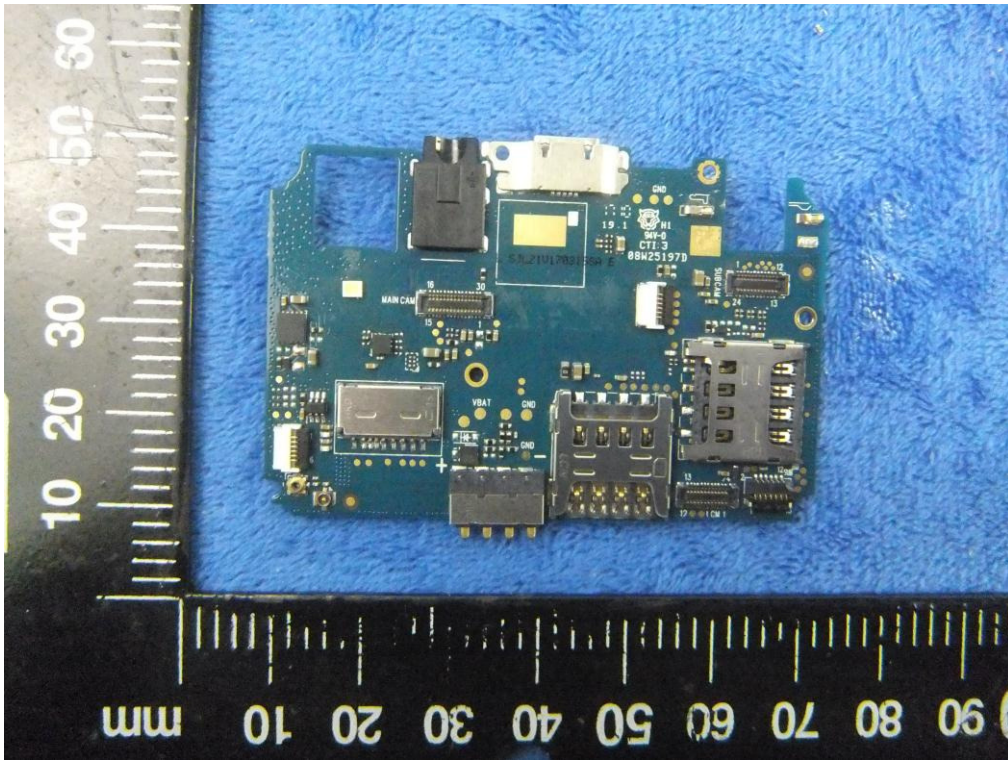

Mainboard with Shielding - Rear View

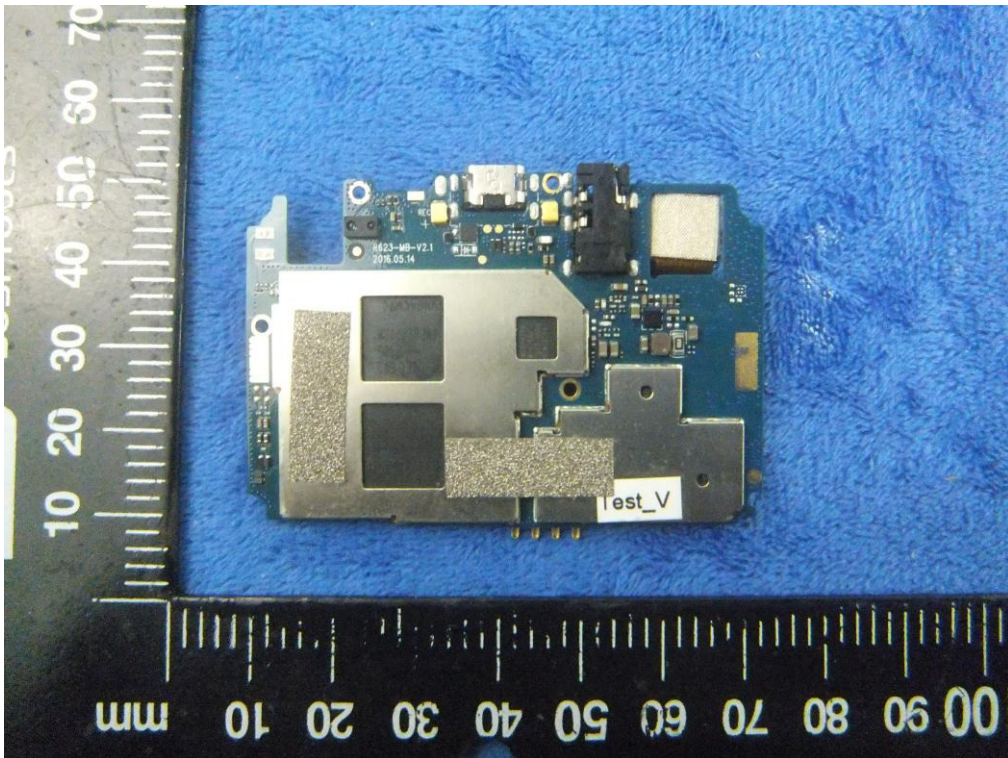

Mainboard without Shielding - Rear View

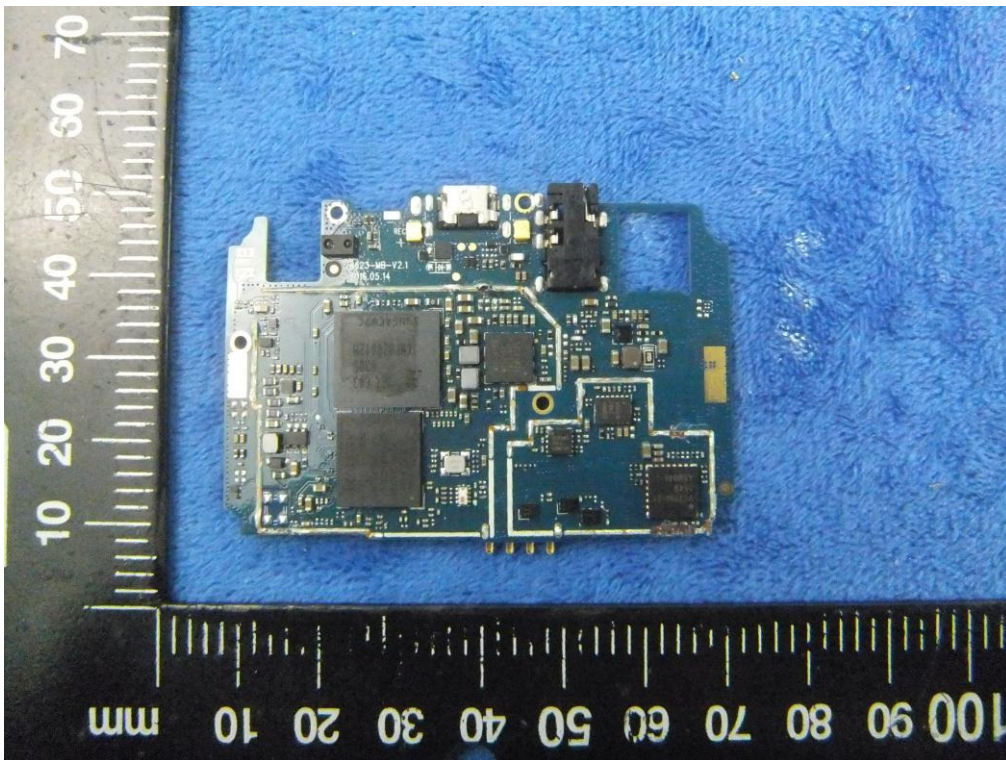

Small Mainboard - Front View

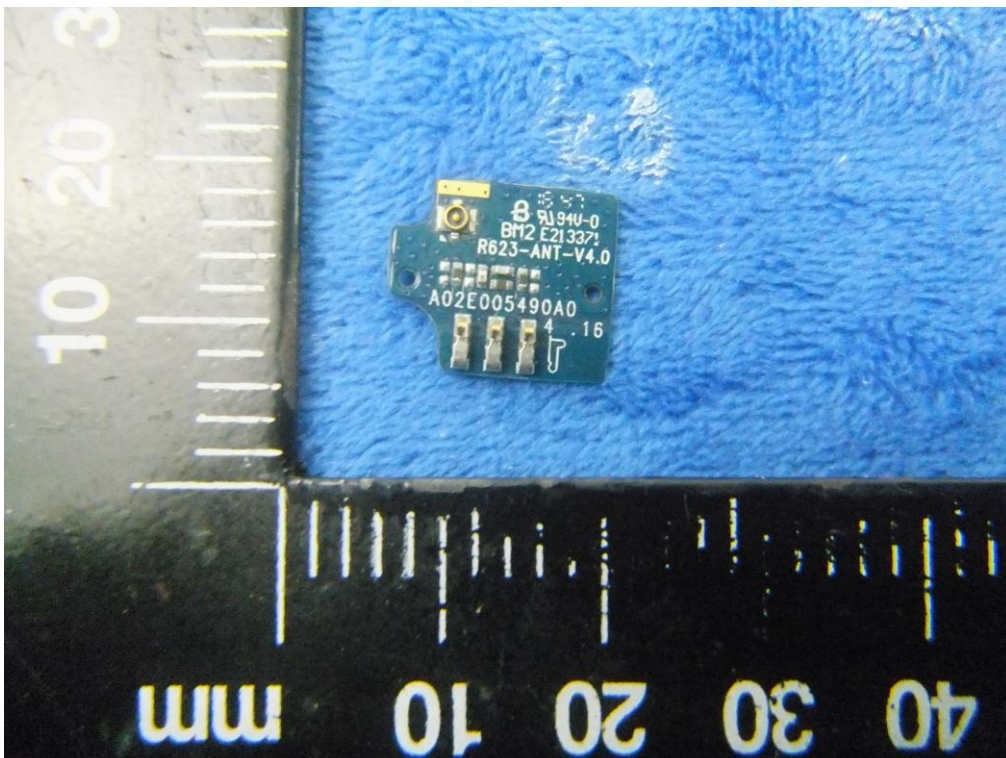

Small Mainboard - Rear View

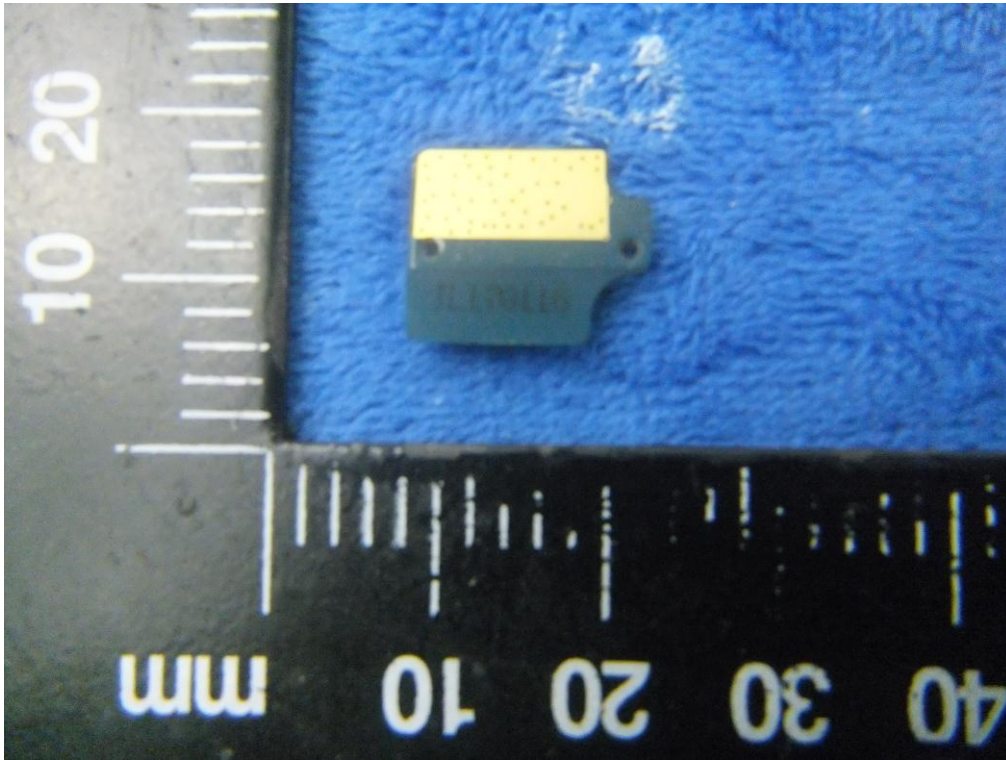

LCD - Front View



LCD – Rear View

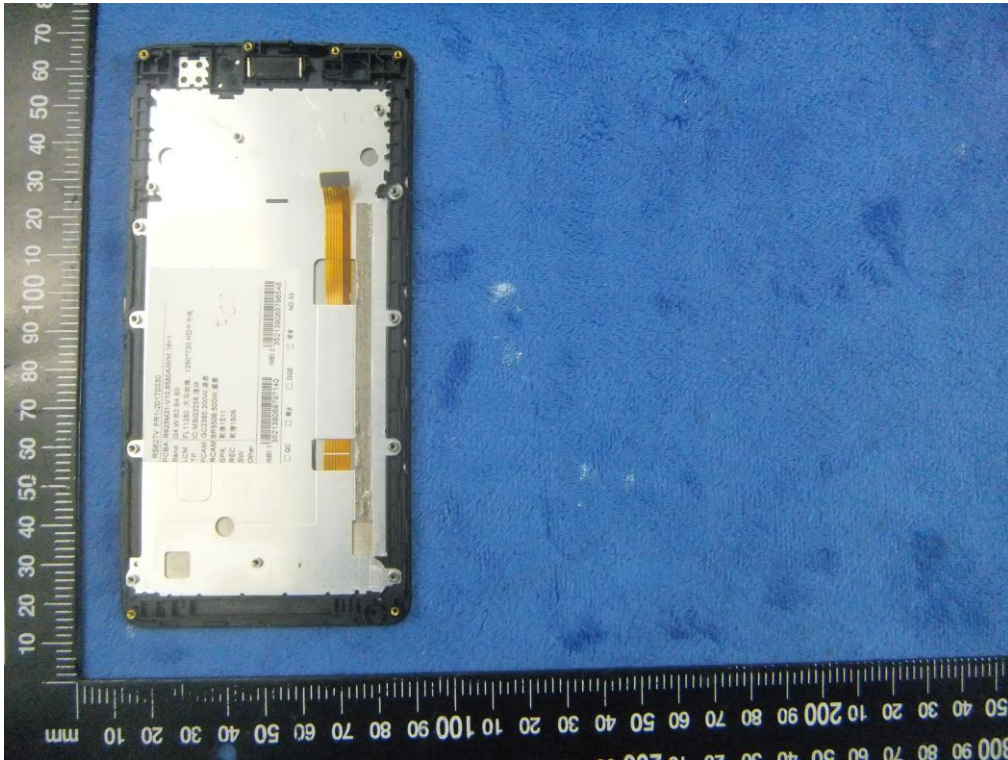

GSM/PCS/UMTS - Antenna View



WIFI/BT/BLE/GPS - Antenna View

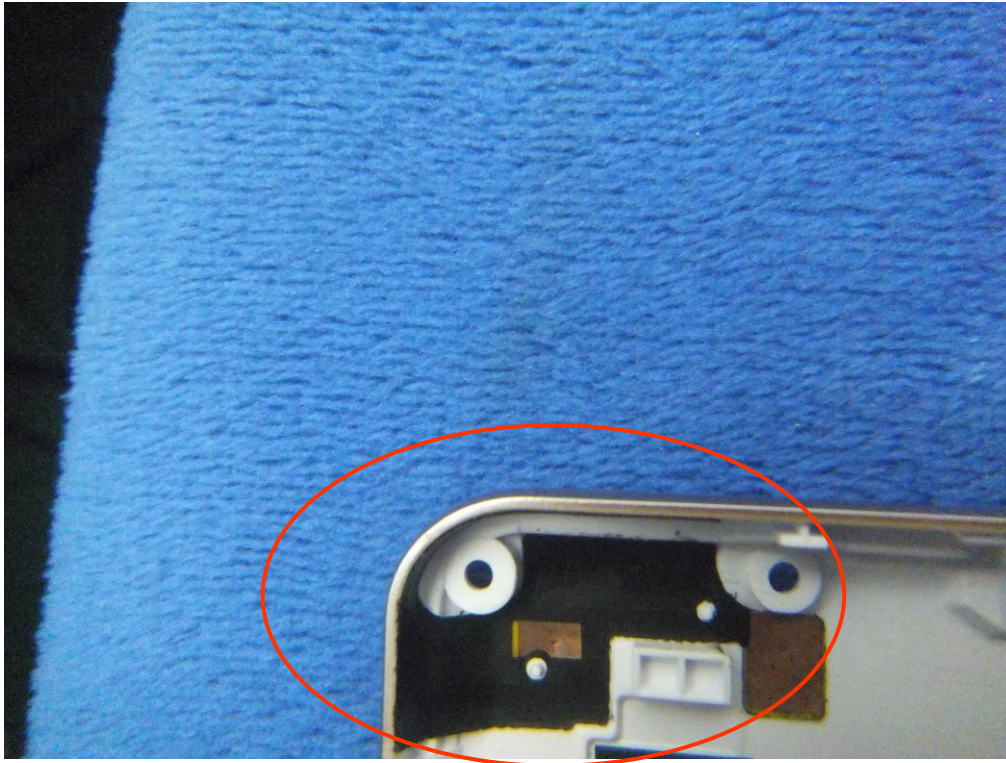

Annex B.iii. Photograph: Test Setup Photo

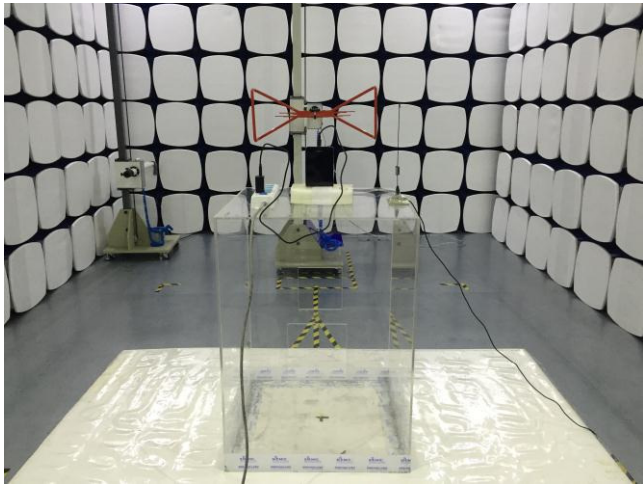

Radiated Spurious Emissions Test Setup Below 1GHz

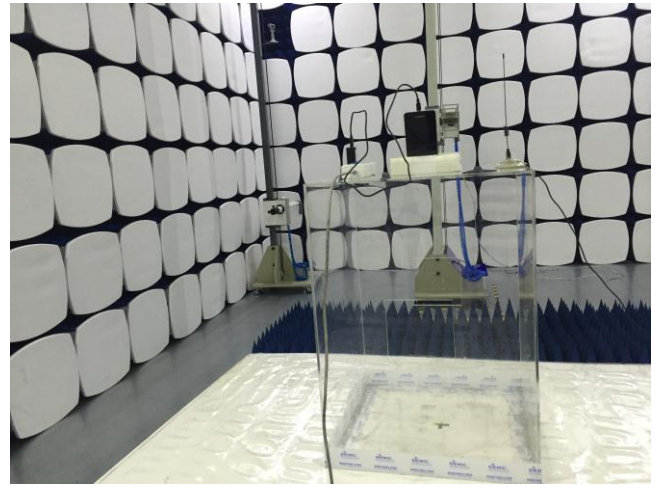

Radiated Spurious Emissions Test Setup Above
1GHz

Annex C. TEST SETUP AND SUPPORTING EQUIPMENT

Annex C.ii. TEST SET UP BLOCK

Block Configuration Diagram for Radiated Emissions

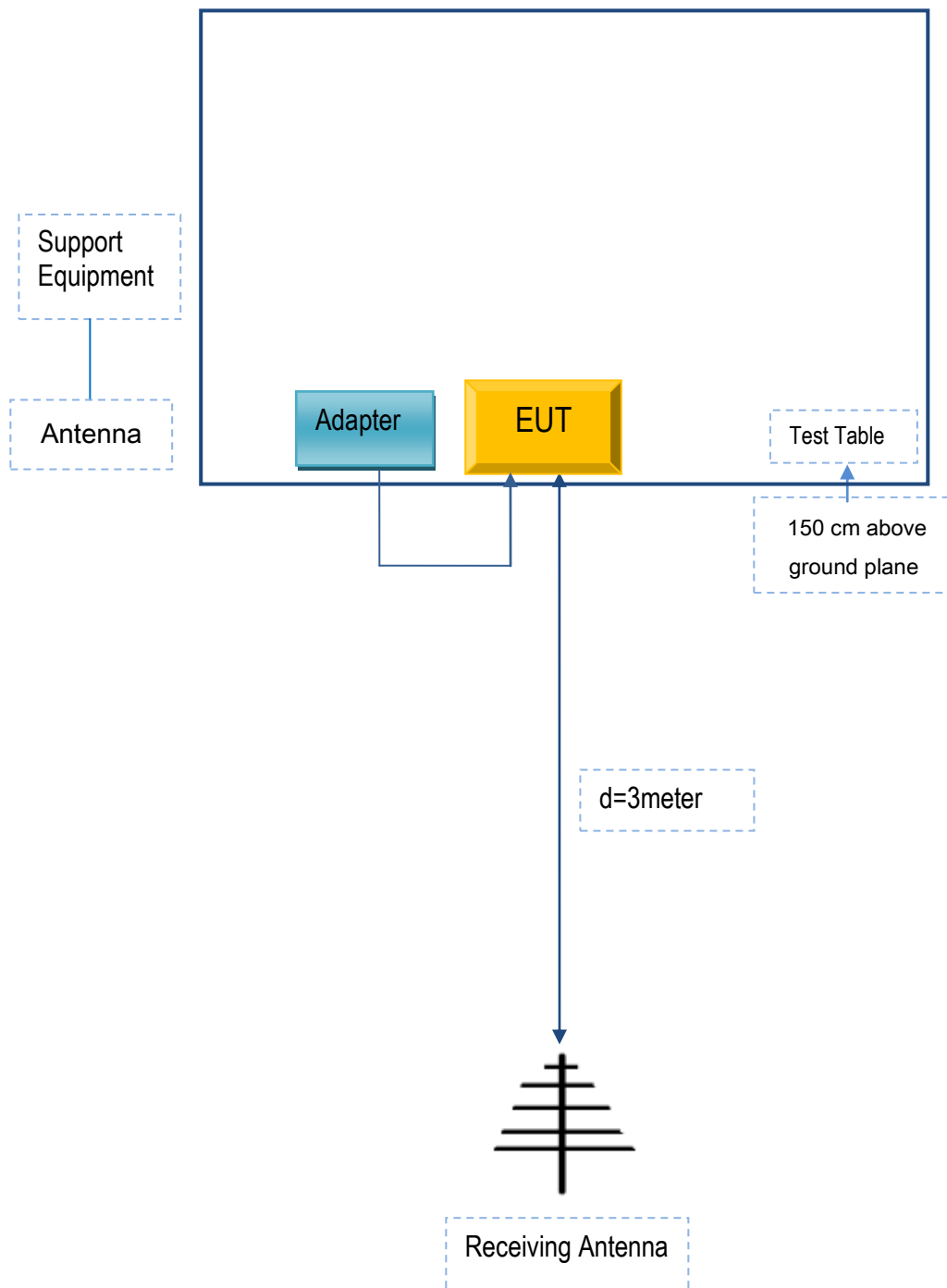

Annex C. ii. SUPPORTING EQUIPMENT DESCRIPTION

The following is a description of supporting equipment and details of cables used with the EUT.

Supporting Equipment:

Manufacturer	Equipment Description	Model	Serial No
Verykool USA Inc	Adapter	TPA-46D050100UU	SA020

Supporting Cable:

Cable type	Shield Type	Ferrite Core	Length	Serial No
USB Cable	Un-shielding	No	0.8m	SA020

Annex C.ii. EUT OPERATING CONKITIONS

N/A

Test Report	17070263-FCC-R1
Page	103 of 104

Annex D. User Manual / Block Diagram / Schematics / Partlist

Please see the attachment

Test Report	17070263-FCC-R1
Page	104 of 104

Annex E. DECLARATION OF SIMILARITY

N/A