

# Verykool USA Inc

## Mobile phone

Main Model:s4510

Serial Model: N/A

July 18, 2014



Report No.: 14070326-FCC-R4

(This report supersedes NONE)



Modifications made to the product : None

This Test Report is Issued Under the Authority of:

		
Wiky Jam Compliance Engineer	Alex Liu Technical Manager	

This test report may be reproduced in full only.  
Test result presented in this test report is applicable to the representative sample only.

# RF Test Report

## To: FCC Part 27: 2013

SIEMIC, INC.  
Assessing global markets



## Laboratory Introduction

SIEMIC, headquartered in the heart of Silicon Valley, with superior facilities in US and Asia, is one of the leading independent testing and certification facilities providing customers with one-stop shop services for Compliance Testing and Global Certifications.



In addition to [testing](#) and [certification](#), SIEMIC provides initial design reviews and [compliance management](#) through out a project. Our extensive experience with [China](#), [Asia Pacific](#), [North America](#), [European](#), and [international](#) compliance requirements, assures the fastest, most cost effective way to attain regulatory compliance for the [global markets](#).

### SIEMIC (Shenzhen - China) Laboratories Accreditations for Conformity Assessment

Country/Region	Scope
USA	EMC , RF/Wireless , Telecom
Canada	EMC, RF/Wireless , Telecom
Taiwan	EMC, RF, Telecom , Safety
Hong Kong	RF/Wireless ,Telecom
Australia	EMC, RF, Telecom , Safety
Korea	EMI, EMS, RF , Telecom, Safety
Japan	EMI, RF/Wireless, Telecom
Singapore	EMC , RF , Telecom
Europe	EMC, RF, Telecom , Safety

This page has been left blank intentionally.

# CONTENTS

<b>1. EXECUTIVE SUMMARY &amp; EUT INFORMATION.....</b>	<b>5</b>
<b>2. TECHNICAL DETAILS.....</b>	<b>6</b>
<b>3. MODIFICATION.....</b>	<b>7</b>
<b>3. TEST SUMMARY.....</b>	<b>8</b>
<b>4. MEASUREMENTS, EXAMINATION AND DERIVED RESULTS.....</b>	<b>9</b>
<b>ANNEX A. TEST INSTRUMENT &amp; METHOD.....</b>	<b>28</b>
<b>ANNEX B. EUT AND TEST SETUP PHOTOGRAPHS.....</b>	<b>31</b>
<b>ANNEX C. TEST SETUP AND SUPPORTING EQUIPMENT.....</b>	<b>42</b>
<b>ANNEX D.USER MANUAL / BLOCK DIAGRAM / SCHEMATICS / PART LIST.....</b>	<b>45</b>
<b>ANNEX E. DECLARATION OF SIMILARITY.....</b>	<b>46</b>

# 1. EXECUTIVE SUMMARY & EUT INFORMATION

**The purpose of this test programmed was to demonstrate compliance of the Verykool USA Inc, Mobile phone and model: s4510 against the current Stipulated Standards. The Mobile phone has demonstrated compliance with the FCC Part 27: 2013.**

<b><u>EUT Information</u></b>
-------------------------------

**EUT**

**Description : Mobile phone**

**Main Model : s4510**

**Serial Model : N/A**

**Antenna Gain : AWS1700: -2.5 dBi**

**Battery:**

**Model: Ar715144**

**Spec: 3.7V 1650mAh**

**Input Power : Limited charger voltage: 4.2V**

**Adapter:**

**Model: UC26A50100**

**Input: AC 100-240V; 50/60Hz 150mA**

**Output: DC 5.0V; 1A**

**Maximum Conducted AV Power to Antenna : UMTS-FDD Band IV: 22.17 dBm**

**Maximum Radiated EIRP : UMTS-FDD Band IV: 18.21 dBm**

**Classification Per Stipulated Test Standard : FCC Part 27: 2013**

## 2. TECHNICAL DETAILS

<b>Purpose</b>	<b>Compliance testing of Mobile phone with stipulated standard</b>
<b>Applicant / Client</b>	<b>Verykool USA Inc 3636 Nobel Drive, Suite 325, San Diego, CA 92122 USA</b>
<b>Manufacturer</b>	<b>ZTE Supply Chain Co.,Ltd. 6/F, South Wing, WanDeLai Building, Keji Road South, Hi-Tech Park, Nanshan District, Shenzhen, P.R.China, 518057</b>
<b>Laboratory performing the tests</b>	<b>SIEMIC (Shenzhen - China) Laboratories Zone A, Floor 1, Building 2, Wan Ye Long Technology Park, South Side of Zhoushi Road, Bao'an District, Shenzhen, Guangdong, China Tel: +86-0755-2601 4629 / 2601 4953 Fax: +86-0755-2601 4953-810 Email: China@siemic.com.cn</b>
<b>Test report reference number</b>	<b>14070326-FCC-R4</b>
<b>Date EUT received</b>	<b>June 23, 2014</b>
<b>Standard applied</b>	<b>FCC Part 27: 2013</b>
<b>Dates of test</b>	<b>July 01 to July 04, 2014</b>
<b>No of Units</b>	<b>#1</b>
<b>Equipment Category</b>	<b>PCE</b>
<b>Trade Name</b>	<b>verykool</b>
<b>RF Operating Frequency (ies)</b>	<b>UMTS-FDD Band IVTX :1712.4 ~ 1752.6 MHz; RX : 2112.4 ~ 2152.6 MHz</b>
<b>Number of Channels</b>	<b>UMTS-FDD Band IV: 202CH</b>
<b>Modulation</b>	<b>UMTS-FDD: QPSK</b>
<b>FCC ID</b>	<b>WA6S4510</b>

# 3 MODIFICATION

NONE

### **3. TEST SUMMARY**

**The product was tested in accordance with the following specifications.  
 All testing has been performed according to below product classification:**

**PCE**

**Test Results Summary**

Test Standard	Description	Product Class	Pass / Fail
§ 1.1307, § 2.1093	RF Exposure (SAR)	See Above	Pass
§2.1046; § 27.50(c.10); § 27.50(d.4)	RF Output Power	See Above	Pass
§ 2.1047	Modulation Characteristics	See Above	N/A
§ 2.1049; § 27.53(a.5)	99% & -26 dB Occupied Bandwidth	See Above	Pass
§ 2.1051, § 27.53(h)	Spurious Emissions at Antenna Terminal	See Above	Pass
§ 2.1053 § 27.53(h)	Field Strength of Spurious Radiation	See Above	Pass
§ 27.53(h)	Out of band emission, Band Edge	See Above	Pass
§ 2.1055 § 27.5(h); § 27.54	Frequency stability vs. temperature Frequency stability vs. voltage	See Above	Pass

*Note: Testing was performed by configuring EUT to maximum output power status, the declared output power class for different.*



## **4. MEASUREMENTS, EXAMINATION AND DERIVED RESULTS**

### **5.1 §1.1307, §2.1093- RF Exposure (SAR)**

**Test Result: Pass**

The EUT is a portable device, thus requires SAR evaluation;  
Please refer to SIEMIC SAR Report: 14070326-FCC-H

## **5.2 §2.1046; § 27.50(c.10); § 27.50(d.4) - RF Output Power**

1. **Conducted Measurement**  
EUT was set for low, mid, high channel with modulated mode and highest RF output power. The spectrum analyzer was connected to the antenna terminal.
2. **Conducted Emissions Measurement Uncertainty**  
All test measurements carried out are traceable to national standards. The uncertainty of the measurement at a confidence level of approximately 95% (in the case where distributions are normal), with a coverage factor of 2, in the range 30MHz – 40GHz is  $\pm 1.5$ dB.
3. **Environmental Conditions**

Temperature	20°C
Relative Humidity	50%
Atmospheric Pressure	1001mbar
4. Test date : July 01, 2014  
Tested By : Wiky Jam

### **Procedures: (According with KDB 971168)**

#### **For Conducted Power:**

1. The transmitter output port was connected to base station.
2. Set EUT at maximum power through base station.
3. Select lowest, middle, and highest channels for each band and different test mode.
4. The instrument must have an available measurement/resolution bandwidth that is equal to or exceeds the OBW. If this capability is available, then the following procedure can be used to determine the total peak output power.
  - a) Set the RBW  $\geq$  OBW.
  - b) Set VBW  $\geq 3 \times$  RBW.
  - c) Set span  $\geq 2 \times$  RBW
  - d) Sweep time = auto couple.
  - e) Detector = peak.
  - f) Ensure that the number of measurement points  $\geq$  span/RBW.
  - g) Trace mode = max hold.
  - h) Allow trace to fully stabilize.
  - 1) Use the peak marker function to determine the peak amplitude level.

#### **For ERP/EIRP: (According with TIA 603D)**

1. The transmitter was placed on a wooden turntable, and it was transmitting into a non-radiating load which was also placed on the turntable.
2. The measurement antenna was placed at a distance of 3 meters from the EUT. During the tests, the antenna height and polarization as well as EUT azimuth were varied in order to identify the maximum level of emissions from the EUT. The test was performed by placing the EUT on 3-orthogonal axis.
3. Remove the EUT and replace it with substitution antenna. A signal generator was connected to the substitution antenna by a non-radiating cable. The absolute levels of the spurious emissions were measured by the substitution.

#### **Sample Calculation:**

EUT Field Strength (dBm) = Reading (Signal generator) + Antenna Gain (substitution antenna) - Cable loss (From Signal Generator to substitution antenna)

### **Test Result: Pass**

**Remark:** Conducted Burst Average power for reporting purposes only

**Conducted Power**

**UMTS Mode:**

**UMTS-FDD Band IV**

Band/ Time Slot configuration	Channel	Frequency	Average power (dBm)
RMC 12.2kbps	1313	1712.6	22.02
	1413	1732.6	22.08
	1512	1752.4	<b>22.17</b>
HSDPA Subtest1	1313	1712.6	21.26
	1413	1732.6	21.30
	1512	1752.4	21.35
HSDPA Subtest2	1313	1712.6	21.53
	1413	1732.6	21.57
	1512	1752.4	21.60
HSDPA Subtest3	1313	1712.6	21.32
	1413	1732.6	21.35
	1512	1752.4	21.39
HSDPA Subtest4	1313	1712.6	21.22
	1413	1732.6	21.25
	1512	1752.4	21.28
HSUPA Subtest1	1313	1712.6	21.76
	1413	1732.6	21.81
	1512	1752.4	21.83
HSUPA Subtest2	1313	1712.6	21.62
	1413	1732.6	21.66
	1512	1752.4	21.69
HSUPA Subtest3	1313	1712.6	21.42
	1413	1732.6	21.46
	1512	1752.4	21.50
HSUPA Subtest4	1313	1712.6	21.34
	1413	1732.6	21.35
	1512	1752.4	21.39
HSUPA Subtest5	1313	1712.6	21.13
	1413	1732.6	21.16
	1512	1752.4	21.18

**EIRP (worst case)**

**EIRP for AWS Band (Part 27)**

Frequency (MHz)	Substituted level (dBm)	Antenna Polarization	Antenna Gain correction (dBi)	Cable Loss (dB)	Absolute Level (dBm)	Limit (dBm)
1712.4	11.12	V	7.76	0.82	18.06	30
1712.4	11.27	H	7.76	0.82	<b>18.21</b>	30
1732.6	10.95	V	7.76	0.82	17.89	30
1732.6	11.09	H	7.76	0.82	18.03	30
1752.6	11.22	V	7.74	0.82	18.14	30
1752.6	10.83	H	7.74	0.82	17.75	30

## **5.3 §2.1047 - Modulation Characteristic**

According to FCC § 2.1047(d), Part 27 there is no specific requirement for digital modulation, therefore modulation characteristic is not presented.

## **5.4 §2.1049, §27.53(a.5) - Occupied Bandwidth**

1. Conducted Measurement  
EUT was set for low, mid, high channel with modulated mode and highest RF output power.  
The spectrum analyser was connected to the antenna terminal.
2. Environmental Conditions

Temperature	21°C
Relative Humidity	51%
Atmospheric Pressure	1002mbar
3. Conducted Emissions Measurement Uncertainty  
All test measurements carried out are traceable to national standards. The uncertainty of the measurement at a confidence level of approximately 95% (in the case where distributions are normal), with a coverage factor of 2, in the range 30MHz – 40GHz is ±1.5dB.
4. Test date : July 02, 2014  
Tested By : Wiky Jam

### **Procedures:**

1. The EUT was connected to Spectrum Analyzer and Base Station via power divider.
2. The 99% and 26 dB occupied bandwidth (BW) of the middle channel for the highest RF powers.
3. Details according with KDB 971168 section 4.1 & 4.2.

### **Test Results: Pass**

UMTS-FDD Band IV (Part 27)

Channel	Frequency (MHz)	99% Occupied Bandwidth (MHz)	26 dB Bandwidth (MHz)
1313	1712.4	4.1808	4.795
1413	1732.6	4.1680	4.687
1512	1752.6	4.1585	4.699

Please refer to the following plots.

**Note:**

AWS1700: UMTS-FDD Band IV

- L: Low Channel
- M: Middle Channel
- H: High Channel

### 99% Occupied Bandwidth & 26 dB Bandwidth

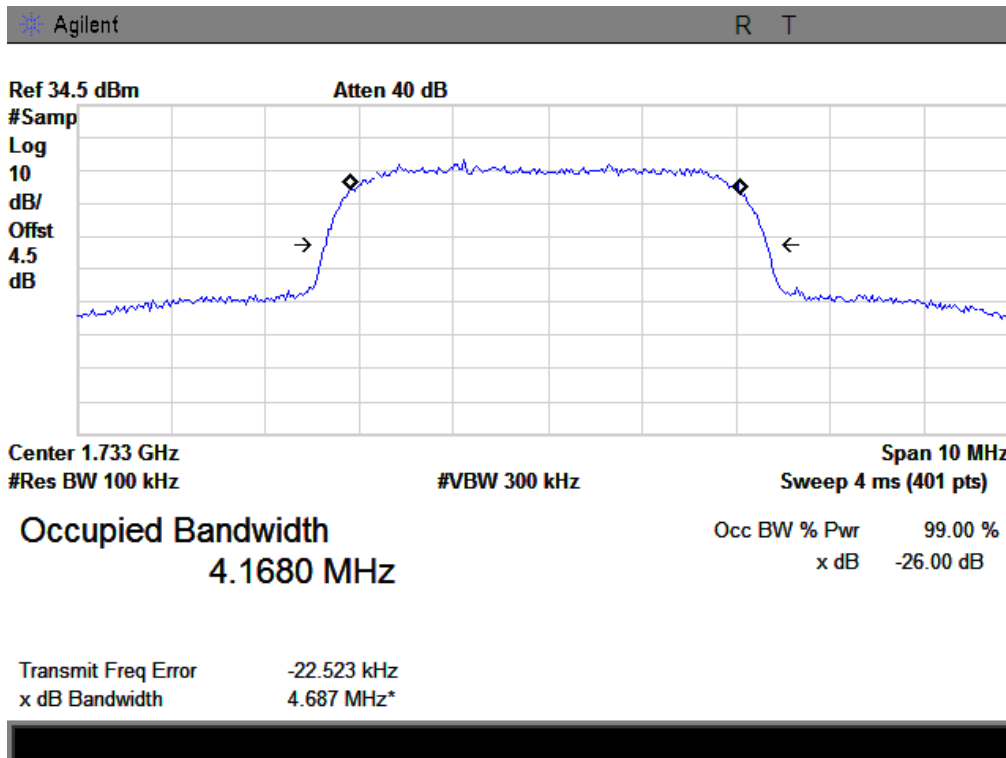
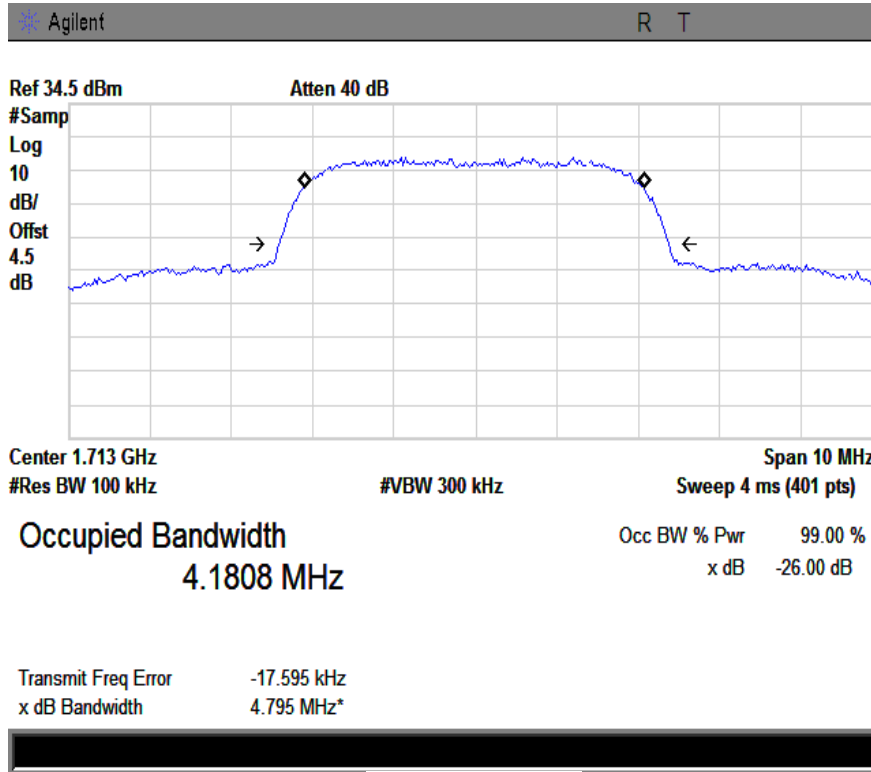

Agilent R T

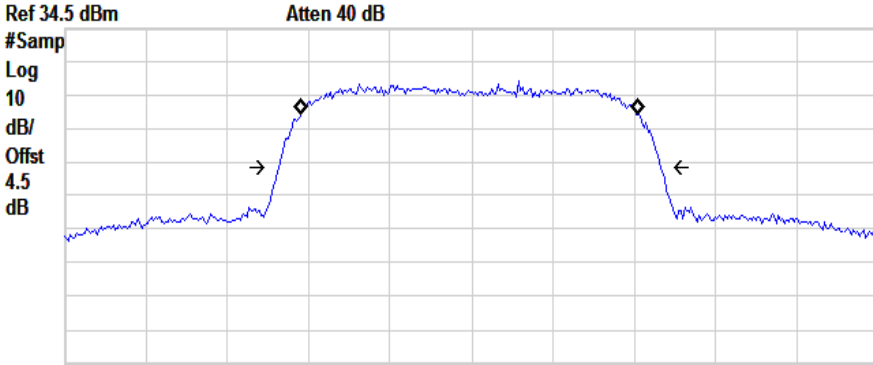

Center 1.752 GHz Span 10 MHz  
 #Res BW 100 kHz #VBW 300 kHz Sweep 4 ms (401 pts)

**Occupied Bandwidth** Occ BW % Pwr 99.00 %  
 4.1585 MHz x dB -26.00 dB

Transmit Freq Error -20.253 kHz  
 x dB Bandwidth 4.699 MHz\*



AWS1700 1752.4M H



## **5.5 §2.1051, §27.53(h) - Spurious Emissions at Antenna Terminals**

1. Conducted Measurement  
EUT was set for low, mid, high channel with modulated mode and highest RF output power.  
The spectrum analyzer was connected to the antenna terminal.
2. Conducted Emissions Measurement Uncertainty  
All test measurements carried out are traceable to national standards. The uncertainty of the measurement at a confidence level of approximately 95% (in the case where distributions are normal), with a coverage factor of 2, in the range 30MHz – 40GHz is  $\pm 1.5$ dB.
3. Environmental Conditions  

Temperature	22°C
Relative Humidity	52%
Atmospheric Pressure	1003mbar
4. Test date : July 03, 2014  
Tested By : Wiky Jam

### **Standard Requirement:**

The power of any emission outside of the authorized operating frequency ranges must be lower than the transmitter power (P) by a factor of at least  $43 + 10 \log (P)$  dB.

### **Procedures:**

1. The EUT was connected to Spectrum Analyzer and Base Station via power divider.
2. The Band Edges of low and high channels for the highest RF powers were measured. Setting RBW as roughly BW/100.
3. Details according with KDB 971168 section 6.0.

### **Test Result: Pass**

Refer to the attached plots.

**UMTS-FDD BandIV (Part 27)**

30MHz -25G – AWS1700

Low Channel

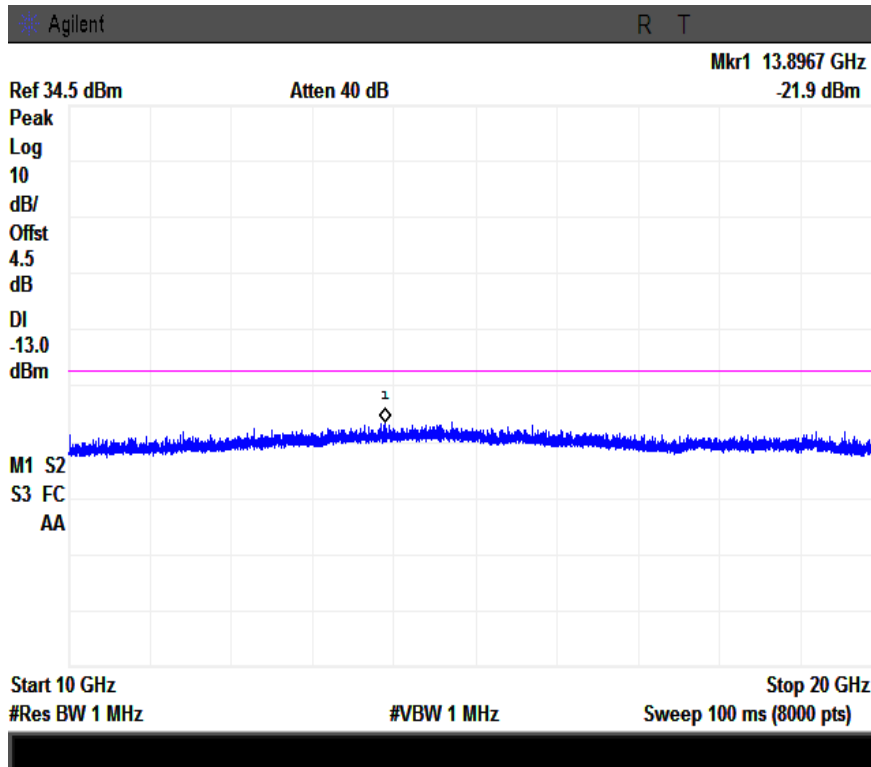
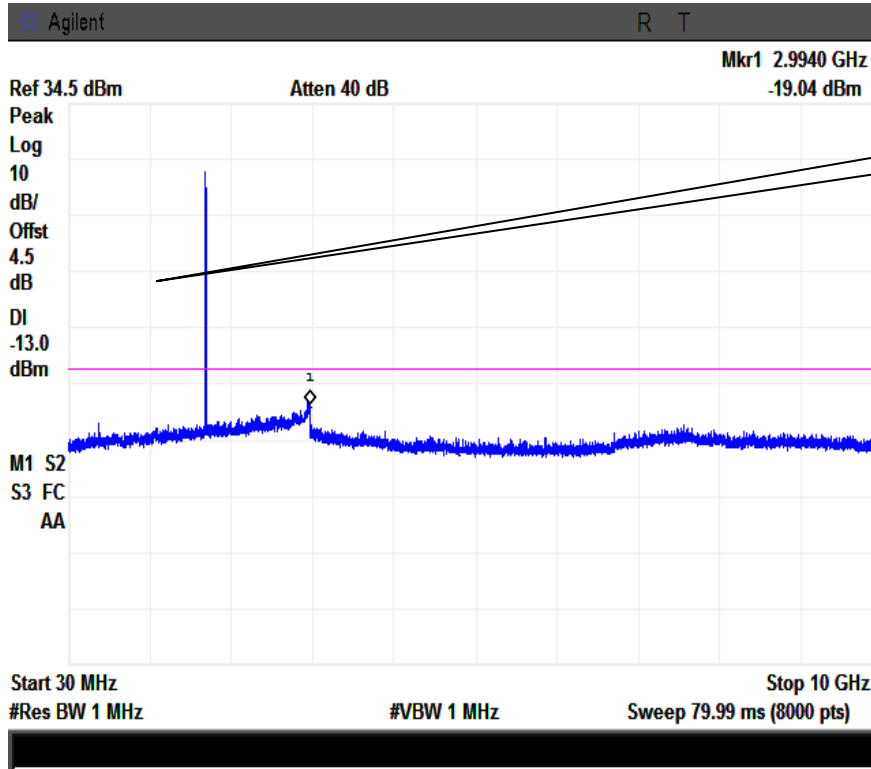

Middle Channel

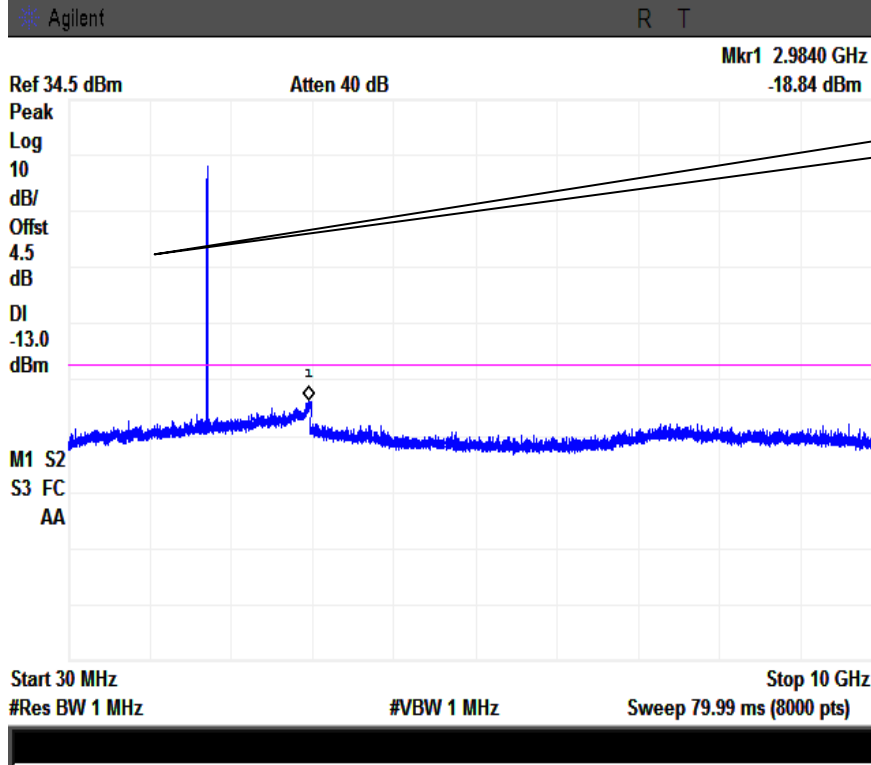

Fundamental

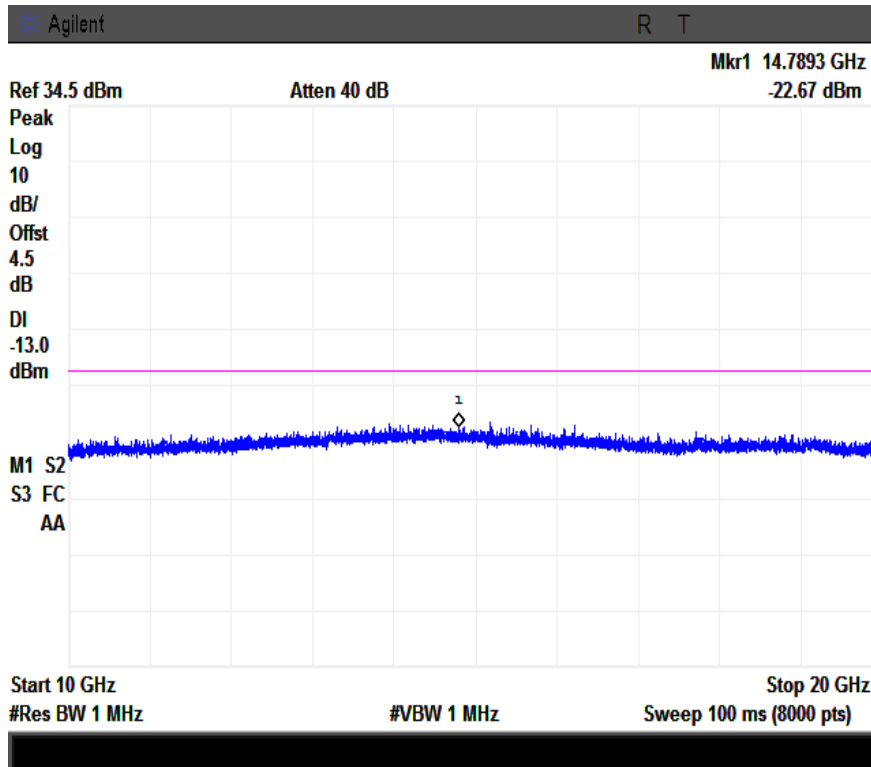

### High Channel

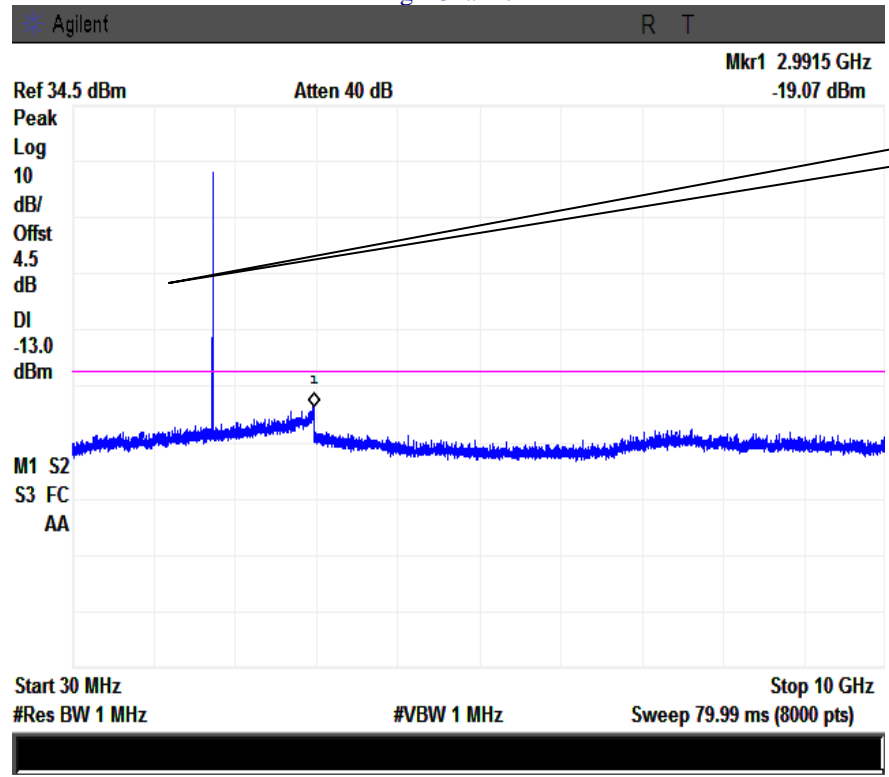

Fundamental

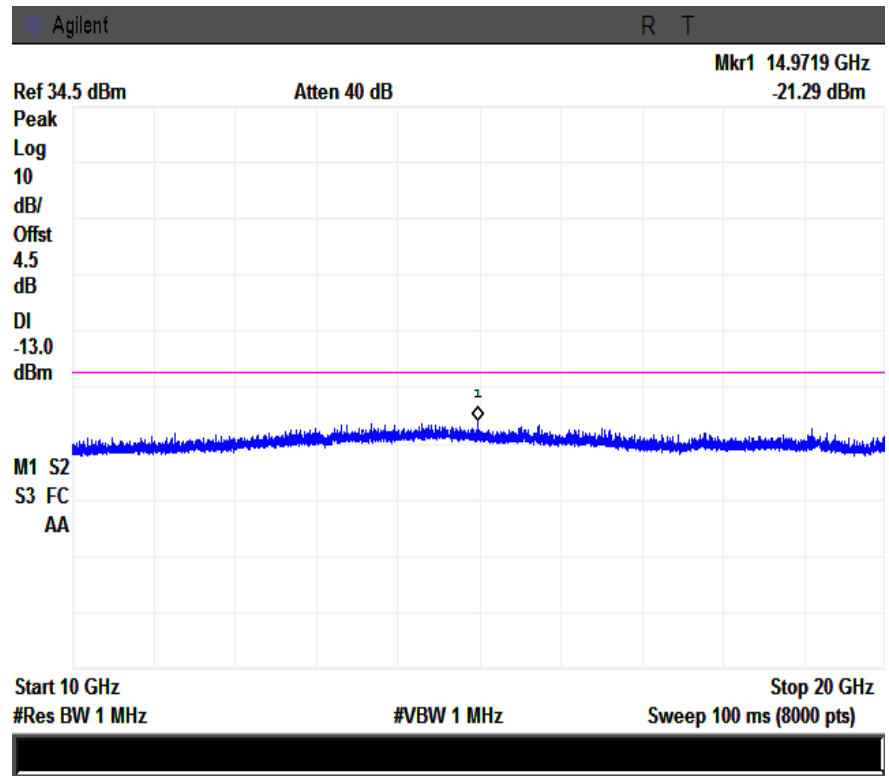

## **5.6 §2.1053, § § 27.53(h) - Spurious Radiated Emissions**

1. All possible modes of operation were investigated. Only the 6 worst case emissions measured, using the correct CISPR detectors, are reported. All other emissions were relatively insignificant.
2. A "-ve" margin indicates a PASS as it refers to the margin present below the limit line at the particular frequency.
3. Radiated Emissions Measurement Uncertainty  
All test measurements carried out are traceable to national standards. The uncertainty of the measurement at a confidence level of approximately 95% (in the case where distributions are normal), with a coverage factor of 2, in the range 1GHz – 40GH is ±6.0dB (for EUTs < 0.5m X 0.5m X 0.5m).
4. Environmental Conditions
 

Temperature	20°C
Relative Humidity	50%
Atmospheric Pressure	1001mbar
5. Test date : July 01, 2014  
Tested By : Wiky Jam

### **Standard Requirement:**

The power of any emission outside of the authorized operating frequency ranges must be attenuated below the transmitter power (P) by a factor of at least  $43 + 10 \log (P)$  dB. The spectrum is scanned from 30 MHz up to a frequency including its 10<sup>th</sup> harmonic.

### **Procedures: (According with TIA 603D)**

1. The transmitter was placed on a wooden turntable, and it was transmitting into a non-radiating load which was also placed on the turntable.
2. The measurement antenna was placed at a distance of 3 meters from the EUT. During the tests, the antenna height and polarization as well as EUT azimuth were varied in order to identify the maximum level of emissions from the EUT. The test was performed by placing the EUT on 3-orthogonal axis.
3. Remove the EUT and replace it with substitution antenna. A signal generator was connected to the substitution antenna by a non-radiating cable. The absolute levels of the spurious emissions were measured by the substitution.

Sample Calculation:

EUT Field Strength (dBm) = Reading (Signal generator) + Antenna Gain (substitution antenna) - Cable loss (From Signal Generator to substitution antenna)

**Test Result: Pass**

## UMTS-FDD BandIV (Part 27)

### Low channel

Frequency (MHz)	Substituted level (dBm)	Polarity (H/V)	Antenna Gain Correction (dB)	Cable Loss (dB)	Corrected Reading (dBm)	Limit (dBm)	Margin (dB)
3424.8	-47.11	V	10.07	2.52	-39.56	-13	-26.56
3424.8	-46.99	H	10.07	2.52	-39.44	-13	-26.44
425.5	-53.87	V	6.30	0.26	-47.83	-13	-34.83
803.4	-50.66	H	6.80	0.41	-44.27	-13	-31.27

### Middle channel

Frequency (MHz)	Substituted level (dBm)	Polarity (H/V)	Antenna Gain Correction (dB)	Cable Loss (dB)	Corrected Reading (dBm)	Limit (dBm)	Margin (dB)
3465.2	-46.94	V	10.09	2.52	-39.37	-13	-26.37
3465.2	-47.22	H	10.09	2.52	-39.65	-13	-26.65
423.7	-54.03	V	6.30	0.26	-47.99	-13	-34.99
803.6	-51.27	H	6.80	0.41	-44.88	-13	-31.88

### High channel

Frequency (MHz)	Substituted level (dBm)	Polarity (H/V)	Antenna Gain Correction (dB)	Cable Loss (dB)	Corrected Reading (dBm)	Limit (dBm)	Margin (dB)
3505.2	-46.86	V	10.09	2.52	-39.29	-13	-26.29
3505.2	-47.02	H	10.09	2.52	-39.45	-13	-26.45
427.1	-53.86	V	6.30	0.26	-47.82	-13	-34.82
802.4	-51.12	H	6.80	0.41	-44.73	-13	-31.73

## **5.7 §27.53(h) - Band Edge**

1. Conducted Measurement  
EUT was set for low, mid, high channel with modulated mode and highest RF output power.  
The spectrum analyzer was connected to the antenna terminal.
2. Conducted Emissions Measurement Uncertainty  
All test measurements carried out are traceable to national standards. The uncertainty of the measurement at a confidence level of approximately 95% (in the case where distributions are normal), with a coverage factor of 2, in the range 30MHz – 40GHz is  $\pm 1.5\text{dB}$ .
3. Environmental Conditions  

Temperature	23°C
Relative Humidity	53%
Atmospheric Pressure	1004mbar
4. Test date : July 04, 2014  
Tested By : Wiky Jam

### **Standard Requirement:**

The power of any emission outside of the authorized operating frequency ranges must be lower than the transmitter power (P) by a factor of at least  $43 + 10 \log (P)$  dB.

### **Procedures:**

1. The EUT was connected to Spectrum Analyzer and Base Station via power divider.
2. The Band Edges of low and high channels for the highest RF powers were measured. Setting RBW as roughly BW/100.
3. Details according with KDB 971168 section 6.0.

### **Test Result: Pass**

Refer to the attached plots.

**UMTS-FDD BandIV (Part 27)**

<b>Frequency (MHz)</b>	<b>Emission (dBm)</b>	<b>Limit (dBm)</b>
1710.000	-13.78	-13
1755.000	-20.56	-13



### UMTS-FDD BandIV, Low Channel

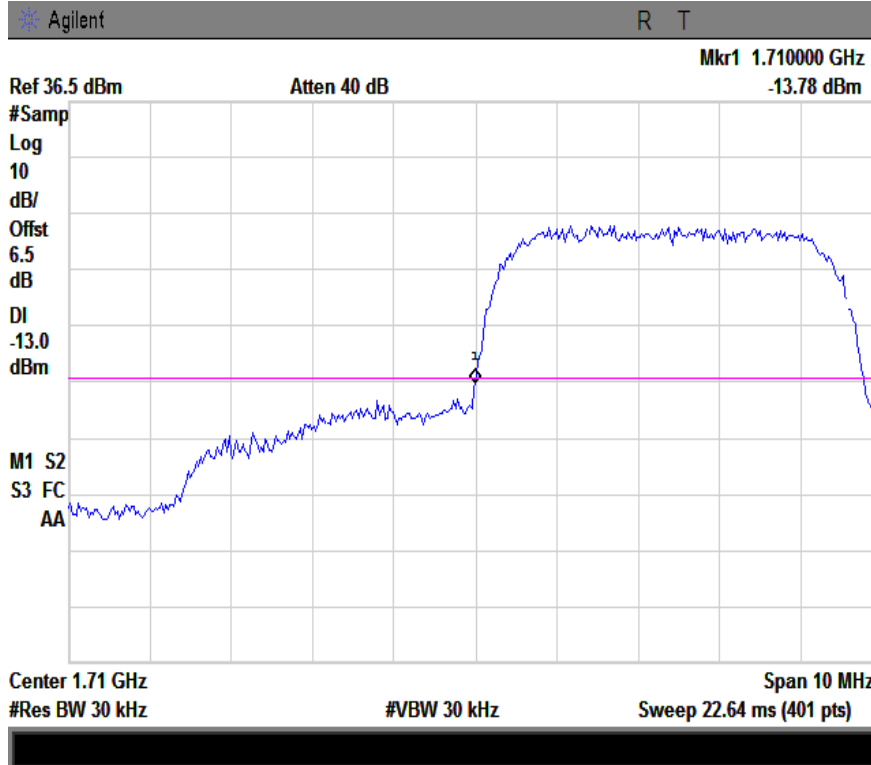

Note: Offset=Cable loss (4.5) + 10log (48/30)=4.5+2=6.5 dB

### UMTS-FDD BandIV, High Channel

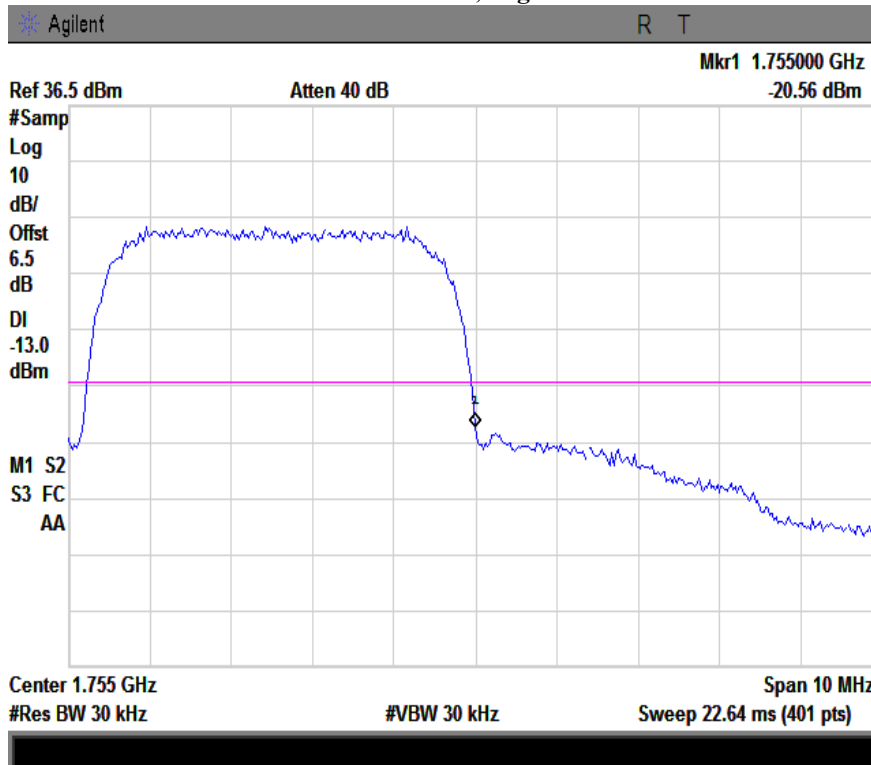

Note: Offset=Cable loss (4.5) + 10log (47/30)=4.5+2=6.5 dB

## **5.8 §2.1055, §27.5(h) & §27.54 - Frequency Stability**

- |    |                           |                      |          |
|----|---------------------------|----------------------|----------|
| 1. | Environmental Conditions  | Temperature          | 23°C     |
|    |                           | Relative Humidity    | 53%      |
|    |                           | Atmospheric Pressure | 1004mbar |
| 2. | Test date : July 04, 2014 |                      |          |
|    | Tested By : Wiky Jam      |                      |          |

### **Standard Requirement:**

The frequency stability shall be sufficient to ensure that the fundamental emissions stay within the authorized bands of operation.

#### Frequency Tolerance for Transmitters in the Public Mobile Services

Frequency Range (MHz)	Base, fixed (ppm)	Mobile ≤ 3 watts (ppm)	Mobile ≤ 3 watts (ppm)
25 to 50	20.0	20.0	50.0
50 to 450	5.0	5.0	50.0
450 to 512	2.5	5.0	5.0
821 to 896	1.5	2.5	2.5
928 to 929.	5.0	N/A	N/A
929 to 960.	1.5	N/A	N/A
2110 to 2220	10.0	N/A	N/A

### **Procedures:**

A communication link was established between EUT and base station. The frequency error was monitored and measured by base station under variation of ambient temperature and variation of primary supply voltage.

Limit: The frequency stability of the transmitter shall be maintained within  $\pm 0.00025\%$  ( $\pm 2.5\text{ppm}$ ) of the center frequency.

**Test Results: Pass**

**Frequency Stability versus Temperature:** The Frequency tolerance of the carrier signal shall be maintained within 2.5ppm of the operating frequency over a temperature variation of -10°C to +55°C at normal supply voltage.

**UMTS-FDD BandIV (Part 27)**

Middle Channel, $f_0 = 1880$ MHz				
Temperature (°C)	Power Supplied (V <sub>DC</sub> )	Frequency Error (Hz)	Frequency Error (ppm)	Limit (ppm)
-10	3.7	10	0.0057	2.5
0		5	0.0029	2.5
10		4	0.0023	2.5
20		9	0.0052	2.5
30		-7	0.0040	2.5
40		13	0.0075	2.5
50		-6	0.0034	2.5
55		7	0.0040	2.5
25	4.2	12	0.0069	2.5
	3.5	15	0.0086	2.5

**Annex A. TEST INSTRUMENT & METHOD**

**Annex A.i. TEST INSTRUMENTATION & GENERAL PROCEDURES**

Instrument	Model	Serial #	Calibration Date	Calibration Due Date
<b>RF conducted test</b>				
Agilent ESA-E SERIES SPECTRUM ANALYZER	E4407B	MY45108319	09/17/2013	09/16/2014
Power Splitter	1#	1#	09/02/2013	09/01/2014
Universal Radio Communication Tester	CMU200	121393	09/17/2013	09/16/2014
Temperature/Humidity Chamber	UHL-270	001	10/22/2013	10/21/2014
DC Power Supply	E3640A	MY40004013	09/17/2013	09/16/2014
<b>Radiated Emissions</b>				
EMI test receiver	ESL6	100262	11/23/2013	11/22/2014
OPT 010 AMPLIFIER (0.1-1300MHz)	8447E	2727A02430	09/02/2013	09/01/2014
Microwave Preamplifier (0.5~18GHz)	PAM-118	443008	09/02/2013	09/01/2014
Bilog Antenna (30MHz~6GHz)	JB6	A110712	09/23/2013	09/22/2014
Bilog Antenna (30MHz~2GHz)	JB1	A112017	09/23/2013	09/22/2014
Double Ridge Horn Antenna (1 ~18GHz)	AH-118	71259	11/20/2013	11/19/2014
Double Ridge Horn Antenna (1 ~18GHz)	AH-118	71283	11/20/2013	11/19/2014
SYNTHESIZED SIGNAL GENERATOR	8665B	3744A01293	09/17/2013	09/16/2014
Tunable Notch Filter	3NF-800/1000-S	AA4	09/02/2013	09/01/2014
Tunable Notch Filter	3NF-1000/2000-S	AM 4	09/02/2013	09/01/2014

**Annex A. ii. RADIATED EMISSIONS TEST DESCRIPTION**

**Definition**

Radiated spurious emissions are emissions from the equipment when transmitting into a nonradiating load on a frequency or frequencies that are outside an occupied band sufficient to ensure transmission of information of required quality for the class of communications desired.

**Test Set-up**

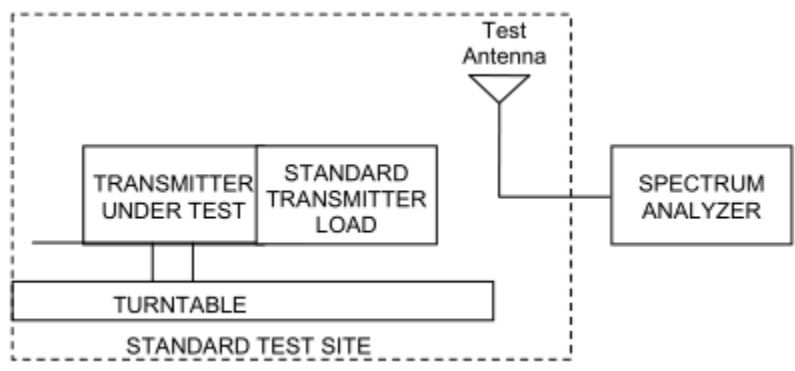

- a) Connect the equipment as illustrated.
- b) Adjust the spectrum analyzer for the following settings:
  - 1) Resolution Bandwidth = 10 kHz for spurious emissions below 1 GHz, and 1 MHz for spurious emissions above 1GHz.
  - 2) Video Bandwidth = 300 kHz for spurious emissions below 1 GHz, and 3 MHz for spurious emissions above 1 GHz.
  - 3) Sweep Speed slow enough to maintain measurement calibration.
  - 4) Detector Mode = Positive Peak.
- c) Place the transmitter to be tested on the turntable in the standard test site, or an FCC listed site compliant with ANSI C63.4-2001 clause 5.4. The transmitter is transmitting into a nonradiating load that is placed on the turntable. The RF cable to this load should be of minimum length. For transmitters with integral antennas, the tests are to be run with the unit operating into the integral antenna.
- d) For each spurious measurement the test antenna should be adjusted to the correct length for the frequency involved. This length may be determined from a calibration ruler supplied with the equipment. Measurements shall be made from the lowest radio frequency generated in the equipment to the tenth harmonic of the carrier, except for the region close to the carrier equal to  $\pm$  the test bandwidth (see 1.3.4.4).
- e) Key the transmitter.
- f) For each spurious frequency, raise and lower the test antenna from 1 m to 4 m to obtain a maximum reading on the spectrum analyzer with the test antenna at horizontal polarity. Then the turntable should be rotated 360° to determine the maximum reading. Repeat this procedure to obtain the highest possible reading. Record this maximum reading.
- g) Repeat step f) for each spurious frequency with the test antenna polarized vertically.

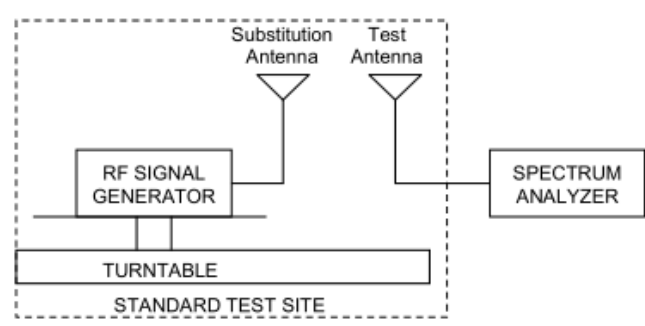

- h) Reconnect the equipment as illustrated.
- i) Keep the spectrum analyzer adjusted as in step b).
- j) Remove the transmitter and replace it with a substitution antenna (the antenna should be half-wavelength for each frequency involved). The center of the substitution antenna should be approximately at the same location as the center of the transmitter. At the lower frequencies, where the substitution antenna is very long, this will be impossible to achieve when the antenna is polarized vertically. In such case the lower end of the antenna should be 0.3 m above the ground.
- k) Feed the substitution antenna at the transmitter end with a signal generator connected to the antenna by means of a nonradiating cable. With the antennas at both ends horizontally polarized, and with the signal generator tuned to a particular spurious frequency, raise and lower the test antenna to obtain a maximum reading at the spectrum analyzer. Adjust the level of the signal generator output until the previously recorded maximum reading for this set of conditions is obtained. This should be done carefully repeating the adjustment of the test antenna and generator output.
- l) Repeat step k) with both antennas vertically polarized for each spurious frequency. m) Calculate power in dBm into a reference ideal half-wave dipole antenna by reducing the readings obtained in steps k) and l) by the power loss in the cable between the generator and the antenna, and further corrected for the gain of the substitution antenna used relative to an ideal half-wave dipole antenna by the following formula:  
 $P_d \text{ (dBm)} = P_g \text{ (dBm)} - \text{cable loss (dB)} + \text{antenna gain (dB)}$   
 where:  
 $P_d$  is the dipole equivalent power and  
 $P_g$  is the generator output power into the substitution antenna.
- n) The  $P_d$  levels record in step m) are the absolute levels of radiated spurious emissions in dBm. The radiated spurious emissions in dB can be calculated by the following:

Radiated spurious emissions (dB) =

$$10 \log_{10} \left( \frac{TX \text{ power in watts}}{0.001} \right) - \text{the levels in step m)}$$

NOTE: It is permissible to use other antennas provided they can be referenced to a dipole.

**Annex B. EUT AND TEST SETUP PHOTOGRAPHS**

**Annex B.i. Photograph 1: EUT External Photo**



Whole Package - Top View



Adapter - Front View





EUT - Front View



EUT - Rear View





EUT - Top View



EUT - Bottom View



EUT - Left View

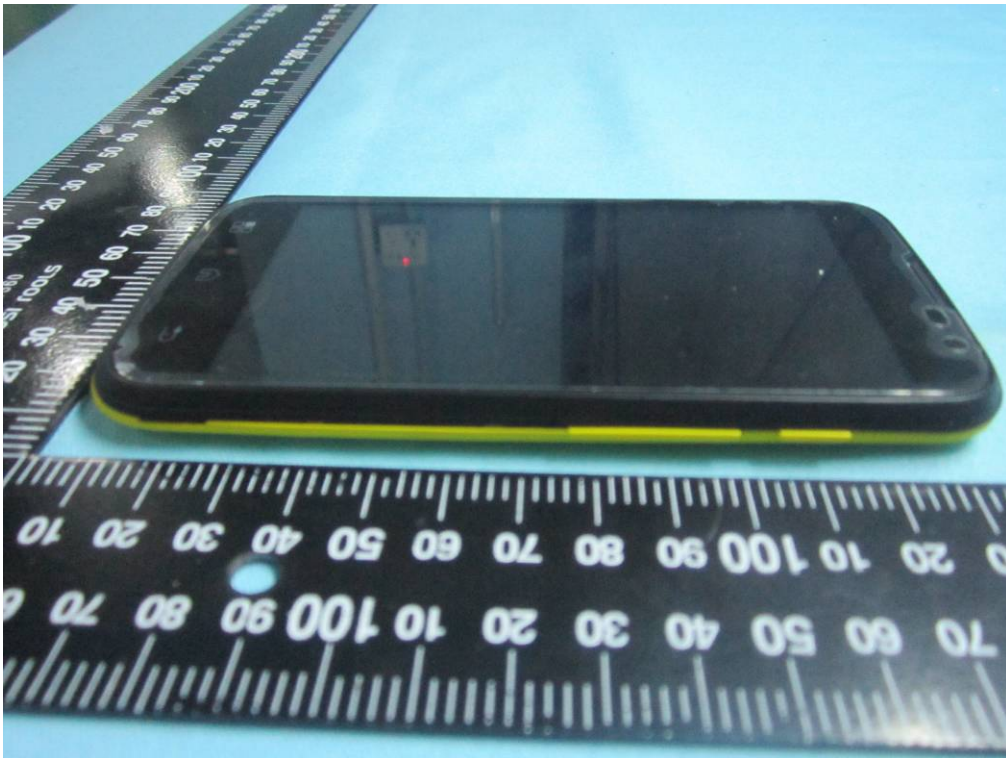

EUT - Right View



**Annex B.ii. Photograph 2: EUT Internal Photo**



Cover Off - Top View 1



Cover Off - Top View 2

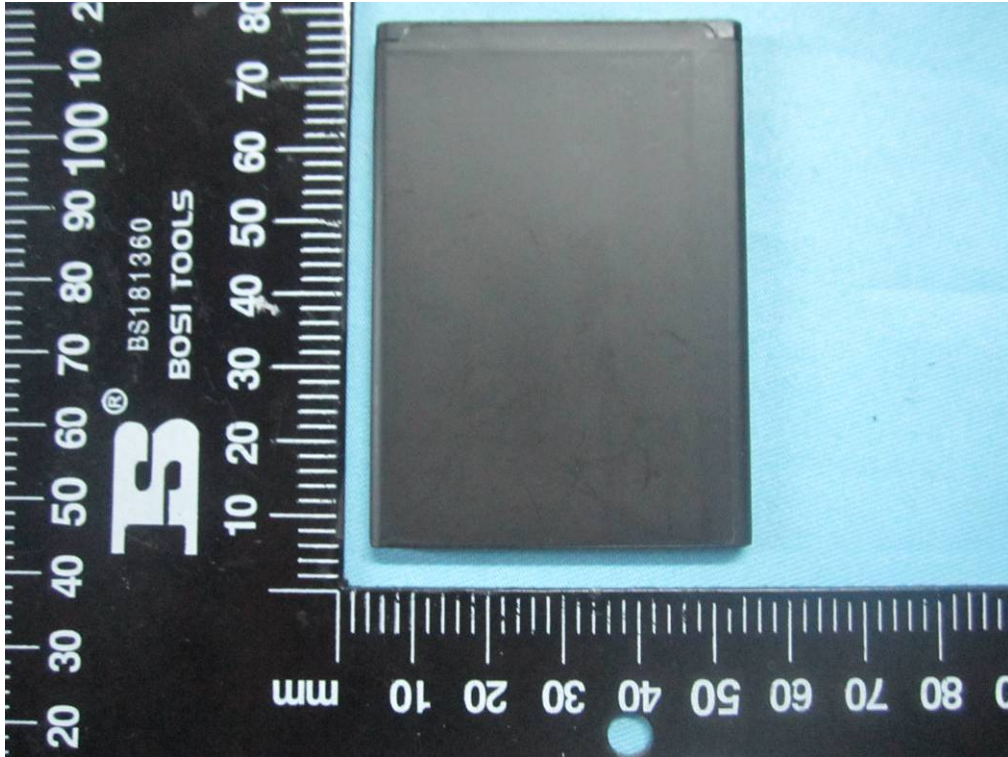

Battery - Top View



Battery - Bottom View





LCD – Front View

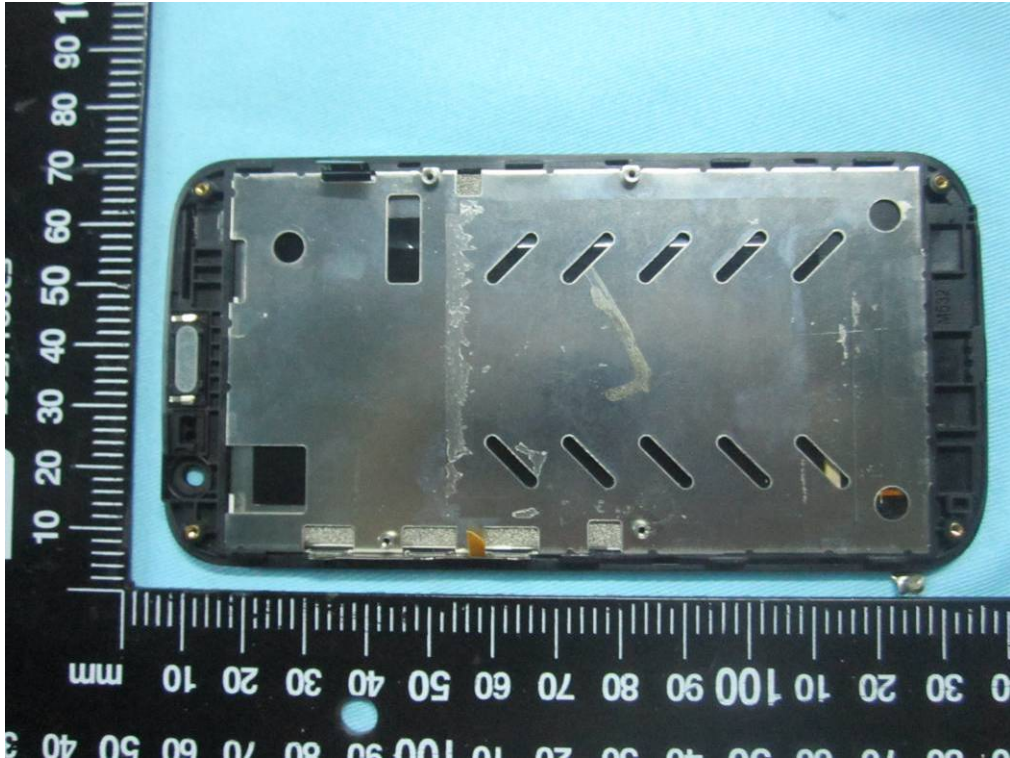

LCD – Rear View

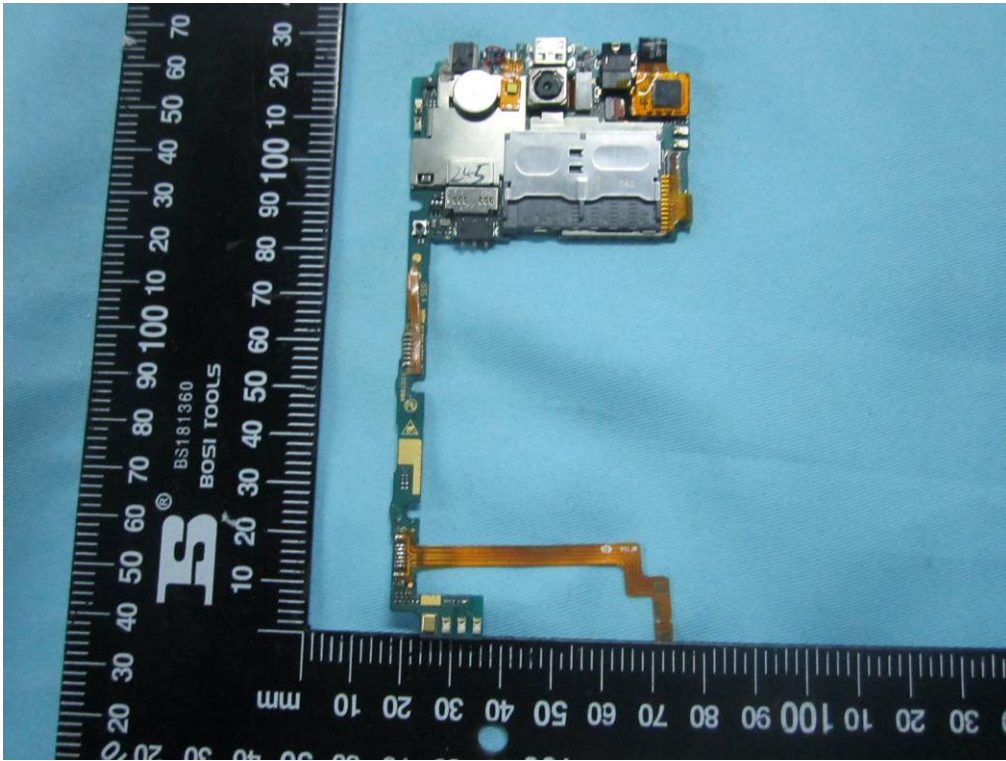

Mainboard With Shielding - Front View

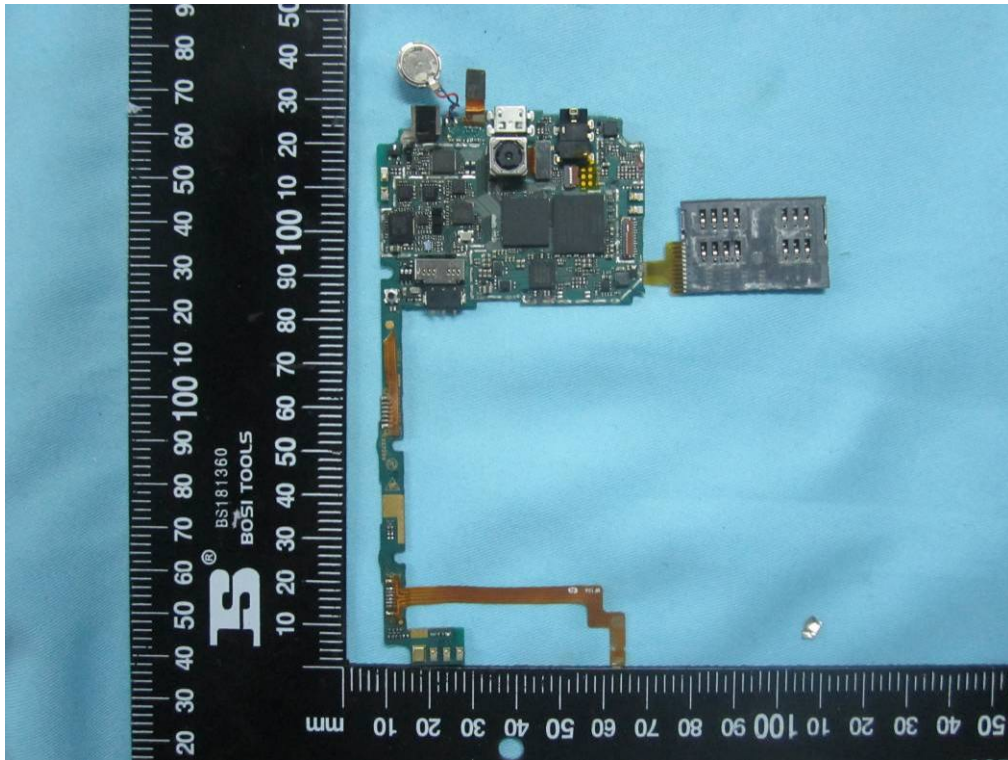

Mainboard Without Shielding - Front View



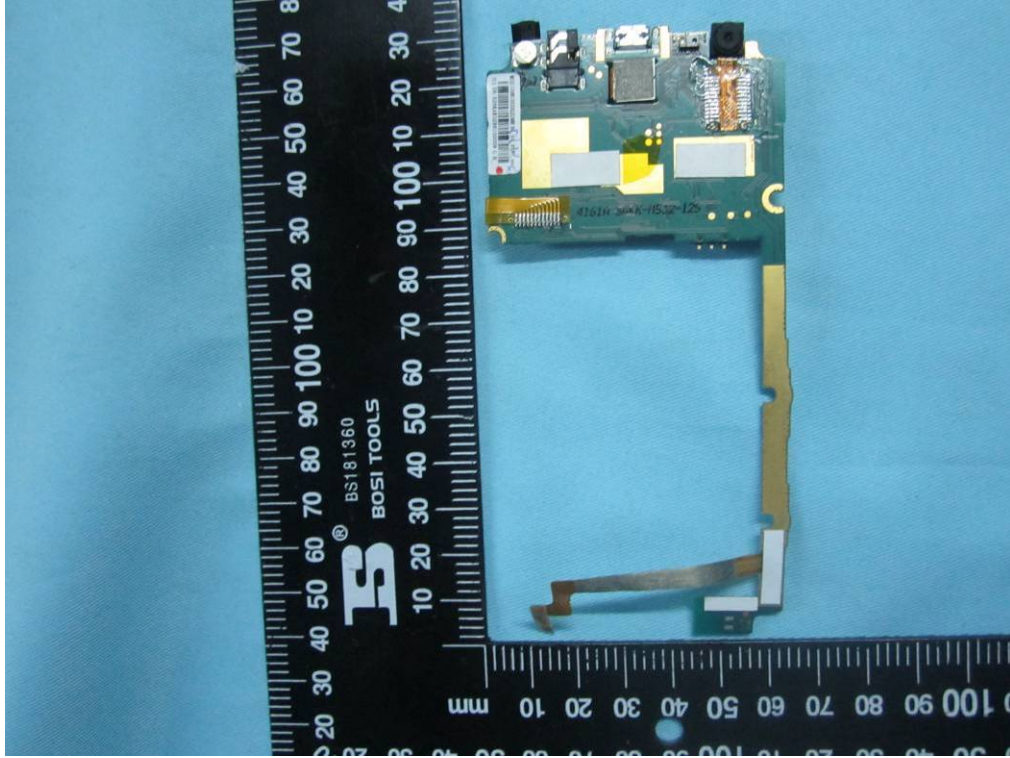

Mainboard- Rear View

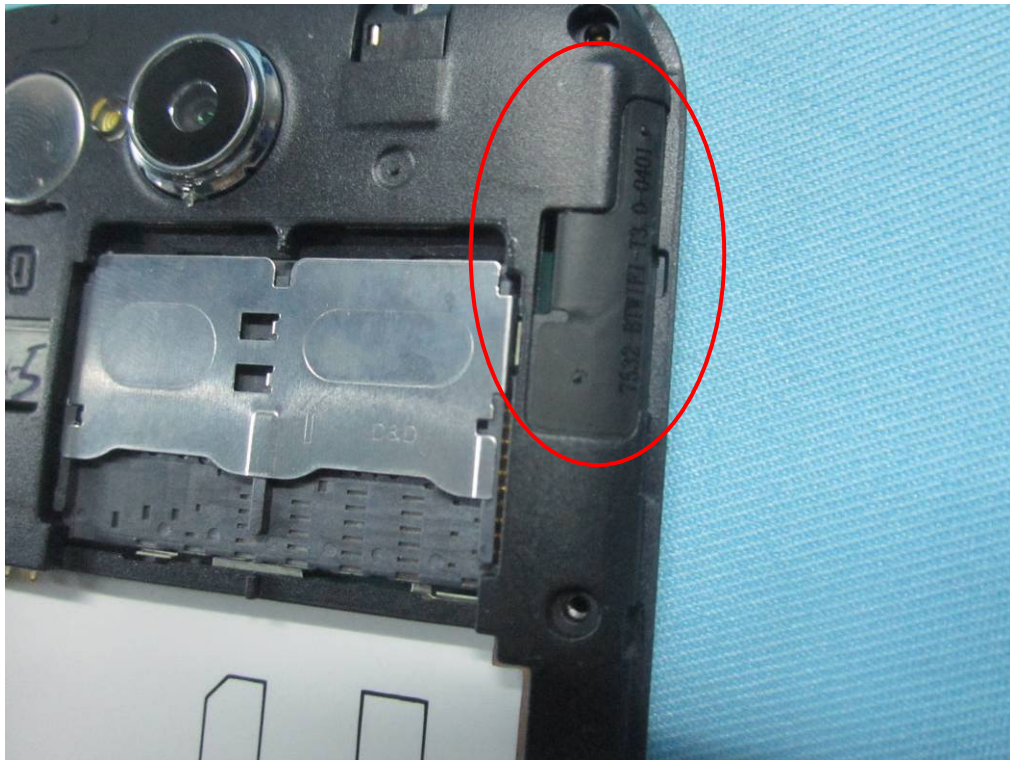

BT/WIFI Antenna View



GSM/PCS/UMTS-FDD Antenna View



**Annex B.iii. Photograph 3: Test Setup Photo**

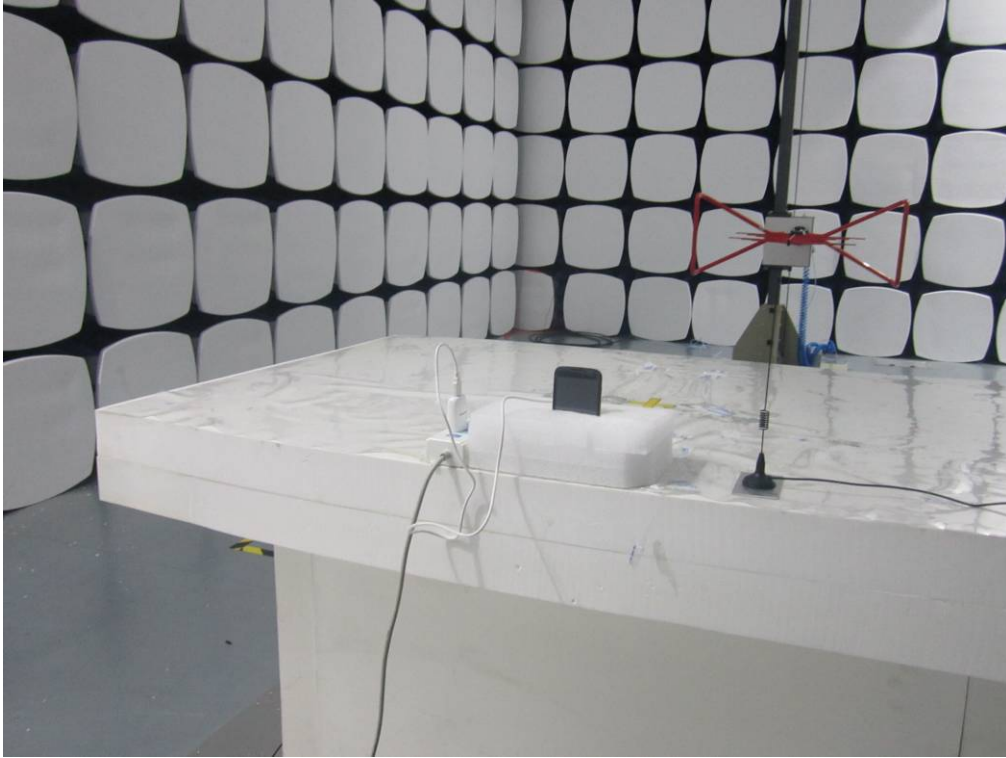

Radiated Spurious Emissions Test Setup Below 1GHz - Front View

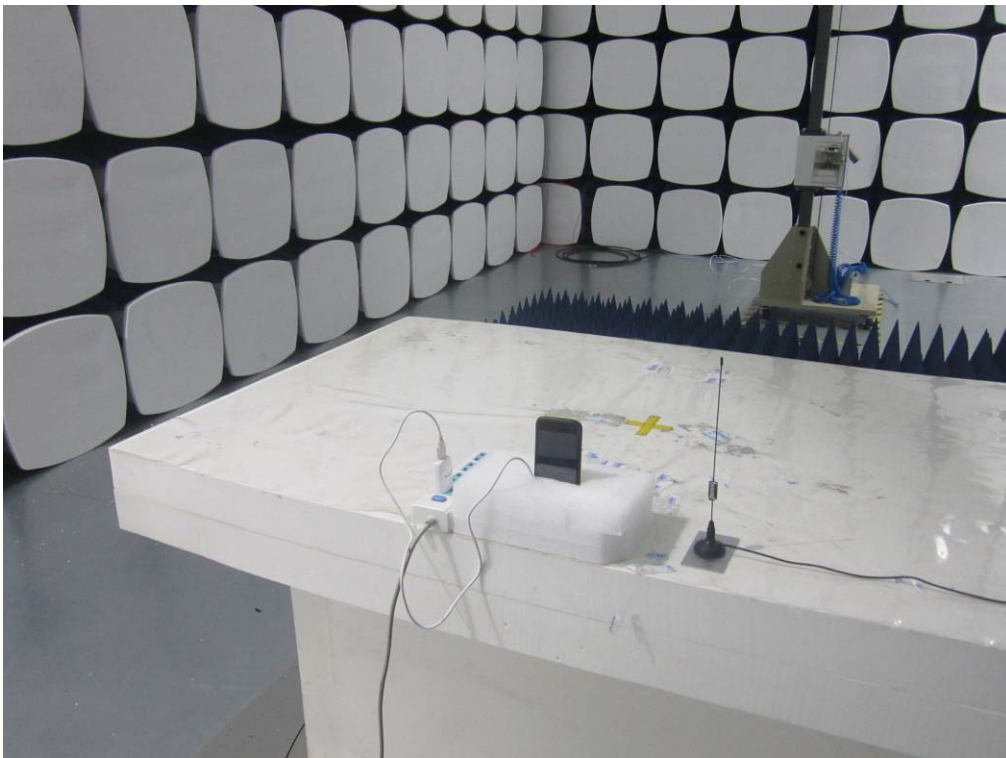

Radiated Spurious Emissions Test Setup Above 1GHz -Front View

**Annex C. TEST SETUP AND SUPPORTING EQUIPMENT**

**EUT TEST CONDITIONS**

**Annex C. i. SUPPORTING EQUIPMENT DESCRIPTION**

The following is a description of supporting equipment and details of cables used with the EUT.

Manufacturer	Equipment Description (Including Brand Name)	Model	Calibration Date	Calibration Due Date
N/A	N/A	N/A	N/A	N/A

### Block Configuration Diagram for Radiated Emissions

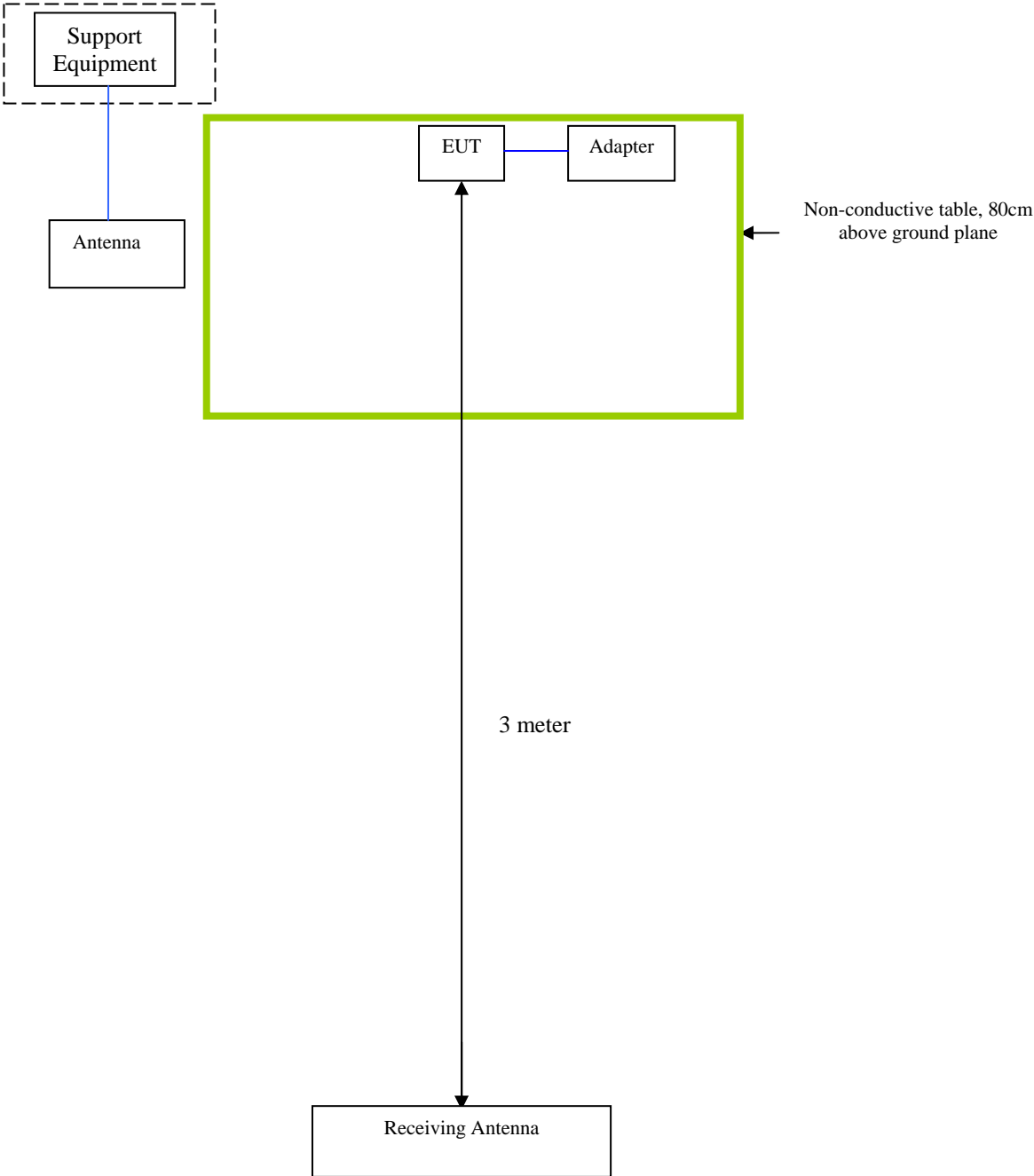

**Annex C.ii. EUT OPERATING CONDITIONS**

The following is the description of how the EUT is exercised during testing.

Test	Description Of Operation
<b>Emissions Testing</b>	The EUT was communicating with base station and set to work at maximum output power.
<b>Others Testing</b>	The EUT was communicating with base station and set to work at maximum output power.

**Annex D.USER MANUAL / BLOCK DIAGRAM / SCHEMATICS / PART LIST**

**Please see attachment**

**Annex E. DECLARATION OF SIMILARITY**